

QST

december, 1943

25 cents

35c in Canada

devoted entirely to

amateur radio

In This Issue:

Radio in the CAP

The Saga of the 209

A Differential Microphone

Frequency Measurement in WERS

Theory of Superregeneration

A Free-Point Tube Tester

Aeroanalysis and V.H.F.

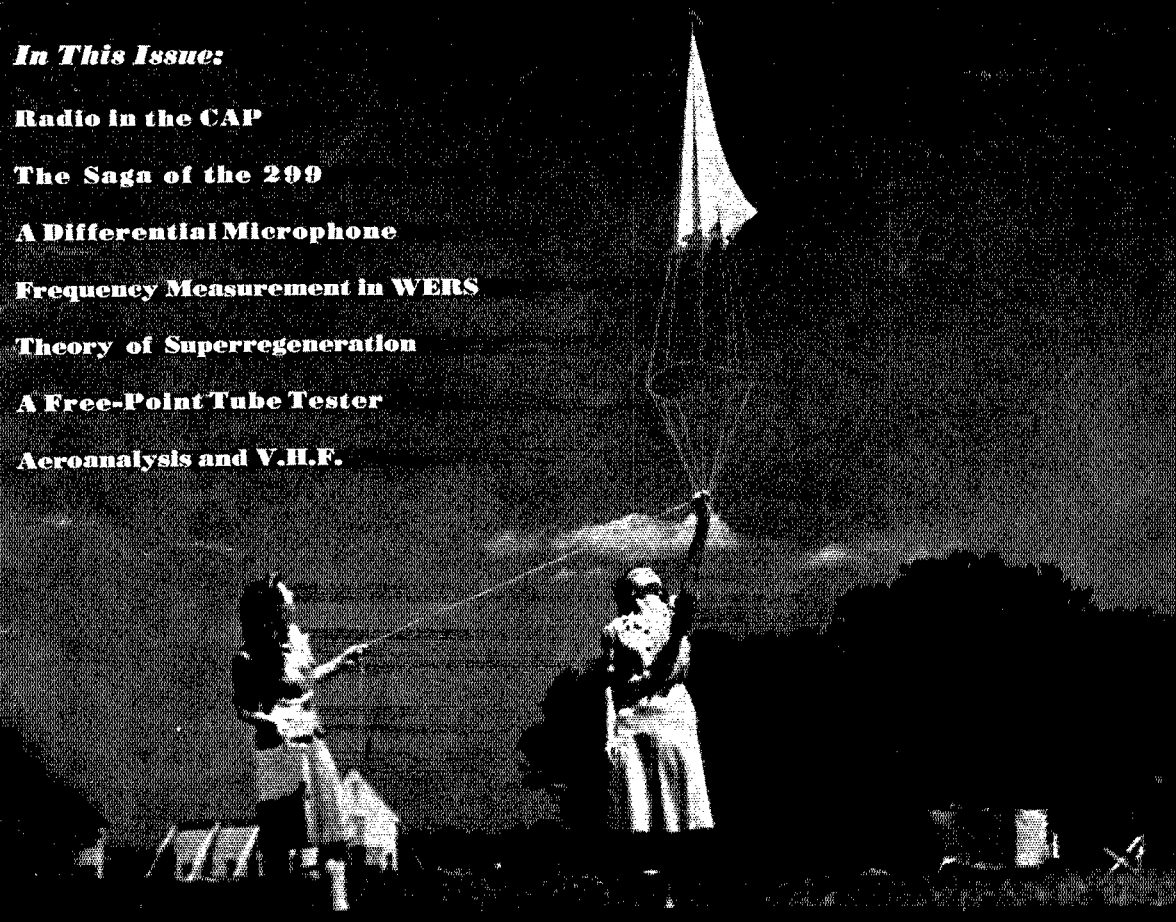

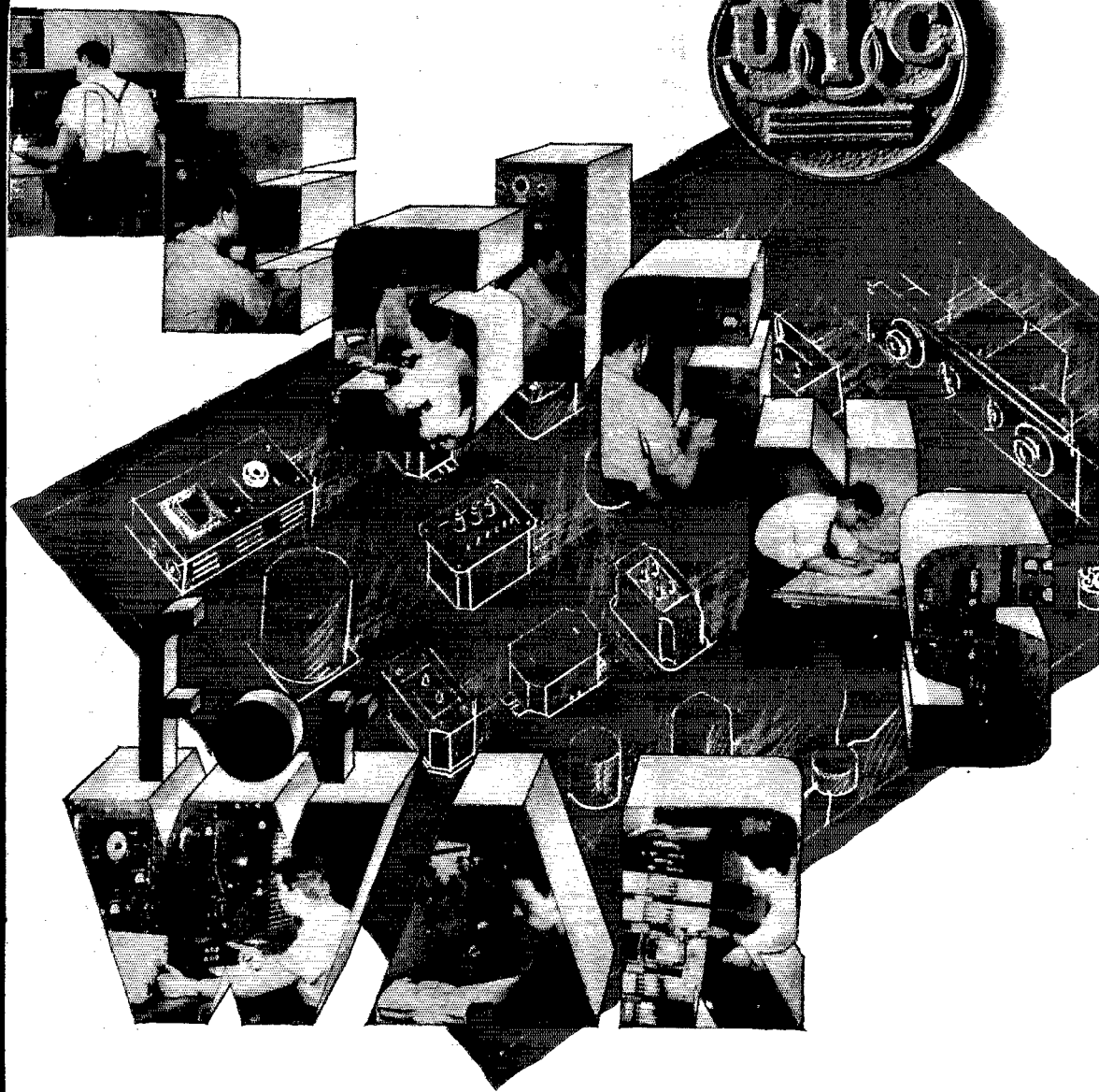
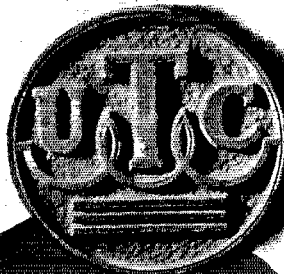

The bulk of UTC production today is on special units designed to specific customers' requirements. Over 5,000 new war designs were developed this past year. These designs ran from open type units to hermetically sealed items capable of many cycles of high and low temperature and extreme submersion tests. They included units from $\frac{1}{3}$ ounce in weight to 10,000 lbs. in weight and from infinitesimal voltages to 250,000 volts. It is impossible to describe all these thousands of special designs as they become available. Our staff of application engineers will be more than pleased to discuss your problem as related to special components.

UNITED TRANSFORMER CO.

150 VARICK STREET • NEW YORK 13, N. Y.
EXPORT DIVISION: 13 EAST 40th STREET, NEW YORK 16, N. Y., CABLES: "ARLAB"



CASH PRIZE CONTEST!

FOR RADIO MEN IN THE SERVICE! "WRITE A LETTER"

As you know, the Hallicrafters make a wide range of Radio Communications equipment, including the SCR-299 Mobile Communications unit. We are proud of our handiwork, proud of the job you men have been doing

with them on every battlefield.

RULES FOR THE CONTEST

We want letters telling of actual experiences with this equipment. We will give \$100.00 for the best such letter received during each of the five months of No-

vember, December, January, February and March! (Deadline: Midnight, the last day of each month.)

We will send \$1.00 for every serious letter received so even if you should not win a big prize your time will not be in vain.

Your letter will be our property, of course, and we have the right to reproduce it in a Hallicrafters advertisement.

Good luck and write as many letters as you wish. V-Mail letters will do.

W. J. Hallicrafters



BUY MORE BONDS!

the hallicrafters co.
CHICAGO, U.S.A.

2611 INDIANA AVENUE · CHICAGO, U.S.A.
MAKERS OF THE FAMOUS SCR-299 COMMUNICATIONS TRUCK

the Betsy Ross of today

BETSY ROSS' part in the American Revolution fight for freedom parallels Hallicrafters Radio employees' role as home-front fighters, to secure the future of this nation and world-wide Peace.

The people of Hallicrafters Radio are making history, filling ever-increasing production quotas. Their ability to meet these quotas has won for them the honor of being the first radio manufacturer to receive the Army-Navy Production Award for the third time.



The World's Largest Exclusive Manufacturer of
Short Wave Radio Communications Equipment

the hallicrafters co.
CHICAGO, U. S. A.

DECEMBER 1943

VOLUME XXVII

NUMBER 12

★
STAFF

Editorial

KENNETH B. WARNER, W1EB
General Manager of A.R.R.L. Publications

CLINTON B. DESOTO, W1CBO
Editor

GEORGE GRAMMER, W1DF*
Technical Editor

DONALD H. MIX, W1TS
Acting Technical Editor

HOLLIS M. FRENCH, W1JLK
BYRON GOODMAN, W1JFE*
Assistant Technical Editors

EDWARD P. TILTON, W1HDQ
Contributing Editor, V.H.F.

WALTER E. BRADLEY, W1FWH
VERNON CHAMBERS, W1JEQ*
Technical Information Service

LOUISA B. DRESSER
Editorial Assistant

JAMES J. LAMB, W1AL*
Research Engineer, A.R.R.L.

Advertising

F. CHEYNEY BEEKLEY, W1GQ
Advertising Manager

Circulation

DAVID H. HOUGHTON
Circulation Manager

RALPH T. BEAUDIN, W1BAW
Asst. Circulation Manager

*On leave of absence



OFFICES

38 La Salle Road
West Hartford 7, Connecticut

Subscription rate in United States and Possessions, \$2.50 per year, postpaid; all other countries, \$3.00 per year, postpaid. Single copies, 25 cents. Foreign remittances should be by international postal or express money order or bank draft negotiable in the U. S. and for an equivalent amount in U. S. funds.

Entered as second-class matter May 29, 1919, at the post office at Hartford, Connecticut, under the Act of March 3, 1879. Acceptance for mailing at special rate of postage provided for in section 1103, Act of October 3, 1917, authorized September 9, 1922. Additional entry at Concord, N. H., authorized February 21, 1929, under the Act of February 28, 1925. Additional second-class entries to cover sectional editions authorized March 20, 1935.

Copyright 1943 by the American Radio Relay League, Inc. Title registered at United States Patent Office.

QST

devoted entirely to

AMATEUR RADIO

PUBLISHED, MONTHLY, AS ITS OFFICIAL ORGAN, BY THE AMERICAN RADIO RELAY LEAGUE, INC., AT WEST HARTFORD, CONN., U. S. A.
OFFICIAL ORGAN OF THE INTERNATIONAL AMATEUR RADIO UNION



CONTENTS

It Seems to Us	9
Splatter	10
Aeroanalysis and V.H.F. Techniques <i>Hollis M. French, W1JLK</i>	11
Superregeneration <i>Loyal S. Fox, ex-W2AHB</i>	17
Radio in the CAP <i>T/Sgt. Karl H. Stello, W3IVZ</i>	20
Frequency Measurement in the WERS . <i>Philip Bliss, W1DXT</i>	23
In the Services	26
Measurement of Antenna Impedance <i>Harry E. Stewart, W3JXY</i>	30
Gold Stars	35
A Differential Microphone <i>F. Cheyney Beekley, W1GS</i>	36
Prisoners of War	38
Missing in Action	38
Silent Keys	38
Happenings of the Month	39
Women as WERS Operators <i>W. C. Walter Jordon, W8SLC</i>	40
U.S.A. Calling!	42
A Signal Corps Report on Enemy Radio Equipment	43
The Saga of the 299 <i>Cy Read, W9AA</i>	44
A Transceiver for Mobile WERS Work <i>W. E. Bradley, W1FWH</i>	48
On the Very Highs <i>E. P. Tilton, W1HDQ</i>	51
Hamfest in Khaki — II <i>Capt. Spencer Allen, W9JGL</i>	52
One Ounce of Prevention "Sourdough"	54
A Ham-Made Free-Point Tube Tester <i>Hollis M. French, W1JLK</i>	56
Experimenter's Section	59
Strays	60
Hints and Kinks <i>Automatic Bias for Battery Tubes — Servicing Receivers — S-Meter with Left-to-Right Scale — Keying the Receiver Input for Code Practice — Removing Loktal Bases — A Method of Rejuvenating Electrolytics</i>	62
Correspondence from Members	64
Operating News	68
Honor Roll	68
Meet the SCMs	72
The Month in Canada	72
Amateur Activities	73
WWV Schedules	86
Ham-Ads	112
QST's Index of Advertisers	114
QST's Annual Index for 1943	117

Another Future Speaker— *already tested and proved!*

This new speaker, recently developed by JENSEN engineers, is but one of many improved types now being manufactured for military uses. Thus another loud-speaker is ready for expanded fields of operation after the war.

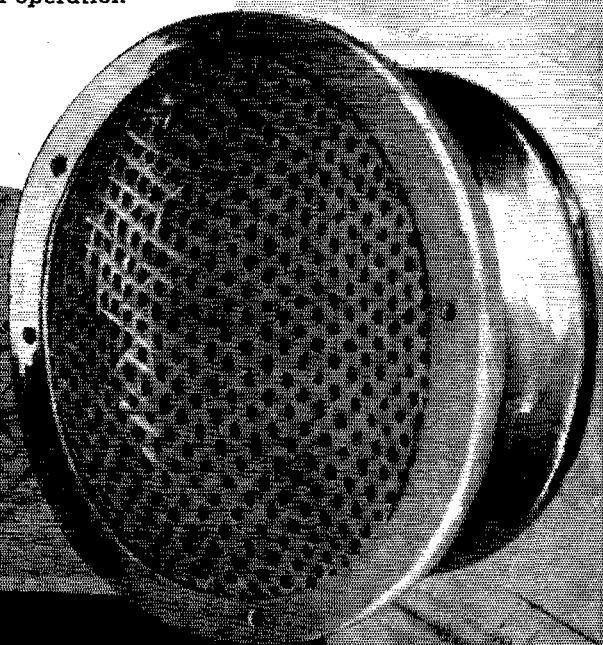

Jensen

RADIO MFG. COMPANY

4601 SO. LARAMIE AVE., CHICAGO

NEVER BE SATISFIED WITH MEDIOCRITY"

From telegraph boy to head of the world's largest plant producing automatic radiotelegraph apparatus . . . is Ted McElroy's* own success saga. And the creed that drove him on—NEVER BE SATISFIED WITH MEDIOCRITY. This same spirit prevails throughout the McElroy organization where inquisitive engineers never copy and never imitate. They create, design, build . . .

Typical of the work they do is the new McELROY MODEL SR-900 SL-990 . . . a superior commercial recorder including an automatic noise limiter and signal leveller. Embodying new principles of design and operation, it will record clean, readable signals at speeds up to 350 words a minute under the most adverse conditions.

Your inquiries are invited. If a McElroy engineer can be of service to you, ask for one.

* WORLD CHAMPION RADIO TELEGRAPHER FOR MORE THAN 20 YEARS

McElroy

MANUFACTURING CORP.
82 BROOKLINE AVE., BOSTON, MASS.

WORLD'S LARGEST MANUFACTURER OF AUTOMATIC RADIO TELEGRAPH APPARATUS

BUY MORE WAR BONDS

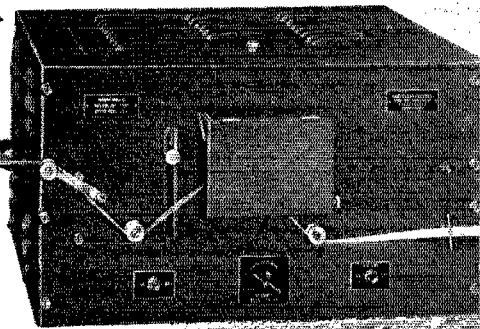
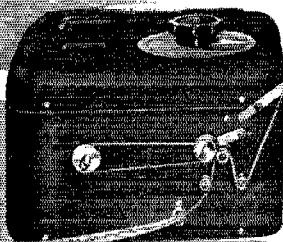

Section Communications Managers of the A.R.R.L. Communications Department

Reports Invited. All amateurs, especially League members, are invited to report communications activities, training plans, code classes, theory-discussion groups, civilian-defense building or planning each mid-month (16th of the month for the last 30 days) direct to the SCM, the administrative official of ARRL elected by members in each Section whose address is given below. Radio Club reports and Emergency Coördinator reports representing community organized work and plans and progress are especially desired by SCMs for inclusion in *QST*. **ARRL Field Organization appointments**, with the exception of the Emergency Coördinator and Emergency Corps posts, are suspended for the present and no new appointments or cancellations, with the exception named, will be made. This is to permit full efforts of all in Emergency Corps plans.

ATLANTIC DIVISION			
Eastern Pennsylvania	W3BES	Jerry Mathis	6208 Master St. 9701 Monroe St.
Maryland-Delaware-District of Columbia	W3CIZ	Hermann E. Hobbs	Silver Spring P. O.
Southern New Jersey	W3GCU	Ray Tomlinson	623 E. Brown St.
Western New York	W8MC	William Beller	186 Dorsey Rd.
Western Pennsylvania	W8CKO	E. A. Krall	703 Broadway
Philadelphia 31			
Linden, Maryland			
Trenton 10			
Rochester			
East McKeesport			
CENTRAL DIVISION			
Illinois*	W9OLZ	George Keith, Jr.	Box 22-A, R.F.D. 2
Indiana	W9RGQ	Herbert S. Brier	385 Johnson St.
Kentucky	W9ARU	Darrell A. Downard	116 N. Longworth Ave.
Michigan	W8DPE	Harold C. Bird	R.F.D. 2
Ohio	W8CBI	D. C. McCoy	Normandy Lane, R. R. 7
Wisconsin	W9RH	Emil Felber, Jr.	1625 N. 18th St.
Utica			
Gary			
Louisville 12			
Pontiac			
Dayton			
Milwaukee 5			
DAKOTA DIVISION			
North Dakota	W9YVE	John W. McBride	420 West 12th St.
South Dakota	W9QVY	P. H. Schultz	118 N. Yankton Ave.
Northern Minnesota	W9FUZ	Armond D. Brattland	Birchmont Drive
Southern Minnesota	W9YNO	Millard L. Bender	608 N. Huron Ave.
Sioux Falls, South Dakota			
Pierre			
Bemidji			
Spring Valley			
DELTA DIVISION			
Arkansas	W5GED	Ed Beck	2503 Bishop St.
Louisiana	W5DWVW	W. J. Wilkinson, Jr.	Room 313, Jefferson Hotel
Mississippi	W5HAV	P. W. Clement	524 Santini St.
Tennessee	W4SP	James B. Witt	R.F.D. 6, Shady Dell Trail
Little Rock			
Shreveport			
Biloxi			
Knoxville			
HUDSON DIVISION			
Eastern New York	W2LU	Robert E. Haight	511 So. Holmes St.
N. Y. C. & Long Island	W2AZV	E. L. Baunach	102 Central Ave.
Northern New Jersey	W2QZD	Winfield G. Beck	617 Spruce St.
Scotia			
Massapequa, L. I.			
Roselle			
MIDWEST DIVISION			
Iowa	W9AED	Arthur E. Rydberg	1617 S. Seneca St.
Kansas	W9AWP	A. B. Unruh	116 S. 45
Missouri*	W9OUD	Mrs. Letha A. Dangerfield	101 Arikari Ave.
Nebraska	W9POB	Roy E. Olmsted	
Mitchellville			
Wichita			
Lea's Summit			
Wau नेता			
NEW ENGLAND DIVISION			
Connecticut	W1KQV	Edmund R. Fraser	48 Willow St.
Maine*	W1AQL	G. C. Brown	379 No. Main St.
Eastern Massachusetts	W1ALP	Frank L. Baker, Jr.	91 Atlantic St.
Western Massachusetts	W1JAH	William J. Barrett	239 Columbia St.
New Hampshire	W1ERT	Mrs. Dorothy W. Evans	P. O. Box 512
Rhode Island	W1RRC	Clayton C. Gordon	70 Columbia Ave., Gaspee
Vermont	W1NLO	Burtis W. Dean	P. O. Box 81
West Haven 16			
Brewer			
North Quincy 71			
Adams			
Concord			
Plateau, Providence 5			
Burlington			
NORTHWESTERN DIVISION			
Alaska	K7GNN	James G. Sherry	
Idaho	W7AVP	Don D. Oberbillig	P. O. Box 486
Montana	W7CPY	Rex Roberts	Box 1088
Oregon	W7GNJ	Carl Austin	1137 Federal
Washington	W7FWD	O. U. Tatro	513 N. Central
Homer			
Boise			
Glendive			
Bend			
Olympia			
PACIFIC DIVISION			
Hawaii	K6ETF	Francis T. Blatt	837 16th Ave.
Nevada	W6BIC	Edward W. Heim	509 Claremont St.
Santa Clara Valley	W6IUZ	Earl F. Sanderson	600 Acacia Ave.
East Bay	W6TI	Horace R. Greer	414 Fairmount Ave.
San Francisco*	W6RBO	William A. Ladley	200 Naylor St.
Sacramento Valley	W6MDI	Vincent N. Feldhausen	113 South Quincy St.
Philippines	KA1GR	George L. Rickard	Box 849
San Joaquin Valley*	W6MIW	Ralph C. Lowry	315 Santa Barbara
Honolulu			
Reno			
San Bruno			
Oakland			
San Francisco			
McCloud			
Manila			
Modesto			
ROANOKE DIVISION			
North Carolina	W4CYB	W. J. Wortman	P. O. Box 566
South Carolina	W4BOE/ANG	Ted Ferguson	1213 College St.
Virginia	W3AKN	Walter G. Walker	217-51 St.
West Virginia	W8JRL	Kenneth M. Zinn	P. O. Box 132
Morganton			
Columbia			
Newport News			
Clarksbury			
ROCKY MOUNTAIN DIVISION			
Colorado*	W9VGC	H. F. Hekel	2743 Julian St.
Utah-Wyoming	W7DIE	John S. Duffy	938 "D" St.
Denver 11			
Rock Springs, Wyo.			
SOUTHEASTERN DIVISION			
Alabama	W4GBV	Lawrence J. Smyth	808 Winona Ave.
Eastern Florida*	W4BYR	Frank C. Fassett	1712 Hills Ave.
Western Florida	W4AXP	Oscar Cederstrom	408 S. Pine St.
Georgia	W4FDJ	Ernest L. Morgan	R.F.D. 4
West Indies (Cuba)	CM2OP	Mario de la Torre	Escobar 110 (Alto)
(Puerto Rico-Virgin Islands)	K4KD	Everett Mayer	24 Lindberg St.
Montgomery			
Tampa			
Warrington			
Lyons			
Habana, Cuba			
Santurce, P. R.			
SOUTHWESTERN DIVISION			
Los Angeles	W6QVV	H. F. Wood	723 N. Las Palmas Ave.
Arizona	W6RWVW	Douglas Aitken	341 S. Mt. Vernon Ave.
San Diego	W6BZE	Richard Shanks	4033 S. Hempstead Circle
Hollywood			
Prescott			
San Diego			
WEST GULF DIVISION			
Northern Texas	W5IAU	N. R. Collins, Jr.	2230 W. Amherst
Oklahoma	W5GFT	Russell W. Battern	Box 290
Southern Texas	W5MNI	Horace E. Biddy	1746 Scheley Ave.
New Mexico	W5HJF	J. G. Hancock	110 S. E. Nevada St.
Dallas			
Enid			
San Antonio			
Portales			
MARITIME DIVISION			
Maritime	VE1DQ	A. M. Crowell	69 Dublin St.
Halifax, N. S.			
ONTARIO DIVISION			
Ontario	VE3EF	Flying Officer Donald R. Gunn	c/o Canadian Bank of Commerce
New Toronto, Ont.			
QUEBEC DIVISION			
Quebec	VE2CO	Sub-Lieutenant L. G. Morris	c/o Room 604, 1111 Beaver Hall Hill
Montreal, P. Q.			
VANALTA DIVISION			
Alberta	VE4GE	C. S. Jamieson	581 W. Riverside Drive
British Columbia	VE5DD	C. O. I. Sawyer	2634 West 31st Ave.
Drumheller, Alta.			
Vancouver			
PRAIRIE DIVISION			
Manitoba	VE4AAW	A. W. Morley	932 Dorchester Ave.
Saskatchewan	VE4SY	Arthur Chesworth	1071 4th Ave., N.W.
Winnipeg			
Moose Jaw			

*Officials appointed to act until the membership of the Section choose permanent SCMs by nomination and election.



the amateur is still in radio

He's not at his haywire rig in the attic...he's holding down key engineering spots in the laboratories, the factories, the army, navy and marine corps. Today the radio amateur is the top electronic engineer who is doing the impossible for his country and for the world. And why not?...the radio amateur has always done the impossible. He's the one who refused to obey the rules...demanded more and ever more from his "ham" rig. The equipment that he used...especially the tubes...had to have greater stamina and vastly superior performance capabilities. Thus the radio amateur literally forced electronics forward. For the products created to stand up under his gruelling treatment represented real advancement. Eimac tubes are a good example, for Eimac tubes were created and developed in the great amateur testing grounds. That's one reason why Eimac tubes have proved so vastly superior for commercial and war uses. Yesterday the leading radio amateurs throughout the world preferred Eimac tubes. Today these radio amateurs are off the air as amateurs but wherever they are, as the leaders in electronics, they're still using Eimac tubes.

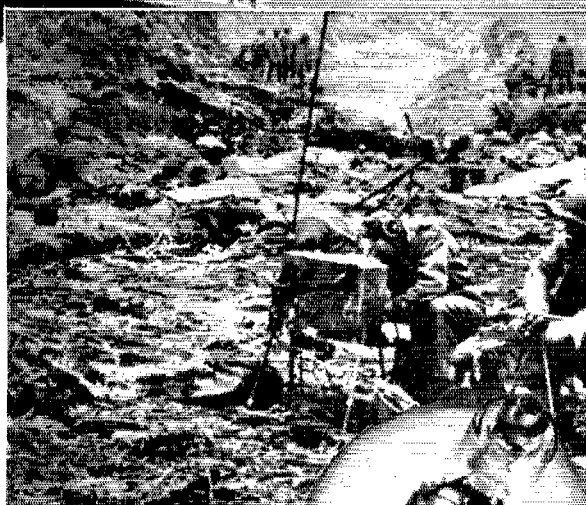

Follow the leaders to

Eimac
REG. U. S. PAT. OFF.
TUBES

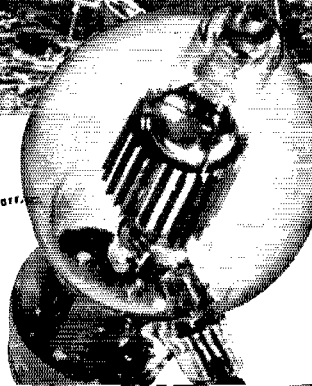

EITEL-McCULLOUGH, INC. • SAN BRUNO, CALIFORNIA
 Export Agents: Frazar & Hansen, 301 Clay St., San Francisco, Calif., U. S. A.

THE AMERICAN RADIO RELAY LEAGUE, INC.,

is a noncommercial association of radio amateurs, bonded for the promotion of interest in amateur radio communication and experimentation, for the relaying of messages by radio, for the advancement of the radio art and of the public welfare, for the representation of the radio amateur in legislative matters, and for the maintenance of fraternalism and a high standard of conduct.

It is an incorporated association without capital stock, chartered under the laws of Connecticut. Its affairs are governed by a Board of Directors, elected every two years by the general membership. The officers are elected or appointed by the Directors. The League is noncommercial and no one commercially engaged in the manufacture, sale or rental of radio apparatus is eligible to membership on its board.

"Of, by and for the amateur," it numbers within its ranks practically every worth-while amateur in the nation and has a history of glorious achievement as the standard-bearer in amateur affairs.

Inquiries regarding membership are solicited. A bona fide interest in amateur radio is the only essential qualification; ownership of a transmitting station and knowledge of the code are not prerequisite, although full voting membership is granted only to licensed amateurs.

All general correspondence should be addressed to the Secretary at the administrative headquarters at West Hartford, Connecticut.



Past Presidents

HIRAM PERCY MAXIM, WIAW, 1914-1936
EUGENE C. WOODRUFF, W8CMP, 1936-1940

Officers

President GEORGE W. BAILEY, W1KH
Washington, D. C.
Vice-President CHARLES E. BLALACK, W6GG
Yuma, Arizona
Secretary KENNETH B. WARNER, W1EH
West Hartford, Connecticut
Communications Manager F. E. HANDY, W1BDI*
Chevy Chase, Maryland
Treasurer DAVID H. HOUGHTON
West Hartford, Connecticut

General Counsel PAUL M. SEGAL
1026 Woodward Building, Washington 5, D. C.

*On leave of absence. Address correspondence to the Acting Communications Manager, George Hart, West Hartford 7, Connecticut.

Directors

President
GEORGE W. BAILEY W1KH
1530 P St., N.W., Washington 25, D. C.

Vice-President
CHARLES E. BLALACK W6GG
Box 108, Yuma, Ariz.

Canadian General Manager
ALEX REID VE2E
240 Logan Ave., St. Lambert, P. Q.
Alternate: Leonard W. Mitchell VE3A
78 Raglan Ave., Toronto, Ont.

Atlantic Division
WALTER BRADLEY MARTIN W3C
Address correspondence to the Acting Director
HERBERT M. WALLEZE W8E
P. O. Box 18, Drums, Pa.

Central Division
GOODWIN L. DOSLAND W9TS
11821 Longwood Drive, Chicago
Alternate: Everett H. Gibbs W8A
405 Broad St., Wadsworth, Ohio

Dakota Division
TOM E. DAVIS W9VV
915 W. Becker Ave., Willmar, Minn.
Alternate: Aaron F. Swanberg W0BH
1487 Breda St., St. Paul, Minn.

Delta Division
E. RAY ARLEDGE W5
340 N.E. 20th Terrace, Apt. 7, Miami 37, Fla.
Alternate: Samuel H. Dowell W5EH
1057 Mildred St., Shreveport 15, La.

Hudson Division
ROBERT AKERIDGE KIRKMAN W2DS
250 Albert Place, Elberon, N. J.
Alternate: George Rulfs, Jr. W2CJ
172-21 Highland Ave., Jamaica, L. I.

Midwest Division
FLOYD E. NORWINE, JR. W9EF
7405 Hiawatha Ave., Richmond Heights, Mo.
Alternate: William H. Graham W9BN
6915 No. 31st Ave., Omaha, Neb.

New England Division
PERCY C. NOBLE W1BV
37 Broad St., Westfield, Mass.
Alternate: Clayton C. Gordon W1HR
70 Columbia Ave., Warwick, R. I.

Northwestern Division
KARL W. WEINGARTEN W7B
3219 N. 24th St., Tacoma 7, Wash.
Alternate: R. Rex Roberts W7CP
110 W. Brennan St., Glendive, Mont.

Pacific Division
J. L. McCARGAR W6E
66 Hamilton Pl., Oakland 12, Calif.
Alternate: Elbert J. Amarantes W6FB
1675 Dale Ave., San Jose, Calif.

Roanoke Division
H. L. CAVENESS W4D
2607 Vanderbilt Ave., Raleigh, N. C.
Alternate: J. Frank Key W3Z
Box 707, Buena Vista, Va.

Rocky Mountain Division
C. RAYMOND STEDMAN W9CA
925 So. Gaylord St., Denver 9
Alternate: Willard C. Wright W9BQ
Box 891, Denver

Southeastern Division
WILLIAM C. SHULTON W4AS
527 Revillo Blvd., Daytona Beach, Fla.
Alternate: William P. Sides W4AU
Fleming Road, Montgomery, Ala.

Southwestern Division
JOHN E. BICKEL W6BK
1834 E. Whittier Blvd., Whittier, Calif.
Alternate: Eldridge E. Wyatt, jr. W6AR
P. O. Box 3597, Long Beach 3, Calif.

West Gulf Division
WAYLAND M. GROVES W5N
% Humble Pipe Line Co., Hawkins, Texas
Alternate: Jennings R. Poston W5J
Box 246, Mabank, Texas

"IT SEEMS TO US—"

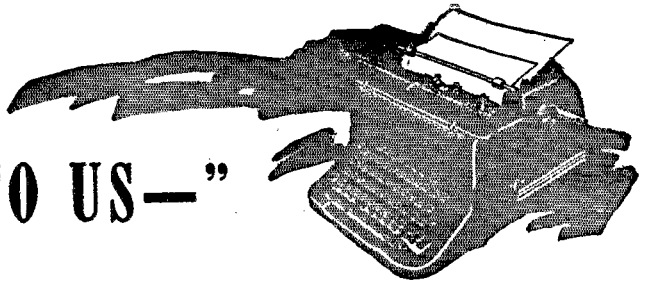

HAM HELLOS

THE letters we get at Headquarters from our hams on military duty in far distant places not only attest their joy at encountering another amateur but the deep pleasure they derive from letters from their fellow hams at home. The soldier or sailor's greatest happiness comes from the receipt of mail from home. This seems particularly true of the radio amateur, since we have always been a deeply rooted bunch with contacts everywhere. Even a routine letter from Hq. is eagerly received out there, and a dog-eared copy of *QST*, months old, is passed on and on and re-read until it falls apart.

Our radio fellows are hungering for mail QSOs with the gang back home. How they long for news on what the old crowd is doing, for a chance to chew the fat over old times and plans for the future! Write them letters, we urge. There are few things that will help the overseas bunch as much as our devoting a little of our time to working up some letters to pass along ham hellos, give them the news, and keep the fires of amateur radio burning.

There is something of all of us — something of you — in every one of the millions of American soldiers and sailors now scattered around the globe. Our own amateur group is part of them, now spread out over the whole earth. Many are our close friends, a countless number are our acquaintances of the ether. They are out there doing a job for America, their thoughts ever on the homeland. We who are still on the home front are, for them, the link between yesterday and to-morrow. Let's not let them down!

PUBLICITY

HAVE you fellows at home the time to take on one more job that needs looking after? Somebody ought to help newspaper editors and rewrite men when they get an item on a local amateur who has distinguished himself in military service and are working up some local background.

The clippings we get usually mention the fact that the man was an amateur, and that's all. No call, no story of his early struggles, no mention of his station or description of the interesting work he used to do, no indication that his amateur training fitted him for the part he has played in the struggle. If only some of

you fellows can make yourselves known to your local editors and offer to help when there is a story on local amateurs, we'd have a fine way of bringing amateurs to public attention, particularly the great work they're doing in the armed forces. It would help the public to realize both the amateur's worth during the war and the necessity for his continued existence afterward. Can do?

K. B. W.

PAPER AND *QST*—A REPORT

CASUAL remarks sometimes are like the bite of a chigger. At the moment there isn't much sensation, but after a while the bite begins to swell — and then you start scratching.

Such a remark was made to us the other day by a ham now in military service. "I see *QST* is growing thinner these days," he said. At the time we simply denied that this was true, and let it go at that.

But somehow the slight sting caused by that remark failed to subside. In fact, it persisted until finally it caused us to do a little scratching. In the process we uncovered some data that seem worth passing along.

Viewed solely as so much paper poundage, it is true, of course, that *QST* is a little thinner these days and weighs less. It may even average a few less pages — but the sum total of the reading matter is about the same. Back in 1939 and 1940 you were getting an average issue of around 120 pages (not counting covers). The average for 1943 is around 112. Don't forget, though, that 1939 was about the biggest year in *QST*'s history; the average in 1941, for example, was about 106 pages.

That 112-page average for 1943 isn't quite a fair figure when we're discussing the paper shortage, however, because paper quotas have affected seriously only the past eight issues. For these the average number of pages was 106, which is the same as the average of the same issues in 1941, and compares with a 115-page average for the entire 1939-1942 period.

However, these are total pages per issue — and we started out talking about editorial content. The actual pages of editorial material for the eight rationed 1943 issues averaged 73.1 per issue. Although less, of course, than the 1942 average of 78.8 reading pages for the same issues, that figure is considerably higher than the 1941 figure of 65.2 pages — and higher even than the total 1939-1942 average of 71.6 pages.

There's still more to the story, though. The enlarged page format adopted beginning with the April issue alone has added the equivalent of 4.25 additional editorial pages per issue. With this adjustment, you can see that *QST* has brought you more reading matter recently than in any of the past few years.

Nor was this accomplished at the expense of circulation; quite the contrary. In fact, during this past year ARRL membership has experienced its greatest growth of any year since 1934. While providing these additional membership copies has made it necessary to curtail newsstand distribution somewhat, it has still been possible to allow a controlled annual increase in total circulation within a predetermined quota limit of about 5 per cent.

Neither — we hasten to add — was it accomplished by playing fast and loose with WPB paper quotas. In the light of rigid WPB restrictions on paper consumption, these figures may seem like a trick with mirrors or a matter of fancy bookkeeping. They aren't, though. They're the result of careful conservation — and of rationing.

The conservation angle comes first in the enlarged page format and the use of lighter-weight paper, and second in exercising the greatest possible care to avoid waste. Our printing plant has done an excellent job in bettering even its previous good record for low spoilage, and our distribution system has been tightened so successfully that every possible copy reaches the hands of a reader. Newsstands returns, a matter in which *QST* always has had an outstanding record, have been reduced to a new low.

But conservation alone only assures maximum use of the pages available; it does not make available additional pages. That's where advertising rationing comes in.

If you've had any experience at all with the publishing game, you'll have deduced that many of these extra editorial pages have been printed at the expense of advertising space.

Not that the advertising wasn't available; never since the days of the radio boom of the early '20s have so many been so eager to advertise so much. Only by a policy of rigid rationing of space, made effective with the May, 1943, issue, has it been possible to keep advertising volume within acceptable limits.

We've mentioned that policy before, and have paid tribute to the cooperative spirit of advertisers which has made it possible. The objective was to cut the total space occupied by paid advertising by one-half — and that is approximately what has been accomplished. Moreover, instead of cutting the over-all size of the magazine proportionately, as is traditional publishing practice, the difference has been allocated to editorial material. We can do that because *QST* advertisers continue to pay as much *money* for half as much *space*, on the understanding that that money is to be used for the eventual restoration of amateur radio.

The result has been that, since the May issue when advertising rationing became effective, the net paid advertising has been only about 28.5 per cent of the content of an average issue. That's about half the percentage in most popular magazines. A recent survey shows that, for the second quarter of 1943, such typical magazines as *Time*, the *Ladies Home Journal* and *Better Homes & Gardens* carried 60.2, 57.3 and 57.3 per cent advertising, respectively. This point is made, not to discredit the importance or usefulness of the advertising messages carried in our columns, but to show that in *QST* the reader-member's interests are paramount.

So much for the past. The future is, as yet, an unknown quantity. Further paper cuts seem certain. Next year's issues doubtless will come to you on even lighter-weight paper, and the average size may be a page or two less. But of this you may be certain: each and every issue will bring you a full quota of technical articles, features and membership information — paper quotas or no. C. B. D.

★ SPLATTER ★

OUR COVER

THE cover this month is a partial concession to "Deke" French, our aeranalysis addict — a concession, because it serves as additional illustration of the technique he discusses on pages 11-16; a partial one, because he thought it should show a pair of hams rather than the YL team of Signal Corps technicians at the Ft. Monmouth General Development Laboratory. But we thought you wouldn't object, and so here they are. It's an official U.S. Signal Corps photo.

PAPER AND YOU — A REQUEST

THE editorial above brings up the basic problem of the paper shortage itself. Actually, it is not so much a paper problem as it is a pulp-wood problem. Magazine (book) paper is made from the basic pulp, with little or no reclaimed-paper content. The problem is to get enough wood pulp cut and transported to the paper mills.

There's not too much that we, as hams, can do about that — except persuade the owners of near-by woodlots to turn their standing timber into pulpwood. Saving old newspapers won't provide magazine paper, but it will help in other ways. Most important of all, however, is to conserve existing stocks of new paper — including commercial paper, business forms, even personal

(Continued on page 108)

Aeroanalysis and V.H.F. Techniques

Our Growing Knowledge of Conditions in the Lower Atmosphere

BY HOLLIS M. FRENCH,* WIJLK

During the past decade remarkable advances have been made in the investigation of v.h.f. wave propagation. Amateurs first were awakened to unsuspected possibilities in the 56-Mc. band by a pioneer in this field, the late Ross A. Hull, whose report on the achievement of consistent 56-Mc. communication between amateur stations in West Hartford and Boston was published in *QST*, for October, 1934. His later article, "Air-Mass Conditions and the Bending of Ultra-High Frequency Waves," published in the June, 1935, issue of *QST*, not only was one of the first systematic studies of conditions governing v.h.f. wave propagation in the lower atmosphere but also pointed the way to an improved method of meteorological research by the use of radio soundings.

This article traces the relationships between the development of the weather-forecasting technique known as "air-mass-and-front analysis" (or *aeroanalysis*, as the author has chosen to call it) and radio techniques, including the construction and use of radiosonde equipment.

HAVING discussed astronomy as it is related to amateur radio,¹ we can now get down to earth, in a sense. The types of wave propagation with which we are here concerned are confined to that relatively thin slice of the earth's atmosphere known as the *troposphere*, which reaches only about seven miles above sea-level. It is the region of the clouds, the turbulent cauldron where weather is brewed. Though we are still up in the clouds, we have descended far from the interstellar spaces and are well below the earth's ionosphere. We should feel a bit more at home in a study of related weather and radio conditions in the lower atmosphere.

In the troposphere we have no such orderly arrangement of refracting layers and reflecting boundaries as we find in the ionosphere. Although it often happens that the relatively stable conditions in the ionosphere are disturbed by exceptional fluctuations in solar radiation, nevertheless we have been able to reduce our knowledge of the ionosphere to something approaching an exact science. Now we shall see that conditions in the lower atmosphere exert a marked influence upon the propagation of v.h.f. waves, and probably of u.h.f. and s.h.f. waves as well. It is distressing at first to realize that those conditions are fully as chaotic and unpredictable as the weather. In fact, they are functions of the weather. We have reached a point where progress in radiocommunication must go hand-in-hand with the development of the science of meteorology.

"Meteorology," says Webster, "is the science, or branch of physics, treating of the atmosphere and its phenomena, especially of its variations of heat and moisture, of its winds, storms, etc." The instrumental branch of this science, under the name of *aerology*, is undergoing rapid advance. While radio is contributing largely to aerological progress, at the same time it is, in turn, indebted to aerology for knowledge that is constantly increasing the effectiveness of our use of the higher

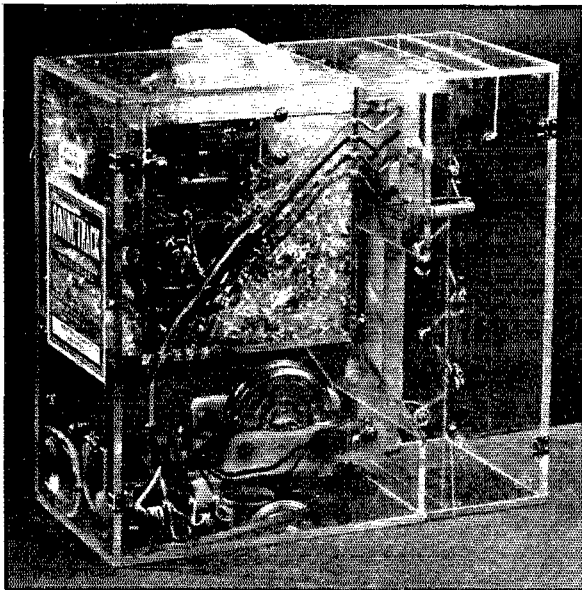

A complete radiosonde unit as used by the U. S. Weather Bureau, shown in its transparent plastic case. The temperature tube is to be seen in the right-hand compartment, together with a hair hygrometer which serves the same purpose as the resistance-type hygrometer described in the text. The transmitter and its dry-battery supply are in the insulated compartment at the upper left, while the pressure-switching mechanism is in the space at the lower left.

* Assistant Technical Editor, *QST*.

¹ French, "Astronomy and Amateur Radio," *QST*, November, 1943, p. 17.

frequency ranges of the radio spectrum. We have already been able to overleap many stubborn hurdles that once limited our use of the very-high frequencies to optical paths alone. The developments through which we have become partners of the "weatherman" make an interesting story.

During the World War of 1914-18 — when normal exchanges of weather information were cut off, as at present, for reasons of military security — a group of aerologists in Norway sought substitutes. Up to that time weather maps had been drawn on the basis of readings of temperature, humidity, barometric pressure, direction and velocity of wind, and type of precipitation, all reported over as wide an area as possible. However, such observations were made principally at ground stations. High-altitude sites were preferred for weather observatories, and some use was made of kites and pilot balloons for occasional soundings of upper air currents. In general, however, the weather maps were little more than two-dimensional pictures of current weather conditions. The Norwegian scientists became convinced that a more practical method of forecasting required systematic soundings of the troposphere. By applying those principles of physics which govern the behavior of fluid masses, they evolved a new technique of physical weather analysis. The rather cumbersome term, "air-mass-and-front analysis," was applied to this type of weather observation.

Principles of Aeroanalysis

At the risk of oversimplification of a topic which actually is quite involved, we shall adopt a substitute term, *aeroanalysis*, and, after explaining the terms *air mass* and *front*, an outline of the principles of aeroanalysis will be undertaken. Then we shall see how radio became an essential instrument in the tropospheric soundings required for aeroanalysis, and describe the radio-sonde gear. Finally, we shall see how a better understanding of the physical characteristics of the lower atmosphere increases our knowledge

of the conditions governing wave propagation there, and how the effectiveness of our v.h.f. techniques may increase with the increasing accuracy of the weatherman's predictions.

An *air mass* is a huge segment of the lower atmosphere which has remained stagnant for some time over a wide area of nearly uniform surface characteristics, such as the Sahara Desert, the Hudson Bay region in winter, or the Gulf of Mexico. Air masses may be hundreds of miles in length and breadth, several miles in depth, and millions of tons in weight. They become characterized by the surface temperature and humidity conditions prevailing in the region over which they have remained at rest. Eventually they must move on, driven by the forces of atmospheric circulation. They may travel very considerable distances, passing over regions quite different from their source region, and retain their original characteristics to a high degree, whether warm-dry or warm-moist, cold-dry or cold-moist. As the air mass comes into contact with surface conditions which are at variance with those of the source region, the resulting modification is gradual. The higher portions of the mass are progressively reluctant to yield to change. This conservatism results in the meeting of air masses of dissimilar composition in the process of circulation. The boundaries or discontinuities thus created are called *fronts* by the weather analyst, and are of great interest both to him and to the radio operator using the very-high frequencies. Fig. 1 gives an idea of the manner in which these fronts evolve.

The front is a weather-breeder. It is a mixing zone between air masses. Light air (warm, dry, rarer in density) over-runs heavier air (cold, moist, dense). Condensation and precipitation take place as a result of the contact. Tremendous forces are in conflict and mighty winds are born. Many factors govern the form and intensity of frontal weather. The relative extent of the air masses involved, the nature of their composition, their rate of movement, the point of convergence and several other conditions need to be observed

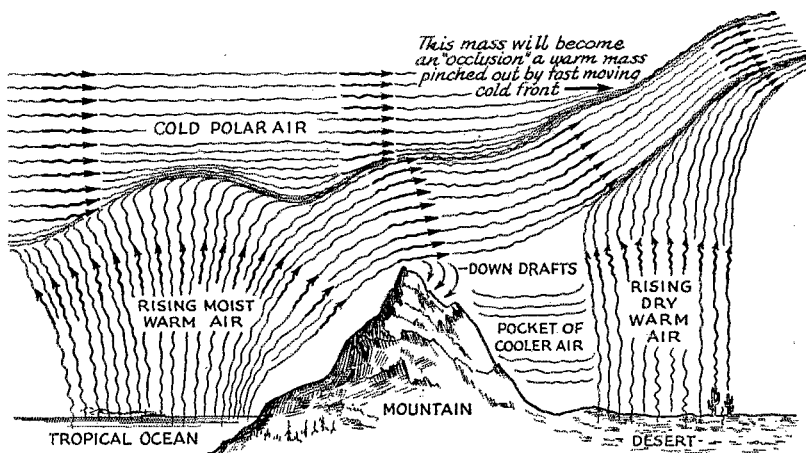
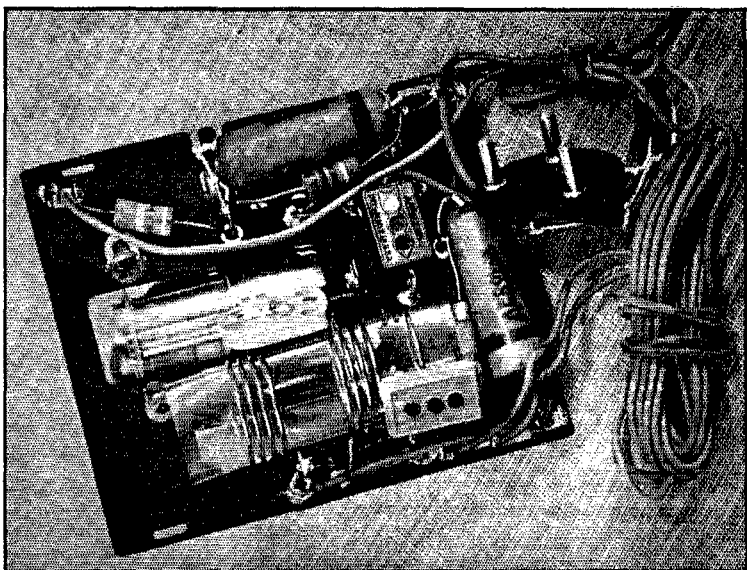

Fig. 1—A simplified diagram which suggests the origins of different types of air masses, and the effects of their meeting in circulation. In the fronts created by such meetings, radio-frequency waves encounter the conditions required for their refraction and reflection in the lower atmosphere. Thus their study is of value to the radio amateur.

◆

The v.h.f. transmitter unit in the radiosonde. The type 19 dual-triode oscillator tube is partly visible through the rectangular opening at the left center of the plastic chassis.

◆



and analyzed by the weather forecaster. He identifies air masses, in accordance with their source region and general characteristics, as Polar Continental, Polar Maritime, Tropical Continental, Tropical Subsidence (air masses of tropical origins, warmed and dried by sinking and spreading) and Tropical Maritime. North American air-masses are further identified as Polar Canadian (a continental mass), Polar Pacific (maritime), Tropical Gulf, Tropical Atlantic and Tropical Pacific (all Tropical Maritime). It will be recognized that, for analysts in other parts of the world, similar regional classifications will be used in weather-map notation. The analyst traces the movements and relative positions of these air masses and resulting fronts. He takes into consideration seasonal conditions and all available localized data of temperature, humidity, pressure and wind velocity and direction, at the surface and aloft as well. He applies known physical laws governing the behavior of fluid masses, and if his data is sufficiently comprehensive he is able to forecast reliably weather conditions for a given area for as much as 36 hours in advance.

If this process has appeared simple to the reader, we have misled him! However, enough has been included in the story to outline the general principles of aeroanalysis and to give some hints as to how radio may be usefully employed for three-dimensional weather analysis. Reliable forecasting depends upon comprehensive and reliable data, not merely from ground stations but from all possible levels within the towering air masses. The usefulness of pilot balloons to indicate wind velocities and directions in the upper air, through visual observation of their drift from ground stations, is limited by the low visibility of such small objects and their final disappearance at relatively short distances. If such balloons, or kites, are used to carry aloft the earlier types of recording instruments, the delay in the recovery

of records may vitiate their value, while some are lost forever. Soundings made by means of high-altitude airplane flights are expensive, and the altitude limitation is unsatisfactory; moreover, soundings cannot be made from ship stations or small islands. The application of radio technique has resolved most of these difficulties.

Radiosonde Design

The *radiosonde* is a combination of compact devices giving measurable responses to changes in pressure, temperature and humidity, together with a tiny radio transmitter capable of transmitting successive indications of all three types of response during the time the instruments are aloft. Sensitive receiving and recording instruments at a ground station make the soundings immediately available to weather analysts.

A typical radiosonde as used by government aerological services was described in a paper published by the National Bureau of Standards in 1940.² Publication of later developments has probably been held in abeyance by wartime restrictions, but it may be assumed that very material increases in efficiency have been achieved since 1940. The development of low-current 1.4-volt miniature tubes, such as the 3A5 dual triode, as well as very efficient miniature "B" batteries, point to reduction in weight and possible refinements of design in the transmitter. Associated indicating devices also were undergoing rapid development at the time the latest published information was issued.

The radiosonde transmitter naturally is an object of prime interest to the radio amateur, yet it has received little attention in any publication known to this writer except for the Bureau of Standards papers. A fundamental circuit is

² Diamond, Hinman, Dunmore and Lapham, "An Improved Radiosonde and Its Performance." Research Paper RP1329, National Bureau of Standards, September, 1940.

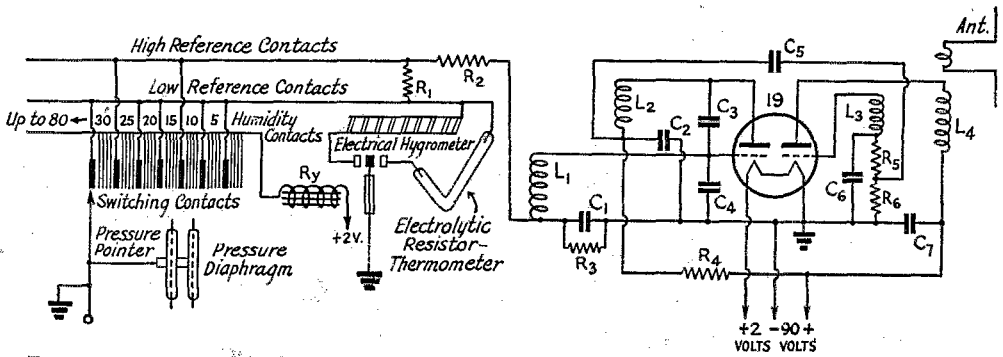

Fig. 2 — Wiring diagram of the radiosonde transmitter unit and the associated pressure-switching assembly.

C ₁ — 0.07- μ fd. mica.	R ₂ — 40,000 ohms, $\frac{1}{2}$ watt.	L ₃ — 7 turns No. 18, spaced to occupy $\frac{1}{2}$ inch, on $\frac{1}{2}$ -inch diameter form.
C ₂ — 0.01- μ fd. mica.	R ₃ — 1 megohm $\frac{1}{2}$ watt.	L ₄ — 9 turns No. 18, spaced to occupy $\frac{1}{2}$ inch, on $\frac{1}{2}$ -inch diameter form.
C ₃ , C ₄ , C ₇ — 250- μ fd. mica.	R ₄ — 25,000 ohms, 1 watt.	
C ₅ — 0.05- μ fd. mica.	R ₅ — 5000 ohms, $\frac{1}{2}$ watt.	
C ₆ — 100- μ fd. mica.	L ₁ , L ₂ — Universal wound 100- μ h. coils.	
R ₁ , R ₅ — 1000 ohms, $\frac{1}{2}$ watt.		

The spaces between contacts on the switching device represent insulating laminations in the conductor stack.

shown in Fig. 2, and the accompanying photographs show arrangements of parts and details of construction. One section of a type 19 dual triode functions as a very-high-frequency oscillator on about 72 Mc., while the other section is used as a modulating oscillator operating at about 1 Mc. In the grid circuit of the latter is a resistance-capacity network consisting of a fixed capacity, C₁, limiting resistors R₁ and R₂, and the variable resistances represented by the electrolytic resistor-thermometer and the surface-leakage resistor-hygrometer when these are introduced into the circuit by the pressure-switching device. The effect of these variable resistances is to alter the value of the audio frequency governed by the RC network. This network operates to block the 1-Mc. oscillator at a rate inversely proportional to the time constant of the RC combination. The limiting resistors are selected so as to establish a range of from 10 to 200 cycles per second for the blocking frequency. This frequency, impressed upon the output of the 1-Mc. oscillator, modulates the carrier of the 72-Mc. oscillator at a variable frequency which is measured by suitable instruments at the ground station. These include a very-high-frequency superregenerative receiver whose audio circuit is adjusted to give maximum response at 20 cycles, with decreasing response for increasing frequency. This clears the receiving system of most types of interference. The output of the receiver is fed into an electronic frequency meter which measures the frequency of the audio component of the radiosonde signal. The frequency readings are then translated on a graphic recorder in terms of humidity or temperature, as the case may be.

Pressure-Switching Unit

Reference has been made to the pressure-switching device. This is composed of a pressure diaphragm or aneroid bellows which drives a pointer-contactor through a suitable linkage, together with a switching contactor. The latter is

made up of a stack of 80 conducting laminations separated by insulating laminations. The conductors are arranged in groups of four narrow intermediate contacts, adjacent groups being separated by wider index contacts. The intermediate contacts, called the humidity contacts for a reason which will presently appear, are all connected together and to the field coil of a miniature low-voltage relay. The index contacts are collected in two groups. The members of one group are connected to the junction of resistors R₁ and R₂, while the members of the second group are connected to the junction of R₁ with the resistor-thermometer and resistor-hygrometer. Those contacts in the first group numbered 15, 30, 45, 60 and 75 are called the high-reference contacts, since, when the pointer-contactor bears against one of them, only resistor R₂ remains in the circuit and a reference modulating frequency is obtained on the high side of the range. Those contacts of the second group numbered 5, 10, 20, 25, 35, 40, 50, 55, 65, 70 and 80 are called the low-reference contacts, because, when the pointer-contactor bears against one of them, both R₁ and R₂ are in the circuit and a lower reference modulating frequency is produced.

The bearing surface of the switching contactor pile is highly polished, to offer a minimum of frictional resistance to the passage of the pointer-contactor across the laminations. This arm, driven by the expansion (or contraction) of the pressure diaphragm, sweeps across the contacts as the ambient pressure changes continuously with the ascent (or descent) of the balloon-borne instrument. Thus the sequence of switching operations is governed by the successive values of atmospheric pressure. As the pressure decreases uniformly with altitude, an actual count of the contacts made provides a pressure-altitude scale on the recording instrument's graph against which the temperature, humidity and reference signals are automatically plotted.

When the pointer-contactor bears against any of the humidity contacts, the field coil of the

relay is energized. The grounded armature of the relay normally rests against its back contact and is thereby connected with the resistor-thermometer. When the field coil is energized, the armature bears against a front contact which is connected to one side of the resistor-hygrometer. This instrument consists of a tube coated with lithium chloride solution, over which is wound a parallel pair of palladium wires. The resistance of the coating between the wires of the pair varies with humidity. Thus, when this resistance is switched into the network, the value of the modulating frequency varies at that instant according to the ambient humidity.

When the pointer-contactor bears against any one of the insulating laminations, since the relay field-coil circuit is then open with the armature resting against its back contact, the resistor-thermometer is in the circuit and its variations will be registered in the form of proportional variations of the modulating frequency. The resistor-thermometer is an electrolytic resistor made up of a very small-bore glass tube filled with an electrolyte consisting of hydrochloric acid and alcohol with a bit of cuprous chloride added. The resistance of the electrolyte changes rapidly with temperature, causing a corresponding change in modulating frequency.

The complete radiosonde consists of the transmitter, the pressure-, temperature- and humidity-indicating instruments, the relay, a battery power supply, suitable thermal insulation and radiation shielding, a supporting balloon or balloons, and the antenna wire, which forms part of the structure by which the instruments are suspended from the balloon. The weight can be kept to about 2½ pounds, and the cost is about \$25.00. A fairly high proportion of the radiosonde units released over land areas are recovered and used again. A label on the container furnishes shipping instructions for the instrument and offers the finder a reward on its return.

Applications to V.H.F. Development

Whether or not amateurs wish to experiment with the design and operation of radiosonde equipment when our operating frequencies are restored, we shall be vitally concerned with their development and with every advance in the science of aeroanalysis. The frontier of technical progress in our art is in the region of increasingly higher frequencies. The beginning made by Ross A. Hull, in his researches preceding and following his papers on air-mass conditions and very-high-frequency wave propagation,³ is an accomplishment of which amateurs may well be proud. Later researches

³ Hull, "Air-Mass Conditions and the Bending of Ultra-High Frequency Waves," *QST*, June, 1935, p. 13.

conducted by Tilton, W1HDQ; Conklin, W9BNX; Pierce, W1JFO; Wilson, W1DEI, and scores of others have made large contributions to our increasing knowledge of v.h.f. wave propagation in the lower atmosphere. Nevertheless, there must be built upon this groundwork a systematic knowledge of the conditions governing such transmissions, and a flexible technique must adapt v.h.f. operation to weather conditions.

Some basic principles are here suggested. All forms of radiation are subject to refraction when the waves are moving obliquely into a medium having a different refractive index from that of the medium which they are leaving. Therefore radio waves are bent as they travel through dissimilar air masses. Differences in moisture content, pressure, and temperature determine the refractive index in the lower atmosphere, just as differences in density of ionization determine it in the ionosphere. In addition to the refractive bending, there is a marked effect of reflection when the radio waves meet the fronts of the air masses. Quoting from the *ARRL Handbook*, 1943 edition, page 154: "Radio waves may be reflected from any sharply defined discontinuity, of suitable characteristics and dimensions, in the medium in which they are propagated. Any good conductor meets this requirement provided its dimensions are at least comparable with the wavelength. The surface of the earth also forms such a discontinuity and waves are readily reflected from the earth."

We all have experienced the effects of ground reflections on all our frequencies. Some of us have had remarkable results in v.h.f. propagation when our transmitting location happened to be placed just right on the side of a hill. How many of us know that one of those air-mass fronts we have been talking about is also a "sharply defined discontinuity" capable of producing reflections

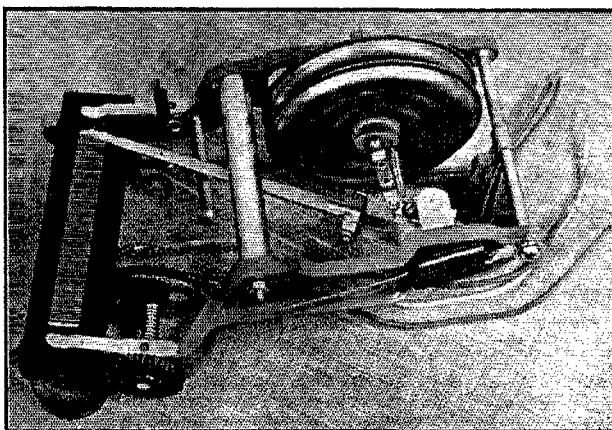

The pressure-switching mechanism in the radiosonde. The aneroid bellows at the right drives the long pointer-contactor across the polished upper surface of the alternate conductors and insulators which make up the laminated switching contactor at the left. When the pointer bears against one of the insulating laminations, the resistance-type thermometer is connected to the modulating circuit. The narrow conductors connect in the resistance-type hygrometer, while the wider conductors connect fixed-reference resistors into the circuit.

of our v.h.f. waves that may startle the uninformed observer? Have we considered that even the updraft on the windward side of a ridge or mountain range or the "thermals" that rise from heated areas of relatively small dimensions may, under certain conditions, be utilized by the v.h.f. operator for "getting out" as they are already used by the glider pilot for "going places"? A number of experimenters have observed propagation effects that cannot be explained satisfactorily unless some such influence is taken into consideration.

Some locations that have appeared practically hopeless for getting out on v.h.f. have been conquered, neither by might nor by power in kilowatts, but by observing the weather. The writer's former location at Gales Ferry, Conn., offers a case in point. The house was on a flat plain, about one mile in diameter and only 50 feet above sea-level, encircled by hills 200 feet or more in height. The soil was of that dry, sandy type which seems to be least conductive and which attenuates the ground wave enormously. We learned there not only to leap the hills to get into Norwich, 8 miles to the north, and New London, 4 miles south, on 56 Mc. with not over 25 watts to a simple vertical antenna, but we battered through a consistent path to W1IJ at North Madison, 30 miles to the west, and to W1KOE at Kingston,

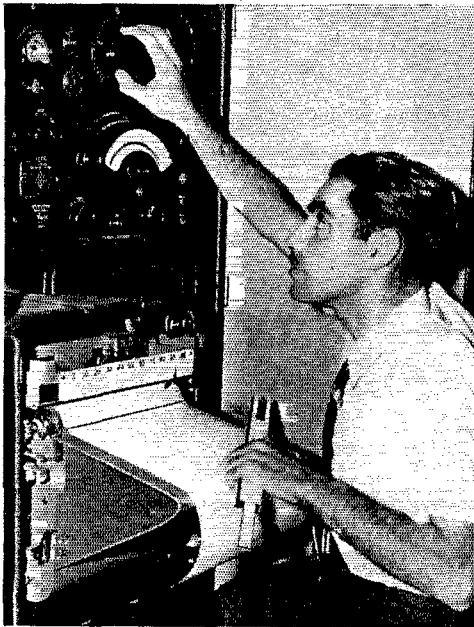

A radiosonde ground station. The operator is seen tuning the superregenerative receiver to the carrier frequency of the balloon transmitter. Audio modulation on this carrier, varied between 20 and 200 cycles per second in accordance with temperature and humidity as registered at the balloon, is measured by the electronic audio-frequency meter shown directly below the receiver. A graphic record of the readings indicated by the a.f. meter is made by the instrument at the bottom. This and the other photographs in this article are reproduced through the courtesy of Dr. C. B. Pear, jr., director of research of the Washington Institute of Technology.

R. I., 30 miles east. This is work of a different nature from the inversion bending which enabled us to make occasional contacts with stations in the Boston and eastern Long Island areas. It is also different, of course, from the long-skip propagation of the sporadic-E type that brought us QSLs from the fourth, fifth and ninth call areas. Getting over the hills that impede the direct-wave or optical-path transmissions to maintain consistent contacts on 56 Mc. or higher frequencies at distances far beyond the horizon is possible, if the amateur is willing to recognize his partnership with the weatherman and learn to read the signs of the sky.

Forecasting Transmitting Conditions

How can we forecast transmitting conditions from our knowledge of weather? What are the signs, and how are they applied to the prediction of conditions for v.h.f. wave propagation? Can any amateur command the data for reliable predictions? In offering an answer to such questions, the writer wishes to remind the reader that aeroanalysis is applicable mainly to the north and south temperate zones, since the tropical belt and the arctic zones are under fairly uniform air most of the time. Moreover, the amateur forecaster must learn to distinguish between large-scale air mass conditions and purely local conditions. With these precautions, together with the further note that the writer's personal experience has been limited to observations in the coastal areas of southern New England, we shall endeavor to show how to make a practical application of aeroanalysis to our amateur radio activities.

First of all, the daily weather maps published (in peacetime) by the U. S. Government Weather Bureau are studied for the location and movement of large air masses, indicated by areas of high and low pressure, precipitation conditions, etc. For obtaining a more immediate check on changes after publication of the map, a systematic listening program on an all-wave receiver provides data from a network of weather broadcasts. This is used for necessary revision of the daily map, at intervals of about six hours.

At this point, a suggestion may be offered for partially supplying the wartime dearth of published weather data. A recent article by Pvt. Perry Ferrell, jr., of the U. S. Army Signal Corps, outlines a system of observation of variation in signal strength from a number of v.h.f. transmitters (f.m. broadcasting stations and transmitters of WERS and other services) plotted on a regional map keyed by means of rectangular coordinates.⁴ At the time of this writing, radio broadcasts of weather information have been resumed on a limited scale.

The amateur locates air masses, notes their rate of movement and direction, and estimates the time when a front will appear over his own location. He tries to determine not only the original character of the oncoming air masses, but

(Continued on page 108)

⁴ Ferrell, "Radio Weather Forecasting," *Radio*, August, 1943, p. 32.

Superregeneration

Its Theory of Operation

BY LOYAL S. FOX,* EX-W2AHH

TO EXPLAIN clearly how superregenerative detection takes place is not a simple matter, but some of its characteristics may be visualized and investigated by using the phenomenon of negative resistance, wherein an increase of plate voltage results in a decrease of plate current.

Noting the circuit of Fig. 1, let the condenser C be charged before closing the switch S . Then close S . When the resistance of the circuit, R , is positive, a decaying wave train occurs, as shown in the sketch of Fig. 1-B. When R is zero the wave train loses no energy from cycle to cycle and persists as a continuous wave. However,

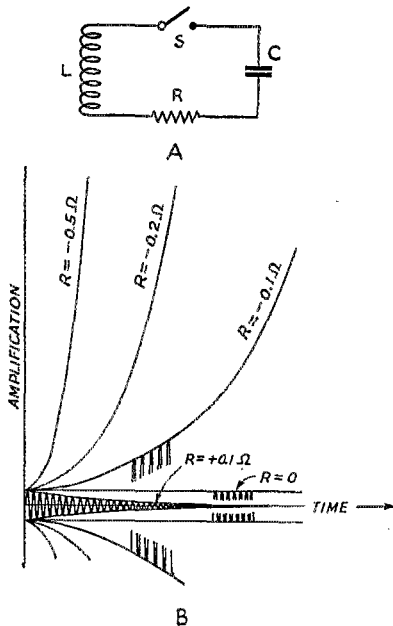

B
Fig. 1

when R is negative the wave train grows exponentially (the inverse of the exponential decay when R is positive) and would build up to infinity if allowed to do so. For example, if R has a negative value of 0.1 ohm, an initial potential of 1 microvolt across C may increase to 20 microvolts in a given length of time; if the value of R is changed to -0.2 ohms, the initial 1 microvolt will increase to 400 microvolts, while a resistance value of -0.5 ohm will result in a growth to 3,375,000 microvolts in the same length of time.

In the case of ordinary regeneration, the circuit is so adjusted that R has a very slight positive value. Hence, the amplification and selec-

Basing his explanation upon the phenomenon of negative resistance, the author conducts a non-mathematical investigation of the action which takes place in a superregenerative detector circuit. The effects of changes in quenching frequency and voltage upon the sensitivity, selectivity and fidelity are discussed. The article concludes with some interesting suggestions toward practical adjustments for best performance.

tivity both are high. On increasing regeneration, R approaches zero and the amplification and selectivity increase enormously, approaching infinity. Any further increase in regeneration will result in a negative value of R , and the circuit will oscillate. With the circuit adjusted so that R is almost but not quite zero, a very high degree of amplification will obtain, but the circuit will be extremely unstable and will tend to break into sustained oscillation. However, let us assume the circuit to be so adjusted. Then let us introduce intermittently a very small voltage at a frequency above audibility, so as to cause R to become periodically slightly more positive. This intermittently introduced voltage is called the *quench frequency* (q.f.). By driving R more positive, it suppresses or "quenches" any tendency of the circuit to oscillate continuously. After introducing the q.f. the regeneration may be increased until R assumes a negative value, except as it is driven positive periodically by the q.f. voltage. Thus, the amplification can be built up to enormous values while R is negative, but any sustained oscillation will be suppressed during the periods when R is positive.

Growth Trains

Superregeneration may be explained as a series of growth trains. Each growth train must be quenched before the next one can be properly "touched off," as illustrated in Fig. 2. Suppose

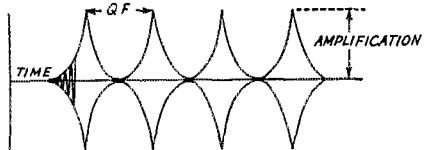

Fig. 2

we have a series of excitations of unlike strengths, instead of all alike. This variation of successive strengths may be regarded as modulation and will

*8839 213th St., Queens Village, N. Y.

lead to a train such as that shown in Fig. 3. The strength to which a growth-train contour builds up is directly proportional to its excitation. Therefore, if it is applied to a linear detector, the a.f. output will be a faithful reproduction of the modulation represented by the variable excitations of Fig. 3.

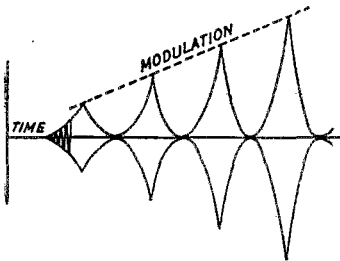

Fig.

One infallible criterion of the degree of amplification obtainable with superregeneration is the characteristic background noise or "rush." It is well to remember that this noise is the result of extreme sensitivity and that it should not be associated exclusively with superregenerative action. This characteristic is found in any form of detection of equal sensitivity. The noise is made up partly of the "shot effect" caused by the irregularity of electron emission, and partly of noises generated by current flowing in the tank circuits or leads. These noise voltages, amplified from perhaps less than a microvolt up to a volt or more, become plainly audible. The circuit requires only a feeble excitation to start a growth train, and such minute excitations in the grid circuit are as susceptible to the tremendous amplification as a signal from an external source. If the amount of superregenerative gain be so great that the tube noise is amplified to the full grid swing, then no room remains on the characteristic for a desired signal. Therefore, the superregenerative amplification should be so adjusted that the circuit noise, when no signal is applied, is as low as possible. Then a weak applied signal which is amplified to suitable audibility will predominate over the circuit noise. In order to accomplish this it may be desirable to decrease the amount of superregenerative amplification and add a.f. gain, so that the signal-to-noise ratio will become more favorable.

Grid-Leak Detection

Grid-leak and condenser detection is almost universally used with superregeneration. With this method, detection is accomplished by rectification in the grid circuit; the resulting voltage drop across the grid leak is amplified in the plate circuit, as it is in any audio amplifier. The grid bias is controlled by the amount of current flowing through the grid leak. With no signal present the grid bias is approximately zero and the tube operates at maximum gain, hence the high amplification of minute circuit noise. When a continuous-wave signal is applied to the grid

the grid current is rectified and a voltage drop appears across the grid leak, which increases the grid bias negatively. The mutual conductance of the tube drops and the plate current decreases correspondingly. The sensitivity of the circuit is reduced, and the circuit noise or "rush" will be reduced automatically by an amount depending on the strength of the incoming carrier. A weak signal, if well modulated, can be heard through the noise even though the latter is only slightly reduced. A strong signal will completely remove all background noise. Insofar as detecting action is concerned, the superregenerative receiver behaves very much like a receiver with automatic volume control.

Unlike ordinary regeneration, superregeneration results in broad tuning and poor selectivity. Most 2½-meter receivers cover a band-width of around 200 kc. at any point on the dial. This is an inherent characteristic of any modulated oscillator, and, of course, the oscillating detector is modulated by the quench frequency. This may be advantageous when it comes to matching the broad carrier of the modulated-oscillator type of transmitter usually employed at the higher frequencies.

It is obvious from Fig. 3 that a faithful transfer of the modulating intelligence to the superregenerative response requires that there be a large number of transferences per a.f. cycle. Thus, for best fidelity, the q.f. should be well above the audio frequencies. When the q.f. is brought down to the high audio range, say around 10,000 to 12,000 cycles, the high audio tones will suffer. However, this effect is not serious in voice transmissions and no intelligibility will be lost with a q.f. as low as 12,500 cycles.

Self-Quenching Oscillator

One method of generating the q.f. is to use a separate q.f. oscillator to modulate the superregenerative detector. Another form makes use of a blocking and relaxing action in the detector itself, so that no extra tube or q.f. circuit is necessary. This self-quenching or relaxation circuit is shown in Fig. 4. Such a circuit functions

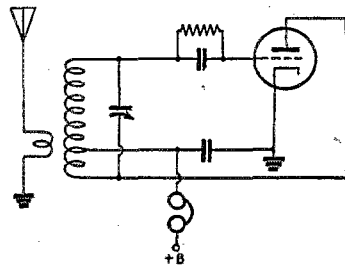

Fig. 4

as an ordinary oscillator in which the value of the grid leak is too high to allow the electrons to leak off at a rate giving a constant value of grid-bias voltage. This causes an increase in the average bias and, because the plate current of the

tube is decreased and the mutual conductance drops, stops the oscillation. With the proper circuit constants this blocking action takes place at a superaudible rate, and thus superregeneration is accomplished.

The frequency of the blocking action (the q.f.) may be readily controlled by the value of the grid leak. The grid leak can be returned to positive "B" as shown, or to the cathode, but with the return to positive "B" there will be less overloading and distortion on strong signals. The by-pass condenser must be large enough to bypass the q.f. surges back to cathode, but not large enough to by-pass audio frequencies to the detriment of intelligibility.

From the data shown in the table below for different values of q.f. at 112 Mc., it may be seen that, by halving the q.f. and holding the negative resistance (q.f. strength) constant, the amplification increases from 4200 to 189,000, while the selectivity remains the same. Also, by halving both the q.f. and negative resistance, the amplification will be doubled, while the band-width will be cut in half. The conclusion is that a low q.f. favors both amplification and selectivity.

Q.F. 25,000 cycles		
Negative resistance	Amplification	Band-width, kc.
0.15	4,200	144
0.2	10,500	192
0.25	30,200	240
0.3	45,000	288
0.35	320,000	340

Q.F. 12,500 cycles		
Negative resistance	Amplification	Band-width, kc.
0.075	8,400	72
0.1	21,000	96
0.125	60,400	120
0.15	189,000	144
0.175	630,000	170

Practical Suggestions

Now for some suggestions for the practical use of these observations. If the value of the grid-leak resistance is low enough, no q.f. will be generated and the detector will become an ordinary r.f. oscillator. Tuning across a carrier will give the customary beat note. If the value of grid-leak resistance is increased to the point where q.f. oscillation begins, the carrier response will correspond to the curve of Fig. 5. The side responses seem to be caused by heterodynes between r.f. and the q.f. oscillations. If we continue to increase the value of the grid-leak resistance, the q.f. is reduced. When a sufficiently high value of resistance has been reached, the q.f. will be brought down into audio frequencies. The best point for both sensitivity and selectivity is just above the audio range, where either a weak, high-pitched whistle or hiss may be heard. Quality will be improved if this slight whistle or hiss is removed with a high-pass audio filter. Such a filter will also take out much of the background noise.

At least with the higher quench frequencies, it is true that higher plate voltages will give louder signals. This is because of the dual function of the

grid leak-condenser detector, detection and audio amplification taking place in the same tube. Increasing the plate voltage increases the audio amplification, but only at the expense of sensitivity, selectivity and noise reduction. So,

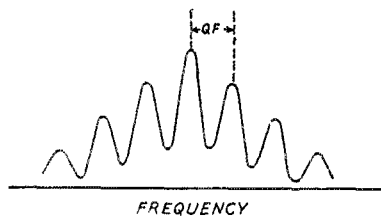

Fig. 5

again, it is better to sacrifice some audio gain in the superregenerative detector and compensate by adding another stage of audio, if necessary. Another argument against high-voltage operation is that superregenerative receivers are notorious radiators. Since the detector oscillates intermittently, the radiated signal is fully modulated by the q.f. voltage. With high plate voltage, this radiation causes serious interference at a distance and over a considerable frequency range. When the plate voltage is reduced so that the detector is just barely oscillating, this range of interference is materially reduced. Thus, all the advantages are with low detector plate voltages — just high enough to assure stable operation.

Acknowledgment

The writer wishes to acknowledge with thanks the kindness of the RCA Laboratories Industry Service Division in permitting the use of material from the report by David Grimes and Wm. S. Barden, "Superregeneration and its Application to High Frequency Reception," which forms the basis of this article.

Strays

If you thought that lightning always travels downward, you will have to revise your thoughts. A lightning expert tells us that lightning bounces upward from the ground 200 times as fast as it travels downward from the cloud. The brilliant part of the stroke travels upward 20,000 miles per second, while the downward stroke travels at only 100 miles per second and its light is so feeble that it often does not affect a photographic film. — *Ohmite News*.

A recent letter from Lt. Linden W. Cochran, ex-W6ARG, reveals that he is in the Deshon General Hospital, Butler, Pa., recovering from flak wounds received in November, 1942, as a navigator in the AAF. He says he is passing the time studying "A Course in Radio Fundamentals" and, to quote him: "You should have heard the head nurse scream when she saw me soldering in bed and wiping the iron on the sheets!"

Radio in the Civil Air Patrol

The Hams Do It Again!

BY TECH. SGT. KARL H. STELLO,* C.A.P., W3IVZ

THE Civil Air Patrol has come a long way since Pearl Harbor, and radio amateurs have played a big part in putting it in the spotlight. The reason is simple — without radio, planes just don't fly for long. When radio contact with a plane on coastal patrol duty fails, the plane returns to the base and is grounded until the radio equipment is restored to operation.

Radio amateurs and small airplane owners had one thing in common when the CAP was started nearly two years ago — both were engaged in a hobby which was cut off by the declaration of war. Together they plunged right in with their planes, time and equipment, regardless of personal sacrifice, to make the CAP a going organization. They saw the job that had to be done on the Axis submarines off our shores, if we were to start winning this war.

One CAP Coastal Patrol base started with a tent for a radio shack. The only test equipment was that which the radio mechanics brought with them — a multimeter, a pair of long-nose pliers, diagonal cutters and a soldering iron. The main transmitter was a converted ham rig. Since no crystal was available for the particular frequency desired, it was operated with an electron-coupled oscillator which did as good a job as a crystal could have done.

Nearly every individually owned plane at a CAP base has a different type of receiver and transmitter, and for every model there are as many different ailments which develop in the course of the thousands of hours piled up. The equipment in use was made for intermittent service, and that salt air over the Atlantic and the Gulf doesn't do radio gear any good. Yet the

This personal-experience narrative by a CAP radio operator-mechanic on active duty tells the story of the men behind the pilots of the Coastal Patrol, who fly far out over the ocean in small landplanes warded by makeshift radio gear that works "only by the grace of God and Smitty." Had it not been for amateur radio, the Axis submarines that have been exterminated through the vigilance of the CAP might still be afloat out there, sinking our merchant ships.

Coastal Patrol provides continuous radio service under all kinds of conditions.

As the commander of one base put it: "The radioman isn't pretty — not unless you are miles out over the water in a little landplane and the motor starts missing, and at the same time the weather begins closing in." Then the radioman becomes very pretty indeed, as you prepare to call MAYDAY to give your location to the rescue planes or boats."

Hams Keep 'Em Flying

Civil Air Patrol radio stations, while licensed by FCC, are under direct control of the U. S. Army Air Forces. The Army takes the responsibility for their operation, and the radio amateurs who run the stations don't let the Army down.

Many of the hams on active duty at CAP bases had never worked with aircraft radio before, and they have found that it presents very different problems. Along with the interference from the motor, there is the vibration of the plane to be taken into account. If you can imagine riding in a Model T Ford at 60 miles per hour, then you know how some of these small planes vibrate in the air. Another example is the problem of shielded cable, which must be bonded to a good ground and installed so that it will not interfere with the controls of the plane — of which there are many. Both the receiver and transmitter must be located so they can be shock-mounted on special mountings, but the controls must also be readily accessible to the pilot.

Aircraft radio equipment is hard to get, even with priorities. Some of the receivers in CAP planes are 14 or 15 years old, and a "new" receiver is one built within the past five years. The transmitters may be composite, but they must be kept working as long as possible because they cannot readily be replaced. Thus the radio mechanic does not have an easy job by any means, with no diagrams for much of the equipment and

*Coastal Patrol Base No. 10, Beaumont, Texas.



Operating position in the radio room at Coastal Patrol Base No. 10. The receiver is an NC-200.

no manufacturers' data booklets. One of the most useful books in the radio shack at a remote CAP base was a copy of the ARRL *Handbook*. I found a portable multimeter to be another necessity, and also a small wavemeter.

The transmitter on a plane may develop trouble just before taking off on a flight. Then the radio mechanic must jump up from his lunch or whatever he may be doing and try to locate the trouble while the crew stands around suggesting this and that.

Of course, if he is unable to get the transmitter going within a few minutes, a stand-by plane is sent out — which is all right until the operations officer runs out of stand-by planes. Then the radioman must forget his blood pressure while he rushes to get the equipment going again. Possibly he does not have the needed part on the shelf in the stockroom, and so he must run to the nearest city or telegraph a radio parts wholesaler for a replacement. Then the telephone rings and the airdrome officer reports that the loudspeaker system isn't working. In the middle of all this he finds that the main transmitter is off the air.

But it's all in a day's work for the CAP Coastal Patrol radio mechanic. Some days may be clear sailing, with nothing more than an installation job in an old plane that never had a transmitter in it. All you have to worry about then is mounting the antenna reel so it won't short out against the frame of the plane and yet will be strong enough to carry the load. You see, the best antenna for transmitting is the trailing type, which is reeled out through an insulating tube in the top or bottom of the plane and has a windsock attached to the end of the wire. The antenna should be 90 feet long for 3105 kc., and extreme caution must be exercised to avoid getting this antenna grounded on the metal parts of the plane. Another of the radio mechanic's headaches is the continual replacement of the windsocks. This results when the pilot forgets to reel in the antenna before landing and tears off the sock. This was partly solved by including in the landing instructions: "Antenna in — check windsock — clear to land at your own discretion."

The best receiving antenna for the aircraft beacon band was found to be a vertical whip antenna. With it, communication is maintained over distances of more than 200 miles using standard aircraft receivers.

Flight Checks

The radio mechanic at a CAP base sometimes has to make flight checks to determine how many turns the antenna should be let out and to tune the transmitter for best output in the air, since there is a great difference in the loading of an air-



W3IVZ at the controls of a Sikorsky amphibian at the CAP Coastal Patrol base in Beaumont, Texas.

craft transmitter in the air and on the ground. It is when he finds himself "over the drink" in a putt-putt plane that seems more like a kite with an outboard motor than anything else that the radioman realizes the comfort that is brought to the crew of the plane. Especially if previously he has not done much flying, he will be very much sobered by this experience and thereafter will go about his work with more care and zeal.

Equally sobering is the realization that, despite the best radio service that can be provided, in the 20,000,000 miles the Coastal Patrol has flown over water, over one hundred planes have been lost and some thirty men have given their lives on coastal patrol duty.

Some of the familiar airport terms soon learned by CAP operators are "Roger" for "received," "Wilco" for "will comply," and "Prep Roger" for "position report." Then there is "A short count," meaning 1 to 5, "A long count," meaning 1 to 10, and "Out" for end of transmission.

The microphones used by the CAP are the standard aircraft "push-to-talk" carbon type, and the best headphones have been found to be the featherweight type with rubber ear cushions.

The principal fault most pilots and observers display in operating their aircraft transmitters is that of shouting too loud into the microphone, trying to talk over the motor noise. The fact is that, if they talk into the mike in a normal voice with their lips touching, they can be heard and the microphone will not pick up the motor noise. But it is hard to realize this when you're in a plane going 100 miles per hour and you can't make yourself understood by your co-pilot above the noise of the motor unless you cup your hands and shout. However, most pilots agree they would rather hear the motor noise than not —

THE RADIOMAN ISN'T
PRETTY-NOT UNLESS YOU'RE
FAR OVER WATER AND
THE MOTOR STARTS MISSING

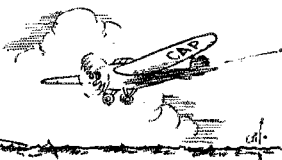

especially when not being able to hear it means that the motor has cut out over water!

It isn't only motor noise that causes trouble, however. The atmospheric noise level at bases near the Mexican border is particularly high, sometimes running 15 db. above S9, yet when men's lives are at stake the radioman has to be on his toes.

One base commander said that his communications department worked "by the grace of God and Smitty" — Smitty being Master Sergeant Smith, an amateur from Oregon who partly

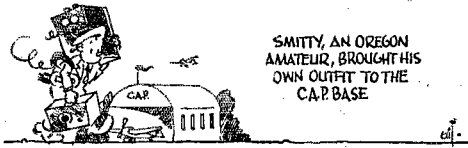

SMITTY, AN OREGON AMATEUR, BROUGHT HIS OWN OUTFIT TO THE CAP BASE.

licked the high noise level with a four-inch spaced feeder line to the receiving antenna which was put in a favorable spot found by the cut and try method of using a portable communications receiver at various places around the base. Smitty brought his own ham rig with him, and I have heard it 400 miles away on 220 kc.

You're as likely to find a W3 or a W7 ham as a W5 on duty at a Texas base. One radio mechanic from the East, assigned to active duty "somewhere in Texas," loaded down his car with all of his receivers, spare parts and tubes, and took them with him, and they really have come in handy in these days when even transportation of high priority parts takes a longer time, especially to remote parts of the country.

It is a job in itself to keep cool at a Texas base in the summer. In the first place you don't wear a shirt while working, but you have to keep one handy to put on when going into the canteen for a drink of water. In the second place you take salt tablets twice a day to make up for the salt lost in perspiration, and in the third place you just can't seem to get enough water. Unless you have a room facing south toward the Gulf you can't get very much sleep because of the heat and high humidity and even if you do the mosquitoes are very bad at times. But we know that all of this is not nearly so bad as the front lines of the battlefield.

Radiomen at Civil Air Patrol bases receive military drill and pass in review on inspections twice a month. Even pilots sometimes have to do a little guard duty, since a prisoner of war escaping from a nearby camp might try to steal an airplane and make his getaway into Mexico. However, we have every night free after the last flight is in at which time it is about dark and we are ready to go to bed.

Civil Air Patrol members on active duty work without pay other than the *per diem* expenses paid by the War Department. They provide their own living quarters, in most cases, and usually eat at a canteen run on a non-profit basis.

Women help out a lot on Civil Air Patrol duty as radio operators and position board plotters,

and of course as clerks, but they are not allowed to fly on coastal patrol duty.

Men in the CAP

The men on CAP active duty are, for the most part, those who are too old for combat flying or who have some slight physical defect that keeps them from foreign service, although in many cases they would give their right arms to be at the front. However, they are doing a big job and a necessary job right here on the home front — in the Coastal Patrol, in carrying on the courier service which rushes small parts and big men to important war centers, in the Fire Patrol which aids the U. S. Forest Service in protecting lumber supplies for war use, in the Southern Liaison Patrol on the Mexican Border, as well as in the local squadrons giving military drill to prospective Army Air Corps cadets and teaching classes on aircraft subjects.

They are all volunteers — in the service because they want to fly and because they want to help win the war, without regard for the danger in the job they are doing. The morale and the spirit of good fellowship around a CAP base correspondingly is high.

They have earned the right to wear the "U. S." on their uniforms — which, incidentally, are regulation Army uniforms with red shoulder loops and distinctive insignia. A CAP member in uniform, if captured by the enemy, is supposed to be treated as a prisoner of war, the same as any member of the regular armed forces.

The adventures of "Smiling Jack" in the comic sections of the daily newspapers portray the lives and times of fictional CAP members. Once,

IF THE HEAT AND HUMIDITY DON'T GET YOU THE MOSQUITOES MAY



it will be recalled, "Smiling Jack" was captured by an enemy submarine, but made his escape as comic-strip heroes always do. Zack Mosely, the writer of this strip, until recently was himself a CAP pilot on active duty at a Gulf Coast base. At present he is a member of the CAP headquarters staff.

When the war is won, the amateur radio fraternity can point with pride to those hams who made a success of their radio work in the Civil Air Patrol radio as they have so ably done with radio in the other services, and who, although they had to stay at home, still carried on voluntarily in the service of their country in Civil Air Patrol active duty under the direction of the Army Air Forces and did a really commendable job considering the circumstances under which they started. It is unlikely that any medals will be awarded for those long, hard hours, but the boys on the job will be able to pat each other on the back and say, "We did it again."

Frequency Measurement in the WERS

A Simplified Stable Oscillator-Monitor for the 112-Mc. Band

BY PHILIP BLISS,* WIDXT

This 112-Mc. oscillator-monitor is the answer to a perambulating district radio aide's prayer. It supplies a stable source of calibrated signal frequencies for checking WERS transmitter and receiver adjustments. It is a handy monitoring receiver. It contains its own primary source of power. And it is really portable.

IN THE course of setting up equipment for the local WERS net, the problem of frequency measurement involved the usual difficulties. Lecher wires proved to be rather unsatisfactory because of body capacity and the difficulty of making a precise measurement of a rather long line. The method proposed by Dr. Woodward¹ works beautifully in his set-up, but was not so good here because of the absence of a good receiver which could be calibrated. Moreover, we wanted some sort of portable standard which would be ready for use anywhere at any time. A Hallicrafter HT-7 crystal oscillator was available, but it would not deliver harmonic output in the 112-Mc. band of sufficient strength to be received on our TR-4s.

At this point W1LH came to our rescue with a suggestion for a calibrated oscillator-monitor which has worked very satisfactorily for us in putting stations of our WERS net on frequency. W1BWL, radio aide for Plainville, also is using a unit copied from ours, with good results.

* 334 Stanley Street, New Britain, Conn.

¹ Woodward, "A Simple Method of Frequency Measurement for WERS," *QST*, Sept., 1942.

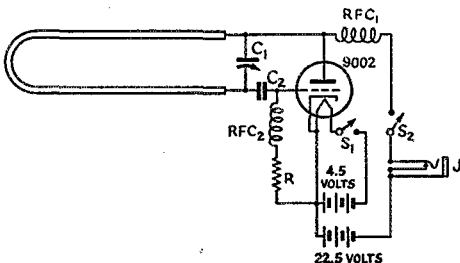
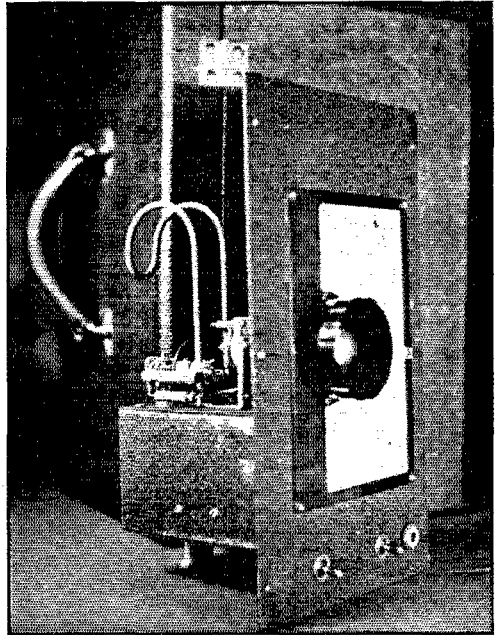

Fig. 1—Circuit diagram of the stable WERS oscillator-monitor. The linear tank inductance is curved around at right angles to the plane of the diagram, on a 2½-inch radius, as shown in the photographs.

- C₁—Cardwell "Trim-air" cut down to one stator and two rotor plates, double-spaced.
- C₂—50- μ fd. mica.
- R—10,000 ohms, ½ watt.
- RFC₁, RFC₂—v. h. f. choke (Ohmite Z-1).
- S₁, S₂—S. p. s. t. toggle.
- J₁—Closed-circuit jack.



A general view of the WERS frequency meter-monitor, showing the panel layout and the carrying case.

Construction

The circuit, shown in Fig. 1, is very simple. The RCA-9002 tube is connected as an ultraudion oscillator with a folded linear tank, tuned with a small variable condenser. We used a Cardwell "Trim-Air" midjet variable stripped to one stator and two rotor plates, with double spacing. W1BWL uses a Cardwell type ZS-4-SS, which is somewhat more rugged, gives greater bandsread, and requires no modification. A short piece of polystyrene rod is tapped and used as an insulating shaft. It must be cemented to the shaft to prevent slipping. In forming the tank inductance, a 16-inch length of 3/16-inch outside-diameter copper tubing was bent at the middle to give one-inch spacing between centers. The tubing was then bent again to make a 2½-inch semicircle in another plane. This is readily seen in the side-view photograph of the unit.

This arrangement gives us a range of 110 to 130 Mc. with the tuning condenser specified. More bandsread could be obtained either by closer spacing of the tank conductors, by using a smaller tuning condenser, or by changing both. In any case, the length of the linear tank will have to be readjusted to hit the band.

The chassis is a U-shaped piece of sheet steel $1/16 \times 1 3/4 \times 5 1/2$ inches, bent and cut as shown in Fig. 2. The variable condenser is mounted on a piece of polystyrene fastened to one upright of the U, while the 9002 socket is fastened to the other upright. This chassis is mounted on one cover of a $5 \times 4 \times 3$ -inch steel box.

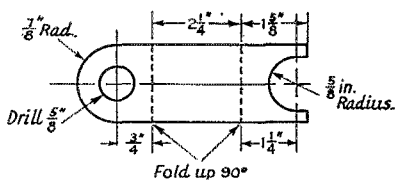

Fig. 2—Layout drawing used in forming the U-shaped chassis bracket on which the variable condenser and tube socket of the oscillator-monitor are mounted.

The linear tank circuit is mounted on a pair of polystyrene stand-off insulators by tapping the ends of the copper tubing to receive the 6-32 screws. The insulators are mounted through the chassis and the cover of the small box, and the plate choke is connected to the end of one screw inside the box. Separate plate and filament switches are provided for stand-by operation.

The entire assembly is mounted in a wooden carrying case, as shown in the general view of the assembled unit. The National ACN dial was used because it was available, although it requires a slightly larger panel and carrying case than might otherwise be used.

Shielding is a problem, with copper and aluminum as critical as they are. We tried coating

the interior of the case with aluminum paint, but it did not do good. However, a metallized aluminum coating might be nearly as effective as sheet aluminum.

The photographs which show top and side views of the instrument will serve to indicate clearly the wiring and placement of parts, as well as the mechanical details of the folded linear tank and the chassis bracket support for the variable condenser and tube socket. The top view shows a four-prong power plug, which later was found to be undesirable and has been eliminated. Wire leads are brought directly to the terminal contacts of the batteries, which are carried in a separate compartment at the end of the carrying case. Space is also provided in the case for a pair of headphones.

The convenience of the carrying case results not alone from the protection it affords the instrument and from the preservation of its adjustments, but also in making the meter truly portable. A busy district radio aide will especially appreciate this when called upon for inspection tours covering a dozen or more towns and many installations. In duplicating the instrument, the design may well be improved and yet more compactness achieved by the use of a smaller precision dial.

The instrument may be calibrated by the method outlined by Dr. Woodward.¹ Once set, the oscillator appears to be as steady as a rock. Even when the filament voltage is reduced from 6 to $4 1/2$ volts, or the plate voltage changed from $22 1/2$ to 45, no appreciable frequency shift is noted. We have observed that in use the unit functions better as a receiver with the lower plate voltage.

Measuring Transmitter Frequency

In checking the frequency of a transmitter, the unit is used as a calibrated monitor. The headphones are plugged in and the monitor tuned to zero beat with transmitter signal. The frequency is then determined by reference to the monitor's calibration chart. Care must be taken not to attempt to use the monitor too close to the transmitter or its antenna. If the monitor is overloaded, the 9002 will go out of oscillation and only the modulation will be heard.

Adjustment of a transmitter frequency to a predetermined spot on the band is achieved by simply using the same procedure in reverse. The monitor dial then is set to the desired frequency and the transmitter is tuned to zero beat with the monitor.

Checking Receivers

When the monitor is used as a calibrated signal source for the calibration of a receiver the 'phones are not required in the monitor circuit, unless it is assumed that the removal of their d.c. resistance from the 9002 plate circuit would appreciably affect the oscillator's frequency and thus detract from the accuracy of the calibration of the monitor dial. When a superregenerative receiver is tuned to the oscillator frequency, the

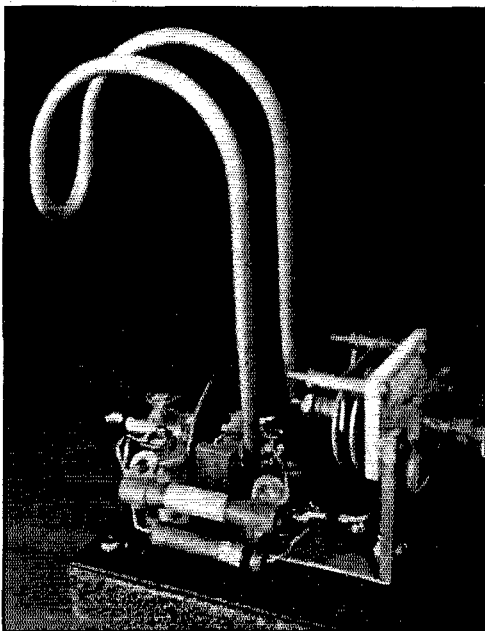

A side view of the WERS monitor-frequency meter.

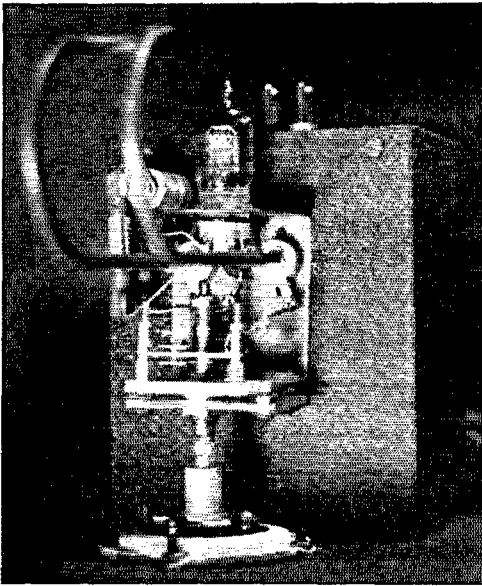

A top view of the stable oscillator-monitor, showing the method of mounting the linear tank circuit.

background hiss will be deadened over a region covering about five points on the receiver dial. The center point of this silent range corresponds to the frequency indicated on the monitor dial. That this assumption is correct has been checked by tuning the transmitter to the dead spot and checking its frequency with the frequency meter.

If the receiver is not superregenerating, a series of "birdies" will be heard which might be used for calibration. However, we have found it difficult, if not quite impossible, to determine which of these is the fundamental beat note. Even if it were possible to avoid the difficulty of proper identification, this method would seem to be impracticable because any change of the regeneration control usually produces a change in the frequency of receiver tuning. Points calibrated with the receiver out of superregeneration would then be useless when the receiver was adjusted for normal reception. If the checks are made with the frequency meter and receiver well separated, careful determination of the center of the "dead spot," as described above, should result in calibration points accurate to within the tolerances set forth in WERS regulations.

If, in constructing this oscillator-monitor, it should be necessary to substitute some other type of tube for the 9002, some changes necessarily must be made in the circuit constants as well as appropriate alterations in the mechanical layout. Use of a RCA-955 acorn would, of course, necessitate little more than a change of socket and leads. Other tubes which might serve are the 1S4 and the 1R5, triode-connected. The use of larger tubes would be inadvisable, because of the likelihood of increased thermal drift resulting from the higher heater power and larger elements.

The Secretary of ARRL would appreciate any available information on the whereabouts of Dr. Curt Lamm.

A newly-developed process of melting tin electrolytically deposited on steel sheet utilizes high-frequency heating at 200 kc. Already at work in one steel plant, the electronic equipment will melt 12 square feet of tin in 0.7 second. Heating equipment is being designed to operate at speeds up to 1000 feet per minute. — *Ohmite News*.

A new movie camera, named the Fastax, has been developed by Bell Telephone Laboratories. Living up to its name, it can take pictures at a top speed of 8000 frames a second, representing an exposure period of 33 millionths of a second. It can lay bare the innermost secrets of moving parts and can even "slow down" electricity itself. The Fastax is adapted to either black and white or color photography, and has a film travel speed of from less than three to almost seventy miles an hour. It employs continuous film drive, and exposure of successive frames is accomplished by a revolving prism acting as an optical compensator.

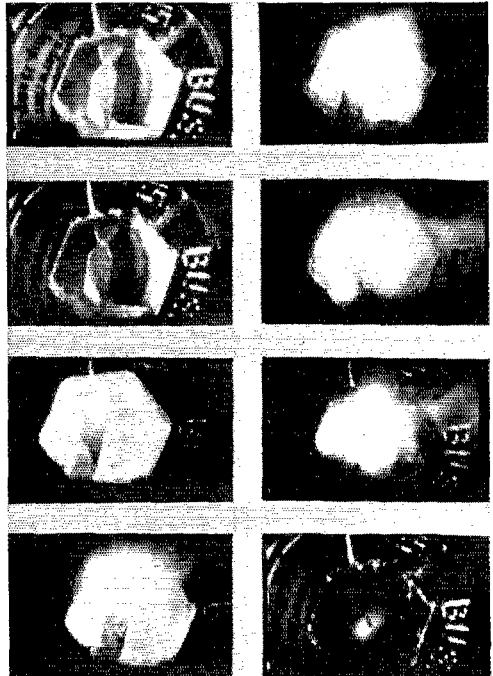

These pictures, taken at 4000 frames per second with the Fastax movie camera, show what happens when an ordinary house-type line fuse blows out. The high-speed photography slows down the action until the melting of the fuse link looks like the melting of tallow.

IN THE SERVICES

Now that fall definitely is in the air, the ITS department is battering down the hatches for the long New England winter ahead. We're anticipating a lot of work in response to our many and varied pleas in the past few issues for you fellows to send in your War Service Records. The returns thus far have not been too encouraging, but we're still very hopeful that sooner or later all you busy hams will be able to snatch a spare minute and mail us your info. You fellows who are having QST sent to your military address can help by passing around the glad word that Hq. is compiling a roster of "hams in service."

Letters from parents are always welcome. If you have a son in the armed forces of whom you are, naturally, proud — tell us about him. Then, when his name appears in QST, there'll be another clipping for the scrapbook.

And while we're on the subject — how about you Canadians?

That friendly VE signature is getting mighty scarce among our correspondence. Canada's record in this war is one of which every Canadian may be justifiably proud, and we'd like your representation in the roster to maintain that fine standard. Let's hit an all-time VE high next issue!

ARMY—SIGNAL CORPS

A LITTLE private overseas One day took time out, if you please,
To say, "We're really on the win —

And now the next stop is Berlin!"
(Pardon us, gang — it's the balmy autumn weather!)

- 1JEC, Leland, Pvt., Camp Crowder, Mo.
- 1JSE, Moore, T/5, foreign duty.
- 1JUC, Linden, Cpl., Ocean Grove, N. J.
- 1KKI, Fox, 2nd Lt., Ft. Monmouth, N. J.
- 1MCL, Handfield, Pfc., Camp Murphy, Fla.
- 1NCT, Kancher, Pfc., Ft. Monmouth, N. J.
- 2ATI, Knakal, Pvt., Ft. Monmouth, N. J.
- 2DMO, Borneman, Lt., Camp Murphy, Fla.
- 2EDI, Schiffin, C. J., T/5, Ft. Monmouth, N. J.
- 2EDI, Schiffin, P. G., W/O, foreign duty.
- 2GMF, Henry, Cpl., Oscoda, Mich.
- 2ICW, Schickler, Pvt., Ft. Monmouth, N. J.
- 2JPG, Slotanick, Pvt., Camp Crowder, Mo.

- 2KFB, Hirsch, Pvt., Camp Crowder, Mo.
- 2KTE, Shedd, Pvt., Ft. Monmouth, N. J.
- 2LMO, Reiss, Pfc., Ft. Monmouth, N. J.
- 2LOT, Smith, Cpl., Camp Crowder, Mo.
- 2MBY, Fitch, Pvt., Camp Crowder, Mo.
- 2NIB, Wittling, Capt., Long Branch, N. J.
- 2NIB, Gillard, Pfc., Oscoda, Mich.
- 3BKU, Cooper, 2nd Lt., Ft. Monmouth, N. J.
- 3EVP, Barnhart, Lt., foreign duty.
- 3JLP, Sparks, 2nd Lt., Ft. Monmouth, N. J.
- 3JFK, Showier, T/5, Camp Murphy, Fla.
- 4BJX, Clark, Lt., foreign duty.
- 4COD, Swencer, Major, Camp Pickett, Va.
- 4GHE, Davidson, M/Sgt., Ft. Sam Houston, Texas.

- 4GOF, Copeland, Pvt., Mobile, Ala.
- 4IAA, Payne, T/5, Camp Murphy, Fla.
- 4IO, Morris, Lt., Camp Murphy, Fla.
- 5FZQ, Manning, Pvt., Warrenton, Va.
- 5HIR, Fox, Pvt., Camp Crowder, Mo.
- 5INT, Dickerson, Cpl., Camp Crowder, Mo.
- 6CTP, Atherton, Cpl., foreign duty.
- 6BZV, Petersen, Sgt., foreign duty.
- 6ICI, Brown, Cpl., Davis, Calif.
- 6QGZ, Cohen, Pvt., foreign duty.
- 7BEB, Gilbertson, CWO, foreign duty.
- ex-7EHD, Haas, S/Sgt., foreign duty.
- 7FFA, Isaksen, M/Sgt., foreign duty.
- 7HYF, Dolan, Sgt., foreign duty.
- 7ILL, Schneider, Sgt., foreign duty.
- 7INR, Boyce, Cpl., foreign duty.
- 7IOX, Morton, Cpl., Davis, Calif.
- 8BOT, Madison, Pfc., foreign duty.
- 8DBP, Carmack, Cpl., Drew Field, Fla.
- ex-8DSX, Bawden, 2nd Lt., Camp Hood, Texas.

- 8FIF, Hosay, Cpl., Camp Crowder, Mo.
- 8KXO, Lewandowsky, Lt., foreign duty.
- 8MZV, Fisher, Lt., Detroit, Mich.
- 8NBL, Zindarsic, Cpl., foreign duty.
- 8NQJ, Dick, T/Sgt., Drew Field, Fla.
- 8OHH, Fuelling, T/5, foreign duty.
- 8OPG, Roof, Lt., Brookley Field, Ala.
- 8PQI, Nyman, Cpl., New Orleans, La.
- 8PSN, Kopper, Cpl., foreign duty.
- 8RVN, Christopher, Cpl., Robins Field, Ga.
- 8TDR, Paragin, Pvt., Flushing, N. Y.
- 8WGL, Pankiewicz, Cpl., Camp Atterbury, Ind.

- 9ABA, Ross, 2nd Lt., Camp Forrest, Tenn.
- 9ADB, Gordon, T/Sgt., Oscoda, Mich.
- 9DRN, Swanson, Pfc., Camp Howze, Texas.
- 9EBK, Beckman, Sgt., foreign duty.
- 9KMA, Hirstand, M/Sgt., foreign duty.
- 9KWR, Roeyes, Cpl., foreign duty.
- 9LEB, Madland, T/3, foreign duty.
- 9LWC, Robertson, M/Sgt., foreign duty.
- 9NVM, Lemen, T/5, Ft. Monmouth, N. J.
- 9OOK, Dybrig, T/3, foreign duty.
- 9PAB, Ayers, Pfc., Camp Crowder, Mo.
- 9PZF, Burch, T/Sgt., Ft. Monmouth, N. J.
- 9RBP, Kaiser, 2nd Lt., Detroit, Mich.
- 9SMP, Weibel, Pvt., New River, N. C.
- 9SXR, Zile, Cpl., Camp Crowder, Mo.
- 9UIC, Dickson, Lt., foreign duty.
- 9UNI, Young, Pvt., Cannelton, Ind.
- 9UXR, Lawrence, Cpl., Camp Crowder, Mo.
- 9YNF, Russell, Lt., Elberon, N. J.

Operator's license only:

- Arnold, Pfc., Davis, Calif.
- Barrere, T/5, San Francisco, Calif.
- Carson, S/Sgt., Brooklyn, N. Y.
- Clark, Pvt., Oscoda, Mich.
- Cole, Pvt., Sioux Falls, S. D.
- Cook, Pvt., Fort McPherson, Ga.
- Erskine, T/4, Camp Hale, Colo.
- Freeman, Cpl., foreign duty.
- Gorlinsky, Lt., Ft. Monmouth, N. J.
- Hantf, Pvt., Camp Crowder, Mo.
- Lake, T/Sgt., foreign duty.
- Murphy, T/Sgt., foreign duty.
- Payonk, S/Sgt., Presque Isle, Maine.
- Ransier, Capt., Camp Crowder, Mo.
- Rathbun, Pfc., Camp Murphy, Fla.
- Scheff, T/Sgt., Fort Jay, N. Y.
- Van Dusen, Cpl., Alexandria, Va.



Some of the personnel of the 43rd Signal Company, shown here with a Japanese radio transmitter captured after the fall of Munda Field, New Georgia, in August. The set is now seeing service with our troops. Front row, l. to r. — Lt. Baker, W1KJQ, and 2nd Lt. Davis, W1BCZ. Back row, l. to r. — S/Sgt. Grzesik, W1HXJ; T/Sgt. Coombs, W1HSS; and S/Sgt. Lopez, W6AAK. (Official U.S. Army Signal Corps Photo.)

NAVY—GENERAL

A UNIQUE AWSR, firmly pasted on a post card, turned up in the ITS department the other day bearing the following instructions: "To remove the form, just soak in hot water. It's stuck on with shaving cream, as no envelope or glue is available."

We were also invited to identify the brand!

LEEP, Grace, RM1c, Block Island, R. I.
 ex-1EGT, Sprague, Ens., Miami, Fla.
 11FI, Trask, S2c, address unknown.
 1MCE, Erlandson, Lt. (jg), Washington, D. C.
 1MMC, Eastman, A/S, Medford, Mass.
 1MWB, Neary, ARM3c, Jacksonville, Fla.
 1NQO, Hanson, CCM, Williamsburg, Va.
 1NSQ, Margi, A/S, address unknown.
 2ADQ, Shannon, Lt., Jacksonville, Fla.
 2KJD, Dorschug, Ens., Washington, D. C.
 2KMQ, Houskeeper, Lt., New York, N. Y.
 2MMT, Adriance, A/S, Newport, R. I.
 3FDZ, Dingley, Cmdr., Washington, D. C.
 3HDL, Popelarski, RM2c, Washington, D. C.
 3HOC, MacClay, address unknown.
 3IVL, Wenner, Sic, Pt. Hueneme, Calif.
 3JSF, Duffin, Hoboken, N. J.
 3JXX, Simon, A/S, New Haven, Conn.
 3UH, Roberts, W/O, Chicago, Ill.
 4FKU, Vann, Lt. (jg), Washington, D. C.
 4GPD, Payton, A/S, Atlanta, Ga.
 4HCP, Thornley, RM2c, College Sta., Texas.
 4HWK, Nassiff, ARM3c, Lakelhurst, N. J.
 5CEN, Patterson, Ens., Washington, D. C.
 5JJC, Bartel, A/S, Norman, Okla.
 5IKB, Wilson, A/S, Ruston, La.
 ex-6AKA, Kimball, Lt. (jg), Mare Island, Calif.

6CJY, Vogelman, Lt., Mare Island, Calif.
 6DR, Swartz, Lt., Chicago, Ill.
 6JNV, Long, ARM1c, San Diego, Calif.
 ex-6JX, Deming, Lt. Cmdr., foreign duty.
 6MLZ, Meyers, Lt. (jg), Vallejo, Calif.
 6QWH, Ruth, Ens., Phoenix, Ariz.
 6QZC, Morris, Sic, College Sta., Texas.
 6RLR, Boquist, A/S, Los Angeles, Calif.
 6RXX, Airola, A/S, Berkeley, Calif.
 6SSH, Darling, A/S, Berkeley, Calif.
 7ESK, Drake, Lt., Washington, D. C.
 7FLX, Gish, CRM, Seattle, Wash.
 7GBY, Meyer, Spic(R), Sheridan, Wyo.
 7GEB, Watson, A/S, Farragut, Idaho.
 ex-7QP, Wallace, Etc Vallejo, Calif.
 8UKB, Ostrow, address unknown.
 8UOC, Miller, ARM2c, Jacksonville, Fla.
 8VZZ, Howell, Ens., address unknown.
 ex-9ABR, Marshall, W/O, address unknown.
 9AKQ, DeBacker, MM2c, Camp Peary, Va.
 ex-9CK, Lowe, Lt. Cmdr., San Bruno, Calif.
 9DXN, Griswold, RM3c, Great Lakes, Ill.
 9LXD, Luensman, SP(s)1c, Chicago, Ill.
 9NWT, Ward, A/S, Chicago, Ill.
 9OPH, Wright, Sic, Stillwater, Okla.
 9PRU, Rutten, Lt., Farragut, Idaho.
 9ZVJ, Tevin, A/C, Terre Haute, Ind.

Operator's license only:

Barnes, RM3c, Staten Island, N. Y.
 Beatty, CPO, Camp Peary, Va.
 Bent, Ens., Chapel-Hill, N. C.
 Crawford, S2c, Lafayette, Ind.
 Edson, RM3c, Evanston, Ill.
 Mullen, Cmdr., Washington, D. C.
 Standish, A/S, Kansas City, Mo.
 Worsham, A/S, Atlanta, Ga.

ARMY—AIR FORCES

ALTHOUGH our Air Forces listing last month consisted mainly of hams with "address unknown," we'd like to add that since that list was published we've been doing some research work, and now we find that many of those so listed actually are on

These two shipmates, RT1c Wafford, W4HVA (right) and RT1c Antrim, W3HLZ (below), joined the Navy shortly after the outbreak of war, went through boot school together, and graduated together from the NTS at Corpus Christi. After a brief separation for duty on opposite coasts, they were re-united as instructors in California. Now, because "Uncle" has broken them up once more, we're running their pictures in this column for "auld lang syne."



foreign service. However, we're still seeking complete data on the rest of those fellows as well as on the "address unknowns" being listed this month—so please consider this a call for better QTH!

ex-1EAT, Tremaine, S/Sgt., address unknown.
 1FNV, Culliton, 2nd Lt., foreign duty.
 1HAG, VonRiegers, T/Sgt., address unknown.
 1LC, Sanborn, Sgt., Sioux Falls, S. D.
 1IOP, Galinsky, A/S, Akron, Ohio.
 1NRW, Tartas, Sgt., address unknown.
 2HUX, Ackerman, S/Sgt., address unknown.
 2JVM, Ballard, Cpl., address unknown.
 2KRL, Bailey, T/Sgt., foreign duty.
 2KWJ, Newman, Lt., foreign duty.
 2LOH, Beach, Pfc., Nashville, Tenn.
 2LOX, Bracher, T/Sgt., address unknown.
 2LXF, Califano, Sgt., address unknown.
 2OBQ, Hellman, Cpl., Bradley Field, Conn.
 2OMH, Davis, Lt., Columbia, S. C.
 3CME, Assenheimer, Pvt., Tampa, Fla.
 3DRK, Showers, M/Sgt., foreign duty.
 3DUR, Hess, 2nd Lt., Waynesboro, Pa.
 3FZG, Moomaw, Cpl., address unknown.
 3GGL, Needre, T/Sgt., Boca Raton, Fla.
 3GON, Lake, M/Sgt., foreign duty.
 3GPH, Wagner, A/C, San Antonio, Texas.
 3GUB, Broome, A/C, Philadelphia, Pa.
 3HQN, McKaig, S/Sgt., Reading, Pa.
 3HZU, Rockey, Major, W. Palm Beach, Fla.
 3IFV, Vernon, Pfc., Camp Maxey, Texas.
 3IKT, Lassiter, Sgt., Camp Claiborne, La.
 3JBB, MacAslan, A/C, Arcadia, Fla.
 3JOP, Smith, T/Sgt., Bradley Field, Conn.
 4EBM, Mason, Cpl., Randolph Field, Texas.
 4FPF, Donan, Lt., address unknown.
 48ST, Duncan, Cpl., Greenville, S. C.
 4FUG, Nichols, CWO, address unknown.
 4GAI, Gordon, M/Sgt., address unknown.
 4GYT, Arnold, Pfc., Sioux Falls, S. D.
 4HPV, Cowan, Cpl., foreign duty.
 4HQC, Hinshaw, A/C, San Antonio, Texas.
 ex-5DGV, Maddox, M/Sgt., address unknown.
 5DON, King, T/Sgt., address unknown.
 5FAS, Adel, T/Sgt., address unknown.
 ex-5FDM, Ryan, Cpl., address unknown.
 5FYB, Kohlenberg, Cpl., Camp Murphy, Fla.
 5GIV, Simpson, M/Sgt., address unknown.
 5JAS, Hight, S/Sgt., address unknown.
 5JEP, McKinney, Boca Raton, Fla.
 5JLH, Allen, T/Sgt., address unknown.
 5JMV, Couch, S/Sgt., address unknown.

5JWL, Harwell, Pfc., Madison, Wis.
 5KJ, Johnston, W/O, address unknown.
 ex-6AQB, Lugo, T/Sgt., address unknown.
 6AQU, Webster, Sgt., Tonopah, Nev.
 6DHK, Parker, T/Sgt., address unknown.
 ex-6HKU, Sykes, Lt., address unknown.
 6IBX, Land, S/Sgt., address unknown.
 6MBJ, Veliz, M/Sgt., McChord Field, Wash.
 6MPE, England, M/Sgt., address unknown.
 6MTO, Wardell, Cpl., Ft. Monmouth, N. J.
 6RAD, Shtatstall, S/Sgt., address unknown.
 6SCU, Turner, S/Sgt., address unknown.
 6SRQ, Clark, Pvt., address unknown.
 6SRY, Rotramel, T/Sgt., address unknown.
 7CPE, Menth, Lt., address unknown.
 7EPE, Klein, T/Sgt., address unknown.
 7HMS, St. Amand, Pvt., address unknown.
 7HPC, Martin, T/Sgt., address unknown.
 8ARE, Miller, Pfc., Sioux Falls, S. D.
 8AXC, Smith, Capt., address unknown.
 8CNR, O'Donnell, Pvt., address unknown.
 8DPR, Phillips, S/Sgt., address unknown.
 8DHF, Dorey, Sgt., address unknown.
 8GRG, Kinsey, M/Sgt., address unknown.
 ex-8HDD, Philabaum, address unknown.
 8LOA, Steinnets, Lt., New Haven, Conn.
 8NBJ, Freland, Cpl., address unknown.
 8OSL, Wengler, T/Sgt., address unknown.
 8PAF, Ebert, S/Sgt., address unknown.
 8QAK, McCracken, S/Sgt., address unknown.
 8QYO, West, T/Sgt., foreign duty.
 8SZA, Duckworth, Sgt., address unknown.
 8SZR, Simon, Sgt., address unknown.
 8UEF, Prince, T/Sgt., address unknown.
 8VYC, McMenamin, Cpl., address unknown.
 9OCB, Olmstead, Pfc., address unknown.
 9BCUC, McLaughlin, Pvt., Sebring, Fla.
 9BRD, Newkirk, S/Sgt., Drew Field, Fla.
 9C10, Robbins, S/Sgt., address unknown.
 9CQK, Derrick, S/Sgt., address unknown.
 9DOK, Zink, Pfc., Reno, Nev.
 9FPY, Mitchell, S/Sgt., address unknown.
 9GZB, Silverman, Cpl., address unknown.
 9HAD, Colewell, Pvt., address unknown.
 9HHH, Slusser, Lt., Sherman, Texas.
 9JBZ, Harding, Lt., Boca Raton, Fla.
 9JYL, Anderson, Lt., Patterson Field, Ohio.
 9KMV, Lieska, Cpl., Scott Field, Ill.
 9MEP, Nielsen, Sgt., Sioux Falls, S. D.
 9MFD, Shull, T/Sgt., foreign duty.
 9OYB, Fisher, Miami Beach, Fla.
 9RCA, Angell, Pfc., Scott Field, Ill.
 9RHP, Pietraszewicz, T/Sgt., foreign duty.
 9SUE, Cooke, S/Sgt., address unknown.
 9TAJ, Garner, T/Sgt., Austin, Texas.
 9TPT, Maiorana, Capt., W. Palm Beach, Fla.
 9UEB, Shook, S/Sgt., address unknown.
 9YAY, Pardee, T/Sgt., address unknown.

Operator's license only:

Banbury, Cadet, Bloomington, Ind.
 Benaglio, Cpl., Camp Murphy, Fla.
 Clark, Sgt., address unknown.
 Coward, Pfc., Scott Field, Ill.
 Edwards, S/Sgt., New Haven, Conn.
 Iverson, Cpl., Long Beach, Calif.
 Kreisinger, Pvt., foreign duty.
 Marsh, Cpl., address unknown.
 McCarrick, Pfc., Mitchell Field, N. Y.
 Myers, Pfc., Sioux Falls, S. D.
 Ornduff, 2nd Lt., San Antonio, Texas.
 Queen, Pfc., Scott Field, Ill.
 Sansone, Lt., address unknown.
 Sutherland, Cpl., address unknown.

ARMY—GENERAL

LT. MARK FEW, JR., W4FFL, relays the latest news on what's doing in Africa these days. So far he's met two hams there but is having conversational difficulties, as they both speak French — which he doesn't know at all. However, radio in any language consists of "Zepps, diagrams and tube numbers," and is, in fact, practically an international language. The F hams both possess a late edition of the *Handbook* in English.

All of which just goes to prove that being a ham has its advantages when you travel abroad!

1FTB, Rantanen, Pvt., Ft. McClellan, Ala.
1GOI, Stevens, T/4, Camp Hood, Texas.
1JOT, Simmington, Lt., East Douglas, Mass.
1KXR, Jack, T/4, foreign duty.
1MFE, Sawyer, Pvt., address unknown.
1NBS, Hennessey, Pvt., N. Camp Hood, Texas.
2HRI, Roche, T/Sgt., foreign duty.
2KPD, Thompson, Sgt., Fort Dix, N. J.
2LBP, Rashak, Pvt., foreign duty.
2LPB, Silzer, Pvt., Camp Upton, N. Y.
2NHR, Morris, Cpl., Seattle, Wash.
2NPC, Slougher, Lt., Ft. Belvoir, Va.
2OHI, Bright, Pvt., Ft. Fisher, N. C.
3CDW, Baumeister, Camp Davis, N. C.
3UD, Uhing, Pvt., Camp Van Dorn, Miss.
3JTL, Brown, Pfc., Durham, N. H.
4HCU, Wilmoth, Camp Haan, Calif.
4HVT, Howard, Pvt., N. Camp Hood, Texas.
4RS, Roberson, Lt., Harlingen, Texas.
5CNH, Redwine, Pfc., foreign duty.
5DQN, Yeagley, Lt., Ft. Sam Houston, Texas.



"Join the Navy and see the world" has more than a smattering of truth when applied to Lt. J. M. Moran, W9FK W, of St. Louis, Mo. He was in Tucson, Ariz., at the time of this picture and has since been in Maine and more recently in Massachusetts. Lt. Moran has followed amateur radio since the 200-meter days and was a broadcast engineer in civilian life.

5KCP, Edwards, Pvt., New York, N. Y.
6DNR, Wise, T/Sgt., Camp John T. Knight, Calif.
6KKO, Deal, Pvt., U. of Calif., Calif.
6RCA, Applegarth, Pvt., Sacramento, Calif.
6RUD, Richards, Pfc., San Bernardino, Calif.
6SBC, Battle, Cpl., foreign duty.
6SEJ, Hamilton, T/5, Sacramento, Calif.
6SOC, Hofmann, Pfc., Philadelphia, Pa.
6UBG, Wilson, Lt., Taunton, Mass.
7GRD, Bunker, Pvt., N. Camp Hood, Texas.
7HVV, Carpenter, Pvt., Sacramento, Calif.
7IAO, Hezel, San Diego, Calif.
7LX, Cowling, Sgt., Portland, Ore.
8OYH, Finney, Major, foreign duty.
8RJV, Mauser, S/Sgt., foreign duty.
8TKG, Hanson, Texas.
8TQE, Cudilo, Pfc., Nashville, Tenn.
8VGI, McGregor, Sgt., address unknown.
8VUI, Looft, Pfc., Bethlehem, Pa.
8ZW, Boudy, Lt., foreign duty.
9AQU, Eyeslage, T/5, Sacramento, Calif.
9AVI, Schumacher, Pvt., Alton, Iowa.
9GUW, Dawson, Cpl., Camp Davis, N. C.
9RDS, Walsh, Pvt., University, Ala.
9EAA, Kark, Sgt., foreign duty.
9E2AV, McDonald, 2nd Lt., foreign duty.
9FKV, Clark, Capt., Camp Tyson, Tenn.
9FLA, Tuttle, Sgt., foreign duty.
9GDW, Rigin, Capt., Camp Chaffee, Ark.
9GNU, Tavenner, Capt., Camp Livingston, La.
9HDA, Carisch, Cpl., foreign duty.
9LZT, Pearson, Pvt., foreign duty.
9VPK, Jones, Pvt., Camp Adair, Ore.
9VYZ, Neben, Cpl., foreign duty.

Operator's license only:

Allen, Pvt., Ft. Benning, Ga.
Benson, Trainee, Kingston, R. I.
DeLafosse, Sgt., Forth Worth, Texas.
Engdahl, Sgt., Camp Van Dorn, Miss.
Fischer, Sgt., Camp Hood, Texas.
Forsting, Pvt., Fort Sill, Okla.
Gregory, Pvt., Camp Croft, S. C.
Griffin, Cadet, Lawrence, Kans.
Kujanpas, Pvt., Camp Wheeler, Ga.
Larmon, M/Sgt., Camp Chaffee, Ark.
Rogers, S/Sgt., Camp Haan, Calif.
Shirk, Cadet, Brookings, S. D.
Smith, Lt., Ft. Benning, Ga.

NAVY—FOREIGN OR SEA DUTY

1ETT, Arbuckle, ARM2c; 1KKX, Barber, EM2c; 2AMD, Murray, Lt. (jg); 2HQQ, Hicks, CRM; 2EVD, Campbell, CSK; 2HYN, Langley, RM1c; 2JYG, Polsten, Elect.; 2MFM, Sokolski, Ens.; 2VHJ, Nelson, RT3c; 3A0O, Hensell, Ens.; 3DIA, Plummer, CRM; 3FGN, Repici, RM2c; 3GXS, Donahue; 3ITW, Popen, CRM; 3JFY, Cole, RM1c; 4ELA, Emmons, RT1c; 4FRS, Ehlerding, RM2c; 4GMM, Hilliard, ART1c; 4HIH, Hatcher, ARM1c; 5AYR, Saylor, ART1c; 5BZH, Compton, CM2c; 5FWO, Tichenor, RM1c; 5BGR, Porter, CMM; 5HPX, Atkinson, RT1c; 61YU, Unger, RM1c; 6NUC, Fisher, CRT; 6NYR, Pauter, ARM1c; 6QEZ, White, RM2c; 6RBM, Fakkema, RT1c; 6RDA, Blankenship, CRM; 6RDE, Ensele, ARM1c; 6SDT, Battani, CRM; 6SHC, Coughran, RM1c; 6SOU, Richardson, RM3c; 6TEC, Sterner, P2c; 6TUY, Minaker, RT2c; 6UAO, Boyte, RM1c; 6UFF, Boudreaux, RM2c; 7BIR, Woodhouse, CWO; 7GVE, Peck, ARM1c; 7GYH, Goodman, ART2c; 7HQJ, Buckbee, ACRM; 8DX, Grant, Lt. (jg); 8EEP, Blaho, RM2c; 8KWI, Burkhamer, ARM1c(r); 8OA, Russell, RE; 8ONS, Smith, CRM; 8PRA, Foster, RM2c; 8AOP, Smith, RT1c; 9DJO, Barber, Lt.; 9DNI, Hanson, ARM2c; 9GOA, Cotter, RT2c; 9IRB, Snider, RM2c; 9JSH, McClelland, RM1c; 9NTR, Stone, RM3c; 9PED, Cramer, ART1c; 9VIE, Pulse, W/O; 9ZKO, Robinson, ART1c; 9ZSC, Haes, RM1c; 9ZUV, Dvorak, ART1c; the following have operator's license only: Migliore, S2c; Wikstrom, RT2c; Zapke, RM1c.

CIVIL SERVICE

1ALJ, Gardner, engineer, NAS, Quonset.
1AWZ, Cushman, AAF, engineer, foreign duty.
1AXE, Kelemen, Navy Dept., inspector, Boston.
ex-1BHR, Gelineau, Navy Dept., instructor, Philadelphia.



Capt. N. H. Young, W1HX, is now seeing service in the Signal Section of the Army Air Forces. He returned to Patterson Field, Ohio, early this summer, after spending some time overseas with the Air Service Command. Before entering the service, Norm was associated with CBS and was in the supporting division of the ARRL Emergency Corps.

1FKV, Bradley, Navy Dept., radio maintenance, Rockland, Mass.
1GDI, Darling, FCC, radio inspector.
ex-1HTR, Hanscom, Navy Dept., foreign duty.
1IAS, Power, Navy Dept., Boston, Mass.
1IIC, Gunning, Navy Dept., Newport, R. I.
1ITH, French, SC, radio mech., Presque Isle.
1JNC, Burnett, engineer, Boston, Mass.
1KBS, Hervey, Navy Dept., inspector, Quincy.
1KHV, Balke, FCC, mechanic-technician, Groton.
1KKS, Matchet, FCC, monitoring officer.
1LIP, Blaney, N.Y., radio foreman.
1LIZ, Patterson, AAF, mechanic-technician, Colorado Springs.
1MDS, Grant, SC, mechanic-technician, Groveton, N. H.
1MFT, Williams, AAF, mechanic-technician, Fairfield.
1MLJ, Dell'Amico, Philadelphia Signal Depot.
1MMO, Merrill, AAF, mechanic-technician, Colorado Springs.
1MND, Camire, FCC, monitoring officer.
1NDM, Long, radio mechanic, Quonset Pt.
1NEO, Barnard, FCC, radio operator.
1NIP, Robbins, AAF, Ft. Bragg, N. C.
2AXJ, Ray, Navy Dept., Hyattsville, Md.
2BZB, Doersam, Research Lab., Edin Field, Fla.
2DBI, Butt, AAF, inspector.
2REL, Sharpe, FCC, Powder Springs, Ga.
2EIL, Bahaly, FCC, radio inspector.
2IBG, Schnabolk, SC, engineer, Ft. Monmouth.
2JA, Carruthers, Maritime Comm., inspector.
2KCN, Pastor, Philadelphia Signal Depot.
2LV, Morris, SC, radio engineer, Washington.
2LVH, Clinton, Washington, D. C.
2MLW, Burke, Scott Field, Ill.
2MMG, Haybach, CAA, Toledo, Ohio.
2MRV, Axelrod, FCC, monitoring officer.
2OCG, Milton, SC, inspector, Cicero, Ill.
2ODU, Cortright, eng. aide, Camp Coles.
3AEZ, Guzy, Signal Lab., Bethlehem, Pa.
3ANA, Huber, Signal Lab., Bethlehem, Pa.
3ASB, Dunne, SC, Bangor, Maine.
3BBO, Humphrey, Navy Dept., Silver Spring, Md.
3BQO, Bartholomew, Signal Lab., Bethlehem, Pa.
3CEU, Rehm, electrician, Philadelphia Navy Yard.
3CHU, Jones, Philadelphia Signal Depot.
3DAL, O'Connell, Navy Dept., Washington.
3DCQ, Zanon, SC, Trenton, N. J.
3EWH, Firdle, SC, radio engineer, Washington.
3FE, Noble, engineering aide, Washington.
3FRM, Smith, engineering aide, Patuxent River, Md.

3FVF, Stout, Navy Dept., engineer, Baltimore.
 3G1F, Hamilton, SC, inspector, Dayton, Ohio.
 3G1J, Maggio, SC, engineer, Baltimore.
 3ELW, Burrows, Navy Dept., inspector.
 3HRQ, Bourland, NRL, Washington.
 3HVT, Massey, Navy Dept., Silver Spring, Md.
 3IAP, Williams, Signal Corps.
 3IIF, Wikstrom, Navy Dept., inspector.
 3IZE, McDougall, Maritime Comm., New Orleans.
 3JDM, Bortel, SC, radio engineer.
 3JON, Buzzard, Navy Dept., inspector.
 3JOW, Whetzel, NRL, Washington.
 3JPR, Kern, Signal Lab., Bethlehem, Pa.
 3JPS, Miner, inspector, Norfolk Navy Yard.
 3JSJ, Roddy, Navy Dept.
 3JXY, Stewart, Navy Dept., engineer, Vallejo, Calif.
 3JZS, Bullis, AAF, inspector.
 4B1W, Lindsey, SC, radio mech.-tech.
 4BYN, Rieben, AAF, radio mechanic.
 4CYT, Harrell, address unknown.
 4CYU, Hecksher, Navy Dept., engineer, Washington.
 4DFT, Johnson, SC, mechanic, Ft. McPherson.
 4EHO, Shaup, Navy Dept., engineer, Washington.
 4FLH, Hunter, radio technician, Key West.
 4FSH, Cooper, Lexington Signal Depot.
 4FVD, Berret, SC, Savannah, Ga.
 4GER, Morrison, SC, engineer aide, Wright Field.
 4HEB, Mayer, FCC, radio operator.
 4HEQ, Norwood, SC, inspector.
 4HLP, Banks, FCC, monitoring officer.
 4HMK, Storrs, SC, engineer, Camp Evans.
 4IEN, Brigman, CAA, Smithville, Tenn.
 4IHZ, Eckhoff, electrician, New York City.
 4K4D, Mayer, FCC, monitoring officer.
 4NT, Seay, FCC, monitoring officer.
 4UJ, Bealy, Navy Dept., instructor.
 5AGH, Welch, SC, Ft. Sill, Okla.
 5AQN, Wright, SC, radio mechanic.
 5ASA, McGuire, AAF, elect., W. Monroe, La.
 5AYL, Oldfield, SC, radio repair, Oklahoma City.
 5BGP, Gusick, AAF, maintenance, Altus, Okla.
 5BYX, Edens, CAA, radio operator.
 5DAA, Brewer, FCC, monitoring officer.
 5DBR, Gustafson, SC, engineer, Los Angeles.
 5DDO, Bridges, SC, instructor, Joplin, Mo.
 5EOA, Boyd, electronic mechanic, San Diego.
 ex-5EOL, Rozell, AAF, mechanic, San Antonio.
 5EWB, Blake, AAF, instructor, Moody Field.
 5FAP, Gray, electrician, Kelly Field, Texas.
 5FBG, Graves, electrician, Patterson Field.
 5FJK, Kints, Randolph Field, Texas.
 5FNP, Pittman, AAF, instructor, San Antonio.
 5FSP, Haines, SC, mechanic, San Antonio.
 5FXK, Ammen, AAF, inspector, Santa Monica, Calif.
 5FYF, Dewey, NRL, Washington.
 5GBY, Banes, CAA, Austin, Texas.
 5GDK, Huebner, FCC, monitoring officer.
 5GPH, Westerman, inst., State College, Miss.
 5GNV, Sanders, FCC, intercept officer.
 5HBT, Fohn, CAA, Austin, Texas.
 5HCT, Guley, AAF, mech., Harlingen, Tex.
 5HPT, Goldberg, CAA, Albuquerque, N. M.
 5HXC, Frampton, FCC, radio inspector.
 5HXW, Hickerson, AAF, inspector, Wichita.
 5IFR, Chipman, AAF, Greenville, Miss.
 5IGO, Ferguson, SC, radio operator, Ft. Sill.
 5IGO, McKensie, FCC, monitoring officer.
 5IHA, Lawson, CAA, Arkansas, Ark.
 5IVI, Padberg, FCC, monitoring officer.
 5IWR, Fizer, FCC, radio operator.
 5LYL, Levesque, FCC, radio operator.
 5JAL, Phares, radio operator, Camp Chaffee.
 5JQH, Wright, radio engineer, Oklahoma City.
 5JXF, Hankins, FCC, monitoring officer.
 5JYZ, Kral, FCC, monitoring officer.
 5KBC, Easterwood, radio engineer, Seattle.
 5KKN, Dohkins, CAA, Dallas, Texas.
 5KPI, Lyman, radio mechanic, Pensacola.
 5KOP, Grice, radio mechanic, Austin, Texas.
 5L SZ, Higgins, FCC, radio inspector.
 5PP, McCollan, Ft. Sill, Okla.
 6BCX, Smith, Navy Dept., radio engineer.
 ex-6BPC, Richard, Navy Dept., Vallejo, Calif.
 6BPQ, Tadlock, Navy Dept., radio mechanic.
 6CAE, Higgins, Navy Dept., radio engineer.
 6CAN, Clark, Navy Dept., radio mechanic.
 6OAX, Silva, radio mechanic-technician.
 6CFN, Bogue, FCC, monitoring officer.

6ORF, Edgar, Navy Dept., inspector.
 6DEG, Dawley, Navy Dept., radio engineer.
 6DZQ, Eckhard, SC, radio maintenance, Presidio of San Francisco.
 ex-6ESG, LaVarnway, Navy Dept., inspector.
 6EUL, Zill, Navy Dept., inspector.
 6EUV, Hindin, AAF, instructor, Ontario, Calif.
 6GCT, Jones, Navy Dept., radio engineer.
 6GYA, Baldock, Navy Dept., radio mechanic.
 6GZH, Edgar, Navy Dept., radio mechanic.
 6HZY, Allan, Navy Dept., Concord, Calif.
 6IKK, Parmenter, Navy Dept., inspector.
 6JRU, Stewart, SC, radio engineer.
 ex-6JUG, Creath, Navy Dept., electrician.
 6KIW, Showalter, Navy Dept., radio lab.
 6LQG, Hagopian, Navy Dept., electrician.
 6LHY, Williams, radio operator, Los Angeles.
 6LMD, Baliros, FCC, monitoring officer.
 6MEY, Delgado, Navy Dept., electrician.
 6MHL, Rogers, Navy Dept., inspector.
 6MYR, Haas, FCC, radio operator.
 6NIN, Dell, FCC, monitoring officer.
 6NZO, Taylor, SC, radio repairman.
 6OBQ, O'Brien, Navy Dept., inspector.
 6OHA, Saltzman, AAF, inspector.
 6OJW, Southwell, SC, engineering aide.
 6PJE, Baker, Navy Dept., radio engineer.
 6QGQ, Pratt, AAF, radio inspector.
 6QKA, Keim, Navy Dept., electrician.
 6LZO, Avila, Navy Dept., mechanic.
 6HFF, Hill, SC, operator, Presidio of San Francisco.
 6KROC, Yamamoto, electrician.
 6RPI, Benham, FCC, monitoring officer.
 6RSE, Shak, radio lab.
 6SCO, Kemper, FCC, monitoring officer.
 6UGX, Houplin, SC, radio mechanic.
 6UJW, Phillips, Navy Dept., radio engineer.
 6UYR, Bloomfield, SC, radio mechanic.
 6URT, Strong, FCC, monitoring officer.
 6UUJ, Bartels, AAF, foreign duty.
 ex-6ZAP, Cornell, Navy Dept., inspector.
 7A0I, Herrmann, FCC, engineering dept.
 7BDS, Rusich, commissioned operator, McClellan Field.
 ex-7BPK, Mayer, Navy Dept., radio mechanic.
 7DQX, Rankin, Navy Dept., radio electrician.
 7DZZ, Gowdie, Navy Dept., radio engineer.
 7EPT, Williams, Navy Dept., radio engineer.
 7FEK, Herndon, FCC, inspector.
 7GHB, Watson, FCC, monitoring officer.
 7GHF, Schultz, AAF, radio instructor.
 7HEY, Schultz, AAF, radio instructor.
 7EQT, Foley, Plentywood, Mont.
 7ICC, Sharp, SC, inspector.
 7IOH, Sly, FCC, radio operator.
 7IRN, Salsbury, CAA, radio electrician.
 7IUO, Ungdruk, CAA, communications.
 7JKN, Twell, Navy Dept., inspector.
 7JBJ, Greenberg, CAA, Augusta, Maine.
 7JL, Katzenberger, inst., Bremerton, Wash.
 7VU, Peoples, SC, instructor.
 8APO, Fattley, SC, radio engineer.
 8AXR, Kell, FCC, monitoring officer.
 8BLE, Lanning, SC, radio inspector.

HAM HOSPITALITY

THIS month a Brazilian ham, Francisco Vita Sobrinho, PY7AX, comes to the fore to extend his hospitality to American amateurs whose war duties may take them to South America.

Señor Sobrinho has already entertained several of our boys and would count it a pleasure to meet any other amateurs who get to Recife, Pernambuco. He wants all American hams to know that their friends in Brazil are in sympathy with their endeavors, and wishes to make this contribution toward cementing amicable relations between the two western continents.

The snapshot reproduced below is one of a collection sent in by PY7AX, all showing groups of our OMs who have met the Señor and taken breakfast or dinner with him. From the happy expressions on the faces, we'd say that Brazilian hospitality must be as warm as the country itself.

One picture in the lot was of a three-element rotary-beam antenna supported on a lattice tower. We imagine Señor Sobrinho used this for 10-meter DX, and wouldn't be surprised if his announcement of an open house for our boys might bring about a personal QSO with a former contact. Better look into it, OMs — it seems mighty inviting to us!

(We're hoping the generosity expressed above will be an incentive for other amateurs to come forward with letters telling of an open latch for our men.)

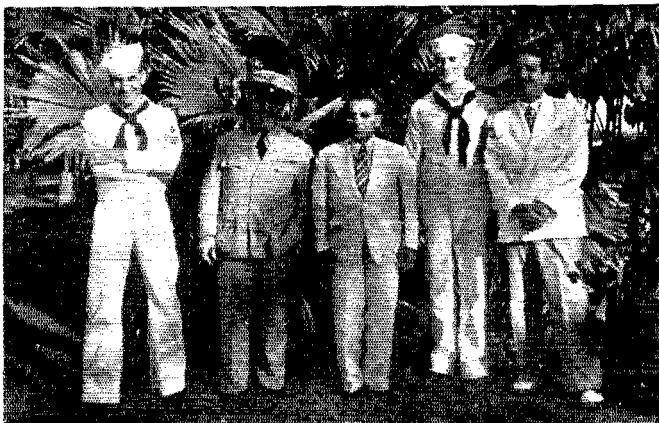

In the jolly group of Ws, Ks, and PYs pictured above we are privileged to view, *l. to r.*, RM1c Preno, ex-W3AXX; CRM Haley, K4FAY; F. V. Sobrinho, PY7AX; RM1c Grady, ex-W6CNA; and J. S. Netto, PY7AY.

Measurement of Antenna Impedance

A Simple Method of Determining Antenna and Transmission-Line Operating Conditions

BY HARRY E. STEWART,* W3JXY

By the use of relatively simple mathematical formulas, W3JXY shows how it is possible to determine antenna impedance and line input impedance from measurements of the standing-wave ratio on the transmission line feeding the antenna. Adjustment of antenna length and matching stubs is also discussed.

BY MEASURING the relative magnitudes of the maximum and minimum values of the standing wave of current existing along a transmission line and noting the distances between current minima and the load end of the line, it is possible to determine the resistance and the reactance components of the terminating impedance or load. The current and voltage magnitudes existing along a transmission line depend upon the terminating impedance as well as on the impedance of the generator connected at the sending, or input, end. The terminating impedance is the one requiring careful matching to the line, because it is this impedance which determines the relative magnitudes and the positions of the current maxima and minima set up along the line; in other words, it determines the amount or value of standing wave existing in the line. The sending-end impedance merely regulates the amplitudes of current and voltage along the line and does not affect the ratio of maximum to minimum of either voltage or current. A high impedance at the sending end results in a condition of high voltage and low current along the line, while a low impedance produces a distribution characterized by low voltage and high current. The standing waves of current and voltage are 90 degrees out of phase, a current minimum and voltage maximum or a current maximum and voltage minimum occurring at the same point on the line.

* 241 Mountain View Ave., Vallejo, Calif.

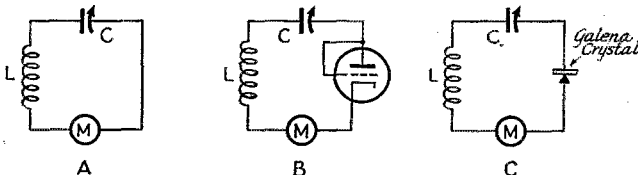

Fig. 1 — Three forms of an r.f. indicating device for checking standing waves on a transmission line. In each case the circuit is tuned to resonance at the operating frequency. The unit should be mounted so that the coil, which provides the pick-up, is held at a constant distance from the line. In A, the meter must be of the r.f. thermocouple type. A d.c. milliammeter can be used in place of the r.f. meter by providing a rectifier, which may be either of the tube type, as shown in B, or the crystal type shown in C.

Measurement of the relative values of current minima, I_{min} , and maxima, I_{max} , is easily effected without the use of elaborate and expensive equipment; the only apparatus required is an r.f. ammeter, arranged as shown in Fig. 1-A, or a d.c. milliammeter connected as shown in Figs. 1-B or 1-C. The various components should be mounted as a unit on a piece of bakelite or similar material, and provision included for hanging the entire unit at various points along the line so that the positions and values of I_{max} and I_{min} may be determined. The reason for hanging the instrument on the line is that care must be exercised in maintaining constant coupling between the coil, L , and the line; otherwise, inconsistent current readings may be recorded.

Calculation of Terminating Impedance

Assume that a series of observations have been made along a line and that the quantities I_{min} , I_{max} , and the distance from the load end of the line to the nearest current minimum, d in Fig. 2, have been measured. The load impedance, Z_r , can be calculated from the following relation:¹

$$Z_r = Z_o \left[\frac{2Q + j(Q^2 - 1) \sin(720^\circ d/\lambda)}{Q^2 + 1 - (Q^2 - 1) \cos(720^\circ d/\lambda)} \right], \quad (1)$$

where

$$Q = \frac{I_{max}}{I_{min}} = \text{the standing-wave ratio,}$$

Z_o = characteristic, or surge, impedance of the line in ohms,²

Z_r = load impedance connected across the line,
 d = distance from load (Z_r) to a current minimum in any units,

λ = wavelength of r.f. power being transmitted in units used for d above.

At first glance equation (1) appears to be quite imposing, but the calculations are not involved.

Consider an actual example, in which

$$\begin{aligned} I_{max} &= 50, \\ I_{min} &= 25, \\ d &= 2 \text{ meters,} \\ \lambda &= 10 \text{ meters.} \end{aligned}$$

¹ Carter, *RCA Review*, Jan., 1939.

² For two-wire open lines, $Z_o = 276 \log \frac{b}{a}$, where b is the wire spacing and a the radius of the conductor. For concentric lines with air dielectric, $Z_o = 138 \log \frac{b}{a}$, where b is the inside diameter of the outer conductor and a the outside diameter of the inner conductor.

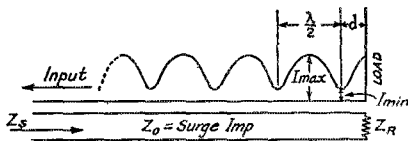

Fig. 2—The distance, d , as used in the calculations in the text, is measured from the load end of the line.

The standing-wave ratio has been computed to be

$$Q = 50/25 = 2.$$

Substituting the numerical values in equation (1),

$$Z_r = Z_o \left[\frac{4 + j(4 - 1) \sin(720^\circ \times 2/10)}{4 + 1 - (4 - 1) \cos(720^\circ \times 2/10)} \right]$$

$$Z_r = Z_o \left[\frac{4 + j3 \sin(144^\circ)}{5 - 3 \cos(144^\circ)} \right]$$

$$= Z_o \left(\frac{4 + j1.7634}{5 + 2.427} \right) = Z_o \left(\frac{4 + j1.7634}{7.427} \right)$$

$$= Z_o (0.538 + j0.237).$$

The load impedance, Z_r , is less than Z_o and contains an inductive component. In the case where an antenna constitutes the load, this indicates that the antenna is too long for the frequency; a capacitive component would indicate a short antenna. If Z_o is 600 ohms, then

$$Z_r = 322.8 + j142.2,$$

$$R_r = 322.8 \text{ ohms resistance,}$$

$X_r = 142.2$ ohms inductive reactance, j being positive.

In the foregoing example, the distance $d = 2$ meters was substituted in equation (1). However, it is permissible to use the distance measured from any one of the current minima to the load as d if it is not possible or convenient to measure the distance to the first minimum. For example, a value of 12 meters would have yielded the same result, since it is the distance from the load to the second minimum. That this is true can be understood by considering the sine term of the above example:

$$\sin \left(\frac{720^\circ \times 12}{10} \right) = \sin 864^\circ.$$

The addition or subtraction of any integral multiple of 360° will not affect the result. In this instance, $2 \times 360^\circ$, or 720° , is subtracted with the following result:

$$\sin 864^\circ = \sin (864^\circ - 720^\circ) = \sin 144^\circ.$$

This agrees with the angle calculated for $d = 2$ meters.

Calculation of Line Input Impedance

It is possible also to calculate the value of the input impedance, Z_s , presented to the generator

supplying the r.f. power to the line. The expression for doing this is:¹

$$Z_s = Z_o \left[\frac{2Q + j(Q^2 - 1) \sin \{ 720^\circ (d-l)/\lambda \}}{Q^2 + 1 - (Q^2 - 1) \cos \{ 720^\circ (d-l)/\lambda \}} \right], \quad (2)$$

where

Z_s = the input impedance,

λ = length of the line in same units as d , and other symbols have the values given in connection with (1). Suppose the line considered above has a length of 43 meters, or 141 feet. Then, the load presented to the generator, or transmitter, is computed as follows:

$$Z_s = Z_o \left[\frac{4 + j(4 - 1) \sin \{ 720^\circ (2-43)/10 \}}{4 + 1 - (4 - 1) \cos \{ 720^\circ (2-43)/10 \}} \right]$$

$$= Z_o \left[\frac{4 + j3 \sin(-2952^\circ)}{5 - 3 \cos(-2952^\circ)} \right].$$

Reducing the angle by adding the largest possible multiple of 360° , in this case the eighth multiple, gives:

$$-2952^\circ + 2880^\circ = -72^\circ.$$

Then,

$$Z_s = Z_o \left[\frac{4 + j3 \sin(-72^\circ)}{5 - 3 \cos(-72^\circ)} \right]$$

$$= Z_o \left[\frac{4 + j3(-0.9511)}{5 - 3(0.3090)} \right]$$

$$= Z_o (0.982 - j0.701).$$

When

$$Z_o = 600 \text{ ohms,}$$

$$Z_s = 589 - j421, \text{ then}$$

$$R_s = 589 \text{ ohms resistance, and}$$

$X_s = 421$ ohms capacitive reactance, j being negative.

Under these conditions coupling the line to a transmitter will detune the latter, since a reactive component is coupled into the transmitter tank circuit. If Z_s had been a pure resistance, the effect of the line would have been merely to load the output stage of the transmitter, the tuning remaining the same. This test may serve as a preliminary tuning check on the antenna system.

It has been shown how the nature of the load impedance across a transmission line and the load presented to the generator, or transmitter, can be ascertained from the three quantities, I_{max} , I_{min} , and d , all of which can be easily and economically determined by the amateur for the cases of open-wire and twisted-pair lines. In the case of the concentric line, however, the measuring of these quantities is not so easily effected. The commercial procedure is to employ a current-indicating device equipped with a probe which can be inserted into openings in the outer conductor provided at regular intervals for this purpose.

Special Cases

It is interesting to observe the results of calculations for the special cases where current minima occur at odd or even quarter wavelengths from the load.

For the first case, a value of $\lambda/4$ is substituted for d .

Then,

$$Z_r = Z_o \left[\frac{2Q + j(Q^2 - 1) \sin(720^\circ \lambda/4\lambda)}{Q^2 + 1 - (Q^2 - 1) \cos(720^\circ \lambda/4\lambda)} \right]$$

$$= Z_o \left[\frac{2Q + j(Q^2 - 1) \sin 180^\circ}{Q^2 + 1 - (Q^2 - 1) \cos 180^\circ} \right]$$

Since $\sin 180^\circ = 0$, and $\cos 180^\circ = -1$, the expression reduces to:

$$Z_r = Z_o \left[\frac{2Q + j(0)}{2Q^2} \right]$$

$$Z_r = R_r = \frac{Z_o}{Q} \quad Q = \frac{Z_o}{R_r} \quad (3)$$

Equation (3) shows that, when the current minima, I_{min} , occur at odd multiples of a quarter wavelength from the load, the load impedance, Z_r , is a pure resistance, R_r , of a value less than the characteristic impedance, Z_o , by the standing wave ratio, Q .

In the second case, a value of $\lambda/2$ is substituted for d in equation (1).

Then,

$$Z_r = Z_o \left[\frac{2Q + j(Q^2 - 1) \sin(720^\circ \lambda/2\lambda)}{Q^2 + 1 - (Q^2 - 1) \cos(720^\circ \lambda/2\lambda)} \right]$$

$$= Z_o \left[\frac{2Q + j(Q^2 - 1) \sin 360^\circ}{Q^2 + 1 - (Q^2 - 1) \cos 360^\circ} \right]$$

Since $\sin 360^\circ = 0$, and $\cos 360^\circ = 1$, the expression reduces to:

$$Z_r = Z_o \left[\frac{2Q + j(0)}{2} \right]$$

$$Z_r = R_r = QZ_o, \text{ or } Q = R_r/Z_o. \quad (4)$$

Again, it is observed that the load impedance, Z_r , is a pure resistance, R_r , but in this instance the value of R_r is greater than the characteristic impedance, Z_o , by the factor Q .

Adjusting an Antenna System

Equations (1), (3) and (4) can readily be applied in the field for tuning an antenna to resonance and for obtaining an impedance match between it and its transmission line. The procedure, briefly, is as follows:

First, excite the antenna with a small amount of power — say 50 watts — and measure I_{max} , I_{min} , and d . Next, convert d into quarter wavelengths. If d is found to be any integral multiple (odd or even) of a quarter wavelength, the antenna is tuned to resonance and only a mismatch of impedances exists. If, however, measurement of d indicates that the minima occur at distances

less than odd quarter wavelengths from the antenna, as shown in Fig. 3, the antenna is inductive, or too long. On the other hand, if the value of d shows that the minima are occurring at positions where distances from the load exceed those of the odd quarter-wave positions, as shown in Fig. 3-B, the antenna is capacitive or too short.

The antenna length then is adjusted as dictated by the results of the preceding step until it resonates, i.e., until the minima occur at integral quarter-wavelength distances from the antenna. If I_{min} is at an odd quarter-wave position, the antenna impedance, R_r , is greater than Z_o as shown by equation (3). On the other hand, if I_{min} is at an even quarter-wave position, R_r is greater than Z_o by equation (4).

In the instances where the impedance mismatch between the line and its load (antenna) is not great, i.e., where the value of Q approaches unity, the accurate location of the point of current minimum is not possible merely by sliding the current-indicating device of Fig. 1 along the line and observing a minimum reading of the meter. The standing wave under these conditions is flattened out, as illustrated in Fig. 3-C, and a pronounced dip in the meter reading is not experienced as the meter is passed through the point of minimum current. When this is the case, the distance, d , can be determined accurately by a process of averaging. First, the approximate location of the current minimum is determined; next, the meter is moved towards the antenna, or load end of the line, to some position such as 1, Fig. 3-C, where the meter deflection and distance d_1 are noted. The meter is then shifted to the opposite side of the minimum to position 2, where the meter deflection is the same as that obtained at position 1, and the distance d_2 is noted. The distance d to I_{min} is then computed by averaging

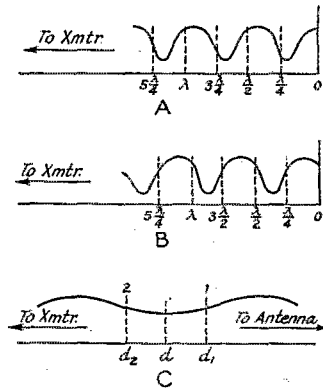

Fig. 3 — Standing-wave distribution under three conditions discussed in the text. At A, the first minimum occurs at less than $\frac{1}{4} \lambda$ from the load end, indicating that the antenna is inductive or too long. At B, the first minimum appears at a distance greater than $\frac{1}{4} \lambda$ from the end. In this case, the antenna is too short.

When the mismatch between the line and the load is not great the standing wave will not be pronounced, as illustrated at C. The difficulty of determining the exact position of the minimum is overcome by averaging readings made on either side of the minimum.

the distances d_1 and d_2 , i.e., $d = \frac{d_1 + d_2}{2}$.

Suppose, for example, that d_1 is found to be 32 feet and d_2 38 feet. Then d is calculated to be:

$$d = \frac{32 + 38}{2} = 35 \text{ feet.}$$

Formation of Standing Waves

The standing waves existing along an improperly terminated line are created through the reinforcement and cancellation of the incident wave by the reflected wave, as the latter travels back along the line from the load and toward the sending end. The points of maximum current and voltage are the result of a combining of the incident and the reflected waves when they are in phase, while the points of minimum current and voltage occur because of a combining of the two waves when they are in phase opposition.

Consider the instance in which the line is open-circuited ($Z_r = \infty$). The current flowing across the load end will be zero, so the incident current wave (wave traveling toward the load end of the line) and the reflected current wave must be equal and in phase opposition in order to reduce the current to zero. However, the voltage existing across the output terminals of the line will be a maximum, so the incident and reflected waves of voltage must be equal and in phase with each other. If, on the other hand, the line is short-circuited ($Z_r = 0$), the current at the output end will be maximum and the voltage zero, so the current waves are in phase, while the voltage waves are in phase opposition for this condition. It is seen from this discussion that the standing waves of current and voltage are always in phase quadrature (displaced by 90°).

If there were no attenuation of the waves as they traveled along the line, the points of minima would be reduced to zero for the two cases cited above. In practice, however, the waves are attenuated by losses, and the reflected wave is always of a slightly smaller magnitude, so it does not completely cancel the incident wave. For other values of load impedance, the values of the maxima will be smaller, while the values of the minima will be greater than for the instances of the open- and short-circuited cases.

In Fig. 4, the current and voltage waves are shown for different terminating impedances which are pure resistances (the effect of reactance terminations was shown in Fig. 3-A and 3-B). It will be noted that the points of minimum current agree with the two equations, (3) and (4), as the value of Z_r is either greater than or smaller than the surge impedance, Z_o . Curves for a great variety of load impedances were shown in a previous issue of *QST*.³

³ In the August, 1943, issue of *QST* the author discussed the reactive properties of short sections of transmission line; and it was shown that the reactance of short- and open-circuited lines is given by the relations:

$$Z_{sc} = jZ_o \tan \frac{2\pi l}{\lambda}$$

$$Z_{oc} = -jZ_o \cot \frac{2\pi l}{\lambda}$$

Since the values of I_{max} and I_{min} depend upon the load impedance, Z_r , or to be more specific, upon the ratio Z_r/Z_o , it seems reasonable that the value of the load impedance, Z_r , could be calculated in terms of the surge impedance, Z_o ,

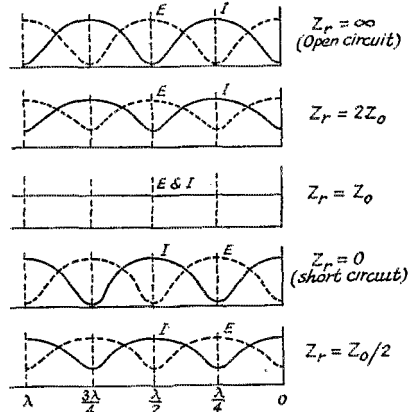

Fig. 4 — Standing-wave distribution when the line is terminated in pure resistances of different values.

when the relative values of I_{max} and I_{min} and their locations are known. Equations (1) and (2) are results of such reasoning.

Theory of the Tuning Stub

The tuning stub illustrated in Fig. 5-A is a device commonly employed for eliminating standing waves from transmission lines. Generally it consists of a short section of line (less than $\lambda/4$) of the same construction and surge impedance as the line itself, and is connected across the line at a point where the resistance component of the line impedance is equal to the surge impedance, Z_o , of the line. If the resistance of a line on which standing waves exist is measured, or calculated, for various positions along the line, it will be observed that a value of minimum resistance occurs at the points of maximum current, I_{max} , while maximum values of resistance will be found at the points of minimum current, I_{min} . The minimum resistance is less than the surge impedance Z_o , while the maximum resistance is greater than Z_o , so a point A, Fig. 5-B, must exist, between the positions of I_{max} and I_{min} , where the resistance is equal in magnitude to the surge impedance Z_o . Although only one such point is shown in

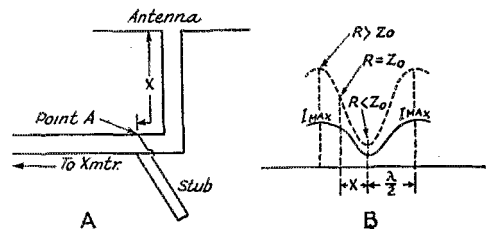

Fig. 5 — The matching stub is placed at a point on the transmission line where the line resistance, R , is equal to the surge impedance, Z_o , of the line.

Fig. 5-B, a similar point exists also at a distance X on the right side of I_{min} , where the resistance component is also Z_0 .

In Fig. 6, a curve for the distance X , which is the distance from I_{min} to the point where the resistance is equal to Z_0 , is plotted for various values of the standing-wave ratio (I_{max}/I_{min}). It is at this point that the tuning stub is attached to the line.

The stub, which is merely a short section of line, is employed as a reactor, and it is so designed as to neutralize the reactive component of the impedance existing across the line. Since the stub is connected at a point where the resistance across the line is equal to Z_0 , and since the stub neutralizes the reactive component of impedance, the line then becomes terminated — at the point of attachment of the stub — in a pure-resistance load equal to the surge impedance, Z_0 . Therefore, standing waves will be eliminated from this point to the input end of the line; they will now exist only on the section of line between the stub and the antenna. It follows that it is desirable that the stub be attached as close to the antenna as practicable.

A stub may be attached to a line at a distance X either side of the point of I_{min} (see Fig. 6). On the input side of I_{min} , the reactance of the line is capacitive, so a short-circuited stub, which is inductive for lengths less than a quarter wave, must be used. On the output side, the line is inductive, therefore an open-circuited stub, which is capacitive for lengths less than a quarter wave, must be employed.

Short- or Open-Circuited Stubs?

In practice, the short-circuited stub — or closed stub, as it is frequently termed — is preferred to the open-circuited type. While the open-circuited stub does possess the advantage of reducing the amount of line upon which standing waves will exist, since it is connected nearer the

antenna, this advantage is offset by two disadvantages. In the first place, a high r.f. potential exists across the open end of the stub, and therefore good insulation must be provided in its construction. Aside from this, the length of the stub is not easily varied for tuning purposes. On the other hand, the short-circuited stub is at zero r.f. potential at the shorted end and, therefore, it may be grounded if desired to provide lightning protection for the antenna system. In addition, the length of the stub is easily varied by merely sliding the shorting bar back and forth along the section. However, the unused ends extending beyond the shorting bar should be pruned off if the extension is longer than a few inches.

In Fig. 6 curves are given for determining the lengths of short- and open-circuited stubs for various values of the standing-wave ratio, I_{max}/I_{min} , and the accompanying sketch indicates where each type is applicable. It should be pointed out that the matching stub is designed and tuned for a single frequency, and this fact should be borne in mind when using it. The amateur is familiar with devices of this kind, since the quarter-wave matching transformer and the various types of multi-element beam antennas are likewise single-frequency, or essentially single-frequency, systems. They may be used with good results over a narrow band of frequencies, such as the 20- and the 10-meter 'phone bands, provided they are tuned at the mid-frequency point of the band.

Note on Wavelength

The wavelength of an r.f. wave traveling through space can be computed from the relation

$$\text{Meters} = \frac{300,000 \text{ kilometers per second}}{\text{Frequency in kc.}}$$

This relationship does not hold, however, in the case of transmission lines, because the velocity of propagation of an r.f. wave along a line is less than that in air and, therefore, the constant, 300,000 kilometers per second, is not applicable. The velocity of propagation depends upon the distributed constants (inductance and capacitance) of the line, and it is given approximately by:

$$V = \frac{1}{\sqrt{LC}}$$

where L and C are, respectively, the inductance in henries and capacitance in farads per unit length of line, and V is given in terms of same unit length of line per second.

In the case of well-constructed open-wire lines, V approaches quite closely

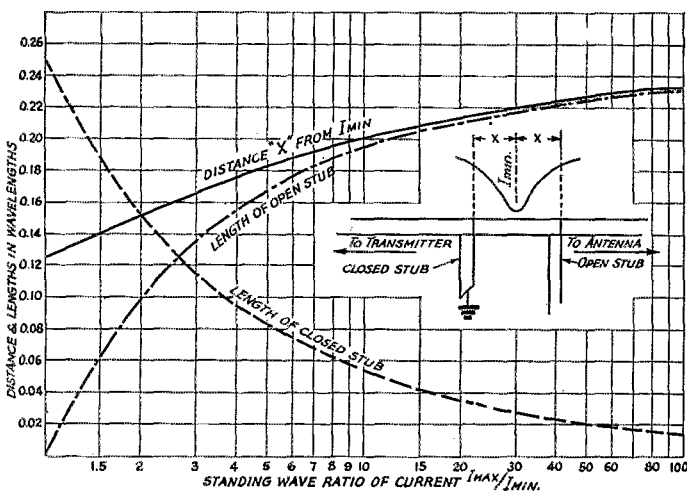

Fig. 6 — Graph for determining matching-stub dimensions and position from the standing-wave ratio of current, I_{max}/I_{min} .

the value of 300,000 km./sec., usually in the vicinity of 95 to 98 per cent of this value. However, for the cases of twisted-pair lines and various types of flexible concentric cable, V may be as low as 55 per cent of the velocity in air, or about 165,000 km./sec. Since the wavelength varies directly with the velocity of propagation, the wavelength of r.f. waves along any of the above lines is reduced by an amount corresponding to the decrease in the velocity of propagation for the line.

In all transmission-line measurements and calculations the *actual wavelength of the r.f. wave along the line should be used, not the wavelength in free space!* For example, a tuning stub is to be attached to a line, and the following data are known:

Frequency = 30 Mc.
 Wavelength in space = 10 meters
 Wavelength along line = 9.6 meters
 X , the distance from I_{min} to attach stub
 = 0.167 (for $I_{max}/I_{min} = 3$)

If the free-space wavelength is used to compute the distance X in meters, a value of 1.67 meters is obtained; but if the line wavelength is used, a value of 0.16 meters is the result. The latter value of 0.16 meters is the correct one to use. The error is not great in this instance, but it should be avoided. Suppose, however, that the impedance-matching device is a quarter-wavelength section of concentric line employed as a matching transformer, and that the velocity of propagation along such a line is 60 per cent of that in air. Now, if the free-space wavelength were used in cutting the transformer section, the length would be 2.5 meters as compared to a length of 1.5 meters resulting from the use of the actual wavelength along the line. In this instance, the error is disastrous. The actual wavelength along a line can be measured by noting the distance between two adjacent current minima and multiplying this distance by two.

Conclusion

Equation (1) should provide the amateur interested in antennas with a powerful tool, because it permits him easily and economically to analyze any antenna system he may design or build. The terminal impedance, or resistance, of his antenna can be computed by means of this equation. In this connection, it should be mentioned that a chart is included in Mr. Carter's article,¹ which greatly facilitates the computation of transmission-line problems. A similar chart, presented in a different form, is included in Terman's new *Radio Engineer's Handbook*.

Strays

Quite amazing is the information about two recently completed transformers to be used for stepping 27,000 volts up to 132,000 for a new aluminum plant. They are each as large as a six-room house and weigh 257 tons. Twelve freight cars were required to ship the units. — *Ohmite News*.



Gold Stars

FLIGHT LIEUTENANT WILFRED LAWRIE CAMERON, RCAF, VE4PX, 31, was killed when the Hampden bomber he was piloting crashed following the siege of Cologne on May 31, 1942. The ship was badly damaged by the enemy during the raid, but he managed to fly it back to England. However, it crashed while landing, and both he and the navigator were killed.



A flying enthusiast as well as a ham, VE4PX was for some years the secretary-treasurer of the Edmonton Aero Club, during which time he qualified as a commercial pilot. He later joined the aviation staff of the Consolidated Mining and Smelting Company. In November, 1939, he joined the RCAF and took an instructors' course at Camp Borden, Ontario. Afterward he served as an instructor at Camp Borden and at Trenton, Ontario, and Brandon, Manitoba. He was promoted to flight lieutenant in March, 1941, and a year later was posted overseas.

ROCCO TORRA, W1FYT, 26, died from wounds received while performing his duties as chief radio operator on a merchantman, when it was torpedoed and sunk in April, 1942. During this ship's many voyages carrying supplies to our fighting men, it was attacked numerous times by Japanese planes, but each time successfully fought off the enemy. On April 8, 1942, Torra's ship was

attacked by a vessel flying no flag. The crew held its ground with stubborn resistance, but was forced to take to lifeboats after several torpedoes found their mark. W1FYT stood by his post, however, transmitting messages for help. Suddenly another torpedo struck the ship, damaging the radio room. Rocco was badly wounded. His few remaining comrades carried him into a lifeboat, where he suffered for many days. Eventually the boat reached India, where he was hospitalized. He died a few days later.



W1FYT joined the merchant marine following his graduation from the Massachusetts Radio School in 1934. When not at sea, his spare time was spent at his home in Boston's "Little Italy," where he operated W1FYT.



A Differential Microphone

Basic Principles of the New Noise-Proof Signal Corps Lip Microphone

BY F. CHEYNEY BEEKLEY,* WIGS

"A midjet microphone, worn on the upper lip, which eliminates outside noises and leaves the hands free, has been adopted for use by the Army Ground Forces and is now in production under the supervision of the Signal Corps, Army Service Forces. . . . Sustained in position by bands around the ears, the 'lip mike' fits easily under gas masks and dust respirators and gives clear and intelligible reproduction with little distortion. . . . Designed particularly for use in tanks and under conditions where free use of the hands is advantageous, the 'lip mike' . . . is supported by metal mounting brackets with two upstanding metal arms attached to loops of cord which fit over the user's ears. . . . A midjet combination—the lip microphone and the earphone headset recently adopted by the Signal Corps—now assures American soldiers of maximum protection and dependable performance." — *Army news release.*

TELEPHONE engineers have long recognized the need for a microphone which would reject noise or other unwanted sounds while providing normal response to the desired sound. There have been many acoustic approaches to the problem and many have found practical application. For use in telephone work, they have ranged from "mouthpieces" to intricately designed cavities and apertures to give directional or frequency selectivity. The well-known "Hush-a-Phone" was a popular adjunct to telephones a few years ago. But means of reducing the access of unwanted noise to responsive surfaces of a microphone have never done more than accomplish a helpful reduction in the amount of noise transmitted along with desired speech.

An interesting approach to the problem which has proved extremely successful is the development which has resulted in the Army's new Model T-45 lip microphone. This microphone is now in increasingly wide use in the U.S. Army

* Advertising Manager, QST.



A group at Ft. Monmouth Signal Laboratories who have been identified with development of the T-45. L. to r. — R. A. Faralla, Signal Corps engineer, Maj. Wm. Marks, Maj. E. K. Morse, F. C. Beekley, WIGS.

Ground Forces and other branches of the service, and another model has already seen battle service with the Allied forces.

For reasons apparent upon examination of its mode of operation, it has been called a *differential* microphone. In this microphone both sides of a single diaphragm, or two complementary diaphragms, are so exposed as to make the microphone unresponsive to unwanted sounds, such as ambient noise, but nevertheless sensitively responsive to wanted sounds, such as certain desired speech. The differential microphone takes advantage of two familiar physical facts: first, that it is relatively easy to so arrange cancellations or balances in mechanical or electrical circuits as to make them unresponsive to external forces, and second, that attenuation of sound in a conducting medium such as air follows an initially steep logarithmic curve.

The Differential Principle

The T-45 is the best current example of a differential microphone. The sketch of Fig. 1 will serve to illustrate the principle upon which it operates. A single diaphragm is supported between two identical cavities which are completely enclosed in the plastic case, *A*, except that each has one small aperture (*J* and *K*), fitted with a moisture-sealing membrane (*G* and *F*) through which sound may enter. *B*, *C*, *D* and *I* form the usual carbon-microphone assembly of carbon granules, retaining ring, fixed contact button, and felt washers. The outer openings of the apertures are spaced in critical relationship. It is apparent that sounds which enter both apertures in equal intensity and identical phase will not cause movement of the diaphragm, because pressures on both sides of the diaphragm will remain equal and opposed. On the other hand, should there be a difference in either amplitude or phase between the sound pressures entering the two apertures, the diaphragm will be actuated by the pressure differential between the two surfaces of the diaphragm and will con-

sequently move in proportion to the magnitude of that differential.

This differential action gives the microphone its ability to distinguish between sounds of close origin and sounds of distant origin. A sound of close origin impinges upon both apertures in the early steep portion of its attenuation curve, in which region the differential in amplitude at the two openings (provided the sound arrives from the correct critical direction) is relatively large. A sound of distant origin, however, is well down on the flat portion of its attenuation curve when it reaches the microphone, and its amplitude is substantially identical at the two openings.

It is surprising that the differential principle was not reduced to workable form at an earlier

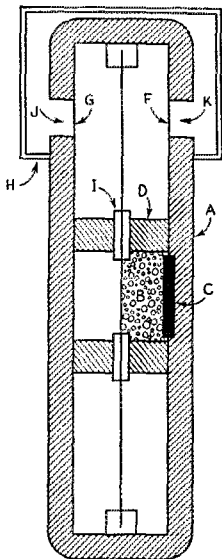
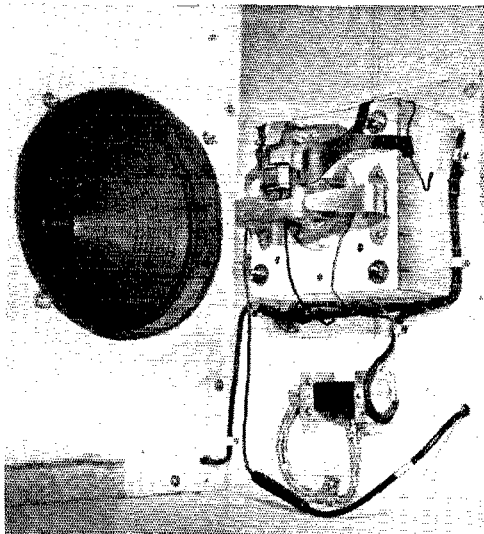

Fig. 1 — Sketch showing the construction of the differential microphone. Details are discussed in the text.

date, since it was not entirely overlooked. A number of engineers thought of canceling out unwanted sounds by exposing to them both sides of a diaphragm. But earlier work failed to attach sufficient importance to amplitude relationship between the two diaphragm surfaces and apparently completely neglected consideration of



The test-chamber in which T-45 microphones are "given the works." The microphone may be seen mounted on the "face," which is actually an artificial voice fed by an audio signal generator. The loudspeaker, fed from recordings of tank noise, maintains within the chamber an ambient noise level of 119.3 db., which is about the deafening level of noise commonly experienced inside tanks. From this location the T-45 will transmit crisp, highly intelligible speech (with only normal conversational voice level at the microphone) with background noise reduced to a scarcely audible level.

phase relationships, with the result that exposing both sides of a diaphragm frequently caused accentuated response to certain frequencies present in the unwanted ambient sound. It is now obvious that, to effect cancellation, the phase angle of relative sound pressures on both sides of the diaphragm must be substantially zero. This has been accomplished by careful design and placement of sound apertures and cavities.

The T-45 is designed to be worn over the upper lip and is held in place by a harness which passes over the operator's ears. The mike itself measures only about $1\frac{1}{4}$ inches square and $\frac{1}{4}$ inch thick. The two sound openings are covered with moisture-proof membranes and the unit will withstand a 10-minute immersion in water without hampering its operation. To increase clearness

Not only in the armed forces but also in industry, the radio amateur — the guy who used to compete for a spot in the BPL or the Century Club, or the "hermit" who strove to make a standard receiving tube perk on one-and-a-quarter — daily is piling up indisputable proof that no substitute exists for the ham's peculiar brand of "know-how." One more "multiplier" has been credited to the hams' war score in the recent release by the Signal Corps of information about a new noise-proof microphone, officially dubbed the T-45. For the prime movers behind this important development, from its original invention to the process of "selling" the Army on its advantages, all were hams who knew what their operator brethren in tanks, planes and other military boiler-factories were facing up at the front. F. Cheyney Beckley, W1GS, *QST*'s long-time advertising manager and an inveterate amateur and experimenter, is the inventor. A. R. Kahn, W9KYM, president of Electro-Voice Mfg. Co., "carried the ball" through the inevitable discouragements of design and redesign. Lt. Col. W. F. Soules, W9DCM, is the man whose patient persistence and first-hand knowledge of military needs kept development work moving in the right direction.

in reproduction, the microphone is fitted with a metal breath shield, *H*, which snaps on over the apertures. This acts as a buffer against puffs of air from the mouth which might cause confusing sounds. Performance curves are shown in Fig. 2.

Principle Applicable to Other Types

In the T-45, the differential principle is applied to a carbon microphone. It is one of the few fundamental improvements in carbon microphones since the work of Emile Berliner. The same differential principle may be applied with equal advantage to microphones of other types. Experimental tests with differential dynamic microphones, for instance, have demonstrated that this type will find wide and valuable applications in both broadcasting and communications. Such microphones will give complete freedom from background noises, such as those encountered in the broadcasting of sports events, and from reverberation in acoustically bad auditoriums. Alternatively, they may be made to pick up a controllable amount of such background, sufficient to provide the desired atmosphere without overriding the speaker's voice. Likewise, differential microphones can be of great usefulness on land-line telephones where background noise at either end of the line frequently and seriously reduces the intelligibility of transmitted speech.

As mentioned previously, the T-45 or "lip" microphone is a strictly wartime development, designed to meet an urgent need for a microphone which would transmit speech of high intelligibility from locations where the ambient noise runs up to deafening levels of 115 db. or higher. Likewise, the T-45 had to fit inside a gas-mask or respirator, had to be "worn" (not hand-held), had to be electrically interchangeable with the long-standard army microphones, and had to meet a dozen other rigid army specifications. The credit for most of the work necessary before the

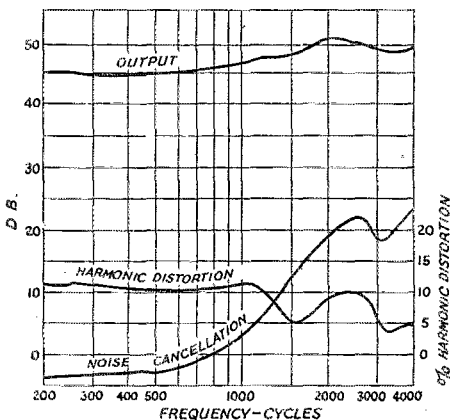

Fig. 2—Performance curves of the differential microphone, showing output of desired signal, harmonic distortion and output of interfering noise vs. frequency, as measured in the test chamber. The noise-cancellation and output curves show relative output with the same sound input level at the microphone.

T-45 was actually in production goes to Louis Burroughs, Chief Engineer of Electro-Voice, and to H. C. Horniekle, Signal Corps Engineer. Much of this work was done under the pressure of greatest urgency and with total disregard of hours or need for sleep and food. The only serious interruption in a solid year of work was when Louis Burroughs took off a Saturday afternoon last summer to get married and was late getting to work on Sunday morning.

Prisoners of War

Ex-W9LBO, Capt. William B. Forsythe, is being held as a prisoner of war. He was shot down while piloting a Flying Fortress on a bombing mission over Germany.

VE2JT, Pilot Officer Lawrence Montgomery, formerly reported as missing in action following the fall of Hong Kong, is being held as a prisoner of war in Java.

Missing in Action

W8UEG, Lt. Howard E. Redding, Avon Lake, Ohio, has been reported by the War Department to be missing following action in Sicily. Leslie H. Richards, W9GDK, of Lake Forest, Ill., also has been reported to be missing in action.

Silent Keys

It is with deep regret that we record the passing of these amateurs:

W2IMQ, Sgt. Bruce W. Castiglione, Paterson, N. J.

W3GOZ, Carl U. Peterson, Somerville, Mass.

W4GIR, L. B. Ussery, Montgomery, Ala.

W6VB, Glenn Gauthier, Venice, Calif.

W7EGY, Harvey G. Selner, Cheney, Wash.

W8DSQ, Rudy Drews, Lansing, Mich.

W8SBH, Jack G. Russell, Williamsport, Pa.

W8STU, Robert L. Long, RM2c, USN, Lockland, Ohio

ex-W9AO, Lt.-Comdr. Fred L. Schoenwolf, Chicago, Ill.

W9ASB, S/Sgt. Leonard V. Anderson, Rockford, Ill.

ex-W9FWC, Theodore N. Johnston, North Platte, Nebr.

W9JYX, Victor C. Ingels, Kokomo, Ind.

W9LFN, Lt. (jg) Allan H. Barstow, USNR, Topeka, Kansas

W9POK, Mildred S. Boreen, Minneapolis, Minn.

W9QGB, Dr. Walter F. Harriman, Sioux City, Iowa

David Grimes, Meadowbrook, Pa.

HAPPENINGS OF THE MONTH



THE AMATEUR WAR RECORD

ATTENTION, amateurs! At ARRL headquarters we are compiling a name-by-name record of the service being performed in the war by American and Canadian amateurs — so as to be able to show after the war what it has meant to our countries to have the services of amateurs available. There are still thousands of you men and women from whom we have not heard. At the bottom of this page is a convenient form easy to fill out which we ask you to clip and send to us — or reproduce its essentials on a post card. Wherever you are in this war effort, if you're an amateur engaged in work with radio or any of its associated branches, we need your record for our common good. And can you give us similar data on your ham associates? Please let us hear from you.

ELECTION NOTICE

To All Full Members of the Midwest Division:

You are hereby advised that no candidates for Midwest Division director and alternate director were nominated under the recent call. By-Law 21 provides that if no eligible nominees be named, the procedure of soliciting and nominating is to be repeated. Pursuant to that by-law, you are again solicited to name Full Members of your division as candidates for director and alternate director. See the original solicitation published at page 39 of *October QST*, which remains in full effect except as to date mentioned therein: Nominating petitions must now be filed at the Headquarters office of the League in West Hartford, Conn., by noon EWT of the 20th day

ARE YOU LICENSED?

When joining the League or renewing your membership, it is important that you show whether you have an amateur license, either station or operator. Please state your call and/or the class of operator license held, that we may verify your classification.

of January, 1944. Voting will take place between February 1 and March 20, 1944, on ballots to be mailed from the Headquarters office the first week of February. The new director and alternate will take office as quickly as the result of the election can be determined after February 20, 1944, and will serve for the remainder of the 1944-1945 term.

You are urged to take the initiative and file nominating petitions.

For the Board of Directors:

K. B. WARNER,
Secretary

November 1, 1943.

ELECTION RESULTS

For the first time in many years the month of November has seen no balloting in ARRL elections. In the Atlantic, Dakota, Delta, Pacific and Southeastern Divisions the only eligible candidates nominated for director were the incumbent directors, and they have therefore all been declared reflected without the need of membership balloting. In fact, except in the Delta, no other candidate was named at all.

(Continued on page 41)

AMATEUR WAR SERVICE RECORD

Name

Present mailing address

Rank or rating

Branch or bureau: Signal Corps, AAF, Buships, WAVES, etc.
If civilian industry, give title and company.

Call, present or ex; or grade of op-license only

SERVICE

- Army
- Navy
- Coast Guard
- Marine Corps
- Maritime Service
- Merchant Marine
- Civil Service
- Radio industry,
100% war

Women as WERS Operators

How Erie, Pa., Solved Its WERS Manpower Problem

BY W. C. WALTER JORDON,* W8SLC

WHEN WERS was first organized in Erie, Pa., in July, 1941, the group consisted solely of men who were licensed amateurs. All of the operating and message handling was done by these hams, and practically no consideration was given the possibility that any other group ever would be necessary to carry on the work they had begun.

As time progressed and the draft made deeper inroads into the manpower of the area, it was found that units were not reporting in for practice periods regularly because of a shortage of personnel. At the same time the organization was expanding, and it became obvious that, if complete coverage on a twenty-four hour basis was to be had, outside help would have to be called upon. This, then, was the problem which the executive committee heads — W8GU, radio aide; W8BHN, communications; W8QJ-W8NOJ, technical, and W8SLC, personnel — found themselves forced to meet.

The plan they hit upon was to hold classes in instruction to train operators for WERS restricted radiotelephone licenses. All members of existing units were encouraged to recruit people in their neighborhoods for instruction in message handling and operation of transmitters.

At first about fifteen men and ten women, the latter being the wives of unit heads, were re-

cruted, and a class was begun. It was decided to hold four classes of two hours each.

At the first meeting instructions on the filling out of the application forms for restricted radiotelephone licenses were given, and sets of questions and answers for Element One were distributed. The next meeting was given over to discussion of the various questions and answers. The following meeting, held two weeks later, was given over to questions pertaining to the examination. At the fourth and final meeting, candidates were given an opportunity to ask questions and to check their credentials for accuracy. All training in actual operation was given during the FCC-assigned practice periods.

As fast as the new WERS operators received their licenses, they were assigned to the control station or to the various units for training under an experienced operator.

Feminine Voices More Easily Copied

The women operators seemed to take to message-handling naturally. Their messages were copied neater, faster, and more accurately. It was found that the higher tonal frequency range of female voices was more easily copied. The executive committee therefore decided to put an item in the local papers requesting women volunteers for WERS, and to do some recruiting through the various civilian defense agencies.

* East High School, Erie, Pa.



A scene at the WERS control center of WJWE in Erie, Pa., during a busy session of practice message handling. The operators, reading from left to right, are: Dorothy Brotherson, Betty Krimmel, Sylvia Broida, Margaret Krimmel, Mildred Green and Eleanor Etter.



An emergency-powered portable field unit of WJWE in action, with Louise Aichner and Esther Bryan as the operators — power and radio, respectively.

With the emphasis thus placed on women volunteers, the initial response far exceeded expectations. The first night 117 persons reported for class. Of these, 82 were women. At this meeting a notary public, a photographer and a state police officer were present, to aid in satisfying FCC requirements regarding applications, fingerprints, etc.

Operators Choose Their Shifts

As each of the new women operators received her ticket, she was assigned to radio control for four hours of practice message-handling. This enabled her to become familiar with the controls, to learn how to keep logs, and to receive, file and transmit messages, including the confidential methods of keying. After each operator had attained confidence and speed and felt satisfied that she could be left "on her own," she was permitted to choose a shift suited to her available time. Although each operator was trained for a zone unit in her neighborhood, she was required also to do a shift at radio control. In this way any operator could be called upon for emergency service, without further training. When any one operator could not keep a schedule, there was a large list of available trained substitutes to be drawn from. All operators were assigned to work in pairs, each cooperating to facilitate the speedy handling of traffic.

All of the new operators who came into the WERS organization in Erie were friends and acquaintances of the original operators. Moreover, they were, in all cases, persons recommended by the original members as showing promise of becoming enthusiastic operators.

Officials Express Approval

The system has worked out very well. Several Army and state civilian defense officials have expressed their approval and commendation. When using men operators, continual difficulties were experienced because of daily working hours, draftings and enlistments. Frequent changes were necessary to keep operators where they were needed. This was largely overcome when the women started taking over as WERS operators. In addition, credit must be given to the women

for their enthusiasm, ability, and willingness to complete assignments.

Although only the unit heads who are responsible for scheduling the operators are amateurs or ex-hams, ham interests have not been "shut out" by any means. Of the whole group of women operators, 10 per cent are working to take the amateur license examination. Regular classes have been set up for this purpose. These classes are being conducted by the school district of the City of Erie as adult night-school classes. By arrangement with the FCC, examinations have been given about every three months. The ham fraternity should be benefited after the war by having such an excellent group to swell the ranks.

As yet no real emergency has been experienced, and there is sincere hope that none will be experienced in the future. Should such an event ever come to pass, however, the women operators of WJWE in Erie would not fail.

Happenings of the Month

(Continued from page 39)

Delta members also nominated W5IRO for director, but he was found ineligible by reason of insufficient continuity of license and of ARRL membership.

As to alternate directors, the Atlantic, Pacific and Southeastern Divisions named only their incumbent alternates, while the Dakota and Delta Divisions also named only one candidate each, although in these two cases he was not the incumbent. Thus the five alternates, three old and two new, were also declared elected without membership balloting.

The Midwest Division alone failed to make nominations. As can be seen from the notice above, the Board of Directors is again soliciting nominations from Midwest members.

The new alternate director of the Delta Division is Samuel H. Dowell, W5ERV, of Shreveport. Mr. Dowell is secretary-treasurer and a director of the Frost Lumber Industries, Inc., manufacturers and wholesalers of yellow pine and hardwood lumber, with which company he has been continuously connected for 44 years. He is an OPS and an OBS.

The Dakota Division chose for its alternate director Aaron E. Swanberg, W9BHY, of St. Paul. Mr. Swanberg has been for many years the service manager of the Northern States Power Company in that city. A past-president of the St. Paul Radio Club and in amateur radio since 1915, he has had a remarkably active career on both c.w. and 'phone, being RM, ORS, OPS, OBS, AEC and AARS. In recent years his chief interest has been in emergency communication and our two Minnesota SCMs have joined in appointing him a statewide assistant SCM for emergency organization. The four splendid emergency nets of the MSN which were in operation at the time of Pearl Harbor were largely his work. He is also Wing Communications Officer of the CAP for Minnesota, with the rank of captain.



U.S.A. CALLING!



DEVELOPMENT WORK

THE president of ARRL, George W. Bailey, W1KH, is technical aide to the director of the Office of Scientific Research & Development, 1530 P Street, N. W., Washington 25, D. C. Dealing largely with personnel matters, he has opportunity from this office to place in interesting and important wartime radio work persons in almost any category of skill. Radio technicians are needed, men as well as women. The particular need is for radio engineers and physicists, and especially for those in the upper brackets of their profession who can assume technical leadership in war problems. You are requested to see our items on this subject in earlier issues. Correspondence is invited with those who seek an opportunity to make the maximum possible technical contribution in the winning of the war, and will be treated confidentially when so requested.

For whatever grade of work in radio one may be qualified, an interesting connection can probably be developed by corresponding with Mr. Bailey at the above address.

BUSTANDS NEEDS LAB MECHANICS

LIFE is pretty interesting these days at the National Bureau of Standards in Washington, particularly in the radio section. The Radio Laboratory has a brand-new second floor, doubling its space; a secluded 400-acre receiving location; a new radio station with four 10-kw. transmitters for standard frequencies. The normal work of the Bureau in developing working standards for this-and-that has now been greatly expanded to involve numerous war projects, many of them of a secret or confidential nature. Although large increases have been made in the staff the Bureau is still in great need of laboratory mechanics, not only in the radio section but in its other activities. While applications are not desired from persons now using their highest skill in war work, the Bureau definitely needs more help—and here is beautiful and interesting work for those who can qualify, particularly in the radio field.

These are civilian positions, the details published in Civil Service Announcement No. 315 at your post office. There are five pay grades, running from \$1752 to \$2798 a year for a 48-hour week. Laboratory mechanics may work in any one of five optional fields: electronic equipment, machine-shop equipment, automotive equipment, electrical equipment other than electronic, and general equipment—which latter may be combinations of the foregoing plus such things as forges, black-smith shops, and so on.

Work deals with the construction, installation, maintenance and operation of such equipment. Applicants must be eighteen years of age unless they reside in Washington or within 50 miles thereof, in which case they may apply for either of the two lowest grades at the age of sixteen. No maximum age.

No written test is required; applicants are judged on their education and experience. A minimum of from six months to 2½ years of full-time paid mechanical experience is required to qualify under the various pay grades; but pertinent education in engineering or industrial arts may be substituted for part of the required mechanical experience. For further particulars, see the item elsewhere in this department on how to apply for Civil Service jobs and get in touch with the nearest Civil Service office.

APPLYING FOR CIVIL SERVICE JOBS

THIS department nowadays carries many items relating to appointment in the federal civilian war service via the Civil Service. These positions are all described in a numbered series of circulars published by the Civil Service Commission and called Announcements. In *QST* we are able to publish only a synopsis of the requirements and opportunities involved in these positions. Those who are interested should go to the nearest Civil Service office and there study the Announcement in detail or write for a copy. The necessary application forms can be obtained from the same source, these varying with different jobs.

In general, this inquiry is to be made of the Secretary, Board of United States Civil Service Examiners, at any first- or second-class post office. However, in certain major cities, listed below, there are what are called United States Civil Service Regional Offices, and in these cities applications should be made thereat rather than at the post office:

Atlanta 3, Ga., New Post Office Bldg.
Boston 9, Mass., Post Office and Courthouse Bldg.
Chicago 7, Ill., New Post Office Bldg.
Cincinnati 2, Ohio, Post Office and Courthouse
Dallas 1, Tex., U. S. Civil Service Commission Bldg., 210 S. Harwood St.
Denver 2, Colo., New Customhouse
New York 14, N. Y., Federal Bldg., Christopher St.
Philadelphia 8, Pa., Customhouse, Second and Chestnut Sts.
St. Louis 1, Mo., New Federal Bldg.
St. Paul 1, Minn., Post Office and Customhouse
San Francisco 2, Calif., Federal Office Bldg.
Seattle 1, Wash., Post Office Bldg.
Winston-Salem 3, N. C., Nissen Bldg.
Honolulu, T. H., Federal Bldg.
Balboa Heights, C. Z., Secretary, Board of U. S. Civil Service Examiners
San Juan, P. R., Chairman, Puerto Rican Civil Service Commission

Forms may also be obtained direct from the U. S. Civil Service Commission, Washington 25, D. C. In any such correspondence the title of the examination desired should, of course, be stated.

NAVY ENGINEERS

THE Navy urgently needs radio engineers to carry out its electronic engineering and radio programs, and offers commissions or warrants to those qualified. In this work there are places both for graduate engineers who have had industrial experience with radio manufacturing or broadcasting and for those who have reached engineer's level through practical experience. Radio engineers capable of administrative work, directing the efforts of groups of engineers, are particularly desired, to head up special development groups in the Bureaus of Ships, Ordnance, and Aeronautics.

Applicants must be American citizens, up to the age of 50. They must be sound physically but special consideration will be given to men with minor physical defects.

For further particulars, communicate with the nearest Office of Naval Officer Procurement.

COMMERCIAL OPPORTUNITIES

MANUFACTURERS and government agencies continue to write us or send up personnel men to examine the qualifications of those who have filed Registrations of Personnel Availability with the League Personnel Bureau. Although the need is not so urgent as in the past, the variety and latitude of employment opportunities should make it worth any man's time to register.

However, we are not magicians capable of pulling the right job for the right man out of a hat. We bring the potential employer and employee together, and the rest is up to them. Nor can we get a release for a man from his present employment because he wants a change. That is a matter between him and the U. S. Employment Service, who will decide whether he can be spared from his present duties to accept a position of higher skill.

If you are definitely on the look-out for something better and feel your education and experience qualify you for more vital work, present your case to the nearest U. S. Employment Service office and get a "Certificate of Availability." In addition, see your Draft Board and determine whether they will allow you to go elsewhere without reclassification to a nondeferrable status.

Unless you hold the necessary permission to leave your present employment, no new employer will consider you. That is not being arbitrary. It would profit neither you nor him to change jobs only to have you inducted soon thereafter. Be sure you can offer him a *corpus delicti* as well as education, training and experience.

So, if you are eager for something better, are available or are in a draft-deferred status, write for a Registration of Personnel Availability blank and our Personnel Bureau will advise you promptly of employment opportunities for which you could qualify.

OPERATORS & TECHNICIANS

EVERY radio amateur interested in changing jobs ought to make it a habit to stop by the post office occasionally and see the Civil Service Announcements. There are many things of interest.

For instance, a bulletin called "Amendments to Announcement No. 134 of 1941" shows the Civil Service Commission seeking radio operators and mechanic-technicians for a number of federal agencies throughout the country. Operator positions pay from \$1970 to \$2190 a year and require a sustained code speed of at least 20 w.p.m. The technician positions pay from \$1752 to \$3163, the beginning requirements being quite modest. See also an item on this subject in November *QST*.

A Signal Corps Report on Enemy Radio Equipment

GERMAN radio equipment is five years behind our own in design, components and construction, according to Capt. James P. Lipp of the U. S. Signal Corps, assigned to the Allied Force Headquarters in North Africa. In a recent report to the Chief Signal officer, Capt. Lipp explained that the Germans apparently standardized their radio apparatus designs during 1934-38. Italian radio gear he dismissed as definitely inferior even to that of their former allies.

Although captured Nazi equipment proved to be obsolete as compared to present American standards, Capt. Lipp reported that it was well built mechanically and could withstand a lot of punishment. He pointed out, however, that the sets tested certainly were not made for use in Africa. They lacked water- and dust-proofing, and stop-gap measures such as tape and various sealing compounds had been used in an attempt to make the sets resistant to moisture and dust. Coils and transformers had not been impregnated to exclude moisture.

Capt. Lipp interviewed a number of German prisoners of war who had been signal men. He commented that, while they seemed to be fairly good operators, they were not well versed in theory or maintenance. In fact, many of the enemy sets picked up had been sealed to prevent the German operators from attempting to make their own repairs. By way of comparison, he said that our own boys, with characteristic Yankee ingenuity, think nothing of repairing or even improvising their own equipment if they have the parts and tools.

Captured radio equipment is not being used by our forces. However, damaged enemy sets are "cannibalized" of such parts as coils, condensers, resistors, tubes, batteries and meters for possible later use in repair and conversion work.

Although much of the captured enemy gear is sent to the Allied Hq. through regular channels, Capt. Lipp and his men scout close to the front lines for their finds.

Three base-loaded vertical antennas are used on the SCR-299. The 15-foot transmitting antenna in the center is held down by a halyard when on the move. The two smaller antennas are for the two communications receivers. When the mobile unit is to be operated from a fixed position, a longer transmitting antenna is used. The antennas are sectionalized and color-coded for ease in erection.

Official U. S. Signal Corps photographs

The Saga of the 299

An Amateur-Type Transmitter Goes to War

BY CY READ, * W9AA

Transmitters and receivers, built for use by hams in peacetime, now are helping to win the battle of communications on our many war fronts. Outstanding in this category is the radio equipment used in the Signal Corps mobile unit, the SCR-299, of which Major General Harry C. Ingles, Chief Signal Officer of the U. S. Army, has said: "That set, scurrying across sands of the desert and over tortuous trails of mountains, helped bring Rommel to his knees in North Africa and helped to keep casualties of American forces surprisingly low in Sicily." This is a story of the part played by hams in the development and production of these vital units for our Army.

MANY a brass-pounder of yesterday is now doing yeoman service "backing the attack" with his skill and patience in the manufacture of outstanding military communications equipment. One of the most famous of all these production jobs with which radio amateurs are directly associated is the Signal Corps SCR-299 high-power mobile radio unit. While the 299 is well-known to most amateur readers, there are many contributing factors in its story which are of particular interest to those operating these sets and to the radio amateur fraternity in general.

On all battlefronts the 299 has proved itself one of the outstanding military communications achievements of this war. The first communication between Generals Montgomery and Alexander in the battle of Tunisia was by means of 299s. They have been used as mobile units, as fixed stations, and as permanent broadcast transmitters. They have been broken down into their various components and flown to our air force in China. They have been landed from amphibious barges. Even while landing operations were in progress on the top side of Africa, the 299 was being used in five networks in connection with the occupation. Communication channels were set up

* 507 W. 62 St., Chicago, Ill.

Seated at one of the duplicate side-by-side operating positions, the SCR-299 operator adjusts loading on the final amplifier by means of the antenna coupler atop the transmitter — which is the military version of the HT-4.

between Oran and England, and from Oran to Casablanca, Gibraltar, Algiers and Accra.

Shortly after the North African campaign was completed, one headquarters corps reported: "During the entire period to date with American forces in North Africa, the SCR-299 radio sets have been a primary and main means of radio communication. They have operated over distances of 2300 miles and have given satisfactory performance at all intermediate distances. . . . The SCR-299 has proven to be the answer to the problem of communications over the extreme distances involved during operations in this theatre. . . . Under combat conditions the SCR-299 has many times been the only link with fast-moving units and proved itself a highly reliable means of communication as constant c.w. contacts were maintained. . . . The SCR-299 is certainly the answer to the demand for an efficient mobile radio station."

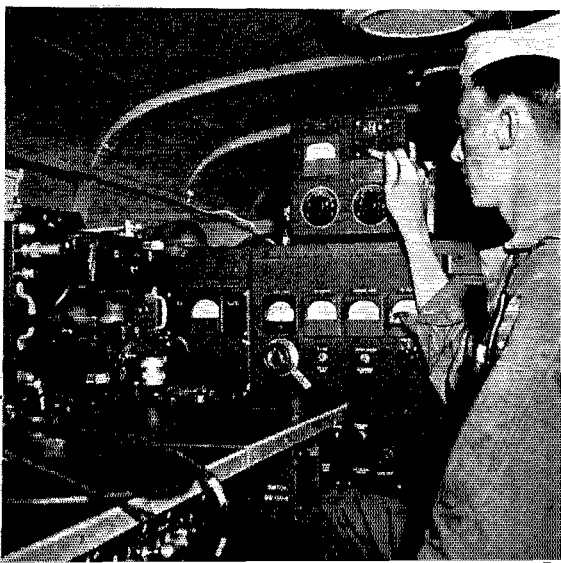

British Generals Montgomery and Alexander credited the speed of their defeat of the Germans in North Africa to the excellent communications provided by the 299. According to General Eisenhower, 299s were credited with directing the re-organization of American troops at Kasserine Pass where U. S. forces counter-attacked and drove the Nazis back to and finally out of Tunisia.

And on the other side of the globe, Lt. Colonel Erwin Stoll, Division Signal Officer in the Southwest Pacific until invalidated home a few months ago, recently reported: "For a period of two months, our only form of communication between New Guinea and the main headquarters in Australia was by the SCR-299."

From the intense heat of Africa to the sub-zero cold of Attu, the 299 has proved itself time and time again. This highly versatile unit has been as important a weapon as the Army's famous jeep or the Garand rifle.

The SCR-299 has played an impressive rôle in winning the battle of communications. Even more impressive, however, is the fact that the heart of the 299 is a ham transmitter — designed by radio amateurs, built by radio amateurs, and originally manufactured for amateur use.

The saga of the 299 begins back in 1938, when a standard transmitter of medium power was placed on the market to provide the amateur with a manufactured unit designed especially for his use. This transmitter was the Hallicrafters HT-4. Its carrier-output rating was 325 watts on 'phone and 450 watts on c.w. The set was designed to cover any three amateur bands with quick-change coils. The over-all frequency range included the amateur bands from 1.7 through 28 Mc. Subsequent selection of any of the three chosen frequency bands was had by means of a switch conveniently located on the front panel.

The original tube line-up was as follows: R.f. — 6F6 crystal oscillator, 6L6 doubler, parallel-RK39 buffer-driver, RK63 final amplifier. Audio — push-pull 2A3 driver, push-pull RK38 modulator. Power — two 5Z3s, two 866s. The accompanying pre-amplifier for voice operation included one 6J7, three 6J5s, and one 80.



From peaceful hamshack to wartorn battlefield — that has been the dramatic history of the HT-4. Here the original 450-watt transmitter, designed and built for amateur use, is shown in a typical prewar amateur installation.

Several refinements were added to the transmitter as time went on. Special antenna couplers were devised to provide maximum transfer of energy to existing antenna systems. The original HT-4 was designed for crystal control only, but a later model, known as the HT-4B, included provision for optional crystal-controlled or m.o.p.a. operation. Otherwise, the unit was essentially the same as the HT-4.

The Army Sees a Need

The next chapter in the story began in 1940, when the Army conducted its now-famed Louisiana maneuvers. It became apparent to Major General Dawson Olmstead, then the Chief Signal Officer, that a highly advanced mobile unit was needed to maintain communications with widely separated troops. Modern blitz warfare with its fast-moving armored forces required the use of specialized units to provide facilities for maintaining vital contact between various forces. A set was required that would be capable of transmitting by voice infallibly over a distance of at least 100 miles.

Faced with the problem of finding such a set, the U. S. Army Signal Corps searched the commercial market. They discovered that the HT-4 transmitter was ideally suited for the job. Because of its compactness and stability, it could be used in an especially designed truck and trailer unit and could be operated either while in motion or at a fixed location.

It is now history that the HT-4 was adopted by the Signal Corps as the basic unit around which the rest of the SCR-299

Hams and will-be hams on the production lines form part of the Victory circuit that supplies the U. S. Army (and the British and French and Chinese armies, too) with BC-610E transmitters for the vaunted SCR-299 mobile units.

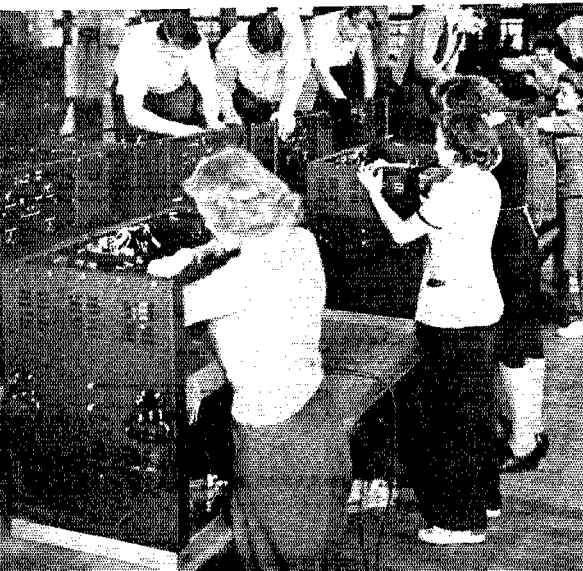

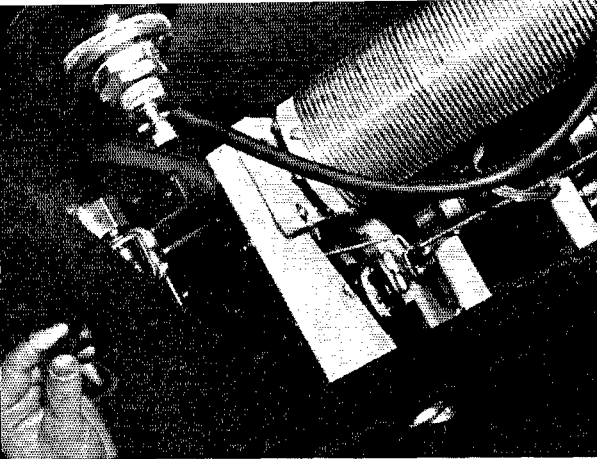

Inside the external antenna coupling and loading unit. Turning the crank-handle drive actuates a gear mechanism which varies the loading-coil inductance. Visible under the coil is a high-vacuum tank-circuit condenser.

was evolved. With certain additional refinements and incorporating an improved antenna coupler, this set has proved its mettle in solving the problem of high-powered mobile communication which is a fundamental in modern techniques of warfare.

One of the first requirements was to adapt the transmitter for complete coverage of various Signal Corps frequencies. When this was completed, an official Signal Corps number was assigned—BC-610. Later models were designated BC-610A, BC-610B, BC-610C and BC-610D. The current model is the BC-610E.

In essentials the transmitter in the 299 is much the same as the original HT-4, a simplified schematic diagram of which is given in Fig. 1. The circuit alterations have been few. To provide more flexible control of the equipment within the mobile unit, several relays were added which afford rapid change-over between 'phone and c.w. Protective relays also were added, to safeguard the equipment from overloads.

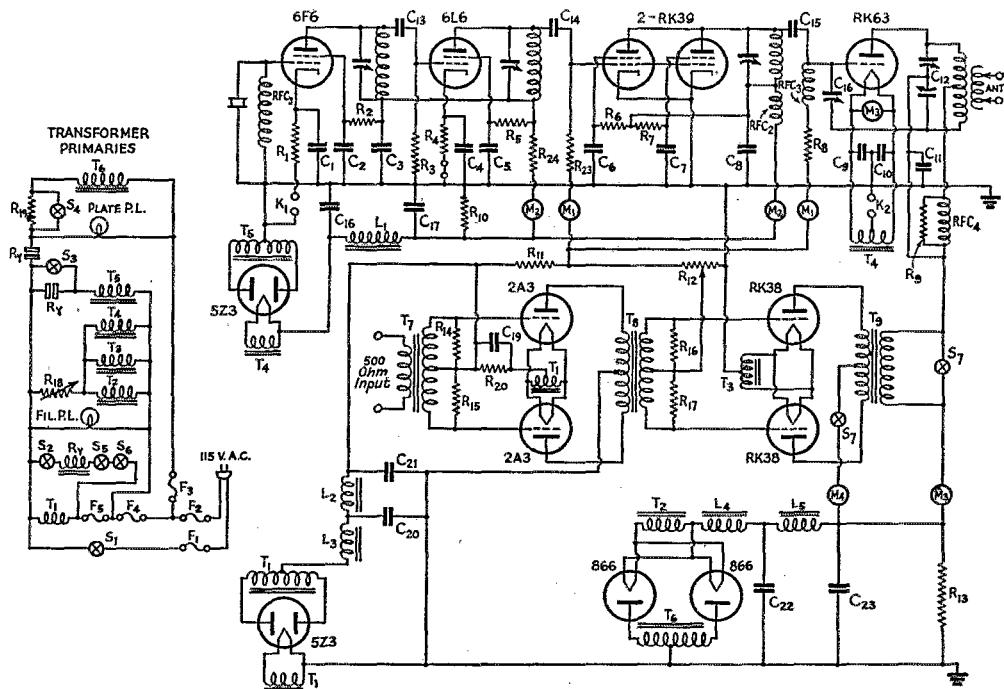

Fig. 1 — Simplified circuit diagram of the HT-4, prototype of the BC-610 — transmitting heart of the 299.

- C₁, C₄ — 0.006- μ fd. mica, 1000 volts.
- C₂, C₃, C₅, C₆, C₇, C₈, C₁₅ — 0.002- μ fd. mica.
- C₉, C₁₀ — 0.01- μ fd. mica, 1000 volts.
- C₁₁ — 0.002- μ fd. mica, 6000 volts.
- C₁₂ — 110- μ fd. per section variable.
- C₁₃ — 100- μ fd. mica.
- C₁₄ — 200- μ fd. mica.
- C₁₆, C₁₇, C₂₀, C₂₁ — 8- μ fd. electrolytic, 600 volts.
- C₁₈ — Neutralizing condenser.
- C₁₉ — 20- μ fd. electrolytic, 100 volts.
- C₂₂ — 2- μ fd. oil-filled, 3000 volts.
- C₂₃ — 4- μ fd. oil-filled, 3000 volts.
- R₁, R₂₄ — 1500 ohms, 10 watts.
- R₂, R₃, R₆, R₇, R₁₆, R₁₇ — 20,000 ohms, 2 watts.

- R₄ — 500 ohms, 10 watts.
- R₈ — 1000 ohms, 10 watts.
- R₉ — 700 ohms, 25 watts.
- R₁₀ — 40,000 ohms, 25 watts.
- R₁₁ — 2500 ohms, 100 watts (adj.).
- R₁₂ — 500-ohm 50-watt variable.
- R₁₃ — 75,000 ohms, 200 watts.
- R₁₄, R₁₅ — 0.1 megohm, $\frac{1}{2}$ watt.
- R₁₈ — 15-ohm 75-watt rheostat.
- R₁₉ — 600-watt heater element.
- R₂₀ — 750 ohms, 10 watts.
- R₂₁, R₂₂ — 50 ohms, $\frac{1}{2}$ watt.
- R₂₃ — 6000 ohms, 2 watts.
- RFC₁-RFC₄ — R.f. chokes.
- L₁ — Exciter filter choke, 300 ma.
- L₂, L₃ — Filter chokes, 250 ma.
- L₄ — Input choke, 500 ma.

- L₅ — Filter choke, 500 ma.
- T₁ — Bias and audio power transformer, 375 volts, 250 ma.
- T₂ — 866 filament transformer, 25 volts, 10 amperes.
- T₃ — Modulator filament transformer, 5 volts, 16 amperes.
- T₄ — Final-amplifier filament transformer, 5 volts, 10 amperes.
- T₅ — Exciter plate transformer, 450 volts, 300 ma.
- T₆ — High-voltage plate transformer, 2000 volts, 500 ma.
- T₇ — Line-to-tube p.p. input transformer.
- T₈ — Driver interstage transformer.
- T₉ — Modulation transformer.

The 299 goes into action. (1) In the truck are two complete operating positions and a transmitter capable of 450 watts c.w. output and 300 watts plate-modulated phone. The gasoline-driven generator is in the trailer. (2) A Signal Corps technician turns on the ignition switch preparatory to starting up the generator. Long power lines are provided so the trailer may be detached from the mother unit and operated a short distance away, minimizing ignition noise. (3) A runner hands the radio operator an urgent message to be transmitted immediately to a headquarters which may be hundreds of miles away. (4) "B for Baker calling headquarters" — and the message is on its way. A "push-to-talk" switch on the microphone throws the transmitter on the air and kills the receivers. The control panel is immediately in front of the operator, flanked by the two receivers. Field telephones may be coupled to telephone lines strung from reels on the rear of the truck when operating at a fixed position. The transmitter can be modulated by a voice miles away by the use of these telephone lines.

Special fastenings were devised to ensure that the heavy transmitter could not be jarred loose from its place within the fast-moving truck. Other refinements included the "floating" or shock-absorbing mounting of the unit. Recent reports from North Africa disclose that several of these units, after having traveled many thousands of miles over the roughest terrain, were still in perfect operating condition both mechanically and electrically.

In recent months several changes have been made in the antenna coupler for the transmitter. The transmitting antenna on the 299 is a vertical ship-type antenna approximately 15 feet long mounted on a rugged insulator of special design, it being impossible to make use of standard long-wire antenna systems on a mobile unit, of course. It was necessary that the coupler be so designed that a maximum transfer of energy to the antenna could be obtained on each of the many frequencies used by the Signal Corps.

There are certain opportunities, in fixed locations, to use conventional antenna systems — some of them highly elaborate. In fact, many of the mobile units are now being used as permanent broadcasting stations which have been set up to handle important communications.

Not only is the 299 capable of giving yeoman service as a radio unit, but other accessories, such as portable telephone sets, broaden its scope considerably by permitting scouting parties to proceed afoot over a considerable distance and yet maintain contact with the truck from remote points by wire.

The contents of the truck would be the envy of any radio amateur. A complete set of spare parts and tubes is carried with each unit. Operators receive complete training in maintenance as well as in the operation of the transmitter and receivers. Many of these units have been serviced under shell fire. In some instances, the gasoline-driven motor generator has been in operation for periods in excess of 3000 hours without overhaul. When one considers the terrific pounding such equipment takes, it might be assumed that considerable difficulty would be encountered from mechanical breakdowns — but such is not the case. Reports received at Washington from many

(Continued on page 98)

December 1943

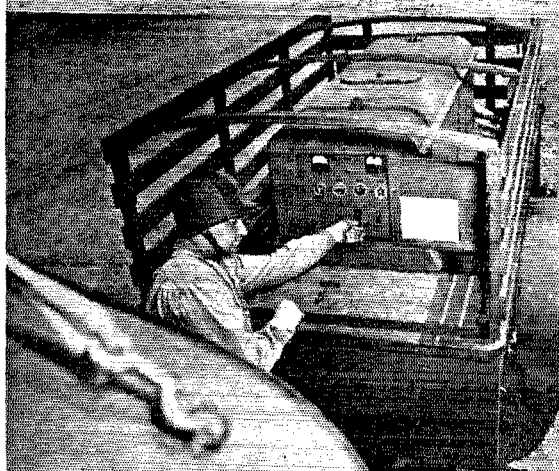

A Transceiver for Mobile WERS Work

A Design for Application

BY W. E. BRADLEY,* W1FVH

Just another WERS transceiver? Don't bet too heavily on that, because this design makes use of some ideas which are well worth considering when plans are being laid for that next WERS rig.

A CASUAL survey of recent articles describing WERS equipment might lead one to the impression that gear for this service is becoming more or less stereotyped. We see a succession of transceivers and transmitter-receivers outwardly of much the same appearance and often using the same tube complement. However, closer study of details will show that each differs from the others in some respect. Each builder has encountered individual problems created by the scarcity of parts for civilian use or the requirements of a particular application, but each has shown us ways of solving at least some of these problems.

The mobile transceiver shown in the accompanying photographs is a case at hand. While it is basically similar to others we have seen, nevertheless it includes certain innovations in circuit and construction which should interest those who are looking for new ideas in WERS gear.

Circuit Details

The circuit diagram of the unit is shown in Fig. 1. The oscillator-detector is quite conventional. Any of several receiving-type triodes will work

* Technical Information Service, ARRL.

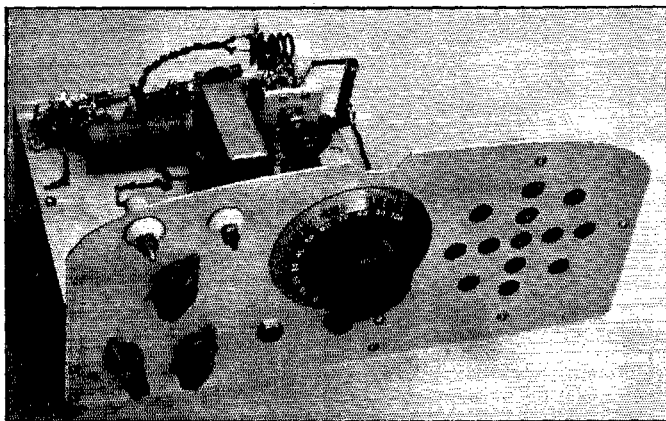

The panel of the WERS transceiver is shaped to fit the glove compartment of a car. The two lower small controls are for regeneration and receiver audio gain, while the upper one is for the change-over switch. The microphone jack is to the left and the insulated headphone jack to the right, under the dial.

satisfactorily in the parallel-fed ultraudion circuit. Parallel feed also must be used in the grid circuit, to permit an arrangement for changing grid-leak resistance when shifting from transmitting to receiving without placing the switch at a point of high r.f. potential. The grid choke is necessary, of course, both to remove r.f. from the lead to the switch and to prevent excessive loading by the low value of grid-leak resistance when transmitting. C_3 is connected to one of the switch points rather than to the arm, so that it does not by-pass the higher audio frequencies when transmitting. R_3 is the usual regeneration control.

Those who have used any of the general run of transceivers have learned that the use of a common audio volume control for transmitting and receiving leaves much to be desired, to say the least. Depending upon the number of visiting firemen and the amount of other racket at the station, the setting of the receiving volume control to give the desired level may be at almost any position within its range. Since proper modulation of the transmitter, on the other hand, requires that the volume control be set at a fixed optimum position, this means continual setting and re-setting of the volume control between transmissions if maximum transmitter performance is to be obtained. Aside from the nuisance angle, most volume controls deteriorate rapidly under constant use of this sort. In this case, the problem was solved very successfully by employing a dual triode as an audio mixer.

The detector output is coupled through T_1 to one grid of the 6N7 while the microphone transformer feeds the second grid, thereby providing a separate and independent audio channel for each and making a transceiver transformer unnecessary. Transformer coupling is used in the detector circuit simply because an old interstage transformer was found in the junk box. If weight is a factor or a suitable transformer is not at hand, resistance coupling may be substituted. A 50¢ bell-ringing transformer normally delivering between 1.5 and 10 volts may be used to replace the microphone transformer. In either case the microphone should be connected to the low-voltage winding, of course. Microphone voltage is taken

from a tap on the cathode biasing resistor for the audio output stage.

R_3 is the receiver volume control. Its adjustment has no effect upon the gain of the microphone amplifier. Since there is no need normally for an alteration in the gain of the latter, once it has been set for proper modulation, no variable control is provided. Initial adjustment may be made by changing the tap on R_3 , which changes the microphone voltage, or by altering the value of R_5 , which limits the voltage output of the mixer stage. If desired, a variable control may be connected across the output of the microphone transformer.

The plates of the audio mixer tube are in parallel, so that signals on either grid will be reproduced in the common plate circuit. If resistance coupling rather than transformer coupling is used in the detector circuit, it may be found desirable to increase the value of R_5 to compensate for the loss in gain through the transformer. J_2 is provided for headphone reception. This jack is connected so that insertion of the plug automatically cuts out the plate resistance, R_5 , and also opens the coupling to the output stage, thereby killing the speaker. The tetrode output stage is conventional.

Since no r.f. switching is involved, the change-over switch requires no special insulation. In the "receive" position it connects the receiving grid leak, the receiver audio channel and the loud-speaker into the circuit, while the microphone voltage is cut off. Throwing the switch over to "transmit" connects the lower-resistance grid leak, shifts the output stage over for modulation,

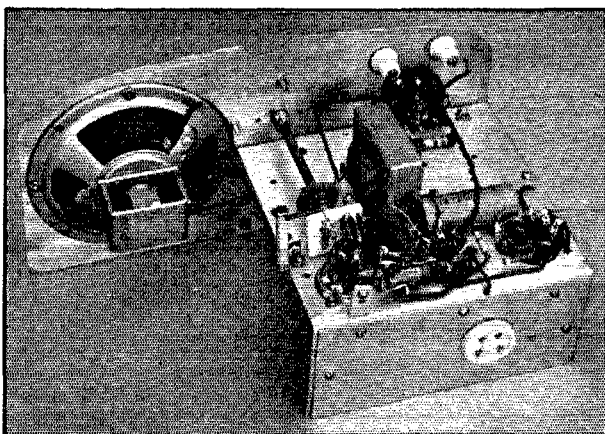

Rear view of the WERS mobile unit. The plate r.f. choke is to the left of the tuning condenser, while the grid choke is behind the condenser.

closes the microphone circuit, and opens the speaker voice coil.

Choice of tubes is by no means limited to the metal types shown in the photographs. These were used simply because they happened to be on hand. A 6C5, 6F5, 6K5G, 6P5G, 6AC5G or 7A4 could be used in place of the 6J5 detector-oscillator with minor adjustments in coil dimensions and grid-leak resistance. Similarly, almost any of the dual triodes such as the 6A6, 6Z7G, 6SC7, 6F8G or 6C8G might be used in the audio mixer stage. A 6A4, 6V6G, 6L6G, 6K6G, 8G6G or 6F6G will substitute for the 6L6 in the output stage.

Construction

Most of the constructional details are apparent from the photographs. The panel is $12\frac{1}{8}$ inches

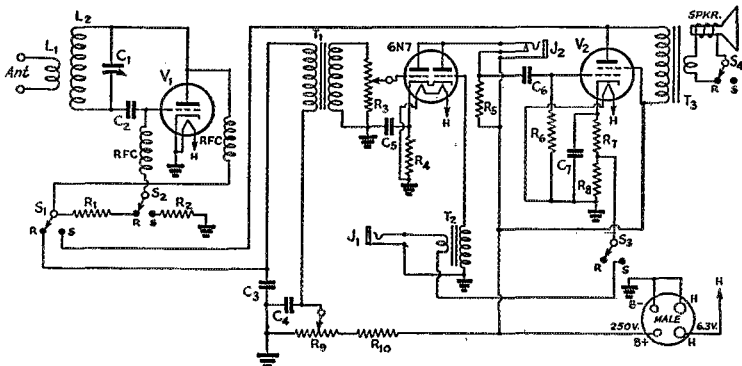

Fig. 1 — Circuit diagram of the WERS mobile transceiver.

- C_1 — 12- μ fd. variable (Hammarlund "micro" type, altered as described in the text).
- C_2 — 50- μ fd. mica.
- C_3 — 0.006- μ fd. mica.
- C_4 — 0.1- μ fd.
- C_5 — 10- μ fd. 25-volt electrolytic.
- C_6 — 0.1- μ fd. 400-volt paper.
- C_7 — 25- to 50- μ fd., low-voltage electrolytic.
- R_1 — 2 megohms, $\frac{1}{2}$ watt.
- R_2 — 5000 ohms, 1 watt.
- R_3 — 500,000-ohm volume control.

- R_4 — 1750 ohms, 1 watt.
- R_5 — 15,000 ohms, 1 watt.
- R_6 — 500,000 ohms, $\frac{1}{2}$ watt.
- R_7 — 250 ohms, 1 watt.
- R_8 — 200 ohms, 1 watt.
- R_9 — 50,000-ohm potentiometer.
- R_{10} — 50,000 ohms, 1 watt.
- L_1 — 1 turn No. 12 or No. 14, $\frac{3}{16}$ -inch diameter.
- L_2 — 3 turns No. 12, $\frac{3}{16}$ -in. diameter, turns spaced to hit band.
- RFC — 55 turns No. 30 d.c.c. on $\frac{1}{4}$ -inch form.

- J_1 — Open-circuit jack.
- J_2 — Closed-circuit jack.
- T_1 — Interstage transformer.
- T_2 — Microphone transformer (see text).
- T_3 — Universal output transformer.
- V_1 — Detector-oscillator tube (see text for suggested types)
- V_2 — Output tube (see text for suggested types).
- S_1, S_2, S_3, S_4 — Sections of 4-pole double-throw rotary switch.

long and 6 inches in over-all height, while the chassis is 6 inches wide, $6\frac{3}{4}$ inches deep and 3 inches high. Both are made of $\frac{1}{16}$ -inch aluminum sheet salvaged from a previous constructional job. This accounts for the "spare" holes scattered about the chassis. The unit was designed to fit into the glove compartment of a 1935 Pontiac, and the dimensions given above may have to be altered somewhat to fit other cars. In this connection, it will be helpful to read the article by W2DVG in the August, 1943, issue of *QST*,¹ which furnishes several good suggestions for doing the metal work. The panel is shaped to fit the contour of the glove-compartment opening. The entire unit may be slid in far enough to the rear to permit closing and locking the compartment door, thereby making it inaccessible for operation by unauthorized persons as required in WERS regulations. However, the unit can be removed from the car in a matter of a few seconds and set up on an operating table for fixed-station use.

The chassis occupies the left-hand half of the panel, leaving room for the 5-inch p.m. speaker on the right. Half-inch holes are drilled in the panel to form a grille for the speaker.

To raise the National type-A dial up from the lower edge of the panel, where it can be operated more conveniently, the tuning condenser, C_1 , is mounted on top of the chassis. The extra plates should be removed from the condenser before it is mounted, leaving but two rotor and two stator plates. One of the protruding stator bars should be cut off flush with the rear stator plate to make room for the rotor terminal, which is bent into position opposite the remaining stator bar. The coil, L_2 , is then soldered into position at these points. By mounting the detector-oscillator tube upside-down, immediately behind the condenser, it is possible to make a direct connection between the condenser stator terminal and the plate terminal on the tube socket. The distance between rotor and grid terminals is shorter than the length of the midjet grid condenser. An insulating shaft and flexible coupling connect the dial to the shaft of the tuning condenser.

¹ Forster, "Constructional Aspects of WERS Mobile Installations," *QST*, August, 1943, p. 34.

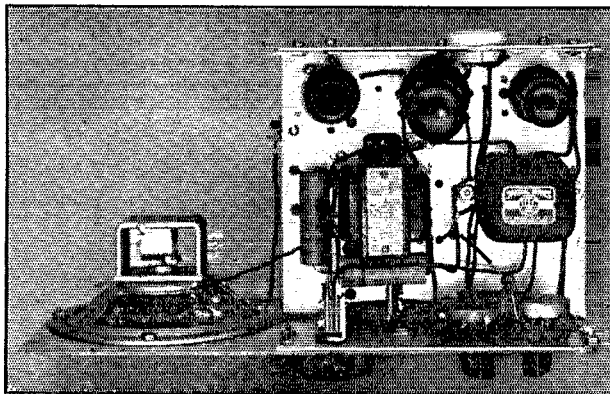

A bottom view of the mobile transceiver — even though it looks like the usual top view. All audio and power leads are kept below the chassis.

A simple arrangement consisting of a fibre lug strip fastened to a metal angle piece provides a means for adjusting the antenna coupling coil, L_1 , with respect to the tank coil. The twisted-pair lead from the coupling coil and the feed-through insulators which serve as antenna terminals has since been discarded in favor of a short spaced line.

The two audio tubes also are mounted in an inverted position, with the dual triode at the left-hand end of the chassis to keep the grids well removed from the r.f. field of the detector coil, and the output stage in the center.

The output transformer, T_3 , is mounted on top of the chassis, while the microphone and inter-stage transformers are underneath. A cut-out must be made in the front edge of the chassis, near the panel, to make room for the change-over switch. Since the lower portion of the switch comes below the chassis, it is not necessary to bring audio leads above the chassis to reach the switch terminals. The regeneration control, R_2 , and the audio gain control, R_3 , are mounted side-by-side underneath. The headphone jack must be insulated from the panel, but the microphone jack may be mounted directly on the panel without insulation. Both jacks are placed below the tuning dial. A four-prong socket, mounted at the rear, is provided for power-supply connections.

Any power supply delivering between 150 and 250 volts is suitable, higher voltage giving somewhat greater output when transmitting. The detector will superregenerate at about 45 volts.

Adjustment and Performance

Unavoidable variations in construction or wiring may make it necessary to make one or two slight adjustments when the unit is placed in operation. For example, it may be found possible to increase the grid-leak resistance without running into squegging. If a higher value can be used, so much the better. In a similar transceiver, a low-frequency growl appeared on the carrier when transmitting. This was eliminated by placing a 50- μ fd. low-voltage electrolytic across R_3 .

The voltage stability seems to be quite good, since there is very little change in frequency when shifting from receiving to transmitting. The audio gain provided by the mixer stage is more than adequate for both transmitting and receiving. Plenty of speaker volume is obtained with R_3 set at about one-third of maximum. This possibly accounts for the fact that, when comparison checks were made against other transceivers, it was possible to reduce antenna coupling appreciably and still keep the same output signal strength. This resulted in a very noticeable increase in selectivity. Two stations which interfered badly on the comparison unit were well separated on this receiver. Signal strength on transmissions does not appear to be reduced noticeably even when the antenna coupling is a full half-inch from the tank coil.



ON THE VERY HIGHS

CONDUCTED BY E. P. TILTON,* W1HDQ

IF EVIDENCE was ever needed to prove to us the importance of the work of the American amateur in his country's war effort, both in the armed services and in important civilian positions, we found it in abundance when we embarked on our new job, which brings us just about as close to the war as a civilian has a chance to come. Wherever there are jobs which call for a good working knowledge of radio principles or the ability to handle communications of any kind, there you will find hams, in quantity, delivering the goods.

Looking over the lists of field engineers of the companies making secret u.h.f. gear, for instance, one finds at least 80 per cent of them to be licensed amateurs, and the men in uniform who operate and maintain the equipment show an equally high percentage of hams. In the group of five men who took preliminary training with your conductor, four were former active amateurs — W4AEW, W4HKP, W3FQY, and the writer — and previous groups followed a similar pattern.

Out on our first field job, at the Boston Navy Yard, we ran into Horsetraders Ernie Grant, W1GJZ, and Ken Bishop, W1EWD. Aboard a French battleship the following day in the company of fellow-employees W1AYG and W1BWR and with Navy Radio Engineer W3EQS in tow, we met Master Radioman Lucien Argouarch, F8JK, of Toulon. Now, for the moment, we are in Miami, where the Radio Material Office has Worcester, W1KVV, and Jenard, W1JMT, in uniform, and Arledge, W5SI (ARRL Delta Division director), and Gardener, ex-XU2MC, civilian engineers. Field engineers representing manufacturers in the u.h.f. field at this office include W4GHC and W4CMP (as well as your conductor) and, temporarily, that v.h.f.-man extraordinary, W6OVK. We understand that, when we go down to Key West next week, we will land in another nest of hams, including Ed Hunter, W4FLH, who used to keep the 5-meter band hot here in Miami in years gone by. And so it goes — everywhere one finds amateurs doing outstanding work, because they have enthusiasm for their jobs and that all-important "know-how" which comes from years of practical radio experience.

We used to hear frequent complaints from would-be 56-Mc. enthusiasts that they would be more active on Five if only there were more stations to work. For their benefit we cite the case of F8JK, who used to plug away on Five with a crystal-controlled doubler in the hope that a contact might some day be forthcoming. His location was close to sea level with hills rising abruptly in back of him, so that the chance of contacts overland was practically nil. His pa-

* 329 Central St., Springfield, Mass.

tience was rewarded on just one occasion, by a contact with another die-hard in Casablanca.

Our conversations with F8JK were quite an experience, as he speaks no English and we are equally tongue-tied in French. But the language of amateur radio is universal, and by means of diagrams, pictures and much gesticulating we were able to complete a "one-hundred per cent QSO." Lucien sends his greetings to all American hams, and he promises to be active again on 56 Mc. as soon as the job at hand is completed. Let's hope that he will provide us with the first W-F QSO on Five — and may it be soon!

— . . . —

Remember W9BJV, who used to be active on Five in Watertown, S. D.? Stan writes from North Africa that he would like to hear from any of the gang he used to work back in '39, '40 and '41. His address: Major S. L. Burghardt, Signal Corps Division Hq., APO 34, New York City.

W1MEG, a former 112-Mc. man who used to be on in Hartford and mobile up around the Boston area, informs us that he has been in the Signal Corps since September, 1942, and is now stationed at Ft. Monmouth. His address: Cpl. Gordon E. Hopper, 11088371, Co. M, 15th Sig. Tng. Reg., Ft. Monmouth, N. J.

We still hear of instances of amateurs of long standing and good qualifications being assigned to jobs in the armed services which do not take their experience into account. One such is the case of W3BYF, formerly on 5 and 2½ at Allentown, Pa. Although holder of first-class commercial and Class A amateur tickets, Pres landed in the coast artillery. He has hopes of an early transfer, however. At last writing, his address was: Pvt. Preston Schuler, 33831251, Bat. C, 509th AAA Gun Bn., Camp Edwards, Mass.

W1JMT, RT3c, Miami, formerly of Pawtucket, R. I., is still kicking himself for not sending in a report of his participation in the June (1941) UHF Relay Contest. Working portable atop Mt. Greylock and Mt. Wachuset over that week-end, he amassed enough contacts to have placed him at the top of the list — a fact he realized only after seeing the summary of the contest results in *QST* some months later!

— . . . —

Many of us are working on devices which are necessarily secret. These devices operate on new principles, in many cases, and some of these systems have interesting possibilities for amateur applications. We're working on frequencies formerly unheard of in amateur circles, too. What effect will all this have on the place of amateur radio in the postwar world? Having had a look at

(Continued on page 108)

Hamfest in Khaki—II

Fort Monmouth Hams Air Postwar Views

BY CAPTAIN SPENCER ALLEN,* W9JGL

MORE than eighty ex-hams and radio hobbyists attended the second annual hamfest held last month at Ft. Monmouth, home of the Eastern Signal Corps Training Center. The principal speaker was Col. Julian Millar, W2BME, of the Signal Corps Board, who related some of his experiences as a ham for many years and gave a preview of innovations in amateur radio that

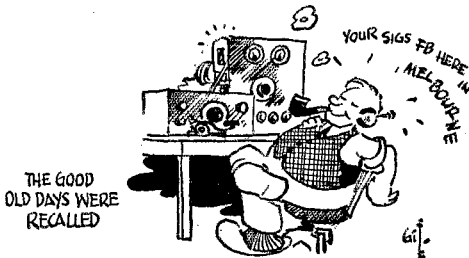

might be expected after the war, particularly in new tube types and in new techniques of micro-wave generation and transmission. Col. Millar also envisioned the resumption of amateur radio after the war as a strong factor in cementing the friendly relations which have developed between the United Nations during wartime.

Following Col. Millar's address, the assembled hams were given demonstrations of the Signal Corps' new f.m. "walkie-talkie" and the police-type f.m. mobile transmitters. The amateurs were particularly interested in the latter rigs as they envisioned these transmitters available after the war in large quantities, returned for 5- or 10-meter mobile operation.

Postwar Discussion

The greater part of the evening was taken up by open-forum ragchewing on topics of postwar interest to hams. Both officers and enlisted men entered into the discussions.

The group was practically unanimous in its opinion that licensing of amateurs should be made stiffer after the war for all three classes of amateur tickets. Most of the amateurs present believed that more stringent licensing would be necessary, owing to the increased number of potential hams created by the Army and Navy. While most seemed to believe that the amateur was obliged to develop his technical knowledge to the highest state of the art, there was a sizable and articulate minority which believed that ham radio is essentially a hobby in which one indulges for pleasure, and that one is not obliged to "become a Steinmetz" so long as he conforms

*Post Public Relations Officer, Fort Monmouth, N. J.

to the standards of operation set forth by the FCC. The pros and cons on this topic would have continued for the rest of the evening had not the moderator moved on to the next subject.

An interesting reaction was obtained from the group on the subject of 40-meter 'phone. 'Phone operation from 7250 to 7300 kc. was authorized by the FCC late in 1941, but Pearl Harbor came along before such operation went into effect. Most of the hams were opposed to 'phone-on-forty for two reasons: one was that 40 meters is the brasspounder's own band, upon whose sacred frequencies no modulated [U. S. amateur] signal was ever heard. The c.w. men wished to keep it that way. The other reason, voiced by the 'phone men, was that a 'phone band 50-kc. wide would be as undesirable as no band at all, because the QRM would be four times as bad as on 20 meters. The 'phone men qualified their objections by suggesting that perhaps 'phone on 40 might be bearable if another 50 kc. were added to the original 50 kc., providing it went from 7300 to 7350 kc. Another suggestion was to authorize 'phone from, say, 7200 to 7300 kc. during daylight hours only.

The discussion of 20 meters brought out the inherent sportsmanship of the ham, both c.w. and 'phone men displaying understanding of the other's problems. The 'phone men would have liked a wider band, but not at the expense of their c.w. brethren—and vice versa. Based on the assumption that no wider band of frequencies than was previously held at 14 Mc. could be obtained after the war, the majority opinion favored moving the 100-kc. 'phone band to one end of the 14-Mc. strip—either the high or low end. This would allow the c.w. men a continuous stretch of operating frequencies free from 'phone signals, although it would be of no particular advantage to 'phone operation.

On the question of power limitation, practically all were in favor of keeping the present standard—one kilowatt input to the final amplifier. Although the majority of amateurs had considerably less than a thousand watts of power, it was something to dream about, went the opinion—and why offer to give away something we already had?

PRACTICALLY ALL WERE IN FAVOR OF THE PRE-WAR POWER LIMIT

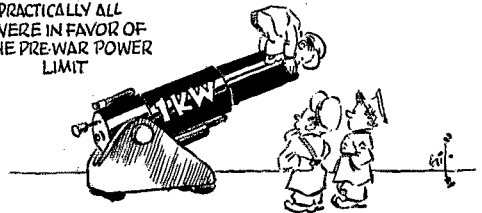

Crystal vs. E.C.O.

Crystal vs. e.c.o. operation also was discussed. Many believed that the e.c.o. would supplant the crystal as a means of frequency control because it is much more flexible. On the other hand, it was pointed out, crystals will be as plentiful as popcorn after the war, and probably just as cheap. The deluxe ham of prewar years who had, say, half-a-dozen crystals will be able to afford perhaps fifty crystals at no more than his prewar outlay for six. On the subject of e.c.o., some of the fraternity who delighted in swishing up and down the band and parking on a DX CQ were brought to task in the discussion. When it was suggested that perhaps an ARRL standard or FCC regulation on the use of e.c.o.s be defined, however, the proposal met with strong opposition.

"That won't be necessary," said one soldier-ham. "Amateurs have always been pretty efficient in policing their own ranks and frequencies. If some fellow gets out of line on the way he operates, e.c.o. or otherwise, the rest of the gang will take care of him. The old 'silent treatment' always works."

One subject on the docket for discussion was "The Ideal Postwar Receiver," but taps sounded before the question could be brought to the floor. However, two or three hams remarked later that they would like to see a receiver with two "front ends" or r.f. sections, and a common audio

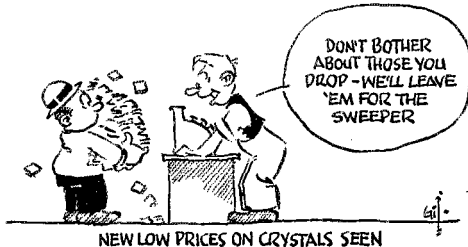

section. One r.f. section would tune from 545 to 15,000 kc., using low frequency i.f.s; the other section would cover from 15 Mc. to 116 Mc., using 1500-kc. i.f.s, with acorn tubes and other special circuits desirable on the higher frequencies. This section would also be combination a.m.-f.m. With such a receiver, the entire spectrum from 545 kc. to 116 Mc. could be covered at maximum efficiency without resorting to two complete and separate types of receivers. Each r.f. section would have band-switching, of course. None of the hams who made these suggestions would venture to prescribe a fair price for such a receiver.

There was general assumption on the part of all hams present that amateurs would have their old frequencies restored after the war. None appeared particularly worried about the fact that many services are now operating in the amateur bands, although there was some question raised concerning domestic commercial broadcast stations now heard in the 7-Mc. strip. On the whole, the hams were quite proud of what they, as a

group, have done in the war effort. Thousands of them, it was pointed out, came into the Signal Corps and the Navy as expert operators and maintenance men, providing the armed forces

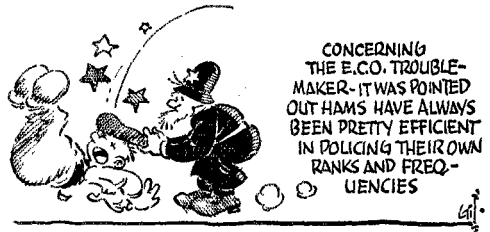

with a pool of communications manpower. As one ham put it:

"Not only will you find our old rigs, meters and frequencies gone to war, but you'll find us right in there pitching personally, either in the Army or Navy as communications men or on the production line in war plants. And the sooner we win this war, the quicker we insure our kind of a democracy in which ham operators can put their antennas back up and talk to other free amateurs all over the world."

Strays

On a recent visit to the Fort Monmouth Signal Laboratory, Maj. Gen. Roger B. Colton, Chief of the Engineering and Technical Service of the Signal Corps, declared that U. S. Signal Corps equipment is the best in the world and that our signal communications and supply also are very good. He cited as advantages the intensive work with frequency-modulated equipment and the widespread use of crystals in field equipment. Crystal-controlled gear eliminates netting procedure, he pointed out. This is an especially valuable feature in landing and combat operations, where all-out action must be preceded by strict radio silence.

The War Department recently revealed that complete training facilities at overseas bases have been in operation for months, and that a radio operator receives his basic training and his training as an operator simultaneously. In from three to five months the trainee is an effective operator and can take his place in a signal company of a combat division, whether that division is still in training or is being committed to combat. — *Telecommunications Reports.*

Speaking of microwaves (or were we?), do you suppose the gink who invented the long-stemmed one-piece front collar button for a soup-and-fish rig could possibly have had any idea that in A.D. 1943 his brain child might be regarded as a rather nicely proportioned back-shielded radiator with a certain magic relationship between stem and base?

One Ounce of Prevention . . .

. . . If Applied the Right Way, May Save a Tube

BY "SOURDOUGH"

SATURDAY afternoon we went down to town to get some things. Martha had quite a time over them stamps. Her natural bent for dickerer kinda got a bit more bent, 'cause she can't bargain with blue and red stamps. So, while she was working over Clem in the grocery, I went to the Polecat County Hardware, Harness & Feed Store to get me a new 6F6. The one in the old b.c. set was getting kinda tired — we listen a right smart amount to the war news these days.

Sherman was right! No 6F6s to be had except you write them fellers in Washington in the WPB. Calculate there ain't no sense in kicking, though. I'd ruther have that bottle calling the signals in a tank somewhere in Spaghetti Land than in my set, anyhow.

That evening after we done the dishes I figure it would be a good idea to sort over the junk boxes and see if maybe there is a bottle that can be made to do in place of the 6F6. After rooting around the house a while, with no luck, Martha reminds me that they might be in the box of junk that she demoted out to the barn some four-five years ago.

I found the box okay and dumped it out. In the rubbish there were two 203As and also a pair of 852s. All had plates that looked like the mice

had been at 'em. That set me trying to remember the details, so back to the house and into the shack for the log books.

Thumbing back through the pages and looking at all the fellows we'd worked made me kinda sad. Wonder what happened to this SP — and that PA0? And how about this PK — did he get away? Boy — how I would like to run that there Hitler and his pal Tojo feet first through my old rotary gap!

Well, to get down to business, after some hunting I dug up the story of those 203As. They had died because they were supposed to get bias off a grid leak, and one time the drive failed. The 852s had been operated with fixed bias off a rectifier. Then one day the rectifier tube gave up the ghost — followed, of course, by the 852s.

Guess that didn't make no difference (except maybe to the pocketbook) in those days. But — remembering that 6F6 — it would make one whale of a difference now, and anyway it warn't reasonable nohow. Downright witless, in fact; kinda thing that comes of being in too much of a hurry and not scheming things out.

Guess it's true that a good many fellers got so caught up in the r.f. part of their transmitters that they didn't give much thought to the supply

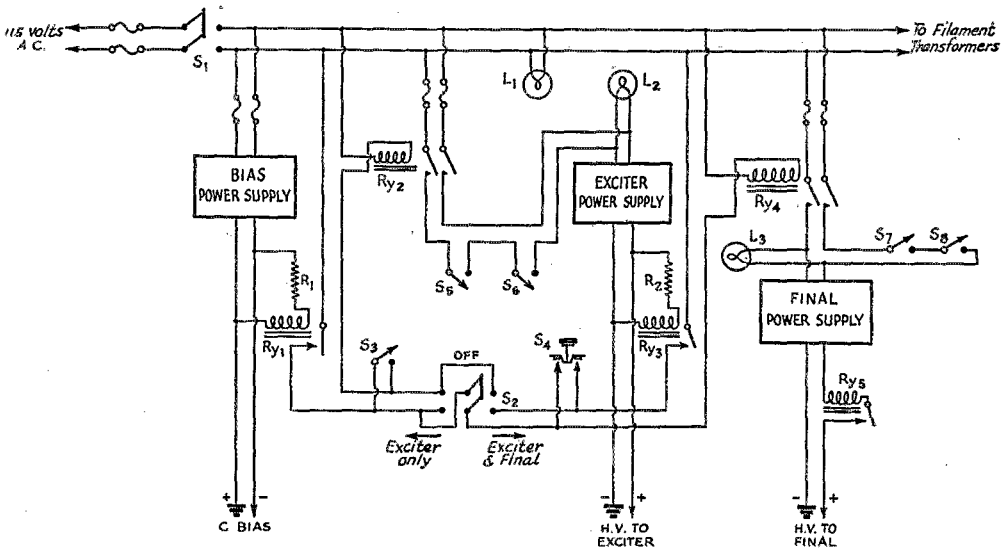

Fig. 1 — Power-supply control circuit designed to save equipment and protect the operator.

R1 — Bias-supply bleeder resistance.
R2 — Driver-supply bleeder resistance.
L1, L2, L3 — Signal lamps.
Ry1, Ry3 — Low-current relay.
Ry2, Ry4 — 115-volt a.c. power relay.

Ry5 — Overload circuit breaker.
S1 — Double-pole knife switch.
S2 — D.p.d.t. telephone-type switch.
S3, S5, S6, S7, S8 — Power toggle switch.
S4 — Push-button switch.

circuits. Know I did. Got a nice white scar on the back of one hand to prove it, too; 2000 volts has some authority.

All of which set me a-thinkin'. It was a case of where something should be done about something. What was wanted was a power-supply control circuit that would prevent power tubes (and operators, too) from going to the undertakers' sooner than had to be.

Squaring up the problem, it seemed like money had to be spent to do it right — but not a penny more than absolutely necessary. I aimed to rig things up so that it wouldn't be possible for any failure anywhere to leave dynamite on the plates of the final when the grids weren't tied down. Another yen was to fix things so that the operator would have to have what they call suicidal intent before he could get across the big volts.

Safety Circuit

Like the Chinese say, "One picture is worth 10,000 words" — so let's get to work on Fig. 1. S_1 is the main "on-off" switch isolating the whole set. When it is thrown to "on" the power line is connected, lighting up all filaments and putting the bias pack to work. Lamp L_1 should be a green one meaning: "Supply on."

R_1 is the bleeder resistor for the "C"-bias pack. Between the bottom of R_1 and ground there is a single-pole single-throw d.c. relay, Ry_1 . If the bias pack is working okay, the bleeder current will hold this relay closed. The power line to the driver power supply is looped through S_5 , S_6 and the contacts of Ry_2 . S_5 and S_6 are door switches guarding the power-supply and transmitter compartments. Ry_2 cuts the exciter-supply in and out of the 115-volt line. The winding of this relay is connected to the supply through S_3 or S_2 and also through the contacts of Ry_1 ; hence, if the bias supply is not perking properly, Ry_1 is open and the driver supply is off.

The winding of a similar relay, Ry_3 , is connected between the driver power-supply bleeder and ground. Until the contacts of this relay are closed, the circuit through the winding of Ry_4 , whose contacts control the primary circuit of the final power supply, cannot be completed through S_2 or S_4 . The final power supply is protected by the door switches, S_7 and S_8 .

S_3 is an "on-off" snap switch mounted on the power-supply housing. It enables the operator to turn power for the driver off and on at will. S_4 , however, is of the push-button type and is used for testing. The minute the thumb is removed from the button, there ain't no more big volts on the final. A push-button switch is used to prevent the power being left on the final accidental-like.

S_2 is located at the operating table. It is a double-pole double-throw switch of the telephone switchboard type. At the middle or "off" position the windings of Ry_2 and Ry_4 are open, and all power except bias and filaments is off. Pushed "up" (to the left, in Fig. 1) it makes the circuit for Ry_2 only and allows the driver stages to get on, but not the final. In the "down" posi-

tion it energizes both Ry_2 and Ry_3 and puts the rig on the air.

Relay Ry_5 is an overload circuit breaker in the high-voltage supply lead to the final.

The two d.c. relays, Ry_1 and Ry_3 , will need to pass only a fraction of an ampere through their contacts. They should be of the low-current-winding type. The power-supply relays, Ry_2 and Ry_4 , carry no r.f. and can be of any inexpensive type. The coils are wound for 115-volt a.c.

Some Day

A while back I got me a big book and printed on the cover, "Ideas for Later On" — just to put down brainstormings like this one. Sure is surprising how it fills up. Sometimes some little bingleswoop of an idea pops up. When you write it down it seems to be small potatoes and few in the hill — but when you look at it a few weeks later you decide it looks good, and you're mighty glad you done it.

Although it has nothing to do with controlling power circuits, I just come across a reason why there are going to be a lot of new hams on the air some day.

Young Cyrus used to have a station over in Tamarack Flats. He's a top sergeant in the Signal Corps these days. Seems like he'd been over in Africa or some outlandish place, and then got sent home to be a teacher.

Cyrus got some leave and brought a couple of the boys in his outfit home for a piece. They all came over last night to see how my cider was getting along. Guess it warn't getting along too bad, cause after a while they was all talking fifty to the minute.

The boys were telling me about the way they handle traffic — "opyrating procedure," they calls it. Seems like their traffic handle is what you might call short and sweet. Even though your buddy is on the same circuit and you both been sitting watch for hours, you can't even say "Howdy bud!" without getting ten thousand years KP.

These boys all allowed as how they would get ham licenses just so they could have a chance to chew the fat after the war. They figured it would be pretty nigh heaven just to get on top of a key and let themselves go.

We old fellers are a'going to have to do some pretty snappy chewin', too. Them boys got ahold of the bug and a code-practice oscillator I had around, and tried to burn one and t'other up. Used to think I was pretty good shakes at Mr. Morse's code myself. Well, son — I AIN'T.

Strays

Typical prewar transmitter advertisement: "Complete, ready to go on the air. Minus only coils, crystal, tubes, meters, microphone, key and cabinet." What we want to know is how you get the dad-blamed thing on the air without them last items. — "Eddie Current."

A Ham-Made Free-Point Tube Tester

Extending the Uses of a V-O-M

BY HOLLIS M. FRENCH,* W1JLK

UNQUESTIONABLY the best test of a tube of doubtful quality is a direct comparison with a tube known to be good, each in turn being subjected to actual operating conditions. When facilities for the ideal test are wanting, however, resort to simpler tests may be permissible. A "duration" shortage of commercial tube-checking instruments, together with a steady increase in the number of tubes that have had to serve more than their allotted time, points to the need for a fresh application of ham ingenuity.

The test panel here described has amply justified the small effort and cost involved in its construction. It is compact and light in weight. The internal battery supply allows of limited use in rural districts where a tester depending upon a.c. supply would be useless. The external a.c. supply is conveniently coupled in when a source is available, and adds but little to the bulk and weight when the instrument must be used away from the home bench. The floating type of socket connections employed, with jumper connectors, allow for exceptional flexibility in the use of the instrument. By adding external resistors and a

*Asst. Technical Editor, *QST*.



The test panel in its carrying case, together with the companion V-O-M, the external a.c. filament and anode supply, and the various types of connectors used.

Constructed in "depression" days to supply the want of a commercial tube tester, this gadget developed into the most useful single instrument in the shack. The very fact that economy dictated the use of salvaged tip jacks in place of rotary switches resulted in a design which has made possible many un-anticipated uses of the instrument. More than a mere tube tester of simple design, it is a convenient experimental breadboard of manifold applications.

source of grid bias, transconductance tests can be applied to tubes together with, or in place of, the emission test. The panel may be used as an experimental breadboard on which simple circuits can be set up for comparing the performance of various types of tubes in the same circuit, or for constructing a temporary oscillator or even a vacuum-tube voltmeter.

The panel was designed as a companion-piece to a Triplett Model 666-H "Hammer." This multi-range V-O-M fits neatly into an old Radiola III cabinet picked up in a salvage store. The first photograph shows the test panel and V-O-M in the carrying case, with the external a.c. power supply connected and jumpers set up for an emission test of a multi-element octal-based tube. Samples of various types of jumpers carried in a kit-drawer behind the meter. A chart listing standard values of meter readings for good tubes is also carried in this drawer. The inside dimensions of the cabinet are 6 × 7 inches, with a depth of 4½ inches. The 4 × 6-inch panel for the test board was cut out of the original Radiola III bakelite panel. Some of the tip jacks and sockets were salvaged from discarded equipment and some, including the two combination sockets used for the older-type tubes, were bought at a "Radio Row" bargain counter. If the combination 4-5-6-prong socket and the combination large and small 7-prong socket cannot be obtained, separate sockets may be wired in for each type of base at the expense of a larger panel and carrying case. Alternatively, one or two 4- or 5-prong sockets could be substituted for the combination sockets, with suitable plug-in adaptors. The use of a rather crude homemade push-button switch was necessary in my construction, but the reader probably will be able to improve upon it. Any non-locking push-button may be used. Mine was improvised from brass strip, a coil spring from an old "Pee-Wee" battery clip, and an insulated binding-post.

Panel Layout and Wiring

The panel arrangement, as shown in the photographs, consists of two sections. The upper section, which accommodates the older tube types, includes the combination sockets and the miniature 5-prong socket. Corresponding terminals on each socket are wired in parallel and connected to the appropriate tip jacks arranged just below the combination sockets. The lower section, with the octal, loctal and miniature 7-pin "button" sockets, is wired in the same manner. These three sockets also have their corresponding prongs paralleled and connected to the eight numbered tip jacks just above the lower socket group. The present RMA numbering system is followed. In this system, when the base is viewed from the bottom with the lug toward the observer the first pin to the left of the locating lug is number 1, and from there on the numbering is clockwise. Each pin position is counted, regardless of whether it is blank or not. In the earlier RMA system the two larger pins were always the filament terminals and the one to the left, when viewed from the bottom with the large pins toward the observer, was number 1. Hence the numbering proceeded clockwise, ending at the right-hand filament terminal.

Four additional floating tip jacks, wired together and connected through a 1000-ohm 1-watt dropping resistor to the meter output jack, are used for bridging-in required socket terminals through the use of U-shaped jumpers made of No. 14 wire. This arrangement lends itself particularly well to the convenient set-up of the test panel as an emission-type tube tester, requiring

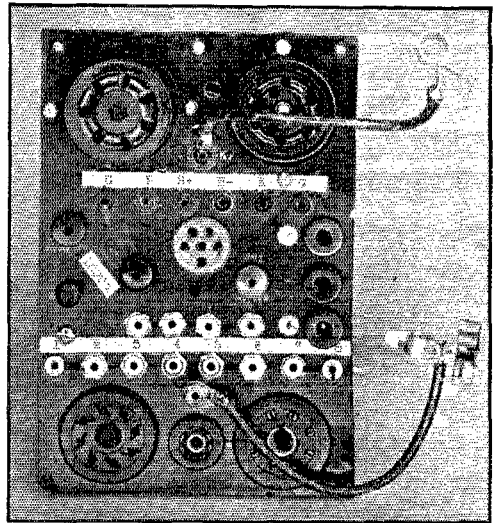

Panel arrangement of the tube tester. The test push-button is at the left, below the jack labeled "To Meter."

the tying together of all tube elements other than cathode and heater. Grid caps are connected by flexible wire leads to additional tip jacks located for convenient attachment to the tube under test, whether in the upper or lower section. Both sections have their cathode and negative filament terminals connected to the "cold" high-voltage input jack through the push-button switch, as shown in the wiring diagram, Fig. 1. Output jacks for the internal dry-cell supply provide voltages of 1.5, 6 and 22.5. These voltages are available for filament and plate application under circumstances where the a.c. supply cannot be used. They are useful also for applying grid bias to any socket when a.c. is being applied to filament and plate.

The use of flexible jumpers of various lengths, with 'phone tips, together with the U-shaped jumpers, permits practically any desired hook-up for a particular socket. External resistors, condensers and coils may be plugged into convenient tip jacks. The meter can be inserted at any point in a circuit set up on the board, and any of its current, voltage or resistance ranges applied for measurements as required.

A.C. Power Supply

The a.c. power supply for the instrument was constructed around an old-style tube-tester transformer having a 115-volt primary and two secondaries, one delivering 10 volts for anode application, the other a tapped winding delivering filament voltages from 1.1 volts through 35 volts. This was mounted in the case of a discarded toy train transformer, using the built-in 7-point tap switch for the 1.1, 1.5, 2, 2.5, 3.3, 5 and 6.3-volt taps. The arm of this switch is connected to a common pin jack outlet, while separate pin jacks serve as output terminals for the remaining taps at 7.5, 10, 15, 25 and 35 volts. The outlets of the separate 10-volt secondary likewise are connected

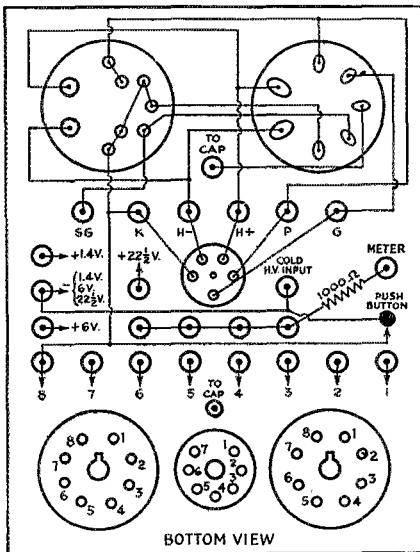

Fig. 1—Layout and wiring diagram of the free-point tube tester. If combination sockets cannot be obtained for use in the upper section, separate sockets may be used. Their corresponding prongs, numbered in accordance with the old RMA system, should be wired in parallel and connected to numbered tip jacks in a manner similar to the lower section of the panel.

to separate pin jacks. A toggle switch was mounted on the side of the case to break the primary circuit. Long flexible jumpers are used to connect any of these outlets with the appropriate tip jacks on the meter and test panel.

Testing Tubes

When using the device as an emission-type tube tester, one side of the anode secondary is plugged into the positive side of the meter input and the other into the "cold" high-voltage jack on the test panel. If the internal d.c. supply is used, the positive 22½-volt outlet is connected to the positive side of the meter input; the negative d.c. is already connected internally to the "Meter" jack on the panel, and the latter is connected to the negative side of the meter input through a low-current pilot lamp or a neon bulb. This bulb, which is used for both a.c. and d.c. operation, is plugged in series by means of permanently attached flexible leads with 'phone tips.

The tube to be tested is placed in its socket, and jumpers are used to tie together all element terminals other than filament and cathode and to connect them with the "Meter" jack through one or more of the four auxiliary tip jacks and, in the case of a low current tube, through the 1000-ohm resistor. The tube data tables in the *Handbook* provide the necessary information concerning socket connections. If the tube has a cap connection, the cap lead is of course applied and its tip jack tied in with the others. The meter is set for the appropriate d.c. current range. This will be the 10-ma. setting for low current tubes and the 100-ma. setting for a.c. cathode-type tubes.

After the proper filament voltage from either the a.c. supply or the internal batteries has been

applied to the heater jacks and the tube has warmed up, the push-button is depressed. The anode voltage thus applied should not be maintained longer than necessary to note the meter reading, if damage to the tube is to be avoided. The current reading, which may range from 1 ma. or less up to 10 ma. for low-current tubes, or to 100 ma. for a.c. power tubes, is to be compared with a list of standard values made from average readings of similar tubes of the same make with known satisfactory qualities.

No list of standard readings will be offered, since the results with a particular unit depend upon the anode voltage from the a.c. transformer. However, a few illustrations will show the order of magnitude of readings obtained with 10 volts applied to the anode and without the 1000-ohm dropping resistor in the circuit: 6V6, 13 ma.; 6J7, 6 ma.; 2A3, 11 ma. A transformer supplying an anode voltage of 25 or 30 would give higher and more useful readings. Using the internal battery of 22½ volts with the dropping resistor in the circuit, a typical reading on a low-drain filament-type tube, the 1E4G, is 11 ma. When making a list of standard readings for use with the internal anode voltage supply, it is important that the battery be checked for full rated voltage and that this voltage be maintained for every test.

If a short-circuit exists between cathode and any one of the tube elements, the series lamp will indicate the fact by a bright glow. It will then be necessary to remove the tying jumpers from plate, control grid and all auxiliary grids, and test each in turn to locate the shorted element.

If the current reading shows a tendency to rise when the push-button is depressed for a moment, the tube is probably gassy and should be discarded on that account. However, if the push-button is held down longer than necessary, say more than three or four seconds, this treatment may *make* the tube gassy!

Another check which may be applied with the same hook-up is through substitution of a lower-than-rated filament voltage and comparison of the resulting current reading with that obtained with normal voltage. If the tube is new, the filament voltage may be reduced by 25 per cent without noticeable effect upon the current reading in the anode circuit. No more than a 10 per cent reduction of anode current should occur as a result of the 25 per cent reduction of filament voltage, if the tube is still in fair condition.

In testing rectifier tubes it is probably the better practice to apply the 115-volt a.c. line voltage directly to the anode circuit, rather than the 10-volt secondary. Each side of a full-wave rectifier tube should, of course, be given a separate test. In this case — and in the normal tests applied to all except the low-drain battery-type tubes — the 1000-ohm dropping resistor need not be included in the hook-up, the meter being connected directly to the "cold" high-voltage input jack.

The hook-up on page 408 of the 1943 edition of *The Radio Amateur's Handbook* may be duplicated on this test panel by the plugging in of

(Continued on page 106)

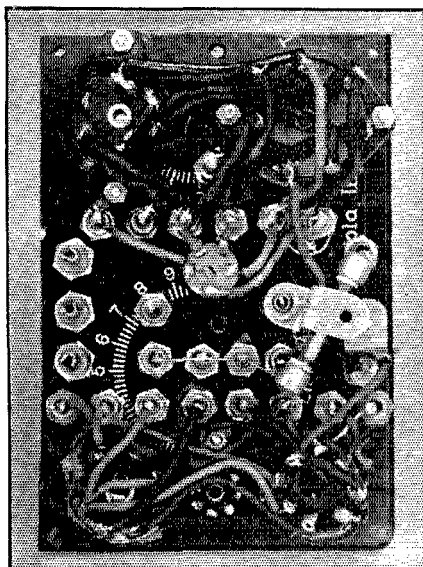

Back-of-panel view of the free-point tube tester. The metal strap over the fixed resistor at the right is the lower contact of the homemade push-button which is used to close the anode circuit momentarily for tests.



EXPERIMENTER'S SECTION

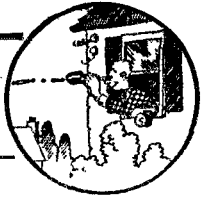

Address correspondence and reports to ARRL, West Hartford, Conn.

PROJECT A

Carrier Current

FOR the past year or so I have been deriving a great deal of interest from the Experimenter's Section. Before I entered the armed forces, W8VHJ and I, using two of the *QST* rigs, succeeded in establishing contact over an airline distance of about three miles. Our receivers were Sky Champions. We heard signals from an airport 15 miles away.

Later we attempted 'phone. Since no modulation transformers were available for the two 8-ohm-output amplifiers we had, we used old speaker output transformers connected back-to-back with those in the amplifiers to secure high-impedance output. Though the modulation was necessarily light and the signals weak, this system worked.

In an effort to improve the circuit, we loaded the equipment into my car. At any point along the line where we could persuade a housewife that we weren't going to blow a fuse, we hooked in a 50-foot extension cord and put out a test call. By this means we found that our home stations had been coupled to different phases of the line. Jumping phases was taking up most of our r.f. Tests showed that, as long as we both operated on the same phase, power didn't make much difference. In fact, with a diode detector and the *QST* transmitter we worked at any point on that phase of the circuit with R9 signals on 'phone.

After the war is over I would like to run some more experiments. Just now I am overseas, and Tom is an aviation cadet far from good old Akron. Keep up the good work on *QST* and in the League activities. I intend to get a "ticket" when this mess is over. — *Cpl. Richard J. Sauer, 35866918, APO 845, c/o Postmaster, New York City.*

From reading the articles in *QST* on the various projects offered as substitutes for the most satisfying hobby of all, I have derived an idea which I would like to pass on to the experimenters.

It seems to me that the principles of c.c. transmission and supersonics could be very effectively combined. Imagine W2FSP's magnetostriction vibrator firmly clamped to a cold-water pipe and several hundred watts poured into it. A supersonic detector clamped to the same pipe should pick up good signals at many times the distance possible when using air as the transmitting medium. It might even be possible to

cover a large-city with flea-power rigs. Of course, we should take precautions to keep the operating frequencies well above the audible range, lest we find ourselves right back in the midst of the BCL interference problem when the neighbor's bathtubs begin CQing. — *J. R. Sechrest, Jr., W4DQF, Canton, N. C.*

A group of the boys here at the Sperry Research Laboratories are interested in c.c. transmission. We expect to get a local network going soon. — *Richard N. Jasper, ex-W3CXB, 147 Chestnut St., Garden City, N. Y.*

W8GAZ, of Minaville, N. Y., and W8FU, of Amsterdam, four miles north of Minaville, had a fine QSO on August 21st, using c.c. on approximately 190 kc. Regenerative receivers were used at both ends. Transmitters used 801 and 841 tubes in Hartley circuits, with 550 volts raw a.c. on the plates. We wish more of the local gang would get on c.c. so that we could have more contacts. So far, c.w. is used exclusively. — *J. C. Nelson, W8FU, 75 Minaville St., Amsterdam, N. Y.*

W9CFS and I put a signal through on c.c. over a distance of about three miles. We had only one transmitter and converter between us, so it was necessary to check one way at a time. I am fairly certain that the receiver and transmitter were not on the same trunk line. The rig is the one described in *QST* a year ago. As I was a bit slow in commencing to build, I was unable to get mica condensers for the tank circuit and substituted non-inductively wound tubulars. At first the note drifted all over the lot, but moving the condensers to provide better cooling resulted in a considerable improvement in the note and no more wandering.

Will anyone interested in a little c.c. rag-chewing look me up in Falls Church? W9CFS will be leaving soon, and I shall be left with no one with whom I can carry on this work. Falls Church is a small town just outside of Washington, D. C. My phone number is FC-2878-R. — *Lt. (jg) Gene R. Cate, W5KRP, USNR, 510 Anne St., Falls Church, Va.*

Again we call attention to the communication in the November issue from Herb Walleze, W8BQ. The answers to many of the questions concerning c.c. operation presented in letters received by this department are to be found there. Beginners in c.c. operation should study W8BQ's article carefully before choosing operating frequencies and designing their equipment.



STRAYS



A total of 576,613 radio receiving tubes have been released for domestic use by the Radio and Radar Division of the War Production Board. The tubes, which originally had been held for export by the Phillips Export Corp., P. O. Box 69, Grand Central Annex, New York City, may now be sold without restriction so long as they are to be used domestically. Resale of the tubes by dealers will be governed by Limitation Order L-265.

The Office of War Information sends out no less than 4000 short-wave programs a week.

If a soldering iron is not available for making wire connections for an antenna flat top or feeders, a good waterproof covering can be obtained by applying a thick coat of DuPont's household cement. — *W3ERV*.

When the white degree lines of a National micrometer dial become filled with dirt after a period of use, the dial can be cleaned by using an old toothbrush and some Carbona (carbon tetrachloride). This method doesn't harm the finish. — *W3ERV*.

One of the major problems confronting Signal Corps soldiers in North Africa is the presence and voracity of the termites, which interfere seriously with pole-line construction. The only effective way to deal with them is to treat the poles with chemicals or place metal skirts around their bases. (No, this isn't a Kee Bird story!)

The New York *Daily News* recently carried this headline: "73 and 88 Get Draw in Fight over Bathtub." Seems that two OMs of these ages couldn't agree on the use of their apartment — so the judge called the battle a draw. — *W20KX*.

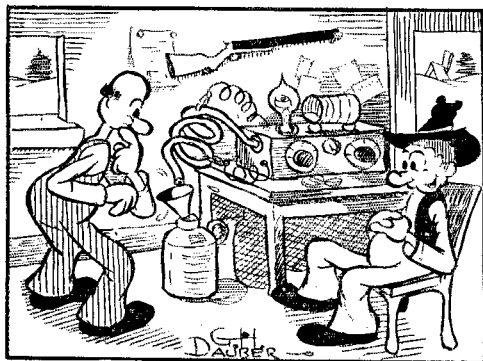

"WHEN HAM RADIO WUZ STOPPED, AN
CONVERTED MA RIG INTO A STILL!"

The Signal Corps on June 30th numbered 280,000 enlisted men and 28,000 officers, which represents twice the enrollment of the whole regular Army in peacetime. These men have been trained at 50 military and 269 civilian schools.

U. S. production of military radio equipment now amounts to \$250,000,000 a month.

According to theory, if a frequency of about 200,000,000,000 (two hundred trillion) cycles could be produced, radiant heat would result. Then again, if a frequency of 800,000,000,000 (eight hundred trillion) cycles could be produced, light would be the result. Perhaps we have in our ranks a ham who has ideas on building a rig that would oscillate on such frequencies. Such a system would be valuable to cities, for they could dispense with street lamps and use the light from the local ham stations. There would be enough light generated to read *QST* in a coal bin at midnight. — *Richard Wells*.

Heard on 15.6 Mc., July 29, 1943, 7:30 P.M. PWT, automatic transmission:
"QRA QRA QRA de WBG5 WBG5 WBG5
Press Wireless NY" — *W1KKS/6*.

The Alfred I. duPont Radio Awards Foundation has been established to assure the continuity of three annual awards in the amount of \$1,000 each. Two of these awards will be made to broadcasting stations, one to the station that develops the most influential service on a nation-wide or world-wide scope and the other to the station that is of the most service in its community. The third award will go to the commentator whose work is the most notable for constructive news interpretation.

Here's the kind of coöperation an editor likes: A recent issue of *ACA News* (commercial operator's union publication) went to press with an erroneous report that ACA Vice-President Oliver M. Salisbury had been torpedoed three times during his career as sea-going radio operator on an escort vessel. Actually, when that item was written Salisbury had not been torpedoed even once. The pay-off is that, before the following issue could appear with a retraction, he wrote a note to the *ACA News* editor, saying: "Never mind that retraction. I made an honest man out of you, completely and precisely. But be careful in the future. I don't want to be forced to such lengths again just to keep a friend honest."

In the interim he'd gone out on three trips and had been torpedoed three times!



HINTS AND KINKS FOR THE EXPERIMENTER



AUTOMATIC BIAS FOR BATTERY TUBES

MANY transceiver and transmitter-receiver circuits for 1.4-volt tubes specify a "C" battery as the grid-bias supply for the output tube. Space and weight may be saved by using a biasing resistor in place of the battery.

As shown in Fig. 1, the biasing resistor, R , is connected between negative "B" and the grounded side of the filament, while the grid return is made to negative "B". Thus the voltage drop across the resistor is applied as bias to the grid, in the same manner as cathode bias in a.c. circuits. The plate voltage is, of course, reduced by the amount of the biasing voltage, but this reduction will be negligible with the small value of bias required for most types of tubes used in portable battery rigs. A value of resistance should be selected which will produce a voltage drop equal to the required bias. The total "B" battery current drawn by all tubes must be used in calculating the value of the resistor.

The same bias may be applied to the grid of a driver tube by connecting its grid return at the same point. If the driver tube requires a lower bias than the output tube, this may be obtained by returning the grid of the driver tube to a tap on the resistor or by using two resistors in series.

Aside from eliminating the need for a "C" battery, the use of resistor bias has the added advantage of automatically maintaining the grid-bias plate-voltage relationship in proper proportion as the "B" battery voltage drops off with use.

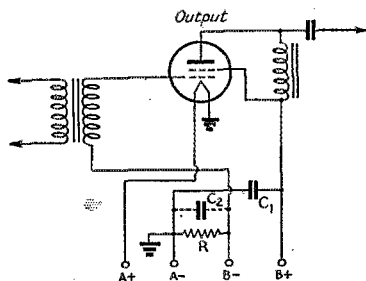

Fig. 1 — Circuit diagram showing the method of applying resistor bias to battery tubes in transceivers.

Condenser C_1 is the usual plate by-pass provided to take care of the conditions caused by increasing internal resistance of the "B" battery. C_2 (which may be an electrolytic low-voltage high-capacity condenser of the midget type), shown in dotted lines across the bias resistor is used only if the improvement in audio quality appears to be worth the cost and space required.

— Loyal S. Fox, ex-W2AHB

SERVICING RECEIVERS

DURING peacetime probably the majority of amateurs either returned their receivers to the manufacturer for repairs or called in the local radio serviceman. Most fellows built their own transmitters, while few built receivers. Consequently, a few notes on "trouble-shooting" may be of service in these times.

When your receiver commences to "act up" or refuses to perk at all, there are short-cuts known to experienced servicemen which will help you to locate the trouble quickly. The first care always should be to check the tubes, either by means of a tube tester or by substituting tubes known to be good.

In each of the following cases we will assume that this has been done, and that all tubes are good. If the receiver is dead, find the diode detector or the first audio amplifier (often a 6R7 or 6Q7) and put your finger on the grid cap. If the tube is single-ended, scratch the grid prong with a small screw-driver. A loud, rough note, like an a.c. hum, should be heard if the power supply and audio amplifier are working properly. If no hum is heard or if it is very weak, first check the power supply. Filter condensers may be leaky, or a filter choke may have an open circuit. A good electrolytic condenser has a fairly high resistance. A reading of a few thousand ohms or less usually indicates that the condenser is leaky.

Electrolytic filter condensers will dry out in time, and the result will be hum in the output. Take a good electrolytic of the same capacity and working voltage as those being tested and shunt it across each of the condensers in the power supply in turn, observing proper polarity. If the hum is eliminated, replace the defective unit. If changing one condenser only partly cuts down the hum, both sections of the filter need replacement. When putting in new condensers always remove the old ones, of course.

If the plates of the rectifier tube glow red when the set is turned on, it is usually an indication of a shorted filter condenser. The suspected unit should be disconnected and checked with an ohmmeter. Remember that, unless the correct polarity is observed in connecting the ohmmeter, even a good condenser will appear to be shorted.

A common source of trouble arises in the audio coupling condensers. If one is leaky some d.c. voltage will appear on the grid of the following tube, upsetting the bias and causing distortion. Look for positive voltage on the control grids, especially that of the power tube. Another indication of this fault will appear in a definite lowering of normal voltages throughout the circuit.

Noisy band switches can be made as good as new, by cleaning the contacts, using carbon tetrachloride (Carbona) with a small brush. Brush the cleaning fluid into the contacts thoroughly; then snap the switch through its range of contacts several times, back and forth, and flush again with the fluid. Wiper contacts on variable condensers may be cleaned by the same method.

If the receiver is in need of alignment a signal generator is needed, to do a real job. Nevertheless, it is possible to touch up the i.f. tuning without one. The antenna should be disconnected from the receiver and a signal tuned in that is just barely audible. The a.v.c. switch should be in the "off" position. If the set has a selectivity switch, it should be set at the "sharp" position. The i.f. trimmers should then be carefully adjusted, one by one, for maximum volume. If the signal being used is built up to considerable volume, tune for a weaker one and continue adjustments with it. Usually the trimmers are not far out of alignment and only very slight adjustments are needed. If they happen to be out considerably, readjustment makes a big difference in "pep."

— George C. Boles, W2NBU

EDITOR'S NOTE. — Necessity for unusual adjustment of the trimmers may indicate that the capacity in the circuit has been altered by failure of fixed condensers or other causes, and should be regarded as a warning to look for further trouble.

— —

S-METER WITH LEFT-TO-RIGHT SCALE

IN AN article by W2JCR in November, 1941, *QST*, which discusses homemade "S" meters, reference is made to the fact that reversed-scale meters are not generally available to hams. By reversing the magnet in an ordinary milliammeter and likewise reversing the polarity of the connections, a left-to-right reading can be obtained for "S" meter applications. When the receiver is turned on with no signal input, the current flow is maximum, but the deflection of the needle is now to the left, the normal zero position. Applied signal voltage decreases the plate current and, as the needle then moves to the right, the calibrations for a scale of signal strength readings will increase normally from left to right.

— Alan S. Betts, VP8AI

— —

KEYING THE RECEIVER INPUT FOR CODE PRACTICE

SOME of the schemes for code practice previously described in "Hints and Kinks," in which a steady carrier is tuned in on a receiver while the input to the receiver is keyed, have admitted the objectionable feature of a simulated "back-wave." When the key merely opens the antenna lead some signal is almost certain to get through, if the receiver is at all sensitive. This is because of the capacity between the key contacts when open. Why not use a wave-trap, tuned to the frequency of the chosen carrier, to eliminate this trouble? The circuit shown in Fig. 2 is self-explanatory. Just put the wave-trap in series with the antenna lead-in, near the receiver, and shunt

it with the key. Hold the key down while tuning the receiver until a good, steady carrier is located. WWV furnishes a good signal source. With the carrier tuned in, release the key and tune the wave-trap for minimum response in the receiver.

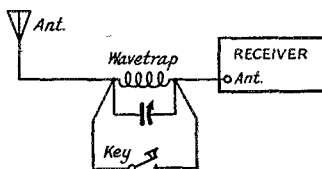

Fig. 2 — Application of a wave-trap to minimize the "back-wave" effect when a received carrier is used as a signal source for code practice.

Some signal may still leak through, but the back-wave effect is lessened to a degree where it no longer interferes with the readability of the keying. The receiver controls can be used in the normal way to regulate volume, tone and sensitivity. An advantage of using the signal from WWV is that it is tone-modulated and therefore will enable the user of a receiver which is not equipped with a beat-frequency oscillator to make use of this scheme for code practice. No need now to let your fist get slow or heavy, when you can get on the air in this way — even if it is in reverse!

— Robert F. Crocker, ex-W8HVS

— —

REMOVING LOKTAL BASES

MUCH better performance at the higher frequencies is obtained from loktal tubes, such as the 7A4, if the metal band at the base is removed. This is easily done if the tube is boiled in water until the cement between the band and the tube has softened. The ring then can be removed with gas pliers.

— Fred Craven, W3ERV

— —

A METHOD OF REJUVENATING ELECTROLYTICS

I WOULD like to pass on a method which I have found to be effective in rejuvenating 90 per cent of wet electrolytics. The reason for the failure of these condensers seems to be a thin dielectric film which forms at the junction of the aluminum anode and the supporting rod.

The unwanted film can be removed by connecting the condenser in series with a 40- or 60-watt lamp across the 240-volt a.c. mains. Usually nothing happens for several minutes. Then the film suddenly breaks down, causing the electrolytic to sizzle and the lamp to light. The power should then be switched off and the condenser reformed by connecting it to a d.c. supply of several hundred volts for about ten minutes. After this it will generally be found that the condenser has acquired a new lease of life.

Obviously, if there is no electrolytic in the condenser to start with, this method will not work.

— VK2ABS, in Amateur Radio (Australia)



CORRESPONDENCE FROM MEMBERS

The Publishers of *QST* assume no responsibility for statements made herein by correspondents.

THE C.A.A. ASKS FOR HELP

Civil Aeronautics Board, Washington 25, D. C.
Editor, *QST*:

As you are no doubt already aware, a fatal accident occurred to an American Airlines passenger plane shortly before midnight on October 15, 1943, between Nashville and Memphis, Tenn. During our investigation of the crash it was determined without reasonable doubt that the captain had attempted to make a last minute transmission to the ground stations along the route. However, due to the fact that it was an unanticipated call, there undoubtedly being no time for a preliminary call-up, the most important part of the transmission was not received.

It occurred to us that there was a bare possibility, and in this business we try not to overlook any possibility no matter how remote, that some of the gang might have been listening on the frequency in use by the air carrier on this evening, and hence might have intercepted any or all of the emergency message transmitted from the plane to ground, but failed to report it in the belief that at least some of the many aviation ground stations must have received it also.

With this thought in mind, it would be greatly appreciated if you would advise your readers that any information relative to the transmission in question would be more than welcome at the offices of the Safety Bureau, Civil Aeronautics Board, Washington, D. C.

— *John M. Charmerlain, WSHEY*
Assistant Director, Safety Bureau

RALLY 'ROUND

APO 980, c/o Postmaster, Seattle, Wash.
Editor, *QST*:

After wandering around the world for over ten months, my certificate of membership in our League finally caught up with me. So far I have not seen any copies of *QST* later than August of last year, but no doubt they either were lost or were confiscated by members of my old organization. I can't readily blame them, for *QST* is the finest magazine of its kind published. . . .

I did intend allowing my membership to lapse, but then I got to thinking that if all the hams did that our League would go on the rocks for lack of support. No red-blooded ham wants that to happen, and now that we are off the air it behooves every amateur to rally 'round and keep the League on its feet, thereby insuring our rightful place on the air after all this mess is over. . . .

— *T/Sgt. Richard L. Walker, W6TYC*

IF JUSTICE REMAINS . . .

c/o Fleet Post Office, San Francisco, Calif.
Editor, *QST*:

. . . Out here, where the fight for the four freedoms is actively going on, the amateur radio fraternity is in the forefront. I am not bragging. That is a statement of fact. I have met a dozen hams, all of them doing a job — and that is only a small fraction of the number actually out here. They are all doing a job which, on their own time and at their own expense, they trained themselves in peacetime to do. I hope President Roosevelt does not forget that. I hope the Congress does not forget — nor the American people.

I do not mean that the hams are any greater heroes than many others. I mean that the hobby of ham radio has more than done the job it was expected to do. Hobby, my eye! The institution of amateur radio is an important part of national defense. Nowhere is that clearer than out here where the bombs are falling.

If a sense of justice remains in the American nation — the people and the Congress — it won't be necessary for us, tired and sick of fighting, to fight again for our frequencies and our other rights when this war is over. Congress and the FCC must see to it that we get them back. The hams out here expect that — and they are going to be damned sore if they are betrayed.

Right now they are planning the rigs they will have when they get back home, even making skeds with one another. One of the things they are fighting for, and dying for, is the right to maintain ham radio — and in essentially its old status. They feel that ham radio has proved its right to exist — not on some useless band, but on 80, 40, 20 and 10 meters. And I know that ham radio is the only practicable means of assuring a satisfactory reserve of operators among civilians. They'll never be able to do it by means of military reserve organizations alone. . . .

— *Capt. _____, USMCR **

WORTH THEIR WEIGHT IN GOLD

935 Valley Road, Glencoe, Ill.
Editor, *QST*:

. . . Have just returned from about twenty-two months of foreign service for reassignment, and don't know where I'll wind up next. . . .

A word in general about hams in the service. All those we've run into so far are worth their weight in gold, as you well know. I just wish there were a million more! . . .

— *T/Sgt. Geoffrey S. Vore, W9QBJ*

*Name withheld by request.

THE "HI" SIGN

172-21 Highland Ave., Jamaica 3, L. I., N. Y.
Editor, *QST*:

The other evening, while riding home from work on the subway, I pondered over the letter by Pvt. Don Wiggins in the October issue of *QST*, wherein he asks for a hand sign to be recognized by all hams as a greeting. I hit upon something that I believe has possibilities, and the more I think of it, the better I like it. Of course, someone else may have suggested it by this time, or there may be some who will not think it appropriate, and probably there will be other suggestions, too.

Anyway, we have the "V" for Victory sign and that well-known beer sign (hi!), so the field is rather limited these days.

What I have in mind is this. Very often we greet one another with a wave of the hand — you know, the "Hi ya, fella" style. Now, to modify that very friendly greeting so that it would mean something to a ham, I think that we might cross the index finger with the middle finger. There you have it — the familiar "keep your fingers crossed"! And, to top it all, the cover-up for a li'l' white lie! After all, aren't we hams well-known fabricators? Oh, no? Remember those liar's contests? Huh?

So, for what it is worth, I suggest "keep your fingers crossed." We have often used that as a sign of good luck, and, since we all want our ham bands back after this mess is over, what could be more appropriate than — K Y F C!

— George Rulfs, jr.

EDITOR'S NOTE. — After reviewing the limitations under which boys in the services travel, it is understood semi-officially that hand signals are not contrary to regulations.

President Bailey suggests that the serviceman hold up four fingers of his right hand and two fingers of his left hand, indicating the word "hi" to anyone facing him. In case only one hand is available, four fingers can be held up first, then changing to two fingers.

31 Allen St., Presque Isle, Maine

Editor, *QST*:

After reading Pvt. Donald E. Wiggins' letter in October *QST*, I feel sure that a lot of hams meet each other every day and do not know that they have the same hobby in common. I suggest a good finger ring as a means of identification. We have pins and buttons, but they are not always on our person. A good ring probably would always be worn. . . .

— Ralph J. Kempton, *W1HXQ*

FROM THE BOTTOMS OF THEIR HEARTS

APO 616, c/o Postmaster, New York, N. Y.
Editor, *QST*:

It has been my policy since I have been a ham to keep my thoughts to myself, but there comes

a time in everyone's life when a little sentimentality causes one to change one's tactics.

While I was installing a receiver at one of the advanced Air Corps bases, I noticed the call W9OQB on one of the Super-Pro receivers we are using. Immediately I saw in my mind's eye some ham giving his much-cherished receiver to the Army for use in the war effort. Being a ham myself, I know what great sacrifice this individual made in giving up his receiver. There must be a million others like him — hams who have given up equipment in hopes of winning the war just a little bit sooner. I want to say to you, W9OQB, and to all the other hams who have given up their equipment, that it is receiving good use. Furthermore, I can assure you that every bit of equipment is being well taken care of.

To these hams we all tip our hats, and say: We hope to meet you all on the air again . . . and from the bottoms of our hearts, grateful thanks for the generosity you Americans back home have shown to us radio operators over here. It is up to us here, and to you there, to keep ham radio alive. We will do our part, and we know you will do the same.

To W9OQB personally, if possible, your receiver will be returned to you in the same condition it was loaned to the United States Army Air Corps.

— T/Sgt. Charles B. Cohen, *W9MUE*

CIPHER SOLUTION: HE DOOD IT!

4518 Ridge St., Chevy Chase, Md.

Editor, *QST*:

Following is a solution of the cipher message appearing in the October, 1943, issue of *QST* . . .

IN THE FIELD OF SECRET COMMUNICATION THERE ARE MANY SCHEMES SUCH AS SECRET INKS AND MASKED LETTERS BUT IN THE CASE OF RADIO THERE ARE BUT TWO GENERAL SYSTEMS CODE AND CIPHER A CODE SYSTEM WHEREIN A PHRASE OR ENTIRE SENTENCE OF PLAIN ENGLISH TEXT IS REPRESENTED BY A SINGLE WORD IS FAR TOO COMPLEX OF ANALYSIS FOR AMATEURS TO CONSIDER AS A FIELD OF STUDY

— G. W. Linn, *ex-W2CJE* — *W2AIO* — *W2ZZO*

HAM SPIRIT

Baltimore, Md.

Editor, *QST*:

About six years ago the Coast Guard cutter *Travis* docked near my home at Deer Isle, Maine. I was then at the "one-tuber" stage in radio, and listened in awe to the 160-meter 'phone stations. Visitors were allowed aboard so I went to sneak a look at the wireless station, which in my estimation was the most important thing on the ship. The operator on watch was Johnson, *W1JCT*. While I was watching from the shack

door he stopped pounding the mill, removed the cans, and asked me to step in. The conversation that followed was typical of one between ham and beginner, and after learning that I did not know the code, Johnson placed me beside him at the operating table with a key and buzzer. When W1JCT went off watch three hours later and I left for home, I had memorized the first nine letters and the answers to a few questions. I was given some precious dry-cells for my one-tube receiver and plenty of good advice about getting my ticket.

Later on, while in high school, I got my ham ticket and built and operated my own station. It was situated in the loft of an unheated garage, but even so I made many warm friendships over the air. After graduating from high school, I spent nearly two years in the textile industry and worked portable around New England. I then spent a few months with Philco, then a year with RCA at Camden, N. J., as a Class A transmitter testman, Class B receiver testman, and working also with radar. I obtained a commercial ticket in April, 1943, and left to pound brass in the merchant marine, seeing action in the South Atlantic.

Wherever W1JCT may be, if he reads this he will realize that the ham spirit he showed that day started one little s.w.l. on the right path, and that those three patiently spent hours were not in vain.

—Radio Officer Edw. B. Watts, USMM, W1NAE

AMATEUR PURCHASING POWER AND THE WAR

21st Airways Communication Squadron,
1600 Textile Tower Bldg., Seattle 1, Wash.

Editor, *QST*:

As one in the services and dealing daily with communication equipment, let me endorse your editorial in the September issue. From the day of my first acquaintance with military communications gear, I have been continually impressed with the tremendous contribution the technique of amateur radio in prewar times has made to the military radio of actual war time.

I could cite instances by the dozen, but they are only typical of the instances which have already received some (but less than adequate) mention in your columns. One contribution which I have not seen mentioned in *QST* before, but which I think is of considerable importance, is this:

Up until the day the Signal Corps "got on the ball" and started placing orders for non-obsolete radio gear, the purchasing power and the rigorous technical demands of the amateur maintained dozens of radio manufacturers tooling up and in business ready for the military expansion. Not that makers of broadcast receivers and their components have not contributed all the resources of their facilities, but the amateur suppliers did have products almost entirely suitable for military utilization, and they were ready to go from the day the contract was mentioned.

Possibly heretofore this has seemed too insignificant a contribution to call up as evidence of the hams' desirability, but to me, now that I am in the service, it appears to be an exceedingly important argument in our behalf. . . .

Let me congratulate you on keeping up the fine standards of our magazine. I find each copy as interesting as back in the days when we awaited the postman for its delivery to see if the next issue had what we needed to improve the rig. . . .

—S/Sgt. John L. Hill, W9ZWW

"FINAGLING" CONSTANT

240 Central Park South, New York, N. Y.

Editor, *QST*:

A few weeks ago the tough radio course I'm taking in high school drove me to read some of George Grammer's swell articles on elementary a.c. math in order to avoid a nervous collapse. While for the most part I thought the articles to be very good, I could not help but be appalled at the shameless way in which Mr. Grammer ignored Mr. O'Malley's "finagling" constant. This constant, as any backward student should know, is the number that one multiplies his answer by to get the correct answer as shown in the back of the book. It may be found in between the divisions on the slide rule, and it has proved an invaluable aid to countless numbers of the fellows in my school. I hope that in the future more respect will be paid to this little value, as the boys and I feel very much hurt at the slight it has received.

—Roy Udolf, W2OLC

AN AUSSIE WRITES

44 Frederick St., Merewether,
Newcastle, N.S.W., Australia

Editor, *QST*:

I am home on a spot of leave at present and, on looking through my pile of *QST*'s, noticed that there were none for 1942-43. I spoke to Santa about it — and, as a result, found enclosed six dollars in my sock in the morning. Hi! . . .

We are all very hopeful of getting our bands back after the war and as so many hams have done and are doing such a sterling job in this show, we should be OK.

The WIA still carries on, I believe, with Wal Ryan, VK2TI, at the helm. I have been away so long. I have lost track of current events. Poor Bill Moore, VK2HZ, is a POW somewhere. He was in Singapore.

I have met many of the W gang and have had some grand ragchews. . . .

You may be interested to know that, just before we got into the war, Don Knock, VK2NO, at Sydney, and I worked each other on 5 meters (about 100 miles) which was the best so far accomplished at that time in Australia. . . . He was a captain in the Army Signals when I last heard from him.

—F/O G. Kempton, RAAF, ex-VK2CI

HE WAS "THERE," TOO

R. 2, Box 15, Sleepy Eye, Minn.

Editor, *QST*:

Have just finished reading the current issue of *QST*. It is the first I have seen for two years, during which time I have been in naval service outside the continental U.S.A. In this time I saw ZLs and VKs in their native land.

I enjoyed reading the article on Japanese transmitters in September *QST*. I was "there," too — and it was in that same area that my ship finally was sunk by enemy action. I was a fortunate survivor and returned to the States, where I am now awaiting assignment to new duty afloat.

I carried a copy of the *Radio Amateur's Handbook* with me from the time I was called to active duty in 1940. It is now on Guadalcanal being used by personnel at NGK. Of course, I was only too happy to buy a new copy. I doubt that you can readily evaluate all the good this publication has done for men placed on their own in the communications end of this war.

— *Herman Radloff, RM1c, USNR, W9AIR*

TWO REASONS

91 East 208th St., New York 67, N. Y.

Editor, *QST*:

. . . It is a pleasure to renew my membership in the League. One reason is that in this way I am helping to insure my return to the air as an amateur after the war is won, and the second reason is that *QST* is a swell magazine. Much of the material, which is appearing for the first time in a formal way in engineering courses, is presented in *QST* in an interesting manner and with many new ideas and suggestions. I have in mind particularly the neat calculator for transmission-line stubs described in the October issue. There are many graphical methods of doing this job, but this is the nicest I have seen.

I also like the manner in which basic subjects such as math and physics have been reviewed. Articles such as "Meet Mister j!" in the October issue are fine for people who are unfamiliar with the material, and at the same time provide a good review for those who have had such work before. . . .

— *Harold Storch, W2MNZ*

TESTIMONIAL

U. S. Naval Station, Navy 1955,
F.P.O., New York, N. Y.

Editor, *QST*:

I received all the ARRL books and I'm surely pleased with them. I find much material in them that I can use every day, and they are helping me get a promotion in radio. They are in simple form and understandable, and I heartily recommend them to any radio amateur or any radio-man. They are worth twice their price.

— *James Paul Wagner, USN*

THE HAMS ARE THE BEST

Corpus Christi, Tex.

Editor, *QST*:

I'm about ready to leave here for an unknown destination in the Pacific. . . . I've been an instructor here in Corpus Christi at the Naval radio school for the past year, and now I'm finally going to get a chance to practise what I've been teaching.

For your information, about 60 per cent of the instructors here are hams, and I might say that the best instructors are hams. Of all the students I've had in my classes, hams made the best grades and were the easiest to teach. They seem to have that natural knack for radio.

You will find copies of *The Radio Amateur's Handbook* in all the labs here — copies which were purchased by the individual instructors. I always recommend that each student take one with him when he graduates and leaves for active duty. You can be sure I'll have one securely stowed away in my sea bag.

Often my students get me off the subject at hand, and I have to tell them about my experiences as a ham. A lot of these new radiomen are going to be hams after the war.

I'll certainly be glad when we can all go back home and get on the air again. I had been on the air for about twelve years before Pearl Harbor. I enjoyed ham radio a lot, and it's the one thing I've missed most since the start of the war. . . .

— *T/Sgt. R. E. Wheaton, USMCR, W9EUI*

LONG-LOST FRIEND

Boise, Idaho

Editor, *QST*:

Finding a copy of *QST* on the magazine shelf of the field Post Exchange was like running into a long-lost friend. . . .

After some months as a cadet in Uncle's Air Forces, I received my wings and commission at Freeman Field, Seymour, Ind. We fly B-24s here and they are really great airplanes. As I look back on some of the rigs I've put on the air and then take a look at the radio equipment in the B-24, I sometimes wonder how I ever got out of my own back yard (of course, there were those times when I didn't!) . . .

— *Fred S. Barnes, W4FZH*

FROM OVER THERE

Somewhere in Sicily

Editor, *QST*:

Just received my back copies of *QST*, which made me very happy to say the least. We don't get any too much reading material here, let alone anything on ham radio.

I surely would like to meet some hams here in Sicily, but I seldom hear of any. . . . Strange to say, I did meet a W6 from a town near my home. I had a long ragchew with him, and found

(Continued on page 88)



OPERATING NEWS



GEORGE HART, WINJM
Acting Communications Manager

CAROL A. KEATING, W9WVP
Assistant Communications Manager

L-265. Sound like a secret code of some kind? Most radio aides will immediately recognize L-265 as a disastrous Limitation Order issued by the War Production Board months ago — an order which threatened to curtail drastically if not to sound the death knell of WERS so far as procurement of equipment was concerned, for, in addition to making no priority rating available for WERS, WPB by this order made it illegal to procure any other equipment which might otherwise have been available without priority.

As a result of vehement protest by OCD officials, who declared that the enforcement of this order would retard if not completely stop the growth of WERS, V. PB replied that this had not been the intention of the order; consequently, Order L-265 was amended on October 9th, by the addition of the wording that the order does not apply (3289.31 (c) (v)) "To gratuitous transfers of electronic equipment to or for the account of War Emergency Radio Service by any person; and to the manufacture or transfer of electronic equipment for the account of War Emergency Radio Service by any individual who is not a commercial producer or supplier of electronic equipment."

While WERS is now no better off than before so far as priorities are concerned, at least by this amendment it is no worse off. Carry on, gang.

More Mobiles. In WERS experience it has come increasingly to our attention that mobile

units are perhaps the most valuable kind of installation that can be made, and we urge licensees and prospective licensees to plan for as many mobiles as possible. While the necessity for keeping rough logs in many instances and of carefully noting locations from which transmissions are made make mobile operation something of a nuisance at times, the advantages derived more than make up for these slight inconveniences; for a mobile unit can be instructed by its control unit to report immediately at the scene of an incident, from which place it can proceed to conduct communication with the control center even more satisfactorily than by telephone, especially if a part of the installation includes a walkie-talkie unit which can report the most minute details on damage with the greatest possible speed — a speed much greater than could be accomplished by any other means.

When a matter of mutual aid comes to the fore, mobile units can be dispatched to points where they are needed miles away from their usual areas of operation — even outside the licensed area, if necessary — and render services which could be of incomparable value to the community in distress. For more complete versatility of communication facilities and for the consequent ability to render better and quicker service, ARRL recommends *more mobiles*.

The ARRL War Emergency Corps. Several of our field officials have written to ask the status of the ARRL Emergency Corps, that colossal registration of some 6000 amateurs pledging their personal and station services to an amateur radio emergency network. The answer is this: During a war, and under our present wartime operating restrictions, what *could* be the status of an organization whose entire framework was based on amateur peacetime operating and on possible peacetime communications emergencies? The AEC is no more. During the greatest possible emergency that could befall a nation, the amateur emergency corps which we worked so hard to build has gradually disintegrated because of its inability to adapt itself to wartime operation, by departure of its most important personnel, and by cessation of operation of all the stations upon which its existence depended. These stations have been replaced by an entirely new category of stations under an entirely new set of regulations, but for the most part operated by the same old gang of amateurs.

As we pull out the file drawer and run our eyes over the thousands of registrations, now for the most part obsolete, we think that this is a helluva time for an emergency corps to disintegrate. The

Honor Roll

**The American Radio Relay League
War Training Program**

Listing in this column depends on an initial report of the scope of training plans plus submission of reports each mid-month stating progress of the group and the continuance of code and/or theory classes. All Radio Clubs engaged in a program of war radio training are eligible for the Honor Roll. Those groups listed with an asterisk teach both code and theory. Those listed with two asterisks teach theory only. * Others conduct only code classes.

- * Detroit (Mich.) Amateur Radio Assn.
- * Dutchess County Sheriff's Emergency Radio Corps, Poughkeepsie, N. Y.
- * Edison Radio Amateurs' Assn., Detroit, Mich.
- * *Iowa-Illinois Amateur Radio Club, Burlington, Iowa
- * Livic Radio Club, Livingston, Mont.
- * **Radio Servicemen's Assn., Wilkes-Barre, Pa.
- * Tucson (Ariz.) Short Wave Assn.
- * West Philadelphia (Pa.) Amateur Radio Assn.

answer may be that WERS has taken the place of the AEC, that radio aides are to WERS what ECs were to the AEC, and that a new AEC would simply parallel and hamper WERS; but we are not entirely satisfied with this explanation. From a long list of prewar amateur activities, only one of which concerned emergency communication, we are left with only *one* activity — and that solely concerned with emergency communication. It has taken into its fold not only amateurs who are interested but much additional non-amateur and non-technical personnel, most of whom are interested in radio and many of whom will some day become amateurs. There is a national OCD organization called the Citizens' Defense Corps to which many of them belong, but radio is only one small and comparatively insignificant part of this Corps. Some of them are members of ARRL, membership in which entitles them to receive *QST* among other privileges. What is lacking is a national organization of WERS participants, a voluntary and honorary organization which costs nothing, requires no allegiance to anything or anyone except the nation and WERS, and which contains various gradations of membership in order to encourage WERS achievement and ambition.

In a recent bulletin to the field organization of ARRL we presented some embryonic ideas for organization of such a corps, which we propose to call *The ARRL War Emergency Corps*. By the time this appears in print the AWEC may have become an actuality, or it may still be held up due to unfavorable reaction or no reaction. In any case, we think you should know about it, too.

Membership in the proposed AWEC, which is only an idea at this writing, would be open to any person holding an amateur operator license and having a bona fide interest in WERS, or to any person holding a WERS operator's permit. In

WERS of the Month

Each month under this heading, beginning with the January issue, we intend to publish the story of an outstanding WERS organization as an item of general interest to all WERS participants. Contributions are solicited from any radio aide or WERS participant, whether he be an amateur or a WERS permittee. Descriptions of organizations which have already been featured in *QST* articles will not be considered. The story can describe the organization in general, how it came into being, how it was set up and how it operates, or it can describe some particular phase of the organization which makes it unusual or unique. Contributions should be brief (three typewritten pages, double-spaced, is a good criterion) and may include photographs, although only one photograph will be printed with each story. Each story must be released for publication by the radio aide of the licensee, in writing. Address your contribution to the Communications Department, ARRL, and mark it: "For WERS of the Month."

order to promote achievement both in procuring a higher class of license and in WERS participation, we propose the following five classes of membership:

Class 1. Those who hold both amateur operator licenses (Class A, B or C) and WERS operator permits, and who have performed extraordinary service to the organization. A prospective Class 1 member must be recommended to the SCM by a radio aide or Emergency Coordinator in writing, giving reasons for the recommendation. Such reasons might include attendance at every drill,

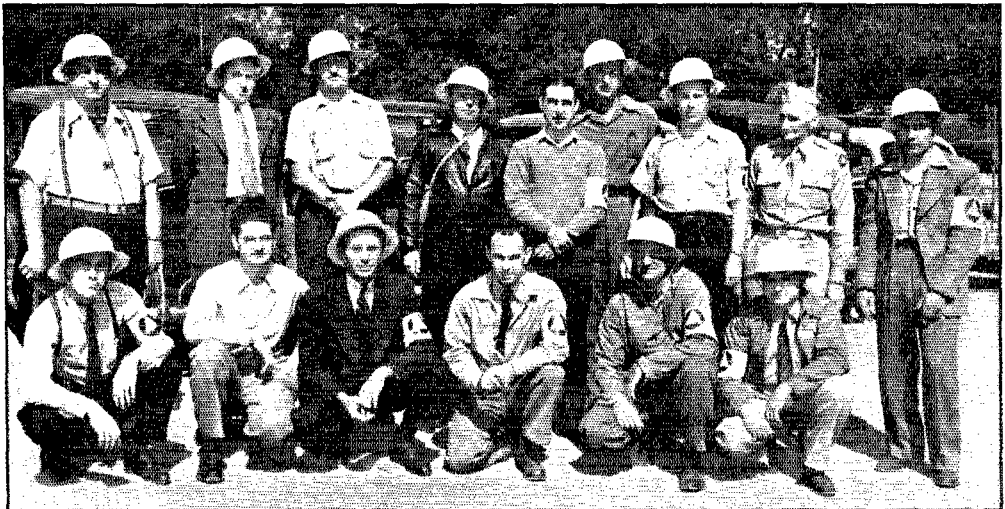

Members of the Oakland, Calif., WERS organization taking part in the OCD demonstration at Lakeside Park in Oakland on October 3, 1943. The sole means of communication with the control station was through the WERS units. All orders were given and carried out through WERS station KFMY. First row: W6RJP, DDO, SFT, FKQ, EE and BBJ. Second row: W6ZM, AXF, MIX, 7EX, 6PSV, P. L. Coggeshall, 6SQ, HHM and TIM.

construction of a certain number of station units, recruitment of a certain number of operators, an outstanding record of performance as the head of any group, etc. The SCM notes his approval or disapproval of the recommendation and passes it along to ARRL Headquarters. Membership in Class 1 will not be available to "just anyone." If the proper procedure is not fulfilled, or if the qualifications do not seem adequate, the person recommended may be placed in Class 3 until further information is received. We want to make Class 1 membership in AWEC really an achievement, a class of membership covered with honor. Radio aides must by no means be considered automatically eligible because of their position. Headquarters will not hesitate to bounce a recommendation if the achievements of the applicant do not seem to be really extraordinary.

Class 2. Those who hold a WERS operator permit but no amateur license and who have performed some outstanding service to the organization. This carries the same qualifications as Class 1, except that no amateur license is necessary. Class 2 members can be transferred to Class 1, upon request, after procurement of an amateur operator license.

Class 3. Amateur licensees who hold WERS permits. Radio aides of licensees are eligible for Class 3 regardless of the type of license they hold, provided they also hold a WERS operator permit.

Class 4. Amateur licensees engaged in organizing WERS but who have not yet received WERS operator permits because of the fact that their communities have not yet been licensed. This classification is open only to amateurs of unlicensed communities, and is not available to amateurs of licensed communities who have no permits. The latter should obtain permits, after which they are eligible for Class 3.

Class 5. Non-amateurs who hold WERS operator permits.

Note the chances of advancement. Class 5 members can jump to Class 3 upon acquisition of an amateur ticket. Class 4 members will be trans-

ferred to Class 3 when their communities are licensed for WERS and they have received their WERS operator permits. The above system thus encourages non-amateurs to secure their tickets, unlicensed communities to become licensed, and all members to perform extraordinary service in order to qualify for one of the extraordinary membership classifications. All members, of course, regardless of their classification, will receive occasional bulletins from Headquarters on subjects of interest to them. ARRL membership will not be required of members of the AWEC.

It should not be hard to see that execution of the above ideas will require a lot of work on the part of your ARRL Communications Department staff, and we do not care to undertake it unless we feel that you want it, especially in view of the fact that the CD staff has diminished in size since peacetime and may soon become even smaller. We are not willing to undertake this project without your general approval, and we cannot undertake it without your cooperation. We expect reactions to be threefold: (1) those who approve of the plan as it stands; (2) those who approve of the idea but dislike the plan above, and (3) those who think that there is no merit in the idea. We shall consider silence as being negative in this case, so let us hear from you if you are interested in AWEC.

WERS Relay Chains. In certain sections of the country, particularly in the heavily populated parts of the East Coast, WERS stations of different licensees have found it possible to communicate with each other; in fact, in some regions inter-licensee interference has become something of a problem. FCC regulations require that cases of interference be dealt with by the licensees concerned "so as to minimize interference, and make the most effective use of the frequencies available" [15.24], but there is nothing in the regs to prohibit inter-licensee communication provided it is within the scope of service of CD-WERS.

The close proximity of some CD-WERS licensees has brought up the question of the ad-



A picture of the group attending the New York City WERS picnic on September 12, 1943. Proceeds of the picnic went into the purchase of equipment for the various New York City WERS units. Photo by W2DTE.

ELECTION NOTICES

To all ARRL Members residing in the Sections listed below:

visability of relay chains over which messages could be relayed between points which could not otherwise communicate by radio. The first thing which should be pointed out in this connection is that WERS is necessarily a local proposition and that its authorization was based on the assumption that communication would be conducted on a local basis only. The possibility of long relay chains connecting points hundreds of miles apart was not considered, and establishment of such chains should be approached with the greatest of care. The local network should and must continue to be the main consideration, and most tests and drills should be held for its benefit.

On the other hand, establishment of relay chains will provide a supplementary means of communication in case of emergency, which is the primary purpose of WERS. We think that such chains can perform a useful WERS function and that they should be developed where feasible. But bear in mind the following restraining points:

- 1) Local network and local communication come first. Relay chains, if any, strictly as a sideline.
 - 2) Only units designated by the radio aide should be allowed to participate, and then only under his supervision and control for the exclusive purpose of establishing communication with the next link of the chain. In most cases it will be necessary for only one unit per licensee to participate; if others are necessary, they should specifically be designated by the radio aide and their duties explicitly outlined.
 - 3) Eliminate all thoughts of "working DX" from the minds of operators. They should make and maintain contact only with the members of the chain on either side of them.
 - 4) Hold tests and drills for such chains at times when other units of the organization are not on the air. The Monday night testing period might well be reserved for this purpose, with the remaining two testing periods per week still devoted to local network drills and tests.
- G. H.

The list gives the Sections, closing date for receipt of nominating petitions for Section Manager, the name of the present incumbent and the date of expiration of his term of office. This notice supersedes previous notices.

In cases where no valid nominating petitions have been received from ARRL members residing in the different Sections in response to our previous notices, the closing dates for receipt of nominating petitions are set ahead to the dates given hereafter. In the absence of nominating petitions from Members of a Section, the incumbent continues to hold his official position and carry on the work of the Section subject, of course, to the filing of proper nominating petitions and the holding of an election by ballot or as may be necessary. Petitions must be in West Hartford on or before noon of the dates specified.

Due to resignations in the Missouri, Eastern Florida, San Joaquin Valley and Colorado Sections, nominating petitions are hereby solicited for the office of Section Communications Manager in these Sections, and the closing date for receipt of nominations at ARRL Headquarters is herewith specified as noon, Wednesday, December 15, 1943.

Section	Closing Date	Present SCM	Present Term of Office Ends
Western Fla.	Nov. 15, 1943	Oscar Cederstrom	Oct. 1, 1943
West Virginia	Nov. 15, 1943	Kenneth M. Zinn	Nov. 21, 1943
Md.-Del.-D. C.	Nov. 15, 1943	Hermann E. Hobbs	Dec. 1, 1943
Connecticut	Dec. 1, 1943	Edmund R. Fraser	Dec. 13, 1943
Missouri	Dec. 15, 1943	Robert C. Morwood (resigned)
Eastern Fla.	Dec. 15, 1943	Carl G. Schaal (resigned)
San Joaquin Valley	Dec. 15, 1943	Antone J. Silva (resigned)
Colorado	Dec. 15, 1943	Stephen L. Fitzpatrick (resigned)
Hawaii	Dec. 15, 1943	Francis T. Blatt	Feb. 23, 1941
Sacramento Valley	Dec. 15, 1943	Vincent N. Feldhausen	June 15, 1941
Nevada	Dec. 15, 1943	Edward W. Heim	Nov. 1, 1941
Oklahoma	Dec. 15, 1943	R. W. Battern	Nov. 1, 1941
Alaska	Dec. 15, 1943	James G. Sherry	June 14, 1942
Southern Minn.	Dec. 15, 1943	Millard L. Bender	Aug. 22, 1942
New Hampshire	Dec. 15, 1943	Mrs. Dorothy W. Evans	Sept. 1, 1942
West Indies	Dec. 15, 1943	Mario de la Torre	Dec. 16, 1942
Maine	Dec. 15, 1943	Ames R. Millett	June 7, 1943
San Francisco	Dec. 15, 1943	Kenneth E. Hughes	July 5, 1943
South Carolina	Dec. 15, 1943	Ted Ferguson	Aug. 25, 1943
Louisiana	Dec. 15, 1943	W. J. Wilkinson, jr.	Jan. 2, 1944

1. You are hereby notified that an election for an ARRL Section Communications Manager for the next two-year term of office is about to be held in each of these Sections in accordance with the provisions of the By-Laws.

2. The elections will take place in the different Sections immediately after the closing date for receipt of nominating petitions as given opposite the different Sections. The Ballots mailed from Headquarters will list in alphabetical sequence the names of all eligible candidates nominated for the position by ARRL members residing in the Sections concerned. Ballots will be mailed to members as of the closing dates specified above, for receipt of nominating petitions.

3. Nominating petitions from the Sections named are hereby solicited. Five or more ARRL members residing in any Section have the privilege of nominating any member of the League as candidate for Section Manager. The following form for nomination is suggested:

(Place and date)

Communications Manager, ARRL
38 La Salle Road, West Hartford, Conn.

We, the undersigned members of the ARRL residing in the Section of the Division hereby nominate as candidate for Section Communications Manager for this Section for the next two-year term of office.

(Five or more signatures of ARRL members are required.)

The candidates and five or more signers must be League members in good standing or the petition will be thrown out as invalid. Each candidate must have been a licensed amateur operator for at least two years and similarly, a member of the League for at least one continuous year, immediately prior to his nomination or the petition will likewise be invalidated. The complete name, address, and station call of the candidate should be included. All such petitions must be filed at the headquarters office of the League in West Hartford, Conn. by noon of the closing date given for receipt of nominating petitions. There is no limit to the number of petitions that may be filed, but no member shall sign more than one.

4. Members are urged to take initiative immediately, filing petitions for the candidate of each Section listed above. This is your opportunity to put the man of your choice in office to carry on the work of the organization in your Section.

— George Hart, Acting Communications Manager

ELECTION RESULTS

In the Eastern Pennsylvania Section of the Atlantic Division, Mr. Jerry Mathis, W3BES, and Mr. William F. Roman, W3ITZ, were nominated. Mr. Mathis received 146 votes and Mr. Roman received 50 votes. Mr. Mathis' term of office began Sept. 23, 1943.

In the Northern New Jersey Section of the Hudson Division, Mr. Winfield G. Beck, W2CQD, and Mr. Forman Bruce Parsons, W2COT, were nominated. Mr. Beck received 135 votes and Mr. Parsons received 66 votes. Mr. Beck's term of office began Sept. 23, 1943.

BRIEFS

From *Ham Chatter*, the official organ of the Radio Amateurs' Society of Johannesburg, South Africa, we borrow the following helpful definitions:

- Amps** — Little devils.
- Catwhisker** — Mouse detector.
- Characteristic curve** — Best observed at the seashore.
- Choke coil** — Primitive instrument of torture.
- Feed-back** — A football player.
- Magnet** — A tiny worm.
- Ohm** — Where factory men go at 5 P.M.
- Soft copper** — A good natured policeman.
- Sweep circuit** — Path traced by a vacuum cleaner.
- Terminal lug** — A bum in a railroad station.
- Toggle** — What the Roman emperors wore.
- Toggle switch** — Persuader for small children.
- Variable** — Any woman.
- Zero** — A fiddler who wore a toggle.
- Microphone** — One millionth part of a headpiece.
- Mu** — Cat's call.
- Multivibrator** — Hawaiian dancer.
- Resistance** — What the boss puts up when you demand a raise.
- Trimmer** — Lawn mower.
- Push-pull** — An accordion.
- Wave-trap** — A storm reducer used in ships.
- Pick-up** — Beautiful blonde.

Meet the SCMs

The featured SCM this month is Orpheus U. Tatro, W7FWD, who took over SCM duties for the Washington section in May. Born in Valparaiso, Ind., on November 12, 1878, his travels finally took him to his present location, where he has served as city clerk, treasurer, and state examiner for twenty-six years. He served in the Army in 1898, and acquired his first interest in amateur radio in 1920. He received his ham license in 1936, with the present call, and has since acted as president, treasurer and trustee of the Olympia (Wash.) Radio Club. W7FWD has been heard on 'phone and c.w. from 160 to 10 meters, but his most-used frequency was located in the 20-meter c.w. band. He keeps up with code and theory by teaching classes to WERS operator candidates. Not content with having ham radio alone as a hobby, W7FWD is also a photography enthusiast and is interested in the training of field-trial dogs. He is a member of the USWV, VFW, and the NWFJ Association; he participates in such active sports as swimming, shooting, skating, ice hockey and football. A recent heart ailment has limited his sporting activity, however, and we've a feeling that radio will hold undisputed first place as W7FWD's hobby after the war.



The Month in Canada

QUEBEC—VE2

From Iin Morris, 2CO:

AL LUNAN, 2NY, writes to relay the good news that Gordie Storey, 2FI, is the proud father of a baby girl. Red Lymburner, 2IC, was on long distance to Washington one day recently and was surprised to find that the fellow on the other end of the wire was none other than "Mac" McAteer, 2EM. "Mac" is on leave of absence from his job in Montreal and joined Rod MacDonald, 2FO, in the Capitol several months ago. Noel Wright, 2DU, lunched with Gordon Southam, 2AX, while in Montreal. Noel has now moved his family to Ottawa. 2CO is the godfather of the infant son of Bob Prinsick, 5TD. With such a background the youngster will doubtless be initiated into the mysteries of ham radio at an early age.

ALBERTA—VE4

From W. W. Butchart, 4LQ:

4AOZ, SLIM MARSDEN, of Milo, comes across with one or two items, as follows: 4EZ, Clare Watts, of Vegreville, is works superintendent at the RAF Field at Bowden. 4AMA has left Pierce Airport for Portage La Prairie, where he will continue his duties as a civilian radio mechanic. 4ASO, Lemore, of Purple Springs, has returned to his farm and is doing a spot of radio servicing on the side. 4FQ, E. L. Gilpin, of Viking, has graduated from the RCAF school at Lethbridge as a WOG (Doesn't sound quite right Slim, as I didn't know they graduated WOG's at Lethbridge—

4LQ.) 5DO, who is with the B. C. Provincial Police, was married on September 4th. 4AOZ is still looking for a late model ham receiver! Can anyone help him out? Tnx for the report, Slim.

The NARC held a weiner roast down at White Mud Creek on the evening of September 26th, and in spite of the early and complete darkness everyone reports having a good time. 4BV, Reg. Mainwood, of Edmonton, showed up astride an English model motorcycle; a contraption called a "Triumph," just in case any of you chaps are interested. Mrs. BV preferred to ride to the roast in the family car. 5MJ, Vernon, B. C., along with YL attended the weiner roast. 5MJ has been down at Ottawa for a while, and has just recently returned to Edmonton. 4ZW, Bill Couch, of Grande Prairie, attended, along with 4RM, Chas. Harris, of Edmonton, and YF. Also 4KK, Bert Fowler, of Grande Prairie, and YF. 4ZW is with C.P.A. installing ground stations. Among others present at the roast were: 4WEI, Hilda Hughes, of Edmonton; 4EA, Roy Usher, of Edmonton; 4NU, Gordon Sadler, of Edmonton; 4ATH, Stan Mitchell, of Edmonton, and 4XF, Pat Sullivan, of Edmonton, with XYL and daughter. In all, about two dozen turned out, which in these times just goes to show that the old ham spirit is still present, and that the gang likes to get together once in a while to swap yarns, etc.

4WY, Mickey Turpie Dodds, has gone to Calgary to live with the OM, who, having finished his schooling with the RCAF at St. Thomas, has been posted to Calgary. By the way, the junior YL op. went south to live too! 4AEN, George Marion, of Edmonton, has been posted to St. Hyacinthe, P. Q. George, by the way, is a petty officer and has a trade of electrical artificer. 4AEV, Norm Lockhart, of Vulcan, and 4AOZ are very busy these days propositioning each other on a receiver dicker, and take it from us, we'll bet neither one will drive an easy bargain. 4XE, Dick Bannard, of Edmonton, is busy these days with signal instruction about five nights a week. 4XF, Sullivan, of Edmonton, takes an active interest in signal instruction, as sergeant in "E" Troop Cavalry Signals.

Via the Edmonton Journal of Saturday, October 9th, we learn that Signalman G. W. Horton and YF announce the birth of a son, in Edmonton. Wonder where Bill holds out these days? (Bill holds down 4AEA here in Edmonton when we're on the air.) 4ANR, Jim Miller, of Edmonton, has joined the RCN, and at present is taking his basic training for a rating, prior to attending school to qualify him as petty officer radio artificer. You should get a load of 4AKK, Bob Lamb, of Edmonton, strutting down Jasper these evenings pushing a baby carriage.

MAILBAG

DONALD RAINS, ex-VE1BM, ex-VE2JB, writes from 4 Wembdon Rd., Bridgewater, Somerset, England, to inform us that he is still alive and kicking, and includes the following report of his activities:

"I left Canada just before the war and joined the RAF as wireless operator, serving as air crew and later on doing ground duties, in which capacity I am still serving, having managed to acquire three stripes. I have met many Canadians but, unfortunately, not one ham, although I know there must be quite a lot here. . . I would appreciate hearing from you regarding VE activities, and if you know the whereabouts of 1EY, 1BV, 2KW, 3WA, or any hams who happen to be this way.

"I was born in England, but went to Canada in 1928. I can honestly say the happiest days of my life were spent there, especially as a ham when I made scores of friends. I'm hoping to be on the air again in the land of the VEs one of these days. . ."

FROM Cliff Norman, 2OM, 527 Laird Blvd., Montreal, Quebec, we received a request to print the following:

"I have been rejected by the active service army and am now working with the recording department of RCA Victor in Montreal. Our main studio was recently built using the principle of convex panelling, each panel being about twenty-five inches wide and reaching from floor to ceiling to eliminate echo. On the other side of the control room is located another smaller studio. In the former we have our recording equipment, which consists of three amplifiers, two transcription and two recording turntables. Most of our present recording is in connection with the coming war loan, which will have passed by the time this gets into print. We are not doing any commercial work at the present time."

AMATEUR ACTIVITIES

ATLANTIC DIVISION

EASTERN PENNSYLVANIA — SCM, Jerry Mathis W3BES — In a fine letter from 8EU, we learn that 8BQ had a confab with 3QV in Melbourne, Australia. The Wilkes-Barre Radio Club folded for the duration. The Radio Servicemen's Association there is teaching radio theory. 8EU has been sending recordings of code and messages to 3BWT who plays them to the Washington Radio Club. Pat wants to know of any ORS left in his section of the state whom he can visit in his travels. 3DQ flew to India with Kickenbacker. 3KT is in the hospital in Florida recovering from an operation. His instructor is 2JPI, who is one of the well known 2AER/2 Field Day gang. 1BZO has moved into the section and made himself known. When things get going again he will be an active ham. Marple Township is considering closing its WERS activities due to lack of operating personnel. Lower Merion will have a new station in their control center, built by 3DOU. 3HFD is starting a deluxe 2½-meter WERS rig which will have many stages, and can be "souped up" after the war for permanent use. The Frankford Radio Club shows renewed activity. KAJJK called on the telephone and we had a good chat about all the KAs we used to work. 3GYV is in Africa. 3JSU and 3JUC left for induction right after the last FRC meeting. 3IXN is planning his post-war rig and will have it well under way by this reading. Thanks for the vote of confidence. Please continue sending me material to write up for QST. The boys in the services want to know what is going on, and look for this column. 73, Jerry

MARYLAND-DELAWARE-DISTRICT OF COLUMBIA — SCM, Hermann E. Hobbs, W3CIZ — Little news this month. WERS activities continue in D. C., where there are nine or ten mobile stations and three or four permanent ones. EKZ, secy. of the DARA, reports that WERS is going along nicely. He leaves the last of October for a promising position in the Army. The WERS gang presented him with a swell wrist watch. 73 and best wishes from us all, and drop us a card now and then. The Washington Radio Club is still figuring on holding a hamfest sometime in November but is having trouble finding a suitable place for the event. Send in some local news. 73.

SOUTHERN NEW JERSEY — SCM, Ray Tomlinson W3GCU — Asst. SCM, ZI; Regional EC, New Jersey state radio aide for WERS and radio aide for Hamilton Twp. WERS, ASQ; EC for Somerville and vicinity including Southbranch, ABS. Much to our regret, we report that Ted Torretti, BAQ, has tendered his resignation as Regional EC for the Southern New Jersey Section because of his duties as civilian radio engineer with the U. S. Services. We are very sorry to lose Ted as he has been very active in this capacity, giving unstintingly of both time and money, and has served on the scene during past emergencies in our section, rendering necessary emergency communication and upholding the traditions of the Amateur Emergency Corps in every instance. We all wish him the best of luck and success. ASQ has been appointed as Regional EC for Southern New Jersey. Dalis is a very active and able appointee, and we have no doubt whatsoever that he will faithfully serve the best interests of both amateur radio and WERS. It is men of this caliber who are needed in such important posts as Regional Coordinators. Hamilton Twp. WERS reports progress. Additional applicants have requested schooling toward obtaining WERS operator permits. ABS reports Hillsborough-Branchburg Twps. WERS are now getting their mobile equipment ready to go as soon as their operator permits come through. Stan is planning exams for ten more third-class operator tickets pursuant to obtaining WERS permits. Hillsborough Twp. now has six amateurs participating. This set-up operates at 115,100 kc. under the call WEXQ. Efforts are being made to establish communication between Hillsborough Twp. and Hamilton Twp. control stations. Both stations have been heard in both locations and it is felt inter-communication will be of mutual benefit. Several localities in the section are getting ready to apply for WERS licenses. ASQ visited Kearny recently to give a talk

on WERS organization, and was greeted with great enthusiasm. Kearny is one of the locations forging ahead on this project. CCO, former SCM, is now project officer attached to Communications & Navigation Division of Aircraft Radio Laboratory, Dayton, Ohio. ATF is now Tech Sgt. R. E. Reed, VMTB 232, Navy 140, c/o Fleet P. O. San Francisco, Calif. IOW expects to take exam for warrant officer. Tony's QTH is Tech. Sgt. A. Constantino, 12011935, APO 828, c/o Postmaster, New Orleans, La. Good luck, Tony. FXM may now be addressed, Sgt. J. J. Santomas, APO 862, c/o Postmaster, N.Y.C., N. Y. Joe sends his 73 to FMP and JAV, as well as the rest of the gang and says he will be glad to hear from any of 'em. ITU writes he was stationed on a target boat to cover the furlough of the regular operator thereon, but the long swells of the briny deep got him down and he was put ashore again. Dave is now pounding brass at Fort MacArthur and can be reached: Cpl. David Nabutovsky, Hq. Btry., 3rd C. A., Fort MacArthur, San Pedro, Calif. Dave is also studying blinker operation; he would like to know if there are any of our Trenton gang thereabouts as he would like to contact them. AXU is in Oklahoma working in connection with his position with Princeton University. DQ is somewhere in India. CCC reports that word of safe arrival in Africa has been received from his son, Bob, who is now Cpl. R. T. Kerr, of U. S. AAF. JTT is now corresponding secretary for SJRA. FBC, who has been somewhere in Ireland for months, has been promoted to master sergeant in the Signal Corps. Congrats and luck, Bob. 2MLW, ground station radio operator for PAA somewhere in Africa, writes that DVRA News has been received in Africa. Charles Moore, director of radio monitoring for DVRA, has been reporting several f.m. broadcasts recently, received with good quality and signal strength; among these was W65H in Hartford, Conn. There is still a world of news to be gleaned from other parts of our section, so come on, fellows, what say? Till next time, 73.

WESTERN NEW YORK — SCM, William Bellor, W8MC — SJV tells us all the available YLs and XYLs up Tonawanda way now have their third-class permits and are rarin' to go on WERS. Ed furnishes quite a bit of the following dope on the boys in the services. Hope to hear from some of these boys, too. WHK is a corporal at Camp Murphy, Fla. VCI is an RT2c at T. S., San Francisco, Calif. NNP is a top sergeant at Camp Edwards, Mass. UOQ is a corporal at Camp Edwards. BPJ is a CRM somewhere in Southwestern Pacific. UYV is S2c, c/o Postmaster, Norfolk, Va. UBR is a sergeant at San Antonio, Tex. Abe Andzer, formerly an operator with WSAY, is now in the Signal Photo Mail Co., South Post, Fort Meyers, Va. Abe says they heard of his other hobby of photography and though he tried to get into radio the Army decided they needed the photographer more. John Briemer, a Rochester LSPH, landed a job as code instructor at Sampson Naval Base, Corning, N. Y., is now officially considering WERS, and a committee with power to act has been appointed with Mayor Stimson as chairman. This is the result of the fine work of QLI as EC. SBU is now at Camp Coles. His wife and family are living at Eatontown, N. J., where the XYL is a welder at Ft. Monmouth and the youngster attends school. TWX breezed in from Spokane, Wash., and VUY from Camp Crowder, and they immediately looked up Bus and a small hamfest was put on over the weekend, and how! TWX and VUY are now at Fort Monmouth. The Syracuse, N. Y., WERS group now have a new workshop through the generosity of the local power corporation; their unit, WKBS, is now enlarged to over thirty stations and is expanding facilities to include more county area. RLI has just completed a beautifully controlled 2½-meter rig with an 829 final. 2BB has been home on leave, after taking a course at a western university; he was promoted to P. O. in RCNVR. Remember, if you like the news in this column, send in your share; there is always someone waiting to read it, especially the boys in the services. So many of them tell us it's their best means of "getting the dope."

WESTERN PENNSYLVANIA — SCM, E. A. Krall, W8CKO — As SCM, I wish to thank all the hams for the work they have done, and I hope their excellent organizing ability extends through the post-war period. Warren County is completely organized for WERS under call letters WKLY. BOZ and HKU are the leaders, and they are continuously training new personnel. WBW did some fine carpenter work on the cabinets for the units. JSQ, PHC and VMW have all had a part in the CDC work. VMW taught the WKLY personnel first aid so they could qualify as CDC workers.

One woman and five men operators, who are not hams, were trained by TOJ. CQA is working for the Army in a civilian job. ESR is with RCA in war job. KYW, NBD and NTJ are in the armed forces. Washington County is organized for WERS, but we do not know who directs operations. How about a report? JAX spent a vacation at home after several years of operating in Liberia. QAN is stationed in Hawaii. After seeing the XYL's brother operating, NCJ expects plenty of competition for the oldtimers and suggests we had better get out the old bug and practice. KWA is now Lt. Henry W. Wickenhiser, USNR; his present QTH is the U. of Houston, Houston, Tex. He was recently married to 2MIY, one of the outstanding AARS operators of the 2nd C.A. Good luck, Wik. The Amateur Transmitters Association of W. Pa., met at the Fort Pitt Hotel in Pittsburgh Oct. 16th, and it certainly seemed like old times to see the gang again. FTY read an interesting article by KBW. KB surely is in there battling for the hams. If you doubt it, read his write-up in *Electronic Industries* magazine. FCO has been on the sick list recently. MPO is enjoying his new home. This section has been absent from these pages because no reports came from the gang. Send in a report before the 20th of the month so that we are represented.

CENTRAL DIVISION

ILLINOIS—Acting SCM, George Keith, jr., W9QLZ—YBY has a new QTH. ATA is now working in the final test department of Hallicrafters. RRY, CQT and NTT are Signal Corps inspectors in the Chicago area. IAW and CCB are still holding their own in Champaign. RLU is a master sergeant with Signal Corps in the Panama Canal Zone. TKS is employed by FCC. GAW is helping keep the local b.c. station on the air. GDM is located in Washington, D. C. UWC has been working at Caterpillar in Peoria. AIK keeps the farm going. YVY does inspection for the U. S. Army Air Forces in Indianapolis. VGN has acquired the rank of lieutenant in the U. S. Army. Major Eddie Pride, formerly of "Ham Forum" on WILL, is RRY's commanding officer. ZYZ works for Western Electric. CRX is an engineer with Allis-Chalmers. NTV is now in the Army Specialized Training Program at Colo. State College. NZU has been busy getting basic training with the AAF at Miami Beach, Fla. RON does radio operating with the ferry command. JQD is a civil service operator at Fort Sheridan. JOX pounds brass with PAA in Mexico. GDV repairs BCL sets around his QTH. CAA radio operator NWW has recently acquired an XYL. Waukegan WERS is under way with JBH doing much of the work. GYW is an RM1c on transport duty. GDK has been reported missing in action. FQE spends his time in the electronics department at General Electric in Bridgeport. ODT reports all paper work completed on the Joliet WERS application and hopes FCC approves. OPT is an RM3c in the Navy, stationed at Miami. He is teaching radio at SCTC Radio School. Well, gang, that simplifies the job of writing a column—keep the news coming. 73—Geo.

INDIANA—SCM, Herbert S. Brier, W9EQG—Mishawaka: AB, radio aide, has applied for authorization for a few more units. Another examination for restricted radiophone permits was given recently. AB is experimenting to learn if f.m. is superior to a.m. on superregenerative receivers. South Bend: YRR, radio aide, is on the air and puts a tremendous signal into Mishawaka. Elkhart County: SVH, radio aide, is covering long hops with low power. Nappanee and New Paris will soon be included in the set-up. Authorization for three more units has been requested. Indianapolis: JYP, radio aide, has sixty operators available, and has a very fine operating manual. Bloomington: HBD, radio aide, has applied for authorization for fifteen units. Howard County (Kokomo): OKU, radio aide, probably has its license for seven units by this time. Grant County (Marion): Ned Underhill, radio aide, after an unexplained delay in Washington, may have received its license for fifteen units. Gary: MVZ, radio aide, now is licensed for twenty-three units, all but two being portable or portable-mobile. Keeping moisture out of the coaxial feed line to the control station antenna is a major problem. A few OCD volunteers have received their WERS licenses. Another group were given the examination October 15th. General News: VTR, ABB and NGB were home on leave from the Navy recently. This was the first time NGB, RM1c, had been home in three years. ABB is a "chief." HZY has been at so many Air Corps stations in the states that he has lost count of them all. He is "ACRT." He is also father of a jr. operator. GOP is with the FCC in Hawaii. VKN is a fighter

pilot stationed in Florida. Clarence Webb, former secretary of the Richmond Radio Club, is now Pvt. Webb, FA, Camp Rucker, Ala. FXM is now radio aide for Richmond. NVA is working for a famous wire company. GPZ is married. So is ANJ. OOG is teaching radio in Fla. IIL, a lieutenant, is studying and working here, there and everywhere. SNF is teaching radio pro. at an AAF school in So. Dak. Those who hold EC appointments and do not send in a report occasionally are likely to get a bitter reminder of the duties of an EC from me. If your appointment has expired or is about to expire, please send your certificate for endorsement. A copy of the *Bison* was sent to more than 175 Indiana hams, Oct. 10th. If there is sufficient demand for it, publication will continue. A report will get you a copy of the next issue and details on how to receive a copy of every issue. 73.—Herb.

MICHIGAN—SCM, Harold C. Bird, W8DPE—Congratulations to 8EBN, of Lansing, on his appointment as WERS state radio aide. Congratulations also to 8DYH on his appointment as state deputy radio aide. Our old friend and DARA secretary is now located at Camp Crowder. The DARA is apparently carrying on its plan of having speakers at each meeting. 8VGC writes that he is the proud papa of twin girls. Now he is wondering if he can swap his rig for a boy. Congratulations, OM. Ed also reports on several boys of the gang at Hamtramck as follows: 8SNR is in New Guinea; 8SLJ is in Greenland; 8SKE is in Florida; 8TEM is in Arkansas and 8TKB is in Illinois. The rest of the boys are doing work for Uncle Sam as follows: 8CLL, 8RRH, 8VGC, 8TOW, 8HQO. Thanks, Ed, for this dope. Received a card from Lt. Comdr. G. T. McAllister, USNR. Mac says he has turned 100,000 miles since last Nov. 1st, and has seen all kinds of radio. Paul Bauerle of Lansing reports installing new antenna to give better reception from mobile transmitters. The reception from the north was not entirely satisfactory due to steel structure of buildings having a shielding effect. Have twenty-one licensed operators: 8VRV, VGC, CBT, UGO, YDC, JPY, UJS, SLQ, SYT, WCI, GSP, CQT, PUK and Joe H. Archambault, operator at KAR. Lew Brewer, radio aide for Grand Rapids, reports as follows: 8WJM joined the staff and was appointed chief engineer of the station. 8AGN in now asst. radio aide in charge of all personnel and net operations. He is a professor in South High School, W. Eastwood, and works as engineer in electronic plant in south end. 8AHM has returned from Ohio. Recently added three new operators: Kenneth Roche, John Nelson and Joe T. Luneke. During summer months no meetings were held, but beginning with last month meetings will be held once a month to mill things over and try to figure ways and means of improving the station. Holding drills on Wednesday nights from 9 to 10 P.M. on the other two allowed test periods we occasionally make equipment adjustments. Lou says still interested in state-wide net. Probably Mr. Walker will have something on this later. The Oakland County WERS station in Pontiac did not prove satisfactory with the equipment used, so now a crystal-controlled 25-watt job is under construction. The boys are making contacts to get the rest of the permanent stations going. A lot of work to do and not much personnel to help with it makes it rather slow going. After station WKYM is definitely on the air would appreciate hearing from anyone who hears it during the assigned test periods. The frequency will be 113.1 Mc. Paul Palmer of East Detroit dropped in for a short chat a week ago. He is to be congratulated on his fine equipment and the ideas he has been sending in to QST of late. S/Sgt. Francis Martin, who is pounding brass for Uncle Sam somewhere in Africa, writes that he would like to hear from some of the old gang in Muskegon. Frank is studying radio from Ohio University by mail and says he surely likes QST; it's what the gang wants. His radio course is by E. E. Burns. Louis Gerbert, RM2c, is now attached to naval communications division in North Africa and writes that he has seen quite a bit of Africa since he has been there. At present there are several hams in their camp. He and GM3FS of the Royal Navy have carried on a few experiments in spare moments. He had the good fortune to meet 8BA or Rabat, Morocco, in person. Louie would appreciate hearing from the boys. His address is Louis Gerbert, RM2c, Fleet P. O., New York, N. Y. Well, fellows, I guess that is all there is for this time. To you fellows over there, we say thanks for your letters and dope. Your buddies must appreciate hearing from you via QST, as we receive requests to write all the news we can. To you fellows at home, you can see by the bits of letters written above how the boys over there appreciate hearing what you are doing

and what your activities are in the radio game. Don't let them down! Come on, give out, and let's give those fighting radio Yanks of ours the dope from this end, 73. Hal.

OHIO — SCM, D. C. McCoy, W8CBI — Your SCM recently met with Don Park, communications coordinator of the State Council to check WERS progress. Activity is needed in the following places: Zanesville, Ashtabula, Elyria, Lorain, Sandusky, Marietta, Ironton, Newark, Mt. Vernon, Findlay, New Philadelphia-Dover, Steubenville, Chillicothe, Marion, Bridgeport, Martins Ferry and Bellaire. *Springfield*: EQN reports the appointment of Paul Crowell as radio aide, and the start of training classes to develop personnel. TIM, now a sergeant and doing radio work, writes from Greenland that he expects to be home on furlough around Christmas. *Chardon*: ANU is going to try to get something started in his community. *Bellevue*: WUI is working on papers for license and on equipment. Eleven transmitters are ready and more coming along. Twenty operators have been trained, eight men and twelve women, and are ready for license examination. WUI has been transferred to the Signal Corps Repair Shop at Columbus. Russell Reiter is helping WUI with the WERS problems. NAB writes from Naval Research Lab. at Washington that he has been at school there five months, stands twenty-third in his class and now has a rating of RT2c. He is rooming with 6PDU, 8UQF and 9HDD. He would like to hear from the gang. *Cincinnati*: MFP reports the revised license, authorizing 106 stations, now includes Hamilton County, Ohio, Kenton and Campbell Counties in Kentucky, and small portions of adjacent Ohio counties in the metropolitan area of Cincinnati. Radio aide TQS has worked hard on the revised set-up. Efforts to recruit additional personnel are under way. Dick Rose (LSPH), reports the Walnut Hills H.S. Radio Club has ten students enrolled in a theory class using the ARRL Handbook as a text. Roger Wetz, chief engineer of WCPO, is the instructor. *Fletcher*: WDG reports fair results with their local WERS with five units in operation. WDG is now assistant superintendent with the Gunned Products Company in Troy. *Mansfield*: JJM is getting ready to start up WERS with ten units. Nine operators are in training. *Alliance*: WUX reports satisfactory tests with four mobile units, two portable and one fixed of his WERS system. SR, SRS, SIM, UDQ and LWG are active in WERS and six new operators are in training. *Tiffin*: ID reports satisfactory results with six units. Ex-ENO is assistant radio aide. *Greenville*: UWA reports some satisfactory drills. Ralph Wietresch and Damon Wilson are assistant radio aides. Eight units are in operation, and three new operators are in training. *East Liverpool*: NDF says city officials are well pleased with WERS. Fourteen new operators are now awaiting licenses. George Kelly, Ross Grimes and Harry McIntosh are participating. Five units are ready and working. *Columbus*: The SCM visited Columbus on the 18th and 19th, and conferred with QQ and radio aide Bob Sweptson. Forty operators are licensed and 110 are in training — half of whom are women. Fifteen additional units are needed. *Dayton*: The WERS mobile units participated in the big civilian defense parade last month. LJ has resigned as deputy radio aide. TOZ, now a sergeant at Chanute Field, was in town recently. QDL, an ensign in the Navy, is stationed at Camp A-17, Fort School, Fort Schuyler, Bronx 61. N. Y. MFV is still at Alamogordo, N. Mex. SVI can now be reached via APO 12315C, c/o P.M., San Francisco, Calif. Over twenty new WERS operators have been added in the past ninety days, and more will be as soon as their 3rd class permits come through. Leona Downs, one of our women WERS operators, is leaving us to attend Port Arthur College. Good luck, Leona, and thanks for your good work at WJTW-2. OVL is working on a new receiver for his mobile unit. RHH has finally gotten the vibrator hash out of his transmitter. IBQ has rebuilt and now has a swell transmitter using an RK34 with long lines and Class-B modulation. KKH is still having power supply trouble. NSS is busy lining up the group in the surrounding towns. PRS has been on the sick list for some time. SID and AZH are about ready to go. RSQ and SDO are all set. CIT took part in his first drill since he has had his WERS permit. *Cleveland*: AVH reports four new district radio aides appointed: AOK, GW, PWY and AXQ. About two hundred units are now in service with more building. One hundred and fifty operators are licensed with one hundred in training, and several hundred more to be trained. The Cuyahoga Radio Assn. meets the first Tuesday of each month at 8 P.M., Room 504, American Red Cross Bldg., 1227 Prospect Ave., Cleveland. New officers are: DS, pres.; QV, vice-pres.; EBB, treas.; ALI,

secy.; AVH, NV and MXK, directors. HC is CRA Bulletin editor; DLD, technical editor and FHE, POQ and RHZ associate editors with PAL editor of the "Rag Chewers' Column." XUGAZ and 6TPH attended a recent meeting. Well, gang, keep the reports coming in and keep after WERS, 73. Dan.

WISCONSIN — SCM, Emil R. Felber, jr., W9RH — NPK will be EC of Kenosha for another year, but reports OCD officials there are not very much interested in WERS. He is working in a defense plant and is doing radio servicing on the side. The Kenosha Kilocycle Club has disbanded for the duration. JCV, stationed somewhere in the Pacific, has been promoted to technical sergeant in USMC. FQW is back in Kenosha after an honorable medical discharge from the USMC. He was acting as a tail gunner and radioman aboard a bomber; was injured by enemy shells when his plane was shot down and was adrift on a life raft on the Pacific for a few days before being rescued. BOB is working for civil service in Detroit and his XYL, EXM, is with him there. GLX is in a defense plant and is also doing refrigerator servicing. SMP, of Merrill, has enlisted in the Marines and is in North Carolina. VAN is pfc. in Wisc. State Guard. FQO is u.h.f. instructor in the Alaska-Washington communication system. NY, radio aide of Milwaukee, is still preparing the WERS license application, but we know when it gets on its way to Washington there won't be any reason for refusal of a ticket. CDY, president of The Milwaukee Radio Amateurs Club, wishes to remind all amateurs that get into Milwaukee on a Thursday night to be sure to come over to the club meetings at 818 W. Wisconsin Ave., Trustees' Room, Milwaukee Public Museum, any time between 8 and 10 P.M. Visitors are welcome. Yours truly wishes to extend greetings to all and hopes to hear from you more often during the coming year. — Emil.

DAKOTA DIVISION

NORTH DAKOTA — SCM, John W. McBride, W9YVF — DNI, RM2c, reports again from the Pacific; UGM is in Africa; UGC is with an airline at Omaha; YTX reports from Honolulu; QGM is in Los Angeles, and your SCM, YVF, is now in the examining room at AAFTS here at Sioux Falls — so the Lidgerwood gang has scattered. RPD is with CAA at Fort Worth; ORE is at KVOX in Morehead, Minn., and WXS is with KDGE at Fergus Falls, Minn., an announcer-operator. Let's have more reports, fellows; get them to me by the 12th. 73. — John.

SOUTH DAKOTA — SCM, P. H. Schultz, W9QVY — Slack on news again this month. ZAL took exam for Class A in Sioux Falls in July. Has it now and is anxious to put it to good use. ADJ, ex-SCM, comes through with the following: TZJ is 1st lieutenant at Jefferson Barracks, Mo. YJX is a captain at Bend, Ore. GCW and AOX have finished Navy school with technical first-class ratings. APT is a captain and is somewhere on the West Coast. ANW is overseas. SWV is a major; whereabouts unknown. IWT is with FCC in Nome, Alaska. ADJ, YOB, GLA and OPS are holding the fort at Rapid City. WERS news from anywhere in State will be most welcomed for the column. 73. Phil.

NORTHERN MINNESOTA — SCM, Armond D. Brattland, W9FUZ — Kindly address this SCM at Birchmont Drive, Bemidji, again. As the Signal Corps schools and others employing civilians are brought to a close, there are quite a few changes. AZJ reports finishing teaching at U. of N. D. GFR went into enlisted reserve in Signal Corps. EHM, formerly of Bemidji and later of Virginia, is located at 1705 Purdy St., New York City. PTB, a sgt., is somewhere in Australia with the Signal Corps. HMH, a epl., is with the Signal Corps in Greenland. CNR, a sgt. in the Air Corps, is stationed at Sarasota, Fla. Rene Vaudrin (pfc.) is in Missouri with M.P.S. QLF is in radar in Fla. KDR is in defense work in Calif., as is Homer Collision, also of the Crookston NMARA gang. RJX is a radio serviceman at San Fernando, Calif., and Johnny Hardine is 2nd lt. in Air Corps at Boca Raton, Fla. ORT is in W.T.S. at Hibbing, Minn. For most of this report I am indebted to DPU, who is now an electronics warrant officer at Drew Field, Fla. 73. — Army.

DELTA DIVISION

ARKANSAS — SCM, Ed Beck, W5BED — Another regular examination has been conducted in Little Rock since last we went to press. The examination was conducted by Mr. DuTriel and some 70 exams were given. Among those present were HNR, FUW and EWX. HUQ is still with

the Navy doing radar work and, since leaving us, has taken upon himself an XYL. HER has moved to an FB new location. GNV is still on the new job in Mobile and is well satisfied. GGW visited GNV in Mobile recently to talk things over. ENH is taking basic training at Keeler Field. FTW is also finishing basic training at Brookley Field. SI has again been nominated for our Delta director. PX is tied up with the usual run of holiday photographic work. BMI is doing a nice job of keeping in the swim of things. FXO has been slightly under the weather lately but is back in line again. Yeah, we knew you wouldn't believe it, but nevertheless it is a fact. After emerging from the usual entanglement of orange blossoms and silver bells, your SCM successfully embarked on the good ship matrimony on the evening of the 16th of October, so when we again take to the air there will be two operators ready and willing to take a turn at pushing buttons. Well, gang, we will do better next time if you get in the necessary reports, so don't eat too much turkey. Very 73 and all the best, Ed.

LOUISIANA — SCM, W. J. Wilkinson, jr., W5DWW — ISF is in Army at Camp Crowder, Mo., assigned to personnel hq. GRE is RT2c in Coast Guard. JXX is RM1c on duty with Navy somewhere, and would like to hear from HBY and HRC. His QTH can be had by writing the SCM. CEW and QH are with Shreveport police radio. The SCM is always glad to hear from those in the services and will be glad to give QTH to the gang if on record. Let us hear from all of you at home and in the armed forces. We will pass the news through this column. Until next time, 73.—Dub.

MISSISSIPPI — SCM, P. W. Clement, W5HAV — We are indebted this month to JUJ for a very nice letter and notes for this column. HEH, RM1c, is expected home on leave after more than a year overseas. KHB is now in the U. S. Navy. JSY is an inspector of radio parts with Bendix Corp. in Maryland. HLZ is now a tail gunner and radioman on a Navy PBY. HEF is still fixing radios for the Army at Fort Sill, Okla. CLD, now a Lt. in the Navy, is communications officer at the Naval Reserve Air Base, Dallas, Tex. EKV has been serving as an instructor in the Army 4th Corps Area Headquarters. We recently received a very interesting letter from HST, RM1c; he has been in the Pacific for more than a year, and sends his regards to DAN, GGP, VJ, DNV, AO and GOU. We hope many of the other men in the services will write us, as we fellows back home want to hear from you, and your fellow-servicemen in the far places will be interested to know of your activities. 73.

TENNESSEE — SCM, James B. Witt, W4SP — HHK is in the U. S. merchant marine as radio officer and says he would like to hear from some of the gang he knew on the air. HXC is at Boston College studying basic engineering in Army Specialized Training School, and states that he has heard some wired wireless. HPO has her first 'phone. HDV is still with WPEC. IDI is in Signal Corps school. GWA is with the 6th Army.

MIDWEST DIVISION

IOWA — SCM, Arthur E. Rydberg, W9AED — Cedar Rapids WERS organization is rapidly getting under way. JIH has been appointed radio aide with WQQ as his assistant. They are planning to build fifty transmitters to a standard design and twenty-five receivers of the superheterodyne type. Collins Radio Co. is donating many radio parts. Seventeen amateurs are taking part and thirty-five operators are being trained, among whom are several women. Burlington WERS is also getting started. PJR is radio aide with LAC and RZV as deputies. They have five station units, and fifteen more are contemplated; three amateurs are taking part and twenty-five operators are being trained. The Iowa-Illinois Amateur Radio Club is still teaching code and theory and is about ready to start a new class. It had a small class for third-class 'phone, which is expected to increase with newspaper publicity. The club has purchased five war bonds and is keeping up its subscriptions to QST to all its members in the services. That's quite a few subscriptions as only seven regular members of the club are left. NLA is going to send the club a kangaroo; guess where he is. PBV is with Philco in Philadelphia. WHC has gone to Merchant Marine Radio School. WGO and TMY are still active in CAP. SWD is now at Boone. UPX is brushing up on a new hobby, playing the organ. TIO is busy getting in soy beans and corn. CGE is still busy working on power lines. New ECs are: SVI, UPX and TIO. Sioux City hams regret death of Dr. Harriman, QGB. AHP of Bettendorf visited old locality recently and called on AEP, DIB and

AED. NMA has a new jr. operator; weighed in at 9½ lbs on Sept. 21st. 73, Art.

KANSAS — SCM, A. B. Unruh, W9AWP — Congratulations to LKD, who is a Signal Corps captain now. KWA issues a challenge for the title of youngest b.c. station chief engineer. He works 15 to 16 hours daily, including Sunday, at KVGB in Great Bend, and is 19 years of age. ASL, formerly of Manhattan and Topeka, and a former instructor at Midland Schools, is now affiliated with the USA at Camp Crowder, Mo. The Sterling gang is showing some activity with carrier current, and reports good results. On September 23rd, at the U. S. Naval Hospital, Portsmouth, N. H., Lt. (jg) Allen H. Barstow, USNLT, said "SK" to the gang who knew and loved him as W9LFN. Lt. (jg) Barstow received his commission in August, 1942. Prior to that he was chief NYA engineer at Topeka for several years after resigning as radio engineer at WIBW. The Kansas gang extend sympathy to the bereaved family. BEZ, formerly active in Wichita, has transferred from Pueblo, Colo., to Albuquerque, N. Mex., where he is a postal inspector. KBN, formerly of St. Marys, now has a commission as ensign. He was radio operator aboard ship at Pearl Harbor, and has since been an instructor in radar at Washington, D. C. JXJ is a Signal Corps lieutenant; he recently completed a course at AAF school in Florida, and is returning to the Northwest. His brother, VPK, took basic training at Camp Adair, Ore. When last heard from, KCS was operating communications office at U. S. Naval Air Station in Corpus Christi, Texas. LFB, of K. G. & E., and FET, of radio station KFBI, have been added to the list of part time c.w. operators at KGPZ. REB assists with maintenance. BGY was promoted to foreman of technicians at Boeing bomber plant. CZN received Army boot training in Florida. 73.

MISSOURI — Acting SCM, Mrs. Letha Dangerfield, W9OUD — AEJ writes from Stillwater, Okla. He will graduate from the Naval radio school on Nov. 6th, the day before his 20th birthday, and will receive the rating of RT3c. Congratulations. WIS is still teaching communications to Naval cadets at William Jewell College; and Mrs. WIS is teaching radio theory at the same place. WIS says she had been exposed to so much ham radio at home that she can keep ahead of the students by studying hard, although she had no actual radio experience previously. How about sending in some dope so all of us will know what goes on with all the rest of us? We mustn't let the Missouri column dwindle down to nothing. OUD is still figuring out how to make the blue and red points go around — not to mention the money. BMS is getting onto this highway patrol operating. The other operators at the station in Lee's Summit are KG, PYK and SJC. Now, how about it, gang? Let's have a little cooperation in the way of news. Good luck, and 73 to you all.

NEBRASKA — SCM, Roy E. Olmsted, W6POB — All that I have on the hook from which to glean your monthly report is a little gossip and a few rumors. A swell letter has come from UJT, RM3c, with the Navy on the West Coast. He moans about the good old days when he used to flap the breeze with LOC, ITS, EAT, FOB, YFG and others on 160. George adds that he met BSP of Olathe (code instruction on 160) who is now a full lieutenant. UJT says he can copy c.w. at 40 per — how's that for a 'phone man? While enroute to Iowa City from their honeymoon at Cedar Point Ranch, UHT and his bride paid a brief but very pleasant visit to your SCM and the Fahrlanders (YOD). Doc has resigned his commission as an admiral in the Kingsley Lake Navy and has beached his P-T boat for the duration. Two of amateur radio's worst operators, a pair of old cronies who have faced the bar on more than one occasion in the past, were nabbed by the FCC recently. On Sept. 25th they were brought before Inspector Benjamin Wolfe at the Grand Island monitoring station and both pleaded guilty to charges of mayhem, arson and having been seen reading the Q and A book. After hearing their pleas for mercy, Inspector Wolfe sentenced POB and YOD to terms of five years as 'phone operators of the first class. YOP, who does maintenance for CAA at Anchorage and intermediate stations, has just finished a demonstration in natural science and has learned exactly what happens when an irresistible force meets an immovable object. It seems that Athey, who knows how and does his maintenance work the right way, met up with a second looney who insisted that it be done the Army way, right or wrong. Congratulations to Mr. White and ARE for knowing the right answers to any questions that might have been asked. KPA, who is pounding brass for PAA from Juneau, writes that as he gets less allergic to

whale blubber sandwiches, he notices that the Eskimo girls seem lighter complexioned. OHU is one of a group who has volunteered for operator service in Alaska and is awaiting his call. That's about all the dirt I have on the hook, but I promise to rattle a few more skeletons in the next issue. However, I want to recall for many of you who know him, the grand war work being done by one of Nebraska's pioneer amateurs, none other than Louis Leuck, ANZ. While his gracious XYL looks after the radio store, Louis is devoting long hours of every day to the manufacture of precision crystals for our armed forces. I can attest to the fact that he has organized a fine plant, knows all about the job he is doing, and is turning out a great quantity of superior "rocks." It seems perfectly natural that Louis, with all his radio background, should be doing just that part of winning the fight. So long, boys and gals; let's have more letters from everywhere. — Pop.

NEW ENGLAND DIVISION

CONNECTICUT — SCM, Edmund R. Fraser, W1KQY — At the annual meeting held in the "GB" clubrooms Oct. 1st, the following were elected to office: TD, pres.; KDO, vice-pres.; ATH, secy.; JQK, treas.; LTZ, IGT and LTB, directors. DDP writes from Ft. Benning, Ga., that he has been advanced from technical sergeant to warrant officer. CD-WERS: BHM has resigned as associate radio aide of New Haven, IGT being his successor. EFW has been released from CAP after eleven months of active duty and now is trying to get into AACs. IKX and BQQ, Tuttle and Galor have done a swell job in turning out equipment for Cheshire WERS. GTH, GSP and BGJ are doing likewise in Southington. CSX, Derby radio aide, has been working seventy to seventy-five hours weekly, finding it rather difficult to devote much time to WERS activities. FMV has been appointed deputy district radio aide to assist KQY in the N. H. warning district. 5JLZ was given a farewell party prior to his departing to accept appointment as assistant professor at U. of Tex. Those present were district radio aides KQY, DEP, DRA, FMV; radio aides IJ, IGT, JQK, LTZ and ex-SF, along with IND, Harper, Tabor, Hoffman and Misses Jackson and Hewitt. 2EW, operator of WNYJ-202, recently dropped in at WJLH-1, 2 and 3 during a Sunday test period. Frank Sanchione, radio aide for Bridgeport, writes units 1, 4, 6, 7, 8, 15, 74 and 75 working very smoothly. While driving home from N. Y., Frank was stopped by WJQA-75, who recognized the antenna. Don Matthews, radio aide for Trumbull, has units 48, 50, 51, 54 and 55 working very well; unit 48 has been acting as relay station between WJLH and WJQA warning districts. We are proud to learn of ARRL rating Connecticut as the number one WERS state in the country. As a reminder to district radio aides — Conn. WERS station licenses expire Feb. 1st and must be renewed at least sixty days prior to expiration, using FCC Form No. 405. During a recent test period of WERS units, traffic was relayed from WMHC, WKNQ, WKOB, WJLH, WKAO and WJQA units in record time. SG-WERS: APA in Bridgeport has units working 100 per cent and has been rewarded for his time and effort spent by having one of the best outfits in the SG. GUP was made aviation chief radioman in August and expects to go to Gainesville, Ga., soon.

MAINE — Acting SCM, G. C. Brown, W1AQL — Your SCM visited the WERS headquarters in Millinocket recently. The boys up there have a nice layout in the fire station; there is also an alternate station in one of the local schools. The station was built by Doc Slate and the gang. Bar Harbor and Millinocket are fine examples of what can be accomplished with a little cooperation between the town officials and amateur radio. KJQ writes that he went through the entire Munda and New Georgia campaign. He says that the general topic of conversation with hams in foreign countries is what type of rig they plan to put on the air after the war. FQ, a major overseas, says that he will be glad to get back home and on the air once more. QH writes that he has received a couple copies of QST and is glad to see Maiae in the picture again. TO has been reapointed EC for the Augusta area and sent in a few items for this report. KOB, Boston, is in charge of the GAA at Millinocket. KEA is communications officer for the Maine Wing CAP, which has a large class of radio students and several 112-Mc. rigs. KCO is a staff sergeant in the Signal Corps. CMO is still looking for radio gremlins. NDC is a radio operator with the Coast Artillery. MNR is a desk clerk with the Maine State Police IOQ is teaching code to a class of Boy Scouts. DBC

has a son who is a radioman with the armed forces. Keep the news coming, gang. The letters received for this report were FB, and thanks a lot.

EASTERN MASSACHUSETTS — SCM, Frank L. Baker, Jr., W1ALP — KDF is now the EC for the Roslindale and West Roxbury section of Boston. NFQ reports that Region 6B has been granted a WERS license under the call of WKKL, and that his town expects to be on with a TR-4 at hq. and four transceivers which he is building. NFQ and XYL have a new son, born in July. NFQ is still working with the Foxboro Co. KQF, who is out in Calif., got married. LBY writes from Colton, Calif., where he is working as an electronic inspector for the swing shift at an Army air field. BUB and XYL have a second baby girl. FZX writes from Florida where he is attending an Air Force school. He expects to go overseas soon. MVF has gone to Norfolk, Va. MTQ reports that WERS, under the call of WJQI, is still going strong in North Easton. EYY has just been drafted into the Army. NCC enlisted in the Navy and is at an electrical engineers' school in St. Louis. EFE is still with the FCC and is also radioman for 52nd Co., Mass. State Guard. LSD and XYL have a new baby girl. KYL and his YL recently got engaged. JCI is still out in San Francisco. MME writes from San Francisco where he is waiting to shove off for somewhere. LLW writes from Camp Crowder, Mo., where he is taking his basic training; he is in the Signal Corps. MPT is now a married man. AXR misses the QSOs on 40. We hear that DNF and DBH will be in the Army soon. FWS is spending some of his spare time in the Coast Guard Reserve. JCX has been working around Boston lately. JBY has been home for awhile. NM is a lieutenant commander and is located at Lakehurst, N. J. HDJ was home on a two-week furlough. We recently met FL in Boston and he wanted to be remembered to all the gang in this section; he is still up in Presque Isle, Me. EHT says that he is very busy these days. KH was in Boston recently. ALP is working in Boston all the time now. William Langan, who was helping out in the WERS in Lynn, is moving to the West Coast. KKK, now in South Seas, sends hq. some very interesting letters. To all ECs: I would appreciate it if you would all kindly send me your certificates for the annual endorsement within a short time after I mail you cards informing you that it is time to endorse them. Your cooperation is requested. If you move away to some other town, drop me a line so that we won't be wondering where you are. 73, Frank.

VERMONT — SCM, Burtis W. Dean, W1NLO — The state is running a radio school in Barre to take the place of the NYA Radio School at Waterbury. CGV and EKV are instructors with twenty-five students. MLJ is back at his old job and living at South Barre. He and the XYL attended the Hamfesteite in Burlington Sept. 10th, bringing with them four students from the radio school in Barre. We have a new YL ham in Vermont: Norma Remily, 147 North Union St., Burlington, with Class B operator license and restricted telegraph. Norma attended the NYA and Barre Radio Schools. Donald Richardson, LSPH, and Everett Chapman, LSPH, of Charlestown, N. H., are at Barre Radio School. Dolores Staab of Kington, N. Y., another graduate of NYA and Barre, has Class A operator license 2nd phone and restricted telegraph. Both Dolores and Norma are working for American Export. MJU graduated Sept. 24th from UVM with Summa Cum Laude in electrical engineering; he also won the A. Atwater Kent prize for outstanding work during his four years of college. Don has gone to Rochester, N. Y., to work for Stromberg-Carlson. Best of luck, OM. LML is chief operator at FEA and lives at 20 Caroline St., Burlington. At the annual meeting of the Burlington Amateur Radio Club, LWN was reelected pres.; Ray Fields, vice-pres.; and NLO, secy. and treas. KJG, GKA and Profs. Buchanan and McKee, UVM, were elected honorary members. LWN and NLO each recently donated a pint of blood to the Vt. Blood Plasma Bank. JRU and XYL visited friends in Morrisville and have gone back to Conn. Drop me a line, gang, and let me know what is going on around the state. 73 and CUL, Burt.

NORTHWESTERN DIVISION

MONTANA — SCM, Rex Roberts, W7CPY — The amateurs of Livingston have organized the Livic Radio Club and have applied for affiliation with the ARRL. The charter members number eight. HWD, ex-9PZU, is president and Gertrude M. Matson is secretary. They are carrying on a code and CD-WERS instruction program. Congrats, Livingston. DSS has been appointed state radio

officer for the Montana War Council. Ex-BLA, ensign in the USNR, visited in the Falls on his way to South Carolina. HEM, RT2c, USNR, is in school at Corpus Christi, Texas. FOA is now test-boardman with the telephone company at Glendive. CBY reports from Butte that their club is still active. They donated \$10 to the AWWB; are planning on experimental work with c.c. transmission. DXQ recently visited hams in Glendive.

OREGON — SCM, Carl Austin, W7GNJ — EC, JN. HVX reports the following hams in electrical and other departments at Willamette: HLB, BJK, ZD, CXK, HTC, DZD, ABZ, GSH, UK, HXG, DZV. FEB says the Valley Radio Club has turned to fishing, pictures and pinhole, and that members now in the service include FBO, AGZ, FHM and EXB all in the Navy, also Chuck Hucka, W7(?) in the Signal Corps. Roger and QSO are radio instructors at Eugene Vocational School. Roger writes, "Volunteered for the Signal Corps last July but was turned down; was I-1-A on Monday, I-A on Wednesday, greetings from the President on Friday and wound up in IV-F Monday — what a week!" From an enclosed news clipping we find that Donald Drenner, W7PHZ(?), joined the British forces in 1941, transferred to American in June of this year, and is now a radio technician with the OWI in London. Formerly he was a radio engineer with BBC. "Am stationed at the remote receiving station of WAR — nearly all the radiomen are hams or ex-hams — it's a real hamfest. GZW and XYL have a new jr. operator — 73, Frank, 7GVD." HLV, formerly of Portland, is now chief engineer at KID and KNFB at Idaho Falls. KID is a 5 kw. b.c. station, and KNFB is a half-kw. police station. HAZ is sector electrician with CAA, also Idaho Falls. From JAA, ART3c, formerly of Salem, we quote in part, "AGZ and I went to Texas A & M and from there AGZ went on a PC boat as RD3c. I went to Corpus Christie and from there to Washington, in the Lab. of Special Devices. It's a ham's paradise. Would like to hear from DZT, ECH, CHO, EO and GAT." GNJ and HHH enjoyed a piece of venison, courtesy GTW and FHX. Don Peglow and Charles Webb, members of CORK, passed Class B exam. 73.

WASHINGTON — SCM, O. U. Tatro, W7FWD — Everett WERS, KFNV, has received its renewal and modified license for eighteen units and is ironing out "bugs," writes IOQ. It has been heard R9 at thirty-five miles and R7 at forty-five miles distant. The active hams are IOQ, UX, BLX, XL, CEC, DYD, IE, FMT, IML, IZG, CQA and 9UXQ. IBC/K7 writes that he is working the PAA circuit with IHB, RM2c; GUU, RT, and that IAG, RM1c (Oregon) is one of the Navy gang. ETO, RM1c, used to operate PAA but is now flying somewhere up there and FED is somewhere in Alaska also. EGG is out on furlough after a year service in Alaska. By V-mail: "Greetings from GYT and FED of the Navy and DXB of the Army. We're all looking forward to the 'new good old days.'" IVC from the Puget Sound Navy Yard writes that he and HMA, DOC, BJP, IVO, DQX, GWL, BPM, HIU, EVO, HPD and EBL are there in the radio lab. and have quite a hamfest now and then. ANL is running a projector in Shelton. KYIEZ, U. S. Signal Corps, Ketchikan, Alaska, says CZY/K7, FSQ, ICQ and HMY are also around there. Mary Louise, eight pounds twelve ounces, came to CWY Oct. 8th; and Nancy Ann, nine pounds fifteen ounces, came to AMA Sept. 1st. We mourn the loss of EGY, Grant Harvey Selner, of Cheney, Wash., who was killed in a plane accident near Walla Walla Sept. 14th. 73 — Tate.

PACIFIC DIVISION

EAST BAY — SCM, Horace R. Greer, W6TI — EC, QDE; EC v.h.f., FKQ; Asst. EC v.h.f., OJU; OO v.h.f., ZM. Oakland WERS is getting plenty of FB practice these days. On Sunday, Oct. 3rd, in big OCD demonstration in Lakeside Park, WERS was sole means of communication with a control station set up on location. All orders came through KFMY and proved once again the value of this type of communication. In fact it would not have been possible at this set-up to have had any other type, according to EE, local radio aide. On Thursday, Oct. 21st, the regular Oakland WERS gang had another successful meeting at the Oakland City Hall. SQ gave an FB talk on TRF receivers and superregenerative detectors, and some good war movies were shown. LHH has a jr. operator. OCD is in action with Pacific Fleet in Communication Pool, and is now a full lieutenant. EHS is now stationed at Porto Rico with Navy. NZG and LCH have finished their advanced train-

ing and are now civilian employees of Navy. AEX is rebuilding his Model-T Ford. What will hams be doing next? Another day closer to victory. — TT.

SAN FRANCISCO — Acting SCM, Bill Ladley, W6RBQ — Asst. SCM, GPB, Our SCM, CIS, received his Naval orders to move on this month, so bear with me, section members, and I'll do my best; but remember, if each of you fails to send in whatever information you may have, it is practically impossible to keep our section members informed on activities in general. Also, you boys in the armed forces, both in the U. S. A. and overseas, drop a card when you can as all here are anxiously awaiting news from you. The following addresses are up to date for those members who have written in and would like to hear from their friends: W9FA, Lt. Comdr. Glen Glasscock, Navy 129, c/o FPO, San Francisco, Calif.; W6ZF, Capt. Ronald G. Martin, Technical Division AACs, Frank AAF, Architects Bldg., Philadelphia, Pa.; W6JWE, Cpl. Frank Johnson, 330 Bomb Group, 460 Bombardment, SG. H, U. S. Army Air Forces, Biggs Field, Tex.; W6EAR, John B. Nelson, 6592652, APO 980, c/o Postmaster, Seattle, Wash.; KB6ILT, Ens. Rodney Whitten, USN, Port Blakely, Wash.; W6IPH, Sgt. Fred W. Feidler, 3984491, APO 525, c/o Postmaster New York City, N. Y.; W6RH, 1st. Lt. W. B. Overstreet, P.E.A., Architects Bldg., Philadelphia, Pa. WERS in the San Francisco section is well organized and operates regularly with some sixty members, which include the older amateurs, a few civilians and women operators. The City of San Francisco has furnished thirty-five new Abbott TR-4s complete, and these plus many home-built 2½-meter rigs comprise the equipment. All of our members have, or are constructing, antennas on their cars so portable-mobile units are immediately available. In next month's report a complete roster of membership will appear. STY is broadcasting at KRE, Berkeley. PIV, at Sacramento, is doing special monitoring. LV, WN and ZS are doing their bit with Eimac. Flash! BIP was married on Sunday, Oct. 17th, to Miss Elsie Jabs of San Francisco. SG, of Mill Valley, is still instructing at the San Francisco University. Alan served under General MacArthur in the Philippines years ago. Drop a card with your news; it takes only a minute and will keep this column going. 73, Bill.

ROCKY MOUNTAIN DIVISION

COLORADO — Acting SCM, H. F. Hekel, W9VGC — 3JIN spends a lot of his spare time in his postwar shack thinking and planning for the future. Some of his other activities are teaching TFP how to blow his own horn and helping WYX build a workshop. WYX also has regular test QSOs with the Forest Service to keep their equipment in shape along with his regular job of taking care of the police department radio equipment. CAA has been shooting trouble on the telephone company's radio set-up and things seem to be OK now. CAA also reports that QYU has been transferred to Massachusetts temporarily. AAROD is in another scrap drive and all money from the sale of scrap goes into war bonds. CAA reports no cooperation from Denver officials on WERS. ESA is still hanging on and hoping. KSE called on ESA and said he expects to leave the wilds of Walsenburg and make his home in Denver. FXQ is building several new mobile transmitters for the police department; also a v.t. voltmeter. 7CCR, head of the local Broadcast Union Local No. 1222, is a very busy man making contact with all the broadcast station operators. He reports that most of these operators are hams. APR is pounding brass for the police department; and speaking of the Shirk boys, has anyone ever heard where EMU is located? Here's one: BQO is learning to play chess. That means that LYJ and VGC can add another member to their very select set. ILO from Somerville, Mass., is visiting WSD, one of our local fire fighters in Denver. ILO is also sporting a ticket marked "telephone first." LYJ is back on flying status as radio man for the Air Transport Command. Ex-9DSY passed through Denver on his way to Seat le, Wash. VIK wrote WYX that he is attending a Naval radio school at Chicago, Ill. BVZ, a lieutenant in U. S. Navy, is in Astoria, Ore., under orders to get aboard an aircraft carrier as soon as it takes to the water. Bob used to be head man at KMYR here in Denver. GMB, when last heard from, was in Hawaii with the Marines. If the rest of you want to get your names in the paper, just send me the dope on the activities in your part of the world and we will do our best. Who is the best man in your community for appointment as FC? Maybe you can handle the job yourself. Send me your recommendations. 73. Heck.

(Continued on page 80)



WHEN you have to build protection in a hurry, and have to depend mostly on your own efforts, materials ready at hand are vital. Fifty thousand sound clean bricks ready to lay in a rampart of strength are priceless at a time when making bricks from virgin clay is an unbearable delay. Let's never forget it!

A toast to the fifty thousand amateur members of the ARRL who have volunteered for service, bringing skilled technique to our Armed Forces, know-how to our factories and resourcefulness to our laboratories and have thereby aided materially in advancing the war program.

May they not be forgotten at the Conference Table when peace comes!

W. A. READY



RADIO AND ELECTRONIC COMPONENTS



Get 'em from Harvey!

No order too large... no order too small. This is our 18th year of representing and warehousing stocks from the best known firms in the industry. We'll take care of your requirements... we'll help you with technical advice and priority problems

From America's Leading Manufacturers!

Practically Unlimited Stocks!

All top-Quality Merchandise!



Trained expeditors will rush your orders as fast as wartime conditions permit... backed by a guarantee of 100% satisfaction.

BRyant 9-1946

HARVEY RADIO COMPANY

103 WEST 43 ST. NEW YORK, N.Y.

Amateur Activities

(Continued from page 78)

SOUTHEASTERN DIVISION

ALABAMA—SCM, Lawrence J. Smyth, W4GBV—Hams from over the state report thirty WERS stations in Birmingham and fifteen in Mobile. Your SCM hopes to have something to report from Montgomery and other parts of the state in the near future. All the hams that knew GIR will be interested to know that the Montgomery f.m. station has been given call letters in his memory. CWB is now a captain, stationed at Luke Field. GPW is a radio research engineer at a Naval research laboratory. GWH is now in the Navy school at Duke University after completing a couple of years of overseas duty. GYJ, stationed at an Army air base in Virginia, is convalescing from an appendicitis operation. He is in the Aviation Engineers, classed as a radio operator, at present getting his basic training. GMU and GQX are in the Navy, studying at a radio school. HAN is in foreign service with the Army. GYX is an ensign in the Navy. EBD and FUJ are in Birmingham doing their bit for defense. BTT, chief engineer of Birmingham radio police, visited GBV. DBA and his XYL, DOM, from St. Petersburg, Fla., have been in Ala. for the past few months. He is with Motorola and is seeing that the f.m. job here is done up in fine shape. AGI, a major in the Marines, visited AHM in Arlington, Va. EHO is a civilian radio engineer with the Marine Corps in Washington. DRZ is senior lieutenant in the Navy in Buships in Washington. EBZ graduated from Signal Corps OCS at Ft. Monmouth and is now a lieutenant. He visited Birmingham and Arlington, Va. with DGS. EOX, a warrant officer in the Navy, is now on foreign duty; he is doing underwater sound work. BOU is a captain at Camp Sulton, N. C. HNG is a first lieutenant in the Signal Corps, temporarily stationed at WAR in Washington. Thanks, fellows, for all the dope. 73 — Larry.

EASTERN FLORIDA—Acting SCM, Frank C. Fassett, W4BYR—Of interest to full League members in this section is the coming election of a director and alternate for the Southeastern Division for the 1944-45 term. Voting will take place between Nov. 1st and Dec. 20th. DWI has returned from Detroit where he obtained a lead dog from the Lead Dog of America Assn. 2BZX (was NCS 80-meter c.w. net, Trunk "B" and manager ARRL net "C") has opened a radio and electric shop in Winter Park. AJG is attending OCS at Miami. QW is in the Naval hospital at Miami and is doing nicely. GIY is now working for pop broadcast station in Jax. IBW is an ensign in the Navy and is located in Boston. ASE is overhauling Mims 3-element dual band. Between code classes at Jax Naval Station, QN is doing some postwar planning. RQ says Upper Pinellas still very much alive. There are five operators with WERS, including AKA; regular drills are held every Monday night. Three more units are under construction, two of them mobile. KK sent first issue of Dade County CD WERS bulletin, *For Better or WERS*, edited by CXB. With apologies to the editor we are lifting the following from the bulletin: Steve Petruff is in charge of installation at central control. Asst. radio aide, JO, is leaving Miami for position in north with radio manufacturer. Francis Carrol is in charge of Div. No. 2. Hialeah will be on the WERS map when you read this. Another fellow at Hialeah is one named Gordon, who built everything but the transmitter. Equipment at Div. 5 was built and is operated by Geo. Davant, and is working through FB in tests. Equipment for Div. 6 is being built by Zairo (Geo.) Marivolti. Div. 10 is in full operation and involves a skywire that is a beauty to behold. Work on No. 10 was done by Geo. Jerguson, CXB and Ed Doll, the latter furnishing 99-44/100 of gear, etc. Bill Carstensen, PM-WKNW-12, finds that a discarded 6-volt generator from old Philco auto radio develops sufficient kick for HY75 and runs cool on 12 volts. CNZ is in Miami with Pan Am. Following stretch at Dinner Key he is now assigned to flight school as code instructor. AGR is base communications officer of advance base organization known as "Lion Four" and is located at San Bruno, Calif. He wants to know where ACZ is. Palm Beach County has successfully completed its campaign to raise \$5,000,000 in war bonds to defray cost of destroyer escort *Hollis* launched Sept. 11th. Ralph was P. B. County's first man to lose his life in this war. EYI says that FZW has advised that he has things well in hand; also that FRE has been head man in his Navy radar class at Washington, D. C., for the past two months. DBA and XYL, DOM, are effecting satisfactory recovery following a recent automobile accident near Troy, Ala. ALP has been appointed Chairman Comms. for Disaster



Famous for endurance

... the SUPER-PRO "SERIES ♦ 200"

HAMMARLUND radio receivers have long been popular with Chinese engineers. And now Super-Pro receivers are aiding our admirable ally in the struggle to preserve her country and its many fine traditions.

THE HAMMARLUND MFG. CO., INC.
460 West 34th Street, New York, N. Y.



HAMMARLUND

Don't call me "JUNIOR"!

You just can't blame him for feeling that way. Though small, he's plenty tough!...and that's the reason why Mallory Small Diameter Controls are not called "Juniors". To do so would infer a sacrifice for size—less capability than their bigger brothers.

If there is chassis room to mount large (1½") diameter controls—if they are available—by all means use Mallory Standard Controls. They are good—so good, in fact, they have established a standard for the industry.

But if your distributor is out of stock on the large units, do not hesitate to substitute Mallory Small Diameter (1½") Controls. Their compactness is the result of modern design—there is no sacrifice of performance. Into their small size is packed long-life, quietness, and ultra-smooth mechanical operation. Remember this news of the interchangeability of the large and small sizes of Mallory Volume Controls, because war-time conditions may delay or prevent the procurement of large size units.

When war-time restrictions bring service problems you don't know how to solve—when you need special technical information—write the Engineering Application Section, Wholesale Division. We're here to serve you.

P. R. MALLORY & CO., Inc.
INDIANAPOLIS INDIANA
Cable Address — PELMALLO

P. R. MALLORY & CO. INC.
MALLORY



(Continued from page 30)

Preparedness and Relief Committee, Tampa Chapter, American Red Cross. Nice letter from DQW, lt. col. Sig. A.W. Bn., who says he plans to buy ground adjacent to his Davis Islands holdings for postwar antenna and Calif. kw. AJX has three sons in service. Capt. Hazelton, of FSG, has just returned from the north where he has been on official business, and has started another inspection trip which will cover the state. GJI is now in CGR as instructor in V/S, blinker and international flags and due for RT/1 next muster. P. B.'s WERS (WKVV) is working in with F.S.G.'s WKRW FB. Gang, please note that GVC and GJI reported this month and we were surely glad to hear from 'em, too.

WESTERN FLORIDA — SCM, Oscar Cederstrom, W4AXP — MS is now a lieutenant (jg) in the U. S. Navy and is awaiting orders. Congrats, and good luck. 5KPI visited Eddie. 5IYL is working at N.A.S. EZT, another Navy operator, is home visiting his parents and friends. ASV is in Norfolk. MS, our QSL man, has 3000 cards and a lot of them are those DX cards you have been wanting. Send him a stamped envelope. GBM is celebrating the arrival of a bouncing boy. George A. Wall, ex-CG operator, announces the arrival of a YL named Denise. FIO and XYL are the proud parents of a new YL named Linda Geraldine; she weighs six dashes and a half a dot; modulation perfect. 6MYZ is now a full lieutenant. QU is a lieutenant commander and is now in Washington, D. C. Lt. G. K. Rollins, 9GR-ICHO-SHW, ex-FCC and RII, is at NAS. He is a Class A and a commercial operator. BQK is now a full-fledged aviator, having acquired a pilot's license. He is rebuilding his 10-meter rig. In our WAVES section we have news of interest. Sally Walker is now going to Officers' Training School. Hallie D. Woodriddle, RM3c, formerly Hallie D. Fulcher, went home on leave and while home forsook single blessedness and married Sgt. Cecil C. Woodriddle of Marfa Air Base at San Angelo, Tex., Sept. 21st. Hallie is now back on the job as radioman at NAS. CQF is now a warrant officer. We will have another meeting of the hams before long. Your reports make the news. Send in one now before you forget it. Best 73, *The Old Maestro*.

GEORGIA — SCM, Ernest L. Morgan, W4FDJ — Out of the hospital minus a leg, I'm back on the job, feeling fine, and grateful for the consideration of the boys who visited and wrote. Here's the dope: BBE, FOL and EGT are in the Pacific area. Ex-DNY left the U. S. some months ago. FWD has twelve WERS stations in Atlanta. GFF is now at Columbus, Ga.; how that boy does travel. GVX has been married over a year, and overseas for a long period. He is now RDM2c, attending Fleet Service School. CZN had a vacation and spent it in Georgia. DIZ is at Pensacola. 73. *Pop*.

SOUTHWESTERN DIVISION

LOS ANGELES — SCM, H. F. Wood, W6QVV — Congratulations to the City of Long Beach. We understand that you will use the call letters KGWE when your WERS operator permits arrive and you get your rigs fired up. Hope that by the time this is in print they have come through as well as the rest of the KGLV permits so that our respective nets can be completely energized and the entire system in this area in full operation. MSO, radio aide for Inglewood, has reported that its license, with call KGIC, was received April 1st and that under the direction of SQC and himself, a network of seven units was placed in operation shortly thereafter. They have participated in numerous incident drills with generally very satisfactory results. He also states that work is about completed on the application for modification of the present license to increase the net to about twice the size of the present group. The Inglewood Amateur Radio Club is undertaking the task of training additional operators in a class conducted by QIR, the club president. The very able secretary of the Inglewood Club, RNN, advises that at a recent meeting the following officers were elected: QIR, pres.; MSO, vice-pres.; RNN, secy. and RNS, treas. He further reported that one-third of their original membership is now serving in the armed forces but that during this year they have been able to increase their membership so that the average attendance is greater than it was before Pearl Harbor. That's a mighty fine record and the rest of the clubs are thereby given something to shoot at. Meetings are held twice a month, the first and third Fridays. KGLV has placed into operation a few more of its "areas" and very good results were had on the night of Oct. 20th, when unit No. 8 was placed on frequency and contact with unit No. 7, manned by QLM, was made with no difficulty. Unit 8 was handled by ANN, whose "Junk Box Frequency

LEADERSHIP

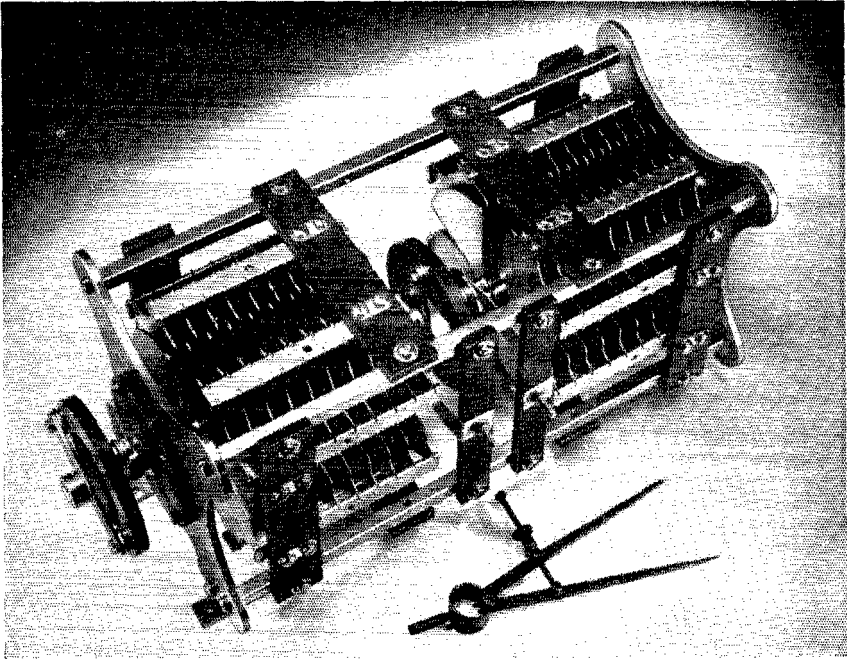

RADICALLY new ideas in the design of Hammarlund condensers will point the way to many improvements in the communications field.

If you are planning a product embodying new technique, Hammarlund is best equipped to lend full engineering cooperation.

THE SIGN OF QUALITY IN RADIO



THE HAMMARLUND MFG. CO., INC.
460 West 34th Street, New York, N. Y.

HAMMARLUND

Will YOU Be Ready . . .



For a Secure Job in the Coming New World of Electronics?

You can be ready to enjoy the security of an important engineering position and take advantage of new career opportunities . . . if you prepare yourself now!

Join the ambitious radiomen who are assuring themselves of secure good-paying jobs with a planned program of CREI technical training in Practical Radio-Electronics Engineering.

You can study at home in your spare time—develop your technical ability—increase your knowledge to keep pace with important developments now taking place in the industry.

When the war is over, the good jobs will go to the "survival of the fittest," so make sure that you will not be left behind. Get ready now for a secure job in the coming new world of Electronics.

● WRITE FOR FREE BOOKLET

If you have had professional or amateur radio experience and want to make more money—let us prove to you we have something you need to qualify for a better radio job. To help us intelligently answer your inquiry—please state briefly your background of experience, education and present position.



CAPITOL RADIO ENGINEERING INSTITUTE

Home Study Courses in Practical Radio-Electronics Engineering
for Professional Self-Improvement

Dept. Q-12, 3224 16th St. N. W., Washington 10, D. C.

Contractors to the U. S. Navy, U. S. Coast Guard and Canadian Broadcasting Co. Producers of Well-trained Technical Radiomen for Industry.

(Continued from page 82)

Checking Meter for 112 Mc." you read about last month. AM is leaving on another trip and will get a chance to visit hams in N. Y., N. J., Washington, Pa., and Ill., as well as the Hq. gang at West Hartford, Conn. From Murray Black, a ham without a call, we learn that NHM is an operator in the Army Air Corps and that Jim had been sent to a new camp before leaving for "somewhere." PTG is now in the South Seas area and is the proud father of a two-months-old son. We have his address for any that can write him. SCT, who has a program on KFVB every Saturday afternoon, has just become the proud possessor of a Hammond organ for his home. RKG has a new jr. operator. PWF is now seaman first class and expects to attend the Coast Guard radio school in New London, Conn. QLC has just been sent to radio school at Seymour Johnson Field in N. C. SSU, in ferry work as radio operator, writes from hither and yon and says he is kept "hopping like a flea in a skillet." PPW is working long hours now, but the XYL reports he's feeling fine again. The other WERS groups in the Los Angeles County have been heard quite consistently in their drills, but we have no details—how about it Harlan, can't we get a report each month to send in? Los Angeles is mighty proud of the monitoring system they have set up for their net and Walt Matnay and Rudy Jepsen are due a great deal of credit for obtaining the personnel they did for this type of work. The gang here missed meeting Miss Carol Anne Keating, the Asst. Communications Manager of ARRL, while she was on a recent trip to our fair city, and from the friendly tone of her letters I'd say it was most certainly our loss. 73. — Ted.

ARIZONA—SCM, Douglas Aitken, W6RWW—RFS is with the CAA and is leaving for a tour of duty in Alaska. He reports he is dad to a future ham. RLC wants any of the gang to write him at Shop 07 No. 07721, Transmitter Section, Pearl Harbor Navy Yard, T. H. TCQ has had his old commercial 2nd renewed. He, too, has a new son and heir. He reports a grand time at a Tucson ham get-together, with one or two off-freqs! Apologies to GS, he is at the Army Airbase at Marana! OZM is now looking after the police and sheriff's radio equipment. GS had a swell time looking over a 1918 1-kw. rotary spark set, and having nostalgic memories of when he became the first licensed ham in the state. The Tucson gang will get to see some of the new equipment being installed at one of the local air bases. ROP has now moved permanently to Phoenix. NZU was home on a visit, bringing his blushing bride. RPS is teaching code to a class of CAP pilots. The Salt River Valley now has twenty-one licensed operators in its WERS set-up. Applications for six more station licenses are pending. REJ was home on furlough and dropped in on the SCM for a pleasant visit. TOZ was over for a visit prior to going into active Navy training. QWG is sailing some one of the seven seas at present. Which about does it for this month— and hey, gang, how about that line from you? Very 73— Doug.

WEST GULF DIVISION

NORTHERN TEXAS—SCM, N. R. Collins, jr., W5IAU—BNQ and CPW are working at Lockheed in Dallas. JBD is working in the control tower at Love Field. BNQ has a 1st-class 'phone ticket. FKM has a 2nd-class 'phone ticket. JJK will take 1st-class 'phone soon. JJF is working night and day out at El Paso to bring back DX. ICB is now worrying about "A" and "B" gasoline tickets instead of amateur tickets. ESC is back in the States. E. A. Hermann of Camp Fannin, Tex., would like to get in touch with local amateurs to help him with his radio. That's all this time. 73, N. R.

NEW MEXICO—SCM, J. G. Hancock, W5HJF—James David Erwin is the new jr. operator at the David Erwin's (LSPH) home. JWA spent a two-week furlough at home and paid the SCM several swell visits. As RM3c he seems to have ranged even farther than his powerful little 45-watter before Pearl Harbor, and will have some real tales to click off after the war is over. AAV has a grand job with Western Electric and will have plenty to click about, too. The fellow that used to hold down this page is still unreported, but rumor has him overseas. Is it true, ENI? New Mexico will surely be on the air when the "filaments go on again." The SCM receives lots of letters from fellows who are getting their first taste of *di-dah* in their Army training, among whom are S/Sgt. Gordon Greaves, Cpl. Leslie Bickham, jr., and Pvt. Nat Hancock (HJF's brother), all of Portales. Keep it up, boys; we will welcome a letter from any of you men who have an intention of joining us when we get back to our own, especially from other cities. 73, Jake.

BLILEY CRYSTALS

RIDE WITH THE SCR-299

Built by **Hallicrafters**

ONE of the outstanding achievements in wartime radio transmitter design is the SCR-299. Serving equally well as a mobile or stationary radio station, this now famous equipment is doing a real job on our battle fronts.

This war is run by radio. The vital importance of maintaining reliable communications necessitates the selection of quartz crystal units that are accurate and dependable. Bliley Crystals are engineered for service . . . they are used in all branches of military communications and are, of course, supplied for the SCR-299.

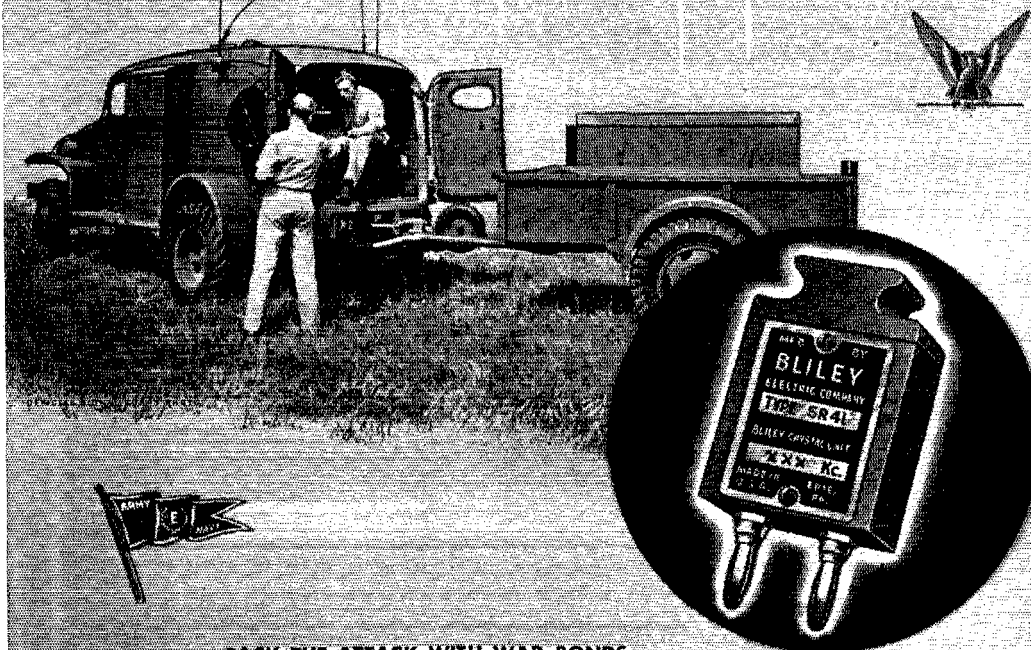

BACK THE ATTACK WITH WAR BONDS

BLILEY ELECTRIC CO., ERIE, PA.



Be
Santa Claus
to
Your Friends

NOT FORGETTING THOSE
IN THE SERVICE

Each year an increasing number of individuals find *QST* to be the ideal gift. A subscription present is unique, too. It serves as a monthly reminder of your thoughtfulness. A yearly subscription, including League membership, costs only \$2.50, little enough for the ones you have in mind. And . . . we'll send an appropriate gift-card conveying your Christmas Greetings at the proper time.

A Monthly Reminder
OF
Your Thoughtfulness
AND
Good Judgment

QST

38 LA SALLE ROAD
WEST HARTFORD, CONN.

WWV Schedules

STANDARD-FREQUENCY transmissions are made available as a public service by the National Bureau of Standards over its standard-frequency station, WWV. The service is continuous at all times, day and night. The standard radio frequencies transmitted are:

5 megacycles (= 5000 kilocycles = 5,000,000 cycles) per second, broadcast continuously.

10 megacycles (= 10,000 kilocycles = 10,000,000 cycles) per second, broadcast continuously.

15 megacycles (= 15,000 kilocycles = 15,000,000 cycles) per second, broadcast continuously in the daytime only (i.e., day at Washington, D. C.).

Each of these radio frequencies carries two audio frequencies at the same time: 440 and 4000 cycles per second. In addition, there is a 0.005-second pulse, heard as a faint tick, every second. These pulses may be used for accurate time signals, and their one-second spacing provides an accurate time interval for physical measurements.

The audio frequencies are interrupted precisely on the hour and each five minutes thereafter, resuming after an interval of precisely one minute. This one-minute interval is provided to give the station announcement and to afford an interval for the checking of radio-frequency measurements free from the presence of the audio frequencies. The announcement is the station call (WWV) sent in code, except at the hour and half hour, when it is given by voice.

The accuracy of all the frequencies, radio and audio, as transmitted, is better than a part in 10,000,000. Transmission effects in the medium may result in slight fluctuations in the audio frequencies as received at a particular place; the average frequency received, however, is as accurate as that transmitted. The time interval marked by the pulse every second is accurate to 0.00001 second. The 1-minute, 4-minute and 5-minute intervals, synchronized with the second pulses and marked by the beginning and ending of the periods when the audio frequencies are off, are accurate to a part in 10,000,000. The beginnings of the periods when the audio frequencies are off are so synchronized with the basic time service of the U. S. Naval Observatory that they mark accurately the hour and the successive 5-minute periods.

During a winter day good service is given on 5 Mc. at distances from 0 to about 1000 miles, on 10 Mc. from about 600 to 3000 miles, and on 15 Mc. from about 1000 to 6000 miles. In general, reliable reception is possible at all times throughout the United States and the North Atlantic Ocean, and fair reception over most of the world.

Information on how to receive and utilize the service is given in the Bureau's Letter Circular, "*Methods of Using Standard Frequencies Broadcast by Radio*," obtainable on request. The Bureau welcomes reports of difficulties, methods of use, or special applications of the service. Correspondence should be addressed to the Director, National Bureau of Standards, Washington, D. C.



"A SYMBOL
OF YOUR GREAT AND
CONTINUING CONTRIBUTION
TO THE CAUSE OF FREEDOM"



WAR DEPARTMENT
OFFICE OF THE UNDER SECRETARY
WASHINGTON, D. C.

25 September 1943

To the Men and Women
of the American Lava Company
Chattanooga, Tennessee

I am pleased to inform you that you have won
for the third time the Army-Navy Production Award for
high achievement in the production of war materiel.

In maintaining the fine record which first
brought you distinction, you have set an inspiring ex-
ample for your fellow Americans on the production front.

This second renewal adds a second White Star
to your Army-Navy Production Award flag, and stands as
a symbol of your great and continuing contribution to
the cause of freedom.

Sincerely yours,

Robert P. Patterson
Under Secretary of War



STEATITE CERAMIC ELECTRICAL INSULATION
FOR ELECTRONIC USES

AMERICAN LAVA CORPORATION
CHATTANOOGA 5 TENNESSEE



AT CARDWELL, we deal with truisms. Here . . . fresh, sound, original designs are combined with materials of merit, and collated by skilled craftsmen . . . for use in practically every type of communications equipment — amateur, commercial and military.

Material things, however, are not sufficient to make Cardwell condensers the quality products that they are. Into them go an additional ingredient — a heritage of pioneering, patience and judgement.

BUY MORE AND MORE WAR BONDS

CARDWELL CONDENSERS

**THE ALLEN D. CARDWELL
MANUFACTURING CORPORATION**
81 PROSPECT ST. ■ BROOKLYN 1, N. Y.

88

Correspondence from Members

(Continued from page 87)

that we had had many QSOs on 112 Mc. It's a small world after all!

Along with many others, I have very much enjoyed the story, "Who Killed the Signal?" It was a very interesting yarn, as well as helpful from the technical side.

The extension of all ham tickets was very good news to us here. We had been wondering just how we would get them renewed. We would like to know how we can get our old calls back when this mess is over. . . . [They'll be here waiting for you! — Eb.]

Being a ham has its advantages, even over in this part of the world. In my spare time I dug up enough junk parts to build up an 8-tube superhet. It is completely battery operated, and it will work very well on frequencies as high as 20 Mc., with no trouble at all. It uses the button-type base tubes. It consists of a 1T4 r.f. amplifier, a 1R5 first detector, 1T4 oscillator, two stages of 1T4 i.f. amplification, a 1S4 second detector and first audio, and a 3S4 second audio. It operates a three-inch p.m. speaker and is just the thing for a portable receiver for ham use. I will send the circuit along as soon as I get the few bugs completely worked out of it. Am also going to add a b.f.o. as soon as I can get the parts together. They come from American, German and Italian equipment. . . .

After reading through the *QSTs* I surely feel the longing to get back on the air again and try out some new ideas I acquired while going through the radio matériel training school. If half the hams have the same ideas I have, ham radio is surely going to see some great changes.

— Frank A. Reed, jr., RT1c, W6PWQ

INTACT

414 Baldwin Drive, Lancaster, Ohio

Editor, *QST*:

I want to express my gratitude and appreciation for . . . replacing the copies of *QST* I did not have.

My letter must have sounded pretty frantic, but I was so extremely anxious to have the magazine here intact on my son's return, as I knew he would never be able to bring his overseas copies home — even if there were anything left of them to bring. He says the boys grab them before he even finishes reading them, and sometimes the print is almost worn off the pages before he gets them back!

It must be a great satisfaction to put out a magazine that can give so much enjoyment to a lot of homesick boys. I think it is a wonderful magazine, and read it from cover to cover myself.

Incidentally, I am taking up code . . . and hope to get my ham ticket before my son returns. . . .

— (Mrs.) Dorothy B. Hermann
(Continued on page 90)

That day the KAIMILOA made electronics history



It was in April, 1925, that we received this message from Mr. M. R. Kellum, skipper of the four-masted schooner *Kaimiloa*, who was gathering scientific data in the South Seas:

"BUILD NEW TRANSMITTER... USE
YOUR OWN JUDGMENT... MEET
YOU HONOLULU THREE WEEKS."

Hampered by tropical static, the 1 KW Navy Standard Spark Set aboard the yacht was not getting through. It was imperative that Mr. Kellum keep in touch with his business interests on the mainland, so he placed the problem in the capable hands of one of the co-founders of Heintz and Kaufman, Ltd.

The solution was the first short-wave transmitter ever installed aboard a ship. Short-wave was then in the experimental stage, and there was great confusion as to how transmitters should be designed. Among other things, the tuned-grid, tuned-plate circuit was said to be worthless on short-waves.

But in the allotted three weeks we were installing the *Kaimiloa's* new transmitter in Honolulu, and it had a tuned-grid, tuned-plate circuit that oscillated down to 10 meters! From then on KFUH put through consistently good signals to the States, and many hams still recall the thrill of working Operator Fred Roebuck in the South Pacific.

The swift and brilliant solution of problems in radio communication, traditional with Heintz and Kaufman engineers, is exemplified by the constantly expanding line of Gammatron tubes which handle the most difficult electronic assignments with unsurpassed efficiency

HEINTZ AND KAUFMAN, LTD.
SOUTH SAN FRANCISCO, CALIFORNIA, U. S. A.

Gammatron Tubes



HK-854... This Gammatron triode, capable of handling high voltages, gives remarkable performance at high and very high frequencies. Maximum plate dissipation, 450 watts.

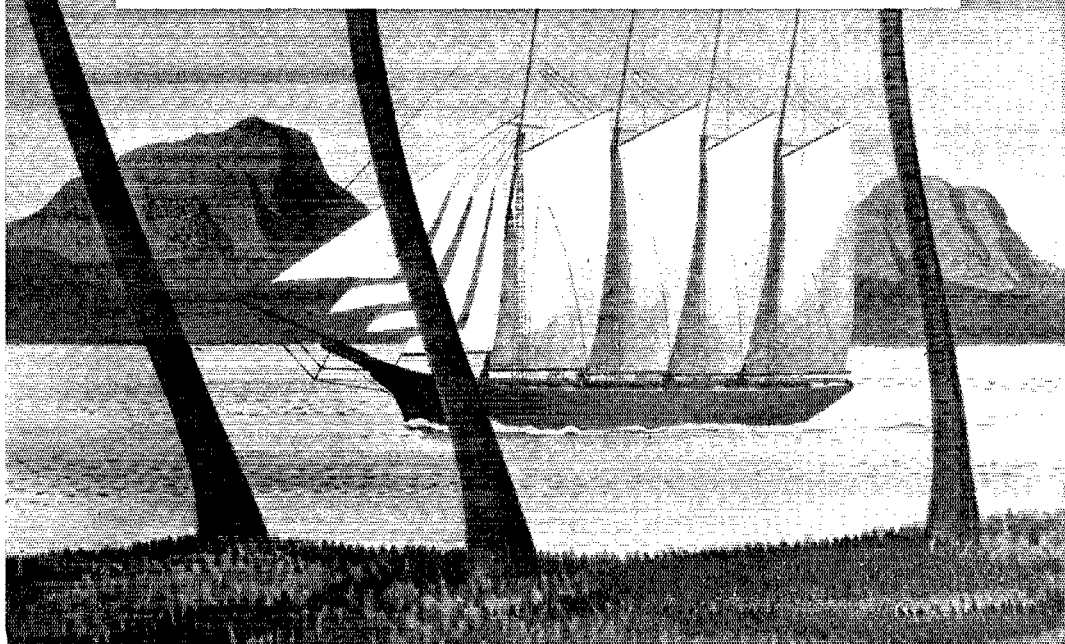

NOW — a really high-powered RADIO ENGINEERING LIBRARY

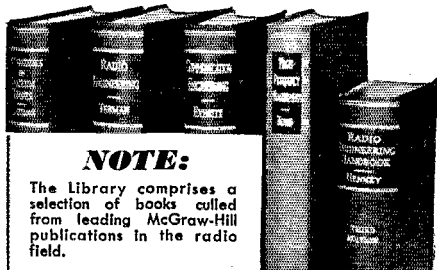

NOTE:

The Library comprises a selection of books culled from leading McGraw-Hill publications in the radio field.

- ➔ especially selected by radio specialists of McGraw-Hill publications
- ➔ to give most complete, dependable coverage of facts needed by all whose fields are grounded on radio fundamentals
- ➔ available at a special price and terms

THESE books cover circuit phenomena, tube theory, networks, measurements, and other subjects—give specialized treatments of all fields of practical design and application. They are books of recognized position in the literature—books you will refer to and be referred to often. If you are a practical designer, researcher or engineer in any field based on radio, you want these books for the help they give in hundreds of problems throughout the whole field of radio engineering.

5 volumes, 3559 pages, 2558 illustrations

- Eastman's FUNDAMENTALS OF VACUUM TUBES, 2nd edition**
- Terman's RADIO ENGINEERING, 2nd edition**
- Everitt's COMMUNICATION ENGINEERING, 2nd edition**
- Hund's HIGH FREQUENCY MEASUREMENTS**
- Henney's RADIO ENGINEERING HANDBOOK, 3rd edition**

**10 DAYS' FREE EXAMINATION
SPECIAL LOW PRICE EASY TERMS**

Special price under this offer less than books bought separately. Add these standard works to your library now; pay small monthly installments, while you use the books.

SEND THIS EXAMINATION COUPON

McGraw-Hill Book Co., 330 W. 42 St., New York 18, N.Y.

Send me Radio Engineering Library for 10 days' examination on approval. In 10 days I will send \$3.00 plus few cents postage, and \$3.00 monthly till \$24.00 is paid, or return books postpaid. (We pay postage on orders accompanied by remittance of first installment.)

Name.....
Address.....
City and State.....
Position.....
Company..... QST-12-43

(Continued from page 88)

PROUD TO BE A C. G.

U.S. Coast Guard, Custom House,
Boston, Mass.

Editor, *QST*:

I'm pounding brass and modulating mikes for the Coast Guard, the oldest U.S. armed force afloat. The Navy is, believe it or not, eight years younger — and, OM, I'm proud to be a Coast Guardsman. . . .

Well, I got my second-class rating on August 25th and I certainly am proud of it. Now I shall go after RM1c and CRM.

During my term as third-class op, I operated on the Great Lakes and in the North Atlantic as far north as the Arctic Circle; I also put in some time ashore on a 'phone job and at various other jobs, such as supervising teletypewriter operation.

Incidentally my transmitter now is doing duty with the Signal Corps. . . . My 2½-meter job and my frequency standard both are working for WERS around Erie, Pa. . . .

RM2c H. A. Munro, WSWRK

WEAK POINTS

1209 5th Ave., Selma, Ala.

Editor, *QST*:

Once in a while I get enough free time to long for those good old days of brasspounding. Here's a suggestion I want to make, although this may not be the most opportune time. . . .

Here's what I'm getting at. Many has been the time when I used to QSO some guy and fairly croaked when he would come back with the sloppiest fist possible. Yeh, his signal was 599 + — but I still couldn't copy him, because he took it for granted that he could send! In my opinion it is more important to practice on sending than on receiving. If you are listening to a good fist it's nothing to copy 30 w.p.m. Most guys are afraid to come out and bluntly tell their listener that his fist is terrible.

My job in the Air Forces is one which has developed in me a critical attitude toward professional ability. I am a flying instructor, and if you ever saw men who stress weak points in people, we're it! If we have a student who can't do some phase of flying we tell him about it in no uncertain terms, and our conscience doesn't bother us in the least because nine times out of ten that guy will go about improving that defect. And, usually, he'll be grateful for our criticism — given without malice, too.

This may be a bit premature, but I believe it would be a good idea to include in the RST report a number from say one to five, revealing the degree of ability the other operator has, according to spacing of characters and words, and length of dots and dashes. Of course, this will have to wait until we get back on the air, but a few ideas packed away for future use are not in vain — unless we let those ideas get too dusty.

Probably pretty soon everyone would be handing out excellent reports to everyone else just the



PAINTED FOR ELECTRONIC LABORATORIES, INC., BY BENTON CLARK

NOT HERE, Hirohito!

● So sorry, son of heaven, but the answer is "NO! You can't land here!" . . . Not with these gallant little sluggers, the PT boats, on the job. They're tough. They're fast. They never sleep. And whatever the occasion demands, they've got what it takes.

As a concentrated package of poison for the Axis, the PT boats are an outstanding example of the way American engineers, workers and management are teaming together to produce the deadliest weapons the world has ever known. And

naturally, we're proud that *E·L* equipment is giving a good account of itself on PT boats.

The widespread use of *E·L* Vibrator Power Supplies as standard equipment—on land, sea and air—for radio, lighting, communications, etc.—wherever electric current must be changed in voltage, frequency or type—is evidence of the efficiency and rugged dependability of *E·L* products.



Electronic
LABORATORIES, INC.
INDIANAPOLIS

E·L ELECTRICAL PRODUCTS—Vibrator Power Supplies for Communications . . . Lighting . . . Electric Motor Operation . . . Electric, Electronic and other Equipment . . . on Land, Sea or in the Air.

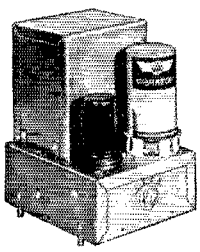

E-L Model 601 Standard Power Supply—Provides high voltage DC from a 6-volt storage battery for plate and grid supply ("B" Power) for radio receivers and transmitters either stationary, mobile or portable. Input Voltage: 6 V DC; Output Voltages: 225 V DC at 50 ma; 250 V DC at 60 ma; 275 V DC at 80 ma; 300 V DC at 100 ma; Output Power 30 watts max.; Dimensions: 4 $\frac{1}{16}$ " x 3 $\frac{15}{16}$ " x 5 $\frac{11}{16}$ "; Weight 6 $\frac{3}{4}$ pounds.

JUST

ONE

ORDER

BRINGS YOU ALL THESE
RADIO PARTS and
ELECTRONIC EQUIPMENT



Available
to authorized purchasing
agents, engineers and
expeditors who write to us
on their company stationery
stating their title. Address
Box ED.

A
Complete
Source
of
Supply

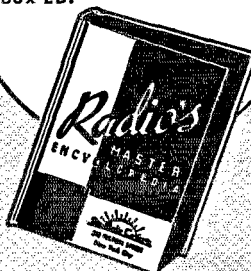

SEND
for this
FREE
CATALOG!

SAVE TIME — SAVE WORRY!

FOR PROMPT SERVICE
Telephone BARclay 7-1840

New York's Oldest and Most Complete
Radio-Electronic Supply House.

SUN RADIO

& ELECTRONICS CO.
212 FULTON ST. • NEW YORK 7

(Continued from page 90)

same as they do with the RST system, without regard to the actual situation. How about those guys who hand out 599 reports the first time and, when you sign over to them, they've lost you? Oh me, guess I'll wait until I get back on before I gripe any more. . . .

— Leon A. Little, jr., W9NXU

THE "GREAT DAY"

302 Starnes Pk., E. Gadsden, Ala.

Editor, *QST*:

I received my Class B ticket yesterday. There never was a guy prouder to get one — nor a guy much more nervous than I was when I took the examination. I could copy 23 to 25 w.p.m. solid and send 13 w.p.m. fair, so I don't know why I should have been so nervous. Hi! Ex-W4CVX, of the Alabama School of Trades, helped me with my sending. . . .

My ARRL books surely helped me a lot. The *License Manual* made the written exam easy. Thanks a million to ARRL for such excellent books. . . .

I'll be right in there with the rest of the gang when the "great day" comes.

— Dawson W. Bearden

TRUE STORY

APO 708, c/o Postmaster,
San Francisco, Calif.

Editor, *QST*:

The following true story of hamdom might be worth your perusal.

Before my enlistment in the Signal Corps, I was public relations secretary for the Washington (D. C.) YMCA. With the cooperation of Lt. Commander John L. Reinartz of the Washington Radio Club, we organized a chapter club to instruct those interested in fundamentals of radio and the International Morse code to enable them to pass the FCC examination. The classes were very successful, under the guidance of our president, Wm. Eller. Mr. Eller had an avid desire to become a ham, and even his handicap of approaching blindness didn't stop his efforts. Before he became blind he obtained his ticket. He is now looking forward to the end of the war, for the further extension of his new outlet for vision.

I think that right there is the true amateur spirit. May there be more hams like that who carry on the traditions of amateur radio.

— Sgt. A. H. Hollister, jr.

"SWELL PAPER"

371 Stegman Parkway, Jersey City, N. J.

Editor, *QST*:

I am only a boy of twelve but I have applied for a Class B ticket. I want to thank you and all the rest of the boys for putting out such a swell paper as *QST*. Without *QST* and the *Handbook* I would be stranded. . . .

— Richard Siegler

(Continued on page 94)



You boys in the services
are getting the "feel" of
these RCA instruments



Plenty of old-timers at home would like to buy these instruments. But all we can make go to war plants and the services.

You are using these instruments—getting the "feel" of them—learning how efficient, how handy they are, how they simplify and speed up every kind

of radio installation, testing, trouble-shooting, repair, or rebuilding job.

These are the instruments you will want to OWN when the war is over.

These are tools you will want to own when the war is won, and you come back—keen to get ahead, in the post-war world—the new world of electronics.

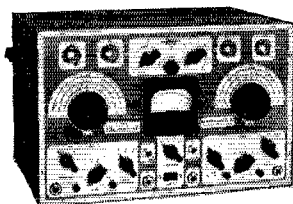

RCA RIDER CHANALYST — TYPE 162-C

Most complete signal-tracing instrument of its type. Contains five channels (RF-IF, OSCILLATOR, AUDIO FREQUENCY, ELECTRONIC VOLTMETER, WATTAGE INDICATING); enables you to check practically every circuit in a radio receiver without interfering with its operation.

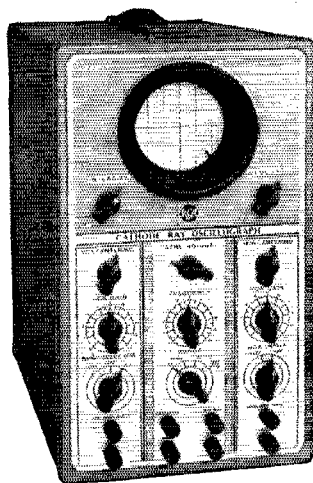

RCA 3-INCH CATHODE-RAY OSCILLOSCOPE—TYPE 155-C

Thoroughly reliable for study of wave shapes and transients, modulation measurements, radio receiver and transmitter adjustments, and peak voltage determinations. Portable, rugged, versatile. A timing axis oscillator circuit giving 10 c.p.s. to 60 KC. range is an important feature. Others are deep light-shield, removable graph screen, directly accessible deflection plates, and new "binding jack," exclusive with RCA—instantly adaptable to either binding post or pin plug—extremely handy for quick connections.

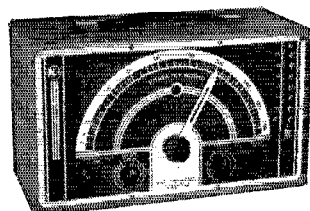

RCA BEAT-FREQUENCY AUDIO OSCILLATOR—TYPE 154

A self-contained A-C operated BFO with an AF range providing continuous coverage from 30 to 15,000 cycles. Useful signal source for testing loudspeakers, audio amplifiers, and for cathode-ray oscillograph studies. Has convenient, accurate means of calibrating against power supply frequency.

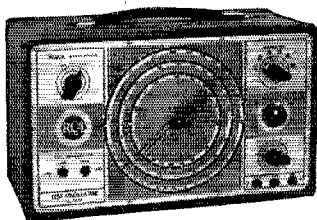

RCA A-C OPERATED TEST OSCILLATOR—TYPE 167-A

Generates signal voltages at 100 to 30,000 KC. Delivers two microvolts to one volt output in three ranges. Internal (400 cycle) or external modulation, with jack for latter.

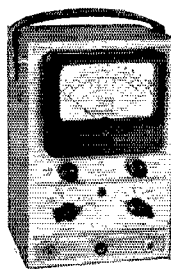

RCA JUNIOR VOLTOHMVYST —TYPE 165-A

Measures D-C and A-C voltages and resistances over very wide range. High input resistance. Easy to operate; foolproof D-C voltmeter, protected against burnout. Voltage and resistance scales need no resetting when ranges are changed. Design permits dynamic voltage measurements in signal-carrying circuits without interfering with their action.



TEST AND MEASURING EQUIPMENT

Engineering Products Department • RADIO CORPORATION OF AMERICA • Camden, N. J.



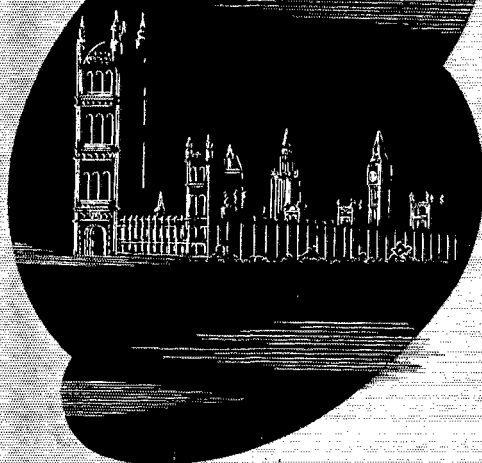

"... THE WORLD OWES SO MUCH TO SO FEW"

The RAF turned the tide in the Battle of (and for) Britain, following the historic retreat at Dunkirk. Radio played an integral part then, and is playing an even more important role now in the defeat and utter annihilation of the Axis forces of evil. It has been said that "no spot in the world is more than 60 hours flying time away from any city." The truth is that "no spot in the world is more than 1/7th of a second away" — by radio. While the globe has been shrunken in size, through the miracles of aviation and radio, man's horizon constantly expands, bringing new fields and visions for future exploration.

The Radio Shack plays its part, too, in contributing to the forward progress of mankind.

The RADIO SHACK
★ 167 WASHINGTON ST. ★
BOSTON, MASS., U.S.A.

(Continued from page 98)

"REMEMBER WHEN"?

1825 East 35th St., Brooklyn 10, N. Y.
Editor, *QST*:

First, a word of praise for the swell work you are doing in *QST*. When one stops to consider the material (or the lack of it, rather) you have to work with now, it is wonderful how you put out such a big issue every month.

Now, a word about something to which I have given much thought. It is all yours, if it should prove interesting. What do you think of a new feature or column in which, every month, you would run a picture or two of a very interesting QSL card of by-gone days. Sort of a "remember when" or "remember this" feature? You could undoubtedly find some very odd, interesting, unique, etc., QSL cards in your station files. If facts are known, you might be able to give a little history of the particular station which the card represents. . . .

— Don Miller, *ARM1c, W2MQB*

QTH?

U. S. Coast Guard Station, Salem, Mass.

Editor, *QST*:

Would it be too much trouble for you to insert a small item in the next *QST* concerning the whereabouts of a few old shipmates of mine who served with the air units at Albrook Field, Canal Zone, in the years '34, '35 and '36 during "good ole peacetime"? I feel sure they will see the article as they are all ardent readers of your mag, and in that way it will be possible for us to hash over old times.

The names are as follows: Victor Marconi, W7CKY; George Clark, who was last known to be holding down a berth with a commercial air unit in the South; Loukulsy of the 74th Pursuit Squadron; and Lawson, also of the 74th Pursuit Squadron.

— James A. Wood, Jr., *RM1C (W1E2P)*

"REAL FAVORITE"

Co. M, 803rd S.T.R., Fort Monmouth, N. J.

Editor, *QST*:

. . . I have finished my course in radio repairing here at Ft. Monmouth, and am waiting to be shipped. . . . I met another ham, W2NEY, and we are spending our time studying antennas. We have a copy of *The ARRL Antenna Book*, and find it a most valuable aid in helping us understand how certain types of antennas work. Without this book we would be lost.

I also spend my time reading *QST* and I enjoyed your story, "Who Killed the Signal?" I believe it taught me more about superhets than four months here at school. Keep up the good work, and let's have one on transmitters. All the hams and SWLs I've met here have enjoyed the story also. *QST* is a real favorite among them . . .

— Bob Arruik, *W2NVO*

(Continued on page 96)

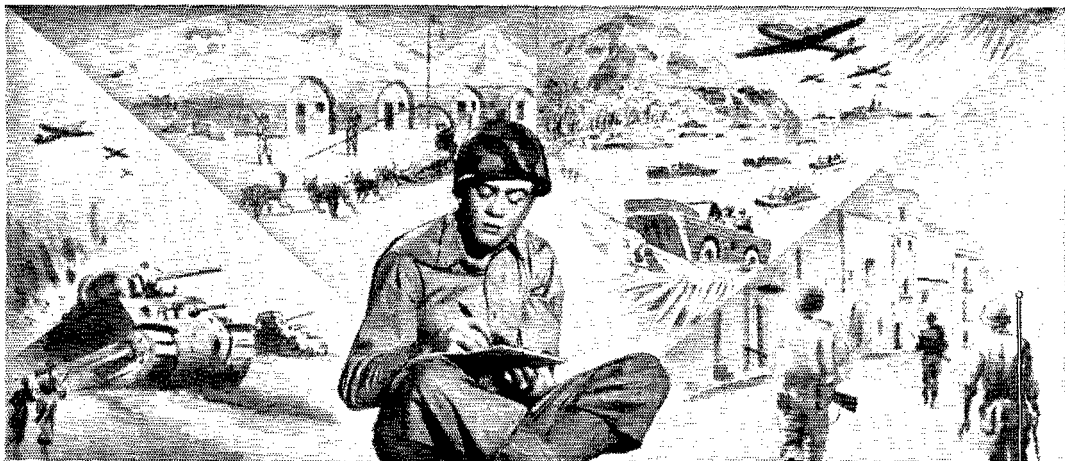

A thousand letters

WHICH BREAK OUR HEARTS

LETTERS!

—THE PILE IS GROWING—

—letters from Privates, Corporals, Colonels, Generals, Seamen and Admirals—from Wacs, Waves, Spars . . . from everybody . . . everywhere.

Their urgent pleas strike a universal note . . . they say in effect:

I know of only one portable radio that will do the work out here—they say, writing from Africa and Alaska . . . from Australia and the South Seas . . . from all over the globe—Only one . . . and that is your Zenith Transoceanic Short Wave Portable Clipper. My folks tell me they have tried everywhere to obtain one with no success. Can you help me?

. . . so these letters come to us.

To each request must go the answer “No”—an unwilling “No”—and our regrets that this must be so. We were over 100,000 sets oversold on this one model when we ceased civilian

production for 100% war work.

Nothing would please us better than to have a great plenty of these justly famous portables to ship to all who need them—especially at this Christmas season—when our thoughts turn to loved ones everywhere. For our Transoceanic Portable Clipper is a real friend to the men and women in the service. Those who managed to get them early feel themselves fortunate; they are the envy of their friends!

BUT THESE PORTABLES MUST WAIT. The entire Zenith organization is now engaged in giving all its efforts to the making of tremendous quantities of urgently needed radionics* materiel for the armed forces. These things must come first—even ahead of the tender link with home which a personal radio provides for the fighting man far from friends and family. Thus we help to speed the day of “absolute Victory”—help to bring closer the next real American Christmas . . . with “Peace on Earth—Good Will to Men” . . . when families shall be reunited—and when home life can once again resume the even tenor of its ways.



ZENITH RADIO CORPORATION
CHICAGO 39, ILLINOIS

RADIONIC PRODUCTS EXCLUSIVELY—
WORLD'S LEADING MANUFACTURER

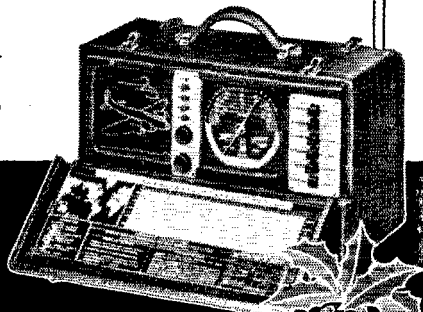

***RADIONICS** —with its subdivisions of Electronics, Radio, etc.

(Continued from page 24)

THE A.R.R.L. WAY . . .

Okay, Ark.

Editor, *QST*:

Appreciation for the work you and others of the ARRL headquarters staff are doing for the interests of amateur radio in these trying times prompts me in writing this letter. I feel that every licensed amateur should, at a time like this, either endorse the efforts of the headquarters gang or make some constructive suggestion if he has one. Above all, we must each and every one maintain our membership in ARRL and give it our full support that we may emerge from the war with a strong, healthy organization which can and will be able to speak with authority on matters affecting amateur radio.

Proper use and study of current issues of *QST* will, without doubt, make better hams of all of us. The many subjects so well covered are a tribute to the ARRL way of handling things.

One service, discontinued with the outbreak of the war, was the transmission of code practice. I believe most amateurs just now fully appreciate the value of the copy material broadcast by WIAW up to the outbreak of the war. Many amateurs with whom I have discussed the matter have expressed the wish that there was some way in which WIAW could continue transmitting code practice material at 15, 20, 25, 30, and 35 w.p.m. for a while each evening. Of course, I have no idea just what difficulties would be involved in arranging such a program, but I am sure that it would be almost impossible to imagine the limits to which such a service would be put. Besides the many amateurs who could use such broadcasts to improve their copying ability with a stick or on the mill, such a service could be used in code classes to give experience under actual operating conditions.

Some of the Press Wireless stations are excellent for practice after an operator is able to copy 25 to 35 solid on the mill, but for learning they are not so good. And when one tunes across the short-wave bands and hears the endless "QRA QRA QRA de" hour after hour and realizes just how much of the band is being wasted, it makes one wonder if one more station sending worthwhile practice material would endanger national security or give comfort to the enemy. Such a service, if it could be given, would round out nicely the already complete, or nearly so, amateur course of study. Anyway, it is just an idea, and having never seen any comment on the subject whatsoever I am just wondering.

— Joe T. Hargis, W5AQF

EDITOR'S NOTE: When, some day, the story of the continuing attempts to secure restoration of WIAW's code practice transmissions can be told, it will prove an interesting commentary on military bureaucracy at its best and at its worst. All that may be said now is that such attempts still continue — vigorously. Okay?

You CAN BUY THEM!

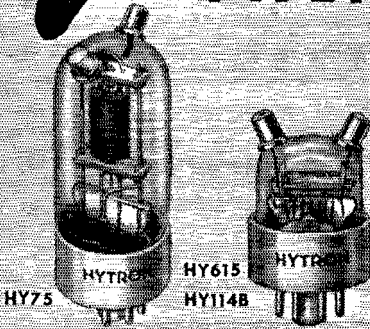

Those incomparable HY75, HY114B, and HY615 tubes which you may have thought unobtainable for the duration except on top priority ratings, can now be delivered to you by your Hytron distributor. The Office of Civilian Defense and the War Production Board jointly interpreting for Hytron the WPB Limitation Order L-265, have cleared the way.

Your Hytron distributor will be pleased to accept your replacement tube order for your favorite u-h-f tubes; and to transmit the order, with L-265 certification, to Hytron. You may expect good deliveries of HY75, HY114B, and HY615 tubes on L-265 orders, because scheduled deliveries on high priority orders are being maintained by expanded production facilities.

Most of the other popular Hytron tubes listed in the new 1944 RADIO AMATEURS HANDBOOK are also obtainable. See the Hytron advertisement.

HYTRON CORPORATION
SALEM and NEWBURYPORT, MASS.

**The Impossible
we do
Immediately...**

HENRY
DISTRIBUTORS
MANUFACTURERS
ENGINEERS

The miraculous takes a little longer. In the Air—on the Sea—in the Field... our Armed Forces are accomplishing the impossible daily—a routine, common occurrence! With Henry, such feats are not performed every day, but we, too, have proven *our ability* to accomplish the impossible.

A major wartime crystal problem arose in the "plastic holder" which contains the oscillating blank. Soldered or bolted connections were insecure; solder flux melted at high temperature, impaired crystal operation; drill particles vibrated loose into the holder cavity; pin entries permitted leakage.

Our engineers saw these defects, refused

to believe that new plastic molding techniques were impossible.

The result:

Henry developed a revolutionary new type holder. Pins, contact plates are now welded permanently together—molded as an integral part of the complete holder. This new holder is now available to the industry in a number of different types.

Thus, cleaner, sturdier, tighter crystal holders than any previously made are now being manufactured and satisfactorily used by our Armed Forces. Another apparently *impossible* task has been accomplished. Through war...into peace...look to Henry for the manufacture of Radio Equipment which will help you accomplish the seemingly impossible.

HENRY



Manufacturing Company

2213 WESTWOOD BOULEVARD • LOS ANGELES 25 • CALIFORNIA

MANUFACTURERS • ENGINEERS • PIEZO ELECTRIC QUARTZ CRYSTALS

RESISTORS

FOR

Industry • Research Communications

IRC makes resistor units of more types, in more shapes, for more applications than any other manufacturer in the world.



INTERNATIONAL RESISTANCE COMPANY

401 N. Broad Street • Phila. 8, Pa.



Founded in 1909

RADIO TELEPHONY RADIO TELEGRAPHY PRE-INDUCTION RADIO

Courses ranging in length from 3 to 9 months. Dormitory accommodations on campus for men and women students. Approved by Texas Department of Education with authority to issue a maximum of 60 semester credits for complete training. *If interested, write for details.*

PORT ARTHUR COLLEGE PORT ARTHUR
TEXAS

The Saga of the 299

(Continued from page 47)

fronts show that, by employing extreme precautions in the design of all parts, breakdowns are kept to a minimum. The chief difficulty arises when these fast-moving units travel over sandy terrain, such as is found on the deserts of North Africa. But even under this handicap the units still carry on and "get the message through."

Amateurs on the Production Line

It is significant that many prominent amateurs figure in the assembly of this famous unit. They perform a wide variety of operations and also serve as inspectors to see that every unit shipped to our fighting men is in top condition.

Take, for example, Ernie Williams, ex-W9ANR, ex-W6OB. Ernie served with the infantry in World War I. A year after the end of the last war he enlisted in the Signal Corps and was a radio operator for a period of thirteen years. Later he returned to civilian life, but when the United States entered the present conflict Ernie again enlisted in the Signal Corps. He was assigned as an inspector at the Hallicrafters plant, and has been on every inspection job on the SCR-299. He started at the transmitter plant and later proceeded to the Signal Corps Depot, where he has kept a watchful eye on Uncle Sam's units ever since. Now he is in charge of final electrical testing of the 299 before it starts on its way to the battlefronts of the world. Ernie was the first Army Net radio operator in America; therefore the "ANR" in his call.

But Ernie is not the only amateur involved in turning out this equipment for Uncle Sam. Scattered throughout the Hallicrafters plants are such well-known hams as Larry Bauer, W9ZJO; Wally Burandt, W9PTD; Fred Conner, W9CUK; Lyell E. Cook, W9ATA; Tom Drury, W9BJH; Norman Foot, W9GOP; Neil Garity, W9AGN; Bill Halligan, W9WZE; Herb Hartley, W9WNG; Jack Jenkins, W9RFX; Jules Leonhardi, W9OYU; Corwin Livenick, ex-W9VAA; Bob Mackie W9VWF; Melvin Malley, W9SRU; F. L. Mitchell, ex-W9QKT; Stanton A. Mitterer, W9MJD; Ed Mudra, ex-W9BVV; John Perasovich, W9LQL; Hal Rensch, W9OKZ; Hans Sauer, ex-W9YEO; Andy Schuble, W9WBB; Lee Stann, W9MUB; Charles Stuart, W8TZO; Ed Voznak, W9NH; Earl Whitman W9LEV; Don Wilbur, W9BRT; Cletus Wiot, W9TDF, and Clarence Zornes, W9TAL. These men serve in every conceivable capacity to be found in a radio manufacturing establishment. Their job is fully as important as that of the man with the Tommy gun, and they are representative of the entire field of amateur operators now serving on the home front.

Hams in uniform are also to be found watching over the production lines turning out the 299. Among the several Signal Corps inspectors located at the Hallicrafters plant are Ed Jackson, W9BIX; Jules Milton, W2OCG; Allan H. Story, W9CCH; Neal Turner, W9SLJ; Ernie Williams, ex-W9ANR — ex-W6OB; and Harold Greenfield,



NEGLIGIBLE HARMONIC DISTORTION

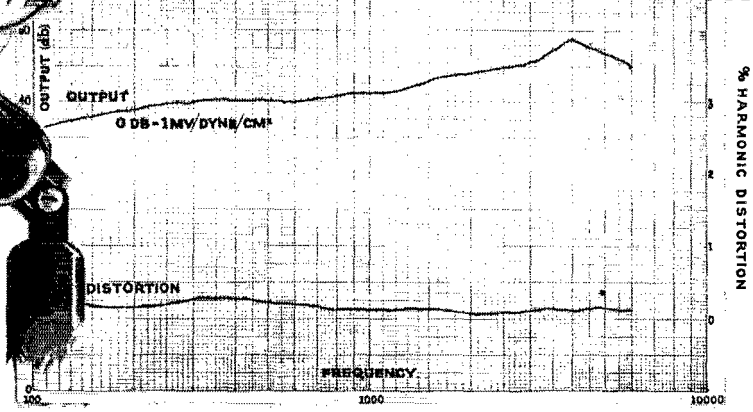

**A Statement of Fact
—Not a Boast**

Every microphone manufactured by Electro-Voice has been designed and developed by our engineers—many in collaboration with the U. S. Army Signal Corps.

Harmonic distortion is the addition of spurious frequencies to the fundamental in definite harmonic relationship. Though the frequency curve may be excellent, harmonic distortion turns up as raspy reproductions, with an unnatural twang, in microphones, amplifiers and speakers. Five percent is considered a satisfactory upper limit for good reproduction, and as much as fifteen percent is allowable for speech communication.

Now come new Electro-Voice Dynamic Microphones with radical innovations in diaphragm fabrication, reducing harmonic distortion to a lower degree than hitherto possible. Cleaner, crisper, more highly intelligible reproductions are achieved. New Electro-Voice Dynamic Microphones are aiding both the CAA and the Signal Corps in securing improved communications. If you are a manufacturer of war equipment, details will be sent upon request.

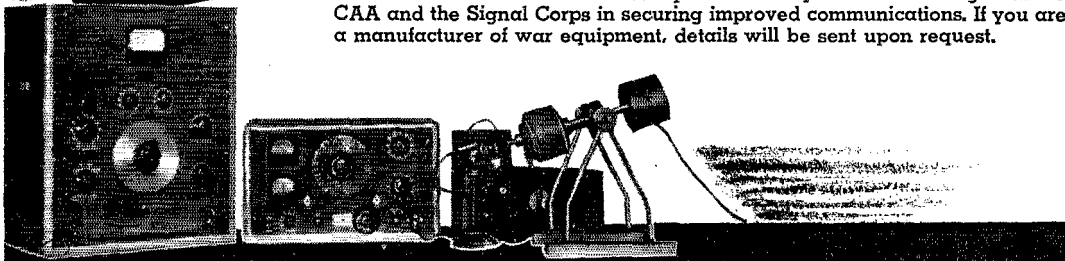

The Harmonic Wave Analyzer measures the presence of spurious frequencies introduced by microphone distortion. To the ear, such frequencies give the feeling of ragged and false speech quality that may be unintelligible under the stress and strain of battle.

Electro-Voice engineers have found a way to eliminate harmonic distortion in microphone design, as proved by the Wave Analyzer; and the completely natural reproduction from the new Electro-Voice microphones.

Electro-Voice MICROPHONES

ELECTRO-VOICE MANUFACTURING CO., INC. • 1239 SOUTH BEND AVENUE • SOUTH BEND, INDIANA
Export Division: 13 East 40th Street, New York 16, N. Y. — U. S. A. Cables: ARLAB

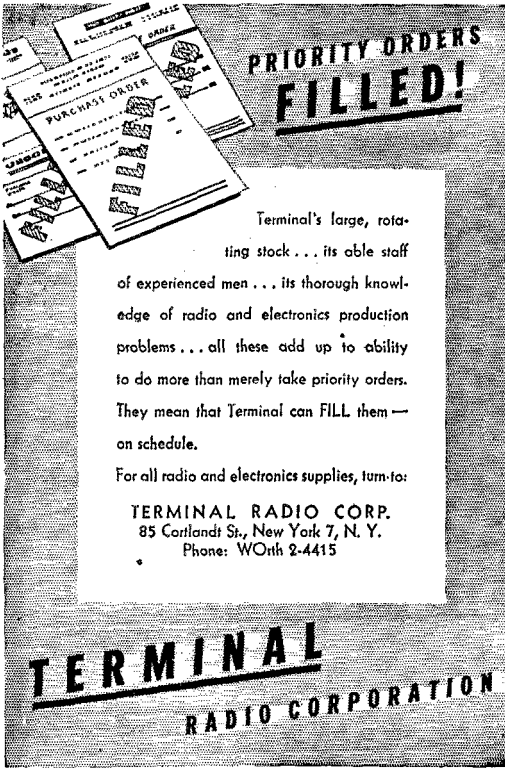

PRIORITY ORDERS FILLED!

Terminal's large, rotating stock . . . its able staff of experienced men . . . its thorough knowledge of radio and electronics production problems . . . all these add up to ability to do more than merely take priority orders. They mean that Terminal can FILL them — on schedule.

For all radio and electronics supplies, turn-to:

TERMINAL RADIO CORP.
85 Cortlandt St., New York 7, N. Y.
Phone: WOnth 2-4415

TERMINAL
RADIO CORPORATION

W3JWU. Their job is to see that every part meets Signal Corps specifications, that wiring is done efficiently and securely, that mechanical problems are met properly, and that the completed units, no matter how small, will stand up under the severe abuse encountered under combat conditions.

Nor must we forget the Navy inspectors, including Ray Frank, W9JU, and Charles A. Morgan, W9LRN. These hams make sure that radio equipment being manufactured for our Navy meets the stringent specifications laid down by that force. Not only are they responsible for checking the construction and performance of the various units but they are skilled in watching for small and often overlooked details, failure of any of which might result in the breakdown of a communications link when it is most needed.

After manufacture, the hundreds of components used in the 299 are assembled into completed units. These assemblies are sent to a huge depot, where they are carefully assorted, stocked and classified. Special conveyor belts and other mechanical equipment have been designed to handle the various assemblies; many of these also were developed by radio amateurs.

Many of the mobile units are shipped overseas, and the precious radio equipment must be protected from the ravages of salt water and dampness. After final assembly and air tests have been completed, each unit is thoroughly sealed with a special tar compound. All doors, cracks, screw and rivet heads are smeared with this preparation to make them practically air-tight. Units so protected were landed on the shores of North Africa in perfect operating condition.

Many of these units will find their way back to this country at the end of the war. Very likely they will be as popular with the ham as the jeep is expected to be with the civilian. When amateur field days again are possible, these units will be highly suited to simulated emergency operating — and to actual emergency use, as well. Their flexibility would eliminate much of the maze of equipment required in the past, and their compactness and portability should greatly increase chances for running up high scores.

The Chief Signal Officer of the Army, Major General Harry C. Ingles, recently pointed out that the civilian producers of radio equipment are entitled to far more credit than they have yet received. Amateurs may well be proud that they have contributed in so outstanding a manner in supplying the finest radio equipment to be found anywhere in the world.

TODAY and TOMORROW

Today's Universal microphones . . . throat models, lip types, hand-held mikes, and other styles . . . are in constant use by the Armed Forces here and abroad.

Tomorrow Universal microphones and accessories will again be available as consumer goods. They will embody the same standard of excellence in material, engineering design

and skilled workmanship, plus rigid inspection and ruggedness that will allow them to function equally as well in extremes of climatic conditions.



UNIVERSAL MICROPHONE CO. LTD.
INGLEWOOD, CALIFORNIA

FOREIGN DIVISION, 301 CLAY STREET, SAN FRANCISCO 11, CALIFORNIA
CANADIAN DIVISION, 360 KING STREET W., TORONTO 2, ONTARIO, CANADA

Strays

Definition of skin effect: When Johnny ham sends \$18.95 for the latest in 12-tube receivers.

Definition of hysteresis: What Johnny ham has when above receiver arrives.

— "Eddie Current"

Now! CONDITION
TRANSMISSION LINES
with Air!

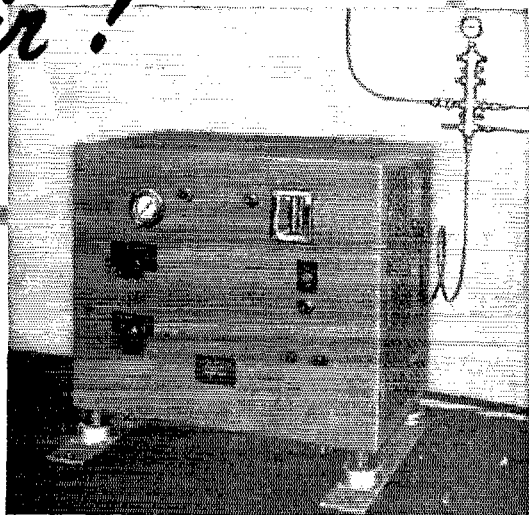

THE NEW AUTO-DRYAIRE, a fully automatic device, utilizes compressed air for conditioning of radio frequency transmission lines. An original Communication Products development, it will function for indefinite periods at the rate of 1000 cubic inches per minute (an "F" cylinder of nitrogen, at such a rate, would be exhausted in two hours).

Auto-Dryaire is completely independent of critical gases and heavy cylinders in which such gases must be stored. It consists of two identical dehydrating units coupled together with a system of electrically operated valves. One unit may be used while the second is being restored to an active state, permitting continuous operation of the Auto-Dryaire unit. The operating cycle has been kept simple, and yet positive in its action.

This is merely one example of how the research, engineering and production facilities of Communication Products are

contributing to the efficiency of communications in wartime...and providing the means for further development after the war. Your inquiry is invited concerning any of the products listed below, either for use in essential production, or postwar designs.

Communication
PRODUCTS  COMPANY

744 BROAD ST., NEWARK, N. J.

FACTORY: 346 BERGEN AVE., JERSEY CITY, N. J.

Coaxial Transmission Lines • Antennas and Radiating Equipment • Auto-Dryaire for Conditioning of Transmission Lines • Sterling Switches • Q-Max A-27 Radio Frequency Lacquer

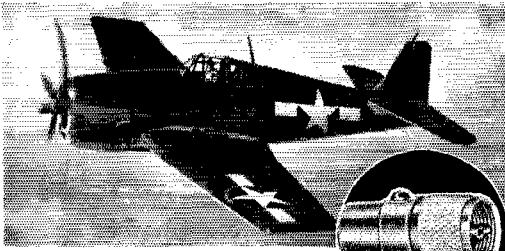

Made to Take it!

● America's speediest and most maneuverable fighter warplane, the new Grumman "Hellcat," carries Astatic Co-axial Cable Connectors on every aerial adventure as part of its radio equipment. The success of each mission . . . the safety of each pilot . . . depends largely upon radio operating efficiency. Astatic Radio Cable Connectors are "made to take it," insuring the fullest measure of dependability under the most trying conditions. Designed and manufactured to meet exacting government standards, Astatic Connectors are extensively used and highly praised by leading manufacturers of wartime radio equipment. Increased manufacturing facilities insure prompt shipments.

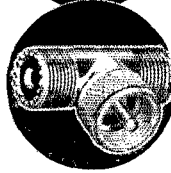
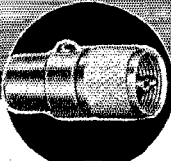

THE ASTATIC CORPORATION YOUNGSTOWN, OHIO

In Canada: Canadian Astatic, Ltd., Toronto, Ont.

You CAN HELP!

We supply radio apparatus for war use. You can help fill this need by selling your equipment to us. We pay highest cash prices without delay or red tape.

Write and tell us what receivers, meters, parts, etc., you have. If in a hurry telephone or telegraph. This is the easiest and quickest way to send your apparatus to war. And we pay you more, too. We promise you a better deal. So let us know what you have.

We also have a store at 2335 Westwood Boulevard, West Los Angeles, California.

HENRY RADIO SHOP BUTLER, MISSOURI

"World's Largest Distributor of
Communications Receivers"

Aeroanalysis and V.H.F.

(Continued from page 16)

also how they will have been altered by the time they reach him. He wishes to know whether the front will be near vertical or horizontal, or at the intermediate angles which are more useful in the bending of v.h.f. signals. The extent of the front will determine the distance that can be covered by a given signal. The angle of the front will have an influence upon the duration of favorable conditions. The character of the opposing air masses will determine the sharpness of the discontinuity, especially the differences in temperature and humidity. A *temperature inversion* occurs when a layer of warm air over-runs a layer of cold air. That is to say, the normal condition of the lower atmosphere, in which the temperature of the air decreases steadily with increasing elevation by about 3° F. per 1000 feet, may be altered or actually reversed in traversing a front. As noted by Hull,³ this condition is particularly conducive to the useful bending of v.h.f. waves. The height of the inversion above ground is an important factor.

Since the temperature inversion is by far the most effective of the various forms of discontinuity in causing refraction and reflection in the lower atmosphere, we should remember to look for any one of four forms. The one just discussed is known as *dynamic* inversion. *Subsidence* inversions are produced when a sinking air mass, heated by compression, becomes warmer than the air below. *Nocturnal* inversions result from the rapid cooling of surface air after sunset at a rate greater than that of air aloft. A fourth type, until now seldom recognized by the amateur, is the *cloud-layer* inversion. The upper surface of a cloud layer is an excellent reflector of the sun's rays, resulting in the heating of air above the layer to produce this type of inversion.

Attempts at local weather prediction, unaided by sounding instruments, will depend a great deal for their effectiveness upon intelligent observation of clouds. The type and height of the clouds, their speed and direction of drift as estimated from apparent motion, and their growth or stability of form are all significant factors.

Familiarity with the cloud formations which characterize various conditions aloft can be improved by study of such a book as "Weather and the Ocean of Air," by W. H. Westrom. His chapter, "Foretelling the Weather," is an excellent summary of the methods which can be used by the radio amateur.

Knowledge of local conditions which may modify the general air conditions for a particular locality must be applied in order rightly to interpret cloud formations and wind directions. The presence of near-by hills or mountains, or of large bodies of water or desert areas, have their local influence on surface temperatures, convection currents, and relative humidity. There appears to be evidence that localized discontinuities may be of sufficient proportions to affect materially the propagation at certain frequencies and over limited distances. An attempt at discussion of this

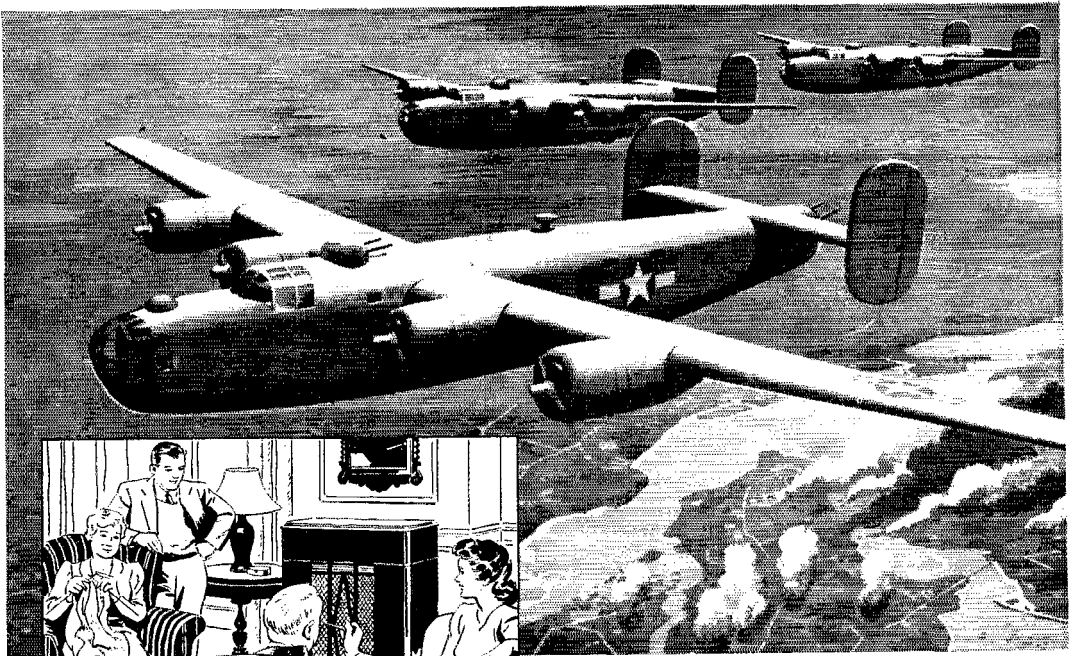

No Place Like Home

Compared with the typical home radio set—protectively nestled in a quiet living room—the electronic devices on a bomber lead a dog's life. Their delicate parts are subjected to the jarring concussion of exploding flak—the "kick-back" of bursting block-busters—the vibration of roaring motors and firing guns . . . a mauling severe for even the most rugged parts. How these sensitive instruments are able to hold up under such bruising punishment is a story that dates back to the early days of automotive radio. Technicians of Delco Radio faced parallel problems—vibration, electrical interference, temperature and humidity extremes, bumping and jarring. They faced a set of conditions totally new and different in the radio field—the special conditions attending "radio in transit."

One by one, these problems fell before the forces of research, experi-

ment, ceaseless testing and trying. Automotive radio became a practical, workable reality. And with success in this endeavor came a fund of special experience, off-the-trail knowledge, that has come in mighty handy in World War II. For Delco Radio engineers have applied their experience in automotive radio to the task of giving the forces of freedom—on land, at sea, in the air—a strong, clear voice. Delco Radio Division, General Motors Corporation, Kokomo, Indiana.

**Back Our Boys
By Buying Bonds!**

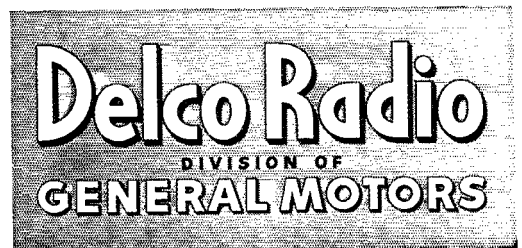

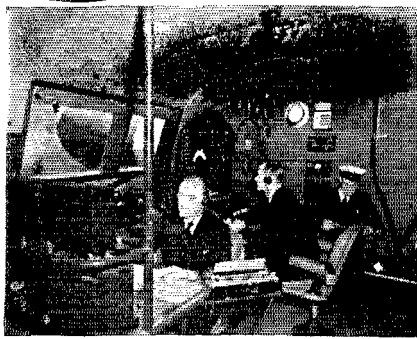

Pan-American World Airways Photo

Your Premax Tubular Antenna is serving in the armed forces on land and on sea . . . not in one or two designs, but in many specially engineered types that'll be available to you when Victory comes. In the meantime, take good care of your present Premax Antenna.

Premax Products

Division Chisholm-Ryder Co., Inc.
4419 Highland Ave., Niagara Falls, N. Y.

RADIO OPERATORS WANTED



Learn to send and receive Radio Code at home or in camp, or prepare for higher proficiency and rating through same easy practical system used in training radio-telegraph specialists. Our world famous system teaches you code by developing in you a "knack" of sound sense and sound consciousness that is the secret of speedy sending and receiving. Thousands of operators needed. Good pay, adventure. Learn at home quickly. Big opportunities now and peacetime possibilities appear equally promising.

FREE 52-PAGE BOOK explains complete training method and shows how to become a "crack" operator. Rush name for it today. It's absolutely FREE.

CANDLER SYSTEM CO.
P.O. Box 928, Dept. 4-O, Denver, Colo., U.S.A.
and at 121 Kingsway, London, W.C. 2, Eng.

WE NEED YOUR HELP

Urgent war orders will be delayed if we don't immediately find

**SIX MODEL 9-1006
MEISSNER SIGNAL CALIBRATORS**

If you have one please write at once giving details regarding condition of the equipment, price wanted, etc.

The Triplett Electrical Instrument Co.
BLUFFTON, OHIO

(Continued from page 108)

topic will be made in a later article, "Topography and Transmitters."

Among a number of local "signs," the smoke or dust layer described by W1HDQ in *QST* for January, 1943, is important, since it gives an advanced visual indication of an oncoming front by indicating the presence of a temperature inversion in an otherwise clear sky. Along the East Coast, a sea breeze at the close of a hot summer day generally provides favorable v.h.f. bending. High cirrus clouds, which often mark the leading edge of a front, will produce the effect of a circle about the moon. This has proved to be a fairly reliable advance warning of favorable bending within 24 hours.

Together with aeronalysis, the amateur may apply controls within his power to take the utmost advantage of a given set of conditions. For example, we are learning that the polarization of a transmitted wave should be varied with changing air conditions. Neither vertical or horizontal polarization can be said to be uniformly the better choice. There are conditions under which waves which are vertically polarized at their origin prove to be horizontally polarized at the point of reception. Vertical angles of radiation can and should be controlled at both receiving and transmitting stations, to obtain optimum results. The dimensions of antennas in v.h.f. to s.h.f. practice are such that they may be tilted as well as rotated by means of simply constructed devices. Knowledge of the angle of an air-mass front will determine the orientation of the antenna. Knowledge of the extent of the front will govern the choice of frequency for covering a particular distance. There is real science, after all, in the propagation of our signals through the turbulent troposphere!

Strays

Who would think that severe sunburn to pilots in the sub-stratosphere would be a wartime problem? The problem was acute enough, however, to cause the need for a new type of glass, which filters out the ultraviolet light. — *Ohmite News*.

A new product, "Polectron," promises to replace strategic mica in fixed condensers. It possesses high-temperature resistance and low dielectric loss. One ton of the new synthetic is expected to replace 10 to 15 tons of imported block mica.

In General Radio's current catalog you will see the following footnote: "See 'Direct Capacitance and its Measurement,' by R. F. Field." This seemed to be a little muddy to me at first glance. Hi! — *W9ADS*.

Radio Marriage

Courtship: He broadcasts. She listens in.
Honeymoon: She broadcasts. He listens in.
Now: They broadcast. The neighbors listen in.
— *New Zealand Radiogram*.

The Radio Amateur's Handbook

"THE ALL-PURPOSE VOLUME ON RADIO"

Text, data book, operating manual — it is all these and more. As a text it is probably more used in radio schools and colleges than any other single volume. As a practical constructional handbook, it stands in a class alone. As an operating manual, it provides information available from no comparable source.

Standard Edition

The latest Edition of THE RADIO AMATEUR'S HANDBOOK is the largest ever published. It includes a comprehensive chapter dealing with War Emergency Radio Service plus other new material — all added without sacrificing the essential information in previous editions which made the HANDBOOK the world's most valuable and widely-used radio book. The theory and design sections cover every subject encountered in practical radio communication, sectionalized by topics with abundant cross-referencing and fully indexed.

\$1.00 In Continental U. S. A.

\$1.50 Elsewhere

\$2.00 Buckram Edition

Special Defense Edition

This edition of the HANDBOOK is designed especially for use in radio training courses. It eliminates those portions of the regular edition which are not useful for instruction purposes and has added chapters on mathematics, measuring equipment and code instruction. The first chapter covers the elementary mathematics necessary for the solution of all formulas and interpretation of graphs appearing throughout the text. A four-place log table is included in the Appendix.

\$1.00 Postpaid Anywhere

A Course in Radio Fundamentals

By GEORGE GRAMMER

The objective in preparing this course was to accent those principles most frequently applied in actual radio communication. "A Course In Radio Fundamentals" is a study guide, examination book and laboratory manual. Its text is based on the "Radio Amateur's Handbook." Either the special edition for war training purposes or the Standard Edition may be used. References contained in the "Course" are identical in both editions. As a text, this book greatly smooths the way for the student of the technicalities of radio. It contains interesting study assignments, experiments and examination questions for either class or individual instruction. It describes in detail 40 experiments with simple apparatus giving a complete practical knowledge of radio theory and design.

Price **50c**

Learning the Radiotelegraph Code

By JOHN HUNTOON

This booklet is designed to train students to handle code skillfully and with precision. Employing a novel system of code-learning based on the accepted method of *sound* conception, it is particularly excellent for the student who does not have the continuous help of an experienced operator or access to a code machine. It is similarly helpful home-study material for members of code classes. Adequate practice material is included for classwork as well as for home-study. There are also helpful data on high-speed operation, typewriter copy, general operating information — and an entire chapter on tone sources for code practice, including the description of a complete code instruction table with practice oscillator.

Price **25c**

The A.R.R.L. Antenna Book

By GEORGE GRAMMER and BYRON GOODMAN

A comprehensive manual of antenna design and construction. Sixteen chapters, profusely illustrated. Both the theory and the practice of all types of antennas used by the amateur, from simple doublets to multi-element rotaries, including long wires, rhomboids, vees, phased systems, u.h.f. systems, etc. Feed systems and their adjustment. Construction of masts, lines and rotating mechanisms. The most comprehensive and reliable information ever published on the subject. Over 100 pages.

Price **50c**

AMERICAN RADIO RELAY LEAGUE, INC., West Hartford 7, Conn., U.S.A.

ORDER FROM NEWARK FOR QUICK SERVICE ON RADIO PARTS

Transformers, resistors, rectifiers, rheostats, condensers, filters, wire, etc., SUPPLIED FROM STOCK on short notice, on properly rated orders.

NEWARK'S SUPER-VALUE FILTER CONDENSERS

9 mfd. 2000 v. DC. With porcelain insulators and brackets for mounting. Size $1\frac{1}{2}'' \times 3\frac{3}{4}'' \times 4\frac{1}{2}''$ high.

\$325

BARGAIN FILTER CONDENSERS

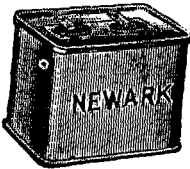

Mfd.	Volts DC.	Size	Price
1	1000 5	$3\frac{3}{4} \times 1\frac{1}{2}$	\$.59
2	2000 4 $\frac{1}{2}$	$3\frac{3}{4} \times 1\frac{1}{2}$	1.50
4	3000 5	$3\frac{3}{4} \times 3\frac{3}{4}$	3.75

ORDER TODAY DIRECT FROM THIS AD. Sorry—NO CATALOGS for the Duration!

NEWARK Electric Company
223 W. MADISON ST. CHICAGO, ILL.



RADIO OPERATORS' CODE MANUAL (WITH TOUCH TYPING)

A complete and thorough self-study and classroom text in code transmission and reception with touch typing procedure. Comprehensive instruction in the construction of code practice equipment and devices. 166 pages, 40 illustrations and touch typing charts. Flexible paperbound edition \$2.00 post-paid or write for descriptive circular.

WAYNE MILLER

The Engineering Building, Chicago, U.S.A.

PRACTICAL RADIO COMMUNICATION

NEW EDITION—THOROUGHLY REVISED—ENLARGED

Radio Principles — Aviation Radio — Broadcasting — Marine Radio — P.M. 6 x 9, 927 pages, 535 illustrations, \$6.00. Money back if not satisfactory. Free circular.



NILSON RADIO SCHOOL, 51 E. 42nd St., New York 17, N. Y.

HARVEY RADIO LAB'S, Inc. Manufacturers of Radio Transmitters

ELECTRONIC APPARATUS
477 CONCORD AVENUE, CAMBRIDGE, MASS.

LEARN RADIO

Pre-Military training for beginners. Catalog on request. We teach all technical branches of radio.

MASS. RADIO SCHOOL

18 Boylston Street

Boston, Massachusetts

Free-Point Tube Tester

(Continued from page 58)

external resistances and the application of grid bias from the internal batteries. This will permit the "grid-shift" or transconductance type of test to be applied to nearly all types of tubes. While the set-up for this test involves a little more effort, the value of the test as an index of tube quality is much superior.

Other Applications

No attempt will be made to treat in detail the use of the test panel as an experimental breadboard, but it is certain that many applications will be discovered by the constructor as occasion arises.

One example is its use as a vacuum-tube voltmeter. Once the user has experienced the advantages arising from its use, he will probably often wish to set up the board using a high- μ tube in the grid-rectifier circuit for a vacuum-tube voltmeter shown on page 395 of the 1943 *Handbook*. This application is practicable only when the sensitivity of the V-O-M as a milliammeter is of the order of 5 ma. or less. The need for such an instrument might not occur often enough to justify the cost of constructing one separately, yet the ability to adapt the old faithful testboard and V-O-M might on occasion become a very valuable asset.

On the Very Highs

(Continued from page 51)

the new techniques, what does the ham himself want to see become of his hobby after the war?

We've had a chance to talk to many hams in many places recently, and the vast majority seem to feel about the same way. The new stuff is mighty interesting and they've filed away several ideas for future reference, but they hope that the picture will not have changed too much when they get back to hamming. They liked their hobby as it was, and, except for the hope for changes in regulations which will permit them to try out the new ideas, they hope to see the picture much as it was when they were forced to drop things back in '41. In the meantime, they're not wasting much time building their postwar rigs on paper. They've got a war to win — and that's job enough for now!

— — —

From here on there is apt to be an increase in the time lag between events and their reporting in this column, as your conductor is on the move frequently and in a pretty big territory. However, if reader interest warrants (and the Editor will use it) we'll continue to compile copy as long as we're within mailing distance of West Hartford.

Arrangements are made for forwarding mail at all ports of call, so anything you send in will reach us eventually. The best address remains the same: 329 Central St., Springfield, Mass.

ZENITH MICROTUBES

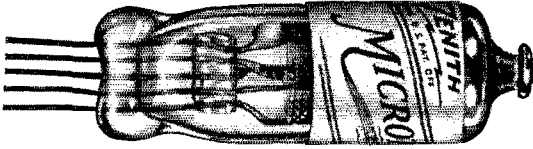

Where space is a factor . . .
where power consumption
must be at a minimum . . .
Zenith Microtubes are rec-
ommended . . .

APPLICATIONS

- POCKET RADIO RECEIVERS
- WEARABLE HEARING AIDS
- NOISE LEVEL INDICATORS
- GEOPHYSICAL APPLICATIONS
- METEOROLOGICAL SERVICES
- BEACON LIGHT RELAY CIRCUITS
- 2-WAY COMMUNICATION DEVICES
- RADIATION METERS
- PHYSCHIATRIC DEVICES
- LIGHT INTENSITY METERS
- VACUUM TUBE VOLTMETERS
- AIRCRAFT INTERCOMMUNICATION
- CONCEALED SOUND PICKUPS

AMATEURS—Here's a small tube that has many uses for small receivers, test equipment or anything you may be building. Available now.

A Booklet containing technical data on Zenith Microtubes is available at the factory.

RADIONIC PRODUCTS EXCLUSIVELY

World's Leading Manufacturer

ZENITH RADIO CORPORATION

6007 DICKENS AVENUE • MICROTUBE DIVISION • CHICAGO 39, ILLINOIS

Radell

Makers of Precision
Engineered
**ELECTRONIC
PRODUCTS**

Radell
CORPORATION

6327 GUILFORD AVENUE, INDIANAPOLIS, INDIANA



ONAN
ELECTRIC PLANTS

Electricity for any Job—Anywhere

ONAN GASOLINE DRIVEN ELECTRIC PLANTS supply power in places where not otherwise available, and for standby or regular service in communications. They provide electricity for many war tasks on all fronts.

From 350 to 35,000 watts. A.C. 50 to 800 cycles, 110 to 660 volts, D.C. 6 to 4000 volts. Also dual A.C. and D.C. output models.

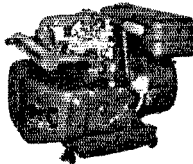

Details furnished on present or past war need for Electric Plants.

D. W. ONAN & SONS
1945 Royalston Ave.
Minneapolis, Minn.

WANTED

For the PHILCO ENGINEERING STAFF

● RADIO TECHNICIANS

Ham operators and radio service men familiar with test equipment.

● RADIO-ELECTRONIC-ELECTRICAL ENGINEERS

Men with degrees in electrical engineering or comparable experience in radio and television.

● DESIGN ENGINEERS—DRAFTSMEN

Men with experience in mechanical designing, especially of small metal parts and of the automatic machinery to mass-produce them.

● MODEL MAKERS

First class precision workers and all-round mechanics capable of starting with blueprints, making the parts and assembling the finished models.

WE expect the men who qualify for these positions to become permanent members of our staff and take an important part in our post-war program.

To maintain the Philco tradition of progressive research and development, is first and foremost in our minds. We provide the finest of technical equipment. But often, even more helpful is the inspiration and personal assistance of working with men who have done so much for the advancement of Radio, Television, Refrigeration and Air-Conditioning.

WRITE US TODAY

Qualified men not now engaged in work requiring their full talents, are invited to write us in detail as to their experience, education, family and draft status, and salary. Letters will be treated in strict confidence.

Hiring subject to local W. M. C. rulings.

WRITE TO MR. GEORGE DALE

PHILCO CORPORATION

Philadelphia 34, Penna.

Splatter

(Continued from page 10)

stationery. Use both sides of the sheet, keep the margins narrow, and eliminate waste.

Paper conservation is more important than you might think. It takes a lot of paper to win a war. For the blueprints used in the construction of a single battleship, as much paper is needed as is required for three entire editions of *QST*. Complicating the paper/pulpwood problem is the fact that vast quantities of pulpwood are required for munitions and other war needs. It takes a cord of pulpwood to provide the powder to fire just two shells from a 16-inch gun, for example.

FOOTNOTES

CONTINUING in the statistical mood, we find that no less than 52 *QST* contributors have been presented in this column so far this past year—or 4.7 + new authors per month. With the picture of a decimated 0.7 + author per month in mind, we tried in this issue to bring the total for the year up to an even 60. But then that paper quota reared its head again, and the best we could do was make it 58.

The six additions to the rolls, when lined up alphabetically, range from Signal Corps to CAP, with a variety of civilians in between. They are:

Capt. Spencer Allen, W9JGL, who, as the post public relations officer, reports on Ft. Monmouth's second hamfest in khaki (p. 52), got into the Signal Corps via a University of Missouri ROTC reserve commission and ten years of pro radio as announcer, producer, writer, program director, news editor, etc. He was a newscaster and announcer at WGN, Chicago, for four years before entering active duty with the Signal Corps. In 1939, sitting around the stand-by studio at WGN night after night making station breaks, with nothing to read in between times, in desperation he started reading an ARRL *Handbook* borrowed from the studio engineers. He got his first ticket three months later and started operating on 10 and 40. . . . If association and experience with precision machinery have anything to do with the development of a WERS frequency-measurement system, **Philip Bliss, W1DXT** (p. 23), should be the man for the job. Ever hear of a Gridley automatic? Well, that's the outfit he's with—the New Britain-Gridley Machine Division. There he's occupied chiefly with the development of industrial electronic equipment. Back of that is a communications degree from MIT ('37), a Class B ham ticket ('31), Class A ('37), and radiotelephone first ('43). Of course, Phil is also a WERS operator in the New Britain network, under the Hartford district call WMHC. . . .

Loyal S. Fox, ex-W2AHB, is a name identified by the amateur fraternity for the past twenty years as practically synonymous with National Carbon Co. and Eveready batteries. His radio career goes back twenty-five years before that, however, beginning with his first exposure as a wireless cadet on the S.S. *St. Louis* of the American Line in 1910. His first ham station (pre-license

Magic!

DONE WITH WIRE

Electronics, Radionics, Radio — weapons that help speed us to Victory. Making wire "harnesses" for these magic swords is another big Wallace job. The production picture in itself is pure magic, too; because it involves improved techniques, discoveries and multiple engineering problems. Here, then, is a well of priceless experience ready to help you produce your own brand of magic — once Victory is achieved.



Wm. T. WALLACE MFG. Co.

General Offices: PERU, INDIANA

Cable Assembly Division: ROCHESTER, INDIANA

TRIPLET

Practi-Quality

PRECISION — DURABILITY — FAIR PRICES

TRIPLET MODEL 645 PORTABLE

Hinged cover protection. Opens flush. Smooth case open or closed. Molded shield protects mechanism, excludes dust, permits plug-in thermocouple or rectifier replacements without exposing sensitive mechanism. Pre-calibration of thermocouples or rectifiers made possible by interchangeable plug-in units. No re-calibration required. In burn-out of thermocouple or rectifier new replacement can be effected "on the job".

THE TRIPLET ELECTRICAL INSTRUMENT COMPANY
BLUFFTON, OHIO

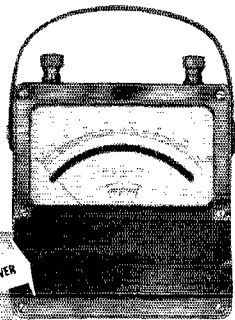
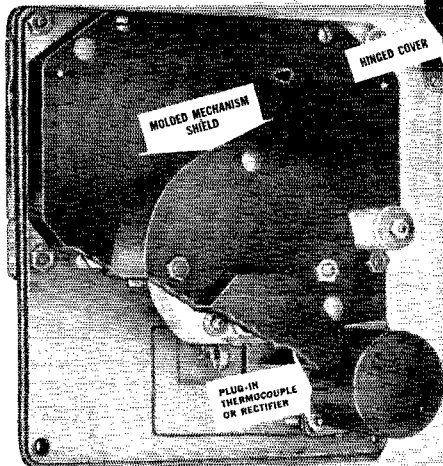

For additional engineering information on Model 645 and other instruments of the same case style write for 645 data sheet.



**BUY
WAR BONDS
AND
STAMPS**

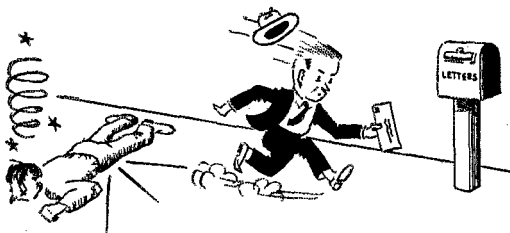

"He just heard about the big 3½ by 4½ ft. radio reference wall map Leo's giving free. Has time charts, station list, amateur zones, networks, world shortwave, etc. 15c for packing and postage brings it."

HAVE YOU GOT YOURS?"

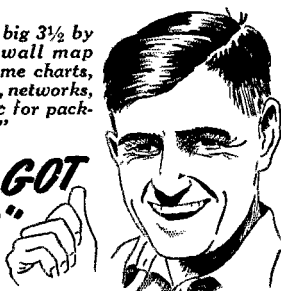

TODAY...Write to LEO-W9GFQ FOR EVERYTHING IN RADIO

Wholesale RADIO LABORATORIES
744 W. Bdwy. Co. Bluffs, Iowa



RF Inductances • RF Chokes • IF Transformers
Condensers • Mica Molded Condensers • Trimmer
Condensers • Miscellaneous Apparatus
The F. W. Sickles Co., Chicopee, Mass.

SICKLES *Electronic Specialties*

(Continued from page 108)

era, of course) went on the air in 1912; the license (call 2OB) came a year later. Although an "ex" since 1939, his continuing interest in amateur radio is attested by his membership in the Jamaica (N.Y.) Ultra-High Frequency Club and his work as chief of the maintenance staff and alternate coordinator of Precinct 105, Queens Borough, New York City WERS. . . . Walter C. Jordon, W8SLC, is another old timer. Back in 1910 he took an old "Westcott" spark coil, a helix and a photographic plate condenser, and worked a couple of fellows across the street. About 1920 he started building b.c. receivers and in 1921 became an instructor in vocational education. He was given sponsorship of a radio class, and from that start his radio teaching activities have gradually expanded. Now he has two full-time senior high classes and an adult night school class. Many of his former students have made radio their life work and those in radio in the armed forces number in the hundreds. Mostly a v.h.f. man — 10, 5 and 2½ — he is a past president of the Erie Amateur Radio Club and trustee of WSTNS. Now he is personnel director of Erie WERS (p. 40). . . .

Cy Read, W9AA (p. 44), is a ham of many distinctions. He was the first amateur in the 9th District to go back on the air after World War I — hence the call W9AA. Furthermore, Cy claims to be the only amateur who ever sent CQ over the entire NBC network. Back about 1937 Cy was playing flute in the Carnation Hour orchestra when they programmed the "Radiophonic Rhapsody" and dedicated it to ARRL. Cy had been instructed to "send" an SOS on his flute during one passage but, fearful of the possible consequences, he substituted "Pse QSL W9AA." As a result, he received more than a hundred QSL cards from all over the country. Since March, 1942, Cy has been with the Signal Corps as radio engineer and administrative officer. Before that he was principal of the Burr Signal School, general supervisor of Burr, Bancroft and Spry Signal Schools, Signal Corps representative to the University of Chicago, and assistant director of the Chicago Radar School. . . . T/Sgt. Karl H. Stello, CAP, W3IVZ, would rather be associated with radio and airplanes than anything else. That's why he is in the CAP (p. 20). An active amateur since 1940, before the war he was on the air on 40 and 160 with a 40-watt transmitter and a Comet Pro receiver, both of which are now in service with the Army. Later he experimented with carrier current and helped organize WERS in Prince George's County, Md., using c.c. A graduate of Eastern University, before joining the CAP a year ago he worked for the supply department of the U.S. Naval Academy at Annapolis and later in the aircraft accessories section of the National Bureau of Standards, from which he is now on leave. He also taught an evening course in radio at Columbia Tech in Washington.

One of the earlier 52 (but not one of the 0.7+!) authors back with us again (p. 30) is Harry E. Stewart, W3JXY (Splatter, August, 1943, p. 96), as is (p. 54) the still-anonymous Sourdough (Splatter, May, 1943, p. 66).

On Every Front!



Crystals are doing a vital war job... approved precision Crystals are in use on every fighting front doing an unseen, but all important function with the communications equipment of our armed forces.

Crystal

PRODUCTS COMPANY
1519 MCGEE STREET • KANSAS CITY, MISSOURI

Producers of Approved Precision Crystals for Pacific Emergency Command

Keep 'Em Running
FOR THE DURATION!

It is difficult to secure new Generating Sets or new Rotary Converters . . . Pioneer is devoting all of its resources toward winning the war . . . but we DYNAMOTORS • CONVERTERS • GENERATORS • DC MOTORS • POWER PLANTS • GEN-E-MOTORS

can, and will, help you keep your present equipment running for the duration. Send your service problems, by letter, to Pioneer's Customer Service Dept.

PINCOR Products
PIONEER GEN-E-MOTOR

CHICAGO, ILL. • EXPORT ADDRESS 25 WARREN ST., NEW YORK CITY
CABLE ADDRESS SIMONTRICE, NEW YORK

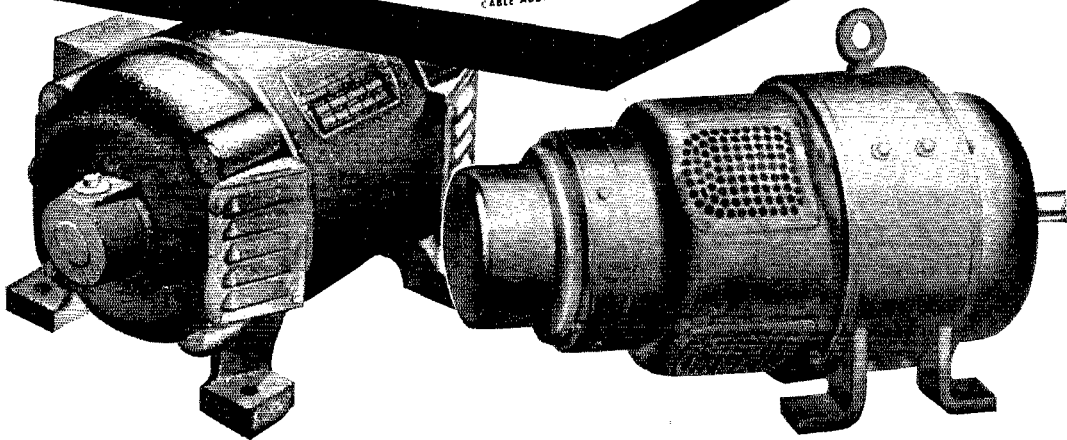

HAM-ADS

(1) Advertising shall pertain to radio and shall be of nature of interest to radio amateurs or experimenters in their pursuit of the art.

(2) No display of any character will be accepted, nor can any special typographical arrangements, such as all or part capital letters be used which would tend to make one advertisement stand out from the others.

(3) The Ham-Ad rate is 30¢ per word, except as noted in paragraph (6) below.

(4) Remittance in full must accompany copy. No cash or contract discount or agency commission will be allowed.

(5) Closing date for Ham-Ads is the 25th of the second month preceding publication date.

(6) A special rate of 7¢ per word will apply to advertising which, in our judgment, is obviously non-commercial in nature and is placed and signed by a member of the American Radio Relay League. Thus, advertising of bona fide surplus equipment owned, used and for sale by an individual or apparatus offered for exchange or advertising inquiring for special equipment, if by a member of the American Radio Relay League takes the 7¢ rate. An attempt to deal in apparatus in quantity for profit, even if by an individual, is commercial and all advertising by him takes the 30¢ rate. Provisions of paragraphs (1), (2), (4) and (5) apply to all advertising in this column regardless of which rate may apply.

Having made no investigation of the advertisers in the classified columns, the publishers of *QST* are unable to vouch for their integrity or for the grade or character of the products advertised

* * * * *

QUARTZ — direct importers from Brazil of best quality pure quartz suitable for making piezo-electric crystals. Diamond Drill Carbon Co., 719 World Bldg., New York City. **COMMERCIAL** radio operators examination questions and answers. One dollar per element. G. C. Waller, W5ATV, 6540 Washington Blvd., Tulsa, Okla.

USED equipment wanted. Highest cash prices paid for receivers, transmitters, meters, parts, etc. I promise you the best deal. Let me know what you have. Bob Henry, W9ARA, Butler, Mo.

IN STOCK: Mac No. 200 keys, \$2.25, Signatone code oscillators \$11.85; condensers, resistors, panels, chassis, transformers, Vibroplexes, radio supplies of all sorts. Your inquiries and orders invited. Henry Radio Shop, Butler, Mo.

CRYSTALS available all types, including 100 KC, 465 KC and 100 KC. Broadcast and Aircraft given prompt attention. Scientific Radio Products, Council Bluffs, Iowa.

TELEPLEXES, Instructographs, bought, sold. Ryan's. Hannibal, Mo.

WHY NOT turn your unused equipment into ready cash which may be applied towards new and better equipment after the war? Leo, W9GFG, offers you the best cash prices for communications receivers and test equipment. Write today for large illustrated catalog. Wholesale Radio Laboratories, 744 W. Broadway, Council Bluffs, Iowa.

TRADE or sell 1½-KV-A G.E. "pole" transformer 115-116/2300 volts. Practically unused. Want good typewriter, Colt or S&W revolver, preferably 22, or what have you? T.W. Hopkinson, W3AVR, 600 Bashford Lane, Alexandria, Va.

WANTED to buy tube tester, signal generator and recorder. J. B. Prince, W9UPX, 1710 West 18th St., Sioux City, Iowa.

FOR SALE: 2 Abbott TR4 transceivers with tubes; 2 Electro-Voice microphones, Model 202S with cords and plugs; 1 Radiart B unit with filter; 1 AC factory built pack. Never used. All in factory cartons. \$150. Charles Boegel, Jr., 1949 1st Ave., E., Cedar Rapids, Iowa.

METERS: quantity of multi-range Triplett 678 ohmmeter, 673 ac voltmeter, 670 ac ammeter in stock. Each in portable leather case. Price \$14.99 prepaid net each. New. 678 has 75 microampere movement, 673, 600 microampere. Don't delay. First rate, like-new panel meters accepted in trade, also up-to-date tube checkers, etc. Hatry & Young, 203 Ann Street, Hartford 3, Conn.

FOR SALE: Two new factory wired Stancor 30-M, 23 watt mobile transmitters complete with tubes and motor generator. Excellent for police transmitters. Also best offer takes 800 watt phone transmitter. See July issue, 1939 "Radio" page 52. Also sound amplifiers for sale. WIAKY.

WANTED: Good SW receiver. Also Riders' Manuals 1 to 5. Write Joseph Tabor, 20420 Riopelle, Detroit, Mich.

WANTED: National BM dial, scale no. 2. WINKW, Ryall, 72 Bowler St., East Lynn, Mass.

WANTED: Wincharger radio tower sections. State number, model, price and condition. Myron E. Kluge, 1913 Montrose Street, Los Angeles 26, Calif.

SELL Hammarlund trans. conds. No. TCD-165-k \$4.50; TCD-75G, \$6.50; 2-98mf.-.192 air gap, \$2.00 each; T125 tube and socket, \$9.00. Fil. trans. T6419-11V.10 amp. \$5.00. W9CHF. **URGENTLY** needed: communications receiver. State price and condition. Pvt. Don Edwards, New York Univ. Co. "D", ASTU, Bronx 53, New York.

INSTRUCTOGRAPH wanted, AC model with tapes; also 3" oscilloscope, late model. State condition, model and price. B. Evans, 13 Williams Lane, Chevy Chase, Maryland.

CRYSTAL pickups, microphones, damaged by moisture, repaired half new unit price plus postage. Lock Laboratory, 3411 San Luis, Tampa 6, Fla.

SALE: 1750-1500 Volt supply; Commercial style. Also miscellaneous parts. W3KJ.

WANTED: Abbott TR-4, complete with tubes and battery operated power supply. Haynes, 2413 Mallery, Flint 4, Mich.

WANTED: More orders for crystals. Immediate delivery on those time-proven Edison commercial crystal units for Aircraft, Marine, Police, Government, etc. Available in the 125-10,000 kilocycle range with temperature coefficients to meet all requirements. Regrinding service also available. "Edison's", Temple, Texas.

WANTED: Broadcast announcer operator, any class license. Send voice transcription. W1BU, Poynette, Wisconsin.

WANTED: New or used battery operated farm radio receivers; 1½-90 volt table models such as Sentinel, Zenith, etc. State price, condition, quantity, etc. Pay cash immediately if at all reasonable. Also want used communications receiver. M. H. Gravelle, Kennedy, Ala.

WANTED: New or used Thordarson T19P68 or Stancor P6163 500 MA 2500 V transformer, or equal. State condition and price. W8CTL, 707 Wolf St., Syracuse, N. Y.

JANETTE rotary converter, 115V-2A-DC to 110V-60cy-1A AC without filter. \$25 shipped from Philadelphia. John J. Armstrong, W3FXR, 1670 BW Tenth St., Miami, Fla.

WANTED: 5 meter transmitter, 20 to 80 watts. Write full particulars, price. W1BB.

WILL swap 500 watt rack type transmitter for 1-KW and will pay cash difference. Fred W. Rudolph, Stryker, Ohio.

PREPARE yourself now for a well paying radio position after the war. Obtain your FCC commercial radiotelephone and telegraph licenses through our home study courses, written for the man who has forgotten higher mathematics. An easily read, easily understood course. Moderate tuition fee.

Write for particulars
AMERICAN RADIO INSTITUTE 44 EAST 23rd St.
NEW YORK CITY.
Teaching Radio Since 1935

GOOD JOBS in RADIO for both men and women

Prepare now for jobs in Radio Engineering; Broadcasting; Marine, Aviation, Police Radio; Servicing; Radio Manufacturing. Our streamlined courses give excellent preparation for Army and Navy Service. Expenses low. Write for free catalog.

THE DODGE TELEGRAPH & RADIO INSTITUTE
408-1 Monroe St., Valparaiso, Indiana



GO TO THE BEST-TRAINED

PREPARE NOW for your lifetime career in Radio-Communications-Electronics. Send for your FREE copy of the Melville illustrated catalogue. Address Registrar, 45 West 45th St., New York 19, N. Y.

MELVILLE AERONAUTICAL RADIO SCHOOL, Inc.

RADIO TECHNOLOGY

RCA Institute offers an intensive two-year course of high standard embracing all phases of Radio and Television. Practical training with modern equipment. Also shorter specialized courses in Commercial Radio Operating, Radio and Television Servicing, and Aviation Communications.

For Free Catalog write Dept. ST-43
RCA INSTITUTES, Inc.
A Radio Corporation of America Service
75 Varick Street New York 13, N. Y.

"THE BOSS IS POUTING BECAUSE
HOGARTH WON'T TRADE
HIS **ECHOPHONE EC-1** FOR
ANYTHING WHATSOEVER"



Echophone Model EC-1

(Illustrated) a compact communications receiver with every necessary feature for good reception. Covers from 550 kc. to 30 mc. on three bands. Electrical band-spread on all bands. Beat frequency oscillator. Six tubes. Self-contained speaker. Operates on 115-125 volts AC or DC.



ECHOPHONE RADIO CO., 201 EAST 26th ST., CHICAGO, ILLINOIS

Designed for

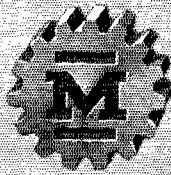

Application

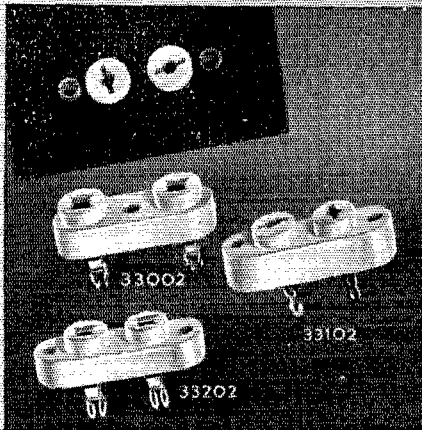

Crystal Holder Sockets 33002 and 33102 Plus new 33202 for CR1

In addition to the original 33002 and 33102 exclusive Millen "Designed for Application" steatite crystal holder sockets there is now also available the new 33202 for the new CR1 holder. Essential Data:

Type	Pin Dia.	Pin Spacing
33002.....	.125	.750
33102.....	.095	.500
33202.....	.125	.500

JAMES MILLEN MFG. CO., INC.

MAIN OFFICE AND FACTORY
MALDEN
MASSACHUSETTS



Index to Advertisers

	Page
Abbott Instrument, Inc.	**
Aerovox Corporation	**
American Lava Corporation	87
American Radio Institute	112
Amerplex Electronic Products, Inc.	**
Astatic Corporation, The	102
Ayers Automatic Code Machines	**
Barker & Williamson	**
Bliley Electric Company	85
Brach Manufacturing Corporation	**
Browning Laboratories, Inc.	**
Candler System Company	104
Capitol Radio Engineering Institute	84
Cardwell Manufacturing Corp., Allen D.	97
Centralab	116
Clarostat	**
Communications Products	101
Crystal Products Company	111
Dodge Telegraph & Radio Institute, The	112
Delco Radio, Div. General Motors	103
DX Crystal Co.	**
Echophone Radio Company	113
Eitel-McCullough, Inc.	7
Electro-Voice Manufacturing Co.	90
Electronic Laboratories	91
Galvin Manufacturing Corp.	**
Hallcrafters Company, The	1, 2
Hammarlund Manufacturing Co., The	81, 83
Harrison Radio Corporation	**
Harvey Radio Company	80
Harvey Radio Laboratories, Inc.	106
Harvey-Wells Communications, Inc.	**
Heintz & Kaufman, Ltd.	89
Henry Manufacturing Co.	89
Henry Radio Shop	102
Hudson-American	87
Hytron Corp.	96
Instructograph Company	**
International Resistance Company	98
Jensen Radio Manufacturing Company	4
Kato Engineering Co.	**
Ken-Rad Tube & Lamp Corp.	**
Kenyon Transformer Co., Inc.	**
Knights, James, Co.	**
Maedel Publishing House	**
Mallory & Co., Inc., P. R.	82
Massachusetts Radio School	106
McElroy Manufacturing Corp.	5
McGraw-Hill Book Co., Inc.	90
Meek, John, Industries	**
Meissner Manufacturing Company	**
Melville Aeronautical Radio School, Inc.	112
Metropolitan Technical School	**
Millen Manufacturing Co., James	114
Miller, Wayne	106
National Company, Inc.	79, Cov. III
Newark Electric Company	106
Nison Radio School	106
N. Y. YMCA Schools	**
Ohmite Manufacturing Company	**
Onan Electric Plants	107
Oxford-Tartak Radio Corporation	**
Pioneer Gen-E-Motor Co.	111
Port Arthur College	98
Premax Co.	104
RCA Institutes, Inc.	112
RCA Manufacturing Co., Inc.	93, Cov. IV
Radell Corporation	107
Radio Control Headquarters, Inc.	**
Radio Manufacturing Engineers	**
Radio Shack Corporation	94
Raytheon Manufacturing Company	**
Scientific Radio Products Co.	115
Shure Brothers	72
Sickles Co., F. W.	110
Simpson Electric Co.	**
Standard Transformer Corporation	82
Sun Radio & Electronics Co.	92
Taylor Tubes, Inc.	**
Terminal Radio Corporation	106
Thordarson Electric Manufacturing Co.	**
Triplett Electrical Instrument Co., The	104, 109
United Transformer Company	Cov. II
Universal Microphone Company	100
Vibroplex Company, Inc., The	**
Wallace, Don	**
Wallace, Wm., Co.	109
Wholesale Radio Laboratories	110
Wilcox Electric Company	**
Yaxley (Mallory)	**
Zenith Radio Co.	95, 107

All of the above advertisers are cooperating with the A.R.R.L. to permit publication of an editorially adequate QST during this period of war-rationing of paper. Using less advertising space but at higher rates, they continue their customary support of QST. Some are using smaller space in each issue and some are using space only every second or third issue. Of the latter, those whose advertising does not appear in this particular issue are indicated by the ** above.



WORN WITH *Equal Honor*

Awarded for distinguished
service . . . to employees of

SCIENTIFIC RADIO PRODUCTS COMPANY

The fighting man with the Distinguished Service Medal on his breast is proud. For it denotes exceptional bravery beyond the call of duty — a personal *extra* contribution toward Victory.

Our workers can be proud that their exceptional contribution too has been recognized. For the "E" pins they now wear signify distinguished service, individual excellence on the production front. To them, not us, must be given credit for outstanding service to the nation.

SCIENTIFIC RADIO PRODUCTS COMPANY

738 WEST BROADWAY — COUNCIL BLUFFS, IOWA

MANUFACTURERS OF PIEZO ELECTRIC CRYSTALS AND ASSOCIATED EQUIPMENT



Centralab Ceramic Trimmers

provide the ideal trimmer capacitor where controlled temperature coefficient and mechanical stability is required.

Temperature coefficients available:
Types 820-822-823-824

Maximum negative .0005 mmf/mm/°C Zero

Types 822, 823, 824 Positive .0002 mmf/mm/°C

Type 823 *Write for Bulletin 695*

Centralab

Division of GLOBE-UNION INC., Milwaukee

Index to Volume XXVII—1943

ANTENNAS

Folding Car-Roof V.H.F. Antenna (H & K) . . .	65, Aug.
Impedance-Matching Transformer, An (Gadwa)	22, Feb.
Measurement of Antenna Impedance (Stewart)	30, Dec.
Notes on Transmission Lines (Stewart)	25, Aug.
Resonant Circuits in Antenna Systems (Espy) .	32, Sept.
Simple Method for Investigating Performance of 112-Mc. Antennas (H & K)	55, Nov.
Three-Element Directional Antenna for Portable 112-Mc. Work (H & K)	65, Aug.
Transmission-Line Matching Simplified (Garret- son)	42, Oct.

AUDIO-FREQUENCY EQUIPMENT

Differential Microphone, A (Beekley)	36, Dec.
Electrolytics in A.F. Circuits (H & K)	68, Jan.
Correction	66, May
Four-Stage High-Gain Amplifier for Aircraft Warning Service (Exp. Section)	49, Jan.
General-Purpose Play-Back Amplifier, A (De- Soto)	58, Feb.
Let's Use Our Modulators (Iversen)	35, July
Correction	86, Sept.
Notes on Inverse Feed-Back (Erhorn)	13, June
Peak-Limiting Amplifier for Recording, A (Lewis)	26, Sept.
Recording Telephone Conversations (Grammer)	34, May
Simple Scratch Filter for Phono Pick-Up (H & K)	64, Feb.
Unscrambling Secret Speech Transmissions (Sil- ver)	16, Mar.
Correction	36, June

BOOK REVIEWS

A.C. Calculation Charts (Lorenzen)	64, Jan.
Amateur Scientist, The (Thomas)	63, Sept.
Basic Electricity for Communications (Timbie)	52, Aug.
Communication Circuits (Ware and Reed)	34, July
Electrical Fundamentals of Communication (Al- bert)	64, Jan.
Elements of Radio (Marcus and Marcus)	52, Aug.
First Principles of Radio Communications (Mor- gan)	52, Aug.
Frequency Modulation (Hund)	52, Mar.
Fundamentals of Electric Waves (Skilling)	12, Apr.
Future of Television, The (Dunlap)	106, Jan.
Guide to Cathode Ray Patterns, A (Bly)	52, Mar.
Handbook of Technical Instruction for Wireless Telegraphists (Dowsett)	106, Jan.
High-Frequency Thermionic Tubes (Harvey) . .	52, Aug.
Laboratory Manual in Radio (Almstead, Davis & Stone)	34, July
Mathematics, Its Magic and Mastery (Bakst) .	39, May
Microwave Transmission (Slater)	50, Mar.
Principles and Practice of Radio Servicing (Hicks)	52, Aug.
Principles of Aeronautical Radio Engineering (Sandretto)	52, Mar.
Principles of Electronics (Kloeffler)	12, Apr.
Principles of Radio (Henney)	39, May
Pre-Service Course in Electricity (Shea)	34, July
Pre-Service Course in Shop Practice (Kennedy)	30, May
Radio Operators' Code Manual (With Touch Typing) (Miller)	53, Aug.
Television Standards and Practice (Fink)	54, Mar.
Traffic Handbook for Radio Operators (Kitchen)	52, Aug.
What You Should Know About the Signal Corps (Davis and Fassett)	39, May

CIVILIAN DEFENSE

(See also "War Emergency Radio Service")

Australian Amateurs in Civilian Defense	21, Feb.
Wired Wireless in Civilian Defense (Wightman and Lyon)	14, Aug.
Correction	86, Sept.

CODE

Another Adaptation of the Receiver in Code Practice (H & K)	49, May
Arabic Telegraphic Alphabet, The (Worrell) . . .	34, Jan.
Correction	90, Mar.
B.C. Audio as Code-Practice Oscillator (H & K)	66, Jan.
Code-Practice Oscillator from Howard Receivers (H & K)	64, Feb.
Combined Receiver-Converter-Code Oscillator- Induction Transmitter (H & K)	56, July
Commercial "Z" Signals	63, Nov.
Curing Cross-Talk in Code-Practice Tables (H & K)	45, Apr.
Hand Perforator for Code-Practice Tape, A (Grammer)	20, June
Hint for Battery-Operated Code-Practice Oscil- lator (H & K)	66, Jan.
Japanese Morse Radiotelegraph Code, The (Holden)	30, Oct.
Keying Receiver Input for Code Practice (H & K)	63, Dec.
Neon-Bulb Code-Practice Oscillator (H & K) . .	88, Mar.
Polarized Relay for Tape Transmitters, A (H & K)	65, Sept.
Russian Telegraphic Alphabet, The (Dresser) . .	19, Mar.
Correction	84, Oct.
Simplest Code-Practice Signal Source (H & K) .	64, Feb.
Simplifying the Wheatstone Perforated-Tape Code-Practice Machine (H & K)	42, Mar.
Siphon Tape Recorder for Radio Telegraph Sig- nals, A (Gillian)	18, Apr.
"Transformerless" Code-Practice Oscillator, A (H & K)	49, May

COMMUNICATION, NON-RADIO

(See also "Experimenter's Section")

Carrier Current Converter (Exp. Section)	34, Mar.
Carrier-Current Transmitter-Receiver (Exp. Section)	52, June
Magnetostriction Oscillator for Detecting Super- sonic Sound Waves (Exp. Section)	32, May
Supersonics for Communication (Weitzer)	9, Oct.
Wired Wireless in Civilian Defense (Wightman and Lyon)	14, Aug.
Correction	86, Sept.

COMMUNICATIONS DEPARTMENT

ARRL Affiliated Club Honor Roll	72, Aug.
Commercial "Z" Signals	63, Nov.
Election Notices, SCMs 70, Feb.; 50, Apr.; 60, June; 71, Aug.; 68, Oct.; 71, Dec.	
Election Results, SCMs 70, Feb.; 50, Apr.; 60, June; 71, Aug.; 68, Oct.; 71, Dec.	
Meet the SCMs W1KQY, 74, Sept.; W3GCU, 67, Oct.; W7FWD, 72, Dec.	
Operating News 73, Jan.; 68, Feb.; 45, Mar.; 49, Apr.; 54, May; 59, June; 62, July; 69, Aug.; 71, Sept.; 65, Oct.; 60, Nov.; 63, Dec.	
War Training Program Honor Roll 75, Jan.; 69, Feb.; 45, Mar.; 49, Apr.; 55, May; 59, June; 64, July; 70, Aug.; 66, Oct.; 68, Dec.	

CONSTRUCTIONAL KINKS

Automatic Circuit Polarizer (H & K)	54, Nov.
Clutch for Automatic Power Tuning (H & K) . .	68, Jan.
Control for High-Power Rigs, A (H & K)	57, July
Ganging Volume Controls (H & K)	61, Oct.
Headphone Connections (H & K)	68, Jan.
Headphone Connections in B.C. Receivers (H & K)	61, Oct.
Method of Rejuvenating Electrolytics, A (H & K)	63, Dec.
Polarized Plug for A.C.-D.C. Gear (H & K) . . .	66, Sept.

Power-Tube Protective Circuit (H & K).....	54, Nov.
Repairing Electrolytics (H & K).....	42, Mar.
Soldering Iron Rest and Heat Control (H & K).....	55, Nov.
Solder Kink (H & K).....	55, Nov.
Switching On or Off From Four Locations (H & K).....	55, June
Using Transformers With 2.5-Volt Windings for 6.3-Volt Heaters (H & K).....	55, June

COURSES

Course in Radio Fundamentals, A (Grammer)	
No. 8 — Wave Propagation, Antennas and Transmission Lines.....	57, Jan.
Elementary A.C. Mathematics (Grammer)	
Part I — Periodic Phenomena.....	31, Feb.
Part II — Vectors.....	24, Mar.
Part III — Average and Effective Values.....	28, Apr.
Part IV — Phase Relationships in Inductance and Capacity.....	19, May
Part V — Reactance and Impedance.....	42, June
Part VI — Parallel Circuits.....	42, July
Part VII — Power, Power Factor, Losses in Reactance.....	56, Aug.
Who Killed the Signal?	
Chapter 1 — "The Thin Man".....	46, Feb.
Chapter 2 — "Beauty and the Beast".....	38, Mar.
Chapter 3 — "The Great Impersonation".....	42, Apr.
Chapter 4 — "The Siamese Twin Mystery".....	46, May
Chapter 5 — "Danger In the Dark".....	48, June
Conclusion — "This Is Murder".....	52, July

EDITORIALS

"Books Are Weapons".....	15, Jan.
Concerning Military Radio Developments and the Amateur.....	7, Sept.
Congratulations, Son.....	7, July
Do Your Part.....	11, Feb.
Greetings.....	15, Jan.
Ham Hellos.....	9, Dec.
In the Services.....	7, June
Mark of the Expert, The.....	9, Mar.
Midstream.....	7, Oct.
Paper and QST — A Report.....	9, Dec.
Publicity.....	9, Dec.
QRD.....	9, Nov.
QST's Job — And Yours.....	11, Feb.
Saboteurs and Spies Loose.....	7, July
Time and Tide.....	9, Mar.
WERS Is Making Progress.....	7, Aug.
What You Can Do.....	7, May
"When Disaster Strikes".....	11, Apr.
Your New Editor.....	8, July

EMERGENCY AND RELIEF WORK

"Ole Mississipp" Rampages Again (Keating).....	30, Aug.
Time and Tide (Editorial).....	7, Mar.
WERS in Lake Erie Dike Break.....	73, Sept.

EXPERIMENTER'S SECTION

(See also "Communication, Non-Radio")

Acoustic Aircraft Detection.....	49, Jan.
Audio-Frequency Induction and Earth-Current Communication.....	41, Apr.
Carrier Current.....	48, Jan.; 33, Mar.; 41, Apr.; 52, June; 38, July; 51, Aug.; 50, Sept.; 52, Oct.; 59, Dec.
Light Beams.....	51, Aug.
Supersonics.....	32, May

FEATURES AND FICTION

Amateur Radio and the Civil Air Patrol (Fram).....	50, Jan.
Avocation Becomes a Vocation, An (Hamilton).....	49, Feb.
"CQ" (Parker).....	50, Aug.
Dessie Belle and Johnny (Clement).....	39, June
ESMWT Radio Training at Rutgers University (DeSoto).....	38, Sept.
Greeter, The (Gardner).....	53, Aug.
Hams in Combat (C. B. D.).....	18, Aug.

Hams Teach AAF Pilots at Maxwell Field (Campbell).....	40, June
Ho-Hum (Gardner).....	41, May
"Introducing Squimp".....	47, Jan.
Life of a CAA Communications Operator, The (Willco).....	40, July
Of Mice and Hams.....	64, Jan.
QST Returns to Gallups Island (DeSoto).....	14, May
QST Visits Camp Hood (DeSoto).....	9, July
QST Visits the Air Forces (DeSoto).....	17, Jan.
QST Visits the Coast Guard (DeSoto).....	13, Feb.
QST Visits the Marine Corps (DeSoto).....	13, Apr.
Radio Instruction in the Royal Canadian Air Force (Patrick).....	9, Aug.
Radio in the Civil Air Patrol (Stello).....	20, Dec.
Saga of the 299, The (Read).....	44, Dec.
Signal Corps and the Blue Grass State, The (DeSoto).....	11, Mar.
Signal Corps Puts On a Show, The.....	42, Nov.
Straight from the Shoulder.....	56, Jan.
Teaching Radio in High School (Saunders).....	9, June
Traffic Cop of the Air, The (DeSoto).....	54, Oct.
Unfit for Further Service ("Helix").....	56, Sept.
Wail of the Kee Bird, The (Hunt).....	50, Oct.
What Is It? (Judd).....	56, Feb.
Women and Radio — Partners in Victory (Dresser).....	9, Sept.

FREQUENCY MODULATION

Two-Tube T.R.F.-Regenerative F.M.Receiver, A (Barbee).....	24, May
Correction.....	86, Sept.; 84, Nov.

HAMDOM

Ex-WIAPJ, WIDDB, W6PHA, W9FLW, W5JQN.....	37, July
W9UZ, ex-W4IU-W4XE.....	39, Nov.

HAPPENINGS OF THE MONTH

ARRL Planning Committee.....	22, Aug.
Board Meeting Minutes.....	20, July
Election Notices, Directors.....	53, Jan.; 39, Oct.; 39, Dec.
Election Results, Directors.....	55, Feb.; 39, Dec.
Elections, Alternate.....	28, Mar.; 39, May
Executive Committee Meetings.....	24, Aug.
FCC Amateur Examinations for 1943.....	53, Jan.
Kilowatt Xmtrs and V-O-Ms Wanted.....	35, June
New Application Form.....	40, Oct.
New Chief Signal Officer.....	24, Sept.
No More Station Applications.....	23, Sept.
Notice to Members Discharged from the Military Services.....	24, July
Operator Licenses Extended!.....	19, July
Proof-of-Use Waived.....	55, Feb.
Radio Technical Planning Board.....	21, Nov.
Re K6OJI.....	55, Feb.
RSGB Hq. Moves.....	24, Sept.
Transmitter Tubes Needed.....	38, May
VWOA Honors War Services.....	27, Apr.
WERS Amendments.....	22, Aug.
WERS Rules Amended.....	22, Mar.

HINTS AND KINKS

January, page 66:	
The Model-T Ford as a Source of Emergency Power Supply.....	
Hint for Battery-Operated Code-Practice Oscillator.....	
B.C. Audio as Code-Practice Oscillator.....	
Clutch for Automatic Power Tuning.....	
An Apartment Station.....	
Headphone Connections.....	
Listening on 600 Meters.....	
Electrolytics in A.F. Circuits (Correction, 66, May).....	
February, page 63:	
Shatter-Proof Insulator for Concentric Antennas.....	
Noise Limiter for U.H.F. Mobile Installations.....	
Simple Scratch Filter for Phono Pick-Up.....	
Simplest Code-Practice Signal Source.....	
Code-Practice Oscillator from Howard Receivers.....	

March, page 42:	Substitute Circuit for Transceiver Transformer Simplifying the Wheatstone Perforated-Tape Code-Practice Machine Repairing Electrolytics Neon-Bulb Code-Practice Oscillator
April, page 45:	Curing Cross-Talk in Code-Practice Tables Soldering-Iron Protective Warning Re Model-T Ford As Emergency Power Source
May, page 49:	A "Transformerless" Code-Practice Oscillator Another Adaptation of the Receiver in Code Practice
June, page 53:	Substituting Pin Jacks for Rotary Switch in V.O.M. Circuits Mica-Trimmer Tank Condensers in WERS Gear Converting An Out-Dated B.C. Receiver to a Communications Job Using Transformers With 2.5-Volt Windings for 6.3-Volt Heaters Switching On or Off from Four Locations
July, page 56:	Combined Receiver-Converter-Code Oscillator-Induction Transmitter A Control for High-Power Rigs
August, page 62:	Notes On Commercial Gear for WERS A.C.-D.C. Gear for 112 Mc. (Correction, 86, Sept.) Notes Covering the WERS Transmitter-Receiver for Allegany County, Maryland Tuned Lecher Wires Three-Element Directional Antenna for Portable 112-Mc. Work Folding Car-Roof V.H.F. Antenna
September, page 65:	A Simple Test Oscillator A Polarized Relay for Tape Transmitters Polarized Plug for A.C.-D.C. Gear A Simple, Reliable and Inexpensive Phototube Relay
October, page 59:	Cooling the Peterson "Pot" Some Hetrofil Snags and Their Solution Combination Modulation and Field-Strength Indicator and External S Meter Headphone Connections in B.C. Receivers Graphical Method for Parallel Resistances Ganging Volume Controls
November, page 53:	That Peterson Pot (A Correction) Emergency Test Board Plug-In Headphone Adapter for TR-4s Re-Use of Home Recording Discs Automatic Circuit Polarizer Power-Tube Protective Circuit Simplified Transmitter-Receiver Switching Arrangement Soldering Iron Rest and Heat Control Simple Method for Investigating Performance of 112-Mc. Antennas
December, page 62:	Servicing Receivers Removing Loktal Bases Automatic Bias for Battery Tubes S-Meter with Left-to-Right Scale Keying Receiver Input for Code Practice

IN THE SERVICES

42, Jan.; 42, Feb.; 30, Mar.; 33, Apr.; 42, May; 29, June; 26, July; 38, Aug.; 28, Sept.; 26, Oct.; 26, Nov.; 26, Dec.

INTERFERENCE

Beat Response (Hamilton) 40, May
Noise Limiter for U.H.F. Mobile Installations (H & K) 63, Feb.
Some Hetrofil Snags and Their Solution (H & K) 50, Oct.

MEASUREMENTS AND TEST EQUIPMENT

Combination Modulation and Field-Strength Indicator and External S Meter (H & K) 60, Oct.
Different Negative-Resistance Oscillator, A (Davidon) 25, July

Emergency Test Board (H & K)	53, Nov.
Frequency Measurement in the WERS (Bliss)	23, Dec.
Ham-Made Free-Point Tube Tester (French)	56, Dec.
Interpolation Oscillator, An (Mills)	46, Nov.
Junk-Box Frequency Meter for 112-Mc., A (Adams)	30, Nov.
Rejuvenating Old Meters (Triplet)	40, Feb.
S-Meter with Left-to-Right Scale (H & K)	63, Dec.
Simple Method for Investigating Performance of 112-Mc. Antennas (H & K)	55, Nov.
Simple Test Oscillator, A (H & K)	65, Sept.
Something from Nothing (Mertz)	20, Mar.
Substituting Pin Jacks for Rotary Switch in V.O.M. Circuits (H & K)	53, June
Transmission-Line Matching Simplified (Garretson)	42, Oct.
Tuned Lecher Wires (H & K)	64, Aug.
V.T. Voltmeter for A.C. and D.C., A (Mayo)	36, Nov.

MISCELLANEOUS

AAF Operators Train on Radio Mock-Ups	51, Nov.
Army-Navy Announce Radar!	51, June
Astronomy and Amateur Radio (French)	17, Nov.
China Celebrates Amateur Radio Day	49, July
China's National Amateur Convention, At	51, Sept.
Circulation Statement	34, June; 20, Oct.
Dessie Belle and Johnny (Clewell)	39, June
Did Marconi Invent Radio?	17, Aug.
Hamfest in Khaki — II (Allen)	52, Dec.
How Jap Radio Transmitters Work — In U. S. Hands (Smith)	44, Sept.
Meet Mister j! (Noll)	21, Oct.
Naval Research Labs Celebrate Twentieth Anniversary	25, Sept.
New Standard-Frequency Service of the Bureau of Standards	53, Oct.
Radar — Now You Read About It and Now You Don't	54, Sept.
Radio and Vision (Fischer)	9, May
Radio Cross-Word Puzzle (Prindle)	61, Aug.
Radiomen	20, Nov.
Rochester Fall Meeting, 1943	22, Nov.
Signal Corps Report on Enemy Radio Equipment	43, Dec.
Silver Plating at Very-High Frequencies (White)	64, Sept.
Simple, Reliable and Inexpensive Phototube Relay, A (H & K)	66, Sept.
VWOA Awards Marconi Memorial Scholarships	49, Oct.
WWV Schedules	114, Jan.; 82, Aug.; 82 Nov.; 86, Dec.

OBITUARY

Gold Stars:	
W2BZ, W9VBL	63, Sept.
W4AGS, W2HDD	57, Oct.
W4AFC, W4BAH	33, Nov.
VE4PX, W1FYT	35, Dec.
Silent Keys	55, Jan.; 26, Feb.; 41, Mar.; 54, Apr.; 64, May; 72, June; 50, July; 24, Aug.; 67, Sept.; 82, Oct.; 22, Nov.; 38, Dec.

OPERATING PRACTICES

(See "War Emergency Radio Service — General")

POWER SUPPLIES

Automatic Bias for Battery Tubes (H & K)	62, Dec.
Gas-Driven Generator for Emergency Power Supply, A (Landes)	54, Feb.
Model-T Ford as a Source of Emergency Power Supply, The (H & K)	66, Jan.
One Ounce of Prevention ("Sourdough")	54, Dec.
Re Model-T Ford as Emergency Power Source (H & K)	46, Apr.

PRISONERS OF WAR AND MISSING IN ACTION

P.O.W.	23, Mar.; 38, June; 34, July; 24, Aug.; 67, Sept.; 82, Oct.; 22, Nov.; 38, Dec.
Missing in Action	33, Jan.; 23, Mar.; 33, May; 34, June; 34, July; 24, Aug.; 67, Sept.; 82, Oct.; 22, Nov.; 38, Dec.

RECEIVING

Converting an Out-Dated B.C. Receiver to a Communications Job (H & K).....	54, June
Headphone Connections in B.C. Receivers (H & K).....	59, Oct.
Servicing Receivers (H & K).....	62, Dec.
Superregeneration (Fox).....	17, Dec.
Two-Tube T.R.F.-Regenerative F.M. Receiver, A (Barbee).....	24, May
Correction.....	36, Sept.; 84, Nov.

RECORDING

General-Purpose Play-Back Amplifier, A (De-Soto).....	58, Feb.
Let's Use Our Modulators (Iverson).....	
Correction.....	36, Sept.; 35, July
Peak-Limiting Amplifier for Recording, A (Lewis).....	26, Sept.
Recording Telephone Conversations (Grammer).....	34, May
Re-Use of Home Recording Discs (H & K).....	54, Nov.
Simple Scratch Filter for Phono Pick-Up (H & K).....	64, Feb.
Siphon Tape Recorder for Radio Telegraph Signals, A (Gilliam).....	18, Apr.

TRANSMITTING — GENERAL

Different Negative-Resistance Oscillator, A (Davidon).....	25, July
Impedance-Matching Transformer, An (Gadwa).....	22, Feb.
"Take It Off — I!" ("Sourdough").....	28, June
That's the Limit! ("Sourdough").....	45, May
Watts — Or Decibels? (Silver).....	37, June

TRANSMITTERS — CONSTRUCTIONAL

250-Watt C.W. Transmitter Using Receiving Type Tubes, A (Barbee).....	30, July
Control for High-Power Rigs, A (H & K).....	57, July
Five-Band Transmitter Exciter, A (Richelieu).....	46, Aug.
QRR Portable, The (Palmer).....	52, Sept.
Saga of the 299, the (Read).....	44, Dec.
"Traffic Cop" Transmitter, The (Palmer).....	38, Jan.

TUBES

3BP1, 3EP1/1806-P1, 7CP1/1811-P1.....	26, Feb.
7C4/1203A, 1R4/1294, 3B7/1291, 3D6/1299, 7E5/1201.....	59, Aug.

U. S. A. CALLING

35, Jan.; 27, Feb.; 35, Mar.; 39, Apr.; 27, May; 18, June; 33, July; 44, Aug.; 46, Sept.; 19, Oct.; 34, Nov.; 42, Dec.

VERY-HIGH FREQUENCIES — GENERAL

Aeroanalysis and V.H.F. Techniques (French) ..	11, Dec.
On the Very Highs.....	54, Jan.; 57, Feb.; 41, Mar.; 37, Apr.; 47, May; 54, Aug.; 55, Sept.; 34, Oct.; 51, Dec.
Silver Plating at Very-High Frequencies (White).....	64, Sept.
Simple Method for Investigating Performance of 112-Mc. Antennas (H & K).....	55, Nov.

VERY-HIGH FREQUENCIES — APPARATUS

112-Mc. Transmitter-Receiver, A (Lynch).....	30, Jan.
A.C.-D.C. Gear for 112-Mc. (H & K).....	62, Aug.
Correction.....	86, Sept.
CD-WERS, 1944 Style (Long).....	11, Nov.
Constructional Aspects of WERS Mobile Installations (Forster).....	34, Aug.
Cooling the Peterson "Pot" (H & K).....	59, Oct.
Correction.....	53, Nov.
Crystal-Controlled Transmitter for WERS, A (Brooks).....	36, Apr.
Economical Transmitter-Receiver for WERS, An (Magee).....	32, June
Folding Car-Roof V.H.F. Antenna (H & K).....	65, Aug.
"Handy Andy" (Palmer).....	35, Oct.

Mica-Trimmed Tank Condensers in WERS Gear (H & K).....	53, May
More Selectivity in WERS Reception (Grammer).....	17, Sept.
Noise Limiter for U.H.F. Mobile Installations (H & K).....	63, Feb.
Notes Covering the WERS Transmitter-Receivers for Allegany County, Md. (H & K).....	63, Aug.
Notes on Commercial Gear for WERS (H & K).....	62, Aug.
On the Spot With a Walkie-Talkie (Burkle).....	23, Nov.
Plug-In Headphone Adapter for TR-4s (H & K).....	54, Nov.
Rebuilding TR-4s for Non-Priority Tubes (Mix).....	17, July
Simplified Transmitter-Receiver Switching Arrangement (H & K).....	55, Nov.
Substitute Circuit for Transceiver Transformer (H & K).....	42, Mar.
Three-Element Directional Antenna for Portable 112-Mc. Work (H & K).....	65, Aug.
Transceiver for Mobile WERS Work, A (Bradley).....	48, Dec.
V.H.F. Transmitter for Emergency Service, A (Hay and Harpster).....	48, Sept.

WIRED WIRELESS

(See "Communication, Non-Radio")

WAR EMERGENCY RADIO SERVICE — GENERAL

CD-WERS in the State of Maryland (McNulty).....	25, June
Fifth Regional WERS, The (Gibbs).....	38, Feb.
Message Handling in WERS (Russell and King).....	42, Aug.
Operating News Leads:	
Army Orders.....	55, May
ARRL War Emergency Corps.....	68, Dec.
CAP-WERS.....	45, Mar.; 54, May
District Licensing.....	70, Aug.
Experimental Data.....	72, Sept.
Identification.....	72, Sept.
Important Notice.....	60, Nov.
Keeping Up Interest.....	65, Oct.
L-265.....	68, Dec.
Move on the New Rules.....	71, Sept.
More Mobiles.....	68, Dec.
More Rules Changes.....	45, Mar.; 69, Aug.
More Testing Hours.....	69, Aug.
Ninth Regional CD-WERS.....	59, June
Operating Discrepancies.....	73, Sept.
Operating Procedure.....	49, Apr.; 62, July
Operator Permits.....	72, Sept.
Priorities.....	69, Aug.
Special Drills.....	70, Aug.
Transfer of Equipment.....	72, Sept.
Visiting Mobiles.....	65, Oct.
WERS Application Discrepancies.....	73, Jan.
WERS Coverage.....	61, Nov.
WERS Licenses Granted.....	74, Jan.
WERS Progress.....	68, Feb.; 64, July
WERS Relay Chains.....	70, Dec.
WERS Rules Changes.....	73, Jan.
What Constitutes Rag-Chewing.....	66, Oct.
Whither WERS?.....	60, Nov.
Some New Thoughts on WERS (Hart).....	24, Apr.
Tri-Part Plan, The (Hart).....	19, Jan.
WERS Amendments.....	22, Aug.
WERS Bibliography.....	60, Sept.
WERS for Seven Million People (Long and Kenney).....	14, Oct.
WERS in Lake Erie Dike Break.....	73, Sept.
WERS in the New Haven Warning District (Fraser and Keating).....	30, May
WERS Is Making Progress (Editorial).....	7, Aug.
WERS Rules Amended.....	22, Mar.
Women as WERS Operators (Jordan).....	40, Dec.

WAR EMERGENCY RADIO SERVICE — EQUIPMENT

(See "Very-High Frequencies — Apparatus" and "Measurements and Test Equipment")

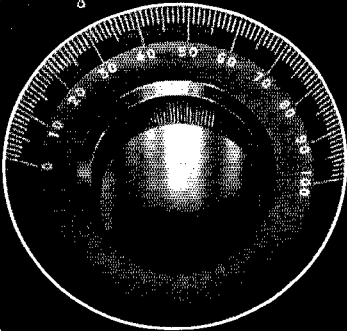

TYPE A
DIAL

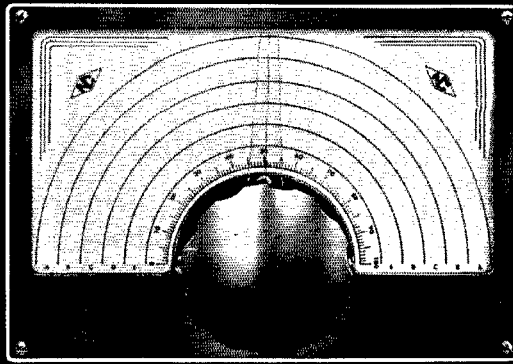

TYPE ACN DIAL

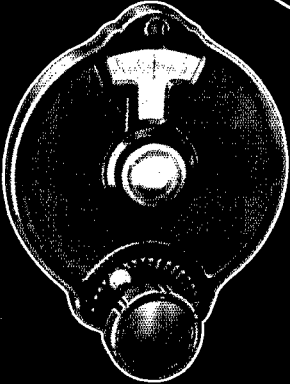

TYPE B DIAL

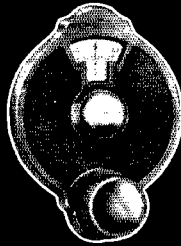

TYPE
BM DIAL

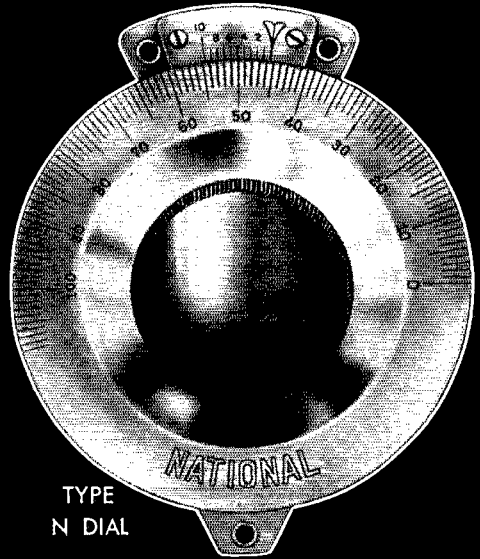

TYPE
N DIAL



ACCURACY — and VELVET DRIVE

In War as in Peace, National Dials provide the smooth effortless control that makes the operator master of his equipment. Enormous increases in our productive capacity are meeting war-time demands, and National Dials are available with reasonably prompt delivery to users having the necessary priority.

NATIONAL COMPANY, INC.
MALDEN, MASS.

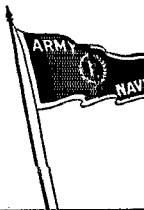

The photograph immediately above shows an installation inside a Pan-American Clipper. National Dials have been in service with Pan-American Airways for many years.

TYPE B DIAL— Four-inch diameter with engine divided scale and flash Vernier 0 to 1000.

TYPE ACN DIAL— Designed for direct calibration—Dial face size 2" x 2 1/2".

TYPE BM DIAL— Compact variable ratio drive—Incorporates bakelite case if lubrication available.

TYPE BN DIAL— Similar to type B but smaller in size and having a fixed ratio.

TYPE A DIAL— The Original Velvet Vernier Dial, an unchallenged favorite for twenty years.

PUSH-PULL
 Beam Power
200 Mc

with these
RCA little wizards

* Small but powerful, RCA-829 and RCA-832 are real buys for the ultra-highs. High efficiency at low plate voltage. Low driving power. High output. Compact. Rugged. Either 6.3 or 12.6-volt heater operation. Neutralization not required. High power-sensitivity simplifies transmitter design. Operates up to 200 mc at full ratings, up to 250 mc at reduced ratings. Army-Navy Preferred Type listing. Over three years of practical field application.

Excellent as frequency triplers and r-f power amplifiers, they give you worth-while advantages in UHF work—FM and AM transmitters, both mobile and fixed, for aviation, emergency, television, and military applications.

Equipment designers can obtain application data and assistance from RCA electron tube engineers. Please write, stating your problem, to Radio Corporation of America, Commercial Engineering Section, 565 South 5th Street, Harrison, New Jersey.

RCA-829—\$19.50 120 WATTS INPUT* AT 200 Mc Typical Operation, Class C telegraph (Continuous Commercial Service): plate volts, 500; plate current, 240 ma.; driving power, 0.7 watt; output, 83 watts.

RCA-832—\$17.00 36 WATTS INPUT* AT 200 Mc Typical Operation, Class C telegraph (Continuous Commercial Service): d-c plate volts, 500; d-c plate current, 72 ma.; driving power, 0.18 watt; output, 26 watts.

*Class C Telegraph

The Magic Brain of All Electronic Equipment! Is a Tube and the Fountain-Head of Modern Tube Development is RCA



TUNE IN "WHAT'S NEW?"
 RCA's great new show,
 Saturday nights, 7 to 8,
 E. W. T., Blue Network

BUY MORE WAR BONDS



RADIO CORPORATION OF AMERICA

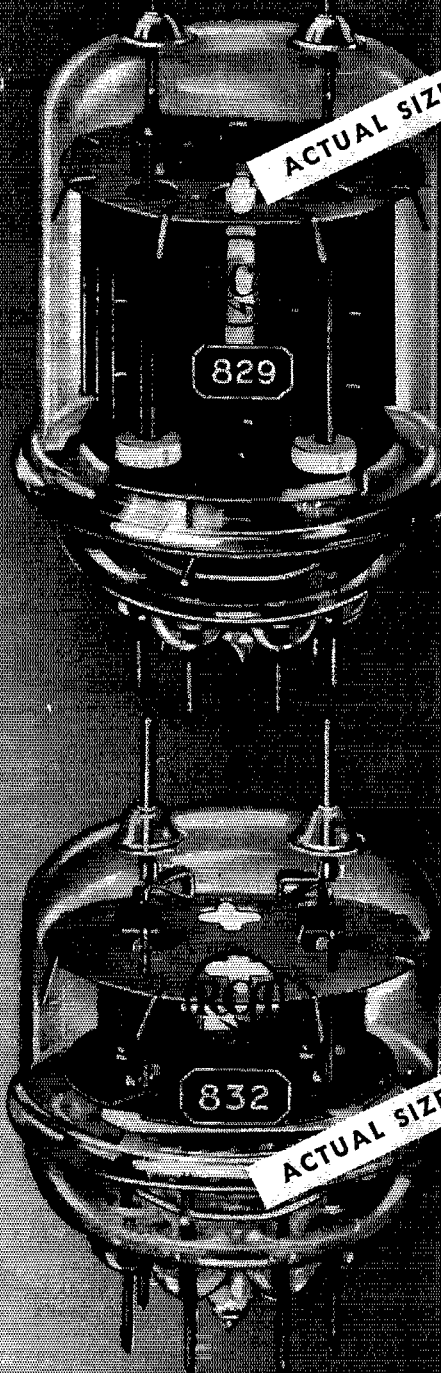

GET YOUR COPY

Send today for the 1945
 for Transmitter Design
 paper created with
 information with a
 North 4th Street, New Jersey

