

QST

september, 1943

25 cents

35c in Canada

devoted entirely to

amateur radio

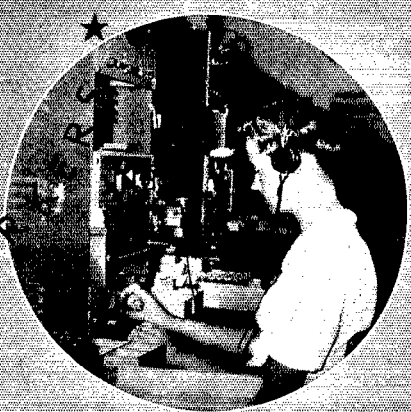
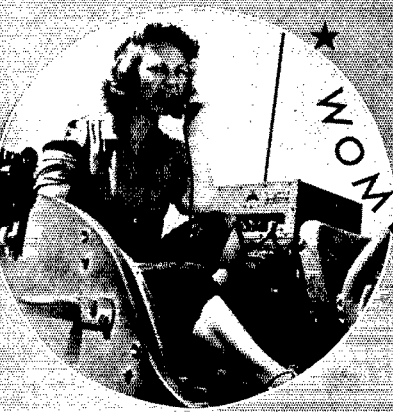
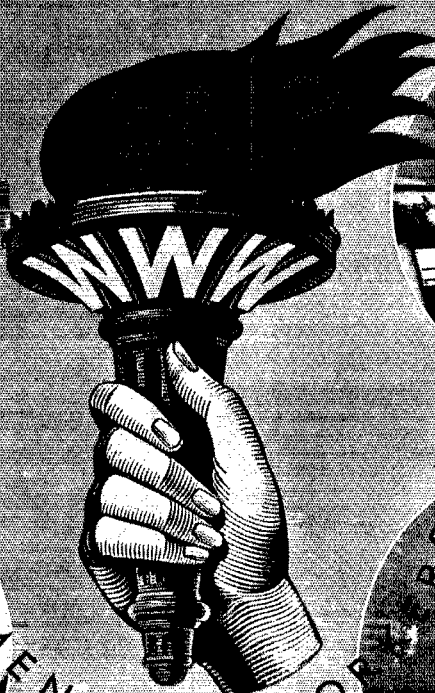

★
WOMEN
WAR
★

Savings in DESIGN

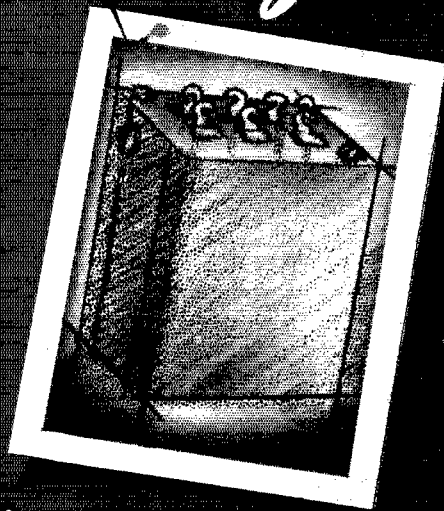

VOLUME REDUCTION 80%

WEIGHT REDUCTION 78%

PRICE REDUCTION 84%

DEPENDABILITY --%

UNITED TRANSFORMER CO.

150 VARICK STREET



NEW YORK 13, N. Y.

EXPORT DIVISION: 13 EAST 40th STREET, NEW YORK 16, N. Y. CABLES: "ARLAE"

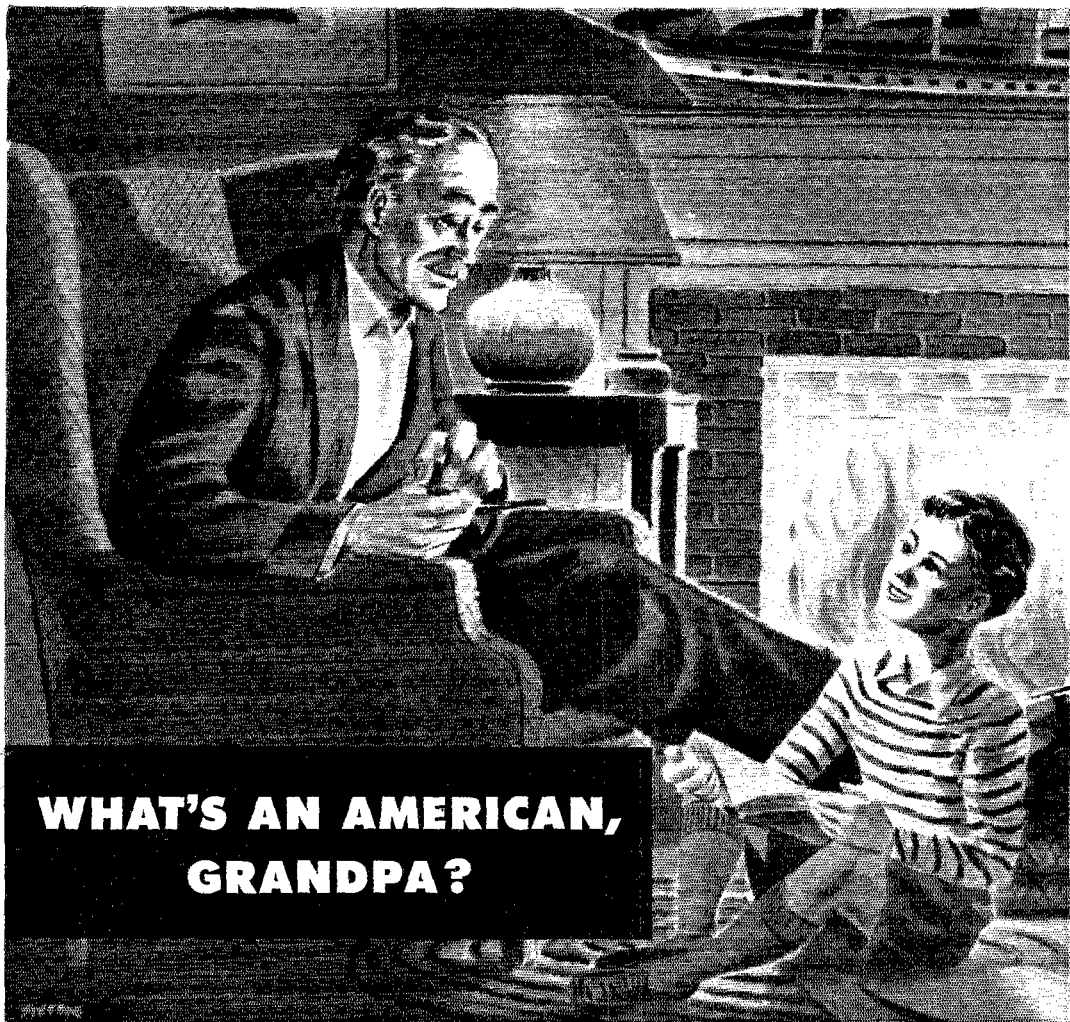

WHAT'S AN AMERICAN, GRANDPA?

Son, it's a little hard to describe an American! Maybe I had better start by saying he is a peaceful fellow, hates to start anything that he thinks will hurt his fellow man. Some folks think he is slow-starting, well, maybe so, but once he gets started he can produce faster than

anyone, especially those who threaten the peace and security of his home or his liberty to go and come or do what he wants to do. . . . Son, an American is the fightin'est fellow I know of when you threaten him with the loss of any one of the real American principles.

BUY MORE BONDS!



hallicrafters
CHICAGO, U. S. A.

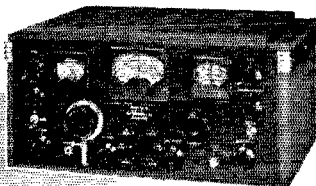

WINNING THE BATTLE OF COMMUNICATIONS!

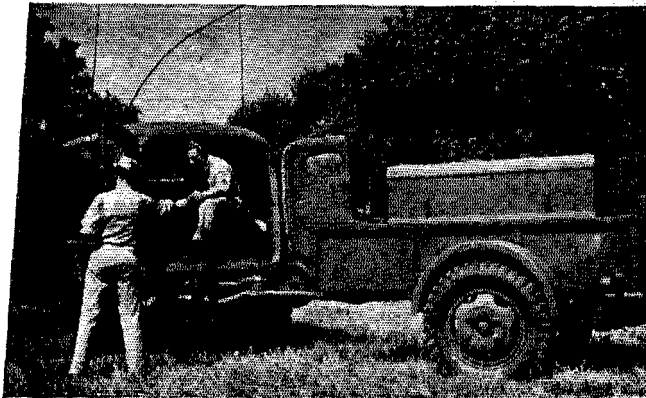
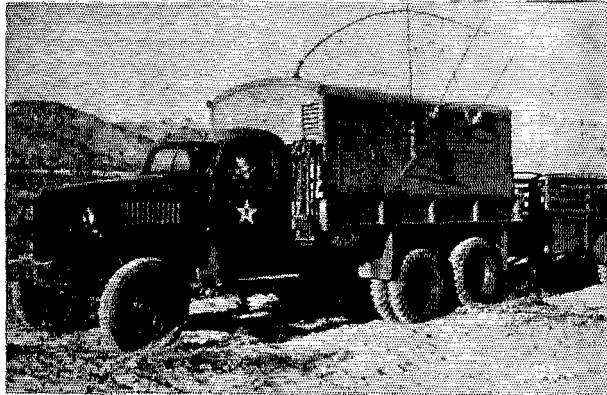

Mobile communications units assembled by Hallicrafters are helping to win the battle of communications on every fighting front. They are built to endure the rigors of modern warfare . . . The consistent performance of SCR-299 has been highly praised by leading members of our armed forces for its adaptability in meeting all the requirements of combat duty . . . A phrase best describing the SCR-299 was given when a leading military authority said, "It is to communications what the jeep is to transportation."

hallicrafters

CHICAGO, U. S. A.



BUY
MORE
BONDS

THE WORLD'S LARGEST EXCLUSIVE MANUFACTURER OF SHORT WAVE RADIO COMMUNICATIONS EQUIPMENT

SEPTEMBER 1943

VOLUME XXVII

NUMBER 9



STAFF

Editorial

KENNETH B. WARNER, W1EH
General Manager of A.R.R.L.
Publications

CLINTON B. DESOTO, W1CBB
Editor

GEORGE GRAMMER, W1DF
Technical Editor

DONALD H. MILK, W1TS
BYRON GOODMAN, W1JPE*
Assistant Technical Editors

EDWARD P. TILTON, W1HDQ
Contributing Editor, V.H.F.

WALTER E. BRADLEY, W1FWH
VENNON CHAMBERS, W1JEQ*
Technical Information Service

LOUISA B. DRESSEK
Editorial Assistant

JAMES J. LAMB, W1AL*
Research Engineer, A.R.R.L.

Advertising

F. CHEYNEY BEEKLEY, W1GS
Advertising Manager

Circulation

DAVID H. HOUGHTON
Circulation Manager

RALPH T. BEAUDIN, W1RAW
Asst. Circulation Manager

*On leave of absence



OFFICES

38 La Salle Road
West Hartford 7, Connecticut

Subscription rate in United States and Possessions, \$2.50 per year, postpaid; all other countries, \$3.00 per year, postpaid. Single copies, 25 cents. Foreign remittances should be by international postal or express money order or bank draft negotiable in the U. S. and for an equivalent amount in U. S. funds.

Entered as second-class matter May 29, 1919, at the post office at Hartford, Connecticut, under the Act of March 3, 1879. Acceptance for mailing at special rate of postage provided for in section 1103, Act of October 3, 1917, authorized September 9, 1922. Additional entry at Concord, N. H., authorized February 21, 1929, under the Act of February 23, 1925. Additional second-class entries to cover sectional editions authorized March 20, 1935.

Copyright 1943 by the American Radio Relay League, Inc. Title registered at United States Patent Office.

QST

devoted entirely to

AMATEUR RADIO

PUBLISHED, MONTHLY, AS ITS OFFICIAL ORGAN; BY THE AMERICAN RADIO RELAY LEAGUE, INC., AT WEST HARTFORD, CONN., U. S. A.:
OFFICIAL ORGAN OF THE INTERNATIONAL AMATEUR RADIO UNION



CONTENTS

It Seems to Us	7
Splatter	8
Women and Radio — Partners in Victory. <i>Louisa B. Dresser</i>	9
More Selectivity in WERS Reception <i>George Grammer, W1DF</i>	17
Happenings of the Month.	23
Naval Research Labs Celebrate Twentieth Anniversary.	25
A Peak-Limiting Amplifier for Recording <i>Robert Lewis, W8MQU</i>	26
In the Services	28
Resonant Circuits in Antenna Systems <i>Dawkins Espy, W6UBT</i>	32
ESMWT Radio Training at Rutgers University <i>Clinton B. DeSoto, W1CBB</i>	38
How Jap Radio Transmitters Work — in U. S. Hands <i>James H. Smith, RT1c, USNR</i>	44
U. S. A. Calling!	46
A V.H.F. Transmitter for Emergency Service <i>Lt. Comdr. R. R. Hay, USN, and Lt. (jg) W. A. Harpster, USN</i>	48
Experimenter's Section	50
At China's National Amateur Convention	51
The QRR Portable. <i>Paul J. Palmer, W8UGR</i>	52
Radar — Now You Read About It and Now You Don't!	54
On the Very Highs. <i>E. P. Tilton, W1HDQ</i>	55
Unfit for Further Service "Helix"	56
WERS Bibliography	60
Strays	62
Book Review	63
Gold Stars	63
Silver Plating at Very-High Frequencies <i>S. Young White, W9GVB</i>	64
Hints and Kinks	
<i>A Simple Test Oscillator — A Polarized Relay for Tube Transmitters — Polarized Plug for A.C.-D.C. Gear — A Simple, Reliable and Inexpensive Phototube Relay</i>	65
Prisoners of War.	67
Missing in Action	67
Silent Keys	67
Correspondence from Members.	68
Operating News	71
WERS in Lake Erie Dike Break	73
The Month in Canada	74
Amateur Activities	75
Ham-Ads	108
QST's Index of Advertisers	110

Section Communications Managers of the A.R.R.L. Communications Department

Reports Invited. All amateurs, especially League members, are invited to report communications activities, training plans, code classes, theory-discussion groups, civilian-defense building or planning each mid-month (16th of the month for the last 30 days) direct to the SCM, the administrative official of ARRL elected by members in each Section whose address is given below. Radio Club reports and Emergency Coordinator reports representing community organized work and plans and progress are especially desired by SCMs for inclusion in QST. ARRL Field Organization appointments, with the exception of the Emergency Coordinator and Emergency Corps posts, are suspended for the present and no new appointments or cancellations, with the exception named, will be made. This is to permit full efforts of all in Emergency Corps plans.

ATLANTIC DIVISION			
Eastern Pennsylvania	W3BES	Jerry Mathis	6208 Master St. Philadelphia 31
Maryland-Delaware-District of Columbia	W3CIZ	Hermann E. Hobbs	9701 Monroe St. Silver Spring P. O.
Southern New Jersey	W3GCU	Ray Tomlinson	624 E. Brown St. Trenton 10
Western New York	W8MC	William Bellor	186 Dorsey Rd. Rochester
Western Pennsylvania	W8CKO	E. A. Krahl	703 Broadway East McKeesport
CENTRAL DIVISION			
Illinois*	W9QLZ	George Keith, Jr.	Box 22-A, R.F.D. 2 Utica
Indiana*	W9SVH	J. P. Gilliam	422 Goshon Ave. Elkhart
Kentucky	W9ARU	Darrell A. Downard	116 N. Longworth Ave. Louisville 12
Michigan	W8DPE	Harold C. Bird	R.F.D. 2 Pontiac
Ohio	W8CBI	D. C. McCoy	Normandy Lane, R. R. 7 Dayton
Wisconsin	W9RH	Emil Felber, Jr.	1625 N. 18th St. Milwaukee 5
DAKOTA DIVISION			
North Dakota	W9YVF	John W. McBride	420 West 12th St. Sioux Falls, South Dakota
South Dakota	W9QVY	P. H. Schultz	118 N. Yankton Ave. Pierre
Northern Minnesota	W9FUZ	Arnold D. Brattland	War Production Training School Greenwood
Southern Minnesota	W9YNQ	Millard L. Bender	608 N. Huron Ave. Spring Valley
DELTA DIVISION			
Arkansas	W5GED	Ed Beck	2503 Bishop St. Little Rock
Louisiana	W5DWW	W. J. Wilkinson, Jr.	Room 313, Jefferson Hotel Shreveport
Mississippi	W5HAW	P. W. Clement	524 Santini St. Biloxi
Tennessee	W4SP	James B. Witt	R.F.D. 6, Shady Dell Trail Knoxville
HUDSON DIVISION			
Eastern New York	W2LU	Robert E. Haight	25 Crane Ave. White Plains
N. Y. C. & Long Island	W2ZV	E. L. Bagch	102 Central Ave. Massapequa, L. I.
Northern New Jersey*	W2IIN	John J. Vitale	106 Orchard St. Elizabeth
MIDWEST DIVISION			
Iowa	W9AED	Arthur E. Rydberg	Mitchellville
Kansas	W9AWP	A. B. Unruh	1617 S. Seneca St. Wichita
Missouri*	W9OUD	Letha E. Allendorf	1015 West Third St. Joplin
Nebraska	W9POB	Roy E. Olmsted	Trimble House Milford
NEW ENGLAND DIVISION			
Connecticut	W1KOY	Edmund R. Fraser	48 Willow St. West Haven 16
Maine*	W1AQL	G. C. Brown	379 No. Main St. Brewer
Eastern Massachusetts	W1AQP	Frank L. Baker, Jr.	21 Atlantic St. North Quincy 71
Western Massachusetts	W1JAH	William J. Barrett	239 Columbia St. Adams
New Hampshire	W1FTJ	Mrs. Dorothy W. Evans	P. O. Box 312 Concord
Rhode Island	W1HRC	Clayton C. Gordon	70 Columbia Ave., Gaspee Plateau, Warwick
Vermont	W1JRG	Clifton G. Parker	Box 537 Morrisville
NORTHWESTERN DIVISION			
Alaska	K7GNN	James G. Sherry	P. O. Box 486 Homer
Idaho	W7AVP	Don D. Oberbillig	Boise
Montana	W7CPY	Rex Roberts	1137 Federal Glendive
Oregon	W7GNI	Carl Austin	513 N. Central Bend
Washington	W7FWD	O. U. Tatro	Olympia
PACIFIC DIVISION			
Hawaii	K6ETF	Francis I. Blatt	837 16th Ave. Honolulu
Nevada	W6BIC	Edward W. Heim	509 Claremont St. Reno
Santa Clara Valley	W6UIU	Earl P. Sanderson	600 Acacia Ave. San Bruno
East Bay	W6TL	Horace R. Greer	414 Fairmount Ave. Oakland
San Francisco	W6UIS	Kenneth E. Hughes	590 35th Ave. San Francisco
Sacramento Valley	W6MD1	Vincent N. Feldhausen	113 South Quincy St. McCloud
Philippines	KA1GR	George L. Rickard	Box 849 Manila
San Joaquin Valley*	W6MIW	Ralph C. Lowry	315 Santa Barbara Modesto
ROANOKE DIVISION			
North Carolina	W4CYB	W. J. Wortman	P. O. Box 566 Morganton
South Carolina	W4BOE/ANG	Ted Ferguson	1213 College St. Columbia
Virginia	W4RKN	Walker S. Walker	217 51 St. Newport News
West Virginia	W8JRL	Kenneth M. Zinn	P. O. Box 132 Clarksburg
ROCKY MOUNTAIN DIVISION			
Colorado	W9CNI	Stephen L. Fitzpatrick	P. O. Box 1101 Kiowa
Utah-Wyoming	W7DIE	John S. Duffy	938 "D" St. Rock Springs, Wyo.
SOUTHEASTERN DIVISION			
Alabama	W4GBV	Lawrence J. Smyth	308 Winona Ave. Montgomery
Eastern Florida*	W4BYR	Frank C. Fassett	1712 Hills Ave. Tampa
Western Florida	W4AXP	Oscar Cederstrom	408 S. Pine St. Warrington
Georgia	W4FDJ	Ernest L. Morgan	R.F.D. 4 Lyons
West Indies (Cuba)	CMZOP	Mario de la Torre	Escoibar 110 (Altos) Habana, Cuba
(Puerto Rico-Virgin Islands)	K4KD	Everett Mayer	24 Lindberg St. Santurce, P. R.
SOUTHWESTERN DIVISION			
Los Angeles	W6QVV	H. F. Wood	723 N. Las Palmas Ave. Hollywood
Arizona	W6RWV	Douglas Aitken	341 S. Mt. Vernon Ave. Prescott
San Diego	W6BZE	Richard Shanks	4033 S. Hempstead Circle San Diego
WEST GULF DIVISION			
Northern Texas	W5IAU	N. R. Collins, Jr.	2230 W. Amherst Dallas
Oklahoma	W5GFT	Russell W. Battern	Box 290 Enid
Southern Texas	W5MN	Horace E. Biddy	1746 Schley Ave. San Antonio
New Mexico	W5HJP	J. G. Hancock	110 S. E. Nevada St. Portales
MARITIME DIVISION			
Maritime	VE1DQ	A. M. Crowell	69 Dublin St. Halifax, N. S.
ONTARIO DIVISION			
Ontario	VE3EF	Flying Officer Donald R. Gunn	c/o Canadian Bank of Commerce New Toronto, Ont.
QUEBEC DIVISION			
Quebec	VE2CO	Sub-Lieutenant L. G. Morris	c/o Room 604, 1111 Beaver Hall Hill Montreal, P. Q.
VANALTA DIVISION			
Alberta	VE4GE	C. S. Jamieson	581 W. Riverside Drive Drumheller, Alta.
British Columbia	VE5DD	C. O. I. Sawyer	2634 West 31st Ave. Vancouver
PRAIRIE DIVISION			
Manitoba	VE4AAW	A. W. Morley	82 Carlton St. Winnipeg
Saskatchewan	VE4SY	Arthur Chesworth	1071 4th Ave., N.W. Moose Jaw

* Officials appointed to act until the membership of the Section choose permanent SCMs by nomination and election.

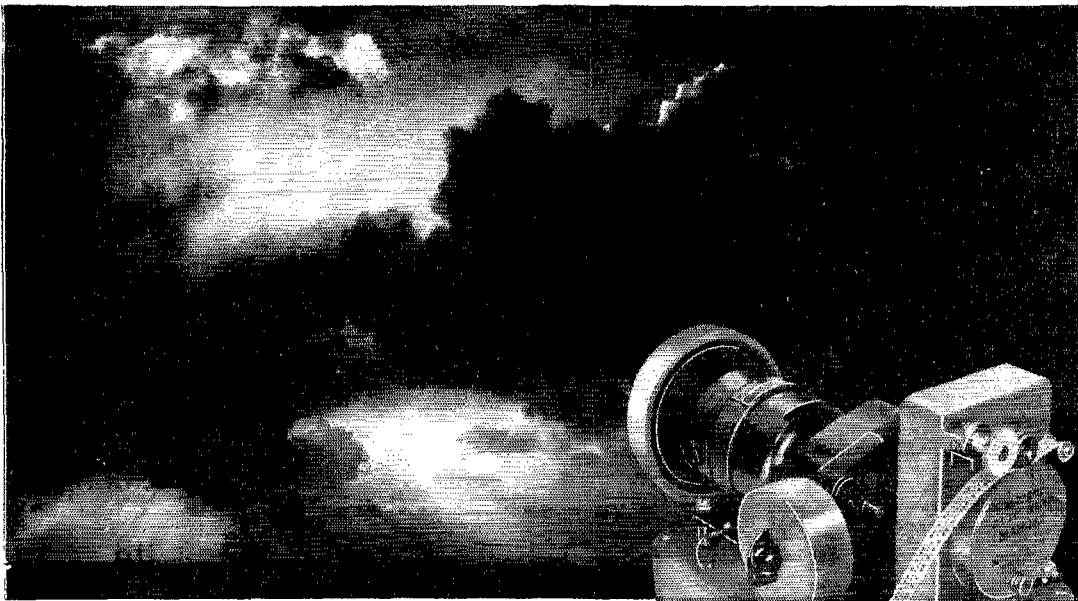

U. S. Navy Official Photo

A new day is coming . . .

Tomorrow . . . maybe the day after . . . the sun will break through to shine down on a new era of peacetime electronic applications. Tomorrow . . . maybe the day after . . . we will come to you with a wealth of experience in diversified electronic techniques which will assist communications and industrial development. Meanwhile, our efforts are limited to designing and building apparatus for the transmission of dots-and-dashes. Ted McElroy and his staff are creative engineers. We never imitate . . . never copy. We create . . . design . . . build. Our services are at your disposal.

Speed The Day!

SUPPORT THE
**THIRD
WAR LOAN
DRIVE**

It's going to be up to the "man on the street," this time. \$15,000,000,000 called for in September. Let's dig into our pockets and come up with the money. That's much easier than digging a foxhole with bullets flying around you.

McElroy

MANUFACTURING CORPORATION
82 BROOKLINE AVENUE BOSTON, MASSACHUSETTS

THE AMERICAN RADIO RELAY LEAGUE, INC.,

is a noncommercial association of radio amateurs, bonded for the promotion of interest in amateur radio communication and experimentation, for the relaying of messages by radio, for the advancement of the radio art and of the public welfare, for the representation of the radio amateur in legislative matters, and for the maintenance of fraternalism and a high standard of conduct.

It is an incorporated association without capital stock, chartered under the laws of Connecticut. Its affairs are governed by a Board of Directors, elected every two years by the general membership. The officers are elected or appointed by the Directors. The League is noncommercial and no one commercially engaged in the manufacture, sale or rental of radio apparatus is eligible to membership on its board.

"Of, by and for the amateur," it numbers within its ranks practically every worth-while amateur in the nation and has a history of glorious achievement as the standard-bearer in amateur affairs.

Inquiries regarding membership are solicited. A bona fide interest in amateur radio is the only essential qualification; ownership of a transmitting station and knowledge of the code are not prerequisite, although full voting membership is granted only to licensed amateurs.

All general correspondence should be addressed to the Secretary at the administrative headquarters at West Hartford, Connecticut.



Past Presidents

HIRAM PERCY MAXIM, W1AW, 1914-1936
EUGENE C. WOODRUFF, W8CMP, 1936-1940

Officers

President GEORGE W. BAILEY, WIKH
Washington 25, D. C.
Vice-President CHARLES E. BLALACK, W6GG
Yuma, Ariz.
Secretary KENNETH B. WARNER, W1EH
West Hartford, Connecticut
Communications Manager F. E. HANDY, WIBDI*
Washington, D. C.
Treasurer DAVID H. HOUGHTON
West Hartford, Connecticut

General Counsel PAUL M. SEGAL
1026 Woodward Building, Washington, D. C.

*On leave of absence. Address correspondence to the Acting Communications Manager, George Hart, West Hartford 7, Connecticut.

Directors

President
GEORGE W. BAILEY WIKH
2101 Constitution Ave., N.W., Washington

Vice-President
CHARLES E. BLALACK W6GG
Box 108, Yuma, Ariz.

Canadian General Manager
ALEX REID VE2HL
240 Logan Ave., St. Lambert, P. Q.
Alternate: Leonard W. Mitchell VE3AZ
78 Raglan Ave., Toronto, Ont.

Atlantic Division
WALTER BRADLEY MARTIN W3QV
Address correspondence to the Acting Director:
HERBERT M. WALLEZE W8BQ
P. O. Box 18, Drums, Pa.

Central Division
GOODWIN L. DOSLAND W9TBN
11831 Longwood Drive, Chicago
Alternate: Everett H. Gilbbs W8AQ
405 Broad St., Wadsworth, Ohio

Dakota Division
TOM E. DAVIS W9VVA
915 W. Becker Ave., Willmar, Minn.
Alternate: Donald M. Beaudine W9RPJ
2821 Carson Way, Sacramento, Calif.

Delta Division
E. RAY ARLEDGE W5SI
340 N.E. 20th Terrace, Apt. 7, Miami 37, Fla.
Alternate: B. G. Lowery Smith W4DEP
19 N.E. 41st St., Miami, Fla.

Hudson Division
ROBERT AKERIDGE KIRKMAN W2DSY
250 Albert Place, Elberon, N. J.
Alternate: George Ruliffs, Jr. W2CJY
172-21 Highland Ave., Jamaica, L. I.

Midwest Division
FLOYD E. NORWINE, JR. W9EPC
7405 Hiawatha Ave., Richmond Heights, Mo.
Alternate: William H. Graham W9BNC
6915 No. 31st Ave., Omaha, Neb

New England Division
PERCY C. NOBLE W1BVR
37 Broad St., Westfield, Mass.
Alternate: Clayton C. Gordon W1HRC
70 Columbia Ave., Warwick, R. I.

Northwestern Division
KARL W. WEINGARTEN W7BG
3219 N. 24th St., Tacoma, Wash.
Alternate: R. Rex Roberts W7CPY
110 W. Brennan St., Glendive, Mont.

Pacific Division
J. L. McCARGAR W6EY
66 Hamilton Pl., Oakland 12, Calif.
Alternate: Elbert J. Amarantes W6FBW
1675 Dale Ave., San Jose, Calif.

Roanoke Division
H. L. CAVENESS W4DW
2607 Vanderbilt Ave., Raleigh, N. C.
Alternate: J. Frank Key W3ZA
Box 707, Buena Vista, Va.

Rocky Mountain Division
C. RAYMOND STEDMAN W9CAA
925 So. Gaylord St., Denver 9
Alternate: Willard C. Wright W9BQO
Box 891, Denver

Southeastern Division
WILLIAM C. SHELTON W4ASR
527 Revilo Blvd., Daytona Beach, Fla.
Alternate: William P. Sides W4AUP
Fleming Road, Montgomery, Ala.

Southwestern Division
JOHN E. BICKEL W6BKY
1834 E. Whittier Blvd., Whittier, Calif.
Alternate: Eldridge E. Wyatt, Jr. W6ARW
5291 E. Broadway, Long Beach, Calif.

West Gulf Division
WAYLAND M. GROVES W5NW
% Humble Pipe Line Co., Hawkins, Texas
Alternate: Jennings R. Poston W5AJ
Box 248, Mabank, Texas

"IT SEEMS TO US—"

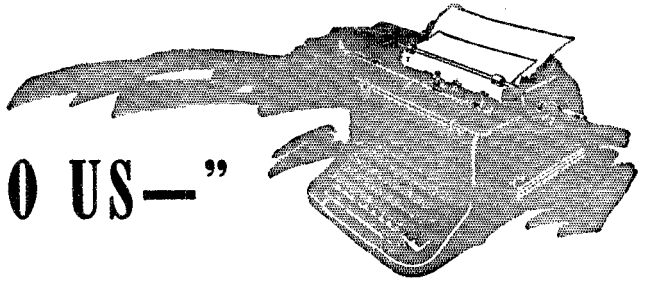

CONCERNING MILITARY RADIO DEVELOPMENTS AND THE AMATEUR

PROPHECY concerning changes in post-war living to be wrought by wartime developments is a widespread practice these days. Especially on behalf of the dawning world of electronics, we are regaled with promises of wonders that hold prospect of banishing the cares of this workaday world — performing every imaginable task from increasing the fertility of seeds to televisually turning away the Fuller Brush man at the door.

Indulgence in fanciful prediction is a pleasant fireside occupation. Even in amateur radio, when good hams get together the talk often turns to glowing (if vague) speculation about the changes in the game that may be wrought by the wonders of war wizardry. We admit to a little of this harmless soothsaying ourselves, at one time or another.

This piece, however, is headed along the opposite track. Its thesis is our considered opinion that, when the future ultimately unfolds, the changes in amateur technique as a result of wartime developments will be found to have been relatively small.

Two facts support this belief. First is the fact that most of the outstanding features of the military *communications* equipment so far put into service are essentially no more than the practical application and refinement of the best of the ham practices in use before the war. Second is the fact that such novel improvements as have been made are chiefly of a specialized military character, of little value for amateur adaptation.

Those statements apply, of course, only to the conventional use of the medium and high frequencies, where the bulk of amateur operation heretofore has been concentrated; the story for the very-highs and the ultrahighs is quite a different one. Note also that the word "communications" is emphasized. It is true that spectacular extensions of the radio and electronic fields have been developed — including radar in its several forms, a long list of intricate aircraft homing, landing, navigational and flight-control devices, automatic ordnance-firing equipment, and a variety of associated devices in the highly-secret category. But these are not communication, to which amateur radio for the most part has been consecrated, and about which we are speaking now.

In that field, to put it plainly, wartime development has not — as yet, at least — produced major changes in technique. The present situation is unlike that of World War I, when radio was still young. Now the basic principles have been pretty well established, and these have not changed. Military radio equipment consists of the same fundamental units as any other — antennas, transmitters, receivers, power supplies, frequency-measuring equipment. Vacuum tubes are employed in the conventional ways and for the conventional purposes — as oscillators, amplifiers, modulators, rectifiers. Tuning is done by varying L and C , and frequency ranges are shifted by switching or plugging in assortments of coils and condensers. Materials may have changed somewhat in selection and emphasis, but "copper" is still synonymous with "conductor" and bakelite and polystyrene and steatite continue to circumscribe the path of the roaming electron. Even the fundamental circuits remain the same. In fact, wherever one looks, the basic pattern for the radio equipment of World War II is the same familiar pattern found in established amateur practice.

That's by no means all there is to the story, of course. We do not mean to say that the military radio equipment in the aircraft and tanks of 1943 is unchanged from that in their pre-war predecessors. Very much the contrary; the improvements in military radio have been great indeed. The differences between the military radio of 1943 and its 1939 counterpart are as great as — well, as great as the differences between a ham rig of 1941 and one of 1931.

For the truth is that, right up to the eve of the present war, standard military gear resembled that used by amateurs in the period from 1928 through 1932. There were exceptions, of course, notably in the case of receivers based on designs originally created for amateur use. But only in the recent years and months of concentrated development has the design of military radio caught up with amateur progress.

The point is that, even now, it has not gone much beyond. Modern military transmitters resemble to a surprising degree the best of the prewar ham rigs. You can look through your *QST* file for the past five years and see in embryo almost every important element of the latest and most advanced military sets. The

manufacturers of Army and Navy equipment have taken these elements — the e.c.o., band-switching, various amateur-developed expedients such as simplified v.h.f. circuits, neutralizing kinks and the like — and combined them to make the new military sets. True, they have eliminated a lot of the bugs, reduced construction to mass-production technique, exercised admirable ingenuity in mechanical design and, in certain cases, achieved miracles of compactness. They have simplified adjustment and operation and have standardized performance in production models. But, with very few exceptions, they have not discovered anything new. The progress that has been made lies chiefly in the successful adaptation of methods already regarded by the amateur as standard practice.

Let it be clearly understood that this statement is not made in a critical vein. If little that is new has been discovered in the art of radio communication at ordinary frequencies, that fact reflects no discredit on the labs. Such wasn't the task they were given to do. Their job has been to give the Army and Navy tried and tested radio gear of proved merit — gear that would provide effective communication anywhere at any time, under any conditions. And that job they have done superlatively well — as anyone with experience in the field will testify. No one can appreciate better than the amateur the hard work, skill, intelligence and resourcefulness required in the process of turning a hand-made experimental model into a mass-production manufactured device — particularly a precision instrument which must meet the rigorous requirements of military service. It might even be argued that the creation of the present highly perfected military radio equipment *without* the aid of any miraculous new development represents a greater marvel even than would have been the hatching of a spectacular new invention.

But the fact still remains that improvements in details, however valuable and important, do not contain the spark of revolution. New inventions, the reduction to practice of novel

or hitherto unused principles — these are required to produce basic changes in technique. It seems axiomatic that, if the war brings no major advances in circuits and principles, it will cause no major changes in postwar amateur technique.

Of course, we can hope for some benefit from the improvements refined in the crucible of huge wartime production and vast-scale testing in use. Manufactured equipment, in particular, should be a superior product. Component parts should be better and cheaper, if only because the military has paid the cost of underwriting design and tooling costs.

But the real emphasis lies in the other direction. It should be placed on the fact that, whatever the problems that confronted us when we went off the air, they'll still be there when we get back on. The Signal Corps Labs and the Naval Research Labs aren't solving our problems for us; they have their own, and they're not spending their time trying to answer those we've left unsolved.

Let's be realistic about it. When the green light for postwar operation is flashed we need not expect that the closed doors of military secrecy will open, revealing brand-new developments on which we can capitalize. Instead, we should look forward to our restoration to the air as an opportunity for tackling anew those problems which are still unsolved.

It's a challenging, beckoning prospect. It will be the greatest opportunity amateur radio has ever faced. We'll be better equipped than ever to do the job — in quality and variety of matériel, in strength of numbers, in skill. The intensive educations our members in the services are receiving alone will be a significant new asset. And we'll be confident in the knowledge that, having done it before, we can do it again.

Let those in other fields count on building their bright new world of the future on the fruits of wartime development. In amateur radio we'll continue to supply our own.

C. B. D.

★ SPLATTER ★

OUR COVER

IF *QST* seems to have gone in for the feminine angle this month, it's only because any realistic appraisal shows that the war production program from here on in will grow or fall in the same measure as the nation's womanpower can be enlisted. WPB Chief Donald M. Nelson put it this way: "Production is now in the stratosphere. To increase it requires supercharging."

Concerning the cover, the blazing torch is, of course, the official insignia of OWI-WMC's

September Womanpower Mobilization Campaign. The array of photos illustrating women war workers in radio shows (beginning at two o'clock and proceeding clockwise) Ola Marie Rogers, Midland Schools grad now employed as an air line radio operator with American Airlines at Chicago; Laretta Cardinal, giving mounted finished crystals their final frequency and activity check at Harvey-Wells; Ruth Szold, civilian radio technician at Ft. Monmouth, testing a vehicular transmitter-receiver mounted in a jeep (official U. S. Signal Corps photo); and Genevieve Piasta lacing meter and power cables on a mobile transmitter for the U. S. Navy. Operators, testers, technicians, production workers — YLs do everything in radio these days.

(Continued on page 84)

Women and Radio — Partners in Victory

*From Factory Work to Engineering, B.C. Announcing to Air-Lines
Operating, Womanpower Runs the Wartime Radio Field*

BY LOUISA B. DRESSER*



"THE manpower problem to-day is in great part a womanpower problem." Those are the words of the Office of War Information in announcing the September Womanpower Mobilization Program, jointly sponsored by OWI and the War Manpower Commission.

We are told that this autumn will bring another crisis in the manpower situation. As critical a labor shortage looms ahead as that which existed in the very early stages of war production. The regular labor reserves have been pressed into service during the past two years, and they are now reaching their end.

That original shortage of skilled labor for war industry and subsequent needs were largely met by drawing workers from among those previously employed in civilian occupations. As we well know, that resulted in a new problem — a shortage of civilian workers in all of the necessary trades, services and professions.

The current manpower program is directed primarily at relieving this civilian-front shortage. Yet the problem is an overall one. To meet the ever-increasing needs for skilled specialists, more and more individuals constantly are being trained in technical skills. These trainees are largely people formerly employed at lower levels in industry or in civilian occupations. Their jobs must now be filled by others, and the jobs these others leave in turn must be filled by still others. It's an up-grading process. And, at the bottom, the final replacements can come only from the ranks of those not now employed.

Already large numbers of new workers have been recruited. Throughout the country in the critical labor areas from 25 to 60 per cent of all high school students now work at part-time jobs in addition to going to school. Even the inmates of institutions and the physically handicapped are doing their bit.

In fact, the substantial sources and reserves of replacement labor, with one exception, have all been exhausted. Yet the shortage exists. It must be filled from that one important remaining reserve of unused manpower — which is not manpower, but womanpower.

Millions of women now are employed in industry and in civilian occupations, but millions more are not. In England, where in effect women are under the same selective service rules as men, nine out of ten unmarried women between the ages of 19 and 45 either are in the uniformed

forces or employed in munitions factories, or are doing essential war work.

We don't know what the corresponding figures are for the United States, but we do know that there are hundreds of thousands of single women or women with children over 14 who could be employed in useful war work and aren't. By useful war work we don't mean joining the WACs or WAVES or taking a job in a munitions plant, either. Any job which releases another man or woman for other work which he or she might do better or which supplies a necessary civilian service is a war job. The women who leave their afternoon teas or bridge games to work as waitresses or receptionists or stenographers are doing war work, too. They carry on in place of those who are qualified to move on to more skilled work directly in the war effort, and thus in turn may release another man or woman for military service or vital allied work.

Our Responsibility

Ordinarily this is not the kind of a problem which would concern *QST*. Manpower shortages are not within the province of an amateur radio magazine. War brings new responsibilities to all,

"I'm one of thousands of war wives, mothers, sisters and sweethearts now working in radio. We're working now, even though many of us have never worked before. We know it's our war, too. We're working to make the day come soon when our men will return home again. This is your war, too. Are you in it? Are you taking the place of a man or woman at the front, doing a civilian job that needs doing? Your country is calling you — now. Will you join us in the fight for Victory and Peace?"



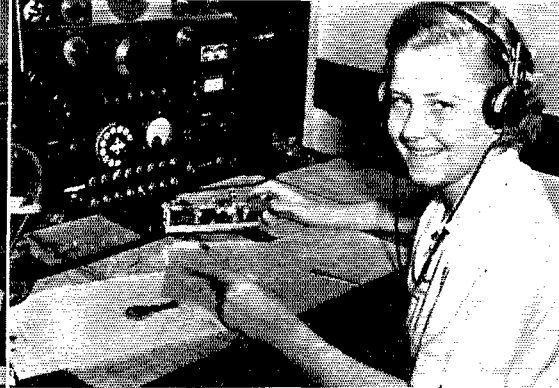
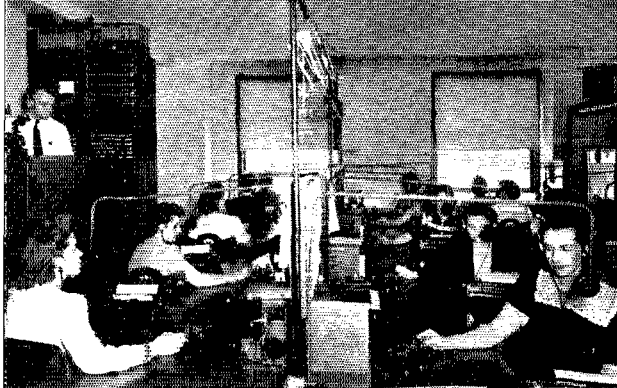

Women operate air lines' radio stations. *Left*— Future operators for the commercial air lines now receiving training at Midland Schools learn to use the automatic key. *Right*— Jacquelyn Hester, commercial aviation's first girl radio telegraph operator, handles an international circuit in the Pan-American Airways radio room at Miami.

however, and we have our "U.S.A. Calling" department in *QST* and the ARRL Personnel Bureau as precedents for interesting ourselves in personnel procurement matters. Not that precedents are needed; the simple fact that the greater the number of workers we have the sooner the war will be won is reason enough.

Amateur radio's job now is to help in winning the war. One way we can help is by applying our own specialized skill in radio — not only in the military, but in support of the radio industry as a whole. Although thousands of hamesses are doing just that, our numbers are infinitesimal compared with those needed. The other way in which we can help is by converting and training other women to work in the radio field.

That is the plea we make now. We ask you YLs (and OMs, too) to become missionaries and teachers. Radio is one of the fields seriously affected by the labor shortage. This shortage can be met only by the conversion of thousands of new women workers — either workers who enter the radio industry directly, or who release others in civilian service occupations by taking over their jobs. The national womanpower campaign preaches the program as a whole, with no specific reference to radio. It is the task of those in the radio field to see that its particular needs are made known. It is *our* task to get women who are not now working to go to work in radio.

Womanpower already occupies a major role in the radio field and the radio industry not only

needs women, but it wants them. Before the war the number of women employees in some of the large manufacturing plants ran as high as 60 per cent. Now, however, that figure has risen to as much as 80 or even 90 per cent. In branches of radio other than industry the advent of women is more recent — war inspired. But their performance in these fields is equally successful.

We know that to be true. We have talked to the people who hire women for radio work, and the consensus is that women can take over readily much of the work formerly done by men and do it equally well. We have watched the women at their work, too, and have found inspiring the keen interest and skill they display in performing their tasks.

The tasks they can perform in the field of radio have been ever increasing. In fact, it is now agreed that there is no ceiling to the responsible jobs open to women. Greeted by skepticism when first they took over work formerly done exclusively by men, they have more than proved their worth. From stock clerk to radio engineer, from restricted 'phone operator to technical instructor, they have made shining records, not only setting new standards of skill and efficiency but giving glowing promise of what may be expected of them in the future.

Air Lines Operators

The nation's radio communications network, that vital nerve system linking every part of our country and reaching to every important center in the world, has long been man's stronghold. Except for a few girl shipboard operators employed for the novelty of it in the early days, men have dominated the radio rooms. True, many a YL signed her call to a QSO on the amateur bands in prewar days — but use women operators on commercial circuits? That was something else again!

Mary Virginia Taylor (left) and Lillian Feigay (right), receiving technicians at RCA Communications' main trans-Atlantic receiving station at Riverhead, L. I. Miss Taylor, a licensed commercial operator, received an honorable discharge from the Navy early this year and was given special training to qualify for her present work.

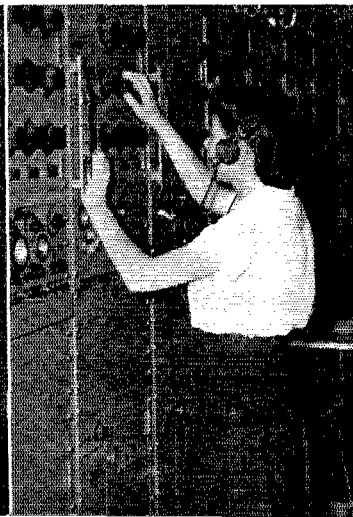

But the gals proved they could do it, and at present the commercial airlines alone employ several hundred girl operators. The demand for them is ever increasing. In many cases the girls are taking over the work of operating the ground stations, so that the men can go into the air as flight radio officers. These YL ops are doing a splendid job — even a better job in some respects, we are told, than the men who preceded them, for it has been found that the feminine voice often carries better through QRN.

Becoming proficient in both 'phone and c.w. operation, they handle responsible assignments. Jacquelyn Hester, who is credited by her employer, Pan-American Airways, with being commercial aviation's first girl radiotelegraph operator, handles an international circuit in the PanAm radio room at Miami. She has won the admiration of her male colleagues at the station, but she still wonders what those at the South American end of her circuit say when they learn that the "JH" sine at the end of their QSOs belongs to a girl of eighteen.

Most of the women operators employed by the air lines hold second class radiotelephone or radio-telegraph licenses, though some have only restricted radiotelephone permits. Wages vary with the employer and the type of station to which the girls are assigned. Those possessing restricted permits start out at approximately \$135 a month, increasing to \$160 at the end of a year when they may qualify for their second class ticket. Those holding second class tickets begin at \$160 a month and can go as high as \$210.

Interested? Oh — you haven't the necessary license. You can train for it, though. A number of schools throughout the country give courses designed to prepare students for operating positions. The Midland Radio School at Kansas City, for example, has already trained between two and three hundred women operators for the airlines. Two courses are offered at Midland. The three-month course covers all essential subjects and graduates students with a restricted 'phone permit. Those taking the six-month course also receive radio telegraph instruction, attaining a code speed of 16 w.p.m. before graduating. A number of other schools offer similar courses in operator training as well as technique.

Women make crystals. *Left* — Using a special X-ray machine, Laura Lusignan inspects and marks a crystal mother at Harvey-Wells. *Center* — Victoria Guerin grinds the crystal blanks to approximate thickness on an automatic lapping machine. *Right* — Cecile Tetreault tests the lapped wafers for frequency before finishing and mounting.



Women teach AAF radiomen. Mrs. Anna Marie Tevlin, W9ONW, (left) and Mrs. Leta Bush, W9DBD, (right), the first women instructors at the Army Air Forces Technical Training Command radio school at Scott Field, Ill., discuss methods of selective analyzer instruction with the sergeant Mrs. Bush relieved for combat duty. *AAF Technical Training Command Photo.*

The vast system of air transport spiderwebbing the nation needs more and more girls trained to handle important radio communications. Ample opportunity is offered those who want to help now, and the air-line expansion inevitable when the war is won should guarantee future careers for women in communications.

At Commercial and Government Stations

In other commercial communications fields the use of women radio operators is newer and as yet less extensive. But it is growing — even the huge coastal point-to-point stations, traditional havens of masculinity, are brightened by their presence.

Some employers train their own operating personnel. RCA Communications, for instance, has what it calls its girls' technical school. To help feminine employees qualify as receiving technicians, daily classes are held at RCA's main trans-Atlantic receiving station at Riverhead, L. I. Known as "student-technicians," the girls spend approximately 26 weeks learning radio theory and code. They are paid \$90 a month during training, and their salary is increased to

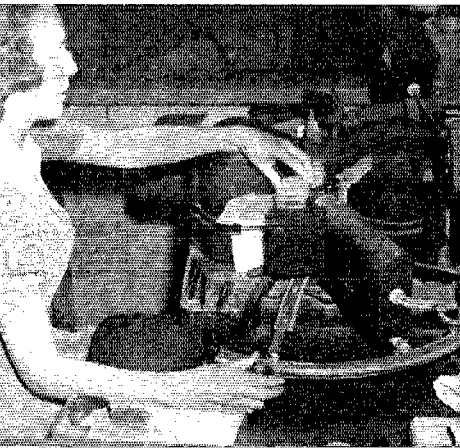



From this girl's skilled fingers, sensitive precision meters receive delicate final adjustments at Westinghouse.

\$150 a month upon assignment to regular operating duties.

Several girls already are working as receiving technicians at RCAC. Among them is Mary Virginia Taylor. Possessor of a commercial radiotelegraph license, she formerly worked as engineer at two Florida broadcast stations, WDLF in Panama City and WMPJ at Daytona Beach.

So successful has been the receiving technicians' class that another school is now being organized for girls who wish to train as transmitting technicians at RCAC's "Radio Central" at Rocky Point, L. I.

Nor is the work of women radio operators confined to commercial communications. Girls now hold operating positions in many government agencies, and more are needed. Most of these positions come under Civil Service, which does

the recruiting and hiring. The various employing agencies do their own training and administering, however.

Among the government agencies now using women in radio are the Civil Aeronautics Authority, which directs the aerial traffic of the nation; the Federal Communications Commission, which controls all wire and radio communication, and the Federal Bureau of Investigation. Trained in CAA schools, girls carry out radio operating duties as trainee aircraft communicators. The FCC employs many in its field offices as radio operators, some of whom help maintain the stations as well as operate them. Others work as junior or assistant radio intercept officers, participating in the control of wartime operation of radio stations. In the FBI, girls operate c.w. systems to Alaska, Honolulu, Puerto Rico and elsewhere.

Civil Service salaries for this type of work begin at \$1440 or \$1620 (plus about 20 per cent for "overtime") and move up with experience and ability.

In Broadcasting

Remember the picture in *QST* a year ago of Marjorie Allen, W2NCR, the first feminine transmitter engineer to operate a b.c. station? Employed at Muzak Corp.'s f.m. station, W47NY, she occupied the triple rôle of transmitter engineer, control-room operator and announcer.

We hear other women announcers these days, too. In fact, many broadcast stations, particularly the smaller ones, are now largely staffed by women — behind the microphone, assembling news, arranging programs, operating in control rooms. Some have risen to executive positions. Patti Littell, for instance, is the new program director of KDKA's affiliate f.m. station, W75P. Her brother is an aviation cadet in training at Maxwell Field, Ala. Several small broadcasting stations are now managed by women.

As control room operators, girls handle the mechanical operations of broadcasting. They place microphones, regulate volume, mix circuits, run transcription turn-tables, cue in records.

Women build tape recorders. *Left* — Ruth McCloud (left) and Mary Anne Ray (right) supervise the making of McElroy code-training tapes for the Army. Ruth's two brothers are in the Canadian Navy. Mary's five cousins are in the U. S. Army and Marine Corps. *Right* — Rose Addonizio (left) and Adele Ricciardi (right) assembling McElroy high-speed tape recorders. Rose's brother is in the Coast Guard on North Atlantic patrol. She has six cousins in the Army and three in the Navy. Adele's husband will soon graduate as an ensign in the Navy.



— everything the men they have replaced once did. Working the same shifts as the men often means showing up at the studio at 5:30 in the morning, but they accept that cheerfully as part of the game. And their male associates are soon aware of the feminine touch — now the equipment is kept clean!

As Instructors

Not only are women learning to be operators and technicians, but they in turn are teaching others. During the past year or two, radio training — both military and civilian — has reached the proportions of a major industry, requiring tens of thousands of instructors. As in other fields, there simply haven't been enough qualified male instructors available. Technically trained women, chiefly those with amateur background, have supplied the lack.

Perhaps nowhere are women instructors performing a more outstanding job than is being done by the scores in the Army Air Forces Technical Training Command, who are teaching the future radiomen of our flying battleships.

"We've found there is no difference between a man or woman instructor with the same background," says Lt. Col. Albert T. Wilson, director of training at the AAFTTC school at Scott Field.

He believes that women who have had ham experience make the best instructors. Proof of this is the fact that the first two women to qualify for instructorships at Scott Field were Mrs. Leta Bush, W9DBD, and Mrs. Anna Marie Tevlin, W9ONW.

Not all AAF women instructors, of course, are hams. They range in background from a church organist to an educational adviser in a CCC camp, from high-school graduate to membership in the honorary scientific society, Sigma Xi. But all have found radio a fascinating field.

Wilma Papila became interested in radio before the war and hoped to obtain a position as operator on a tanker, but Pearl Harbor put a crimp in her plans. A licensed amateur, she also was among the first to be graduated from the instructors' school at Scott Field, and now teaches code to the 12 and 16 w.p.m. classes. Harriet O'Neil, a violinist who also taught and composed music, had never thought of radio before the call for instructors went out over a year ago. To-day, radio is her major interest. She teaches d.c. theory to students of radio fundamentals.

Paid between \$2000 and \$2600 a year at the start, these girls have the opportunity to earn up to \$5400 annually.

The enlisted men whom these women replaced as instructors are now winning fame as radiomen—

Women make vacuum tubes. *Top* — Lavinia Senior, Westinghouse electronics worker, seals the ends of high-power radio transmitting tubes in a device which is 100 per cent more rapid than methods formerly used. *Center* — Evelyn Meachko spot-welds spiral filament on the swing shift at Eitel-McCullough. Her husband is an aircraft communicator in the CAA. *Bottom* — In a completely air-conditioned room at Westinghouse, white-gloved women workers assemble delicate electron-tube elements for use in military radio equipment.





gunners on bombers around the world. There may not be as much glory attached to the job that the women are doing back at Scott Field, at least in terms of newspaper headlines, but their contribution in the end may prove just as great.

In Industry

On the radio manufacturing industry rests a great responsibility. It is the manufacturers' Herculean task to produce rapidly and well the radio equipment needed by all branches of the military — 7½ billion dollars worth this coming year alone.

The use of womanpower is nothing new to the radio industry. In the mass production of broadcast receivers, girls and women long have done the bulk of the routine mechanical operations — assembling, wiring, soldering. Nimble fingers, supple wrists, sensitivity of touch, the capacity for infinite care, imperviousness to monotony — these qualities endow them with the ability to do the exacting work required.

But the types of work they can do and the numbers employed have been extended until, at present, some plants are staffed 90 per cent by women. From factory workers doing simple mechanical operations, they now range to lab technicians and even design engineers. In many plants they work side by side with men, doing every job the men do. Women even supervise the work of men in some instances — and, incidentally, do it so diplomatically and well that there is no resentment.

Of course, there are many positions held exclusively by women, those where painstaking care and precision are required. To expand the range of work women can do, manufacturers are constantly re-engineering the tougher jobs formerly held only by men, adapting them to feminine abilities by simplifying the technical details wherever possible, and eliminating the hazards and physical strains.

Women on the production lines. *Top* — Aproned girl workers assemble transmitters on the final assembly line at Hallcrafters. *Top center* — Ever align an HRO? This girl does it all day long. Approximately 40 per cent of the test work on components and complete equipment at National is now performed by women. *Lower center* — Wiring a sub-assembly for a mobile transmitter at Harvey-Wells. A correctly wired chassis is used as a model. *Bottom left* — The coil assembly department at National is entirely staffed by women. The only males in it are foremen. *Bottom right* — Mildred Kuski calibrates the tuning unit of a new Super-Pro receiver at Hammarlund, which now has hundreds of girl employees.

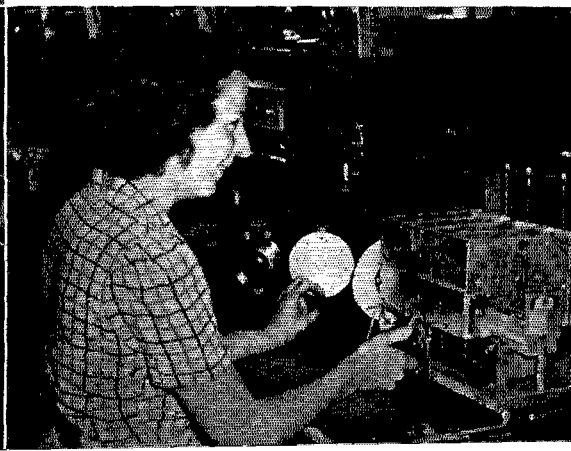

In the manufacture of crystals, for example, women perform practically every operation from X-raying the raw quartz before cutting on up through to the testing of the finished product. They charge the saws with diamond dust and operate these saws with skill and precision. They inspect the wafer-thin slices of quartz and mark out the perfect sections for dicing. On the lapping machines women grind the crystals down to approximate thickness.

In the final finishing of the crystals women are unequalled. The mounting and testing operations are completely dominated by women. Those without technical training learn to test the crystals by recognizing beat notes in the headphones rather than by measuring frequency on complex deviation meters.

In vacuum-tube manufacturing, women have been tried on every job. They have stayed there, too, except in a few cases where "only an OM (and a pretty tough one, at that) seemed able to stand the gaff." There are women glass crackers, flare spinners, tube benders, glass annealers, pump operators, spot welders, precision shearers and final testers — to mention only a few of the specialized jobs.

The assembly operations on large transmitting tubes are manned almost entirely by women, usually under male supervision. Women, too, hold supervisory positions, however, having worked their way up by their own shoulder straps. One of these is 22-year-old Marsha Wolfe, supervisor on the "graveyard" shift in the straight-filament department at Eitel-McCullough. Juanita Redmond, whose husband is stationed in the Aleutians with a Naval "SeeBee" battalion, is supervisor on the "swing" shift in the glass department. Neither had held a job of any kind before joining Eimac.

In other branches of precision radio manufacturing — building detection devices, receivers, transmitters, keyers, instruments — women run drill presses and punch presses, operate burring and milling machines, do wiring, soldering and welding, inspect and assemble parts, and finally test the equipment to insure that it will operate perfectly at the crucial moment.



At Solar, blind women are more accurate than precision gages at inspecting mica spacers for flaws and grading them to tolerances of 0.0015 of an inch. Mary Murphy, second from right, veteran of the group, proved so efficient that other blind workers were added.

With Skill and Devotion

One thing is certain — the work that women do in the radio industry is well done. The equipment they produce is made and tested as carefully as skill and devotion can do it. Practically all women war workers have relatives or friends in the services; in some plants as many as half are "war widows," their husbands off to the sterner tasks of this war. These women thrill to the thought that some day their own men may be using the very piece of radio gear they are building or testing now.

Age and physical disability offer no handicaps. At Harvey-Wells Communications, one gray-haired woman in her sixties is working in a factory for the first time in her life. At her side works a crippled woman with a hunch back. True, their job of stamping numbers on mounted crystals is not a complicated one, but their willingness to serve is great.

Even the blind are contributing magnificently to industry. At the Solar Manufacturing Co., a number of sightless women perform work of un-

Woman radio engineers. *Left* — Beattina Alexander, RCA-Victor woman engineer, checks small parts by projection against a drawing of specifications. *Right* — Rita Carlin, member of the manufacturing engineering staff at Westinghouse Lamp Division, inspects high-power glass-envelope transmitting tubes being made for the Navy.

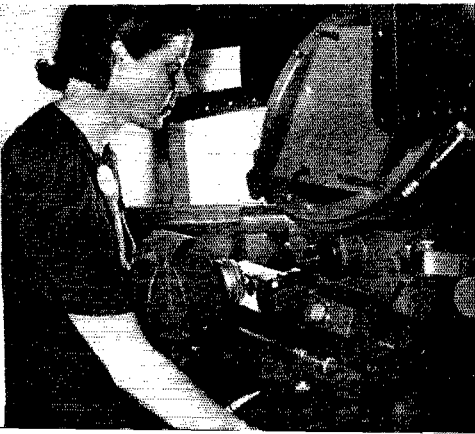



A Signal Corps lab technician services the f.m. transmitter in an M-3 tank. *Official U. S. Signal Corps Photo.*

believable precision in measuring with their finger tips the mica spacers used in condensers. Their disability has served to sharpen their sense of touch to a keenness such that they are able to inspect the mica for flaws and at the same time distinguish six gradations of thickness in the inch-square pieces to a tolerance of 0.0015 inch — half the thickness of a human hair!

Mary Murphy, the first blind girl to prove her ability at Solar, has not seen light since the age of seven. Yet at the end of her first week at work she was 25 per cent more efficient than the best "normal" girl on the job. Substituting for two sighted operators using a \$50 steel gage, Mary's sensitive fingers search out the flaws and

feel the thickness of some 3500 mica spacers each day! You may be sure that Mary leads a busy life — and a happy one, for she feels she is taking a personal part in America's fight for freedom.

Technicians and Engineers

The crying need since the beginning of this war has been for persons with technical radio knowledge, or with sufficient schooling and intelligence to enable them to acquire a technical training in minimum time. Women possessing these qualifications have found their opportunities practically unlimited. This will be even more true in the future, as more men are called to service or to jobs farther up the ladder.

Thousands of technicians are needed in industry alone, to fill the more specialized jobs. The final testing of radio equipment, for instance, is frequently highly complex work requiring a considerable degree of technical and manual skill. Formerly done almost exclusively by men, women are proving themselves just as adept at alignment and checking — even of intricate multi-stage transmitters and receivers.

At RCA Victor's Camden plant, for instance, some sixty girls are now engaged in testing completed apparatus for the Army and Navy. Beginning with simple circuit checkers, they have advanced to measuring frequency drift and are now making vibration and altitude tests. In this last operation the girls virtually become groundling test pilots. Placing the equipment in an altitude chamber, they "take it up" to 30,000 feet and operate it under sub-stratosphere conditions which show up the slightest imperfection.

That's rigorous work, but the girls love it. They wouldn't be doing anything else. One of the test girls, Mrs. Elizabeth Montgomery, likes it so much she now devotes all the time previously spent in the skies around Philadelphia as a CAP pilot to this "vacuum-bottle" flying.

In more advanced technical work there are the

(Continued on page 100)

Women technicians in the meteorological section of the Signal Corps General Development Laboratory at Ft. Monmouth, N. J. *Left* — Following the flight of a free balloon, this girl measures wind direction and velocity. *Right* — Releasing a free balloon with parachute and meteorological radio attached. The miniature radiosonde transmitter automatically sends weather information back to the ground crew. *Official U. S. Signal Corps Photograph.*

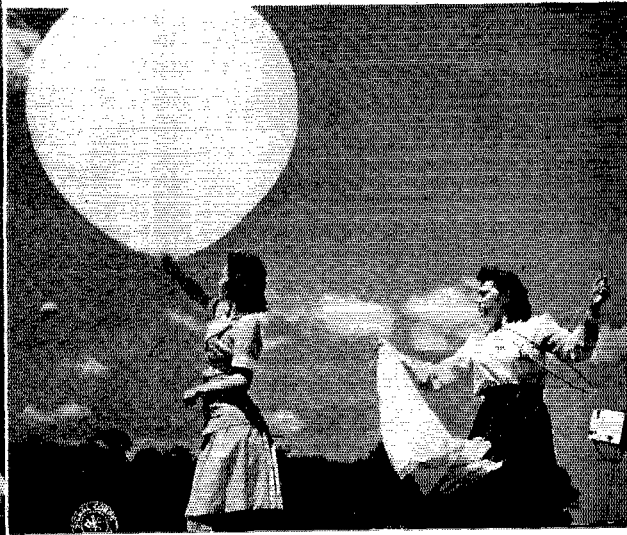

More Selectivity in WERS Reception

A Superregenerative Superhet Using Standard Tubes

BY GEORGE GRAMMER,* W1DF

In WERS networks where interference is a problem, something more than the ordinary superregenerative receiver is called for, particularly at control stations. Here is a simple superhet which, using commonly available triodes, duplicates a good superregenerator in sensitivity and increases the effective selectivity by a factor of at least three or four.

FROM the very beginning, WERS operations have been dominated by the necessity for getting along with the amateur gear extant at the time radio production was diverted from civilian to military equipment, plus such additional sets as could be constructed from parts still obtainable — chiefly by salvage. Consequently we have been forced to use and to continue to build the simplest kind of apparatus: modulated-oscillator transmitters and superregenerative receivers. It is no use pretending that the resulting conditions of operation have been entirely satisfactory, because in the more congested areas the interference problem frequently has been considerable. It would be wonderful if all our transmitters could be crystal controlled and all our receivers selective superhets, but that is obviously only something to dream about. In the meantime, a little constructive work on the problem is likely to be more productive than gnashing of teeth.

If we may be permitted to editorialize a moment, it is our humble opinion that a lot of the trouble is directly traceable to an excessively ham attitude toward WERS operations. In a purely utilitarian setup, organized into local networks with control, sub-control and field stations, channels through which traffic flows are definitely laid out. Except for such special arrangements as may be necessary to take care of emergencies, a field station normally communicates only with his sub-control station, and the latter only with his own local network and his main control station. Under any reasonably logical plan of operation the distances in a local net should be comparatively small. If we could eradicate from the WERS picture the ham's ingrained desire to "get out," and recognize the fact that, so far as the field stations at least are concerned, the only consideration is that of reliable communication with the immediately superior control station, we should have gone a long way toward solving the interference problem. For then we should realize that there is no justification for using more power than just the amount necessary

*Technical Editor, QST.

for reliable communication with the control station, and should also appreciate the value of directive antennas not only for the purpose of providing a better signal where it is needed but also for the purpose of reducing interference to other networks. An approach from this viewpoint, plus judicious assignment of frequencies within an area, should go far toward overcoming congestion.

But be that as it may, a sub-control or main control station still has its problems, since by the nature of the setup it is in general forced to dispense with such accessories as directive antennas. The necessity for having instantly available communication on at least two frequencies also poses some technical difficulties, particularly in reception, because of the mutual interference set up by two superregenerative receivers operating near the same frequency. An ingenious solution to this has been worked out in Massachusetts, and we hope to present the details in the near future. In the meantime, we are concerned here with a type of receiver which provides greater selectivity than the superregen while retaining its advantages, and also lends itself to interference-free operation of two or more units in the same band. There is nothing new about the fundamental design, since it is simply a superhet with a superregenerative detector as the i.f. system, but we do feel that something has been accomplished in stepping up performance with standard tube types.

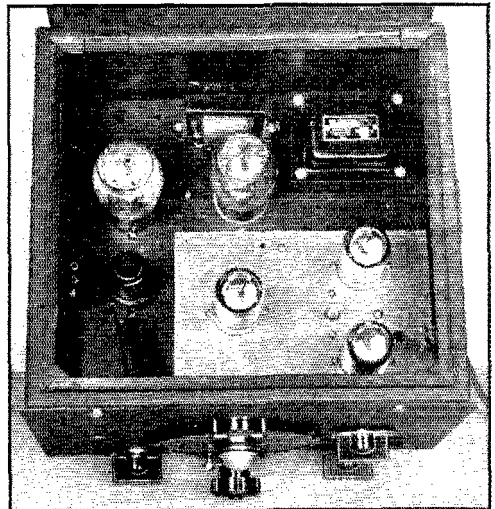

In this view of the receiver with the r.f. unit installed, the audio section is along the left edge of the chassis, and the power supply is at the upper right. The cabinet is approximately 9½ inches square and 7 inches deep.

Previous experience with basically similar circuits had been rather disheartening. Good performance was possible with acorns and their equivalents in the r.f. end, but mixer circuits with ordinary tubes were disappointing—only special “super” amplifiers such as the hard-to-get television tubes would give sensitivity comparable to that of a straight superregenerative receiver.¹ By direct comparison, the present model shows about the same effective sensitivity as a 112-Mc. receiver using an acorn superregenerative detector. As a matter of interest, weak signals which were perfectly readable on either the superhet or acorn outfit were just detectable on straight superregenerative receivers using standard tubes; by careful listening it was possible to tell that the signal was there, but that was about all. The selectivity was greater with the superhet than with any of the other receivers because its superregenerative detector operates at a considerably lower frequency. Incidentally, the acorn receiver was far better in this respect than any of the superregens using standard

¹ Goodman, “Receivers for 112-Mc. Emergency Work,” *QST*, January, 1942.

tubes, a comparison which seems to hold good in all the receivers we have observed. This is to be expected, since the acorns load the circuits less than their larger brothers at 112 Mc.

Mixer Considerations

As we go higher on the frequency scale a point eventually is reached where even acorns are incapable of operating to advantage. At this point special diodes are frequently used as mixers, making it possible to carry the frequency limit still higher.² Although the diode is incapable of giving amplification, many of the factors which tend to limit the effectiveness of multi-element tubes are missing. From the standpoint of signal-to-noise ratio the diode is probably as good as anything which can be devised, so there is no serious objection to the lack of gain provided the following amplifiers do not themselves introduce too much noise. In view of this u.h.f. practice it seemed reasonable to approach the question of 112-Mc. operation with standard tubes on the basis that a diode mixer might provide a solution.

² Lewis, “A Microwave Superhet,” *QST*, December, 1940.

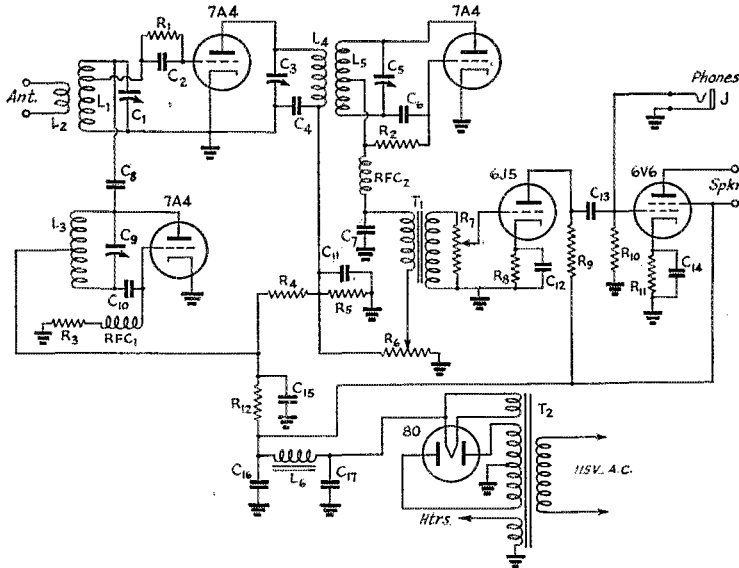

Fig. 1 — Circuit diagram of the 112-Mc. superregenerative superhet for WERS main or sub-control stations.

- | | | |
|---|---|---|
| <p>C₁ — 3-plate midget, app. 5 μfd. (National Type UM-15 cut down).</p> <p>C₂ — 50-μfd. mica.</p> <p>C₃ — 3-30-μfd. trimmer.</p> <p>C₄ — 500-μfd. mica.</p> <p>C₅ — 35-μfd. variable (Millen Type 20035).</p> <p>C₆ — 100-μfd. mica.</p> <p>C₇ — 0.002-μfd. mica.</p> <p>C₈ — See text.</p> <p>C₉ — 15-μfd. variable. For band-spread, use a 2-plate variable similar to C₁ in parallel with a 3-30-μfd. trimmer.</p> <p>C₁₀ — 100-μfd. mica.</p> <p>C₁₁ — 0.01-μfd. paper.</p> <p>C_{12, C14} — 25-μfd. elect., 25 volts.</p> <p>C₁₃ — 0.1-μfd. paper.</p> | <p>C_{15, C16, C17} — 3-μfd. electrolytic, 450 volts.</p> <p>R₁ — 2 megohms, $\frac{1}{2}$ watt.</p> <p>R₂ — 5 megohms, $\frac{1}{2}$ watt.</p> <p>R₃ — 10,000 ohms, $\frac{1}{2}$ watt.</p> <p>R₄ — 50,000 ohms, 1 watt.</p> <p>R₅ — 50,000-ohm volume control.</p> <p>R₆ — 0.5-megohm volume control.</p> <p>R₇ — 2000 ohms, 1 watt.</p> <p>R₈ — 50,000 ohms, 1 watt.</p> <p>R₉ — 0.5 megohm, $\frac{1}{2}$ watt.</p> <p>R₁₀ — 750 ohms, 1 watt.</p> <p>R₁₁ — 15,000 ohms, 10 watts.</p> <p>L₁ — 5 turns No. 14, $\frac{1}{2}$-inch diameter, turns spaced slightly more than diameter of wire; grid tap $3\frac{1}{2}$ turns from ground end.</p> | <p>L₂ — 1 turn, same diameter as L₁.</p> <p>L₃ — 4 turns No. 12, diameter $\frac{1}{2}$ inch, length $\frac{1}{2}$ inch.</p> <p>L₄ — 12 turns No. 24 d.s.c. on $\frac{1}{2}$-inch form, close wound.</p> <p>L₅ — Same as L₄ but tapped at center, spaced $\frac{1}{2}$ inch away from L₄.</p> <p>L₆ — 10-henry, 50-ma. filter choke.</p> <p>J — Open-circuit jack.</p> <p>T₁ — Interstage audio transformer.</p> <p>T₂ — Power transformer, 250 volts at 50-60 ma., with rectifier filament and 6.3-volt heater windings.</p> <p>RFC₁ — 1$\frac{1}{2}$-inch winding, No. 30 s.c.c., $\frac{1}{4}$-inch diameter form.</p> <p>RFC₂ — 2.5-mh. r.f. choke.</p> |
|---|---|---|

Our first attempt therefore centered around a 6H6 mixer, but after a considerable amount of work the straight diode was discarded for the reason that the superregenerative detector which constituted the i.f. system was far from capable of meeting the requirement of introducing a minimum of noise, especially when dealing with weak signals. Since the superregenerative detector was an essential part of the system, because of its simplicity, gain, and ability to handle broad signals, the only answer appeared to be to give it a stronger signal with which to work.

Additional gain before detection can be secured either by using a mixer circuit in which some gain can be realized or else by providing i.f. amplification before detection. In our case the latter would have meant a more complicated receiver, which we did not want. A possible alternative to conceding the necessity for an acorn mixer appeared to be to combine the diode with an amplifier, exactly as is done in the familiar grid-leak detector. This was tried, using an ordinary receiving triode, and from the results described above appears to be at least a satisfactory solution even though in some respects it falls considerably short of the ideal. Since the mixing takes place in the grid circuit, the plate circuit need handle only the i.f. component, as contrasted to the more common plate mixing where all three components — signal, oscillator voltage, and i.f. — must appear in the plate current. Poor amplification at the signal and oscillator frequencies is, we believe, responsible for the poor efficiency of plate- or electron-stream mixing at very high frequencies, but with the grid-leak mixer amplification is required only at the intermediate frequency. This requirement is fairly easily met since the intermediate frequency is comparatively low. The real point is the efficiency of the grid-cathode circuit operating as a diode. If the tube is constructed with fairly close spacing between the grid and cathode it should function fairly well at 112 Mc. even though it utilizes standard construction. We have obtained about equally good results with both 7A4s and 6J5s; 7A4s were used in the receiver shown chiefly because their more compact construction makes them look as though they *ought* to work better in this frequency region — and of course they do permit the use of somewhat higher L/C ratios than can be used with 6J5s.

The choice of an intermediate frequency will be determined to some extent by local conditions. The lower it is the better the selectivity, but superregenerative performance is generally better at the higher frequencies. Also, for stability it is advantageous if the local oscillator can be operated on a relatively low frequency, which in turn means that the i.f. should be high. A reasonable compromise seems to be to put the i.f.

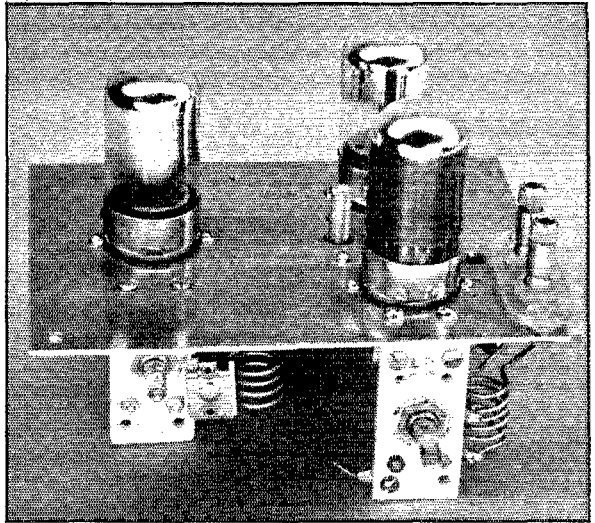

The r.f. unit, consisting of the mixer, high-frequency oscillator and superregenerative detector, is built on a small subchassis. The hole between the mixer tube and antenna binding-post assembly is for screwdriver adjustment of the i.f. transformer primary.

in the vicinity of 28 Mc. The frequency should not be such that harmonics of the superregen detector fall in or near the 112–116-Mc. band, nor should it be subject to interference from other services such as police radio operating in the region above 30 Mc. We used 26 Mc., finally, so that the local oscillator in this particular receiver has to tune from 86 to 90 Mc. to cover the 112–116-Mc. band.

Circuit Details

* A complete circuit diagram of the receiver is given in Fig. 1. Because an old cabinet we happened to have available was large enough to permit it, we included a power supply with the receiver proper. Although this is convenient, it also turned out not to be an unmixed blessing, since the audio transformer coupling the superregenerative detector to the first audio stage picks up some hum from the power transformer despite the fact that in the actual set it is placed as far as possible from the transformer and has its windings oriented so that the coupling is minimized. This trouble will not occur if the receiver and power supply are separate. The audio section of the receiver consists of a 6C5 and 6V6, and can be dismissed with the comment that the circuit is conventional except for the fact that the 'phone jack is simply shunted across the 6V6 grid circuit rather than being arranged to disconnect the audio signal from the speaker tube when the 'phones are plugged in. This allows others to hear what is going on while the operator excludes outside noise by wearing 'phones. Some may prefer the customary circuit which silences the speaker when headphones are in use.

The mixer input circuit consists of the tuned circuit, L_2C_1 , coupled to the antenna or feeders by the one-turn coil, L_1 . Since the grid-cathode

portion of the tube acts as a diode rectifier it takes energy from the tuned circuit, consequently some sort of rough impedance match between the circuit and tube is necessary for maximum energy transfer. This can be brought about by tapping the grid down on the coil, as indicated in the circuit diagram. A few trials, with the receiver in operation and picking up signals, will show which turn on the coil represents the best spot for attaching the grid tap, the position of the tap simply being adjusted for maximum signal strength. Voltage from the oscillator is capacity-coupled to the mixer circuit through C_8 , a condenser of quite small capacity. The construction of this condenser will be described later.

In the mixer plate circuit it is advisable to have a low-impedance path to ground for the signal and oscillator components of plate current, and it is of course necessary to develop a reasonable value of impedance for the intermediate frequency. This is accomplished by tuning the plate circuit to 26 Mc. and making the tuning condenser connect directly between plate and ground, adjusting the L/C ratio so that a fairly high value of tuning capacity can be used. The tuning condenser is a 30- μ fd. mica trimmer worked near its maximum capacity. To prevent short-circuiting the d.c. plate voltage, a blocking condenser, C_4 , is incorporated in the tuned circuit. The plate coil, L_4 , is inductively coupled to the superregenerative detector coil, L_5 . For optimum sensitivity the mixer plate voltage should be in the vicinity of 20 to 25 volts, just as in the case of the ordinary grid-leak detector. This voltage is obtained from a voltage divider, R_4R_5 . It was found necessary to use a fairly good-sized by-pass (C_{11}) across the ground-end section of this divider. It is decidedly worth while in the preliminary work to provide a means for varying the detector plate voltage so that the optimum voltage can be determined, since the range of voltage which gives maximum signal strength is fairly limited. The surest way of losing sensitivity is to use too much or too little plate voltage.

The circuit of the local oscillator is familiar to anyone who has worked at these frequencies. There is not much to be said about it except that it should have a fairly high- C tank circuit to insure stability, and that the grid-leak resistance should be low enough to prevent squegging — a tendency toward which is only too common. We found a value of 10,000 ohms to be satisfactory with the oscillator operating at approximately 100 volts on the plate, but in some cases it may be necessary to go still lower. There is no r.f. choke in the plate circuit, the plate-voltage lead simply being tapped on the coil at the nodal point, which is usually near the center of the coil. If there are any doubts, it is easy to play safe by installing a choke similar to that used in the grid circuit.

The superregenerative detector uses the favorite circuit in which a high-resistance grid leak is returned to the positive plate voltage lead rather than to ground. This circuit is generally smooth-working and of course requires no especially dif-

ferent treatment here than is the case when it operates at the signal frequency. For optimum results it will probably pay to try different values for the grid leak, R_2 , and the plate by-pass condenser, C_7 , since both affect the sensitivity and "handling." The detector should superregenerate with 10 to 15 volts on the plate. Although not incorporated in this receiver, a method of varying the coupling between the mixer and detector coils, L_4 and L_5 , might be advantageous in furnishing a means for arriving at optimum energy transfer. In the diagram the grid leak, R_2 , is shown connected to the "hot" side of RFC_2 , but it seems to make no particular difference in the operation of the detector if the grid leak is returned to the "cold" side of the choke.

Constructional Considerations

One of the penalties of using salvaged material is that it is not always possible to arrange things as one would like mechanically. There are several layout features of the receiver shown which we do not particularly care for, but which were forced on us by the size and shape of the cabinet and chassis. For this reason it is neither necessary nor desirable to attempt to follow the whole layout if a similar receiver is to be constructed. The r.f. section of the outfit is the only part which requires particular care; as shown in the photographs, this is assembled on a small subchassis of its own and can be removed as a unit from the rest of the receiver. The subchassis is a 4×6-inch piece of aluminum and mounts to the main chassis by means of three brass-rod pillars a little over $2\frac{1}{4}$ inches long — just long enough to permit the Isolantite slabs on the tuning condensers to clear the chassis when the unit is fastened in place.

The chief requirement in laying out the r.f. end is to keep the leads which carry r.f. as short as possible. This naturally leads to fairly compact construction. Viewed from the top, the oscillator is to the left, the mixer is in the right foreground, and the i.f. tube is at the rear right. The oscillator is mounted somewhat back from the front to allow room for an insulated coupling and extension shaft, necessary because both ends of the tuning condenser are "hot." Since the rotor of the mixer tuning condenser is grounded and needs no insulated extension, this condenser is mounted right at the front of the subchassis so that its shaft can extend through the front panel. The tank coils in both the oscillator and mixer circuits are mounted directly on the condenser terminals. By mounting the tube sockets as close as possible to the tuning condensers, the leads from the tank circuits to the tube elements can be kept down to minimum length. The bottom view of the r.f. unit should give a good indication of the actual wiring.

The i.f. coils, L_4 and L_5 , are wound on a polystyrene form mounted between the mixer and detector as shown. The low-loss form is convenient and of course desirable, but could be replaced by a piece of half-inch wooden dowel or something of the sort if a regular form cannot be

obtained. Since it is necessary to adjust the i.f. circuit when the receiver is in operation, the tuning controls should be brought out through the top of the subchassis. The detector condenser, C_5 , is air-tuned and is mounted on the subchassis. Both sides must be insulated from ground. The primary tuning condenser, C_3 , is a mica trimmer mounted so that its adjusting screw is accessible through a hole in the subchassis. The movable plate should be connected to ground so that body capacity can be avoided in making adjustments. The plate choke, RFC_3 , is supported at one end by the tap on L_5 and at the other by C_7 , the grounded terminal of which is soldered to a lug fastened under one of the socket-mounting screws.

The sensitivity of the receiver depends a great deal on the amount of oscillator voltage injected into the mixer grid circuit. Of various methods of injection tried, simple capacity coupling not only worked better but represented the simplest system both electrically and mechanically. The sensitivity will be poor if the oscillator voltage is too small, but once enough is secured a further increase has relatively little effect. The "condenser" actually used is formed by fastening a machine screw in one of the mounting holes in the isolantite frame of C_1 so that it is fairly close to one stator mounting post of the condenser. The small capacity thus provided seems ample when the oscillator is operated with about 100 volts on the plate. Too much capacity is undesirable because the closer the coupling between the oscillator and mixer circuits the greater the interaction in tuning; with the small capacity that results from a condenser such as that just described the tuning of one circuit is practically unaffected by the tuning of the other.

In the oscillator circuit originally used the tuning condenser, C_3 , was a 15- μ fd. variable, with L_3 adjusted so that band was covered with C_3 operating in the maximum-capacity region. While it was realized that this would not give bandsread, it was hoped that vernier action in the tuning dial would give sufficient compensation. However, this turned out to be unsatisfactory in practice, so the variable condenser was cut down to two plates and the remaining capacity made up by connecting a 3-30- μ fd. mica trimmer in parallel. To keep the leads short the trimmer was soldered right on the variable-condenser terminals, but it thereby becomes inaccessible when the r.f. unit is installed in the cabinet and consequently has to be adjusted beforehand. A better arrangement would be to use an air padder with its shaft brought out so that it is accessible for tuning after the receiver is finally assembled. Alternatively, of course, an entirely different chassis arrangement could be

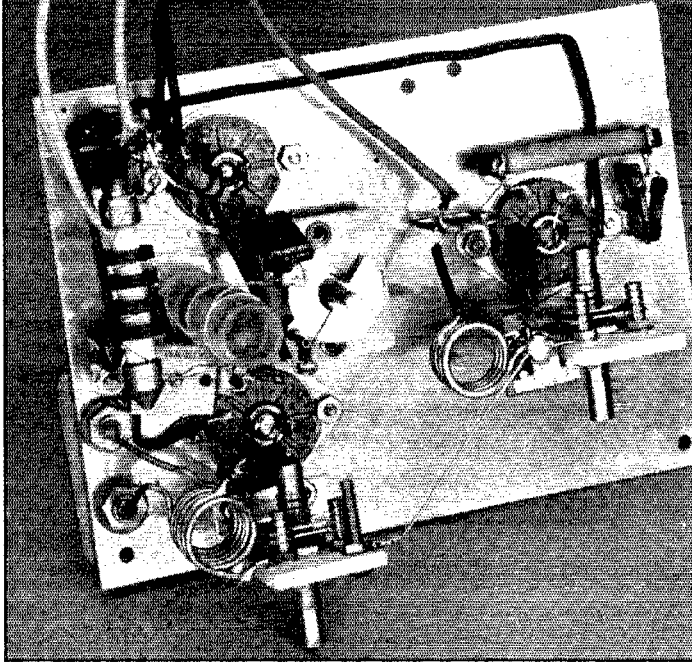

A bottom view of the r.f. unit. Mixer circuit at lower left, detector above, and oscillator to the right. Note the machine screw (on the mixer tuning condenser) which forms one "plate" of the oscillator-mixer coupling condenser. The mica padders in the oscillator and i.f. circuits were used as a matter of convenience, but their replacement with air padders would be preferable for long-time stability.

used so that all the components could be reached at any time. This would be much to be preferred, but was not practicable with the salvaged cabinet we used.

Alignment and Adjustment

In making preliminary adjustments the r.f. unit should not be assembled in the box, if a similar subchassis arrangement is used, but should be left out in the open and connected to the various sources of voltage by temporary leads. The first operation is to get the superregenerative detector on frequency, which is best done by listening for its "hash" output on a regular communications receiver which is tunable to the approximate intermediate frequency of 26 Mc. The mixer and detector should be in their sockets but the oscillator should either be out or its plate voltage disconnected. Set the detector in operation, adjusting R_6 until superregeneration occurs, and tune C_5 to put the detector on frequency. Then tune C_3 to resonance, which will be indicated by absorption of energy from the detector circuit so that R_6 has to be advanced to maintain superregeneration. Since tuning one circuit affects the tuning of the other, it will be necessary to go through this process several times to maintain the desired frequency. If the primary circuit extracts too much energy the superregenerative hiss will lose its smooth character and the sensitivity will be poor. This condition can be corrected either by loosening the coupling between the two coils or by detuning the primary sufficiently to obtain satisfactory operation.

Lacking means for measuring frequency di-

rectly, it may be a little difficult to get the oscillator on frequency initially. Perhaps the simplest way is to set up a low-power 112-Mc. oscillator somewhere in the vicinity, then tune C_2 until a signal is heard. If the bandspread system with a mica padder is used the movable plate should be fairly close to the fixed plate, but not squeezing the mica. The padding capacity required is of the order of $10 \mu\text{mfd.}$, depending upon the inductance of L_3 , which will vary somewhat with the turn spacing. Some care must be used, because it is readily possible for harmonics of one or both of the oscillators to beat to produce a spurious i.f. signal; consequently, if several signals can be heard in adjusting the padder the strongest one should be chosen. For the same reason the 112-Mc. oscillator should be operated at quite low plate voltage and should not be too close to the receiver. An actual distant signal of moderate strength would be best of all, but can be counted on only at limited times under present conditions.

Once the signal is spotted, the mixer circuit should be adjusted to resonance. It is probable that the coil will have to be pruned or the turn spacing altered to bring the signal definitely on the tuning scale of C_1 . The coil size also depends upon the position of the grid tap, since the greater the number of turns included between the tap and ground the greater is the effect of the shunting tube capacity. By a process of cut-and-try the coil size and tap position which give maximum signal strength can eventually be determined. The specifications in Fig. 1 will serve as a starting

point; this circuit tunes to the band with C_1 at about minimum capacity.

The final adjustment is to set the oscillator padder so that the band is centered on the tuning dial. The coverage can be regulated to some extent by bending one plate of the oscillator tuning condenser in relation to the other, but in the set-up illustrated the tuning range is almost exactly 4 megacycles without such manipulation of the plates, so that the band is spread over practically the whole dial. Putting the r.f. unit in the cabinet will probably change the tuning conditions slightly because of the proximity of the metal, but not enough to make any real difference.

Once the receiver is in operation it will probably be helpful to trim up the primary condenser, C_3 , of the i.f. circuit. This adjustment is fairly critical, especially if the two circuits are overcoupled, and the sensitivity as well as smooth operation of the receiver depend on it to a considerable extent.

In practice the tuning is effectively single control, since it is not necessary to do more with C_1 than to set it at about the center of the band, the circuit being broad enough to give good response at both ends under these conditions. The regeneration control is not affected by tuning of the r.f. circuits except when the primary condenser, C_3 , is set very close to the critical point with L_4 and L_5 overcoupled. Under these conditions any small change either in loading or capacity can throw the detector into or out of oscillation, and since the mixer is a triode such changes can be reflected from the r.f. circuits through the grid-plate capacity of the tube. Under optimum i.f. adjustments this does not occur.

If the oscillator tube is squegging, the receiver will give a multiplicity of responses on an incoming signal. Oscillator squegging also superimposes a second superregenerative-type hiss on the normal hiss and is easily recognized, especially if squegging takes place at some dial settings of C_2 and not at others. The remedy, as pointed out before, is to use a smaller value of grid-leak resistance.

Radiation from a receiver of this type is practically negligible. Although it is customary to think of a superhet as being non-radiating at the signal frequency, in this type of circuit the mixing works both ways: not only does the signal mix with the oscillator frequency to produce an intermediate frequency, but the oscillator frequency also beats with the output of the oscillating detector to produce a superregen-modulated output at the signal frequency. Because this represents a rather inefficient method of generating a signal, and because the detector operates at very low plate voltage, the signal-fre-

(Continued on page 89)

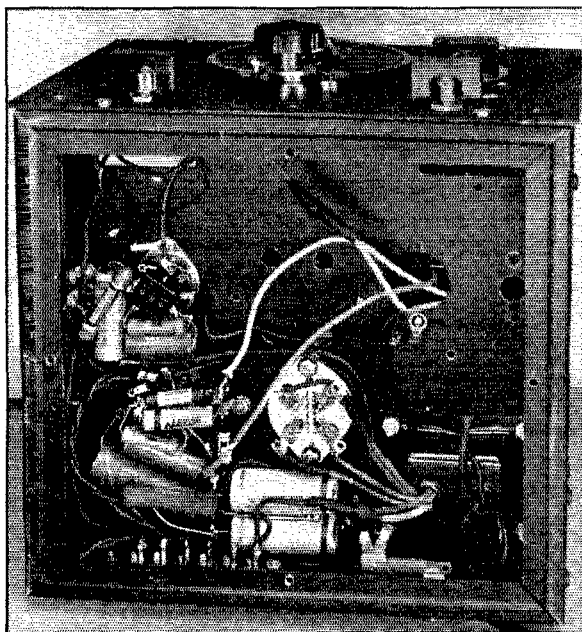

Below-chassis layout and wiring, as shown in this view, is chiefly a question of finding convenient mounting points for the parts and running connections as required. The only wiring which requires care is in the r.f. unit, all of which is above the main chassis.

HAPPENINGS OF THE MONTH



OPERATOR LICENSES EXTENDED

SOME of you fellows serving in the far corners of the world may see only an occasional issue of *QST*, so we repeat the good news published in our July issue:

FCC, on May 25th, reinstated and extended for three years from the stated date of expiration all amateur operator licenses expiring between Pearl Harbor and May 25, 1943. And every amateur operator license due to expire between May 26th of this year and December 7, 1944, was extended for three additional years. Thus there will now be no expiration of a ham op. license until December of next year and no action or renewal application is necessary until that time approaches. If the war is still on, there will probably be another extension. The action was covered by FCC's Order No. 115.

This is immensely welcome news to amateurs in the armed services and those in war work away from home—in whose behalf the action was primarily taken. It eliminates the need to remember about renewing and to mess with it under wartime conditions; and, for those who forgot to apply or were unable to do so, it eliminates the need to be reexamined after the war. It also saves the overworked FCC both the interim paperwork and the reexamining. And it shows that FCC hasn't forgotten about us.

The reinstatements and extension do not apply to any licensee who has failed to prove citizenship and file fingerprints; his ticket is dead. Nor do they apply to licenses voluntarily sent in to FCC for cancellation; such licensees will have to be reexamined. Nor do they apply to licenses which have been suspended by FCC or are in future suspended; a ticket can still be washed out for cause.

NOTARIZATION REQUIRED

THE examining and licensing of applicants for new amateur operator license continues as usual.

We got ahead of ourselves in July *QST* when we reported that notarization is no longer required on applications for any grade of operator license. Seems FCC is now reprinting all of its operator forms to simplify them, eliminating the requirement for an oath before a notary. Included in the revisions is the amateur application, Form 610. But that elimination will not take place until the new forms are available and distributed around the country, since it is possible to do away with the oath only after the applicant has been put on notice that he is subject, under the Criminal Code, to fine and/or imprisonment for making a false statement to the government. Since the old forms do not serve that notice on the applicants, they must be notarized as heretofore, as long as they remain in use.

In the very near future, however, possibly by early September, the revised Form 610 will be in distribution. After that time the old form will no longer be accepted by the Commission, because the revised form contains a new question concerning the criminal record of the applicant (page 24, July issue), and because it is a much simpler form. So in another month or so we shall expect to republish our original item that notarization is no longer required with the revised form. Hi!

NO MORE STATION APPLICATIONS

IT WILL be remembered that, back in September, 1942, FCC, by its Order No. 87-B, discontinued the issuing, modifying or renewing of amateur station licenses until further order, holding that it was unnecessary work during the period that amateur operation is not permitted. Nonetheless, all things considered, we have advised that amateurs file applications for renewal of station licenses, even though FCC has been laying such applications to one side without present action.

Recent actions of the Commission necessarily change that advice. As mentioned in the item above, the amateur application Form 610 is being revised. In conformity with the provisions of Order 87-B, that portion of our old familiar application form concerned with amateur station licenses is being entirely eliminated. The Commission now says that, until Order 87-B is rescinded, any applications they receive for new, renewed or modified station licenses will be returned or otherwise disposed of without action.

The press release accompanying Order 87-B states that "insofar as it is possible and practicable to do so, the call letters of outstanding amateur station licenses will be preserved for assignment to the present station licensees upon proper application when licensing of amateur stations is resumed." FCC points out that "this intent is in no way dependent upon applications for renewal or modification . . . being filed prior to the resumption of the licensing of amateur stations. Such applications as have been received since Order 87-B was adopted have uniformly been placed aside without attention, and have not been acted upon or considered by the Commission. It is intended that when Order 87-B is rescinded, a new application form for amateur station license will be issued which all prospective licensees must file, irrespective of, and without regard to, any other applications for renewal or modification of station license filed since September 15, 1942." So our advice to you about station licenses now necessarily becomes: Don't do anything. There is no necessity for it and there is no longer anything to be gained by it.



NEW CHIEF SIGNAL OFFICER

Shown above is Major General Harry C. Ingles being sworn in as the new Chief Signal Officer of the Army by The Adjutant General of the Army, at a brief ceremony in the OCSO on July 1st, before a distinguished gathering of high-ranking officers and officials. He succeeds Major General Dawson Olmstead who, after a sterling job, has been relieved at his own request to assume certain important duties.

The new Chief is a Nebraskan and a West Pointer, with World War I service. He has been Signal Officer of the Philippine Department and Director of the Signal School at Fort Monmouth. In July, 1927, he was graduated with honors from the Command and General Staff School at Ft. Leavenworth, remaining there as instructor until August, 1931. In June, 1932, he was graduated from the Army War College at Washington. In September, 1935, Gen. Ingles was assigned to the Operations and Training Division of the War Department General Staff, and in August, 1939, was appointed a member of the Signal Corps Board. He was assigned in November, 1940, to Third Army Headquarters at Ft. Sam Houston, Texas. Early in 1941 he was assigned to the Car-

ibbean Defense Command, and in 1943 went to the European theatre of operations.

R.S.G.B. HQ. MOVES

After having had its wartime headquarters at the home of Secretary Clarricoats in Palmers Green the past several years, the Radio Society of Great Britain has now opened new headquarters in a suite of six rooms in a modern building in central London. The new address is New Ruskin House, 28/30 Little Russell Street, London, W. C. 1. Little Russell Street is about five minutes from Holborn Tube Station and very close to the British Museum. R.S.G.B. is flourishing, its membership having grown during the war from 3500 to 5500. Visiting amateurs are more than welcome, especially those from overseas, and it is hoped that the convenient new location will make it possible for an increased number to look in and get acquainted.

AMATEUR WAR SERVICE RECORD

Both for the information of those "In The Services" and for the ARRL statistics on what the amateur is doing in this war, we are still banging away at the compilation of the Amateur War Service Record. You men and women can see how important it may be to our cause to be able to lay the data on the table after the war and thereby show what the amateur did for his country "during the duration."

We want the information on you. The request is very simple: cut out and mail the convenient form you find on this page, or duplicate its essentials on a post card.

Some amateurs seem to think that we are interested only in the record of the man in uniform. We call particular attention to the last several categories under the heading "Service" on the form: We also want the record of those in civilian radio work. We must be able to tell our whole story. Wherever you are in the war effort, if you're an amateur in radio or communications, please report yourself to ARRL.

AMATEUR WAR SERVICE RECORD

Name

Call, present or ex; or grade of op-license only

Present mailing address

SERVICE

Rank or rating

- Army
- Navy
- Coast Guard
- Marine Corps
- Maritime Service
- Merchant Marine
- Civil Service
- Radio industry, 100% war

Branch or bureau: Signal Corps, AAF, Buships, WAVES, etc.
If civilian industry, give title and company.

NOTICE TO MEMBERS DISCHARGED FROM THE MILITARY SERVICES

ARRL by-laws have been amended to preserve your eligibility to hold ARRL office, insofar as there is a requirement for continuous membership which may have been interrupted while you were in uniform, provided you resume your membership within ninety days after release from active military duty. See further particulars on page 24 of July *QST*. Those desirous of taking advantage of this arrangement are asked to claim the right when renewing membership, stating the beginning and ending dates for their military service. The arrangement applies only to those serving for the United States, and cannot be made retroactive for those who have already been out of military duty for more than the prescribed ninety days.

ARE YOU LICENSED?

When joining the League or renewing your membership, it is important that you show whether you have an amateur license, either station or operator. Please state your call and/or the class of operator license held, that we may verify your classification.

Naval Research Labs Celebrate Twentieth Anniversary

ON JULY 2, 1923, the Naval Research Laboratory held its formal opening exercises in its two bright, white new buildings along the shores of the Potomac at Anacostia, D. C.

On July 2, 1943, the Naval Research Laboratory held anniversary exercises in its new, greatly expanded establishment, celebrating twenty years of research work on behalf of the U. S. Navy.

Between those two dates lies a record of accomplishment greater even than the span of two decades might serve to indicate. That accomplishment was fittingly commemorated in ceremonies attended by a long list of distinguished guests, among them ARRL President Bailey.

Following an address of welcome by NRL's director, Rear-Admiral A. H. Van Keuren, the ceremonies included addresses by Under Secretary of the Navy James V. Forrestal, Capt. Thomas L. Gatch, USN, formerly commanding officer of the historic Battleship "X," and Dr. Charles F. Kettering, chairman of the National Inventor's Council. The program concluded with the presentation of 20-year continuous service certificates to twenty-five veteran NRL employees.

To many in the radio world, NRL and Navy radio are virtually synonymous. Radio is one of the most important of the seven divisions of research carried on at the Laboratory. A large proportion of the permanent civilian organization of scientists and technicians employed at the Laboratory is assigned to this department.

Actually, it is more than a department; it is a group of large, well-equipped, specialized laboratories and training centers. The Radio Research Laboratory at Bellevue was added some time ago to provide additional facilities required by NRL's expanding activities. The Radio Matériel School, established in 1929, has grown to be one of the major centers for training enlisted personnel in the maintenance of shipborne radio and radar equipment. A separate annex of several major buildings was recently constructed on Chesapeake Bay for tests of radiolocating equipment.

The Naval Research Labs work both in fields of pure research and on specific development problems assigned by the various Navy Department bureaus. Work in theoretical science is complemented by design, experimental and shop departments that translate ideas into practical form, as well as by liaison with the operating branches to determine the effectiveness of new developments in use.

Out of the work in pure research have come many basic developments of importance not only in naval warfare but ultimately of importance to the world as a whole. Such developments cover a wide range of fields, but in none have more important contributions been made than in radio. Outstanding, of course, is the major role played by the radio scientists on the staff (most of whom, we are proud to add, are former amateurs) in the conception and development of radar.

U. S. War Bonds for Stories of War Service

QST wants reports on the experiences of radio hams in active service on the battle fronts — for immediate publication, where feasible, or to be held confidential where security considerations so require.

Do you have a story of war service to tell — either your own or that of some amateur you know? Then sit right down and write us a letter giving full details, including photographs, clippings and other substantiating data where available. If your story is published in *QST*, you will receive a \$25 U. S. War Bond.

For the kind of material required, read the article "Hams in Combat," in August *QST*, p. 16. Please indicate clearly on the report if it is available for publication in its entirety, if names, dates or places should be deleted before publication, or if all information must be held confidential.

That's all there is to it — write us a letter relating your own war-service experience or the record of someone you know. If it is published, you'll receive your \$25 War Bond in return.

A Peak-Limiting Amplifier for Recording

The Use of Instantaneous A.V.C. to Prevent Over-Cutting

BY ROBERT LEWIS,* W3MQU

By using two tubes in push-pull in the controlled stage, it is possible to make an audio a.v.c. system which goes into action with extreme rapidity, thus keeping sudden peaks from exceeding the limitations of the amplifier or recording system.

WHILE ham radio is off the air for the duration, most of us still have the bug in our veins and are investigating some of the other phases of the radio game. One of these branches which has many interesting possibilities is home recording.

The amplifier described herein was built for the purpose of remedying one of the bad features of most recording amplifiers — the likelihood of over-cutting when a signal of excessive amplitude strikes the diaphragm of the microphone. Naturally, it is impossible for the operator to anticipate such peaks, and when they do come it is just as impossible for him to cut the gain before the damage has been done.

The ideal volume-control system should react almost instantly to excessive peaks and still not introduce distortion. It was with this in mind that the amplifier to be described was evolved. Of course, in addition to providing an excellent recording amplifier, it could be used for p.a. service, with or without the a.v.c. feature. Then, too, the future of such a device is good, in that after the war it may be used to drive a Class-B modulator. If adjusted correctly, it should be impossible to overmodulate a ham transmitter regardless of the amplitude of the incoming signal, yet a much higher average level of modulation percentage could be maintained. It is common knowledge among 'phone operators that a low-power transmitter capable of being modulated at a high percentage consistently is much more effective than a high-power transmitter that can only be modulated an average of 50 per cent.

The first attempts to construct a suitable peak-limiting amplifier centered around the circuits which have been published in *QST* and the *Handbook*. These circuits, although they work out satisfactorily in the duty of driving modulators in ham service, did not seem to operate rapidly enough to prevent over-cutting of acetate recording blanks. Because a single control tube is used in these arrangements, some filtering of the a.v.c. voltage is absolutely necessary to prevent feedback and "thumps" which result from the sudden

application of bias to the grid of the controlled tube (usually a 6L7). With any amount of filter in the a.v.c. line the action is bound to be slowed up to some extent, the delay being in direct proportion to the values of resistance and capacity used in the filter. With sufficient filter in the a.v.c. circuit to prevent feed-back and thumping, the limiting action is slowed up sufficiently to allow over-cutting on large peak voltages.

The apparent solution to the problem is to use two tubes in push-pull in the controlled stage. By this means any audio component in the a.v.c. voltage can be applied to both grids in phase, and will cancel out in the plate circuit. Therefore, it is obvious that no filtering of the a.v.c. voltage will be necessary if the controlled stage is balanced. With no filter, the automatic bias will be applied almost instantaneously to the grids of the 6K7s.

Transformer-Coupled Pentodes

Theoretically, pentodes do not perform well when their plates are transformer-coupled because the tubes have high plate resistance, while the usual coupling transformer has a relatively low primary impedance. However, the circuit in question seemed to work satisfactorily even though the coupling transformers used were of standard grade. The results of a frequency run on the amplifier showed fairly good response, but this might possibly be improved by using high-grade transformers. If standard transformers are used it is suggested that they be rotated on the chassis before being bolted down, in order to find the position that gives the least hum pick-up. Luckily, the transformers used in the writer's amplifier picked up the least hum when mounted symmetrically. However, this would not be likely to occur in every instance.

Since parts are practically impossible to obtain now, no constructional details will be given. Most hams probably will have to dig down into the junk box to find the parts. Incidentally, the push-pull interstage transformer used in the writer's amplifier was salvaged from a junked Sparton receiver; after sanding the surface (which had accumulated some rust) it was given a coat of crystal lacquer, and then looked as good as new. Aside from the a.v.c. feature of this amplifier, it is straightforward; in fact, the input and output sections can be varied about as the builder pleases.

During actual tests with the amplifier, using a Presto magnetic head and acetate discs, signals from an oscillator were suddenly increased as much as 40 db. by switching out attenuators. Yet no over-cutting occurred on the record. No method was available for determining just how rapidly

* 1578 Simpson Dr., Route 5, Pontiac, Michigan.

IN THE SERVICES

THE ITS department says, "Tnx and FB!" Thanks for all those swell lists we've received lately. They have certainly swelled the proportions of our roster. However, many times we receive just call letters alone, and to a newshound that's not news enough. So, just as a reminder, please be sure to include rank or rating, branch of service, and present assignment, if possible.

Lately we've received a few amusing anecdotes about true experiences of amateurs in the service. Since hams are almost always in the center of things, lots of you fellows must have funny happenings up your sleeve. How about sending them in so we can all enjoy them? Remember — the fellows with whom you held QSOs in the good old days are eager to keep track of you now, so dig out that pen the office gang gave you when you left and drop us a line!

NAVY—SPECIAL DUTY

ONE amateur, standing at ease during a recent blackout at Fort Schuyler, N. Y., became rather bored and softly whistled CQ. The monotony was immediately broken by what sounded like the 40-meter band not so long ago. The QSOs that resulted were silenced by the CO, but needless to say a hamfest was held when the blackout was over.

3JKU, Dietz, RT2c, Great Lakes, Ill.
4EQM, Bledsoe, ART1c, foreign duty.
4HQK, Moore, RT2c, Corpus Christi, Tex.
5BRV, Fischer, ART1c, Corpus Christi.
5FSC, Beck, ART2c, Norfolk, Va.
5HPC, Stephenson, ARM1c, foreign duty.
5JLS, Fischer, RT2c, Corpus Christi.
6JLY, Levy, ART1c, Memphis, Tenn.
6HKN, Weidman, address unknown.
6MRJ, Stephens, Ens., foreign duty.
6NGG, Ashe, Lt., Corpus Christi.
60PF, Silberberg, ART1c, Lakehurst, N. J.
60MH, Merritt, RT2c, Corpus Christi.
6SBJ, Otto, RT1c, Treasure Island, Cal.
6TSZ, Burkhard, RT2c, Stillwater, Okla.
6UQW, Sweeley, RT2c, Corpus Christi.
7IZL, Rosenthal, RT2c, Treasure Island.
80PF, Silberberg, ART1c, Lakehurst, N. J.
80PE, Roth, RT1c, New River, N. C.
8VHC, Gecewicz, RT2c, Washington, D. C.
8VHY, Yeoman, ART1c, Corpus Christi.
8WBZ, Miller, RT2c, Grove City, Pa.
9BLC, Greathouse, ARM2c, Quonset Pt., R. I.
9GCU, Uffelman, RT2c, Chicago, Ill.
9KAH, Spencer, RT1c, Stillwater, Okla.

9MFK, Shelton, RT2c, Stillwater, Okla.
9OCJ, Bossoletti, RT3c, Chicago, Ill.
9SPE, Horvath, ART1c, Corpus Christi, Tex.
9TVQ, Tidemann, RT3c, Stillwater, Okla.
9ZEL, Waycullis, ART2c, Lake City, Fla.

Operator's license only:

Hirschl, S2c, Washington, D. C.
Steward, RT2c, Treasure Island, Cal.

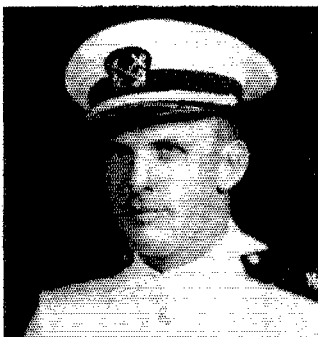

A "Beantown" ham out doing his bit. Radio Electrician Olin F. Miller, jr., WIBBX, when last heard from, was on sea duty with the Navy. In civil life he worked in the engineering department of the Yankee Network in Boston and was an active amateur from 1930 to 1941. Earlier in his service career he was Warrant Radio Officer at the Radio Material Office in Louisiana, where most of the personnel, both officers and enlisted men, held amateur licenses.

ARMY—SIGNAL CORPS

ONE amateur now in communications work in our armed forces writes, saying, "The fellow who worked into the wee hours to get a modulator to modulate, or the kid who used to pound CQ on 40, is a very valuable link in the communications system we have to-day." Keep up the good work — you fellows are truly appreciated!

1JLY, Barker, foreign duty.
1KBK, Moore, Cpl., Camp Crowder, Mo.
1KCO, Abbott, S/Sgt., Ft. Dix, N. J.
1LCL, Glazier, 2nd Lt., Ft. Monmouth.
1MBX, Berry, Lt., Presque Isle, Me.
1MKP, Jones, 2nd Lt., Ft. Monmouth, N. J.
1MVR, Fick, 2nd Lt., Ft. Monmouth, N. J.
1NI, Jackson, 2nd Lt., Ft. Monmouth.
1NMI, Sloanaker, T/5, Ft. Monmouth, N. J.
1NTL, Paul, Cpl., Camp Crowder, Mo.
ex-2ACA, Wilson, Major, Washington, D. C.
2BBE, DuPont, 2nd Lt., Drew Field, Fla.
2BXL, D'Amato, Cpl., Ft. Monmouth, N. J.
2DGG, Vandervoort, Cpl., Ft. Monmouth.
2DLV, Margolies, 2nd Lt., Ft. Monmouth.
2DWK, Cullen, 2nd Lt., Ft. Monmouth.
2DFI, Wendell, 2nd Lt., Ft. Monmouth.
2HOZ, Cronshey, Lt., Ft. Monmouth.
2HWP, Peck, 2nd Lt., Ft. Monmouth.
2HZA, Spedding, Lt., Ft. Monmouth.
ex-2ING, Gelb, Lt., Ft. Monmouth.
2LDC, LaRue, Cpl., Ft. Monmouth.
2MYB, Turner, Pfc., Columbus, Ohio.
2NGV, Lundbloom, Cpl., Camp Crowder.
2NKD, Ryan, Sgt., Camp Mackall, N. C.
2NVO, Avrutik, Cpl., Ft. Monmouth.
2OJM, Nichols, Lt., Ft. Monmouth.
ex-3AUD, Robertson, M/Sgt., Ft. Jay, N. Y.
3DYS, Ward, 2nd Lt., Ft. Monmouth.
3ECA, Curry, 2nd Lt., Ft. Monmouth.
3ECZ, Crawley, Lt., Davis, Cal.
3EKK, Swedloff, Lt., Drew Field, Fla.
3GHK, West, S/Sgt., Drew Field, Fla.
3IED, Aaron, 2nd Lt., Ft. Monmouth.
3IGN, McCracken, 2nd Lt., Ft. Monmouth.
3INF, Miller, Cpl., Camp Crowder, Mo.
3JKY, Brown, Pvt., Camp Crowder, Mo.
3JOZ, Beaman, Pvt., Ft. George Meade, Md.
4ALT, Winstead, Maj. Wright Field, Ohio.
4AON, Carmichael, 2nd Lt., Ft. Monmouth.
ex-4ESG, Langbein, Cpl., Camp Crowder.
4BWK, Oglesby, 2nd Lt., Ft. Monmouth.
4FAD, Owen, Lt., Camp Davis, N. C.
4FVX, Williams, 2nd Lt., Ft. Huachuca, Ariz.
4GBN, Davie, Lt., Ft. Monmouth.
4GLB, Black, 2nd Lt., Ft. Monmouth.
4HGU, Mullaney, 2nd Lt., Davis, Cal.
4HXO, Gordon, Pvt., Ft. McPherson, Ga.
4HYI, McKinstry, 2nd Lt., El Centro, Cal.
5DEN, Tipton, Lt., Ft. Monmouth, N. J.
5ELW, Miller, 2nd Lt., Ft. Monmouth.
5HLG, Wilder, 2nd Lt., Ft. Monmouth.
5HOF, Wilder, Lt., foreign duty.
5HSU, Stringfellow, 2nd Lt., Ft. Monmouth.
5HTG, Koenig, 2nd Lt., Ft. Monmouth.
5IIB, Mitchell, Pvt., Ft. Monmouth.
5IUP, Greathouse, Cpl., Camp Crowder.
5JEF, Koch, Camp Crowder, Mo.
5JNZ, Elliott, 2nd Lt., Davis, Cal.
5JVN, Guillery, Cpl., Camp Crowder.
5JZI, Purcell, Pvt., Davis, Cal.
5KKV, Wright, Cpl., Camp Crowder.
5MM, Tripp, 2nd Lt., foreign duty.
5QT, Irvin, T/5, Davis, Cal.
5WH, Henning, W/O (lg), Ft. Myer, Va.
6CMR, White, T/5, Camp Crowder, Mo.
6EHQ, Edmunds, Cpl., Davis, Cal.
6IPH, Fiedler, T/4, foreign duty.
6LCH, Williams, Lt., Ft. Monmouth.
6NUY, Nally, Camp Crowder, Mo.
6OCV, Kipps, 2nd Lt., Ft. Monmouth.
6ODQ, Girouard, Lt., Ft. Monmouth.
6OJJ, Tillotson, 2nd Lt., Camp Murphy, Fla.
6PNE, Newton, Cpl., Ft. Monmouth.
K6QDV, Shoop, 2nd Lt., Ft. Monmouth.
6RIM, Christensen, Lt., Ft. Monmouth.
6RKM, Buech, Pvt., address unknown.
6SPC, Mackintosh, Pvt., Davis, Cal.
6SZN, Sherbig, Lt., Ft. Monmouth.
6TGV, Talican, 2nd Lt., Ft. Monmouth.
6TRY, Hanson, T/5, Camp Crowder, Mo.
6TYP, Chapman, T/5, Davis, Cal.
6ULY, Combs, T/5, Davis, Cal.
7EHW, Storm, Cpl., Camp Crowder.
ex-7EQU, Organ, Sgt., Camp Crowder.
7FIU, Keagle, T/5, Camp Crowder, Mo.
7FSM, Keenan, Lt., Ft. Monmouth, N. J.
ex-7GIT, Feild, Lt., Ft. Monmouth.
K7GJW, Dudley, T/Sgt., foreign duty.
7GPK, Pierce, Cpl., Camp Murphy, Fla.
7HZU, Evans, Camp Crowder, Mo.
7ICB, Weigel, 2nd Lt., Ft. Monmouth.
7IEG, Holdiman, 2nd Lt., Ft. Monmouth.
7IP, Nyberg, Cpl., Camp Crowder.
7ISR, Campbell, Lt., Ft. Monmouth.
7IVN, Nicholson, Lt., Ft. Monmouth.
ex-8DQR, Stocum, S/Sgt., Camp Crowder.
8FGE, Bergquist, Cpl., Camp Crowder.
8GNH, Donnell, 2nd Lt., Ft. Monmouth.
8HJJ, Folger, Pfc., Mitchell Field, N. Y.
ex-8JXV, Franta, Cpl., Camp Crowder.
8MCB, Ryan, address unknown.
8OB, Grewell, T/4, New Orleans, La.
8OUB, Ward, 2nd Lt., Ft. Monmouth.

80QJ, Ranney, 2nd Lt., Ft. Monmouth.
 80QP, Walsh, 2nd Lt., Ft. Monmouth.
 8PCU, Norman, 2nd Lt., Ft. Monmouth.
 8PMV, McDonough, 2nd Lt., Ft. Monmouth.
 8QCZ, Prysock, T/5, Camp Crowder, Mo.
 8QEP, Frasier, Lt., Ft. Monmouth, N. J.
 8RDN, Andrew, Cpl., foreign duty.
 8RML, Castner, foreign duty.
 8RVG, Dunson, 2nd Lt., Ft. Monmouth.
 8RWK, Nelson, T/5, foreign duty.
 ex-8SMU, Kryskalla, Pvt., Camp Pinedale, Cal.
 8T0C, Zell, T/5, Camp Crowder.
 8TTD, Tauser, Camp Crowder.
 8TTJ, Albert, Cpl., Camp Crowder.
 8TVK, Williamson, 2nd Lt., Ft. Monmouth.
 8TZA, Babcock, T/3, Tallahassee, Fla.
 8TAA, Knouiton, T/5, address unknown.
 8ULO, Paquette, Pvt., foreign duty.
 8UMI, Chaney, Cpl., Camp Crowder.
 8USW, Metz, T/Sgt., Camp Crowder.
 8UVA, Strama, 2nd Lt., Ft. Monmouth.
 8UVQ, O'Connor, Pvt., Camp Kohler, Cal.
 8VKU, Masur, Pvt., Murco, Cal.
 8VLJ, Groh, T/5, Camp Crowder, Mo.
 8WJV, Ehrlich, Lt., Ft. Monmouth.
 8WPQ, Kidd, Camp Crowder, Mo.
 8WUB, Kennedy, Lt., Ft. Monmouth.
 ex-9AZT, Stoll, Lt. Col., foreign duty.
 9BRB, Steinberb, 2nd Lt., Ft. Monmouth.
 9BTS, Ekstrom, 2nd Lt., Ft. Monmouth.
 ex-9CCS, Jacobs, Cpl., Camp Crowder.
 9CHP, Gumble, Cpl., Camp Crowder.
 9COL, Worby, Lt., Ft. Monmouth.
 9CQM, Pittman, Pvt., Reno, Nev.
 9DHP, Gould, Camp Crowder, Mo.
 9DMA, Smith, Sgt., foreign duty.
 9DZP, Riffle, Lt., foreign duty.
 9EPN, Davis, Camp Crowder, Mo.
 ex-9FPG, Muckendorf, Sgt., Camp Crowder.
 9HUP, Smith, Lt., Camp Crowder.
 9JTM, Freeland, 2nd Lt., Ft. Monmouth.
 9KWW, Meadors, Pvt., Camp Crowder.
 9KZO, Hombeck, Cpl., Ft. Monmouth.
 9LBJ, Seidner, Lt., Ft. Monmouth.
 9LFY, Stein, Cpl., Fresno, Cal.
 9MAS, Stewart, T/5, Davis, Cal.
 9NLA, Caldwell, Cpl. Tech., Ft. Lewis, Wash.
 9OBY, Comella, T/5, address unknown.
 9OEU, Brennan, Cpl., New Orleans, La.
 9OIP, Blythe, 2nd Lt., Ft. Monmouth.
 9OSK, Stearns, Sgt., Camp Crowder.
 9PCK, Green, Cpl., Camp Crowder.
 9PGB, Hieber, Cpl., foreign duty.
 9PGU, Marshall, 2nd Lt., Ft. Monmouth.
 9PNP, Cigoj, T/5, Camp Crowder.
 ex-9PWS, Mitchell, Cpl., Camp Crowder.
 9QBC, Joska, Camp Crowder, Mo.
 9QFD, Foreman, 2nd Lt., Ft. Monmouth.
 9QOF, Orahoud, Camp Crowder, Mo.
 9QVE, Mack, T/5, Camp Crowder, Mo.

9RHA, Stricker, Pvt., Camp Crowder.
 9RTN, Gabrielson, Cpl., Camp Crowder.
 9RYY, Richardson, T/5, Davis, Cal.
 9SHY, Hill, T/Sgt., foreign duty.
 9SLU, Beck, Cpl., Camp Crowder.
 9TCW, Wellman, T/5, Camp Crowder.
 9ULK, Riemann, T/5, Camp Phillips, Kan.
 9UPU, Strimple, 2nd Lt., Ft. Monmouth.
 9VBN, Nielsen, 2nd Lt., Camp Crowder.
 9VKA, Browning, Cpl., Camp Crowder.
 9VKM, Heimerl, address unknown.
 9VMI, Roth, Pvt., Davis, Cal.
 9VXG, Layson, Camp Crowder, Mo.
 9VYU, Bitfield, T/5, Camp Crowder.
 9WRJ, Hiestand, 2nd Lt., foreign duty.
 9YUJ, Strimple, 2nd Lt., Ft. Monmouth.
 9YOA, Klein, Lt., Asbury Park, N. J.
 9ZOF, Harter, 2nd Lt., Ft. Monmouth.
 9ZQB, Olson, Camp Crowder.

Operator's license only:

Blake, Lt., Ft. Monmouth, N. J.
 Clark, Pvt., Camp Framingham, Mass.
 Euseber, 2nd Lt., Camp Crowder, Mo.
 Gallo, S/Sgt., Birmingham, Ala.
 Hendricks, T/5, Camp Ellis, Ill.
 Kerber, Lt., Ft. Monmouth, N. J.
 McNutt, Pvt., address unknown.
 Waterman, Cpl., New Orleans, La.
 Wiggin, Pvt., Camp Framingham, Mass.

NAVY — GENERAL

APPARENTLY all our "blue-jacket" hams have gone sailing off to sea. Anyway, there has been a decided drop in names received from the Coast Guard, Marine Corps, Navy and Merchant Marine. The Army seems to be staying more steadily "on the beam" and is taking over a good part of this department. Come on you seafarers — send in your AWSR to-day.

1BNO, Sandstrom, RM, address unknown.
 1MMG, Newbold, RM2c, Pleasanton, Cal.
 1MZB, Coyle, Lt., address unknown.
 2FHU, Kolb, RM1c, address unknown.
 2HTT, Hansen, CWO, address unknown.
 2GUO, Whitlock, Lt. (jg), Washington, D. C.
 2LZS, Eagle, A/S, Lafayette, Ind.
 2NKK, Marchetto, address unknown.
 2NOF, Summers, Lt., address unknown.

2OJC, Szula, A/S, Schenectady, N. Y.
 3HTP, Podgoriski, RM3c, Jacksonville, Fla.
 4AQM, Roberts, ORM, Lauderdale, Fla.
 4BGM, McMullen, Lt. (jg), Pensacola, Fla.
 4FIL, Baker, RM2c, address unknown.
 4GCU, Bullock, Ens., Annapolis, Md.
 4QD, Barker, Lt. (jg), Atlanta, Ga.
 5FPH, DeVilbiss, Ens., Newton, Mass.
 5GZ2, Hopson, RM2c, New Orleans, La.
 5HHH, Arnold, RM3c, San Diego, Cal.
 5JMJ, Kelly, A/S, address unknown.
 6GCU, Jensen, A/S, New Orleans, La.
 6KCO, Barth, CRM, San Diego, Cal.
 6MPC, McNair, Ens., Washington, D. C.
 6TCG, Wallace, A/S, Los Angeles, Cal.
 6UAW, Cook, A/S, Austin, Tex.
 7DET, Vandermay, Lt. (jg), address unknown.
 K7FW, Vincent, A/S, Washington, D. C.
 ex-8AQA, Miles, Lt. Comdr., Malden, Mass.
 9VTP, Ivory, ARM1c, Daytona Beach, Fla.
 8KIT, Parkas, Ens., New York, N. Y.
 8OSQ, Richards, Lt. (jg), Philadelphia, Pa.
 ex-8QXA, Landers, RM1c, Key West, Fla.
 8SNO, Warner, Sp2c, Chicago, Ill.
 8WOB, Dunlap, A/S, Sampson, N. Y.
 9ALM, Caldwell, West Lafayette, Ind.
 9IWO, Brown, A/S, Urbana, Ill.
 9KHM, Talmo, A/S, Minneapolis, Minn.
 9KNT, Cook, address unknown.
 9ITW, Menne, A/S, Ames, Iowa.
 9MFW, Serena, A/S, Farragut, Idaho.
 9MPN, Olsen, A/S, Great Lakes, Ill.
 9MUX, Orscheid, Lt. (jg), Charleston, S. C.
 9NOB, Devine, Ens., Lakehurst, N. J.
 9NRE, Metzger, S1c, address unknown.
 9ROM, Rohde, ARM3c, Memphis, Tenn.
 9RVV, Zaczey, RM1c, address unknown.
 9RXV, Engle, Lt. (jg), address unknown.
 9WEF, Asp, A/S, Northfield, Minn.

ARMY — AIR FORCES

WHILE W2KIF is on foreign duty with the Airways Communications Squadron, his mother keeps us posted with the latest news. Seems he's saving every bit of "jack" he can in order that the receiver that was in the shack at home at the end of this war may be replaced immediately with a brand new Super-Pro.
 ex-1DDU, Shovlin, Pfc., Scott Field.
 1GM, Foster, Lt., Scott Field, Ill.
 1KUM, Hull, Pvt., Atlantic City, N. J.
 1LYE, Earnshaw, Pfc., Truax Field, Wis.

Some of the Texas A & M "slip-stick" gang. Soldiers, sailors and marines, all working with that new field — radar.
 First row, l. to r. — Ashley, RT2c, W7HMJ; Metcalfe, RT3c, W7HML; Gose, RT2c, W5CJF; Williams, RT2c, W7DCI; St. Germain, Pvt., W9LFV; Simmons, RT2c, W1VK; Dehler, RT3c, W2NKF; Leuker, RT2c, W9KZZ; Parslow, RT2c, W7LJ; Rusche, RT2c, W5F1; Blum, RT2c, W2MY; R. Sturdivant, RT3c, W4FRA; W. Sturdivant, Sgt., W4FQS. Second row, l. to r. — Sharpe, RT2c, W1KSO; Sarver, RT2c, ex-W5ATJ/AZJ; Frisbee, RT2c, W4AYT; Page, RT2c, W4EJZ; Holland, RT2c, W8VTL; Gustin, RT3c, W6NCY; Mommertz, RT2c, W9RLS; Weeman, RT2c, W7FAG; Crosser, RT2c, W5JJR; Small, RT2c, W1KSN; Smith, RT2c, W8SLL; Allen, RT2c, OPLO; Ham, RT3c, W6UMH. Third row, l. to r. — Henderson, RT2c, W6QNE; Brogan, RT2c, W6MVI; Smith, Pvt., OPLO; Long, RT2c, W5JBM; Thornley, RM3c, W4HCP; Schmidbauer, RT2c, OPLO; Stany, RT2c, W9FUC; Stecker, S2c, W8QBD; Simpson, S2c, W9E2C; Wasson, RM3c, W6NNV; Glade, RT2c, W6GK; Liedes, RM3c, W7AZA; Birdsong, RT2c, W5JLT; Artigues, Pvt., OPLO; Harty, RT2c, W9ORU.

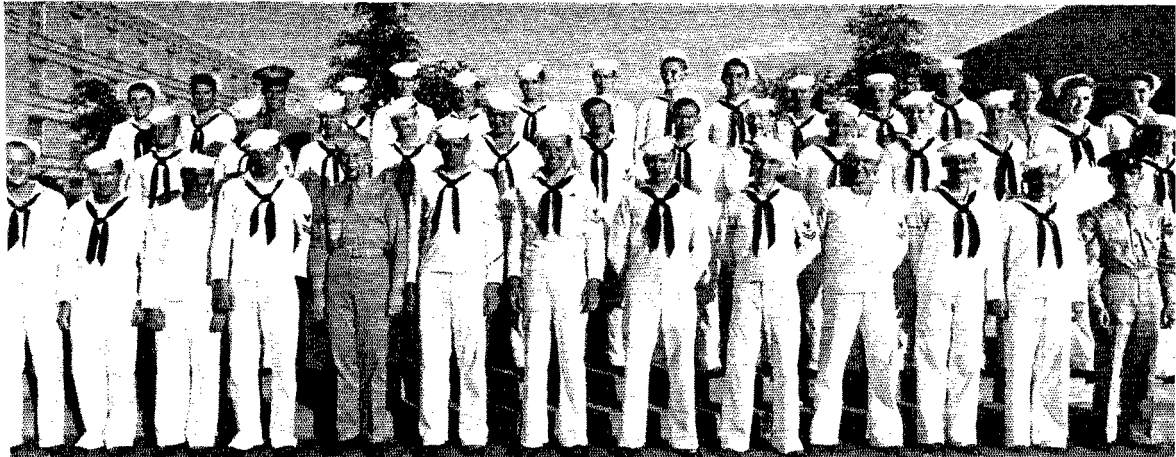

1MFG, Clement, Cpl., Camp Crowder, Mo.
 1MJR, Thurston, Pfc., Scott Field, Ill.
 1NDJ, Zagroski, Pvt., Camp Pinedale, Cal.
 2DPM, Blakeslee, Maxwell Field, Ala.
 2HJW, Carr, CWO, foreign duty.
 3HRW, Rubin, 2nd Lt., Asheville, N. C.
 2JNC, Smith, Lt., foreign duty.
 2MAC, Jacobs, Pfc., Scott Field, Ill.
 2CF, Foss, Lt., foreign duty.
 3JF, Gironda, Lt., address unknown.
 2NKB, Butekant, FRO, Whitehaven, Tenn.
 3HRW, Rubin, A/C, Kutzow, Pa.
 3HZZ, Capner, Sgt., Morrison Field, Fla.
 3LDM, Moulton, A/C, Maxwell Field, Ala.
 3IRM, Campbell, A/C, Maxwell Field, Ala.
 3JMY, Tilley, Pvt., Sheppard Fld., Tex.
 3GGS, Robinson, Pvt., Gulfport Fld., Miss.
 3JLU, Parker, Cpl., Boca Raton Fld., Fla.
 3JVA, True, Pfc., Scott Field, Ill.
 3JVC, Gibson, Lt., address unknown.
 4DPB, Carr, Pvt., Miami Beach, Fla.
 4FOX, Hawkins, A/C, Boca Raton Fld., Fla.
 4FTC, Rebik, Pvt., Memphis, Tenn.
 4GKU, Campbell, Capt., Maxwell Fld., Ala.
 4HBM, Walker, Maxwell Field, Ala.
 4HBU, Harper, Pfc., Craig Fld., Ala.
 5BXY, Horn A/C, Boca Raton Fld., Fla.
 5BYO, Crimmins, Maj., Asheville, N. C.
 ex-5CBO, Freeman, Pfc., Sioux Falls, S. D.
 5DGH, Doherty, Pfc., Bowman Field, Ky.
 5GML, Cain, 2nd Lt., Mather Field, Cal.
 5GXE, Raley, M/Sgt., Asheville, N. C.
 5HCP, Soulgas, Pvt., Walnut Ridge, Ark.
 5HMO, Welch, Cpl., Asheville, N. C.
 5HPB, Lerner, M/Sgt., Asheville, N. C.
 5HQD, Corcanges, Lt., Greenville, S. C.
 5HZI, Brogan, Pvt., address unknown.
 5IXN, Adams, Cpl., address unknown.
 5JLF, Clark, Cpl., Sioux Falls, S. D.
 5JOM, McPherson, Cpl., Asheville, N. C.
 5JWP, Sparks, 2nd Lt., Columbia, S. C.
 5KEN, Kessinger, Cpl., Sioux Falls, S. D.
 5KLV, Connaway, S/Sgt., Laredo, Tex.
 5KBF, Miller, address unknown.
 5TG, Hunt, Maj., Asheville, N. C.
 6LFW, Cook, A/C, Ellington Fld., Tex.
 6NHM, Samardindycyk, Cpl., Camp Crowder.
 6NKK, Hill, Pfc., Sioux Falls, S. D.
 6NVX, Bishop, A/C, New Haven, Conn.
 6QDV, Bickmore, Pfc., Mitchel Fld., N. Y.
 6TFM, Garrigus, 2nd Lt., address unknown.
 6TGZ, Gottwald, Pvt., Berkeley, Cal.
 7EYO, Grant, Cpl., Sioux Falls, S. D.
 7GGO, Luse, Lt., McChord Fld., Wash.
 7GSV, Hansen, Cpl., Long Beach, Cal.
 7HYK, Geyser, Lt., foreign duty.
 8FXQ, Tice, Pfc., Asheville, N. C.
 8HIV, Griffith, Cpl., Dow Field, Me.
 8LFS, Brenz, Pvt., Fresno, Cal.
 8NDD, Casprigi, Cpl., foreign duty.
 8OFG, Ball, Pfc., Sioux Falls, S. D.

8PHV, Closey, Cpl., Camp Crowder, Mo.
 8PLR, Mitzo, Cpl., Sioux Falls, S. D.
 8VXQ, Luten, Pfc., Asheville, N. C.
 8TCN, Colvin, Cpl., Atlantic City, N. J.
 8TVO, King, Cpl., Atlantic City, N. J.
 8WTB, Collier, Pfc., Scott Field, Ill.
 8WKO, Sarick, Cpl., Camp Murphy, Fla.
 8WOS, Dowler, Pfc., Scott Field, Ill.
 8BCV, Haas, Sgt., Truax Field, Wis.
 9DEE, Erdmann, Pvt., Gambier, Ohio.
 9DUF, Medhurst, Sgt., Hamilton Fld., Cal.
 9HDJ, Dahl, Sgt., Scott Field, Ill.
 ex-9JDK, Hansen, Pfc., Sioux Falls, S. D.
 9JGC, Moline, S/Sgt., Venice, Fla.
 9JYF, Young, A/C, Granville, Ohio.
 9LJG, Anderson, Pvt., Fresno, Cal.
 9MWS, Graves, S/Sgt., foreign duty.
 9NXU, Little, Lt., address unknown.
 9OAP, Smiddy, A/C, Maxwell Fld., Ala.
 9OTV, Medlin, Cpl., address unknown.
 9PVB, Bashor, Pfc., Asheville, N. C.
 9EXV, Irwin, 2nd Lt., Asheville, N. C.
 9QNY, Bobeck, Sgt., Turner Field, Ga.
 9TBW, Smith, Cpl., Sioux Falls, S. D.
 9UBL, Witte, Sgt., foreign duty.
 9VAV, Hutson, S/Sgt., Orlando, Fla.
 9VCE, Anderson, Pfc., Sioux Falls, S. D.
 9VGO, Osley, Pfc., Asheville, N. C.
 9VIW, Pickens, Pvt., Camp Crowder, Mo.
 9VYQ, Deal, Cpl., foreign duty.
 9WLV, Mock, Lt., Mather Field, Cal.
 9YKD, Radosevich, 2nd Lt., Boca Raton Field, Fla.
 9YTH, Roach, Maxwell Field, Ala.
 9ZJB, Dawson, Pvt., Asheville, N. C.

Operator's license only:

Dyner, Pfc., Scott Field, Ill.
 Fabris, A/C, Boca Raton, Fla.
 Gibson, Lt., Bayville, N. Y.
 Gutierrez, Pfc., Sioux Falls, S. D.
 Kohan, Cpl., Athens, Ga.
 Koslowski, Pfc., Sioux Falls, S. D.
 Lewis, Pfc., Scott Field, Ill.
 Miller, Pvt., Keesler Fld., Miss.
 Noble, Lt., Boca Raton Field, Fla.
 Romanisky, S/Sgt., Washington, D. C.
 Snover, Pfc., Sioux Falls, S. D.
 Uta, Cpl., Biggs Field, El Paso, Tex.
 Whitman, Pvt., St. Petersburg, Fla.
 Wiggins, Pvt., Clearwater, Fla.

ARMY—GENERAL

WSTZE, 'way off at the end of nowhere, finds time to do a little day-dreaming, and tells us he's looking forward to the day "when the war will end and we will be able to get back to the old dust-covered rig, blow it off, crank it up and cut loose with all that she will take."

1FJK, Raymonosky, Cpl., address unknown.
 1HOP, Kramer, Lt., Camp Stewart, Ga.
 1IVE, Cole, 2nd Lt., Ft. Sill, Okla.
 1LCH, Sock, address unknown.
 2FRA, Hoar, Cpl., foreign duty.
 2GKE, Smith, address unknown.
 2HNY, Rehm, Lt., address unknown.
 2HQU, Wilkening, Sgt., Ft. Meade, Md.
 2JDM, Berlin, 2nd Lt., Ft. Knox, Ky.
 2MJN, Svec, S/Sgt., Camp Breckinridge, Ky.
 2NKT, Conklin, Cpl., address unknown.
 2NUK, Mannion, Lt., foreign duty.
 2NVR, Ruggiero, Lt., foreign duty.
 2OCU, Connolly, Pvt., Camp Fannin, Tex.
 3BUH, Chapman, Sgt., foreign duty.
 3DNF, Eib-rhart, Sgt., foreign duty.
 3IVZ, Stello, T/Sgt., Beaumont, Tex.
 4GOX, Murdock, Sgt., Pullman, Wash.
 4HKS, Campbell, Pfc., Stanford Univ., Cal.
 5D TJ, Abbott, M/Sgt., address unknown.
 5IHC, McGuire, Lt., Ft. Sill, Okla.
 5IVW, Read, Capt., Ft. Smith, Ark.
 5KFT, Beggs, T/4, Camp Hood, Tex.
 6DKJ, Jacks, T/5, Ft. Knox, Ky.
 6NHA, Dodds, Pfc., address unknown.
 6QKE, Wann, T/5, Ft. Benning, Ga.
 6QZF, Bartley, address unknown.
 6KSFN, Yamamoto, Pvt., Camp Shelby, Miss.
 6TEU, Bigler, Pvt., Ripon, Wis.
 6RPD, Chuljian, Pvt., Camp Robinson, Ark.

7FFZ, Thayer, Sgt., Vancouver, Wash.
 7GQB, Dodge, address unknown.
 7CGG, Vogle, address unknown.
 7HZI, Hay, Logan, Utah.
 7TIB, Newton, Lt., foreign duty.
 8AXW, Renaud, Cpl., New Orleans, La.
 8EFI, Malec, Pvt., Ft. Logan, Colo.
 8OIT, Wassell, T/Sgt., Langley Field, Va.
 8QFL, Schearrer, Sgt., foreign duty.
 8SNC, Schwearin, Maj., Postoria, Ohio.
 8URM, Eisenman, Pvt., Camp Wallace, Tex.
 8UTB, Kovach, S/Sgt., foreign duty.
 8VAX, Hauck, Pvt., Camp Hood, Tex.
 8VMC, Gimpert, Pvt., address unknown.
 8WJZ, Wyman, Cpl., Newport, R. I.
 8WNR, Newman, Pvt., Ft. Knox, Ky.
 9ABK, Flory, M/Sgt., Crossville, Tenn.
 ex-9BZT, Connors, Minneapolis, Minn.
 9DAK, Eisel, Ft. Lewis, Wash.
 9DIT, Walker, Cpl., foreign duty.
 ex-9EGE, Altobell, Cpl., Ft. Knox, Ky.
 9E5F, Rinker, Burlington, Iowa.
 9FMB, Harrington, W/O, foreign duty.
 9NFF, Jensen, T/5, Ft. Knox, Ky.
 9HAD, Colwell, Pvt., Ft. Lawton, Wash.
 9IRU, Dunn, Ft. Lewis, Wash.
 9JRK, Leubke, Pvt., address unknown.
 9JMD, Higginson, Pvt., St. Louis, Mo.
 9JWP, Hart, Ft. Lewis, Wash.
 9JQP, Carson, address unknown.
 9KED, Everhart, address unknown.
 9JNC, Benson, T/Sgt., foreign duty.
 9NVE, Bell, Ft. Lewis, Wash.
 9OYM, Schlierstrom, foreign duty.
 9RCQ, Baird, 2nd Lt., St. Louis, Mo.
 9RNT, Klouda, T/Sgt., Ft. Monroe, Va.
 9SEQ, Burdick, Ft. Lewis, Wash.
 9STV, Welch, Ft. Lewis, Wash.
 9UBT, Schram, Pvt., Camp Hood, Tex.
 9VKS, Schmidt, Cpl., Los Angeles, Cal.
 9VBT, Johnson, Lt., Los Angeles, Cal.
 9ZJG, Senninger, Camp Davis, N. C.

Operator's license only:

Landry, M/Sgt., foreign duty.
 Sayot, Pvt., Brookings, S. D.
 Seifert, Pvt., Ft. Knox, Ky.
 Shaner, address unknown.

CIVIL SERVICE

1AKA, Lavalette, Philadelphia Signal Depot.
 1FXO, Kenyon, FCC, monitoring officer.
 1GYI, Johnson, SC Labs, Ft. Monmouth.
 1HFS, Lawrence, SC Labs, Belmar, N. J.
 1IIN, Jackson, SC, inspector, Kansas City.
 1IJX, Marston, SC, Boston, Mass.
 1IP, Jacob, AAB, Manchester, N. H.
 1IPZ, Jubb, SC, radio technician.
 1IUP, Maloff, FCC, Portland, Me.
 1JYX, Litvenko, SC Labs, Ft. Monmouth.
 1JZN, Lee, Philadelphia Signal Depot.
 1KJO, Kujampaa, Philadelphia Signal Depot.
 1LJF, Marzetta, Naval Res. Lab., Washington.
 1LQN, Holbrook, Navy radio insp., Chicago.
 1MRZ, Lindgren, address unknown.
 1NBY, Kovaleski, SC Labs, Ft. Monmouth.
 2AJC, Laventhal, Signal Labs, Ft. Hancock.
 ex-2ANT, Liberman, Sig. Labs, Ft. Hancock.
 2AWL, Johnson, SC Labs, Ft. Monmouth.
 2CJU, Landau, SC Labs, Ft. Monmouth.
 2CPL, Inslerman, SC Labs, Ft. Monmouth.
 2CTY, Herlin, SC, radio inspector.
 2DFB, Lefferson, Signal Labs, Ft. Hancock.
 2DGM, Johnson, War Dept., radio mechanic.
 2DSV, Kelleher, SC Labs, Ft. Monmouth.
 2DSY, Kirkman, SC Labs, Ft. Monmouth.
 2EJK, Henderson, SC Labs, Ft. Monmouth.
 2ERC, Huebner, SC Labs, Ft. Monmouth.
 2GNJ, Kusterman, SC Labs, Ft. Monmouth.
 2GTU, Jones, SC Labs, Ft. Monmouth.
 2HJK, Lewis, SC Labs, Ft. Monmouth.
 2HKY, Krause, SC Labs, Ft. Monmouth.
 2HSJ, Louloff, Signal Labs, Ft. Hancock.
 2IJU, Kronenberg, SC Labs, Ft. Monmouth.
 2JTX, Ikonomou, SC Labs, Ft. Monmouth.
 2JLY, Maresca, SC Labs, Ft. Monmouth.
 2JYT, Lord, Signal Labs, Ft. Hancock.
 2KDG, Karg, SC Labs, Belmar, N. J.
 2KJY, Kirshuber, SC, radio engineer.
 2KRA, Krasner, FCC, radio intelligence.
 2KUG, Lathrop, SC, radio inspector.
 2LBU, Herrman, Signal Labs, Ft. Hancock.
 2LEN, Liebowitz, Signal Labs, Ft. Hancock.
 2LPT, Levine, Signal Labs, Ft. Hancock.
 2NF, Mayer, SC Labs, Ft. Monmouth.
 2NQV, Kenigson, SC, radio engineer.
 2NTH, Levine, AAF, radio instr. Scott Field.
 2NYT, Kaplan, Signal Labs, Ft. Hancock.



Lt. Raymond J. Fowler, W3GJZ, was last reported on active duty with the RAF as a member of the U. S. Signal Corps. This picture was taken at Fort Monmouth, just before he left with other members of the BTG for extremely interesting service.



Here's a picture that should make every VE ham, and all others, too, swell with pride. Group Captain A. H. Keith Russell, ex-VE9AL, is now serving as director of technical training of the RCAF at Ottawa. Formerly a Toronto lawyer, he is one of Canada's best and oldest hams, and was the first Canadian General Manager of the League.

- 2NZC, Kiensien, Signal Labs, Ft. Hancock.
- 2OEF, Kravatz, SC Labs, Ft. Monmouth.
- 3AEA, Krebs, FCC, eng. dept., Washington.
- 3AG, Hunton, SC, radio instr. Baltimore.
- 3AIX, Kamenshine, Phila. Signal Depot.
- 3AJL, Herring, Naval Research Lab, Bellevue.
- 3AOC, Hensell, Naval Research Lab, Bellevue.
- 3AVR, Hopkinson, Naval Res. Lab, Anacostia.
- 3CRB, Kirk, SC Labs, Belmar, N. J.
- 3DOT, Hogan, address unknown.
- 3EDG, Koontz, Naval Res. Lab, Bellevue.
- 3EIV, Long, Naval Research Lab, Bellevue.
- 3EJE, Kass, SC Labs, Ft. Monmouth.
- 3EUJ, Mackenzie, Naval Res. Lab, Bellevue.
- 3EUJ, Harnen, Naval Res. Lab, Bellevue.
- 3FGD, Herman, Naval Res. Lab, Bellevue.
- 3FRX, Herotage, SC Labs, Ft. Monmouth.
- 3GHE, MacGeorge, radio eng., Philadelphia.
- 3GNJ, Malkin, Philadelphia Signal Depot.
- 3HXU, Maroon, SC, inspector.
- 3IGS, Jordan, SC, inspector.
- 3IOS, Jones, Naval Research Lab, Bellevue.
- 3JAP, Huntley, Naval Research Lab, Bellevue.
- 3JGD, Hodges, Naval Research Lab, Bellevue.
- 3JDH, Liebson, Naval Research Lab, Bellevue.
- 3JCC, Kreyling, Philadelphia Signal Depot.
- 3JEV, Jetter, Signal Labs, Ft. Hancock.
- 3JXQ, Liebensperger, Phila. Signal Depot.
- 3JF, Lazretti, SC Labs, Ft. Monmouth.
- 4AEL, Marshburn, SC Labs, Belmar, N. J.
- 4AGL, Higgins, address unknown.
- 4BME, Heath, instructor, Jacksonville.
- 4FCL, King, Signal Labs, Ft. Hancock.
- 4FMT, Mathis, SC, Camp Croft, S. C.
- 4FWJ, Jurafsky, Signal Labs, Ft. Hancock.
- 4JG, Kirby, Lexington Signal Depot.
- 4UC, Hicks, instructor, Pensacola, Fla.
- 5AXI, Hutchins, radio op., Ft. Sam Houston.
- 5CRL, LeBlanc, radio work, Randolph Field.
- 5EOS, Jonas, radio instructor, Duncan Field.
- 5EPJ, Huckabee, FCC, monitoring officer.
- 5GAV, Levy, Lexington Signal Depot.
- 5GP, Irwin, radio instructor, Cushing, Okla.
- 5GWL, Lats, Lexington Signal Depot.
- 5HNP, Holmes, SC, inspector.
- 5HQN, Kramer, radio work, Corpus Christi.
- 5HWL, Henley, Lexington Signal Depot.
- 5HXT, Hill, address unknown.
- 5IVY, Mathis, Philadelphia Signal Depot.
- 5IWN, Lamb, address unknown.
- 5JAH, Laurents, radio operator, Laredo, Tex.
- 5JDB, Hinson, radio foreman, Cushing, Okla.
- 5JIU, Matthews, FCC, monitoring officer.
- 5JXW, Keasterson, radio mechanic-technician, Fine Bluff, Ark.
- 5KMC, Irby, Lexington Signal Depot.
- 5LE, Johnson, SC Labs, Belmar, N. J.
- 5TB, Lewis, Lexington Signal Depot.
- 5ZZF, Hooper, Lexington Signal Depot.

- 6FRN, Keeler, address unknown.
- 6GRI, Holdredge, SC, radio instructor.
- 6GTL, Kennedy, SC, radio technician.
- 6MBX, Jones, Navy Dept., inspector.
- 6QFP, Kallman, Naval Res. Lab, Washington.
- 6PE, Mallander, address unknown.
- 6TDW, Kesselhuth, address unknown.
- 6TEG, Loewenstein, radio lab, Wright Field.
- 6TQE, Johnson, Portland Air Base, Oregon.
- 7EKL, Jenkins, address unknown.
- 7HNT, Klein, radio engineering draftsman, Puget Sound.
- 7IFK, Krause, radio maint., Stanfield, Ore.
- 8ABI, Johnston, Signal Labs, Ft. Hancock.
- 8BKE, Hedges, FCC, intercept officer.
- 8BOA, Little, SC, engineer, Washington.
- 8BOT, Madison, address unknown.
- 8BPC, Kemper, radio engineer, Wright Field.
- 8BQX, Kenyon, address unknown.
- 8IP, Kalmbach, address unknown.
- 8JDB, Maine, signal school, Philadelphia.
- 8KHK, Maxwell, FCC, monitoring officer.
- 8LCK, Liming, Lexington Signal Depot.
- 8OHL, Herb, radio lab., Wright Field.
- 8OW, Magz, Naval Res. Lab, Washington.
- 8OZT, Hekking, FBI, monitoring officer.
- 8QBJ, Henry, radio mechanic-technician, Paterson Field.
- 8QNG, Lowstuter, Signal Labs, Ft. Hancock.
- 8SKB, Hock, address unknown.
- 8VGS, Majewski, AAF, St. Louis, Mo.
- 8WMB, Jubinville, SC, inspector.
- 9AFP, Kramar, address unknown.
- 9AMJ, Johnson, Lexington Signal Depot.
- 9AMJ, Marriner, AAF, radio op., New Haven.
- 9AVM, Humphrey, Navy Dept., radio instr.
- 9BDB, Lindbert, SC Labs, Ft. Monmouth.
- 9BEA, Klingler, address unknown.
- 9BJK, Jackson, SC, radio inspector.
- 9BPK, Kimber, FCC, operator, Sturgis, S. D.
- 9BPE, MacDonald, Lexington Signal Depot.
- 9CDI, Irion, address unknown.
- 9CJS, Junkins, AAF, Sioux Falls, S. D.
- 9CKT, Marquart, Lexington Signal Depot.
- 9CSW, Jacobs, radio lab, Wright Field.
- 9CTE, Klein, Las Vegas Air Depot.
- 9DAG, Lovell, Lexington Signal Depot.
- 9DAC, Johnson, address unknown.
- 9DBO, Kleppin, FCC, radio operator.
- 9DH, Leach, Dept. of Aero. Eng., Minneapolis.
- 9DSB, Maynard, radio installation, Ogden.
- 9DWL, Martin, signal repair shop, Ft. Knox.
- 9EON, Lester, address unknown.
- 9EGJ, Kibourn, Philadelphia Signal Depot.
- 9EKK, Kinsey, radio engineer, Omaha, Nebr.
- 9FGZ, LaBlonde, AAF, instructor, St. Louis.
- 9GRH, Malloy, address unknown.
- 9HHE, Lorenz, address unknown.
- 9HPS, Leonard, R., address unknown.
- 9IJJ, Leonard, J., address unknown.
- 9NEP, Martin, SC, radio school, Paducah.
- 9OJM, Lehr, Lexington Signal Depot.
- 9PKT, Koehler, SC, instructor, Ashland.
- 9PZJ, Malmquist, AAF, instructor, Chicago.
- 9QXL, Kreger, SC, radio mechanic.
- ex-9SQM, Manning, radio lab, Wright Field.
- 9WOK, Landick, SC Labs, Belmar, N. J.
- 9YQX, Marks, AAF, instructor, Chicago.

CANADA

A NUMBER of the following names were sent in to us by a VE amateur serving with the RCAF in England. He says the boys over there are looking forward to lighting up the ionosphere after this job is finished,

Take a sharp look at Col. Robert C. Bohannon, W8AV, and you'll note plenty of reason for this ready smile. The Colonel served with the Field Artillery in France in the last war and consequently wears the American Defense Ribbon and the Victory Ribbon. Since then he has been in the Air Corps Reserve, later transferring to the Signal Corps. At present he is signal officer at XII Corps headquarters. He has been an active amateur ever since 1910.

and many of them have cooked up some wicked designs for post-war brass pounding.

Seems several of the calls were found written up on a wall where one usually finds verses, etc. We've heard of calls on box cars, trucks and hotel menus, but this is a new Call Book substitute.

Remember, we're depending on you fellows to keep the service records coming in to us. The Canadian listing is an important part of our ITS department — don't let it fall behind!

RCAF

- 1BO, Patrick, W/C, Montreal.
- 1HS, McPadden, AC2, Montreal.
- 1KD, Tucker, Sgt., Montreal.
- 2DF, Stobo, AC2, Montreal.
- 3QI, Logan, Sgt., Montreal.
- 3AJP, Reid, F/S, Montreal.
- 3AIP, Townsend, Sgt., Montreal.
- 3ANM, Shank, P/O, foreign duty.
- 3AFY, Hudson, Sgt., Montreal.
- 3BAI, Hill, Sgt., Montreal.
- 3BBE, Butt, Sgt., Montreal.
- 3BBG, Osborne, AC2, Montreal.
- 3CO, Buller, Sgt., Montreal.
- 3JB, Cowan, Sgt., Montreal.
- 3TM, Ross, AC1, Montreal.
- 3VY, Erb, Sgt., Montreal.
- 4AAV, Forsyth, Sgt., foreign duty.
- 4AEZ, Appelt, Sgt., Montreal.
- 4AEO, Barratt, Cpl., address unknown.
- 4AU, Sedore, AC2, Montreal.
- 5AAG, Benckritis, Sgt., foreign duty.
- 5AAJ, Vews, AC2, Montreal.
- 5AAT, Johnson, AC2, Montreal.
- 5ADN, Wckel, AC2, Montreal.
- 5AIF, Burton, AC2, Montreal.
- 5FR, Thwaites, AC2, Montreal.
- 5JN, MacLean, Sgt., Montreal.
- 5MZ, Woodford, P/O, foreign duty.
- 5NT, Grant, AC2, Montreal.
- 5QA, Pearsall, P/O, foreign duty.
- 5QL, Pearsall, Sgt., foreign duty.
- 5SO, Joe, AC2, Montreal.

RCCS

- 1EK, Street, Cpl., Halifax.
- 2BZ, Plante, Signalman, address unknown.
- 2OZ, Tomlinson, Capt., address unknown.
- 5ABN, Bramham, address unknown.
- 5HL, Mauris, Signalman, address unknown.

RC CIVIL SERVICE

- 1DC, Horne, J., Chatham, N. B.
- 1EP, Grant, Halifax, N. S.
- 1FL, White, St. John, N. B.
- 1GL, Horne, W., Chatham, N. B.
- 3AUW, Smith, address unknown.
- 3OD, Sturgess, address unknown.
- 4IO, Ainlay, Calgary.
- 5AE, Stark, Sidney, B. C.

RC MERCHANT MARINE

- 1GX, Scott, radio operator; 3AFY, Scott, radio operator; 5ADM, Hunt, radio operator; 5AGP, Birkett, wireless officer, and operator's license only, Peyton, radio officer.



Resonant Circuits in Antenna Systems

Some Circuit Fundamentals and Their Application to Amateur Problems

BY DAWKINS ESPY,* W6UBT

When we get back to worrying about on-the-air problems — for instance, how to make multi-element arrays work on two bands — the ideas in this article undoubtedly will find a lot of practical applications in amateur communication. Now's the time to get familiar with the principles involved, as set forth here.

THE use of resonant circuits as elements in an antenna system offers a multitude of interesting and useful possibilities. The ease with which resonant-circuit impedance characteristics may be controlled is added reason why this simple method should be employed.

Through the use of resonant circuits in antennas, it becomes possible to cause a single radiator to act as a half-wave antenna on several different frequencies, to convert a single-band three-element beam into a two-band beam, to operate many phased arrays on more than one band, to use the same radiator for simultaneous operation from two transmitters on two frequencies without interaction, and to devise many useful arrangements for improving feeder systems for multiband operation. These are but a few of the uses of this principle. It is desirable to examine the fundamentals involved and their application to a few common cases.

Series-Resonant Circuits

Before proceeding to examine the function of resonant circuits in connection with antenna systems, it is well to discuss some of the properties of series, parallel, and series-parallel resonant circuits. Of particular interest in a resonant circuit is the impedance characteristic — in other words, the way in which the impedance changes as the frequency of the applied voltage is varied.

Fig. 1-A shows a simple series circuit consisting of a coil and condenser. Just as with resistors in series, where the resultant resistance is the sum of the resistances, the resultant impedance of the series circuit is the sum of the two reactances in series. Since the reactance of a coil or condenser varies with frequency according to the formulas:

$$\text{Reactance of Coil} = X_L = 2\pi fL \quad (1)$$

$$\text{Reactance of Condenser} = X_C = \frac{1}{2\pi fC} \quad (2)$$

their sum or the resulting series impedance also varies with frequency.

*358 30th St. Dr., S. E., Cedar Rapids, Iowa.

Fig. 1-B shows the inductive and capacitive reactances of a series circuit plotted on the same graph. The sign of the inductive reactance is positive, while that of capacitive reactance is negative. If the values of these reactances are added at every frequency, the result will be the series-circuit impedance curve shown in Fig. 1-B.

Series resonance is defined as the frequency of zero reactance, or the frequency at which the positive inductive reactance becomes just equal to the negative capacitive reactance. At resonance the reactances in equations (1) and (2) become equal, and thus if the two equations are set equal and solved for f , the resonant frequency is:

$$X_L = X_C \quad (3)$$

or

$$2\pi fL = \frac{1}{2\pi fC} \quad (4)$$

Multiplying both sides by f ,

$$2\pi f^2L = \frac{1}{2\pi fC} \quad (5)$$

dividing both sides by $2\pi L$,

$$f^2 = \frac{1}{4\pi^2LC} \quad (6)$$

and taking the square root of both sides yields the well-known formula

$$f = \frac{1}{2\pi\sqrt{LC}} \quad (7)$$

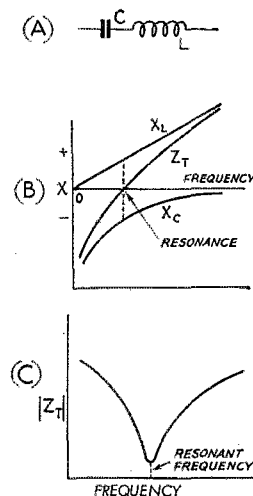

Fig. 1

The theory indicates that, because the net reactance is zero in a series-resonant circuit, the impedance would also be zero at resonance. This is not strictly true in practice, because there is always some resistance in the coil. It is true, however, that at resonance the impedance takes on a minimum value equal to the resistance of the coil, and that it increases on each side of resonance as indicated in Fig. 1-C. Fig. 1-C is a plot of

the absolute value¹ of the sum of the coil and condenser reactance curves of Fig. 1-B, taking into account the fact that the coil resistance prevents the impedance from going to zero at resonance.

Parallel-Resonant Circuits

Fig. 2-A shows a simple parallel circuit consisting of a coil and condenser. Such a parallel circuit may be thought of as a coil and condenser shunted across a line, as shown in Fig. 2-B. An oscillator or generator appears at the left-hand end of the line and a load (antenna or other device being driven) at the right-hand end. If the generator has internal resistance the maximum energy will reach the load when the coil and condenser combination has the least shunting effect. In other words, to have the greatest possible power in R_L , the current drawn by coil-condenser combination must be as small as possible in comparison to the current drawn by R_L . This condition will be attained if the impedance of the parallel-resonant circuit is high in comparison to R_L . A high impedance at resonance is a characteristic of the parallel-resonant circuit. We shall now see why this is so.

The resultant of two resistances in parallel is given by the formula

$$R_T = \frac{R_1 R_2}{R_1 + R_2} \quad (8)$$

This same formula applies to parallel branches consisting of condensers and coils as well as resistors, but is written in the form

$$Z_T = \frac{Z_1 Z_2}{Z_1 + Z_2} \quad (9)$$

where Z_1 and Z_2 are the total series impedances of each parallel branch. For example, in the parallel-resonant case shown in Fig. 2-A, the resulting parallel impedance is given by the formula

$$Z = \left| \frac{X_L X_C}{X_L - X_C} \right| \quad (10)$$

Again considering the circuit shown in Fig. 2-B, it may be seen that, since the inductive reactance increases with frequency and the capacitive reactance decreases with frequency, the frequency at which the two reactances become equal will yield the highest impedance and thus the least shunting effect on the line. At frequencies somewhat greater than resonance the capacitive branch will have less reactance than the inductive branch (see Fig. 1-B) and so the parallel impedance approaches the reactance of the condenser alone. This is true, of course, because in parallel circuits the branch having the least numerical value of impedance becomes the controlling branch, the net value of the circuit impedance approaching the value of this smaller branch. At frequencies somewhat lower than resonance the inductive branch has a reactance smaller than that of the capacitive branch and thus becomes the controlling factor for the reason outlined above. It is seen that the impedance of a

parallel-resonant circuit varies from a comparatively low value at frequencies below resonance to a high value at resonance and back to a low value at frequencies above resonance.

Since it has been shown that the separate branch impedances should be equal in magnitude

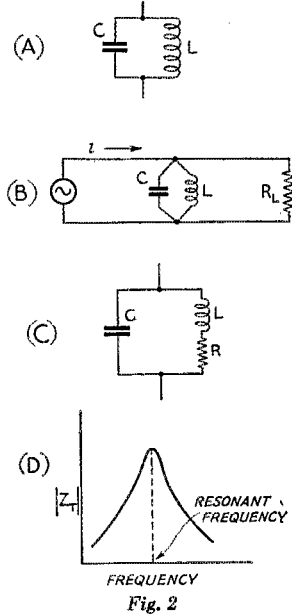

Fig. 2

at resonance in parallel-resonant circuits, it will be observed that the denominator of equation (10) for parallel-resonant impedance becomes zero, and thus the impedance is theoretically infinite at resonance. However, as mentioned previously, there is always some resistance in the coil which will prevent this from happening. This case is illustrated in Fig. 2-C. Substituting the impedances of the two parallel branches in equation (9), we get²

$$Z_T = \frac{(X_L + R)(-X_C)}{X_L + R - X_C} = \frac{-X_L X_C + R X_C}{X_L - X_C + R} = \left| \frac{X_L X_C + R X_C^2}{X_L - X_C + R} \right| \quad (11)$$

If the coil is good, the Q (ratio of X_L to R) will be 10 or greater, and the term $R X_C$ may be neglected with no serious loss of accuracy. Considering this and the fact that at resonance $X_L = X_C$, equation (11) reduces to

$$Z_T = -\frac{X_L X_C}{R} = \left| \frac{X_L X_C}{R} \right| \quad (12)$$

Since at resonance X_C may be replaced by its equal, X_L , and X_L/R is designated as Q , the formula for the impedance of a parallel circuit at resonance for Q s of 10 or more may be written

$$Z = \frac{X_L^2}{R} = Q X_L \quad (13)$$

¹ The numerical value without regard to sign. Two vertical bars, such as enclose equation (10), indicate absolute value.

² Equation (11) is not strictly true, since X_L and R should actually be added vectorially, but no appreciable accuracy is lost provided $X_L \gg R$ (read "is much greater than").

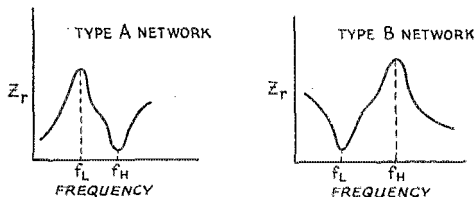
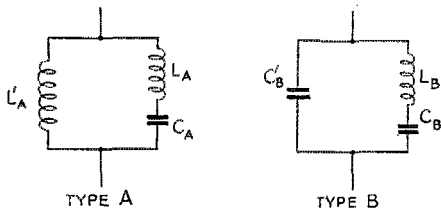

Fig. 3

The parallel-resonant impedance can never become infinite so long as R is not zero, but it may be made large by causing R to be small in comparison to X_L . Fig. 2-D shows the impedance of a parallel-resonant circuit plotted against frequency.

Series-Parallel Resonant Circuits

Two types of series-parallel resonant circuits are illustrated in Fig. 3. Type A has a parallel-resonant frequency and a series-resonant frequency, the latter being the higher of the two. Type B also has parallel- and series-resonant frequencies, but in this type the series-resonant frequency is lower than the parallel-resonant frequency.

In Type A, coil L_A and condenser C_A in the series branch form a series-resonant circuit. At some lower frequency where the capacitive reactance of C_A is greater than the inductive reactance of L_A , the net reactance (which is capacitive) in the series combination forms a parallel-resonant circuit with coil L'_A . At frequencies higher than the series-resonant frequency the series branch is predominantly inductive and thus parallel resonance with the other branch is impossible in this range.

In Type B, the coil, L_B , and the condenser, C_B , form a series-resonant circuit. At some higher frequency where the inductive reactance of the coils is greater than the capacitive reactance of the condenser, the resultant inductive reactance is parallel-resonant with the condenser, C'_B . At frequencies lower than the series-resonant frequency the series branch is predominantly capacitive, and therefore parallel resonance is impossible in this range.

Graphs of the impedance characteristics of Types A and B series-parallel resonant circuits are shown under the circuits in Fig. 3. Type A is used when it is desired to have a high impedance at a given frequency and a low impedance at a higher frequency. Type B is used when it is desired to have a high impedance at a given frequency and a low impedance at a lower frequency.

Derivation of Formulas for Calculation

Consider the Type A configuration. Let X_{L_A} be the reactance of L_A , X_{C_A} the reactance of C_A , and $X_{L'_A}$ the reactance of L'_A . The reactances X_{L_A} and X_{C_A} are taken at the series-resonant frequency, while the reactance $X_{L'_A}$ is for the frequency of parallel resonance. At the series-resonant frequency

$$X_{C_A} - X_{L_A} = 0 \quad (14)$$

Let f_H be the higher resonant frequency, in this case the series-resonant frequency, and f_L the lower resonant frequency, in this case the parallel-resonant frequency. Multiplying and dividing by the factor f_H/f_L in order that the series-circuit reactances may be expressed in terms of the new frequency, f_L , and equating the net series reactance to the parallel reactance of $X_{L'_A}$,

we have

$$\left(\frac{f_H}{f_L}\right) X_{C_A} - \frac{X_{L_A}}{(f_H/f_L)} = X_{L'_A} \quad (15)$$

Letting $a = f_H/f_L$, we get

$$aX_{C_A} - \frac{X_{L_A}}{a} = X_{L'_A} \quad (16)$$

Multiplying through by a ,

$$a^2X_{C_A} - \frac{aX_{L_A}}{a} = aX_{L'_A} \quad (17)$$

Recalling that $X_{C_A} = X_{L_A}$,

$$(a^2 - 1)X_{L_A} = aX_{L'_A} \quad (18)$$

or

$$\frac{aX_{L'_A}}{X_{L_A}} = a^2 - 1 \quad (19)$$

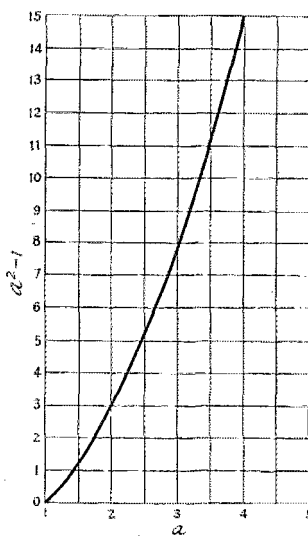
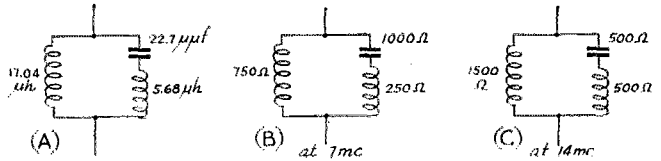

Fig. 4

Fig. 5



But X_{L_A} has been defined as $2\pi f_H L_A$, while $X_{L'_A}$ was defined as $2\pi f_L L'_A$. Thus

$$\frac{\alpha X_{L'_A}}{X_{L_A}} = \frac{\left(\frac{f_H}{f_L}\right) 2\pi f_L L'_A}{2\pi f_H L_A} = \frac{L'_A}{L_A} \quad (20)$$

Therefore

$$\frac{L'_A}{L_A} = a^2 - 1 \quad (21)$$

Similarly it may be shown that for the Type B network

$$\frac{C_B}{C'_B} = a^2 - 1 \quad (22)$$

Fig. 4 shows a graph of this equation so that, for a given ratio of f_H to f_L (high-frequency resonance to low-frequency resonance), the corresponding ratio, L'_A/L_A or C_B/C'_B , may be found.

Design Procedure

(Given: Type of network, f_H and f_L .)

Type A:

- 1) Choose a value of L_A .
- 2) Determine the value of C_A from the formula

$$C_A = \frac{1}{4\pi^2 f_H^2 L_A} \quad (23)$$

where C_A is in farads, L_A in henrys, and f_H in cycles.

- 3) Calculate the value of a and determine $a^2 - 1$ by calculation or from Fig. 4.
- 4) Calculate the value of L'_A from equation (21).

Type B:

- 1) Choose a value of C_B .
- 2) Determine the value of L_B from the formula

$$L_B = \frac{1}{4\pi^2 f_L^2 C_B} \quad (24)$$

where C_B is in farads, L_B in henrys, and f_L in cycles.

- 3) Calculate the value of a and determine $a^2 - 1$ by calculation or from Fig. 4.
- 4) Calculate the value of C_B from equation (22).

Fig. 6

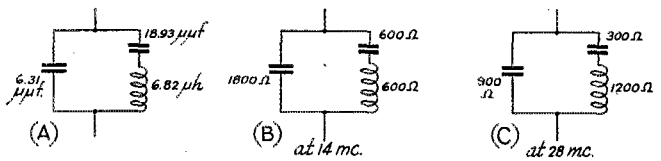

Examples

Suppose it is desired to design a Type A network, with $f_H = 14$ Mc. and $f_L = 7$ Mc.

- 1) L_A is chosen as 5.68 μ h.
- 2) From equation (23)

$$C_A = \frac{1}{4\pi^2 (14,000,000)^2 \left(\frac{5.68}{1,000,000}\right)} = 22.7 \mu\mu\text{fd.}$$

$$3) \quad a = \frac{f_H}{f_L} = \frac{14}{7} = 2$$

$$a^2 - 1 = 2^2 - 1 = 3$$

- 4) From equation (21)

$$\frac{L'_A}{L_A} = 3 \text{ or } L'_A = 3L_A = 3 \times 5.68 = 17.04 \mu\text{h.}$$

Fig. 5-C shows that at 14 Mc. the reactances of the elements of the series branch are equal, indicating series resonance at this frequency. Fig. 5-B shows that at 7 Mc. the difference between the reactances of the series arm is of the opposite kind and equal in numerical value to the reactance of the parallel branch.

Assume that a Type B network is required, with $f_H = 28$ Mc. and $f_L = 14$ Mc.

- 1) C_B is chosen as 18.93 $\mu\mu$ fd.
- 2) From equation (24)

$$L_B = \frac{1}{4\pi^2 (14,000,000)^2 \left(\frac{18.93}{1,000,000,000,000}\right)} = 6.82 \mu\text{h.}$$

$$3) \quad a = \frac{f_H}{f_L} = \frac{28}{14} = 2$$

$$a^2 - 1 = 2^2 - 1 = 3$$

- 4) From equation (22)

$$\frac{C_B}{C'_B} = 3 \text{ or } C'_B = \frac{C_B}{3} = \frac{18.93}{3} = 6.31 \mu\mu\text{fd.}$$

Fig. 6-B shows that at 14 Mc. the reactances of the elements of the series branch are equal, indicating series resonance at this frequency. Fig. 6-C shows that at 28 Mc. the differences in the

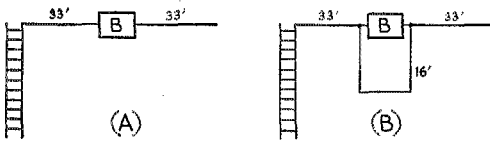

Fig. 7

reactances of the series arm are of the opposite kind and equal in numerical value to the reactance of the parallel branch.

Single-Wire Applications

Suppose it is desired to feed an antenna from one end and to have the antenna operate with maximum radiation broadside to its axis on the 7-Mc. and 14-Mc. bands. A half-wave wire on 7 Mc. would satisfy the requirement for this band, but a quarter-wave phasing stub would have to be inserted at the center of the wire to satisfy the requirement at 14 Mc. By inserting a Type B network in the antenna at its midpoint, and designing this network so that the low-impedance frequency is 7 Mc. and the high-impedance frequency is 14 Mc., the desired result may be obtained. The parallel-resonance effect at 14 Mc. makes the network exhibit a very large impedance to a current of that frequency attempting to flow across the midpoint of the antenna. This is illustrated in Fig. 7-A.

A better method of fulfilling this requirement is to put the 14-Mc. quarter-wave stub around the Type B network, as shown in Fig. 7-B. On 7 Mc. the stub is shorted out by the network, while on 14 Mc. the network opens up to a high impedance and allows the stub to complete the circuit between the two halves of the antenna. This causes the system to operate as two half-waves in phase, giving the required broadside radiation. This method forms the basis for the more complicated arrays which will be mentioned later.

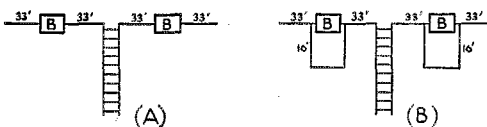

Fig. 8

A very similar single-wire application is shown in Fig. 8-A. A center-fed antenna, operating as two half-waves in phase, is made to operate in the same manner at a higher frequency by placing a Type B network in series with each half of the antenna at the proper point. If the higher frequency is twice the lower frequency, the networks may be shunted with quarter-wave stubs for the higher frequency as shown in Fig. 7-B. This utilizes the whole antenna and causes the system to operate as four half-waves in phase at the higher frequency.

Three-Element Beam Applications

Directors and reflectors may be electrically opened at desired points by using the Type B

network, as shown in Fig. 9. If the frequencies of operation have approximately a ratio of 2 to 1, a Type B network can be placed in the center of the director and another in the center of the reflector, so that at the higher operating frequency the reflector and director are split or opened up into two parts. Each part of the reflector or director

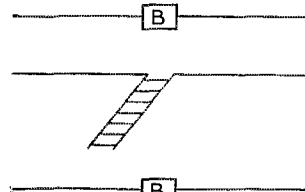

Fig. 9

then operates separately from the other part which is adjacent to it. In such arrays directors or reflectors are parasitically excited by the associated driven element, and are not affected to any appreciable extent by the presence of an adjacent collinear reflector or director element. Therefore it is not necessary to use phasing stubs between adjacent collinear parasitically-excited reflectors or directors. The arrangement shown in Fig. 9 is well suited for a combination 10- and 20-meter beam.

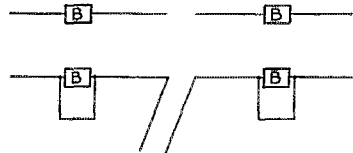

Fig. 10

Phased Arrays

The remarks regarding single-wire applications and three-element beam applications may be taken in combination to apply to more complicated phased arrays. One example of what can be done is shown in Fig. 10. Here the driven element is broken up into four parts at the higher operating frequency by Type B networks, and these four parts are kept in phase by the usual phasing stubs. The two halves of the reflector system are each broken into two parts at the higher frequency by Type B networks, allowing normal reflector action to take place. An antenna of this type was used very successfully on 20-meter 'phone at W7OGZ (W6UBT operating) in the last Sweepstakes contest.

Simultaneous Operation

Fig. 11 shows how Type A and B networks may be used to allow simultaneous operation of two transmitters on the same antenna without appreciable interaction. In this case each network is series resonant (low impedance) at the frequency in its own feed line and parallel resonant (high

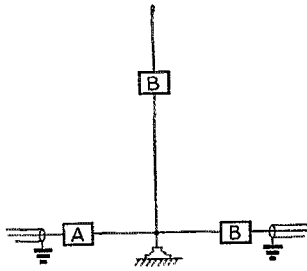

Fig. 11

impedance) at the frequency of the other feed line. Furthermore, the antenna may be made the correct length for the lower frequency and opened to the optimum length for the higher frequency by a Type B network inserted in series with the antenna at the proper point. The illustration shows concentric-line feed to a vertical radiator, but the principle may be applied equally well to balanced-line systems.

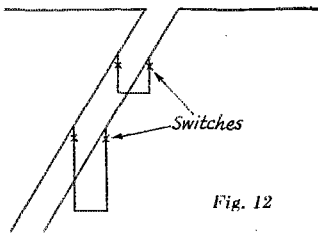

Fig. 12

Feed-Line Applications

Type A and B networks find wide application in feed lines. Most amateurs are familiar with the arrangement shown in Fig. 12, in which stubs of various lengths are switched on the feed line so as to cause the total distance from the antenna to the stub section to be a quarter wavelength. The stub is positioned so that the line taps on the stub at the proper distance from the shorting bar. A series of such stubs allows flat-line operation on the several bands involved.

Ordinarily the necessary switching is done with knife switches. Fig. 13 shows how Types A and B networks may be used to do this switching automatically in a simple case. A Type A network is

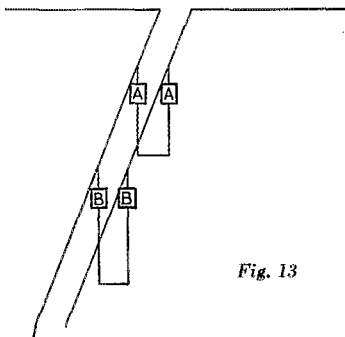

Fig. 13

used in the higher-frequency stub so that it acts to open up the stub at the lower frequency. The lower-frequency stub uses a Type B network which opens up the stub when the higher frequency is being used. This system is particularly well suited for use in conjunction with the antenna illustrated in Fig. 10. This method, however, requires too many network units to be practical in the case where more than two frequencies are employed.

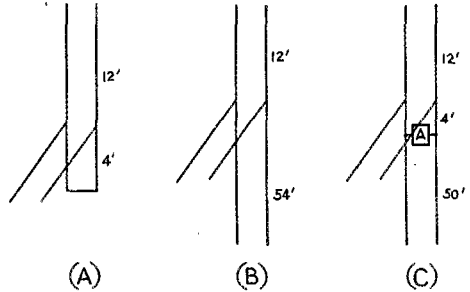

Fig. 14

Another method of automatic stub changing when the frequencies are approximately harmonically related is available. Fig. 14-A shows a 14-Mc. quarter-wave shorted stub with the approximate dimensions. Fig. 14-B shows a 7-Mc. half-wave open stub with typical dimensions. The two systems may be combined to feed a dual-band antenna, as shown in Fig. 14-C. A Type A network shorts the stub at the proper length when the system is excited at the higher frequency, and opens up to allow half-wave open-stub operation on the lower frequency. The two frequencies must be nearly harmonically related so that the optimum point of attaching the feed line in Figs. 14-A and 14-B will not differ too greatly. In the system of Fig. 14-C, the point of attaching the feed line should be chosen to give the best compromise between the two frequencies involved.

Acknowledgment

The helpful suggestions and criticisms of Hal Bumbaugh, W6HI, and Dr. S. J. Haefner, W2HTF, in writing this paper are greatly appreciated.

Strays

To separate heat-treated parts from those not so treated but of identical appearance, a magnetic discriminator has been developed. It works on the principle that heat treating increases the permeability and thus gives a stronger magnetic field. A system of balanced magnetic fields used with an oscilloscope provides easy visual determination of the difference. — *Ohmite News*

ESMWT Radio Training at Rutgers University

*A Case History of a Representative
U. S. Office of Education
ESMWT Program*

BY CLINTON B. DE SOTO,* WICBD



Left— Girl draftsman taking an E S M W T course in mechanical drawing at Rutgers.

TIME was when the horizons of college training were those of the college campus. Recent years have seen a widening of these horizons, however. A decade or two ago tentacles known as extension courses commenced feebly to reach out from the cloistered centers of learning, embracing those distant from the inaccessible campus who yet hungered for college-level training. With Uncle Sam's benign aid via the postal service, correspondence courses came into being, linking the college and the isolated student.

More recently certain advanced educational institutions have gone a step further, establishing branch classes in outlying centers with extension courses augmenting the work of the parent institution.

Now the war, as one of its innumerable innovations, has brought about still a greater extension of the nation's college-level educational facilities, through the ESMWT program and its precursors — EDT and ESMDT.

It is probable that 99 out of 100 *QST* readers have seen those initials — ESMWT. Yet prob-

ably not 9 of the 99 have any comprehensive concept of all that they signify.

Here, briefly, is the background:

Nearly three years ago a group of leading educators foresaw the critical shortage of technically trained personnel that would result as the defense program progressed. In an attempt to forecast a solution, EDT — Engineering Defense Training — was sponsored by the U. S. Office of Education to provide short courses of college grade to meet the shortage. Limited at first to engineers, the program later was broadened to include chemists, physicists and production supervisors in war industries, and the name was changed to ESMDT — Engineering, Science and Management Defense Training. That program began in 1941.

It was at about the point when "defense" became "war" and the name changed to ESMWT that the training of radio technicians entered the program. Under ESMWT, tax-exempt colleges and universities offering recognized degrees with majors in the prescribed fields now organize short courses for the training of personnel to fill shortage jobs. Generally these courses are planned to supply industrial or other essential war personnel needs of the nearby region.

In essence, the ESMWT program operates on the principle of determining the kinds of technically trained personnel required, estimating the probable number and qualifications of available applicants, and setting up courses designed to do the necessary training job.

*Editor, *QST*.

Typical Rutgers-ESMWT classrooms. *Left* — Students in a theory class display their knowledge in a blackboard review. *Right* — The teaching of "elementary" electricity requires complicated apparatus — at least when regular college lab instruments are used. Contrast this array with the "traveling radio laboratory" shown on pages 40 and 41.

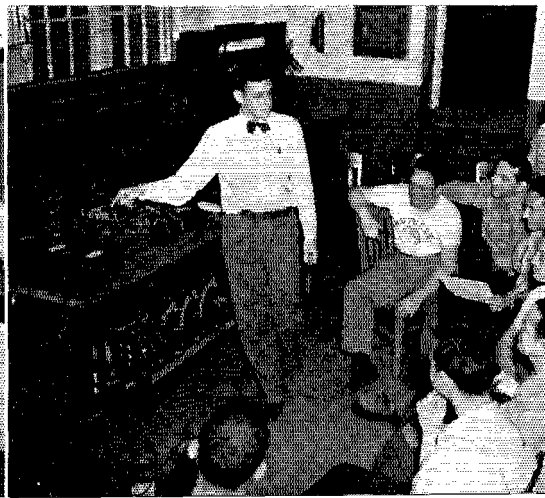
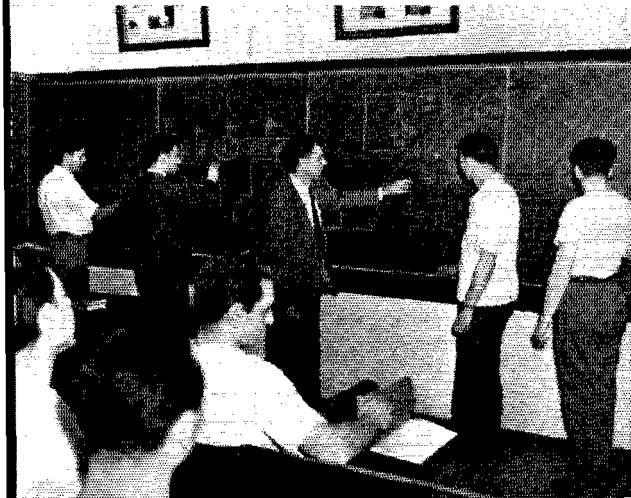

This is the kind of story the telling of which resembles the classical magician's trick called the "nest of boxes." You remember how it goes — a borrowed article is vanished and a large box produced. This box is unlocked, only to find another inside it, and another inside that, and so on. The vanished article is found within the smallest of the nest of locked boxes.

In this instance, the outer box opens to disclose the largest specialized college-level training program in the nation's history, involving the enrollment of nearly a million students, the organization by more than two hundred institutions of over a thousand separate courses, and the expenditure of well over fifty million dollars of federal funds.

That program is ESMWT (Engineering, Science and Management War Training) in its national scope. Within it are the individual specialized courses, specifically those dealing with radio and electronics. They are the box within the outer box — a score or more of them, some of an elementary nature requiring only high school preparation, others vastly more advanced; some dealing with broad principles, others tailored to meet the specific needs of the military services or of industry.

So large is this box, so diversified and complex its content, that it becomes necessary to look at a smaller box still the program as carried on within a single institution — in this case, the work of the ESMWT department at Rutgers University.

Inside that box is the object of the search — the ESMWT program reduced to a common denominator. That is the story told in the accompanying article.

The result has been the addition of large numbers of vitally needed technical people in a large number of essential fields. In 1940-41, EDT engineering courses were offered in 144 institutions with a total enrollment of 120,000. In 1941-42, ESMDT courses were conducted in 196 institutions, with 438,000 students enrolled. In 1942-43, some 12,000 short courses of college grade were taught to more than 600,000 enrollees.

Radio in the ESMWT Program

These courses are of all kinds. They range from engineering drawing to refined specialties such as geometric optics and the X-ray diffraction analysis of metals. Radio and electronics are only a part of the ESMWT program.

But they are a large and vital part. Figures recently released show that more than 80,000 men and women have completed radio war training courses since 1940. Another 18,000 were enrolled in electronics courses. These men and women attended classes established in hundreds of different communities by the colleges and universities cooperating in the program. A high percentage have taken pre-radar and radar in engineering colleges with advanced facilities, and advanced u.h.f. classes have been offered in 65 engineering colleges with more than 2500 trainees enrolled.

Lab sessions. *Left* — The twenty students in each lab section work as four five-man teams. Shown here is a new section busy on a simple constructional project early in the course. *Right* — Another lab section at a later stage in the course, performing transmitter experiments with the aid of audio signal generators, analyzers and oscilloscopes.

The objective of these courses is the supplying of personnel trained to the exact specifications of industry and, in some cases, the military. They are tailor-made courses, designed to provide the particular knowledges and skills required. Usually they are taught by skilled specialists from industry, rather than by professional pedagogues.

Class sections are located for the convenience of the trainees rather than of the administering institutions. The courses, while of college grade, are not designed to lead to degrees or to replace established curricula. They are at various levels — and at all levels they represent the finest kind of technical radio training.

Such is the radio portion of ESMWT on its national scale, as revealed to us one hot and sultry summer afternoon in the U. S. Office of Education.

We were there at the invitation of W. T. Clark, ex-W3AKQ, ESMWT's information specialist. Our purpose was to learn the present status of the ESMWT program. In that search, incidentally, our guide and mentor was Mr. Clark's assistant — a personable YL named Mitchell. (We mention this because, as some *QST* readers may know, before moving down Constitution Avenue to the Office of Education, Miss Mitchell was for several years ARRL Prexy George Bailey's right-hand man in his OSRD job.)

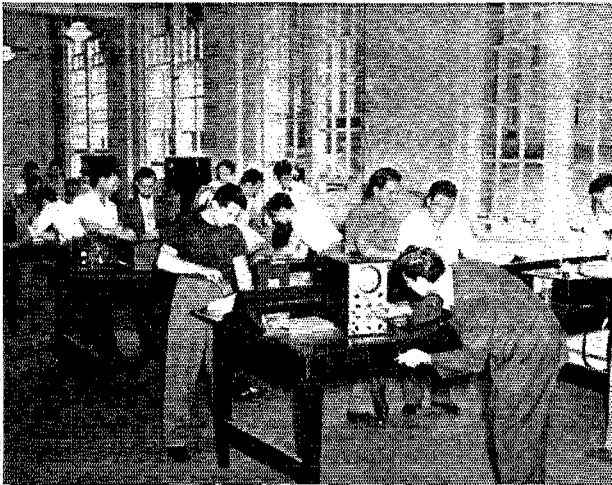
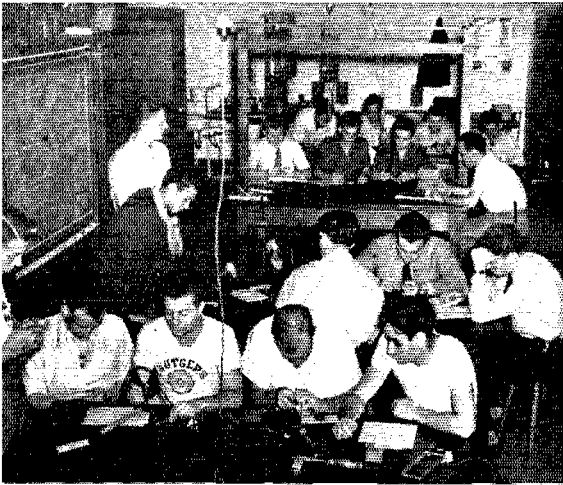

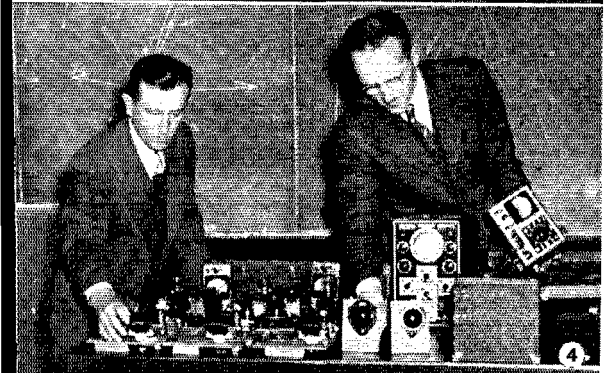

The climax of our explorations came in an interview with Dean George W. Case, whose able administration of ESMWT is largely responsible for its notable accomplishments. (Incidentally, Dean Case also knows amateur radio. His son, an ex-ham now in military service, credits his amateur background with helping him attain his present highly technical assignment. Dean Case recounted how the ARRL membership-QST subscription he regularly gave his son on his birthday was the lad's most valued gift.)

From his detailed grasp of the entire program, Dean Case supplied a picture of ESMWT on its national scale—the information summarized in the foregoing. It was a broad picture with infinite detail which could be viewed only from a distant perspective, however. What we wanted was a close-up. So far we had seen only the broad generalities of the ESMWT program, as viewed from the national headquarters. How did a typical ESMWT establishment function, we asked? How did it accomplish its intricate and specialized purposes? How were courses organized? How were they taught?

Dean Case spread his arms and smiled a characteristic smile. "There are no 'typical' ESMWT programs," he explained. "Each institution has its own, organized according to the needs of the community. Each is different in scope, range, organization and detail."

"But can't you suggest one college or university we could visit that would serve as an example?" we persisted. "One that is at least representative, if not typical?"

"Yes, I think perhaps I can," Dean Case replied musingly. "Let me see. You might go to Pennsylvania State College. It's probably the largest—although Illinois is a close second. Then there's Purdue, and the University of California. . . . But what you're interested in is radio training. To get that story, I suggest you visit Rutgers University," he finally decided.

Rutgers University ESMWT Department

That Rutgers had an outstanding record in ESMWT work was not news, of course. Everyone connected with radio training is aware of the pioneering work accomplished there. Furthermore, we happened to know that there were a number of good hams associated with its program. All in all, Rutgers was a welcome choice.

Thus it was that another hot and sultry day found us climbing the stairs to the ESMWT offices on the second floor of the red-brick Engineering Building at Rutgers University in New Brunswick, N. J., ready for our close-up view of ESMWT.

The picture panels on these pages constitute a travogue of the unique Rutgers traveling radio laboratory. (1) Tom Garretson, W2ASB, (left) and his corps of assistants evolve a new experiment in their stockroom-workshop. (2) Standard procedure for demonstrating the experiment is carefully worked out and notes are compiled for the benefit of lab instructors. (3) All packed up and ready for the road, Lab Instructor Howard B. Van Liew sets out for his week's work. (4) At the classroom, Van Liew and Charles Hawley, class instructor, set up the experiment before the lab session begins.

Heading the entire ESMWT program at Rutgers is the famous educator, Dean Parker H. Daggett, dean of engineering. In that program radio training is, of course, only one segment. Some 80-odd different ESMWT courses are currently being given at Rutgers to over 750 class sections, in all fields of engineering, science and management.

But radio is an important segment. Of the nearly 19,500 students enrolled in all sections as of May 30th, over 10 per cent were taking radio training. Incidentally, the radio training program is one that Rutgers regards with particular pride because of its own pioneering role.

Prof. Maurice A. Chaffee, the energetic associate director of the Rutgers ESMWT Department, explained how it all came about. It was in early January, 1942, when the now-historic meeting was called in New York City where educators from all over the New York-New Jersey area heard from representatives of the National Association of Broadcasters of the enormous number of technically trained radio people that would be required when the projected vast military expansion got under way.

(Parenthetically, this is a good place to clear up a long-standing misunderstanding as to NAB's part in that picture. Both then and since there has existed a mistaken belief that NAB undertook the promotion of ESMWT radio classes more or less on its own initiative, for the purpose of training a reserve of engineering operating personnel to replace b.c. technicians leaving the industry for military service. The truth is that NAB was asked by the War Department to take on the job principally because of its unequalled facilities for blanketing the nation speedily with recruiting publicity, and the product of the ESMWT classes, as planned, was destined primarily for military service rather than civilian replacement. However, matters didn't work out quite as planned. So effective was the NAB publicity, with its hundreds of daily spot announcements, that enrollment figures skyrocketed. Presumably dismayed at the landslide precipitated by the small stone it *thought* it had turned, the War Department in another of its multiple personalities backtracked and began to disclaim responsibility. It was then that the program began to assume its hydra-headed nature, with civil service and industrial as well as pre-military training objectives.)

But that's only an interesting now-it-can-be-told sidelight. This article is concerned with the training job accomplished, not the administrative throes accompanying the accouchement.

(5) A receiver experiment set up, with the four individual breadboard units assembled on the wooden base and interconnecting wires attached. (6) Lawrence G. Avery, director of Rutgers-ESMWT radio training, places the last unit of a transmitter experiment in position. (7) W2ASB closely observes the efforts of a student lab team working out the receiver experiment. (8) Another pair of students has the transmitter experiment all set up and putting out. One calls "Test" and adjusts the buffer tuning while the other listens on a standard receiver which accompanies the experiment.



Getting back to that New York meeting, despite the NAB oratory there was, oddly enough, little response from the floor. Prof. Chaffee described his own initial reaction: not himself a radio man, he felt reluctant to speak. Then it occurred to him that perhaps the others present felt the same way. They, too, were professional educators and administrators — not radio engineers, or even radio instructors.

Dean Daggett and he discussed the matter. It seemed obvious that success in such a training effort would hinge on the availability of competent instructors, preferably men with plenty of practical professional and/or amateur experience who could accept part-time evening-class teaching assignments. And where was there a better chance of meeting this requirement than in the region surrounding Rutgers? Within a radius of fifty miles there was perhaps the highest concentration of radio manufacturing as well as one of the densest ham populations in the entire country.

Furthermore, Rutgers was especially well equipped to lead in the work. The experience already gained through EDT and ESMDT had established that. This type of training has many of the characteristics of extension work, and Rutgers had a perfected extension organization with 18 years of experience in just the kind of on-the-scene teaching called for in ESMWT.

“We’ll Take It On”

By the end of the meeting Dean Daggett and Prof. Chaffee had made up their minds. They gave Arthur Stringer, secretary of NAB’s national defense committee, their answer. “We’ll take it on,” they said.

Almost the next day the program was under way. Lawrence G. Avery was appointed director of radio training. Under him the work was divided under two heads — classroom, or lecture-theory, and laboratory, or experimental, work.

Prof. James L. Potter of the Rutgers Electrical Engineering Department was selected as educational advisor, and Thomas A. Garretson, W2-ASB, was placed in charge of the lab work. H. J. Holsten, Watson Buhler, Forrest Catherman, W. A. Fisher and Theodore Fulton were named class supervisors, and Samuel Quaranta as lab assistant. Philip S. Carter, ex-WICRA, also assisted in the lab on a part-time basis.

This staff began laying out the course. They signed up instructors, organized class sections, procured texts and matériel. Time was as short as the scope of the project was large. An urgent order for two thousand copies of the prescribed textbooks brought not only the books but the publisher himself down from New York the very next day. That one order represented more copies than he normally sold in an entire year, he explained, and so he’d hopped the first train to find out what was up.

From the outset it was apparent that the least of their worries was to find classes to teach. There might be shortages of instructors and matériel — but not of students. Spot announcements over the local b.c. stations brought in applications by the hundreds daily.

As fast as the applications were received, class sections were organized. A quota of 20 students per class was established as the maximum one instructor could handle efficiently. When 20 acceptable enrollees were found in a community, a new section was begun. Soon half a dozen sections a week were being organized.

Only the administrative direction was handled at the University. It was found that one essential in this type of training is close coordination between the individual instructors and the centralizing administrative head. Without it, individual classes are prone to drift off on private little bypaths at the whim of the instructor. The required liaison was supplied by a corps of half dozen field men who traveled from Rutgers to the individual classes, assisting the instructors, coordinating the training. The policy was to have one such field man visit every class at least once a week — answering questions, checking on the instructors.

There was but one course, at this stage — “Fundamentals of Radio — Parts I and II,” the standardized course outlined by the NAB committee to be given in all ESMDT radio classes around the country. While basic, it was a college-level course nominally available only to high school graduates and therefore somewhat more intensive than other elementary courses with lower preliminary requirements. It was a 32-week course, meeting three nights a week, with two theory lectures and one lab session weekly.

The plan called for separate lab and theory instructors for each class. Theory instructors weren’t too hard to find, but competent lab men with the requisite practical background — well, that was a different matter. It was difficult to locate enough good lab instructors to go around.

Apparatus Procurement Problem

Then there was the problem of lab equipment. With new sections being enrolled at a rate of eight per week, there just wasn’t enough gear available to perform all the experiments for the prescribed program.

Quiz contest: Which is the instructor? You’re wrong; it’s the YL — Nancy Redens, only woman among the 103 class instructors on the Rutgers-ESMWT staff. Here she checks the work of a student in her ERC class.

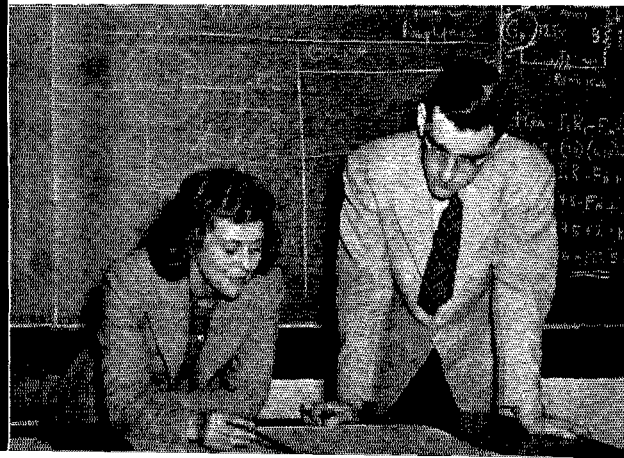

Resolved to better Dad's record, enlisted reservist Edward Hughes, jr., puts in a little homework on his ESMWT course under the helpful tutelage of his father, Edward Hughes, sr., a World War I Signal Corps officer and currently a Rutgers day-time laboratory assistant.

Figure it out. Each class did one complete experiment a week. The students worked in teams of five, requiring four sets of equipment per class. With 100 sections, that meant 400 duplicate sets of equipment for each experiment. When you consider that the course ran 32 weeks, meaning 32 experiments, the total gets slightly astronomical. In fact, it works out to more than 13,000 individual experiments!

The regular university lab could do little to supply such a demand; for each oscilloscope or milliammeter it possessed, hundreds were required. They took the problem to the purchasing department. The purchasing agent was entirely cooperative; sure, he'd get the orders sent out in the morning. All they had to do was list the items and the firms that manufactured them. When it was explained to him that you didn't buy radio equipment quite that easily in wartime, that there were priorities and things to worry about, he threw up his hands.

That's where Tom Garretson took over. His orders were simply to get the gear. How to do it was his problem. He solved it with characteristic ham acumen. The word quickly spread around amateur circles in New Jersey — "Rutgers wants your meters, test equipment, spare tubes and parts." A ham in a local radio store was appointed assistant purchasing officer and acted as appraiser; every item was valued and bought for cash as it came in.

The apparatus began to roll in. But even more was needed — immediately. New sections were being enrolled nightly. So Tom got in his car and drove up to New York City. For hours he prowled the radio stores, beginning uptown and working down. Anything and everything that could be used in the course he bought. He searched the fly-bitten junk stores along what once was Radio Row. He dug into dark, dusty corners, uncovering boxes of parts that hadn't seen the light of day in years. He bought up distress merchandise, odd lots of condensers, tubes, salvaged meters and test equipment. The next day, and on quite a few other days, he was back, leaving the stores with armloads of parts while amazed dealers stood shaking their heads in his wake.

But still there was a shortage of certain items — fixed condensers, resistors. Then Tom, profiting by his contacts with the industry via four decades of ham experience, arranged with manufacturers to purchase parts unsuitable for military use because of minor imperfections. He bought boxes full of condensers and resistors rejected for trivial mechanical defects which did not affect their electrical performance.

With each new source the shortage grew less acute. But meanwhile, in the midst of the initial parts famine, there had been born the unique idea that distinguishes the Rutgers program — the traveling laboratory.



The Traveling Radio Laboratory

The Rutgers traveling laboratory was conceived as a formula for obtaining maximum service from both instructors and apparatus. The key to the formula is the fact that theory class sessions were held twice a week, lab sessions only once. Why not, then, stagger the lab periods for the different classes? That way one lab instructor could take a different section each night in the week. Each class would have its own permanent theory instructor, but five classes could share the same lab instructor — and use the same equipment for experiments.

The plan was tried. It proved successful, and immediately was adopted as standard procedure. Here's the way it worked. Take Experiment No. 1. Four sets of it would be made up and packed into a 36-inch Sears-Roebuck tool box. On Sunday afternoon a lab instructor assigned to that experiment would drive over to New Brunswick, pick up the kit, watch a practice demonstration, get a little indoctrination from Tom Garretson and his crew, and then go home. Each night that week he'd travel to a different class in his vicinity and put on the experiment, the lecture part of the course having been arranged accordingly. The next Sunday he'd return Experiment No. 1, pick up No. 2, and repeat the whole process.

If anything had gone wrong with one of the No. 1 units in the meantime — bad tube, burned-out resistor, blown condenser — the instructor would tie a red tag to it, and a perfect unit would be substituted. The next day Tom and his crew would replace the defective part. Monday was always repair day. The rest of the week would be spent doping out new experiments, then going into production and building up the gear.

As each new experiment was completed, the corps of lab instructors would spend most of the following Sunday learning it so they could take it out that week and teach it effectively. Before adopting a new experiment Tom would try it out before class himself, working out the routine, locating any possible bugs or lapses in the demonstration. When the instructors arrived on

(Continued on page 88)

Captured Japanese transmitters used by the U. S. Marines on Guadalcanal, and the men who operated them. *Left to right* — Loren Van Hoy, RT3c; James H. Smith, RT1c, and Leon Woodard, RT1c, W5JWV.

quency rigs having a frequency range of from 3700 to 18,200 kc. The fourth was a low-frequency job with a range of from 50 to 600 kc. The latter isn't of particular interest here; it's enough to say that it consisted of a 2-kw. vacuum-tube oscillator in a self-excited Hartley circuit.

The three high-frequency transmitters were all of the same type, as indicated in the accompanying photograph. The circuits and tube line-up were as shown in the schematic (on the opposite page), traced out wire by wire by the author and Leon Woodard, W5JWV.

This schematic shows the transmitters exactly as they were originally designed by the Japs, with two exceptions. These exceptions are in the grid-bias system for the final stage and in the provision for keying. The transmitters as used by the Japs were 'phone rigs employing grid modulation. We put them on c.w., however, necessitating a redesign of the biasing arrangement. This also required a keying relay, and the only one available was a polarized d.c. relay of Japanese make. Because of designing difficulties, this relay was made to control the plate current to the oscillator tube. It's the resulting circuit, as modified, that appears in the diagram.

The circuits used in the transmitters were of conventional, although somewhat out-dated, design. The layout started with a Hartley oscillator, either crystal- or self-controlled. This oscillator, parallel-fed, was capacitively coupled to a screen-grid buffer stage. Succeeding amplifiers used additional tetrodes of progressively higher power, ending up with an 861 in the final stage. The tubes, although of Japanese make, were perfect replicas of our own.

Band-switching with tapped coils was employed in the interstage circuits to cover the 3.7 to 18.2 Mc. frequency range, while the antenna coupling circuit made use of a variable inductor. All variable condensers and inductors, incidentally, were controlled by complicated dial mechanisms containing just about every type of gear drive conceivable.

Many other oddities in constructional methods came to light in these sets. The master band switch was a maze of shafts and universal joints which controlled all stages simultaneously. The band switch arranged circuits so that only one dip could be found on each plate milliammeter as its corresponding stage was brought to resonance, reducing the likelihood of mistuning.

The main power switch was an exceptionally elaborate multiple-contact enclosed type in which

The terminal-board connection label pictured here is a memento confiscated from a Jap field radio set captured on Guadalcanal by a U. S. Army infantry communications unit. This label was received from Sgt. D. Atkinson, W1MYH, who wrote: "Did not miss up on my QST's even during the months on Guadalcanal, and kept my copy of the *Handbook* right along with me, too."



the high voltages were brought up in sequence on each r.f. stage as it was tuned. The meters were all mounted on insulators and had two glass faces with a two-inch air space between them. The filament rheostat was a very heavy-duty tapped resistor with a knife-type contactor. The mechanical construction throughout was elaborate and rugged, contrasting strongly with the archaic electrical design.

The power supplies for the transmitters (not shown in the photograph) were conventional three-phase rectifier systems, each unit incorporating three complete d.c. supplies. Power for operating the transmitters was obtained from a large Japanese diesel-powered generator which supplied the entire island. Emergency power was supplied by a Jap 4-cylinder gas-driven generator.

The voltage regulator used on the transmitter power supplies was a masterpiece. Briefly, it consisted of a transformer built as a motor — a field and an armature, with bucking coils. The armature rotated through an arc of 180°, driven by a three-phase motor geared down to a very slow speed. The starting, stopping and direction of rotation of this armature were controlled by a magnetic switch and relays. The magnetic switch consisted of a vane mounted between two elec-

(Continued on page 59)

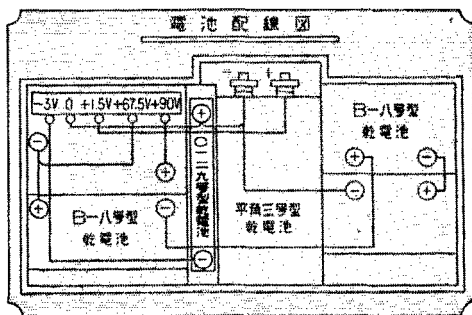



U.S.A. CALLING!



EXPERIENCED INSTRUCTORS WANTED

AT A long-established institution in New England where important instruction in electronics and radio is being given (uh-huh), expanding work has created need for a considerable number of additional well-qualified radio instructors. Only qualified teachers with experience in instructing on the technical side of radio are wanted. A successful teaching record is perhaps as important in this work as technical radio knowledge. As a matter of fact, good teachers who are not quite abreast of modern electronics can be given special schooling to bring them up-to-date before engaging in the work.

We know what this project is but cannot publish details in *QST*. We can say, however, that it is work of national importance and that it offers opportunity for better-qualified teachers to locate at once in continuing and satisfying activity. Contract employment, not Civil Service or military. Good salary, commensurate with ability and former earnings.

For further information, give full particulars on yourself at once to G. W. Bailey, OSRD, 2101 Constitution Ave., N. W., Washington 25, D. C.

ELECTRONICS TRAINING GROUP FILLED

THE requirements of war change quickly. Notices in *QST* of opportunities available one month may be completely altered before publication. One example is the Electronics Training Group of the Signal Corps. Every month since its formation we have carried an article on its need for skilled amateurs, on the remarkable opportunity offered to acquire new technical knowledge. But while the presses were turning out the copies of our August number, announcement was made by the Signal Corps that no further civilians would be appointed to commissions in the ETG. The quota is filled.

Meanwhile the ETG is doing an important job on all fronts. Some day we hope to publish the story of the Group. Amateur radio operators made possible the formation of this Group, for which the original need was so urgent. These amateurs have made a splendid record, not only for themselves as members but for the Group as a part of the Signal Corps. No better demonstration has ever been given of the potential value of radio amateurs to the country than the enrollment of officers in this Group.

COMMISSIONS, MEN

RECENTLY the Signal Corps has announced that no further commissions in that Corps will be offered to civilians. Past appointments of that type, together with the officers being turned out

by the Officer Candidates School, are filling the requirements for technical officer personnel. The Army Air Forces have also announced that their requirements are filled. The Navy still offers a few opportunities for graduates of accredited colleges holding degrees in electrical engineering or physics. The Marine Corps also still makes appointments, but, as in the Navy, limits them strictly to holders of college degrees in electrical engineering or physics. Applicants uncertain as to their eligibility are invited to write for advice to the president of the League, G. W. Bailey, 2101 Constitution Ave., N. W., Washington 25, D. C.

RADIO ENGINEERS AND PHYSICISTS

THERE is still an urgent need for electrical engineers and physicists with radio experience, both young and old, to take places high in the important technical work of this war. There are still many opportunities for participation in work that is 100 per cent war effort and 100 per cent important. Do you feel that you are doing all you can do and should do in this war? Would you like an opportunity to investigate quietly, without disturbing your present connections, the possibility of employing your highest talents in greater usefulness? Responsible people in responsible jobs, capable of exercising technical leadership or possessing outstanding qualities as individual workers, are invited to write under personal cover to the president of the League, G. W. Bailey, Technical Aide to the Director of the Office of Scientific Research & Development, 2101 Constitution Ave., N. W., Washington 25, D. C. Strict confidence will be preserved with all correspondents and the opportunities will be mutually explored.

ATTENTION, INDUCTEES

OCCASIONALLY ARRL Hq. knows of a branch of the armed services in need of men with amateur radio experience. If you are about to be inducted and are not certain of assignment to radio duties, we would be glad to assist in bringing your availability to the attention of the proper authorities if we have any requests pending at the time. Of course we can offer no definite assurance of such assignment, since the decision must necessarily lie with the military.

Should you wish League assistance, telegraph us the following information immediately upon induction and during pre-assignment furlough: name, age, call, radio experience and license held, *military serial number*, date of induction, date when your pre-assignment furlough ends, and full address of the reception center to which you will report. We shall pass on your dope if we have any "takers" at the time, so that the necessary ar-

rangements may be made. We emphasize that we must have the full information well ahead of the time you report for duty.

WOMEN NEEDED

TO THE best of our knowledge at press time, every one of the opportunities for women reported last month is still open. The WACs, WAVES, SPARS and Marines still want recruits, still give splendid radio training, still have commissions available for qualified college women. As far as we have heard, the Signal Corps has not yet filled its quota for the WAC Signal Corps Trainees, described on page 44 of our last issue — the plan under which enrolled WACs are given inactive duty, trained from three to six months in Civil Service status with pay at \$100 a month or so while learning the stuff the Signal Corps needs, then being called to active duty in the WACs with uniform and all.

From the Civil Service secretary at your post office you may also obtain information on the Signal Corps program to train women as civilian acceptance inspectors for duty in factories producing military communications equipment. There is an instruction course of six weeks, but pay at \$1752 a year starts when the trainee begins the course and there are good opportunities for advancement and increased pay.

Women already possessing technical radio training can be put in touch with important technical work directly connected with the war by writing Mr. George W. Bailey at 2101 Constitution Avenue, N. W., Washington 25, D. C.

MERCHANT MARINE OPERATORS

WE ARE very pleased to receive reports of an increasing number of amateurs interested in brasspounding in the Maritime Service, since we believe this is one of the most important contributions that an amateur can make. Superb training is given at a crack school to remedy any deficiencies in knowledge, and there is plenty of action in the seagoing life these days. For further information, we would like to refer those interested to the comprehensive article "QST Returns to Gallups Island" in our May issue, particularly page 90 thereof. And if you live in a large city there is probably a Maritime Service enrolling office near you, or you can get further information direct from The Commandant, U. S. Maritime Service, Washington, D. C.

RADIO OPERATORS, LAND

BOTH the FBI and the CAA still need radio operators, as do some other government agencies. These are Civil Service jobs, for duty on dry land. Full information is to be had from any district office of the Civil Service Commission, from its headquarters at Washington, or at any first- or second-class post office.

COMMERCIAL OPPORTUNITIES

THE need for good radio men continues. Industrial expansion develops new departments which must be staffed with experienced personnel and the immediate needs of the war effort do not

allow much time for the instruction and schooling of green men. The emphasis is on men with college degrees in physics, electrical or electronics engineering, or, lacking that, plenty of hard practical radio experience backed up by a commercial license or two. Many radio manufacturers are finding that women not only make good workers on delicate assembly jobs but are also competent laboratory technicians and assistant engineers. We now receive fewer calls for operators and service men, although a commercial air line or manufacturer occasionally asks our Personnel Bureau for names of available candidates on file.

If you are not working at your highest skill and can readily change positions without running afoul of your draft board, list your qualifications with the ARRL Personnel Bureau. It operates for your convenience and as one of the League's activities contributing to the war effort. If you have had special training in a field supplemental to radio, by all means tell us about that too: requests for radio personnel with added experience in aerology, under-water sound detection, seismology and other scientific fields have been received, and if we cannot refer your name to an interested manufacturer we can pass it along to some agency in closer touch with those needs.

A word about draft status. It is not the policy of concerns in vital defense work to request draft deferment for men who have been with them less than six months, even in key positions; and if you are in I-A, prospective employers will not take you and ask for reclassification. If you are in II-B or other deferred status but liable to reclassification in case you change positions, the new employer is still not interested. You must go to a position of higher skill, and since the interpretation of what constitutes higher skill may vary considerably, it would be well to consult your local board before changing jobs.

Employers shy away from applicants currently engaged in Civil Service or under contract with government agencies, even though the new position may — and usually is — one of higher skill. It smacks of "pirating" and the employer definitely wants to avoid possible kick-backs. If you are determined to quit government employment in any case, do so first or get a statement from your bureau chief that you are free to leave "without prejudice."

There are still plenty of good high-priced jobs going begging for the right man. If you are available, write for a "Registration of Personnel Availability" blank. If your status is uncertain, write us the facts and we will advise you.

Strays

According to the War Department, 91 out of every 100 men in the Army are specialists. To help fill the demand for men with a technical background, half a million high-school youths are now receiving pre-induction training. Of every 100 such high-school graduates, 60 will enter the Army.

A V.H.F. Transmitter for Emergency Service

A Simple Stabilized Push-Pull Oscillator Rig

BY LT. COMDR. R. R. HAY, USN, AND
LT. (JG) W. A. HARPSTER, USN*

THE transmitter described herein was built from salvage parts as an emergency rig, pending the delivery of permanent equipment. Despite this fact, it has stood up under twenty-four-hour service for several months while exposed to the weather and to considerable vibration and shock.

Frequency stability is adequate for reception on a superheterodyne receiver. In this respect, the unit is considerably better than the usual run of modulated oscillators.

The transmitter was constructed in two units, one for the r.f. section and one for the modulator and power supply. As shown in the photograph, the r.f. section is mounted on top of the modulator and power-supply section. However, it might be placed in any desired remote location, such as the roof of a building.

*c/o Fleet Post Office, New York, N. Y.

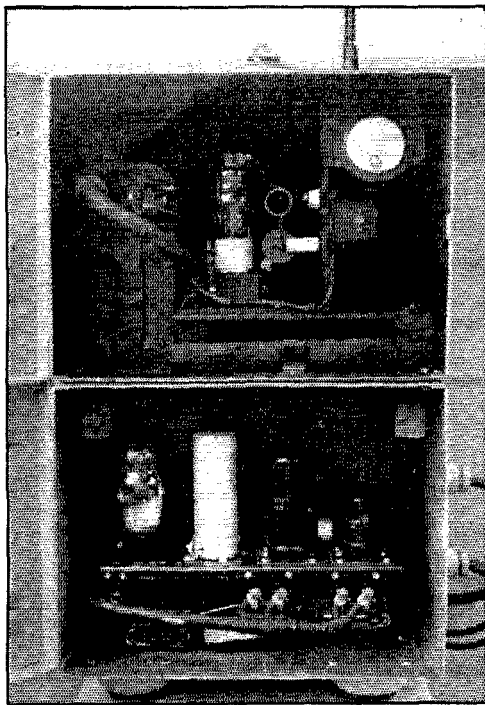

A 2 $\frac{1}{2}$ -meter emergency transmitter built chiefly from salvage parts. The upper compartment contains the r.f. unit and filament transformer, while the lower section houses the power and audio equipment. Interconnections are made through the cables at the right.

Power Supply and Modulator

A discarded broadcast receiver provided the parts for the power supply and modulator. The original audio amplifier had a Class-AB output stage, using two 6L6s. Removing one 6L6 left us a 6-watt Class-A modulator and reduced the load on the power supply sufficiently to provide power for the r.f. section. As shown in Fig. 1, a 6SJ7 is used in the first stage to give enough gain for a dynamic microphone, while two VR-150 tubes are used to stabilize the plate voltage at 300. The original push-pull output transformer is used as a 1:1 autotransformer to couple the modulator to the oscillator. The secondary winding is not used. A series resistor, by-passed for audio frequencies, drops the oscillator power input sufficiently to permit about 70 per cent modulation, which appears to be adequate for good speech transmission.

A salvaged chassis and cabinet from an old Antennaplex amplifier were used as the mounting for this unit. On the side of the cabinet are mounted the power-supply switch, the "push-to-talk" switch and the microphone jack. The "push-to-talk" switch is arranged to cut out the speaker of the receiver used with the rig while the carrier is on. The gain control is adjusted by screwdriver and is mounted on the chassis. The edge of the cabinet door was made weather-tight by a strip of adhesive tape, which was applied after all internal adjustments were completed. The a.c. supply leads, microphone connections and connections to the r.f. unit are all brought into the cabinet through sealed watertight fittings.

R.F. Section

Since the complications of a multi-stage r.f. unit were not deemed necessary for the purpose, an RK-34 tube was used in the push-pull modulated-oscillator. A separate filament transformer for this tube was mounted close to the socket, so that the rest of the power supply need not be mounted close to the r.f. unit. The transformer shown in the photograph is homemade; it happens to be about three times the normal dimensions because the only core available was of a larger size than required.

The remainder of the r.f. unit is mounted on an inverted T-shaped chassis. The vertical portion supports the plate choke and by-pass condensers, tank-circuit components, the antenna coil and condenser, and the plate milliammeter. The horizontal portion serves as a base and holds the tube socket, grid choke and filament by-pass con-

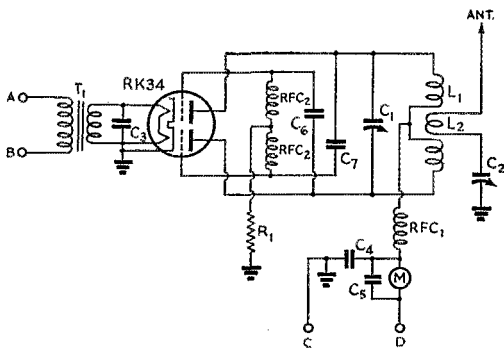

Fig. 1 — Circuit diagram of the two units of the v.h.f. emergency transmitter.

- C₁ — 10 μ fd., approximately (see text).
- C₂ — 100 μ fd.
- C₃ — 0.01 μ fd.
- C₄ — 500 μ fd.
- C₅ — 0.002 μ fd.
- C₆, C₇ — 20 μ fd. (see text).
- C₈ — 12 μ fd., 450 volts.
- C₉, C₁₀ — 8 μ fd., 450 volts.
- C₁₁ — 10 μ fd., 75 volts.
- C₁₂ — 8 μ fd., 200 volts.
- C₁₃ — 0.01 μ fd., 600 volts.
- C₁₄ — 0.1 μ fd., 200 volts.
- C₁₅ — 10 μ fd., 20 volts.
- R₁ — 5000 ohms, 2 watts.
- R₂ — 50,000 ohms, 1 watt.
- R₃ — 25,000 ohms, 2 watts.
- R₄ — 500 ohms, 10 watts.
- R₅ — 200 ohms, 10 watts.
- R₆ — 1 megohm, $\frac{1}{2}$ watt.
- R₇ — 250,000 ohms, 1 watt.
- R₈ — 1000 ohms, 1 watt.
- R₉ — 500,000-ohm potentiometer.
- R₁₀ — 500 ohms, 2 watts.
- R₁₁ — 1 megohm, 1 watt.
- L₁ — 4 turns No. 10 wire, $\frac{3}{4}$ -inch diameter.
- L₂ — 2 turns No. 12 wire, $\frac{1}{2}$ -inch diameter.
- L₃ — 15 henries, 200 ma.
- F — 2-ampere fuse.
- J — Closed-circuit jack.
- M — Milliammeter, 0-250-ma.
- RFC₁ — 30 turns No. 24 d.s.c., $\frac{1}{4}$ -inch diameter, center-tapped.
- RFC₂ — 60 turns No. 30 d.s.c., $\frac{1}{4}$ -inch diameter, center-tapped.
- T₁ — 6.3-volt filament transformer.
- T₂ — Power transformer, 375-0-375 volts, 200 ma.

denser. The chassis is mounted on a base of wood, supported on sponge-rubber blocks. The whole unit is carried in a cabinet similar to that of the modulator and power supply.

The tank coil for the oscillator is self-supporting and is wound of No. 10 copper wire on a diameter of $\frac{3}{4}$ inch. The spacing of the turns was adjusted experimentally to put the oscillator approximately on the desired frequency with the condenser plates in mid-position. The center of the coil is supported on a feed-through insulator which also serves to carry the plate-supply connection. The ends of the coil are soldered directly to the tuning-condenser terminals.

Two copper discs, about $1\frac{1}{2}$ inches in diameter, were used to construct the tuning condenser. One is mounted stationary on its stand-off insulator, while the position of the other is adjusted by means of a 10-32 screw which is tapped and

sweated into the disc at its center. A thin film of solder on the screw threads prevents vibration from changing the setting.

Antenna coupling is provided by a link of two turns of No. 12 wire mounted at the center of the tank coil. Rough adjustment of coupling was made experimentally. The wire was insulated with a piece of spaghetti tubing to prevent accidental contact with the tank coil.

The vertical antenna is supported by a feed-through insulator located in the top of the cabinet of the r.f. unit, and is connected to the antenna-coupling coil by a piece of copper braid. The length of this rod is not critical; about two feet of antenna gave good results.

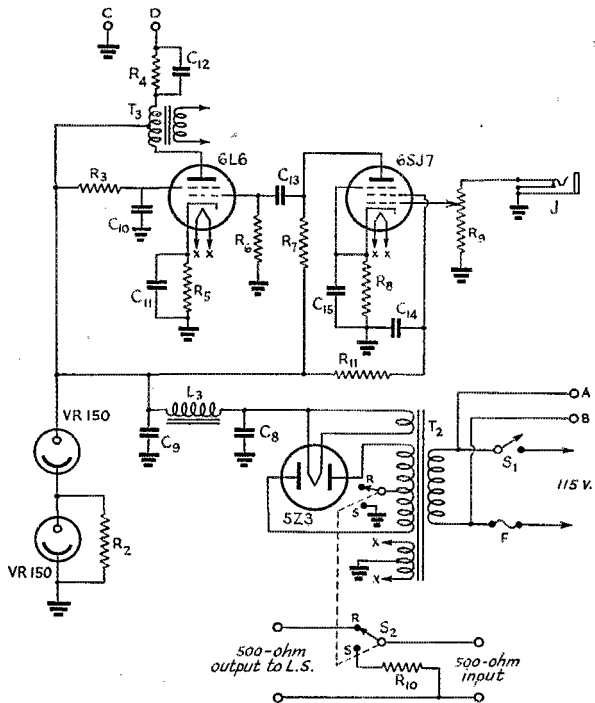

Adjustment

Adjustment of the transmitter is comparatively simple. The plate circuit is first tuned to the desired frequency, using an *insulated* screwdriver. The antenna condenser is then adjusted for correct plate current and the plate tuning readjusted for any change in frequency. Adjustment to the correct value of plate current, as determined by test, is important if good modulation is to be obtained. In this case it was 80 milliamperes, but the value will vary with frequency, plate voltage, characteristics of individual tubes, etc. The grid condensers, C₆ and C₇, preferably should be variable in order to control the feed-back.

Care should be taken that both sections of the tube are adjusted for the same plate current. This can be done by removing one plate cap while the

(Continued on page 69)



EXPERIMENTER'S SECTION

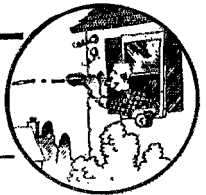

Address correspondence and reports to ARRL, West Hartford, Conn.

PROJECT A

Carrier Current

ALTHOUGH carrier current is not radio communication and so does not come under the provisions of FCC licensing, there is one important restriction upon its use. If you live or maintain your equipment within the boundaries of prohibited zones designated by the Army, or within restricted zones as outlined by Public Proclamations Nos. 1, 2 and 3 of the commanding general of the Eastern Defense Command (or corresponding proclamations issued for other areas), then you are prohibited from having *any signal device* in your possession without special military authorization. That includes carrier-current transmitters and receivers, as well. In fact, the restriction covers any equipment capable of being used for reception of amplitude-modulated radio waves above 1750 kc. or below 540 kc.

Copies of the public proclamations abovenamed are displayed for public inspection at every Selective Service local board, post office, court house, and at every town hall within the military area. It is up to you to find out whether your location is in a prohibited or restricted zone and be governed accordingly.

I would like to get in touch with anyone in Flatbush, Brooklyn, who is interested in carrier current communication. I am now building the rig described in *QST* for March, 1942. — *James H. Rosenquist, 1182 E. 35th St., Brooklyn, N. Y.*

For about two months I have had a 25-watt Hartley using an 809 on 134 kc., but as yet I haven't had any QSLs. I'm using the call WW9NW and sending my address frequently. So far I haven't put together a receiver, but I would like to hear from anyone interested in carrier current in the Chicago area.

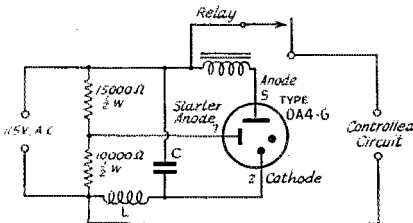

Fig. 1 — Circuit diagram of the carrier-current remote-control device described by Charles Compton.

I'm using i.c.w., with 650 volts a.c. on the plate, drawing 40–50 ma., and putting out a good broad signal with some drift, as the components heat up quite a bit. I'm going to shift the frequency up to 175–200 kc. occasionally to see what results, if any, I get there. — *Norman H. Williams, 1535 Lake Ave., Wilmette, Ill.*

I have been reading the Experimenter's Section with reference to the wired wireless articles and am very much interested. I have quite a few transmitting and receiving parts. I have noticed that quite a few fellows interested in w.w. are in the East. Do you know of any in the Chicago area? If not, would you put my name in *QST* one? I think that if we could get this thing going it would keep a lot of the hams together. — *Don Nolde, 2800 N. Leavitt St., Chicago, Ill.*

I have read the article in June *QST* on carrier current transmission and am very much interested. — *Eugene Bush, jr., 4 Bowles Pl., Oakland, Calif.*

Ever since I first read of the c.c. work being done by some of the hams, I wondered just how many of them were using the OA4-G for signaling. While not at present engaged in c.c. work, my interest has been prompted along that line. In the July, 1943, issue of *QST*, WW8DMD asks how he can turn on another receiver which is remotely located. Well, the OA4-G was made just for that application.

The circuit is shown in several communications books and is included herewith (Fig. 1). It has been put to practical use in the remote control of power-line operated equipment.

Obtaining the OA4-G tube will be difficult at this time, since it is used extensively in many circuits vital to the war effort, but some stores may have a couple left on their shelves.

Technically known as a gas-triode starter-anode tube, the OA4-G receives a relatively small amount of electrical energy supplied to the starter-anode circuit, initiating a glow discharge between the cathode and the starter-anode. The discharge produces positive ions which assist in initiating the main discharge between the cathode and anode. The anode current flowing during the cathode-anode discharge actuates a relay or other circuit connected in the anode circuit. It is particularly applicable to c.c. work because the discharge can be initiated with little energy, and therefore it is practical to use remote-control impulses generated at r.f. and transmitted over the same power line.

(Continued on page 66)

At China's National Amateur Convention

The pictures on this page were made at sessions of what is probably the only national amateur radio convention to be held anywhere in the world in this year of war. Furthermore, they show members of the national amateur organization of the only one of the United Nations in which amateur radio stations as such are still permitted to function.

China's radio amateurs, numbering to-day in the thousands, have been on the air throughout the war. A radio net with outlets throughout Free China is in regular operation. This net was organized even before the outbreak of the Pacific war, to provide communication between the scattered cities dotting China's vast expanse. Its stations in Occupied China are now, of course, silenced, but those in Free China carry on. They represent the only means of communication between many wide-spread parts of the country, and are officially credited as a great asset to the Chinese government in the prosecution of the war.

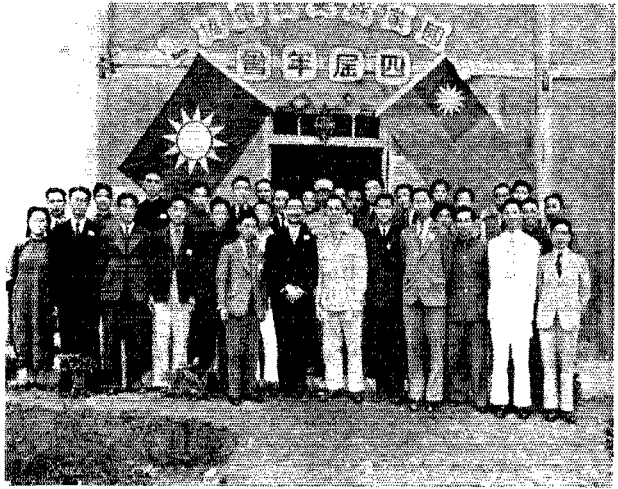

Above — Before starting their Fourth Annual Convention, members of the China Amateur Radio League (Chungking Division) line up in front of their "ham shack" — the well-equipped building containing their headquarters offices, club room and radio station.

Left — In the typical Chinese setting of the club room at the Chungking headquarters of CARL, Glen Akins, W3ART, U. S. OWI radio technical representative in Chungking, discusses the theory of radiophoto transmission. Seated near him (facing the group) is K. T. Chu, vice-president of CARL and technical adviser on communications matters to the Chinese National Resources Commission.

Below — As part of the convention program, CARL members tour the radio manufacturing plant of the National Resources Commission. Here they are seen inspecting the manufacture of variable gang-tuning condensers for military use.

Official OWI photos

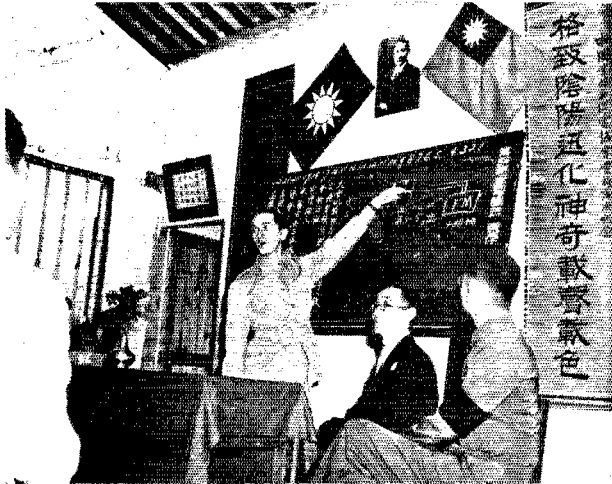

In recognition of this achievement, the Chinese government designated May 5th of this year as official China Amateur Radio Day, and on that day the Chinese Amateur Radio League held its Fourth Annual Convention. To make it truly national in scope, despite the handicap of war conditions, a number of district meetings were held simultaneously in various regional centers, under the common auspices of the national headquarters at Chungking. Greetings were transmitted between these district conventions and discussions exchanged by means of the amateur net, which operated throughout the convention. Over this network also was relayed a program of greetings from U. S. amateurs, transmitted to China via radio through the agency of the U. S. Office of War Information (see *QST*, July, 1943, p. 49). The program included technical sessions, and displays of ham radio gear, literature and miscellany contributed by amateurs of other nations (*QST*, April, 1943, p. 47).



The QRR Portable

A Transmitter-Receiver for 40 and 80

BY PAUL J. PALMER,* W8UGR

"Hi there, fellers," said Tuffy 6L6G. "Dis guy 8UGR musta got some Scotch in 'im. He's so tight he cudn't git me inta his lunch box. Sed I wuz too fat in de hed—de noive o' sun peeples brats. Soooo, me skinny brudder 6L6 gits th' chanct. He's purty near's gud's me. Oh, yeah, meet de kid sister, 6F8G—she's de yodder half o' de combination. Dem two's oke'n' dey'll do right well by ya in a blow er sumpin, 'sides bein' just de ticket fer dat field-day picnic—'member 'em? Say, dis rig's been used on de nets 'n' done swell. O'course y'can't put de putter-outer part on de air rite now, but better days is comin'—remember dat! S'long, -gang . . . dis stooge o' 8QBW's sure tinks he's sumpin', but it'll be a helluva spell 'fore enybuddy takes Fred's place. Oh, oh, here's P. J.! Mum's de woid wot I tole ya else he'll pick on me—de big bully."

AS WITH Fred Sutter's little rigs, an effort has been made to provide a portable transmitter-receiver unit requiring but little space and a minimum of power-supply equipment. The QRR is a rig that the OT as well as the tyro can use. The receiver section can operate either from a small a.c. pack or from a 3-volt dry-cell "A" battery and a small-size 45-volt "B" block, while a vibrapack, small genemotor or a.c. unit will supply the power necessary for the transmitter.

* 868 Whittier Blvd., Grosse Pointe Park, Mich.

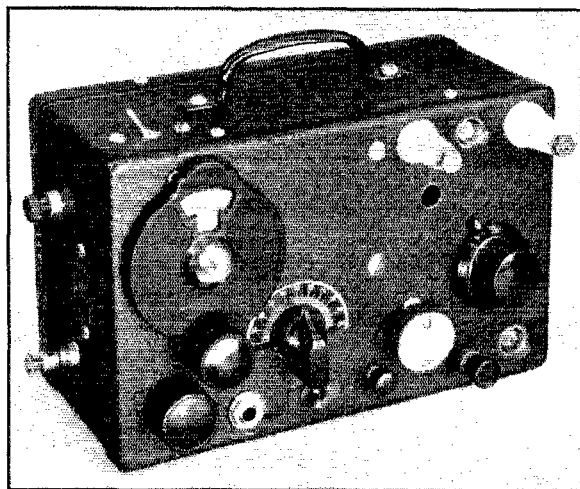

Panel arrangement of the QRR portable. Receiver controls (at the left) include regeneration control, tuning dial and band-set condenser knob with scale. The crystal socket and tuning knob for the transmitter tank circuit are at the right. Dial lamps substitute for tuning meters. The toggle switch on top is the 80-40-meter bandswitch. Power socket and antenna-ground terminals on the left.

In an emergency, several blocks of 45-volt "B"s could be used for plate supply; for QRP work a single block will do.

The case shown in the photographs is 5½ inches high, 8½ inches wide and 4 inches deep. In the event one cannot be purchased, it is a simple matter to build a case out of sheet metal. The back should be covered to keep out dirt. Self-tapping sheet-metal screws may be used. A handle should be provided for carrying purposes.

The portion of the case occupied by the receiver measures 4½ inches in length. A small metal chassis, 2 inches wide and 4½ inches long with ¾-inch turned-down flanges, carries the coil and tube sockets. The audio transformer is mounted on the shield separating the two compartments. The bandset, bandspread and regeneration-control condensers are mounted on the front panel. The 'phone jack and the send-receive switch, which cuts the plate voltage from the receiving tube during transmission periods, are mounted close to the lower edge of the case.

Receiver Circuit

The circuit of the receiver, shown in Fig. 1, is the old tried-and-proved triode regenerative-detector and audio-amplifier arrangement, in which the two sections of a single 6F8G dual triode are used to perform both functions. The grid inductance is tapped for a turn-shortening switch, mounted on top of the case, so that both the 40- and 80-meter bands can be covered without changing coils. With this particular circuit and the 6F8G tube, it has been found that best operation is secured by using only 3 volts on the heater. This permits operation from two 1½-volt dry cells, a 3-volt "A" battery, or from the center tap of a 6.3-volt filament transformer. No volume control is needed, since the output can be controlled by the degree of regeneration. Headphone volume is excellent.

The grid coil for the receiver, L , is wound on a standard 1½-inch plug-in form. The cathode tap should be so placed that, when oscillation starts (as indicated by a light rushing noise), the rotor plates of the regeneration-control condenser, C_3 , will be about half meshed with the stator plates. If it is not possible to hear c.w. signals, or if 'phone signals can be received without any regenerative "squeal" with the regeneration-control condenser at full capacity, the cathode tap on the coil should be moved nearer the top, or grid, end of the

coil. If, on the other hand, the regenerative whistle cannot be stopped by turning C_3 to minimum capacity, the tap should be moved nearer the ground end of the coil. The band-selecting tap for the shorting switch should be placed so as to give the desired coverage. Coil dimensions used in the original model are given under Fig. 1.

Tuning and Calibration

In tuning the receiver for the first time and when calibrating band coverage, condenser C_2 should be set at minimum capacity and condenser C_1 rotated towards maximum until the high-frequency edge of the band is found. Since signals of known frequency are now difficult to find in the amateur bands, other means may have to be employed if calibration is desired. If you have access to a communications receiver, it is possible to calibrate this receiver by listening on the communications receiver for the signal generated by the oscillating detector and spotting its location on the frequency chart of the latter. A calibrated wavemeter or an r.f. generator of the type used for aligning b.c. receivers will serve the same purpose. By setting the oscillating detector at various frequencies within the tuning range, one can make up a curve which will enable the operator to spot commercial, police, or known government frequencies as published in *QST*.

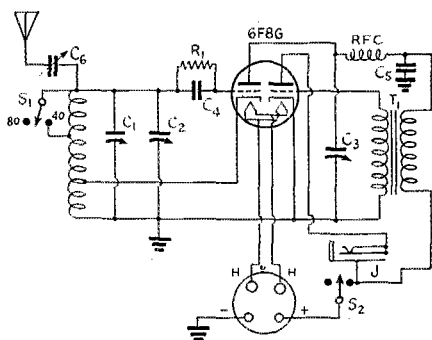
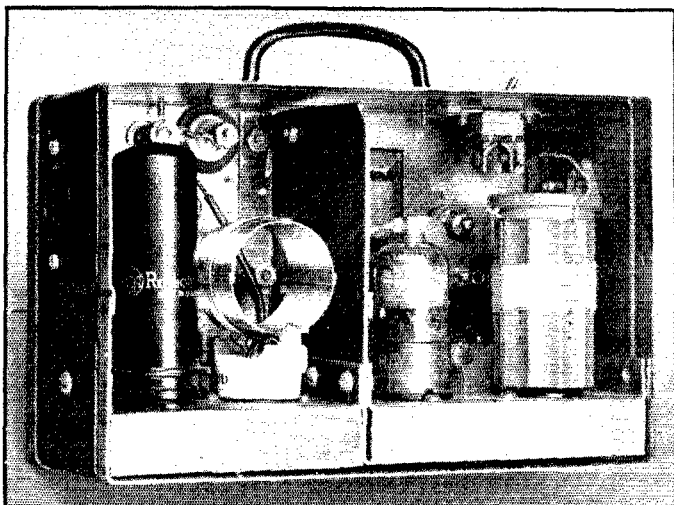

Fig. 1 — Circuit diagram of the receiver section of the QRR portable.

- C_1, C_2 — 100- μ fd. variable.
- C_3 — 15- μ fd. variable.
- C_4, C_5 — 100- μ fd. mica.
- C_6 — 30- μ fd. mica trimmer.
- R_1 — 1.5 megohms, $\frac{1}{2}$ watt.
- J — Open-circuit jack.
- Rfc — 2.5-mh. r.f. choke.
- S_1, S_2 — S.p.s.t. toggle.
- T_1 — 3:1 audio transformer.
- L — 28 turns $1\frac{1}{2}$ inches diameter, $\frac{3}{4}$ inch long (No. 24 d.c.c. close-wound), tapped at 4th turn from ground end for cathode connection and 14th turn from ground for bandswitch.



Rear view of the QRR portable showing transmitter and receiver compartments. Coil and tube sockets are submounted on bases bent up from sheet metal.

When the receiver is tuned to frequencies at which the antenna is resonant, the antenna may take so much energy from the receiver that it cannot oscillate. This will result in spots in the frequency range at which no c.w. signals can be heard. These spots can be minimized by adjusting the antenna condenser, C_6 , reducing its capacity with the adjusting screw until the detector again oscillates. For any given band of frequencies, condenser C_6 should be set so that the detector oscillates over the whole range, using as much capacity as possible. This will give the best compromise between "dead" spots and signal strength. Also, less frequent adjustment of the regeneration-control condenser will be required at the high-frequency end of the range.

A suitable antenna for the receiver would be a wire 50 to 75 feet long and as high as possible. This antenna can also be used for the transmitter, when transmission again becomes permissible, by employing a single-pole double-throw switch in the antenna-tuner unit (which may be required for the transmitter, as will be mentioned).

Transmitter Circuit

The circuit for the transmitter, which occupies the other half of the case, is shown in Fig. 2. It is the simple tetrode circuit used so successfully by Fred Sutter. The circuit components are the same as those used by him in his "Runt Sixty."¹ There is a small chassis, measuring $2\frac{1}{2}$ inches wide and $3\frac{3}{4}$ inches long, for the coil and tube sockets. A small cut-out in front of the 6L6 may be required to provide clearance for the tank condenser, which is mounted on the panel with insulating washers around the shaft bushings. At the right side of the panel are located the crystal socket, tank-condenser knob and the two feed-through insulators which form the antenna

¹ Sutter, "The Runt Sixty and the QSL 60," *QST*, p. 50, September, 1939.

terminals. The key terminals are on either side of the crystal socket; one of these must be insulated from the panel. The plate-current indicating bulb, B_2 , is in the lower-right-hand corner. Another bulb has been provided for antenna-current indication, while a third, B_1 , may be used in series with the crystal to obtain an indication of r.f. crystal current.² The antenna terminals can be connected directly to the antenna feeders, if they are close to one-quarter wavelength or an odd multiple of one-quarter wavelength long; or an antenna tuner can be mounted directly on the terminals, if desired, so that any type of antenna can be used.

At each end of the case there is a four-prong power-supply socket, one for the receiver and the other for the transmitter. This is done to segregate these circuits and to aid in preventing interference between them. However, a common plate supply could be used if the output voltage does not exceed that permissible for the receiver.

By placing a 6C5 triode in the transmitter tube socket and using 22½ volts on both receiver and transmitter, the rig can be used as a fine code-practice oscillator. The signal from the transmitter is then weaker than that produced by the oscillating receiver, but it is still sufficient to operate the receiver at good volume. The rig could also be used for testing other receivers in the same room or dwelling. Some crystals might require higher plate voltage on the 6C5, since the activity varies with different crystals; this can be ascertained by test. When using the rig in this way, disconnect both the transmitting and receiving antennas to minimize the possibility of radiation. By using only half the rated filament voltage on the 6C5, any overly strong output from the transmitter is reduced.

² Sutter, "What, No Meters," *QST*, October, 1938. See also p. 62, *QST*, March, 1939.

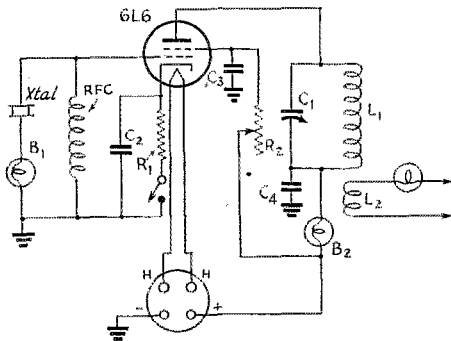

Fig. 2 — Circuit diagram of the QRR transmitter.

- C_1 — 100- μ fd. variable.
- C_2, C_3, C_4 — 0.01 μ fd.
- R_1 — 200 ohms, 10 watts.
- R_2 — 25,000 ohms, 25-watt variable.
- L_1 — 21 turns No. 18, 1½ inches diameter, 2 inches long (or manufactured 80-meter coil) for 3.5 Mc. 15 turns No. 18, 1½ inches diameter, 2 inches long (or manufactured 40-meter coil) for 7 Mc.
- L_2 — Two- or three-turn link winding.
- B_1 — 60-ma. dial lamp.
- B_2 — 60- or 150-ma. dial lamp.

Radar — Now You Read About It and Now You Don't!

THE ban on radar publicity, officially lifted by the joint Army-Navy pronouncement of April 25th (*QST*, June, 1943, p. 51) is now on again — at least so far as the War Department is concerned.

This newest phase of radar's in-again out-again career as a military secret results from memoranda to manufacturers and the Army public relations staff directing the withholding of "approval for publication" of individual publicity articles and advertisements, rather than as a blanket edict of censorship. Its effect, however, is to veil the subject in secrecy almost as complete as that which was imposed following the initial disclosures in 1941.

Speculation in industry circles is to the effect that the action was inspired primarily by the sensational advertising of certain manufacturers claiming unwarranted credit for radar development. A further aggravation was controversial publicity issued by various individuals and firms (as well as by government and military agencies). In this connection, Col. J. T. Winterich, chief of the War Department's Review Branch, recently stated in a letter sent to a number of radio-radar prime contractors: "Other types of publicity have promoted controversy as to the allocation of credit for the development of radar. This has not been conducive to cooperation at home and abroad — cooperation which is essential to the winning of the war."

Thus again unbridled irresponsibility on the part of one or two flagrant opportunists results in hampering the legitimate activity of the serious and responsible workers in the field. Although aimed primarily at advertisers and contentious claimants for credit, regrettably the ban also serves to suppress *bona fide* reporting of non-secret details by technical publications. While, significantly, the controversial advertising and publicity has appeared almost entirely in the daily press and general magazines (*QST*, it should be noted, having carried none of it) the technical press suffers equally under the blanket ban.

The War Department order not only proscribes all advertising of radar but also instructs its review branch to "discourage writers from using radar as a subject, appealing to their patriotism, etc.; . . . clear no radar publicity whatever that originates in any agency of either of the armed forces; . . . refuse to recognize the principle of prior publication where radar material is involved; . . . disapprove publication of any pictures, sketches or diagrams of radar installations or parts; . . . delete all controversial material involving national or personal credit for the invention or development of radar; . . . do not clear articles or advertisements on specific lines of successful electronics research."

It looks as though you won't be reading much about radar (or any of the other new electronic developments) for a while.



CONDUCTED BY E. P. TILTON,* W1HDQ

THE wide distribution of WERS licenses shown on the wall map in the ARRL Headquarters office suggests that WERS operation might well serve a secondary, and purely amateur, purpose — that of providing those of us interested in following the vagaries of v.h.f. wave propagation with an opportunity for continuing our observations. While the service performed by WERS units is not such as to encourage long-range operation, in most cases it would seem that the average installation is probably not much different in its possible coverage from its amateur predecessors in the 112-Mc. band; hence, the presence of anything abnormal in the way of v.h.f. conditions during a WERS test period could easily produce some interesting results for the careful listener. We would be glad to have reports of anything unusual in the way of reception of WERS signals.

— —

Remember Perry Ferrell who used to cook up those interesting notes on v.h.f. conditions in *Radio*? He'd still like to hear from his old correspondents, but his address is no longer Pleasantville, N. J. He informs us, via V-Mail, that he is now Pvt. Perry Ferrell, APO 631, c/o Postmaster, New York City. He'd particularly like the whereabouts of W6QLZ. The last we heard, Clyde was attached to the veterinary hospital, Ft. Bliss, Tex.

One of the old Ozark Five-Meter Net, W9VAV, writes that he has run into hams from all U. S. call areas, K4, K5, K6, K7, VE, XU and G since he's been in the service, but the only 56-Mc. man to date was W9HAQ, whom he met in New York. Roy's address: Staff Sgt. Roy Hutson, Hq. & Hq. Sqd., ADD, AAFSAT, Orlando, Fla.

After a line from the Ozark Net, we counter with another from one of the Horsetraders. W1KFA writes that this department seems like a personal message from home, with its frequent mention of familiar names and calls recalling happy days on Five. He'd like to see a list of the Horsetraders, giving their present whereabouts. There are many we don't know about, but we do know that they are spread well around the world! W1KFA is communications officer with the 31st Troop Carrier Squadron at Bergstrom Field. Address: Lt. Morris Kasanof, AC, 31st T. C. Sqd. 89th T. C. Group, Bergstrom Field, Delvalle, Tex.

The training now being given thousands of hams and future hams in the armed services is bound to have a profound influence on the shape of things to come in the amateur picture. W1MEP, now completing his radar training, says that he's chock full of ideas for his ham station of the future. Chet writes that he has changed outfits again, his new address being: Cpl. George C. Mallory, 564 S.A.W. Bn., Co. A, Drew Field, Tampa, Fla.

From W8FGV, now in his second year in India, we hear that *QST* arrives rather irregularly over there. In a letter dated July 11th (not bad service — it was received here on July 26th) Frank says that he had just received his May issue. He hopes that February, March and April will be along any day now! As a result of our publicizing his address, Frank reports that he has heard from quite a few of the old gang, but that he has lost most of their addresses. He doesn't tell us just how it happened, but he worked his way up the ladder, got himself an honorable discharge, and has now been sworn back into the Army as a warrant officer. Frank's new address: W. O. Frank Platner, APO 884, c/o Postmaster, New York City.

Experimenter's Section

(Continued from page 60)

In the circuit shown, by means of the bleeder tap the starter-anode is maintained at a potential just below that required for breakdown. When a carrier having the frequency of the tuned circuit, *LC*, is impressed across the power line, a resonant voltage appears across *L* and *C*. (The *L* and *C* values should correspond with the values in the tuned tank circuit of the c.c. rig.) The effect of the voltage across the condenser, *C*, is to increase the negative potential peaks on the cathode, and thus to increase the potentials between the potentials between the cathode and the starter-anode. The peaks start a discharge between cathode and starter-anode. This discharge produces free ions which enable the discharge to transfer to the anode, if the circuit values are such that sufficient starter-anode current flows. Because a.c. is supplied to the anode, the OA4-G ceases to discharge when the carrier is off.

By putting the carrier on the wire, a receiver or other device may be operated at the remote position. In the case of WW8DMD, not only might he put the receiver at WW8JHD in operation but also he could put the WW8JHD transmitter in condition to operate.

The circuit values shown have been used successfully in commercial work. It is desirable to have at least 200 microamperes flowing in the starter-anode circuit for actuation of the relay circuit. For relay service, it is desirable to limit the peak anode current to about 100 ma. and the d.c. cathode current to 25 ma. maximum. The peak a.c. starter-anode voltage should be 70 volts maximum and the peak r.f. starter-anode voltages should be 110 volts minimum.

I would appreciate hearing from anyone in the vicinity of Mineola, Long Island, N. Y., who is interested in c.c. — Charles G. Compton, Albertson, L. I., N. Y.

* 329 Central St., Springfield, Mass.

Unfit for Further Service

A Short Story

BY "HELIOS"

I WONDERED why the battered radio tube should occupy such a prominent position. It rested in a small glass case. Just an old radio tube! The glass envelope was scratched, the base chipped; but, in spite of obvious rough usage, the glass was not broken. On the composition base I could just make out the letters "KYKO."

Then I looked at the card in the show case. It told, briefly, what had brought that old radio tube to a place of honor in Bagley's "Strange Facts Museum." But the printed facts were only fuel to the fires of my imagination. Mr. Bagley himself could tell me little more, since he had but checked the authenticity of the stories which had followed that tube over the world and brought it at last, a battered relic, to his famous collection. I resolved right there to check up on every bit of that queer story and obtain first-hand information from the persons concerned.

It took a long time, a lot of luck and some pure coincidence. But here at last are my findings — the story of a radio tube and its wanderings.

STATEMENT OF BERT RANDALL, RADIO OPERATOR:

One day in May of '32 I was about a day's run off the Galapagos Islands, busy checking over some supplies that had come aboard the old *Roxbelle* at the Canal. She went down later off San Diego. I was checking supplies and, since there wasn't much room in the spare parts locker, I cleaned it out. The locker had a bunch of junk in it, for sure. There were some old tubes and other stuff. I remember testing the tubes and — since some of them were clear dead, burned out — heaving them out the porthole. Two of the tubes, a couple of old 201As, were "unfit for further service" — below the standard set for our receiver. Something prompted me to scratch the ship's call on the bases. Oh, I don't know why. I've never done such a thing before or since. But, you know — I'm kinda glad at that. I just scratched KYKO on the bases of the two old tubes and heaved them out. Never thought about it afterwards — until Bagley wrote me a few months ago. . . .

The next part of the tube's history was picked up at Albuquerque, where I found Asher, formerly

of the U. S. Air Corps and one of the survivors of that ill-fated survey flight from Balboa to New Zealand via the Pitcairn group.

STATEMENT OF JAMES ASHER, LT., AIR CORPS, USA:

Sure, I'll tell you all I know — only you probably won't believe me. You know, sometimes I don't believe it myself. Here's how it was.

We were flying about three thousand and having good going of it. Fifteen hours out of Balboa, and everything had been fine. Motors okay, radio conditions good and weather perfect. Then it happened. First the radio went on the blink. The receiver worked, but the transmitter wouldn't. Johnny Butler, our radio man, said there was something wrong that he couldn't fix in mid-air. We didn't worry, thinking we could get along without it.

Then one of those squalls came up that cause a flier so much grief. We battled on through it and kept to our course. But the storm got worse instead of better. Rain, wind — and not far below us, the raging waters of the Pacific . . . Only it didn't live up to its name that day. Tossed about in the air, somehow we managed to stay aloft. Hour after hour, flying through the storm. . . .

Finally, after some of the worst weather I've ever seen, the plane came out of it into bright skies. There was no rain and a much calmer sea. Things looked good again. A shot at the sun showed that we had been blown miles north of our course. The new course was plotted, and we turned towards the Pitcairn group.

Now, like too many ocean-hoppers, we had a landplane, with wheels — not a seaplane. However, near the famous Pitcairn there was a small island where we thought we could land.

We'd checked our gas supply right after the storm, and the gauges showed an adequate reserve. But the gauges weren't working properly, I guess. Anyway, about an hour later the gas in the tanks was measured again. Only enough was left for an hour's flying!

The two big motors were throttled down to save fuel. Our navigator and pilot went into a huddle. The radio transmitter still wouldn't work, although Butler tried to improvise repairs. Survey of the charts showed no islands in our calculated position. All we could do was to keep in the air — and try to spot a place to land.

Another danger loomed ahead. It was almost sunset, and when that blazing sun hit the horizon darkness would follow swiftly. Then we would be lost — flying in the dark, with only enough gas to carry us a few minutes more.

All hands searched the horizon for a possible island in that broad expanse of water. We checked.

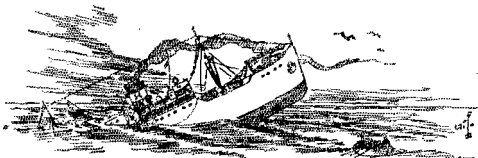

THE OLD ROXBELLE LATER WENT DOWN OFF SAN DIEGO

the gas continually, as if to stretch it out. Finally the pilot cried out:

"Hey, skipper! Land ahead! An island — dead ahead — about ten miles."

My heart lifted itself from my feet. There was a chance yet, if we could make a decent landing.

"Gas is almost gone, sir." That warning brought me back to our critical situation.

"Skipper, I'll just have to get her down — somehow. No chance to look for a soft spot." Merrill Parker grinned at me over his shoulder as he maneuvered the ship into a long glide toward the island, now growing steadily in size.

The right motor died first. That was an awful feeling! The plane glided on jerkily as the left motor started to cut. In a minute it, too, stopped. Parker had the ship under perfect control. I could feel his delicate movements on the controls as he tried to lengthen out the glide. The plane lost altitude. The island seemed to leap up at us.

There was no talking. Every eye was on the island ahead and below. Now the details began to appear. Swiftly a picture was painted in our brains, never to be erased. A small bit of land, not over a mile in length, and very narrow. A few stunted trees, lots of rocks and — a beach. It wasn't much of a landing field, but it looked large enough to get down on.

"Hold tight, boys — here we go!" Parker shouted. "Happy landings!"

Those were the last words we heard from Merrill Parker. For, after making a perfect glide to safety and as good a stall landing as possible, the ship rolled on the beach — and hit a rock! In an instant the plane flipped over on its back.

Parker? Yes, he got it. Parker, and Johnny Butler, too. Poor devils — they never knew what happened. Johnny still had his headphones around his neck and Merrill had a piece of the wheel in his hands.

But — well, anyway, we were down, and there were three of us still alive. Pete Hope, the copilot, Bob Newhall, our mechanic, and myself.

I won't go into detail about the first few weeks of our stay on the island. It wasn't any fun. Luckily there was water, and food of a sort.

Naturally, we dismantled the plane and carried what we could to our camp. The radio outfit was smashed into bits. Except for that, it wasn't so bad. The ship had been equipped with emergency supplies and there were some hand tools.

We estimated our location about three hundred miles north of the Pitcairn group — entirely off the steamer lanes. A large distress signal was flown on the highest point on the island, and fire was laid for a smoke signal if ever a ship was sighted. But none was. You see, ours was not an official army flight. No one would come out looking for us. By then we were long overdue, anyway.

We were busy, there on Flight's End, as we called our island. There wasn't much time to loaf

around or to think of what would become of us — except at night. Then I guess all of the boys did a lot of thinking.

We had been on the island just a little over six months when Pete Hope found the radio tube. We had gone to the beach, just fooling around, when suddenly Pete cried out, "Here — catch!"

I lifted my hand automatically and caught the object he had thrown. I didn't think about what it was and idly tossed it back. Then he yelled, "Hey — take it easy! This is a radio tube!"

"Sure," I said, still miffing it. "What of it?"

"It isn't from our set. This one isn't smashed! Where do you suppose it came from?"

I cleaned the scum off the tube. It was slimy with sea-growth. The base was battered from being tossed around in the surf. When the tube was clean we saw the letters "KYKO" scratched on the base.

"Must be the call of some ship. Wonder if it's any good?"

"Maybe — but how can you tell?" I asked Hope.

"Perhaps we can build up something to use it in — if it works."

You see, when we had salvaged the plane, Newhall had taken the dry batteries and the parts from the smashed radio set back to our camp. Some of the batteries were broken open and some seemed damaged beyond repair, but Bob had saved them all.

The day after Pete found the tube, Newhall came running up to

me and said, "That tube lights! I'm going to see if I can make some sort of a transmitter to use it in. I used to monkey with radio — a long time ago!"

Newhall set to work. He had plenty of parts to work with, but even an inexperienced radio man like myself could see that most of those parts were beyond repair. A couple of days later, Newhall told me he was pretty discouraged. The "B" batteries were OK, but the filament batteries had no life left. They wouldn't keep the tube lit very long. In fact, not long enough for him to get the set tuned up properly. We were stumped.

Then Pete Hope joined in the discussion. Neither he nor I really understood the whys or wherefores of radio more than enough to know how to operate one, but Pete said, "How about the storage battery in the plane?"

Newhall's face split in a wide grin. "That's it! The battery must still be in the ship. If it is, and if it still works —"

That storage battery was OK! It had been overlooked and left in the plane, but although the water was a little low, it still worked. Bob put some rain water in it. In a day or so he tested it again, and it gave off a good spark.

"I got a transmitter going, Jim," Newhall reported a few days later. "It's working OK, too; awful low power, but I'm going to try to send an SOS on it. I'll transmit on the distress wave for a while and then try near the ham bands."

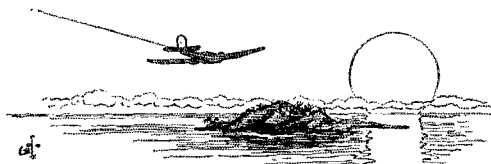

HE MANEUVERED THE SHIP INTO A LONG GLIDE TOWARD THE ISLAND

He came back awhile later with a long face. "Gosh, Jim, that damn tube burned out. All I got to send was SOS a few times on 600 meters and then a few more on what I figured was around 20 meters. Then the tube burned out, right in the middle of an SOS."

I passed it off lightly. Of course, I had no way of knowing then what those few minutes on the air would mean to us all.

The whole story came out later, as you know. . . .

I'll interrupt Lt. Asher's story at this point to tell of an episode that took place not on the ocean or on a desert island but in the heart of Cleveland, Ohio, where I talked with David Murray as we sat in his radio room some months later.

STATEMENT OF DAVID MURRAY, CLEVELAND RADIO AMATEUR:

The SOS from the Balboa-New Zealand plane? That was a queer thing. One of the strangest coincidences in my radio career. You know, I sometimes think there is something supernatural about radio. Often I am sitting here, reading or working on something, and then I get an urge. Something makes me turn on the receiver — often to some band entirely different from the one I've been operating on — and there will be a pal of mine, some guy I haven't contacted for months or even longer. . . .

Well, that's what happened in the Asher case. I was just *drawn* to the set and to their frequency. I didn't know those men — not even Newhall, the man who built that emergency set.

I was busy out here that night — working hard, too — when suddenly I was drawn to the table and just idly turned on the receiver. I wasn't thinking what I was doing. I'd been operating on 20 meters. As I spun the dial around thoughtlessly into that space between 14 and 7 Mc., a signal froze me to the spot. Wobbling around with a chirpy, weak flutter, I heard:

SOS SOS DE KHQXO. SOS DE KHQXO LAT 23 S LONG 125 W ASHER PLANE 300 MILES NORTH PITCAIRN

The message was repeated up to the middle of the position report, and then it stopped abruptly. I listened around for some time, but didn't hear anything more. I noted the dope in my log.

Next day I wrote the National Air Association, giving them the dope. But I'm afraid it sounded a little pessimistic; I myself was skeptical of the authenticity of the message. The Association was, too, for they replied that naval authorities reported no land charted in that area. They also wanted to know why Asher had waited six months before sending an SOS.

I couldn't answer that one. Frankly, I, too,

doubted that the SOS was valid. There had been too many bogus distress calls picked up lately. I didn't want them to check up and say, "Aha — another false SOS picked up by an amateur!"

But a month or so later, when I was talking by radio to Bill Underwood down in Sydney — you know Underwood, the fellow who sailed around the world in a small sloop — I mentioned the SOS to him. He said that he was going up that way and would have a "look see." Neither of us dreamed what he would find. . . .

Some months passed after talking to Dave Murray before I tracked down Bill Underwood in Chicago. He was making a personal appearance at the Travelers Club there. He was surprised to find out I was on the trail of what I now called the "tube story."

"Sure, I know Dave Murray put you on to me. I'm always glad to help out a fellow writer. By the way, did you read my latest book?" he asked.

"Of course," I replied, "but there wasn't anything much in it about this tube business except that you called at the Pitcairn group and picked up the survivors of the Asher flight."

Underwood smiled enigmatically.

"Why didn't you say more?" I asked him.

His answer startled me. "There was too much to put in a few paragraphs, and besides

it wasn't exactly the kind of story I like to tell. But since you're interested. . . ."

STATEMENT OF BILL UNDERWOOD, YACHTSMAN:

When I talked to Dave, I promised him I would have a look around. When I reached the position given in the SOS there was no land in sight. Having nothing better to do, I cruised in widening circles, using that point as the center. After a few days of roaming about I spotted a tiny island. I put in, and finally I saw a smoke signal rising from a hill on the island. As I got close in I could see three figures on the beach. What had happened to the others? There had been five men aboard that Balboa-New Zealand plane. I had been in Balboa shortly before they hopped off and had met all the boys.

It was with a sinking heart that I drew in and anchored. But when I rowed the small boat in to shore — well, such a greeting I'll never receive again this side of the Pearly Gates! . . .

CONCLUSION OF STATEMENT BY LT. JAMES ASHER:

We had given up all hope of ever being taken off that island. Months had passed since Bob Newhall sent out that short call for help. Nothing had happened. No ships had been sighted, although we kept a close watch on the horizon. There was enough to eat, and life went on. Hope of rescue had passed out of our hearts.

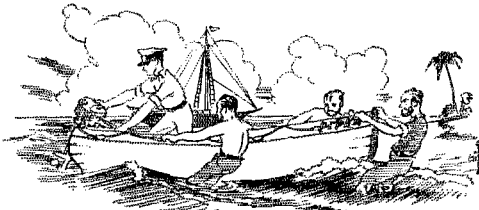

WE BROKE THROUGH THE SURF AND PULLED THE BOAT UP ON THE SAND.

Then one day we heard Newhall cry out. "Sail ho! A ship!" he shouted. We started running toward the hilltop. Bob was the fastest. He beat us, and long before we could reach the top he had smoke and flames billowing out from the ever-ready beacon fire.

There was a ship! It was still way out, but it was heading toward the island. What thoughts surged through our minds as we watched that boat draw closer! We hurried to the beach.

There, alongside the wreckage of our plane, we waited impatiently for the oncoming small boat. The three of us broke through the surf and pulled the boat up on the sand. When we stood on the beach again, my hand gripping that of our rescuer, I could not speak. Finally I blurted out, "I'm Asher. This is Hope and Newhall. We were forced down on a Balboa-New Zealand flight."

"Sure, I remember you. I'm Underwood, sloop *Sea Cloud*. I met you boys in Balboa. But where are the others — Parker and Butler?" Underwood demanded.

I pointed to the tangled wreckage of our plane. "They were killed in landing."

"Oh . . . Then it was genuine — that SOS?" Underwood asked.

"Yes," Newhall said. "Did you pick us up?"

We told Underwood about the tube, and then he told us about Dave Murray hearing that SOS, those long months ago.

And that's about all there is to the story. There wasn't room to take anything much off with us, but we did take along that old 201A. That's how Bagley happened to have it in his museum. He paid us well for it, too.

The money? We bought a marker for the boys we had to leave behind on Flight's End. If you are ever near the island, go up on the hill and see it. No, we didn't hesitate to take Bagley's money. That old radio tube was worth it. After all, it had saved three lives, hadn't it? Even if it did burn itself out trying.

More Selectivity in WERS Reception

(Continued from page 22)

quency beat is quite weak and causes negligible interference to other receivers in the same room.

Although the improvement in selectivity over a straight superregenerative receiver is obvious on direct comparison, it is difficult to give a quantitative estimate. It will, of course, be in the ratio of the selectivity of a superregenerative detector operating at 26 Mc. to the selectivity of a similar detector at 112 Mc. Using the harmonic of a modulated variable-frequency signal generator for checking, it was determined that three times as many weak signals can be accommodated without interference as on a good 112-Mc. acorn superregen. On strong signals the comparison favors the superhet still more, since a strong signal does not block out the hiss over nearly as wide a frequency region at 26 Mc. as it does at 112 Mc. In such a case the selectivity ratio is more nearly

in proportion to the wavelength, or about 4 to 1. As we said before, the acorn superregen had a great deal more selectivity than the receivers using standard tubes with which we compared it, so that comparing the superhet to one of the latter sets is a good deal like comparing an ordinary communications super to an old-time regenerative detector. Further improvement in selectivity could be secured by going to a lower-frequency i.f., the limit being set by the frequency at which the superregenerative action becomes poorer and the point at which the selectivity becomes too great to accommodate the frequency modulation typical of many of the modulated oscillators used in WERS work.

How Jap Transmitters Work

(Continued from page 45)

tromagnets which acted as a single-pole double-throw switch. The magnets, through corresponding circuits, represented high and low voltage changes. When a change of voltage occurred the vane moved, making contact and completing a circuit which ran the motor in the right direction to oppose the change. As neutral was reached the vane balanced, thus stopping the motor.

All filaments were supplied by a d.c. source consisting of dry-disc selenium rectifiers and corresponding filter circuits. The large rigs drew 38 amperes of filament current.

Various types of antennas were used, ranging from Zepps to ordinary quarter-wave verticals. In the end we more or less standardized on the latter, because they were the easiest to repair when Jap shells knocked them down.

And that's the story of the Japanese radio equipment we used on Guadalcanal. I think we got as much use out of those transmitters as the Japs ever intended to, at that. It wasn't much like operating a ham rig, though. We spent a large part of the time in our dugouts, and often it was necessary to work on the equipment under shell fire and during air raids. But we kept the sets working and on the air.

A V.H.F. Transmitter

(Continued from page 49)

plate current is being adjusted and checked on the other plate. *Be sure that the plate voltage is off before you touch the plate cap!* A very noticeable reduction in r.f. output will result if the plate currents do not balance. A rough check can be made with a neon bulb. When excitation to both sections of the tube is the same, the bulb will give little or no r.f. indication at the center of the coil.

The filaments are left running continuously to permit instant operation. This keeps the r.f. unit at an even temperature and undoubtedly contributes to the frequency stability. Other factors are the stabilized plate voltage, rigid mechanical construction and shock-proof mounting.

The greatest distance at which this transmitter has been tested is 15 miles. Performance at that distance was entirely adequate.

WERS Bibliography

DURING the past two years a large volume of material has been published in *QST* on the subject of civilian defense. In fact, the total adds up to well over 100 individual articles, editorials, etc., or an average of nearly five per issue. So large a number of references makes the problem of locating any one particular item a difficult one.

To remedy this difficulty, all material on the subject, beginning with the December, 1941, issue, is here listed, subdivided into technical and organization-regulation categories. Some of the organizational material listed is pre-WERS, of course, but it all relates to civilian defense and is therefore useful. Some of the technical articles describe gear not originally intended for WERS but nevertheless of practical application in this field.

Taken altogether, the references listed constitute a comprehensive compilation of civilian defense radio communications, of value to everyone concerned with or interested in WERS.

Technical Articles

- "112-Mc. Emergency Gear," Grammer, Dec. 1941, p. 9. Outline of requirements and recommendations on standardization; components, antenna systems.
- "A 112-Mc. Emergency Transmitter," Grammer, Dec. 1941, p. 14. Compact oscillator and modulator for vibrator plate-supply source; 6V6GT oscillator, 6J5-6N7 modulator; unique U-shaped high-Q tank inductance.
- "A Compact Receiver for 112 Mc.," Chambers, Dec. 1941 p. 31. 9002 superregenerative detector, 6J5-6V6 audio, with built-in relay control for mobile work.
- "An Experimental 112-Mc. Receiver," Brannin, Dec. 1941, p. 36. Superhet with superregen final detector; 9003 r.f., 1232 mixer, 6C5 h.f. oscillator, 6SK7 i.f., 7A4 superregen second detector, 6C5-6V6 audio.
- "Power Supply for Emergency Equipment," Grammer, Jan., 1942, p. 9. Construction of vibrator-type supplies for 300-volt 100-ma. output, including rewinding of power transformers.
- "Receivers for 112-Mc. Emergency Work," Goodman, Jan. 1942, p. 18. Superregen receivers with 7A4 or 6J5 detectors, 6J5-6F6 audio, speaker. Superhet with 6AC7 mixer, 6J5 oscillator, 6J5 second detector, 6J5-6F6 audio, speaker.
- "Antennas for 112-Mc. Mobile Work," Goodman, Feb. 1942, p. 14. Quarter- and half-wave car antennas; suggestions for feeding.
- "More Gear for Civilian Defense," Grammer, Feb. 1942, p. 17. Circuits and constructional details of two modulators, including provision for audio tone modulation; 6J5-6L6 and 6C8C-6L6. Transportable operating table.
- "Defense Network Control Station," Stiles, Feb. 1942, p. 21. 112-Mc. crystal-controlled transmitter in New Rochelle net. Five-stage chassis-mounted unit; 50L6GTs in tetrode oscillator circuit and capacity-coupled doublers, link-coupled 807 final.
- "Westchester County's Hams Are Prepared," Taylor, Feb. 1942, p. 34. General description of equipment used in Westchester County (N.Y.) emergency net.
- "Kinks for the DK-3 Transceiver," H & K, Feb. 1942, p. 43. Suggestions for converting for a.c. operation, tone modulation and elimination of microphone battery.
- "A Simple Collapsible Rotary Antenna for 2½-meter Mobile Work," H & K, Mar. 1942, p. 46. Four-element parasitic array with "J" antenna.
- "A Pack Set for 112-Mc. Defense Work," Chambers, April 1942, p. 21. Battery transmitter-receiver; tank switching; 1Q5GT detector-oscillator, 1Q5GT audio-modulator.
- "A Simple Transceiver for Two and One-Half," H & K, April 1942, p. 46. 1G4G oscillator-detector, 1G4G-1Q5GT audio, speaker.
- "A 112-Mc. Transmitter-Receiver Combination," Brannin, May 1942, p. 18. Simple inductively tuned superhet; 1232 mixer, 6C5 h.f. oscillator, 6J5 superregen second detector, 6C5G audio in combination with HY75 oscillator modulated by 6C5-6V6.
- "An Analysis of the Signal-to-Noise Ratio of Ultrahigh-Frequency Receivers," May 1942, p. 30. Discussion of factors contributing to inherent receiver noise and their relationship to signal-to-noise ratio.
- On the Ultrahighs (Tilton), May 1942, p. 54. Notes on converting National NHU receiver for 2½-meter operation.
- "Notes on 225-Mc. Converter Design," Bent, May 1942, p. 56. Construction of an experimental unit; 954 mixer, 955 oscillator.
- "Feeding the Coaxial Dipole with an Open-Wire Line," H & K, May 1942, p. 58.
- "A Talkie-Walkie for Civilian Defense," Kopetzky, June 1942, p. 9. Battery-operated pack transceiver; HY-114B oscillator-superregen detector, 1T4-184-6G6G audio, dynamic speaker-microphone combination.
- Off the Very Highs (Tilton), July 1942, p. 64. Circuit diagram of W6ANN's 112-Mc. superhet; 9003 r.f., 9001 mixer, 9002 oscillator, 7A4 second detector, 7C5 audio.
- "Technical Aspects of the WERS Regulations," Grammer, August 1942, p. 25. Transmitter stability data and suggestions for frequency measurement.
- "Simple Modulator for Portable Work," H & K, Aug. 1942, p. 75. Circuit for single-button microphone driving push-pull 6V6GTs; microphone voltage taken from cathode resistance.
- "Reducing Radiation from the MRT-3 Transceiver," H & K, Aug. 1942, p. 75. Installation of a regeneration control to control detector plate voltage.
- "Building WERS Gear from Salvaged B.C. Sets," Mix, Sept. 1942, p. 15. Example of a workable 2½-meter transmitter-receiver made from a defunct receiver.
- "A Simple Method of Frequency Measurement for WERS," Woodward, Sept. 1942, p. 26. Using a 14-Mc. crystal oscillator and communications receiver.
- "A.C.-D.C. Transmitter-Receiver for Two and One-Half," H & K, Sept. 1942, p. 73. 12K7GT superregen detector, 12J5GT oscillator, 50L6GT audio and 35Z5GT rectifier.
- "A 4-Element Continuously-Rotatable Antenna for 112 Mc.," H & K, Sept. 1942, p. 75.
- "A Transceiver for WERS," Grammer, Oct., 1942, p. 11. Simple Equipment from junk-box components; 6J5, 6C5, 6V6, 6F6, etc., oscillator-detector; 6J5 or 6C5 and 6V6 or 6F6 audio; speaker. A suitable vibrator-pack power supply with 6X5 rectifier is included.
- "Revamping 5-Meter Transceivers for 2½," H & K, Oct. 1942, p. 70. 6J5GTK oscillator-detector; 41, 42, 6F6, etc., audio; speaker.
- "A Simple Transmitter-Receiver for War Emergency Work," Rand, Nov. 1942, p. 23. 6J5GT doubler, 7A4 doubler, 7A4 doubler, 815 final with linear tank circuit; crystal mike, 6SF5, 6C5, 6L6s Class-B audio. Modulation indicator, power supply and control circuits. Picture and brief description of crystal frequency checker.
- "Mica-Trimmed Tank Condensers in WERS Gear," H & K, June 1943, p. 53.
- On the Very Highs (Tilton), June 1943, p. 47. Notes on antenna performance at 112 Mc. Antenna height vs. range, multi-wire doublet vs. extended double Zepp.
- "An Economical Transmitter-Receiver for WERS," Magee, June 1943, p. 32. 6J5 superregen detector, 6V6GT oscillator, 6J5GT-6V6GT audio, built-in speaker, microphone operated from cathode bias, vibrator pack. Notes on hash interference.
- "Rebuilding TR4s for Non-Priority Tubes," Mix, July 1943, p. 17. Substituting 6J5 detector and 6V6 oscillator.
- "Constructional Aspects of WERS Mobile Installations," Forster, Aug. 1943, p. 34. Suggestions for car glove-compartment jobs. Includes diagram of mobile transmitter-receiver; 6V6 oscillator, 6J5GT detector, 6J5-41 audio, speaker.
- "Notes on Commercial Gear for WERS," H & K, Aug. 1943, p. 62. Installing regeneration control and separate receiver volume control in Abbott MRT-3 and TR-4.

"A.C.-D.C. Gear for 112 Mc." H & K, Aug. 1943, p. 62. Circuits for transmitter and receiver operating from 110-volt lines. Transmitter: 70L7 rectifier-modulator, 12J5 oscillator. Receiver: 6J5 detector, 6J5-25L6 audio.

"Notes Covering the WERS Transmitter-Receiver for Allegany County, Md." H & K, Aug. 1943, p. 63. Transmitter-receiver with 76 or 6J5 detector, 7A4 or XXL oscillator, 6J5-6V6 audio; speaker.

"Three-Element Directive Antenna for Portable 112-Mc. Work," H & K, Aug., 1943, p. 65. Simple three-element rotary array for portable units.

"Folding Car-Roof V.H.F. Antenna," H & K, Aug., 1943, p. 65. Simple rotary antenna for mobile units.

Organization and Regulations

"For Civilian Defense" (Operating News), Dec. 1941, p. 56. Stresses place of ARRL Emergency Corps in this new field.

"Interim Report" (editorial), Jan. 1942, p. 7. Preview of OCD plans.

"War Comes!" (editorial insert), Jan. 1942, opp. p. 32. Suspension of ordinary amateur activities and outline of "special authorization" plan.

"Amateur Stations for Civilian Defense" (AARS), Jan. 1942, p. 35. Comments from commanding generals and corps area commanders.

"... for Civilian Defense Availability?" (Operating News), Jan. 1942, p. 42. Reports from early CD set-ups.

"Defense U.H.F. Nets," Smith, Jan. 1942, p. 48. New York City activity.

"Garden City Radio Club U.H.F. Program," McMinn, Jan. 1942, p. 48.

"Civilian Defense" (editorial), Feb. 1942, p. 7. Extended discussion of amateur participation in war emergency work.

"What the OCD Communications Plan Will Say About Amateurs" (box), Feb. 1942, p. 9. Preview of OCD plans.

"Flash!" (box), Feb. 1942, p. 13. QRX on applications.

"Note to Reactivated Stations" (What the League is Doing), Feb. 1942, p. 24. Instructions not to use 3800-3900 kc.

AARS Activities, Feb. 1942, p. 31. Announcement of suspension of activities.

"Westchester County Hams Are Prepared," Taylor, Feb. 1942, p. 34. Survey; operator training program; emergency organization.

"The Immediate Job" (Operating News), Feb. 1942, p. 47. Club programs; opportunity and challenge of war emergency; operating precautions and discipline necessary.

"A.R.P. Communications" (editorial), March 1942, p. 7. New licensing plans; police department set-ups.

"Providence Adopts New Plan for Civilian Defense Radio" (Operating News), March 1942, p. 52. Police-amateur liaison plan.

"The Providence Mobile Radio Patrol" Rev. Charles Mahoney and Perry O. Briggs, April, 1942, p. 13. Description of police-amateur liaison plan adopted when FCC petition fails.

"Defense Programs for the Amateur" (Operating News), April 1942, p. 50. Comment on FCC action; liaison with local OCD.

"Providence Plan Efficient in First Test," April 1942, p. 52. News report.

"Providence Footnote" (Happenings), May, 1942, p. 29. No cure-all.

"Civilian Defense Plans" (Happenings), June 1942, p. 18. Nothing has happened to date! Also, p. 53, "Still no news . . ."

"The Green Light" (editorial), July 1942, p. 9. WERS is not an amateur communications system, yet it is our job, and we accept it.

"The War Emergency Radio Service," July 1942, p. 11. Announcement; FCC rules governing WERS stations.

"Civilian Defense Radio Plans Here" (Operating News), July 1942, p. 68. Discussion and advice to field organization.

"Planning WERS for Your Community," Huntoon, August 1942, p. 22. Block diagrams of OCD set-up discussion of application forms.

"Technical Aspects of the WERS Regulations," Grammer, Aug. 1942, p. 25. Regulations concerning transmitter stability; data and suggestions for frequency measurement.

"Operating Procedure in WERS" (Operating News), Aug. 1942, p. 81. Responsibility of radio aide in setting up operating procedure.

"We Must Not Fail" (editorial), Sept. 1942, p. 9. Importance of WERS.

"Massachusetts Civilian Defense Radio," Doremus, Sept. 1942, p. 11. Organization plan for Mass.; suggested channels; schools.

"Training Civilians for Wartime Operating," Huntoon, Sept. 1942, p. 52. Planning courses; training aids.

"Frequency Allocations in the WERS," Ling, Oct. 1942, p. 16. Plan for clear-channel operation.

"Training Auxiliary Operators for WERS," Huntoon, Oct. 1942, p. 52. Network organization; sample procedures.

"WERS Licensing"; "WERS Agreements" (Operating News), Oct. 1942, p. 77. Discussion of FCC forms; sample intermunicipal agreement.

"WERS License Applications" (Operating News), Nov. 1942, p. 73. Establishing proof of liaison with Army Fighter Command.

"WERS Needs You Too" (editorial), Dec. 1942, p. 9. Brunt of the job falls on home-keeping amateurs.

"Akron and the WERS," Brown and Moody, Dec. 1942, p. 11. Organization, equipment and field tests.

"OCD Announcement" (Operating News), Dec. 1942, p. 74. FCC no longer looks with disfavor on application from individual town or municipality.

"Amateur Radio and the Civil Air Patrol," E. Fraim, Jan. 1943, p. 50. CAP Organization.

"WERS Rules Changes" (Operating News), Hart, Jan. 1943, p. 73. Applications must be signed by highest official of applying agency; receipt of possible orders from Army must be provided for; if required, communication with U. S. government stations is permitted; tests may be held during both Sunday and Wednesday periods during the first three months of the life of any WERS station license; application discrepancies pointed out; list of licenses so far granted.

"The Tri-Part Plan," Hart, Feb. 1943, p. 19. OCD's recommendations for selection of frequencies for WERS systems.

"The Fifth Regional WERS," Gibbs, Feb. 1943, p. 38. Maps; dissemination of information; committee; results.

"OCD Booklet"; "WERS Progress" (Operating News), Feb. 1943, p. 68. Distribution of licenses by states.

"WERS Rules Amended" (Happenings), March 1943, p. 22. Inclusion of CAP stations; changes in equipment; identification.

"More Rules Changes" (Operating News), March 1943, p. 45. As above, with interpretations.

"When Disaster Strikes" (editorial), Apr. 1943, p. 11. OCD urges immediate establishment of WERS networks to protect communities in natural disaster.

"Some New Thoughts on WERS," Hart, Apr. 1943, p. 24. Illustrating the isolation of the independent licensee.

"WERS Reports" (Operating News), Apr. 1943, p. 49. Returning required forms; operating procedure.

"WERS in the New Haven Warning District," Fraser and Keating, May 1943, p. 30. Organization; equipment; frequency measurement.

"On the Very Highs (Tilton), May, 1943, p. 37. News of stations.

"CD-WERS in the State of Maryland," McNulty, June 1943, p. 25. Centralization of activities in a state headquarters; organization; procurement; state network.

On the Very Highs (Tilton), June 1943, p. 47. Springfield network; photos.

"Ninth Regional CD-WERS" (Operating News), June 1943, p. 59. Discussion of non-participation.

"Operating Procedure" (Operating News), July 1943, p. 62. Identification; report forms; other than warden traffic; progress.

"WERS Is Making Progress" (editorial), Aug. 1943, p. 7. Review of development; ARRL's dealing with varied problems; dependence upon amateurs.

"WERS Amendments" (Happenings), Aug. 1943, p. 22. Modification of various sections of regulations; adoption of two new sections.

"Message Handling in WERS," Russell and King, Aug. 1943, p. 42. Control center procedure; priority system for messages; description of control panel.

On the Very Highs (Tilton), Aug. 1943, p. 54. News.

"More Rule Changes" (Operating News), Aug. 1943, p. 69. Discussion of changes listed in "Happenings"; priorities for WERS equipment; bootlegging; district licensing.



STRAYS



The amateur fraternity received a new characterization in a letter received at Hq., presumably typed by a stenog who had never heard of us (or maybe she had!). She wrote it this way:

“ . . . you can perhaps give me some assistance with consequent benefit to the immature fraternity in general.”

The U. S. Office of War Information reports that radio receivers and transmitters are now being manufactured on a small scale in several parts of Free China. This program is being carried on under the Chinese National Resources Planning Board, to which K. T. Shu, vice-president of the China Amateur Radio League, is technical adviser on communications matters. Ninety per cent of the parts used are locally made, including some tubes. The United States supplies 75 per cent of all raw materials going into the production of this equipment.

OWI's radiophoto circuit, now in operation between Chungking and San Francisco, is the first such circuit ever established across the Pacific between China and America. Chalk up one for OWI — and one for amateur radio, too! For it was Glen Akins, W3ART, OWI's radio technical representative in Chungking, who engineered that end of the difficult job.

A funny thing happened to me recently. I entered the North Carolina State Tennis Tournament, and in the first round whom should I draw but a ham — W4EJ. I guess it never ceases. Hi! However, I was on the short end, 4-6, 7-5, 6-0. — W9ZJB.

The Signal Corps employs sixty different types of power equipment for ground use alone, all of which can take the worst beating that weather can give. They range in size from a 300-watt unit which a soldier can carry in a pack to a 50,000-watt unit powered by a “jeep” engine. All are designed not to create radio interference.

The “Gibson Girl,” a hand-powered, foolproof emergency radio transmitter, is reportedly becoming the “sweetheart of the Air Forces.” When a plane makes a forced landing at sea, the transmitter, a collapsible box kite, two deflated balloons, two hydrogen generators, two spare rolls of aerial wire and a signal light—all in two buoyant bags strapped together—are dropped by parachute at the same time as the life raft. The equipment is said to be unsinkable and waterproof, and is easily recovered.

The antenna is raised by kite or balloon. By turning a small crank the transmitter generates an automatic SOS on the distress frequency of 500 kc., with an effective coverage of 100,000 square miles. It can also be keyed by hand and messages can be sent by signal light. Instructions and the International Morse code are printed on the top of the transmitter.

The string on the box kite that carries aloft the antenna of the emergency radio transmitter used by fliers who have made crash landings at sea is made of glass yarn. The yarn possesses great strength and will not deteriorate from the effects of salt water and sunlight. It is twisted and plied from continuous-filament glass fibers which can be drawn to lengths measurable in miles.

Portable automatic transmitters are now being used by the Coastal Command in Great Britain. The apparatus, dropped in buoyant bags from patrolling aircraft to shipwrecked seamen, transmits a continuous SOS signal as long as the handle is turned. Reports of ocean rescues are being received, including one of a lifeboat with 19 survivors which was located after five days, having been lost by the patrolling aircraft due to bad visibility.

I am 14 years old and hold both first class 'phone and second class telegraph licenses. Can any ham better this record? — Norman H. Williams.

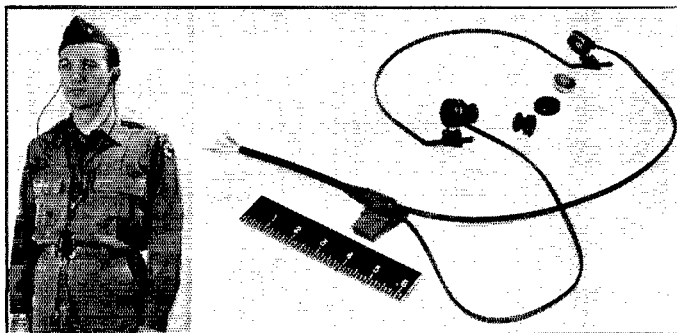

The new Signal Corps headset with its flat, narrow headband fits easily under a soldier's helmet. Small removable plugs of neoprene which fit into the ears do away with the larger rubber ear cups formerly used. The soft plugs afford protection from blows against the ear and enhance sanitation, since a new pair of plugs is ordinarily issued to each new wearer. Attached to the cord is a clothes clip which attaches to the shirt, preventing pull on the cord. Using far less material for manufacture, the new headset offers high sensitivity and flat response over its entire useful range.

★ BOOK REVIEWS ★

The Amateur Scientist, by W. Stephen Thomas. Published (1942) by W. W. Norton and Co., Inc., New York. 291 pages, 5 × 8; illustrated. Price, \$3.00.

The American Philosophical Society, founded by that notable amateur scientist, Benjamin Franklin, sponsored the project in adult education in science whose aims, methods and results are illustrated in this book. Our own Editor Clinton B. DeSoto and Atlantic Division Director Walter Bradley Martin were among those who made contributions to the development of the radio project which is reported under the title, "Radio Ionosphere," and the work of the ARRL is given favorable notice among the references to organizations of amateur scientists.

The characteristics of the amateur scientist, his books and equipment, the functions of amateur scientific clubs and societies, the organization of amateur research projects together with sample programs for amateur scientific research — these are among the topics treated which will have a strong appeal for many radio amateurs.

— H. M. F.

"How to Use Diagrams in Radio Servicing," is the title of a new booklet intended to aid radio students, beginner servicemen and members of the armed forces. Written by M. N. Beitman, it is available from Supreme Publications, 328 S. Jefferson St., Chicago, Ill., for 10 cents.

Data covering the possible substitution of tube types in a.c.-d.c. receivers, together with the principal circuit changes to be made, appear in chart form in *Sylvania News* for May-June, 1943. Copies of this issue may be obtained from Sylvania Electric Products, Inc., Emporium, Pa.

"Allied's Radio Data Handbook," edited by Lt. Nelson M. Cooke, USN, is a condensed handbook of mathematical data, formulas, charts and other information most commonly used in the field of radio and electronics. It is available from Allied Radio Corporation, Chicago, Ill., for 25 cents, postpaid.

Strips of pressure-sealing adhesive applied to one or both edges of a new masking paper secure the paper to flat surfaces or protruding parts which have to be masked against paint spray. The paper itself resists paint and the adhesive strips off clean after painting is completed. The use of this Edge-Gummed masking paper shows marked economy and increases ease of removal. — *Scientific American*.

A patent has recently issued to Roy Sinclair, an employee of the Muzak Company in New York City, covering a simple device which automatically receives and removes the shavings or thread from any disc being instantaneously recorded. The invention employs a cylinder cone which rolls on and by contact with the disc and adjusts itself to untrue or wobbly turntables and record discs.

Gold Stars

T. (JG) SAMUEL JACKSON, JR., USNR, W2BZ, 37, was killed in action in the Pacific on the night of August 9, 1942, when his vessel, the heavy cruiser U.S.S.



Vincennes, engaged Japanese naval craft at Savo Island in the Solomons. Stationed in Battery Two, he stuck to his post until the last. Survivors stated that he could have been saved had he not remained behind to succor a wounded fellow officer. For his gallantry in action beyond

the line of duty, W2BZ was posthumously awarded the Order of the Purple Heart.

W2BZ was an ardent radio amateur, holder of a Class A license and a founder of the old Hudson Radio Club. He was also an amateur deep-sea yachtsman and participated in two New York-Bermuda races, those of 1930 and 1932. Commissioned an ensign in January, 1941, he was first assigned to the NCR school at Noroton. Later he took specialized training at an RAF school in Canada, before being detailed to the *Vincennes*.

TECH. SGT. ALBERT C. McARTHUR, W9VBI, 24, of Villa Park, Ill., died in a Japanese prison camp in the Philippines early this year. First listed as missing in action following the Japanese occupation of the Philippines, it was not until nearly a year later that he was reported a prisoner of war. On June 11, 1943, word was received that he had died in prison camp. The circumstances of his death at the hands of the Japanese have not thus far been revealed.

Inducted into the Army in 1940 as a National Guardsman, W9VBI graduated from the radio engineers' course at the Armored Force School, Ft. Knox, having progressed rapidly from private to sergeant. When the famous 192nd Tank Battalion was ordered to the Philippines in October, 1941, W9VBI — who had been married just two weeks before — went along as tank radio operator. There he received two further promotions, first to staff sergeant and then to technical sergeant, before his capture.



Silver Plating at Very-High Frequencies

The Effect of Platings and Base Materials on Coil Q

BY S. YOUNG WHITE,* W9GVB

THE writer recently had occasion to investigate the effect of silver plating inductances to be used in the frequency region from 100 to 400 Mc. The results were rather unexpected, but — as is usual — pretty obvious after we had analyzed the phenomena.

Conductors grouped themselves into two categories, those bearing nickel or iron and all others. If we wind a coil with Invar wire or strap to minimize the change in dimensions with temperature, we find that the nickel and steel cause serious r.f. losses. We then silver plate the coil to increase the surface conductivity and also to form a shield around the magnetic material so flux cannot penetrate. At this point we discover that there are several varieties of silver platings.

The ordinary frosty-looking silver coat is put on fast and the surface under a microscope is very rough. Two very bad effects are noted. The conductivity of the silver put on this way is quite poor and the roughness of the surface markedly elongates the current path, and so the Q of the circuit is low. To put on a high-conductivity silver plating, a so-called "jewelers plate" must be used. This is very dense, takes a long time to put on and, needless to say, is quite expensive. If it is plated on thicker than about 1 mil at a time, it begins to be less dense on the top.

To overcome the increased length of path introduced by surface roughness the coating must be buffed to a nice optical finish, which removes some of the material. If we calculate the depth of penetration of current at 150 Mc., we find that the formula says the current is 90 per cent confined to a depth of a few ten-thousandths of an inch. So we find that, after buffing, we have about $\frac{3}{4}$ mil of nice dense silver left, and measure the Q . It is not very good. We then plate on another coat and buff it down to a good finish, ending up with about $1\frac{1}{2}$ mils this time. The Q is definitely better. To make some dozens of experiments shorter, we find worth-while improvement up to three such platings and buffings — and still some improvement after that, but not enough to be worth going to any great expense to procure.

In plating Invar one difficulty is that, if the apparatus must be exposed to great temperature changes, the Invar, broadly speaking, does not expand with temperature, while the silver does. This places a strain on the bond between the metals and, if the Invar is nice and smooth, the silver will "check" or form islands of silver completely divorced from each other. Sometimes the checking can hardly be seen, but the clue

is a steady loss of Q . Etching the Invar gives a firmer bond and the dense silver plate mentioned then will be free from checking.

If we start off with non-nickel or iron bearing conductors, the effect is somewhat different. Copper coils have little resistance loss, anyway, since at u.h.f. the length of wire, strap or tubing is so short that very often the d.c. resistance is well below 0.001 ohm (1 milliohm). Silver plating is then a waste of time, since it will not be possible to reduce the copper loss to a lower figure by plating. It is well known that metals in thin films do not have the same conductivity per unit cross section as the same material in solid form, such as a drawn wire. It would be necessary to go to a thick, dense film, nicely buffed, to keep the resistance as low as that of the original copper.

At once we think of corrosion, and recall that silver oxide is a much better conductor than copper oxide. In our experience, normal corrosion, showing up as a dulling of the copper, makes almost no difference in Q . Evidently the current will not leave the solid metal underneath to travel in a poorly conducting surface layer.

The next point that comes to mind concerns metals in the field of the coil at u.h.f. When we investigated this point, we had a real surprise. It was found that any non-magnetic metal had the same losses as any other. That is, if we bring a copper plate close to the coil under controlled conditions, the frequency and Q will change a certain amount. If we now carefully substitute a dural, brass, zinc or other non-ferrous, non-magnetic plate, the Q will be lowered by exactly the same amount. This proved so interesting that cores of various metals were made up and introduced into a coil to change the frequency of a resonant circuit by identical amounts. In every case the Q was the same — about 90. This circuit originally had a Q of 400 before the cores were inserted.

The final conclusion was that, aside from its esthetic value, silver plating in general is of little help. On copper it must be carefully and expensively applied merely to avoid exceeding the resistance the copper had in the first place. On brass in the field of the coil it is useless. Under corrosion it is of no help. However, if iron or nickel parts must be used in the field of the coil, a very thorough silvering is a definite help.

An experimental investigation discloses some interesting facts about the effect of silver plating on the Q of coils.

*Consulting Engineer, Room 202, 170 Broadway, New York 7, N. Y.

HINTS AND KINKS FOR THE EXPERIMENTER

A SIMPLE TEST OSCILLATOR

THE circuit of a simple test oscillator for lining up receivers is shown in Fig. 1. The tetrode section of the 117L7 is connected as a triode in a simple Hartley circuit, while the rectifier portion supplies plate voltage through the resistance-capacity filter, consisting of R_2 and C_2 . Plate voltage may be adjusted by altering the value of R_2 . With the value given, a plate voltage of about 10 will be obtained.

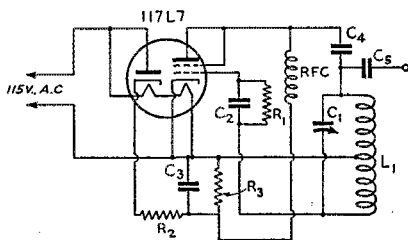

Fig. 1 — Circuit diagram of a simple test oscillator for receiver alignment.

- C_1 — Old b.c. condenser, about 350 μfd .
- C_2 — 250 μfd .
- C_3 — 40- μfd ., 250-volt electrolytic.
- C_4 — 0.001 to 0.005 μfd .
- R_1 — 0.1 megohm.
- R_2, R_3 — 50,000 ohms, approx.
- L_1 — See text.
- RFC — 10 mh. or larger, or the winding from an old i.f. transformer.

C_1 may be an old b.c.-receiver tuning condenser with a maximum capacity of 250 to 350 μfd . I used two discarded i.f.-transformer windings in series for L_1 , although other inductances may be used, depending upon the frequency desired. For instance, a 2.5-mh. r.f. choke with a 350- μfd . condenser will just about cover the range of 465 kc. to 175 kc. This range includes all of the most commonly used intermediate frequencies, while harmonics will cover the higher-frequency ranges. The most common type of r.f. choke is wound in four pies, so that a tap may be brought out from the center. It may be necessary in some instances to add a mica trimmer condenser in parallel with C_1 to cover the desired range.

The oscillator may be calibrated quite accurately, if desired, by beating harmonics against signals of known frequency in the b.c. band. Frequencies between 465 kc. and 275 kc. may be spotted by using the second harmonic of the test oscillator, while the remainder of the range to 175 kc. may be checked using the third harmonic. — Bert Felsburg, W8VD.

A POLARIZED RELAY FOR TAPE TRANSMITTERS

SHOWN in Fig. 2 is another relay arrangement for the Wheatstone-tape code machine described in November *QST*. I used it because I couldn't get any telephone-type relays. It has some advantages over other types; it requires only one relay contact, no dependence need be placed upon springs, and the relay, which is polarized, is power-operated on both opening and closing cycles, which should make it faster. (The polarized relay is universally used in commercial installations for this reason. — Ed.)

A polarized relay can be made quite easily from the works of an old magnetic phonograph pick-up or magnetic speaker. These vary considerably in construction. Some types may require extension of the armature or replacement of the armature by another having a longer rod for the external contacts.

Assuming that the contacts, *A*, are the "make" contacts, a hole in the tape will allow these contacts to close, sending a momentary current through the relay winding to cause the external contacts to close. Having been pulled against, or close to, one of the permanent-magnet poles, the armature will be held in this position until the current through the winding is reversed by closing the "break" contacts, *B*. Thus, the armature is moved from side to side entirely by magnetic pull and no springs are required.

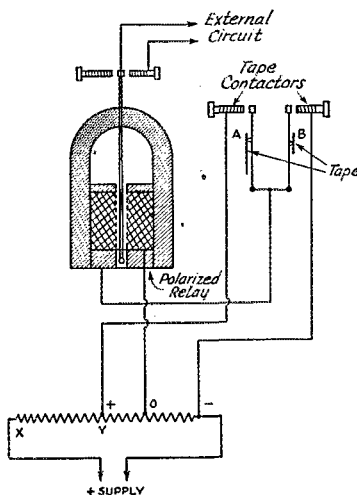

Fig. 2 — Polarized-relay circuit for the Wheatstone-tape transmitter. The relay may be made from an old magnetic pick-up or speaker unit.

Adjustment is quite simple. The armature should not quite strike the pole pieces, yet they should be permitted to approach close enough so that the action is quick and clean. My relay has a 1000-ohm coil and it operates very well on a current of 10 to 15 ma., but it can be set to operate on as little as 5 ma. The voltage divider should have enough resistance so that the current drawn through the section between *X* and *Y* does not exceed the rating of the divider or the rectifier tube with either contact closed. — *Gerald Benedict, WINDL.*

POLARIZED PLUG FOR A.C.-D.C. GEAR

IN SEVERAL issues of *QST* I have noticed articles suggesting just what to do when we are using power supplies where the chassis of the power supply is grounded to one side of the power line, especially in the use of the 117L7 and other tubes where one section of the tube is used for power and the other for oscillator, etc. Probably someone has said something about this, but I have not seen it, so stop me if it is old stuff.

If you will look carefully, you will find that in most of the outlets used in house wiring and passed by underwriters, the opening for the neutral prong is longer than the opening for the prong connected to the hot side of the line, as shown in Fig. 3. It looks as though they had made it for the special purpose of polarizing one side of the line. If anyone will check the sockets, he will usually find that the neutral or grounded white wire of the 115-volt system goes to the prong with the longer opening.

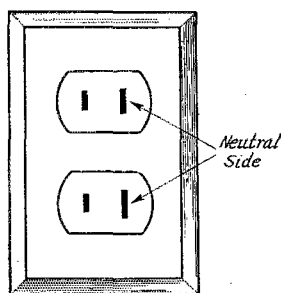

Fig. 3 — Most approved power outlets have prong openings of different sizes. Plugs may be polarized by flattening one of the prongs.

Now just take a hammer, flatten the prong of the plug which goes to the case or chassis, so that it will fit only the larger of the two outlet openings and there you have it. In all my messing around, I just stumbled onto that the other day. I have found this type of outlet in several homes and dime stores sell the same type, so they must be scattered around in many parts of the country.

Before inserting the plug, it is a good idea to make sure that the grounded side of the line is connected to the outlet prong with the larger opening. — *R. B. Murphy, W4IP.*

A SIMPLE, RELIABLE AND INEXPENSIVE PHOTOTUBE RELAY

THE irresistible urge to be doing something with a soldering iron and a pair of long-nose pliers has resulted in the very simple phototube relay circuit shown in Fig. 4. This circuit seems especially appealing, since it does not require material that is critical or otherwise difficult to obtain. Most ham shacks could supply parts for two of these units by looking behind the workbench. The relay used for controlling the external circuit need not be especially sensitive, and good results can be expected from one constructed from odds and ends; for instance, the poles and coils from a discarded high-impedance headphone. The circuit shows a meter in the plate lead of the tetrode. This was included to make comparisons between photocells and light intensities. This meter can and should be left out of the circuit. (Sell it to the Signal Corps through the ARRL when they are called for again.)

The compact 117L7GT was used because of its dual-purpose features. By employing the diode portion in a half-wave rectifier circuit, reasonably smooth d.c. voltage is available for the operation of the amplifier section of the tube. This arrangement also eliminates the condenser used across the relay in self-rectifying types of photocell-relay circuits. The 117-volt filament makes unnecessary the use of dropping resistors or ballast tubes. While the 117L7GT seems to be the logical tube to use, there is no reason why a separate rectifier or amplifier tube could not be used if a 117L7 is not under the work bench. The photocell is an RCA 868. The author is a theatre projectionist and finds discarded 868s relatively numerous. Almost any projectionist would be glad to donate a discarded photocell to a ham, if only to keep him from collecting butterflies for the duration. The discarded cells are not necessarily "duds." In theatre amplifiers the gain is usually rather high, on the order of 125 db. Consequently, a cell which is low is usually discarded rather than having to lower the sensitivity of the remaining cell and then raise the gain of the amplifier. The discarded cell is usually far from being useless.

Here is how the circuit works. The power supply delivers d.c. at a voltage depending on the capacity of C_1 . The condenser value shown was used because it happened to be the highest value on hand. If experience shows the cell being used to be free of excessive gas, the plate voltage could be raised by using a 40- μ fd. tubular condenser rated at 200 volts. The 868 cells are rated for 90 volts of applied potential. New cells often glow at this voltage, while on the other hand a "hard" cell can be operated at 135 volts without glow. All cells have some gas introduced to assist the electron transit from the cathode to the anode and to increase the sensitivity by secondary emission, so beware when increasing the supply voltage. Do not expose the cells to direct sunlight. If they are used out of doors in the daytime, efficient shielding will be required to exclude all but the operating light beam. Ionization within a cell is indicated by a faint glow, purple in color.

When this takes place you have a VR tube instead of a photocell. With as poor a cell as could be found, the plate current of the amplifier could be driven as high as 12 ma. with sufficient light to reach the saturation point of the cell.

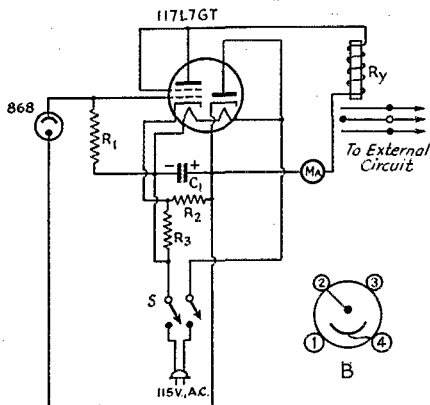

Fig. 4—Circuit diagram of the photocell relay.

- C₁ — 16 μ d., 450-volt.
- R₁ — 10 megohms, $\frac{1}{2}$ -watt.
- R₂ — 25,000 ohms, $\frac{1}{2}$ -watt.
- R₃ — See text.
- R_y — 1000-ohm (approx.) relay.
- M — 0-15-ma. d.c. meter.
- S₁ — D.p.s.t. switch.
- B — Base connections for 868, bottom view.

To select the proper value of R_3 , the drop-out current of the relay to be used should be determined by performing the following experiment. With the photocell removed from the socket try increasingly higher values of resistance, starting with 1000 ohms, until the relay will no longer stay locked up when the armature is pressed toward the pole face with the finger. Adjusting the resistance value closely will give a plate current just under the release point of the relay. This allows the relay to operate by itself when the plate current is increased by the application of light after the photocell has been inserted in the socket, since increased light reduces the bias on the grid of the control section of the tube. The amount of plate-current increase necessary is the difference between the pick-up and drop-out values, plus the difference between the static and drop-out values. By narrowing down this difference to as small a value as possible without making the relay action sluggish, good sensitivity and quick action are insured. This action can be more easily understood if it is realized that the photocell is in reality a variable resistor between the positive end of the power supply and the grid of the tube. More light in the cell simply overcomes the negative bias applied through R_1 .

In the dark, a two-cell, focusing-type flashlight gave positive operation at a distance of 23 feet. A stronger light source with a simple lens to direct the filament image of the source directly into the cell would, of course, operate over a greater distance. Sensitivity can also be increased by adding a condenser lens in front of the cell to pick up light over a greater area and converge

it onto the cathode of the cell. Those who would like to conceal the light beam will find the 868 photocell especially sensitive to infra-red radiation, and good performance can be had with an ordinary tungsten-filament lamp and a filter composed of alternate layers of dark red and purple gelatine sheet. Do not use blue. Sufficient attenuation of the visible spectrum can be had without too serious a decrease in operating distance, using the invisible beam which cannot be seen even when looking directly at the light source.

This circuit, with the relatively slow-operating telephone-type relay employed, followed keying accurately at 20 w.p.m. when the light beam was completely interrupted. The relay should have a single-pole, double-throw arrangement of contacts so that an external circuit can be completed or broken when the light is applied or removed.

Go ahead and open your garage doors with it, too; we don't care. — *John T. Seiler, W6TGD.*

P.O.W.

Frank I. R. Hunt, ZL2GQ, of Napier, New Zealand, is reported being held a prisoner of war in Germany.

A letter received from Mervyn R. Campbell, VK3MR, indicates that he is being held a prisoner of war in Italy. For the complete letter, see "Correspondence from Members."

Missing in Action

Clarence Reed, RM1c, W8AQD, has been officially reported missing in action. He was a radio operator on the *Houston* when it was sunk.

Silent Keys

It is with deep regret that we record the passing of these amateurs:

- W4BAH, D. S. Williams, Wallace, N. C.
- W6JBB, Joseph C. Schutte, jr., San Jose, Calif.
- W9AFL, Howard J. Smithback, Madison, Wis.
- W9CMR, Richard A. Jablonski, Berwyn, Ill.
- W9GBC, Walter J. Bartram, Hannibal, Mo.
- W9SLN, Lt. Russell L. Callison, AAF, East St. Louis, Ill.
- W9WNQ, Pfc. Glenn R. Schlingerman, Green Bay, Wis.
- W9YHU, Billy H. Cobb, Lexington, Ky.
- K4IIM, ex-W2KIQ, Phillip M. Houston, San Juan, P. R.
- ZL2OC, Sgt. William C. Hutchison, RNZAF, Gisborne, N. Z.

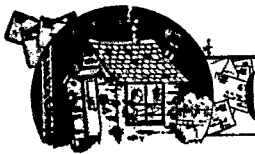

CORRESPONDENCE FROM MEMBERS

The Publishers of *QST* assume no responsibility for statements made herein by correspondents.

FROM O.W.I.

Office of War Information, Washington, D. C.
Editor, *QST*:

With reference to the article you published in June *QST*, calling the attention of amateurs to our needs for volt-ohm-milliammeters and a 1-kw. transmitter, we wish to thank you very much.

We have secured the necessary transmitter and meters, and I feel certain that without your co-operation this would have been impossible. May we again thank you for your kindness.

— C. L. Jeffers, *Radio Engineer*

SUNRISE OF VICTORY

37 Rue Laporte, Quebec City, P. Q., Canada
Editor, *QST*:

I must congratulate you for the July issue's very thoughtful cover. . . .

May the sunrise of Victory take out the antenna array from the dark, to carry on again the expression of the most fascinating hobby in the world: Amateur Radio.

— Victor Livernois, *VE2NK*

THOSE C.A.A. JOBS

Naval Air Station, Sitka, Alaska
Editor, *QST*:

I just received my copy of July *QST* and finished reading the article, "The Life of a CAA Communications Operator," by Roger Willco. . . . I have a lot of respect for the CAA, after working for them for nearly eleven years, and there is a lot more to one of those jobs than was emphasized by Roger the 4th. Take it from one who stuck around in the CAA long enough to find out what it was all about, I really have a lot of respect for all the examining officials, inspectors, engineers, and supervisors with whom I came in contact. They were men who knew their stuff, and you soon learned your job or else you were on the outside looking in again. . . .

Here are a few of the qualifications you had to have to be a CAA operator. First of all, you had to possess good horse sense. You had to be a qualified weather observer, a good typist, and a radio operator able to send and receive code at not less than 20 w.p.m.; be able to repair and maintain radio receivers, transmitters, teletype-writers, perforator equipment, Weather Bureau instruments, field and lighting equipment; stand guard on about six different receivers, plus an interphone circuit and a teletype circuit; carry on two-way communication with aircraft; prepare and dispatch flight plans and position reports; make up weather reports (the six hourly

reports took about twenty minutes' time to complete); broadcast all NOTAMs (notices to air-men) and all special weather reports that appeared on the teletype circuit within a certain radius of the station; maintain the communication log plus at least two monitoring logs of other range stations. And, if the station was designated to monitor circuits for discrepancies, the operator usually had to maintain a couple more logs during his watch. Then, too, if he were at a point-to-point station he had to get all the traffic and weather reports from one or two stations by radio and relay them on a teletype circuit, and also relay all traffic and reports that concerned his point-to-point stations.

After standing an eight-hour watch, if he were at a station that had remotely controlled equipment (which usually consisted of a couple of Kohler plants for emergency power and dual transmitters, both high- and low-frequency), he had to drive about three to five miles down to the transmitter building to change transmitters daily, log meter readings, test the emergency power plants and then operate them for at least four hours continuously each week. After that, he could call it a day's work — unless some of the equipment broke down and the operator on duty was unable to get it repaired, in which case he was called back to get things in working order. . . .

The old timers put in twelve hours a day for \$100 per month and no leave for a good many years when the airways were first getting under-way. . . . I well remember those days. It took us about five years to get the shifts down to an eight-hour day. We could have two weeks annual leave a year, providing reliefs were available. Some of the fellows managed to get leave while the others just kept plugging along, feeling mighty glad to have only an eight-hour shift, let alone any leave. Then along came the depression, and \$100 a month was pretty big money. They began to find a lot of employees . . . the majority of them ex-Navy ops. The experience gained in the Navy was a great benefit to them, and the majority had the initiative to dig in and learn their jobs.

When one stops to think what the airways are used for, it simmers down to the fact that the CAA operator is sitting down there on the ground with the lives of pilots and passengers and millions of dollars' worth of equipment in his hands. . . . The pilots who fly the airways depend entirely upon the CAA operator to give them guidance and keep them advised of other air traffic in the area and of landing and weather conditions at all times. When flying in bad weather, their lives depend on his equipment. . . .

Yes, I am inclined to believe that, after the war is over, these so-called "war service appointees" or "war babies" will be taken in off the doorstep and given a name in a great organization. But the ones that are lucky enough to be taken in will certainly have to show a lot of ability — much more than to be able to punch a typewriter. . . .

— CRM T. S. Lym, W7HGA

P. O. Box 672, Orlando, Fla.

Editor, *QST*:

As for you, "Roger Willco," it is easy to understand why you are in IV-F.

As for you, Editor, is writing material getting so scarce that you have to print such half-baked trash? What is it that you have against the CAA? As I remember, you have never printed a decent article about the CAA. If you don't know what a fine organization it is, please refer to the recent article in the special edition of *Radio News*. If you are spending membership fees to pay for this kind of rubble, brother, count me out when it comes time to renew membership. And just look what you show on the front cover of that July issue!

— Randall E. Smith, W4DQA/W5KIX

EDITOR'S NOTE. — One would almost think that the diet "Roger Willco" described had something to do with this comment! The story in question was printed solely to aid the CAA recruiting effort. It has proved effective, too; a number of inquiries from prospective applicants already have been received.

QST MAKES THE JOB EASIER

Ordnance Instrument Shop, Ft. Sheridan, Ill.
Editor, *QST*:

Thanks for the splendid job you are doing in preparing men and women for the armed services. The many articles in *QST* on the fundamentals of electricity and mathematics have helped us and the candidates for this advanced training school in use of radar and range instruments. Our job is made much easier and promotions come faster for the men if they have studied lessons such as your magazine has published.

We find that we can also select readers of *QST* to act as assistant instructors, as they are usually more advanced in their knowledge of the fundamentals of radio. . . .

— Zachary Roseman, W9RTT

SOURDOUGH SPEAKS A PIECE

Pine Notch, Polecat County

Editor, *QST*:

'Long comes July *QST* and sure glad to see it, though it seems we sort of woke up old man Rapp.

You jest tell him that, come the day he's recovered from the hangover caused by celebratin' the end of this here scrap, to come on up to Pine Notch. Between his brains and my corn squeezin's, we sure oughta be able to work out somethin' purty dandy. Only trouble is, I can't offer him no laboratory like he has. We country folks stick to Chic Sales.

OM Rapp's got no cause for worry about my raw meat ration. Fact is, we'uns up here eat mostly bear, muskrat, gopher and polecat — and the OPA boys ain't got tickets on them yet.

Kinda puzzled about neighbor Rapp's mention of going barefoot. Shucks! We allus go barefoot, 'cept in the middle o' winter, and then we jest whittles a pair of boots outta bog elm, packs 'em with straw and pulls 'em on over the callouses.

Seems like life down to the city is real complicated. Reckon I'll stay right here in the Notch and churn my own butter, catch my own fish and cut wood out in the north forty for them airyp-plane factories.

— Sourdough

P.S.: That sure was an elegant article Mr. McMurdo Silver wrote — but I betcha them brute strength and ignorance boys won't like it. Myself, I never could see this idee of up with the power bill and let the splash fall where it may.

HE SIGNS HIS NAME!

4613 Rokeby Road, Baltimore 29, Md.

Editor, *QST*:

The ideas for determining when the transmitter frequency is out of the prescribed ham band, as brought forth by "Sourdough" and Larson E. Rapp, make very interesting reading. I would not say that any of them were "ill-considered."

However, instead of going to all that trouble just to have a device that tells when the transmitter frequency exceeds the band limits, it would seem more desirable to take the problem in hand and have a continuous and direct measurement of the transmitted frequency. Such a piece of equipment might use a 100-kc. crystal, a 10-kc. crystal, a 10-kc. multivibrator and a calibrated heterodyne frequency meter coupled to a detector-amplifier, which is also coupled to the e.c.o. and has an audio-frequency meter in the output as well as headphones. After setting the transmitter frequency, the calibrated heterodyne frequency meter is turned on while a quick rough check is made of the frequency. This is to determine which side of zero beat of which harmonic of the multivibrator the e.c.o. is on. Frequencies can be checked to within a few cycles by this method. All the operator has to do is to watch the transmitter drift (!) in the a.f. meter until a new frequency is desired; then the process is repeated. The equipment need not be elaborate or costly, and would more than comply with FCC orders on frequency measurement in amateur stations.

I was very pleased to read such an article as McMurdo Silver's "Watts-Or-Decibel" in the June issue, and would like to see more of the same calibre. However, W2MWX's abortion in the July issue is a direct reversal, showing very poor engineering and misuse of good equipment. I know that suitable magazine material may be hard to get in this day and age, but you should not have to stoop to printing "How to Burn Up Tubes" or "Don't Hold that Dash too Long" articles.

— Wayne W. Cooper, W6EWC

A MERCHANT MARINER SPEAKS HIS PIECE

McCormick Steamship Co., c/o Postmaster,
San Francisco, Calif.

Editor, *QST*:

I am now in the merchant marine, and the only thing I don't like about it is that I can't get *QST*.

Commercial operating is almost like hamming, except that you must be a little more business-like. I don't like long waves. There is too much static, and it has been my experience that long waves are useless except for short-range communication, regardless of what W1JPK says about it in the November, 1942, issue of *QST*. If you can hear anything on long waves three days away from the station location, you can be sure you are very lucky. This is the first time I have heard of anyone hearing S8 signals so far away from the station. I am very thankful that the ham bands are on the higher frequencies. . . .

On the whole, commercial operating on shipboard is about the best occupation in existence — plenty of spare time and good food, and the equipment is really swell. The transmitter (which, of course, is sealed) is one of the most beautiful rigs I have ever seen. The receiver also is a beautiful piece of equipment.

The automatic alarm which rings a bell when a ship is in distress is one of the most complicated and clever gadgets in existence. It is very efficient and serves a good purpose — except for the occasional errors. It is annoying to be asleep and then, all of a sudden, have the bell in your quarters start ringing. You come slowly to life and start feeling around on the floor for your shoes. When you are fully awake, you realize what is happening. It's the automatic alarm bell. Maybe some ship is in distress! You dash from your quarters into a cold, lifeless radio room, plug in the 'phones, punch the re-set button — and hear nothing. You stand there shivering and wonder if the automatic alarm is out of order. Nothing happens. Finally somebody feels pity for you and brings in your pants.

You put them on and then, as you are tightening your belt, somebody opens up with an important message. You sit yourself in the freezing swivel chair and grab for a piece of paper and start pounding the mill. After a while the radio room gets filled up with thousands of people from all over the ship, peering over your shoulder and blowing onion breath down your neck. Then somebody opens his mouth and says, "I wonder if Sparks is getting it?" You snatch a breathing spell and yell, "Quiet!" at the top of your lungs. Then everybody tells everyone else to be quiet, in the loudest voices they can muster. Finally you get the message, and then give everyone a good cussing for making so much noise while you were copying it.

Maybe then you go back to sleep. After a short time the mate on watch comes in and howls at you to come out of the daze. You stop dreaming of the new rig you're going to build after the war and walk bleary-eyed into the radio room and go back to work. So goes the routine on shipboard.

Regardless of the twenty-four-hour-a-day watch you stand in emergencies, commercial operating is swell. What other job can you find where it is a two-second jump from your bedroom to your office? Man, it's perfect!

Probably there are some hams still not in the services. If you're one of them, you should hurry up and get a commercial ticket and get to work. We have a hell of a job to do, and this is the best way a ham can do it. Get in some service, whether it's the Merchant Marine, Army, Navy or Marines. And for the fellows who can't get in anywhere because of physical or other handicaps, keep up the good work with wired-wireless and earth-current communication or anything else. Don't forget to have a lot of practice with that fist. . . .

How about working on the FCC to let W1AW back on the air? I would like to spend my off hours listening to some ham news and get a little code practice as I used to before W1AW had to shut down. I think many fellows in the Merchant Marine and the other services feel the same way. The FCC should be told that it is in the public interest, convenience and necessity to have W1AW back on the air. [They have been told. — Ed.]

— Lawrence D. Kelsey, jr., (LSPH)

"HOLIDAY" IN ITALY

A.C.I. 9190, P.G. 52, P.M. 3100, Hut 35, Italia
Editor, *QST*:

I send greetings to the staff and all the boys from my "holiday" in Italy. I have been "in the bag" just about two years — and all is well.

I'm sure that if I was at home I would be having many a personal QSO with the boys from W who have joined with us in the struggle. I have met many of the boys from other countries — including Germany! One of these Ds happened to be looking after me. He was quite excited about meeting a VK ham, and insisted on shaking hands. We spent hours talking of radio, mostly in the Q code and slang, as he did not know English and my German was not the best. . . .

I'm running three radio classes here and they will produce quite a few hams of the right type. No text books, though. . . .

I have had many letters from the boys in England and from many strangers. It's a great life if you don't weaken, and we are far from that. I often wonder about the new tubes on the market, and wish for the dope.

Keep the ARRL going. I paid up my membership for three years on leaving — nearly up now!

It will be great to get on the job again. . . .

— Mervyn R. Campbell, VK3MR

A CADET TAKES THE TIME

484 Hawthorne Ave., Yonkers, N. Y.
Editor, *QST*:

Time is precious here at the Army Air Corps cadet college, but I am dropping you just a line to thank you for all the help you and W1AW have given me. *QST* has helped me no end and has been my guide in my activities. . . .

— Barton Halter, W2NGP



OPERATING NEWS



GEORGE HART, WINJM
Acting Communications Manager

CAROL A. KEATING, W9WVP
Assistant Communications Manager

More on the New Rules. Since last month's comments on the amended FCC rules for WERS were somewhat sketchy, we wish to examine and comment on them a bit more in detail for the benefit of those who were uncertain of their meaning, much as we were. Closer examination, discussion and unofficial comments from Washington have given us several new slants on the amendments which we now wish to pass on to you. Refer to August *QST*, p. 22, for the amended text.

An FCC release of June 26th did much to clarify the meanings of the new rules. The new Section 15.63 is the subject of most discussion since it refers to the scope of service of CD-WERS stations and unavoidably is difficult to untangle. Most of the other amendments are obvious enough in intent and need little discussion.

First of all, let us point out that Section 15.64 pertains to Section 15.63, in that whatever communication is allowed with other stations must be under the scope of service permitted under 15.63. For example, 15.64 says that CD-WERS stations may communicate with other stations in the War Emergency Radio Service, which would mean stations of all three categories; however, 15.63 says that we may communicate with SG- and CAP-WERS stations only if requested by them to do so in specific instances, but that such communication is permitted during "emergencies endangering life, public safety, or important property" (not necessarily in connection with civilian defense or national security, although most such emergencies can be considered in this connection.) Nothing is said about communication with other civilian defense stations, so we may communicate with other licensees of CD-WERS at will, so long as such communication pertains to the scope of service prescribed in the first sentence of 15.63. Many CD-WERS licensees have not recognized the fact that 15.63 is a proviso to 15.64.

Whether or not this in itself constitutes an increase in the scope of service of CD-WERS stations is open to question. It is a restriction in that communication with SG-WERS is not now allowed unless requested by the State Guard licensee. It is an expansion in that, when such communication is requested, it applies to all emergencies endangering life, public safety, or important property. The important thing to remember is that the initiative for such communication lies with the other two categories of the service, and that CD-WERS should stick to its own category unless such requests are made.

Section 15.56, under the subheading "Licensees," is an entirely new section granting a new

possibility of service to all three categories of WERS. Presumably this section was included under this seemingly improper subheading so that it could apply to all three categories of the service without having to be written out in full in the specific rules of each category.

The complete re-writing of Section 15.63 is the most significant amendment, and its wording definitely increases the scope of service of CD-WERS stations, first of all (a) by saying that CD-WERS stations "may be used during emergencies endangering life, public safety, or important property, for essential communication relating to civilian defense or national security." This of course includes natural disasters—floods, hurricanes, earthquakes, disastrous ice storms, and so on—and such things as dangerous forest fires. There seems to be a common tendency to think that CD-WERS is now expanded to deal with all such disasters, but note well that this authorization is qualified by the condition that such communication still relate to civilian defense or national security. There could be some emergencies endangering life and property that did not involve civilian defense or national security, in which case operation is *not* authorized unless under the new Section 15.56, or under the old and well-known Sec. 2.63.¹ In either case, it is necessary to notify both FCC Inspector and FCC Washington of such operation.

However, it seems to us that most of the natural disasters we will encounter could properly be considered as endangering national security, and that the official tendency will be to view favorably the invoking of CD-WERS operation under such conditions. For instance, a flood that threatens to inundate the homes of war-plant workers will interfere with war production and therefore threaten national security. A large forest fire not only consumes national resources but may threaten other important property and production operations, and so again endanger the security of the nation. National disasters along our coasts might tend to weaken defenses to the point of inviting enemy action, thus involving both civilian defense and national security.

The most significant subsection under "Scope of Service" is 15.63(b), and it is likewise the most difficult to interpret. This introduces an entirely new authorization, whereunder, upon special application and showing, specified control units may communicate during the first fifteen minutes of each hour with certain other units, including control units of other licensees, *not for testing* but for the exclusive purpose of handling essential

¹*QST*, April, 1943, p. 11.

communications preparatory to any anticipated emergency involving safety of life or important property, and in connection with defense or security. FCC says that "This operating privilege is granted in order that the latest available information may be obtained by various state control centers at hourly intervals if necessary regarding the availability of emergency facilities to be used on a 'mutual aid' basis in accordance with new legislation recently enacted by some states as a temporary wartime measure."

While it is common knowledge that certain states are trying to tie their CD-WERS communications systems together into statewide networks, we were not aware that there was any general tendency in this direction as yet. Aside from the state angle, it appears that a considerable part of the need that has been felt for such an arrangement relates to the municipal services, chiefly fire departments, in their mutual-aid arrangements with outlying communities. This 15-minute period will also provide opportunity for those control units which are manned 24 hours per day to establish and maintain around-the-clock contact with control units of adjacent or nearby licensees for the purpose of being able to summon mutual aid without delay in the event it is needed. Such control units can likewise maintain contact with headquarters of municipal services which also can be manned on a 24-hour basis, such as fire headquarters, police headquarters and hospitals.

Expansion in scope of service, at last a reality, will mean expansion of existing CD-WERS organizations and the establishment of more new ones. This, in turn, will mean an increase in the number of operators to operate the new units; at least enough to maintain the required 24-hour service among those licensees who apply for and obtain authorization to use this 15-minute period. There aren't enough amateurs to fully man units under the present set-up, and the inevitable influx of additional personnel to meet the increased demands of this expanded service will make the amateur percentage of participating WERS personnel even lower than it is at present. How big and how important a percentage of the participating personnel will be amateurs is entirely up to us. Now, of all times, we must get in there and pitch. CD-WERS is going places and we are going with it, if we want to — and we do.

Transfer of Equipment. FCC regulations do not rigidly limit the geographical area in which a WERS station may operate; they only say that the operator may operate only a unit licensed to his particular licensee. This means that it is possible and perfectly legitimate for a licensee to dispatch equipment licensed to it, and the operator to operate that equipment under the call letters of his licensee, to an adjoining community if deemed necessary. Since all operation is under the direction and supervision of the radio aide, this does not mean that a mobile unit can wander "out of bounds" at will and without authority. A good rule is to stick to your own licensed area unless there is a very good reason why you wish

to operate one of your units elsewhere (such as establishing radio contact with a district warning center located in an unlicensed community, or to provide service to an unlicensed community, or a licensed one with seemingly inadequate facilities, during a real emergency).

FCC has also indicated that, in extreme cases in which it is found absolutely essential as the result of an *existing* public emergency to transfer equipment from one licensee to another, the Commission's nearest field office and the Commission in Washington be notified of the facts at the earliest possible moment and request made for a temporary operating authorization.

Operator Permits. If an operator wishes to become affiliated with more than one licensee, he must submit a completed Form 457 through the radio aide of each licensee with whom he wishes to become affiliated. Each radio aide through whom the application is made should understand that this operator necessarily will have to share his operating time among the various licensees to whom he is licensed. There may be local regulations prohibiting this. The licensee should be in a position to maintain control of all affiliated WERS permittees as part of its responsibility to FCC for proper operation of the station. Therefore, a licensee may request any affiliated operator permittee to surrender his permit, which thereafter should be forwarded to FCC for cancellation.

Experimental Data. In its release of June 26th, FCC requested that radio aides and engineers working in WERS voluntarily furnish them with information on the apparent communication range, reliability, interference conditions, variations in signal strength, types of antennae used and their effect on transmission, and other related data. ARRL wishes to second this suggestion, and we point out that, if such data are furnished reliably and voluntarily, it will enable the Commission to have a better understanding of our problems and our needs, as well as contribute to the advance of v.h.f. communication. *Note well*, however, that WERS primarily is a communications system, and that the only purpose of its existence is to carry on such communication as is permitted under its scope of service. There is no room for experimenting as such, just as there is no room for ragchewing or DXing. FCC's request refers only to those data which are observable in the normal functioning of the system, and is not an invitation for budding young Marconis to do their stuff.

Identification. Our attention has been called to the fact that, inadvertently, we have been recommending something in *QST*² which is strictly illegal. WERS stations are required, under the present rules, to give identification at the beginning and end of each complete exchange of communication. This identification must be given at all times *unless the Army has issued a limited-transmission order*. During practice alerts such an order normally will not be issued, which is a little detail we neglected to mention in this

² *QST*, April, 1943, p. 24.

column a couple of months ago. The rule to follow is to give complete identification unless your d.w.c. directs you to observe limited transmission.

Operating Discrepancies. Despite our frequent haranguing in this column on the subject of ragheewing, the practice continues. Not long ago we received unofficial information to the effect that the state of "amateur chatter" among certain licensees was becoming intolerable in the eyes of at least one Army defense commander. We have reason to suspect that such a practice, even if limited to a certain area (which it is not), will have the effect of a nationwide ban on further WERS communication.

ARRL does not understand why this practice is allowed to continue. Testing of transmitters does not require a technical discussion over the air, merely a report of signal strength, quality, stability; the details can be discussed in person or by telephone. For drilling and practice in operating procedure it is necessary to transmit, of course, but not necessary for control to call each operator by his first name, or vice versa, or to say "Good evening," or to tell Joe Doakes that you saw his brother at the fights last night.

We amateurs, through our technical excellence and resourcefulness, have been instrumental in getting WERS started. No one will question that. It was the amateurs who plagued local defense councils, the amateurs who built most of the equipment from their own junk boxes, and the amateurs who supplied the initial personnel. So much has been to our credit; but, as it was the amateurs who started WERS, so it may be the amateurs who will finish it with our irresponsibility on the air and our seeming inability to adapt ourselves to a new mode of operation made necessary by the exigencies of war. The good name we made for ourselves at the beginning is being spoiled by the activities of a few groups who refuse to limit their operating procedure to necessities only. Look yourselves over and make sure that your group is not one of those few.

Another dangerous practice being engaged in by some licensees is DXing. Long-range contacts

made under abnormal conditions are of absolutely no value to the service and therefore are illegal. They must be avoided. If you hear a WERS station you do not normally hear, drop the licensee or radio aide a line. He will be interested. Drop Ed Tilton a line, too, for his v.h.f. column. But keep it off the air.

— G. H.

WERS In Lake Erie Dike Break

Once again WERS has proved its worth in a flood emergency. On July 6th an 800-foot section of the dike in the Reno Beach and Howard Farms area, guarding communities located 15 miles from Toledo, Ohio, on Lake Erie's southern shore, crumbled under pressure and yielded to the raging waters which flooded the entire area for a distance of three-quarters of a mile inland. By July 7th a total of 1500 feet of dike had collapsed and the inundated area extended to a mile and one-half inland at some points.

As soon as the lake waters began spreading on the evening of July 6th, Paul H. Chapman, commander of the Toledo Civilian Defense Corps, immediately mobilized all Lucas County emergency services. William H. Smith, W8VYJ, chief communications officer of WERS, and Rollind O. Holloway, W8UQL, radio aide, called five units for immediate duty, placing three of them at strategic points where the danger was most imminent and two in emergency stand-by status.

All telephonic communication with the affected area was cut off at the time of the last break-through, on Wednesday morning, and the only means of communication was the CD-WERS radio system, operating with five mobile stations in the flood sections. The operators in the automobiles kept in close contact with the station at the main control center until telephonic communication was restored.

In this first act of emergency test, the Lucas County WERS units won the praise of city and county officials. Chief Communications Officer Smith said the battery-operated sets "did a perfectly swell job under pressure" and that some of the operators had been on 24-hour duty continuously. In commenting on the work of the civilian defense and WERS units, Fred L. Mollenkopf, city editor of the Toledo Blade, said: "They did a magnificent job. Our respect for Civilian Defense and its allied services has been enormously increased by virtue of their response during an emergency that might have been disastrous. We, and I mean by that our reporters, who are pretty hard-boiled about many things, have the greatest admiration for what they accomplished."

Others who participated were: W2MMG, 8ARF, FED, HSW, JEX, JJK, JLQ, RB, RRZ, SLR, TIV, TWU, UEL, ULG, WCB, WEW, WHS, Carl Betz, Art Herman, Samuel Lewis, Frank Poucher, Fred Sattiswaite and Vic Zang.



These photographs were taken at a South Jersey Radio Association turkey dinner. Reading from front, in photo 1, left: 3FBZ, 3IIC, Mrs. 3IIC, Mrs. 3KW, daughter, 3KW, 3IPZ, 3HND. Right: Mrs. 3AEJ, 3GPU, Mrs. 3GPU, Mrs. 3FBH, 3FBH, Hank Bennett (Class B ticket), Mrs. Bennett, Miss Bennett.

In photo 2, left: Mrs. 3FBZ, YL and Bob Boehme, Julius Krivos, Mrs. Westcott, Bill Westcott (Class B ticket), John Cummings. Right: Mrs. 3IAS, 3GZS, Mrs. 3GZS, George Matthias, Mrs. Matthias, 3IAS, Ed O'Brien.

Others present were 3FDF, 3HLY and Mrs. 3HLY, 3BCP and Mrs. 3BCP, 3GYM and father, 3AEJ, Joe Nelson and Frances Schuelleim, 3EIA and Mrs. 3EIA, Dave Toy, 3DAJ and Mrs. 3DAJ.

BRIEF

John A. Bolan, W8OQI of 15804 Calcutta Ave., Cleveland, Ohio, has found a unique way to contact other hams and obtain their QSLs. He works as a railroad brakeman for the New York Central Railroad out of Cleveland. During the latter part of 1941 he started marking railroad box cars with his call and the letters "QSL" beneath. In the past year and one-half hundreds have seen these box cars, and many have sent him cards and letters. So far W8OQI has "worked" all districts via the railroad cars — and he sent the QSLs in to Hq. to prove it! He claims reception of cards from 22 states and Toronto, Canada, as a result of his yellow chalk markings.

Meet the SCMs



WIKQY

Ed Fraser, WIKQY, Connecticut SCM, became interested in radio back in 1921, but his first license was acquired in 1937 under his present call. Since that day he has become one of the better-known members of the fraternity. Previous to his election as SCM, he held appointments as ORS, RM and Emergency Coördinator. One of the most active stations in Connecticut, WIKQY participated in almost every contest sponsored by ARRL, including ORS parties, Sweepstakes, DX, Field Day, WAS parties and RMnite get-togethers — and in most of them he came up with a sizable score each time. Ed took courses in radio at the Naval Training School in Norfolk, Va., and at the Naval Submarine Base in New London, Conn. From 1923-37 he served in the Navy as RMLc, and he now holds a second-class radiotelephone license. He served three terms as vice-president of the New Haven Amateur Radio Association, from whose station (W1GB) he did some emergency operating during the 1938 hurricane. Besides ham radio, he is interested in swimming, golf, baseball, basketball and skating. His present occupation is that of transmission man for AT&T.

The Month in Canada

ALBERTA — VE4

From W. W. Butchart, 4LQ:

4HM has returned from his trip East and reports a very FB time all around. He met several of his ham friends and fraternized with them whenever possible. He met the famous 4GM while lunching in Ottawa one day. GM had the YF along, and according to Chas. they were enjoying themselves to the full. Then 4WJ, formerly of Calgary and now stationed at Ottawa, returned to that city from The Pas, Manitoba, the day after Chas. arrived in Ottawa, so he enjoyed a visit with both Ernie and Elva. Sgt. Harvey Runnalls, 4AHY, who lives at the "Y" in Ottawa, secured a room there for Chas., so that the two spent quite a bit of time together. Harvey took him down to the testing lab, where new models of communication equipment for the Army are built up and tested. While very "hush-hush,"

Charlie was able to get a pretty fair idea of how work is carried on in the lab, and says it's just a ham's paradise, no foolin'! Then, on the road back West again, Charlie stopped off in Toronto and looked up Fred Heath, 4QX, who is doing very well for himself as liaison officer between the government and manufacturers of electrical and radio equipment. By the way, Chas. says that the Dominion Observatory is a wonderful place, too. Electronic clocks, etc., there caught his eye, as well as the big telescope.

Come July, and 4BW, 4HT, 4XE, 4XF and 4LQ trek southward to Sarcee camp for two weeks with the Reserve Army. XE is already in the southern city of Calgary, after spending six or eight weeks at Medicine Hat.

At last report Mickey, 4WY, and the junior YL op were doing nicely, thanks! Don Langbell, 4ANQ, is now on the announcing staff at CJCA, having changed from GFRN.

News seemed to be extra scarce this month until we received a very newsy letter from 4AES. It appears that the Pere' has found a ham's paradise as far as location is concerned. He is at Lac La Biche, a hundred or so miles north of Edmonton. His quarters are in the hospital there, and to make it doubly inviting he operates a private commercial radio station, CH3M, which communicates with Breyntat. Both stations were built up by AES, and they run a regular schedule daily at 7:00 P.M. on 3040 kc. Besides his clerical duties and operation of the radio station, Pere' prints a weekly newspaper and is the commanding officer of the Lac La Biche Signal Cadet Corps, affiliated with MD 13, Calgary. All in all it would appear that he has his hands full, as we noted a month or two ago when he had been selected to sit on the local ration board of the village. Any of you chaps who want to drop AES a line may do so to the following address: Rev. Fr. J. E. McGrane, P.P., Lac La Biche, Alberta. Take it from us, it will be welcomed by the OM. In the meantime, Pere', thanks a lot for the nice letter and glad to hear that you have things so well organized up there.

MAILBAG

From W. R. Peyton, radio officer in the Canadian Merchant Navy, we receive the following news:

5VR attended the University of British Columbia in Vancouver last winter. 4AOL-5VA studied in Vancouver for second-class commercial. 5ADP received his second-class commercial and when last heard of was casting eyes toward salt water. 5AJO is operating at Vae Estevan, B. C., for DOT. 5ABN, widely known through his association with the Canadian Forestry Association, joined the RCCS. 4WX was in Vancouver trying for his second-class commercial. 5JD, after a spell in northern Saskatchewan with CM&S, came out to Vancouver last winter and then went back to Edmonton for Canadian Pacific Airlines. 4KI came down from Surf Inlet in January, and after a spell in Vancouver went home to Strathmore. 5ADM is in the Canadian Merchant Navy as an operator. 2OZ is a captain in the RCCS.

In a recent letter from Frank Meadows, jr., 4AC, is this note: "Would like to correct the notice in April QST stating that I was now with the RCCS in Kingston, Ont. Wanting to get a personal crack at Hitler and company for depriving me of my hobby, at the outbreak of hostilities I tried to join the armed forces, but they would not have me. Finally got into the Reserve Army with a D1 category. Gee, I must be a helluva wreck!"

This letter, written back in April by John H. Scott, 3AFY, found it's way to Hq. just recently:

"Probably this should go in the 'VE' news as that's what I am — Scotty, 3AFY. For about the last year I've been radio operator aboard a Norwegian motorship, but early in March was torpedoed. Spent nine days in a lifeboat, etc., and am now trying to get a ship back to the U.S.A.

"In the course of my travels I've had the good fortune to meet many brother amateurs, and they are all tops — will do anything for another ham. Incidentally, this is being written at ZSIT, C. A. W. Rieder. Have met a lot of the ZS gang as well as others — special mention to G3FW and G8IH. Of course, during my stays in the U.S.A. I have also come across many W hams.

"I would really like to hear from any of the gang I used to work, or from anyone else, for that matter. If mail is addressed to me at 16 Powell Ave., Ottawa, Canada, it will catch up with me eventually. Often wonder what all the Ottawa gang are doing these days. Many are in the services, I know, so here is best of luck to you all!"

AMATEUR ACTIVITIES

ATLANTIC DIVISION

EASTERN PENNSYLVANIA — SCM, Jerry Mathis, W3BES — BNK is radar instructor at Camp Murphy. He and XYL are living at West Palm Beach. He states that many Phila. hams pass through his place. HFW is stationed at Camp Crowder, Mo., where he is doing a lot of telephone work. It is quite time to him after working on u.h.f. and radar. H1 FVO is on lighter-than-air duty now. IXN passed his Class A exam. BXE is back in Phila. and works at Philco. We hope it is a trend. GET is building a super duper receiver. IJN is fed up with the "lakes" section of southern California. You see, the lakes have been fresh out of water for quite a few centuries. GHM is taking his television seriously. Did you see ASB's picture in the papers? He is serving in Sicily with the Signal Corps. The nearby WERS are experiencing inter-city QRM and have reshuffled the frequency allotments. 73, *Jerry Mathis, W3BES.*

MARYLAND-DELAWARE-DISTRICT OF COLUMBIA — SCM, Hermann E. Hobbs, W3CIZ — Cpl. 8AZT, now located at Fort Story, Virginia, has need of two-watt neon bulbs. If anyone has them to spare he would be glad to hear from them. Address Hq. Bty., 3rd Bn., 2nd C.A. IEM, formerly located at Miami, is now pfc. and located at 805 TSS, Bks., 1027, Sioux Falls, So. Dak. 2IJC, now at Catholic University, Brookland, would be pleased to contact some of those interested in WERS. IVZ, now a t/sgt. with the CAP, is at Coastal Base No. 12, San Benito, Texas. Jean Hudson is now counsellor at a girls' camp in the Catskills. The Washington WERS, WJDC, now has nine stations in the local set-up. The Montgomery County police department will shortly be outfitted with two-way radio communication facilities. Send in a card now and then with items of interest to the gang. 73, *H. E. Hobbs, W3CIZ.*

SOUTHERN NEW JERSEY — SCM, W. Ray Tomlinson, W3GCU — Asst. SCM, Ed. G. Raser, ZI; Regional EC in charge of Emergency Coordination, Theodore Torretti, BAQ; Asst. EC & Radio Aide for Hamilton Twp. WERS, H. Dallas Fogg, ASQ; EC for Somerville & vicinity including Southbranch, P. S. Case, ABS. Hi-ya gang! Notsomuch this time, but hello to all of ya! This month brings forth a crop of new locations of our brothers in the Service. HAZ is now Staff Sgt. Wm. F. Petty, Jr., 803rd Signal Training Bn., Co. I, Fort Monmouth, N. J. T/cpl. William E. Bryce is at 15th Signal Training Regt., Co. C, Fort Monmouth, N. J. DAF, Robert E. Leahey, is in USNR, ARM School, NATTC, Naval Air Station, Jacksonville, Fla. He is warrant officer, and has moved the XYL and youngster to Florida. Bill Stryker was home recently and left his QTH as ARTIE, U.S.N.A.T.T.C., Bks. 55, Memphis, Tenn. HTP is RM3c at Box 30, Naval Air Station, Jacksonville, Fla. ARN and ex-CYW have met and are now stationed at the same school. They are Anthony S. Rua, RT3c, Class 2-44, Section F, Bliss School, USN, Tacoma Park, 12, Md., and Alex McLees, RT3c, Class 9-43, Section B, Bliss School, USN, Tacoma Park, 12, Md. IHZ is Sgt. Capner, 4th Com. Sqdn., AACs, Morrison Field, Palm Beach, Fla. He is holding down the highest speed circuit in the Air Corps. IOW is T/Sgt. Anthony Constantino, 12011935, APO 817, c/o Postmaster, New Orleans, La. ITU is Cpl. Dave Nabutovsky, Artillery Engineers, Huntington Park, Cal., P.O. Box 429. He is hobnobbing with the elite in Hollywood. VE is Major Samuel S. Kale, last heard from at Pine Camp, N. Y. How about a line or two from the rest of you fellas? We can promise all of you an answer. Ed. jr., ZI's YM, is doing fine at the Navy College Training Program V-12, at Cornell University, Ithaca, N. Y. Bob Worley, jr., HWO's YM, is also enlisted under the special service V-12 program, but we do not have his QTH as yet. Ex-BAP is coming along nicely after nine weeks of illness in hospital. He is chief op. at WTNJ, Trenton. FTU is spending some of the summer at his hide-a-way up in Maine. Hamilton Twp. WERS is shaping up very nicely under the directorship of radio aide ASQ. Equipment has been installed in control center, and police hq. antennae have been installed at four of the nine fire houses in the set-up. Examinations were held on July 23rd

at the Greenwood school building, with 58 of the applicants attending. Request has been made for permission to hold another examination, for the balance of those who attended the classes in the various fire houses, on the second Friday in August. This program is receiving the complete cooperation of our Twp. officials, as well as the police department, with Mr. Frank Priest, Twp. Communications Officer under Twp. Committeeman, Armit A. Harrison, chairman Hamilton Twp. Defense Council; and Clarence Allen, Twp. police radio technician under Hamilton Twp. Chief of Police, Richard Brittell. It is expected that a complete story of this set-up will be submitted for QST publication when the set-up is finished. The set-up as it stands at present is: JOL, chief operator in charge of control center; C. N. Harris, GSP, in charge of instruction; HTJ, in charge of maintenance and equipment installation; TL, in charge of antennae installation; and GCU, in charge of equipment construction. The entire program is under the supervision of ASQ, radio aide for Hamilton Twp. It was erroneously reported last month that control center equipment was designed by JOL and built by HTJ. This should have read: designed and built by JOL and HTJ. ABS reports Hillsborough-Branchburg Twps.-Somerville WERS application still awaiting FCC action. Hillsborough Twp. radio school has completed its second successful year and is now closed. CCO has returned from research expedition through Texas to his base at Wright Field, Dayton, Ohio. Landline activity in all previously mentioned localities has almost completely given way to WERS activities. This is the bill for this month, and, with another appeal for news, especially of WERS activities, we say so long till next time, and 73 to all. — *W. Ray Tomlinson, W3GCU.*

WESTERN NEW YORK — SCM, William F. Bellor, W8MC — QLI has been appointed EC for the Corning area and, as there are very few hams available down that way, he is anxious to hear from anyone interested in WERS work. PK has left WHAM and is installing radar for the Navy. VOX is teaching electronics at the University of Rochester. DOD is teaching code at Vocational High in Rochester. CFA is active in CAP. GWO has been appointed war service director for station W51R. Fred Ambrose, an operator at WHAM, would like to hear from others in the vicinity who are interested in wired wireless. DFN is now building an electron-coupled frequency meter.

DAKOTA DIVISION

SOUTH DAKOTA — P. H. Schultz, W9QVY — DB reports that he and the others at Sioux Falls Training School are turning out a lot of good radio operators. At present he has four hams in his class, and appears to be enjoying the work as well as accomplishing something down there. CQK of Sioux Falls enlisted in the Air Corps in Jan. 1941 and after a lot of training and moving he is located at a ground station somewhere overseas. His address is S/Sgt. J. A. Derrick, 17018928, APO 913, c/o PM, San Francisco, Calif. He sure would like to hear from the old gang. QAK sold his home in Northville and is a confirmed Army man. His address, in case any of you would care to write him, is T/Sgt. Ernest J. Johnson, 82nd RCN Sqdn. (F) AAF, Laurel Army Air Base, Laurel, Mississippi. Thanks for the reports, gang and keep them coming! Can use lots more. 73, *Phil.*

NORTHERN MINNESOTA — SCM, Armond D. Brattland, W9FUZ — MSW has been visiting her husband, BCT, lt. (jg) in radar, Bowdoin College, Brunswick, Maine. VVA has been visiting at Glenwood. He is putting in time toward private pilot ticket. Closing of NYA radio schools may change the address of this SCM, but until further notice, address your reports here to Glenwood.

CENTRAL DIVISION

ILLINOIS — Acting SCM, George Keith, jr., W9QLZ — AOI had an unfortunate display of fireworks when lightning struck his antenna. DUX has moved to St. Louis. HXO is with Signal Corps at Ft. Monmouth. BIN reports lots of work and hopes to catch up soon. DBO, in Army, sends regards from Camp Wallace, Texas. TLC and BIN have frequent QSOs via the land line. ATA is working in the engineering department at Hallicrafters. ODT, EC Will County, reports continued progress with WERS in the Joliet area. NIU is now a full-fledged deputy sheriff. YJF has entered the armed forces. TAY is interested in ways and means of obtaining a commercial ticket. SIGW/WLRE, the 5th

district outlet for ILN, passes along 73 to all the gang from Illinois. Hal is a lt. at cadet ground school in Greenville, Miss., and is busy teaching the boys that W5 hf. technique. PNV reports WERS now going great-guns in Chicago. Regret to report the death of Dick Jablonski, CMR, an old timer on 160 in and about Chicago. He was trapped while trying to escape from a burning building, while performing his duties as fireman. For the benefit of everyone, more news is needed. You fellows know what makes news, so take your pen in hand! — *Geo/W9QLZ*.

INDIANA — Acting SCM, J. P. Gilliam, W9SVH — You fellows have a new SCM this month, so don't expect too much! YMV is now in N. Y., Sect. 493, Comt. H58, Bks 5, U. S. Maritime Service Training Station, Sheepshead Bay, N. Y. Roy says that he found a good spot for a ham who wants his war first hand, and to tell the fellows to look into it, when and if the draft board gets close. EHT has been under the care of the medico. Highland CD bigwigs were so pleased with the showing made by SNF and his crew that their WERS is being expanded from two to eight units. CWO and YGH are helping. YWE is back from Chicago, now at Crown Point with the Signal Corps. YDA's XYL now has a Class B ham ticket. From Crown Point, NZZ reports that everything is under control, what with working 7 days a week on the r.r. and then 6 hours a day at Dodge Institute in Valpo. Terre Haute received its WERS license June 14th. More dope later, we hope. EOC reports no WERS in Bicknell as yet. How about it, boys? Sullivan WERS was standing by during recent high water in that locality. UZW is corp. in the 11th Marines, and reports via V-mail. Gary WERS, WKMR, had a visit from the RI during a recent county-wide blackout, an he gave them a good report. New radio aide there is MVZ. Ft. Wayne reports with some classy newspaper clippings re: WERS and hams. NVA reports from Richmond that WERS has a few bugs. Elkhart County was licensed WEPH, 1 to 12 on July 7th, with 20 WERS ham ops. licensed. See you next month, 73 Doc.

KENTUCKY — SCM, Darrell A. Downard, W9ARU — While reports are heard of sections of Kentucky working on WERS, no information has been received as to actual work being done. The call WJKK has been assigned to WERS in Jefferson County, and work of installing stations goes right along. At this time eight stations are in actual operation with the intention of installing some thirty to forty to complete the coverage. The control station is located in the clock tower of the city hall, seven or eight stories above the street level. A Hallicrafter's high-frequency receiver and a transmitter, consisting of a 6A6 modulated by a 6L6, does the work in fine shape. Several of the stations have been heard at Fort Knox, approximately 30 miles air line, which information, when received, proved to some of the skeptical that an antenna doesn't have to put out a half inch arc of r.f. on 112 Mc. to lay an S9 signal all over the county. Three types of antennas are being used; the SCM and his gang installing delta-matched systems, CNE sticking by the Johnson Q, and MRF the J and the Q. So far credit should go to the following fellows for doing a swell job: 9RPF, DFW, Tom Parrot, SFD, MRF, Giles Allen, Jerry Hollinseed, GOM, AEN, CNE, AYH and BAZ. If I have overlooked anyone, my apologies.

MICHIGAN — SCM, Harold C. Bird, W8DPE — DARA of Detroit reports losing their well-liked secretary, Ken Glass, WSUQR, to the armed forces. He is Navy lieutenant in radar. Present address not available as yet. AIU now teaching radio at Fort Knox. SCW now t/sgt. FX reports HKT now a lt. cmdr. LSF is now epl., U. S. Army. Box 2631, Washington 13, D. C. DARA had annual trip to Boblo on August 1st. The Oakland County Radio Club is holding meetings each Thursday night and making plans for WERS in Pontiac City. They are marking time now, awaiting the outcome of their license application. After each meeting, which is held at the home of MPX, the gang enjoys several reels of talking pictures. Several rigs have been built and more are under construction to take care of all the needs of the city. The usual discussions take place as to the type of antennas to be used and the type of equipment. The big problem that seems to confront the gang is where all the equipment can be obtained. Extensive plans have been made for installation of equipment, taking field strength measurements and training personnel to take over the operating when the license is received. They plan to train at least fifty operators to handle this work. There have been rumors that Saginaw Valley has been warming up to WERS and have already got some equipment together. Mt. Clemens is also

becoming interested in WERS. No reports from the licensed cities of Grand Rapids, Detroit and Lansing. As a personal favor to your SCM, please let me hear from any locality in this section who would like information on WERS or any problems. If you are thinking of setting up WERS for your locality, why not get in touch with your SCM and see what he can do to help you? Remember, WERS can now be used in emergencies and QMN was an emergency net. Come on, gang, give out and let's get going again! You are going to see a lot of u.h.f. after this thing is over, so why not get busy now? Would you like to see the Michigan section left out of QST? Well, you will, if you don't give out with your activities! So long and 73, Hal.

WISCONSIN — SCM, Emil Felber, jr., W9RH — The MRAC-Shorewood High radio schools are closed for summer, expect to reopen late August, with new code classes. ML courses will be taught as well as advanced radio. Over 600 people were enrolled in the various night classes the past season. Edgar L. Bailey, a W9 from Normal, Ill., has been added to the regular school faculty. The senior graduating class has presented the school with a sum of money earmarked for the purchase of electronic equipment. HWO, GPI and CCD continue in charge, assisted by many of the club members. QIH is seeing duty on one of the new converted carriers. The newly elected officers of the Milwaukee Radio Amateurs' Club are: CDY, president; GIL, vice-president; IZO, secretary, and RH, treasurer. The first meeting of the new club season will be Thursday, Sept. 9, 1943, at 8:00 p.m., trustees' room, Milw. Public Museum, 8th and W. Wisconsin Ave. Visitors are welcome. Meetings will be held every Thursday thereafter. The following members with op. licenses are now in the services: Ray P. Charney, J. Deisinger, Frank J. Detzek, Donald L. Hayner, Ernest L. Behagen, John Holmes, Curtis C. Schultz and ANA, a lt. in the USN. JWT is now a capt. in the Marines. ROM and QCJ also are recent joiners. RQM, up to two months ago employed as radio instructor at the Signal Corps School at Ashland, is now at Billings, Mont., and employed by Northwest Airlines, Inc., as radio instructor. The RI was there several weeks ago, and RQM wrote all 6 elements of the commercial radio operators' examinations. He now has radiotelephone first and radiotelegraph second. JBF is also located and working with R. Goetsch. The Wisc. Valley Radio Assn. has closed up for the duration and voted by mail to turn the entire club treasury into war bonds amounting to over one hundred dollars. IJB, 16 years old, was listed as the youngest instructor on the university's faculty. TVM is chief engineer of WPDJ-Marathon County's high frequency police system, engineer at Wausau BC station, instructor of the ESMWT course at local vocational school and also part owner of a local radio service store. Incidentally, WSAU's engineering staff is entirely manned by hams. ESV is chief engineer, assisted by PRM, FEO and TVM. RLB is in CS, monitoring for FCC. RNZ received his class A ticket. HEE received his honorable discharge from active Army service. Wait until you hear some of his tall tales as radio op. on Uncle's bombers. LWX and ZTO left town as new employees of Employers Mutual Insurance Co. LWX is located in Rhinelander while ZTO moved to Dallas, Texas. FPB was dispatcher at Vernon Co. sheriff's office station WBWL at Viroqua, then attended the Signal Corps junior repairman trainee course in Chicago, was stockroom clerk at the school and now for the past 10 months has been employed at a remote monitoring station at Crown Point, Ind. He passed the amateur class A and broadcast endorsement for restricted radiotelephone permit. Expects to be drafted soon. SHL is still linotype operator on the *Vernon County Censor* at Viroqua. HWI is instructing at Truax Field. IGU has completed another year of teaching rural school and now she is attending summer school at La Crosse Teachers' College. CUW sends nice folder of school at L.A. He met former Milwaukee ham ex-LUM, an instructor there. VIB is now an instructor at Troy, Alabama, and he married one of his students. DIJ is still in Florida. Commander DTK was visiting in Milw. for a few days. YSZ writes to tell us of the death of Howard J. Smithback, 9AFL of Madison, Wis. He was drowned on June 27th, when his speedboat overturned. He is survived by a wife and 2-yr.-old son. Condolences also go to 9ILJ and XYL upon the loss of their only daughter on June 3rd. YSZ took a three week trip to Tucson, Ariz., in early July, planning to look up the local hams there as well as finishing his business. The WERS in Milwaukee proceeding with 10 completed rigs with permission by the local common council to apply for license and final signing of other communities in the county, Milwaukee's license

should be received by the time this appears. Fellows, please send more state news! 73, *Emil*.

DELTA DIVISION

ARKANSAS — SCM, Ed Beck, W5GED — BLG spent recent furlough in Little Rock. Ex-IQ recently accepted commission in Army, now performing duties as instructor. ICM recently received change in work and is at present well satisfied. INO is putting in short time at AAF preflight at San Antonio. HJA has commission in Army ordnance at Aberdeen Proving Grounds. 9WQC, formerly of Little Rock, accepted ensign commission in Navy, after leaving RCA. FXO is recovering from a recent illness and expects to resume activities shortly. SI is very busy these days with commission in Navy, as well as doing good job with Alternate's duties. FUW and XYL visited in Little Rock during recent examination and dropped in on KLRA. IDQ planning rebuilding campaign as soon as plans are complete. Ex-CIU, recently entered Army service, plans visit home soon. Another quarterly examination has just been completed in Little Rock. The examination was conducted by DU, and as usual, was rather well attended. Some sixty of the various examinations were given during the two-day visit by the radio inspector. Don't forget to send in an account of yourselves and what you are doing so that we can let the gang know. 73, and all the best, *Ed*.

LOUISIANA — SCM, W. J. Wilkinson, Jr., W5DWW — HSH is up for promotion to RT1c. DKR advises Short Wave Amateur Club of America still active and wants to hear from all members and others who would like to join. His address is Box 44, La Place, La. He also has need of a signal generator. The Shreveport WERS is functioning satisfactorily and is being used by CD officials during all test blackouts. Could use dope on other Louisiana WERS in this column. How about it — Lake Charles, New Orleans, Monroe, Alexandria and Baton Rouge? DWW is still engineering KRMD along with 5AGJ. May we hams here at home take this opportunity to congratulate you hams in the armed forces for the swell job you are doing? We would like to hear from lots of Louisiana hams and all letters and QSLs will be answered. CU fellows and YLs again next month. Until then, 73 and keep 'em flying! — *Dub*.

MISSISSIPPI — SCM, P. W. Clement, W5HAV — EBF and his XYL, GAF, formerly of Starkville, are now stationed at Peterson Field, Colo. He is a lieutenant in the Air Corps, and is at present an instructor in aerial photography for combat crews of B-17 and B-24 planes. BK is now in the Army. GXO is engaged in educational work in Pascagoula. DAN is in Army teletype school. JSH, after completing an extensive course in radar, is now going into the Army. KFV is in the Merchant Marine. 6TXP, who worked portable in 5th District, is now an instructor at Gulfport Field. FJC, 1st lieut., spent a few days in his home town recently. IBO is now a captain in the Army, and is now stationed in Texas. KDQ is principal of the new junior high school in Biloxi. Mississippi hams, wherever you are, let us hear from you! Your friends back home and in the Service throughout the world will be glad to hear from you through this column.

TENNESSEE — SCM, James B. Witt, W4SP — PGJ sent in nice letter from Kingsport and says that since installation of vertical J antenna, reception has improved 100%. The following have received restricted radiotelephone licenses: Clifford Brown, Lila W. Charles and Sterling Manis. CXY says things are going fb in the State Guard. Pvt. Robert M. Gordon, HXC, former operator for WMPS in Memphis, is now with the Signal Detachment, Hdq. 4th Serv. Cmmnd., Radio WVR, Fort McPherson, Georgia. He would like to hear from a few of the fellows in and from Memphis. His boss is ex-FL. GMW is now a cpl. at New Orleans, La. Let's have more reports gang.

HUDSON DIVISION

NORTHERN NEW JERSEY — Acting SCM, John J. Vitale, W2IIN — EC: IIN. Regional EC: CQD, in charge of emergency coordination for Northern New Jersey. CWK writes that he is tied up in WERS, serving New Brunswick and Highland Park. LO is the radio aide, and his present staff are AIN, EIP, GPV, OK, Andy Minwegan, Sal Romano and CWK. They have four mobile units at present and more coming soon — Abbott TR4s are being used. The call letters are WKHM and an xtal xmtr is in the making for the control station. He reports that the Raritan Valley Radio Club is at present inactive because most of its members are in the Service. 3COP/2JME is radio

aide for South Plainfield and EC for the Plainfields; WERS call is WJSQ and has been in operation since last October. Control station is xtal, using an 832 in the final, and they have seven active units, four of which are mobile. KP built the excellent frequency checking equipment for their setup, and NLY built the xtal rig for control station. Others sharing in the honors are NTN, CPU, IVI, MDD and OMJ. Many WERS radio aides would like to read about this frequency measuring equipment, so do write it up and send it to us. A coordinated effort is necessary in this area in solving WERS problems such as frequencies, interference and stability. It has been suggested that a meeting of radio aides would be the best way to solve the problems. The matter is being worked out by regional EC CQD and he is being assisted by the Acting SCM, IIN. News for this column is dependent on you; if you don't write it up, your SCM cannot put it in the print. So let's get going, wat say?

MIDWEST DIVISION

KANSAS — SCM, A. B. Unruh, W9AWP — CIK, who was formerly a radio instructor for AAF in Illinois, is now ARO in California. He says the ground equipment is a "ham's dream." BYC received sergeant's rating and has been shipped to Alaska. Tom says overseas training is "pretty tough." FZW spent furlough with folks in Winfield. Glen is an instructor in a GI radio school in Georgia. NGQ is radio inspector with North American Aviation in Kansas City. YOS, formerly SNCS of the KN Army net, is ground station operator for Boeing, as are WKA (formerly SNCS, New Mexico) and DMF. They are well supplied with licenses, holding amateur and commercial FCC tickets, and AAF radio operator permits. QQT moved from Eldorado to Planeview, Wichita (Govt. housing barracks). DJI, works in flight service at Wichita plane factory, and belongs to Caterpillar Club. MQB left station KFBI to accept job as electrical test technician with Boeing. NQX and OZN of Wichita Police Dept. have added commercial telegraph second licenses as result of trip to Kansas City. VBQ, EC for Lawrence, reports that a number of stations could be set up for WERS, but that the CD is interested only in land line and bicycle communication. CGU has returned to Lawrence, having received an over-age discharge. KYV is civil service AAF inspector in Wichita. JYZ and LCC are foremen of electrical and radio plane installations in Wichita bomber factory. JTN operates part time at station KANS in addition to working full shift at Boeing. Letters which the SCM has received from Kansas hams in the armed forces all over the world indicate they enjoy reading news of the old gang. Whether you are in the armed forces, in war industry, or just plain boosting on the home front, please drop the SCM a line with news of yourself or others. 73, *Abie*.

MISSOURI — Acting SCM, Letha E. Allendorf, W9OUD — If no news is good news, you can pucker up and start whistling now, because it applies to most of the Missouri gang. Jim Harvey, call unknown, but referred to in an earlier issue as RM3/c. USN, wrote me a long letter full of dope about hams he has met from Missouri, also PYs, Gs and FYs, but the censor wouldn't pass it so Jim wrote another saying tnx for AYP's address, 73 to everyone and he will be looking for the gang on the air when, etc. KCG, who has been at Macon since last September with the highway patrol, has left for San Francisco to take training as 2nd radio flight officer with PAA. Alec says the jr. op, five months old, doesn't know the code yet, but is transmitting under full power with no restrictions by the FCC. SAJ sent some info about the St. Joseph gang. NMD and CHE are in the Air Corps, NMD being over seas; WVI, POT, CPZ and CRE are in the Army; OUB was in Denver, Colo. LSL was commissioned a 2nd lt. at Ft. Monmouth; OCC is working for the Signal Corps at Lexington, Ky. SAJ is with the Signal Corps in Philadelphia and would like to contact OCC. BMS is learning the routine of the Jefferson City highway patrol radio dept. OUD has ivy poisoning again. Lots of luck, and 73 to you all.

NEBRASKA — SCM, Roy E. Olmsted, W9POB — News is very light. Just discovered that MBS has been teaching radio on the graveyard shift here at NSTS for several months, without advertising his amateur standing. Forgot to mention in my last report that DXY, past-SCM, paid our school an informal visit recently. With his Guadalcanal coat of tan, I scarcely recognized him. Do you remember, DI, the famous Nebraska amateur who always opened a QSO with a wx report? Got a nice letter from him and he started out with, "Today it has been cooler —." Bill has

been teaching radio at Scott Field for over two years and adds that he met IVW from Auburn at GE in Schenectady, last spring. A late report from KPA states that he is now in the Navy and still operating in Alaska. ZFC has been at home in Omaha on furlough from Santa Monica Air Base. This month's best report comes from EC EAT. On June 20th the following amateurs and their families held a picnic at Lincoln: BXJ, LEF, ZNI, KYD, ROE, GDB, DTT and EAT. The subject of radio was not mentioned. On July 11th BXJ, HYR and HQQ met with EAT to test WERS KGLZ. HOT has joined the staff of KFH at Wichita, going there from KFAB-KFOR in Lincoln. LEF is making application for WERS for Brainard. Both LEF and YCG now have class A tickets. VAS is studying radio theory and math and playing with c.c. DWB has received his phone 1st class ticket. That's all folks. Regards. — Pop.

NEW ENGLAND DIVISION

CONNECTICUT — SCM, Edmund R. Fraser, W1KQY — EEM has been appointed EC for Waterbury. DGG and BW continue as ECs for Milford and Branford respectively. EYM resigned as EC of Fairfield due to pressure of other activities. Will others holding EC certificates which need endorsement please forward them? KKS writes from Calif. that he now has radio tel. 1st and radio tgh. 2nd class licenses. DDX, RM1c USN paid SCM a visit. He expects advancement to CRM shortly. JHN, BM1c USCG, also paid a visit. BCG, ex-Nutmeg member of long standing and former EC for New Canaan and CBA official, sends 73 to gang from Boston, where he is in war work of a secret nature. 9AND, instructor in AAFTS at Yale, changed his QTH from West to New Haven. Says 9WHN from Chgo. was transferred to Yale. Steven Hoffman, Norwich WERS op, is now at Yale and participating in New Haven WERS. Charlotte Keogh, former West Haven WERS op, is now a WAVE at Oxford, Ohio, and reports she is doing better than 15 wpm on mill and likes radio more than ever. Merugliano, Kaplowitz and MacMillen, three of GB's members in the Services, are in the Army and the Navy respectively. Notify ARRL of your new QTH when you go into the Service, boys. NEK, district ra of New London, reports license call received WKOB. EEM, new district RA for Waterbury dwe, reports license applied for 44 units in Bristol, Wolcott, Southington, Cheshire, Prospect, Waterbury and Naugatuck. OTI, asst. SCM and Norwalk RA, writes WJQA units operating very satisfactorily. Reports of SG-WERS, CAP-WERS and CD-WERS will be appreciated. 73, Ed.

MAINE — Acting SCM, G. C. Brown, W1AQL — FBJ, state radio aide in Winn, says that local aides have been appointed in Portland, Lewiston, Augusta, Bath, Bangor, Waterville, Presque Isle, Houlton, Millinocket, Bar Harbor and Rockland, but Millinocket and Bar Harbor are the only towns that have been organized to the point where they have received their station licenses. This is a wonderful chance for the gang to be of real help to their community, and it is an outlet for us ole timers to do something for the home front, so why not get busy and have a real honest-to-gosh organization? If you are having any difficulty with CD Officials etc., get in touch with FBJ and he will lend a helping hand. His present address is Box 777, Rockland. HGX has been retired from the USNR with the rank of lieutenant. He is now in the toll test room of the telephone co. in Portland. With the exception of the above two items the news this month are items picked up personally by your SCM and it will necessarily continue to be so unless some of you fellows send in something. AID received a card from MWH who says he is a cpl. in the Signal Corps, in New Orleans. 4HFZ is with the CAA in Bangor. CRI has heard from QH in Norfolk, Va. UP is the local radio aide for the Bangor dwe. ATS is the radio aide at Bar Harbor. DLC is chief op at WABI and until recently has been teaching a code class for the NYA. EFW and MVD are with the CAP at Trenton, Me. TB recently paid MVD a visit.

EASTERN MASSACHUSETTS — SCM, Frank L. Baker, Jr., W1ALP — A few new ECs in this Section: GWK for Boston, FEC for Middleboro and LI for Reading. These hams are also the radio aides for their towns. C. A. McElroy reports that the City of Somerville has received its WERS license under the call of WKRN, with 12 operators and 3 fixed stations using Abbott TR4s. We hear from JJJ's folks that he is now a captain in the Air Corps, doing communication work. At last report he was on vacation, down in Australia. Your SCM received a V-mail letter from L. D. Tallman in London, and he has just transferred to the American

Merchant Marine and is now radio officer. LTT has been on vacation down on Staten Island, N. Y. Two more hams, AR and MR, have married. AKY is teaching radio to the WACs in Boston. QD was released from the Army and is now working in a defense job. MMP is in Dayton, Ohio. NQA says that he is going to be married and will have a new QTH. RH is now a lt. emdr., USNR, down in the South Pacific. JOY is back in Nahant after being away for two years. NKW says he received a W9 QSL for Field Day QSO in 1941. ERH has returned from overseas duty and will be located at Wichita Falls, Texas, as lt. MQO is radio tech. 1st class, now in Boston. GAG reports that recent modifications call for 73 units in region 5B, where he is radio aide. Woburn will be on soon. He has the following assistants in these towns: Lewis K. Scott, Melrose; BB, Winthrop; Thomas Transaglah, Revere; LI, Reading; HMK, Malden; MBB, Everett; JDG, Medford, and EKT, Wakefield. FI is now instructing at Noroton Heights, Conn. MBS is now in Navy pre-flight. Ex-KFH is working for the Signal Corps in Boston as a civilian. NPZ reports that she is radio aide for Weston. The call there is WKVL, and they have two Abbott TR4s and one built by Brattle Radio Co. They have three WERS ops; Charles M. Ganson and John A. Blanchard (class B ham licenses), and Wm. G. Perrin, 3rd class restricted license. KWA is in the Navy and located at Quonsett Point, R. I. CAY, ex-BNI and DBD are civilians in the Signal Corps out of Boston. KHW is working in Groton, Conn. NOX moved to Roslindale and expects to go into the Army very soon. NKE spends most of his time in Cambridge and is helping out on the WERS work there. MAN says his draft board put him in 4F so he is going to help out in the CAP or Coast Guard Aux. Fearing Pratt and MD are trying to get some operators for Hingham WERS work. AHP from Fall River reports that the WERS in his city is coming along fb. They expect to add a few more units to the 30 already in operation. ALP has been working down New Bedford way. EVJ writes from Falmouth that his time is taken up with the CAP where he has been radio technician since October. Keep the letters coming, gang. You're doing fine but don't stop. No letters, no column.

WESTERN MASSACHUSETTS — SCM, William J. Barrett, W1JAH — DCH is now at Signal Corps school at Camp Crowder, having been transferred there from Infantry Comm. school. He sends along news of the following: KIK is sgt. with tank destroyer outfit somewhere in North Africa; AKZ is at Fort Monmouth; AUN is govt. inspector at GE, Schenectady; LQS is cpl. in Air Force; CGY is with ski troops at Camp Hale, Colo.; DJQ is cpo with Atlantic fleet; BIV is teaching code at Gardner High School and organizing WERS in Gardner. JXE writes from Sedalia Army air field, Mo., where he is a capt. in Air Force and acting group communications officer of 437th Troop Carrier group. ICW reports from WAR at Washington, where he is now tech. sgt. Ralph wants to be remembered to all the gang on the old WMS AARS net. IOR reports on the fly — Chet is govt. radio man, and says he is moved around so fast his laundry never catches up. Since being in govt. service he has been on convoys out of Boston, taught school in Phila., worked in radar labs and now is at Signal Aircraft Maintenance at Wright Field, Ohio. Best news around here is the addition of the two new test periods for WERS — with active operating personnel here at WJPG running about 90% third class ticket holders, the additional time will be a big help in training personnel in actual operation. AZW-LUD and JAH have been trying to bridge the gap between North Adams and Pittsfield for emergency WERS use to tie in regional and district warning centers. By picking the right combination of high spots, it can be done so WKHW and WJPG can pinch hit for wire lines. Well, fellows, how about a card to reach here by the fifteenth of the month?

RHODE ISLAND — SCM, Clayton C. Gordon, W1HRC — Al McGinn is on sea duty now, since we last heard from him, He finds himself quite busy, having been made junior officer of the deck, mess treasurer, postal officer, member of the censor board and a lot of other things. He has met several hams, but does not mention any calls. He has also attempted to be something of a snake, having shed his skin after a nice sunburn. The new address is B. A. McGinn, RE, c/o Fleet PM, New York. From MAE, radio aide for the town of Westerly, comes word that he has been very busy with CD and plant victory garden. They have lost all but four of their hams to the armed forces or civil service. They have a control station in the old town hall in Westerly, a portable station at Bradford and two portable-mobile sets. They

have examined 10 fellows taking 3rd class fone, a substantial number received their tickets.

VERMONT—SCM, Clifton G. Parker, W1KJF—Announcement has been made of the marriage of Marion Field, LJZ, of Newport and "Chan" Mould, KUY, now stationed in the Canal Zone. Congratulations from the gang! IQG, JVS and LWN are sporting etc uniforms at the air school in Burlington. Dick Evans now is pfc. at Scott Field, Ill., where he is attending radio school. Reports indicate MYS has joined the armed forces but definite address and service not known at this writing. BD has application pending for construction permit on a radio shack with all the fixin's. Roy also acquired his 2nd and 1st 'phone tickets on a recent trip to Boston. Burlington Amateur Radio Club is now holding meetings on Monday and Friday evenings at fire station No. 3.

NORTHWESTERN DIVISION

IDAHO—SCM, Don D. Oberbillig, W7AVP—ITN reports he is busy farming. IGE is studying meteorology at Portland, Ore. AQQ left for Northern Idaho. ABK working at Mountain Home. AVP flying with Civil Air Patrol. H. E. Toedtemeier, chief op at KIDO has been commissioned lieutenant in the Army. He and Mrs. Toedtemeier are also parents of a daughter, born in June.

MONTANA—SCM, R. Rex Roberts, W7CPY—DXQ is active in his large victory garden. CT is not too far away as he gets to stop at home in Seattle occasionally. FGZ reports with nice letter. He's working as long hours as he used to in a DX contest, plus teaching three hours daily. Your SCM had an operation on June 1st and was out of circulation for six weeks, so no report last month. AYG is ranching now. GZA is helping out at ranch work when able to get away from duties as superintendent of schools. HEM, RT2c, USNR, is on furlough at home in Great Falls. DSS, radio aide for WERS KFRP, reports they were complimented highly on their set-up and operation—after a complete military inspection. CT has been promoted to Warrant radio electrician and is taking additional schooling in the Naval Research Laboratory in Washington, D. C. HZJ has joined the WACs. FCW is control tower operator at Great Falls. A letter from one of the gang overseas says the first thing looked for when they get a QST is the Activities report, and he laments that there are so few of them. How about it, gang? A postal card will tell your gang, all over the world, what you, or others you know of, are doing.

OREGON—SCM, Carl Austin, W7GNJ—EC: JN. From FPR/K7 comes a note of interest. He was with a very efficient warning net with Govt. rocks, beside regular radio op job with CAA and PAA. Then he got the yen to fly, so, at the time of writing was aviation cadet at Santa Ana air base. HVX, in new QTH in Portland. He is hooking up radio xmtrs etc. for Uncle Sam, and says they use very fb equipment. He met HSZ, ERA, HLB, HXG and UK, who are in same line of work. JN called on GNJ/HHH, and had an evening of code practice and tape cutting with bug. GTW is now with Army Engineers in Portland. Roy Mickel, LSPH, now EC for Hood River. Now that his xmtr is idle, FAL has built a regular small farm, complete with chickens and a cow. BS is tinkering with 112 Mc. oscillators. IKK, former teacher for CORK, now ART1c, was surprised to see Earl Dawson, former CORK student, show up in his radio class recently. Phyllis Coe, LSPH, and HHH are training an incapacitated young man for amateur license. He needs a low price receiver for code practice. Address Oregon SCM, Leo Mickel, LSPH, sety. CORK, reports small but interested class about ready for class B exam. GSI superintended 3rd rt exam for about 40 pilots. More reports please. 73.

WASHINGTON—SCM, O. U. Tatro, W7FWD—CMX, state radio officer, reports that Bremerton is preparing to apply for WERS license. The city has appropriated some money and the hams are building some equipment. Let me hear of your progress, fellows, so due credit can be given in this column. Kenneth Hager now has a class B ham ticket, minus a call, since graduating from the Olympia Radio Club class. JCS promoted to capt. and is now AW-officer working out of Fort Monmouth. FWB is in Providence, R. I., working for the Navy as a helper radio mechanic. She left the University of Utah to see her OM, IOC, who has been out on patrol in the North Atlantic, and got a job with the Navy. FET transferred from Texas to Fort Wright at Spokane. AMA is with KOIN-KALE, Portland, Oregon. He has been teaching radio and math

on the side at Oregon Institute of Technology, NYA radio school, and now at Benson Polytechnic high school. Your SCM expects to be out of bed by August 10th. 73. *Tate*.

PACIFIC DIVISION

SANTA CLARA VALLEY—SCM, Earl F. Sanderson, W6IUZ—RM: LLW. QLO is commanding officer of the radio dept. of the 2nd signal aircraft warning training battalion, training operators and radio electricians at Tampa, Fla. The code department is in the capable hands of 2BBR. He reports QOY, now in North Africa, looking forward to his QST and SCV news; address him, Sgt. Robert A. Eisen, 39840416, APO 525, c/o Postmaster, New York, N. Y. MZQ also in Signal Corps as 1st Lt. FQY, promoted to capt., would also like letters. Address him APO No. 465, c/o Postmaster, New York City. Achv is new principal of S. J. Technical High. HC passing the cigars—it's a YL op. FBW and DHV are QRL in the victory garden after the trip East. GWF must be popular among fellow prisoners held by Japs, as he's received three short-wave mentions recently. Regret to report JBB among the Silent Keys after a three-month illness. Bud had been in radio for ten years and will be greatly missed by his friends in the SCV gang. Keep the reports coming, fellows. 73. *Sandy*.

EAST BAY—SCM, Horace R. Greer, W6TI—EC: QDE; EC u.h.f.: FKQ; Asst. EC u.h.f.: OJU; OO u.h.f.: ZM. On Thursday, July 13th, at the Oakland City Hall, a meeting of all WERS operators of KFMV was held. Instructions to mobile unit operators and KMFY broadcast procedure were discussed, and a definite program was outlined by EE, radio aide, and 100% voted in favor. All rules and regulations have been sent to each member in booklet form, along with other helpful suggestions. The following WERS members were present: EE, TT, AEX, HJM, KZN, SFT, AUZ, GZT, RBK, NZJ, MIX, RCE, PLB, FKQ, SQ, ZM, TLM, GIU, HJE, JJ, DDO, EY, TFV, TI, MNG, AXF, HHM, TWL, IJA, TNM, RJP, JFA, PB, BUY, WP, QJT, BBJ, RRK, E. King, J. Friedigkeit, P. Coggeshall and 7EX. A report from Napa says WERS is in progress, with an application already sent to Washington. Twenty-seven stations are being planned on for the county set-up, and CAN is radio aide and QKA his asst. QKA is an elect. ltd. at the Mare Island Navy Yard and will be Commander of Napa Post 113 of the American Legion. In the late issue of "Life," showing the many that have been killed in action to date, Alameda County hams were missing from the list, although many have seen plenty of action. TI is asst. to the electrical supt. at Hurley Marine Works. AEX is recovering from broken wrist. TT and DUB still are ace victory garden experts. Let's have the latest news to pass along, as many of the gang in the Service enjoy reading all the gossip. IIN now working in Berkeley. OJU/2 reports, "This month ends one year of my employ by Uncle Sam as a radio engineer in the Signal Corps at Fort Monmouth." "Another day closer to victory." 73, *TI*.

SAN JOAQUIN VALLEY—Acting SCM, Ralph C. Lowry, W6MIW—AXI is the radio sparkplug for the CAP in and around Modesto and is busy training other members of the organization in the whys and wherefores of radio. COJ is keeping his crystals clean and the dust off of his AARS station hoping for the day—when and if—RFO, RT1c, writes that his ham experience is proving invaluable down there in the South Pacific. Years of improvising and substituting for specified parts is standing him in good stead now that he is several hundred miles from the nearest radio store. WERS is in the formative stages in Modesto with QJP and MIW doing most of the pushing. LMT and AXI are interested in CXR current systems. Fresno reports that FTA is quite active in CAP work and advises that they have great need for more hams for the two flights stationed there. QFR and IHV are active in WERS work in and around Fresno. JCB, KPW, BRU, KPM and FTA are doing a lot of work for the Bell System on the cable CXR systems and finding their ham experiences of great help. JHD is servicing radio equipment on the thunderbirds at Hammer Field. MGM, the backbone of ham activities around Fresno, is busy as city electrical engineer. That's all for this time, fellows. Drop me a card and let me know what's doing in your locality. 73. *Ralph*.

ROANOKE DIVISION

SOUTH CAROLINA—SCM, Ted Ferguson, W4BQE/SANG—HEV dropped by the office for a nice long chat and was sporting his gold bars, having just finished his officer training at Ft. Monmouth. EXJ has received another

half stripe and is now lt., senior grade. FFH reports that he is now chief radio electrician. CUS is busy with the Civil Air Patrol. BAT keeps busy at his service shop on King Street. AFQ keeps the communications clicking for Eastern Air Lines. Haven't heard from CZA in some time, but know that he holds them down at Moultrieville. Capt. HWZ is still with the 102nd cav. ICK (2FSQ) is now stationed in New Jersey. W/O 2GBY reports that all is well with him in Africa. We had a nice report from Lt. IAI, who says things are fine in the Pacific. VL just returned from a trip to Florida. DQY says that he likes his work and will have a lot to talk about when it is over. DPN, sgt., USMC, reports that all is well with him in the Pacific. EDQ is now 8WXC, and located at Columbus, Ohio. Let's hear from you! 73, Ted.

WEST VIRGINIA — SCM, Kenneth M. Zinn, W8JRL — Well, boys, after being among the missing in QST, here we are again! Sorry we haven't been in, but you can't keep a column going when there isn't any news. How about rounding up all the news and sending it in? OK is captain in the Army at Langley Field, has a good assignment and likes it fine. PSR is lt. comdr. in the Navy, recently back from sea duty and attached to section base at New Orleans, La. PTJ is lt. in Navy, attached to section base at Ocracoke, N. C., as communications officer. Last heard TDQ was RM1c, but rumors have it that he is someplace around Alaska with the Navy. RSR, RT2c in the Navy, is still going to school in Corpus Christi, Texas. BDD is still in Huntington, taking care of police radio. W. S. Patrick is RM1c in Navy, located at Cape Henry, just out of Norfolk, Va. AFB is still working at telephone office. AHF is electrician at Marshall College, and EZR spent about two and one-half years at NOB at Norfolk, then was made warrant officer and wound up in Bremerton, Wash., waiting for a ship. CVX, now with WGY at Schenectady, and the XYL are proud parents of a baby girl. Richard R. Ross is now with the U. S. Coast and Geodetic Survey as chief radio technician aboard a motor vessel, somewhere in the Pacific, 73, and let's hear from all of you. — Ken.

SOUTHEASTERN DIVISION

ALABAMA — SCM, Lawrence J. Smyth, W4GBV — Your SCM has just received a "jacking up" in correspondence from a fellow ham, reading thus: "Needless to say, I'm quite disappointed some months to find that the report for Alabama is missing. That column is a good means of keeping the hams in contact with each other and wish there were some way you could induce them to send in occasional reports." My apologies for the omission of the column, and with everyone's help it won't happen again. FYC is an aviation radio technician in Texas, rating first class. He's been instructor in Texas for the past nine months. He reports that he has met so many 6's and 7's that he almost forgets he is a W4. DEW is an instructor in radio in Texas. EPA is an ensign in the Navy, stationed in New Jersey. He was a recent visitor of DGS, our former SCM, who is still in Washington. FTV of the highway patrol who was stationed in Birmingham, is now living in Montgomery and is a regular visitor at WMPM. GGC was in Montgomery the other day, and is now with Kenrad Tubes. GIR is with the highway patrol, now in charge of the new FM radio set-up for the State. FVT is now an operator at WASP in Selma, Alabama. Visited EFD of the 160-meter fone net in days gone by, and found he had turned his shack into a chicken house! He says he will have to build another shack, "when." 73, Larry.

EASTERN FLORIDA — Acting SCM, Frank C. Fassett, W4BYR — KK, EC for Dade County, is in East on vacation. Is checking WERS set-ups there and we hope to have nice report from him for next issue. IP/NF reports: HJQ writes from the Pacific that he is attached to fleet comms. as lt. NB is now asst. to comm. supt. at PAA. CNZ is on ship ckt at WDKL and likes it. Merf is also pounding brass at WDKL for PAA. His stepson, Donald, 17 years old, just came through with class B and RT2c, and is flying Africa and Orient. ES continues busy with Navy in Miami. Capt. Hazelton, 8BUN, regional EC, and comms. ofcr. FSG, reports FCC issuance of WERS license WKRW to FSG for 56 station coverage. This license is state-wide. Have no report from anyone on FSG activity except HGO in Sanford and Lt. Dave Brown, ex-VA, who is in charge of Tampa detachment. HGO writes that he and Boyle (LSPH) are right in there pitching as 36 and 37 WKRW and WKMQ (Sanford) 1 and 2. Appears these boys are leading double life. First Signal Co., Tampa detachment FSG, meets every Wednesday night. First inspection was held July 19th and the boys

came through with flying colors. HGO is working up card swapping deal. If you wanna get in, write him at 708 Park Ave., Sanford. HXM is with SC at Camp Crowder, Kansas City. Reports meeting and talking with Deanna Durbin there. EYI sez that he took his vacation and went fishing at Apopka. ERU left for induction at Camp Blanding, June 23rd. CXL last heard of with RCA Victor at Beaumont, Tex., but no reply yet to card sent to that address. Letter from TZ, still in Deal, N. J., tells of EOA visiting him recently. Picture card received from HAD mailed from Victoria, B. C. Is DVO going literary, or what? See "Life," July 12th number, letters to editors, page 6, if you want to learn how Cy straightened out the misinformation department. Hillsborough County WERS now under way with WKPG 1-10. TARC club rooms undergoing alterations to provide shop facilities for the building and testing of equipment. Some installations already made and first tests run with satisfactory results. Application to FCC for six additional operator permits about to be made. Happy to state that this Section now has nine active ECs. Only two of the nine sent in anything for this report. Again call your attention to fact that material for those reports cannot be picked out of thin air. A post card to this address around the 15th of each month is better than nothing at all. Come on fellows, let's give the boys on Attu, New Georgia, Rendova and Sicily something of interest to read.

WESTERN FLORIDA — SCM, Oscar Cederstrom, W4AXP — The Section had another fine ham meeting this month with a good attendance. MS was the MC again. 5GOK was one of the newcomers. Further steps are being taken to get the WERS set-up going. Bob Watson has gone on his vacation, the first in about two years as a radio instructor. ABY is now a lt. commander. Ex-6BRG, c.r.e., USN, is a real old timer — both as a Navy man and a ham. He is still a ham and a radio enthusiast, and can spin some interesting yarns about Navy life and adventure on the high seas. He kept a regular schedule with ABY, Calif. to Tenn., and now they are both working in the same hangar. CPO, Adams, one of the ops from Byrd's Little America expedition, is here too. He ran across one of the boys who drove some dogs down there, right here in the Navy Yard! Ensign 5BDM is here in the hangar with AXP and the rest. Some of the WAVES say they are going to take exams for licenses, so the boys will have to look to their laurels after the war. Seale, one of the instructors and a ham, took commercial exams at New Orleans this month. Well boys, best 73 and see you next month! AXP, "The Old Maestro."

GEORGIA — SCM, Ernest L. Morgan, W4FDJ — No Georgia items this month, because your SCM is in the hospital, recuperating from an amputation operation on his leg. How about sending him a card, gang? He will be back next month, and hopes to have a flood of news to report, both from the gang at home and overseas. The boys in more distant places are beginning to see the Georgia Section in Amateur Activities.

SOUTHWESTERN DIVISION

LOS ANGELES — SCM, H. F. Wood, W6QVV — The first batch of 78 operator permits under KGLV have been received. Unit numbers are being assigned, classes are being held in operating procedure, instructions are being given for obtaining third class 'phone restricted licenses, and the other work started — so Los Angeles is really back on the air. First actual tests are expected to be held early in August. We will endeavor to set forth in detail the general outline of the organization in a later issue so that those of you away from home may know what is going on here. Applications still keep coming in from those interested and the roster is rapidly being filled, but we need to know more about any equipment that is available. AM reports that the Long Beach gang have not to this date received their license. They are still holding their drills, though, and patiently waiting. RO and all the gang are to be commended for keeping up the interest in face of the long, dry spell. ON sends in a clipping on the activities in the Baldwin Park group. During a regular scheduled CD drill there, a real fire alarm was reported to the fire station by WERS operators. Auxiliary firemen were sent to the scene and handled the situation without loss. The message got to the fire station well in advance of the regular telephone report of the fire, so Ora Martin, George Leif and W. E. Walters sold WERS to the officials in that area. SCQ also reported a similar incident in his community during a Sunday drill. FFN has given a fine report on the activities for the whole

(Continued on page 88)



IF YOU WISH to see a baffled man, watch a radio engineer the first time he sees a power circuit diagram. Only don't laugh; you may have to figure one out yourself some day. If you go in for industrial electronics at all, you certainly will have to.

There is nothing wrong with the diagrams. The trouble is that they are different. A few symbols are shown below. These are all in common use in power circuit diagrams. A glance at them will show that they are not only different from radio practice, but what is worse, the same symbol may have one radio meaning and an entirely different power meaning. For instance, a zig-zag line means a resistor to you, but it means a coil to a power circuit engineer.

Layout principles are different, too. Most power circuit working diagrams are arranged like the radio "picture diagram." All components such as terminals, relays and resistors are shown in their exact relative positions. Usually even the connecting wires are drawn where they actually go. However, unlike a picture diagram, symbols instead of pictures are used to represent the various parts.

Power engineers also use schematic diagrams, and one of these is shown below. These are very schematic, because it is customary to take units apart for greater freedom in draughting. For example, in drawing a relay with five contacts, it is good practice to scatter the coil and five contacts all over the page. If there are a number of relays, the coils and contacts must be numbered to show which coil operates which contact.

This system has many advantages, but its disadvantages may be more apparent the first time you use it. The diagram shown below is a very simple circuit often used in radio transmitters. You will probably figure it out very quickly, but it will show you how confusing a really complicated diagram could be to anyone used to radio symbols.

DANA BACON

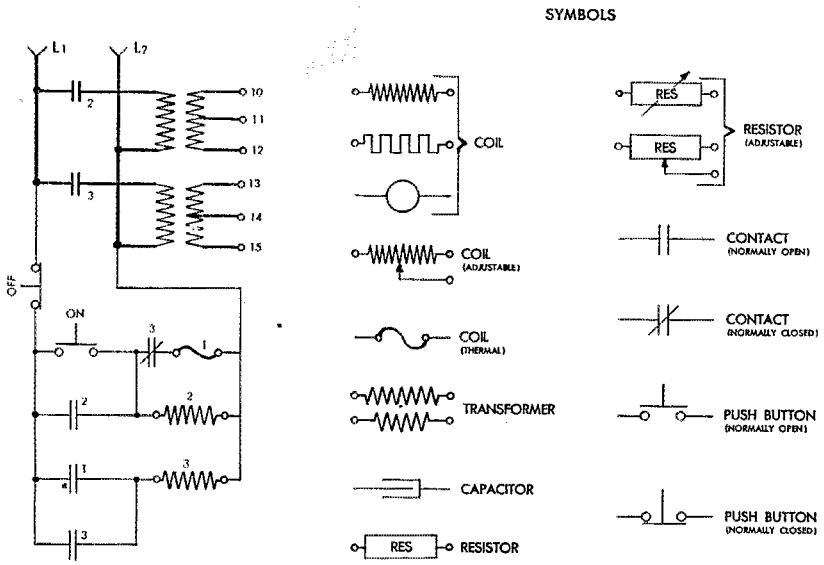

X-RAY

In the fall of 1895, Wilhelm Konrad Röntgen discovered that rays of mysterious properties could be developed under certain conditions during passage of electrical current through a vacuum tube. These rays, accordingly, were termed X-rays.

Equipment for the practical utilization of X-rays has been developed most rapidly until today, the X-ray has lost much of its mystery. Every school boy knows how X-rays can pierce the human body to locate broken bones or imbedded objects; he automatically associates the X-ray with the dentist, the doctor and the hospital.

Not widely known, however, is the fact that the X-ray is a powerful tool in many industrial processes. In the manufacture of quartz crystals, for instance, the X-ray provides the only rapid precise means for determining and checking the angle at which the crystal blanks are cut from the raw quartz — an all-important quality to the operating characteristics of finished oscillating crystals. At Bliley, X-ray machines are in continuous service checking and rechecking to assure maximum performance from the finished product.

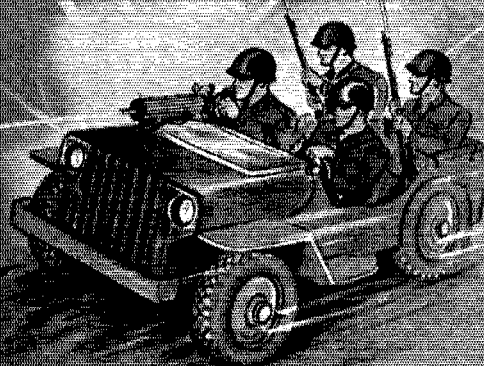

BLILEY ELECTRIC CO., ERIE, PA.

Amateur Activities

(Continued from page 80)

group and the report has been forwarded to ARRL. Now that we have really got started in this work, how's about hearing from Santa Barbara and Ventura Counties, and Riverside and San Bernardino? Isn't anyone doing anything about WERS in any of these districts? Come on, fellows, get in the picture! Contact your OCD officials, form your groups and do your bit by helping your communities in this way. The local FCC offices have all the necessary application forms, etc., or I'll be glad to get them and send them to you. The Culver City and Inglewood groups are holding their tests and drills regularly. Also hear that Huntington Park is coming to life and forming a group. That shouldn't be too difficult, for I remember that whole area being covered with u.h.f. boys. Please keep me informed of your progress. UOF, whose home QTH was Burbank, reports that he likes the Islands pretty well by this time. He is now chief at Army commercial station and says he has met several of the K6 gang and finds them a swell bunch. TRD, with whom he handled some traffic, is now in radio intelligence, detached overseas. UOF would like to hear from AQM, formerly of the nite owl net. MQM and SSU are both at Consolidated in radio, on ferry hops. 7FHB wants very much to contact PPK. If we can help you locate someone, let us know and we sure will try. That's all for now. Get busy on WERS and send us your reports by the fifteenth of each month, if you want 'em to get in *QST*. 73, Ted.

ARIZONA — SCM, Douglas Aitken, W6RWW — The gang down in Tucson comes through with their usual report of big classes in code and theory when they aren't at their regular jobs over at Consolidated. OZM is caring for the local police and sheriff equipment during off-hours. The Tucson Short Wave Assn. is making plans for the annual summer picnic. KOL has been transferred to Philadelphia. 9UPT is now in Tucson. Raul Rouzaud and Raymond Queen recently got their ham op tickets — through the classes of MLL — and are now in the armed forces. PDA is announcer at KPHO, LSK working at Luke Field and HIB assistant to highway patrol radio engineer. RLC has accepted a civilian radio job with the Navy and is in the Hawaiian Islands. NRI is back in the State and now located up in the Kaibab country. ILA, with his new bride, dropped in during the month. RXQ is now attending the Navy radio school at the University of Houston. Phoenix reports WERS going full blast there, equipment in fine shape and drills going swell. Still need an occasional card from you fellows scattered all around the world! Vy 73, Doug.

WEST GULF DIVISION

SOUTHERN TEXAS — SCM, Horace Biddy, W5MN — Bill Curtis, with the Texas State Guard, is organizing a WERS unit in Alice, Texas, and needs an 8-27 receiver. Can someone help him? Lee "Bill" Keith, married and now a 2nd lt., reports from Waco where he is doing his duty as an instructor in the Air Corps. GTL reports from "Shangri-La," where he is doing his stuff in the Air Corps. BD drops a line between trips at sea. CCD passed through San Antonio on way to Corpus Christi. JPC in the Merchant Marine reports meeting a few hams overseas: 9FIR, 9FOR, HNH, 3JPG, 9ORG, 6SRH, 9KAY and 9FIR. KEE is pvt. in Air Corps, stationed at Shepperd Field. ILN is at OCS in Fla. FGT is working for FCC at Kingsville. DUX is with the Signal Corps at San Antonio and 90XX is in the Navy. BKW is a 1st lt. in the Air Corps, and post communications officer at Moore Field in Mission, Texas. The Houston Amateur Radio Club is still continuing weekly meetings and is busy with WERS. These reports mean a lot to the boys over there when they get a chance to read *QST*, so don't let up now! 73, Horace.

NEW MEXICO — SCM, J. G. Hancock, W5HJF — Francis J. Gormley, LSPH, sends in a nice report on the Santa Fe gang. Gormley is busy in State Guard and reports his superiors are very much interested in a state-wide WERS set-up. Quite an order. Can we do it, gang? DYV is instructing and inspecting radar at the Corpus Christi Naval base. CJP is doing defense work. ENI has completed a special course in X-ray. JWA participated in the battle of Attu. David, Erwin, LSPH, is still instructing at Radio and Sound lab. at San Diego Naval base, and still reads this page. HJF is still doing as little as ever. Thanks a meg, every blooming one of you, for the swell reports, and please keep them rolling! 73, Jake.



Attack Signals MUST Get Through

... the SUPER-PRO "SERIES ♦ 200"

Where there is an important job to be done — where absolute dependability is essential — where vital messages are counted on to come through at precisely the right moment, there you'll find a "SUPER-PRO." And well chosen, too, for engineers know they can rely on the "SUPER-PRO."

THE HAMMARLUND MFG. CO., INC.
460 West 34th Street, New York, N. Y.

THE SIGN OF QUALITY IN RADIO



HAMMARLUND

Are You Making Good in Your New Radio Job?



New Jobs Create NEW OPPORTUNITIES

There's no "ceiling" to the better jobs available today. CREI home study courses can give you the practical technical training you need to "make good" now—and to enjoy security in the years to come in the expanding fields of radio and industrial electronics.

Hundreds of practical radiomen have been given responsible jobs throughout the radio industry—government jobs, broadcast jobs, technical manufacturing jobs, aviation radio jobs—jobs which in many instances require a thorough knowledge of practical radio engineering.

- If you are a practical radioman who realizes that fortunate circumstances have placed you in a job requiring technical ability of high calibre . . .
- If you are smart enough to know that you will "get by" with your better job only so long as a fully qualified man is unavailable . . .
- If you have the ambition to make good in your new, better job and to rise to even a still better job . . .

—then a CREI home study course in Practical Radio Engineering will help you to acquire the necessary technical knowledge and ability which is demanded by the better, higher paying positions in technical radio.

WRITE FOR FACTS TODAY about CREI Home Study Courses

If you have had professional or amateur radio experience and want to make more money, let us prove to you that we have something you need to qualify for a better radio job. To help us intelligently answer your inquiry, PLEASE STATE BRIEFLY YOUR BACKGROUND OF EXPERIENCE, EDUCATION AND PRESENT POSITION.



Capitol Radio Engineering Institute

Home Study Courses in Practical Radio Engineering
for Professional Self-Improvement

Dept. Q-9, 3224 16th St. N. W., Washington 10, D. C.

Contractors to U. S. Signal Corps—U. S. Navy—U. S. Coast Guard
Producers of Well-trained Technical Radiomen for Industry

Splatter

(Continued from page 8)

GOLD STARS

PAGE 63 of this issue inaugurates a new QST department, designed to appear hereafter as a regular feature. It is dedicated to those members of the amateur fraternity in the uniformed forces and the merchant marine who have given their lives for their country. As the "In the Services" department lists the blue stars on the service flag of amateur radio, so the simple, unadorned citations in "Gold Stars" pay tribute to those who have given the supreme measure of devotion.

FOOTNOTES

WE'RE always especially happy to have QST articles from men in the services; at the very least, the fact that they take the time to write for us proves that they're still thinking in terms of ham radio. But, as far as this column is concerned, there's one disadvantage. Some of them, especially those in the Navy, are what might be called "hit and run" authors. They pound out a yarn, drop it into the mail when they land in port—and then are off again before we can overtake them to delve into their personal lives.

That's why, despite the fact that they obviously are interesting personalities, we can't tell you very much about Lt. Comdr. R. R. Hay and Lt. (jg) W. A. Harpster (p. 48) or about RTlc James H. Smith (p. 44). We do know that Lt. Comdr. Hay is ex-W1JC and ex-W3ADO, but we haven't been able to get a thing on Lt. Harpster. As for Radiotechnician Smith, the best we can do is refer you to his own story of his doings on Guadalcanal.

Back on the civilian front, Robert Lewis, W8MQU, (p. 26) apparently has two major interests in life. Now 24, he got his first Class B ham ticket in 1934, graduated to Class A in 1936, operated 20-40-80 c.w. and 75 'phone. That activity terminated, he turned his attention to getting married in September, 1942, and achieving fatherhood (a bouncing baby girl) this past Fourth of July. Somewhere in that record belongs the fact that he is an engineer at WCAR in Pontiac. . . . S. Young White, W9GVB, (p. 64) is the White of the well-known team of Loftin-White (of direct-coupled amplifier fame). Following a G.E. test course at Schenectady in 1918, he was a sea-going radio op for four years, with Naval Research Labs for two, and then joined partnership with Commander Loftin in 1924. Subsequent activities include developing direct-recording picture transmission, the standard superhet oscillator circuit with the combination padding-coupling condenser, automatic frequency control and, for the past five years, what he calls "disciplined u.h.f. tunable gear". . . . "Helix" (p. 56) is a pseudonym hiding the identity of a well-known amateur now serving the armed forces in a civilian capacity which requires him to wear a cloak of secrecy day and night. If any of the nine different ham calls he has pounded out could be mentioned, QST read-



MEISSNER EXTENDED FREQUENCY RANGE SIGNAL SHIFTER

With newly developed general coverage series plug-in coils... cover frequencies from 1000 kc. to 16,500 kc.

THE Meissner Extended Frequency Range Signal Shifter is a variable frequency exciter of exceptional stability... may be used alone as an auxiliary or "Short-Haul" C-W transmitter. All tuned circuits are ganged... controlled by a high quality precision vernier dial.

The Signal Shifter permits instant frequency change in any given band... right from the operating position.

Continuous coverage of a frequency range from 1000 to 16,500 k.c. is provided without any sacrifice in stability... no crystals required!

Available only on priority.

MT. CARMEL, ILLINOIS

 *Meissner*

"PRECISION-BUILT ELECTRONIC PRODUCTS"



WILL YOU PINCH HIT?

In some localities, we are in danger of losing the greatest of all morale builders—radio reception. The enlisting and drafting of radio servicemen for essential work in our armed forces has made it impossible in these communities to have receivers repaired.

A.R.R.L. members—if you live where such conditions exist, it is your patriotic duty to do radio repair work in your spare time. Whether you charge for the work or fix a set for a friend without charge is immaterial. The important thing is that radios must play.

An informed America will win this war. Much of our information comes by radio broadcasting. Do your part—keep 'em listening.

P. R. MALLORY & CO., Inc.
INDIANAPOLIS INDIANA

Cable Address — PELMALLO

P. R. MALLORY & CO. Inc.
MALLORY



ers would recognize a widely traveled ham with over twenty years of solid brass-pounding experience. The job he's doing, incidentally, is one that proves the military recognizes the value of practical ham experience.

We bid welcome to these newcomers to our roster. Equally welcome is the return of **Dawkins Espy, W6UBT**, p. 32 (Splatter, Dec. 1942) and **Paul J. Palmer, W8UGR**, p. 44 (Splatter, Jan., 1943).

... —
FEEDBACK

LONG before researchers in the field of philological biology discovered gremlins, squimps and other forms of the Little People whose mission in life is to plague folk, the earliest known species in this category were accomplished veterans. These are the type lice, who love surreptitiously to turn sentences wrong side out, transpose lines, and otherwise make the printer's (and the editor's) road one paved with mortification and shame. Perhaps their best trick is to associate the wrong illustrations with the right captions, and vice versa.

Last month the type lice at *QST* Factory had a Field Day. In not one but two instances they succeeded in getting cuts and cut captions reversed. Strangely enough, both cases involved substituting transmitters for receivers and vice versa. In the Wightman-Lyon wired-wireless story, the circuit diagram of Fig. 3 (p. 15) belongs with the caption of Fig. 4 (p. 16), and vice versa. And in the W2DKH 112-Mc. a.c.-d.c. "Hint" on pages 62-63, the diagram marked Fig. 2 is actually that of the transmitter; conversely, the circuit labeled Fig. 3 belongs with the receiver caption, Fig. 2.

As if that were not enough, the Monotype imps also succeeded in stealing a cipher from the value of R_1 in the transmitter parts list (Fig. 3). It should be 2000 ohms, instead of 200. The value of C_4 in the receiver, as diagrammed, should have been given as 0.5 μ f. However, W2DKH tells us that he has now eliminated C_4 altogether; by changing C_5 to a 0.001- μ f. fixed mica condenser, he finds that the additional by-passing is no longer required.

While warming up for August, the type gremlins made a practice raid on W7AW's volume expander circuit, shown on p. 35 of the July issue, and lifted an important wire, thus effectually putting the amplifier out of commission. R_{19} should have been drawn as a potentiometer, as described in the text, with its variable tap connecting to the junction of R_{24} , C_{20} and the center-tap of T_3 .

This next one we won't blame on the gremlins. Frankly, it was our own fault. In the audio-amplifier circuit diagram for W2MWX's regenerative f.m. receiver, Fig. 2 on page 26 of the May issue, the wire shown running from the grid of the lower section of the 6N7 to ground should have been omitted. Also, the grid resistors, R_6 and R_7 , should each be 250,000 ohms, while the resistor (also labeled R_6) connected between the junction of the grid resistors and R_8 , the cathode resistor, should be 300,000 ohms.

THE RESPONSIBILITY OF LEADERSHIP

CONSTANT PIONEERING . . . *the unceasing search beyond present horizons for a Better Way . . . this is the responsibility of Leadership.*

As man reaches for the stars, through the science of electricity . . . the miracles of Radio and Television . . . the amazing new world of Electronics, we at American Lava Corporation have paced each new achievement with insulation engineered to the new requirements.

When war came upon us with its demands for tremendously expanded production . . . its requirements for higher performance in Communications . . . we were ready with the KNOW HOW gained from 40 years' experience in pioneering, developing and perfecting steatite ceramic insulation.



ALSiMAG
TRADE MARK REGISTERED U. S. PATENT OFFICE

STEATITE CERAMIC INSULATION

AMERICAN LAVA CORPORATION

CHATTANOOGA • TENNESSEE



AWARDED JULY 27, 1942

Where stability is an important requirement, ALSiMag Steatite ceramics are unsurpassed for lending rigidity and permanence of alignment to electronic circuits

OUT OF TODAY'S RESEARCH . . . TOMORROW IS ENGINEERED



Service- YOU BET

The service we gave you "Hams" in peacetime is now proving to be an important factor in the war effort. We have, and we will continue to deliver to the branches of the service all the vital parts that are at our disposal.

In peacetime for the amateur—and in wartime for the Armed Forces—the Radio Shack will go on doing its share.

BUY WAR BONDS and STAMPS

The **RADIO SHACK**

★ 167 WASHINGTON ST. ★
BOSTON, MASS., U.S.A.

ESMWT at Rutgers

(Continued from page 43)

Sunday, he'd have an entire standardized presentation worked out.

In practice, very few lab instructors were found who could work the full five nights a week. To get around this, they usually worked in pairs. Two instructors — either neighbors or employees in the same plant — would take one set of equipment between them. When one couldn't teach, the other would take over.

The theory instructor, on the other hand, worked the full week through, including lab night. His would be the responsibility for collecting and correcting notebooks and other records. The lab instructor merely brought the experimental gear to class, set it up, demonstrated it, and then went home — his job done.

Over 100 Experiments

It would take a book to describe the traveling laboratory. In fact, it does take a book — one of 200 multigraphed pages — to supply instructors with brief notes on procedure alone. To describe all the experiments in detail would take as much space again.

In all more than 100 experiments have been devised. They are designed to teach everything from simple resonance — using iron-core inductances and banks of paper condensers at 60 cycles — to advanced u.h.f. technique.

There are dozens of cute little gadgets. Take the directional antenna experiment. A tiny baseboard holds an HY-615 oscillator and a 25Z6 rectifier. The oscillator, audio-modulated by an *R/C* circuit, feeds either one or two dipoles through a concentric line and a half-wave pipe which serves as an impedance-matching transformer. The dipoles, which are separately rotatable, can be fed singly or jointly, in or out of phase.

A crystal detector in a probe can with a quarter-wave vertical antenna, feeding an amplifier which drives both an output voltmeter and a speaker, is placed a short distance away. The voltmeter gives a visual indication of field strength, while the speaker provides a dramatic aural demonstration for those not close enough to see the meter.

With that set-up the effects of a variety of combinations can be demonstrated in terms of directivity, polarization, field patterns. A similar unit with three elements — radiator, director and reflector — completes the assortment.

The demonstrations are fascinatingly ingenious — but equally so is the basic design of the experimental outfits. They are the acme of simplicity, with not a single dispensable component, not a wasted stroke in construction — yet they work faultlessly, disassemble into compact units, assemble almost instantaneously.

Equally ingenious are the receiver and transmitter experimental assemblies, which are built up on pigeon-hole frames pegged so they stack neatly for storage and transportation. Separate



PARTS

by Centralab

Steatite Insulators • Ceramic Trimmers
High Frequency Circuit Switches
Sound Projection Controls
Wire Wound Controls
Ceramic Capacitors

Centralab
CRL

Division of GLOBE-UNION INC., Milwaukee

(Continued from page 88)



Every ABBOTT should be doing a war job

If you own ABBOTT equipment, and if you are not already one of those thousands of amateur radio operators working for this important branch of civilian defense, we urge you to donate your time, talent, and equipment to this worthy cause. If, for some reason, you are not personally able to participate, why not lend your equipment for use by the WERS! In any event, do what you can do—America will certainly appreciate it.



One of the ABBOTT Transmitters and Receivers now "on duty" is the Model TR-4 . . . a standard, compact and efficient ultra-high frequency transmitter and receiver.

Here's one more thing you can do . . . loan your money to Uncle Sam . . . invest in War Bonds and Stamps.

ABBOTT INSTRUMENT, INC.

8 West 18th St., New York 3, N. Y.

stages assembled on breadboards fit into these frames. The breadboards are imprinted by photo-offset with circuit diagrams showing the wiring connecting the various parts. There are four units in the receiver — mixer, i.f. and detector, a.f. and speaker, and power supply. The transmitter has six units — oscillator (optionally Hartley, e.c.o. or crystal), buffer, final (Class C), speech amplifier (Class A), modulator (Class B), and power supply. Take one of these units, add an r.f. signal generator and a signal analyst in the case of the receiver, or an audio signal generator and an oscilloscope with the transmitter — and you have apparatus that can be used to demonstrate just about any radio principle you can name.

We could go on for pages describing the other gadgets — coupling experiments, simple v.t. voltmeters, simple oscillators built in salvaged tin cans, superregenerative receivers, collapsible Lecher wire systems — dozens of simple, ingenious, inexpensive, unpretentious gadgets that (by practical test) teach radio as well or better than the most elaborate laboratory gear.

2500 Civilians Trained in First Classes

The traveling laboratory having solved the last major problem, the program thereafter moved along in highly successful fashion. In the eight months of that first phase of civilian training, 2500 boys and girls were enrolled in the classes. Of these, a total of 1800 completed the course, or 60 per cent — a good showing, considering the voluntary nature of the program.

In this phase, it should be understood, enrollment was entirely without obligation. Anyone with the requisite background and general qualifications required could take the course. On enrolling he signed an agreement to "make every reasonable effort to use any technical ability that I may obtain to further the cause of National Defense," and he was expected to take a job in Civil Service or industry, but there was no penalty if he failed to do so.

During the summer of 1942 another job came along. Rutgers, together with a number of other ESMWT institutions, was asked by the Philadelphia Depot of the Signal Corps to undertake the training of a group of Civil Service technicians. The course taught was much the same as the Fundamentals of Radio course, but given over a 12-week period, 48 hours per week. The other major difference was that, of all the ESMWT classes, this was the only one conducted on the Rutgers campus proper (except for local New Brunswick sections of the regular classes). A total of 550 students were trained for the Philadelphia Signal Depot, in six different classes.

The Enlisted Reserve Corps

Then came the biggest job of all — training members of the Enlisted Reserve Corps for the U. S. Signal Corps.

You remember the ERC. It was the outfit the younger lads joined on the understanding that, immediately after enlisting, they would be placed



The devil rode that night . . .

"Driven by an angry wind, rain beat down with the fury of bullets and waves swept across the deck like a frenzied mob. As orders went out clearly over the microphone, I remembered a night back in 1932 when a similar storm swallowed words even as I spoke them, and lack of proper communications resulted in tragedy for some of my men."

Purely hypothetical is the case above . . . but you may be sure that after the war, when entirely new Electro-Voice Communication Microphones are released for general use, they will fill a definite need aboard ships. Fitting easily into the hand or attached snugly to the face, weighing barely more than a whisper, Electro-Voice Microphones are incomparable from the standpoint of stability, articulation and reduction of background noise.

Builders of war equipment may secure information concerning new Electro-Voice developments from us. However, if limited quantity needs can be filled by any of our Standard Model Microphones, with or without minor modifications, contact your local radio parts distributor.

In order to maintain existing civilian equipment at maximum efficiency, we suggest that you submit your Electro-Voice Microphone to your supplier for TEST and REPAIR at our factory.



Electro-Voice MICROPHONES

ELECTRO-VOICE MANUFACTURING CO., INC. • 1239 SOUTH BEND AVENUE • SOUTH BEND, INDIANA
Export Division: 13 East 40th Street, New York 16, N. Y. — U. S. A. Cables: ARLAB

Rapid Delivery
**RADIO AND
 ELECTRONIC
 COMPONENTS**

**TUBES!
 CAPACITORS!
 RELAYS!
 COILS!
 RESISTORS!
 TRANSFORMERS!
 TEST EQUIPMENT,
 ETC.!**



IN STOCK!

**COMPONENTS AND
 EQUIPMENT OF
 EVERY NATURE!**

We've got them . . . or can get them for you as fast as wartime conditions permit!

For 17 years, we've done nothing but buy and sell electronic equipment. We know what's available and where. We know how to pick and choose, selecting only the best. We can work with you, advise you, save time and eliminate headaches.

**Tell us what you need!
 WE'LL DELIVER!**

Telephone orders to BRyant 9-1946

**HARVEY
 RADIO COMPANY**

103 WEST 43 ST. NEW YORK, N.Y.

(Continued from page 90)

on inactive duty for 32 weeks to receive pre-service training in civilian status before being called to active duty.

At least, that's what it was until direct enlistments were washed out. Then ERC also was suspended, of course. Before that happened, however, more than two thousand young reservists had been enrolled under ESMWT at Rutgers, saving the Army the burden of their training.

The ESMWT-ERC training project was initiated in July, 1942. During the period from September through November the program made rapid strides. ERC classes were planned for some 30 centers; of these, 21 actually commenced operation. New sections were being organized at a rate of eight per week, and all indications were that this rate could be maintained. There were teachers and equipment enough lined up for the job. They were prepared for continuous enrollment of double the figure already attained — 160 new students per week, with a maximum active enrollment of approximately 5000.

Then the ax fell. On December 5, 1942, by executive order, voluntary enlistments were stopped. Except for those students already enrolled, the Enlisted Reserve Corps was washed up. The reservists already inducted were allowed to complete their training. They were just finishing up that job at Rutgers when we were there.

While it lasted, it was some program! At the peak there were 102 sections — 102 classes of 20 men each, meeting five nights a week. This meant more than 10,000 experiments performed, nearly 100,000 hours of instruction.

And it was a successful program, too. In fact, the performance has been officially described as "marvelous." Attendance was almost perfect; in many classes it was perfect — 100 per cent. Few classes fell below a 99 per cent record. Of course, there was a reason for that. The enrollees weren't allowed to forget that they were not in the Army — even if they still dressed in civvies. Two consecutive absences meant an immediate call to active duty. Where absence because of illness was unavoidable, the men were simply dropped back to another class on their return. Their own class went along without them; they couldn't wait.

So successful was the Signal Corps program that, in the autumn, the Air Forces requested Rutgers to do a similar job in their behalf. Details were worked out and the plan was all set to go through. In fact, the first lot of application blanks were made up ready to go out — and that very day the word was received that direct enlistments had been stopped!

Signal Corps Ground Crew Training

But there were still many necessary jobs clamoring to be done. It wasn't long before the Signal Corps itself was back. Ft. Monmouth — or rather, the entire Signal Corps establishment in that region, including Monmouth and Camps Belmar, Coles and Wood — had large numbers of civilian technicians requiring training. In mid-April of this year a group of tuition-free courses was offered the Civilian Training Branch of the Signal

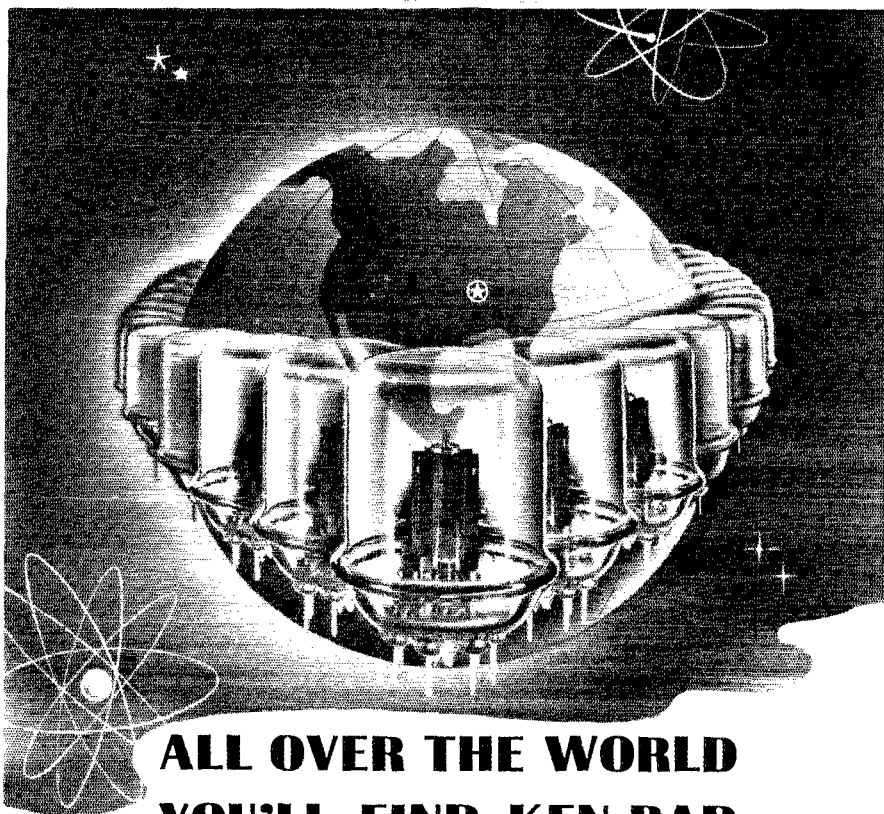

ALL OVER THE WORLD YOU'LL FIND KEN-RAD

All over the embattled world Ken-Rad tubes
help to make our victory certain and complete

Not until victory can the story be released
Then it will merge with the headlines of elec-
tronic triumphs in the worlds of tomorrow

Industry will then utilize the electronic develop-
ments of the war to produce for better living

KEN-RAD

TRANSMITTING TUBES
CATHODE RAY TUBES

SPECIAL PURPOSE TUBES
METAL AND VHF TUBES

INCANDESCENT LAMPS
FLUORESCENT LAMPS

OWENSBORO KENTUCKY U S A

(Continued from page 92)

Corps Ground Signal Service, starting off with 19 sections containing over 500 students.

Some of the trainees needed only a limited amount of highly specialized training; others had to start with the basic fundamentals. Those possessing sufficient academic background were to be trained for higher level engineering and design work; others with lesser natural equipment were to be given only enough training to make them competent technicians. The problem of giving each exactly what he needed was handed to Rutgers.

In solving it they set up a highly flexible schedule, including fifteen different courses. Ten of these are directly associated with radio; the remainder are related courses covering electrical meters, radio mathematics, materials testing, machine drawing and advanced machine design.

The radio courses are at two levels. They begin with the simplest fundamentals and continue through advanced radio engineering. The neophyte in radio — provided he is a high school graduate with at least two years of math and one of science — can take D.C. and A.C. Electricity; Vacuum Tubes; Electromagnetic Waves, Transmission of Signals, and R.F. Circuits; Transmitters and Receivers; and Wave Propagation and Antenna Systems. With the exception of D.C. and A.C. Electricity, which is 12 weeks, these are all 10-week courses.

A college graduate, on the other hand, could start right in on the distinctly higher-level advanced courses, available only to students with credits in college mathematics above calculus. These courses include Advanced D.C. and A.C. Theory; General Communication (covering the entire field from speech and hearing through wire systems and electronics to radio); Electron Tubes and Circuits (analysis and design); Communication Networks (complex networks, transmission lines, r.f. impedance matching); and U.H.F. Techniques (receivers, generators, lines, radiation and propagation, wave guides). These are each 12-week courses. The student who completes this training is, without reservation, a qualified radio engineer.

Of course, as was pointed out before, many of the trainees take only one or two of the courses — those which will aid them in their particular specialty. That's the whole philosophy of the Rutgers-ESMWT system — to give precisely the kind of training required, with no excess to waste time or cause confusion.

Industrial Training

Nor is it only in the Signal Corps training that this philosophy is pursued. All Rutgers ESMWT training is based on the same formula, including that for industry, as well.

The training job for industry is an increasingly important part of the Rutgers' program. Although carried on usually in small units, in the aggregate the industrial training bulks surprisingly large.

It must be understood that this is not haphazard training of large numbers of miscellaneous

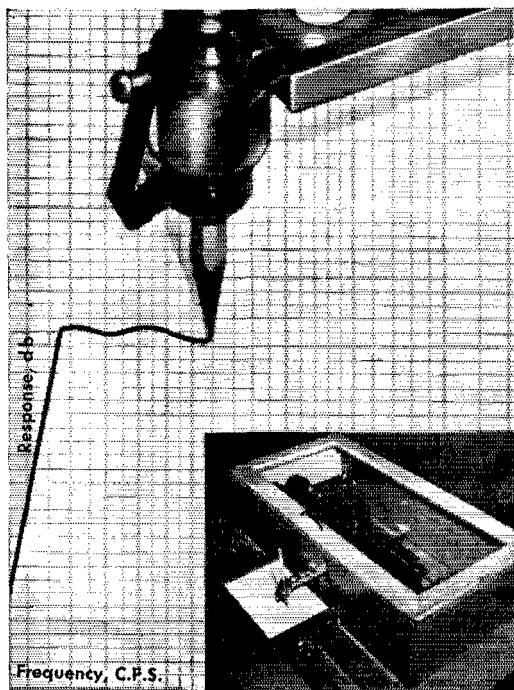

It writes by ear...

For years, Shure Engineers have relied upon accurate and scientific measurement in determining microphone performance. They do not rely, alone, upon listening or point by point measurement.

Shure Engineers designed this Automatic Curve Recorder to plot the operating characteristics of our microphones. It writes by ear.

This and other advanced testing techniques have enabled Shure to meet and often exceed the rigid requirements of microphone design demanded by the Army and Navy. You will have every right to expect new standards in microphone performance after the war is won.

SHURE BROTHERS, 225 W. HURON ST., CHICAGO

Designers and Manufacturers of Microphones and Acoustic Devices



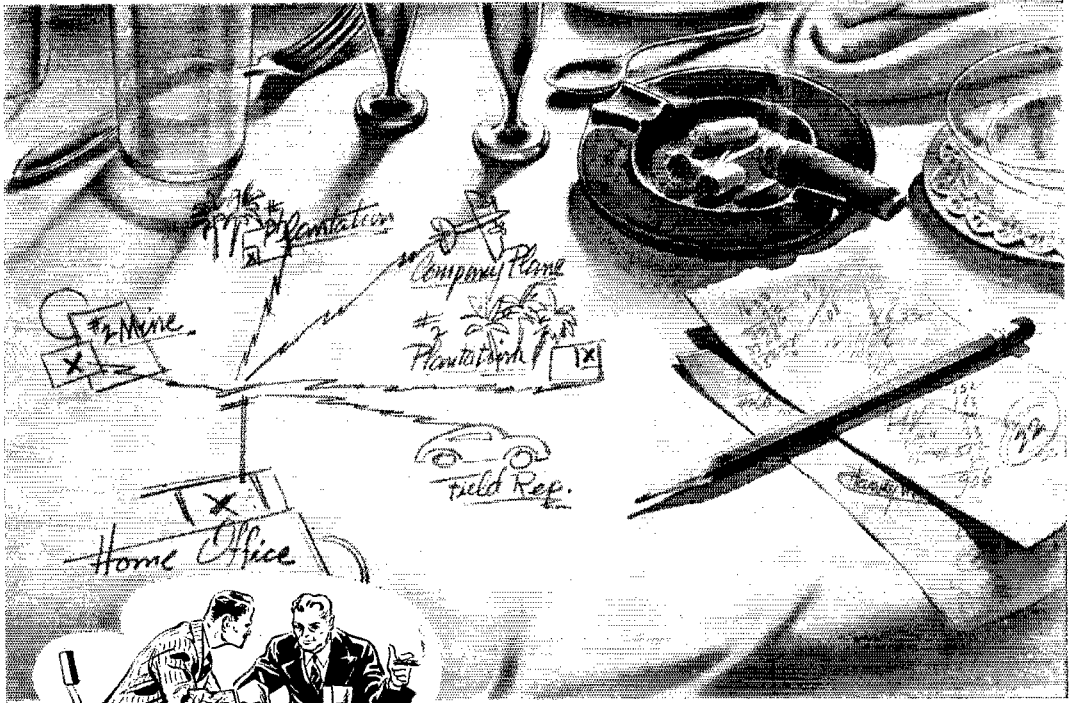

"AS A MINE AND PLANTATION OPERATOR, HAVE YOU THOUGHT OF USING COMMUNICATIONS AFTER THE WAR?"

"Tablecloth" Communications

... or just plain pencil doodlin'—perhaps—and no doubt you've been doing some yourself, planning for post-war operations in your own business.

Our job right now is making specialized communications equipment for our government; and what we're learning now will be of utmost value to communications in YOUR business, post-war and after.

Since infinite peacetime applications come from the stimulation of war—YOUR communications equipment will be BETTER than ever. Better in design, lighter in weight and more compact through skilled manufacturing.

Here we have done a bit of doodlin' for applications in a mine and plantation set-up. Future "Tablecloth Communications" will dramatize possible uses of Harvey-Wells equipment in industries, transportation, lumbering and other allied fields.

HARVEY-WELLS
Communications inc.
*
HEADQUARTERS
For Specialized Radio Communications Equipment
SOUTHBRIDGE, MASS.

NOW—a really high-powered **RADIO ENGINEERING LIBRARY**

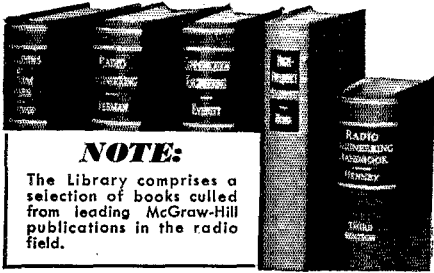

NOTE:

The Library comprises a selection of books culled from leading McGraw-Hill publications in the radio field.

- ➔ especially selected by radio specialists of McGraw-Hill publications
- ➔ to give most complete, dependable coverage of facts needed by all whose fields are grounded on radio fundamentals
- ➔ available at a special price and terms

THESE books cover circuit phenomena, tube theory, networks, measurements, and other subjects—give specialized treatments of all fields of practical design and application. They are books of recognized position in the literature—books you will refer to and be referred to often. If you are a practical designer, researcher or engineer in any field based on radio, you want these books for the help they give in hundreds of problems throughout the whole field of radio engineering.

5 volumes, 3559 pages, 2558 illustrations

- Eastman's **FUNDAMENTALS OF VACUUM TUBES**, 2nd edition
- Terman's **RADIO ENGINEERING**, 2nd edition
- Everitt's **COMMUNICATION ENGINEERING**, 2nd edition
- Hund's **HIGH FREQUENCY MEASUREMENTS**
- Henney's **RADIO ENGINEERING HANDBOOK**, 3rd edition

10 DAYS' FREE EXAMINATION

SPECIAL LOW PRICE

EASY TERMS

Special price under this offer less than books bought separately. Add these standard works to your library now; pay small monthly installments, while you use the books.

SEND THIS EXAMINATION COUPON

McGraw-Hill Book Co., 300 W. 42 St., New York 18, N. Y.

Send me Radio Engineering Library for 10 days' examination on approval. In 10 days I will send \$3.00 plus few cents postage, and \$3.00 monthly till \$24.00 is paid, or return books postpaid. (We pay postage on orders accompanied by remittance of first installment.)

Name.....

Address.....

City and State.....

Position.....

Company..... QST-9-43

individuals who may or may not ever produce in industry. It is done only in response to specific requests by industrial firms to equip selected personnel to meet well-defined needs. For example, a radio manufacturing firm already may have or may want to procure a group of employees who need a certain amount of instruction to perform certain work — testing or assembly, for example. This may call for a general education in fundamentals, or perhaps only intensive training in a few specialized details.

The Rutgers staff ascertains precisely what is needed, assembles a course tailor-made to fill the requirement, and then teaches it to the employees designated by the firm.

That's the formula for all industrial training at Rutgers, not only in radio but in other fields, as well. They build individual courses to fit the job at hand, instead of offering only an inflexible standardized course from a catalog.

Such was the system by which several classes of workers were trained for RCA-Victor at Harrison, for example. The subject requirements were varied — from industrial cost accounting to principles of radio engineering. A total of 17 courses were offered, ranging in length from 12 to 18 weeks and including the following diversified subjects: D. C. and A. C. Electricity, Principles of Radio Engineering, Communication Engineering, Principles of Electronics, Principles of Electron Tubes, Cathode-Ray Tubes and Circuits, Electrical Meters, Physics (mechanics, heat and electricity), Engineering Problems (Part I; through trigonometry), Engineering Problems (Part II; through calculus), Engineering Drawing, Production Control and Industrial Cost Accounting.

Obviously, almost any RCA employee could benefit from one or more of these courses — and many did. There was one class which contained a number of girl workers whose jobs required a knowledge of vacuum-tube principles. Not radio science as a whole — just vacuum tubes. D.c. and a.c. theory to start with, of course, but nothing about such (to them) extraneous details as circuits or antennas. Two specialized ESMWT courses gave them exactly what they needed, with no time wasted on irrelevant matters.

The same principle is applied throughout in the setting up of all industrial electronics courses. Westinghouse Elevator Co. had a crew of inspectors working on Mark 50 gun directors being manufactured for the Navy. These fire control assemblies included a considerable amount of complicated equipment — stuff about which the mechanics-minded inspectors naturally had little or no knowledge. Yet to do their job they had to know just what made this equipment tick and why. Rutgers trained them in a course covering precisely the details required.

That's the way it was at Bendix, and at Cornell-Dubilier, too. But there's no point in going into detail about these other examples. It's enough to say that Rutgers, along with all the other institutions cooperating with the U.S. Office of Education, has done and is doing a work of incalculable value in supplying vital technical

OPPORTUNITY

for men with a knowledge of
**COMMUNICATIONS
EQUIPMENT**

★ Help your country and yourself. A war plant making vital equipment for the Army, Navy, Air Force, and Coast Guard is in urgent need of personnel with knowledge of communications equipment to become:

ELECTRICAL INSPECTORS
MECHANICAL INSPECTORS
INSTALLATION SUPERVISORS
JUNIOR ENGINEERS
LABORATORY ASSISTANTS
DRAFTSMEN

JOBS EVERYWHERE — some at factory; others at military and naval centers throughout country. Plant is located in the Chicago area. Modern equipment, excellent working conditions, old established firm, promising future after war.

FREE TRAINING: Experts teach you quickly at no cost. Earn while you learn.

WRITE FOR DETAILS: Will be sent on receipt of your letter stating experience, education, age, references, draft status.

Do Not Apply if 100% in War Work!

Our entire personnel knows of this advertisement

WRITE BOX 60 **Care Q. S. T.**
W. HARTFORD, CONN.



EAR

to the ground

Two kinds of news that does not reach the public prints is known to Stancor engineers: new applications of electric energy to war communications, and new ideas for using electronic devices in peacetime production. Both are secrets of victory, not to be told until the war is won.

While devoting major attention to war production, Stancor engineers keep their ear to the ground . . . alert for news of developments that will help you to meet the challenge of a new industrial era.

STANCOR

STANDARD TRANSFORMER CORPORATION
1500 NORTH HALSTED STREET - CHICAGO



(Continued from page 96)

instruction to key personnel in war industries through ESMWT.

Future Prospects

As to the future of ESMWT in the radio field? Well, that's a crystal ball assignment. There's only one thing really certain, and that is that ESMWT will continue — for the duration. It'll be largely industrial, of course. The courses given will be aimed at specific objectives; no mass training for pegs without holes to put them in. These courses will resemble those currently given at Rutgers — specialized curricula created to specifications for the training of personnel for specific needs.

Rutgers, for example, now continuously canvasses manufacturing companies in the New Jersey area to determine what kinds of trained personnel are needed, how many, how soon. Where workers already employed need additional training, classes will be established right at the plant. Rutgers will lay out the course, supply the instructors, do the entire job. Where new personnel must be recruited, they'll dig up the applicants, train them, and turn them over to the firm ready to go to work.

There is only one proviso. The manufacturer must be prepared to pay his trainees while they are receiving their training. That's the only way manpower can be obtained these days, it seems; people just won't go to school, even if it's free, unless they get paid while learning.

That proviso met, the manpower can be obtained, it appears. That a need exists for additional trained personnel — in radio as well as in other fields — is also apparent, as indicated by recent surveys. Thus the two requirements for continuance of the ESMWT program — a need for training and the availability of trainees — would seem to be met.

All in all, there still remains a big and useful job for ESMWT to do in the months that lie ahead. Congress apparently thought so, too. The appropriations bill recently passed included 25 million dollars for the continuation of ESMWT through June 30, 1944.

And the U. S. Office of Education wants it known that the director of ESMWT will send any interested person a list of ESMWT Institutional Representatives to whom applications for enrollment should be directed; and, for industrial managers, a list of ESMWT Regional Advisers who will be glad to consult with industries concerning tailor-made courses to meet their training needs is available. Address the Director, ESMWT, U. S. Office of Education, Washington, D. C.

 **Strays** 

We still have plenty of QSL cards in case some of the W gang who have worked us and have not exchanged QSLs would be interested in doing so now. — *K4KD and K4HEB.*

OHMITE

RESISTANCE UNITS

do the job... and do it well!

The design and construction of Ohmite Resistance Units enable them to meet the toughest requirements. Today Ohmite A—Rheostats, B—Brown Devils, C—Dividohms, D—Plate Chokes, E—Dummy Antennas, “carry on” to help speed victory... tomorrow, these rugged units will be ready to meet new peacetime needs.



Send for Ohm's Law Calculator

Solves any Ohm's Law Problem with 1 setting of slide. Available for only 10¢ to cover handling, mailing.

OHMITE MFG. CO.
4865 Flournoy Street, Chicago, U. S. A.

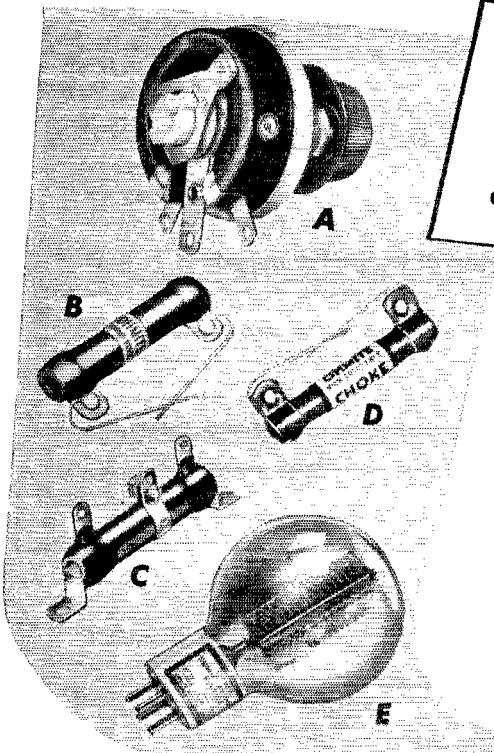

AMATEURS

Amateurs of today, of course, are serving with all branches of the Armed Forces. But, when peace comes, they will once more be pounding keys and holding gabfests with other ham ops the world over. Naturally, the number of amateurs after the war will far surpass the number of other years. But all these men and women who are now becoming communications conscious are rapidly becoming acquainted with Universal products, because this organization is manufacturing microphones and other voice communication components for nearly every arm and branch of the services. To these new friends, and our old ones as well, Universal wants you to know that when peace comes Universal will once more produce for civilian consumption products that will combine the same standard of quality in material, workmanship and engineering principles that have marked Universal microphones and accessories the past fifteen years.

UNIVERSAL MICROPHONE CO., LTD.
Inglewood, California

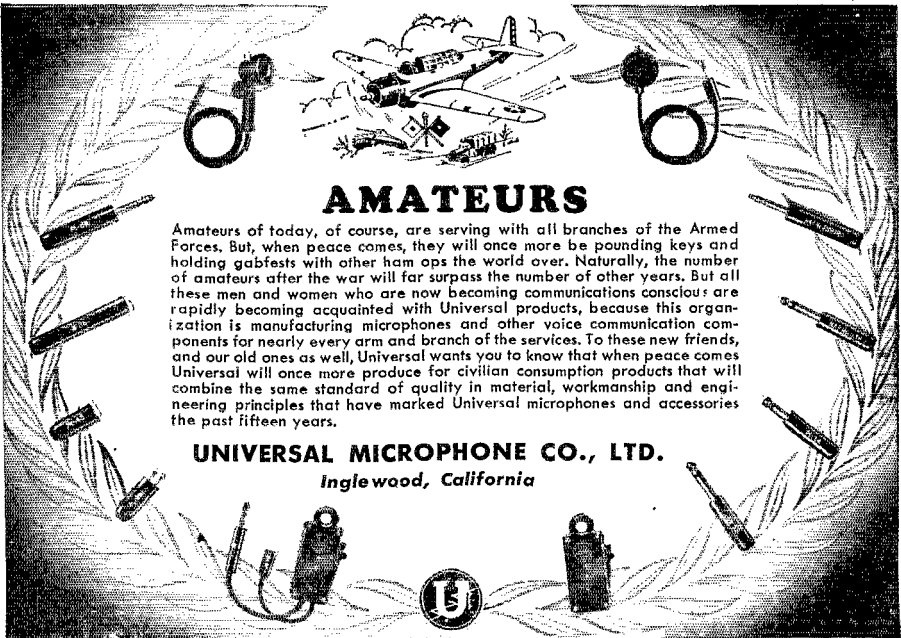

RESISTORS

FOR

Industry • Research Communications

IRC makes resistor units of more types, in more shapes, for more applications than any other manufacturer in the world.

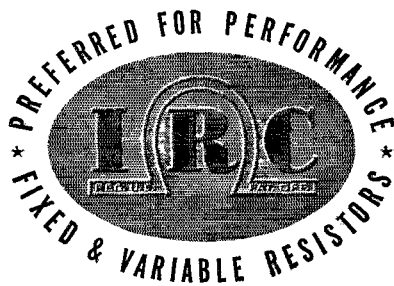

**INTERNATIONAL
RESISTANCE COMPANY**

401 N. Broad Street • Phila. 8, Pa.

Radell

Makers of Precision
Engineered
**ELECTRONIC
PRODUCTS**

Radell
CORPORATION

6327 GUILFORD AVENUE, INDIANAPOLIS, INDIANA

● WANTED ●

TO PURCHASE—

Hammarlund Super Pro SP-110X or 200-X for War
Purposes. Top price paid. Replies giving particu-
lars to

BOX No. 55, QST

Women and Radio

(Continued from page 18)

draftswomen and women engineers. Not all of these are newcomers since the war. One veteran in the field of drafting is Sarah Eppard, who joined the drafting department at Electronic Laboratories seven years ago. In fact, she was the drafting department. More recently, however, she has been writing instruction books.

Among women engineers is Beattina Alexander, employed at the Victor Division of RCA. She performs such precision work as checking small parts by projection against drawings of specifications. Another woman engineer is Rita Carlin, who is on the engineering staff of the Westinghouse Lamp Division. She majored in physics and is now being trained in factory engineering to help produce high-power transmitting tubes for our armed forces.

Many another woman with technical ability is employed at Army and Navy posts and in the field offices of the CAA as radio mechanic-technicians, constructing and repairing radio equipment of many types. The CAA also has women trainee radio electricians. After completing their schooling at the CAA maintenance center school at Ft. Worth, Texas, they are assigned to the duties of repairing and maintaining radio gear.

The Signal Corps uses women Civil Service technicians in many and varied jobs. Trainee repairmen, for instance, learn to overhaul, maintain, inspect and test Signal Corps equipment. At Ft. Monmouth they install and test radio gear in everything from a jeep to an M-3 tank. In the meteorological section they make soundings of the upper atmosphere by the radiosonde method, sending aloft free balloons carrying meteorological instruments and a miniature transmitter which signals the instrument readings back to ground to be recorded.

In college, university, industrial and government laboratories from one end of the country to the other there is tremendous activity on secret research projects, for it is only through developing and perfecting new weapons of war that we can hope to beat the enemy. Women already are making a vital contribution in this field, and when this war is ended there will be a lot of feminine radio laboratorians and technicians—not to mention top-flight engineers and physicists, as well.

Some women are assisting in drafting, having completed ESMWT or other courses in this subject. Others have received three months' instruction in machine-shop practice and now work as machinists. A large number are employed as technicians, building up experimental gear under the direction of engineers. Some of these girls have progressed to minor design work. One YL who holds a Ph.D. in astronomy is now doing radio research work.

Other women with technical training and Civil Service ratings are employed as physicists and engineers by the Bureau of Standards, the Navy Department, the Army Air Forces and in the Office of the Chief Signal Officer.

(Continued on page 102)

TRIPLETT

Combat Line INSTRUMENTS

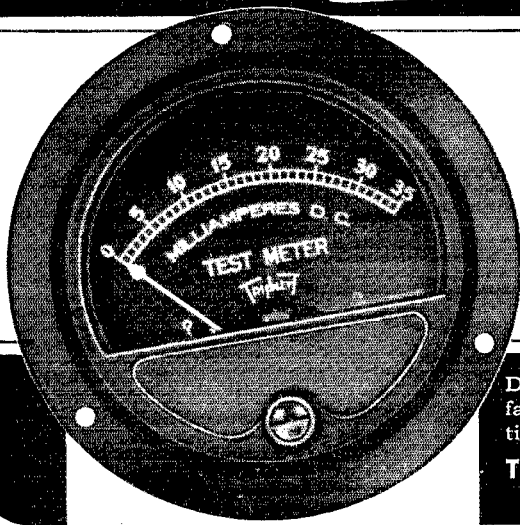

Thin Line
MODEL



Deliveries under government requirements are facilitated by two large sub-contracting organizations combining to greatly increase Triplet output.

TRIPLET ELECTRICAL INSTRUMENT CO.
BLUFFTON, OHIO

THE RADIO AMATEUR'S LIBRARY

Many requests are received for the complete list of our publications. The list follows:

<i>Title</i>	<i>Price</i>
QST.....	\$2.50 per year*
List of Stations.....	Discontinued
Map of Member Stations.....	Discontinued
Operating an Amateur Radio Station	Free to members; to others 10¢
The Story of The A.R.R.L.....	Discontinued
The Radio Amateur's Handbook	
a. Standard Edition.....	\$1.00**
b. Special Defense Edition.....	\$1.00
The Log.....	35¢ each; 3 for \$1.00
How to Become a Radio Amateur.....	25¢
The Radio Amateur's License Manual.....	25¢
Hints & Kinks for the Radio Amateur.....	50¢
Lightning Calculators:	
a. Radio (Type A).....	\$1.00
b. Ohm's Law (Type B).....	\$1.00
Amateur Radio Map of the World.....	\$1.25
Two Hundred Meters and Down: The Story of Amateur Radio.....	\$1.00
Building an Amateur Radio-telephone Transmitter.....	Out of print
A.R.R.L. Antenna Book.....	50¢
Emergency Communications Manual.....	10¢
The Minilog.....	25¢
Learning the Radiotelegraph Code.....	25¢
A Course in Radio Fundamentals.....	50¢

*In the United States and Possessions — other Countries \$3.00 per year.
**Postpaid in Continental U. S. A. — \$1.50, postpaid, elsewhere.

(No stamps, please)

The American Radio Relay League, Inc.
WEST HARTFORD, CONNECTICUT

AS IN THE GOOD OLD DAYS

... when youngsters depended on Browning-developed products for attic shack experiments...

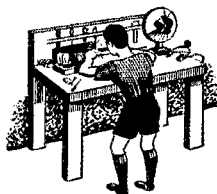

SO NOW AND

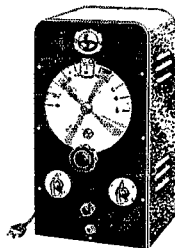

IN THE FUTURE

... ham, war, police, and other emergency communications facilities can and will depend on the Browning Frequency Meter and other products of Browning Laboratories research.

BROWNING
Laboratories
INCORPORATED
WINCHESTER·MASS.

Training

Perhaps the most notable impression — apart from the love of the work and the devotion to duty — that one receives from a study of the rôles women are playing in radio is that every job is a skilled one, requiring specialized abilities and training. In some instances, as in the case of Mary Murphy, this requirement is met by the possession of unusual faculties. A keen sense of touch, exceptional hearing, a nicely modulated speaking voice — these may be qualifications enough to get into radio.

But the great number of women in radio started with no such natural capabilities. Their skills were acquired by training. Where did they get this training? That, too, is a part of the story of women war workers in radio. Women on the whole have had less industrial experience than men and far less technical training. Even the reading of a dial requires some knowledge, and no inexperienced person can perform the highly specialized work required in radio technique.

To meet this problem, most branches of the industry have set up training programs designed to expand the ever-increasing numbers of women workers and to increase their usefulness.

The simpler mechanical operations are comparatively easy to master. For these occupations the training usually is done on the job, taking anywhere from a day to several weeks.

Thereafter experience on the job may provide additional training — as well as the opportunity for advancement. Up-grading schools are provided by many concerns, the women being placed in progressively more responsible positions as they demonstrate their fitness. One such school, meeting after working hours, is carried on at Hallcrafters. Beyond the beginning class, which all employees attend during their first week, there are intermediate and advanced classes which include laboratory work at the Illinois Institute of Technology. Also given are engineering classes. These are primarily for men, but it is entirely possible for a girl possessing the necessary qualifications, interest and ambition to complete these classes and take her place with the engineering staff. Several girls are attempting to accomplish just that. Corinne Foot, whose husband is an engineer at Hallcrafters, believes that she can do it. Already possessed of a radio background, she started in the blueprinting department and then enrolled in the advanced class. Now Corinne is also sitting in on engineering lectures, hoping one day to become an assistant to her husband.

At the big Westinghouse plant at East Pittsburgh, classes have been organized to train women for various kinds of work done exclusively by men since 1918. Under the "earn-learn" program now in effect, women receive classroom instruction in machine tools, mathematics and blueprint reading, and then spend 36 hours each week putting into practice their newly acquired knowledge. Young women with college degrees are given special training which prepares them for semi-technical engineering positions.

At Hammarlund, hundreds of women have

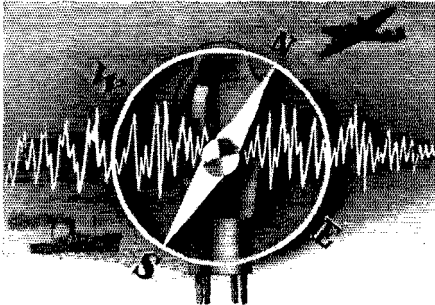

THE NEW WORLD of the FLYING WORD

The swift progress of aeronautical-radio is outstripping all expectations. Even we who have spent our lifetime in aviation communications are astonished by the gigantic strides into the new world of tomorrow.

Here is the young man's future. Electronics is revolutionizing the industrial world — and *electronics* is the *basis* of every course in radio transmission and reception taught at the Melville Aeronautical Radio School, under personal direction of our pioneer-founder, Frank Melville. If you plan to aim your career at aeronautical or marine radio, you'll want to know the facts regarding the value which Army, Navy and Airline officials attach to this organization of experts and authorities in the training of men and women for tomorrow's big jobs.

MELVILLE

AERONAUTICAL RADIO SCHOOL, INC.
 45 West 45th Street New York City
Training Men & Women for Radio in the Service of
AIRLINES - ARMY - NAVY - MARINES - MERCHANT
MARINE - COAST GUARD - INDUSTRY



Founded in 1909

Pre-Induction "RADIO"

A maximum of thirteen weeks to prepare for military service — code — printing — typing — procedure — and fundamentals of tube and transmitter servicing. If interested, write for details.

PORT ARTHUR COLLEGE
 PORT ARTHUR, TEXAS

ANTS in his PLANTS!

TINY CRYSTALS ARE HELPING DO IT

Every time a Nazi factory of war is blown sky high—every time that Hitler's tools of destruction are themselves reduced to scraps of rubble—tiny radio crystals had something to do with the job.

For communication is a vital part of warfare... and crystals ride with the raiders. To fulfill their responsibility, they must be perfect. Here at Scientific Radio Products Co., we're turning out perfect crystals... rapidly, skillfully, steadily for Hitler's destruction.

Our facilities are such that we may be able to serve you, too, in your efforts to bring destruction to the enemy.

Write us!

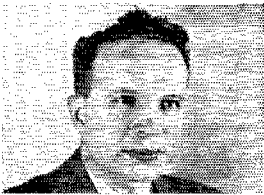

LEO MEYERSON
W9GFQ



E. M. SHIDELER
W9IFI



RADIO OPERATORS WANTED

Be a "Key" man. Learn how to send and receive messages in code by telegraph and radio. Army, Navy and Commerce need thousands of men. Expansion of air commerce and freight after war should create an even bigger peacetime demand for operators. The famous Candler System, maker of world's champions, teaches that is the secret of speedy sending and receiving. Good pay, adventure. Learn at home quickly.

FREE 52-PAGE BOOK explains extra course of training. Rush name for it today. It's absolutely free.

CANDLER SYSTEM CO.
Dept. 4-K, P.O. Box 928, Denver 1, Colo., U. S. A.
and at 121, Kingsway, London, W.C.2, Eng.



ONAN

Electricity for Any Job — Anywhere

ONAN GASOLINE DRIVEN ELECTRIC PLANTS supply power in places where not otherwise available, and for standby or regular service in communications. They provide electricity for many war tasks on all fronts.

From 350 to 35,000 watts. A.C. 50 to 800 cycles, 110 to 660 volts. D.C. 6 to 4000 volts. Also dual A.C. and D.C. output models. Air or water cooled engines.

Details furnished on present or post war need for Electric Plants.

D. W. ONAN & SONS
1943 Royalston Ave.
Minneapolis, Minn.



10 KW!

A Typical B & W High-Power Coil

Over 10" in diameter, by 20" long, and designed for 10KW service, this variable-link final amplifier plate coil is a good example of B & W engineering at work on the job of matching modern Air Inductor requirements. Coils in this unit are of

5/8" copper tubing, while other types have tubing as large as 1". That's a whale of a jump from the midget Band-Hoppers of pre-war days but, as always, when it comes to Air Inductors, you can count on B & W to deliver the goods.

BARKER & WILLIAMSON
Air Inductors and Variable Air Condensers
235 FAIRFIELD AVENUE, UPPER DARBY, PA.

(Continued from page 102)

what is a TERMINAL?*



*A POST OFFICE is a terminal for mail. (Write those boys in the Services more often!) It is also a terminal for War Bonds and your patriotic cash. And TERMINAL is a terminal for all radio and electronic supplies and for folks who need them. (After Victory, we'll again handsomely care for those who only want them.) TERMINAL Radio Corp., 85 Cortlandt St., New York, N. Y. WOrth (at least!) 2-4415.

picked up where the boys left off when they went into service. Through an extensive program of training, promising employees are up-graded from other jobs. Mildred Kuski, for example, was a cable maker before the shortage of manpower made an opening for her. She went through a period of training, and now calibrates receiver tuning units — doing that intricate job quickly and with extreme precision.

The RCA-Victor Division in its Camden plant carries on a comprehensive program of instruction. "Vestibule" training classes have been instituted to increase opportunities for employees and shorten the time between initial employment and full productive capacity. Every woman employee is eligible for aptitude tests. If these show that she might do better at something other than her present job, she is given intensive special training and put to work at the new task.

At RCA's Bloomington plant, 20-year-old Maxine Jackson, who conducts the "vestibule" training, is herself an illustration of the way it operates. Going to RCA from high school, she was made an inspector in four months, a group leader in another four months, and a few months later assumed her present position.

This enterprising program was started originally at the RCA Harrison plant, where more than two-thirds of the workers now are women — a ratio which it is expected will increase even more, since women have been found particularly adapted to the work of radio-tube making carried on there.

Up-graded through training, a large number of women at other RCA plants are now doing complicated test work on equipment for the Army and Navy. Most of them were drawn from the ranks of workers in the plant. Attending classes in radio theory an hour each day, they will receive an over-all picture of radio, rather than learn only why a certain part is right or wrong.

Perhaps the most ambitious program in progress is the one RCA-Victor is carrying out in cooperation with Purdue University. Receiving pay while they learn, 85 girls between the ages of 18 and 22 are being trained as radio technicians. On completion of the course, which provides for two terms of 22 weeks each, the girls will be assigned to various RCA plants as engineering aides.

In addition to instruction given by employers, voluntary part-time radio courses are now being given by various agencies. The American Women's Voluntary Services in New York City, for instance, offer courses for those wishing to undertake them in their spare time. From a single class of 30 persons two years ago, the enrollment has grown to the present total of 2000 students under the tutelage of 79 voluntary instructors. Nearly 500 "placements" already have been recorded by the AWVS staff. In addition to a six-month course designed to prepare the enrollee for a Class-B ham ticket, classes are also held in high-speed code transcription, radio mathematics and advanced theory. Recently a new laboratory was opened where students of radio theory are given training in radio construction and repairing.

Many other women are receiving part-time in-

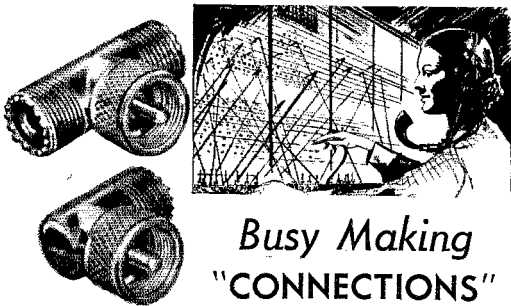

Busy Making "CONNECTIONS"

★ The operator at the switchboard is no busier making connections than is The Astatic Corporation in the volume production of many types of Army and Navy approved Constant Impedance High Frequency Connectors, Co-axial Cable Connectors and Multi-contact Plugs and Sockets for wartime electronic equipment. While Astatic production facilities are devoted in large part to the manufacturing of these important products, a limited number of Microphones and Phonograph Pick-ups, for which Astatic is so widely known, are still being made for government use and industries with high priority ratings.



THE ASTATIC CORPORATION

YOUNGSTOWN, OHIO

In Canada: Canadian Astatic, Ltd., Toronto, Ont.

Keep 'Em Running FOR THE DURATION!

It is difficult to secure new Generating Sets or new Rotary Converters . . . Pioneer is devoting all of its resources toward winning the war . . . but we

can, and will, help you keep your present equipment running for the duration. Send your service problems, by letter, to Pioneer's Customer Service Dept.

DYNAMOTORS · CONVERTERS · GENERATORS · DC MOTORS · POWER PLANTS · GEN-E-MOTORS

PINCOR Products PIONEER GEN-E-MOTOR

CHICAGO, ILL. • EXPORT ADDRESS 25 WARREN ST., NEW YORK CITY
CABLE ADDRESS SIMONTRICE, NEW YORK

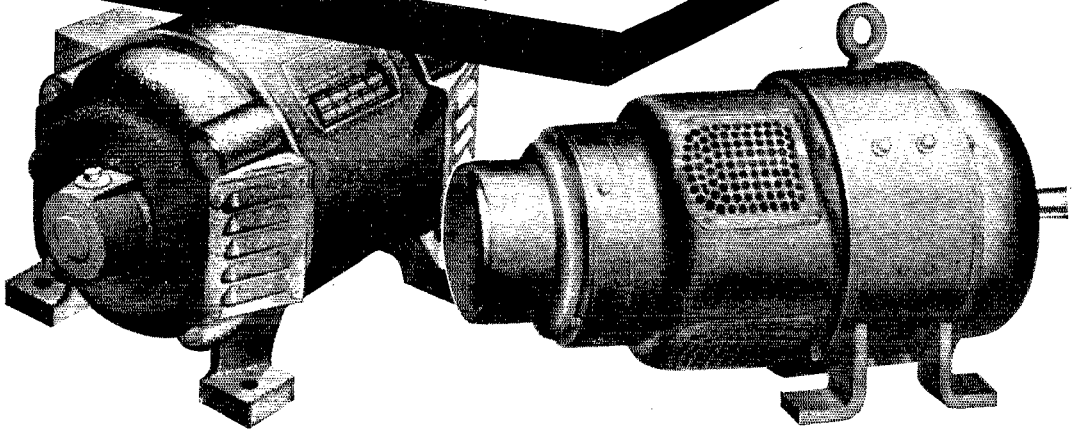

RADIO OPERATORS' LICENSE MANUAL

Complete and authentic question and answer manual on commercial radio operator license examinations. 1297 questions and answers, 230 pages of vital information for radio operator license candidates. \$3.00 Post-paid or write for descriptive circular.

1943 **WAYNE MILLER**
Edition The Engineering Building, Chicago

McELROY CODE MACHINES FOR RENTAL . . .

Deliveries of these famous code machines are now on schedule again. You can rent a new G-813-A automatic code machine complete with tapes and the famous McElroy chart for code speed and have the equipment shipped to you the same day your order is received. Build your code speed beyond your requirements with a minimum of time, effort and expense. *Write or wire . . .*

**AYERS Automatic
CODE MACHINES COMPANY**

711 Boylston Street, Boston, Massachusetts

★ **WAR BONDS PAY YOU!**
★ **\$6²⁵ ON \$18⁷⁵ INVESTMENT!**
★ **THINK OF IT!** Your money increases one-third in 10 years time! Buy War Bonds now . . . serve your country . . . protect yourself against the future

NEWARK'S SUPER-VALUE FILTER CONDENSERS

9 mfd. 2000 v. DC. With porcelain insulators and brackets for mounting. Size 1 3/4" x 3 3/4" x 4 1/2" high.

\$3²⁵

➔ **NO PRIORITY REQUIRED!**

BARGAIN FILTER CONDENSERS

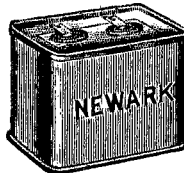

Still have limited stock of the old reliable NEWARK SPECIAL filter condensers. Oil filled and impregnated. Thousands of them have been sold.

Mfd.	Volts DC.	Size	Price
1	1000	5" x 3 3/4" x 1 1/2"	\$.59
2	2000	4 1/4" x 3 1/4" x 1 1/4"	1.50
4	3000	5" x 3 3/4" x 3 3/4"	3.75

➔ **ORDER TODAY DIRECT FROM THIS AD**
Sorry—NO CATALOGS for the Duration!

NEWARK Electric Company
323 W. MADISON ST.
CHICAGO, ILL.

JUST PUBLISHED!

**NEW! SECOND EDITION
PRACTICAL RADIO
COMMUNICATION**

by
Arthur R. Nilson and
J. L. Hornung

The book you need to succeed in technical radio. Indispensable to the radio student, priceless to the man on the job.

FOUR BOOKS IN ONE

- Radio Principles, including FM
- Aviation Radio
- Broadcasting, including FM
- Marine Radio

Excellent for license examination preparation and as a general text book, 6 x 9, flexible binding, 950 pages, 540 illustrations, \$6.00.

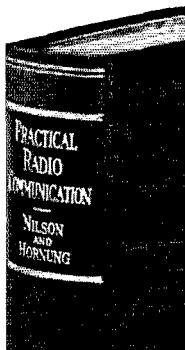

ALSO FOR YOU BY THESE AUTHORS

Radio Operating Questions and Answers, \$3.00.
Radio Code Manual, \$2.50.

Pre-examination tests on FCC elements for operators. \$5.00 per element. All postpaid.

EXAMINE THESE BOOKS AT NO RISK

Free circular 5Q on request or send a check or money order. Money back if not satisfied and books returned in 10 days.

**NILSON RADIO SCHOOL
51 E. 42nd STREET, NEW YORK 17, N. Y.**

**CAN YOU FILL ONE OF THESE
MOST IMPORTANT WAR JOBS?**

If you have a college education (not necessarily a graduate) and know theory and practice, you are urgently needed by a non-profit, non-commercial organization assigned to vital war research.

- Electronic Engineers
- Radio Engineers
- Electrical Engineers
- Physicists
- Electrical Designers
- Electronic Designers
- Acoustical Specialists
- Communication Engineers
- Geophysicists
- Seismograph Technicians
- Mechanical Engineers

If you are in one of the above categories and your highest skill is not being utilized to help save lives and materials, to help shorten the war, please write! ACT NOW!

Salaries range from \$3,000 to \$8,000, depending upon experience, ability, education and past earnings. In addition, we will pay all expenses of transportation, moving, etc., for you and your family. You must be free to travel. Living quarters will be made available. If granted an interview, we will compensate you for all expenses incurred in coming to New London. Don't wait! Write, stating background and experience to . . .

PERSONNEL DEPT.

P. O. Box 271, New London, Conn.

(Continued from page 104)

struction under the U.S. Office of Education's Engineering, Science and Management War Training program. Most ESMWT classes for industry now are composed largely of girls and women. Some are factory workers whose principal qualifications are mechanical dexterity plus mental alertness. Others are college girls with sufficient grounding in mathematics and the sciences to go directly into advanced courses.

And they do all right, too. At Rutgers University, where one such program is being carried on, the ESMWT staff is unanimous in its contention (it almost sounds more like a concession!) that women make good radio men. They're given the same training as the men. In shop work, their nimble fingers and dexterity often make them superior competition on wiring and assembly. Intelligent girls keep well abreast of the boys in theory, too.

Of course, some women simply haven't got the fundamental something it takes to understand radio — but that's true among men, too. Others have plenty of it. Prof. Chaffee, associate director of ESMWT at Rutgers, believes that almost any college girl with that essential innate capacity can go all the way up through advanced radio theory without stumbling. If she has only a liberal arts education, she'll have to start at the bottom with the basic fundamentals, of course. But many who have had physics and math (above calculus) go right into advanced theory, even with little or no previous radio experience.

Home-Front Heroines

The picture we have seen revealed in the radio plants and laboratories more than demonstrates that women workers in radio deserve what OWI characterizes as a "salute to the unsung heroines of the home front, who have rolled up their sleeves and pitched into full-time paid work."

The women in radio must be given unbounded credit for the magnificent job they are doing in keeping up vital communications, producing necessary radio equipment and assisting in the development of new electronic devices.

Actually, however, this is a job just begun. As the war progresses in our favor at an even faster rate than anticipated, our fighting forces must have more and more materials. The dire need now is for the manpower — or womanpower — to produce these materials.

To fill these necessary war jobs, our government estimates that by the end of 1943 at least 17,400,000 women must be at work in all of the essential trades, services and professions. Most of these must be recruited from the ranks of those not now working. Communications is one of the most vital needs in this war, both at home and on the fighting fronts, and in the field of radio there is no aspect in which women cannot participate — from opening the daily mail to unriddling the secrets of radar.

Ernest Bevin, British Minister of Labor and National Service, has said: "Our women tipped the scales of war." It may well be that the women of America are now helping to weight the pan in favor of the Allies. A little more help — and the job will be done.

PROUDLY IN THE
Nation's Service

As in the First World War, BRACH radio and electrical equipment is once again proving its excellence and dependability under the most exacting conditions...the products of 36 years' experience in "QUANTITY-plus-QUALITY" manufacture.

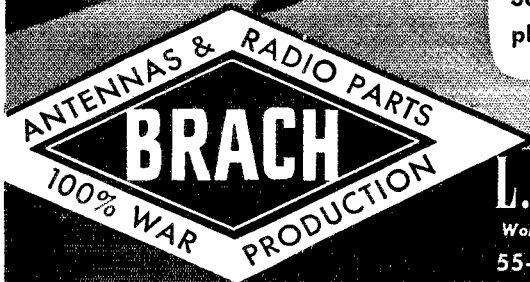

L. S. BRACH MFG. CORP.

World's Oldest and Largest Manufacturers of Radio Aerial Systems

55-65 DICKERSON STREET • NEWARK, N. J.

SICKLES COILS

ALL TYPES OF RF AND IF WINDINGS

Manufactured by

F. W. SICKLES COMPANY

P. O. Box 920

Springfield, Mass.

HARVEY RADIO LAB'S, Inc.
*Manufacturers of
Radio Transmitters*

ELECTRONIC APPARATUS

447 CONCORD AVENUE, CAMBRIDGE, MASS.

EASY TO LEARN CODE

It is easy and pleasant to learn or increase speed the modern way—with an **Instructograph Code Teacher**. Excellent for the beginner or advanced student. A quick and practical method. Available tapes from beginner's alphabet to typical messages on all subjects. Speed range 5 to 40 WPM. Always ready, no QRM, beats having someone send to you.

MACHINES FOR RENT OR SALE

The **Instructograph Code Teacher** literally takes the place of an operator-instructor and enables anyone to learn and master code without further assistance. Thousands have used and endorse the **Instructograph System**. Write today for full particulars and convenient payment and rental plans.

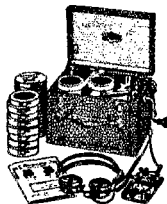

INSTRUCTOGRAPH COMPANY

4709 Sheridan Road, Chicago, Illinois

Representative for Canada:

Radio College of Canada, 54 Bloor St. West, Toronto

"HARRISON HAS IT!"

Practically everything in hard-to-get Electronic equipment and parts for Laboratories, War Plants, Government Agencies, and other *high priority* requirements.

Give us your orders—large and small. We can "deliver the goods"—sooner!

» Phone **WORTH 2-6276** «

And here are a few items for our old friends now in WERS and other civilian activities:

110 AC/6 DC VIBRATOR PACKS

Electronic Labs model S-1093. Delivers 300 volts DC at 100 ma, filtered. With cable and plugs.....\$29.50

CODE PRACTICE SET

Nickel plated buzzer-key mounted on wood base. Adjustable high pitch. Works on one or two flash cells. Not so hot, but OK for code practice.....\$1.95

PM DYNAMIC SPEAKERS

5-inch, with transformer for 8000 ohm plate.....\$1.95
Magnavox 10-inch, 16 oz. magnet! 6 ohm VC.....\$5.25

6L6G TUBES

Tested and guaranteed! \$1.37 ea., 3 for \$3.75 (Postpaid).

CQ — Local Hams!

Come in and look over the bunch of parts, sets, etc., we've piled on our counters for close-out sale!

HARRISON
RADIO CORPORATION

10 WEST BROADWAY • NEW YORK 7

HAM-ADS

(1) Advertising shall pertain to radio and shall be of nature of interest to radio amateurs or experimenters in their pursuit of the art.

(2) No display of any character will be accepted, nor can any special typographical arrangements, such as all or part capital letters be used which would tend to make one advertisement stand out from the others.

(3) The Ham-Ad rate is 30c per word, except as noted in paragraph (6) below.

(4) Remittance in full must accompany copy. No cash or contract discount or agency commission will be allowed.

(5) Closing date for Ham-Ads is the 25th of the second month preceding publication date.

(6) A special rate of 7c per word will apply to advertising which, in our judgment, is obviously non-commercial in nature and is placed and signed by a member of the American Radio Relay League. Thus, advertising of bona fide surplus equipment owned, used and for sale by an individual or apparatus offered for exchange or advertising inquiring for special equipment, if by a member of the American Radio Relay League takes the 7c rate. An attempt to deal in apparatus in quantity for profit, even if by an individual, is commercial and all advertising by him takes the 30c rate. Provisions of paragraphs (1), (2), (4) and (5) apply to all advertising in this column regardless of which rate may apply.

Having made no investigation of the advertisers in the classified columns, the publishers of *QST* are unable to vouch for their integrity or for the grade or character of the products advertised

* * * * *

QUARTZ—direct importers from Brazil of best quality pure quartz suitable for making piezo-electric crystals. Diamond Drill Carbon Co., 719 World Bldg., New York City.

COMMERCIAL radio operators examination questions and answers. One dollar per element. G. C. Waller, W5ATV, 6540 Washington Blvd., Tulsa, Okla.

USED TELEPLEXES, Instructographs bought, sold. Ryan's, Hannibal, Mo.

GUARANTEED 04A's, 849's, Laboratory instruments, high voltage condensers, etc. Box 1583, Indianapolis.

WANTED: Radio Operators for merchant marine. Must have commercial license. Wages \$340 to \$380 monthly. Radio Officers Union, 265 West 14th Street, New York, N. Y.

WHY NOT turn your unused equipment into ready cash which may be applied towards new and better equipment after the war? Leo, W9GFQ, offers you the best cash prices for communications receivers and test equipment. Write today for large illustrated catalog. Wholesale Radio Laboratories, 744 W. Broadway, Council Bluffs, Iowa.

CRYSTALS available, all types, including 100 KC, 465 KC and 1000 KC. Broadcast and Aircraft given prompt attention. Scientific Radio Products, Council Bluffs, Iowa.

QST's complete set \$50, RADIO \$10, 852's \$5 each; W.E. 618A dynamic \$50, G. E. West, 2519 New P. O. Dept. Bldg., Washington, D. C.

USED equipment wanted. Highest cash prices paid for receivers, transmitters, meters, parts, etc. I promise you the best deal. Let me know what you have. Bob Henry, W9ARA, Butler, Mo.

IN STOCK: Mac No. 200 keys, \$2.25, Signatone code oscillators \$11.85; condensers, resistors, panels, chassis, transformers, meter rectifiers, radio supplies of all sorts. Your inquiries and orders invited. Henry Radio Shop, Butler, Mo.

WANTED: Communication receiver, Sky Champion, Sky Buddy, or EC-1. State price and condition. Clarence Schulke, 201 East Fifth, Wewoka, Oklahoma.

WANTED: Good used portable mill with case. Cash. T/S Harold N. Christianson, 502 CA (AA) MOB. Hq. Btry, 1st Bn, Paterson, N. J.

ICONOSCOPES wanted—amateur or large size. Submit data proving good operating condition. W6XAO, 380 Mount Lee Drive, Hollywood, 28, California.

FOR SALE: Kaar type 10-A radiophone transmitter. Band-switching 160-10. HY-69 final, Class B modulation. Sell complete except crystals. All inquiries answered. W9YFB, J. Wendell Rasmus, Oakdale, Iowa.

WANTED: BCL receiver, GE Model F-80 or F-85, less cabinet. Bert Felsburg, W8VD, Frackville, Pa.

WANTED: JACKSON 637 tube checker, condenser tester, multimeter, test osc, tracer, signal gen., or what have you. Dean Morrison, 2801 Hiawatha, Kansas City, Kansas.

SELL: Commercially built National "600" phone and cw transmitter in Par-Metal "De Luxe" cabinet. NTE-B exciter and speech amplifier, 814 buffer, PP 100th's final. Modulator 810's Class B, 2000 and 1500 volt power supplies. 800 watts input conservative. Complete including Variac control, \$675.00. W3FLL, 1012 Wilde Avenue, Drexel Hill, Pa.

COMMUNICATION receiver wanted for broadcast and short wave in such models as National NC-100XA or Hammarlund HQ-120X or RME-99. Send offers to Office 358, Jefferson Physical Laboratory, Cambridge, Mass.

WANTED: *QST's*, 1916 issues. Wayland Groves, Hawkins, Texas.

WANTED: Small compact self-contained combination cw phone transmitter, 25 to 100 watts. Give full details, WIBB.

CASH for test instruments and meters of all kinds regardless of age. State condition and price. LeRoy Green, 402 North Gloster St., Tupelo, Mississippi.

CRYSTALS: prompt delivery on time-proven Eidson commercial crystal units in the 1600-10,000 kilocycle range. Dependable crystals with temperature coefficients to meet all requirements. Order from us, especially if it's rush. "Eidson's," Temple, Texas.

SELL Instructograph, practically new—Oscillator, key; or trade for auto radio. George Kishi, Box 7, Genoa, Texas.

WANTED: Communication receiver, give description, price. Gene Hitchon, VE3AJS, Belleville, Ontario.

RME 99 DE LUXE for sale, like new, with speaker, \$110.00. C.O.D. plus handling. E. Shafer, 2889 East 116th St., Cleveland, Ohio.

SELL or trade: Inter-communicator, 1 master, 1 sub. Will take up to 10 sub stations. Want SW receivers, test equipment, Riders Manuals. Fred E. Vaughn, Box 546, Eugene, Oregon.

SELL power supply 2000 volts 500 ma. transformers, Thordarson series 19, \$50.00. W9CHF.

WANTED: Echophone EC-1. State condition and price. Lt. James Richardson, Headquarters Ninth Bomb Group, Orlando, Florida.

SKY BUDDY receiver wanted. J. Ralph Strite, 31 North Grant, Waynesboro, Pa.

WANTED: Sky Champion, Sky Buddy, Howard 435-A, 436-A, 437-A, or EC-2. State condition, price. Ted Beauchamp, 1488 Prairie St., Galesburg, Ill.

RADIO TECHNOLOGY

 RCA Institute offers an intensive two-year course of high standard embracing all phases of Radio and Television. Practical training with modern equipment. Also shorter specialized courses in Commercial Radio Operating, Radio and Television Servicing, and Aviation Communications.

For Free Catalog write Dept. ST-43

RCA INSTITUTES, INC.

A Radio Corporation of America Service

75 Varick Street New York City

LEARN RADIO

Pre-Military training for beginners. Catalog on request. We teach all technical branches of radio.

MASS. RADIO SCHOOL

18 Boylston Street

Boston, Massachusetts

GOOD JOBS in RADIO for both men and women

Prepare now for jobs in Radio Engineering; Broadcasting; Marine Aviation, Police Radio; Servicing; Radio Manufacturing. Our stream-lined courses give excellent preparation for Army and Navy Service. Expenses low. Write for free catalog.

THE DODGE TELEGRAPH & RADIO INSTITUTE

408-1 Monroe St., Valparaiso, Indiana

PREPARE yourself now for a well paying radio position after the war. Obtain your FCC commercial radiotelephone and telegraph licenses through our home study courses, written for the man who has forgotten higher mathematics. An easily read, easily understood course. Moderate tuition fee.

Write for particulars

AMERICAN RADIO INSTITUTE 44 EAST 23rd ST.

Teaching Radio Since 1935

**-THAT'S HOGARTH,
HE'S DIGGING A FOX-HOLE ANNEX
FOR HIS ECHOPHONE EC-1!**



Echophone Model EC-1

(Illustrated) a compact communications receiver with every necessary feature for good reception. Covers from 550 kc. to 30 mc. on three bands. Electrical bandspread on all bands. Six tubes. Self-contained speaker. Operates on 115-125 volts AC or DC



ECHOPHONE RADIO CO., 201 EAST 26th ST., CHICAGO, ILLINOIS

Designed for

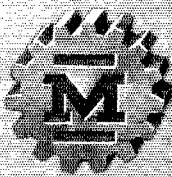

Application

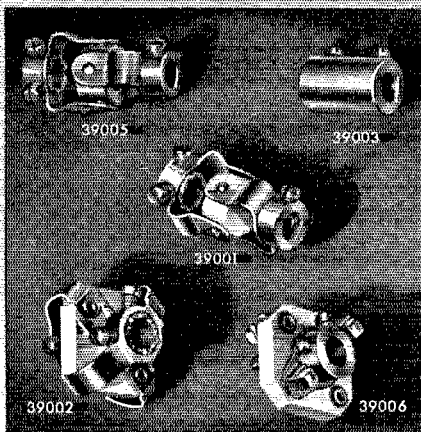

FLEXIBLE COUPLINGS

The No. 39000 series of Millen, "Designed for Application" flexible coupling units include, in addition to improved versions of the conventional types, also such exclusive original designs as the No. 39001 insulated universal joint and the No. 39006 "slide-action" coupling (in both seatite and bakelite insulation).

The No. 39006 "slide action" coupling permits longitudinal shaft motion, eccentric shaft motion and out-of-line operation, as well as angular drive without backlash.

The No. 39005 is similar to the No. 39001, but is not insulated and is designed for applications where relatively high torque is required. The seatite insulated No. 39001 has a special anti-backlash ball and socket grip feature, which, however, limits its serviceable operation to torques of six inch-pounds, or less. All of the above illustrated units are for 1/4" shaft and are standard production type units.

JAMES MILLEN MFG. CO., INC.

MAIN OFFICE AND FACTORY
MALDEN
MASSACHUSETTS



Index to Advertisers

	Page
Abbott Instrument, Inc.	90
Aerovox Corporation	4*
American Lava Corporation	87
American Radio Institute	108
Ampere Electronic Products, Inc.	**
Astatic Corporation, The	104
Ayers Automatic Code Machines	105
Barker & Williamson	103
Bliley Electric Company	82
Brach Manufacturing Corporation	107
Browning Laboratories, Inc.	101
Candler System Company	103
Capitol Radio Engineering Institute	84
Cardwell Manufacturing Corp., Allen D.	**
Centralab	89
Clarostat	**
Crystal Products Company	**
Dodge Telegraph & Radio Institute, The	108
Echophone Radio Company	109
Eitel-McCullough, Inc.	**
Electro-Voice Manufacturing Co.	91
Electronic Laboratories	**
Galvin Manufacturing Corp.	**
Hallcrafters Company, The	1, 2
Hammartund Manufacturing Co., The	83
Harrison Radio Corporation	107
Harvey Radio Company	92
Harvey Radio Laboratories, Inc.	107
Harvey-Wells Communications, Inc.	95
Heintz & Kaufman, Ltd.	**
Henry Radio Shop	**
Instructograph Company	107
International Resistance Company	100
Jensen Radio Manufacturing Company	**
Ken-Rad Tube & Lamp Corp.	93
Kenyon Transformer Co., Inc.	**
Knights, James, Co.	**
Maedel Publishing House	**
Mallory & Co., Inc., P. R.	80
Massachusetts Radio School	108
McElroy Manufacturing Corp.	5
McGraw-Hill Book Co., Inc.	96
Meck, John, Industries	**
Meissner Manufacturing Company	85
Melville Aeronautical Radio School, Inc.	102
Metropolitan Technical School	**
Millen Manufacturing Co., James	110
Miller, Wayne	105
National Company, Inc.	81, Cov. III
Newark Electric Company	105
Nilson Radio School	106
Ohmite Manufacturing Company	99
Onan Electric Plants	103
Oxford-Tartak Radio Corporation	**
Pioneer Gen-E-Motor Co.	105
Port Arthur College	102
RCA Institutes, Inc.	108
RCA Manufacturing Co., Inc.	Cov. IV
Radio Control Headquarters, Inc.	**
Radio Manufacturing Engineers	**
Radio Shack Corporation	88
Raytheon Manufacturing Company	**
Scientific Radio Products Co.	103
Shure Brothers	94
Sickles Co., F. W.	107
Standard Transformer Corporation	98
Sun Radio Company	**
Taylor Tubes, Inc.	**
Terminal Radio Corporation	104
Thordarson Electric Manufacturing Co.	**
Triplet Electrical Instrument Co., The	101
United Transformer Company	Cov. II
Universal Microphone Company	90
Vibroplex Company, Inc., The	83
Wallace, Don	**
Wholesale Radio Laboratories	**
Wilcox Electric Company	112
Vaxley (Mallory)	86

All of the above advertisers are cooperating with the A.R.R.L. to permit publication of an editorially adequate *QST* during this period of war-rationing of paper. Using less advertising space but at higher rates, they continue their customary support of *QST*. Some are using smaller space in each issue and some are using space only every second or third issue. Of the latter, those whose advertising does not appear in this particular issue are indicated by the ** above.

The Radio Amateur's Handbook

"THE ALL-PURPOSE VOLUME ON RADIO"

Text, data book, operating manual — it is all these and more. As a text it is probably more used in radio schools and colleges than any other single volume. As a practical constructional handbook, it stands in a class alone. As an operating manual, it provides information available from no comparable source.

Standard Edition

The latest Edition of THE RADIO AMATEUR'S HANDBOOK is the largest ever published. It includes a comprehensive chapter dealing with War Emergency Radio Service plus other new material—all added without sacrificing the essential information in previous editions which made the HANDBOOK the world's most valuable and widely-used radio book. The theory and design sections cover every subject encountered in practical radio communication, sectionalized by topics with abundant cross-referencing and fully indexed.

\$1.00 In Continental U. S. A.

\$1.50 Elsewhere

\$2.00 Buckram Edition

Special Defense Edition

This edition of the HANDBOOK is designed especially for use in radio training courses. It eliminates those portions of the regular edition which are not useful for instruction purposes and has added chapters on mathematics, measuring equipment and code instruction. The first chapter covers the elementary mathematics necessary for the solution of all formulas and interpretation of graphs appearing throughout the text. A four-place log table is included in the Appendix.

\$1.00 Postpaid Anywhere

A Course in Radio Fundamentals

By GEORGE GRAMMER

The objective in preparing this course was to accent those principles most frequently applied in actual radio communication. "A Course in Radio Fundamentals" is a study guide, examination book and laboratory manual. Its text is based on the "Radio Amateur's Handbook." Either the special edition for war training purposes or the Standard Edition may be used. References contained in the "Course" are identical in both editions. As a text, this book greatly smooths the way for the student of the technicalities of radio. It contains interesting study assignments, experiments and examination questions for either class or individual instruction. It describes in detail 40 experiments with simple apparatus giving a complete practical knowledge of radio theory and design.

Price **50c**

Learning the Radiotelegraph Code

By JOHN HUNTOON

This booklet is designed to train students to handle code skillfully and with precision. Employing a novel system of code-learning based on the accepted method of *sound* conception, it is particularly excellent for the student who does not have the continuous help of an experienced operator or access to a code machine. It is similarly helpful home-study material for members of code classes. Adequate practice material is included for classwork as well as for home-study. There are also helpful data on high-speed operation, typewriter copy, general operating information — and an entire chapter on tone sources for code practice, including the description of a complete code instruction table with practice oscillator.

Price **25c**

The A.R.R.L. Antenna Book

By GEORGE GRAMMER and BYRON GOODMAN

A comprehensive manual of antenna design and construction. Sixteen chapters, profusely illustrated. Both the theory and the practice of all types of antennas used by the amateur, from simple doublets to multi-element rotaries, including long wires, rhomboids, vees, phased systems, u.h.f. systems, etc. Feed systems and their adjustment. Construction of masts, lines and rotating mechanisms. The most comprehensive and reliable information ever published on the subject. Over 100 pages.

Price **50c**

AMERICAN RADIO RELAY LEAGUE, INC., West Hartford, Conn., U.S.A.

WILCOX EQUIPMENT

Proves Dependable for Eastern Air Lines

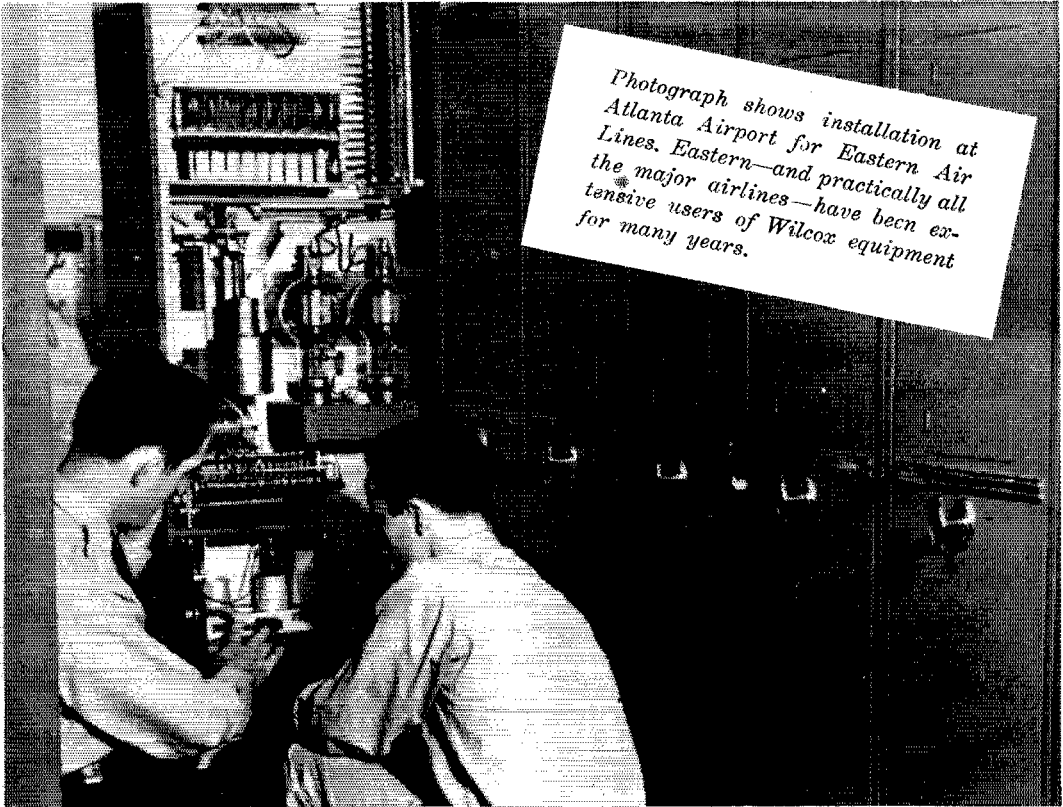

Photograph shows installation at Atlanta Airport for Eastern Air Lines. Eastern—and practically all the major airlines—have been extensive users of Wilcox equipment for many years.

Photo, Courtesy Eastern Air Lines

Communication Receivers
Aircraft Radio
Transmitting Equipment
Airline Radio Equipment

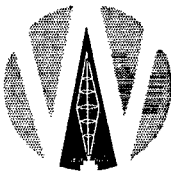

Today, the experience of years in manufacturing flight control radio equipment is turned to production for military needs. Tomorrow, this added experience with present developments will be reflected in greater radio advantages for a peacetime world.

WILCOX ELECTRIC COMPANY

Quality Manufacturing of Radio Equipment

14th & CHESTNUT

KANSAS CITY, MO.

THERE MUST BE DEPENDABLE COMMUNICATIONS

THIS picture might have been taken almost anywhere. All over the world small groups of soldiers are guarding our outposts against attack. Vigilant, lonely and unafraid, these men rely on their skill . . . and on radio. Radio for warnings. Radio for help when needed. Radio for coordination. Radio for entertainment. Radio for Victory.

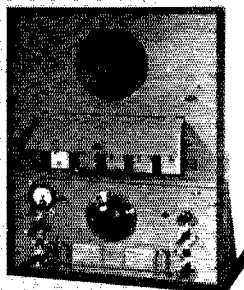
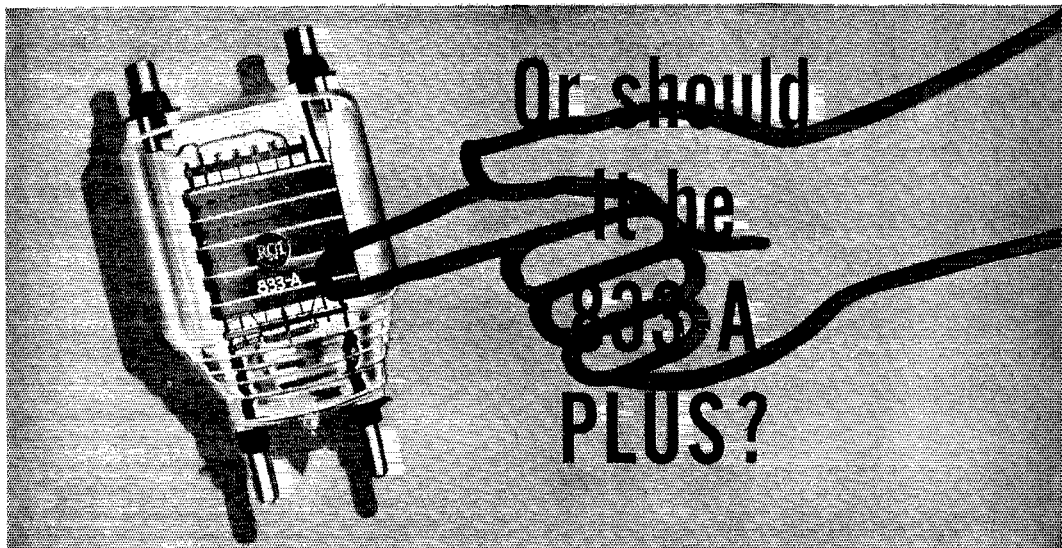

PHOTO BY
U. S. ARMY SIGNAL CORPS



NATIONAL COMPANY
MADE IN MASSA U.S.A.



THE RCA 833 became the RCA 833-A long before Pearl Harbor — when important design changes made improved ratings possible.

Now the price is 10% lower—\$76.50 instead of \$85.00 because fine performance has meant wide acceptance, resulting in production economy.

ZIRCONIUM-COATED ANODE: This famous RCA anode gives the 833-A a 44% higher input rating and 33% higher plate dissipation. To a designer, that means wider application possibilities; to a user, it means the 833-A will give longer life than the 833 it replaced.

EMISSION RESERVE: The 100-watt thoriated

tungsten filament of the 833-A has a tremendous reserve of emission. That means less chance of damage in case of unexpected overloads, plus longer filament life.

FILAMENT SHIELDING: The 833-A's plate is specially constructed to shield the filament, thus eliminating bulb bombardment by stray electrons.

FORCED AIR COOLING: Design refinements in the 833-A made it possible for RCA to announce increased ratings when forced-air cooling is used. That means you can increase power by the use of 833-A's instead of 833's—or, you can operate at the same power and run the 833-A's cooler.



Operation with Forced-Air Cooling	Class B A-F		Class C 'Phone		Class C T'graph	
	CCS*	ICAS†	CCS*	ICAS†	CCS*	ICAS†
Typical Operation						
Plate Volts	4000	4000	3000	4000	4000	4000
Power output, watts	2400	2700	1000	1500	1440	1600
Driving power, watts.....	29	38	37	42	26	35
Max. frequency, Mc:						
at Full input	—	—	20	20	20	20
at 65% input	—	—	75	75	75	75



*Continuous Commercial Service.
†Intermittent Commercial and Amateur Service.

RCA ELECTRON TUBES

RCA Victor Division • RADIO CORPORATION OF AMERICA • Camden, N. J.



SEND FOR THIS BOOK!

For a wealth of information on RCA Transmitting Tubes and how to use them, send 35¢ for the 72-page "RCA Guide for Transmitting Tubes." Write to RCA Commercial Eng. Section, Radio Corp. of America, 475 South Fifth St., Harrison, N. J.