

# QST

may, 1943  
25 cents  
35c in Canada

devoted entirely to

# amateur radio



***In This Issue:***

**The Electron Microscope**

**QST Returns to Gallups Island**

**Recording Telephone Conversations**

**An Economical Two-Tube F.M. Receiver**



## More tube hours are going into battle

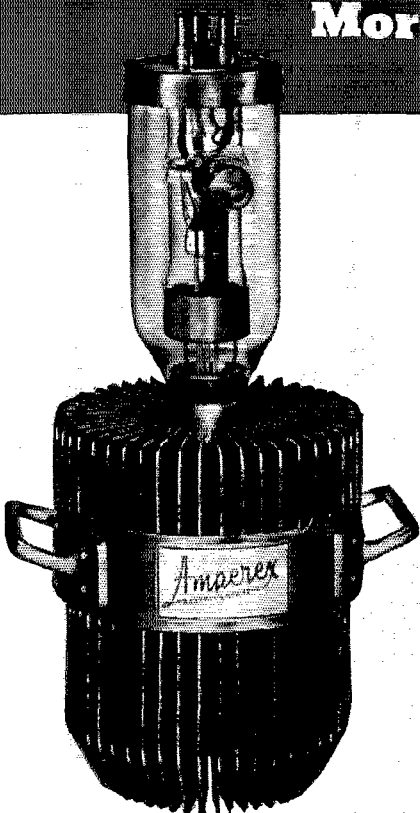

Through a series of design and construction developments tending to prolong normal operating life, we have increased the length of actual service that is being derived from each AMPEREX tube. Basically, our facilities are of laboratory type. And any measure of our war production, computed solely on the number of tubes manufactured, would not be a true indication of our total effort.

We, at AMPEREX, have kept pace with numerical production increases being registered throughout the nation. But we are infinitely more proud of our attainments in building longer life into our transmitting and rectifying tube designs. Each AMPEREX radio and military electronic tube is bringing extra hours of performance to equipment at the front.

**AMPEREX ELECTRONIC PRODUCTS**  
79 WASHINGTON STREET    BROOKLYN, NEW YORK

# THE MEN WHO LICKED THE JAPS IN NEW GUINEA!

... and they do an excellent job of it, too, against almost insurmountable obstacles. When there is a chance for a few moments off duty, a Hallicrafters short wave radio is the means of hearing voices from "back home" and a very welcome sound indeed. This is only one of the many wartime uses of Hallicrafters short wave radio communications equipment.

## hallicrafters

CHICAGO, U.S.A

Hallicrafters Model S-29 (illustrated). A completely self-contained portable short wave communications receiver.

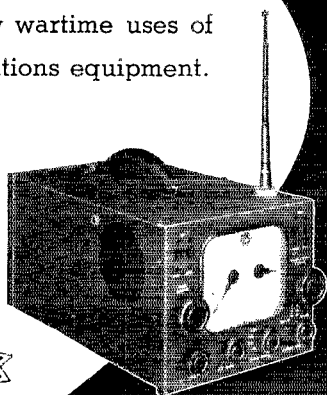



# A FIRST IN FM!

Hallicrafters are pioneers in FM! Producers of the first general coverage U.H.F. communications receiver to incorporate both FM and AM. Time and research have added much to the performance capabilities of Hallicrafters FM-AM communications receivers... wartime experience is adding invaluable engineering advantages... all of which will be available to you in your peacetime Hallicrafters communications receiver.

**hallicrafters**  
CHICAGO, U.S.A.



World's Largest Exclusive  
Manufacturer of Short Wave  
Radio Communications  
Equipment



MAY 1943

VOLUME XXVII

NUMBER 5



STAFF

Editorial

KENNETH B. WARNER, W1EH  
Editor and Business Manager

CLINTON B. DeSOTO, W1CBD  
Executive Editor

GEORGE GRAMMER, W1DF  
Technical Editor

DONALD H. MIX, W1TS  
BYRON GOODMAN, W1JPE\*  
Assistant Technical Editors

EDWARD P. TILTON, W1HDQ  
Contributing Editor, U.H.F.

WALTER E. BRADLEY, W1FWH  
VERNON CHAMBERS, W1JEQ\*  
Technical Information Service

LOUISA B. DRESSER  
Editorial Assistant

JAMES J. LAMB, W1AL\*  
Research Engineer, A.R.R.L.

Advertising

F. CHEVNEY BEEKLEY, W1GS  
Advertising Manager

Circulation

DAVID H. HOUGHTON  
Circulation Manager

RALPH T. BEAUDIN, W1BAW  
Asst. Circulation Manager

\*On leave of absence



OFFICES

33 La Salle Road  
West Hartford, Connecticut

Subscription rate in United States and Possessions, \$2.50 per year, postpaid; all other countries, \$3.00 per year, postpaid. Single copies, 25 cents. Foreign remittances should be by international postal or express money order or bank draft negotiable in the U. S. and for an equivalent amount in U. S. funds.

Entered as second-class matter May 29, 1919, at the post office at Hartford, Connecticut, under the Act of March 3, 1879. Acceptance for mailing at special rate of postage provided for in section 1103, Act of October 3, 1917, authorized September 9, 1922. Additional entry at Concord, N. H., authorized February 21, 1929, under the Act of February 28, 1925. Additional second-class entries to cover sectional editions authorized March 29, 1935.

Copyright 1943 by the American Radio Relay League, Inc. Title registered at United States Patent Office.

# QST

devoted entirely to

# AMATEUR RADIO

PUBLISHED, MONTHLY, AS ITS OFFICIAL ORGAN; BY THE AMERICAN RADIO RELAY LEAGUE, INC., AT WEST HARTFORD, CONN., U. S. A.:  
OFFICIAL ORGAN OF THE INTERNATIONAL AMATEUR RADIO UNION



## CONTENTS

It Seems to Us	7
Splatter	8
Radio and Vision	Robert B. Fischer, W9WJX 9
QST Returns to Gallups Island	Clinton B. DeSoto, W1CBD 14
Elementary A.C. Mathematics	George Grammer, W1DF 19
A Two-Tube T.R.F.-Regenerative F.M. Receiver	B. C. Barbee, W2MFX 24
Our Cover	26
U.S.A. Calling!	27
WERS in the New Haven Warning District	
Edmund R. Fraser, W1KQY, and Carol A. Keating, W9WFP	30
Experimenter's Section	32
Missing in Action	33
Recording Telephone Conversations	George Grammer, W1DF 34
On the Very Highs	E. P. Tilton, W1HDQ 37
Happenings of the Month	38
Book Reviews	
Principles of Radio — Mathematics, Its Magic and Mastery	
— What You Should Know About the Signal Corps — Pre-Service Course in Shop Practice	39
Beat Response	G. Edward Hamilton, W9GSS 40
Ho-Hum	41
In the Services	42
That's the Limit!	"Sourdough" 45
Who Killed the Signal?	Clinton B. DeSoto, W1CBD 46
Hints and Kinks	
A "Transformerless" Code-Practice Oscillator — Another Adaptation of the Receiver in Code Practice	49
Strays	50
"Victory" Parts List	51
Correspondence from Members	52
Operating News	54
Honor Roll	55
The Month in Canada	56
Amateur Activities	57
Silent Keys	64
Ham-Ads	92
QST's Index of Advertisers	94

## Section Communications Managers of the A.R.R.L. Communications Department

**Reports Invited.** All amateurs, especially League members, are invited to report communications activities, training plans, code classes, theory-discussion groups, civilian-defense building or planning each mid-month (16th of the month for the last 30 days) direct to the SCMI, the administrative official of ARRL elected by members in each Section whose address is given below. Radio Club reports and Emergency Coördinator reports representing community organized work and plans and progress are especially desired by SCMs for inclusion in QST. ARRL Field Organization appointments, with the exception of the Emergency Coördinator and Emergency Corps posts, are suspended for the present and no new appointments or cancellations, with the exception named, will be made. This is to permit full efforts of all in Emergency Corps plans.

ATLANTIC DIVISION				
Eastern Pennsylvania	W3BES	Jerry Mathis	6208 Master St. 9701 Monroe St. Silver Spring P. O. 623 E. Brown St. 136 Dorsey Rd. 703 Broadway	Philadelphia
Maryland-Delaware-District of Columbia	W3CIZ	Hermann E. Hobbs		Linden, Maryland
Southern New Jersey*	W3GCU	Ray Tomlinson		Trenton
Western New York	W3MCP	William Belter		Rochester
Western Pennsylvania	W8CKO	E. A. Krall		East McKeesport
CENTRAL DIVISION				
Illinois	W9ILH	Mrs. Carrie Jones	2407 Central Ave.	Alton
Indiana	W9VMV	LeRoy T. Waggoner	1721 Winton St.	Indianapolis
Kentucky	W9ARU	Darrell A. Downard	116 N. Longworth Ave.	Louisville
Michigan	W8DPE	Harold C. Bird	R.F.D. 2	Pontiac
Ohio	W8CBI	D. C. McCoy	Normandy Lane, R. R. 7	Dayton
Wisconsin	W9RH	Emil Felber, Jr.	1625 N. 18th St.	Milwaukee
DAKOTA DIVISION				
North Dakota	W9VVF	John W. McBride	420 West 14th St.	Sioux Falls, South Dakota
South Dakota	W9QVY	P. H. Schultz	118 N. Yankton Ave.	Pier
Northern Minnesota	W9FUZ	Armond D. Brattland	War Production Training School	Glenwood
Southern Minnesota	W9VYQ	Millard L. Bender	608 N. Huron Ave.	Soring Valley
DELTA DIVISION				
Arkansas	W5GED	Ed Beck	2503 Bishop St.	Little Rock
Louisiana	W5DWV	W. J. Wilkinson, Jr.	Room 313, Jefferson Hotel	Shreveport
Mississippi	W5EGE	S. Benton Cain	321 E. Monticello	Brookhaven
Tennessee	W5P	James E. Witt	R.F.D. 6, Shady Dell Trail	Knoxville
HUDSON DIVISION				
Eastern New York	W2LU	Robert E. Haight	356 West 34 St.	New York City
N. Y. C. & Long Island	W2AZV	E. L. Baunach	102 Central Ave.	Massapequa, L. I.
Northern New Jersey	W2LMN	Edward Gursky, Jr.	367 Van Winkle Ave.	Hawthorne
MIDWEST DIVISION				
Iowa	W9AED	Arthur E. Rydberg		Mitchellville
Kansas	W9AWP	A. B. Unruh	1617 S. Seneca St.	Wichita
Missouri*	W9OUD	Letha E. Allendorf	1015 West Third St.	Joplin
Nebraska	W9FOB	Roy E. Olmsted	Trimbale House	Milford
NEW ENGLAND DIVISION				
Connecticut	W1KQV	Edmund R. Fraser	48 Willow St.	West Haven
Maine	W1BAV	Ames R. Millett	37 Morning St.	Portland
Eastern Massachusetts	W1ALP	Frank L. Baker, Jr.	91 Atlantic St.	North Quincy
Western Massachusetts	W1JAH	William J. Barrett	239 Columbia St.	Adams
New Hampshire	W1FTJ	Mrs. Dorothy W. Evans	71 No. Adams St.	Manchester
Rhode Island	W1HRC	Clayton C. Gordon	70 Columbia Ave., Gaspee	Plateau, Warwick
Vermont	W1KJG	Clifton G. Parker	Box 537	Morrisville
NORTHWESTERN DIVISION				
Alaska	K7GNN	James C. Sherry		Homer
Idaho	W7AVP	Don D. Oberbillig	P. O. Box 486	Kenos
Montana	W7CPY	Rex Roberts	Box 1088	Glendive
Oregon	W7GNJ	Carl Austin	1137 Federal	Bend
Washington*	W7FWD	O. U. Tatro	513 N. Central	Olympia
PACIFIC DIVISION				
Hawaii	K6ETF	Francis T. Blatt	837 16th Ave.	Honolulu
Nevada	W6BIC	Edward W. Heim	509 Claremont St.	Reno
Santa Clara Valley	W6IUZ	Earl E. Sanderson	600 Acacia Ave.	San Bruno
East Bay	W6TI	Horace R. Greer	414 Fairmount Ave.	Oakland
San Francisco	W6CIS	Kenneth E. Hughes	590 45th Ave.	San Francisco
Sacramento Valley	W6MDI	Vincent N. Feldhausen	113 South Quincy St.	McCloud
Philippines	KA1GR	George L. Rickard	Box 849	Manila
San Joaquin Valley*	W6MIW	Ralph C. Lowry	315 Santa Barbara	Modesto
ROANOKE DIVISION				
North Carolina	W4CVB	W. J. Wortman	P. O. Box 566	Morganton
South Carolina	W4BOE/ANG	Ed Ferguson	1213 College St.	Columbia
Virginia	W3AKN	Walter G. Walker	217-51 St.	Newport News
West Virginia	W8JRL	Kenneth M. Zinn	P. O. Box 132	Clarksburg
ROCKY MOUNTAIN DIVISION				
Colorado	W9CNL	Stephen L. Fitzpatrick	P. O. Box 1101	Kiowa
Utah-Wyoming	W7CZG	Henry L. Schroeder	663 N. 10th St.	Laramie, Wyoming
SOUTHEASTERN DIVISION				
Alabama	W4GBV	Lawrence J. Smyth	808 Winona Ave.	Montgomery
Eastern Florida*	W4BYR	Frank C. Fasset	1712 Hills Ave.	Tampa
Western Florida	W4AXP	Oscar Cederstrom	115 No. Baylen St.	Pensacola
Georgia	W4FDJ	Ernest L. Morgan	R.F.D. 4	Lyon
West Indies (Cuba)	CM2OP	Mario de la Torre	Escobar 110 (Altos)	Habana, Cuba
(Puerto Rico-Virgin Islands)	K4KD	Everett Mayer	24 Lindberg St.	Santurce, P. R.
SOUTHWESTERN DIVISION				
Los Angeles	W6QVV	H. F. Wood	723 No. Las Palmas Ave.	Hollywood
Arizona	W6RWW	Douglas Aitken	341 S. Mt. Vernon Ave.	Prescott
San Diego	W6BZE	Richard Shanks	4033 S. Hempstead Circle	San Diego
WEST GULF DIVISION				
Northern Texas	W5IAU	N. R. Collins, Jr.	2230 W. Amherst	Dallas
Oklahoma	W5GFT	Russell W. Battern	Box 290	Enid
Southern Texas	W5MNV	Horace E. Bidy	1746 Schley Ave.	San Antonio
New Mexico	W5HJF	J. G. Hancock	110 S.E. Nevada St.	Portales
MARITIME DIVISION				
Maritime	VE1DQ	A. M. Crowell	69 Dublin St.	Halifax N. S.
ONTARIO DIVISION				
Ontario	VE3EF	Flying Officer Donald R. Gunn	c/o Canadian Bank of Commerce	New Toronto, Ont.
QUEBEC DIVISION				
Quebec	VE2CO	Sub-Lieutenant L. G. Morris	c/o Room 604, 1111 Beaver Hall Hill	Montreal, P. Q.
VANALTA DIVISION				
Alberta	VE4GE	C. S. Jamieson	581 W. Riverside Drive	Drumheller, Alta.
British Columbia	VE5DD	C. O. L. Sawyer	2634 West 31st Ave.	Vancouver
PRAIRIE DIVISION				
Manitoba	VE4AAW	A. W. Morley	82 Carlton St.	Winnipeg
Saskatchewan	VE4SV	Arthur Chesworth	1071 4th Ave., N.W.	Moose Jaw

\* Officials appointed to act until the membership of the Section choose permanent SCMs by nomination and election.



## Neither were planned for war

We're not raising new generations to die on battlefields; we're not designing implements for future wars. We Americans are a peace and freedom-loving lot, with an economy that is geared to the home . . . washing machines, automobiles, radio . . .

But we first must finish an unpleasant job of blasting the daylights out of those who deliberately attacked our way of life. For that purpose, we've given our men. And our men are getting the very best tools for that piece of grim business.

We thank heaven that change, progress and mass production are an integral part of a system that enabled us to redesign our products for military applications. True, our new designs were speeded by war necessity—but we like to think of these latest Electro-Voice microphones as no different from the others in our evolutionary scale.

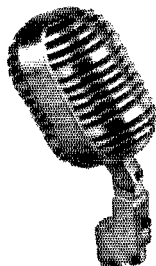

For, as eagerly as any soldier on a fighting front, we retain a vision of returning again to our natural mode of living. We plan to build better microphones for civilian communication . . . for music . . . for laughter . . .

# *Electro-Voice* MICROPHONES

ELECTRO-VOICE MANUFACTURING CO., INC.

1239 SOUTH BEND AVENUE, SOUTH BEND, INDIANA

# THE AMERICAN RADIO RELAY LEAGUE

## Directors

*President*  
GEORGE W. BAILEY.....W1KIH  
2101 Constitution Ave., N. W., Washington

*Vice-President*  
CHARLES E. BLALACK.....W6GG  
Box 108, Yuma, Ariz.

*Canadian General Manager*  
ALEX REID.....VE2BE  
240 Logan Ave., St. Lambert, P. Q.

*Atlantic Division*  
WALTER BRADLEY MARTIN.....W3QV  
*Address correspondence to the Acting Director:*  
HERBERT M. WALLEZE.....W8BQ  
42 No. Rockburn St., York, Pa.

*Central Division*  
GOODWIN L. DOSLAND.....W9T3N  
11831 Longwood Drive, Chicago

*Dakota Division*  
TOM E. DAVIS.....W9VVA  
915 W. Becker Ave., Willmar, Minn.

*Delta Division*  
E. RAY ARLEDGE.....W5SI  
340 N.E. 20th Terrace, Apt. 7, Miami, Fla.

*Hudson Division*  
ROBERT AKERIDGE KIRKMAN.....W2DSY  
250 Albert Place, Elberon, N. J.

*Midwest Division*  
FLOYD E. NORWINE, JR.....W9EFC  
7405 Hiawatha Ave., Richmond Heights, Mo.

*New England Division*  
PERCY C. NOBLE.....W1BVR  
37 Broad St., Westfield, Mass.

*Northwestern Division*  
KARL W. WEINGARTEN.....W7BG  
3219 N. 24th St., Tacoma, Wash.

*Pacific Division*  
J. L. McCARGAR.....W6EY  
66 Hamilton Pl., Oakland, Calif.

*Peanoke Division*  
H. L. CAVENESS.....W4DW  
2607 Vanderbilt Ave., Raleigh, N. C.

*Rocky Mountain Division*  
C. RAYMOND STELMAN.....W9CAA  
925 So. Gaylord St., Denver

*Southeastern Division*  
WILLIAM C. SHELTON.....W4ASR  
527 Revillo Blvd., Daytona Beach, Fla.

*Southwestern Division*  
JOHN E. BICHEL.....W6BKY  
1834 E. Whittier Blvd., Whittier, Calif.

*West Gulf Division*  
WAYLAND M. GROVES.....W5NW  
% Humble Pipe Line Co., Hawkins, Texas

THE AMERICAN RADIO RELAY LEAGUE, INC., is a non-commercial association of radio amateurs, bonded for the promotion of interest in amateur radio communication and experimentation, for the relaying of messages by radio, for the advancement of the radio art and of the public welfare, for the representation of the radio amateur in legislative matters, and for the maintenance of fraternalism and a high standard of conduct.

It is an incorporated association without capital stock, chartered under the laws of Connecticut. Its affairs are governed by a Board of Directors, elected every two years by the general membership. The officers are elected or appointed by the Directors. The League is non-commercial and no one commercially engaged in the manufacture, sale or rental of radio apparatus is eligible to membership on its board.

"Of, by and for the amateur," it numbers within its ranks practically every worth-while amateur in the nation and has a history of glorious achievement as the standard-bearer in amateur affairs.

Inquiries regarding membership are solicited. A bona fide interest in amateur radio is the only essential qualification; ownership of a transmitting station and knowledge of the code are not prerequisite.

All general correspondence should be addressed to the Secretary at the administrative headquarters at West Hartford, Connecticut.



## Past Presidents

HIRAM PERCY MAXIM, W1AW, 1914-1936  
EUGENE C. WOODRUFF, W8CMP, 1936-1940

## Officers

*President*.....GEORGE W. BAILEY, W1KIH  
Washington, D. C.

*Vice-President*.....CHARLES E. BLALACK, W6GG  
Yuma, Ariz.

*Secretary*.....KENNETH B. WARNER, W1EIH  
West Hartford, Connecticut

*Communications Manager*.....F. E. HANDY, W1BDI\*  
Washington, D. C.

*Treasurer*.....DAVID H. HOUGHTON  
West Hartford, Connecticut

*General Counsel*.....PAUL M. SECAL  
1026 Woodward Building, Washington, D. C.

\*On leave of absence. Address correspondence to the Acting Communications Manager, George Hart, West Hartford, Connecticut.



# "IT SEEMS TO US—"

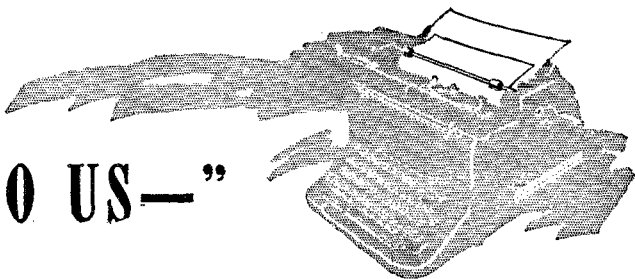

## WHAT YOU CAN DO

WE HAVE written several pieces for this page urging every individual amateur to do his part in the present total effort of the American people. We have received a number of letters from amateurs still on the home front asking us to enumerate specifically the things that a stay-at-home ham can do to help. Here is a check list of ARRL's current urgings and recommendations: -

Radio personnel is needed everywhere. The military needs and other government calls are listed each month in "U. S. A. Calling." Get in if you can. And if you can consider a change in your regular civilian employment, you are asked to register with the ARRL Personnel Bureau so that we may put you in touch with some of the needs.

If you can't consider a full-time change, see if you can't help as an instructor in some of the radio courses near you, either theory, code or mechanics. Probably there are evening classes where you could assist one or two evenings a week. Perhaps you could give it an occasional day or half-day. They need you.

There are insufficient amateurs and u.h.f. apparatus to man WERS adequately. The services and gear of every available amateur are needed. Offer yourself to the local ARRL Emergency Coördinator or to the local WERS radio aide. If you do not know them, write your SCM for guidance. His address is in the front pages of every *QST*.

Register your factory-built transmitters and receivers for sale through the ARRL Apparatus Bureau if you are not able to put them into the war effort through some local Signal Corps depot. Buy War Bonds with the proceeds, so that you'll have a stake for refitting after the war. Schools and colleges giving radio training courses are very short of oscilloscopes, testing equipments and some parts; make yours available to the local institutions on loan, rental or sale. Observe in *QST* the many appeals for power tubes and for meters, and see if you cannot send yours where they will do something useful. There will be much better new tubes after the war.

Turn in your nonferrous scrap, which is valuable even in small quantities. Copper is particularly needed. Your transmitting antenna is mostly a liability and a hazard these days. Take it down and send it to war.

Maintain your FCC licenses by filing renewal applications sixty days before expiration, or for modification whenever you change address. Apply on behalf of both operator and station license, returning your old license. FCC will renew only the operator portion, but the station portion remains on file for quick authorization after the war.

Assist other amateurs, and the relatives of absent amateurs, in making proper applications for FCC certificates of registration of transmitters, as required by FCC Orders 99 and 101.

Keep your local club going even if it can be only in a small way. Run a mimeograph bulletin of what the local gang is doing and send it to your members in the services. It will be vastly appreciated.

Help the compilation of the record of what the amateur is doing in the war by notifying Headquarters of the names and calls of your local amateurs in the war effort, whether in the armed forces or in Civil Service government radio work.

Seize this time to improve yourself. Study up on theory and math. Employ your new knowledge to plan that new rig for after the war. See what you can do about participating in some group of the Experimenter's Section in the development of alternative modes of communication, not only for fun but for its value in local civilian-defense communications.

Don't let your code speed slump. Instead, improve it. Do some listening-in. Learn to copy on the typewriter. Get an acquaintance with some of the foreign codes which use different alphabets. Run a buzzer line around your office, to help keep your hand in. Or a telegraph line to that ham down the block will give you the opportunity you've always wanted to learn American Morse.

Keep your eyes and ears open. You know radio. You may be approached by an enemy agent. If you are, keep him dangling and get in touch with F.B.I. If you hear improper signals on the air, tell the nearest FCC office about it.

Give your best to everything you do. Be both a good citizen and a good amateur.

... -

In many of the magazines of America you will see this month an illustration of a wounded soldier and a man who might be you. The page carries this wording:



## Would you turn your back on a wounded Soldier ?

*Would you turn your back on a wounded soldier?  
 You think you wouldn't . . . you don't mean to . . .  
 But unless you are giving every precious minute of your time . . . every ounce of strength that you  
 can spare . . . towards helping win this war as a civilian, you are letting down those soldiers who  
 are sacrificing their lives to win it for you.  
 What you are asked to give up isn't much compared with what they're giving up. The extra work you  
 undertake is small compared with the gigantic effort they are making. But to a wounded soldier, what  
 you do can mean the difference between life and death.  
 You make the choice.*

K. B. W.

---

# ★ SPLATTER ★

---

### FREQUENCIES

**BEGINNING** with this issue of *QST*, you will see in use a new system of frequency-classification designations and abbreviations in accordance with the standard classification table recently adopted by FCC. In this table the entire "useful radio spectrum" — i.e., the "total number of frequencies or wavelengths which may be

used for the transmission of energy, communications or signals by radio" — from 10 kc. to 30,000 Mc. is divided into seven major bands. These bands are as follows (with their designations and *QST* abbreviations):

	Frequency in kilocycles	Designations	Abbreviations
	10 to 30 inc.	Very-low	v.l.f.
Above	30 to 300	" Low	l.f.
"	300 to 3,000	" Medium	m.f.
"	3,000 to 30,000	" High	h.f.
"	30,000 to 300,000	" Very-high	v.h.f. —
"	300,000 to 3,000,000	" Ultrahigh	u.h.f.
"	3,000,000 to 30,000,000	" Superhigh	s.h.f.

*(Continued on page 64)*

# Radio and Vision

## A Glimpse At the Electron Microscope

BY ROBERT B. FISCHER,\* W9WJX

The electron microscope, while not radio in the usual sense of the word, is built upon principles and with the aid of circuits which do find wide application in radio communication. This article describes some of the features of the microscope likely to be of particular interest to the amateur. Like the cyclotron described in *QST* a few months ago, the electron microscope represents a development in an allied art about which every amateur should have at least general knowledge.

WITH the construction of a practical electron microscope, the science of optics has become one of the many fields of scientific endeavor which has successfully turned to electronics and radio research for a solution to some of its problems. As light microscopes were improved and as the knowledge of optics increased, it became evident that the wavelength of light was the limiting factor in man's attempt to see smaller and smaller things.

Therefore, the field of microscopy turned toward radio research soon after the demonstration that a beam of electrons possessed wave characteristics similar to those of a beam of light, yet with a wavelength many times shorter. Previously it had been discovered that X-rays travel with a wave motion, but it was found to be impossible to construct an "X-ray microscope" because there is no known method of focusing an X-ray beam. The actual wavelength of a stream of electrons with a push of fifty thousand volts behind it is about a five-billionth of an inch, as compared to a wavelength of about a fifty-thousandth of an inch for visible light (try putting up a half-wave antenna for that!).

The first real attempts at the construction of an electron microscope were made in Europe in 1931, in 1934 and in 1937, and in the United States in 1934. In 1939 the construction of a microscope very similar to the present RCA instrument was announced in Canada.<sup>1</sup> The RCA Type B instrument is the first practical laboratory electron microscope. The instrument now in constant use in the laboratories of the University of Illinois, under the direction of Prof. George L.

\* 314B Noyes Chemistry Laboratory, University of Illinois, Urbana, Illinois.

<sup>1</sup> A. Prebus and J. Hillier, "Construction of a Magnetic Electron Microscope of High Resolving Power," *Canadian Journal of Research*, April, 1939.

Clark, is one of the first few constructed by RCA. There are now about fifty of these microscopes in operation in university and industrial research laboratories in the United States. The specifications given in this article refer to the type of instrument in use at the University of Illinois; however, the general principles of operation and construction apply to any electron microscope.

With the exception of two vacuum pumps which keep the microscope proper at a high vacuum during operation, the present instrument is contained within a cabinet seven feet high, twenty-one inches wide and thirty-seven inches deep. Present-day electron microscopes are able to separate two points a ten-millionth of an inch apart. In other words, an electron microscope reveals detail as sharply at a magnification of 100,000 times as does an optical microscope at 1000 times magnification.

The general principles of electron microscope operation are very similar to those of a light microscope. In place of the usual light beam, a stream of electrons is used, and in place of the

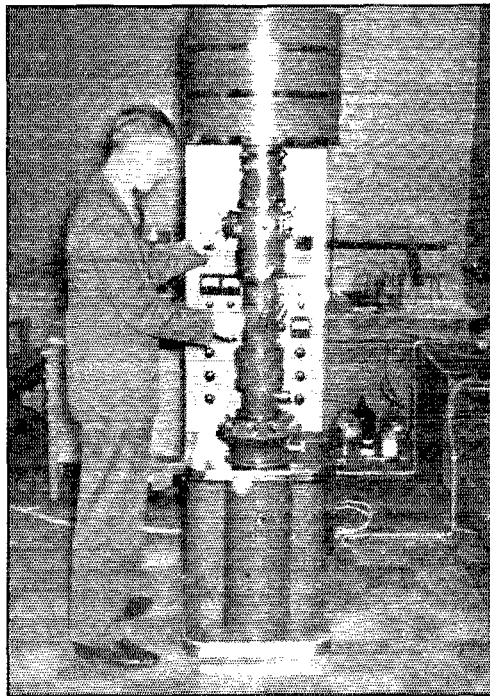

The author at the controls of the electron microscope installed in the laboratory of the University of Illinois.

usual glass lenses, electrostatic or electromagnetic fields are used. While the focusing of a light microscope is done by moving the lenses, an electron microscope is brought into focus by varying the strength of the fields which comprise the

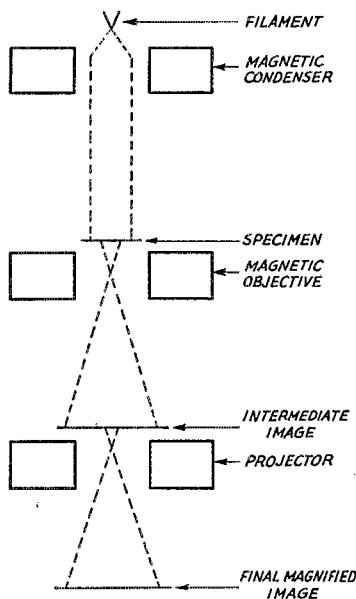

Fig. 1 — Column of the electron microscope. This shows the basic optical arrangement.

“lenses.” The final image is viewed upon a fluorescent screen placed in the path of the electron beam. (No, electrons are not green; that is just the color of fluorescence of the screen material!)

Since electrons are absorbed and scattered by any matter, even air, the instrument must be operated at a fairly high vacuum. Thus, the entire instrument may be considered as a huge vacuum tube with associated power supplies. The microscope column is diagramed in Fig. 1. The electron stream is emitted from the tungsten filament at the top of the instrument, “pushed” by a voltage adjustable in steps from 30,000 to 60,000. The beam passes through the condenser “lens” to the specimen. Absorption and scattering of electrons there occur in accordance with the density and the thickness of the specimen; the modified beam then passes through the magnetic objective to an intermediate image screen, where the image may be observed at low magnification through “port-holes.” A selected portion of the beam is directed through a small hole in the center of the intermediate screen, after which it is magnified greatly by the projector “lens” and allowed to fall upon the fluorescent screen for viewing. A photographic film placed immediately below the screen allows pictures to be taken of the image, the screen itself moving back to serve as the shutter.

The specimen may be moved about from outside the instrument by means of a special bellows

arrangement. Both the specimen section and the camera section may be shut off from the rest of the instrument to allow changing specimens or film without losing the vacuum in the entire system.

Probably the things concerning the electron microscope of most interest to the present reader are the power supplies and the voltage control circuits. A constant power must be supplied to the electron gun and to the windings of the three magnetic coils, since the “focal lengths” of the apparatus are dependent upon the power characteristics. In the present instrument, stabilities must be within the following tolerances:<sup>2</sup>

- Overall voltage — 0.015 per cent
- Projector lens current — 0.068 per cent
- Objective current — 0.0075 per cent
- Condenser lens current — 0.1 per cent

To produce and to control the necessary voltages, fifty-three vacuum tubes are used. Of these tubes, all but two are standard types frequently encountered in radio work, while the other two are special rectifiers for the high electron-gun voltage. With the exception of the tubes in the vacuum indicator circuits, all of the tubes, along with their associated components, are used to produce, from the 115-volt a.c. lines, and to regulate the power for the three lenses and for the electron gun.

The entire power system is enclosed to the rear of the microscope column. Much compactness is made possible by the use of radio frequencies to generate the high voltage. Advantages of the r.f. arrangement are the decrease in size of the transformer and filter components which would otherwise be required and mechanical stability, without which the power supply could not be placed in such close proximity to the microscope column.

The currents for the three lens coils are controlled by very sensitive regulators which make use of the usual types of circuits. However, the high-voltage arrangement is of special interest. Fig. 2 shows a block diagram of the entire high-

<sup>2</sup> V. K. Zworykin, J. Hillier and A. Vance, “An Electron Microscope for Practical Laboratory Service,” *Electrical Engineering*, April, 1941.

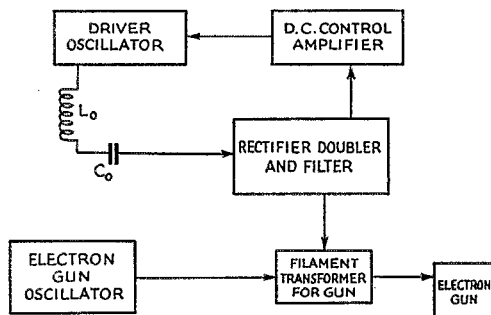

Fig. 2 — Block diagram of the high-voltage system. Voltage for the electron gun is obtained by first generating a radio frequency, building it up by a resonant circuit, and then rectifying it.

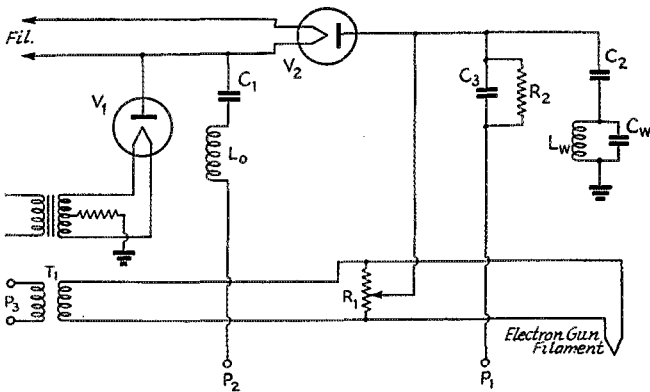

Fig. 3 — Simplified schematic of the rectifier-doubler and filter. Terminal  $P_1$  connects to the d.c. control amplifier ( $P_1$  in Fig. 4);  $P_2$  is the lead from the driver oscillator;  $P_3$  connects to the source of r.f. power which heats the electron-gun filament.  $V_1$  and  $V_2$  are special rectifier tubes (RCA-6132).

voltage system, while Fig. 3 shows a somewhat simplified circuit diagram for the actual microscope rectifier unit (the "rectifier-doubler" of Fig. 2). As shown in Fig. 2, the basic principle of the system is a high- $Q$  net series-resonant to the driving oscillator and parallel-resonant to the high-voltage output rectifiers. The resonant circuit is composed of coil  $L_0$  and capacitance  $C_0$  (a lumped capacitance including  $C_1$  of Fig. 3 and the stray and distributed capacitances of the circuit). To obtain best operating characteristics, 32 kc. has been selected as the frequency for the driver oscillator, and the resulting  $Q$  is about 200.

The entire rectifier-doubler unit (Fig. 3), including rectifiers, inductances, transformer  $T_1$  and other components, is kept immersed in an oil tank which comprises the upper portion of the power rack. It is interesting to trace out the action within this unit as it receives the 32,000-cycle signal from the driver oscillator and delivers 60,000 volts d.c. across the microscope anode and cathode, which comprise the load circuit. Upon a positive increase in input voltage (assuming zero to start),  $V_1$  conducts and  $V_2$  opens, allowing the entire input voltage to appear across  $C_1$ . A negative increase of the input voltage causes  $V_1$  to open and  $V_2$  to conduct, so that the charge divides between  $C_1$  and  $C_2$  (inversely proportional to their capacities). The next positive half-cycle recharges  $C_1$  to full value; the next negative half-cycle adds another bit to the charge of  $C_2$ . This continues until  $C_2$  is fully charged (it reaches its full value of 90 per cent of the peak-to-peak input voltage in 0.003 seconds!). This unit is, then, a rectifier and a voltage doubler.

The negative side of the 60-kilovolt d.c. potential at the anode of  $V_2$  is then applied to the microscope cathode through the divider resistor,  $R_1$ .  $L_w$  and  $C_w$  form a wave trap for any 32-kilocycle ripple which may be present.  $C_3$  and  $R_2$  are a part of the control circuit, but are situated within this unit. The final output of  $T_1$ , the primary of which is fed by a conventional Hartley type oscillator, is the power for the electron-gun filament.

A simplified schematic circuit diagram for the d.c. control amplifier unit is given in Fig. 4. This circuit functions to keep constant the 60-kv. accelerating voltage for the electron gun. In brief, a comparison of the high voltage with a standard 550-volt bank of standard dry "B" batteries controls the screen grids of the driver oscillators. This regulates the amplitude of the 32,000-cycle radio-frequency signal which, in turn, regulates the sixty-thousand-volt accelerating potential.

A regulated 400 volts is supplied to the anode of  $V_1$  (Fig. 4), the bias for which is obtained from a "voltage divider," consisting of  $R_2$  in Fig. 3,  $R_1$  in Fig. 4 and battery  $B_1$ . The grid of  $V_1$  is connected between the two resistances, so, were it not for  $B_1$ , would be negative by about 555 volts, as governed by the ratio of the two resistances (1000 megohms to 10 megohms). However,  $B_1$  provides a bucking voltage of 550, so the bias is set at a variable value within good operating range.

In tracing out the regulating action, it is evident from the diagrams that a drop in potential of the 60-kv. source causes the grid of  $V_1$  (Fig. 4)

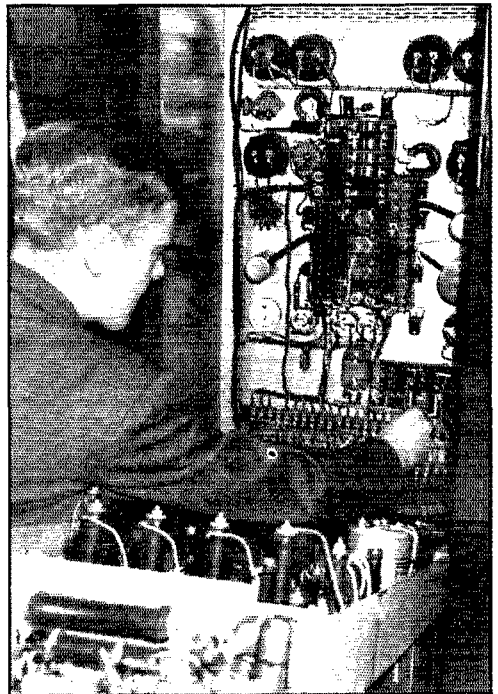

A glimpse at some of the power-supply circuits. The wiring appears a bit complicated, as might be expected of a circuit which uses 53 tubes!

to become more positive. The plate of  $V_1$  then becomes less positive, so the grids of  $V_2$  and  $V_3$  (all in Fig. 4) become less positive and their anodes more positive. Thus the screens of the driving oscillators ( $P_2$  of Fig. 4) become more positive, so that the amplitude of the r.f. signal is increased and the 60-kv. source brought back to the proper value. A rise in potential of the high voltage, conversely, causes the opposite effects throughout the same feed-back circuit. In this manner the high voltage is kept constant. Lower potentials of the "B"-battery bank cause the maintenance of the electron gun accelerating voltage at lower, yet constant, values. The selector switch shown provides the choice of battery voltages ranging from 275 to 550, which correspond to high voltages of 30 kv. to 60 kv. in steps of 5 kv. each.

It might be expected that an instrument as new as is the electron microscope would be chiefly in the development stage, yet the electron microscope has already found wide application and usefulness in many fields of science, including biology, bacteriology, medicine, chemistry and ceramics. Contrary to the opinion held by many of the uninformed, the electron microscope is not for the purpose of seeing electrons! (The author's usual reply to the uninitiate who asks what an electron looks like is that electrons have never been seen, yet that they probably have red hair because they are so easily excited.)

The fact is that many things hitherto invisible have been seen and studied by means of the electron microscope. As mentioned before, the electron microscope permits the viewing of particles many times smaller than does a light microscope of maximum theoretical capabilities. The commercial value of the achievements of the electron microscope are demonstrated by the fact that about half of the instruments now in use in this country are in industrial laboratories, while the other half are in university laboratories.

Many of the applications to which electron microscopes have been subjected are of direct war importance and so cannot be discussed at the pres-

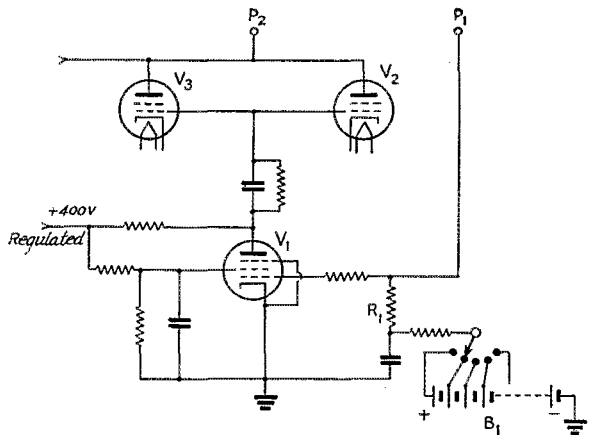

Fig. 4—Simplified schematic circuit diagram of the d.c. control amplifier. Terminal  $P_1$  connects to  $P_1$  in Fig. 3;  $P_2$  to the screen grids of the driver oscillator tubes.  $V_1$  is a 12SJ7,  $V_2$  and  $V_3$  are 6Y6Gs.

ent time; however, a few typical examples may be mentioned. Smokes and dusts have been studied as preservatives and as pigments, as well as concerning health hazards involved. Carbon black, a rubber reënforcing agent dependent upon its fineness of division, has been studied by the electron microscope in conjunction with X-ray studies. A typical application to ceramics has been the dehydration study of various materials. Electron microscope pictures have revealed useful secrets of large organic polymer and plastic molecules.

Biological and medicinal specimens, because of their low density, are peculiarly well adapted to electron microscope work. Much has been learned concerning the various types of bacilli and viri. Because the influenza virus has actually been seen, it has been possible to isolate the virus and to open up the way for the making of a vaccine for influenza. These few examples of electron microscope application serve merely to show the wide range of applied usefulness of the instrument.

The question is frequently asked as to just what effect, if any, the electron beam has upon the specimen being observed. By comparing pictures taken with optical microscopes and with



These two photographs are of sub-microscopic particles of magnesium smoke such as is formed in the combustion of an incendiary bomb. In the original of the picture at the left the magnification is 5000 times; in the one at the right, 20,000 times.

◆

Left: Electron micrograph of a diatom, the skeleton of a unicellular animal of sub-microscopic dimensions. Right: This piece of lime, photographed in the electron microscope, appears as a single solid particle in the ordinary light microscope.

◆

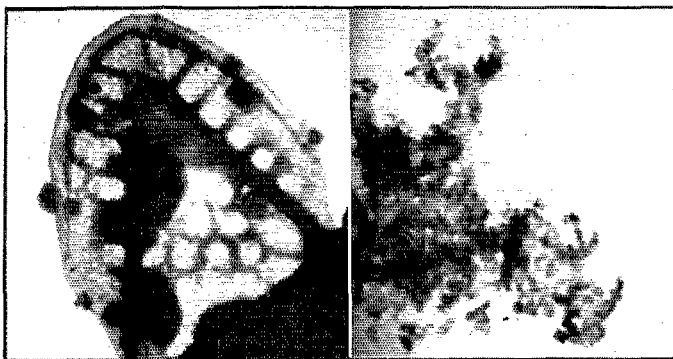

the electron microscope at corresponding low magnifications, it has been shown in many instances that the final image seen in the electron microscope is a true representation of the specimen.

The type of electron microscope now in general use may be converted into an electron diffraction unit by replacing the entire projection lens with a special adapter, which includes a specimen holder and a special focusing lens. The unit is then so arranged that a point source of electrons hits the object, from which reflection or diffraction takes place. Many types of analyses and crystal structure determinations may be made by observing the characteristic reflection or diffraction effects which occur in the electron diffraction instrument.

The voltage accelerating the electron beam determines to a large extent the penetrating ability of the beam. For extremely thin specimens of a material with very low density, a voltage lower than 60,000 is sufficient. Because the entire specimen becomes transparent to the beam at sufficiently high voltages, it is desirable to use a voltage only as high as is needed for proper "contrast" in the final image. For this reason a variable voltage is distinctly advantageous. A maximum of 60,000 volts has been found sufficient for the proper penetration of most materials, but for more opaque objects higher voltages have been used. Thus far, instruments operating at voltages higher than 60,000 are in the experimental stage. However, the present instrument will continue to be satisfactory for most applications.

For the study of metals, which are considerably too opaque for electron microscope work in the usual manner, a "replica" technique has been developed. A plastic replica of the metal surface is made and viewed under the microscope. In this manner, surface studies of the metal are possible. It might be noted that a method, perhaps the best method, of calibrating the magnification of the electron microscope is by use of a plastic replica of a ruled grating.<sup>3</sup>

A different, yet closely allied, method for the study of metals is by use of a separate instrument called the "Electron Scanning Microscope."<sup>4</sup> The principles of this instrument are much the same as in television and in picture transmission.

Recently two new smaller models of the elec-

tron microscope have been announced. They are expected to find wide application because, in spite of their compactness, they possess the high resolving power of the larger instrument. One of these new instruments<sup>4</sup> is only sixteen inches long and operates at a constant potential — about 30,000 volts. These new models will undoubtedly be of much value in both testing and in research, but will not detract in the least from the value and importance of the larger instrument, with its versatility and resultant wide range of application.

The electron microscope is one of the newest applications of electronics and radio research, yet has already proved to be one of the most remarkable and useful.

<sup>3</sup> C. Burton, R. Barnes and T. Rochow, "The Electron Microscope," *Industrial and Engineering Chemistry* (Industrial Edition), Dec., 1942.

<sup>4</sup> V. K. Zworykin, "Electron Microscope in Chemistry," *Electronics*, Jan., 1943.

## ⚡ Strays ⚡

In a paper delivered recently before a joint meeting of IRE and AIEE, Dr. George G. Southworth looked forward to the day now clearly discerned when, for certain communication and signaling purposes, electricity will flow inside pipes rather than in wires or through the air. Energy may now be so transmitted through tubes, called *wave guides*, and if the tube is filled with insulating materials even the metallic outer covering may be removed, the energy flowing through the insulation. Such a wave guide requires no return path through the earth or a second wire to complete the circuit. If desired, the tube may be terminated in a flare and the energy radiated much as sound waves are emitted from a horn. The length of waves so transmitted is of the order of one-half inch.

— — — — —

Phototubes are now used in some large power stations to control the combustion of fuel automatically by the smoke and gas density in the stack. — WINDL.

# QST Returns to Gallups Island

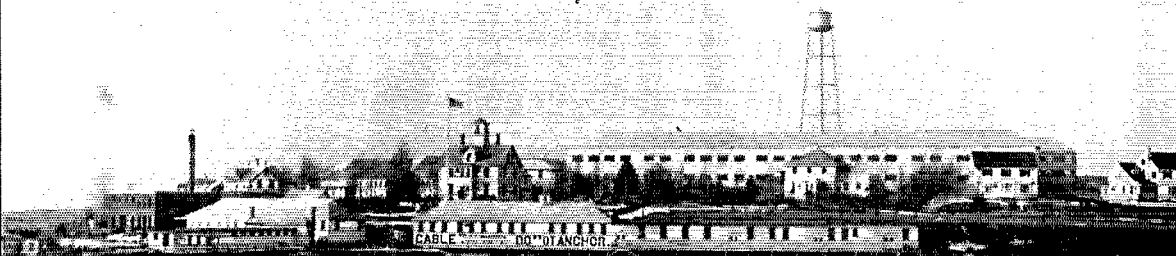

## How Marine Radio Operators Are Trained Under the U. S. Maritime Service

BY CLINTON B. DESOTO,\* WICBD

IT WAS nearly two years ago that *QST*, in the persons of Clark Rodimon, then managing editor, and Frank Beaudin, our staff photographer, first visited the Gallups Island Radio School in Boston Harbor and brought back the story appearing in the June, 1941, issue. Widely reprinted and distributed by the U. S. Maritime Service, that *QST* story became official recruiting literature for the merchant marine training program. In fact, so successful was it that, early this year, the War Shipping Administration's director of training suggested a return visit.

In the intervening two years a number of changes occasioned by the developing urgency of war needs had taken place, and it was felt that the 1941 story no longer revealed an accurate picture of the school. Last September, for example, the entire administration of the school changed hands when the Maritime Service was transferred from the Coast Guard to the War Shipping Administration. Enrollment is now more than double the original figure, and new buildings have been constructed to provide additional capacity for the increased numbers. Entrance qualifications were revised to cope with the competitive manpower situation, and the length of the course has been progressively reduced. There have been other changes, too.

Even the character of the students and the nature of the job they are training for has changed. Two years ago the United States was still looking inward, clinging doggedly to its isolation in a world at war. There was a shortage of maritime radio operators for the rapidly-growing merchant fleet, but the job itself was scarcely more than the humdrum equivalent of peacetime voyages.

Nevertheless, some members of that first 40-week class at Gallups Island had yet to step aboard their own decks when dawn broke with the ruddy glow of Hell-fire over Pearl Harbor on December 7th and the U. S. awoke from its Sunday-afternoon nap to find itself at war. For

the men of the merchant marine the declaration of war meant that hardship and death had become their constant companions. Many a Sparks in his lonely radio room had scarcely finished copying the electrifying words "Pearl Harbor attacked!" when he felt the deck shiver beneath his feet, vibrating until the dull "boom" caught up with the explosion, and he turned his attention to rapping out a despairing SOS while a dying freighter or tanker sank wearily into the sea. Some, even, heard the hiss of enemy-launched torpedoes before ever they heard the news that their country was at war.

Yes, the job changed then. It became a grim and reckless one, a death-defying calling whose followers literally thumbed their noses at the enemy. We've reported the experiences of one or two of these men in *QST* — the few about which details could be released. But for the most part they are unsung heroes — hard, jesting, self-reliant men of the sea, with the kind of guts it takes to face death not once but many times out there in the lonely wastes of the North Atlantic or the deceptive sultry blue of the Caribbean or the rolling vastness of the South Pacific. Men with the kind of courage it takes for survivors of soul-searing voyages on lifeboat or raft to come ashore grinning, anxious for another crack at Jerry or the Jap.

That's the kind of men they're training at Gallups Island — men who are resolved, despite what may lie ahead, to do their part in maintaining the lifeline of supplies to our fighting forces.

### By Cutter to Gallups Island

It was to see these men and the training they receive that we went to No. 22 India Wharf on Boston Harbor's motley waterfront one morning not long ago. There, in company with Ensign Ralph J. Meyers, USMS, of the local Maritime Service training procurement office, we boarded the cutter *Roderick* on the outgoing leg of its daily round-trip voyage to the Island.

\* Executive Editor, *QST*.



Signal flags flying in conformity with strict war-time harbor regulations, the sturdy old cutter, aged but still salty, pushed through the restless water while all around the big harbor strained at its work. Vigilant Coast Guard patrol boats scurried by; overhead, planes circled and roared.

Some forty minutes later we approached Gallups Island. As the cutter swung around and approached from seaward, the island resembled a seaside colony of comfortable white-painted homes rising tier on tier from the water's edge to the summit of an elongated hill. Then, as the soft thrum of the Diesels brought us nearer, the seashore-resort mirage metamorphosed into rows of long frame barracks and school halls.

As the *Roderick* slipped smoothly into its mooring, its passengers disembarked onto the husky new dock, recently completed as part of the school's expansion program. There were the usual formalities — the Maritime Service is as vigilant as any military post, and for the same reasons. Finally, after being duly checked and logged aboard by the officer of the day, the executive officer, Lt. Comdr. Richard J. Casilli, USNR, informed us that the superintendent, Commander Sherman W. Reed, USMS, was waiting to give us our official welcome aboard the station.

Comdr. Reed proved to be an old sea-faring man with a record of 25 years at sea, an able executive whose affability and suavity failed to conceal the alert intelligence that makes his administration of the Gallups Island establishment so successful. From him we gained a general picture of the Island's war-time development.

#### *Expansion for War Needs*

The basic story of the Island's conversion from a U. S. Public Health Service quarantine station was told in the June, 1941, *QST* story. The original school was designed to be the best-equipped and most efficient radio school ever established — and the result was just about that. The superior quality of Gallups Island alumni became famed from coast to coast, and the successful training methods developed there were adopted in military-training schools subsequently established.

But within a few months after its completion the original school, built to accommodate 400 students, bulged at the seams. Additional buildings and facilities were constructed — in itself a major feat, since every item of material down to the last nail had to be transferred to the Island by boat — until the capacity was increased to handle a full quota of 1040 men, in addition to some 280 men in the permanent company including 34 instructors.

As the school expanded to keep pace with the mushrooming merchant marine, the course of study was reduced in length from 40 to 29 weeks and the entrance requirements were lowered to

The men in charge of Gallups Island training. *L. to r.* — Lt. Comdr. John A. Clark, USMS, officer in charge of training, Comdr. Sherman W. Reed, USMS, superintendent of the station, and Lt. Comdr. Richard J. Casilli, USNR, executive officer.

ensure the needed constant flow of trainees. At the outset a candidate for Gallups Island training was required to have two years of high school math and one year of physics. He must also have passed an elementary examination in radio and be able to take code at a speed of 13 w.p.m. — in other words, the equivalent of a newly-licensed Class B amateur. Now only the first requirement — two years of high school math, including algebra — remains; no prior radio training is required.

Yet the surprising fact is that, despite the changed preliminary requirements and the condensed course, graduates of Gallups Island rate as high or higher than the product of any comparable school. They matriculate equipped to pass the FCC exam for second-class radiotelegraph license by a comfortable margin. They come off the Island ready to step on deck and take over a watch on any ship in Uncle Sam's merchant fleet.

Following the interview with Comdr. Reed, Lt. Comdr. John A. Clark, USMS, the training officer in charge of the radio school, took us in tow. A tall, laconic veteran of the Maritime Service with a reassuring proclivity for understatement, Lt. Comdr. Clark outlined the course of instruction.

The actual training period is concentrated into 28 weeks, the final week being reserved for review and final examinations — including the culminating FCC examination at the Boston inspection office. The course is organized under five basic headings — code, procedure, theory, lab and seamanship training. Code training is carried on throughout the 28 weeks, with seamanship training terminating in the 26th week. Theory classes are held for the first 21 weeks, overlapping the laboratory work, which begins with the 16th week. Lab continues until the final week of the course, as does the procedure class which begins with the 18th week.

#### *Code and Procedure*

Code training is by the original "GI" system — with modifications. In the first week the entire alphabet and all numerals are memorized in the basic EISH5, TMOJØ, etc., combinations. By the end of the second week the student is able to copy plain language at 4 w.p.m. Thereafter, if he keeps up to schedule, his speed advances at the rate of about 1 word per week until at the end of 25 weeks he must take a minimum of 23 w.p.m. plain

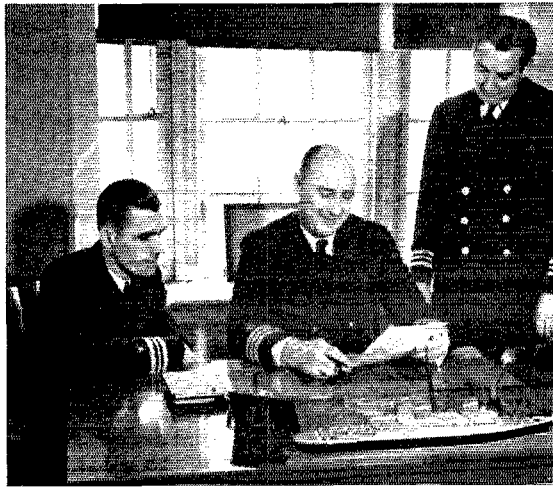

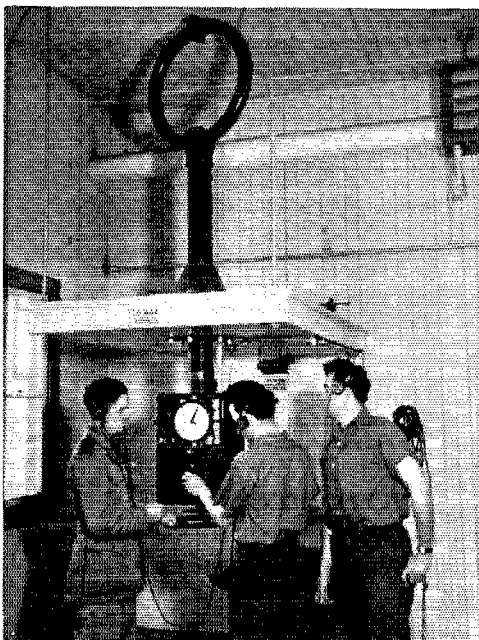
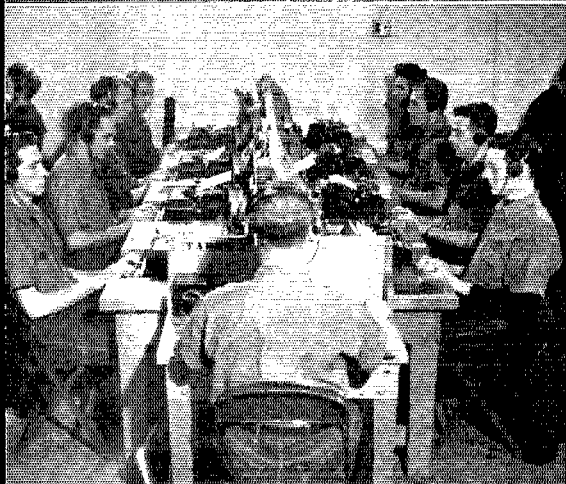
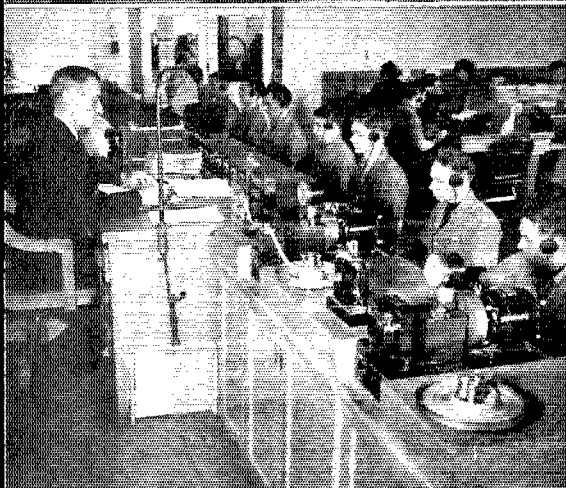

Code and operating training is half the battle at Gallups Island. *Left (from top to bottom)* — (1) Code class in session. Tone from audio oscillator and switchboard on rack, keyed by automatic tape transmitters on table in front of instructor, is fed to each position via individual switch panels. (2) Advanced code and network-procedure class, showing instructor's position and dual tape-keying heads. (3) Network-procedure group. Man in foreground is net control; the drill simulates actual operation at sea. (4) Practical watch-standing class, with students operating RCA marine receivers (three at each position, covering all frequency ranges) in typical shipboard installations. *Above* — Lt. (jg) J. J. Canavan, head of lab instruction, teaching d/f technique on a Mackay direction-finder.

language and 18 w.p.m. in coded groups. These minimum speeds, although 2 w.p.m. less than the previous standards, provide a satisfactory margin over FCC requirements.

Most recent among the modifications in the code-training course is the separation of initial code and touch-typing practice. Originally both were begun simultaneously, but under the shortened course basic code and typing instruction are given separately for the first four weeks — two hours of code and one of typing daily. In the following weeks the student learns to correlate the two, and after the fifth week all copying is directly on the mill.

Training in sending commences with the 13th week, the student's receiving speed then having reached a minimum of 13 w.p.m. Practice in both sending and receiving — plain language and mixed code — continues until the end of the course. After the 17th week, however, the code-class periods are reduced from 15 hours per week to 5 with the introduction of procedure training.

In procedure class all phases of marine operating are covered, including calling and answering, use of frequencies, Q signals and other oper-

ating abbreviations, radio laws and regulations, international treaties and agreements; traffic handling (including such details as computing charges, conversion of the gold franc, etc.), direction finding, the complicated details of distress communications and the myriad other procedural details the accomplished marine operator must know. This part of the course concludes in a series of practical drills and watch-standing sessions, closely simulating operation at sea.

Both code and procedure classes are conducted in an atmosphere calculated to give the student the true feeling and spirit of an operator. In the watch-standing classes the individual positions exactly duplicate standard shipboard operating conditions — two rows of positions on either side of a long room, one side equipped with Mackay equipment and the other with RCA.

### Theory and Lab

That's the operating side of the picture. In parallel with it is the theory and lab instruction. There are some radio operating jobs in which the man at the key needs only to know which knob to turn or which switch to throw, but the marine

The other half of the battle is theory and lab instruction. *Right (top to bottom)* — (1) Typical theory class. CRM Robert F. Clough, W90MU, lectures on neutralization of r.f. amplifiers with the aid of a versatile demonstration set ending up in a "50-watter." (2) One lab group hears CRM C. V. Bradley explain the workings of a standard RCA h.f. marine transmitter. (3) Another lab group studies the Mackay "victory set," as installed on all Liberty ships, with CRM E. Waller. This compact unit is a self-contained radiotelegraph station with transmitter, receiver, power supply equipment — complete even to clock, desk and lamp. (4) The well-stocked supply room off the general lab contains every needed component and instrument. *Below* — A student group at work on a transmitter-construction project.

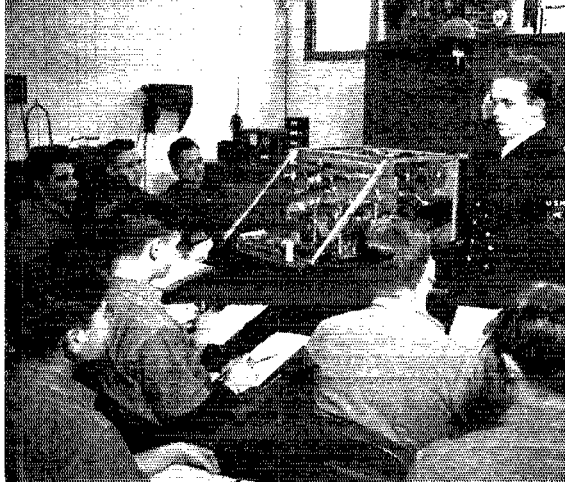
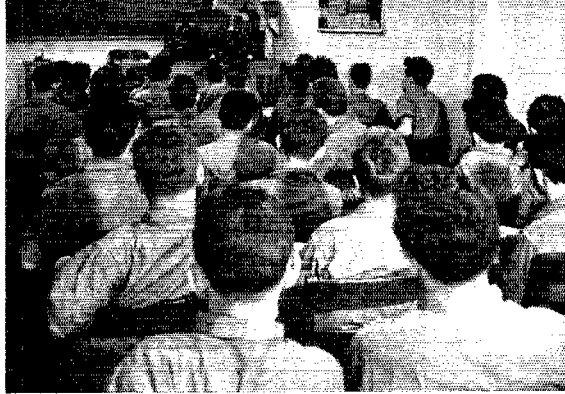

radio operator must be the "complete radioman," familiar with every technical detail of his equipment and qualified to service and repair it.

As much training time is devoted to the technical end as to operating, therefore. Theory classes begin with the simplest electrical fundamentals and work up through a well-rounded course to complete transmitters and receivers, winding up with a week on wave propagation and antennas. Qualified instructors — most of them hams — lead the novice through the technical maze along a well-thought-out route which skirts the non-essentials while providing a well-balanced understanding not only of how radio works but why. The theory department, appropriately enough, is staffed almost entirely by hams, including W9QMG, who is in charge, W9CEE, W1NGL-ex-W4ARP, W9OMU, W9MUQ, W9KWI and W9VQE.

Texts for the theory classes are pamphlets prepared by the staff to meet the specialized requirements of the course. A comprehensive reference library of standard reference texts and handbooks is also provided.

Practical application of the theoretical knowledge thus acquired comes with the beginning of laboratory classes in the 14th week. There are three laboratory classrooms — the general lab, storage battery lab and marine radio lab. Each has its own important role.

Work in the general laboratory begins with the types and uses of tools and continues through elementary electrical experiments and assorted constructional projects involving the building of oscillators and simple receivers. This well-equipped lab has been the envy of many a service school, with its individual tool drawer complete with every needed hand tool for each student and its well-stocked supply room outfitted with ample quotas of everything from condensers and resistors to signal generators and oscilloscopes.

The storage-battery lab is just what its name implies — a place where students learn all about the maintenance, care and operation of storage cells, those indispensable elements of marine-radio installations.

It is in the third room of the laboratory section that the equipment-minded visitor lingers long-

est, however. Here, in the standard marine radio installation laboratory, is to be found at least one example of each type of radio equipment now being installed aboard vessels constructed for the U. S. Maritime Service, including crystal-controlled intermediate and high-frequency transmitters, t.r.f. and superhet receivers, radio direction-finding equipment, automatic distress-signal alarm equipment, stand-by equipment, lifeboat transmitting and receiving equipment, small-craft radiotelephone equipment and all the associated accessories.

This equipment is assembled in rows along the room, each unit completely installed and operating. Classes assemble on folding chairs in small groups before individual installations, several such groups assembling simultaneously in various parts of the room, while the instructors take the equipment up unit by unit. On completing this part of the course the student knows every electrical and mechanical detail of each type of equipment he may be called upon to operate. Coupled with his operating training, it makes him a thoroughly proficient radio man.

### Seamanship

But a marine radioman must be more than a good radio operator and technician. He must be a seaman, as well, and two hours of each week throughout the course are devoted to teaching seamanship. It takes an astonishing amount of specialized knowledge to be a sailor, as anyone who has fitted and sailed even an 18-foot yawl can testify. Of course, a radioman doesn't need to know everything a regular seaman does — but he must learn the names and uses of the basic nautical devices from anchors to marlinspikes, the hundred and one varieties of sailor's knots, the art of getting into rubber life-saving suits and the technique of lifeboat drills.

All in all there's plenty to do in the formal classroom day from 9 A.M. to 4 P.M. — to which may be added evening periods for boning up. In this connection, classrooms are kept open evenings and instructors are on hand to assist with individual instruction and counsel where needed. For students who drop behind in their work spe-

*(Continued on page 84)*

Sea-going radiomen are trained in the rudiments of nautical lore at Gallups Island. *Left* — Surrounded by typical items of marine equipment, one student learns the art of donning a rubber life-saving suit — the "Man from Mars" suit — while another studies a complex sailor's knot. *Right* — Lifeboat drill is an important part of the training of seafaring men in war time, and Maritime Service radiomen get plenty of it.

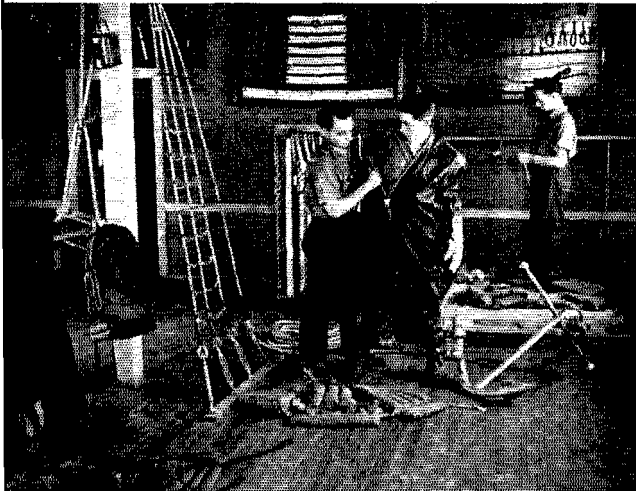

# Elementary A.C. Mathematics

## Part IV\*—Phase Relationships in Inductance and Capacity

BY GEORGE GRAMMER,\*\* WIDF

**R**ETURNING now to the question of how variable phase relationships can arise in a.c. circuits, we shall find that some new mathematical ideas — “new” in the sense that they are additional to those already discussed — must be considered. First, however, we can dismiss a purely resistive circuit from consideration, since it was previously established that in such a circuit the current and voltage always are in phase. Any change from the in-phase condition must arise as the result of energy storage in the circuit; in turn, this storage is associated with inductance and capacity.

To approach the problem let us first look at a simple d.c. circuit containing a condenser and an adjustable source of voltage as in Fig. 21-A. We assume that there is no resistance anywhere in the circuit. The quantity of electricity that can be placed on a condenser is proportional to the voltage at its terminals; that is,  $Q = CE$ , where (in the practical system of units)  $Q$  is the quantity in coulombs,  $E$  is the voltage, and  $C$ , the constant of proportionality, is the capacity in farads. On closing the switch the condenser will instantly acquire its full charge; in other words, the number of electrons representing the quantity  $Q$  will instantly<sup>1</sup> accumulate on the plate connected to the negative terminal of the voltage source and there will be a corresponding deficiency of electrons on the other plate.

Suppose that the source of voltage in Fig. 21-A is adjustable from 50 to 200 volts in 50-volt steps. If the condenser has a capacity of 1 microfarad, the application of 50 volts will cause it to accumulate instantly a charge of  $50 \times 1 \times 10^{-6}$  coulombs, or 50 microcoulombs. If the voltage

tap is moved to the 100-volt point the charge will become 100 microcoulombs, and so on through the remaining taps to 200 volts and 200 microcoulombs. Now if the tap is moved back to 150 volts the condenser will *discharge* into the source of voltage, returning the difference between 200 and 150 microcoulombs to the source. As the voltage is decreased in successive steps the discharging process continues until finally, when the applied voltage is zero, the last 50 microcoulombs are returned to the source. Note that when the applied voltage is being increased, a larger and larger charge is accumulating on the condenser; that is, current is flowing *into* the condenser.

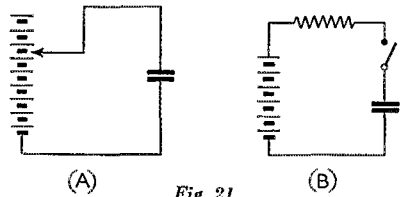

Fig. 21

When the applied voltage is being decreased, current is flowing *out* of the condenser. Thus, although the polarity of the applied voltage is unchanging, the direction of current flow may change simply as the result of changing the *value* of the voltage. This can happen only because the condenser possesses the property of storing and releasing electrical energy.

### Condenser Current with Applied A.C.

Now suppose we apply a sine-wave alternating voltage to the condenser. On the basis of the d.c.

\* Part I appeared in *QST* for Feb., 1943; Part II, in *QST* for March, 1943; Part III, in *QST* for April, 1943.

\*\* Technical Editor, *QST*.

<sup>1</sup> The word “instantly” implies that no time is consumed in charging the condenser, and since current is the time rate of transfer of charge, or  $I = Q/t$ , the current must be infinitely large because  $t$  is zero. Of course such a statement will not stand examination; what is meant by an infinitely large current which flows for zero time — i.e., does not flow at all? (Such a paradox merely illustrates why division by zero is specifically excluded from arithmetical operations.) However, let us suppose that a resistance is connected in series with the source of voltage and the condenser, as in Fig. 21-B. Then at the instant of closing the switch the maximum current that possibly can flow into the condenser will be  $I = E/R$ . The movement of electrons which results when the voltage is applied causes an accumulation on one plate of the condenser and a deficiency on the other, so that the condenser acquires some charge. The charge causes a voltage to appear across the condenser terminals; this voltage opposes the voltage of the source, as is easily seen by tracing through the series circuit, so that the resultant voltage across the resistor decreases. The current then also decreases, but the condenser continues to acquire more charge because so long as current flows electrons continue to be taken from one plate while a corresponding number is de-

posed on the other. Consequently the voltage across the condenser continues to increase, until finally it is so nearly equal to the source voltage that there is no measurable difference between the two. At this time the current is also so small as to be unmeasurable, and conditions become static.

Thus with resistance in the circuit, the process of charging the condenser requires an appreciable interval of time. If the value of the resistance is reduced to one-half, the rate at which the condenser becomes charged is twice as rapid, because the current is twice as large and consequently twice as much electricity is transferred to the condenser in a given period of time. As we continue to reduce the value of the resistance the charging time becomes shorter and shorter. Although it is meaningless to say that the charging time is zero if the resistance is zero, it is perfectly safe to say that the charging time *approaches* zero as the value of the resistance *approaches* zero. Then if the resistance is small enough to neglect, for practical purposes, the charging time also is small enough to be neglected. We know that no circuit can be completely without resistance, but we also are familiar with the fact that in many applications the effect of resistance may be safely neglected; the latter is assumed to be the case in the discussion. Then for convenience we can use the word “instantly” to mean “in a time interval so small that it can be neglected.”

behavior outlined above we can easily predict in a general way what will happen. Let us imagine that the condenser is initially uncharged and that the voltage is rising from zero in the positive direction. So long as the voltage is increasing the condenser will acquire an increasing amount of charge — that is, current will flow into the condenser. The direction of current flow is therefore in the “normal” direction; i.e., the current has the same polarity as the applied voltage. At the peak of the positive half-cycle of voltage the condenser will have acquired its maximum charge, and when the voltage starts to decrease (still with positive polarity) the condenser will begin to discharge into the circuit. Hence the direction of current flow reverses, so that — although the applied voltage is still positive — the current is now flowing in the negative direction. As the voltage continues to decrease, more and more of the energy stored in the condenser is returned to the circuit until finally, when the voltage reaches zero, the condenser is completely discharged. At this point the polarity of the applied voltage reverses, becoming negative, and the voltage again builds up. Again the condenser acquires charge, again the current flow is in the “normal” direction. But this time the voltage has negative polarity and consequently the current also is negative. When the voltage reaches its peak on the negative half-cycle and then begins to decrease, the energy stored in the condenser is returned to the circuit. Again the direction of current flow reverses, now becoming positive. The current continues to flow in the positive direction until the voltage reaches zero, when the whole process begins once more. Note that the transition points occur at quarter-cycle intervals, since the zero and maximum points of the applied sine-wave voltage occur at quarter-cycle intervals. From the above we can make a small table to show the relative polarity of current and voltage in each quarter cycle:

Quarter cycle	1st	2nd	3rd	4th
Voltage.....	+	+	-	-
Current.....	+	-	-	+

The problem now is to determine how the instantaneous value of the current varies during the periods when the direction of flow is constant.

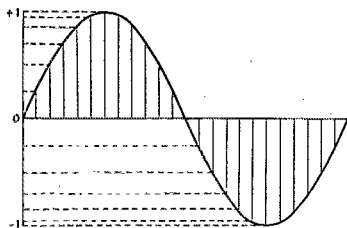

Fig. 22

Fundamentally, current is the rate at which electricity moves past a point in a circuit. If the rate (that is, the current) is constant this is ex-

pressed by  $I = Q/t$ , where  $I$  is the current in amperes if  $Q$  is the quantity of electricity in coulombs and  $t$  is the time in seconds; one ampere is a rate of flow of one coulomb per second. In the case of a condenser being charged or discharged, a constant current into or out of the condenser can be obtained only if the voltage across its terminals increases or decreases at a uniform rate. This is easily demonstrated: The quantity of electricity stored in a condenser is  $Q = CE$ ; if we divide both sides of this equation by  $t$ , we have

$$\frac{Q}{t} = C \frac{E}{t}$$

$Q/t$  is current, and  $E/t$  is the rate of change of voltage, expressed in volts per second if fundamental units are used. Assuming that the capacity,  $C$ , is fixed, the rate of change of the quantity of electricity (in other words, the current) must be proportional to the rate of change of voltage.  $Q/t$  (or  $I$ ) therefore will be constant only when  $E/t$  is constant. For example, if the voltage is increasing at the rate of 50 volts per second, a constant current will flow into the condenser. But if the voltage increases at the rate of 50 volts per second for the first second, then 40 volts per second for the next second, 30 volts per second for the next, and so on, the rate of voltage increase is not uniform and the current will not be constant. By inspection it is readily verified that the rate at which a sine-wave voltage increases or decreases is not uniform; if the wave is divided up into sections taken at equal time intervals, as in Fig. 22, it is obvious that the voltage change per interval is larger when the voltage is near zero than when it is near its peak value. (The voltage change in each interval is represented by the vertical distance between adjacent dashed lines running horizontally to the vertical axis.) The current flowing into or out of a condenser to which such a voltage is applied therefore will not be constant, and a method must be found for determining how the value of the current varies from instant to instant.

### Rate of Change

The solution of this question hinges on the concept of “rate of change.” The idea of “rate” is not at all unfamiliar; it is quite natural, for instance, to think of an automobile moving at the rate of 25 miles per hour, or of a man walking at the rate of 3 miles per hour. In both of these homely examples the rate is constant; in the case of the automobile the distance traveled will be 25 miles at the end of the first hour, 50 miles at the end of the second, and so on, each additional hour adding 25 more miles to the distance. The mathematical expression covering such cases is quite simple: The rate (or speed) is merely equal to the distance divided by the time required to traverse it, or  $S = D/t$ , using the letters  $S$ ,  $D$  and  $t$  to represent speed, distance and time, respectively. If we use miles for  $D$  and hours for  $t$ , the rate or speed is expressed in miles per hour; if we use feet for  $D$  and seconds for  $t$ , the rate is in feet per second, and so on. Although distance

and speed may provide the most familiar illustrations, there are plenty of examples of rate of change not involving distance. For example, the rate of flow of water through a pipe may be expressed in gallons per minute; a motor shaft may turn at the rate of so many revolutions per minute; an article may be manufactured at the rate of so many units per day, or an electrical current may flow at the rate of so many coulombs per second. The fact that the term "ampere" is used as a substitute for "coulombs per second" tends to conceal the fact that the current is fundamentally a rate of change; it seems that only in electrical practice is this duplication of unit names characteristic, although possibly similar examples could be found in other fields.

If two quantities are so related that when the value of one is changed the value of the other changes in direct proportion, the graph showing the relationship will be a straight line. In such a case the relationship is said to be *linear*. Several examples are shown in Fig. 23, where coulombs are plotted along the Y axis and time in seconds along the X axis. The curves thus show the rate of change of coulombs with respect to time. In Curve A, each one-second interval sees the addition of  $\frac{1}{2}$  coulomb to the quantity of electricity already accumulated; in Curve B the rate of increase is 1 coulomb per second; in Curve C, 2 coulombs per second; in Curve D, 3 coulombs per second. The higher the rate of increase the more steep is the graph representing the relationship. The steepness of the graph is called its *slope*; hence the greater the slope of the curve the higher the rate of increase of the Y quantity with respect to the X quantity. When the graph is a straight line the numerical value of its slope can be found by choosing any two points along the curve and then determining the X and Y values of the points; the difference between the two Y values divided by the difference between the two X values is the slope of the curve. We might, for instance, choose the values 2 seconds and 3 seconds as the points along the X axis. Using curve C in Fig. 23, we find that when  $t = 2$  seconds,

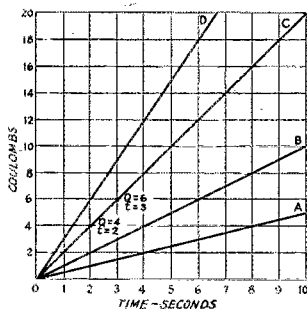

Fig. 23

$Q = 4$  coulombs, and that when  $t = 3$  seconds,  $Q = 6$  coulombs. The slope of the curve is therefore  $6 - 4$  coulombs divided by  $3 - 2$  seconds, or 2 coulombs divided by 1 second. This is of course 2 coulombs per second, so we say that the

curve has a slope of 2 coulombs per second, or simply a slope of 2, meaning that the coulombs increase twice as fast as the seconds.

To make the discussion more general, let us dispense with the relationship between concrete

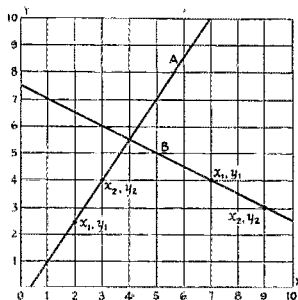

Fig. 24

quantities and simply deal in  $x$  and  $y$ . There are two cases, one where the graph slopes upwards to the right and the other where the slope is downward to the right. These are shown in Fig. 24. To find the slope we may choose any two points along the graph; in Fig. 24 one is the point  $x_1, y_1$  and the other is the point  $x_2, y_2$ . Then from the definition of slope just given,

$$\text{slope} = \frac{y_2 - y_1}{x_2 - x_1}$$

On graph A, the values are  $y_2 = 4, y_1 = 2\frac{1}{2}, x_2 = 3, x_1 = 2$ , and substitution gives  $1\frac{1}{2}$  for the value of the slope. On graph B, the values are  $y_2 = 3, y_1 = 4, x_2 = 9, x_1 = 7$ . In this case we have

$$\text{slope} = \frac{3 - 4}{9 - 7} = -\frac{1}{2}$$

Here the slope is negative, indicating that  $y$  decreases as  $x$  increases. There are also two special cases: If the graph is a horizontal straight line, the value of  $y$  is the same for any value of  $x$ , hence  $y_2 - y_1$  always is equal to zero and the slope is zero. In such a case the rate of change of  $y$  with respect to  $x$  is zero; that is,  $y$  is a constant. If the graph is a vertical straight line, the value of  $x$  is the same for any value of  $y$ , so that  $x_2 - x_1$  always is equal to zero. In this case the slope is infinite, indicating that  $y$  may assume any value while the value of  $x$  is constant.

### Slope of a Curve

So much for the relatively simple case of straight lines. If the graph is a curved line the method described above for finding its slope does not work. For example, consider the graph of the equation  $y = x^2$ , shown in Fig. 25. Suppose that we choose the points  $x_2 = 6, y_2 = 36$ , and  $x_1 = 4, y_1 = 16$ . Then from the formula previously used the slope should be

$$\frac{36 - 16}{6 - 4} = 10$$

However, suppose that  $x_2 = 8, y_2 = 64$  and we

retain the previous values for  $x_1$  and  $y_1$ . Then the slope should be

$$\frac{64 - 16}{8 - 4} = 12$$

Evidently the value to be obtained for the slope depends upon the choice of the points from which

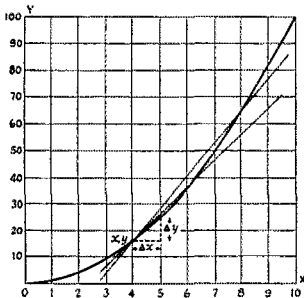

Fig. 25

it is to be calculated, whereas in the case of a straight line points chosen anywhere we might please along the curve always gave the same result. It is apparent, then, that this method merely gives the slope of a straight line through the two points chosen, as shown in Fig. 25. It is obvious that neither of the straight lines in this drawing can be considered to represent the actual slope of the curve. We need to amplify our definition of slope so that it will have some meaning when applied to a curved line.

Going back to the straight-line graphs of Fig. 23, let us imagine that a point or particle starts at the origin of the graph and travels along any one of the lines shown. Since the path along which the particle moves is straight, the particle always is traveling in the same direction. The directions will be different for the different lines, of course, and we can in fact define slope in terms of the direction taken by the moving point; for example, the slope might be specified in terms of the angle which the particular line considered makes with the X axis. Now suppose that a particle similarly starts from the origin in Fig. 25 and travels outward along the curve. In this case its direction is continually changing, never being the same from one instant to the next. If we consider slope to be identical with direction, it is plain that the slope of a curved line is different at every point along the line. At any point we can define the slope as the *instantaneous direction* of a particle moving along the curve when it passes through the point. A straight line drawn through the point in the same direction will be a *tangent* to the curve at that point; that is, it will touch the curve (but not intersect it) only at the point considered. The problem of finding the slope of a curve at a point is thus fundamentally one of finding the slope of the tangent to the curve at the point.

Let us suppose that we want to find the slope at the point  $x = 4$ ,  $y = 16$  in Fig. 25. To sim-

plify notation we let  $\Delta x = x_2 - x_1$ , and let  $\Delta y = y_2 - y_1$ . (It will be remembered that the symbol  $\Delta$  means "a difference.") Then the slope of a straight line passing through the points  $x_1$ ,  $y_1$  and  $x_2$ ,  $y_2$ , will be  $\Delta y/\Delta x$ . It will be illuminating to choose a number of different values for  $\Delta x$ , find the corresponding values for  $\Delta y$ , and observe the way in which the slopes vary. Taking successively smaller values of  $\Delta x$  and arranging the results in tabular form:

$\Delta x$	$\Delta y$	$\frac{\Delta y}{\Delta x}$
2	20	10
1	9	9
0.5	4.25	8.5
0.25	2.0625	8.25
0.1	0.81	8.1
0.01	0.0801	8.01
0.001	0.008001	8.001
0.0001	0.00080001	8.0001

If this process could be continued indefinitely we should find that as  $\Delta x$  becomes smaller and smaller,  $\Delta y/\Delta x$  becomes nearer and nearer to the value of 8. It would be meaningless to say that the slope is 8 when  $\Delta x = 0$ , because if  $\Delta x = 0$  than  $\Delta y$  also is equal to zero, and  $\Delta y/\Delta x$  becomes  $0/0$ , a fraction which has no interpretation. But so long as  $\Delta x$  is *not* zero it can be made as small as we please, and the smaller we make it the closer do we approach to the limiting value of 8 for  $\Delta y/\Delta x$ . We say, then, that as  $\Delta x$  approaches zero  $\Delta y/\Delta x$  approaches 8 *as a limit*, and that in the limit the slope of the curve at the point  $x = 4$ ,  $y = 16$  is 8. The limit is indicated by substituting the letter  $d$  for the sign  $\Delta$ , so that the limit of  $\Delta y/\Delta x$  as  $\Delta x$  is allowed to approach zero is indicated by writing  $dy/dx$ . The symbol  $d$  is not an algebraic quantity, hence  $dy$  does not mean  $d$  multiplied by  $y$ , nor does  $dx$  mean  $d$  multiplied by  $x$ . Symbols such as  $\Delta$  and  $d$  are called *operators*, because they indicate the nature of a mathematical operation to be performed, just as the signs  $+$ ,  $-$ ,  $\times$  and  $\div$  indicate operations rather than quantities.

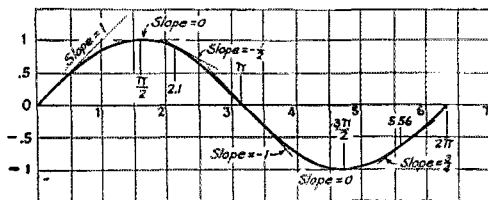

Fig. 26

In the example above the numerical value of the limit (or slope of the tangent to the curve) becomes evident after a few successive calculations. The slope at other points of the curve could be found readily by a similar procedure. By using symbols rather than numerical values, it can be



shown<sup>2</sup> that the value of  $dy/dx$  or the slope of the tangent to the curve  $y = x^2$  at any point is equal to  $2x$ . Generally speaking, methods exist for finding the slope at a point of any continuous curve but (just as in the case of the summations previously considered) for our present purposes it is

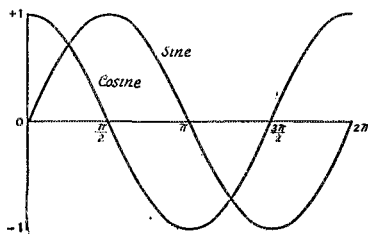

Fig. 27

sufficient to have an understanding of the graphical interpretation of the process. The important ideas here are that the rate of change of a quantity is given by the slope of the curve at the particular point considered, and that the slope of a curve at any point is equal to the slope of the tangent to the curve at that point.

### Slope of a Sine Curve

Since the current flow into a condenser depends upon the rate of change of the applied voltage, we can apply these principles to a sine wave to determine the rate at which the instantaneous value of the wave changes with time and thus determine how the current varies. A fairly good idea of the general nature of the variation can be obtained by graphical means. In Fig. 26 a sine curve is plotted to scale, using radians as a measure of time during one cycle so that consistent numerical results will be obtained. Tangents to the curve have been drawn at a number of selected points. Thus at zero time or angle the slope of the curve is 1. At time  $\pi/2$  (90 degrees) the slope is zero; at 2.1 radians (120 degrees) the slope

<sup>2</sup> This can be shown as follows: The equation of the curve is  $y = x^2$ . If  $x$  takes on a small increment  $\Delta x$ , then  $y$  will take a corresponding increment  $\Delta y$ . Then  $x_1 = x + \Delta x$  and  $y_1 = y + \Delta y$ . The slope of the straight line through the points  $x, y$  and  $x_1, y_1$  is then

$$\frac{y_1 - y}{x_1 - x} = \frac{\Delta y}{\Delta x}$$

Substituting  $x + \Delta x$  for  $x$  and  $y + \Delta y$  for  $y$  in the original equation, we have

$$y + \Delta y = (x + \Delta x)^2$$

Expanding the right-hand member gives

$$y + \Delta y = x^2 + 2x\Delta x + \Delta x^2$$

We now subtract  $y$  from  $y_1$  (which equals  $y + \Delta y$ ) and  $x$  from  $x_1$  (which equals  $x + \Delta x$ ) in order to have only the differences between these quantities, since only the differences enter into the calculation of the slope. This is done by subtracting the original equation from the above expression. This gives

$$\Delta y = 2x\Delta x + \Delta x^2$$

To find  $\Delta y/\Delta x$  we divide both sides of this expression by  $\Delta x$ , obtaining

$$\frac{\Delta y}{\Delta x} = 2x + \Delta x$$

As  $\Delta x$  is allowed to approach zero as a limit, the limit of  $\Delta y/\Delta x$  (that is,  $dy/dx$ ) obviously approaches  $2x$  as a limit. Thus, in the limit, the slope of the curve at any point is equal to  $2x$ .

is  $-1/2$ ; at  $\pi$  or 180 degrees the sine curve again is passing through zero and the slope is  $-1$ , etc. If the slope is determined for a sufficient number of points and a curve is constructed to show the variation in slope with time or angle, it will be found that the slope curve is a cosine curve. That is, the rate of change of the sine curve at any given angle or instant of time is equal to the cosine of that angle. Hence the curve showing the rate of change of a sine curve has the same shape as the sine curve, but is displaced by  $\pi/2$  or 90 degrees. The sine and cosine curves are shown in Fig. 27. If the sine curve represents the voltage applied to a condenser, the cosine curve represents the current flowing through the condenser. The two curves have exactly the same shape, but

there is a phase difference of  $\pi/2$  or 90 degrees between them. Since the current reaches its maximum value on the same side of the reference line 90 degrees before the voltage reaches its corresponding maximum value, the current leads the voltage by 90 degrees.

### Inductance

The concept of rate of change also plays a basic part in the analysis of the inductance case. Let us suppose that an inductance is connected through a switch to a source of d.c. voltage, as in Fig. 28. At the instant of closing the switch a current will flow in the circuit, and the flow of current will be accompanied by the creation of a magnetic field. The field represents stored energy, so that work must be done in bringing it into existence. Work is accomplished by expending power for a period of time, and in the electrical circuit power is equal to the product of current and voltage. The consequence of this is that there must be a voltage drop in the inductance (even though the inductance is assumed to have no resistance) extending over a length of time sufficient to permit the storage of all the energy that the circuit conditions permit.

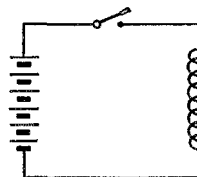

Fig. 28

This inductive voltage drop is comparable to the voltage drop in a resistor, since it (together with the current) represents power taken from the voltage source. We find, therefore, that when a magnetic field is increasing in strength there is induced in the conductors which it surrounds a voltage which "opposes" the voltage applied in the circuit, in the same sense that the voltage drop in a resistor opposes the voltage applied to it. The more rapidly the field strength increases the more rapid is the rate at which energy is stored, hence the greater the induced voltage. Thus the induced voltage is proportional to the

(Continued on page 74)

# A Two-Tube T.R.F.-Regenerative F.M. Receiver

*Low-Cost Reception of Frequency-Modulated Signals*

BY B. C. BARBEE,\* W2MWX

**M**OST HAMS are interested in f.m. these days. Many of them are experimenting with f.m. receivers but others are not, mainly because they cannot obtain the scarce and expensive parts required or do not feel equal to the job of building an elaborate receiver such as many of those described in current literature. The receiver shown in the photographs was built with only a handful of used parts from the junk-box, and its circuit is almost as simple as any beginner's two-tube a.m. receiver.

As the diagram of Fig. 1 shows, the system consists only of a 6SJ7 r.f. amplifier-limiter and a 6H6 discriminator. This may be followed by any audio amplifier with sufficient gain. That idle speech amplifier will do nicely, and its power-supply will never miss the 6.3 volts at 0.6 ampere and approximately 100 volts at 1 or 2 ma. drawn by the receiver. (The discriminator requires no plate power.)

The r.f. amplifier-limiter is regenerative and it behaves like a weak, unstable e.c.o., whose low-Q tuned circuit allows it to lock in and follow the perturbations of the signal frequency. Regeneration is controlled by varying the plate and screen voltages with the usual potentiometer. The discriminator, a genuine Foster-Seeley type, operates in the usual manner.

The one disadvantage in the system is that the

\*109 Hammond St., Cambridge, Mass.

frequency deviation ratio is only approximately one-tenth what it would be if the signal were first converted to 4.3 Mc., the usual intermediate frequency. This means that, for a given signal strength, only one-tenth as much audio voltage is obtained from the discriminator. But isn't it easier and cheaper to stick in an audio-amplifier stage with a gain of 10 than to bother with a complicated frequency converter stage? Indeed it is, especially when high-frequency parts are so hard to get nowadays. Besides, the average speech-amplifier or p.a. system has sufficient

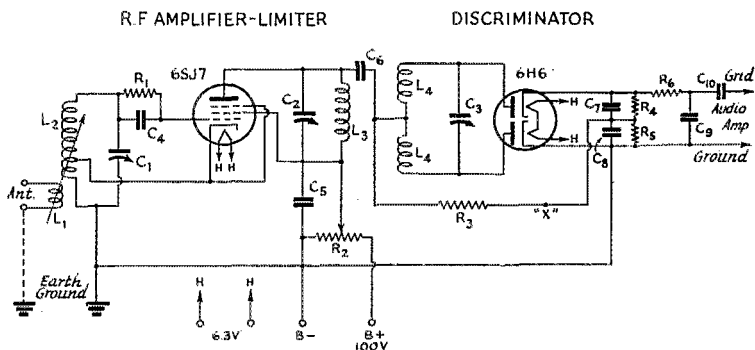

Fig. 1 — Circuit diagram of the two-tube T.R.F.-regenerative f.m. tuner.

C<sub>1</sub>, C<sub>2</sub>, C<sub>3</sub> — 25- $\mu$ fd. variable air trimmers.  
C<sub>4</sub>, C<sub>5</sub> — 10- $\mu$ fd. mica.  
C<sub>6</sub>, C<sub>7</sub> — 100- $\mu$ fd. mica.  
C<sub>8</sub>, C<sub>9</sub> — 25- $\mu$ fd. mica.  
R<sub>1</sub> — 250,000 ohms,  $\frac{1}{2}$ -watt.  
R<sub>2</sub> — 100,000-ohm pot.

R<sub>3</sub>, R<sub>4</sub>, R<sub>5</sub> — 100,000 ohms,  $\frac{1}{2}$ -watt.  
R<sub>6</sub> — 50,000 ohms,  $\frac{1}{2}$ -watt.

L<sub>1</sub> — 2 turns No. 14,  $\frac{3}{4}$ -inch diameter, no spacing.  
L<sub>2</sub> — 5 turns No. 14,  $\frac{3}{4}$ -inch diameter, no spacing.  
L<sub>3</sub> — 5 turns No. 14,  $\frac{3}{4}$ -inch diameter, no spacing.  
L<sub>4</sub> — 6 turns No. 14,  $\frac{3}{4}$ -inch diameter, spaced at center to admit L<sub>3</sub>.

audio gain to shatter the windows when operating from this little receiver.

It is evident that f.m. reception can be superior in quality only if the audio amplifier and speaker are designed for high fidelity. With the r.f. portion properly adjusted, the fidelity is limited

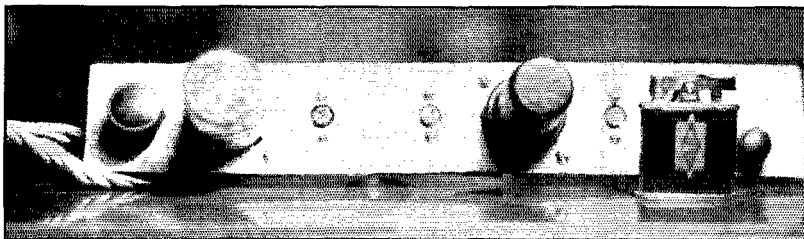

Top and bottom views of the two-tube f.m. tuner. The regeneration control, R<sub>2</sub>, is at the extreme left, next to the 6H6GT discriminator tube. The discriminator and limiter plate tuning condensers, C<sub>3</sub> and C<sub>2</sub>, are between the two

Nothing fancy here, but it works! Side view of the simple f.m. tuner, showing the inductances suspended from the tuning-condenser terminals. Antenna and input-circuit coils are underneath and at the right-hand end of the chassis.

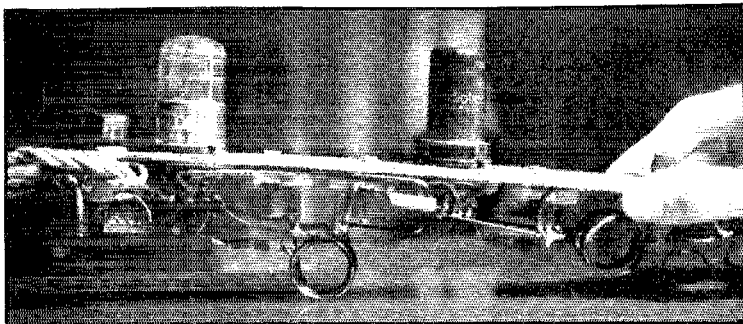

only by the apparatus following the discriminator. The audio system shown in Fig. 2 will give sufficiently good results to enable the listener to distinguish the difference between f.m. and standard broadcasts. A woofer-tweeter speaker combination will make the high-frequency response even better. The tube line-up consists of a 6SJ7 pentode amplifier, 6N7 phase-inverter and 6L6Gs in push-pull. Other audio power-amplifier tubes may be substituted, changing the bias resistor, plate voltage and load impedance to match. The 6L6Gs appear to have the least harmonic distortion of all, however, according to published tube data.

As may be seen from the pictures, the parts for this set came from the junk box. The front view shows the Masonite panel and the controls. From left to right, they are: regeneration control, discriminator tuning control, limiter plate-tuning control, limiter grid-tuning control and antenna-coupling adjustment. The 6H6GT discriminator tube appears between the regeneration control and the discriminator tuning condenser, while the 6SJ7 r.f. amplifier-limiter is placed between its two tuning condensers. Rear and bottom views show how the various parts are mounted.

Note that all r.f. leads are of No. 14 wire (from the old ham antenna) and are as short and direct as possible. Note also that the limiter plate coil is mounted in the exact center of the discriminator coil. It is quite important to secure exact symmetry at this point, since it is the heart of the whole circuit.

No attempt was made to gang the condensers, since three alike could not be found. A search is now under way for condensers suitable for ganging, and a receiver with ganged condensers and plug-in coils is contemplated which will

permit coverage of both the f.m. broadcast and the high-frequency ham bands.

Low-loss sockets were unavailable, but the bakelite ones used seem not to detract too much from the results obtained. All resistors and condensers also came from the junk-box; their values are not at all critical. Most of them may vary 50 per cent below or 100 per cent above the values given without impairing results.  $R_4$  and  $R_5$  and  $C_7$  and  $C_8$  should be of equal value for perfect balance, however. It was found impossible to obtain discriminator balance with a high-frequency r.f. choke in place of  $R_3$ , no doubt because of the distributed capacity of the choke. Lucite rod was used for the shaft supporting and varying the position of the antenna coupling coil because it was available, but bakelite would probably do as well since the coil should be at a voltage node if the right antenna is used.

In aligning the receiver, first start the limiter oscillating by means of the potentiometer,  $R_2$ . Then squeeze or spread the turns of  $L_2$  until the tuning condenser,  $C_1$ , covers the f.m. broadcast range as verified by a regular f.m. receiver or a communications receiver tuning the f.m. range. (Beware of images.) Any other means of checking frequency may also be used. The plate coil,  $L_3$ , is likewise adjusted until its tuning condenser,  $C_2$ , tracks with  $C_1$ . Resonance between the two circuits is indicated by the r.f. stage going into oscillation as resonance is passed, with the regeneration control set just below the point of oscillation. Oscillation is indicated by a faint pop and hiss, just as in the usual regenerative a.m. receiver so familiar to all. The discriminator coil,  $L_4$ , is adjusted in a similar manner, care being taken to keep it symmetrical. Resonance is indicated by maximum deflection on a sensitive voltmeter across either  $R_4$  or  $R_5$  (not both).

tubes. To the right of the 6SJ7 r.f. amplifier-limiter tube are the limiter grid tuning condenser,  $C_1$ , and the antenna-coupling control.  $L_3$  is wound in the exact center of  $L_4$  and both are mounted between the two tuning condensers.

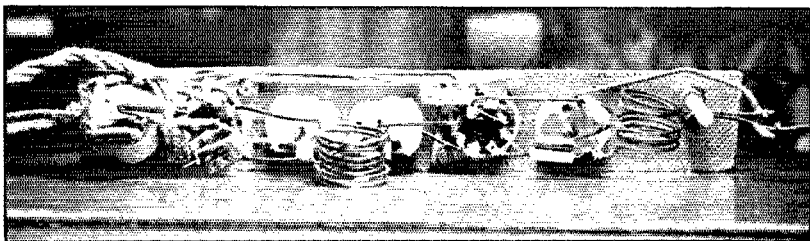

After the discriminator coil is adjusted to track, it must be checked for balance. With no antenna connected, swing the limiter's oscillating frequency back and forth with  $C_1$ , and notice the d.c. voltage across both  $R_4$  and  $R_5$  in series. It should be zero when the limiter is tuned to the same frequency as the discriminator, and should rise to equal values, with opposite polarities, on each side of resonance. The original

well-placed half-wave doublet antenna DX reception should be possible when the skip is right. For local reception it was found that about three feet of wire laid across the table was sufficient.

Because of the high gain of the audio amplifier its chassis should be grounded to prevent hum pick-up.

Any comments on the circuit described will be welcomed by the author.

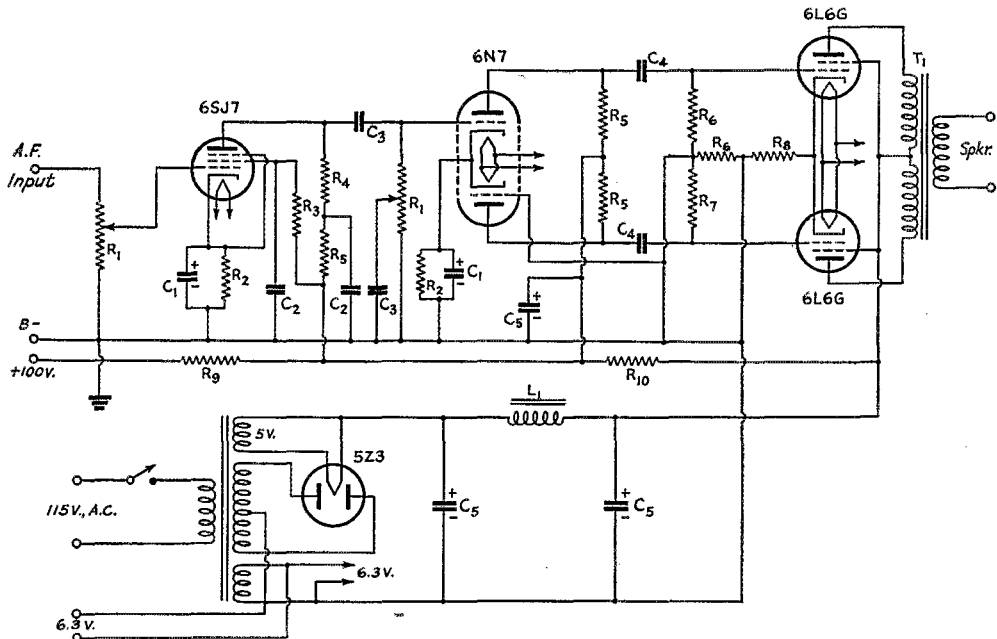

Fig. 2 — Circuit diagram of a suggested audio amplifier system for the f.m. tuner.

- |   |  |  |
|---|--|--|
| $C_1$ — 10- $\mu$ fd. 50-volt electrolytic. | $R_4$ — 500,000 ohms, $\frac{1}{2}$ -watt. | $R_{10}$ — 5000 ohms, 1-watt.  |
| $C_2$ — 0.25 $\mu$ fd., 400-volt.           | $R_5$ — 100,000 ohms, $\frac{1}{2}$ -watt. | $L_1$ — 20-hy. 175-ma. filter choke.                                 |
| $C_3$ — 0.01 $\mu$ fd., 400-volt.           | $R_6$ — 250,000 ohms, $\frac{1}{2}$ -watt. | $T_1$ — 5000 ohms plate to plate, secondary to match speaker.        |
| $C_4$ — 0.05 $\mu$ fd., 400-volt.           | $R_7$ — 300,000 ohms, $\frac{1}{2}$ -watt. | $T_2$ — 400-0-400 volts, 175 ma.; 6.3 volts, 4 amp.; 5 volts, 3 amp. |
| $C_5$ — 8 $\mu$ fd. 450-volt electrolytic.  | $R_8$ — 125 ohms, 5-watt, wire-wound.      |  |
| $R_1$ — 500,000-ohm potentiometer.          | $R_9$ — 150,000 ohms, $\frac{1}{2}$ -watt. |  |
| $R_2$ — 1000 ohms, $\frac{1}{2}$ -watt.     |  |  |
| $R_3$ — 1 megohm, $\frac{1}{2}$ -watt.      |  |  |

model of this receiver produced a maximum of 12 volts each side on a 25,000-ohms-per-volt meter, using the 60-volt scale.

Once aligned the receiver handles just like an ordinary t.r.f.-regenerative a.m. receiver. The regeneration control is advanced until oscillation occurs, and the signal, which is heard as a blurred whistle, is tuned in. The regeneration is then backed off until the program comes through clearly. A slight readjustment is usually necessary to tune in a station perfectly, and on weak signals the antenna coupling control should be adjusted for maximum signal strength and smoothness of regeneration.

With a quarter-wave vertical antenna local stations have been heard in the basement. With an ordinary b.c. antenna reception of f.m. stations was perfect in mid-town Manhattan, while standard broadcast stations were all but smothered under the local man-made QRN. With a

## Our Cover

THIS might have been a picture of a fighting man — the Coast Guard radioman who formerly occupied the shore-station operating billet depicted. Instead it's a photo of the SPAR who freed him for sea duty by taking over his job ashore. They're doing a tremendous job, these women reservists of the U. S. Coast Guard — especially in radio. But they need many more technically-qualified YLs as well as others without experience but interested in receiving competent training in radio operating and technique. Join the SPARS and speed the day of victory and peace!

(An official U. S. Coast Guard photograph, made especially for QST by the Coast Guard's Chicago district public relations office.)



# U.S.A. CALLING!



## ELECTRICAL ENGINEERS NEEDED BY THE SIGNAL CORPS

THE Army Signal Corps still has a need and opportunity for electrical engineers as commissioned officers, particularly those qualified in the fields of radio and electronics. Men with education and experience in these specialties are invited to apply to the Officer Procurement Service, which processes applications to fill requisitions for specialized officers from the Signal Corps and other branches of the Army.

While the appointment of officers from civilian life has been considerably reduced under recent policies of the Secretary of War, applications are urgently desired from men qualified as radio engineers and electronic physicists. These occupations, under present policy, have been classified as scarce categories, and men in this group between the ages of 22 and 45 are eligible for commission. For other branches of electrical engineering, men may be commissioned if they have reached the age of 35.

Some of these men may be assigned immediately to Army duties which they are qualified to perform by virtue of their civilian experience. Others may be assigned to special officer-training courses and technical training in electronics and high-frequency radio, in order to fill vital positions in specialized Signal Corps activities.

Persons interested in commissioned service with the Army, in accordance with the foregoing program, should apply to the local Officer Procurement District office nearest to their homes. They should not apply to the Chief Signal Officer, since the procurement function has been taken over by the Officer Procurement Service.

Address yourself to Officer Procurement District at the nearest of the following addresses (telephone numbers are shown in parentheses):

Boston: 80 Federal St., Suite 1407 (Hubbard 3760)  
Hartford: 248 Farmington Ave. (7-3281)  
New York: 50 Broadway, Room 400 (Hanover 2-5200)  
Albany, N. Y.: 90 State St. (5-8807)  
Buffalo: 290 Main St. (Madison 4132)  
Baltimore: 1144 Baltimore Trust Bldg. (Saratoga 0370)  
Philadelphia: 2442 Fidelity Philadelphia Trust Bldg. (Pennypacker 6972)  
Pittsburgh: 1710 Clark Bldg. (Atlantic 2760)  
Richmond: 612-13 Richmond Trust Bldg. (2-8117)  
Atlanta: 740 Citizens & Southern National Bank (Jackson 2046)  
Birmingham: 910 Watts Bldg. (3-7162)  
Nashville: 1131 Third National Bank Bldg. (5-0521)  
Charlotte: 505 Johnston Bldg. (4-3093)  
Columbus: 733 Huntington National Bank Bldg. (Main 7541)  
Cincinnati: 1407 Ingalls Bldg. (Parkway 8382)  
Cleveland: 740 Society for Savings Bldg. (Cherry 3578)  
Indianapolis: Post Office Bldg. (Market 1561)  
Louisville: 432 Post Office Bldg. (Jackson 1361)

Chicago: 20 North Wacker Drive, Room 1100 (Randolph 1311)

Detroit: 1300 Penobscot Bldg. (Randolph 0791)

Milwaukee: 110 E. Wisconsin Ave. (Marquette 2669)

Omaha: 410 Faidley Bldg. (Jackson 7909)

Denver: 708 Railway Exchange Bldg. (Cherry 8416)

Kansas City: 223 Porter Bldg. (Westport 5213)

Minneapolis: 375 New Post Office Bldg. (Atlanta 5565)

St. Louis: 649 U. S. Court House & Customs House (Garfield 0360)

Dallas: 1013 Santa Fe Bldg. (Riverside 6951)

San Antonio: 1001 Smith-Young Tower (Cathedral 7241)

Houston: 1640 Commerce Bldg. (Charter 6793)

New Orleans: 1102 Hibernia Bank Bldg. (Canal 4432)

San Francisco: 870 Market St. (Sutter 3304)

Los Angeles: 1418 Post Office Bldg. (Madison 7411)

Portland, Ore.: 316 U. S. National Bank Bldg. (Atwater 7421)

Salt Lake City: 449 Federal Bldg. (4-2552)

Seattle: 904 Lloyd Bldg. (Main 5450)

Washington, D. C.: 3814 Munitions Bldg. (REpublic 6700, Ext. 78405)

## OPPORTUNITIES IN THE NAVY

NAVY men in the field of radio have made an exceptional contribution to the war effort. They have operated and maintained the Navy's lines of communication, sometimes under the most trying conditions. Many of them brought previous radio experience into the Navy with them. All of them have had Navy training in radio and have attained petty officer ratings in such branches as radioman and radio technician.

Most of the Navy's radio personnel completed basic training before being assigned to a special service school for their specific training in radio work. In the Navy's radio schools they pursued courses in subjects such as theory, procedure, code, reception and transmission, if they were to become radio operators; or applied mathematics, electricity, engines, servicing and mechanical practices to become radio technicians. Many better-qualified men have been trained in new and important fields akin to radio. Many licensed amateur radio operators have used the skill and experience they acquired in their hobby to qualify them for Navy radio training and petty officer ratings in the radio field.

Radiomen in the Navy draw a great variety of assignments aboard every type of ship and in every type of shore establishment. In all cases, however, their duties are similar and consist of the operation of transmitting and receiving equipment, maintenance and care of batteries, sending and receiving messages, enciphering and deciphering Navy code messages. In addition, radiomen are able to adjust and repair direction finders and sound equipment and they must understand the basic operating principles of all Navy radio and electrical equipment.

Petty officer ratings and monthly base pay vary

according to the proficiency and experience of the individual as follows:

RADIOMEN	
Chief Radioman .....	\$138
Radioman, first class .....	114
Radioman, second class .....	96
Radioman, third class .....	78
RADIO TECHNICIAN	
Chief Radio Technician .....	\$138
Radio Technician, first class .....	118
Radio Technician, second class .....	96
Radio Technician, third class .....	78

Practical knowledge of value to men interested in radio and related ratings includes electricity, radio and sound, vacuum tubes, typewriting, plane geometry, relative motions. Nothing, however, can take the place of actual experience in both operating and repair work. Voluntary enlistment of men between the ages of 18 and 37 years, inclusive, is prohibited under an executive order of the President. However, Navy Recruiting Stations have full details on opportunities for men in the Navy and on procedures for induction through Selective Service.

The Women's Reserve of the U. S. Naval Reserve is accepting women for training as radio operators. WAVES are assigned only to shore establishments within the continental limits. Full information on the Women's Reserve is also available at Navy Recruiting Stations.

#### ELECTRONICS TRAINING GROUP

ALMOST every month we have had an item on the Electronics Training Group of the Signal Corps. This group is now going full blast and doing very important work. We recommend it to the amateurs who can qualify: age limits, 18 to 35, combat physical condition, graduates of an accredited college either in science with a major in electronic physics or in EE. It seems there are still many eligible men who are contemplating ETG but who have not yet applied because they are in a deferred draft classification. There is one new development of interest: In the past, the arrangement was that if a man made application and meanwhile was inducted, he could still be commissioned. This is now changed and the candidate must actually receive his commission before he does his induction notice, or he is out of luck. It therefore behooves anyone thinking of applying to do so at once.

For full particulars, give data on yourself to G. W. Bailey, 2101 Constitution Ave., N.W., Washington, D. C.

#### OTHER COMMISSIONS

COMMISSIONS are still available in the Navy, the Signal Corps and the Marine Corps for well-qualified men who can take on radio duties ranging all the way from service with communication and special troops to design work in headquarters offices. We have an item in this department about the Signal Corps' need for electrical engineers. Please see also our items last month, page 39. Briefly:

The Marine Corps is commissioning for its Aircraft Warning Service, which is an euphonious

term for the word they won't let us mention. Action with troops, after special technical training. College graduates with either degrees or special training in the appropriate subjects, ages 20 to 45. Particulars from The Commandant, Headquarters, U. S. Marine Corps, Washington; or advice from G. W. Bailey (address below).

The Navy offers commissions in three technical groups, as we mentioned last month, with particulars available from The Commandant of your Naval District, or advice from Mr. Bailey. Applicants must possess a college engineering degree and be between 18 and 45 years of age.

Mr. Bailey can also tailor some jobs to fit well-qualified candidates over 35 years of age, at various places in the armed forces, various kinds of radio duties. Candidates must be either college-bred engineers or possess long experience on the technical side of commercial radio. Write him.

#### RADIO ENGINEERS AND PHYSICISTS

THE President of ARRL, George W. Bailey, with wartime duties at the Office of Scientific Research & Development, 2101 Constitution Ave., N.W., Washington, D. C., is in position to engage in confidential correspondence with engineers and physicists who would like to investigate quietly the possibility of employing their higher skills in a manner that would make the maximum contribution toward the winning of the war. There is a very serious need for top-drawer brains in the technical leadership of this most technical of wars. It is known that many men who are well connected are not convinced that they are doing their full duty or that they are altogether indispensable to their present enterprises, and that they would relish an opportunity to discuss the possibilities with a competent official of the government if that could be done in a manner which would hold no embarrassment to their present connections. This arrangement has been set up for that specific purpose. Previous references to this subject occurred on page 35 of March *QST*, and page 39 of the April issue. Well-trained engineers and physicists are invited to see the previous articles and to address themselves to the personal attention of Mr. Bailey at the address given above.

#### TECHNICAL & SCIENTIFIC AIDS

MEN and especially women are sought to fill positions as Technical & Scientific Aids in the Federal Government. They are needed to do research and testing in eight fields, included in which are radio, physics and math. These are Civil Service positions with five pay grades running from \$1620 to \$2600, plus about 21 per cent for overtime.

Applicants may qualify through experience or education. For the assistant grade, at \$1620, applications will be accepted from persons who have completed one year of paid experience or a war-training course approved by the U. S. Office of Education. One year of college study, including one course in the field selected, is also qualifying. Persons now enrolled in war-training

or college courses may apply, subject to completion of the course. For the four higher grades, successively greater amounts of education or experience are required.

The majority of the positions are in Washington, but some will be filled in other parts of the country. There are no age limits, and no written test is required. Applications and complete information may be obtained from the Civil Service Secretary at any first- or second-class post office, from the regional offices of the Civil Service or from its main office in Washington.

See also our notice on page 40 of the April issue about trainee positions in technical and scientific work in Washington. While receiving \$1440 a year plus overtime, eligible trainees are taught the necessary technique for work in government laboratories. The only educational requirement is that the applicant must have completed one high-school credit in physics, chemistry, math, biology or general science.

### COMMERCIAL OPPORTUNITIES

THERE is no slacking off of calls for radio personnel from defense industries and Civil Service. During the past month there have been requests for radio instructors for Army schools, broadcast engineers with first-class radiotelephone licenses, a production superintendent for a new radio factory, women radio technicians with amateur licenses, radio inspectors and intercept officers for FCC, plus assorted kinds of radio engineers, laboratorians and maintenance men for foreign and domestic employment with commercial concerns. By the time you read this, these positions will have been filled but new ones are coming in almost daily. If you are unemployed or not employed at your highest skill, by all means register with the League Personnel Bureau. Typewrite the information required on the Registration of Personnel Availability, page 38 of October 1942 *QST*, or we will send you a blank on request.

For the information of those registering, we furnish your name to the employer as available and meeting his general requirements. The employer then writes you for detailed information and all subsequent correspondence takes place between employer and prospect. We do not enter into it. However, we do ask that you advise our Personnel Bureau promptly if you do or do not accept employment so we may incorporate this information with your registration and remove your name from the active file if you are no longer available. This will make room for other men.

The need for experienced radio personnel, especially college graduates with electrical engineering or communications degrees, or men with commercial radio licenses, is particularly pressing. Employment of service men and amateur licensees in production and inspection capacities by radio manufacturers continues. We are glad to recommend men for positions of their highest skill but we cannot recommend untrained men for specialized jobs calling for previous experience.

For instance, the possession of an amateur license does not in itself mean that the licensee is a qualified theory instructor. Previous teaching experience, education, age and an ability to impart knowledge are contributing factors. If you are uncertain of the type of employment for which you are best suited, we will examine your registration carefully and grade it according to the information you furnish. But register NOW!

### ENLISTED WOMEN

THE various branches of the armed forces are going great guns with their women's auxiliaries. Very good opportunities exist in these services for a licensed YL operator, and excellent radio training is available for those who do not yet know much about radio but wish they did. Regulations vary slightly amongst the different services, particularly as concerns age limits, marital status, etc., but their general functioning is the same: women in uniform, with skill in communication, relieve a man in uniform for duty on a hotter front. There are the Army's WAACs, the Navy's WAVES, the Coast Guard's SPARS and the Marine Corps' Marines. Many of them offer opportunities for officer candidates. You may investigate their offerings locally, find the one in which you can make the greatest contribution or which has the greatest appeal to you. The particulars are available from the local recruiting offices of the Army or Navy.

### TEACHERS

THERE are many opportunities for instructors in radio operating, radio engineering and electrical engineering, available in civilian capacities with the military and naval forces. For details, write your qualifications to G. W. Bailey, 2101 Constitution Ave., N.W., Washington, D. C.

### V-7 IN THE NAVY

JUNIORS and seniors in college, at least 18 years old and under 28, and who are majoring in engineering, physics, naval architecture, mathematics and electronics, are eligible to enter the Navy under the V-7 program. Candidates must be single and must sign an agreement not to marry until commissioned.

The procedure for joining V-7 is as follows: Applicant must go to the nearest Naval Officer Procurement Office and ask to be given an examination for V-7. His qualifications will be examined and, if qualified, he will be given a letter to his draft board saying that he is acceptable to the Navy for a commission. Applicant should then deliver this letter to his draft board and apply for induction into the Navy if the quota is not already filled. He will then be inducted into the Navy as an apprentice seaman in V-7 and will remain on inactive status until he is graduated from college. At that time he will be sent to midshipman school as an apprentice seaman for approximately 30 days and as a reserve midshipman for approximately 90 days. At the end of that time he will be commissioned an ensign and will be ordered to such duty as the Navy designates.

# WERS in the New Haven Warning District

## Some of the Problems of District Net Operation

As related by

**EDMUND R. FRASER,\* W1KQY**

to

**CAROL A. KEATING,\*\* W9WWP**

If you're interested in watching a successful district net function, a Sunday evening at WJLH in New Haven should provide just the thing you're looking for! The state radio aide of Connecticut, two members of the headquarters gang and an FCC engineer are all unanimous in their approval of the New Haven Warning District WERS net operation.

The New Haven Warning District received its WERS license on November 5, 1942, after quite a few headaches in planning the details, followed by many trial-and-error constructional sessions by Ed Fraser, W1KQY (the hard-working SCM of Connecticut and district radio aide for New Haven); John Mongillo, W1IGT, and Alfred R. Spose, W1MNZ (two of the several ingenious technical men at WJLH).

It is hoped that this description of WJLH and the little kinks that were solved in the process of making it a functional reality will be of help to others engaged in organizing district nets.

### Organization

The New Haven Warning District net includes six towns and one city, with a total of 33 transmitters and 54 licensed operators. The associate radio aides appointed by these communities are all ARRL Emergency Coördinators. They are: New Haven, W1BHM; West Haven, W1AGT; Hamden, W1JQK; East Haven, W1LTZ; Bran-

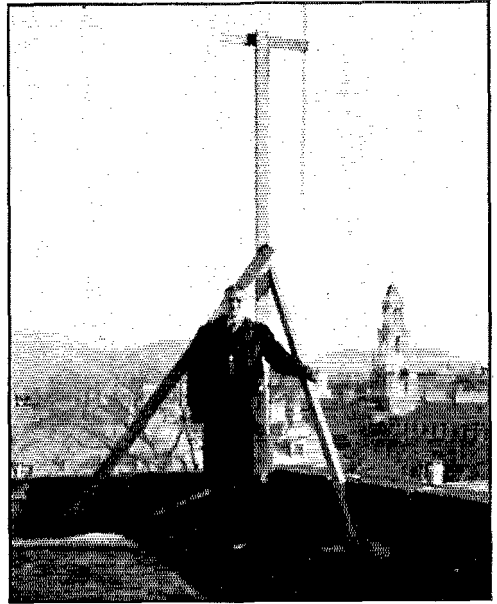

Ed Fraser, W1KQY, district radio aide, and the vertical dipole antenna used at the control station.

ford, W1BW; Guilford, W1KAT, and Madison, W1IJ. There are ten other prospective town stations in the warning district, where hams are working zealously to find suitable equipment so that they may complete the roll call of active WERS stations in the New Haven Warning District net. By the time this goes to press, the number of transmitters licensed will number 45 or 48 and the total number of operators in the district will total about 200.

\* 48 Willow St., New Haven, Conn.

\*\* Assistant Communications Manager, ARRL.

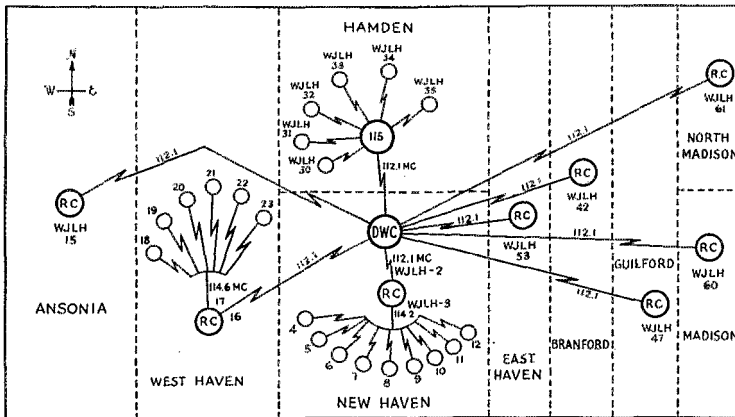

Map of the New Haven warning district, showing d.w.c. and report centers in the net.

The report centers or control points in those towns already operating each have one unit on 112.1 Mc., which is the frequency of the warning district net. The three largest of these (New Haven, Hamden and West Haven) have additional units on their town frequencies. These are, respectively, 114.2, 115.0 and 114.6 Mc. It is to be noted that New Haven has the most remote frequency of the lot. This is because it was desired to have



simultaneous transmission by both units at the report center control point, without interference with units of other towns. Consideration had to be given to the harmonic frequencies of the police transmitters operating frequency-modulated transmitters in the same building or very close by. Some interference between units in towns near each other was reported at first, but this was remedied by reducing power or using reflectors, and by allowing a spread of 400 kc. between town frequencies.

### Equipment

Experimental work in connection with the type of antenna to be used at the control station began immediately after receipt of the license. It resulted in the use of a vertical dipole to eliminate directional effects. This vertically-polarized "Q" antenna, using a quarter-wave matching section and a 500-ohm untuned transmission line, is working out very satisfactorily.

Guilford and Madison, two towns located about 25 miles away from the district control station in New Haven, are using multi-element arrays with very consistent success in transmitting to New Haven. This is of particular interest because of the fact that New Haven is surrounded by some good-sized hills.

Open-wire transmission lines are used almost entirely throughout the net. Paraffin-dipped wooden spreaders are used in most instances, as some of the transmission lines must be woven around fire escapes, building windows, etc., for 160 feet. Pieces of wooden "2 by 4" fastened to the buildings with lag bolts make effective supports for the radiating portions.

With two exceptions, the equipment in use at the WERS stations in the New Haven District is commercially built. In general, separate circuits are used for the transmitter and receiver, the oscillator tube being modulated. When the problem of what to substitute for the difficult-to-obtain HY-75 tubes arose during construction

of the units, it was found after some experimentation that if the base were removed from a 7A4 tube and the size of the grid resistor changed, it functioned as an excellent substitute, with very good stability, on reduced power. The transmitter at the district control station operates crystal-controlled on a frequency of 112,064 kc. It was designed and built by F. E. Brooks, W5JLZ — ex-W9WSK (an electrical engineering instructor at Yale University).<sup>1</sup>

### Frequency Measurement

Frequency measurement presented another problem. At first a 7 Mc.-output frequency meter was used at the main control station, but it was abandoned because of the weak harmonic output. A crystal-controlled crystal-switching frequency meter with 2 watts output on 112 Mc. was then constructed. The crystals used (supplied by the hams themselves and from other sources) have frequencies which offer a 200-kc. spread on 112 Mc. A month's operation has proved this new frequency meter to be very satisfactory in operation.

In use, receivers are calibrated against the frequency meter and transmitters brought to the desired frequency by cross-checking with other stations. All the dial settings have been carefully recorded and will be examined after a time to test whether the individual units may be left unchanged over a period of time and still maintain their original tuning. If so, it is planned to remove the transmitter tuning dials, thus making the job of inexperienced operators a simpler one.

### General

All of the transmitters and receivers are vibrator powered, and are operated from 6-volt batteries. A.c. supplies have been added, with relays for automatic switching from a.c. to vibrator in the event of failure of utility power.

At the report center station each of the units is housed in a neatly-constructed wooden cabinet, the top door of which folds down to serve as an operating desk. These cabinets are, of course,

*(Continued on page 80)*

<sup>1</sup> Brooks, "A Crystal-Controlled Transmitter for WERS," *QST*, April, 1943, p. 36.

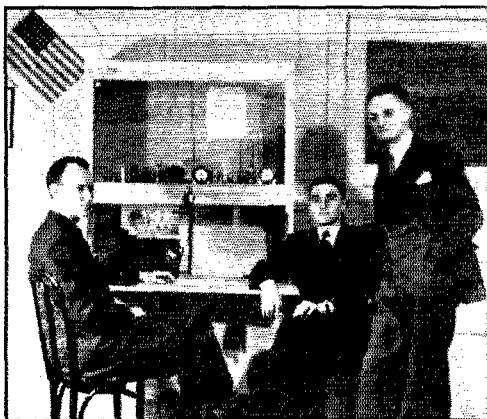

Above — F. E. Brooks, W5JLZ; Ed Fraser, W1KQY, and Walter M. Shorthouse, W1JQK, shown at the district control station position. Right — C. Bronson Weed, W1BHM, city radio aide for New Haven, operating at the local net control station, WJLH No. 3.

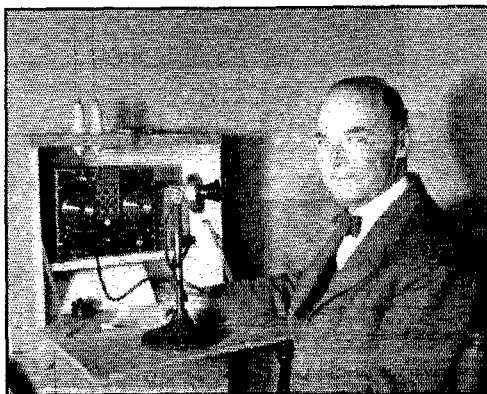

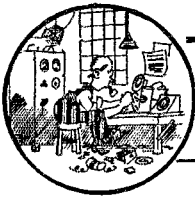

# EXPERIMENTER'S SECTION

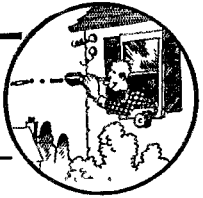

Address correspondence and reports to ARRL, West Hartford, Conn.

## PROJECT A

### *Carrier Current*

I HAVE followed all the articles on c.c. operation to date and would sure like to swap findings with someone. Here in the San Joaquin Valley I haven't been able to locate anyone else interested in the project. The XYL and myself are building up a couple of rigs and contemplate some field checks if we can't do anything else. If anyone around here is interested in c.c. experimentation, I wish they'd get in touch with me. —A. F. Weber, W6RLJ, 704 Woodrow Ave., Oildale, Calif.

Carrier-current experiments here continue with success. We thought we were on 160 kc., but a check with a Midwest receiver showed we had picked the wrong harmonic for calibration and that we were actually operating on 215 kc. So others beware! I'll correspond with anyone on c.c. — Arthur Grant, W5KHH, 405 Hilten St., Monroe, La.

Since I am interested in carrier-current transmission, I would like to know if there is anyone in my locality who is experimenting with this means of communication. — Steve Yaniv, 2113 Concord Ave., Youngstown, Ohio.

I have been doing a little work with carrier current but do not, as yet, have a rig going, although I have all the necessary apparatus. I do have a receiver which I think lots of the fellows interested in c.c. would like to know about, since it no doubt will be quite easy to procure. This receiver is an old Crosley all-wave b.c. receiver, Model 1014. It has one stage of r.f. and 11 tubes in all. It covers a range in frequency of 100 kc. to approximately 23,000 kc. in 5 bands. It makes a very fine ham receiver as well as a c.c. receiver. The lowest-frequency band, covering the c.c. frequencies, has a range of approximately 100 kc. to 360 kc.

Most fellows interested in obtaining one of these receivers should be able to find one in the basement of some radio repair shop, since it came out in 1935. They can be bought very reasonably, probably for much less than a converter can be built.

If there are others in the Norfolk area interested in c.c. operation, I would like very much to have them communicate with me, since I have been unable to find any hams or anyone else hereabouts interested enough to get a rig going. — R. F. Sanders, W7W3BFD, 547 Clifton St., Berkley, Norfolk, Va.

## PROJECT F

### *Supersonics*

THE recent interest of radio amateurs in supersonics has brought up the question of a simple means of producing and detecting supersonic sound waves. The magnetostriction rod lends itself very well to this problem. The following is a description of a magnetostriction oscillator which can form the transmitting end of a supersonic communications system. The receiving end can be another magnetostriction rod with suitable pick-up coil and amplifier. References to supersonic receivers can be found under the bibliography.

In Fig. 1, a magnetized rod is shown rigidly supported at the center and having a coil wound around it. If now this rod is lengthened or shortened by applying tension or compression, a voltage will be induced in the coil during the deformation process. Allowing the rod to return to its original length will, of course, again induce a voltage but of reversed polarity. If, then, this rod is continually vibrated transversely, an a.c. voltage, the frequency of which will be the frequency of the vibrating rod, will be induced in the coil. One way to vibrate the rod is to allow sound waves to strike its ends. At one particular frequency, the rod will resonate and maximum induced voltage will be produced. If the rod is supported in the middle as shown, there will also be frequencies at every odd multiple of the fundamental at which the rod will resonate.

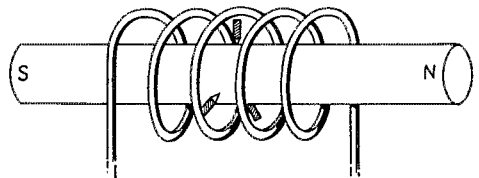

Fig. 1. — Magnetostriction rod in coil.

The action just described can be reversed. A voltage can be fed into the coil and the rod will vibrate lengthwise at the frequency of the applied voltage. In this case, sound waves will be radiated from the ends of the rod. As before, maximum points of vibration, and consequently maximum sound intensity, will occur at the fundamental period of the rod and at every odd multiple thereof. This affords a convenient device for

producing supersonic sound waves. The problem is then to set the magnetostriction rod to vibrating, preferably at its resonant frequency.

One method of producing oscillations in a magnetostriction rod is to allow it to excite itself in much the same manner of operation as a crystal oscillator. The oscillations will then occur at the resonant frequency of the rod or one of its harmonics. A circuit for doing this is shown in Fig. 2. The magnetostriction oscillator is essentially a tuned two-stage amplifier, the input of which is received from  $L_1$ , coupled to the vibrating magnetostriction rod, and the output of which drives the rod through  $L_2$ . The grid coil,  $L_1$ , and the plate coil,  $L_2$ , are shielded from each other and their polarity is such that if there were coupling between the coils it would be degenerative. Hence, the oscillator will oscillate only when the magnetostriction rod is in place.

The tuned circuit which determines the harmonic at which the rod will vibrate is composed of the inductance,  $L_3$ , and capacitors,  $C_3$  to  $C_{13}$ . Electrical output may be taken from the plate of  $V_2$  through the coupling condenser,  $C_{16}$ .  $V_2$  may be a 6F6 or similar tube. A neon bulb is connected across the output to indicate the presence of oscillations.

If the rod were not magnetized it would tend to shorten every time a flux was set up in it, regardless of the direction of this flux. This would cause the rod to vibrate at twice the frequency of the exciting voltage. Therefore, in Fig. 2, some method must be provided for magnetically polarizing the rod. This is done with the aid of the push-button switch,  $S_1$ , which can be momentarily pressed. This operation causes a high current to flow through the coil  $L_3$ , magnetizing the rod. The magnetic polarization is maintained by the normal plate current through the coil.

The materials best suited for magnetostriction rods are the alloys of iron containing nickel. Common names for such alloys are Invar, Stoic Metal, and Nichrome. Of these, a Nichrome rod is the best oscillator. Rods from  $\frac{1}{8}$  to  $\frac{1}{2}$  inch in diameter are most easily handled. The velocity of sound in Nichrome is about  $1.96 \times 10^5$  inches per second, and so the following equation can be written:

$$(\text{Nichrome}) = 1.96 \times 10^5 / f$$

Since the rod is a half-wavelength long at its fundamental period of oscillation,

$$\begin{aligned} L &= 1.96 \times 10^5 / 2f \\ &= 9.8 \times 10^4 / f \end{aligned}$$

where  $L$  is in inches and  $f$  in cycles per second. For example, the length of a rod whose fundamental frequency is 20 kilocycles is given by,

$$\begin{aligned} L &= 9.8 \times \frac{10^4}{20 \times 10^3} \\ &= 4.9 \text{ inches} \end{aligned}$$

With this oscillator it is possible to secure magnetostrictive oscillations over a range of from 5 kilocycles to 50 kilocycles. With one 5-kilocycle rod it has been possible to produce strong oscilla-

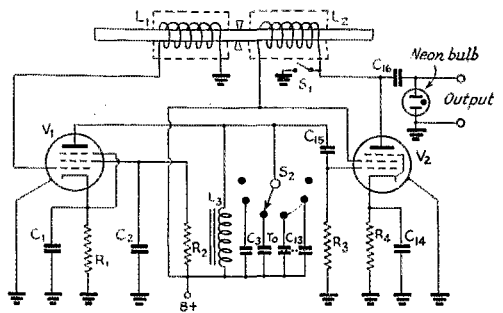

Fig. 2 — Magnetostriction-oscillator circuit.

$C_1$ — 10 $\mu$ f., 25-volt.	$R_1$ — 820 ohms.
$C_2$ — 0.01 $\mu$ f., 400-volt.	$R_2, R_3$ — 150,000 ohms.
$C_3$ — 22 $\mu$ f.d.	$R_4$ — 470 ohms.
$C_4$ — 100 $\mu$ f.d.	$L_1$ — 1200 turns No. 36
$C_5$ — 330 $\mu$ f.d.	d.s.c., $\frac{5}{8}$ -inch di-
$C_6$ — 560 $\mu$ f.d.	ameter, $\frac{1}{2}$ -inch
$C_7$ — 0.001 $\mu$ f.d.	long.
$C_8$ — 0.0018 $\mu$ f.d.	$L_2$ — 2400 turns No. 36
$C_9$ — 0.0027 $\mu$ f.d.	d.s.c., $\frac{5}{8}$ -inch di-
$C_{10}$ — 0.0039 $\mu$ f.d.	ameter, $\frac{3}{4}$ -inch
$C_{11}$ — 0.0047 $\mu$ f.d.	long.
$C_{12}$ — 0.0068 $\mu$ f.d.	$L_3$ — 0.25 to 0.5 henry.
$C_{13}$ — 0.01 $\mu$ f.d.	$S_1$ — Push-button switch.
$C_{14}$ — 10 $\mu$ f., 25-volt.	$V_1$ — 6SJ7.
$C_{15}$ — 0.01 $\mu$ f., 400-volt.	$V_2$ — 6F6 or similar tube.
$C_{16}$ — 0.01 $\mu$ f., 400-volt.	

tions on all odd harmonics up to and including the ninth. The stability of the magnetostriction oscillator is remarkably good with no temperature compensation. By the combination of two metals having opposite temperature coefficients, one in the form of a rod pressed into a tube of the other, a temperature stability can be obtained which approaches that of a crystal. For supersonic work the end of the rod can be coupled into an exponential horn and directive effects obtained. If the frequency is relatively high, the horn becomes quite small (about 4 inches long at 20 kc.). For a more complete discussion, refer to the references given in the bibliography.

### Bibliography

"Magnetostriction Oscillators," by G. W. Pierce. *Proceedings of the IRE*, Volume 17, No. 1, page 43.

"Improved Magnetostriction Oscillator," by G. W. Pierce and A. Noyes, Jr., *Journal of the Acoustical Society of America*, Volume 9, page 185, 1938.

"Apparatus for Acoustic Research in the Supersonic Frequency Range," by A. Noyes, Jr. and G. W. Pierce. *Journal of the Acoustical Society of America*, Volume 9, page 205, 1938.

"Supersonic Measurement of the Directional Characteristics of Horns," by Stanford Goldman. *Journal of the Acoustical Society of America*, Volume 5, page 181, 1934.

— W. P. Bollinger, W3JDF

### MISSING IN ACTION

Albert C. McArthur, W9VBI, Villa Park, Ill.  
2nd Lt. T. P. Douglas, G3BA, R.S., Daventry, England.

# Recording Telephone Conversations

*An Inexpensive Amplifier for Use with Office Dictating Machines*

BY GEORGE GRAMMER,\* WIDE

WITH so much business being transacted via telephone a more or less permanent record of an important telephone conversation frequently becomes a desirable thing to have. Memories sometimes are short, and hastily-jotted notes often are not completely intelligible later when questions come up as to the exact nature of telephoned instructions or the wording of a voice-transmitted document.

The Dictaphone Corporation makes a suitable recorder, but like many items of electrical equipment it is obtainable only on rather high priorities. Anything of the sort must have three main divisions, a pick-up device for getting voice from the telephone line, an amplifier and a recorder. All of these are familiar ground to the amateur. This description of a homemade set-up is offered with the thought that some hams in industry can put their knowledge and handicraft to work in supplying a need — or at least a convenience — which otherwise could not be filled.

Of course the usual type of home recorder making disc records can be used. If a permanent record is wanted, this is perhaps the preferable way to do it, since the discs are not fragile and can be stored in a relatively small space. However, in this instance an alternative method, mak-

ing the records on the wax cylinders of an ordinary office dictating machine, was available. After some consideration of both methods the question was decided in favor of the dictating machine, for the principal reason that the running time of the wax cylinder is about twice as long as that of an ordinary record blank of reasonable size. But there were subsidiary advantages as well; the records could easily be reduced to writing by means of the regular transcriber, and since the recording machine was already installed it would be unnecessary to make a separate turntable-cutter installation. The chief disadvantage was the fact that it would be necessary to convert the output of the amplifier to sound before it would be possible to record, since the dictating machine is not electrically operated.

As for the amplifier, the principal requirements are sufficient gain and power output, and an a.v.c. system which will hold the output level at the optimum recording intensity regardless of wide variations in the intensity of the "local" and "distant" voices. Frequency response is not much of a consideration, since any reasonable choice of circuit values will reproduce everything either the telephone line or recorder will handle.

If a disc recorder is used, the output stage of the amplifier should be designed to give the power required by the particular cutting head on the assembly.<sup>1</sup> For making Dictaphone records a single pentode provides more than enough power: consequently the amplifier shown in Fig. 1 ends up with a 6F6. To a considerable extent the gain required in the preceding stages depends upon the voltage available from the pickup device, but an additional consideration is the fact that more gain must be provided than is actually used so that the a.v.c. will have a chance to work effectively. After some preliminary tests the stage line-up shown in Fig. 1 was considered to meet the requirements. The first stage, using a 6J7, provides high gain and has its output coupled to a 6L7 gain-control tube. Although this second stage also is inherently capable of considerable gain, in actual use it amplifies only when the signal is weak. The third stage, a 6C5 or 6J5, boosts the signal to a value suitable for the grid of the 6F6. The whole set-up is capable of handling fairly weak signals: with some pick-up arrangements it would readily be possible to eliminate the triode stage.

## Automatic Gain Control

The 6SQ7 provides a separate amplifier stage for the a.v.c. circuit and also incorporates the

<sup>1</sup> DeSoto, "How Recordings Are Made," *QST*, September, 1942.

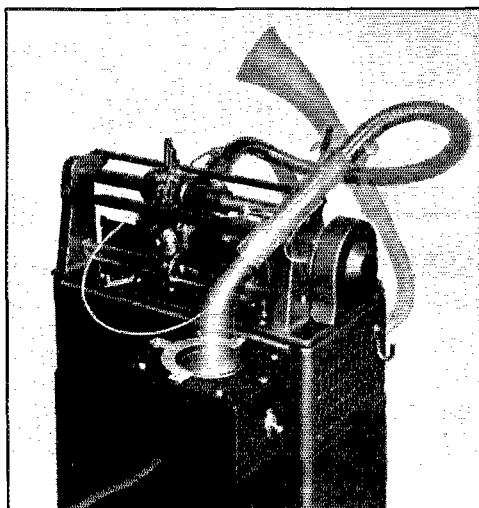

The speaker and control switch are contained in a 3 × 4 × 5-inch box which mounts on the rear of the Dictaphone. The semi-circular metal piece is mounted above the case by washers just thick enough to allow the lip of the mouthpiece to fit snugly under it. The weight of the hand grip and tube prevent any tendency on the part of the mouthpiece to slip out of position.

diode needed for rectification of the audio signal to obtain control voltage. A separate amplifier is quite desirable even though its gain may not be needed, since it isolates the rectifier circuit from the speech channel and thus prevents distortion from the unsymmetrical load offered by the rectifier to the source of audio voltage. The audio voltage to operate the a.v.c. amplifier is taken from the grid circuit of the 6F6 by means of the volume control,  $R_{12}$ . The triode section of the 6SQ7 is resistance-coupled to the diode section, and the rectified output is then filtered and applied to the injection grid of the 6L7.

With proper adjustment of the gain and a.v.c. controls ( $R_4$  and  $R_{12}$ , respectively) it is readily possible to hold all signals at the same average output level except during the short periods when the a.v.c. is trying to "catch up" with a sudden strong signal. The time constant of the filter, which consists of condensers  $C_{10}$  and  $C_{11}$  with resistors  $R_{14}$ ,  $R_{15}$  and  $R_{17}$ , must be adjusted for satisfactory operation in this respect. If the time constant is short the a.v.c. will go into action rapidly, but the gain will vary between words or even syllables and produce a rather annoying wobble in intensity. On the other hand, if the time constant is made long enough to eliminate the wobble there is some danger that the gain will not recover rapidly enough to catch a weak interjection from the distant voice; also, a sudden strong signal may blast the amplifier for a syllable or two before the control voltage builds up. The values shown in Fig. 1 have proved to be a satisfactory compromise. It was necessary to divide the filter into two sections to

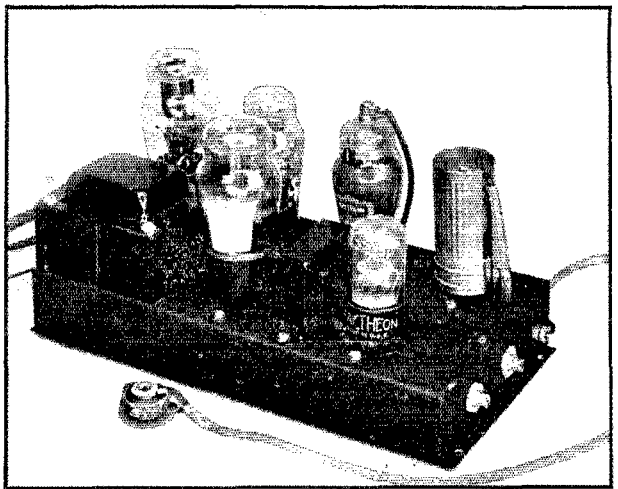

A view of the amplifier unit, with self-contained power supply, on its 5 × 9-inch chassis. The power transformer, rectifier tube, filter choke and a.v.c. tube are along the front edge, from left to right. The first speech amplifier is in the rear right corner, followed (going to the left) by the 6L7 control tube, triode third amplifier, and pentode output tube. The a.v.c. and volume controls are on the right-hand edge, with shafts sawed off short and slotted for screwdriver adjustment. The terminal at the rear is for a ground connection.

prevent instability and to assure adequate suppression of the rectified audio component. If any of the rectified audio gets through to the 6L7 injection grid it mixes with the signal to produce distortion, hence it must be eliminated.

The ideal a.v.c. characteristic possibly would be one which went into action instantaneously and had a delay in recovery sufficient to prevent the wobble. It is possible to get faster initial action, with no effect on the delay, with a slight modification of the resistance-coupled circuit, but in this particular case a form of instability resulted when the gain was high (no signal). Since the records were quite satisfactory with

Fig. 1 — Recorder amplifier circuit diagram.

- $C_1, C_9, C_{13}$  — 25- $\mu$ fd., 25-volt electrolytic.
- $C_2, C_6, C_{11}$  — 0.1- $\mu$ fd. paper, 400 volts.
- $C_3, C_{14}, C_{15}$  — 8- $\mu$ fd., 450-volt electrolytic.
- $C_4, C_7, C_8, C_{12}$  — 0.01- $\mu$ fd. paper, 400 volts.
- $C_5$  — 25- $\mu$ fd., 50-volt electrolytic.
- $C_{10}$  — 0.5- $\mu$ fd. paper, 200 volts.
- $R_1, R_5$  — 1200 ohms,  $\frac{1}{2}$  watt.
- $R_2, R_9$  — 2 megohms,  $\frac{1}{2}$  watt.
- $R_3, R_{14}$  — 0.5 megohm,  $\frac{1}{2}$  watt.
- $R_4, R_{12}$  — 0.5-megohm volume control.
- $R_6, R_{11}$  — 0.1 megohm, 1 watt.
- $R_7, R_{16}$  — 0.1 megohm,  $\frac{1}{2}$  watt.
- $R_8$  — 15,000 ohms, 1 watt.
- $R_{10}, R_{15}$  — 5000 ohms,  $\frac{1}{2}$  watt.
- $R_{13}$  — 500 ohms, 1 watt.
- $R_{15}, R_{17}$  — 0.25 megohm,  $\frac{1}{2}$  watt.
- $L_1$  — 40-ma. filter choke (8 to 12 henrys).
- $T_1$  — Power transformer, 250 v. d.c. at 40 ma., 6.3-volt, 2 amp., and 5-volt, 2-amp. fil. windings.
- $T_2$  — Output transformer, 7000 ohms to voice coil.
- $S_1$  — S.p.s.t. toggle switch. Pick-up coil — See text.

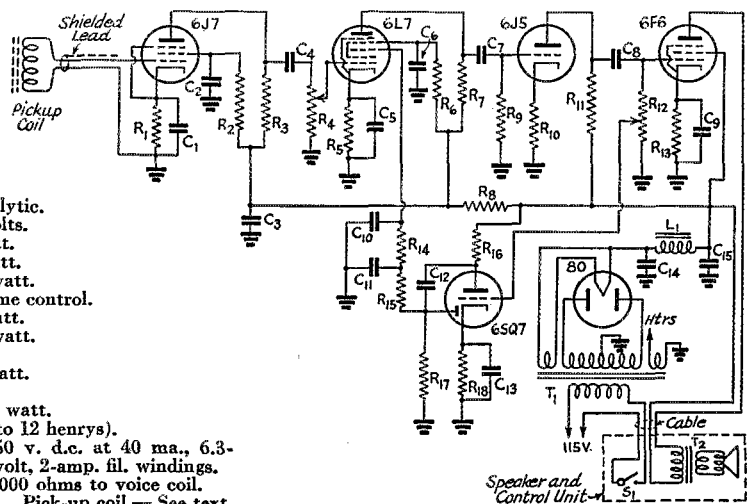

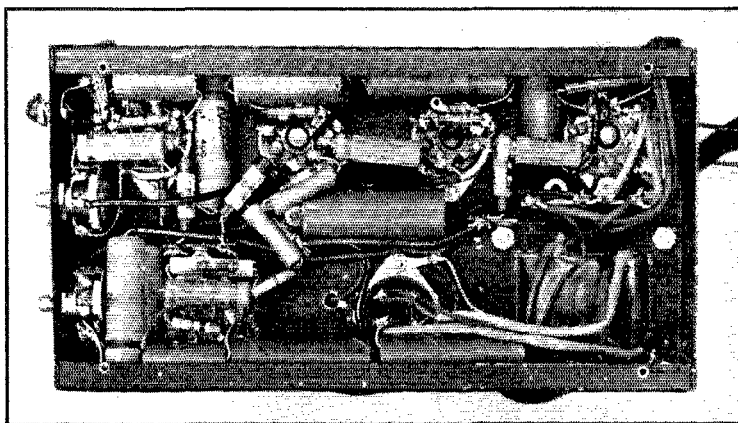

In this below-chassis view the sockets for the speech tubes are lined up along the bottom. Placement of parts is not critical; in this case, the layout was largely dictated by the necessity for finding room for the larger condensers.

respect to blasting with the circuit shown, no further work was done on this point. Still more rapid initial action can be secured by using transformer coupling between the amplifier and rectifier, but although this was tried in a separate circuit and worked out according to theory, it was found that too rapid action had a somewhat unpleasant effect to the ear on play-back.

#### Pick-Up

In most localities any sort of connection to the telephone line is illegal, so direct use of the voice currents in the 'phone circuit is out of the question. The Dictaphone device uses a pick-up coil which is simply placed outside the 'phone box in such a way that maximum voltage is induced from the coil that is installed in each box (or installed in the base of the newer type desk 'phones). We used the same idea, but did not make a special coil for the purpose. Good results were obtained with coils varying from 25-mh. r.f. chokes (shown in the photograph) to 300-henry iron-cored inductances. In general, the higher the inductance the greater the induced voltage, although this may not be true of inductances having closed iron cores and hence lower susceptibility to outside fields. Inductances of large value also have considerably greater sensitivity to hum fields than the smaller coils. A coil having an inductance of the order of 25 to 100 millihenrys will pick up relatively little 60-cycle hum; such hum as is present usually is the result of electrostatic rather than electromagnetic pick-up. This can be reduced to a low level by shielding the line between the pick-up coil and the amplifier proper.

The construction of the two units comprising the installation is shown in the photographs. The amplifier and speaker were separated so that the part which had to be mounted on the dictating machine could be as small as possible, and also to allow using a short lead between the pick-up coil and the amplifier. A four-wire cable carries audio output to the speaker and provides a line for the 115-volt control switch mounted on the speaker box. The dictating-machine mouth-piece is held over the speaker opening by the

semi-circular metal piece when a recording is being made.

To put the assembly in operation it is advisable to turn the a.v.c. control to "off" and then explore around the telephone box with the pick-up coil while a telephone conversation is being carried on. One or two trials readily will locate the position which gives maximum audio voltage. The gain control,  $R_4$ , should then be adjusted so that the amplifier does not overload on strong signals, after which the a.v.c. control should be adjusted to set the output at a level which gives satisfactory recording. For very weak signals it may be necessary to boost the gain a bit and make a further adjustment of the a.v.c. control; there is some interlocking in these two adjustments, but it is not hard to find the proper settings.

Although, as stated above, there are some ways in which at least theoretical improvements can be made, the circuit shown has proved to be a practical one. It has the advantage that for the most part it can be made out of spare or junk-box components, since only the ordinary run of tubes, resistors and condensers is required. It will not make audible things that cannot be heard in ordinary telephoning, of course; it simply takes what is on the line. But with a reasonably good connection the recorder can be turned on with the certainty that what is heard in the telephone instrument can later be played back with dictating-machine intelligibility. It can help speed up telephone calls — an end now greatly desired even by the telephone company!

#### Strays

Panels of cloth, arranged in code groups on the ground, are often used for communication between ground and aircraft. In classroom demonstrations of the system, tiny Alnico magnets are now used by instructors to fasten the panels to a steel wall, saving considerable time and energy over the old method of pinning. Instructors are sometimes required to make as many as 100 changes in the course of a single class session.



# ON THE VERY HIGHS

CONDUCTED BY E. P. TILTON,\* W1HDQ

IT'S STRANGE how time can change things. In ten years of v.h.f. work we've had our share of thrills and we'd become somewhat bored with the idea of talking to anyone, even on 112 Mc., unless he was at least one hundred miles distant. But after fifteen months of inactivity we got a first-class thrill out of our initial contact from WKHF-1, even though it was only a matter of talking, via 2½, with WKHF-3 a half mile away!

Our WERS Plan is not everything we amateurs would have liked it to be, of course, and it was a mighty long time in coming. Most of us here in the Springfield district were pretty thoroughly disheartened with the seemingly-unnecessary red tape and interminable waiting before our permit came through, and we know from correspondence from all parts of the country that many others have felt the same way. But when we consider the status of the amateur in every other country now engaged in the war, it occurs to us that we are fortunate in living in the one country which thinks enough of its amateurs to have provided a definite plan for the utilization of their skill and experience in its war effort. For the WERS is essentially an amateur outfit doing an amateur job in an amateur way. We feel that everyone of us not now serving his country in uniform should be doing what he can to provide his community with WERS facilities.

At this writing close to 200 permits have been issued by the FCC, though we don't have too much news from the various licensees. The New York gang must have some good publicity connections, however—they were heard on the Columbia network some time back as contestants in the Julia Sanderson-Frank Crummit quiz show. W4FBH writes that Atlanta is now in operation under the call WKGO, with Phil Jones, W4FWD, as radio aide. From W1LSN we learn that Portsmouth, N. H., has W1CUZ as radio aide, with W1GCK and W1JWJ among the licensed operators. More are needed. The call at Portsmouth is WJSP. "Deke" French, W1JLK, is serving as radio aide for Easton, Mass., call WJQL, where they have been going strong since last November. He is also handling the radio aide assignment for the Brockton Warning District of eighteen towns, whose application is now on file in Washington. A recent addition to the fraternity in Massachusetts is the Northampton Warning District, WKKW, where Walt Barrows, W1MLU, has done a fine job as Radio Aide.

Vince Dawson, W9ZJB/W3JSL, who will probably be in the Army by the time this appears in print, brought us up to date on the Washington situation just before he left the Capital for his home town of Gashland, Mo., to answer the

\* 329 Central St., Springfield, Mass.

"call." W8KG, W3RL, and W9SMM are at RMS Navy School, and at the Navy Department Radio and Sound Branch are Lt. Comdr. Bill Conklin, W9BNX, Lt. (jg) Bob Haskins, W4DRZ, and Lt. (jg) Web Wilson, W1QB. Wilmer Allison, W5VV, is now a lieutenant colonel in the Air Corps, and he has W5EEX somewhere helping him win the war. Vinde's old DX partner, W9VWU, of Topeka, Kan., graduated from Kelly Field as an Air Corps lieutenant.

W8QXV, now a first lieutenant in the Medical Corps, writes that W8FGV is still somewhere in India. He says that Frank's only complaint is that, even with a big V-beam, he still gets bad fading and flutter on his reception of U. S. broadcasts. Frank's QTH appeared in these pages some months back. Doc may be addressed as follows: Lt. Harry S. Berlesky, M. C., Billings General Hospital, Fort Harrington, Ind.

Vernon Russell, W1NCQ, having graduated from the USNR school at Ward Island, Corpus Christi, Tex., was retained as an instructor. Vern relates that the supply of amateurs and others with radio "know-how" seems to be just about exhausted. This shows up in the necessity for repeated slowing-down of the instruction at Ward Island, especially in lab periods, while students who have had no previous radio experience acquire the knack of working around radio gear. W1NCQ, who used to be on Five from Leicester, Mass., may be addressed as Vernon H. Russell, ART 2/c, USNR, Instructors Barracks, Ward Island, Corpus Christi, Tex.

From his sister, who got her amateur license too late to get a call along with it, we learn that W1LOW, formerly of Athol, Mass., is now a flight radio operator for Pan American Airways Africa, Ltd., on the continent of Africa and in India. Vic used to make a lot of noise on Five in days gone by with a 150-watt mobile rig which he'd cart up to the summit of Mt. Wachuset.

W1LSN reports a concentration of amateurs at the Portsmouth Navy Yard, including W1s E1O 1WV LB BCP DZJ JOG CKY AMP GQA LKP GKK LLA GRI KEX EUH KAS HA and W8BHY. At the Somersworth Branch are W1IWU and W1LBJ. W1MDN, formerly on Five at Amesbury, Mass., is now Pvt. Al Kaski, 27th Ferrying Squadron, N.C.A.A.B., Wilmington, Del.

—•••—

Some nice f.m. DX was heard by W4FBH in mid-December. On the 15th, the first of several nights in a row when the band was open, conditions reminded Roy of happier days on Five and Ten, when DX was not confined to listening. Detroit was heard first, and then the opening

(Continued on page 32)

# HAPPENINGS OF THE MONTH



## BOARD AGENDA

THE ARRL Board of Directors expects to have its annual meeting in Hartford on May 7th, as usual. It is the Board's custom to publish in May *QST* each year the known items of business on the hook, inviting members to write to their directors on these and related matters. It is to be assumed that the Board this year will be concerned chiefly with the future of amateur radio; but the items available for cataloging as actually being on the Board's docket at the time we go to press are few in number and relate to some changes in the By-Laws on which advance proposals have been made:

It is proposed that if no eligible nominee be named for director or alternate in our elections during the war, the incumbent shall serve for another two years.

Another proposal has for its purpose the establishment of a flexible arrangement whereunder the Board would be able, at its own discretion, to dispense with its meetings for the duration of the war or to hold a meeting whenever desirable. There is no option at present, the Constitution requiring a meeting in May each year.

A third proposal would provide that, for the duration of the war, a member serving in the armed forces, and who fails to renew his membership, will not make himself ineligible to hold office in the League, so far as the League requires continuity of membership to be eligible for SCM or director, provided membership is renewed within ninety days after hostilities have ceased.

Members may be sure that their respective directors will be pleased to hear from them with comments and suggestions for the betterment of amateur radio.

## THE AMATEUR'S WAR RECORD

FOR the future of amateur radio, it is highly desirable that ARRL headquarters have statistics on what the amateur is doing in this war. For that purpose, and that purpose alone, we are endeavoring to compile a record of all hams serving in the armed forces or elsewhere in the government's service. As the League's field covers both Canada and the United States, we're as much interested in VEs as we are in Ws and Ks. While we particularly desire the dope on amateurs in the armed forces and the merchant marine, we equally want the information on those in war-radio work in the Civil Service. And by amateurs, we mean those with operator license only as well as old-timers with station calls.

We print on this page a form which may be either cut out or reproduced. This lists all the information we need — we don't want any data that may be restricted. That much, however — with some indication of who you are and what you're doing — is highly necessary to look after our future interests. Won't you do your part by reporting in to ARRL headquarters? Such a report also serves the incidental purpose of supplying data for mentions in our department with those "In the Services."

## RENEW YOUR LICENSE!

WE can't tell you all the reasons why we believe it to be very good business for every amateur to maintain a valid amateur operator license and to take all of the customary steps toward the maintenance of a station license. Suffice it to say that there are reasons. Sixty days in advance of the expiration of your licenses you should apply for the renewal of both station and operator license;

## AMATEUR WAR SERVICE RECORD

Name

Present mailing address

Rank or rating

Branch or bureau: Signal Corps, AAF, Buships, WAVES, etc.

Call, present or ex; or grade of op-license only

### SERVICE

- Army
- Navy
- Coast Guard
- Marine Corps
- Maritime Service
- Merchant Marine
- Civil Service



---

## ★ BOOK REVIEWS ★

---

and if you change address, you should immediately apply for the modification of both of them. You get the form from any district office of the Commission, but you mail it direct to FCC in Washington, attaching your existing license. The Commission will renew or extend your operator license. They won't act similarly as concerns your station license, and the station side of your new ticket will be marked void, but the application will be in their file and it will protect your amateur status.

Be smart and don't let your license expire!

### TRANSMITTER TUBES NEEDED

THE broadcasting stations of the country are having difficulty obtaining power tubes and are asking amateurs to sell theirs. When a ham tube goes onto a job like this, a new bottle in any event is spared for military use. Since we do not register tubes in the ARRL Apparatus Bureau, we ask amateurs who are willing to sell their power tubes to address themselves direct to the National Association of Broadcasters, attention Howard S. Frazier, Director of Engineering, 1760 N Street, N.W., Washington, D. C., listing the type, age and price desired, with all pertinent data on condition. NAB forwards the information to the broadcasting stations and you will hear direct from those who want to buy.

### REX ROBERTS REELECTED

IN a delayed special election for alternate director, the members of the Northwestern Division again chose R. Rex Roberts, W7CPY, as their No. 2 for 1943-44. Mr. Roberts received 243 votes and his opponent, Orpheus U. Tatro, W7FWD, received 96. Mr. Roberts is manager of the Mountain States Telephone & Telegraph Company at Glendive and Wibaux, Montana.

### METER PROGRAM ENDED

THE ARRL activity which resulted in the collection of thousands of milliammeters of amateurs for the Signal Corps has now ended, and every amateur who sent in a meter should now either have been paid or received his meter back again if it was rejected. That is, in all but the following two mix-ups, almost inevitable in a program as large as this one:

Record of ownership has been lost on one Triplett 321 milliammeter accepted by the Signal Corps. We owe somebody \$3 but don't know who. Will owner please identify himself and claim the three bucks by properly describing the other characteristics of the unpaid-for Triplett?

All thermocouple meters were rejected, but we have one, a Jewell, not yet returned because ownership record has been misplaced. Owner may have it back, with our apologies, by identifying himself through a description of the other characteristics of the meter.

Incidentally, although no tubes were solicited in this program, we have found an RCA 865 tube with no identification of owner. Will the owner please identify himself and let us return it?

**Principles of Radio**, by Keith Henney. Published by John Wiley & Sons, New York. 549 pages, 5½ × 8; illustrated. Price, \$3.50.

"Principles of Radio" for many years was almost the only "intermediate grade" general radio text available — not over-simplified for popular consumption nor adopting the style of treatment and details characteristic of the elementary engineering text. In this fourth edition Mr. Henney has hewed to the line set out at the beginning, so that the book is still more or less in a class by itself as to method of approach.

The general plan of the book is much the same as that of previous editions; the modifications are chiefly in the line of modernizing the illustrations and in clarifications of the text, where necessary, with new material accounting for about fifty additional pages as compared with the preceding edition. About half the text deals with the fundamentals of electricity and vacuum tubes, the other half with amplifiers, receivers, transmitters, power supplies and antennas. Ample problem material is included to give practical application to the points discussed, and we are glad to note that these too have been considerably revised to eliminate some of the ambiguities that arose in the previous edition.

**Mathematics, Its Magic and Mastery**, by Aaron Bakst. Published by D. Van Nostrand Co., New York. 790 pages, 6 × 9; illustrated. Price, \$3.95.

A popular-style book on elementary mathematics, including number systems, arithmetic, algebra, logarithms, mensuration, and trigonometry. While not a home-study course, it presents a great deal of information in entertaining style. It is filled with practical examples and interesting sidelights, historical and otherwise, which ordinarily never come to the surface in the regular study of mathematics.

The past few years have seen the publication of several books of the same general nature, the purpose being to present mathematics in as interesting a light as possible, in contrast to the ordinary textbook which seems too frequently to go to the opposite extreme. Everyone who has occasion to use mathematics ought to read at least one book of this type, even if it covers no processes new to him. Such reading will result in the acquisition of a new viewpoint which cannot help but put more meaning in the more or less mechanical processes by which specific problems are solved.

— G. G.

**What You Should Know About the Signal Corps**, by Harry M. Davis and F. G. Fassett, jr. Published by W. W. Norton & Co., Inc., New York. 214 pages (including topical index), 5¼ × 8; illustrated. Price, \$2.50.

The latest in a group of "practical handbooks of important information about our war services" issued by this publisher, "What You Should Know About the Signal Corps" is designed to acquaint both the civilian and the serviceman with this vital branch of the service, recently characterized by Gen. Olmstead as "the keystone of the whole military arch." In attempting to fulfill their purpose the authors have included information of just about every category from the early history of communication to predictions concerning the future of radio and electronics. While the result has the obvious defect of including material which may seem superfluous to certain classes of readers, the book as a whole is a worth-while exposition of the background and present functions of the Signal Corps. All classifications of Signal Corps work are discussed in some detail, including wire and radio communications, photography, visual signaling, carrier pigeons and meteorological observation.

An "official" publication (one of the authors being an employee in the Office of the Chief Signal Officer), the viewpoint is distinctly that of the Signal Corps. Other branches

(Continued on page 80)

# Beat Response

## A Frequently-Overlooked Cause of Interference

BY G. EDWARD HAMILTON,\* W6GSS

IT HAS frequently been observed that there exists a "sum" and "difference" frequency between two broadcasting stations. The writer recently had occasion to investigate a case of interference arising from the operation of WILL on 580 kc. and WDWS on 1400 kc. The difference frequency is  $1400 - 580$ , or 820 kc., while the sum frequency is  $1400 + 580$ , or 1980 kc. Since the sum and difference frequencies are both produced by the same process, the discussion will be limited to the difference frequency only.

We recall that it is necessary to have a "non-linear" circuit element present to produce any

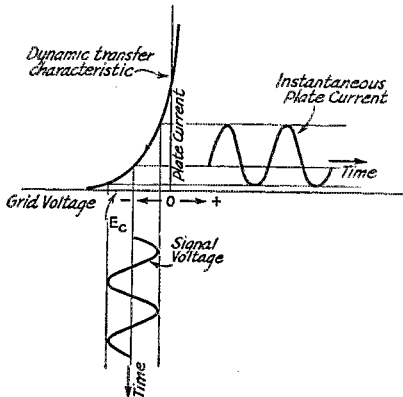

Fig. 1 — Typical rectifier characteristic, essential to the production of beats. The plate current waveshape differs from that of the signal applied to the grid, indicating non-linearity.

sum or difference frequency. To review the effects of linear and non-linear circuit elements, let's consider the case of the first detector in a superheterodyne. Why have a first detector? A first detector is used so that the input signal will "mix" or beat with the oscillator signal and produce the intermediate frequency. To make this occur, the first detector is operated so that the output is not an exact replica of the input signal voltage applied to the grid, but approaches the result shown in Fig. 1. In other words, the detector is operated on a curved portion of the grid-plate transfer characteristic of the tube; that is, the graph showing the relationships existing between instantaneous grid voltage and plate current. A tube operated in this manner is a non-linear circuit element, and this non-linearity *must* be present for the production of sum and difference frequencies. Examples of non-linear circuits are the crystal detector, vacuum tube detectors, Class-B ampli-

\* 602 South Vine St., Urbana, Ill.

fiers, Class-C amplifiers, the old iron-filing detector and the copper-oxide rectifier. The Class-A amplifier is theoretically a linear circuit element.

We may therefore conclude that if a sum and difference frequency are present there *must* be a non-linear circuit element somewhere in the transmitting-receiving circuit. A few of the possible non-linear elements which were considered when the difference frequency of 820 kc. was discovered are:

(1) The signal from one station being picked up by the other final stage, amplified, and radiated as a spurious frequency. This obviously is a very remote possibility.

(2) Poor antenna or ground connections which, with the action of the elements, produce a rectifying system similar to the copper-oxide rectifier.

(3) If the first stage in the receiver has a non-linear characteristic, and if the grid circuit tunes broadly, sufficient signal strength could produce the frequencies under question. It is well known that no vacuum-tube amplifier actually has a straight-line relationship between the instantaneous grid voltage and plate current, but only approaches this ideal condition.

The equipment used to check this spurious radiation was a battery-operated loop receiver, a series-parallel wave trap and a coupling loop which was used in conjunction with the receiver loop. A battery receiver was used so that it would be isolated from power-line effects, and also to eliminate possible non-linearity from poor antenna connections. Fig. 2 shows the input circuit to the receiver.

It was found that, when the receiver was tuned to the "difference" frequency in the open (away from all tall conductors), the signal was not present, but that when the receiver was brought near any tall conducting medium such as grounded vertical antenna supports, grounded lightning rods, gutter downspouts, etc., the signal became quite strong. It was also observed that

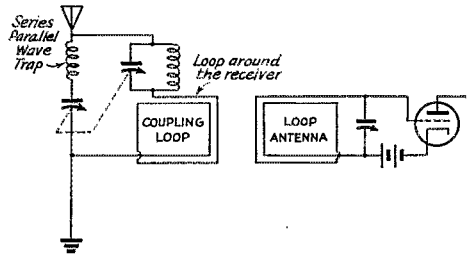

Fig. 2 — Receiver set-up used in tests for ascertaining the cause of beats.

the re-radiated signal fell off rapidly in strength when the receiver was moved away from the radiator — approximately inversely as the square of the distance.

In the case of one grounded vertical antenna support the ground connection was removed and the coupling loop and the wave trap inserted in series with the ground and the support. With the receiver tuned to 820 kc., it was found that, as the wave trap was tuned to first one station and then the other, the "difference" frequency of 820 kc. diminished in strength, and also that when the trap was tuned to the "difference" frequency the strength fell to a new low. From the appearance of the corroded ground rod it was assumed that the electrical connection to the ground was not good, thereby producing a non-linear element.

When the receiver was tuned to 820 kc. and a horizontal antenna was connected in series with the pick-up loop of the receiver, the wave trap, and a good ground system, it was found, as the wave trap was tuned to first one station and then the other, that the "difference" frequency was practically eliminated. When tuned to the "difference" frequency no drop in signal strength was observed, indicating that the beat of 820 kc. was being generated in the first r.f. stage of the receiver.

From the above results we may conclude that if a poor ground exists a non-linear condition results, since the same type of rectifier as the old iron-filing detector or copper-oxide rectifier is present. If the ground system is good, and the "sum" and "difference" frequency still exists, we may conclude that the circuit in the receiver is not linear and therefore produces the beat between the two frequencies under consideration.

"Difference" frequency interference in the broadcast band can be caused by an amateur station operating, for example, on 1850 kc. and a broadcast station operating on 750 kc. The difference would be 1850 - 750, or 1100 kc. Or an amateur station operating on 1850 kc. and a broadcast station operating on 1100 kc. would give a differ-

(Continued on page 68)

## Ho-Hum

### A "Hey, Marge!" Story

You have at last completed that ideal 100-watt 'phone and the results have exceeded your fondest hopes. There is only one minor flaw in it, which will, of course, respond to simple remedies. Reports agree that you have HUM.

Painstaking effort has gone into the design, layout, selection of components, construction and wiring, and so the trouble obviously is caused by some minor oversight which can be quickly recognized.

You are methodical. You carefully search the text books and other literature, listing in order all the possible causes of hum. You solicit advice during each contact and add these suggestions to your list. Hay-wire methods are not to be

tolerated in this dream rig! At last you have a complete set of data on the cause and cure of hum.

The next step is to check off those items which were satisfactorily incorporated in the original layout. You then proceed to correct or improve every doubtful condition.

The shielded mike cable is examined and a new connection made to the plug. The jack is carefully shielded and the shield grounded. The grid lead receives the same treatment. A new and improved type of gain control is installed at a cost of \$1.65. The power line cord is by-passed to ground at wall receptacle and chassis. Filament leads are by-passed to ground and centertaps are also grounded. Audio transformers are moved apart and placed at critical angles to each other. Eight microfarads of capacitance are added to the filter. Such factors as load resistance and impedance matching are all recalculated and verified. Current and voltage measurements are made in

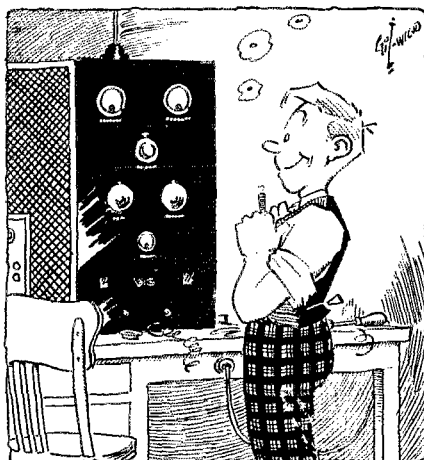

"YOU PONDER FOR A MOMENT ON WHAT THAT GANG OF HECKLERS DOWN AT THE CLUB WILL SAY ABOUT THIS RIG"

all involved circuits. Condensers and resistors are inspected and tested for short and open circuits.

In short, you do everything possible, within the range of your limited but efficient laboratory equipment, which might detect or remedy defects.

You eat a cold dinner, forget a dentist appointment, burn your left index finger on the soldering iron, blow a filter condenser and miss an important sked bud, when it is over, you reflect that it was worth it. You inspect your handiwork with a feeling of pride and ponder for a moment on what that gang of hecklers down at the club will say about *this* rig.

W3YQZ is calling CQ. You answer, and wait impatiently for your report.

"You're putting in a swell signal over here, old man, but you seem to have considerable hum. However, you can probably clear a little thing like that up without any trouble."

"Hey, Marge, what picture are they showing at the Strand to-night?" — *Whit, W3IBX*

# IN THE SERVICES

**T**HIS month, what with three groups graduating from the Signal Corps OCS at Ft. Monmouth in addition to the usual correspondence, we are practically all Signal Corps. Perhaps you have noticed that the department is back to three pages on account of the paper situation, but we're making up for it by using smaller type. Don't worry; we will list you — so keep writing.

What's happened to the Marine Corps? After last month's article, you should be all the more anxious to keep your names in the mag. Come on and let us know!

Again read "Happenings of the Month" and be sure you are on record.

## ARMY—SIGNAL CORPS

**LT. FREDERICK F. YUNCK, W9KDH** (temporarily a "G-2" overseas with the Electronics Training Group), puts in a good plug for the ham fraternity. "All amateurs I've met are doing well and marking up points on the credit side of the ledger. ARRL and amateur radio should emerge from the war stronger than ever."

1BGW, Berman, Master Sgt., Ft. Monmouth, N. J.  
1BLA, Grenier, Cpl., Shreveport, La.



A couple of Hudson Division hams "somewhere in England!" On the left, Major David Talley, W2PF, and on the right, Major Robert E. Hertzberg, W2DJJ — both in the Signal Corps. W2PF writes us regularly and we'd say he isn't missing anything over there! Even to copying code on the mill, all in the day's work.

1DOP, Coderre, 2nd Lt., Ft. Monmouth, N. J.  
1FZX, McAllan, Lt., Ft. Monmouth, N. J.  
ex-1HAG, Lacy, Pvt., Ft. Jackson, S. C.  
1HRA, Symonds, Sgt., foreign duty.  
1IKS, Handleman, Lt., Cambridge, Mass.  
1IUX, Hamson, Master Sgt., Camp Claiborne, La.  
1KCP, Saltus, 2nd Lt., Ft. Monmouth, N. J.  
1KJQ, Baker, Lt., foreign duty.  
1KPF, Thebado, Master Sgt., Framingham, Mass.  
1KQT, Hornak, Staff Sgt., foreign duty.  
1KYG, Apostolos, 2nd Lt., Ft. Monmouth, N. J.  
1LEA, Lasonde, Staff Sgt., foreign duty.  
1LQF, Vogel, Staff Sgt., foreign duty.  
1LTA, Calfain, Staff Sgt., Ft. Monmouth, N. J.  
1MJF, Hastings, T/4th, foreign duty.  
1MUT, Nathan, Cpl., Ft. Monmouth, N. J.  
1NJZ, Phillips, 2nd Lt., Ft. Monmouth, N. J.  
1NLR, Jordan, 2nd Lt., Ft. Monmouth, N. J.  
1NR, Carles, Staff Sgt., Ft. Monmouth, N. J.  
1NSS, Barnard, 2nd Lt., Ft. Monmouth, N. J.  
1NUP, Anderson, Sgt., South Boston, Mass.  
KA1RR, Arbis, Staff Sgt., foreign duty.  
ex-2AQF, Conway, 2nd Lt., Ft. Monmouth, N. J.  
ex-2AVS, Lang, Pvt., Ft. Jackson, S. C.  
2CEK, Van Winkle, Pvt., Ft. Jackson, S. C.  
2CGC, Rokosky, Cpl., Ft. Myer, Va.  
2DBY, de Jager, Pvt., Camp Forrest, Tenn.  
ex-2DZM, Hoffman, 2nd Lt., Ft. Monmouth, N. J.  
2EPG, Kraszewski, Pvt., Ft. Myer, Va.  
2FWB, Brynes, 2nd Lt., Ft. Monmouth, N. J.  
2GLD, Miesel, 2nd Lt., Ft. Monmouth, N. J.  
2GMV, Haas, 2nd Lt., Ft. Monmouth, N. J.  
ex-2GTE, Winick, 2nd Lt., Ft. Monmouth, N. J.  
2HBJ, Lillvik, 2nd Lt., Ft. Monmouth, N. J.  
2HMR, Burns, 2nd Lt., Ft. Monmouth, N. J.  
2HVC, Dube, T/4th, address unknown.  
2HZQ, Stolpensky, Sgt., foreign duty.  
2IHO, Huether, T/4th, address unknown.  
2IQD, Black, 2nd Lt., Ft. Monmouth, N. J.  
2IXZ, Broanan, Pvt., Washington, D. C.  
2JLE, Brodie, 2nd Lt., Ft. Monmouth, N. J.  
2JRB, Leopold, foreign duty.  
ex-2JRO, Strimple, 2nd Lt., Ft. Monmouth, N. J.  
2KBR, Filiak, 2nd Lt., Ft. Monmouth, N. J.  
2KLD, Held, Staff Sgt., foreign duty.  
2KOD, Dodge, Tech. Sgt., foreign duty.  
2KRF, Gulatsi, Pvt., Ft. Monmouth, N. J.  
2KVK, Haugk, Pvt., Ft. Jackson, S. C.  
2LAD, Kiem, 2nd Lt., Ft. Monmouth, N. J.  
2LAU, Rebell, 2nd Lt., Ft. Monmouth, N. J.  
2LOC, Grey, Cpl., Athens, Ga.  
2LRD, Stirberg, Staff Sgt., address unknown.  
2MDY, Jones, 2nd Lt., Ft. Monmouth, N. J.  
2MEQ, Galston, Pvt., Ft. Jackson, S. C.  
2MNE, Littleton, 2nd Lt., Ft. Monmouth, N. J.  
2NNB, Weber, Pvt., Ft. Monmouth, N. J.  
2NUS, Rutherford, Pvt., foreign duty.  
2OCM, Rizzo, Ft. Monmouth, N. J.  
2OKJ, Kovalski, T/4th, Camp Murphy, Fla.  
3ASB, Dressler, 2nd Lt., Ft. Monmouth, N. J.  
ex-3BDA, Gould, 2nd Lt., Ft. Monmouth, N. J.  
ex-3BKS, Beatty, 2nd Lt., Ft. Monmouth, N. J.  
ex-3BPI, Lester, Lt., Camp Cooke, Calif.  
3CVA, Doerfein, Pvt., Camp Crowder, Mo.  
3FXV, Miller, T/5th, Chicago, Ill.  
3FYV, Staffy, Lt., Ft. Monmouth, N. J.  
3GSL, Petrilli, 2nd Lt., Ft. Monmouth, N. J.  
3HCJ, Bik, 2nd Lt., Ft. Monmouth, N. J.  
3IVN, Carr, Tech. Sgt., foreign duty.  
3JKI, Boice, 2nd Lt., Ft. Monmouth, N. J.  
KA3RA, Page, 2nd Lt., Ft. Monmouth, N. J.  
4AEZ, Griffin, Sgt., Jackson, Miss.  
4CZH, Hanson, Sgt., foreign duty.

4DNV, Riles, Pvt., Camp Pinedale, Calif.  
 4EJH, Anderson, 2nd Lt., Ft. Monmouth, N. J.  
 4ETB, Thomas, 2nd Lt., Ft. Monmouth, N. J.  
 4FKX, Wood, 2nd Lt., Ft. Monmouth, N. J.  
 4GMJ, Patrick, Lt., Camp Breckinridge, Ky.  
 4GNV, May, Tech. Sgt., foreign duty.  
 4HLB, Cooley, Lt., Ft. Benning, Ga.  
 4HLX, Pickering, Lt., foreign duty.  
 4JUJ, Kersey, Sgt., foreign duty.  
 4MV, Settle, Capt., foreign duty.  
 K5AM, Monti, 2nd Lt., Ft. Monmouth, N. J.  
 5BIO, Lewis, 2nd Lt., Ft. Monmouth, N. J.  
 5DSE, Cobb, 2nd Lt., Ft. Monmouth, N. J.  
 5EBB, Gaston, Major, Barksdale Field, La.  
 5EIW, Thornton, 2nd Lt., Ft. Monmouth, N. J.  
 5EWF, Schulte, 2nd Lt., Ft. Monmouth, N. J.  
 5FXF, Moseley, T/4th, Camp Beauregard, La.  
 5GSR, Kautz, Sgt., foreign duty.  
 5HYI, Harvill, 2nd Lt., Ft. Monmouth, N. J.  
 5HZE, Alexander, 2nd Lt., Ft. Monmouth, N. J.  
 5IGE, French, T/4th, foreign duty.  
 5ILF, Balch, Cpl., foreign duty.  
 5JJO, Humphries, Staff Sgt., Kansas City, Mo.  
 5KDY, Porter, Staff Sgt., foreign duty.  
 5KKK, Roberts, Staff Sgt., Camp Breckenridge, Ky.  
 5KQC, Schmidt, 2nd Lt., Ft. Monmouth, N. J.  
 6AAK, Lopez, Sgt., foreign duty.  
 6BNQ, Flugge, Staff Sgt., foreign duty.  
 6BV, Lake, Lt., Ft. Monmouth, N. J.  
 6CZP, Webster, 2nd Lt., Ft. Monmouth, N. J.  
 6EZZ, Woolcock, Capt., Indiantown Gap, Pa.  
 6EAS, Fitzgerald, 2nd Lt., Ft. Monmouth, N. J.  
 6FTE, Lincoln, 2nd Lt., Ft. Monmouth, N. J.  
 6KBK, Blair, Lt., Ft. Monmouth, N. J.  
 6KVI, Johnson, 2nd Lt., Ft. Monmouth, N. J.  
 6MBY, Townsend, Master Sgt., foreign duty.  
 6NUY, Nalley, Pvt., Camp Crowder, Mo.  
 K6PDQ, Robinson, Master Sgt., foreign duty.  
 6PQV, Gwynn, Cpl., Presidio of Monterey, Calif.  
 6RXN, Von Bargaen, 2nd Lt., Ft. Monmouth, N. J.  
 6UAD, Wickenkamp, 2nd Lt., address unknown.  
 6UHY, Gaw, Staff Sgt., Ft. Monmouth, N. J.  
 6UJJ, Hughes, T/3rd, foreign duty.  
 K7BTM, Lind, 2nd Lt., Ft. Monmouth, N. J.  
 7EYR, Thurston, 2nd Lt., Ft. Monmouth, N. J.  
 7FAW, Sawin, 2nd Lt., Ft. Monmouth, N. J.  
 7GDB, Johnstone, Pvt., Camp Kohler, Calif.  
 7GVD, Williams, Pvt., Athens, Ga.  
 K7GVV, Welcker, 2nd Lt., Ft. Monmouth, N. J.  
 7HPB, Peters, Pvt., foreign duty.  
 7HYI, McKeon, 2nd Lt., Ft. Monmouth, N. J.  
 K7IO, Moore, T/4th, foreign duty.  
 ex-7IPK, Narloch, 2nd Lt., Ft. Monmouth, N. J.  
 7IQN, Smith, 2nd Lt., Ft. Monmouth, N. J.  
 K7IVS, Henson, 2nd Lt., Ft. Monmouth, N. J.  
 8AUM, Gertz, 2nd Lt., Ft. Monmouth, N. J.  
 8AV, Bohannan, Col., Columbia, S. C.  
 8BFF, Kahn, Cpl., Stout Field, Ind.  
 8BKR, Gilmour, 2nd Lt., Ft. Monmouth, N. J.  
 8CGI, Sawyer, 2nd Lt., Ft. Monmouth, N. J.  
 8DAM, Andrew, Cpl., Ft. Meade, Md.  
 8EMP, Horian, Lt., Ft. Myers, Fla.  
 8FJN, Lindley, Capt., foreign duty.  
 8HDM, Covell, Chicago, Ill.  
 8IHG, vom Scheidt, 2nd Lt., Ft. Monmouth, N. J.  
 8LEY, Drodziak, Lt., foreign duty.  
 8LZQ, Morris, Cpl., Ft. Monmouth, N. J.  
 8MAM, Harris, 2nd Lt., Ft. Monmouth, N. J.  
 8MGD, Dively, 2nd Lt., Ft. Monmouth, N. J.  
 8MHH, Stuart, Lt., address unknown.  
 8NBB, Anderson, 2nd Lt., Ft. Monmouth, N. J.  
 8OSE, Oliver, 2nd Lt., Ft. Monmouth, N. J.  
 8OVZ, Van Maele, 2nd Lt., Ft. Monmouth, N. J.  
 8OWF, Link, Lt., Cambridge, Mass.  
 8PFB, Miller, 2nd Lt., Ft. Monmouth, N. J.  
 8PIH, Erndt, 2nd Lt., Ft. Monmouth, N. J.  
 8PJV, Barkdull, 2nd Lt., Ft. Monmouth, N. J.  
 8PNV, Mulvey, 2nd Lt., Ft. Monmouth, N. J.  
 8PTG, Schuman, Lt., Camp Hood, Texas.  
 8PUA, Adkins, Lt., Ft. Sam Houston, Texas.  
 8PUC, Wheeler, 2nd Lt., Ft. Monmouth, N. J.  
 8QHF, Panek, Lt., Hill Field, Utah.  
 8QZU, Swartz, 2nd Lt., Ft. Monmouth, N. J.



Ten of the hams who recently graduated as 2nd lieutenants at the ESCTC, Ft. Monmouth, N. J. A happy group, all set to go out after some of that GI equipment! *Top row, l. to r.:* Nils L. Hanson, WINAM; Paul J. Sawin, W7FAW; Daniel E. Zauner, W8WMK/W2KE5; Charles McCamish, W9GGY; Gilman Welcker, K7GVV. *Bottom row, l. to r.:* Robert Chaplin, W8RCY; William Bulger, W3GYQ; John X. Mulvey, W8PNV; Marion Henson, W6NKR/K7IVS; and Robert Binford, W9LKD. *Official U. S. Army Signal Corps Photo.*

8RCY, Chaplain, 2nd Lt., Ft. Monmouth, N. J.  
 8RFU, Wight, Cpl., Warrenton, Va.  
 8SLG, Pearson, Lt., Cambridge, Mass.  
 8SRU, Rowe, Pvt., Camp Blanding, Fla.  
 8TGO, Kowall, Cpl., foreign duty.  
 8TPT, Fettig, Cpl., Rapid City, S. D.  
 8TQQ, Macomber, 2nd Lt., Ft. Monmouth, N. J.  
 8URU, Badovinac, 2nd Lt., Ft. Monmouth, N. J.  
 8VCN, Ostrow, Lt., Rapid City, S. D.  
 8VVF, Shea, Staff Sgt., foreign duty.  
 8VXS, Kelley, 2nd Lt., Ft. Monmouth, N. J.  
 8WIN, Labovitz, Pvt., Ft. Monmouth, N. J.  
 8WOY, Back, Tech. Sgt., Ft. Monmouth, N. J.  
 8WUY, Altenberg, Pvt., Clovis, N. M.  
 9ACC, Gunther, Pfc., Ft. Lewis, Wash.  
 9ACD, Ray, 2nd Lt., Ft. Monmouth, N. J.  
 9BDR, Carsner, 2nd Lt., Ft. Monmouth, N. J.  
 9BCM, Minski, Pvt., Camp Crowder, Mo.  
 9BTL, Barnes, Lt., foreign duty.  
 9CQE, Boppert, Cpl., Camp Crowder, Mo.  
 9CZB, Sweeny, 2nd Lt., foreign duty.  
 9CZJ, Smith, 2nd Lt., Ft. Monmouth, N. J.  
 9EWY, Olberg, Lt., address unknown.  
 9FJK, Gierke, 2nd Lt., Ft. Monmouth, N. J.  
 9FKZ, Bensen, Tech. Sgt., Ft. Monmouth, N. J.  
 9FQO, Reidel, Staff Sgt., Ft. Monmouth, N. J.  
 9FVN, Fairchild, Major, Miami Beach, Fla.  
 9GGY, McCamish, 2nd Lt., Ft. Monmouth, N. J.  
 9HLO, Finger, Lt., Ft. Monmouth, N. J.  
 9HMQ, Havlik, 2nd Lt., Ft. Monmouth, N. J.  
 9IIL, Buccione, 2nd Lt., Ft. Monmouth, N. J.  
 9INT, Nuckols, Lt., foreign duty.  
 9ITG, Theleen, 2nd Lt., Scotia, N. Y.  
 9JGL, Allen, Capt., Ft. Monmouth, N. J.  
 9JHC, Kohler, Cpl., Ft. Monmouth, N. J.  
 9JJK, Nocerini, 2nd Lt., Ft. Monmouth, N. J.  
 9JWB, Muggli, 2nd Lt., Ft. Monmouth, N. J.  
 9KJE, Ristow, 2nd Lt., Ft. Monmouth, N. J.  
 9KTS, Macbee, Sgt., foreign duty.  
 9LKD, Binford, 2nd Lt., Ft. Monmouth, N. J.  
 9LMP, Harding, Pvt., Camp Crowder, Mo.  
 9NJJ, Batteau, Tech. Sgt., Ft. Monmouth, N. J.  
 9NWP, Raasch, Cpl., Ft. Monmouth, N. J.  
 9NYM, Bergum, Pvt., Atlantic City, N. J.  
 9PDS, O'Neil, Lt., foreign duty.  
 ex-9PUE, Schmitz, Capt., Scott Field, Ill.  
 9PZY, Field, 2nd Lt., Ft. Monmouth, N. J.

9QK, Campbell, Sgt., foreign duty.

ex-9RHI, Keller, Pvt., Camp Cooke, Calif.

9ROF, Kozman, Staff Sgt., foreign duty.

9SEZ, Vincent, 2nd Lt., Ft. Monmouth, N. J.

9SWZ, Bachman, 2nd Lt., Scotia, N. Y.

9TEK, Fenimore, 2nd Lt., Cambridge, Mass.

9TFY, Wirt, Lt., foreign duty.

9TNO, Schafer, 2nd Lt., Ft. Monmouth, N. J.

9TPL, Strand, Pvt., Camp Crowder, Mo.

9TTR, Copening, 2nd Lt., Ft. Monmouth, N. J.

9UEC, Gordon, 2nd Lt., Ft. Monmouth, N. J.

9UGX, Childs, Cpl., Camp Crowder, Mo.

9UKF, Anthony, Lt., Cambridge, Mass.

9URO, Jackson, 2nd Lt., Ft. Monmouth, N. J.

9UUJ, Rungren, Staff Sgt., foreign duty.

9VGM, Nelson, 2nd Lt., Ft. Monmouth, N. J.

9VUM, Wise, Lt., Miami Beach, Fla.

9VW, Brooks, Lt., Drew Field, Fla.

9WGX, Davidsmeyer, Major, foreign duty.

9WHB, Rabe, 2nd Lt., Ft. Monmouth, N. J.

9WMO, Kobzina, 2nd Lt., Ft. Monmouth, N. J.

9WNV, Bahr, 2nd Lt., Ft. Monmouth, N. J.

ex-9WVN, Rindfleisch, 2nd Lt., Ft. Monmouth, N. J.

9YEG, Lambrecht, Sgt., foreign duty.

9YLS, Arbelius, Cpl., Camp Blanding, Fla.

9ZGS, Stubbs, Cpl., Ft. Monmouth, N. J.

9ZII, Entrekin, 2nd Lt., Ft. Monmouth, N. J.

Operator's license only:

Bunnell, Pfc., Edmonds, Wash.

Coile, Capt., Arlington, Va.

Hester, Sgt., Ft. Clark, Texas.

Kern, Lt., foreign duty.

Leskinen, 2nd Lt., Ft. Monmouth, N. J.

Levingston, Tech. Sgt., foreign duty.

Miller, 2nd Lt., Ft. Monmouth, N. J.

Mohn, Sgt., Biggs Field, Texas.

Schultz, Pvt., address unknown.

## NAVY—FOREIGN OR SEA DUTY

SINCE we cannot publish the location of men on ships or duty outside the continental limits of the United States, here are only their calls, names, and rank or rating:

1BBR, Kachele, RM1c; 1IHE, Ingalls, RM1c; 1MAB, Mazzoni, RM3c; 1MBX, Berry, WO; 1MQR, Covall, RM2c; ex-2BEG, Field, Lt.; 31FR, Morris, RM3c; 31FT, Fisher, RT1c; 31XY, Kane, Lt. Cmdr.; 3JJP, Haines, ARM2c; 4CRC, Bennett, Sp2c(M); 4GWW, Chrismon, RM2c; 4HC, von Dohlen, Lt.; ex-5FR, Sorensen, RM1c; 5GCJ, Lee, RT2c; 5HEJ, Robbins, RT2c; 5IBF, Skelton, RT2c; 5INL, Spencer, Lt. (jg); 5JCC, Alden, Ens.; 6CQK, Pitts, RM1c; 6MUV, McMaster, RT1c; 7FNK, Wheeler, RM2c; 7HNX, Wolf, RM2c; 7IQZ, Hensley, RM2c; 7IWL, Rose, EM2c; 7LV, Robinson, Lt.; 8AQD, Reed, RM1c; 8LVZ, Jones, CRM; 8NVH, Plummer, RT2c; 8OZA, Sievert, RM2c; 8PWL, Siverling, RM1c; 8SMW, Herr, RM2c; 8UIHF, Sampson, RM2c; 9BBV, Patton, ARM1c; 9BIS, Billett, Lt. Cmdr.; 9BQA, Eddleman, RM2c; 9HZ, Johnson, RM1c; and Elliott, RM3c; Reynolds, Ens., and Woodruff, QM1c, op. license only.

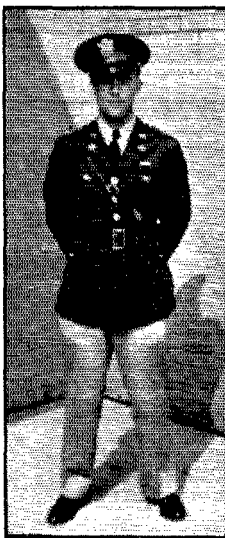

Up against a stone wall! Lt. Robert J. Potter, W2LJQ, is an instructor in electricity, radio, etc. at the Signal Corps OCS, Ft. Monmouth, N. J. Wonder if he's glad to see those hams in his classes?

## CANADA

THANKS for writing in with corrections as well as some brand new names. How about some pictures for your part of this column? Is this possible? If so, preferably in uniform, clear, and maybe with a little background!

### RCA

1IK, McKay, Capt., address unknown.  
ex-2CX, Frissick, Lt., address unknown.  
2EE, Comach, Lt. Cmdr., address unknown.  
2IO, Ashdown, Sqdn. Ldr., address unknown.  
3AEZ, Ford, Sgt., Hamilton, Ont.  
3ALU, Barker, Sgt., address unknown.  
ex-4AHC, Turner, Signalman, Prince George, B. C.  
4ATJ, Currie, foreign duty.  
5AEB, Chaney, Edmonton, Alta.  
5FG, Hoeking, address unknown.  
5MJ, Jones, Cpl., Edmonton, Alta.

### RCAF

1FW, McLeod, foreign duty.  
1HB, Howell, Sgt., Moncton, N. B.  
1HV, Murphy, P/O, Halifax, N. S.  
1KJ, Harris, P/O, Halifax, N. S.  
1LE, Stevens, Cpl., Halifax, N. S.  
1MN, Stevens, Cpl., Halifax, N. S.  
1MW, Campbell, Sqdn. Ldr., Toronto, Ont.  
1OM, Johnson, AC2, Halifax, N. S.  
2OL, Gartshore, P/O, Winnipeg, Man.  
3AAO, Williams, Sgt., Summerside, P. E. I.  
3AAR, Hitehon, Cpl., foreign duty.  
3ACR, Erdeley, F/Sgt., Saskatoon, Sask.  
3ACS, Morgan, F/Sgt., Summerside, P. E. I.  
3AHV, Brown, foreign duty.  
3AHX, Blachford, foreign duty.  
3AQN, Mann, P/O, B. C.  
3AZN, Beaumont, F/O, foreign duty.  
3EB, Crofton, P/O, Hamilton, Ont.  
3IX, Gwinn, F/Lt., foreign duty.  
3LS, Wilson, Cpl., Ottawa, Ont.  
3PF, Beck, F/O, foreign duty.  
3EQI, Overn, foreign duty.  
3VS, Bennett, Hamilton, Ont.  
3WI, Storey, address unknown.  
4ABP, Staryk, Sgt., foreign duty.  
4ACO, Thompson, Winnipeg, Man.  
4ACP, Peters, P/O, address unknown.  
4AMB, Davidson, LAC, address unknown.  
4AMC, Dollard, Sgt., address unknown.  
4BJ, Duncan, LAC, address unknown.  
4CZ, Hone, W/C, B. C.  
4EI, Coats, F/O, Winnipeg, Man.  
4FS, Leitch, F/Lt., Winnipeg, Man.  
4IF, Elliott, F/Lt., foreign duty.  
4MD, Macarthur, Sgt., Yorkton, Sask.  
4MF, Johnson, Sgt., Halifax, N. S.  
4PC, Chalmitzky, address unknown.  
4PZ, Row, address unknown.  
4QO, Mawdsley, F/O, address unknown.  
4SS, Sheffield, F/O, Winnipeg, Man.  
5UN, Dickinson, Cpl., foreign duty.

### RCCS

1DR, Mullins, foreign duty.  
1FQ, Fader, Halifax, N. S.  
ex-1EF, Foster, Sgt., Halifax, N. S.  
1JA, MacPhail, Sydney, N. S.  
2MR, Hume, address unknown.  
4AHE, Coutts, address unknown.  
4AHL, Allison, address unknown.  
4ARM, Hyman, Sgt., address unknown.  
4JE, Burton, address unknown.  
5ABV, Robbins, 2nd Lt., Kingston, Ont.

### RCN

1FN, Doull, Lt., address unknown.  
2CO, Morris, Sub. Lt., Ottawa, Ont.  
3AER, Roberts, L/Tel., address unknown.  
AGFerg, Halifax, N. S.  
4TJ, Jebb, Sub. Lt., Edmonton, Alta.  
5GS, Schuthe, Sub. Lt., Halifax, N. S.

# That's the Limit!

BY "SOURDOUGH"

**T**HERE'S one thing about being off the air; it gives a man time to think. Back in the good old days we probably didn't put enough good old-fashioned thinking into our rigs. Come a new idea in *QST* or some gadget we heard tell of at the club meeting, off we went to the old work bench and whipped us up one, for better or worse, usually the latter. Of course, a lot of fellows did work it all out, but, run of the mill, we mostly just built.

That build-as-you-go system was probably a pretty good thing. It got us through a lot of territory, and what we missed in careful planning we picked up in breadth of experience.

Now that we have an enforced layoff, though, it is a good investment to take the time to really work things out. It would be a safe bet that Ws in the Solomons, Gs in Libya and all the others — PAO, SP, LA and the rest — while away a good many hours working out one detail or another for the rig that certainly — one day — will be back on the air. I bet it is easier to wait in a foxhole for the barrage to lift when you have something to put your mind to.

Sure as I stick my head out of Pine Notch, that man Warner gets ahold of me and wants something worried out for him. Some day I'll have enough sense not to leave them thar hills. This time he wants a gimmick that will provide one hundred per cent insurance that no e.c.o. can be twisted around far enough to collect a pink ticket. Seems to me it would be mighty comforting to know that Grand Island could never find *your* signal creeping along on the wrong side of the fence.

Before you set a trap it's a pretty good idea to know what you're trying to catch. Let's first study up just what we want this thing to do. It is pretty simple. We want some positive — almost brutal — way of being pulled up short when we run into forbidden territory on either side of the band. If we could dope it out so that the transmitter was shut down when we passed the deadline, then being snapped off the air a couple of times, inadvertent-like, would probably cure our crowding of the edge.

One way would be to calibrate the e.c.o. very carefully and then put a couple of stop pins on the dial so's it could be turned no farther. Since oscillators drift, that wouldn't be entirely safe.

If mechanical stops aren't secure we are going to have to use electrical ones. Maybe we could put a pair of wavemeters, tuned top and bottom of the band, as indicators. That's not so good because the tuning of a wavemeter — short of a laboratory standard — is not reliable, and anyhow we'd probably take a chance and go too far and get bit. Let's make it really safe; a good crystal won't drift enough to matter unless it is right on the extreme thin edge of the band — which it shouldn't ought to be.

Years ago, when some of you young fellers weren't more'n knee high to a houn' dawg, Mister Jim Lamb of *QST* went and did something mighty big. The Lamb "sniggle, sniggle, snooper" crystal-filter circuit killed the big, bad QRM bug and made life a lot easier for the ham. It didn't take the commercial boys long to borrow it either — as if they knew anything about QRM!

Like the Jap in the Zero said when a P-38 opened up on him, "That which goeth up must cometh down — including me!" Likewise that what goes in a receiver should ought to go just as well in any similar circuit. Ain't nothing like admitting you don't know much and learning from a good man — especially Jim Lamb.

If you cast an eye on Fig. 1 you'll see the old familiar Lamb crystal gate fixed up for this job.

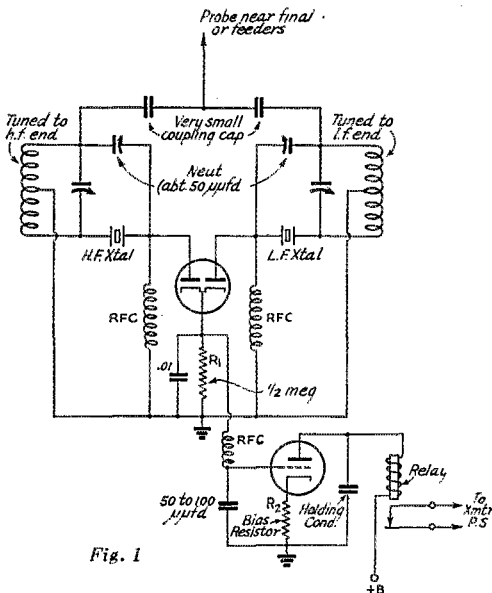

Fig. 1

It is a simple and fairly inexpensive set-up. We have two tuned circuits, hooked to crystal resonators. It will mean buying a crystal at each limit of the band. The crystals will provide good check points for calibrating the e.c.o. as well. The neutralizing condensers will be needed to balance the stray stuff that gets through the crystal-holder capacity, so we get our output only at the crystal frequency. A double diode has one plate connected to each tuned resonator. The cathodes are common and go back to ground return through resistance  $R_1$ . At the top of  $R_1$  we connect, through a suitable r.f. filter circuit, the grid of a relay tube. A 2A3 would be suitable.

(Continued on page 82)

# Who Killed the Signal?

A Radio Mystery Serial

BY CLINTON B. DESOTO,\* WICBD

## Chapter 4—"The Siamese Twin\*\* Mystery"

### Synopsis:

The characters in this story, which interprets radio principles in the guise of a detective-mystery yarn, are radio parts living on the chassis of a receiver standing silent and dark, dust-covered from disuse. The Signal is dead—murdered by an unknown hand. The Great Sleuth, an amateur detective and therefore a good one, was called in on the case, along with his three assistants—Ohm Meter, Volt Meter and Milly Am Meter. At first, lanky, brown-complexioned Power Cord seemed a logical suspect. Then Volt Meter discovered Cord's helper, Power Plug, asleep on the floor beside the wall socket—a derelict from duty. Even when Plug plugged himself in and the lights gleamed again inside the cabinet, however, the set still refused to function. Following the path of the current, the Sleuth continued his investigation, interviewing in turn Power Transformer, Rectifier Tube and finally Filter Choke and Filter (Miss "Electrolytic") Condenser. At first the rumor Ohm Meter picked up that Filter Condenser had been serving "rough" current to the set seemed like a promising lead, but then Volt and Milly Am Meter themselves tried some of the current and found it pure. Swallowing their disappointment, the Sleuth and his minions resumed their search. So complicated was the maze of wiring that the Sleuth obtained a circuit diagram—a sort of map or chart of the set. With its aid they traced the current to Output Tube, who described the amplifying process by which he made the Signal strong, and thence to Output Transformer, a very sharp character indeed, and his puppet stooge, Loud Speaker. Antagonized by Output Transformer's jive talk, the Sleuth tried unavailingly to pin the crime on him, but the sly, quick-witted Transformer talked his way clear. Thwarted but still suspicious, the Sleuth decided to begin his investigation anew at the Antenna terminal, where the Signal entered the set. The story continues. . . .

THE manhunt had come to a temporary halt. The Great Sleuth, seated on a convenient terminal strip, puffed slowly at his underslung pipe and gazed into the distance. Measuring their chief's mood, the three Meters sat around in corresponding attitudes of contemplation.

"That's the trouble with investigating a case in a strange community like this," Volt Meter broke the silence. "We don't know enough about the people—what their standards are, how they react to various impulses."

"What you mean is *you* don't know enough about 'em," Ohm Meter retorted acidly. "Now take me—I'm a born judge of character. I can analyze any circuit, even when it's only idling."

\* Executive Editor, QST.

\*\* With apologies to Ellery Queen for making triplets out of the Siamese twins (a perfectly plausible circumstance in the fantastic land inhabited by Radio Parts, where anything can happen—and probably has).



THE GREAT SLEUTH PUFFED AT HIS UNDERSLUNG PIPE

But *you* can't read a voltage unless the pressure is so great anyone with no sensitivity at all could feel it. And then the polarity has to be right!"

Stable, even-tempered Volt ignored Ohm's outburst, without replying. Milly, however, rushed to his defense. "You think you're so smart!" she cried, her pointer vibrating indignantly. "Just because Volt can't read those little microvolts, when they're so small nobody could see them without an electron microscope—especially when they wiggle up and down so many million times a second! Well, if *you're* so sensitive, why did the Sleuth have to send for those two outside operatives? Didn't you probe that Antenna Terminal for *hours* and get nothing but a short circuit?"

Ohm wagged his head reprovingly. "Now, now, Milly," he chided, an undercurrent of malice in his tone. "Don't let your emotions get the better of you. Everybody knows you and Volt are that way, but you don't have to make it so obvious!"

Milly reddened furiously, but before she could summon a retort the Sleuth interrupted. "Here they come," he announced, pointing with the stem of his pipe. Craning, they could see two strange-looking figures approaching over the flat tableland surrounding the receiver.

One was a lumbering, elephantine individual with a toothy grin and staring round eyes set wide apart. The other bore a certain resemblance to the three Meters; his face was similar but he wore a long, square-cornered polished-oak case.

The Sleuth rose to greet the newcomers. "Glad you could come," he welcomed them.



He turned to the three Meters. "This is Signal Generator," he said, introducing the larger of the pair. "And this is his associate, Output Meter. They're going to break this case—I hope."

"I hope they break their necks," Ohm growled beneath his breath. The Sleuth silenced him with a warning glance, but the remark was not lost on the new arrivals. Signal Generator's dial lighted with amusement.

"Well, let's get going," the Sleuth told them. "You fellows know what to do, so go ahead."

The newcomers turned and walked off. Output Meter began climbing the cable path to Loud



Speaker's housing, balancing himself precariously on the narrow cable. Signal Generator followed the chassis wall until he reached the Antenna and Ground entrance. Taking hold of the two terminals with the clamp-like hands extending from his braided-metal sleeves, he waited silently.

"Signal Generator is a great mimic," the Sleuth explained. "He can imitate any kind of Signal to perfection. His partner, Output Meter, is a versatile instrument equipped to register alternating current. He can follow any audio signal — modulated, code or plain language."

At this Ohm favored Volt with a derisive sneer. The latter pointedly ignored him, listening attentively while the Sleuth continued to explain.

"Signal Generator is going to send an artificial signal into the set while Output Meter watches to see if it gets through alive. If nothing comes through, we'll know that it was done away with somewhere along the way — presumably by the same Part that killed the real Signal."

"Pretty clever, at that," Volt said admiringly. "Nonsense," Ohm disagreed. "What'll that tell us that we don't know now?"

But the Sleuth's attention had been diverted. "Look — they're ready to start!" he exclaimed.

Only a faint musical sound, like middle C on a piano, could be heard in the electric silence. Output Meter's face was clearly visible as he stood just outside Speaker's housing. They watched intently, but there was no indication of response.

After a few minutes Signal Generator released the terminals and dropped his arms. "Nothing doing," he admitted. "It didn't get through."

"You mean it was ambushed along the way?" Milly asked excitedly.

"Looks that way," Signal Generator sighed.

"That means we'll have to continue by a process of elimination," the Sleuth observed quietly. "Where do we start?"

"Well, according to the book I should climb up there in the chassis, start with Output Tube and work back. Hate to do it, though — it's such a climb, and I haven't been getting much exercise lately." Signal Generator looked sadly down at his bulky frame. "Guess I'm getting lazy. I think I'll start work from this end just this once."

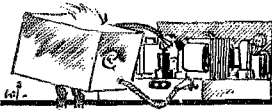

THE CLAW-LIKE FINGERS GRASPED THE TOP CAP OF THE METAL-JACKETED TUBE

With one hand he again took hold of the Ground terminal, while the other long, tentacle-like arm stretched over the top of the chassis. The stubby claw-shaped fingers grasped the top cap of a small metal-jacketed Tube near the edge.

When the powerful fingers closed over its head, R.F. Tube — identified by the Sleuth from his circuit diagram — uttered a piercing shriek.

"It's all right," the Sleuth called up. "We won't hurt you — we're just making a test."

"But I'm not used to being handled like this," the frightened Tube wailed. "Just look what you've done — you've upset my bias!"

"It'll only be for a minute," the Sleuth reassured him. Signal Generator studied the flustered Tube, then whispered to the Sleuth. "Go up there and ask him some questions, to take his mind off what I'm doing," he instructed.

The Sleuth nodded. "Would you mind telling me a little about your work for the set?" he began, climbing up on the chassis.

R. F. Tube gulped nervously. "What do you want to know?" he asked, his voice shrill.

"Just start from the beginning and tell me the whole story," the Sleuth prompted.

"Well, all right," R. F. Tube answered in a more normal voice. "To start with, you understand of course that our field contact man, Antenna Wire, picks up the Signal in the shape of an electromagnetic field which comes along in waves of varying strength and length, depending on its amplitude and frequency. And that this field induces a corresponding radio-frequency current in Antenna Wire."

"Yes, I know that," the Sleuth acknowledged. "That's why we had to call Signal Generator in on the case; we couldn't seem to find any way of detecting whether the Signal was coming in or not. But go on with your story."

"Well, as I say, Antenna Wire brings this induced current into the set through the Antenna terminal and delivers it to Antenna Coil. He's one of that row of three Parts all dressed up in shiny aluminum cans — the one on the left."

"Who are the other two?" the Sleuth asked.

"They're R. F. Interstage Coil and Oscillator Coil. I'll tell you about them a little later. First, though, I should explain that these Coils are actually members of the Transformer family — although a different branch from those iron-cored Transformers. These have air cores and can respond to the Signal's alternations even when it's in the r.f. state. They behave much like Transformers in other ways, though. Antenna Coil, for example, has two windings, induces current from one to the other, transforms impedance and voltage, and so on. By the way," R. F. Tube lowered his voice confidentially, "I wouldn't want this to get around, but — his secondary is *resonant!*"

"What does that mean?" the Sleuth asked curiously.

"Well, I don't want to gossip, but as I understand it there's some connection between Antenna Coil and the front section of those Siamese triplets over there — the Variable Condenser gang, we call them." There was a sly leer on his face.

"I don't understand," the Sleuth replied. "How can a Siamese triplet —"

"Don't ask me. But I have heard that Interstage and Oscillator are linked with the other two sections in some way, too, so there must be something to it. Of course, everyone knows that when

EVERYONE KNOWS THAT WHEN A COIL AND CONDENSER GET TOGETHER WITH JUST THE RIGHT FREQUENCY THEIR HEARTS BEAT AS ONE



a Coil and a Condenser get together with just the right frequency their hearts beat as one."

"You mean that then they're in tune?"

"Exactly. And when they get that way we call it a resonant circuit — which is why I say that Antenna Coil's secondary is resonant."

The Sleuth shrugged. "Well, if it doesn't affect his work I don't suppose it matters."

"Oh, but it does have an effect — for the better, I must admit. It boosts Antenna Coil's voltage amplification many times over that of an ordinary Transformer," R. F. Tube admitted.

"How can that be? I'm mystified."

"I'll try to explain. As you know, a Transformer operates by taking the current through his primary and inducing a corresponding voltage in his secondary. If the secondary has more turns, the resulting voltage across it will be greater than that originally supplied the primary — in other words, it will be stepped up. Right?"

"I think so. The voltage will be greater — but the current will be smaller."

"Naturally. However, while that is true in the case of an iron-core Transformer, where practically all of the flux in the primary is conducted to the secondary by the core, a fellow like Antenna Coil with his air core is at a disadvantage. Since air isn't nearly as good a magnetic conductor as iron, he can't get enough coupling between his primary and secondary to transfer more than a few per cent of the energy supplied his primary."

"Quite a handicap. How can he step up the voltage at all, if he loses most of it at the start?"

"That's where this resonance business comes in. By the way, have you read about the respective phase relationships of current in a Coil and a Condenser in George Grammer's math article on p. 19 of this issue of *QST*?"

"No, I'm afraid I haven't."

"Well, you should. He explains how it is that the current in a Coil trails behind the voltage by 90°, while in a Condenser it leads by 90°. (This shouldn't be news to you; you've probably learned by now that the female of the species is usually ahead of the male!) Anyway, if they are hooked up in parallel and an a.c. voltage is applied, the current in the Coil lags and that in the Condenser leads. The result is that, if the frequency of the a.c. voltage is just right, the reactances of the two cancel out."

"Why?"

"You'll have to take my word for it. I can't bother to explain every detail," R. F. Tube replied irritably. "Oh, all right — I'll tell you this much. It's because the Coil's reactance is positive and the Condenser's negative. At the right frequency the two have the same value of reactance, but going in opposite directions. Ergo — they cancel out. Now, then. If the reactances cancel out, that leaves only the residual internal resistance of the circuit, which is low, to impede the current flow — and so the induced current from the primary goes through practically unresisted."

"But if there's no resistance there shouldn't be much pressure and the secondary voltage should be lower instead of higher," the Sleuth argued.

"That's the funny thing about it. The resistance of the circuit as a whole is low, and therefore the current reaches a high value. But in order to get through the circuit the current has to pass through the Coil and the Condenser, the individual reactances of which are high — and so it builds up a terrific voltage across them."

The Sleuth shook his head in bewilderment. "That's too deep for me," he confessed.

"I'm afraid you haven't much romance in your soul," R. F. Tube sighed. "Don't you know that



when a Coil and a Condenser are perfectly mated each helps to sustain the other? When one is weak the other is strong. What happens is that, when the voltage comes along, the current goes through the Condenser first. She takes the energy from it and turns that energy over to the Coil, who stores it up. Then the next half-cycle comes along, and he gets his share. So he gives the energy he has stored up back to Condenser until it's her turn again. They keep on doing that over and over, passing the same energy back and forth between them — each using the high current to build up maximum voltage from it all the time."

"You mean to tell me they take advantage of the current, which thinks it is working only with their common resistance, and use it to build up voltage across their individual reactances?"

"That's right," R. F. Tube affirmed.

A look of triumph swept the Sleuth's face. "Very ingenious. There's only one thing wrong."

"What do you mean?"

"It's illegal! A direct violation of Ohm's Law — exceeding the power ration. I'm going to put them under arrest right now!"

But R. F. Tube held out a restraining hand. "I'm afraid you still don't understand. There's nothing illegal in what they're doing. The only power actually consumed is that required for the current to pass through their low internal resistance. The rest of the voltage they make themselves from the energy they've stored up. It's called reactive, or wattless, power — and they make it without using up a single point in their power ration books."

The Sleuth shook his head. "I wish my wife could learn to do that," he muttered. With an effort he brought his mind back to the problem at hand.

"But it's illegal to make power from nothing," he said, making a final stand. "There's another law covering that — the law of conservation of energy."

"You overlook the fact that no additional power is consumed," R. F. Tube reminded him austere. "You're thinking of power as merely the equivalent of energy used. In this case, the only energy used is that consumed by the Coil and the Condenser (chiefly the Coil) in passing

(Continued on page 68)



# HINTS AND KINKS FOR THE EXPERIMENTER



## A "TRANSFORMERLESS" CODE-PRACTICE OSCILLATOR

THE diagram of Fig. 1 shows a simple audio oscillator that requires no transformer and which can be built entirely from parts and tubes of any obsolete receiver. A pair of triodes of almost any type will prove satisfactory. Types 71A, 10, 45, 26, 30, 76, 56, 6J5 and 6C5 have all been used with equal results. A double triode, such as a 6N7, could be used to save space. When using directly-heated tubes, the cathode connection should be made to a center-tapped resistor across the filament supply.

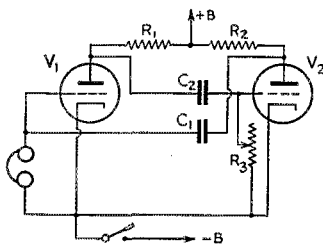

Fig. 1 — Circuit diagram of the "transformerless" audio oscillator for code practice.

$C_1, C_2$  — 0.1 or 0.01  $\mu\text{fd}$ .  $R_3$  — 500,000-ohms variable.  $R_1, R_2$  — 50,000 ohms.  $V_1, V_2$  — Any pair of triodes.

The two condensers should be equal in value and may be either 0.01 or 0.1  $\mu\text{fd}$ . The generated frequency, variable from about 120 c.p.s. to the inaudible, is controlled by the variable resistor,  $R_3$ , which may be any rheostat or potentiometer having a resistance of 500,000 ohms or more.

With any type of tubes (or a combination, when rated filament voltages are equal), a supply voltage of 90 volts d.c. will be sufficient to drive a small p.m. speaker for group code practice. An increase in plate-supply voltage will raise the output level accordingly.

This circuit is a variation of the multivibrator oscillator circuit, and the note contains a certain amount of harmonics and is not altogether independent of the supply voltage. Inserting a variable high resistance in series with the output will make it possible to lower the frequency to as low as 20 c.p.s. Larger values of capacitance at  $C_1$  and  $C_2$  will also serve to lower the frequency. — *Herbert F. Spiner, Springfield, N. J.*

## ANOTHER ADAPTATION OF THE RECEIVER IN CODE PRACTICE

FOR those of you who wish to maintain or improve your code-sending speed, or for beginners who wish to acquaint themselves with code characters, the idea shown in Fig. 2 will prove very useful. All that is needed is an ordinary receiver with a fairly sensitive audio amplifier. The only extra parts required are a convenient length of double insulated wire (preferably twisted pair), a telegraph key and, if your receiver does not have a phonograph connection, a s.p.d.t. change-over switch.

Insert the switch in the circuit as shown in the diagram, ground one side of the voice coil on the output transformer and connect the other side through the key to one of the switch contacts or phonograph input, leaving the loudspeaker connected. If the audio amplifier does not oscillate, producing a tone in the speaker when the key is depressed, reverse the connections to the voice coil. If it still refuses to work, inspect the wiring of the voice coil and switch, making sure that all connections are correct and soldered. If no results are obtained after following the above procedure, the reason may be traced to lack of sufficient overall sensitivity in the audio amplifier to sustain oscillation.

The circuit oscillates by virtue of the audio voltage fed back into the grid, forming a simple feed-back circuit. I have used the arrangement with my home recorder and obtained excellent results. The tone may be varied by inserting a variable resistance in series with a condenser in the feed-back line. I have not tried the idea with a receiver having only a single audio stage, but if the stage were sensitive I believe the attempt would be successful. The arrangement seems to work equally well with either single-ended or push-pull output stages. — *Joe Tucker, W5KLG.*

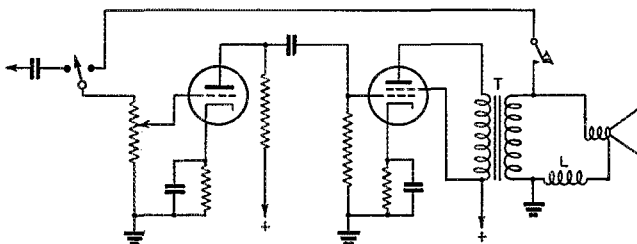

Fig. 2 — Arrangement for using a receiver's audio system as an oscillator for code practice. The connection through the key from the grid of the first audio to the output transformer is the only alteration required.  $T$  is the output transformer and  $L$  the hum-bucking coil found in some speakers.



# STRAYS



Mystified by persistent reports that tube checkers were indicating short-circuits from grid to filament in tubes which appeared to operate satisfactorily when placed in a receiver, Sylvania laboratories conducted an investigation, with the following findings:

In a commercial tube checker, for reasons of simplicity, it is usually the practice to make available only one supply voltage. For most types of tubes the value of this voltage is not too important, and consequently a value usually above 150 volts is employed. When filament-grid shorts are checked, however, the potential gradient between these elements is very high in any type tube, since the spacing between these elements is very small. The high potential gradient results in a considerable electrostatic attraction between the elements, which, in the case of 1.4-volt types, is sufficient to bring the grid and filament together during the period of test in the checker. With tubes of this type the test voltage should be kept below 50 volts. — *Sylvania News*.

— . . . —

Some of the new plastic wire coverings brought out as a substitute for rubber require no additional protection, since the covering material itself is proof against water, chemicals, fire and abrasion.

— . . . —

Harold P. Westman, formerly technical editor of *QST* and for the past 14 years secretary of the Institute of Radio Engineers, resigned this position recently to join the staff of the American Standards Association, where he will spend full time in work on war standards for radio.

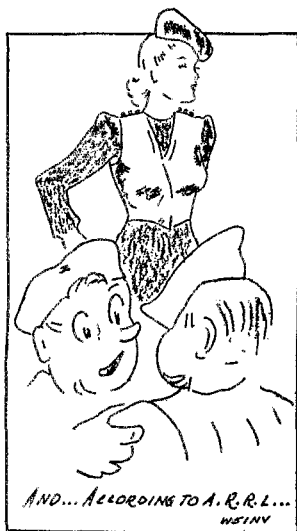

◆ A tradition-shattering portrayal of what men in the services talk (and think!) about, as depicted in *The War Dial*, weekly publication of the U. S. Naval Training School (ARM), Corpus Christi, Texas.

◆

Coast Guard radio operators in training at the Atlantic City school lived up to their motto — *Semper Paratus* (Always Ready) — when the February issue of *QST* arrived on board. The ship's service store on the station sold out its initial supply of 250 copies within 10 minutes and a second lot of 300 copies inside half an hour!

— . . . —

Ellery W. Stone, recently elected president of the Postal Telegraph System, started his career in communications as a licensed amateur in 1911, while in Oakland, Calif.

Following his education at the University of California, several years of specialized service with the Department of Commerce in radio inspection and his term with the Navy during World War I, in 1924 Mr. Stone became president of the Federal Telegraph Co., a pioneer radiotelegraph system and predecessor of the Mackay System. Subsequently he was named vice-president of American Cables and Radio, Inc., and was in charge of radio operations of other IT & T subsidiaries. In 1938 he joined Postal as vice-president.

Mr. Stone, who is now 49 years of age, is regarded as one of the most energetic and forceful officials in the industry.

— . . . —

Springs lost from a straight key may be replaced by the contact spring from a Ford V-8 distributor. While this is the leaf-type spring instead of the usual spiral type, it fits the usual straight key well and seems to be entirely satisfactory. — *W3VD*.

— . . . —

The Army requires about 31 radio operators for every 2000 enlistments. To-day it is getting one. The need for radio servicemen and technicians is seven in every 2000 enlistments. On this basis, an army of 10,000,000 men would require 155,000 radio operators and 35,000 servicemen.

— . . . —

Remember the chubby lad holding the neon bulb on the 1942 *Handbook* cover? In case we've never mentioned it before, his name is Bob Kelley, and when the cover was made he was employed at the studio which does *QST*'s photographic work. Now he's a radio technician in the Army Air Forces, at Athens, Ga. We heard from him the other day. Seems they had a lot of those *Handbooks* around the post, but when Bob tried to tell the fellows it was his picture on the cover they just laughed and laughed. To convince them, he finally had to dig up an original print of the photo. Apparently the Kelley silhouette had undergone considerable streamlining in the interim! All of which only goes to show what a little Army training will do for a fellow.

A handy new reactance slide rule, which speeds up the solution of reactance and resonant-frequency problems, may be obtained from Shure Bros., 225 West Huron St., Chicago, for 10 cents in coin or stamps to cover postage.

Copies of the 5th edition of Sylvania's *Technical Manual* may be obtained for 35 cents from Sylvania Electric Products, Inc., Emporium, Penna., or any of their distributors.

A chart showing Continental, Morse, Greek, Russian, Arabic, Turkish and Japanese radio codes, international and airways Q and commercial Z abbreviations, semaphore and international flag signals may be obtained upon request from McElroy Mfg. Corp., 82 Brookline Ave., Boston, Mass.

A pocket manual covering simplified radio servicing with simple equipment may be obtained from the Allied Radio Corp., 833 W. Jackson Blvd., Chicago, for 10 cents.

A series of large charts for classroom use, showing the internal construction of vacuum tubes of various types, is available to residents of U. S. A. and Canada from the Commercial Engineering Section, RCA, Harrison, N. J., for 10 cents.

Rotational speeds beyond comprehension have been obtained experimentally. A 3/32-inch steel ball, suspended magnetically in a vacuum, has been spun to a speed of 110,000 revolutions per second! The ball was spun by means of a rotating magnetic field produced by four air-core driving coils supplied with energy from a high-frequency oscillator-amplifier. Many steel balls explode before reaching this record speed. — *The Australasian World*.

And then there was the fellow who built himself a wavetrapp to try to trap some WAVES!

— W5DZE

## "Victory" Parts List

For the duration of the war WPB is limiting production of radio replacement parts to a restricted list called the "Victory" line. These components should be sufficient to fill most servicing needs. The values and characteristics authorized are as follows:

### Paper Condensers

0.00025  $\mu$ d., 600-volt  
0.002  $\mu$ d., 600-volt  
0.005  $\mu$ d., 600-volt  
0.01  $\mu$ d., 600-volt  
0.02  $\mu$ d., 600-volt  
0.05  $\mu$ d., 600-volt  
0.1  $\mu$ d., 600-volt

### Electrolytic Condensers

100  $\mu$ d., 25-volt  
10-10  $\mu$ d., 50-volt  
20  $\mu$ d., 150-volt  
20-20  $\mu$ d., 150-volt  
40-40  $\mu$ d., 250-volt  
10  $\mu$ d., 450-volt  
10-10  $\mu$ d., 450-volt  
40  $\mu$ d., 450-volt

### Untapped Volume Controls

10,000 ohms, reverse  
25,000 ohms, reverse  
250,000 ohms, audio

500,000 ohms, audio  
1 megohm, audio  
2 megohms, audio

## IF YOUR COPY OF QST IS LATE—

Bear with us and the nation's transportation systems. We are both doing our best — QST is being printed one to three days earlier to help keep deliveries on schedule — but unavoidable wartime delays do occur.

### ARRL Members:

1. Slowness of delivery is beyond our control; your copy is mailed at the same time as all others for your vicinity.

2. Don't write us about non-delivery until at least the 10th of the following month; your copy is on the way.

3. Renew early and keep your file intact; the supply of replacement and back copies is sharply limited.

4. Please allow plenty of time for acknowledgment of new and renewed membership-subscription entries.

### Newsstand Readers:

Because of paper limitations, newsstand quotas are unavoidably reduced. To make sure of getting your copy, buy it from the same dealer each month. That way we can allocate available copies to maximum advantage.

### Overseas Members:

Note the expiration date on your membership-subscription certificate and renew 3 to 4 months in advance. We can no longer backdate renewals or supply missing issues. All entries are now being made effective with the issue of QST current as of the date new or renewal order is received.

Under present conditions QST is mailed overseas at the subscriber's risk and we cannot duplicate copies.

### Tapped Volume Controls

500,000 ohms, tapped 150,000 ohms  
1 megohm, tapped 300,000 ohms  
2 megohms, tapped 15,000 and 500,000 ohms  
2.25 megohms, tapped 1/2 meg. and 1 meg.

### Wire-wound Controls

10,000 ohms, linear

### Volume-Control Switches

S.p.d.t., d.p.s.t., s.p.d.t. and 4 p.s.t.

### Filter Chokes

6 hy., 50 ma., 300 ohms  
15 hy., 120 ma., 350 ohms

### Power Transformers

Volts	Ma.	Volts	Amp.	Volts	Amp.	Volts	Amp.
325-0-325	70	2.5	9.0	5.0	3.0	—	—
325-0-325	120	2.5	12.5	2.5	3.5	5.0	3.0
210-210	50	6.3	2.0	5.0	2.0	—	—
300-0-300	70	6.3	3.0	5.0	3.0	—	—
300-0-300	120	6.3	5.0	5.0	3.0	—	—
350-0-350	200	6.3	6.0	5.0	3.0	—	—

### Audio Transformers

Interstage — 3:1, 10 ma. max.  
Interstage — 1:1, 3:1 or 6:1, single or p.p. input and output, 10 ma. max.  
Driver — 1:1, 1.5:1 or 6:1, single or p.p. input and output, 35 ma. max.  
Output — 4 watts, 50 ma. max., 2500-15,000 ohms primary to 2, 4, 6, 8 and 15 ohms  
Output — 8 watts, 70 ma. max., 2500-13,000 ohms primary to 4, 6, 8 and 15 ohms  
Output — 15 watts, 90 ma. max., 2500-13,000 ohms primary to 4, 6, 8 and 15 ohms.



## CORRESPONDENCE FROM MEMBERS

The Publishers of *QST* assume no responsibility for statements made herein by correspondents.

### THE STORY BEHIND A PICTURE

Santa Ana Army Air Base, Santa Ana, Calif.  
Editor, *QST*:

. . . There is a little story behind that picture Mom sent you (p. 33, April, 1943, *QST*). . . . It was taken about 0530. . . . The clothes are lighter than usual, as it got rather warm in the mess hall toward morning. The usual clothing consisted of wool socks and "John Ls," turtle neck sweater, wool-lined pants, coveralls, leather "A-2" jacket and a rubber suit and water-proof boots which left only the hands and face exposed. . . . They have the world's worst weather up there in the Aleutians.

For flying we doffed the rubber suit and water-proof boots and put on a pair of fur-lined, chest-high pants, knee-high fur boots with thick rubber ridges on the soles, helmet, gloves and then a fur parka with a double flap on the front. Even then a fella got pretty cold at 30,000 feet! However, most of the time I *couldn't* wear all this junk, as I was the gunner in that ball turret on the Fortress (B-17E) belly. So I wore an electrical suit. They aren't much thicker than a pair of pants, but are they warm! O boy!

I was plenty scared on my first raid, at least on the way down. But after we got there things happened so fast I didn't have time to think. On the interphone I heard, "Jap at five o'clock, low." I swung myself, my two .50 calibres and the turret around and down. There he was, out of range. So I swung back forward in time to see another Jap come out of a cloud under the lead ship in the flight. I think everyone in the whole outfit opened up at him. Anyhow, all those tracers couldn't have been mine. But he dove back into a cloud and disappeared. The next thing I knew we were out of the harbor and almost to Amchitka Island. So I crawled out of the turret, cranked it back into position and went in the radio room. There I found the tail gunner and the two waist gunners (the radio op is a waist gunner on those ships). So we sat around and yap-yapped about what a cinch it was and when the hell was a plane going up to Anchorage because we wanted to give one of the guys four hundred bucks so he could get us a case of Scotch, and so on.

On seventeen other occasions I went out there, most of the time as a gunner on a B-17E or a B-24D, but sometimes as radio op. We used to listen to KGEI or KWID when coming back from a "mission"; they would pour in up there like a ton of bricks.

They awarded our pilot the DFC and everyone else on the crew Air Medals. I really don't know what for or why. We just did what we were told

and then they said, "You get decorated!" It doesn't make sense.

The part of the country I was in is a ham's dream. Miles of rolling hills and flat spaces for rhombics, vees or anything else. No electrical storms at all, no ignition noise (well, a little, now!) — only the aurora in the winter. Then I'll bet "five" would go nuts! Ah me — 'tis nice to dream. . . . Anyhow, my issues of *QST* were always welcomed with open arms by all the radio men and were usually battered wrecks when returned.

At present I am an aviation cadet, in pilot "pre-flight" training. . . . I hope to wind up on any front where there's plenty of action, flying a B-17F, or a B-24D. But I'll settle for anything as long as it carries guns and bombs to kill those — — — — — Japs or Nazis (those dashes mean words, not 0). . . .

— Al Faries, W7IXX/6 — ex-W600U

### QSOS ON ACETATE

Randolph-Macon Academy, Front Royal, Va.  
Editor, *QST*:

. . . Since amateurs are off the air for the present, it is desirable for us to keep in contact, to continue the friendliness and close relationship between amateur operators. W8SOF and I have been communicating on records for several months now and we find it an exciting and economical means of communication. . . .

Several months ago W8SOF announced his plan for QSOing on homemade records. My station license being void because of the present world conditions, I was anxious to get into some amateur activities so I gave W8SOF a call on the acetate. He answered right away, and since that time we have been keeping up a regular schedule. So far there is just W8SOF and myself in this program, so I am pleading to all the "record cutters" to get into the fun and give W8SOF or myself a call on the "acetate band." If you are a bug on c.w. or desire a little code practice, pound your brass on a record and send it right along to us; W8SOF sends mean code on a harmonica. . . .

— Richard Wells

Browning, Ill.

Editor, *QST*:

. . . I would like to exchange records with any of the fellows, so if you print a list in *QST* you may include my call. . . .

— Francis Walton, W9ACU

## THE AUSSIE GIRL'S REPLY

Somewhere in Australia

Editor, *QST*:

. . . In November *QST* there appeared a poem entitled "Somewhere in Australia." With all due respect to Sgt. Becker, may I add the "Aussie Girl's Reply" to that previously mentioned bit of verse? This is the way we found it, but I am quite certain that not all "Aussies" feel the same.

Somewhere in Australia, where the Yankees are  
a curse

(If I wasn't such a lady, I could think of some-  
thing worse),

Where the Yankees' hide is thicker than the  
brick-red dust they scorn

And the baseball players' howling wakes the  
roosters up ere morn.

Somewhere in Australia, where a woman is  
never seen

With a Yank like you, sad poet — what a mug  
you are, old bean.

Where the din of their canned music robs a girl of  
blessed sleep

And she wakes at early morning to the snorting  
of a jeep.

Somewhere in Australia, where the air-raid sirens  
scream,

Where the Aussie girls are getting thin for lack  
of their ice-cream,

Where the picture shows are crowded out with  
Yankees pleasure-bent

Who think the world was made for them, their  
dollar and their cent.

Somewhere in Australia, where the mail is always  
late,

Where you never get a case on time "for the  
Yankees mustn't wait,"

Where you can't buy any chocolate since the  
Yankee horde has come

And you can't walk down the footpath without  
commandeering gum.

Somewhere in Australia, there's a Yank whose  
name is Mud

And we'll never rest 'twixt Heaven and Earth  
until we have his blood.

So take him back to 'Frisco, let him hear that  
mission bell —

For despite the Japs and Tojo, we can manage  
just as well.

— *S/Sgt. John R. Ehr, ex-W7HOQ*

---

## "WONDERFUL OPPORTUNITY"

Barksdale Field, La.

Editor, *QST*:

Have just finished reading Warner's editorial in March *QST* and can't help but say I agree with him. This is a wonderful opportunity for many of the older hams to get right on theory.

This type of training should furnish all the clubs still active with a very worth-while activity to keep up interest during our temporary (I hope) absence from the air.

Most of us who are in the Services will have some theory pounded into us whether we like it or not. . . . Anyone in the Army who admits having a slight acquaintance with radio is likely to be snatched up and placed on communications of some kind. . . .

For the record, I have been a ham since 1916 and this is the first time I have been unable to resist the urge to write about an editorial.

— *Major M. H. Gaston, W5EBB*

---

## INSURANCE

Hamilton Field, Calif.

Editor, *QST*:

Attached is check for another year's membership in ARRL. Not that I expect *QST* to be able to follow me around; I don't. It's just insurance. I, for one, expect the League to stay in there pitchin' and to be a damn good one when we come back. . . .

The *Handbook* is standard equipment in all stations. It's even the bible on the colonel's desk. . . .

— *Capt. E. B. Abbett, W6MHZ*

---

## OPPOSES SEGREGATION OF BEGINNERS

2485 West 7th St., Cleveland, Ohio

Editor, *QST*:

I agree with W9BRD, whose letter appeared in March *QST*, that it's too early for definite post-war planning for the use of our ham bands. . . . I wouldn't think of picking an argument with my good ham friend, W9BRD. . . . However, since he touched upon the treatment to be accorded those receiving "all the free radio education and radio training being dispensed to the multitude," I would like to speak a few words for these new hams-to-be. Not as a new ham, but as one who for five years went through about all ham radio had to offer. . . .

What would be the benefit to ham radio as a whole from segregating or, to use a harsher word, discriminating against the new hams? None at all, as far as I can see. The suggestion is made that the new hams be restricted to 160 and 5 meters. Of course . . . other hams would then hardly be found using these frequencies. Therefore, the new hams would almost exclusively have to QSO among themselves. After a year of this, just how would our neophyte friends fare in . . . operating proficiency and technical achievement? Would not a new ham who was permitted to throw in with the old timers on the same bands progress to a point where in a few months he would be more proficient than if he had to struggle alone with others equally inexperienced for a full year? He would find that almost without exception the old timers abide by point four

(Continued on page 84)



# OPERATING NEWS



**GEORGE HART, WINJM**  
Acting Communications Manager

**CAROL A. KEATING, W9WWP**  
Assistant Communications Manager

**CAP-WERS.** A directive recently issued by national headquarters of the Civil Air Patrol contains much that will be of interest to amateurs who wish to participate in CAP-WERS. Aside from the new rules for the service drawn up by FCC (Rules & Regulations, Part 15, of which Secs. 15.91-15.97 inclusive are devoted exclusively to CAP), most of what has been said heretofore on the subject was on the basis of a proposed directive. Now we get the real dope.

What the average interested amateur will want to know is, "How do we go about getting a license?" Before we can answer this question it will be necessary to have an idea of CAP organization; then we can follow the preparation of the license application from its embryo. At the top is the national commander who has command over the Civil Air Patrol throughout the entire nation, and under his direction is the national communications officer. The next step down brings us to the *wing* (state) commander and his communications officer. Under the wing commander in some wings, or states, are several *group* commanders, and under each group commander are several *squadron* commanders. Thus, coming down the line, we have national headquarters, wing, group and squadron. Your local CAP is a squadron and a squadron commander and squadron communications officer constitute a part of its personnel.

CAP-WERS licenses are applied for by and issued to the wing commander, who requests certain information from each squadron commander. This information is prepared by the squadron communications officer for his commander and forwarded to the group commander if that particular wing has such; otherwise, to the wing commander. Assuming that there is a group command in the wing, the group communications officer then checks the material sent in by the various squadron commands and, if found to be satisfactory, obtains the endorsement of the group commander who then forwards the material collected to the wing commander. All such material is then checked by the wing communications officer, who has the responsibility of preparing the station license application (Form 455, the same form used for CD-WERS applications) in much the same manner as application forms for civilian defense stations, after which the wing commander executes the application and forwards it to national CAP headquarters, *not* to FCC.

This sounds as though no license will be applied for by any wing unless it is the desire of the wing commander to do so — and this is actually the case. However, in most cases, if enough squadrons

indicate their interest in CAP-WERS organization, a license will probably be applied for by the wing commander. It therefore behooves amateurs who are not already engaged in civilian defense or state guard WERS, or those who would like to add some CAP activity to their present WERS participation, to get in touch with their local squadron commanders and see what the service has to offer. You will more than likely receive a warm reception, for now that CAP is expanding its radiocommunication facilities there is urgent need for radio men — radio men of just the calibre of the average ham.

CAP-WERS license applications, aside from the above major differences and a few minor ones, are handled in much the same manner as are licence applications for CD-WERS. A brief digest of the minor differences may be of interest:

1) No priorities are available for purchase of equipment for CAP-WERS. Only equipment available without priority will be utilized.

2) On FCC Form 455, 9 (a), no map need be included as all operations will be within state boundaries of each station licensee and station units will be portable, portable-mobile or mobile.

3) The usual list of supplementary statements must be submitted. Operating procedure will conform to recognized aviation terminology; transmissions will relate strictly to CAP activities.

4) Wing, group and squadron communications officers will be held strictly accountable for monitoring, supervising and controlling of all units under their jurisdiction.

5) *During actual air raid conditions all Civil Air Patrol transmitters will be silent.* Note that this conflicts with former statements that have been made in this column. CAP stations will monitor key broadcasting stations and cease transmission upon receipt of instructions or signals from the station in control of the area.

6) Operator permits are applied for on FCC Form 457 and must be processed in the same manner as the station license. National headquarters (CAP) has assumed responsibility for the certification of all operating personnel and has passed this responsibility along to wing commanders and communications officers. Operators must be members of the Civil Air Patrol. The permit is valid only when certified by the wing communications officer and only for those station units licensed to the particular wing of which the operator is a member.

7) Communication with CAP stations of another wing or with other classes of stations will be conducted only upon specific order or authori-



# Honor Roll

## The American Radio Relay League War Training Program

Listing in this column depends on an initial report of the scope of training plans plus submission of reports each mid-month stating progress of the group and the continuance of code and/or theory classes. All Radio Clubs engaged in a program of war radio training are eligible for the Honor Roll. Those groups listed with an asterisk teach both code and theory. Others conduct only code classes.

- \*Amateur Radio Transmitting Society, Louisville, Ky.
- \*Bloom Radio Club, Chicago Heights, Ill.
- \*Burlington (Vt.) Amateur Radio Club
- \*Canton (Ohio) Amateur Radio Club
- \*Central Oregon Radio Klub, Bend, Ore.
- \*College of City of New York Radio Club, Bronx, N. Y.
- \*Edison Radio Amateurs' Assn., Detroit, Mich.
- \*Genesee County Radio Club, Flint, Mich.

- \*Hamden-Sydney College Radio Club, Hampden-Sydney, Va.
- \*Jersey Shore Amateur Radio Assn., Long Branch, N. J.
- \*North High School Radio Club, Worcester, Mass.
- \*Olympia (Wash.) Radio Club
- \*Reading (Pa.) Radio Club
- \*Richmond (Ind.) Amateur Radio Assn.
- \*South Jersey Radio Assn., Merchantville, N. J.
- \*Tucson (Ariz.) Short Wave Assn.
- \*Withrow High School Radio Club, Cincinnati, Ohio

zation of the wing commander. A complete explanation of the circumstances justifying or necessitating such operation, together with a copy of the log covering the actual transmission will be forwarded to national headquarters, Civil Air Patrol, immediately following the operation.

Sound interesting? Okay, go to it!

**Army Orders.** Supplementary to previous information published in *QST*\* we can now present an excerpt from the ARP regulations of the Eastern Defense Command (First, Second, Third and Fourth Service Commands and the Military District of Washington, D. C.) as concerns radio.

### Section VII — Radio.

43. Radio stations will be silenced at such time and for such periods as may be ordered by fighter command<sup>1</sup> as follows:

a. Radio stations operating on frequencies between 3,000 and 30,000 kc. will not be silenced.

b. Radio stations operating on frequencies below 3,000 and above 30,000 kc. will be ordered silenced when the tactical situation warrants, except as follows:

(1) During periods of blackout and air raid, special broadcast messages on selected frequencies may be made under the specific direction and control of the service command.<sup>2</sup>

(2) Army and Navy stations may operate to a necessary minimum when necessity dictates as determined by the local commander.

(3) Police, fire and other special emergency radio stations may remain in operation upon the following basis:

(a) Each transmission will not exceed 30 seconds.

(b) Transmissions will be at intervals of not less than 2 minutes.

(c) The normal call letter will be omitted.

(d) The intelligence transmitted will not disclose identity or location of station.

\*"Some New Thoughts on WERS," *QST*, April, 1943, p. 24.

<sup>1</sup> Consideration is given to visibility prior to imposing radio silences.

<sup>2</sup> The selected frequencies will be announced by the service command. Persons having radio receivers should keep them tuned to one of the selected frequencies during periods of blackout or air raid. No broadcasts on any frequency are authorized during periods of blackout or air raid except as authorized by the service command on the selected frequencies.

**A Note to Affiliated Clubs.** Questionnaires for the annual survey of club activities are just beginning to trickle back to Headquarters. Have you sent yours? You should let us know your situation, even if it is a bad one. If your club secretary has not returned the questionnaire, build a fire under him. We need the dope for our records. All clubs not reporting will be placed on the inactive list and bulletin mailing will be discontinued.

The number of clubs reporting no activity is alarming. Is there any *real* excuse for it? We realize that better than 50 per cent of most clubs are in the armed services or have moved away, and those remaining are too busy with war activities to take an active part in club activities; but surely there is *some* way to keep the old gang together. It seems that every group should be able to arrange a meeting at least once a month and to carry on some sort of activity such as participation in one of the categories of WERS, training programs, establishment of wired wireless, light beam or other nonradio communication networks. Don't let your gang drift apart now, fellows. Somehow we must all keep organized so that the postwar period will not find us scattered both in mind and body — so that we can get back in there and start pitching just as soon as the peace whistle blows, and in the meantime render valuable service to our country and to our beloved hobby. Obstacles or no, we must somehow hang together.

**Licensed Since Pearl Harbor.** Those of us who were fortunate enough to acquire our amateur licenses before Dec. 7, 1941, have become accustomed to knowing each other and calling each other by call letters rather than by names. During peace times an amateur was known by his call letters, not by his name. How many call letters sounded familiar to *you* — call letters of amateurs whose names you never heard, and wouldn't have recognized if you did hear? That is as it should be; it is a characteristic way in which the

typical amateur thinks. He knows that W9XYZ's first name is John, perhaps, and he *thinks* his last name is Smith, but he isn't sure. It didn't even matter, then -- identification as W9XYZ was enough. Should they meet at a hamfest, they would introduce themselves by call letters, knowing that names wouldn't mean a thing.

Now we have among us hundreds of amateurs who, alas, have no calls. They have been licensed since Pearl Harbor (LSPH). They are just as much amateurs as the rest of us and have the right so to identify themselves. We suggest that they do so, by adding "(LSPH)" after their names. But the rest of us should not forget our calls, should not cease to know each other by call letters simply because those call letters are no longer heard on the air. Some day (soon, we hope) we will be using those same call letters again, and we want our old friends to recognize them just as they did before Dec. 7th. Let's retain the old ham spirit and remain "call conscious."

— G. H.

### BRIEF

"I suggest, in conjunction with the WERS training program, the use of two amplifiers with speakers in different rooms and equipped with receive and transmit switches to simulate the actual transmitters as an aid to teaching the procedure of calling and handling of messages and warden reports. We are using this method here in Lexington and find that, in an hour of operating in class after discussion of the questions, much has been accomplished in teaching those who have had no experience whatever with a transmitter a much smoother procedure than could be accomplished in any other way." — WIKOR.

— . . . —

## The Month in Canada

### ALBERTA — VE4

From W. W. Butchart, 4LQ:

Jan.-Feb.: We have several items of interest to report this month. Gordon Anderson (4ATH?) wrote us a swell letter. He is "somewhere in England" and is now staff sergeant. By his promotions he must be doing an FB job. Gordon reports that 4SQ is also on the same station, and holds rank of lieutenant. You will remember 8Q as the chap located at the Canadian College down at Lacme for a year or so. His home QTH as I recall it was Waldheim, Sask. And all the Edmonton gang will remember Mel Hicks, 4AOT, former contact man for Loveseth Service Station. Well, Mel is on the same station. Thanks for the swell letter, Gordon, and keep us posted.

4VJ kicks through with some news of the Jones boys, ex-4ABH. He says that Harold is settled at Lumby, B. C., and that he has a new junior op, Stan, the boy who really put ABH on the map as far as Edmonton is concerned, is on the civilian staff of the RCAF at Vancouver.

The Edmonton ARP net is still hanging fire. The boys are experiencing a bit of trouble on the license end of it, 4BW, 4HT and 4LQ have passed Part One Qualification exams as lieutenants in the reserve Army.

A Christmas card from Cpl. Frank Willan, RCMP, 4ANS, now at Coppermine, N.W.T., arrived somewhat late (about a month), but it nevertheless is much appreciated. 4ANS was on the Peace River Detachment of the RCMP when 4YD, Pete Fair, was up there. Frank has gone as far from civilization as possible by making his QTH in Coppermine. His Xmas card, by the way, bears an FB snap of the OM himself. If any of you chaps care to write to ANS, his QRA is: C/o Coppermine Detachment, RCMP, Coppermine, N.W.T. If Pets Fair happens to see this item, Frank would very much like to hear from him.

4XE's "Undulator" is doing nice work checking code

sending on his Part 2 Signals School. It surely shows up a guy's faults, too, no fooling! We tried it! 4BV and 4EA have been putting in a lot of time filming and editing on the Ciné Club project film, which we understand will be ready for its premiere about March 1st.

4HM and his YF have reason to be proud of the fact that their daughter Betty has been accepted in the WRENS. She left for the East about three weeks ago. Their son Roger has passed his medical for the RCAF, but will not be called until July or August. We might add that Roger is an F/Sgt. in the Edmonton Squadron, Air Cadets.

And 4VJ tells us that 4AKK has left CFRN and gone to work over at No. 2 AOS.

4AH has been laid up with pneumonia for a week. We wish him a speedy recovery. Frank's sickness and 4AKK's loss leave 4EA and 4VJ the job of keeping CFRN on the air, and Ken says the shifts are a bit tiresome.

Tommy McLaughlin, 4AQQ, is still around Edmonton.

Feb.-Mar.: We reported last month that HM's daughter had joined the WRENS. This month we have to report that HM's son Roger has joined the RCAF. Roger has been a member of the Edmonton Squadron, Air Cadets since its inception, and held the rank of flight Sgt.

At a "sneak preview" of the Ciné Club's group production on which 4EA and 4BV are closely associated, it became evident that BV has been wasting his talents in optometry business. He starred as a down-trodden commuter trying to devise a substitute for rubber, and even if the affair did end up with his wife's baking mixture as the basis for ersatz rubber, Reg made a noble contribution to the thespian art!

4ATH reports that 5AEB is still stationed at No. 2 AOS in Edmonton, and that he has been up North engaged in the hunt for two missing transport planes, believed down in the bush. 5MJ, Sid Jones of Vernon, is also back in town after taking part in the same search. He holds a corporal's rank now. 4AKK has settled down nicely to his job with CATL. 4SM has left the employ of CATL and is now doing service work with Adam's Radio Service in Edmonton. 4VJ lost all his photographic materials when the severe cold spell froze and cracked the bottles.

Edmonton newspapers carried a picture of 4ATJ's wedding which took place over in England. Some of you chaps will remember ATJ as Ken Currie, who joined up in 1939 with the RCA and has been overseas ever since.

Arrangements for the NARC Social are well under way now, and it is planned for April 3rd. A good program has been worked out, and we expect a good turn-out.

The other half of 4WE, Mary McIntyre, is back in Edmonton after about a year's absence at Edson, Trail, etc. She is still with the CNR.

The March issue of QST carries a list of VE hams in the services. If any of you chaps can furnish further information regarding yourselves or other hams in the services just shoot it along to QST. We notice several discrepancies in the list as regards rank, present location and unit or branch.

That winds it up for this month, gang. How about a few letters with some news from southern Alberta?

### MANITOBA — VE4

From Art Morley, 4AAW:

THANKS to 4AMS, there is a column this month. Gert's big news is that her OM, 4IF, has received another promotion and is now a squadron leader. Congrats from all, Jim. Gert also handed me the following dope. 4AFY was married and is now overseas with the RCAF. 4AFX and 4DO are also overseas with the RCAF. The Army seems to have gotten several of the Brandon gang with 4AFV, 4AFE, 4AGM and 4ALD all in it somewhere in Canada. Incidentally, 4AGM is a lieutenant. 4AKH is also an Army man and at the time of writing is somewhere in England. 3ANQ and 5CO are with the RCAF stationed in Brandon. 4AGL is with station CKX in Brandon. 4EE is married. 4NR is in the radio service game. 4BE works for the telephones. 4RK was seen on the street. Thanks, Gert, and keep them coming.

4GC was seen a short while ago purchasing a ticket to go back to his work in Ottawa. Reg is with the Navy. 4AHL is somewhere up north with the Army. 4JN was recently promoted to the rank of flight sergeant. 4ACO has left the wireless school, destination unknown. 4SS is a flight lieutenant stationed at the wireless school in Winnipeg. 4QV is still with the RCMP in Winnipeg.

That's another month, boys. Once more I remind you — this column is up to you, so drop a line once in a while.

# AMATEUR ACTIVITIES

## ATLANTIC DIVISION

**EASTERN PENNSYLVANIA** — SCM, Jerry Mathis, W3BES — DLR listens on wired wireless nearly every night from 9:00 till midnight and covers 125 to 200 kc. He would like to hear from any person interested in wired wireless or any other form of communication we are permitted to use. His new QTH is 1128 Broad St., Collingdale, Pa. HIR, FPE and GWO are interested also, but are not on yet. The Reading Radio Club is still operating, and held their third anniversary luncheon. The same officers were retained for another term. JBC left the Frankford Radio Club for the Army. The number of transmitters available for Phila. WERS is said to total 111, of which 13 are licensed at present. More applications are reported going in about April 1st. The Lower Merion WERS lads have the fixed location transmitters in operation now, so they are testing out portable mobile units and are tackling 1 1/4 meters. HFD and DOU have rigs there now, and IXN will have a rig there soon. The Haverford gang claims the development of an extraordinary antenna for mounting on a car. It is only two feet long and doubles back on itself and is voltage fed with a concentric line. One of the Lower Merion radio servicemen (no call) built a swell 2 1/4-meter portable using an HY615 with 3 watts input and it gives competition to a TR4 with 20 watts input. WJQN's pair of T55s in a line oscillator sure put a nice signal into West Phila. HFV, the wizard v.h.f. experimenter, goes into the Army this week, just after he got his 350-Mc. superhet perking. IKW, who was stationed locally in the Navy, has now shipped out after receiving his commission. DRQ is out on the West Coast teaching radio in the Army. HXX expects to install 2 1/4-meter gear in his car.

**MARYLAND-DELAWARE-DISTRICT OF COLUMBIA** — SCM, Hermann E. Hobbs, W3CIZ — 3BAK is working in a ship yard on defense work in Wilmington, Del. 3CVA is now in the Signal Corps at Camp Crowder, Mo. 3FJE is to go in the Army in the next few weeks. Baltimore City has licenses for 53 WERS stations, and has made contact between that city and Laurel, Md. The Baltimore Amateur Radio Association has loaned its code instruction tables and equipment to the Civil Air Patrol. 73.

**SOUTHERN NEW JERSEY** — Acting SCM, Ray Tomlinson, W3GCU — Asst. SCM, ZI; Regional EC in charge of Emergency Coordination, BAQ. Will those who hold Emergency Coordinator appointments and who have moved out of the Southern New Jersey Section, please send me their new QTH? CCO has been transferred to room 531, Hotel Severin, Indianapolis, Ind. Lt. Allen is now assigned to aircraft signal service, Wright Field, Dayton, Ohio. Arn has also been transferred to radio material office, Navy Yard, Portsmouth, Va., installing radio equipment. FXV, after one year of service with Merchant Marine, has signed up with Signal Corps, and is now opl. with T/5 rating. He is going to Coyne Electrical Institute, Chicago, Ill. He may be addressed, Grier B. Miller, 1637 S.U. Alamac 221, 500 S. Paulina St., Chicago. HYY, RT2c, has graduated from Navy radio school in Bellevue, and HOJ, RM2c, expects to graduate from Bellevue, D. C., in a couple of weeks. IOW advises us that he is in need of some good audio transformers, 3 to 1 ratio, to build up some emergency equipment down there with Tony. If any of you fellas have these parts, advise W. R. Tomlinson, W3GCU, 623 East Brown St., Trenton, N. J., where this is being collected and is awaiting shipment upon receipt of permission from Tony's Co. The DVRA Club receiver was used on the receiving end of a contact which saved the lives of three air cadets via communications. ZI has been doing some experimenting with FM and reports much success. DAF, formerly of the Trenton Police Radio Division, has joined the Navy. He has been assigned as Warrant Officer at U. S. Naval Air Station, Anacostia. ABS reports Hillsboro and Branchburg twps. still awaiting some sort of action on the WERS plans and organization material of the two twps., from Trenton OGD for two or more months. Hamilton twp. is still awaiting action by FCC on their WERS license application. ABS still working on wired wireless, as are JAG, GCU, JNO, and

some others. GCU is just recuperating following illness. The regular monthly meeting of the SJRA was held on Thursday evening, March 8th, at Hotel Walt Whitman, Camden, N. J. FDF continued his theory and code classes.

**WESTERN NEW YORK** — William Bellow, W8MC — RLI has been revamping a car radio in his spare time to an xtal police-frequency job. The officials of Monroe County and the city of Rochester have appointed the EC (MC) as radio aide and a fast growing WERS unit is being formed. RDX has an xtal job with an 829 in the final, all set to go on 112.1 Mc. Joe Paterchok, LSPH, has just received his Class A ticket, and also holds a first-class phone license. BHN, ANQ, BGN, BEN, AHK, ATH, GWO, CFA, and DOD all are operators at WHAM and are teaching radio classes at the University of Rochester. PK has joined R.C.A. on special assignment. CFA has been instructing a C.P.T. group. UNA is with the Army at Sioux Falls, S. D. Fellows, your new SCM invites you to send in your news. W8MC.

**WESTERN PENNSYLVANIA** — SCM, E. A. Krall, W8CKO — Asst. SCM in charge of EC — VYU. We are indebted to PX of R9 Crystals for a host of reports. OKU is busy these days installing transmitters and receivers on sub-chasers. AMY is at the Phila. Navy Yards doing strategic work. AYH is a chief radio op. with the Navy. DJE and ex-AOA are flying instructors. TGG is in the Army Air Forces and is located at Connelville. PX and FCO are turning them out fast for Uncle Sam. TTC is an instructor at a Pittsburgh radio school. RBO is instructing at Fort Monmouth. RUE of 5-meter fame is now in uniform and is stationed at Edgewood Arsenal. Bob Haas, our DX and power man, is reported a lt. commander in the Navy. QXT, after instructing in radio code and theory for a while, has transferred his activities to the electronic division of the WPB. Lt. Devey, RTU, radio officer on a carrier, sent in a nice letter, and would like to hear from the gang. Send his mail c/o postmaster, San Francisco, Calif. VYU has been busy preparing for graduation exercises, but still finds time for her code and theory classes. UT is testing Army tire pumps at his place of employment, and CDG is working on a boat-control job at the same establishment. MP is the electrical engineer at one of the largest steel companies in the Pittsburgh district.

## CENTRAL DIVISION

**INDIANA** — SCM, LeRoy T. Waggoner, W9YMV — Fort Wayne, first in Indiana to be licensed for WERS, is still the pace-setter in CD communications. Plans have been made to have an alternate station assume temporary control in event of control station failure. UDD, as radio aide, shares credit for achievement in WERS with fellow members of the Fort Wayne Radio Club. The Richmond Amateur Radio Association has just been granted a charter of affiliation with ARRL. Richmond hams have surged ahead with concerted efforts on behalf of WERS. Anderson WERS is experiencing some difficulty in getting started. EMQ reports that they have 14 Abbotts for which no tubes are available. Plans have been discussed for rewiring to convert to a standard receiving tube, such as the 6J5. Additional operators are being trained. WQA has gone to the wars, and his position as radio aide and EC for Bloomington has been taken by HBD, at present working with RCA at Bloomington. SVH reports that WERS is being planned on a county wide basis in Elkhart County, with stations in each of the telephone exchanges. FWS is deputy radio aide. SNF advises that WERS prospects are good in Highland, where he is radio aide and EC. The town has two licensed transmitters, one of which has been heard in Gary, five miles airline. Newest EC in Indiana is ANH of Terre Haute. PQL is with Uncle Sam's Communications at Seattle, Wash. EHT and AB have been in sick bay recently. VGT is in Chicago doing experimental work. NVP is a railroad telegrapher at Colfax now. VFC has been transferred back to the States from Peru, where he worked for Pan-American Airways. DFE is with RCA at Indianapolis. BQF was home on furlough from Signal Corps. OUQ arrived safely in Africa. PQZ, in Civil Service in Panama, received another promotion. 8NAF/9 is having a lot of fun with 112-Mc. receivers. 3DSD/9 is interested in operating WERS with the CAP. I am interested in making my file of Indiana hams in the Services as complete as possible. Send me complete details when you make your report on the 15th. Transcripts are sent in to League Hq. Will you help? 73. — Roy.

Michigan — SCM, Harold C. Bird, W8DPE — Pleased to report Lewis D. Brewer as EC for Grand Rapids, Mich.

Lewis is also radio aide there and he reports very successful tests in their WERS setup. CYX reports the ERAA still maintaining their radio classes. A new class started this month at Ferndale, Mich., with an enrollment of about 90 students. Arthur Lyman, radio aide of Detroit, reports the following: We have two WERS tests here in Detroit under license WKAU. Maurice LaBarre has been appointed asst. radio aide for Detroit; also SWI, UYG, Leslie Thayer, and EWO as deputy radio aides. Additional deputy radio aides will be appointed in near future. RX reports the CAP using the ARRL study course in teaching their students. FX thinks it good idea for the gang to register with OGD as ops. UEO reports he is now sporting a class A ticket and a telephone 1st class. DYH says DARA/QMN bulletin by subscription only for the duration. The printing and cost of paper prohibits sending it free now. CW is now teaching radio at the Detroit Engineering College. AHV of Lansing reports WERS call letters there are WKCI. He is in charge of all auxiliary communications and is a member of the CD staff of City of Lansing. The relay station runs on 112 Mc., the transmitter on 115.8 Mc. The receiver modulates the transmitter when calls come in. VRV has xtal control on 150 Mc. KSR has a concentric line feeding the antenna. Paul Palmer reports that NGO turned over the 212-Mc. oscillator, the modulator, a couple of power supplies and some meters to Art Lyman, the radio aide for Detroit. All affiliated clubs should fill out the annual report which was sent direct from Hartford. Let's hear from the rest of the state as to your WERS progress. 73. — Hal.

OHIO — SCM, D. C. McCoy, W8CBI — An issue of "Wartime duties of ECs" is being sent to all ECs active in Ohio. This should be carefully studied, as it has a vital bearing on successful operations during the war. Forms 8 and 5 should be filled out. In the general letter to ECs, November 25, 1942, you were asked to extend your appointment for one year from November 25, 1942, to avoid paper work for all concerned. This will save the necessity of mailing your certificates in to be endorsed by the SCM. Headquarters has been instructed to continue you on the list for one year from November 25, 1942, unless you subsequently resign or are removed from office due to inactivity or other legitimate reasons. A bulletin was issued from headquarters dated January 19th, requesting certain reports on WERS activities for headquarters. These should be filled out and mailed promptly to headquarters. Would appreciate receiving a copy of this report for my own records so that I can better keep track of details of WERS activities in the state. We also wish to acknowledge receipt of a copy of the fb YLRL Bulletin from STAY. Cincinnati Region: Letters from EC Wiehe and radio aide Thornell indicate progress on the Cincinnati WERS operations. Station license has been issued, call letters WKHO, and 43 operators have been issued permits. Middletown: 8DGU has been officially appointed as radio aide, and reports progress in developing his organization. Lima Region: A nice letter from Jim Lisk, EQ, tells us that interest is being stirred up at Lima in WERS activities. NN was inducted into the Army December 1st, and has recently received his corporal stripes. He can be addressed c/o the 99th Signal Company, APO 449, Camp Vandorn, Mississippi. SJF tells us she is busy with war work of a confidential nature in Columbus, but had to return home recently because of poor health of her son. Fostoria: CVZ has been appointed as radio aide for Fostoria, and most of the groundwork for their WERS system has been finished. They will file applications for station license of 5 units and for 8 operator permits. Van Wert: No EC has yet been appointed. How about a volunteer? Napoleon: SXU at Wauseon reports that he is the only amateur left in that area, and is busy instructing an evening code and theory class of 10. Bowling Green, Bryan and Defiance: No ECs appointed for these territories yet. We are still looking for suggestions. Understand 8ZY was appointed radio aide at Defiance. Chillicothe Region: PUN has been trying to prod the local defense council into doing something about WERS, and finally has aroused some interest. He is now teaching a war-training class in the fundamentals of radio and will try to draw upon this source for WERS operators. Jackson & Gallipolis: PUN reports that to his knowledge, all amateurs have left these towns. If any are left, we would appreciate their accepting an EC appointment and getting active on WERS. Portsmouth & Ironton: No reports from ECs in these two territories for some time. Information from local hams would be appreciated. Washington Court House:

UHY can now be reached at: C. J. Yeoman, RM2c, Aviation Radio Materiel School, Instructors Company, Ward Island, Corpus Christi, Texas. Pomeroy: VUS has been appointed EC for the Pomeroy area, and we expect some good activity down that way. DGZ is ready to help with WERS activities, as are Edison Forsythe and 6 service men and experimenters. Zanesville Region: 8TGU says about 20 amateurs in the Zanesville Region, but most of them have joined the armed forces. Cambridge: TGU reports only one amateur in Cambridge. Marietta: VZ is now a Lieutenant (jg) in the Navy, and has resigned as EC. He can be reached at the U. S. Naval Training Station, Corpus Christi, Texas. Athens: LKU is busy with organizing his WERS set-up, and also teaching radio classes. Columbus Region: Tests of WERS system are continuing, and improvements are being made. All of Franklin County is now included in the Columbus City license. Granville: ANJ has been offered appointment as EC for Granville and vicinity. Dayton Region: Temporary WERS equipment has been installed at main control center. Several Sunday drills, and two dim-outs have been held. 37 operators are now licensed; 140 students are in training for 3rd class and WERS operators' permits. RHH, on a recent business trip to New York, located 8 Abbott TR-4 units, and thus enabled us to make a big forward step in solving the equipment problem for some of our fixed stations. The city stepped up immediately, furnished the funds, and purchased these units. WKN and OHU visited us on February 21st for our test. JC was in town on January 22nd. A card and letter from MFV. The last letter from Duke came from Kelly Field, Texas. He reports 8SVI now at Camp Murphy, Florida. He can be reached c/o the 3rd Communication Squadron at that field.

VNJ reports the death of JFZ, who was killed in an airline crash in South America during December. The local boys mourn the loss of Jim, who was a swell fellow.

Eaton: SID is busy constructing 2½-meter equipment, and expects to complete it soon. VYE has Abbott equipment ready to go. Greenville: John Dunn, UWA, has been appointed radio aide to replace ARW, who is unable to carry on because he is employed in defense work. Piqua: Five new permits have been issued for students who passed their 3rd class examination, and more are expected to follow. Regular drills are held every Sunday with the stations now available, and most of the time is spent in transmitting test incident messages. Springfield: EQN reports that local amateurs left have now signed up as members of the police guard. Canton Region: MWL is resigning as EC. ADQ will be appointed as EC to succeed Rod. ADQ is also county radio aide making progress with WERS in Stark County.

HCP of Dover, Ohio, was killed in an airplane accident, January 23rd.

AVH reports fine progress with WERS in Cleveland. License has been granted to Cleveland, call letters WJJI. Modification has already been asked for their license to increase the number of mobile units and fixed stations. Three hundred operators are in training, and 75 are now licensed. Youngstown: TAD reports that they have applied for license for 35 units in the name of Mahoning County and are also including Trumbull County in this license. Plans are also on foot to later have this amended to include Columbiana County and the City of Alliance. Ashtabula: An EC is still needed for Ashtabula. Lorain: An EC is still needed for Lorain. H. C. Kauffman of the Lorain Police Department has been appointed radio aide for Lorain. REC is now flight radio officer for Western Division of Pan American Airways. LCE is stationed at Corpus Christi, Texas. CJN is also there. Warren: TGA is resigning as EC for Warren. Sandusky Region: An EC is still needed in Sandusky. Also in Tiffin. Mansfield: FQK is aviation chief MM at Grosse Isle air base, FQY is working at Westinghouse in Mansfield, and BAH is at the Howard Radio School. "73" and "V" — Dan.

## DAKOTA DIVISION

**SOUTH DAKOTA** — SCM, P. H. Schultz, W9QVY — DB reports that the Sioux Falls AATTS school is still turning out some good ops. SOB has been transferred from Annapolis to a ship out on the West Coast. SMS is working in the West for North American Aircraft Co. SGI is working for Consolidated at San Diego. WUU says he is in radio school at Drew Field, Tampa, Fla. KQO is in Signal Corps school at Rolla, Mo., after finishing work at the Aberdeen, South Dak. school. MNI is in the Merchant Marine as a radio op. TXX is in the Army in Africa, with headquarters radio detachment. OKF is with CAA at Watertown, So. Dak., and VT, GBN and ex-PKV are with him there. TCW is with the Signal Corps at Camp Crowder, Mo. BLK is now at Sturgis, in the Radio Intelligence of F.C.C. He is junior monitoring officer. LR, GJB, EVP, and DJM are also there. PZI is in the Navy at Corpus Christi, Tex. AOZ, GCW, and FWX are with the Navy. ANW is in North Africa. IWT is with the F.C.C. in Alaska. ONV is with CAA at Philip. AKO and ZWL are civilians with the Army. KNV, APT, GLA, SWV are all with the Army. TZJ is in OCS at Fort Belvoir, Va. 73.

**NORTHERN MINNESOTA** — SCM, Armond D. Brattland, W9FUZ — Wally Lamb (op license) is doing his best to hold radio interest at Thief River Falls, teaching code and theory to the Boy Scouts. TEF was home on furlough and HZM was transferred from Ft. Meade to Camp Young in Calif. OOK, formerly a radio instructor here at Glenwood, reports from Camp Crowder that he has come across a number of former students from here. LSC has been employed by Northwest Airways and is taking a leave of absence from the Glenwood school. "Sodie" will be training personnel. ORT has finished his CPT ground school and flight training at Bemidji. ZWW, now in training at Kansas City, Mo., gives his address as 511 W. 11th St. WUU, now training at Camp Murphy, Fla., writes that a ham roster among the instructors at some of the training schools he has attended shows the great number of amateurs taking part in proportion to non-amateurs, especially among radio instructors. LSM is an instructor at the Air Force Technical School in Sioux Falls, So. Dak. WPR is located at Army Air Force school in Madison, Wis. TEF is assigned to the U. S. Coast Guard Training Station, Atlantic City, N. J.

## DELTA DIVISION

**ARKANSAS** — SCM, Ed Beck, W5GED — FGS is reported doing quite well with the armed forces, down under. ARH is back on his previous job as chief "cop-op" on the north side, after returning from the ninth call area where he was doing aircraft radio work. HER has been quite busy with night work at the ordnance plant at Jacksonville. GIC was recently presented with a pair of junior operators. Ex-DRR recently reported in from San Francisco, headed West. SI and DHU are very busy with Navy work in Florida. GNV has departed for Mobile, Ala., where he will take up new duties with FCC. FXO is very anxious to make a few "platters" demonstrating his pianistic dexterity. ENH anticipates service in the armed forces if he doesn't get located satisfactorily. 73 and all the best, gang. — Ed.

**LOUISIANA** — SCM, W. J. Wilkinson, Jr., W5DWW — QJ, GKJ, HCO, JFZ and HCB are doing radio and electrical work at a New Orleans shipyard. HIC is RM1c in Coast Guard. GDU is working on a radio and electrical job. HSH has been transferred to Tampa. WERS in Shreveport getting under way. License has been received and quite a number of rigs are being made ready for service. ITY is a Lt. on the staff and faculty of the Southern Signal Corps School at Camp Murphy, Fla. 73 until next month.

**TENNESSEE** — SCM, James B. Witt, W4SP — How about you fellows who hold active Emergency Coördinators' appointments dropping me a line so that I can report your activities in this column? There are several localities where there is no EC, and any live-wire amateur interested in becoming an EC should get in touch with the SCM and we will get things going. Knoxville Communications Club's code class is still going fb. Let's have more reports!

## MIDWEST DIVISION

**IOWA** — SCM, Arthur E. Rydberg, W9AED — The Des Moines Radio Amateur Association in connection with their WERS have appointed the following: URK, radio aide; OLY, technical assistant; DAZ, personnel officer;

UOP, installation and maintenance; SEJ, construction and monitoring, and PNT, procurement officer. Such organization was needed to facilitate licensing their WERS unit. PNT has sent letter to all amateurs in Polk County asking for loan of any equipment that may be used in the construction of transmitters and receivers. DAZ will contact amateurs for information in regard to license. Ex-EC VKZ reports from McClellan Field, Calif., and says he is a new daddy to a daughter. CCE has been asked to help with a high school course in radio theory. LDM, lieut. (jg), who has been attending Navy training school at Dartmouth College, is expected home shortly on leave. IFI is busy engineering crystal grinding for war use. BAL, DIB and SCJ took advantage of the pheasant-hunting season. AEP is considering carrier current, if it can be done before victory garden season. PNK enjoys his FM work at the Des Moines Ordnance plant, and says he is still hamming. UFL has been elected secretary of the Sioux City Amateur Radio Club. POY is working in a war production plant. AUL has recently gone into the radio repair business on his own. UAD of the Merchant Marine, recently home on a visit, has gone back to sea. SQV is a radio technician in the Navy. 73.

**KANSAS** — SCM, A. B. Unruh, W9AWP — OOU is working in Dayton Signal Corps repair depot as inspector. NSZ works at KTSW while attending college. UQV is radio engineer at Wright Field, Dayton. Mack mentions seeing EDU and SSG there, as well as several VK's, G's, and South Americans; and to top it off, he has K7GRX for a beer buddy. MFEL, who is Lt. in Navy stationed at Pearl Harbor, advises us by V-mail that the boys really gather 'round when the mail comes in. JVH left for Gallups Island, and JLL will be comms. officer with rating of lt. (sg) in Maritime service. GWN, with another Wichita Boeing worker, received the March bond award made by Wings, government-sponsored magazine for the distribution of best aircraft manufacturing procedures. GWN and his associate developed a control device and analyzer for use in servicing electric spot-welding machines. TPF received commission as lt. (sg) and left for West Coast. CKV is teaching code class. 5HXW is now with civil service as an inspector in Wichita aircraft plant. IJK finished course at Sioux Falls Tech. Training school of the AAF as valedictorian of his class. The RI made his semi-annual appearance in Wichita, and among others present were: LFB, GVN, OZN, QQI, KNQ, GCS, NJS, and AWP. 73 — Abie.

**MISSOURI** — Acting SCM; Letha Allendorf, W9OUD — To put it briefly, CJR is with the highway patrol at station KIUK in Carthage. Ex-PSM is operating for the patrol at Ft. Leonard Wood. WIS is at Wm. Jewell College teaching Navy cadets about airplane motors and such secrets. GZR is working for the Empire District Electric Company. OUD is wondering if these chat piles would turn patriotic and support a victory garden for a change. And that's the best of the news as it looks from here, ladies and gentlemen. 73 and good luck. Don't forget to write!

**NEBRASKA** — SCM, Roy E. Olmsted, W9POB — Reports from Nebraska amateurs scarce this month. Two things I wish to remind you of, however, is that each communications post in all branches of the armed forces — Army, Navy, Marines, Coast Guard — should have a subscription to *QST* coming regularly for the benefit and pleasure of the new men in radio work. I believe you, who are still enjoying home comforts, should see that our magazine goes to an amateur friend on active duty. Another thing — WERS in Nebraska needs a shot in the arm. To date there is only one completed license, and that one in one of our smaller towns. Total war calls for total effort of all amateur licensees in the state. So let's put more effort into getting our key cities organized, huh? KPA writes from Seattle that he has completed training and is on his way toward the North Pole. OYB is now at radio school here at Milford. ZFC says that he has been transferred to AAF, has completed schooling on the East Coast and is now stationed in Nevada. He wants to hear from any of the Nebraska gang (write for addresses of any members in Service). GKZ is doing inspection work for the Signal Corps at Omaha and his inspections must be good cuz he recently married one of the YL inspectors. He corresponds with EWO, who is a Naval instructor at Treasure Island. NRE reports from Charleston Navy Yard and would like to hear from the gang up Fremont way. E. K. Anderson writes from Wausa and wants to contact a licensed amateur who will give him a Class C exam. Somebody please take care of him. — Pop.

## NEW ENGLAND DIVISION

**CONNECTICUT** — SCM, Edmund R. Fraser, W1KQY — We regret hearing that EWI has been confined in a New Haven Hospital because of a brain concussion sustained in an auto accident, necessitating a very delicate brain operation. Congrats to NAM, Glynn, and Charwood, all hams from New Haven area, completing Officer Candidate School at Ft. Monmouth. GUP, formerly of Stamford, is now ARM1c at Naval Air Station, Norfolk, Va. Your SCM was recently visited by 9ZZU, formerly of Chicago, now RM2c, USN, at New London. 9AND also from Chicago, code instructor of Army Air Corps cadets at Yale, is now taking active part in New Haven WERS activities. The New Haven ARA extends an invitation to all hams in the service to drop in at Friday night gatherings, in the building at the corner of Washington and Howard Avenues. IM, dist. rdo. aide Bridgeport warning district, reports 15 stations in operation in six towns, namely: Bridgeport, Fairfield, Easton, Stratford, Trumbull and Milford, under call letters WKAO. IM's XYL, MRC, is doing nice job as control operator at the d.w.c. station. DGG, Milford radio aide and EC reports excellent progress being made on the home-built units, and class for restricted radio-telephone operators is being conducted. BIH writes Torrington warning district has been issued call letters WKJA. Dist. rdo. aide KXB has 13 units in two towns, with 8 operators licensed. Applications for 23 more operators have been forwarded and should be licensed soon. Six members of KXB's former code class have received their amateur "B" licenses. ALW, dist. rdo. aide of Norwich warning district, writes several tests have been successfully held. KDK, dist. rdo. aide, has just received license for the Hartford warning district. Asst. SCM CTI, of the Stamford warning district WJQA says class for restricted radiotelephone ops. is being held in Norwalk. Emergency gas generator has been successfully tried and additional units have been added in a recent modification. During two recent blackouts many stations in the New Haven Warning District WJLH were in operation, with successful handling of traffic, etc. ECs whose certificates are due for endorsement should forward them.

**EASTERN MASSACHUSETTS** — SCM, Frank L. Baker, Jr., W1ALP — We are sorry to hear that DIR, Bill Meekin, is back in the hospital again. Fellers, why not drop him a line at the U. S. Marine Hospital, Brighton, Mass., Bed No. 128, West? DEC is now RT1c U. S. Coast Guard Base, Chelsea, Mass. CKW is now at M.I.T. FPU is now a 2nd lt., and at last report he was in the Solomons. HM is laid up with a sprained ankle. JKR is active on the Brockton Unit of the State Guard. KNX is RT1c and is stationed at Norfolk, Va. Your SCM had a nice letter from MIM, and she is stationed at Ogdensburg, N. Y. She reports that her husband, LDV, is now out in the South Pacific someplace. MBX is a 1st lt. in the Army Signal Corps. FJN is EC for Scituate and LIO for Newton. UU is now living in Cedarhurst, L. I., N. Y. BAP has moved to Dalton, Mass. AYG is going to work with Sub Signal in Boston. CED is now working with WBZ. Your SCM met KH in Boston recently on his way to Washington, and George wanted to be remembered to all the gang. MEG has a new jr. op. AGR sent a card from Lexington, Ky., where he and FXC are going to school. MZE writes from Burlington, Vt., where he, LMO, and GKA are going to organize a school for radio ops. for the Army. Fred has his commercial 2nd class telegraph, 1st class 'phone, and Class A ham ticket. MDN writes from Montreal, where he is attending the R.A.F. Ferry Command School. KCP is now a 2nd lt. in the Army Signal Corps, having graduated from officer candidate school. IVI is now in the Navy. LIO's daughter was married to Donald Berry of the Waltham Radio Club. MUT of Chelsea is now at Fort Monmouth, N. J., and he is a corporal technician, studying radio repair work. GAG is now the radio aide for Region 5B, Malden and surrounding towns. They have received their WERS license with the call WKXH. JFH is working nights in a defense plant, NKW and KJ are working alternate watches at WJID No. 25 report center. WJID is the WERS call of Region 4C, Salem and surrounding towns. F. Alvin Stacy is the district radio aide. JGQ is the aide for Lynn. NBT is now at Fort Monmouth, N. J. MYO is working at Hytron. MQR is in the Navy as RM2c. "Bald Headed Eagle" finally got his ticket. IVL is working at G.E. If any hams are visiting or staying around greater Boston I'd like them to give me a call on the land phone and visit me. HLL, GAG and EKT are working on plan for WERS. HLL sold a lot of his equipment to the Signal Corps. LVV and

MDH are working at G.E. EKT is radio aide for Wakefield. MJ did a fine job teaching code in the radio classes operated by BNT and EKT, which turned out about 25 third-class ops for WERS. ALP met WTASZ, who is now a capt. in the Army and located at Fort Wright, N. Y. 1HJP is now married and has a 3-mo.-old daughter, and is working as a test engineer in Schenectady, N. Y., with G.E.

**NEW HAMPSHIRE** — SCM, Mrs. Dorothy W. Evans, W1FTJ — BDN is planning her garden for the summer. FTJ had nice visit recently from MUW and JMY. CEA is teaching a course in practical electricity nights at the Hampton High School. Northwood has received their WERS permit and has been assigned the call WKLW. ITF is to be their radio aide. CME tells us how busy he has been. IVU is a brand-new uncle to twin!

**RHODE ISLAND** — SCM, Clayton C. Gordon, W1HRC — MEK's address is Pvt. R. E. Young, AAF, 21st Comm. Sqn., A.A.C.S., Gowen Field, Boise, Idaho. He is c.w. operator there and says the work is just like the old A.A.R.S., but glorified. He corresponds regularly with LCH who is still with the Tank Corps at Camp Cooke, Calif., as a staff Sgt. We heard that KZN is now a lieutenant, and has been in Africa. CAB was in town recently, en route to Annapolis for more skull practice. LLC writes from Atlantic City on a super-duper card. Ralph graduated from the C.G. radio school there, this week, as RM3c. He wants to hear from the rest of the gang from P.R.A. that are in service, and requests addresses. Suggest some of you boys write Ralph Alley, RM3c, 122 S. Virginia Ave., U.S.C.G. Tr. Stn., Atlantic City, N. J. JP says he hears from LYE quite regularly. Your SCM hauled four truck loads of excitement for a Victory Garden.

**VERMONT** — SCM, Clifton G. Parker, W1KJG — The mail bag this month brings news from AHN, who is now in French North Africa. He is interested in hearing from the gang, and letters may be sent to him, Lt. R. E. Osgood, 0-425489, Signal Section, U. S. Fighter Command, A.P.O. 525, c/o Postmaster, New York City. Ed has recently been promoted to 1st lt. and has been awarded the Purple Heart. The Northeast Airlines Flight School at U.V.M. is going strong, and the following are there as radio instructors: MZE, LMO, LWN, IQG and BJL. NLO has been accepted as student instructor with the U. S. Army Air Forces Technical Schools. JXS has just graduated from Tufts College with a degree in E.E. and has gone to Bridgeport, Conn., where he has employment with G.E. He is living at the YMCA, and mail may be sent to him there. 9TGI, who is instructing at the flight school in Burlington, has just been discharged from the hospital, following a crash. JVS and XYL announce the arrival, March 1st, of a boy.

## NORTHWESTERN DIVISION

**MONTANA** — SCM, Rex Roberts, W7CPY — Benjamin Hespen, ex-W7, ex-W9ENX for many years in Chicago, is again in Montana, at Dillon, with the CAA. His call now is W7JZC. FOA is with the telephone company at Billings. CVQ is busy with radio repair work. GRR is working in a defense plant at Portland. He has his own Piper Cub and is active in CAP work there. IGG is in the Navy at Bremerton. HEM also is in the Navy at Bremerton. ANT is visiting the old gang and friends in Great Falls. He is now located at Seattle. BMX spent his furlough at home in Great Falls. He is an ensign C-V(G) in the Naval Reserve. GFT has moved to Salt Lake City. CC is in the Naval Reserve and located in Alaska. A class of 19 were given examinations at Great Falls for 3rd class radiotelephone licenses looking toward WERS operation. Al Beck, secretary of the Butte-Anaconda Radio Club, reports: "We are still meeting 2nd and 4th Fridays with a reduced membership of 12." BDP is taking advanced work at the School of Mines. EMF is doing special installation work for police and state highway. DCZ is with the RAF in England. GOB reports HWZ with TWA.

**OREGON** — SCM, Carl Austin, W7GNJ — EC: 7JN. DXF, former Oregon SCM, called on GUNJ-HHH recently while touring his territory for CAA. FHB is instructor in Signal Corps training program at Eugene, and has had HLV, HLB, and AQO with him as instructors. HLV is now instructor at Multnomah College. IIK is teaching aviation radio. IEJ, who is radio op, says out of a 7-man crew, 6 are hams. Frank Williams, GVD, is with Army Signal Corps, at Athens, Ga. JN convicts troops and is seldom home. The following report from Roy Mickel, LSPI, secy. CORK: Phyllis Coe and Paul Mickel received 20 w.p.m. certificates.

Phyllis Coe tried for Class B, and is now waiting. Leo Mickel also waiting. Present club membership, about 35. KFNX, City of Bend, is working very satisfactory, especially with mobiles. 73.

WASHINGTON — Acting SCM, O. U. Tatro, W7FWD — Correction: New officers of Olympia Radio Club — EGV, pres.; ERU, vice-pres.; FWR, secy.-treas.; FWD, trustee. Code and theory radio classes are held six hours per week at Olympia Radio Club, and they have WERS license KFIQ but no operators' permits. (See Warner's article in March QST.) Smooth working WERS at Everett, KFNV, and they are ready now to give or do a public service. Will report on Tacoma next month. IHJ in Casablanca enjoying French wines of vintage '69. IHK, his XYL, now in La. HMJ, RT2c, now in Texas. HML, up a trade to RT2c, has left the "frozen north." JCS, graduated from Harvard, MIT, and Stuart, Fla., is now instructing. EKW went up another grade to full lt. IGM and HXU now in new home on one of Seattle's pinnacles, EGV with state patrol, installing and repairing. IVE is with a broadcasting concern in the Capitol City. Please write any info about hams of this State to O. U. Tatro, W7FWD, Acting SCM, 513 N. Central, Olympia. Thanks and 73. — *Tate*.

#### PACIFIC DIVISION

SANTA CLARA VALLEY — SCM, Earl F. Sanderson, W6IUZ — F. H. McCann, W6LLW, RM. PBV reports building carrier current receiver and that it works fb but needs some DX. HJP is now 1st Lieut., Army Air Force, stationed at Chico. We'd like more reports from you fellows in the service as well as those of us on the home front. How about it, gang? 73. — *Sandy*.

EAST BAY — SCM, Horace R. Greer, W6TI — EC: QDE, EC U.H.F.: PKQ, Asst. EC U.H.F.: OJU, OO U.H.F.: ZM. At the request of the commander of the Oakland Civilian Defense Council, radio station KFMV (WERS for Oakland) was activated between the hours of 10 A.M. and 12:15 P.M. on Feb. 28th. The reason for the use of this equipment was an OCD test held at the above time. The test included the movement of one piece of equipment of the 18 protective services. The demonstration involved the use of approximately 200 to 500 persons. The event attracted at least 300 observers. Station KFMV was used to transmit emergency messages between the scene of the incident and the Oakland control center. This was used to determine the time intervals between the time of telephone messages and those dispatched and received by radio. The actual times for messages sent from the field to control center and back again to the field, with the desired information, averaged not more than 3 minutes per message for both ways. The following gang have been licensed as WERS operators for Oakland and are using their own equipment: EE, IMA, SSN, TT, AEX, QBU, HJM, EHS, TAT, KZN, SFT, MPJ, IJA, AUZ, GZT, MIX, SLP, RCE, ACF, PLB, RGQ, FKQ, SQ, ZM, TPE, TLM, GIU, AFX, RBK, UHM, DKS, HJE, HHM, NPS, NZJ, TWL, JJ, SMF, RQE, IJA, TNM, MVR, RJP, JFA, PB, and 7EX. The following are WERS operators for Oakland only: CDA, GAV, UIG DDO, EJA, EY, BNH, TFV, PSV, ACA, DIP, TI, BPU, SFE, MNG, NRA. The following, as well as being WERS operators, have donated 2½-meter gear to station KFMV: Ellis King, P. Coggeshall, J. Proedigkeit, and Francis Niemon. If your call is not on the above lists, it should be, so apply today to EE and do your part for WERS. — *TT*.

SAN FRANCISCO — SCM, Kenneth E. Hughes, W6CIS — Asst. SCMs, GPB, RBQ, ECs: DOT, RBQ and GPB. The Marin Radio Amateurs' dinner party, held at the Travelers' Hotel on Feb. 27th, was a big success. The following hams (and most of the XYLs) attended: AN, EY, SG, GPB, MNE, FVK, PAZ, HVX, AOF, 7IDO, RBQ, JFP, KNZ, PVC, SQX, 9FA, RGY, TJJ, Roy Ewing, Mansfield Lewis, Carl Cherry, Lt. Delasso. Major Whittaker, SG, acted as MC and talks were given by AN, EY and Comdr. Glasscock, 9FA. Another old timer, RE, has joined the Services as a 1st lt. He was formerly at BC station KYA and has left for Ft. Monmouth, N. J. 9FA, now a lt. comdr., who has been stationed here in SF for the past year, has been ordered to duty in the Pacific, and will be on his way before this appears in print. KB6ILT is back in the States for duty (CRM) after 7 years' foreign service. DOT advises the licenses have been OK'ed for WERS here in SF, so things will be under way very soon. Anyone interested in helping in this work should contact DOT, 27 Gaviota Way, S. F. ZF has been advanced to the rank of

capt. in the U. S. Signal Corps. 9EKY is still in Hawaii on special work for the govt. as a civilian. RBQ has gone in for a victory garden in a big way. JWF, who is stationed in Fla., returned to town recently when his dad passed away. Hams reading this report are invited to drop a line. I want to thank RBQ and GPB for most of this report. 73 to all. — *KH*.

#### ROANOKE DIVISION

NORTH CAROLINA — SCM, W. J. Wortman, W4CYB — The dope contained in this report has been obtained from the secretaries of radio clubs Asheville and Charlotte: FSE and CAY. FSO has been commissioned a 2nd Lieut. in Air Corps Communication, stationed at Hunter Field, Georgia. ECW, BWT and DEL are all RM1c at Balboa, C. Z. ABN and DPF have passed radiotelephone 1st and 2nd with idea of supplementing the growing shortage of bc ops. EFX, Ensign, USNR, has been transferred from fleet to shore duty, and is at Annapolis now. FST is in Army public relations at Camp Croft. CJN is in training at Miami, and recently commissioned ensign in USNR. BC is now a major in Army Air Corps, stationed at Miami. W7JAL, ex-W4CVF, has been transferred from Montana to Chicago, and is with U. S. weather bureau. FSE took a tour of the country north, visited ARRL, and W8SSV and W8TAY (who is president of YLRL). The Charlotte gang have installed new officers as follows: BX is president, NX is vice-president, CAY is secy.-treas. NX was appointed radio aide for Mecklenburg County, and they have the WERS call of WJVT. Ten stations operate in the net. Drill is carried on twice weekly. Seventeen WERS operators at present: BX, NX, EJE, CBN, FUA, FUU, CLB, EYF, GAY, HJY, EIZ, also non-hams Edwards, Painter, Miscally, Richardson, and Ingram. DLX and DSY are with CAP as operators. DIS is overseas. It is understood that the Greensboro Club has disbanded for the duration, but GXB, ex-president, is radio aide for Guilford County, with WERS call WJSY. Has twelve stations with six in operation. ABT, AHF and DCQ are doing radio work in Norfolk Navy Yard. — *"Buck"*.

SOUTH CAROLINA — SCM, Ted Ferguson, W4BQE/ANG — BG is now with the U. S. mail service and is located in Columbia. CZA still does his bit for the cause, and is with the ordnance dept. at Charleston. AFQ sticks to his radio work with Eastern Air Lines. BAT/CKC is doing a service and supply business in Charleston. DNR is with the ordnance dept. at Charleston. FFH is CRM with the Navy. FDN is a radio operator with the Merchant Marine. FXH is with Eastern Air Lines and is located in Florida. CZN is with Eastern Air Lines and is located at Miami. DFC is a lt. in the Navy. We miss that DXF fist, but he is still in Charleston. CXE is with the Civil Coast Patrol. BVV still does his bit with the Southern Bell Tel. and Tel. CUS/PG is now with Civil Coast Patrol. DGD is with Southern Bell Tel. and Tel. FCK is now a lt. in the Army. DQY says that he is thrilled with his new job. 73. — *Ted*.

VIRGINIA — SCM, Walter G. Walker, W3AKN — Thanks for the increased response from several of the old Va. gang! HAE still at Hampden-Sydney College and reports his code and theory classes there still going strong. HBF has passed the board for Signal Corps radio school and hopes to be transferred from Coast Artillery to Signal Corps. CIE, formerly of Norfolk, has been recently promoted to the rank of major, Signal Corps, somewhere in England. GAL is working in the Norfolk Navy Yard. IEM is now in the Army. IUU is in Army Enlisted Reserve at William and Mary College and expects to be assigned to the Signal Corps upon call to active duty. GGI was recently promoted to tech. sgt., and is still instructor in radio at Boca Raton, Fla. JXN now with 810 S. Bn., Fort Hancock, N. J., reports the following dope: FHO is instructor in radio at Orangeburg, S. C., and ENQ is now at Camp Crowder. BWA of Norfolk reports he is working and going to night school, where he is taking armature winding and motor repair. Your SCM had a visit from BC, Major Robinson, formerly of Langley Field, now stationed in Washington, D. C., where he is in radio work. AKN, GGP, HJW and JGZ have all built or begun to build the wired wireless rigs shown in March 1942 QST. EZL of Charlottesville writes to say that he is in 4-H, still with the Va. Public Svc. Co., and has a WERS rig all built and ready. AJA has again been confined to the Dixie Hospital at Hampton. ICZ is still in the radio repair business, and states when he gets settled in his new home he will give wired wireless a whirl. IFJ,

formerly of Newport News, is now in Army Engineers Corps stationed in Texas. 1KT, also of N. N., is now stationed at Camp Claiborne, La. Curtis, GGP, reports that old friend HKE of Norfolk is expecting his induction into the Army any day. 2JOF is located at Fort Meyer, Va. 73. — *Wall*.

**WEST VIRGINIA** — SCM, Kenneth M. Zinn, W8JRL — Sorry we had to miss last month's edition of QST, but you can't send in a report unless you have some news! PQQ, now Lt., is located at Fort Monmouth, N. J. QFN reports that plans are going forward for an early organizing of WERS for the Huntington territory. ETX of McMehehen says he is still feeding the people plenty of bread, but is wondering what has happened to WERS in this state. PAJ, a Lt. in the Navy, visited his parents in Clarksburg. His dad, by the way, is MIP. Congratulations to the fine code class in Wheeling under ADI and Ralph Gould. 73. — *Ken*.

#### ROCKY MOUNTAIN DIVISION

**COLORADO** — SCM, Stephen L. Fitzpatrick, W9CNI — HCP is now instructing at the Lexington signal depot. His brother, ex-FPG, is a Signal Corps 2nd Lt. AIG is now in the Navy, on probation until graduation from Colorado State. If you have some good dope on the use of Rochelle salt crystals, please send it to Ensign B. J. Bittner, 635 South Loomis, Fort Collins, Colorado. HLL is a senior in veterinary medicine at Colorado State. KHQ has accepted a change in work and expects to be in Scott City, Kansas, before this report. Ex-RTQ, now 6ERC, has been in the USNR as CRM since February 23, 1942, and is now stationed in the A and R shops at the NAS in Norfolk, Va. PDA is teaching radio school in Craig, Colo. PCB is with the FCC in California. HCQ is a sergeant in airways comm. some place in the Caribbean. The AAROD has just purchased its fifth war bond. CNL resigned as president of the AAROD, and CAA was elected the new president. Is there any activity in the WERS in the State of Colorado? If so, the ARRL and your SCM would like to hear from you. The SCM's new QRA is P. O. Box No. 1101, Kiowa, Colo. 73.

#### SOUTHEASTERN DIVISION

**ALABAMA** — SCM, Lawrence J. Smyth, W4GBV — ENO is now chief engineer of radio station KGVO, which runs 5000 watts. ERM from Kellyton is now with Philco Radio in Phila., and he is going to school to learn how to build them the Army way. IDZ and HDI of the Lanier Radio Club keep regular wired wireless schedules between their homes, a distance of three miles. HVP is now at WSFA. HVY is at Auburn taking radio engineering. GDO left a few days ago, headed for the Army. 73. — *Larry*.

**EASTERN FLORIDA** — Acting SCM, Frank C. Fassett, W4BYR — HGO reports that he and Boyle (LSPH) are still running wired radio in Sanford. DEN is no longer at MacDill. Word received from YF of TZ informs that he is under "travel orders." We recently visited DVO in his new MEXPET set-up — FB private office "in everything. EYL, GJL, and GVC have accepted reappointments as ECs in their respective areas. Spence reports FOD returned from radio school because of illness and is now working in Tampa shipyard. EZG is now in Army radio, thanks to ham ticket. 1K is instructor for U. of F., radio extension course. DZT is proud father of new daughter. COW is in Miami with EAL. Congrats to DBG who has returned from London and has taken unto himself a YF. CPG is somewhere in Mass. HXM is in Army SC. COZ is at Banana River. CCC is running CAP radio class one night weekly in Bartow. Good news for everyone that GJI continues on the mend. WERS application for P.B. in Wash. at this writing. Very fb report received from Lieut. Hazelton, FDF, comms. officer in S. C., advising of recent maneuvers held first at Miami and then at St. Augustine. Those wishing to contact Hazelton direct can do so by addressing Lt. J. W. Hazelton, SC, Communications Officer, FDF, P. O. Box 958, St. Augustine, Fla.

**WESTERN FLORIDA** — SCM, Oscar Cederstrom, W4AXP — John B. Venters of Gallups Island radio training school is home with his family for a short visit. BCZ has been made chief radio instructor at Lively Vocational School. He has J. D. Devane, M. I. Brundage, 3IPD-4CDY, and J. M. Feinberg as his instructors. Anyone interested in getting trained for war work should write to Phil. FJV is now in charge of equipment in Atlanta Vocational Schools. 9NLF is at Sqdn. 7, NAS. He is an aviation radioman 2c. GRI spent a couple days with ECT and FJR. HJA is back with FAB Amusement Co. UW is teaching an OCD class. He keeps WCOA perking, too. — *"The Old Maestro" AXP*.

**GEORGIA** — SCM, Ernest L. Morgan, W4FDJ — EGT has been in the Navy the past year. FVI is in the Sig. Corps. EF, FKN and GYH also in S. C. GYH stationed outside USA. HAH and AEF are with CAP. GNV is with civil service. FFL is now Lt. and is overseas. CYC is a Lt. in the Army, as is FGU. FJL is teaching code for Navy. GTX is teaching code for Army outside the USA. EFB is on duty on the high seas. EEE is the only local ham left at Athens, and he is teaching code. GQD is on the high seas. FOL is at Atlanta. DAA and WZ work WPDQ at Jax. 73. — *Pop*.

#### SOUTHWESTERN DIVISION

**LOS ANGELES** — SCM, H. F. Wood, W6QVV — The license for Los Angeles proper has been completed, and the "lend lease" contract covering the use of the apparatus by the City has been approved. Ex-TEY, now modified to 8WVY, has been transferred back to Sunny California and is now Lieut. Hotchkiss in the 22nd Signal Section, and will be stationed in Los Angeles soon. Walt Matney is the radio aide for Los Angeles. We need more listings of available equipment. Hurry and get the 'dope to us! If you are still available, let me know so that AEC reappointments can be made. BUK reports that KLN is in the Navy, BRY has sold his rig complete, and QQM is in the Army, while BUK is just "an old man" in 4L. Saw MFJ in San Francisco recently, and he is looking swell and is more and more sold on the Navy and their equipment. UQL has now been sent back to Aberdeen. SSU is now out at Vega as radio flight test inspector, salesman or what have you, and he boasts of a nice new 2nd class commercial. Another young protégé, Murray Black, called to say he had gotten his ticket the other day. Saw HUX and he is busy on the draft board along with other duties. SSU is gathering all the licenses he can when he is not flight testing radio equipment for Vega, and now has both second- and first-class radio telephone and his class A. Ralph Click, former SCM, has moved to San Diego. FZQ wants address of K6OGS. ZBO wants to get in touch with 6DH, HJP is 1st Lt. Air Corps at Chico, and now chief instructor in radio. 73 es C U L. — *Ted, W6QVV*.

**ARIZONA** — SCM, Douglas Aitken, W6RWW — The Phoenix gang reports that they are now holding WERS drills and things are going fine. For the duration, the Radio Club of Arizona has suspended meetings. OAS has taken on the emergency sound engineer job for the local movie houses. An auction was held of OMD's ham gear in March. REJ is now in training at the Lincoln, Nebr., airbase, and says it's cold up there. FZQ says he'd like to hear from any of the old gang. He's a lieut. at Perrin Field, Sherman, Texas. PAO, who holds the rank of capt., is now overseas some place, and DNP is a major in the finance office at Childress, Texas. The Tucson Short Wave Assn. has turned out many graduates from their code and theory classes. In their present ones, they have some girls from the WAVES. At their latest meeting they had 32 in attendance, including 5 XYLS. 5HMT is now located in Nogales, and 8VJY is at Kingman. HXQ is now in the Navy and undergoing boot camp training. SGG and his XYL dropped in for a ragchew. Glad to see any of the ham bunch who gets through these parts. The second edition of the "Cactus News" has been mailed out. If we missed any of you and you'd like to be on the mailing list, drop either MLL or myself a line. — *Doug*.

#### WEST GULF DIVISION

**SOUTHERN TEXAS** — SCM, Horace Biddy, W5MN — IXO passing out cigars to celebrate the coming of a fb jr. op. HIP, SCM for North Texas, is now working in San Antonio. FPB, BKI, JMP and EDX were all back in S. A. for a few days. 9NBU, ex-5FMG, is teaching an ESMWT course in radio at St. Mary's U. EIS tied the old marital knot a few days ago. JKU is working at KMAC as xmitter op. BD is home for a spell after being to sea on a liberty ship. CVQ is doing radio war work in Dallas. HNH is op. on a liberty vessel. ITK is in Signal Corps and is reported in Iceland. EUL had to resign as radio aide of WERS due to leaving for officers' training school. FNA last reported in NYC after making the trip across as radio op. FDR, busier than ever down in Florida, wants to hear from some of the Stx. gang. Write me for his address. BHO reports he is busy at Kelly Field. San Antonio Radio Club members in the services having op. licenses but no call are: Sif. Sgt. L. G. Parsons, Marine Corps, North Carolina, studying radio; Sif. Sgt. L. F. Birdsong, Marines, North Carolina; Leslie Germer, Navy, Calif.; Alex Fabris, Air Corps Reserve, QSO cadet, due to leave for Florida; Pvt. Calvin R. Graf, Marines, Calif., due to go to radio school. 73. — *Horace*.





HITLER began speaking. Thousands of miles away, in the African jungle, a French girl's hand began flying over the pages of a shorthand notebook. Hitler spoke for two hours, but nobody relieved the French girl. Nobody could.

Nobody else understood both German and shorthand. She was bathed in perspiration; her right hand was stiff and unbelievably tired. But she paused only to snatch another notebook from time to time, to throw the filled one onto a pile that grew steadily.

When Hitler finished, the French girl's work was just beginning. For seven more hours she typed out her pothooks, translating them into French as she went along. The sheets spewed from her typewriter; other people took them, translated them into English and other languages. Thus, Radio Brazzaville was one of the few Allied stations with a complete account of Hitler's speech.

Almost every day almost everybody does a Trojan's task at Radio Brazzaville, the voice of Fighting France, the world's strangest broadcasting station.

Brazzaville is, first of all, the unlikeliest spot on earth for an important radio station which rivals in efficiency anything in London or New York. Brazzaville is real Africa, some 300 miles up the Congo River. It is steaming hot; the sun is a sledge hammer; fever and worse are always at hand.

Nobody in his wildest moments would have thought that Brazzaville would be one of the world's radio capitals. It became so by chance, by necessity, and by the efforts of three men:

First, the brothers Desjardins — Captain François, the elder, Lieutenant Pierre, the younger — both experienced French newspapermen. At Brazzaville, De Gaulle asked the two brothers to set up a *Service de l'Information*, a radio mouthpiece for Fighting France. The third man is a mild little radio engineer named Defroyenne, a sort of Gallic Thomas Edison, able to work all kinds of miracles with meager equipment.

There existed only a Morse Code station and a fleapower amateur station with a midget 50 watts. The code station had to be

modulated. The amateur station was boosted to 350 watts. All this work was done on a night-and-day schedule with almost no letup — except once, when a 20-foot boa constrictor turned up in the radio station grounds and had to be shot.

The voice was ready. So they went straight to the source of news — the Morse Code service of the great news agencies.

The Allied news agencies quickly granted permission for them to copy the service. They never bothered to ask the enemy services.

One momentous difficulty reared its ugly head: Who was going to copy the Code? Only one man in the outfit understood Morse, and the Free French Navy was demanding him.

Within three months the Negroes had learned (a) the Morse Code and (b) how to work a typewriter. The Negroes haven't the vaguest idea what they're writing. All they know is that when they hear, for instance, a dash and two dots, they're to hit a certain typewriter key. It happens to be "D" but they don't know that. In this fashion, they take down millions of words from the ether, in French, in English, in any other language. The editor quickly corrects their few mistakes.

Aside from news gathered in this fashion, Radio Brazzaville has first rights to strictly Free French news, and De Gaulle naturally gives them his best stuff. They also collect reports that are often amazing scoops from correspondents all over the French world, including an extraordinarily active corps in France itself, occupied and unoccupied.

One of the Desjardins' smartest tricks is to broadcast messages from Free Frenchmen to their relatives back in France. Homefolk risk anything to listen in, hoping to find out what happened to sons, fathers, husbands who followed the Cross of Lorraine.

Ambitious as these programs are, they're nothing to what's ahead, in the very near future. En route to Brazzaville is the most powerful short-wave transmitter ever built in America — a 50,000-watter which can thunder anywhere in the world. Radio Brazzaville will soon be broadcasting around the clock in some 20 Allied languages, plus counter-propaganda in enemy tongues, plus news in Morse Code to the Free French sailors.

*As part of the new station, five HRO Receivers with complete equipment went to Radio Brazzaville. The story of Radio Brazzaville above is reprinted from Gordon Gaskill's article in the American Magazine for December, 1942. We regret that due to space limitations Mr. Gaskill's very interesting story had to be severely abridged and we recommend the original to you as fascinating reading.*



# ULTRASONICS

The term ultrasonics refers to wave energy similar to sound but occurring at frequencies above the normal limit of human hearing. Ultrasonics is the subject of recent physical research and offers considerable promise in many fields of applied science. Of particular interest is the fact that the first practical application of quartz crystals was in the field of ultrasonics.

In 1918, P. Langevin employed ultrasonics for secret undersea directional signalling and for the detection of submarines, mines, reefs, icebergs, etc. By means of quartz crystals, electric oscillations were converted into pressure waves with sea water as the conducting medium. These waves, carried by the water, served for communication when an appropriate receiver was installed on the other vessel. Likewise, the presence of another vessel, a reef, an iceberg or other obstacles could be detected through the waves being reflected from the object back to a receiver located in the transmitting vessel.

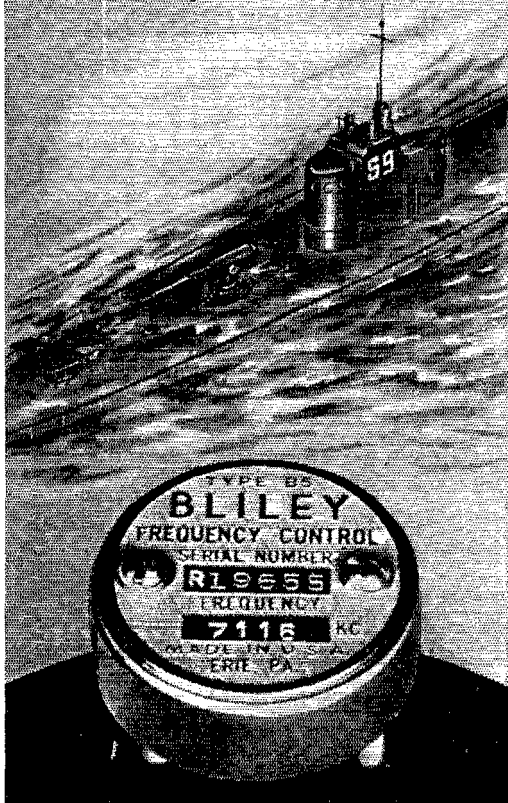

**BLILEY ELECTRIC CO., ERIE, PA.**

## Silent Keys

It is with deep regret that we record the passing of these amateurs:

F.O. Fred Charles Allen, VE3SA, Schumacher, Ont.

Lt. Col. William H. Bache, W5IQD/W5JEI, San Antonio, Texas

Sgt. Pilot R. T. Batchen, GM5GK, RCAF, Edinburgh, Scotland

H. W. Clark, W4UK, Jacksonville, Fla.

Harold S. Dix, W2DPA, Westfield, N. J.

John W. D. Green, ex-W6DWH, Salt Lake City, Utah

W. D. Laurie, VE2PC, A.S., RCNVR, LaPrairie, Quebec

Louis P. LeBlanc, W5JUA, New Orleans, La.

Alban E. Reese, W6SCP, Glendale, Calif.

William Sadowski, W1DPD, Amesbury, Mass.

James W. Seegar, W8JFZ, Dayton, Ohio

Raymond C. Wardwell, W8VFD, Baroda, Mich.

## Splatter

(Continued from page 8)

It will be noted that "160" becomes a m.f. (medium-frequency) band; that the bands from 3.5 to 30 Mc., inclusive, are h.f. (high-frequency) bands, and that our bands from 56 Mc. up to 230 Mc. are now v.h.f. (very high-frequency) bands. The latter represents the major deviation from previous practice. We have been accustomed to calling these bands the "ultrahighs," but hereafter that term will be reserved for frequencies between 300 and 3000 Mc. — that part of the "microwave" region between 0.1 and 1 meter.

The classifications above are identical with those recommended by the last CCIR, with the single exception that the 3000-30,000-Mc. region is called "superhigh" in the FCC table while it was simply designated "super" in the CCIR list.

The new table represents an extension of current military terminology to all civilian and other fields, and is to be used throughout government and industry. You'll be seeing these designations everywhere from now on, so it's a good idea to get them firmly fixed in your mind. The bands are arranged in decades of frequencies which coincide roughly with broad subdivisions of use, a fact which should help eliminate the confusion which has resulted in the past few years because the term "ultrahigh" has been applied indiscriminately to a tremendously broad frequency region.

## FOOTNOTES

THE additional editorial content in this issue made possible by advertising rationing and other paper-space conservation measures (see this column, March and April issues) results in an unusually long list of non-staff QST contributors.

# PERMANENCE

---

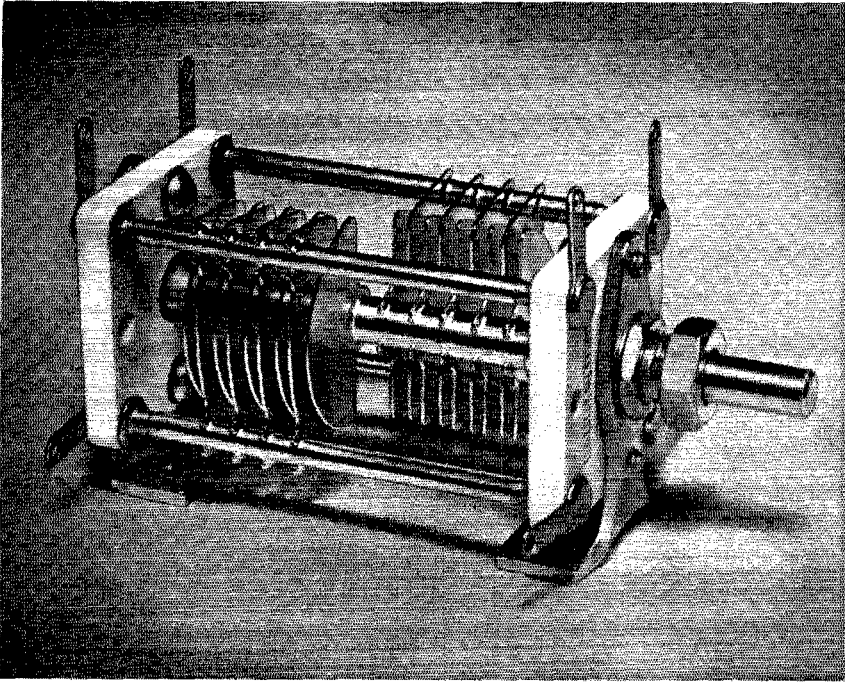

High-stability variable condenser.

**M**ILITARY equipment must perform continuously with a minimum of attention. Permanence of electrical and mechanical characteristics has won a high place for Hammarlund condensers.

---

THE HAMMARLUND MANUFACTURING CO., INC.  
460 West 34th Street, New York, N. Y.



### "My dad's a radio man—

He told me when this war's over and he gets home, he's going to teach me to be a radio man, too. And I'll have an Abbott, just like the one he's using now . . .

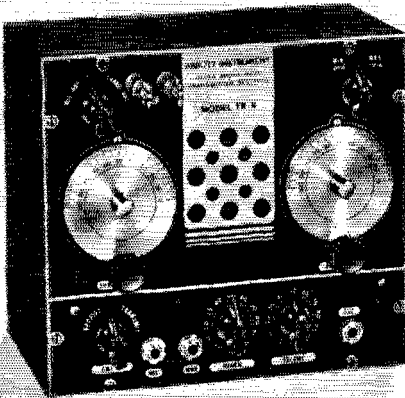

This is an ABBOTT TR-4, one of our standard models—a compact and efficient ultra high frequency transmitter and receiver. It is only an indication of the *type* of apparatus that we can and do produce. Our facilities may be of assistance, if you have a problem within the scope of our activities.

**ABBOTT**  
**INSTRUMENT, INC.**

8 WEST 18 STREET • NEW YORK, N. Y.

Reading alphabetically from left to right, we have with us, first, **B. C. Barbee, W2MWX**, who saves the day for those fascinated by f.m. but appalled by the complexities of an orthodox f.m. superhet (p. 24). Apparently our own deviation ratio isn't very high these days, because we couldn't get much response from MWX to our plea for personal dope (or maybe it's just that f.m. and "splatter" don't associate any more). All we know is that he is ex-W5FPJ, has been occupied as chairman of the radio service department at Melville Aeronautical School since Oct. 1, 1942, and is or soon will be working on some very special stuff up Boston way. . . . **Robert B. Fischer, W9WJX** (p. 9), is another scientific ham whose hobby is radio and whose professional work is in another field—in this case, chemistry. Now a teaching and research assistant at the University of Chicago's William Albert Noyes Laboratory, he also has a commercial ticket and has done a little b.c. operating. Always a low-power man (in seven years W9JWX never exceeded 35 watts), it must have seemed a logical step from microscopic power to power microscopes—which the electron mike certainly is.

For the past few months the drive that made **Edmund R. Fraser, WIKQY**, an outstanding Nutmeg State traffic-handler has gone into WERS, with noteworthy results (p. 30). An A.T.&T. employee, communications are meat and drink to Ed—whether in the doing or in the organization. In line with the latter, he is Connecticut's SCM and assistant New England Division ARRL director. The carefully-programmed New Haven district WERS is perhaps his crowning accomplishment. **G. Edward Hamilton, W9GSS** (p. 40), highlights his career as follows: "Born Ely, Nev., September 1, 1912. Received early education all over U. S., finishing high school at East St. Louis, Ill. Obtained license as W9GSS in 1930. Answered 'I do' to a registered nurse in 1934 (and still does). Began working for WDWS and WILL and on an engineering degree at the University of Illinois in 1937. Now employed by the university as sound technician and code teacher in a CAP training program." All of which fails to suggest any particular susceptibility to or experience with interference problems—but it must be there, as witness his article. . . . **Sourdough** (p. 45) is the non-deplume of a ham in government service the nature of which requires him to remain anonymous. In real life he's neither a sourdough nor a sourpuss but a fellow of many parts whose past career and present job are both so interesting we only wish we could tell you more about them. The day when that can be done will come, perhaps; meanwhile, we'll content ourselves with enjoying his current output.

#### FEED-BACK

THROUGH an oversight, a resistor was omitted in the Hint on page 68 of the January issue concerning electrolytics in a.f. circuits. An isolating resistance of 10,000 ohms should be connected in series with the polarizing lead to either of the pairs of condensers in Fig. 5-B.

# MALLORY TECHNICAL DATA SHEET

## Vibrator Operating Conditions (Continued)

Mallory Technical Data Sheet No. 4 explained the importance of circuit timing and the use of a buffer condenser. The "ideal" wave form was illustrated, and it was explained that the "ideal" wave form was impractical for commercial use because it did not allow for the normal increase in contact spacing from wear, and further that the ideal adjustment was excessively critical.

This data sheet will illustrate the practical wave forms as shown by an oscilloscope connected to the primary of a vibrator power transformer.

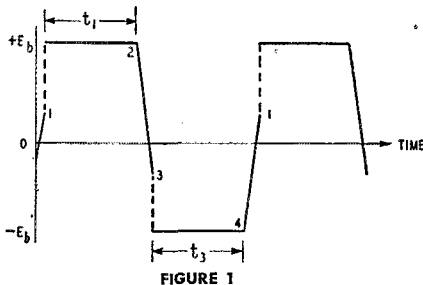

FIGURE 1

Figure 1 shows the practical wave form for best vibrator life and represents what the oscilloscope will show in a properly designed vibrator power supply of the tube rectifier type, operating with a new vibrator. The same type of wave form will be noted in a synchronous or self-rectifying power supply when it is operating without a direct current load but with the first filter condenser in the circuit. Vibrator power supplies are invariably operated into condenser input filters.

The solid slanting vertical lines show how the voltage is smoothly lowered and reversed in polarity through the resonant effect of the tuned transformer. The short dashed-vertical lines

represent the abrupt change in potential when the contacts close. The portion of the trace caused by transformer resonance is called the "closure", and should represent about 60% of the "off-contact" interval.

If the buffer condenser is too small the closure will exceed 100% and the voltage of the winding will exceed the voltage of the contacts the instant before closing. This condition is very harmful.

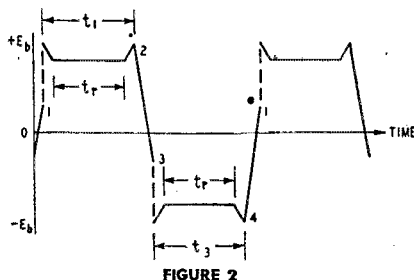

FIGURE 2

Figure 2 shows the wave form of a synchronous or self-rectifying vibrator power supply operating under load. With the synchronous or self-rectifying vibrator the rectifying contacts have slightly wider gaps than the primary contacts, and as a result the primary voltage drops slightly when the secondary contacts close. The short regular peaks on the horizontal lines result from this effect and these peaks should not be confused with the humps observed from over-closure through the use of a too small buffer condenser. The closure should be approximately 60%, the same value as for a tube rectifier or interrupter type vibrator.

The subject of Vibrators and Vibrator Power Supplies is treated in detail in Chapter 4 of the MYE Technical Manual, obtainable from Mallory distributors.

*This advertisement is No. 5 of a series to acquaint you with the practical application of radio products.*



P. R. MALLORY & CO., Inc.  
**MALLORY**

**P. R. MALLORY & CO., Inc.**  
INDIANAPOLIS INDIANA  
Cable Address — PELMALLO

# TRIPLETT

## Combat Line

### INSTRUMENTS

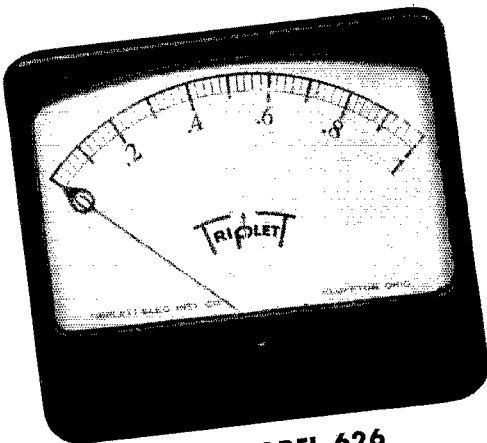

**TRIPLETT MODEL 626**  
with long 5.60" scale

This illustration is  $\frac{1}{2}$  actual size. Note broad scale and minimum panel space required.

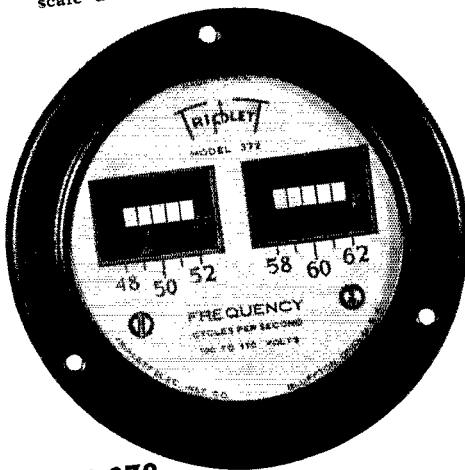

**MODEL 372**

Vibrating Reed  
Frequency Meter.  
This illustration is  
 $\frac{3}{4}$  actual size.



#### A WORD ABOUT DELIVERIES

Naturally deliveries are subject to necessary priority regulations. We urge prompt filing of orders for delivery as expeditiously as may be consistent with America's War effort.

TRIPLETT ELECTRICAL INSTRUMENT CO., BLUFFTON, OHIO

#### IF YOU CHANGE YOUR ADDRESS —

Please give us as much advance *direct* notice as is possible — also be *sure* to put both your *new* and your *old* address on the letter or card (not the envelope).

#### Beat Response

(Continued from page 41)

ence frequency of 750 kc. When the amateur station operates on 1800 kc. and a local broadcast station operates on any frequency between 550 and 1250 kc., the difference frequency will fall in the broadcast band. When the amateur station operates on 2000 kc. and a local broadcast station operates on any frequency between 550 and 1450 kc., the difference frequency will fall in the broadcast band. No station operating on the 80-meter or lower bands can produce this type of interference. Also, sum and difference interference exists only where the signals are strong.

It is to be noted that not only poor ground or antenna connections cause this difficulty. Oxidized change-over relay contacts, poorly soldered connections in the antenna circuit of the receiver, poor connections in band-change switches and similar imperfect contacts all would produce the same results.

#### Who Killed the Signal?

(Continued from page 48)

that stored-up charge back and forth between them — their own internal resistance, as I said before. The energy in the charge itself isn't lost at all; it's like a tennis ball going back and forth from one player to the other. The voltage charge they create doesn't cost them an erg of energy — even when they turn it over to me. I just use it as a bias potential, without drawing any current."

"Well, I've heard about living on love, but I never thought it could be done."

"It can be done, all right. Antenna Coil there boosts the Signal voltage as much as 50 or 60 times — that is, when its frequency is right. If a Signal comes along with a frequency different from the one to which he and his Variable Condenser are tuned he won't have anything to do with it — simply refuses to pass it along."

"Selective sort of chap, eh?"

"Precisely what he is. Selectivity is one of his strong points — that's why he and all the other resonant couples around here are so valuable to the set. They pass along the particular Signal we want and keep all the others out."

"That's a neat trick, too."

"It certainly is. I'll tell you how it's done. Remember I said that only at one frequency would the reactances of the Coil and Condenser be equal and therefore cancel out, resulting in high current *and* voltage at the same time? At any other frequency one will have more reactance than the other — the Coil if the frequency is high and the Condenser if it is low. The extra react-

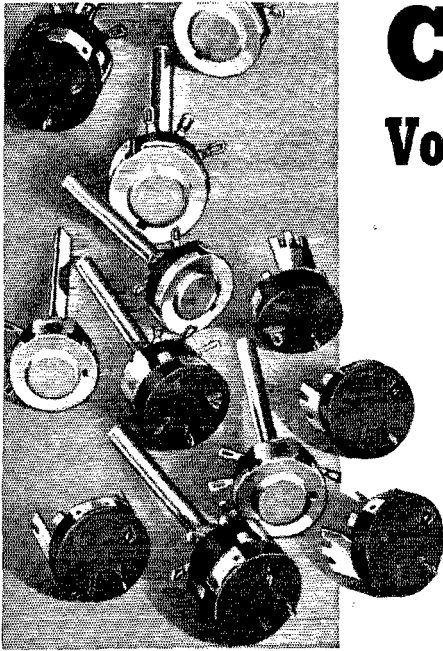

# Centralab's Volume Control Tapers

The resistance curve of a volume control is more important than the maximum resistance. Curves 1, 2 and 4 are drawn by measuring the resistance between the Right Terminal and the Variable Terminal and plotting values corresponding to different shaft positions. Curves S, 3 and 6 show the resistance between Left Terminal and Variable Terminal for different shaft positions. The chart reproduced here indicates the percent resistance change with rotation.

**CURVE 1.** Linear taper. Has uniform resistance change from either end. Used as a voltage divider, will dissipate 1 Watt through total resistance,  $\frac{1}{2}$  Watt through half the total resistance, etc.

**CURVE 2.** Right hand log taper used as "C" bias rheostat or in cases where only right and center terminals are used.

**CURVE 3.** Tapered at both ends. Used where a very slow resistance change from minimum volume end with smooth change from right end is required. Used as an antenna shunt and "C" bias of 1 or 2 tubes without bleeder current.

**CURVE 4.** Slow resistance change from maximum volume with a short taper from the left end for antenna shunt. With the same overall resistance as Curve 3, Curve 4 will carry much more current in the "C" bias circuit because of the more gradual resistance change from the right terminal end. Use where "C" bias change gives the principle volume control effect.

**CURVE 6.** A log curve with slow resistance change from the left end. Use as a straight antenna shunt without "C" bias connection; in audio grid or as a tone control.

**S CURVE** A linear taper with uniform resistance change from either end but tapered at both ends. Will dissipate slightly less current than Curve 1.

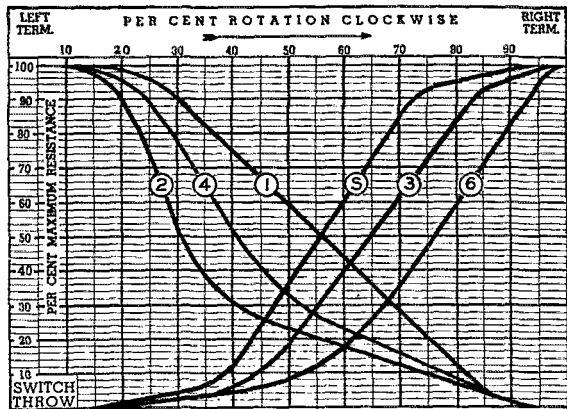

*Always Specify Centralab*

# Centralab

Division of Globe-Union Inc., Milwaukee, Wisconsin

**NOW—a really high-powered  
RADIO  
ENGINEERING  
LIBRARY**

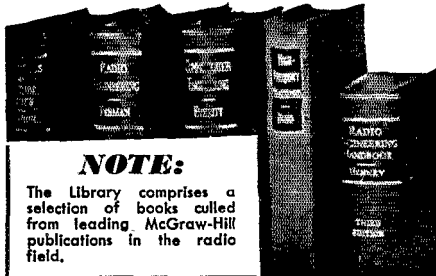

**NOTE:**

The Library comprises a selection of books culled from leading McGraw-Hill publications in the radio field.

- ➔ especially selected by radio specialists of McGraw-Hill publications
- ➔ to give most complete, dependable coverage of facts needed by all whose fields are grounded on radio fundamentals
- ➔ available at a special price and terms

THESE books cover circuit phenomena, tube theory, networks, measurements, and other subjects—give specialized treatments of all fields of practical design and application. They are books of recognized position in the literature—books you will refer to and be referred to often. If you are a practical designer, researcher or engineer in any field based on radio, you want these books for the help they give in hundreds of problems throughout the whole field of radio engineering.

**5 volumes, 3559 pages, 2558 illustrations**

- Eastman's **FUNDAMENTALS OF VACUUM TUBES**, 2nd edition
- Terman's **RADIO ENGINEERING**, 2nd edition
- Everitt's **COMMUNICATION ENGINEERING**, 2nd edition
- Hund's **HIGH FREQUENCY MEASUREMENTS**
- Henney's **RADIO ENGINEERING HANDBOOK**, 3rd edition

**10 DAYS' FREE EXAMINATION**

**SPECIAL LOW PRICE**

**EASY TERMS**

Special price under this offer less than books bought separately. Add these standard works to your library now; pay small monthly installments, while you use the books.

**SEND THIS EXAMINATION COUPON**

McGraw-Hill Book Co., 330 W. 42 St., N. Y.

Send me Radio Engineering Library for 10 days' examination on approval. In 10 days I will send \$3.00 plus few cents postage, and \$3.00 monthly till \$24.00 is paid, or return books postpaid. (We pay postage on orders accompanied by remittance of first installment.)

Name.....  
 Address.....  
 City and State.....  
 Position.....  
 Company..... QST 5-43

(Continued from page 68)

ance, which isn't cancelled out, then limits the current flow—which means there's that much less current for the circuit to build up voltage with. Even a little difference in frequency will reduce the output voltage to a fraction of its value for the frequency at which the Coil and the Condenser are in tune. As a result, any Signal of a frequency different from the one we want quickly finds he isn't welcome, and gives up in disgust," R. F. Tube concluded complacently.

But the Sleuth's attention was wandering. "Very interesting, I'm sure," he replied absently, turning to see what was happening below. Signal Generator seemed to be working hard, his fat cheeks puffed out with the effort of imitating the Signal, but there was no evidence of response on Output Meter's part. Turning back to R. F. Tube, the Sleuth resumed his questioning.

"Now tell me what part you play in all this."

"Oh, I work between Antenna Coil and R. F. Interstage Coil. I'm an amplifier, of course," R. F. Tube replied with offhand pride.

"Like Power Tube over there?"

"We're related, but only distantly," he said condescendingly. "I'm a voltage amplifier instead of a power amplifier, for one thing. Then, too, I'm a pentode and he's only a triode."

"A pentode? You mean you have five elements instead of three?"

"Yes — three of them grids."

"Why do you need three grids?"

"They're quite essential in my job, really. One, of course, is a control grid, just as in any Tube. Except that my control grid is wound with a variable pitch — the spacing between wires is progressively increased from one end to the other.

THE WIDELY-SPACED PART WILL STILL LET A FEW ELECTRONS THROUGH



That way, one part 'closes' faster than the other when my bias is increased. The widely-spaced part will still let a few electrons through even when the rest of the grid is entirely closed. That gives me a variable- $\mu$  characteristic (meaning a variable amplification factor), so that I can be made to amplify weak signals more than strong ones. My remote cut-off grid — as it's sometimes called — keeps me from overloading, too; I can handle the biggest signal there is without bending my characteristic!" R. F. Tube boasted.

"I see. Now about the other two grids?"

"Well, the middle one is the screen grid. It's in there to keep the Signal from being coupled back from my plate circuit to my grid. When it varies up and down my plate current also changes. That varies the voltage drop in my plate load impedance, and so the instantaneous voltage on my plate changes correspondingly — except that the resulting a.c. voltages on my plate and grid are 180 degrees out of phase. That is, when my grid goes negative the plate current is less, mak-





**RME**  
TIME WILL TELL

## OUR FUTURE

IS A DEFINITE PART OF THE PRESENT

WHAT WE DO NOW AND HOW WE DO IT MAKES  
POSSIBLE OUR STANDARDS OF LIVING FOR TOMORROW

For you we will have brand new radio equipment—ultra modern receivers—(RME would like to tell you all about them)—instruments for every type of reception—including automatic signaling—robot operators—ad infinitum. . . .

RIGHT NOW **RME** IS BUSY DAY AND NIGHT PRODUCING — HELPING FIGHT THE BIGGEST JOB ON EARTH — TO MAKE IT POSSIBLE FOR US TO BUILD THOSE INSTRUMENTS FOR YOU TOMORROW —

**RADIO MFG. ENGINEERS, INC.**

304-306 FIRST AVE.

★

PEORIA, ILL., U.S.A.

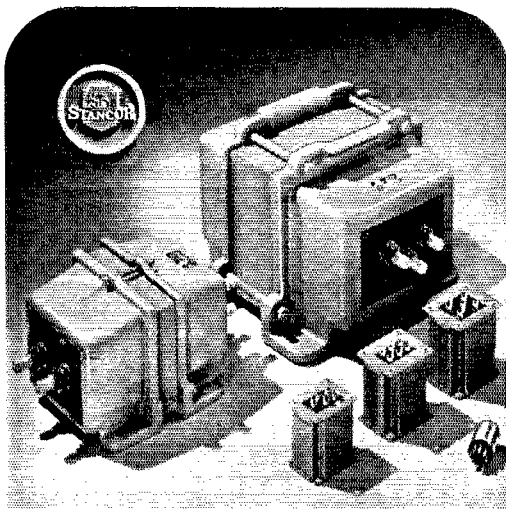

*Now Available . . .*

# STANCOR

## PROFESSIONAL SERIES TRANSFORMERS

**T**HE Stancor Professional Series Transformers are now available to manufacturers who are doing essential war work. Built to fit many needs, the multiple features of these transformers combine to make them the finest and most versatile group of units Stancor ever has designed.

For information write for catalog No. 240 or contact our representative nearest you. See list below.

### SALES OFFICES IN PRINCIPAL CITIES WIRE OR CALL THE NEAREST PRINCIPAL SALES OFFICE

**ATLANTA**  
Main 5878  
**BOSTON**  
Hancock 0200

**BUFFALO**  
Washington 2517

**CLEVELAND**  
Academy 4932

**COLUMBUS**  
Adams 8928

**DALLAS**  
Tennessee 37093

**DENVER**  
Emerson 2437

**DETROIT**  
Vermont 7-5310

**KANSAS CITY**  
Victor 7057

Main Office and Warehouse • CHICAGO • Mohawk 5300

**LOS ANGELES**  
Richmond 6363

**MEMPHIS**  
2-0612

**MILWAUKEE**  
Concord 7799

**NEW YORK CITY**  
Rector 2-1423—2-5334

**PHILADELPHIA**  
Walnut 3575

**ST. LOUIS**  
Franklin 0482

**ST. PAUL**  
Emerson 8619

**SAN FRANCISCO**  
Hemlock 2625

**SEATTLE**  
Main 8811

**STANDARD TRANSFORMER CORPORATION**  
1500 NORTH HALSTED STREET, CHICAGO

# STANCOR

(Continued from page 70)

ing the drop or loss through my load impedance less, and therefore increasing the instantaneous voltage on my plate — making it more positive. On the positive half of the grid cycle the process is reversed and my plate voltage goes down — becomes more negative, or just the opposite of the grid voltage. Do you follow me?"

"It's a little complicated, but go ahead."

"Well, the result is that the instantaneous potential difference between my grid and plate is always changing, the grid voltage coming up to meet the plate voltage and vice versa. This constitutes an a.c. voltage that charges the grid-plate interelectrode capacitance (there's actually the equivalent of a little condenser inside me, with my grid and plate as the two electrodes, you know). If that voltage were to get back into my input circuit (they call that feed-back) it would get all mixed up with the incoming Signal, and there'd be the devil to pay. It doesn't matter so much to a triode operating at low frequencies, but in a radio-frequency job like mine it would be fatal. So I have this screen grid — it's nothing more than a grounded electrostatic shield, really — which eliminates the capacity between my grid and plate and so prevents any feed-back."

"But why doesn't the screen stop the flow of electrons to the plate?"

"I guess I confused you by saying it was grounded. It is, as far as r.f. is concerned; that little Screen By-Pass Condenser there short-circuits the r.f. to ground for me. But it's not grounded for d.c.; in fact, my screen is supplied with a positive d.c. voltage — not as much as on the plate, but enough to encourage the electrons to keep coming."

"Hmm. Now tell me about the third grid."

"That's my suppressor grid. Its job is to keep electrons from bouncing off my plate or knocking other electrons off when they hit. They do that sometimes, you know. It wouldn't matter if the instantaneous plate voltage didn't fall below the screen voltage when a strong signal comes along, but when that happens the electrons start rushing back to the screen because, for the moment, it is the more positive. The suppressor grid is put in there next to the plate to keep them where they belong. It is grounded — or at least connected direct to my cathode — but it is made with such wide spacing that it doesn't interfere with my normal flow of plate current."

When R. F. Tube finished speaking the Sleuth looked hopefully down at Signal Generator. The strain of these prolonged technical dissertations was obviously wearying. Signal Generator was still hard at work, however, and so the Sleuth turned resignedly back to R. F. Tube.

"That's fine," he said with assumed heartiness.

"Now if you'll tell me where the Signal goes after you have finished with it —"

"Of course. I send it along to R. F. Interstage Coil. His primary is my plate load circuit. Except for the fact that his primary is a high-impedance winding (I just don't feel right unless I have a high load on my plate), he's exactly like Antenna

# PIONEERS...in war and peace

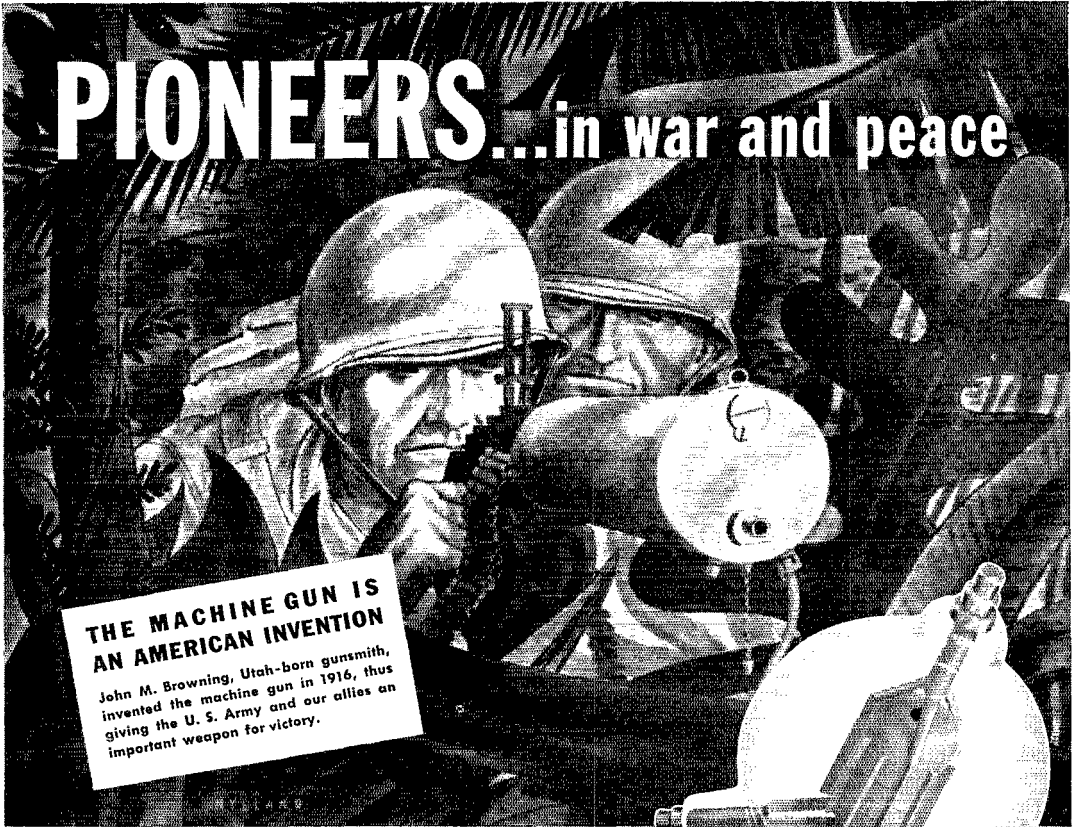

**THE MACHINE GUN IS AN AMERICAN INVENTION**

John M. Browning, Utah-born gunsmith, invented the machine gun in 1916, thus giving the U. S. Army and our allies an important weapon for victory.

## HEINTZ AND KAUFMAN ORIGINATED THE TANTALUM ELECTRON TUBE

GAMMATRON tubes exemplify the ability of Heintz and Kaufman engineers to meet difficult design problems with exceptional skill and ingenuity.

Faced with the need for tubes which can endure great physical and electrical punishment without faltering, our engineers were the first to appreciate the unique advantages of tantalum as a plate and grid material. In addition they pioneered new principles of construction which discarded all internal insulators. As a result, GAMMATRONS are inherently gas-free.

Heintz and Kaufman brought this same pioneering spirit to the UHF band. Some of the accomplishments of GAMMATRONS at high frequencies are well known, but many developments are today classed as restricted information. Until the full story can be told, keep GAMMATRONS in mind for postwar applications... for then as now they will help open new frontiers for electronics.

**HEINTZ AND KAUFMAN, LTD.**  
SOUTH SAN FRANCISCO · CALIFORNIA · U. S. A.

*Gammatron Tubes*

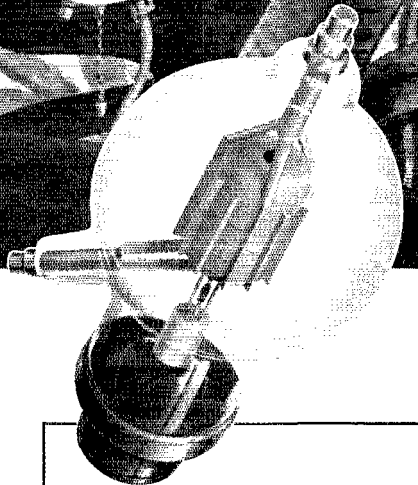

### HK-1054 TRIODE OPERATING DATA

*As an RF Power Amplifier,  
Class C, Unmodulated.*

	Typical	Maximum
Power Output . . . . .	3000 Watts	—
Driving Power . . . . .	140 Watts	—
DC Plate Voltage . . . . .	5000 Volts	6000
DC Plate Current . . . . .	750 M.A.	1000
DC Grid Voltage . . . . .	-950 Volts	-2000
DC Grid Current . . . . .	105 M.A.	150
Peak RF Grid Volts . . . . .	1475 Volts	—
Plate Input . . . . .	3750 Volts	3750
Plate Dissipation . . . . .	750 Watts	750

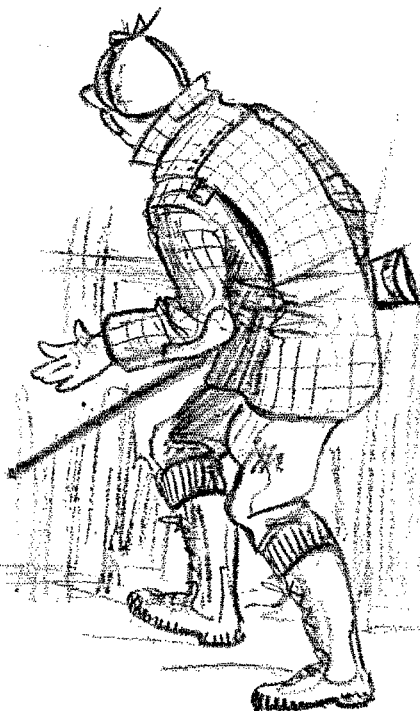

# a-hunting we will go

With scarcities of critical radio materials developing everywhere, we've become an emergency "procurement" agency for many manufacturers and branches of our military services.

We are hunting for good used apparatus . . . to purchase . . . to speed deliveries of this material to places where it is needed urgently.

Please take "dust covers" off anything that you may have. Inspect it, and if it's in good operating condition, write to us immediately. Specify type, make, model numbers and the general condition of your Communication Receivers, Test Equipment, Meters, etc.

**SPECIFY THE PRICE YOU EXPECT TO RECEIVE.** If satisfactory, we'll send our check or, if you prefer, the equivalent amount in war bonds and stamps.

## HARVEY

### RADIO COMPANY

103 WEST 43 ST. NEW YORK, N.Y.

(Continued from page 72)

Coil. He has a tuned secondary, too — the middle Variable Condenser, you know. Between the three of us — Antenna Coil, Interstage Coil and myself — we boost the Signal voltage plenty."

At that moment Signal Generator's strident voice was heard. "Hey, come on down here, Sleuth. I want to talk to you," he commanded.

"Excuse me," the Sleuth said hastily. Clambering down the chassis, he approached Signal Generator. "What have you learned?" he demanded anxiously.

"Nothing definite — yet. There's something funny going on here, though," replied the man of many voices. "I finally managed to get an indication from Output Meter by pushing through an artificial signal with every ounce of voltage I've got — which is a lot more than any real Signal is likely to have. But something in there kills any Signal of normal strength cold."

"What's the explanation?"

"I don't know — yet. But we'll find out if we have to put every Part in the set through the third degree," Signal Generator declared grimly.

"That's the spirit! By the way, something interesting came up while I was quizzing R. F. Tube. It seems that the Coils associated with him contribute a remarkably high order of amplification to the set — and the only reason they can is because they are in resonance with those Siamese triplets over there, the Variable Condensers."

"Come, come," Signal Generator objected impatiently. "This is serious business. We've no time for idle gossip."

"I'm not gossiping," the Sleuth denied with asperity. "But suppose there'd been a falling out of resonance on the part of some of these circuits. Suppose they were out of alignment with each other — no longer in tune. Wouldn't the loss of amplification account for what you've observed?"

Signal Generator stared sharply at the Sleuth with his unwinking round eyes. "Could be you've got something there, at that. But no — it wouldn't make *that* much difference. I don't think it would, anyway. But we'd better look into it."

The Sleuth rubbed his hands. "Now we're getting somewhere," he exulted hopefully.

(To Be Continued)

## Elementary A.C. Mathematics

(Continued from page 23)

rate of change of field of strength. It is also proportional to the amount of inductance, since the field strength is proportional to inductance when the current is constant.

In a d.c. circuit such as that of Fig. 28 the rate of change of field is most rapid at the instant of closing the switch, since at that instant the field changes from zero to some finite value. The induced voltage consequently is highest at that instant, being practically equal to the applied voltage. (It could not exceed the applied voltage because if it did the current would flow in the opposite direction, which would mean that the inductance would be supplying energy to the source. Such a condition obviously is impossible



★ ★ ★ ★ ★ ★ ★ ★ ★ ★ ★ ★ ★ ★ ★ ★

**A PROMISE  
OF  
THINGS TO COME**

We call it the "American Way" of life—the right to think, speak, act and worship as we please, and respect the right of others to do the same. For the preservation of these principles we are again at war. We of this company are proud of the major role we and the radio-electronic industry are privileged to play in this struggle. The free world we are fighting for will be a vastly happier and more comfortable world thanks to war-time radio and electronic advances now little known to the public.



The contributions we will be able to make in new parts, new designs, new principles are multiplying daily. We're fighting harder now to hasten the day when we may release for constructive peaceful purposes the fruits of these many months of war production and research.

**JOHNSON**

*a famous name in Radio*

E. F. JOHNSON COMPANY  
W A S E C A , M I N N E S O T A

THANKS to improved techniques and plant expansion, most variable condensers, tube sockets, inductors, insulators, hardware and other parts can now be shipped more quickly than heretofore. We will be pleased to quote price and estimate delivery for your war requirements. Ask for free catalog 967J.

(Continued from page 74)

# OHMITE

## Rheostats and Resistors

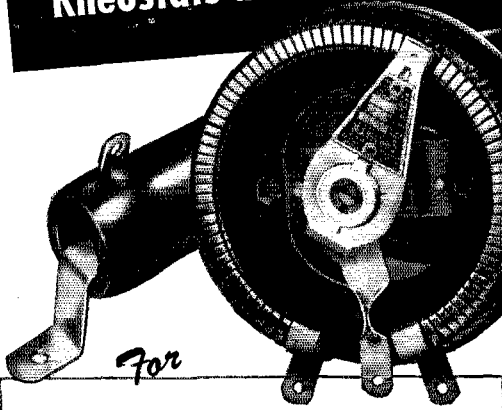

For

# CONTROL

*of Electronic Tubes and Devices  
... Today and Tomorrow*

The advancement of electronics has meant wider use of Ohmite Rheostats and Resistors in communications and industrial applications. These time-proved resistance units insure accurate, dependable control of electronic tubes and devices... from radio and television to instruments and machines, from x-ray equipment to airplanes. Today, Ohmite Rheostats and Resistors help speed Victory. The electronic world of tomorrow will find Ohmite units ready to meet new peacetime requirements.

### Send for Handy Ohm's Law Calculator



*Solves any Ohm's Law problem with one setting of the slide. All values are direct reading. Available for only 10c to cover handling and mailing. Also available in quantities.*



**OHMITE MFG. CO.**

4864 Flournoy St., Chicago, U.S.A.

before any energy has been stored in the magnetic field.) The current at the instant of closing the switch therefore is quite small. The current cannot remain at the initial value because if there is no change in current there is no change in the field strength and therefore no induced voltage to oppose the applied voltage. Consequently the current increases — and with it the magnetic field — but at a continually decreasing rate, the induced voltage becoming smaller and smaller as time goes on. Eventually the induced voltage will be negligible in comparison with the applied voltage and only the resistance in the circuit will limit the current flow. At this time the maximum energy is stored in the field, but when no more energy is being put into the field no power is required from the source of voltage. The only power consumed under these “steady-state” conditions is that used in the resistance.

The effect of resistance on this process can be described as follows: At the instant of closing the switch the current is very small, as explained above, hence the voltage drop in the resistance is negligible. As the current increases the resistance drop also increases, leaving less voltage across the inductance. Since the induced voltage becomes proportionately smaller than the voltage applied to the inductance as the current builds up, and since the applied voltage is simultaneously decreasing, the net result of the two actions is that the induced voltage decreases at a more rapid rate as the ratio of resistance to inductance is increased. Consequently a shorter time is required for the current to reach its final value (this final value is of course smaller as the resistance is increased, the source voltage being the same). Or, stated another way, the smaller the resistance compared to the inductance the longer the time required for the current to reach its final value. Although there is always some resistance present, we can here apply the previous line of reasoning<sup>1</sup> and say that as the resistance approaches zero the time required for the current to reach substantially its final value approaches infinity. As a consequence of this the induced voltage must always equal the applied voltage — another paradox resulting from bringing infinity into the picture — and the “final” current is infinitely large. Confusion can be avoided by allowing the resistance to approach zero as closely as we please, but not actually to reach it. Under these conditions the induced voltage can be considered equal to the applied voltage for any length of time we like, “equal” meaning that the difference between the two voltages is negligibly small.

If the switch is now opened, the current which maintains the field will be interrupted and the field will disappear. The stored energy is then returned to the circuit, by the mechanism of a new induced voltage (the value of which again depends upon the rate of change of field strength) which forces a current through the circuit. In this case the induced e.m.f. has the opposite polarity, since the field is decreasing instead of increasing. Hence the current continues to flow in the same

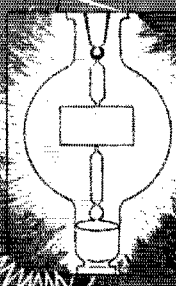

# Electronic briefs: television

To produce a moving picture it becomes necessary to break down the necessary scene into a series of still pictures. Each still picture is flashed on the screen individually but done so rapidly that the human eye sees a smooth action. If the motion picture projector is slowed down the action becomes jerky. Each still picture is called a frame and the conventional movie projector flashes between 24 and 30 frames per second on the screen. Television is based upon the same principle but the problems involved are much more complex.

Television, using the same basis for creating picture action as the movies, breaks down the picture or scene to be broadcast into a series of still pictures also called frames. But each frame must also be broken down into approximately 200,000 tiny segments, each segment being broadcast separately and reassembled at the receiving end so rapidly that 30 frames can be flashed on the screen every second. Thus some 6,000,000 separate signals must be transmitted per second. Furthermore each of these signals starts as light, is converted into an electrical impulse, broadcast and then reconverted to light again. To make television talk, a conventional sound transmitter must be coordinated and synchronized with the picture broadcast.

As with all things in the field of electronics, vacuum tubes are what make television possible. Remember; Eimac tubes enjoy the enviable distinction of being first choice among leading electronic engineers throughout the world.



EITEL-McCULLOUGH, INC., SAN BRUNO, CALIFORNIA  
EXPORT AGENTS: FRALAR & HANSEN, 301 CLAY ST., SAN FRANCISCO, CALIF., U. S. A.

Follow the leaders to

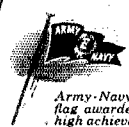

Army-Navy "E" flag awarded for high achievement in the production of war material.

**Eimac** REG. U. S. PAT. OFF.  
**TUBES**

**"They'll hear you all right—your transmitter checks to the cycle!"**

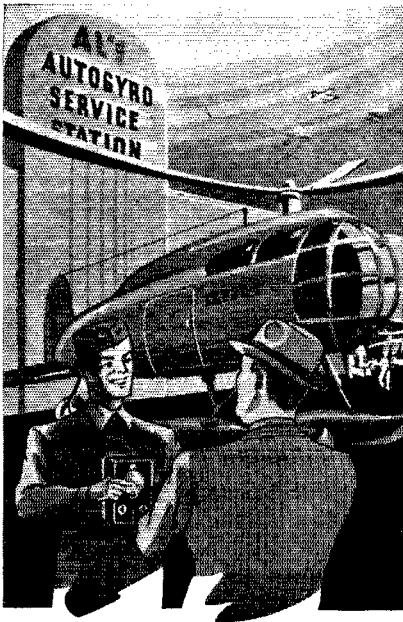

Then, as now and in the past, Browning will make available what it takes to know that transmitters are "right to the cycle." Then, as now, Browning will be in the forefront of electronic development and commercial production of useful apparatus.

Type S-2  
Frequency  
Meter

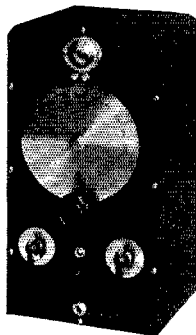

**BROWNING**  
*Laboratories*  
INCORPORATED  
WINCHESTER·MASS.

(Continued from page 76)

direction. In practice, since the energy must be dissipated rapidly when the switch is opened and the circuit is broken, the current flows through a spark or arc which forms at the switch contacts.

The storage and release of energy in an inductance is comparable to the storage and release of energy in a condenser. In the condenser circuit when the voltage is increasing energy is being stored; in the inductive circuit when the current is increasing energy is being stored. In the condenser circuit when the voltage is decreasing energy is released; in the inductive circuit when the current is decreasing energy is released. The current flowing in a condenser is proportional to the rate of change of voltage; the voltage across an inductance is proportional to the rate of change of current.

Now consider the conditions existing when an alternating current is flowing through an inductance. As the current increases from zero in the positive direction energy is being stored in the magnetic field and the polarity of the induced voltage also is positive,<sup>3</sup> since the energy being stored is coming from the source of current. That is, the power during the storage period is positive. When the current passes through its positive maximum and decreases, energy is being restored to the circuit; the power is then negative and since the current is still positive the induced voltage becomes negative. When the current reverses polarity and increases toward the negative maximum, energy is again being stored in the field, again the power is positive and the voltage must have the same polarity as the current. When the current decreases from the negative maximum the power once more becomes negative and the voltage must have the opposite polarity; that is, it becomes positive. Thus the relationship between current and voltage in the inductance is the same as that between voltage and current in a condenser. Since the rate of change of the sine-wave current is a cosine curve, the voltage, which is proportional to the rate of change of current, must follow a cosine curve. Thus the voltage wave has the same shape as the current wave but is a quarter cycle or 90 degrees ahead of the current in time.

In this case we have used the current as a reference and found the voltage which must exist across the inductance when the current flows. This is the easiest way of visualizing the process. However, it is plain that if the procedure is reversed—that is, if an alternating voltage is applied to the inductance—the same relationship between current and voltage must hold, since the voltage at the terminals of the inductance can have only one value at a given instant, and in the absence of resistance the induced voltage always must equal the applied voltage.

(Part V will appear in an early issue.—Editor.)

<sup>3</sup> In the same sense as the voltage drop in a resistor. In a circuit containing a source of e.m.f. and a resistance, the identical voltage appears across the source and the resistance. From the series standpoint, however, the source represents a rise in voltage and the resistance a drop in voltage, so that the resistance drop "opposes" the source voltage.





## ON THE JOB

Whenever our Flying Fortresses fulfill their missions for victory, AlSiMag ceramic insulators are on the job to help make the flight a success.

AlSiMag steatite insulation can be found in all vital electronic components and is selected by designers of electronic equipment for dependable service.

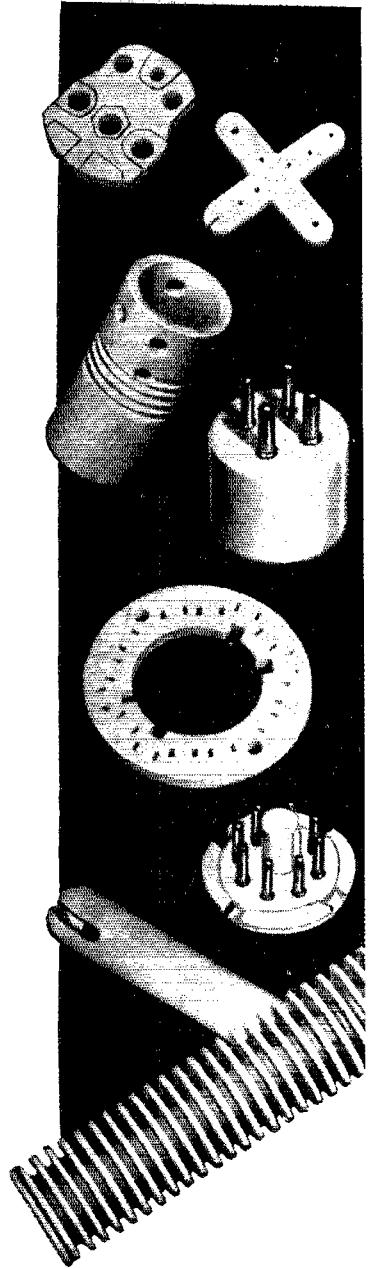

AWARDED JULY 27, 1942

# ALSiMAG

TRADE MARK REGISTERED U. S. PATENT OFFICE

## AMERICAN LAVA CORPORATION

CHATTANOOGA, TENNESSEE



It isn't  
so  
today...

J. P. is in New York -  
with his O. K. we  
can go ahead!

but it will  
be so  
tomorrow!

It's O. K. with me -  
go ahead and  
start building.

HARVEY-WELLS communications equipment will hold a vital position in the world of *tomorrow* ... because we are preparing *today*.

At the present time, we're doing a tremendous war-time job ... helping to produce the finest communications instruments in the world. The skill and experience learned through this war production will be reflected in the ultra-modern equipment of *tomorrow* ... for police, plane or plant ... in the home ... in the auto ... and on the train.

**OUR POLICY**

To anticipate the need and keep the lead... to develop the finest military communications equipment ... so that after victory is ours, the Communications fantasy that isn't so today... will be so tomorrow!

★  
HARVEY-WELLS COMMUNICATIONS  
Are Helping to Win this War  
★

**HARVEY-WELLS**  
*Communications inc.*

★  
HEADQUARTERS  
For Specialized Radio Communications Equipment  
SOUTHBRIDGE, MASS.

**WERS in the New Haven Warning District**

(Continued from page 31)

locked when the units are not in operation, and keys have been given to each of the individual station operators. The associate and district radio aides have master keys for all units.

A word should be given to the unique microphone holders which a member of the constructional crew at WJLH put together. Obtaining automobile tail-light lamp holders from a junk pile, he mounted them on a stand and supported the "mikes" within them with plaster-of-Paris.

The experience of the New Haven net is that a period of about ten weeks elapses between the time when operators are examined and the required forms sent to Washington and when they receive their licenses. It is therefore suggested to other district nets that possible further delays may be avoided if the examiners will take sufficient time to inspect the various forms, birth certificate, etc., submitted by each individual, for omissions and lack of required data.

To quote W1KQY, "It is hard to single out individuals who aid in the success of an organization of this type. It remains mainly in the combined efforts and splendid cooperation of all participating." How typical this should be of all of us in our WERS organizational efforts!

**Book Reviews**

(Continued from page 39)

of the service as well as the industry might conceivably be disturbed at the almost jealously-aggressive insistence on ascribing to the Corps major developments of the communications art as a whole. We, for example, could wish that more background had been included crediting amateur radio's contribution to military radio, both in terms of recruiting and technique. Yet on the whole the partisan viewpoint is perhaps only natural in a promotional work of this type. Certainly no present or prospective member of the Signal Corps reading this book could fail to glow with pride at the accomplishments it records.

— C. B. D.

**Pre-Service Course in Shop Practice**, by William J. Kennedy. Published by John Wiley & Sons, Inc., 440 Fourth Ave., New York. 337 pages, 5½ × 8½; illustrated. Price, \$2.00.

Although written particularly for use in the pre-service courses now being conducted in high schools, this treatment of hand tools and their uses singularly fits the requirements of the radio ham who worries each time he is confronted by constructional problems in furnishing equipment for the station. Of chief interest to the ham, of course, are the chapters on working metals, which cover the proper use and care of tools for the purpose, and the one on measuring tools and their uses. Only slightly less important are the sections on soldering, wiring and wire splicing. The amateur constructor will also find the material devoted to woodworking and finishing of more than casual interest. More than one handy tip in the erection of antennas may be gleaned from the chapter on ropes, splices and knots.

The book concludes with a useful appendix containing conversion tables, wire and drill tables, cutting lubricants, drill speeds and other reference material. All in all, the volume should make a fitting addition to the amateur's bookshelf.

— D. H. M.



# MEISSNER SIGNAL CALIBRATOR GIVES YOU EXACT FREQUENCIES!

**A Precision Frequency Standard for Laboratory Use.** The Meissner Signal Calibrator is the answer to calibrator checking which is a problem so often encountered in the manufacture of products used in the war effort. Solves the problem of providing accurate signals from 10 KC to 60 megacycles for checking calibration. Provides modulated and unmodulated signals every 10, 50 and 100 KC. Vernier control is provided for adjusting to zero beat against WWV or other primary standard.

Entire unit, including 110 volt A.C. power supply, housed in black crinkle finished cabinet measuring 8" x 8" x 12". Supplied complete with tubes. On special order the Signal Calibrator can be arranged to provide 100 KC and 1000 KC output.

*See your Meissner distributor or write*



**Meissner**  
MOUNT CARMEL, ILLINOIS

"PRECISION-BUILT PRODUCTS"



## WORDS on the WING

Without words winging between planes there'd be no teamwork—without teamwork there'd be no bombing—without bombing there'd be no Victory! But always they must be the *right* words at exactly the *right* instant, spoken by men who *know* their radio! And that's our part of the job! Melville-trained, licensed radio operators and technicians are serving today on every fighting front—in a host of jobs at vital bases—on commercial airlines that thread the world. After the war, many of these Melville-trained men and women will be important executives in the new world of aircraft and radio.

## MELVILLE

AERONAUTICAL RADIO SCHOOL, INC.  
45 West 45th Street New York City  
Training Men & Women for Radio in the Service of  
AIRLINES - ARMY - NAVY - MARINES - MERCHANT  
MARINE-COAST GUARD-INDUSTRY

## WANTED MAN or WOMAN

for trouble shooting electronic instruments. Good opportunity and advancement for party with suitable radio background. Supply full details, education, ham experience and starting salary expected. Location metropolitan N. Y. area. Box 40, QST.

## INSTRUMENTS WANTED

The Signal Corps, Aircraft Radio Laboratory, Wright Field, Dayton, Ohio, and associated critical war industries, have need of meters and test equipment for use in training programs.

Write stating type, condition of equipment, and price desired to

**Director, Aircraft Radio  
Laboratory,**

**WRIGHT FIELD . . . DAYTON, OHIO**

## On the Very Highs

(Continued from page 37)

swung west in true sporadic-E fashion, with Chicago and Milwaukee coming through, to be followed by K45LA, Los Angeles, for a 45-minute period ending at 11 P.M. Reports of such trans-continental reception with receivers generally inferior to those used on Five point up the possibility that we may have muffed many chances for choice DX simply because there were not enough stations active in the right places at the right times. No W4-W6 work was ever done on Five.

And here's one more report on f.m. DX. Cpl Allen A. Burk, W3JPX, 27th C. A. Bn., APO 856, New York City, heard W41MM between 1800 and 1930 on January 2nd. All we need to know now (censor, please note) is the location of APO 856!

## That's the Limit!

(Continued from page 46)

The relay tube has a bias resistor,  $R_2$ , of suitable value to bias back the grid and prevent the relay tube from taking much current.

Suppose we couple the two tuned circuits extremely loosely to the aerial feeders. The minute the transmitter frequency reaches the frequency of the crystal, there is a flow of current through that side of the diode. The diode rectifies the current and a plus potential builds up at the top of  $R_1$ . This plus potential is applied to the grid of the relay tube, which promptly draws current and closes the relay.

A holding condenser is connected between the plate of the relay tube and ground. This is to prevent the possibility of snapping through the frequency so quickly that the relay is not closed. When the relay tube is actuated the condenser will accumulate a charge which will leak away slowly and hold the relay closed.

The relay contacts can be used in any number of ways to indicate that "that's the limit." The best answer is a kick-out relay on the power supply so that the transmitter comes right off the air.

Seems to me that that kick-out relay would be a pretty easy thing to make. Come next month I'll have one all cooked up that won't need any machine shop — just the tools in the cellar and a couple of pieces out of the junk-box.

If an e.c.o. is used with a multiband transmitter, the problem is a little more complex. Here the limiter could be coupled to the e.c.o. direct instead of to the output stage. Connection of the limiter at this position loses the advantage that if the final "runs away" and self-oscillates it will not be caught by the limiter.

'Course you fellows can probably improve this goobisnoop a lot. As for me, this dope is only reasoned out, as Uncle Sam don't want us fiddling with tx circuits right now. It hasn't been tried yet — but it'll work!

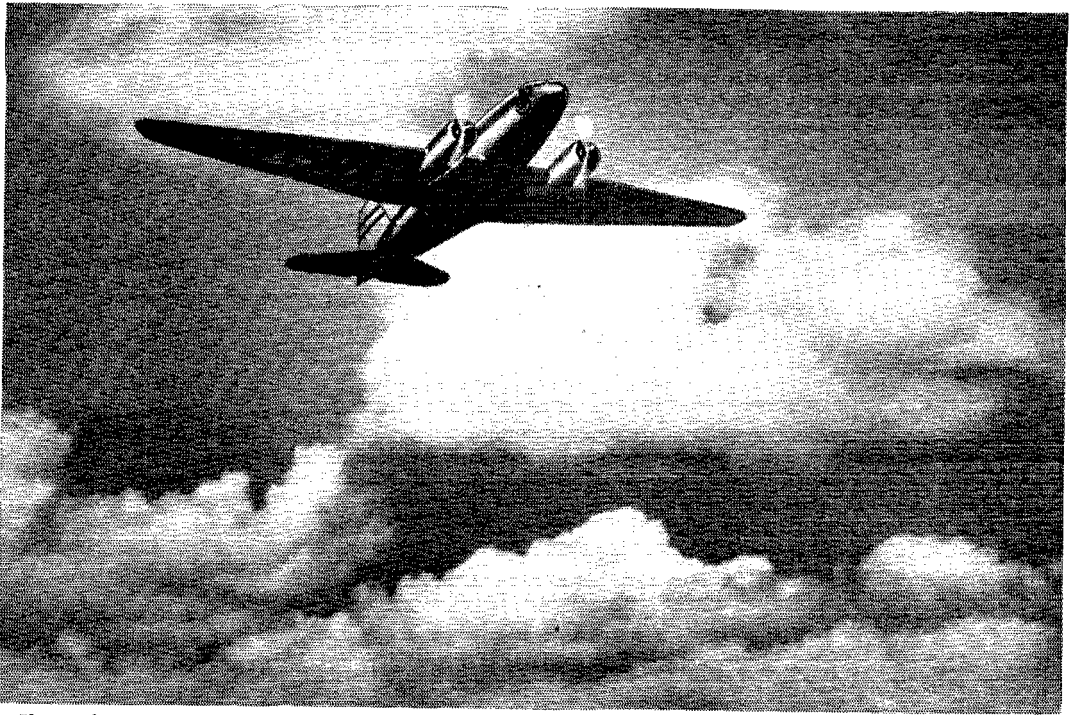

Photograph, courtesy Transcontinental and Western Air, Inc.

## **THERE MUST BE DEPENDABLE COMMUNICATIONS**

The reliability of Wilcox communications and other radio equipment has made them invaluable servants of leading commercial airlines.

Now, the entire output of Wilcox factories is going to wartime uses, and the experi-

ence gained during peacetime is standing in good stead for military operations.

Thus, Wilcox is keeping pace with the miracles of flight... and, after Victory, new Wilcox developments will be available for the better-to-live-in world.

Communication Receivers  
Aircraft Radio

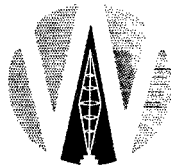

Airline Radio Equipment  
Transmitting Equipment

## **WILCOX ELECTRIC COMPANY**

*Quality Manufacturing of Radio Equipment*

14TH & CHESTNUT

KANSAS CITY, MISSOURI

## RADIO PLUGS, SOCKETS AND CONNECTORS

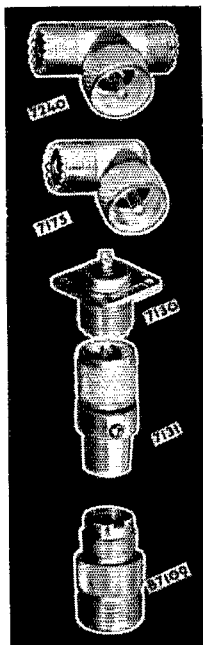

### For Aircraft, Tanks and Ships

Expert workmanship assures the highest degree of efficiency with Astatic's government approved Co-axial Cable Connectors and Multi-contact Plugs and Sockets for secure contacts and the quick connection or disconnection of radio circuits. Now supplying many manufacturers of war-time radio equipment.

# ASTATIC

THE ASTATIC CORP.  
YOUNGSTOWN, OHIO

IN CANADA:  
CANADIAN ASTATIC, LTD.  
Toronto, Ontario

## Correspondence

(Continued from page 55)

of the amateur's code, which reads: "The amateur is friendly. Slow and patient sending when requested, giving friendly advice and counsel to the beginner: these are the marks of the amateur spirit." Now wouldn't this type of introduction to ham radio make for a more proficient ham and instill in him the fraternal spirit that ham radio possesses? Compare this to a ham entering the regular ranks after a year of probation and segregation. . . .

I for one am perfectly willing and eager to have the new hams work alongside of me on any and all bands. Of course it will mean more undesirable QRM, but don't we hams pride ourselves on having developed an r.f. stage and a crystal filter in each of our tin ears? . . .

— George Sangrik, W8ROX

## QST Returns to Gallups Island

(Continued from page 18)

cial evening classes are made compulsory. Those who fall too far behind are dropped back a class, while for those who make exceptional progress the converse may be true. If a man fails to make the grade after several chances he is disenrolled. This never happens until after the fourth week, however; every student is given at least one full month to get straightened out and show what he can do.

Throughout the course a close relationship exists between students and instructors, and much of the training is on a personalized, individual basis.

All training activities are carried on in terms of classes — the weekly quotas of newly-arriving students. Each class is given a number; although individual students may drop behind or move ahead, the class as a whole remains a unit. For administrative purposes classes are organized as platoons, a leader and two assistants being selected for each platoon from among its members. The leader is given a temporary rating two grades higher than his fellows, and his assistants are given ratings one grade higher.

From 8 A.M. Monday mornings until Saturday noon the students are required to remain aboard the station. Over the week-end shore liberty is granted, and each Saturday noon finds the cruise decks of the converted Long Island Sound pleasure boat *Calvert* overflowing with hundreds of holidaying students going ashore.

Certain platoons are required to stay aboard each week-end for fire watch and other duties. These platoons then receive liberty on Wednesday night of the following week as compensation. In addition, the platoon which ranks highest in scholastic accomplishment for the week rates special Wednesday-night liberty the following week, and a perpetual competition is carried on between the platoons for this privilege.

Just published . . . A thorough quick guide to essentials of good AERONAUTICAL RADIO DESIGN

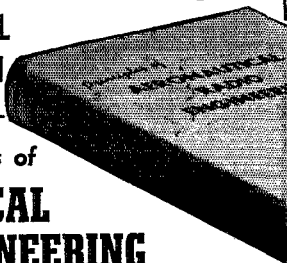

Sandretto's Principles of

## AERONAUTICAL RADIO ENGINEERING

414 pages, 6 x 9, 228 illustrations, \$3.50

This book presents a clear engineering treatment of radio as used in aeronautical navigation and communication. It briefly discusses the aeronautical problem, treats in detail the nine radio facilities used in air transport, covers the performance, installation, operation and servicing factors influencing design of each, and outlines fundamentals and methods developed for handling them.

-----10 DAYS' FREE TRIAL-----

McGRAW-HILL BOOK CO., INC., 330 W. 42nd St., New York  
Send me Sandretto's Principles of Aeronautical Radio Engineering for 10 days' examination on approval. In 10 days I will send you \$3.50 plus few cents postage or return book postpaid. (Postage paid on cash orders.)

Name .....

Address .....

City and State .....

Position .....

Company ..... QST-5-43



CALLING ALERT MEN  
 CALLING ALERT MEN  
 CALLING ALERT MEN

**RADIO OPERATORS  
 WANTED**

Good pay, adventure, interesting work! Army, Navy and Commerce need thousands of men who can send and receive Radiotelegraph Code. Learn Code at home or improve your proficiency and rating through the famous Candler System . . . the same easy, simple system used in training Radiotelegraph Specialists in Signal Corps, Navy, Marines, Coast Guard, Naval Reserve, Airlines and Amateurs.

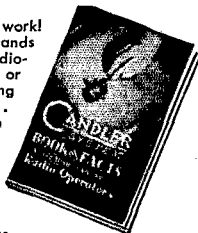

Qualify quickly. No long-drawn-out studies. Candler System established over quarter century. Candler has trained world's champions, experts in telegraph communications, can give you fast sending and receiving technique. Tremendous new field for operators both in and out of Armed Services.

Instruction for beginners and operators. You can learn code or increase your w.p.m. speed and improve proficiency. We help you qualify in half the usual time for amateur or commercial license and a good rating.

Write today for FREE Candler Book of Facts. It costs you nothing.

**CANDLER SYSTEM CO.**

P.O. Box 928, Dept. 4-E, Denver, Colorado, U. S. A.

Craven House, 121, Kingsway, London, W.C.2.

**"ROGER!"**  
 --- WILL LAND ON EAST RUNWAY \*



You Can't Work 'Em, If They Can't Hear You!

\*Radio "Shorthand" for R or --- meaning, "Your message received!"

AIRPORT RADIOPHONE TRAFFIC CONTROL BY

**OXFORD-TARTAK RADIO CORP.**

3911 S. MICHIGAN AVE., CHICAGO, ILL.



**TO KEEP  
 DEMOCRACY SAFE FOR**

*Future "Hams"*

For the "HAM" to be . . . get those meters and instruments that you have in the cellar or attic into Industry or the Signal Corps . . . get yourself on the firing line in radio — there is a tremendous need for skilled radio men.

"Hams" having always carried the ball in every emergency must now more than ever keep the record intact for the future of democracy.



**BUY WAR BONDS and STAMPS**

*The* **RADIO  
 SHACK**

★ 167 WASHINGTON ST. ★  
 BOSTON, MASS., U.S.A.

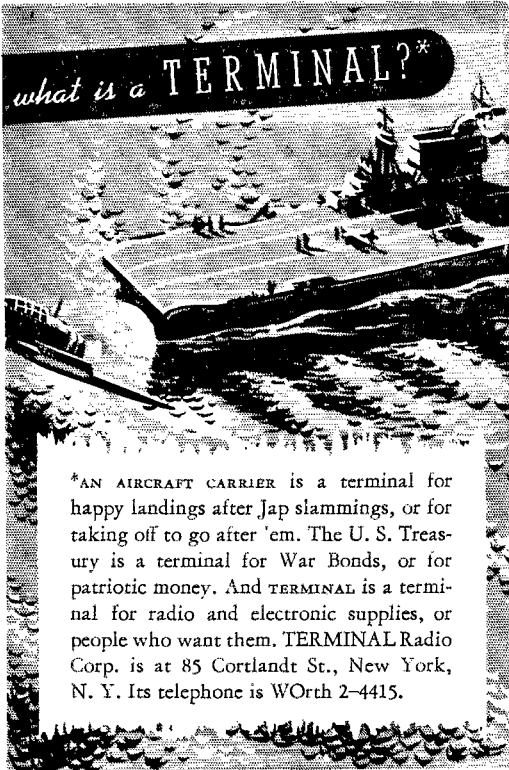

\*AN AIRCRAFT CARRIER is a terminal for happy landings after Jap slammings, or for taking off to go after 'em. The U. S. Treasury is a terminal for War Bonds, or for patriotic money. And **TERMINAL** is a terminal for radio and electronic supplies, or people who want them. **TERMINAL** Radio Corp. is at 85 Corlandt St., New York, N. Y. Its telephone is **W**Orth 2-4415.

## THE RADIO AMATEUR'S LIBRARY

Many requests are received for the complete list of our publications. The list follows:

Title	Price
QST .....	\$2.50 per year*
List of Stations .....	Discontinued
Map of Member Stations .....	Discontinued
Operating an Amateur Radio Station .....	Free to members; to others 10¢
The Story of The A.R.R.L. ....	Discontinued
The Radio Amateur's Handbook	
a. Standard Edition .....	\$1.00**
b. Special Defense Edition .....	\$1.00
The Log .....	35¢ each; 3 for \$1.00
How to Become a Radio Amateur .....	25¢
The Radio Amateur's License Manual .....	25¢
Hints & Kinks for the Radio Amateur .....	50¢
Lightning Calculators:	
a. Radio (Type A) .....	\$1.00
b. Ohm's Law (Type B) .....	\$1.00
Amateur Radio Map of the World .....	\$1.25
Two Hundred Meters and Down: The Story of Amateur Radio .....	\$1.00
Building an Amateur Radio-telephone Transmitter .....	Out of print
A.R.R.L. Antenna Book .....	50¢
Emergency Communications Manual .....	10¢
The Minilog .....	25¢
Learning the Radiotelegraph Code .....	25¢
A Course in Radio Fundamentals .....	50¢

\*In the United States and Possessions — other Countries \$3.00 per year.

\*\*Postpaid in Continental U. S. A. — \$1.50, post-paid, elsewhere.

(No stamps, please)

**The American Radio Relay League, Inc.**  
WEST HARTFORD, CONNECTICUT

Even during the week, however, the students do not lack for recreation. Excellent facilities for ping pong and other sports are provided, and a large new recreation hall is now under construction. Motion pictures are shown nightly, supplemented by occasional smokers, boxing matches, amateur nights and other entertainment supplied by Boston organizations. There is a station newspaper and a p.a. system that broadcasts music after school hours (not to mention orders of the day, announcements of disciplinary actions and other less welcome entertainment). And then, of course, there is the ocean — itself a major attraction in good weather.

### The FCC Ticket

Returning now to more academic details, at the end of the 23th week the course outline has been completed and a final exam, based on the government license examination, is given. During the week the class will go ashore in groups to be given the FCC commercial license exam by the local inspector. Those whose relative standings are highest go first; the rest are given additional time for intensive brushing up on code or weak spots in theory or procedure. No student is allowed to take the FCC examination until he has displayed to the satisfaction of the assistant training officer, Lt. T. H. Grant — himself a former FCC inspector — that he is qualified.

Usually graduates of Gallups Island pass the government exam without a hitch; most classes go through intact. Now and then, however, a student acquires an acute case of buck fever. At the school he may have been letter perfect, but when he faces the awesome finality of the inspector's office he becomes as nervous as the most frightened would-be ham. In fact, they tell of one apprehensive lad who went up for his ticket three times. Each time he'd break into a nervous sweat. His muscles would tighten and his mind would go blank, and he'd become too paralyzed to write. So acute was his distress that blisters broke out on his hands, and the last time he went up they were entirely swathed in bandages. That time, though, he made it.

For most the exam is not so difficult, however — just one more formality on the road to shipping out. Once over, they return to the Island one last time to collect their personal gear. Then they receive a certificate of graduation and, ticket in hand, prepare to put their training to actual use.

### After Graduation

A part of each class may be retained on active duty in the Maritime Service, some as operators and others who display special aptitude occasionally being kept on as instructors. But most are placed in inactive status in the Maritime Service and prepare to enter the merchant marine.

Perhaps a word of definition is in order here. The U. S. Maritime Service, formerly a branch of the Coast Guard, is now part of the War Shipping Administration, the federal agency which has control of U. S. shipping during the war. The



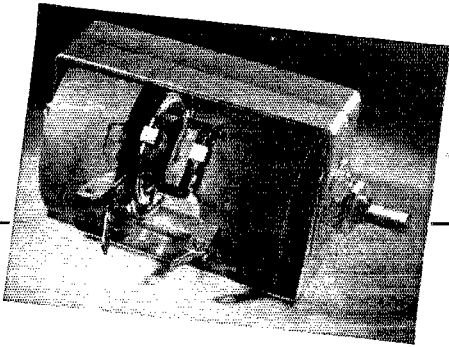

## POWER RHEOSTATS

★ Clarostat power rheostats are designed mechanically and electrically for exceptional performance and durability. 25 and 50 watt sizes. Also in multiple controls of two or more units in tandem. Any combination of resistance values, tapers, terminals; made to order. ★ Available at present on high priorities only. ★ Ask our jobber about these and other Clarostat items.

CLAROSTAT

*Controls and Resistors*

CLAROSTAT MFG. CO., Inc. • 295 7 N. 6th St., Brooklyn, N. Y.

# Are You Making Good in Your New Radio Job?



## New Jobs Create NEW OPPORTUNITIES

There's no "ceiling" to the better jobs available today. CREI home study courses can give you the practical technical training you need to "make good" now—and to enjoy security in the years to come!

Hundreds of practical radiomen have been given responsible jobs throughout the radio industry—government jobs, broadcast jobs, technical manufacturing jobs, aviation radio jobs—jobs which in many instances require a thorough knowledge of practical radio engineering.

- If you are a practical radioman who realizes that fortunate circumstances have placed you in a job requiring technical ability of high calibre . . .
- If you are smart enough to know that you will "get by" with your better job only so long as a fully qualified man is unavailable . . .
- If you have the ambition to make good in your new, better job and to rise to even a still better job . . .

—then a CREI home study course in Practical Radio Engineering will help you to acquire the necessary technical knowledge and ability which is demanded by the better, higher paying positions in technical radio.

### WRITE FOR FACTS TODAY about CREI Home Study Courses

*If you have had professional or amateur radio experience and want to make more money, let us prove to you that we have something you need to qualify for a better radio job. To help us intelligently answer your inquiry, please state briefly your background of experience, education and present position.*



### CREI STUDENTS AND GRADUATES

The CREI Placement Bureau is flooded with requests for CREI trained radiomen. Employers in all branches of radio want trained men. Your government wants every man to perform his job, or be placed in a job, that will allow him to work at maximum productivity. If you are or will be in need of re-employment write your CREI Placement Bureau at once.

## Capitol Radio Engineering Institute

Home Study Courses in Practical Radio Engineering  
for Professional Self-Improvement

Dept. Q-5, 3224 16th St. N. W., Washington, D. C.

Contractors to the U. S. Signal Corps and U. S. Coast Guard  
Producers of Well-trained Technical Radiomen for Industry

## The JAMES KNIGHTS CO. SANDWICH ILLINOIS



*Precision Cutters of  
Quartz for Radio  
and Optical  
Uses*

# Rent a Time Saver

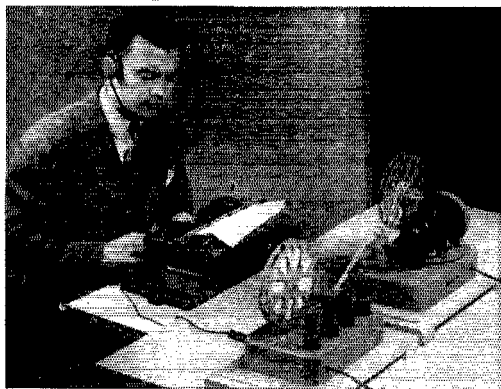

Copy code from the start easily, quickly, efficiently. The new McElroy automatic keyer plus plenty of code tapes will put you in the operator class. Hundreds of machines available for rental—immediate delivery. Write or wire . . .

**AYERS Automatic**  
**CODE MACHINES COMPANY**

711 Boylston Street, Boston, Massachusetts

## RADIO OPERATORS' LICENSE MANUAL

Complete and authentic question and answer manual on commercial radio operator license examinations. 1297 questions and answers, 230 pages of vital information for radio operator license candidates. \$3.00 Post-paid or write for descriptive circular.

1943 **WAYNE MILLER**  
Edition The Engineering Building, Chicago



Founded in 1909

## Pre-Induction "RADIO"

A maximum of thirteen weeks to prepare for military service — code — printing — typing — procedure — and fundamentals of tube and transmitter servicing. If interested, write for details.

**PORT ARTHUR COLLEGE**  
PORT ARTHUR, TEXAS

(Continued from page 86)

Maritime Service has the specific job of training personnel for the merchant fleet. The merchant marine comprises all privately-owned U. S. shipping — the activities of which, under war-time conditions, are rigidly controlled and administered by WSA, including not only the loading and routing of vessels but the supplying of personnel.

Officers and men of the Maritime Service wear the same type of uniform with Maritime insignia and hold the same kinds of ratings as those in the Navy. Men in the merchant marine, on the other hand, may but are not required to wear regulation uniforms and do not hold permanent ratings. No officer will wear the Maritime Service insignia of a higher rank than called for by his position aboard ship, regardless of the designation of grade held by said officer, their nominal rank at any given time depending on the ship and the nature of their berth.

The first step taken by the prospective merchant marine operator after graduation from Gallups Island is to register at the WSA manning office to which he has been ordered to report. He may go home on leave for a time without pay before shipping out at the discretion of the manning officer.

When he does sign up he'll be assigned an order of precedence. As soon as his number comes up he'll be assigned a ship, all jobs being filled in rotation. If there's no immediate vacancy he'll be placed in "stand-by" status, receiving \$7 per day until assigned — his time meanwhile being his own.

Once on active duty he'll find that he's a pretty important man aboard ship. He'll enjoy privileges usually accorded officers and be furnished quarters and messing facilities appropriate to that status. His base pay as a radio operator in the merchant marine may range from \$105 to \$220, probably averaging around \$165-\$185, depending on his experience and the nature of the assignment — and it'll all be money in his pocket when he comes ashore. If he's required to perform clerical duties in addition, as happens in many cases, he'll be paid an extra \$25 to \$50 a month. On top of that, there's a 100 per cent bonus for off-shore runs in war-time, doubling his base pay.

Which adds up to a very nice figure — particularly considering that he may know he is serving his country in a critically-valuable role, and that during his training period he has been paid at the rate of \$54 for the first three months and \$66 thereafter. This on top of being furnished quarters and subsistence, as well as all his clothing, texts and other needs.

### Enrollment in the Maritime Service

The students assigned to Gallups Island come from three sources — U. S. Maritime Service Training Stations at Sheepshead Bay, N. Y., Avalon, Calif., and St. Petersburg, Fla. Before attending radio school, they must have apprentice seaman training for five weeks and, if found to have special aptitude, will be sent to the preliminary radio school at Huntington, L. I., for

## AMATEURS of YESTERDAY and TOMORROW

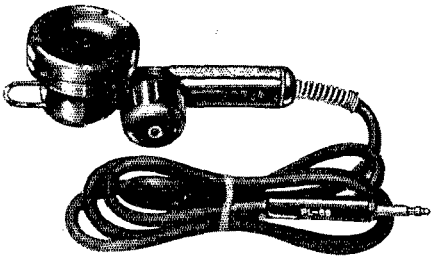

know Universal microphones. Many amateurs of before the war days, and many who will become amateurs when peace comes, are now using Universal microphones in many branches of the armed forces. Series 1700, pictured above, is withstanding rugged usage in many types of mobile units. A single button type microphone, 1700 series is lightweight, molded plastic case. Has response characteristics especially efficient at voice freq. to the exclusion of motor noises. Heavy duty double pole single throw press-to-talk switch provides easy control of transmitter by relay. Switch contacts easily accessible for cleaning and adjustments. Works equally well in extreme heat or bitter cold. Including cord, plug and hanger hook.

Series 1700 was developed through experiments in conjunction with the U. S. Army Signal Corps.

**UNIVERSAL MICROPHONE CO. LTD.**  
Inglewood, California, U. S. A.

## Going WERS?



Send Today  
for **FREE Radio**  
**BARGAIN BOOK**

Largest stock parts and rigs on hand... but they're going fast. Better hurry! Send today for free illustrated catalog, low prices, terms. Write to Leo, W9GFQ.

★ Wartime Emergency Radio Service

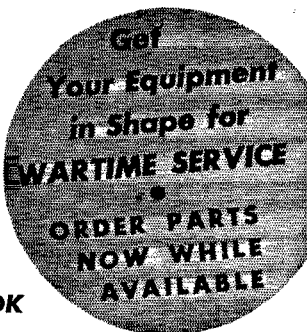

**WHOLESALE RADIO LABORATORIES**  
744 West Broadway  
Council Bluffs Iowa

## Attention! Newark Customers



### It's NOT because we don't WANT to —

When all or part of your radio equipment orders turn up "missing in action," you can blame the enemy for it. Blame Hitler and Tojo... and *slap 'em back* by buying War Stamps with your money instead!

To the best of our ability, we're *filling orders every day* with what we have in stock. Some orders, however, must be cancelled in whole or in part, **NOT BECAUSE WE DON'T WANT** TO fill them, but because we *can't sell or obtain* certain merchandise without priority ratings.

Believe us when we say "We'll do our best"! Work for Victory. Have confidence in America... and in Newark. We'll be here for the duration... and a long time after... and always at your service.

### Still Have CONDENSERS **59¢** AND UP

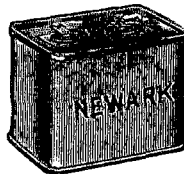

Oil Filled and Oil Impregnated condensers still available at pre-war prices! Real quality too. Guaranteed at Rated Voltage. No priority required.

Mfd.	Volts DC.	Size	Price
1	1000 5	x 3 3/4 x 1 3/4	\$ .59
2	2000 4 3/4	x 3 3/4 x 1 3/4	1.50
4	3000 5	x 3 3/4 x 3 3/4	3.75

### NO MORE CATALOGS

We're not printing a new catalog this year, because most merchandise is available on priorities only.

## NEWARK ELECTRIC CO.

323 West Madison Street, Chicago, Illinois

**IMPORTANT** PLEASE STATE, WHEN ORDERING,  
WHICH EDITION YOU WISH

# The Radio Amateur's HANDBOOK

*"the all-purpose volume on radio"*

Text,\* data book, operating manual — it is all these and more. As a text it is probably more used in radio schools and colleges than any other single volume. As a practical constructional handbook, it stands in a class alone. As an operating manual, it provides information available from no comparable source.

## Standard Edition

Geared to war needs, the latest Edition of THE RADIO AMATEUR'S HANDBOOK is the largest ever published. In addition to the established features it includes a comprehensive 50-page chapter dealing with the vitally-important War Emergency Radio Service plus other new material — all added without sacrificing the essential information in previous editions which made the HANDBOOK the world's most valuable and widely-used radio book. Retained is the highly successful treatment of fundamentals which was an innovation of the 1942 edition. Stripped to essentials, the theory and design sections cover every subject encountered in practical radio communication, sectionalized by topics with abundant cross-referencing and fully indexed. An ideal reference work, the 1943 Edition also contains all the constructional information on tested and proved gear which has always been the outstanding feature of the HANDBOOK.

**\$1** IN CONTINENTAL U. S. A.  
**\$1.50** ELSEWHERE

## Special Defense Edition

This edition of the HANDBOOK is designed especially for use in radio training courses. It eliminates those portions of the regular edition which are not useful for instruction purposes and has added chapters on mathematics, measuring equipment and code instruction. The first chapter covers the elementary mathematics necessary for the solution of all formulas and interpretation of graphs appearing throughout the text. A four-place log table is included in the Appendix.

**\$1** POSTPAID ANYWHERE

\* The book "A Course in Radio Fundamentals" is based on the text of either of the above mentioned editions of the HANDBOOK — PRICE 50 cents.

**AMERICAN RADIO  
RELAY LEAGUE, INC.**

West Hartford, Connecticut, U. S. A.

two months and then to Gallups Island for four additional months.

For applicants who seek assignment, the basic qualification is two years of high-school math. Beyond that, to be eligible for enrollment as an apprentice seaman in the Maritime Service, the applicant must be "of good moral character, physically sound, well-formed and of robust constitution." He must be a U. S. citizen, between 18 and 35, and must agree to serve at least one year in the American merchant marine after completing the course.

Naturally, anyone who has a background of training and experience superior to the basic requirements will be all the more heartily welcomed. A man who holds any kind of ticket, amateur or commercial, will be given first consideration for selection. Such a man should, of course, complete the training in less than the regular time; we were told of one Class A ham who got through the entire course in just five weeks.

To attract a maximum number of qualified candidates, the enrollment procedure has been made as simple as possible. U. S. Maritime Service enrolling offices have been established in all coastal cities and in most of the principal inland cities; if you live in one of these, all you do is apply at the local office. If not, you can start the ball rolling by writing the Commandant, U. S. Maritime Service, War Shipping Administration, Training Organization, Washington, D. C.

In either case you'll be given, locally, a simple entrance test and a medical examination by an officer of the U. S. Public Health Service. If you pass these tests you'll be entered as an approved applicant and placed in line to await your turn for assignment to one of the seaman training schools. Such assignments are made in terms of monthly quotas for each section of the country.

As concerns draft deferment, so long as you have not actually been inducted or called for induction, you are eligible to apply for this training.

Immediately upon enrollment as a trainee you'll be given a rating as apprentice seaman in the U. S. Maritime Service. Upon completion of training as seaman and being assigned to the Huntington School, you'll automatically be raised in rank to seaman second class. After twelve weeks of school, eight of which will be at the Huntington School, you will be made a seaman first class and after finishing the complete course you will graduate as radioman third class.

Anyone interested in radio who receives assignment to Gallups Island may consider himself fortunate. Not only will he be afforded a magnificent opportunity for self-advancement and receive competent training in a high-paying field, but he'll be serving in a responsible position in a vital part of the war program. It's a job that calls for men of the highest type—and that's the kind of men they're training at Gallups Island.

*Don't let your operator's  
license expire!*



*"Little Things" are Weapons, Too!*

IT'S not just mammoth tanks and planes that win the fight these days. Working right beside them for Victory are the "tiny things" of today's warfare... product of man's constant scientific advancement.

Radio crystals are among those "tiny things." We're making them — as quickly and as perfectly as possible. For they're in the fight, too.

## Scientific RADIO PRODUCTS CO.

738 W. 8dwy.

LEO MEYERSON W9GFQ  
E. M. SHIDELER W9IFI

Council Bluffs, Iowa

MANUFACTURERS OF PIEZO ELECTRIC CRYSTALS AND ASSOCIATED EQUIPMENT

### RADIO CODE *Taught without instructors by the Voice Code Method*

A set of 10 phonograph records comprising a complete radio course up to 16 words per minute.

Simple and Economical ■ Complete Set \$20.00

AMERICAN RADIO INSTITUTE 44 EAST 23rd ST.  
Teaching Radio Since 1935 NEW YORK CITY

### MASTER COURSE IN RADIO COMMUNICATION



Fits you for a job, advancement or license examination. Course by A. R. Nilson for home study covers same scope as resident school course. Every Nilson graduate to date has commercial license, or a good radio job.

FREE circular 3-Q gives full information. Write today.

NILSON RADIO SCHOOL, 51 East 42nd St., New York

## GOOD JOBS in RADIO for both men and women

Prepare now for jobs in Radio Engineering; Broadcasting; Marine, Aviation, Police Radio; Servicing; Radio Manufacturing. Our streamlined courses give excellent preparation for Army and Navy Service. Expenses low. Write for free catalog.

THE DODGE TELEGRAPH & RADIO INSTITUTE  
408-1 Monroe St., Valparaiso, Indiana



### RADIO COURSES

for Men and Women

PRE-INDUCTION AND  
CIVILIAN TRAINING

Write, Phone or Call 9 a.m. to 8:30 p.m.

METROPOLITAN TECHNICAL  
SCHOOLS

Licensed by State of New York

RADIO DIVISION

Dept. 5

7 CENTRAL PARK WEST, N. Y. Circle 7-2515

## BETTER COILS FOR TODAY'S JOBS

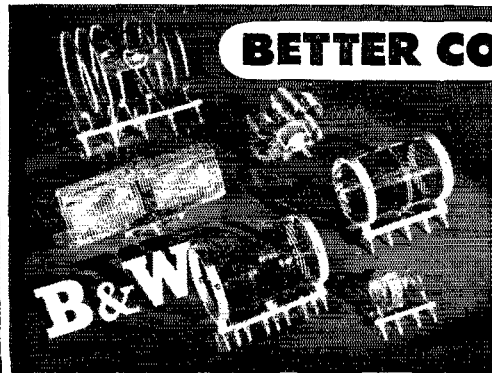

It is a matter of record that most of today's exacting wartime applications can be met—fully and completely—by standard B & W Air Inductors or their adaptations.

It is also a matter of record that B & W is producing Coils by the most modern "line" methods—faster and better than they have ever been made before. Thus, whether you're looking for Coils for wartime uses—or looking forward to resumption of Amateur Radio after the war, you can count on B & W for the quality that you need.

### BARKER & WILLIAMSON

Manufacturers of Quality Electronic Components for 10 Years  
235 FAIRFIELD AVENUE, UPPER DARBY, PA.

# HAM-ADS

(1) Advertising shall pertain to radio and shall be of nature of interest to radio amateurs or experimenters in their pursuit of the art.

(2) No display of any character will be accepted, nor can any special typographical arrangement, such as all or part capital letters be used which would tend to make one advertisement stand out from the others.

(3) The Ham-Ad rate is 30¢ per word, except as noted in paragraph (6) below.

(4) Remittance in full must accompany copy. No cash or contract discount or agency commission will be allowed.

(5) Closing date for Ham-Ads is the 25th of the second month preceding publication date.

(6) A special rate of 7¢ per word will apply to advertising which, in our judgment, is obviously non-commercial in nature and is placed and signed by a member of the American Radio Relay League. This advertising of bona fide surplus equipment owned, used and for sale by an individual or apparatus offered for exchange or advertising inquiring for special equipment, if by a member of the American Radio Relay League takes the 7¢ rate. An attempt to deal in apparatus in quantity for profit, even if by an individual, is commercial and all advertising by him takes the 30¢ rate. Provisions of paragraphs (1), (2), (4) and (5) apply to all advertising in this column regardless of which rate may apply.

Having made no investigation of the advertisers in the classified columns, the publishers of QST are unable to vouch for their integrity or for the grade or character of the products advertised

\*\*\*\*\*

**QUARTZ**—direct importers from Brazil of best quality pure quartz suitable for making piezo-electric crystals. Diamond Drill Carbon Co., 719 World Bldg., New York City.

**COMMERCIAL** radio operators examination questions and answers. One dollar per element. G. C. Waller, W5ATV, 6540 Washington Blvd., Tulsa, Okla.

**USED TELEFLEXES**, Instructographs bought, sold. Ryan's, Hannibal, Mo.

**ELECTRONICS ENGINEERS**, Electrical engineer to design electronic devices as applied to industrial control, welding and similar applications. Also an electrical engineer with knowledge of electronics for application work. Write Westinghouse Electric & Manufacturing Co., Room 1415, Union Bank Building, Pittsburgh, Pennsylvania, for application blank.

**WHY** not turn your unused equipment into ready cash which may be applied towards new and better equipment after the war? Leo, W9GFQ, offers you the best cash prices for communications receivers and test equipment. Write today for large illustrated catalog. Wholesale Radio Laboratories, 744 W. Broadway, Council Bluffs, Iowa.

**COMMUNICATION** Receivers wanted to buy. Good-All's, Ogallala, Nebraska.

**IN** stock for immediate shipment Mac No. 200 keys, \$2.25. Henry Radio Shop, Butler, Mo.

**USED** Communications receivers wanted. Highest cash prices paid immediately. Send details. Bob Henry, W9ARA, Butler, Mo.

**WANTED**—0-1 MA and AC-DC Tester. Needed badly. W5JOB, 1137 East Center, Milwaukee, Wis.

**SELL** GE 6 V. M-G. 300 V. @ 200 MA, \$25; GE 6 V. M-G 250 V. @ 50 MA., \$7.50; SW3 with 5 sets coils, \$17.50. F. Timberlake, Avon, N. J.

**WANTED**—Oscilloscopes, Volt-ohm-milliammeters, Vacuum-tube Voltmeters—RCA, Hickok, Supreme, Precision, or equivalent makes, Hallcrafters SX28, SX25 Receivers, Super Pro's and HRO's. Also 0-1 milliammeters and 0-5, 0-10, 0-25 AC or DC ammeters, 3-inch size. Idle test units and meters are needed for the War effort. Help train thousands of radio personnel by selling your equipment now. Send equipment for liberal appraisals to Allied Radio Corporation, Dept. 27X-E-3, 833 West Jackson Boulevard, Chicago.

**HERE'S** an interesting job for a wide-awake ham! Progressive New Jersey Manufacturer, well established in the radio field, needs a man to help build a real live-wire inspection department. Prefer draft deferred man that is not using his field skill in war work. Write W9GVZ, 1 Central Ave., West Orange, N. J.

**WANTED**—A Meissner DeLux Signal Shifter. Write, giving full description and price wanted. W3HPO, Fred L. Kost, 24 Green Lane, Chester, RFD No. 1, Penn.

**SELL**—Abbott TR4, new with tubes. Registered. \$37.50. Fluharty, 161 Lawson Ave., Rockville Centre, L. I., N. Y.

**WANT** Gas Triode 884 2050 or similar. John Kaye, 1122 East Allen, Fort Worth, Texas.

**WANTED**: McMurdo Silver VI. Will trade NC 100X. M. Schumacher, Juneau, Wis.

**WANTED**: 6614" Par-Metal relay rack. W. S. Brackenridge, W7ZD, 3621 N.E. 64 Ave., Portland, Oregon.

**WANTED**: DC SW3 coils, No. 10-22 inclusive, also 14A. ALSO, small compact self-contained CW or Phone Transmitter. Give full details. Price, W1BB.

**VOLT-OHMETER** Wanted. Write detailed description, cash price. Stanley Linn, 923 East Chestnut, Yakima, Wash.

**IMMEDIATELY** wanted: Hallcrafters SX-28 or SX-32. Air-mail complete description and cash price. R. E. Beck, R. D. No. 1, Jeannette, Pa.

**VOLT-OHMETER** wanted, also 0-1 Ma. Meter, and Riders Manuals. W9SPN, 1029 Haskell, Kansas City, Kansas.

**WANTED**: Radio books published between 1900 and 1925. Please state author, title, condition, price on postcard. John M. Avery, RCA-Communications, Tuckerton, N. J.

**EC1**—902—884 wanted. State condition, price. W6HJE, 3717 Madrone Ave., Oakland, Calif.

**WANTED**: Hallcrafters SX-28. Give condition and price wanted. C. Fyfe, 403 Hyde Park, Hutchinson, Kansas.

**CRYSTAL**-cutting and grinding outfit wanted; also raw quartz. Vincent Bly, Leesburg, Va.

**WANTED**—Thordarson Splatter Choke—T-15C32. Low, High and Band-pass audio filter UTC-VT-10. W. E. Ramsey, W4FHE, Bennettsville, S. C.

**WANTED**—V-O-M. Send description and price to W8VVD, 467 Park, Birmingham, Michigan.

**WANTED**—One dual section Variable Condenser. Can use Bud MC-911, Bud MC-912, Hammariund MCD 100M or MCD 140 M, new or used, F. S. Anderson, W3GWQ, 4013 MacArthur Ave., Richmond, Va.

**SIMPSON** Model 240 "Hammer", or similar Volt-Ohmmeter wanted. Mention ranges and price. M. W. Walsh, Casa de Vallejo, Vallejo, Calif.

**NEED** crystals immediately? Call or order from Eidson's, very prompt delivery on small or medium quantities. You will like our time-proven type E62 and E64 Steatite units suitable for frequencies in the 1600 to 10,000 kilocycle range. Subject to priority and M-146 certification. "Eidson's", Temple, Texas. Phone 3901.

**WANTED**—Two or three-inch cathode ray tube. Box 574, Perth Amboy, N. J.

**SELL**—NC 81X receiver. W. P. Cecil, Box 1321, Big Spring, Texas.

**SELL**—NATIONAL NC 101-X receiver, excellent condition, \$75. W9ABA, Carleton P. Ross, 118th Signal Radio Intelligence Company, Camp Forrest, Tennessee.

**FOR SALE**—New Carter Generator 6 volt, input 350, volt output 200 mils. Keith Maring, PAA, Brownsville, Texas.

**HARVEY** RADIO LAB'S, Inc.  
Manufacturers of  
Radio Transmitters  
**ELECTRONIC APPARATUS**  
447 CONCORD AVENUE, CAMBRIDGE, MASS.

## LEARN RADIO

60-page catalog on request. Oldest, largest and best equipped in New England. New classes now forming. Write for new catalog.

**MASS. RADIO SCHOOL**

18 Boylston Street

Boston, Massachusetts

## EASY TO LEARN CODE

It is easy and pleasant to learn or increase speed the modern way—with an **Instructograph Code Teacher**. Excellent for the beginner or advanced student. A quick and practical method. Available tapes from beginner's alphabet to typical messages on all subjects. Speed range 5 to 40 WPM. Always ready, no QRM, beats having someone send to you.

### MACHINES FOR RENT OR SALE

The **Instructograph Code Teacher** literally takes the place of an operator-instructor and enables anyone to learn and master code without further assistance. Thousands have used and endorse the **Instructograph System**. Write today for full particulars and convenient payment and rental plans.

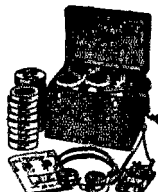

## INSTRUCTOGRAPH COMPANY

4799 Sheridan Road, Chicago, Illinois

Representative for Canada:

Radio College of Canada, 54 Bloor St. West, Toronto

**CHARMED-  
I'M SURE!**



SGT. KILDAY  
CAMP LEE

### **Echophone Model EC-1**

(Illustrated) a compact communications receiver with every necessary feature for good reception. Covers from 550 kc. to 30 mc. on three bands. Electrical bandspread on all bands. Six tubes. Self-contained speaker. Operates on 115-125 volts AC or DC.



**ECHOPHONE RADIO CO., 201 EAST 26th ST., CHICAGO, ILLINOIS**

Designed for

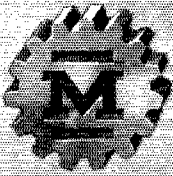

Application

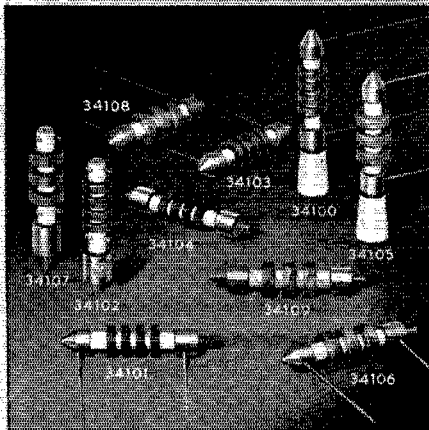

**THE 34100 SERIES  
R F CHOKES**

Many have copied, few have equalled, and none have surpassed the genuine original design Millen *Designed for Application* series of midjet RF Chokes. The more popular styles now in constant production are illustrated herewith. Special styles and variations to meet unusual requirements quickly furnished on high priority.

General Specifications: 2.5 mH, 250 mA for types 34100, 34101, 34102, 34103, 34104, and 1 mH, 300 mA for types 34105, 34106, 34107, 34108, 34109.

**JAMES MILLEN  
MFG. CO., INC.**

MAIN OFFICE AND FACTORY  
**MALDEN  
MASSACHUSETTS**



*Index to Advertisers*

	<i>Page</i>
Abbott Instrument, Inc. . . . .	66
Aircraft Radio Laboratory . . . . .	82
American Lava Corporation . . . . .	79
American Radio Institute . . . . .	91
Amprex Electric Products, Inc. . . . .	Cov. 11
Astatic Corporation, The . . . . .	84
Ayers Automatic Code Machines . . . . .	88
Barker & Williamson . . . . .	91
Bliley Electric Company . . . . .	64
Browning Laboratories, Inc. . . . .	78
Candler System Company . . . . .	85
Capitol Radio Engineering Institute . . . . .	87
Centralab . . . . .	69
Clarostat Manufacturing Company . . . . .	87
Dodge Telegraph & Radio Institute, The . . . . .	91
Echophone Radio Company . . . . .	93
Eitel-McCullough, Inc. . . . .	77
Electro-Voice Manufacturing Co. . . . .	5
Galvin Manufacturing Corporation . . . . .	95
Hallcrafters Company, The . . . . .	1, 2
Hammarlund Manufacturing Company, The . . . . .	65
Harvey Radio Company . . . . .	74
Harvey Radio Laboratories, Inc. . . . .	92
Harvey-Wells Communications, Inc. . . . .	80
Heintz & Kaufman, Ltd. . . . .	73
Instructograph Company . . . . .	92
Johnson Company, E. F. . . . .	75
Knights, James, Company . . . . .	87
Mallory & Company, Inc., P. R. . . . .	67
Massachusetts Radio School . . . . .	92
McGraw Hill Book Company, Inc. . . . .	84, 70
Meissner Manufacturing Company . . . . .	81
Melville Aeronautical Radio School, Inc. . . . .	82
Metropolitan Technical School . . . . .	91
Millen Manufacturing Company, James. . . . .	94
Miller, Wayne . . . . .	88
National Company, Inc. . . . .	Cov. III, 63
Newark Electric Company . . . . .	89
Nilson Radio School . . . . .	91
Ohmite Manufacturing Company . . . . .	76
Oxford-Tartak Radio Corporation . . . . .	85
Port Arthur College . . . . .	88
RCA Manufacturing Company, Inc. . . . .	Cov. IV
Radio Manufacturing Engineers . . . . .	71
Radio Shack Corporation . . . . .	85
Scientific Radio Products Company . . . . .	91
Standard Transformer Corporation . . . . .	72
Terminal Radio Corporation . . . . .	86
Thordarson Electric Manufacturing Company . . . . .	96
Triplett Electrical Instrument Company . . . . .	68
Universal Microphone Company . . . . .	89
Wholesale Radio Laboratories . . . . .	89
Wilcox Electric Company . . . . .	83





# **F.M.** Emergency Communications by *Motorola*

**RADIO ENGINEERING FOR TODAY**  
*that means a lot for Tomorrow*

Motorola engineers are today applying their accumulated skills and scientific knowledge to problems which confront our country, its states, counties, cities and towns. Housed in a new Engineering Building, with greatly expanded facilities, the Motorola capacity for service is greater than ever. Electronic knowledge thus gained will one day be applied to the peacetime demands of a nation eager for better things in all phases of its living.



**THE ARMY-NAVY "E"**—Awarded for excellence in the production of Communications Equipment for America's Armed Forces

**Motorola Radio Communication Systems**  
**Designed and Engineered to Fit Special Needs**  
**GALVIN MFG. CORPORATION • CHICAGO**

1  
2  
3  
4  
5  
6  
7  
8  
9



The stature of  
**LEADERSHIP**  
is measured by  
**ACCOMPLISHMENT**

Not fulsome promises..but performance!..THAT  
has been the keynote of Thordarson's progress  
through the years. Whenever, and wherever  
transformers are discussed, the reputation for  
quality leadership enjoyed by Thordarson is in-  
variably an important part of the conversation.



**THORDARSON**

ELECTRIC MFG. COMPANY  
500 WEST HURON STREET, CHICAGO, ILL.

*Transformer Specialists Since 1895*



PHOTO BY U.S. ARMY SIGNAL CORPS

## LOOK FOR THE ANTENNA

Radio equipment has become the symbol of the modern instrument of war. The fast action, quick decisions and perfect coordination of today's war of movement demands perfect communications, and radio provides communication "on the move".

We are proud of the part that National Radio Equipment is playing.



**NATIONAL COMPANY, INC., MALDEN, MASS.**



**LONGER  
LIFE**

**HIGHER  
CURRENT**

Maximum Peak Plate Current . . . 2 amperes  
Maximum Average Plate Current . . . 0.5 amperes

**FOR VALUES of PEAK INVERSE  
VOLTAGE up to ~~200~~ VOLTS MAXIMUM  
2,000**



**866-A**

**866**

**HALF-WAVE  
MERCURY  
VAPOR  
RECTIFIER**

**\$1.50**

*1/2" Base for use in a Long Life*

**REBUILT TUBES**

RCA Types 207, 891,  
891-R, 892, and 892-R

As a wartime emergency service to help keep broadcast stations on the air, RCA offers a Tube Rebuilding Service on the types listed above. Actual use has proved the efficiency of these RCA Rebuilt Tubes beyond question. Ratings of characteristics are in no wise impaired. If your station uses any of the five listed types, write today for full details.

**FOR DESIGN PURPOSES—**

Most manufacturers advantage of the well known and outstanding design features of the RCA 866-A/866-RT/866-RTA and Mercury Vapor Rectifier tubes are their long life and high efficiency—more than twice the average life of other tubes.

These tubes are designed for long life and high efficiency—more than twice the average life of other tubes.

**FOR REPLACEMENT PURPOSES—**

When you replace a tube with a RCA 866-A/866-RT/866-RTA or Mercury Vapor Rectifier tube, you get the best of the tube when it is replaced—more efficiency, but the improvements which make possible a greater dependability, a greater margin of safety, and consequently longer life to the tune of hundreds of additional hours.

**RCA RADIO-ELECTRONIC TUBES**

RCA Victor Division, RADIO CORPORATION OF AMERICA, Camden, N. J.

Buy War Bonds and Stamps Every Payday