

QST

June, 1942

25 cents

35c in Canada

devoted entirely to

amateur radio

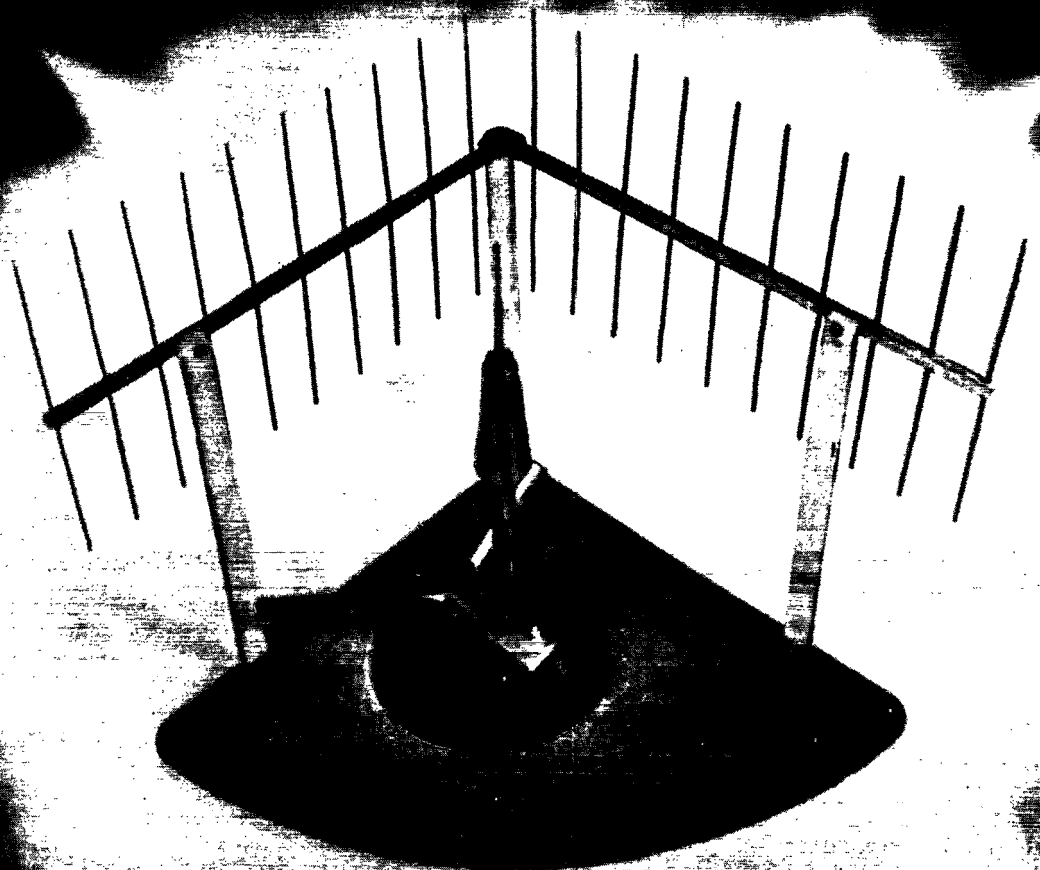

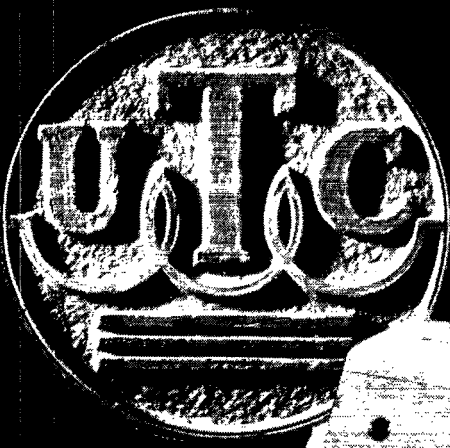

Leads the field

UNITED TRANSFORMER CO.
150 VARICK STREET ★ NEW YORK, N. Y.



In the 1941 ARRL Sweepstakes contest Hallicrafters Communications Equipment occupied a prominent position with the winners. Another tribute to Hallicrafters Engineering resources. The achievements of our Communications Equipment in civilian use and with the Armed Forces are an outstanding example of better communications performance. Engineered by the world's largest Exclusive Radio Communications Manufacturer. SX-28 (Illustrated) 15 Tubes. 6 Bands. Covers from 550 kc. to 42 mc.





Heroes All!

The defense of Bataan will go down in history along with the Alamo as one of our most heroic stands. Despite the impossibility of getting supplies or reinforcements they held their posts with a vengeance . . . the type of defense that we are proud our armed forces can always be counted upon to deliver.

*Hallicrafters Sky Buddy Model
S-19R (illustrated) in use at a
former listening post on Bataan.*

the hallicrafters co.
CHICAGO, U. S. A.

Keep Communications Open

JUNE 1942

VOLUME XXVI

NUMBER 6



STAFF

Editorial

KENNETH B. WARNER, W1EH
Editor and Business Manager

CLINTON B. DESOTO, W1CBD
Assistant Editor

CLARK C. RODIMON, W1SZ*
Managing Editor

GEORGE GRAMMER, W1DF
Technical Editor

DONALD H. MIX, W1TS
BYRON GOODMAN, W1JPE*
Assistant Technical Editors

EDWARD P. TILTON, W1HDQ
Contributing Editor, U.H.F.

VERNON CHAMBERS, W1JEQ*
WALTER E. BRADLEY, W1FWH
Technical Information Service

LOUISA B. DRESSER
Editorial Assistant

JAMES J. LAMB, W1AL*
Research Engineer, A.R.R.L.

Advertising

F. CHEYNEY BEEKLEY, W1GS
Advertising Manager

Circulation

DAVID H. HOUGHTON
Circulation Manager

RALPH T. BEAUDIN, W1BAW
Asst. Circulation Manager

*On leave of absence



OFFICES

38 La Salle Road
West Hartford, Connecticut

Subscription rate in United States and Possessions, \$2.50 per year, postpaid; all other countries, \$5.00 per year, postpaid. Single copies, 25 cents. Foreign remittances should be by international postal or express money order or bank draft negotiable in the U. S. and for an equivalent amount in U. S. funds.

Entered as second-class matter May 29, 1919, at the post office at Hartford, Connecticut, under the Act of March 3, 1879. Acceptance for mailing at special rate of postage provided for in section 1103, Act of October 3, 1917, authorized September 9, 1922. Additional entry at Concord, N. H., authorized February 21, 1929, under the Act of February 28, 1925. Additional second-class entries to cover sectional editions authorized March 20, 1935.

Copyright 1942 by the American Radio Relay League, Inc. Title registered at United States Patent Office.

QST

devoted entirely to

AMATEUR RADIO

PUBLISHED MONTHLY, AS ITS OFFICIAL ORGAN, BY THE AMERICAN RADIO RELAY LEAGUE, INC., AT WEST HARTFORD, CONN., U. S. A.; OFFICIAL ORGAN OF THE INTERNATIONAL AMATEUR RADIO UNION



CONTENTS

It Seems to Us	7
Splatter	8
A Talkie-Walkie for Civilian Defense <i>Karl A. Kopetzky, W9QEA</i>	9
Practical Microwave Oscillators <i>John C. Reed, W6IOJ</i>	14
Happenings of the Month	17
Optical Fundamentals for Amateurs <i>R. B. Bourne, W1ANA</i>	19
U. S. A. Calling!	22
25 Years Ago This Month	25
A Course in Radio Fundamentals <i>George Grammer, W1DF</i>	26
In The Services	32
Experimenter's Section	34
Army-Amateur Radio System Activities	37
Ohm's Law in Rhyme <i>Eileen V. Corridan</i>	38
Power Tuning for the Amateur Transmitter <i>Henry E. Rice, Jr., W9YZH</i>	39
Visual Signalling <i>Clinton B. DeSoto, W1CBD</i>	42
Off the Ultrahighs <i>E. P. Tilton, W1HDQ</i>	46
Hints and Kinks <i>Eliminating Gas-Driven-Plant Interference — Low-Cost Beam-Rotating Mechanism — Hints on Winding Coils on Small Polystyrene Forms — Operating a Half-Wave Doublet at the Second Harmonic — Homemade Circle Cutter</i>	48
Correspondence from Members	50
P. O. W.	51
Operating News	52
Honor Roll	53
Meters Needed	54
Amateur Activities	55
The Month in Canada	70
Silent Keys	84
Hamads	91
QST's Index of Advertisers	94

Section Communications Managers of the A. R. R. L. Communications Department

Reports Invited. All amateurs, especially League members, are invited to report communications activities, training plans, code classes, theory-discussion groups, civilian-defense building or planning each mid-month (16th of the month for the last 30 days) direct to the SCM, the administrative official of ARRL elected by members in each Section whose address is given below. Radio Club reports and Emergency Coordinator reports representing community organized work and plans and progress are especially desired by SCMs for inclusion in *QST*. **ARRL Field Organization appointments**, with the exception of the Emergency Coordinator and Emergency Corps posts, are suspended for the present and no new appointments or cancellations, with the exception named, will be made. This is to permit full efforts of all in Emergency Corps plans.

ATLANTIC DIVISION			
Eastern Pennsylvania Maryland-Delaware-District of Columbia Southern New Jersey Western New York Western Pennsylvania	W3BES W3CIZ W3CCO W8PLA W8CKO	Jerry Mathis Hermann E. Hobbs Lester H. Allen Fred Chichester E. A. Krall	6208 Master St. 9701 Monroe St. Silver Spring P. O. 704 Quinton Ave. 703 Broadway Philadelphia Linden, Maryland Trenton Sonyea East McKeesport
CENTRAL DIVISION			
Illinois Indiana Kentucky Michigan Ohio Wisconsin	W9ILH W9YMV W9ARU W8DPE W8AQ W9EYH	Mrs. Carrie Jones LeRoy T. Waggoner Darrell A. Downard Harold C. Bird E. H. Gibbs Walter Wallace	2407 Central Ave. 1721 Winton St. 116 N. Longworth Ave. R.F.D. 2 405 Broad St. 929-A W. Hadley St. Alton Indianapolis Louisville Pontiac Wadsworth Milwaukee
DAKOTA DIVISION			
North Dakota South Dakota Northern Minnesota Southern Minnesota	W9RPI W9ADJ W9FUZ W9YNO	Don Beaudine E. C. Mohler Armond D. Brattland Millard L. Bender	620 First N St. Box 149 Birchmont Rd. 608 N. Huron Ave. Fargo Rapid City Bemidji Spring Valley
DELTA DIVISION			
Arkansas Louisiana Mississippi Tennessee	W5GNV W5DWW W5EGE W4DDJ	John R. Sanders W. J. Wilkinson, Jr. S. Benton Cain M. G. Hooper	P. O. Box 1563 Room 313, Jefferson Hotel 221 E. Monticello 4908 Georgia Ave. Little Rock Shreveport Brookhaven Nashville
HUDSON DIVISION			
Eastern New York N. Y. C. & Long Island Northern New Jersey	W2LU W2AZV W2LMN	Robert E. Haight E. L. Baunach Edward Gursky, Jr.	356 West 34 St. 102 Central Ave. 367 Van Winkle Ave. New York City Massapequa, L. I. Hawthorne
MIDWEST DIVISION			
Iowa* Kansas Missouri* Nebraska	W9PIR W9AWP W9AEJ W9WKP	L. B. Vennard A. B. Unruh Wm. G. Skinker Garold Bennett	1113 So. 9th St. 1617 S. Seneca St. 7126 Pershing Ave. 214 East St. Burlington Wichita University City Hastings
NEW ENGLAND DIVISION			
Connecticut Maine Eastern Massachusetts Western Massachusetts New Hampshire Rhode Island Vermont	W1KOY W1BAV W1LAP W1JAH W1FTJ W1HRC W1KJG	Edmund R. Fraser Ames R. Millett Frank L. Baker, Jr. William J. Barrett Mrs. Dorothy W. Evans Clayton C. Gordon Clifton G. Parker	48 Willow St. 37 Morning St. 91 Atlantic St. 239 Columbia St. P. O. Box 312 70 Columbia Ave., Gaspee Box 537 West Haven Portland North Quincy Adams Concord Plateau, Warwick Morrisville
NORTHWESTERN DIVISION			
Alaska Idaho* Montana Oregon Washington	K7GNN W7AVP W7CPY W7GNI W7EPB	James G. Sherry Don D. Oberbillig Rex Roberts Carl Austin Carl F. Hofmann	P. O. Box 486 Box 1088 1137 Federal 4413 East E St. Homer Boise Glendive Bend Tacoma
PACIFIC DIVISION			
Hawaii Nevada Santa Clara Valley East Bay San Francisco Sacramento Valley Philippines San Joaquin Valley	K6ETF W6BIC W6IUZ W6TI W6CIS W6MDI KAIGR W6QDT	Francis T. Blatt Edward W. Heim Earl F. Sanderson Horace R. Greer Kenneth E. Hughes Vincent N. Feldhausen George L. Rickard Antone J. Silva	837 16th Ave. 509 Claremont St. 101 Claremont Ave. 414 Fairmount Ave. 590 35th Ave. 113 South Quincy St. Box 849 Route 5 Honolulu Reno San Jose Oakland San Francisco Milbaud Manila Modesto
ROANOKE DIVISION			
North Carolina South Carolina Virginia* West Virginia	W4CYB W4BOE/ANG W3BZE W8JRL	W. J. Wortman Ted Ferguson Thomas S. Jones Kenneth M. Zinn	P. O. Box 566 1213 College St. 2918 Montrose Ave. P. O. Box 132 Morganton Columbia Richmond Clarksburg
ROCKY MOUNTAIN DIVISION			
Colorado Utah-Wyoming	W8CNL W7GZG	Stephen L. Fitzpatrick Henry L. Schroeder	25 Emerson St. P. O. Box 731 Denver Laramie, Wyoming
SOUTHEASTERN DIVISION			
Alabama* Eastern Florida Western Florida Georgia West Indies (Cuba) (Puerto Rico-Virgin Islands)	W4GBV W4PEI W4AXP W4AOB CM2OP K4KD	Lawrence J. Smyth Carl G. Schaal Oscar Cederstrom William U. Hanks Mario de la Torre Everett Mayer	808 Winona Ave. Lakeview Hotel Second St. & Bruce Ave. 4 Hunter St., S.E. Escobar 110 (Altos) 24 Lindberg St. Montgomery Clermont De Funiak Springs Atlanta Habana, Cuba Santurce, P. R.
SOUTHWESTERN DIVISION			
Los Angeles Arizona San Diego	W6MOM W6MML W6BZE	Ralph S. Click Gladys Elliott Richard Shanks	1038 Milwaukee Ave. 218 Loma St. 4033 S. Hempstead Circle Los Angeles Nogales San Diego
WEST GULF DIVISION			
Northern Texas* Oklahoma Southern Texas New Mexico	W5CY W5GFT W5MN W5ENI	Gordon Ash Russell W. Battern Horace E. Biddy Dr. Hilton W. Gillett	111 So. Ravinna Drive Box 290 1746 Schley Ave. Dallas Enid San Antonio Lovington
MARITIME DIVISION			
Maritime	VE1DQ	A. M. Crowell	69 Dublin St. Halifax, N. S.
ONTARIO DIVISION			
Ontario	VE3EF	Flying Officer Donald R. Gunn c/o Canadian Bank of Commerce	New Toronto, Ont.
QUEBEC DIVISION			
Quebec	VE2CO	Lindsey G. Morris	Apt. 6, 4510 Girouard Ave., N.D.G. Montreal, P. Q.
VANALTA DIVISION			
Alberta British Columbia	VE4GE VE5DD	C. S. Jamieson C. O. I. Sawyer	581 W. Riverside Drive 2634 West 31st Ave. Drumheller, Alta. Vancouver
PRAIRIE DIVISION			
Manitoba Saskatchewan	VE4AAW VE4SY	A. W. Morley Arthur Chesworth	747 McMillan Ave. 1071 4th Ave., N.W. Winnipeg Moose Jaw

* Officials appointed to act until the membership of the Section choose permanent SCMs by nomination and election.



Standard of Comparison

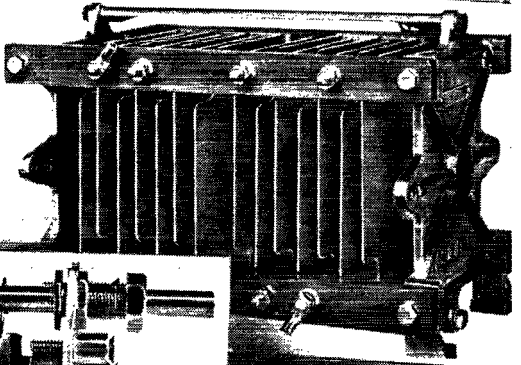
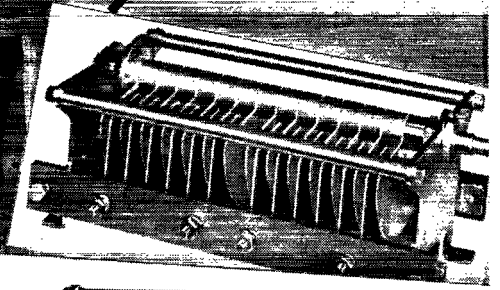
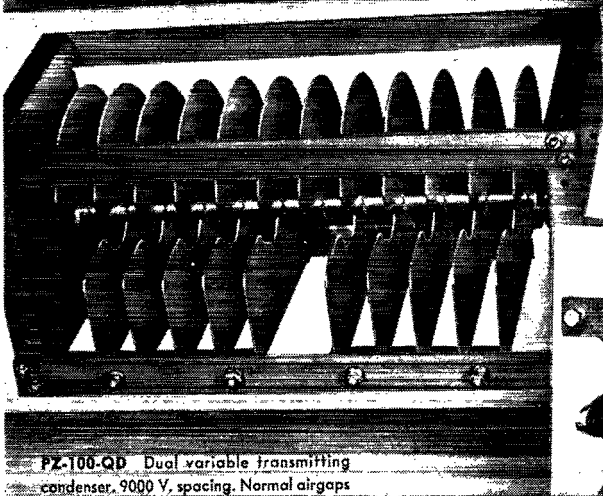

PZ-100-QD Dual variable transmitting condenser, 9000 V. spacing. Normal airgaps to 1/2 inch.

TC-100-UD Dual variable transmitting condenser. Normal maximum airgap .294 inches. 1/2 inch airgap available in 80 mmf. single or 40 mmf. dual.

HZ-100-ZD Dual fixed transmitting condenser. 1/2 inch airgap 100 mmf. per section.

A-220 Micro-capacitor bridge adjuster. Typical of the many special components that are produced to customer specifications.

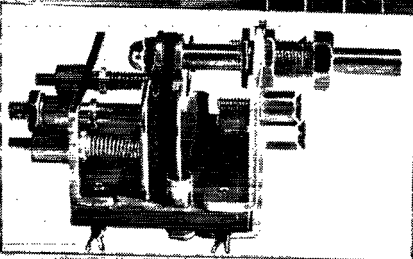

CARDWELL CONDENSERS

Specified and used generously in practically every type of communications equipment from the lowest power transmitters to the highly complex controls of frequency checking devices, CARDWELLS have never failed to justify their selection.

THE ALLEN D. CARDWELL MANUFACTURING CORPORATION

83 PROSPECT STREET

BROOKLYN, N. Y.

THE AMERICAN RADIO RELAY LEAGUE

Directors

<i>President</i>	
GEORGE W. BAILEY	W1KHX
74 Webster Road, Weston, Mass.	
<i>Vice-President</i>	
CHARLES E. BLALACK	W6GG
Box 55, Yuma, Ariz.	
<i>Canadian General Manager</i>	
ALEX REID	VE2BE
240 Logan Ave., St. Lambert, P. Q.	
<i>Atlantic Division</i>	
WALTER BRADLEY MARTIN	W3QV
c/o Naval Air Station, Lakehurst, N. J.	
<i>Central Division</i>	
GOODWIN L. DOSLAND	W9TSN
11831 Longwood Drive, Chicago, Ill.	
<i>Dakota Division</i>	
TOM E. DAVIS	W9VVA
915 W. Becker Ave., Willmar, Minn.	
<i>Delta Division</i>	
E. RAY ARLEDGE	W5SI
P.O. Box 286, Pine Bluff, Ark.	
<i>Hudson Division</i>	
ROBERT AKERIDGE KIRKMAN	W2DSY
250 Albert Place, Elberon, N. J.	
<i>Midwest Division</i>	
FLOYD E. NORWINE, JR.	W9EFC
7405 Hiawatha Ave., Richmond Heights, Mo.	
<i>New England Division</i>	
PERCY C. NOBLE	W1BVR
37 Broad St., Westfield, Mass.	
<i>Northwestern Division</i>	
KARL W. WEINGARTEN	W7BG
3219 N. 24th St., Tacoma, Wash.	
<i>Pacific Division</i>	
J. L. McCARGAR	W6EY
66 Hamilton Pl., Oakland, Calif.	
<i>Roanoke Division</i>	
H. L. CAVENESS	W4DW
2607 Vanderbilt Ave., Raleigh, N. C.	
<i>Rocky Mountain Division</i>	
C. RAYMOND STELMAN	W9CAA
925 So. Gaylord St., Denver	
<i>Southeastern Division</i>	
WILLIAM C. SHELTON	W4ASR
Box 652, Daytona Beach, Fla.	
<i>Southwestern Division</i>	
JOHN E. BICKEL	W6BKY
1834 E. Whittier Blvd., Whittier, Calif.	
<i>West Gulf Division</i>	
WAYLAND M. GROVES	W5NW
Route 1, Overton, Texas	

THE AMERICAN RADIO RELAY LEAGUE, INC., is a non-commercial association of radio amateurs, bonded for the promotion of interest in amateur radio communication and experimentation, for the relaying of messages by radio, for the advancement of the radio art and of the public welfare, for the representation of the radio amateur in legislative matters, and for the maintenance of fraternalism and a high standard of conduct.

It is an incorporated association without capital stock, chartered under the laws of Connecticut. Its affairs are governed by a Board of Directors, elected every two years by the general membership. The officers are elected or appointed by the Directors. The League is non-commercial and no one commercially engaged in the manufacture, sale or rental of radio apparatus is eligible to membership on its board.

"Of, by and for the amateur," it numbers within its ranks practically every worth-while amateur in the nation and has a history of glorious achievement as the standard-bearer in amateur affairs.

Inquiries regarding membership are solicited. A bona fide interest in amateur radio is the only essential qualification; ownership of a transmitting station and knowledge of the code are not prerequisite. Correspondence should be addressed to the Secretary.



Past Presidents

HIRAM PERCY MAXIM, W1AW, 1914-1936
EUGENE C. WOODRUFF, W8CMP, 1936-1940

Officers

<i>President</i>	GEORGE W. BAILEY, W1KHX
	Weston, Mass.
<i>Vice-President</i>	CHARLES E. BLALACK, W6GG
	Yuma, Ariz.
<i>Secretary</i>	KENNETH B. WARNER, W1EH
	West Hartford, Connecticut
<i>Communications Manager</i>	F. EDWARD HANDY, W1BDI
	West Hartford, Connecticut
<i>Acting Treasurer</i>	DAVID H. HOUGHTON
	West Hartford, Connecticut
<i>General Counsel</i>	PAUL M. SEGAL
	1026 Woodward Building, Washington, D. C.

Address all general correspondence to the administrative headquarters at West Hartford, Connecticut.

"IT SEEMS TO US—"

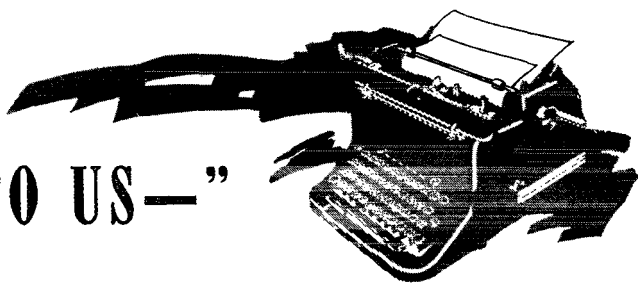

OUR PART IN THE WAR

It's a good habit to take stock of one's progress and position occasionally. The government makes frequent analyses of its war production and training efforts. When the showing is bad it indicates what corrective steps must be taken. When the statistics are good, as they have been lately, they lend encouragement all down the line. When we look at amateur radio in that same manner, what's the score?

First off, we find that there are fifteen thousand licensed amateurs now in the military services, plus untallied additional thousands in civilian status in government agencies, research and development laboratories and the manufacturing industry, all geared to the job of winning the war. That's a good showing, one that can give all amateurs a certain amount of pride.

But by comparison with the national needs it's not enough. Every outfit going overseas is in need of more trained radio men. Every day there are fresh pleas from government agencies, civil as well as military. Communications are one of the most important ingredients of modern war and the need for skilled people runs from the urgent to the desperate. The numerous earnest searches for more and yet more radio specialists are summarized in every issue of *QST* for your attention. One requirement of victory is that every radio man and woman who can be spared from home should associate himself with some communications aspect of the united national effort.

With the shortage of radio hands as great as it is, every ham who enters the country's service should go into radio work. Occasionally one hears of a good ham whose unit commander, not being particularly impressed with radio, has put him to work driving a truck or doing some similar job that can be done equally well by a man who has none of these specialized abilities. It's a crime for a qualified radio man to be working on anything but communications. If you're by any chance in that position, or have a friend who is, and can't get radio duty, you are asked to report the circumstances to ARRL Hq. We

have a channel that has frequently resulted in setting such cases aright and making a proper employment of the amateur's talents.

From the standpoint of station operation we've had, in common with the military itself, to modify our perspective. The idea of a few years ago that radio had pretty well eclipsed other modes of signaling has necessarily given way in many branches of this war to the superior considerations of security: the need to protect against disclosures of critical information or of location or bearing. Many radio plans have been junked where silence is more important than continuous communication. Yet the importance of the amateur in short-range emergency communications for civilian defense and for the relief of natural disasters is as great as it ever was, and it is going to be recognized. We have suffered discouraging delays in being given the green light but the end of all that is said to be in sight now. We shall then have a task before us of great dimensions and of a degree of sober importance that is apparent to us all. It will heavily tax the capabilities of those of us who are available for the job. It scarcely needs to be said that the radio amateur will require no needling to give his best to his own community's protection.

On the Headquarters front we're a mighty busy crew, working harder than we ever did before in our lives. The League offices are not a war industry in the sense that we manufacture munitions, yet "war industry" is what we haven't got much of anything else but around here. You'll be glad to know that it requires no elasticity of imagination to say that your League is engaged in an active support of the war effort. We claim no credit, for we do nothing more than every American is doing — his best — but we thought it would please you to know that apparently we are succeeding in being of quite a lot of help. Of course we still have some internal activities — membership correspondence, technical advice, the maintenance of the mechanism of our system of government, the ever-essential safeguarding of our future — and one of the jobs of *QST* is to hold us all together during this period of closed stations. But aside from these funda-

mentals everything that the League organization is doing to-day is directly down the war alley. The things that used to occupy us have long since been put on the shelf. Our Personnel Bureau and our Apparatus Bureau in particular are doing vital work. We have never a day without requests from government agencies or a visit from a military officer for help in one of these subjects. "Can you locate a hundred skilled c.w. operators of unquestionable loyalty within the next three weeks?" "Where can I buy six 400-watt transmitters by noon to-day?" "Can you recommend a traffic expert for this particular job?" "Can you help us get four so-and-so receivers aboard a plane for Deletia by this time to-morrow?" It takes doing but you bet we can! That's what your registrations of personal availability and of apparatus help us to do. And the needs are hot and important, too. What with these bureaux and the dope in *QST*, we're near to being a recruiting office. We're also helping in the setting up of radio training classes of different sorts all over the country, writing a considerable amount of training literature in one form or another. (Incidentally, we're finding that our books and booklets, originally written purely for our own kind of practising amateur, make swell training texts, and their increased sales are helping to hold that old debbil wolf an extra three feet from our threshold while the useful work goes on.) Although we design and build almost no new radio gear, our shop and lab are not altogether idle, either, and

we've helped in the progress the experimenters' gang is making in the development of nonradio means of communication. Maybe we'd better make it clear that the real motive behind this quest for alternative methods is local civilian defense needs. There won't be enough radio sets to go around and there'll always be problems with the use of radio. To the extent that we can lick any of these other methods we shall contribute to the solving of the emergency communication problems of our communities. Sure it's fun, and relaxation from the cares of a wartime occupation, but it has got a deeper purpose: its direct usefulness in a current need. (Are you enrolled, by the way?)

Much remains to be done but we know that the amateurs of this country, including the Headquarters gang, will more than do their part. Our whole institution addresses itself to the nation's one aim. The situation of our League is that which we are sure every member wishes it to be: QRX on our own affairs beyond the essentials of existence, while we devote what skill we have and what earnings we can make to helping the country's effort. ARRL hasn't any government appointment and it has no particular official recognition; it is just that it has long since dedicated itself to using every resource at its hand to assisting the national effort.

May we bespeak the continued support of every amateur, that the work may not falter? You and the League have never needed each other more than at present. K. B. W.

★ SPLATTER ★

BUY U. S. WAR BONDS AND STAMPS

How much money did you spend on amateur radio last year? The year before? This year? One or the other of the first two figures unquestionably is larger than the last one. What have you done with the difference? Here's a tip: The surest way to guarantee the investment you now have in amateur radio is to buy U. S. War Bonds and Stamps, for that is the surest way to win the war.

Remember, this is war — *your* war. Your war, as radio amateurs, because it is to preserve just such institutions as amateur radio that this war is being fought. Add the difference between your past and present annual expenditure for radio to the 10% you're buying bonds with now.

OUR COVER

Quite in the spirit of the times technically is W6IOJ's 750-800 Mc. oscillator, set up complete with its radiator and square-corner re-

flector. The quarter-wave antenna together with the flared quarter-wave skirt can be seen clearly in this view. The oscillator itself is shown pictorially and diagrammatically on pages 14-16.

Apparently we do have mystery-story readers in the ham fraternity, judging from the response to the stray on page 104 of May *QST*. Sorry, though, OMs; the ARRL Book Department can't accept orders for "For Murder Will Speak." You'll have to get it through your bookseller.

Speaking of response, the preliminary returns on the proposal to begin a comprehensive crypt-analysis course, broached in John Huntoon's dissertation on the subject in the May issue, are most encouraging. Based on what seems to be a genuinely widespread interest in the project, we are scheduling a series of articles to begin in the July issue. Meanwhile, for the benefit of those still struggling with W1LVQ's concluding exercise, here is a hint: The problem is a simple substitution cipher, and the analysis closely follows that used in the example.

(Continued on page 16)

A Talkie-Walkie for Civilian Defense

**112-Mc. Dry-Battery Transceiver
with Unique Features**

BY KARL A. KOPETZKY,* W9QEA

Here's a transceiver with several novel wrinkles designed to increase its utility in civilian defense communication where pack operation is called for. Ease of operation and complete freedom of hands and ears are primary features. The term "talkie-walkie" is used to distinguish it from the military "walkie-talkie."

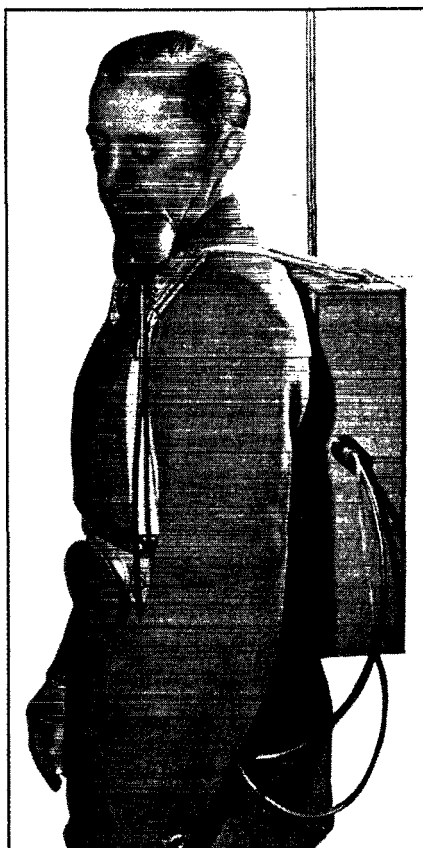

The wearer of this pack transceiver has both hands free and has his hearing unobscured by a headset. The loudspeaker on the shoulder mounting also serves as a microphone. Send-receive switching is conveniently accomplished by pressing on the disc fastened to the belt, thereby operating a control relay in the unit.

WHILE it is true that at present the amateur is completely off the air, it is also a fact that some of us may be restored to operation on short notice for the purpose of helping out in home defense. We should be prepared for the eventualities with the best equipment for the occasion.

Some of the drawbacks of the average 112-Mc. portable gear which the hams have been using are: (1) the headphones shut out the wearer effectively from the outside world; (2) the range is limited, especially in large cities with their massive buildings, and (3) the wearer or operator of the equipment is unable to use his two hands at the same time he is using the equipment, since one hand must hold the handset or microphone.

The talkie-walkie to be described gets away from these limitations. It permits good loudspeaker operation at most times, has an increased range, and lets the wearer have both hands free.

Circuit

For the most part, the circuit is not new. There are a few changes, though. The loudspeaker is used as a microphone as well as in its

* 3911 So. Michigan Ave., Chicago, Ill.

accustomed rôle. Also, the unit is remotely operated by means of a small 4-pole double-throw relay, the coil of which consumes only 50 ma. at six volts. Additional features of the circuit are its capability for use on keyed i.c.w. or for transmitting a tone before the voice transmissions. The construction permits "knapsack-carrying," and the unit is water-proof except in a pouring torrent. Some of the condensers, notably C_3 and C_2 , may seem strange, but they are easily made.

The question naturally arises as to what effect priorities will have on the availability of parts. A large percentage of the parts used are still to be found on dealers' shelves, and it seems logical that should hams be re-licensed for defense work they will be given the necessary priorities with which to secure parts. The most difficult circuit components to obtain are the batteries. In the matter of the 6-volt unit, the author used a $7\frac{1}{2}$ -volt battery which is intended for b.c. set use. A resistor of suitable value was placed in series with the positive lead of the battery to provide the required voltage drop. As the battery wore out, the resistor was eliminated. This feature is not shown in the diagram.

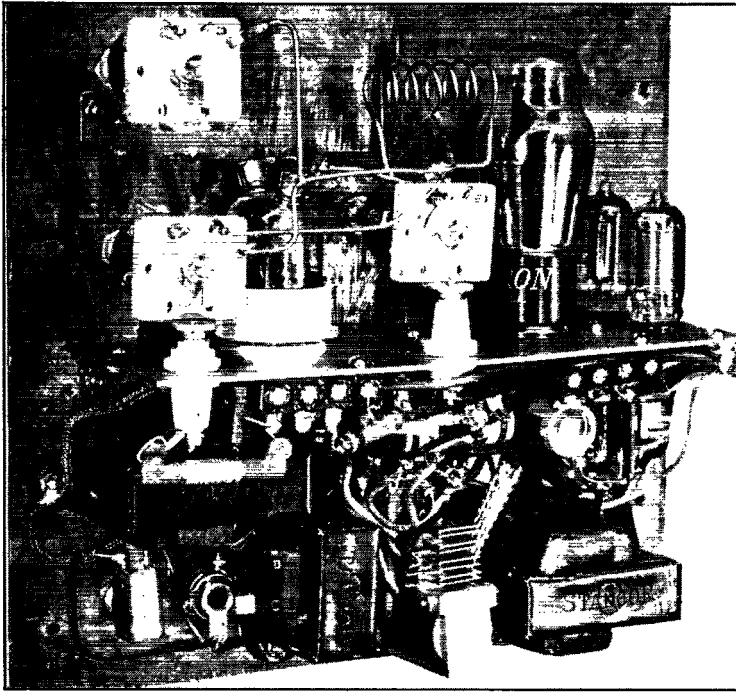

The entire unit is mounted on the panel, the r.f. circuits being on a small metal shelf. Layout of parts is described in the text.

Construction

The unit is worn knapsack-fashion on the back of the operator. As the photograph shows, the mike-speaker is mounted on the left shoulder. The wearer is a right-handed man, therefore he would want his right arm free. The button, that disc seen slightly to the front on the belt, is the remote-control switch operating the relay. Should the wearer be a "lefty," he should wear the mike-speaker on his right shoulder and the control to the right of center under his right arm, leaving his "working" hand and arm free.

The mike-speaker unit is mounted on the side strap. This is accomplished by clamping the base of the unit under an old speaker housing which has been sawed in half. These housings are available in any b.c. store for a small sum. They are of the midget variety, and will exactly fit the unit's base. The two pieces of the housing are bolted (two bolts to each piece) to two rectangular pieces of bakelite or light veneer wood with the strap sandwiched between them. Thus the unit can be slid up or down the shoulder strap to suit the wearer's physical dimensions and it can also be turned on its axis to allow for differences in facial and neck contours.

The shoulder strap is a regular Army belt such as can be obtained from any Army and Navy store for 50 cents. The waist-belt is a 1917-vintage cavalry man's belt also obtainable from the same

source for about \$1.00. The hooks which attach the shoulder straps to the waist belt are from a set of cavalymen's suspenders, also vintage 1917, available from the same store for 35 cents each. You will need but one pair. But be sure to purchase a belt, shoulder strap and suspender which show no signs of rot. Some are in this condition because they have lain so long without use.

The remote-control button is fashioned from an ordinary house-bell push-button. Remove the outside and get at the button itself, which should be of the hollow metal variety—the cheapest type manufactured. Drill a hole neatly and exactly through the center of the button and mount a disc (a panel meter-hole cut-out) by means

of a machine screw and two or three nuts, as shown in Fig. 2. Test the button after it has been assembled to make sure that it will work regardless of the angle at which pressure is brought against the disc. Considerable tailoring and jiggling will be necessary for the button to work properly, but you may rest assured that once adjusted it will not get out of whack easily. The button is mounted on the waist belt by means of No. 18 wire, from which the insulation has been stripped, strung through the holes in the base of the button and the holes in the belt. That is crude and cheap, but very effective. The waist belt is adjustable for the girth of the wearer, and should be fixed to fit you. By using wing-nuts on the mounting of the mike-speaker, the unit becomes readily demountable and can be used by a second person while the talkie-walkie is being carried by the operator. The remote button should be retained by the operator and used by him because of the law prohibiting the turning on or off of a transmitter by any other than a licensed amateur.

The belt is fastened to the case by means of a metal plate and six nuts and bolts through holes with which the belt comes equipped. The bolt heads are turned inside, the nuts outside, and the belt fastened along the lower edge in the center, as shown in the rear-view photograph.

The case can be constructed either of fibre put

together with small angle pieces, or it can be a 9 × 17 4-inch chassis such as the author used. The chassis weighs a lot, and the fibre case will save wear and tear on the shoulders. Paraffin-impregnated wood can also be made to serve for the case, with about the same results as fibre. The front panel is made of steel (or aluminum if you have some); wood, fibre or bakelite cannot be used here.

The hinges are also homemade. Purchased from a dime store, one third of each hinge was cut off with a hack-saw leaving a "demountable" hinge. The cover can be swung up, as shown in the front view, or it can be removed entirely. This last feature is valuable if the unit is to be used at any time on an operating table. The hinged front also provides for rainproofing and

against tampering when the cover is closed. A cupboard-type snap lock is used to keep the cover closed.

Tubes are removable from the back. This is important because the entire set need not be disturbed when such a change is necessary. A hole is cut in the back of the case and four self-tapping screws with the combination hex-nut and screw heads used to hold the cut-out in place. These screws are readily obtainable in any hardware store and have the additional feature of being removable with a screw-driver or a small wrench or even a "spintite." In emergency equipment all things must be considered. The scarcity of a certain type of tool is as important as anything else if everything is to function perfectly and without a hitch.

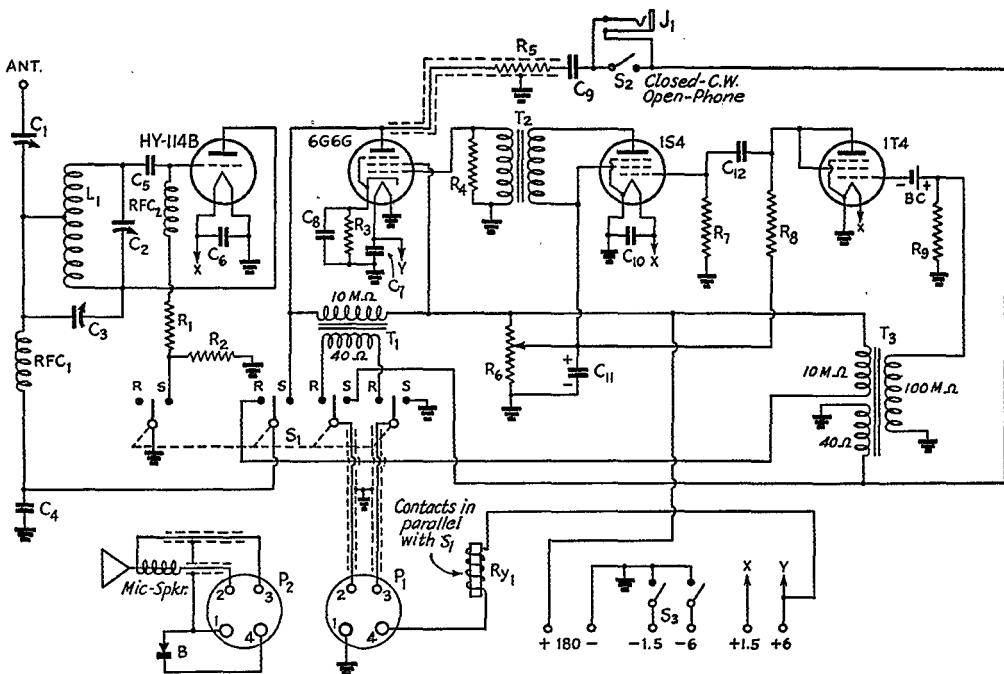
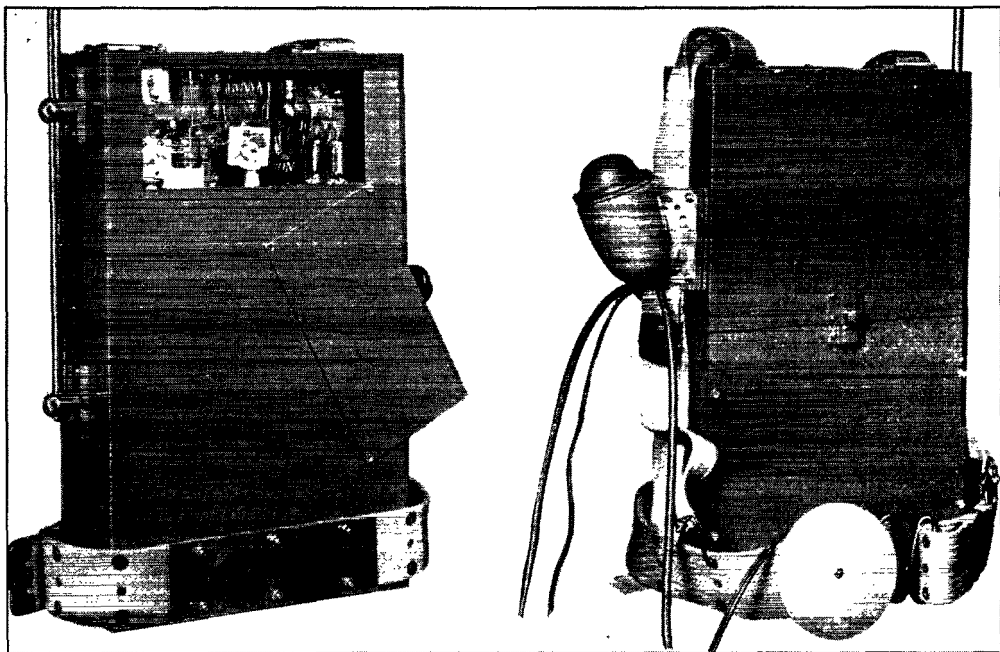

Fig. 1 — Circuit diagram of the 112-Mc. transceiver.

- C₁ — 35- μ fd. midget variable (Hammarlund HF-35).
- C₂, C₈ — Midget three-plate variable (cut down Hammarlund HF-15; see text).
- C₄ — 0.002- μ fd. mica.
- C₅ — 100- μ fd. silvered mica.
- C₆, C₇, C₁₀ — 0.01- μ fd. paper.
- C₉ — 10- μ fd. electrolytic, 25-volt.
- C₉ — 0.1- μ fd. paper.
- C₁₁ — 8- μ fd. electrolytic, 250-volt.
- C₁₂ — 0.05- μ fd. paper.
- R₁ — 15,000 ohms, 1 watt.
- R₂ — 0.125 megohm, $\frac{1}{2}$ watt.
- R₃ — 300 ohms, 5 watts.
- R₄ — 0.25 megohm, $\frac{1}{2}$ watt.
- R₅ — 5000 ohms, $\frac{1}{2}$ watt.
- R₆ — 0.1-megohm midget potentiometer.
- R₇, R₉ — 10 megohms, $\frac{1}{2}$ watt.
- R₈ — 1 megohm, $\frac{1}{2}$ watt.

- L₁ — 6 turns No. 14, diameter $\frac{1}{2}$ inch, length approx. $1\frac{1}{2}$ inches (see text).
- RFC₁, RFC₂ — 112-Mc. r.f. choke (Ohmite Z-0).
- S₁ — 4-p.d.t. switch.
- S₂ — S.p.s.t. toggle switch.
- S₃ — D.p.s.t. switch (mounted on R₆).
- BC — 1-volt bias cell.
- T₁ — Audio transformer, 40 ohms to 10,000 ohms pri. to sec. (Stancor or Cinaudagraph).
- T₂ — Interstage audio transformer, small size, 3-1 ratio.
- T₃ — Transceiver transformer, 40-ohm and 10,000-ohm primaries, 100,000-ohm secondary (Stancor or Cinaudagraph).
- Ry₁ — 4-p.d.t. relay, 6-volt 50-ma. coil (Guardian).
- J₁ — Open-circuit jack.
- P₁, P₂ — 4 prong plugs and sockets.
- B — Remote control button (see text).
- Microphone-speaker — 2-inch special speaker (Cinaudagraph Type 2-CZN-M).



Left: A small cut-out on the back provides access to tubes when replacements become necessary, thus avoiding the necessity for taking the unit apart. This view also shows the antenna mounting.

Right: The complete outfit. The case is a standard chassis provided with a metal cover, the upper part of which is hinged to give access to the controls.

The antenna is derived from the usual 72- or 96-inch automobile whip antenna which can be obtained everywhere. Discard the porcelain insulators and the lead-in cable with which it comes equipped, and use two pieces of polystyrene or Micalex as insulators. Cut holes in the case about $\frac{1}{4}$ inch larger in radius than the mounting screws of the antenna and use National bushings as interior insulating washers. The Victron pieces are held in place by flat-head screws countersunk to prevent flash-over. Connection is made to the top antenna post after the set has been mounted in the case, and is wired to C_1 from the back.

Connection to the mike-speaker and the remote-control button is by means of a 4-way plug and socket arrangement mounted on the opposite side to the antenna. Separate cables are run to the mike-speaker and the button to permit the speaker being used *off* the shoulder of the operator while the button remains with him, as has been explained previously.

Batteries are placed in the lower half of the case and secured with small blocks of wood cut to size (these are not shown in the photograph). Two separate dry cells are used in parallel for the 1.5-volt supply to assure longer operation. A $7\frac{1}{2}$ -volt battery is used for the 6-volt supply, dropped to that value by a resistor. The "B"

supply consists of four 45-volt batteries (Burgess M30's) and the drain on them is small enough to assure about 20 hours of continuous operation.

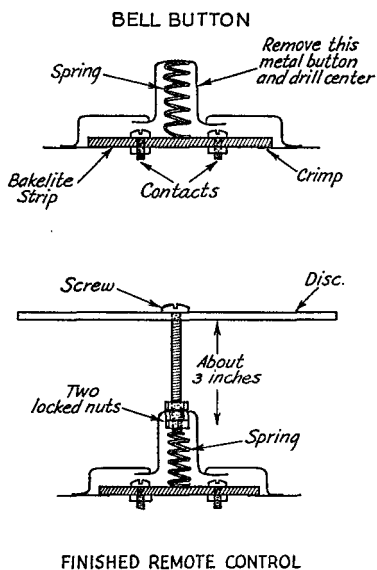

Fig. 2 — Construction of the remote-control button.

Turning to the circuit, Fig. 1, condensers C_2 and C_3 are made from Hammarlund 15- μ fd. variables. With a hot soldering iron remove all but two stator plates and all but a single rotor plate. With a pair of heavy cutting pliers, remove the excess shafts. Carefully loosen the nut holding the condenser together, and turn the large rotor connector to the position indicated in the rear view. This will make wiring easier and the leads shorter. Tighten the nuts and the condenser is finished.

Cut the small sub-panel from a piece of Eraydo metal or from chassis steel. It should be just about $2\frac{1}{2}$ to 3 inches wide and not over 7 inches long. On this mount the tubes, the condensers (on small stand-offs) and the associated circuit connected with the tubes which is not included in the transformer-i.c.w.-relay circuit. Be sure to leave long leads for interconnecting the little subchassis before attempting to mount it on the front panel. Failure to do this will make wiring the two units together well-nigh impossible. Condensers are all fitted with insulating shaft couplings to avoid hand capacity.

One word about switch S_3 . This is mounted on the back of volume control, R_6 . It must be connected as shown, although it might seem that an s.p.s.t. switch could be used and the two negative battery returns joined on one terminal. Such, however, is not the case; with the switch open the 6-volt battery would override the 1.5-volt battery and light the filaments of the 1T4 and 1S4. If you disbelieve, draw out the circuit and see for yourself. We found to our horror that we had burned out our 1.5-volt tubes with the switch in the "off" position, and it took us two days to discover why. That is the reason why a double-pole single-throw switch *must* be used.

The mounting of the rest of the components presents no particular problem, except that the arrangement shown in the rear view should be carefully followed. To deviate much from the layout will introduce variations in the circuit for which it will be hard to compensate. The coil L_1 is wound of No. 14 tinned antenna wire. The diameter is $\frac{1}{2}$ inch, and we recommend the back of any ordinary screw driver as filling the bill for a winding form. The spacing is not critical, and the coil can be squeezed or drawn out until the frequency spread is correct. With the particular coil in the model, a spread of about 40 condenser scale units covered the 112-Mc. band.

The panel is recessed in the case to permit the cover to be closed without hitting the knobs. Use small angle pieces on which to mount the panel, affixing them to the case first, and using self-tapping screws to hold the panel to the angles.

The name plates are cut from the regular types made by Gordon. They are glued with model airplane cement directly to the panel. There is not room behind the panel for the screws with which the plates are generally mounted.

In mounting the relay the following procedure is best followed. Solder different-colored wire leads to each terminal of the relay contacts. These should be about 4 inches long, the different colors being used for easy identification. Solder the ends of the wires to their respective switch contacts so that the relay contacts and the switch contacts are in parallel. Then mount the relay on the panel by means of the screw which holds the relay coil to its own frame. Using a lock washer, tighten it as much as possible. It is virtually impossible for the relay to be wired in any other way.

One final word on the wiring. Use the direct method. No fancy square turns or pretty curls. Short and direct is the watchword. Use only one panel "ground" per tube, and interconnect the "grounds" with a piece of No. 14 tinned antenna wire. No ground connection is brought out, and none is needed for operation.

Operation

Turn on the filaments by advancing the volume control as far to the right as possible. You
(Continued on page 86)

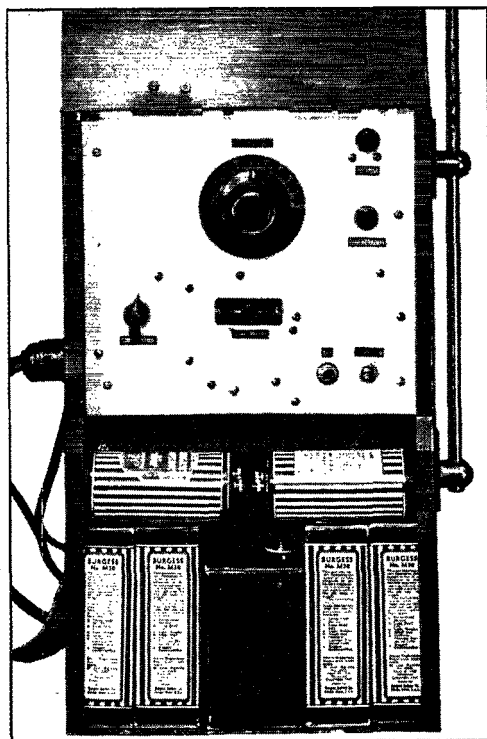

The case with the cover removed. Batteries are in the compartment below the hinged cover. The large dial is of course the tuning control. Antenna coupling and regeneration controls are at the upper right. The key jack and 'phone-c.w. switch are in the lower right-hand corner. The pointer knob at the left is the audio gain control.

Practical Microwave Oscillators

Shielded Parallel-Rod Acorn-Tube Circuits for 400 and 750 Mc.

BY JOHN C. REED,* W6IOJ

Those amateurs to whom the centimeter waves are still strange and foreign territory will find these oscillators described by W6IOJ to be simple but effective models for experimental microwave work. And if u.h.f. experience is valuable these days, familiarity with microwave technique is even more so. A word to the wise!

THE design and construction of oscillators for use in the cm.-wave region necessarily means a compromise between efficiency and stability. A variety of special arrangements have been devised for securing improved stability, but invariably this is accomplished only at a substantial loss in efficiency. For maximum power output with a given input, there is still nothing much superior to the conventional parallel-rod linear oscillator at the very high frequencies.

Although the stability of the parallel-rod oscillator is relatively poor, it has been found that in many cases the lack of stability in a microwave oscillator lies not so much in the electrical design as in the mechanical construction. With this in mind, and also considering that the os-

cillator is often used both as a transmitter and as a superregenerative receiver, the oscillator should be required to tune smoothly, be shielded from external objects to minimize stray radiation, and have a mechanically rigid antenna system; these items add to the stability of the oscillator under actual operation.

The microwave oscillators described in this article have worked out very well for experimental communication. The half-wave parallel-rod type of oscillator was used because of its un-failingly consistent operation and because of its ability to transfer a relatively large percentage of its power output into the antenna, as compared to other oscillators designed for higher stability.

The 2-inch copper pipe is the basic structure for the oscillator. This pipe serves the dual purpose of effectively shielding the parallel rods and also of serving as a solid mechanical support for everything connected with the oscillator. This shield provides an excellent ground for radio-frequency by-pass condensers at any point on its surface. Shielding of the parallel rods aids stability by eliminating all hand-capacity effects, and also allows perfect by-passing for the power leads.

The mounting of the tubes as shown in the photographs indicates the precautions that must be taken to prevent inductive and resistive losses. All connections should be made direct and with

*7521 Lankershim Blvd., North Hollywood, Calif.

A 750-800-Mc. oscillator of the shielded parallel-rod type, using conventional quarter-wave radiator together with a quarter-wave skirt. (Left) The simplified acorn-tube mounting. Grid and plate pins are inserted in small holes in the ends of the parallel rods, filament connections being made through small spring connectors which hold the tube in place. The cathode pin is strapped to one filament pin. (Center) Dismantled view, showing 2-inch outer shell with filament lines and radiator in place. The tuned-circuit parallel lines with their polystyrene insulators are seen in foreground, feed chokes projecting. The hemispherical end shields are hammered copper made to fit tightly inside ends of shell, painted black for the sake of appearance. (Right) Tuning mechanism. Turning the knob in its threaded bushing varies the spacing between the curved copper strip and the parallel-rod assembly.

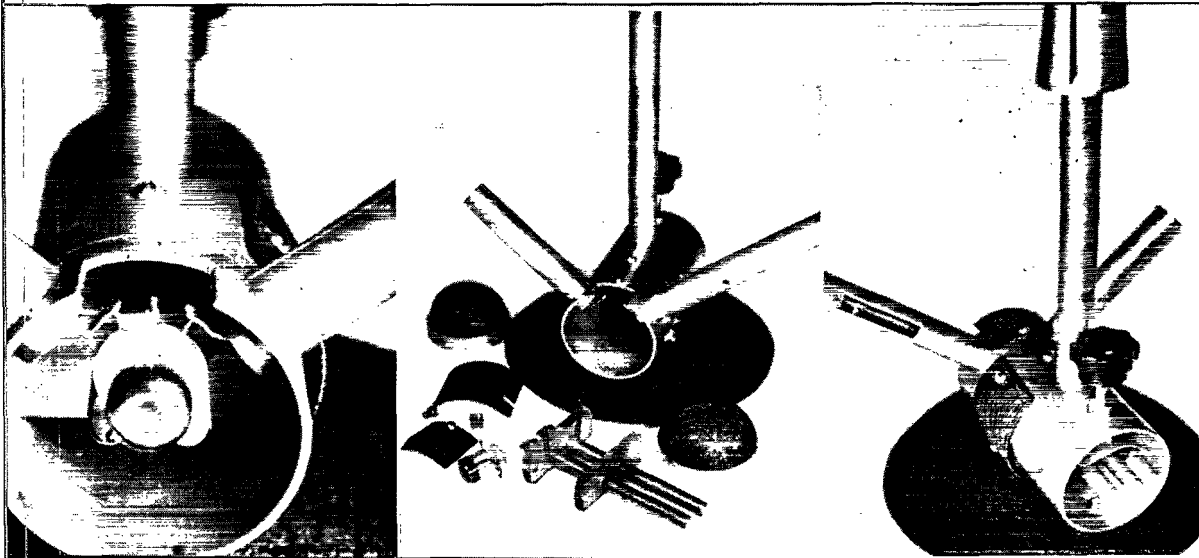

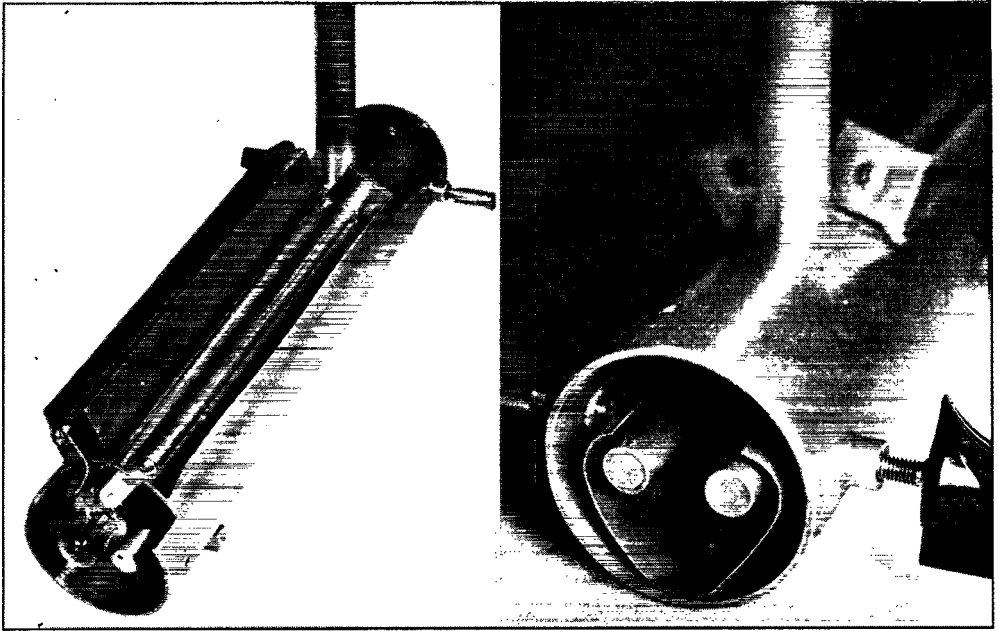

Parallel-rod oscillator for 400 Mc. (Left) General view, showing trough-type filament lines parallel with shell and tube mounting. (Right) Tuning mechanism. Only one adjustment is actually used in tuning; the other balances the lines for maximum output.

no, or little, insulation supporting them if they are at voltage nodes. The tuning system again illustrates the necessary low-loss construction.

In explaining the tuning, it can be compared to the normal variable condenser; the surface of the rods acts as the stator plates and the grounded copper strip which is varied in distance from the parallel rods is analogous to the rotor.

Since the acorn 955 is used, filament lines are not really necessary for operation on 400 Mc., as filament chokes would serve practically the same purpose. The lines were used to simplify the design and to stabilize the mechanical construction, however. The use of such lines leaves no doubt as to the efficiency of the filament circuit, and as the frequency is raised their superiority over r.f. chokes becomes more pronounced.

The photographs show two types of construction for the filament lines. The trough line facilitates adjustment, since it is an easy matter to insert sliders between the trough and the inner conductor to adjust the electrical length for optimum results. One trough line is fastened solidly to the shielding pipe while the other is insulated from the pipe with mica sheet, for the necessary filament connection. Using the regular concentric line instead of the trough complicates the manner of adjustment. The line with the closed end is cut to the approximate length and soldered in place with no means of adjustment, while the second line is made a quarter-wave longer. The end of the longer line is at a voltage

node and is left open, allowing the length of the inner conductor to be varied for the filament circuit adjustment, and at the same time it leaves one side of the filament insulated from the shield. The filament connection is made through an r.f.

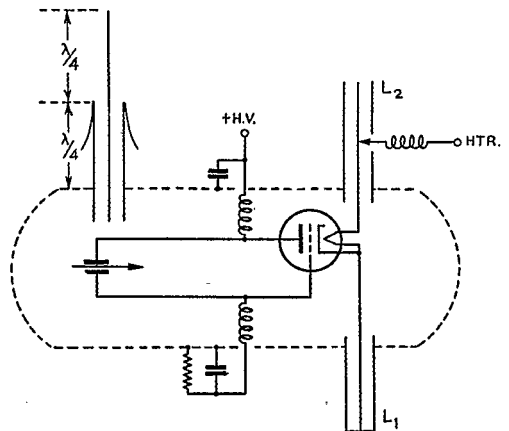
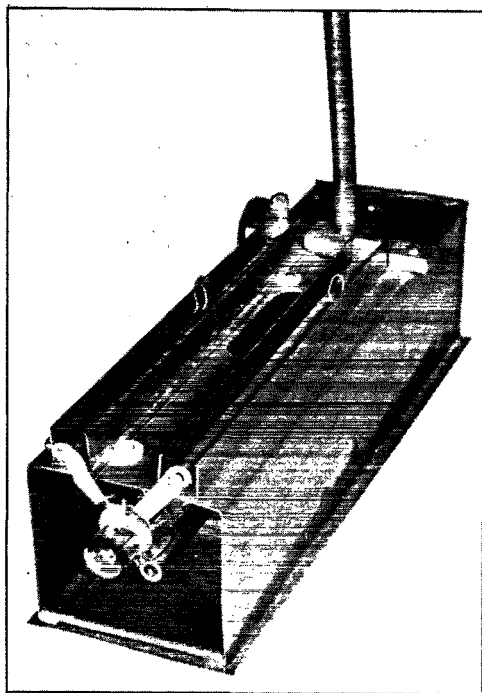

Fig. 1 — Circuit of the shielded parallel-rod micro-wave oscillator. The parallel resonant lines are made of $\frac{3}{8}$ -inch copper tubing, spaced $\frac{1}{4}$ inch between centers; 4 inches long for 750–800 Mc., 10 inches long for 400 Mc. Closed filament line (L_1) for 750 Mc. is slightly longer than one quarter wave, L_2 the length of L_1 plus a quarter wave. The 400-Mc. filament circuit is made from two trough lines $\frac{3}{8}$ -wave long; one line is insulated from the shell by a thin mica sheet.



Trough-type microwave oscillator used by Dr. A. W. Bellamy, W6MYJ, in making the 60-mile tests discussed in the text. This oscillator is of the same general design as the others, except that a rectangular copper box is used for the shell instead of the copper pipe.

choke tapped at the current node on the inner conductor.

The coaxial antenna consists of an ordinary quarter-wave radiator, with a quarter-wave skirt attached to the outer conductor. The skirt in this case is made of sheet copper, bent so that the upper end fits tightly over the outside conductor, while the bottom flares out so that it will have a clearance of one-half to one inch from the coaxial line. Four or more quarter-wave wires or copper-tubing elements may be used in place of the skirt with practically the same results. In coupling the coaxial line to the oscillator, either inductive or capacitive coupling may be used. Although the inductive coupling is the most convenient, as the frequency is raised the capacitive coupling seems to be the more satisfactory.

In the case of the 775-Mc. oscillator there is enough coupling with a copper strip a quarter of an inch wide and three-quarters of an inch long, lying parallel to the plate rod; this strip is connected directly to the coaxial line.

The most frequent mistake in antenna adjustments is the overcoupling of the antenna to the oscillator, and the best method of making this adjustment is through the use of a field strength meter. A crystal detector in the center of a half-wave pick-up antenna, coupled through r.f.

chokes to a 0-1 ma. meter, will serve as a field-strength meter of ample sensitivity. With this type of meter good indications have been obtained at a distance of four or five wavelengths from the transmitter with a few watts input.

The 400-Mc. oscillator operates normally in every way. The radiated output is as good or better than the average $2\frac{1}{2}$ -meter rig with the same power input. In tests over a line-of-sight distance of sixty miles with approximately two watts input to each transceiver, signals were extremely loud. The radiation from the receiver of the second station was plainly audible (representing only about 0.2 watts input). Square-corner beam reflectors were used while making the tests.

It cannot be said that the 750-775-Mc. oscillator operates in normal fashion, since the tube is operating near its critical frequency as a regenerative oscillator. The highest frequency of this particular oscillator is approximately 800 Mc., with a small usable output at frequencies between 750-775 Mc. So far the signal has been heard only three miles. The oscillator will not superregenerate of itself at that frequency, so in order to make a superregenerative receiver of it, it must be modulated with a low-frequency signal.

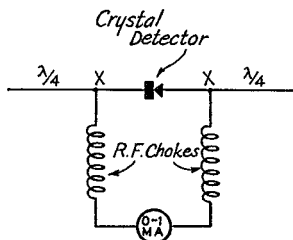

Fig. 2—Simple field-strength meter for checking microwave radiators. This device also serves as a sensitive indicator when making frequency measurements by connecting Lecher wires at X-X.

Splatter

(Continued from page 8)

And for those who wonder just what purpose might lie behind all this emphasis on cryptology, we suggest as a gentle hint an examination of the telegraphic message quoted on page 25.

...—

There will be discussion of a lot of other interesting topics besides cryptography in the July issue, too. The first practical constructional data to be published on a panoramic converter for the average ham receiver, for one example, and the first section of an illuminating two-part article on microwave technique, for a second. Plus another installment of George Grammer's radio course, and a flock of other interesting features. All in all, it promises to be a big issue—big in size as well as quality of content. Don't miss it!

HAPPENINGS OF THE MONTH



WEST GULF ELECTION

IN THE special election ordered in the West Gulf Division, former Director Wayland M. Groves, W5NW, was the only candidate lawfully nominated. There was a petition for Dr. H. W. Gillett, W5ENI, the New Mexico SCM, but it bore an inadequate number of signatures. This left the race to Mr. Groves, who was thereupon declared elected without balloting by his members. His term of office includes the remainder of the present term plus the next full one of two years, thereby running until the end of 1944.

Jennings R. Poston, W5AJ, was similarly the only candidate for alternate director and was similarly elected without balloting for the same term.

"Soupy" Groves is one of the best-known amateurs in the Southwest, having been in the game since 1923 and previously serving as director of the West Gulf from 1935 to 1938. He is an engineer for the Humble Pipe Line Company and has previously been a radio and wire operator and a seismographer. Commercial ship operating and oil-company missions have taken him to many a foreign land. By odd coincidence, "Pronto" Poston is also a Humble man, being telegraph operator and gauger at the Groesbeck main line pump station.

BOARD MEETING

THE ARRL Board of Directors was in all-day session for its annual meeting in Hartford on May 8th, with every division represented. This, the first wartime meeting, had a different and more serious atmosphere, evidenced in the first place by several uniforms amongst the attending officials. The date was too late in the month to get the minutes in this month's *QST*, but we can give you a few highlights and the minutes themselves will follow next month.

The Board of course made a careful examination of the effects of the war upon amateur radio. The directors found the League excellently prepared to weather the storm. They were one in feeling that the League must carry on, both to coordinate the amateur contribution to the war effort and to look after our interests as amateurs.

President George W. Bailey was reelected by unanimous acclamation, being the only candidate. Vice-President Charles E. Blalack was also reelected. David H. Houghton was appointed the permanent treasurer of the League. Leave of absence was granted the communications manager, Major F. E. Handy; and John Huntoon, W1LVQ, was appointed acting communications manager.

Reports were heard from every division and from the Finance Committee, and the officers supplemented their recent written reports with up-to-the-minute oral reports. A careful examination was made of all factors influencing the position of the League and amateur radio, and present activities — particularly those in support of the war effort — were carefully scrutinized. The Board renewed the pledges heretofore given of wholehearted cooperation with the communication policy of the government, tendered the services of the League's official station, W1AW, and expressed the hope that the reactivation of that station could be found consistent with the war effort. The grant of extraordinary funds and powers to President Bailey for the protection of amateur rights was reaffirmed. The present members of the Finance Committee, under the chairmanship of Mr. Reid, were continued in office and arrangements made for the Board to maintain continuing contact with the financial affairs of the League.

There was considerable discussion of whether it would be possible to continue, in the normal manner, the elections of directors and alternates, and of SCMs, and the holding of Board meetings. There was some feeling that so many of the fellows are away from home that the spirit of these provisions in our system of government cannot be carried out during the war. But the opinion prevailed that it would be better to continue all of these elections in the usual manner and that the Board should continue its meetings as usual, at least as far as can be judged at this time.

The League-membership requirement of affiliated clubs was amended so as not to require the canceling of affiliation if drop in membership is attributable to the war. The arrangements for permitting the attendance of SCMs and QSL Managers at conventions were continued, as were provisions for taking care of the administrative expenses of directors in the coming year.

Studies were ordered of the desirability of increasing the newsstand price of *QST* so as to make League membership more attractive; and of the feasibility of preparing, for the interest of members, a facsimile reproduction of the first issue of *QST*.

The Board did not consider it possible at such a time as this to examine what changes in regulations it would like to ask of FCC after the war is over. The first job is to win the war. A proposal to go on record now in favor of moving the 20-meter 'phone band to the low-frequency end was defeated.

The rules governing eligibility to the Board of Directors were repaired to exclude radio advertising agents and to make eligible persons who only incidentally engage in radio service work.

In times like this, the plans of civilians perhaps are not worth too much. Yet the feeling in our Board is that the League is succeeding in performing some very helpful aids to the war effort and that we must carry on with all we have — for the sake of that, for our future, and so that *QST* may continue to come to us every month. There was no speck of doubt about that.

We'll give you the actual minutes next month.

CIVILIAN DEFENSE PLANS

It is unbelievable that another month has rolled around without action on OCD's request for regulations permitting the employment of amateurs and their gear as the nucleus of the secondary communications system for community civilian defense — yet that is the sad fact. That drafting job is taking a whale of a time. Our information is that all agencies concerned in the plan are in favor of it and that it is just a case of the length of time it takes to bring the job to fruition, with all of the overload of pressing war-time matters. We possess our own souls of what patience we can and recommend that you do the same. We find no reason to suspect that we are being given the runaround and we continue to believe that the OCD plan will pop out any day now. One trusts that it will be in time.

The elaborate organizations for air-raid relief are equally capable of serving the community in time of natural disaster. There is some reason to suspect that the OCD communications plan will provide for radio operation when the wires go out in nature's disasters as well as those that may be created by the enemy. That would be logical. It would also be a good thing, since there is no other provision for the use of amateur facilities in time of flood, storm and earthquake. This vast country is fortunate that it has successfully gone so long without any of the large-scale visitations for which only we have been able in the past to supply the emergency communication facilities.

REMINDERS

WE JOG your memories on five matters frequently treated in recent issues of *QST*:

If you are available for a wartime job in radio, file immediately with ARRL the information requested in the registration form that appeared on page 27 of the December issue, or write us for a form.

If you are in the military service in communications work, please report the fact for the ARRL roster. See page 34, November *QST*.

If you're willing to sell your manufactured transmitters and receivers, register the data with us after the style of the form on page 17, April *QST*.

If you'll sell, give or rent apparatus to training

schools in your vicinity, follow the suggestions of page 27, May *QST*.

Any interested person is eligible to League membership but voting membership is confined to licensed amateurs residing in ARRL divisions. When joining the League or renewing membership, please show whether you have an amateur station or operator license, to permit properly classifying you.

WHAT TO DO

WHAT should an amateur do if, listening in, he hears fishy radio signals that seem to be of an enemy-agent or subversive origin and which he believes the government should know about? He should communicate at once with the nearest monitoring station of FCC, giving data that will enable FCC to spot the transmission: frequency, characteristics, time, etc. Such possible fishy stuff definitely includes u.h.f. along the coast. Note that this is FCC's pigeon, not FBI's.

What should an amateur do if he is approached with a proposal for the improper operation of his apparatus or for the acquisition of his apparatus under circumstances that excite suspicion? He should keep the proposer dangling and take the matter up at once with the nearest office of FBI. Note that this is FBI's concern, not FCC's.

BROADCAST OPERATOR REGS RELAXED

BECAUSE wartime needs have produced a shortage of operators for broadcast stations, FCC has made a further relaxation of operator requirements. Holders of restricted radiotelegraph or radiotelephone operator permits (the so-called third-class certificates) are now added to the authorized classes, provided, however, that they are first examined for proficiency in radiotelephone theory and secure endorsement of that fact on the permit.

This may be done through special examination at an FCC field office, the examination containing questions on 'phone theory similar to those in the Class A amateur exam. Necessary endorsement of the permit may also be secured by a Class A amateur if he submits both the restricted radiotelephone permit and his Class A license to a field office of the Commission. Moreover, a person having one of these licenses may qualify by satisfactorily completing examination for the other — and it is a well-known fact that any Class A amateur can pass the examination for a third-class certificate in five minutes.

The above supplements what was said on page 28 of May *QST* and will be of large interest to amateurs who would like to enter broadcast work.

 **Strays** 

Harry Star, WIMWO, works Ben Moon, WIINU.

Optical Fundamentals for Amateurs

Things You Need to Know for Light-Beam Communication

BY R. B. BOURNE,* WIANA

WITH increasing interest in communication by means of light beams it seems desirable that some of the fundamental principles which govern the behavior of light should be presented, so that those of the gang who are going ahead will not have to dig out the necessary facts for themselves. Although the subject of optics is one of great complexity, the prime purpose of this article is to treat simple systems and to forget all about the refinements — practically all of which, fortunately, are unnecessary encumbrances for the purposes at hand.

Any practical system of light-beam communication will of necessity use lenses or concave mirrors, unless distances of only a few feet are

* 27 Sulgrave Rd., West Hartford, Conn.

If you're going in for light-beam communication, you'll have to acquire a few facts about the behavior of lens systems. Here is a simplified explanation of the way lenses work, written especially with applications to light-beam signalling in mind.

contemplated. Lenses have the power to concentrate light on a small target. The familiar burning glass collects light rays from the sun over an area represented by the surface of the lens, and concentrates the energy in a relatively small spot at a certain distance behind the lens.

In this case, the distance from the center of the lens to the smallest spot obtainable is called the "focal length" of the lens. Fig. 1 indicates such a system.

Now that we have a simple optical system familiar to everyone, let's see what goes on in a little detail. It is of course apparent that the light waves which strike the edge of the lens are bent in some manner so that they converge toward the focus. Fig. 2 shows a bundle of parallel light rays or pencils travelling in a relatively rarefied medium (air) and striking, at an angle, a relatively dense medium (glass). The wave fronts, which are at right angles to the direction of propagation, are crowded together in the dense medium because the velocity of light in glass is less than it is in air. In going from a rare into a dense medium the light is always bent toward the normal. Conversely, light in going from glass into air is bent away from the normal. The angle the incident light makes with the normal is called the angle of incidence (i in Fig. 2) while the angle the bent or refracted light makes with the normal is called the angle of refraction (r). The ratio of the sines of these angles

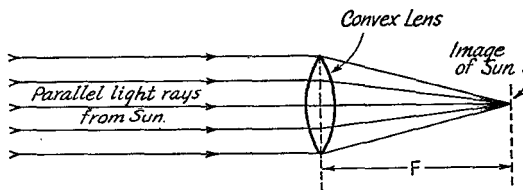

FIG. 1

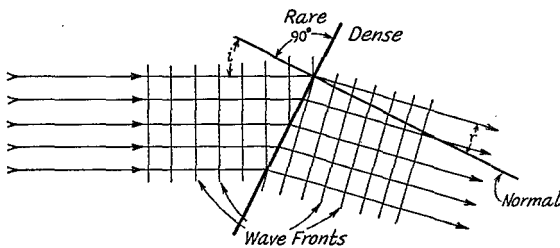

FIG. 2

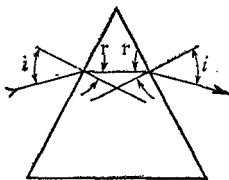

FIG. 3

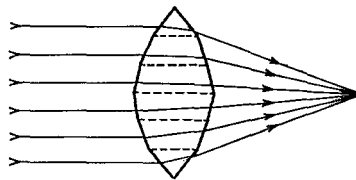

FIG. 4

is called the index of refraction for the substance, with respect to a vacuum or, approximately, air. This term, which is generally design-

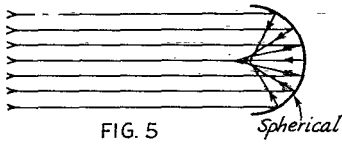

FIG. 5

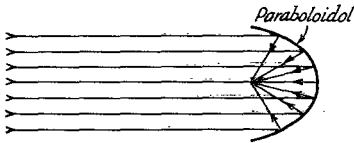

FIG. 6

nated by the symbol μ , represents one of the most important properties of materials used in optics. μ is also equal to the ratio of the velocities in the two media. Thus, $\mu = V_{\text{rare}} / V_{\text{dense}}$. Fig. 3 shows the path of a light ray through a prism. If a convex lens is thought of as a number of sections of straight-sided prisms of increasing angle, as indicated in Fig. 4, it is easy to see how a lens can focus light to a small spot or point.

Unfortunately, a simple lens does not focus parallel light at the same point for different parts of the lens. If we make the focal length sufficiently great with respect to the diameter of the lens, this effect (*spherical aberration*) will be reduced to a point where it is not serious. Another undesirable defect in simple lenses is production of colored fringes on images because different colors (that is, light of differing wave lengths) are bent to a different degree as they pass through a lens. This *chromatic aberration* is likewise reduced by using lenses of long focal length with respect to the diameter. Other defects in simple lenses need not greatly concern us here. However, if the experimenter has a long focal length camera lens or an achromatic telescope objective, either is much to be preferred to simple lenses of the reading glass or eye-glass type, since the aberrations are minimized in the more complex lenses.

Mirrors may be used in place of lenses for some applications. A mirror has one great advantage in that no chromatic aberration is present, since the light does not pass through the mirror. Mirrors with spherical surfaces do produce spherical aberration, however, and the cure is to use long focal length mirrors, or mirrors having paraboloidal surfaces. Such mirrors are illustrated in Figs. 5 and 6. Another great advantage possessed by mirrors is that they may be made very "fast," that is, possess tremendous light-gathering ability, especially when the receiving end of a communication system uses a photoelectric cell and sharp focus is not important. An automobile headlight reflector is admirably adapted to such a use, but would not be sufficiently accurate for

use as a beam transmitter where it is desirable to concentrate the available light in as narrow a beam as possible.

To return to the simple lens having a focal length f , such a converging or "positive" lens is capable of forming images of objects, and the distances between lens and object and between image and lens bear a definite relation to the focal length. To illustrate this, refer to Fig. 7, which shows a double convex (so called because both faces of the lens are convex) lens L , an object P at a distance p from the lens, and an image Q at a distance q on the other side of the lens. The focal length of the lens is the distance f on either side. The relation between the so-called *conjugate distances* p and q to the focal length f of the lens is given by

$$1/p + 1/q = 1/f$$

Suppose, for example, we have a lens of 4-inch focal length. If we place an object, P , at a distance of 6 inches in front of the lens and solve the equation for q , we find that an image of P is formed at Q , 12 inches behind the lens. Furthermore, the size of object is to the size of the image as the distance of the object from the lens is to the distance of the image from the lens. In the present example, if P is 2 inches in diameter, say, Q will be $12/6 \times 2$ or 4 inches in diameter. It should be apparent by now that the lens will work both ways, we can make Q the object and obtain an image at P . If we make $p = f$, q becomes infinite; in other words, we can get parallel rays of light from a point source placed at the principal focus of a lens. This is the reciprocal of the idea of the burning glass illustration given earlier. Generally speaking, all optical systems are reversible.

The experimenter with a reading glass and a flashlight bulb can perform a few simple experiments which will teach him these fundamentals in a very convincing way. Using the lighted bulb as the object, hold a piece of white paper at the right distance behind the lens and you will get an image of the filament. By juggling the

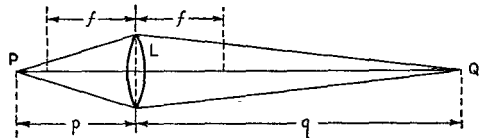

FIG. 7

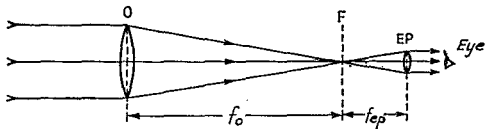

FIG. 8

three distances, f , p , and q , you can get an image of any size you like. In a view camera, the image of the landscape is focused on the ground glass

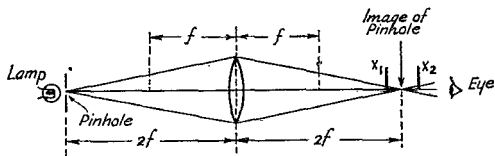

FIG. 9



FIG. 10

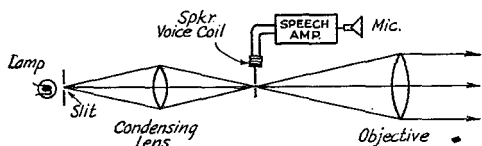

FIG. 11

plate in the camera. The image would be there even if you removed the ground glass. To prove this, we could examine the image with a pocket magnifier and thus have a telescope! Which brings us pretty close to communication by light beams.

A simple telescope is shown in Fig. 8, with the telescope tube omitted for simplicity. The objective lens O , in this case focused on infinity, produces an image at its principal focus F at a distance f_o from the lens. If we had a piece of paper or ground glass at this point we would see a real image of the distant object. An eyepiece EP having a focal length f_{EP} is placed beyond the focal plane F at a distance equal to f_{EP} . Remembering what has gone before, it is obvious that the light from a distant source will emerge from the eyepiece in substantially parallel rays. If we put the eye up to the eyepiece we will see a magnified view of the image made by the objective at F . The eyepiece is simply a microscope or magnifier used to view the real image at F . The total magnification of the telescope is given by

$$\text{Mag.} = f_o / f_{EP}$$

Thus, an objective of 10-inch focal length and an eyepiece of $\frac{1}{2}$ -inch focal length gives a magnification of 20. The distant object will appear bottom side up as viewed with this simple telescope. This is the case with all astronomical telescopes. As a matter of fact, it is surprising how quickly the observer

learns to use an inverted image. The image may be inverted again if desired by the use of an inverting eyepiece, commonly called a terrestrial eyepiece. Such an eyepiece consists ordinarily of four simple convex lenses, the first pair taking the diverging rays from the principal focus F and forming a new image which is then viewed with the second pair. Eyepieces usually have two simple lenses instead of one because such combinations may be made to give a wider field of view and to suffer less from chromatic aberration than do single lenses.

Having our simple telescope, and remembering that light will pass through it in either direction, we may use the telescope to produce a very narrow beam of light if we place a source of light at the principal focus. See *May QST* for details of this rig.¹

Let's now apply some of the foregoing dope to the problem of mechanically modulating a light beam. We will set up a simple lens having a focal length f as shown in Fig. 9. At distance of $2f$ we place a piece of black paper having a pinhole which is illuminated by a small bulb, as shown. The pinhole then becomes a very small source of light. Since it is positioned at a distance of $2f$ from the lens, the image of the pinhole will be formed at a distance of $2f$ on the other side of the lens. If we look toward the lens from the right in the drawing, and if the eye is placed so that the image of the pinhole falls on the pupil of the eye, then the lens appears full of light, since light emanating from the pinhole enters the eye no matter what part of the lens it may have traversed. Take a black card and bring it in from the right while looking at the lens, the card being a little inside of focus (toward the lens) as at X_1 . The shadow of the card will appear to come in from the right and the lens will appear as at A, Fig. 10. Now repeat the experiment, but this time with the card just outside of focus (nearer the eye) as at X_2 . Even though the card is still brought into the beam from the right, it will appear to come in from the left, as shown at B, Fig. 10. The closer to focus the card is placed, the less distinct will be the edge of the shadow. When the card is placed exactly at the focus, the shadow does not appear to come in from any particular direction; as the card is advanced, the illuminated disc of the lens simply gets dimmer. When the light is about half extinguished, a very startling thing happens. The imperfections of the lens all stand out like hills and dales and the surface of the lens appears to

(Continued on page 84)

¹ Experimenter's Section, *QST*, May, 1942.

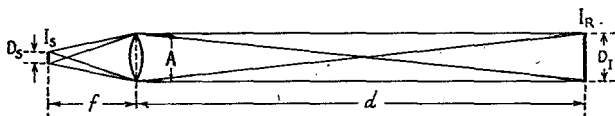

FIG. 12



U.S.A. CALLING!



THE MARINES HAVE LANDED

THE Marine Corps steps forth this month for its first appearance in this column with a plea for applications from qualified radio men to become either officers or NCOs. There are many who would rather serve with the famous Devil Dogs than with any other branch of the service. Here's your opportunity.

Appointments as commissioned officers in the Marine Corps Reserve, for assignment to special aircraft warning duty, are now being offered to men holding a B.S. degree in electrical, communication or radio engineering or electronic physics. Also eligible are those with a B.S. in another engineering subject but some practical radio experience; or those with two years of college engineering and considerable experience; or those who can offer the equivalent in practical experience in u.h.f. design and maintenance. Men appointed as second lieutenants receive annual pay and allowances of \$2196, plus an additional uniform allowance. Commissions in higher ranks may be awarded applicants with exceptional qualifications. Physical defects which normally would be disqualifying may be waived in certain cases. Men with dependents may be commissioned.

After completing a brief indoctrination course in customs of the service, officers selected will attend a three- to six-months' course of instruction on aircraft warning equipment at one of the service schools. They will then be assigned to Marine Corps units to supervise the operation and maintenance of AWS and allied equipment, and will also organize and train AWS personnel and units for both ground and air forces.

Prospective candidates should apply in writing, with particulars on themselves, to The Commandant, Headquarters, U. S. Marine Corps, Washington, D. C.

The Corps also urgently needs enlisted operators, technicians and repairmen.

Appointments in the Marine Corps Reserve with initial rank of staff sergeant have been opened to qualified men between the ages of 17 and 35, with the assurance that they will be assigned to aircraft warning maintenance duty. The pay of staff sergeants ranges from \$72 a month, in addition to food, clothing, shelter and medical care, upward to \$121.50, including allowances. Candidates must be high-school graduates and must hold or have held an amateur Class A or B license or a commercial first or sec-

ond class. Also acceptable is three months' professional experience in radio repair or service work. Men accepted will be transferred at once to a Signal Battalion for assignment to a special course of training in the maintenance of aircraft warning gear. Those not completing the course will be released from the service if they so desire.

Men who meet the requirements except as to being high-school graduates may be enlisted as privates in the regular Marine Corps or Marine Corps Reserve with assurance that they will be assigned to general communication duties. They will be assigned to radio schools at Quantico, Va., or San Diego, upon completion of recruit training. Those who fail to finish the course remain in the Corps for general duty.

During assignments to duty outside the United States all NCOs and enlisted men receive a 20% increase in their base pay.

Interested amateurs should apply to the nearest Marine Corps recruiting officer, or by letter to The Commandant, U. S. Marine Corps, Washington.

COMMISSIONS IN AIR FORCES

THE Army Air Forces, as every American delights in knowing, are engaged in vast expansion. They urgently need a large number of officers, for ground duties of many descriptions. The National Research Council's radio office, under ARRL President Bailey, has been asked to find the needed communication and allied specialists.

Commissions are available for hundreds of men in ranks from second lieutenant to major, depending upon age and experience. Ground duties. Candidates may be married. Read through this list of needs that lie in our field; you'll probably find that you are wanted:

1. Electrical engineers with experience in television or u.h.f.
2. Electrical engineers with experience in radio laboratories or shop maintenance.
3. Executives with knowledge of radio fundamentals and experience in the maintenance and installation of aircraft radio equipment, particularly as to shop management.
4. Persons with radio knowledge and experience in the operation of aircraft and ground radio navigational facilities.
5. Radio engineers with communication experience.
6. Anyone who is experienced in codes and ciphers.

7. Mechanics with experience of code and cipher machines.

8. Anyone with particular skill in the mechanics of mimeograph and photostat machines.

9. Accountants and executives with experience in business administration and the preparation of statistics, with preference given the holders of amateur licenses.

10. Persons with practical experience in the operation and maintenance of commercial wire telephone and telegraph circuits.

The need is very urgent. Write, giving full particulars on yourself, to G. W. Bailey, National Research Council, 2101 Constitution Avenue, N. W., Washington, D. C. Keep 'em flying!

F.C.C. NEEDS ENGINEERS

How would you like to work in the engineering department of the Federal Communications Commission at Washington, dealing with engineering aspects of the administration of radio services other than broadcasting? It's a good start for a career in administrative engineering. FCC needs several radio engineers for employment in Civil Service Classifications P2 and P3, beginning salaries \$2600 and \$3200. The necessary qualifications are set forth in C.S. Announcement No. 173, which you can see at your local post office, but you should write with particulars on yourself direct to E. M. Webster, Assistant Chief Engineer, FCC, Washington.

TRAINEE-REPAIRMAN, SIGNAL CORPS

TO TRAIN civilian personnel for the maintenance and repair of Signal Corps apparatus at U. S. depots, the Signal Corps will give advanced training as radio repairman and telephone repairman for a six months' period *with pay*, to both male and female applicants between the ages of 16 and 50. This is the opportunity originally reported on page 25 of April *QST* as available only until April in New England. The arrangement has now been expanded to cover the country and extended in time.

This is something new — pay while learning. After completion of training at an Army school, trainees are eligible to the position of Junior Repairman, \$1620 a year, with subsequent advancement dependent upon ability. For qualifications and further details, consult April *QST* or see the Civil Service announcement at your post office, or write or visit the nearest Civil Service district manager.

F.B.I. RAISES ANTE

ON page 22 last month we reported the need of the Federal Bureau of Investigation for radio operators and engineers, civilian status, at a beginning salary of \$2000. Just too late to catch the presses, FBI informed us that the beginning figure should read \$2600. Other specifications in the article are correct. Further particulars are

available from the nearest office of FBI or direct from the Bureau at Washington.

DEFERMENT FOR RADIO STUDENTS

THE Signal Corps offers a scheme where-under men enrolled in the radio technician's training course sponsored by the NAB and Office of Education under the ESMDT radio program may enlist in the Signal Enlisted Reserve Corps and thereby be removed from the jurisdiction of the Selective Service, yet not be called to active duty with the Army until they have completed the training course. This will assure radio duty in the Army and qualify one for a noncom appointment when vacancies exist.

Applicants must meet the ordinary Army requirements: 18 to 45 years of age, height between 5 feet and 6 feet 6, weight at least 105 pounds. If married, they must furnish certified statement that their wives are not dependent upon them for support. To permit time for the papers to go through, they must also obtain from their local draft board the Form 190, stating that they will not be inducted for at least one week.

Applicants for this reserve enlistment and deferment should file application with the Officer-in-Charge, Enlisted Reservist Training, Office of the Signal Officer, at any Army Corps Area headquarters — list on page 31 of February *QST*. The Army will then arrange for an interview and give further instructions.

NAVY AVIATION SPECIALISTS

THE training division of the Bureau of Aeronautics of the Navy has openings for men with some college training (physics and electrical engineering preferred) plus a commercial or amateur radio license. Radio training and experience are absolutely necessary. They will be commissioned in ranks from ensign to lieutenant-commander, depending on age and experience. They will first receive special schooling and will then deal with the installation and maintenance of air-borne radio equipment. The men will not fly, but a knowledge of airplanes is in their favor; and, although a pilot's license or flying experience is not necessary, it will help. These officers will be classified as Aviation Volunteer Specialists.

For particulars, apply to George W. Bailey, National Research Council, 2101 Constitution Avenue, N. W., Washington.

NAVY COMMUNICATIONS ENGINEERS

THE Navy has recently announced that persons who have had two years of college training in electrical engineering or physics, plus an amateur license, may apply for reserve commissions as communications or radio engineers. There are three classifications: Aviation Volunteer Specialists, Ordnance V.S. and Engineer V.S. For details, write to Mr. Bailey at the address in the item above.

ELECTRONICS TRAINING GROUP

HERE is the ideal opportunity for young college graduates in E.E. or physics, preferably with amateur radio licenses, to receive an appointment as second lieutenant in the Signal Corps, provided, of course, they are physically fit. The training which they will receive will be interesting, and valuable in future years when the instruments of war are converted to implements of peace. Many hams are already in the Group and giving a good account of themselves. Write to George W. Bailey, National Research Council, 2101 Constitution Avenue, Washington, for full particulars.

CIVILIAN MECHANIC-TECHNICIANS

THE Signal Corps is making a big drive for a large number of civilian radio mechanics required for the maintenance of their tremendous amounts of apparatus. Recruiting missions are traveling around the country, with advance newspaper publicity, and may very well visit your city.

If not, you may obtain the information yourself by seeing Civil Service Announcement No. 134, as amended, at any first- or second-class post office or at the nearest U. S. Employment Service office (where you may also obtain Application Form 8 and Supplementary Form 3785 for mailing to the nearest office of the U. S. Civil Service).

What are needed are radio mechanics with amateur or serviceman background, for work in signal depots. The pay will be \$1440, \$1620, \$1800, \$2000, \$2300 or \$2600 per year, depending upon qualifications, with most appointments in the \$1620-\$2000 range. Training programs are available for applicants in the lower-salary group. Applicants must have successfully completed some sort of formal radio training course, or have had at least a year of full-time paid experience in some branch of technical radio work.

Some of the successful applicants will specialize on transmitters or receivers and some will receive interesting and very special training in the maintenance of radiolocator gear. Some of these courses represent invaluable instruction.

The Signal Corps is also looking for civilian radio engineers through the Civil Service and some of the better-qualified mechanic-technicians may quickly qualify for appointment to these professional grades with salaries of \$2600 to \$3800, and we know that for the exceptionally-qualified there are some jobs open with salaries as high as \$5600. Particulars may be had from Civil Service Announcement No. 173 at your post office.

ADVICE

IF THE notices in "U. S. A. Calling" do not exactly suit your case, and yet you wish to do your part in the war effort, write to G. W. Bailey, National Research Council, 2101 Constitution Avenue, N. W., Washington, and describe your

qualifications. He will be glad to advise you as to where you may best use your talents in the national effort.

ENGINEERING STUDENTS AS OFFICERS

DON'T leave college to enlist! The Signal Corps offers commissions as second lieutenant to junior and senior students majoring in electronic physics or electrical engineering, upon graduation, with deferment from active duty until graduation. Engineering students should not let the draft interrupt schooling. Get deferment, finish up, serve as an officer. Here's the dope:

You will be temporarily enlisted in the Enlisted Section, Electronics Training Group, Signal Corps. Application for such enlistment should be made direct to the Chief Signal Officer of the Army, Washington. It must be accompanied by a statement by your Dean of Engineering that you may reasonably be expected to graduate. If your college has an ROTC unit, you should have a statement from its Provost Marshal to the effect that you are officer-candidate material. (If no ROTC, a Signal Officer will interview prospects.) When accepted, you are allowed to complete your schooling and, upon graduation, are appointed a second lieutenant. Your Dean of Engineering has further particulars.

COLLEGE WOMEN

CIVILIAN appointments as junior physicists and junior engineers at \$2000 a year are available right now in the Bureau of Ships at Washington, and some in the Naval Research Laboratory. For college women who hold amateur licenses, appointments are immediately available in radiolocator work, in research laboratories, or in the development and installation of communication facilities. The appointments are available now only in the Navy, but the Signal Corps will probably soon offer similar opportunities. Send your qualifications to G. W. Bailey, National Research Council, 2101 Constitution Avenue, Washington.

WOMEN WITH AMATEUR LICENSES

YLs or XYLs, with an amateur license, but without a college education, may obtain civilian appointments in the Bureau of Ships at Washington right away, working on radio communication facilities at \$1620 a year. Here is a good opportunity for girls who are studying radio to get into this war effort. Just as soon as you get your amateur ticket, you are eligible for one of those jobs. Send your qualifications to G. W. Bailey, National Research Council, 2101 Constitution Avenue, Washington.

CIVILIAN APPOINTMENTS

THERE are many opportunities for appointments in civilian capacity in the Army and Navy. College men are preferred for these posi-

tions, particularly those who have studied the physical sciences and who hold an amateur or commercial license. However, there is a chance for a man who does not hold a college degree but who has had considerable practical experience in radio and holds a license. If you are doubtful about your qualifications, send them to G. W. Bailey, National Academy of Sciences, 2101 Constitution Avenue, N. W., Washington, stating if you have a preference for the Bureau of Ships of the Navy or the Army Signal Corps. He will be glad to advise you.

SIGNAL CORPS ENLISTMENTS

If you hold an amateur radio license but have not had a college education, and yet would like to try for a commission, there is a chance for you. Go to the nearest Army recruiting office and show your amateur license to the recruiting officer and tell him you wish to enlist in the Signal Corps. In some cases these officers have not been fully informed as to the directive on this subject and have declined to act. In such a case a telegram to G. W. Bailey, National Research Council, 2101 Constitution Avenue, N. W., Washington, will help to have the situation corrected. Upon enlistment in the Signal Corps you may be sent to the nearest Signal School, and after some weeks of training you may have a chance to attend Officers Candidate School and obtain a commission as second lieutenant.

AIR TRANSPORT COMMAND

A NEWLY-FORMED branch of the Army Air Forces is calling for fifty amateurs for work that may be intensely interesting to some of you who are not qualified for other openings. The Air Transport Command will make second lieutenants of radio amateurs who are willing to serve outside of continental United States and who are also willing to go into the air. This information comes just as we are going to press, so we do not have complete details other than that a college degree is not required, applicants may be of draft age, and the work is communications. Applicants must have had amateur experience and, of course, be physically fit. Make application through George W. Bailey, National Research Council, 2101 Constitution Avenue, N. W., Washington, D. C.

RENEW YOUR LICENSE

As a result of many interviews in Washington with candidates for appointments in the armed forces, ARRL President G. W. Bailey has found that a number of radio amateurs have allowed their licenses to lapse. Some did not know that it was no longer necessary to show proof of use in order to get a renewal. Many of these amateurs have found, to their chagrin, that failure to hold an active amateur license has meant the difference between receiving an appointment and

being turned down. To men who enlist, the possession of a license means a definite advancement in rating at the start. So renew your license; you never can tell when it may be very useful.

(Stay-at-homes ditto: FCC will probably soon require unlicensed radio gear to be registered, and you'll save yourself the trouble if you keep your station ticket alive.)

AIR FORCES CRYPTANALYSTS

JUST at closing time we have the following self-explanatory telegram from the Army Air Forces, with the request that we get it into *QST*: ARMY AIR FORCES HAVE URGENT NEED FOR CRYPTANALYSTS WITH RADIO KNOWLEDGE. THERE IS A GOOD POSSIBILITY OF THE APPOINTMENT AS COMMISSIONED OFFICERS OF SOME AMATEURS WHO HAVE MADE A HOBBY OF CRYPTANALYSIS AND WHO POSSESS A GOOD GENERAL EDUCATION. PLEASE HAVE THOSE INTERESTED IN FULL INFORMATION WRITE, WITH SOME PARTICULARS ON THEMSELVES, TO THE DIRECTOR OF COMMUNICATION, HEADQUARTERS, ARMY AIR FORCES, WASHINGTON, D. C.



THOMAS A. EDISON has discovered *QST*, and in a letter reproduced on the inside cover of the June, 1917, issue he says, "It seems to me that a magazine so ably conducted ought to accomplish much for the advancement of the art in general, and I wish for *QST* a successful future."

This is a small issue, down to 36 pages, but immensely interesting. A. L. Groves' correspondence, resulting from his first article, leads to the contribution of a humdinger of a 7-page article on "Long & Short Wave Audion Sets," in which the maestro gives invaluable practical dope on how to do it, chiefly with the aid of long cardboard tubes wound full of s.s.c. wire. In an article written by special request, Stuart Ballantine leads off the issue with "Lightning Phenomena," with data on the significance of these enormous forces of nature. "The Old Man," in an article simply entitled "Rotten!!" splutters all over the place about this "rottenest of all rottenest," the closing of amateur stations.

The first three pages of the correspondence section this month are given over to a letter of enormous length from 9JT-9FW in Cairo, Illinois. His name is K. B. Warner. If he knew what he was talking about it would make a good article. As it is, the perplexed editor runs it under the heading "QST!—Who Can Answer These Questions?" The writer wants to know whether altitude above sea-level affects the range of a sta-

(Continued on page 74)

A Course in Radio Fundamentals

Lessons in Basic Theory for the Amateur

BY GEORGE GRAMMER,* W1DF

No. 1—Electricity and Magnetism

THE average amateur of normal times is a fellow who has acquired — usually to a pretty high, and often to a superlative, degree — the ability to get results from equipment far beyond what might reasonably be expected, and who, in the process of developing that skill, has also built up for himself a fairly good-sized fund of technical knowledge. That skill and knowledge account for the fact that the amateur is so much in demand to-day — in the military services, in industry, in the laboratories. But since the actual knowledge so acquired was pointed to certain very definite ends — which is, after all, natural enough, because amateur radio is fundamentally a hobby of radio communication — there has frequently been a tendency to skip or forget some of the things which underlie the practice. The very fact that the amateur is being sought out for this and that kind of job is responsible for the feeling, now in evidence, that something ought to be done about filling those gaps in “theory.” That feeling has led to a large number of suggestions from amateurs that a “brush-up” course in *QST* would be a mighty good thing, and it is in response to these suggestions that the present course is being started.

That, and another reason. We have had plenty of calls for help from hams who are undertaking to instruct classes in radio fundamentals — and, too, from people in the teaching profession who find themselves faced with the necessity for instructing radio classes without having had any previous experience in the field. We therefore have a double-barrelled purpose: To outline a course of study for the amateur who wants to put his technical knowledge on a sounder basis, and also to provide classroom experiments and demonstrations as well as quiz questions and problems for the use of those teaching elementary radio classes.

To avoid needless repetition in *QST*, the course will be based on the 1942 *Handbook* as a text. Either the Regular or Defense editions may be used, since we’re confining ourselves to principles. (The chapter on formulas and graphs in the latter edition may be helpful to those who’ve forgotten the simple algebra they’ll need for solving problems.) The general plan will be to assign a

* Technical Editor, *QST*.

certain section of the *Handbook* for study, supplementing it with additional information in *QST* whenever desirable (the *Handbook* is necessarily condensed), then providing a list of questions to be answered after the assigned portion has been thoroughly digested. In addition, since we’re firm believers in the idea that the best way to learn about something is to make it happen, a series of experiments will be prescribed — experiments designed to demonstrate the principles being studied, insofar as that is possible with equipment which it might reasonably be expected that the average amateur can make or borrow.

Most of the equipment needed in the experimental series can easily be made from odds and ends to be found around amateur stations. The series has been planned to minimize the amount of gear needed, by coördinating experiments so that certain pieces of apparatus can be used in as many different experiments as possible. In most experimental work the first requisite is a means for measurement, so that meters of various description naturally are essential. In this respect our series will be no exception, and there is going to be a need for a.c. and d.c. milliammeters and voltmeters of various ranges — a need best met by the multi-range volt-ohm-milliammeter which has acquired such popularity during the past several years. Many amateurs have them already, and those that don’t probably will be able to borrow, buy or swap from some neighboring ham who does. It doesn’t appear likely that they can be bought over the counter, in view of the shortage of instruments. Lacking a built-up instrument, it may be possible to make one at home with a 0-1 milliammeter as a basis; constructional information is to be found in the *Handbook*. But aside from such a measuring instrument, most of the parts needed can be taken from the junk box or borrowed temporarily from the now-silent transmitter.

Now for a few final suggestions regarding a plan of study. Don’t try to move too rapidly. Write down your answers to questions; it’s surprising how many people “know what’s meant but can’t express it.” If you can’t express it you don’t really know it. If you can explain a point to someone else and make him understand it you can feel sure you really know it yourself. (This is

helpful, by the way, if you have the opportunity to do it; you'll be surprised to find how hazy you are on some points when you try to make another understand them. Finding it out may come as a shock, but it will have a salutary effect if it inspires you to do some further digging.) Be sure of your ability to answer questions on one assignment before going on to the next, and be sure to complete the experiments associated with that assignment. Answers to questions and problems propounded each month will be given in the subsequent issue of *QST*, except in those cases where the answer is to be found in the *Handbook* or the accompanying *QST* material.

Keep a notebook in which to record the observations made in the experiments. Make your observations as complete and detailed as possible and include an explanation of what is observed, even though it may seem a superfluous repetition of what is said in the description of the experiment in *QST*. Such written notes will go a long way toward fixing the phenomena and the reasons for them in your mind, although at first the whole procedure may seem slightly silly. If you observe anything not covered by the description of the experiment, or try some variations not touched upon in the description, by all means record them and attempt to formulate an explanation — also written. If the subject matter under study suggests some experimental possibilities with the equipment which have not been suggested in the series, try them out — with notes. Or if you have available some additional equipment which is usable for the purpose, and permits extending your experimental range, put it to work. The more experiments you perform — and interpret properly — the better will be your knowledge of the subject.

And now to work.

ASSIGNMENT 1

Study Sections 2-2 and 2-3 (pages 21 and 22). Perform Experiments Nos. 1, 2 and 3.

Questions

- 1) What is meant by the electrostatic field, and how is its strength described?
- 2) Define capacity.
- 3) From Sec. 2-3 and the remarks under Experiments 2 and 3, in what way would you expect the following factors to affect the capacity of a condenser? Give the reason in each case:
 - a) area of plates;
 - b) separation between plates;
 - c) dielectric material between plates;
 - d) number of plates, when the condenser consists of a set of interleaved plates with alternate ones connected together.
- 4) What is meant by the resistance of a conductor?
- 5) What is the nature of the force between two electrostatic charges if
 - a) both are positive;
 - b) one is positive and one is negative;
 - c) both are negative.
- 6) What is the meaning of potential difference?
- 7) Name five conductors and five insulators.
- 8) What is the fundamental unit of electricity?

9) What is the nature of positive and negative electric charges?

10) Name the units for each of the following, giving a suitable definition in each case:

- a) difference of potential;
- b) quantity of electricity;
- c) capacity;
- d) electromotive force.

11) Explain (a) how an insulated conductor can be charged by contact with a charged body; (b) how such a conductor can be charged by induction.

12) Is capacity necessarily associated only with a condenser?

ASSIGNMENT 2

Study Section 2-4 (page 23).

Questions

- 1) What is meant by an electric current?
- 2) How does conduction take place in metals?
- 3) Describe briefly the fundamental difference between the two general types of batteries as exemplified by the dry cell and the lead storage battery. One type is called a primary battery or cell and the other a secondary battery or cell. Which term do you believe should be applied to which type?
- 4) What is meant by ionization?
- 5) Name four types of electrical conduction.
- 6) How can current flow be established in a vacuum?
- 7) What is the convention with respect to direction of current flow?
- 8) In a metal the flow of current is proportional to the applied electromotive force, since there is an unlimited supply of electrons available to form the current. Is this same proportionality true of current flowing in a gas? Would you expect it to be true in a vacuum, when the current is formed of electrons emitted by a hot cathode?
- 9) What is the unit of electric current?

ASSIGNMENT 3

Study Section 2-5 (page 24) and perform Experiments Nos. 4, 5 and 6.

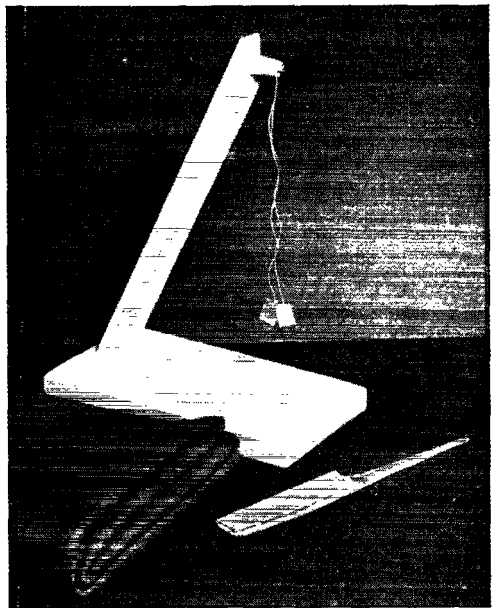

Fig. 1

Questions

- 1) Describe self-induction.
- 2) The laws of forces existing between magnetic poles are similar to those governing forces between electrostatically-charged bodies. What, then, will be the nature of the force between:
 - a) a north pole and south pole;
 - b) two north poles;
 - c) two south poles.
- 3) Calculate, from the diameter of each coil and the length of wire, the approximate number of turns on each winding of the electromagnet used in Exp. 4. Using first one battery and then the two in series, measure the corresponding currents through Coil 1 alone, Coil 2 alone, and Coils 1 and 2 connected in series as described in the experiment. Calculate the ampere turns for each of the six cases. Which of the six should show the strongest magnetic effect? Check experimentally.
- 4) Using the equipment of Exp. 4, connect the two coils in series as described in the experiment and apply the 3 volts from the battery. Observe the magnetizing effect by the attraction for a piece of soft iron. Disconnect the two coils and connect the two "starting" ends of the windings together, applying the battery to the other two ends. How does the magnetizing effect now compare with the original strength? Explain why there is a difference.
- 5) Under what conditions can a voltage be induced in a conductor?
- 6) Is inductance necessarily associated only with wire wound in a coil?
- 7) How is the intensity of a magnetic field described?
- 8) Name the various units of inductance, and describe their relationship.
- 9) What is meant by the term permeability?
- 10) What factors determine the inductance of a coil?
- 11) What is the direction of flow of an induced current compared to the direction of flow of the current causing the induction?
- 12) When the current through a coil is broken, is the induced voltage larger or smaller than the voltage induced when the current is started? Why?
- 13) How is an unmagnetized piece of iron attracted by a magnet?
- 14) Upon what factors does the strength of the magnetic field set up about an electromagnet depend?

EXPERIMENT I

Electrostatic Induction

Apparatus: This experiment requires only very simple equipment: a few bits of metal foil, a little thread (preferably silk, which is a better insulator than cotton), a celluloid comb, and a piece of felt on which to rub the comb to work up an electrical charge by friction. Many materials can be substituted for the celluloid and felt; hard rubber (a fountain pen or comb) or glass rods will do very well in place of the celluloid, for instance, and wool cloth in place of the felt.

It is convenient to have a simple mounting for the suspended pieces of foil, as shown in Fig. 1. (The same mounting can be used for the subsequent experiment.) A wooden base about 4 × 8 inches will be adequate. The support is a piece of 1 × 1 wood fastened to the base at an angle of about 60 degrees. A stand-off insulator is mounted horizontally at the top of the support, and the threads holding the foil pieces are held under the top screw of the insulator. The insulation should be as good as possible, since even a little leakage will greatly affect the way in which the apparatus responds in the experiment. The insulator should be kept clean and dry, as should also the threads and the wooden support. In humid weather it may be almost impossible to build up a sufficient charge or to retain it for any length of time.

The foil pieces should be about $\frac{1}{2}$ × $\frac{1}{4}$ inch in size, and should be quite thin. The lighter the weight the better, so aluminum foil is to be preferred to tin or lead foil. Although thin aluminum foil is still to be found on some kinds of candy, probably the best source is an old tubular paper by-pass condenser (a blown-out unit will provide plenty of foil). Cut two pieces to size, smooth them out, punch a hole

with a needle at one end, and tie on lengths of thread. A seven-inch length is about right. When mounting the foil pieces, make sure that both hang at the same height.

Procedure: Only one foil piece is required for the first step in the experiment. The other may be hung over the wooden support to keep it out of the way. Rub the comb briskly on the felt and bring it near the suspended foil. As the comb is brought nearer the foil will be attracted and will approach the comb edge on. If it is allowed to touch the comb or to approach near enough for a spark to jump, it will immediately be repelled by the comb, and will continue to be repelled so long as both foil and comb retain their charges.

The explanation for this is as follows: When the comb is rubbed on the felt it acquires electrons from the latter and thus becomes negatively charged. When brought near the foil so that the latter is in the electrostatic field of the comb, free electrons on the foil are repelled by the field and collect on the end of the foil farthest from the comb. The foil turns edge on because the forces acting tend to keep the collection of electrons as far from the comb as possible. The movement of electrons on the foil away from the comb causes the far side of the foil to be negatively charged, and since the foil is insulated and no new electrons can enter it, there is a deficiency of electrons on the edge nearest the comb. Thus the near edge is positively charged, and since this charge is opposite in sign to the charge on the comb the near edge is attracted to the comb. The positively charged end, being nearest the comb, is in a stronger part of the comb's field than the far edge, hence the force of attraction is greater than the force of repulsion. Therefore the foil moves toward the comb.

When the foil touches the comb or comes near enough for a spark to jump, a portion of the charge on the comb is imparted to the foil. That is, some of the excess electrons on the comb flow into the foil so that the latter then has an excess of electrons. It has thus acquired a negative charge and is immediately repelled from the comb since both comb and foil now have the same kind of charge. The charges on both will gradually leak off with time, or they may be discharged intentionally by touching them with a grounded conductor or semi-conductor. A touch with the finger is usually sufficient, since the human body is large enough to accommodate the excess electrons on the charged objects, and has enough conductivity to allow the charge to be dissipated instantly.

Besides the contact method of charging the foil just described, a charge (and generally a stronger one) may also be imparted to the foil purely by induction. Touch the uncharged foil with the end of a piece of stiff wire several inches long held in the hand. Use the wire to hold the foil so that it cannot move when the charged comb is brought near it. Under these conditions the repelled electrons will flow down the wire to the body, leaving a positive charge on the foil. Now take away the wire and as quickly as possible (but after the wire is removed) move the comb away from the foil so that the latter cannot touch it. Removing the wire leaves the foil with an insulated positive charge, and since the foil is then charged oppositely to the comb, the two will attract each other. Should they touch, the foil will again be charged by contact and repulsion will occur. Thus charging by contact gives a charge of the same sign as the charge on the comb, while charging by induction gives a charge of opposite sign.

In charging by contact the charge imparted depends upon the surface leakage on the comb, and since celluloid is a good insulator only a limited number of electrons can flow into the foil. When charging by induction the field set up by the accumulation of electrons on the comb is used, and electron movement on the comb is not essential. Hence it is frequently possible to impart a stronger charge by induction than by contact under these conditions, particularly when the area of the conductor to be charged is appreciable compared to that of the comb (or other insulator) which has the original charge.

Now let both pieces of foil hang freely and bring the charged comb in the vicinity. Observe the sequence of happenings. Explain.

Give both pieces of foil the same kind of charge so they repel each other. Write an explanation for what is observed to happen.

EXPERIMENT 2

Capacity

Apparatus: The equipment and set-up for this experiment are shown in Fig. 2. The stand used in Exp. 1 supports a 5-or 6-inch length of stiff copper wire (No. 12 or 14) to the lower end of which has been soldered a small piece of very fine bare wire (No. 38 if available) rounded in the form of a hook. Two triangular pieces of thin aluminum foil about $\frac{3}{8}$ inch on a side hang on the hook. The holes through which the hook passes can be punched through the foil with a needle, and should be as close as possible to one apex of the triangle. The two "leaves" should be free to move on the hook without interfering with each other. This forms a simple electro-scope, or instrument for measuring the intensity of a charge.

On a block of wood about 4×6 inches mount a flat metal plate $2\frac{1}{2} \times 3\frac{1}{2}$ inches, using two stand-off insulators as supports. This plate must be well insulated from the wooden base. Attach a length of wire to the plate.

Procedure: First charge the electro-scope as strongly as possible by induction, using the procedure outlined in Exp. 1. The best charge can be obtained by holding the charged comb close to and lengthwise with the wire support so that the wire is in the strongest possible field. On removing the grounding wire and comb, the two leaves should spring apart. Since the tops of the leaves are not free to move very far, the leaves will take the position of an inverted V; with a good charge the angle of the V should be about 90 degrees.

Now take the wire from the insulated plate and, handling it with an insulated rod (the comb will serve), touch it on the wire support for the leaves. The leaves will drop toward each other, but will not completely lose their charge. Now remove the wire and the leaves will not change their position. The wire from the plate may be touched on the electro-scope again but the position of the leaves will not change. With the wire off, discharge the electro-scope with the finger, then touch the wire from the plate to the wire support again. The leaves will once more repel each other, but to a lesser extent than in either of the previous two cases.

In the first case a certain quantity of electricity is placed on the electro-scope, the intensity or potential being indicated by the extent to which the leaves repel each other. On connecting the plate to the electro-scope some of the charge flows into the plate, distributing itself over the surface of the plate as well as over the surface of the electro-scope. Although the total quantity of electricity involved remains the same, the intensity or potential is lowered, as indicated by lesser repulsion between the electro-scope leaves, because it is now spread over a larger area. The quantity of electricity distributes itself so that the whole system has the same potential (or voltage), so that reconnecting the plate wire after once removing it causes no further redistribution of charge; both the electro-scope and the plate are then at the same potential and hence current will not flow from either one to the other.

With the wire removed and the electro-scope discharged, the plate is left with its acquired charge. On connecting the wire once more, some of the electricity on the plate flows back into the electro-scope, recharging it — but this time at a lower potential because there is less electricity available

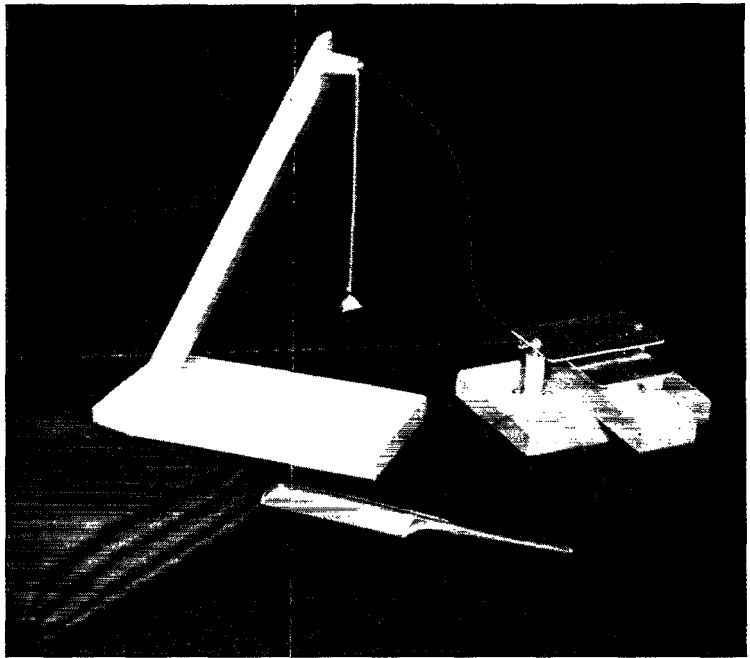

Fig. 2

than formerly, that part which was drained off the electro-scope by discharging it now having disappeared.

The conclusion to be drawn from this experiment is that the system with the larger surface — i.e., the electro-scope and plate connected together as compared to the electro-scope alone — will have a lower potential, for a given quantity of electricity, than that with the smaller surface — i.e., the electro-scope alone. The ratio of quantity to potential is called the capacity of the system; that is,

$$C = \frac{Q}{E}$$

where C is capacity, Q quantity and E potential. In practical units C is expressed in farads, Q in coulombs, and E in volts. A given quantity of electricity on a high-capacity conductor will give a smaller potential than the same quantity on a low-capacity conductor. Or if two conductors of different capacities are charged to the same potential, the one with the higher capacity will take the larger quantity of electricity. Under these conditions the quantity of the charge, or amount of electricity stored, will be directly proportional to the capacity of the conductor.

As a variation, the insulated metal plate alone may be charged and then connected to the electro-scope. The leaves will spring apart, the extent of the repulsion being an indication of the potential of the plate.

EXPERIMENT 3

Condensers

Apparatus: The same equipment is needed as in Exp. 2, with the addition of a 2×3 inch metal plate mounted flat on one end of a piece of wood 2 inches wide and 5 or 6 inches long. Add a wooden shim, if necessary, so that when the second plate is slid under the first, as shown in Fig. 2, the two plates will be separated by about $\frac{1}{8}$ inch. Attach a length of wire to the plate. Provide a piece of clean glass about 2×3 inches in size. Ordinary window glass is satisfactory.

Procedure: Connect the insulated fixed metal plate to the electro-scope and charge the system by induction. Con-

nect the wire from the movable plate to ground. (In many cases an actual ground will not be necessary because there will be sufficient leakage through the wood to give the same effect.) Slide the movable plate under the fixed plate, being careful to get no metal-to-metal contact, which will discharge the system. The electroscopes leaves will drop toward each other. Raise the movable plate until it is as close as possible to the fixed plate, taking care not to touch the latter and discharge it. The closer the two are to each other, the more the electroscopes leaves will drop. Finally, take away the movable plate and the leaves will move apart to their original position.

The fact that the electroscopes leaves indicate a lower potential when the movable plate is inserted shows that the capacity of the system has been increased ($E = Q/C$) since none of the stored electricity can have escaped from the system. Since the cause of the lowered potential is the presence of the second plate near the first, the two-plate arrangement evidently has larger capacity than one plate alone. Such a combination is called a condenser. The further decrease in potential which results when the separation between the two plates is decreased shows that the capacity of the condenser increases as the plates are brought closer together. The decrease in potential is the result of the fact that the second plate becomes charged by induction, and since the charge is opposite in polarity to that on the fixed plate, the electrostatic field from the induced charge lowers the potential at the fixed plate. The effect is more marked when the two plates are close together because the fields become more nearly equal in intensity under these conditions. When the movable plate is taken out, the potential of the fixed plate returns to its original value, since the opposing field is no longer present. The electroscopes leaves therefore return to their original positions.

Now charge the fixed plate and electroscopes once more and insert the movable plate. Slide the piece of glass between the two plates. The electroscopes leaves will drop still more when the glass partially replaces the air between the plates, indicating that the potential is lowered more with glass than it is with air. The presence of the glass therefore has increased the capacity of the condenser. Evidently there is less drop in electrostatic field strength through glass than through air, since the capacity can be increased only by lowering the potential, and inserting the glass has the same effect as moving the plates closer together when the medium between them is simply air. The medium is called the *dielectric*, and the ratio of the condenser capacity with a given dielectric to its capacity with air dielectric, all dimensions remaining the same, is called the *specific inductive capacity* of the dielectric or, more frequently (in the practical system of units), the *dielectric constant*.

EXPERIMENT 4

Electromagnetism

Apparatus: This experiment requires the apparatus shown in Fig. 3. A homemade electromagnet having two windings is needed, arranged with a removable core. The core should be soft iron, cylindrical and about $3\frac{1}{2}$ inches long. A suitable core can be made from a $\frac{3}{8}$ -inch diameter bolt having an unthreaded section of the required length, by sawing off the head and threaded portion. Procure or make a cardboard tube of the same length as the core and having an inside diameter such that the core will fit in it fairly snugly, but loose enough so that the core can easily be slid in and out. Cut out pieces of thin wood or masonite and drill them to fit over the ends as mountings, as shown in Fig. 3. Then wind on about 100 feet of No. 28 enamelled wire, leaving ends for terminals, cover the winding with tape or paper, and put on a second winding of about 200 feet of wire of the same size. Wind both coils in the same direction (that is, same direction of rotation in winding; the layers can travel back and forth along the coil) and label the terminals so that the "start" and "finish" ends are readily identifiable. The wire should be wound fairly evenly, but perfect layers are not at all essential. Considerable time and effort can be saved by using a hand drill for the winding, mounting the drill in a vise and running a bolt of appropriate size through the cardboard tube and into the chuck so that

the tube will turn when the drill handle is turned. A small piece of wood with four machine screw terminals mounted on it makes a suitable base for the coil.

Current can be furnished by a pair of ordinary dry cells connected in series. The current-measuring instrument can be a 0-500 milliammeter or a multi-range test set of the general type shown in the photograph. A permanent magnet, either bar or horseshoe, should be provided.

Procedure: Connect one wire from the battery to the smaller coil (Coil No. 1) and insert the iron core in the coil. Hold one end of the permanent magnet near the core, close enough to feel the magnetic pull but not close enough to make the core piece move. Now touch the other battery wire to the remaining terminal of the coil. The permanent magnet will be either attracted or repelled, depending upon the polarity. Repeat, holding the other end of the magnet near the core. If the magnet was repelled in the first place, it will now be attracted, and vice versa. Using either end of the magnet, note whether attraction or repulsion takes place when current flows through the coil. Now present the same end of the magnet to the other end of the core. The opposite effect will take place at opposite ends of the core with the same magnet pole. Note that when the current is cut off these effects disappear, and that either end of the core will be attracted equally well by either end of the magnet.

Since the same effects can be observed by going through the same procedure with a permanent bar magnet substituted for the coil and soft-iron core, it is evident that the current flowing through the coil makes the coil and core equivalent to a bar magnet. That is, the current has caused a magnetic field to be set up. Some of the properties of electromagnetism can be demonstrated by continuing the experiment as follows:

Connect one dry cell, the smaller coil (Coil No. 1) and the test set in series, selecting the proper current scale on the latter to read the current in the circuit (the 500-ma. scale, or nearest to that value, will be suitable). Insert the iron core in the coil. Note the current and bring a piece of soft iron (the remainder of the bolt will do) near the core. When the iron is brought close it will be attracted to the core. Open the circuit and the iron is no longer attracted. (If any attraction still exists, the bolt probably is steel instead of soft iron and has retained some of the magnetism imparted to it when attracted to the core. This property is called *magnetic retentivity*, and since it tends to obscure the principles involved in these experiments, soft iron, which has little or no retentivity, is to be preferred.) Now use the two cells in series, which should double the current, approximately, and repeat. The attraction will be noticeably stronger.

Connect the two coils in series, running a wire from the "finish" terminal of Coil 1 to the "start" terminal of Coil 2, and connect the dry cells and meter in series with the remaining terminals. Again bring the iron near the core and note the attraction. Compare this attraction with that which occurs when Coil 1 alone is used with a single dry cell.

The iron is attracted for reasons quite similar to those given to explain the attraction of an electrically charged body for one without charge (Exp. 1). In the molecular theory of magnetism the iron molecules are miniature magnets which, in a piece of iron showing no magnetism, are assumed to be in random positions so that on the whole their individual fields cancel out, so far as external effects are concerned. When such a piece of iron is brought near a magnet, the molecules tend to align themselves so that they lie parallel with the lines of force. If the field is from an *N* pole, the *S* poles of the molecules will turn toward the magnet and the *N* poles away from it, since unlike poles attract and like poles repel. Hence the iron becomes a magnet itself, with its *S* pole (in this example) facing the *N*-pole source of the field. The two magnets therefore attract each other, and if the field is strong enough and at least one of the magnets is free to move the two will be pulled together. The same mechanism explains how the iron core becomes magnetized under the influence of the magnetic field set up by the current flowing through the coil. (The coil itself will attract iron and exhibit all the properties of a bar magnet, without the iron core, if the current through it is large enough. With the apparatus described the field without the core is rather weak, so that only small and therefore light pieces of iron

will be attracted, but the effect can be clearly observed if a battery of 6 volts or more is used.)

The force of attraction is naturally greater the stronger the field, hence increasing the current through the coil, as is done in the second part of the experiment by increasing the battery voltage applied to Coil 1, must cause a stronger field to be set up, since the attraction is greater with greater current. That the field strength also depends upon the number of turns is shown by connecting the two coils in series. Although the current through the two in series with 3 volts applied is somewhat less than the current through Coil 1 with the single dry cell, the attraction is nevertheless stronger (hence the magnetic field is stronger) with the greater number of turns despite the smaller current. If other dimensions remain the same, the field strength will be proportional to the current for a given number of turns and proportional to turns for a given current. This dual proportionality can be combined in the single expression *ampere-turns*, or product of amperes through the coil times number of turns in it. The number of ampere-turns thus is a measure of the magnetizing force.

EXPERIMENT 5

Electromagnetic Induction

Apparatus: Same as in Exp. 4, with the exception that the permanent magnet is not needed. Set the scale of the test set to use the instrument as a milliammeter having a maximum deflection of 1 milliampere (or the nearest range to 1 ma. provided on the particular test set used).

Procedure: With the core out of the magnet assembly, connect the milliammeter across the terminals of the larger coil (No. 2). Connect one side of the battery to one terminal of the smaller coil (No. 1). Connect a wire to the other side of the battery and touch its free end to the remaining terminal of Coil 1. When the contact is made the milliammeter needle will show a small instantaneous deflection but will quickly return to the zero position. Now remove the wire from the terminal and the needle will deflect in the opposite direction, again returning quickly to zero. The deflections probably will be quite small — less than 0.1 milliampere. Repeat the experiment with only one dry cell instead of two, when it will be found that the deflections are of the same type, but smaller. Note the direction of the deflection on making contact and if it is not the same as the normal direction of needle movement, reverse the meter terminals.

Now insert the iron core and close the circuit through Coil 1. The deflection should be of the order of 0.5 milliampere. While the circuit is still closed, reverse the meter terminals. Now open the circuit and the needle will deflect again, this time in the same direction since the meter has been reversed. The purpose of reversing the terminals is to avoid a large deflection in the direction opposite to normal; although this probably will do no harm to the instrument, the needle does not travel very far before hitting the stop and frequently will bounce in the opposite direction (that is, the normal direction of motion) giving the impression that the deflection is in the same direction both on closing and opening the circuit. That this is not the case is easily demonstrated by reversing the meter terminals while current is still flowing through Coil 1.

The observed phenomena can be explained as follows: On closing the circuit a magnetic field is set up by the current flowing through Coil 1. While the field is changing — that is, growing from zero to its final intensity — electrons in Coil 2, which is in the field, are forced to move, causing the current indicated by the milliammeter. Since current can flow only when there is a voltage present to force it to flow, it is evident that the changing magnetic field has caused a voltage to be induced in Coil 2, even though there is no direct connection between this coil and the battery. When the field becomes steady the milliammeter shows no deflection, hence the phenomenon of induced voltage must be associated only with a changing field. On

opening the battery circuit the field disappears and, in the process of changing from its steady value to zero, again causes a voltage to be induced in Coil 2, as shown by the milliammeter deflection. Since the deflection on opening the circuit is in the opposite direction to that on closing the circuit, the induced voltage must have one polarity when the field is increasing in intensity, and the opposite polarity when the field is decreasing.

Changing the battery voltage, and hence the amount of current through Coil 1, showed that the induced voltage depends upon the strength of the magnetic field, since the field is stronger with greater current, other things being equal. In the last part of the experiment the current remained the same, but much larger deflections were obtained by inserting the iron core. Hence the core must have greatly increased the intensity of the field or, stated another way, many more lines of magnetic force must be set up in iron than in air for the same magnetomotive force (represented by the current flowing in the coil). The ratio of the number of lines of magnetic force which will be set up in a given material to those in air, the dimensions and magnetizing force being the same, is called the *permeability* of the material. The experiment demonstrates that iron has many times the permeability of air.

EXPERIMENT 6

Electromagnetic Induction — (Cont.)

Apparatus: Same equipment as in Exp. 5.

Procedure: Repeat Exp. 5 with the iron core in the coil. Note the direction of current flow in Coil 1. (Use the conventional direction; that is, assume that the current flows from the positive terminal of the battery through the coil and back to the negative terminal.) Close the circuit and note the direction of current flow through Coil 2. Remember that the meter indicates normally (pointer deflection to the right) when its positive terminal is connected toward the positive side of the circuit, hence current normally flows from positive terminal to negative terminal through the meter. On opening the circuit the current through Coil 2 reverses, as shown by Exp. 5.

What is the relationship between direction of current flow in Coil 1 and that in Coil 2 on closing the circuit? Trace the current through the coils, both having been wound in the same direction. What is the relationship between the two currents on opening the circuit? On closing the circuit the induced current flowed in the opposite direction to the current in Coil 1 while the latter current was increasing from zero to its steady value. On opening the circuit the current in Coil 2 reversed its direction, the current in Coil 1 now being decreased from its maximum value to zero. The direction of flow of the induced current is such as to oppose the change in current which caused it. If the original current increases, the induced current will oppose the increase. If the original cur-

(Continued on page 88)

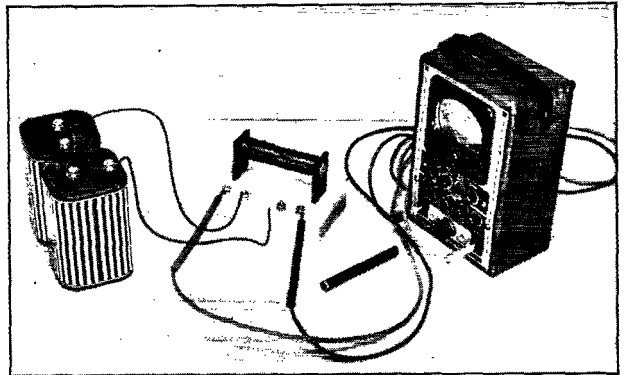

Fig. 3

IN THE SERVICES

SIGNAL CORPS

FORT MONMOUTH cannot escape a continuing influx of amateurs. These fellows took advantage of their amateur licenses to enlist in the Signal Corps, and are now receiving advanced radio training there: Pvts. Ferenc, 8TVB; Carr, 3IVN; Marotto, 1HHP; Zenis, 1GOF; Rogers, 1MHA; Caika, 1LZK; Tomblin, 9ULO. Former Capt. Snyder, 2DVC, transferred to the Signal Corps and now wears a major's insignia. Lts. Friedman, 8FPL; Mackenzie, 2GGV; and Fowler, 3GJZ, are with the electronics training group. Lts. Johnson, 9RAB; Pond, 3JLV; Thurmond, 2MHD; are taking specialized schooling at the post. Lt. Johnson, 5INE, writes training literature for the enlisted men's school where we find Pvt. Gordon, 8WAW; Nelson, 8RWK; and Haas, 3HCL. Lt. Forbes, 1KTB, is receiving advanced electronics training at Harvard.

In a current class receiving advanced operating training at the Midland School in Kansas City are Cpls. Warning, 9AEM; Miller, 9WYN; and Pvts. Blades, 9NFS; Caruthers, 6MOY; Antolich, 8OAJ; Bloomdahl, 7BTN; Hulme; Swingle, 4GEV. Members of the operating staff of the Camp Grant, Illinois, radio station are Staff Sgt. Daniels, 9YXH; Tech. Sgt. Husting, 9RSR; and Koch, 9TRX. Cpl. Downes, 1LDQ, and Finnegan, 9VUA, are assigned to the new Signal Corps school at Camp Crowder, Mo.

Lorentz Morrow, 9VKF, has just received his commission and waits active assignment. Lt.

Peck, 6LDD, has communications duties with the interceptor command at Camp Haan, Calif. Tech. Sgt. Acin, 2KIZ, has charge of maintenance of radio equipment at Ft. Dupont, Del. Directing the radio communications school at Camp Berkeley, Texas, is Lt. Blackwell, 5EZD. Pfc. Gerstein, 2MQG, is in the aircraft warning service in Honolulu. Pfc. Filley, 7AST, has fixed station operation at Seattle, Washington. Selectee Wagenfohr's amateur call of 2NRL obtained him a Signal Corps assignment — as has happened in so many cases. Pvt. O'Brien, 2EQS, is now assigned to signal work at Ft. Monmouth, one of the number of selectee amateurs transferred to communications duties through League efforts. Among the communications people assigned to Paine Field, Wash., are Pvts. Seek, 9LPY; Keefe; Smith, 9YBO; DeWalle, 9JMA; Fox, 9OTW; all are enlisted men whose amateur licenses got them Signal Corps assignments. The same is true of Pvt. Savage, 1CPV, at Ft. Devens, Mass. Pfc. Grzesik, 1KXX, is stationed at Camp Shelby, Miss. Tech. Sgt. Weber, 6NGT, instructs in radio intelligence division at Hamilton Field, Calif.

NAVY

HERE are some recent volunteers for the free training in radiolocator technique plus a rating of radioman, second class, offered by the Navy: Parker, 8NNW, enlisted at Philadelphia. Bird, 5HGC and Humphreys, 5JYT, left the Oh-pe-kah club gang in Oklahoma for radar work. Hitchcock, ex-9AYH, is now on temporary duty at Key West, Fla. Kauphusman, 9ZSA, and Strang, 9RFT, are two of the many taking preliminary training at the Utah State Agricultural College, Logan. Wright, 6QYP, and Scranton, 6UGV, are two of many more at Treasure Island. Cook, 9FWW, has finished the advanced course and is now in installation and service at the Naval Air Station, Alameda, Calif. Jayson, 2HAP, and Heritage, 7AFZ, are awaiting assignment to schools. Wendt, 9HRD, is at College Station, Texas, and Charnesky, 8QHP, is at Great Lakes in Chicago.



This class at Fort Monmouth, N. J., is brushing up on mill copying technique. Nearly all selectees with past amateur experience are sent to a signal school for communications training.

Assistant League Director Eldred, 9SG, was commissioned Lt. (jg) and assigned to the district communications office at Great Lakes. On duty in the Navy department in Washington we find Ensign Sobel, 2FCE; Y3c Hanson, 8MKA; Y3c Morrison, 8QAO; Y3c Smith, 2ITN; RM3c Stapleton, 8KXG; Y2c Fertick, 8REO; Lt. Anderson, 3JRT; Lt. (jg) Hargreaves, 3FY; Lt. (jg) Comfort, 3JRW; Y3c Hill, 5FDV. Ex-ham Lt. Brewster Marshall is serving on the Army-Navy Munitions Board in Washington. ARRL's General Counsel Segal, 3EEA, is on active duty as a Lt. in the Navy's legal department. Lt. Countryman, 3HH, is executive officer at Cape May, N. J.

Amateurs now at Noroton, Conn., taking the regular four-months course are Yerga, 8LOU; Turner, 8WNI; Carey, 2NRS; Foley, 1NLY; Kenney, 1MOP; Colburn, 8VYX; Arvonio, 2JYM. RM2c Holland, 5ATY, is taking a "refresher" course. The communications staff at Floyd Bennett Field is composed pretty much of hams. There are Chief Radiomen Tarditi, 2BPV; Schug, 2BVE; Frederickson, 2FLD; RM1c Cabanillas, 2BNJ; Nagata, 2EGI; LaManna, 2HPE; Miller, 2MQB; Meyer, 3EQF; RM2c Waltman, 2HOP; Ellis, 2LYG; Teatsorth, 5GUV; Barnes, 8SZG; RM3c Keller, 2HBO; Woltz, 2HQT; Spieker, 2KTJ; Schneeloch, 2LCL; Dabney, 3GWW; Rubens, 9MPE; Czarniewski (operator only). RM3c Pope, 1MXA, has interesting duties in Newfoundland. Lt. Comdr. Zuckerman is assigned to the Naval hospital at Puget Sound Navy Yard, Washington. In communications work aboard ships, whose names we cannot mention, are RM3c Williams, 8WEG; Ensign Sobczyk, 9BBF; RM1c Steavenson, 9DFO; Lt. Ellis, 3HSB; RM1c McCullough, 8LZK; RM2c Siebert, 8LHN; RM2c Christians, 1DNM; Briggs, 2NUC; Noyes, 1MIP; De Hosnery, 6QQT; Scott, 3HOJ; Ensign Gray, 3HSU. Allen, 4GBW, attends the school at Charleston, S. C.

In communications work at various Naval air stations are RM3c Small, 1DYH, in Hawaii; Krebs, 3HML, and Dimmack, 8BWK, at Norfolk; Stanley, 9WKU, at San Diego; Coast Guardsman Simmons, 1EBT, at San Diego. Amateurs at fixed radio stations include RM2c Young, 8VCB, at Lakewood, Ohio; Schmidt, 5JYE, at Imperial Beach, Calif.; and RM3c Smith, 3HAC, in Puerto Rico. Ensign Jones, 5IHK, is on active duty in the Eighth District Naval Headquarters in New Orleans. RM2c Wickenhiser, 8KWA, has duties in the district communications office at Philadelphia. Upon graduation from Noroton these reservists were sent to the Canal Zone: RM3c Morgan, 9MRS; Lazear, 3GXN; Kaminski, 1NEH. Lt. Sweeney, 4CZD, is in a communications office of the Charleston, S. C., Navy Yard. Receiving advanced Naval communications training are Rademacher, 9KET, in Washington; Bonner,



Amateurs in all the United Nations are contributing their bit to the communications end of the war effort. These Zedders were enroute to Canada for advanced training when the ship's chief radio operator, Kalakowsky, 1IUY, discovered they were hams. Left to right, front: Jarman, ZL1HO; Goodwin, ZL1MO; Budd, ZL2NU; Rian, ZL2JI. Standing: Elsmore, ZL2BA; Kalakowsky; Millhollin, 6RNH, assistant ship op; Cobbe, ZL2ND.

9CLX, at San Diego; Drew, 6RBL, at the University of Colorado; RM2c Papamarcos, 2FZM, in Bellevue, D. C.; RM1c Williams, 8MMZ, is an instructor at Treasure Island.

Lt. Sayre, 9KER, is at Harvard; Finch, RM3c, 6UJN, is in Naval aviation at San Juan, P. R.; Lt. (jg) Cervantes, 2DB, is hospitalized at the Brooklyn Naval Hospital; Ens. Remorenko, 3GUF, is at the Phila. Navy Yard and RM2c Axelrod at Naval Radio Lab., Anacostia, D. C. RM3c Hodge, 6RFO, is at sea; RM2c Humphreys, 5JYT, is at Naval shore station, Ft. Morgan, Ala.

OVERSEAS DIRECTORY

For the benefit of United Nations' hams who may be on active duty in countries near the war theaters and who may wish to contact amateurs there, a list of several IARU societies is published below. From a number of these societies have come invitations expressly directed at W hams and others in military communications work to call at the respective headquarters addresses shown when their assignments take them to these countries.

Radio Society of Great Britain. 16 Ashridge Gardens, London. Secretary, Jack Clarricoats, G6CL.

Wireless Institute of Australia. 191 Queen St., Melbourne. (Box 2611W) Secretary, R. Anderson, VK3WY; or 21 Tunstall Ave., Kinsford, N. S. W., Secretary, W. Ryan, VK2TI.

New Zealand Association of Radio Transmitters. Box 489, Wellington. Secretary, F. Sellens, ZL2MY.

Newfoundland Amateur Radio Association. 88 Pleasant St., St. John's. Secretary, W. E. A. Nosworthy, VO1S.



EXPERIMENTER'S SECTION

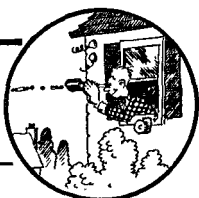

Address correspondence and reports to ARRL, West Hartford, Conn.

WHAT are you doing with the time you have been accustomed to spend on ham radio? Most of us, no doubt, are consuming those hours which formerly represented spare time in longer working days. We know of some, however, who are simply sitting back yearning for the good old days and waiting impatiently for the end of the war to bring the reopening of amateur radio. This in spite of the fact that there are plenty of useful and interesting things to be done by amateurs who won't be licked. We think it is the duty of those who have the free time and ability to investigate the alternative short-haul communication systems which have been suggested in *QST*, with the idea of developing them for civilian-defense purposes. Several of the systems already have shown that they have possibilities promising a duplication of the ranges which might normally be expected from $2\frac{1}{2}$ -meter radio gear. Why not give some of them a whirl?

PROJECT A

Carrier Current

THE number of hams who have built carrier-current equipment and who are beginning to get results is steadily increasing. W9NQT reports that two fellows in Wisconsin are covering a distance of eight miles with S-9 signals. This is the record distance reported thus far. Unfortunately no details of the type of line being used are given in the report. W9NQT also reports that, in addition to himself, W9KWN, W9CLJ, W9FRB and W9MVW are busily engaged in building transmitters and receivers similar to the units described in March *QST*.

W3JAS has worked W3HAL at a distance of three miles. They are planning to work out a system for alerting air-raid wardens by this method of communication.

Using a small receiving-tube oscillator, W1NEI is putting across a strong signal at a distance of three miles.

W8PUN and W8PRW are in contact over an air-line distance of $2\frac{1}{4}$ miles ($3\frac{1}{2}$ miles via the power lines), using *QST* rigs. The most significant part of this report is that they are located on opposite sides of a substation, which shows that it can be done!

W7FRA reports that W7GGH is picking up the

signals from a commercial c.c. station in Pasco, Wash., fairly consistently over his home lighting circuit at Moscow, Idaho. The signal evidently is fed over the 110-k.v. line to Moscow and then over the local distribution system. W7GGH says he cannot hear the signal unless the receiver is connected to the line. The air-line distance between Pasco and Moscow is about 100 miles!

W3AAL is getting an S-7 plus signal at a distance of over one mile while using 4/10-watt input to a 6V6 with a plate voltage of 80. He has revamped an old ham-band receiver to cover the range of 160 to 200 kc.

R. L. Wardle and several others around Morgantown, W. Va., have *QST* rigs set up and have been able to hold communication over a consistent distance of two miles at any hour of the day or night. Efforts to contact one station three miles beyond have thus far been unsuccessful. The group plans to run tests to determine if the substation in between is responsible for the lack of success.

In addition to those already mentioned, W8RTV, W8AJE, W3JJN and the operators of W1MKU of the Plymouth (Mass.) High School Radio Club have signified their intention of working on the project. — D. H. M.

PROJECT B

Light Beams

FIG. 1 shows a sketch of a variable-light gate as constructed at W1ANA. A small dynamic speaker was obtained and the cone cut away with a razor blade, leaving a stub cone A about an inch and a half in diameter. The speaker used had a corrugated supporting paper diaphragm B which kept the voice coil C nicely centered. The frame supporting the rim of the cone was cut away leaving two oppositely-positioned arms D which served to hold the bridge E. Attached to the bridge is a spring member F holding the top gate G. This piece may consist of a small piece of brass soldered to F, or F and G may be made from a single piece. A machine screw H is threaded into the wooden bridge member E by which the top gate may be raised and lowered. The bottom and movable gate I is made of 1/16th-inch balsa wood and it resembles a banjo bridge in construction. The light gate is painted flat black. The slit

J, formed between G and I is what the image of the filament or primary slit is focused on. (See article on fundamental optics elsewhere in this issue.)

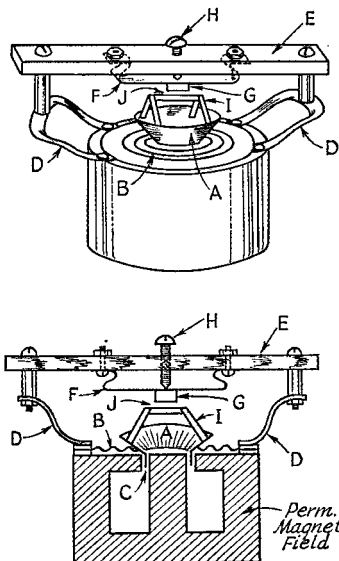

Fig. 1 — Sketches showing the construction of W1ANA's light gate for modulating a light beam. The gate is made from a small p.m. speaker. Lettered parts are identified in the text.

For receiving, we are constructing a relatively large light gatherer as shown in Fig. 2. This consists of a sun bowl heater K with an auxiliary conical mirror, positioned as shown to direct the light into the photocell M. We hope to have this in operation in time for the next report and anticipate some good results.

R. B. Bourne, W1ANA.

PROJECTS C & G

Audio-Frequency Induction & Earth-Current Communication

IF YOU'RE wondering why we're combining these two this month, the answer is that we've run into difficulty in distinguishing one from the other under certain circumstances. Suppose we have two ground rods, spaced 100 feet or so, connected to the output of a high-power audio amplifier as the transmitter and a similar pair of rods connected to the input of a high-gain amplifier as a receiver. Is the signal picked up at the receiving end transmitted through the earth between the two sets of grounds or by induction between the two loops formed by the wires connecting the ground rods?

This question came up soon after we started some experimental work to determine what could be done with earth currents. At the transmitting end, we rigged up a 250-watt modulator (which had helped to knock off a PK or two in the last DX contest). The modulator was driven by a speech amplifier and driver fed from an audio oscillator at a frequency of approximately 1000 cycles. One of its output terminals was connected to the local water-supply piping, while the other terminal was connected through a long wire to a metal fence about 300 feet distant. The fence was grounded every ten feet through the iron supporting posts, several of which were imbedded in permanently-wet soil. Attempts to check the resistance of the ground circuit with an ohmmeter were not entirely successful, since it was found that a potential of several volts was developed between the two grounds, possibly the result of chemical action. This caused the ohmmeter reading to depend upon the polarity with which it was connected. Averaging the readings gave a resistance of about 15 ohms. A low-load resistance was indicated when the modulator showed evidence of overload with the output transformer adjusted for a load of 200 ohms, the lowest value obtainable at the secondary. Accordingly, the output transformer, with the taps set at 200 ohms, was fed into the 110-volt primary of a decent-size filament transformer. The secondary

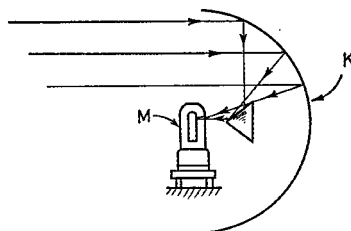

Fig. 2 — Sketch showing how a reflector and conical mirror are used to focus the received light rays on the photoelectric cell for light-beam reception. Lettered parts are explained in the text.

of this transformer has two 7.5-volt windings and one 2.5-volt winding, all of which were connected in series to give a step-down turns ratio of about 6 to 1. This arrangement provided a very close match, since the modulator could be run at full rated input and the ground current was multiplied several times to a value of 5 or 6 amperes. This indicated an actual load of 10 ohms or less.

At the receiving end, a small two-stage high-gain amplifier with 6J7 and 6J5 into a pair of headphones was used with a single-button mike transformer at the input as a matching transformer. Early tests showed so much racket from electrical devices in the neighborhood that a circuit tuned to the frequency of the transmitter tone was placed between the mike transformer and

the input of the 6J7. This served to reduce noise to a practical level.

Several attempts were made to pick up the signals from the transmitter with grounded electrodes in various positions at a distance of about $4\frac{1}{2}$ miles without success. We were somewhat hampered in making extensive field tests by the fact that people were found to object to having strangers drive pipes in their front lawns, even though it might contribute to the progress of science! A new receiving location was found at a distance of less than two miles, but results were no more successful.

In the course of subsequent tests in the lab, it was found that a strong signal was obtained the length of the building without having the receiver-input terminals grounded. The signal was evidently being picked up by induction by the coil in the tuned filter circuit. This coil was similar to the honeycomb type with air core. The receiver was placed in a car so that the field could be explored. Induction noise from a vibrator pack was so severe that it was necessary to operate with 135 volts of "B" battery. With this arrangement, it was possible to obtain a readable signal at a distance of about one mile in any direction from the transmitter.

To determine the effects of using ground connections at the receiving end, we drove to a point where weak signals were obtained by induction. This point happened to be between a pair of "no-parking" signs along a street running parallel with the wire connecting the fence to the transmitter. Being temporarily near-sighted, we parked and used the signs, separated about 100 feet, as ground connections. Upon making the connections, the signal promptly disappeared!

The next step was to wind a larger receiving loop and to improve the transmitting loop. The new receiving loop was two feet square, wound with 600 turns of No. 26 wire. The Q of this loop was inferior to that of the smaller coil, so it was impossible to obtain the sharp tuning peak of the circuit with the smaller coil. However, since much less noise was picked up by induction, maximum selectivity was not required. Accordingly, the loop was simply connected to the input terminals of the microphone transformer.

The wire running from the transmitter to the fence was elevated on trees to form a loop about 50 feet high and 300 feet long, using ground as the bottom side of the loop. Using this arrangement, we were able to boost the readable range to about two miles. If we had any doubts that we were getting out, they were soon put at rest when we began to get telephone calls from users of the telephone and office intercommunicating systems within a radius of several blocks reporting S-9 signals!

In the next step, we plan to boost the transmitter frequency to about 5000 cycles, slightly above the limit of the telephone frequency range.

To bring the received signal down to a more readable frequency, we plan to use a converter with a local oscillator operating at about 6000 cycles. With this arrangement, we hope to get around the trouble of interference with telephone communication. We also plan to try a large receiving loop similar to the one at the transmitter, since we found that the transmitter range was reduced drastically when using the two-foot multi-turn loop for transmitting. A fixed receiving loop, however, will not be so effective for all-direction work, since it must be properly orientated with respect to the transmitting loop for maximum signal. Both nulls and maxima are quite sharp.

Incidentally, if you do any portable or mobile exploring with a loop in defense areas, it is a good idea to carry some form of personal identification, otherwise you may have to explain why you shouldn't be shot at sunrise — as we found out!

— D. H. M.

PROJECT D

R.F. Induction Fields

SEVERAL new members have enrolled in the project and one or two systems are reported in operation over moderate distances. As far as is known these set-ups utilize conventional apparatus, and most of them seem to operate on comparatively high frequencies up near the broadcast band. Reports from others interested concerning novel technical features or practical experiences in the application of the r.f. induction field are invited.

We'd like to repeat the warning contained in last month's report: As far as possible, stay clear of the broadcast band, especially in crowded residential areas. There is no surer way to get in trouble than to interfere with b.c.l.s, and even the lowest-powered "low-power device" is often capable of putting in a pretty fair signal at the house next door. Move down into the lower frequencies — and be sure then that the spot you pick is free of occupancy insofar as any local service is concerned! (It isn't altogether a matter of interference, either; the lower frequencies will give you greater permissible range and better performance all around.) — C. B. D.

PROJECT E

Acoustic Aircraft Detection

REPORTS of technical progress on this project are lacking this month. We have one interesting idea, however, from W7FTV who suggests using a dry wading pool (if you happen

(Continued on page 80)



ARMY-AMATEUR RADIO SYSTEM ACTIVITIES



War Department, Office of the Chief Signal Officer, Washington, D. C.

THIS so-called inactivity period for the average amateur is so full of things to be done that there is definite danger of necessities being crowded out by luxuries. This page, for example, might receive less attention than usual, by reason of the prolonged concentration ordinarily demanded by it. For the good of the soul, therefore, we are this month giving you copy that is a good defense against any loss of *esprit de corps* because of the suspension order.

Experience has shown that the whole of anything is equal to the sum of its parts. Know each part and you know the whole. The purpose of this article is to familiarize the amateur operator with parts of the Signal Corps necessary to insure operation of its vast communications system.

PROCUREMENT OF PERSONNEL

TO EXPEDITE procurement of urgently-needed radio and telephone personnel for civilian positions with the Signal Corps, a special recruiting mission will visit the principal cities of the nation in a coast-to-coast tour during April and May. The group represents both the Civil Service Commission and the Chief Signal Officer. Purpose of the Civil Service representative is to give the Commission's approval on the spot. In this way it is possible to interview, hire and assign an applicant within a few hours. This procedure is necessitated by the need for personnel to maintain and operate radio and telephone equipment now being turned out in large quantities. To give you some idea of the enormous quantity, two years ago Signal Corps equipment was being acquired at the rate of \$10,000,000 a year. At present there is an appropriation of \$3,000,000,000 for Signal Corps material. The positions available carry pay ratings ranging from \$1800 a year up. Ratings are dependent on education, experience and type of job. Communications and other companies in which men needed for engineering and technical work are now employed have been most cooperative in releasing such men for the Signal Corps. Mr. Leslie Atlas, vice-president of CBS, encouraged all employees of his company who could be spared to apply, promising that everyone who entered the service would have his job waiting for him on his return. As a result the Signal Corps received the services of a number of highly-qualified engineers.

Meetings will be held by the recruiting mission in Los Angeles, San Francisco, Denver, Dallas, New Orleans, Atlanta, Cincinnati, Pittsburgh, Boston, New York and Philadelphia. The exact dates will be announced locally.

SURVEY OF AMATEUR EQUIPMENT

A SURVEY of amateur equipment is being conducted by the Office of the Chief Signal Officer. The Liaison Officer of the Army-Amateur Radio System is charged with the coordination of this information with divisions of the Signal Corps that are interested in the purchase, lease or loan of such amateur equipment for possible future use. In this connection, and if your equipment is of commercial type, please forward information as to make, type, power and type of emission, type of receivers and the disposition you desire to make of it direct to Captain William L. Montgomery, Liaison Officer, Army-Amateur System, Office of the Chief Signal Officer, Room 3429, Munitions Building, Washington, D. C.

FACILITIES AT REMOTE POINTS

RADIO stations in the national forest, telephones in Indian territories and telegraphic facilities in isolated border customhouses will be made available for aircraft warnings and other military messages as a result of a communications map-making project recently completed in the Office of the Chief Signal Officer. A survey by Signal Corps officers, begun last summer, has turned up a wealth of separate wire and radio systems operated by private companies and government departments. Many of these cover remote and sparsely populated sections where public telephone and telegraph channels are comparatively scarce. To make emergency use of these facilities, originally built for varying purposes, it was necessary to correlate the data concerning them. This project, made possible by the cooperation of other government departments and private companies, was rushed to completion by the War Department cartographic engineers. The Department of Agriculture maintains more than 60,000 miles of telephone wire as well as a short-wave radio network in its forest service. Special communication facilities are operated by the Department of Justice in connection with immigration and by the Treasury Department in connection with customs. Both of these services provide coverage of the national frontiers. The Department of the Interior has radio and wire equipment in the Indian reservations and national parks and in areas covered by its Fish & Wildlife Service and its Grazing Service. Again, communication networks are operated by railways along their own rights-of-way, by pipe-line companies engaged in transportation of oil and natural gas and by electric power companies. All of these facilities are now being made available for use by

Corps Area commanders in sending word from aircraft spotters and issuing warnings of enemy raids, as well as other messages of military nature. They will also serve as a secondary reliance should there be damage to the regular network of the communications companies and the Signal Corps.

REMARKS BY GENERAL OLMSTEAD

THE Chief Signal Officer, at graduation exercises for the Officer Candidate Department, Army Signal Corps School, Fort Monmouth, on April 10th, spoke as follows:

It is with much pleasure that I visit my old command to-day. You have just passed through a vital phase of your military life. As Chief Signal Officer of the Army, I have followed your progress with great interest.

The Signal Corps offers many opportunities for distinctive and meritorious service, but there are vast responsibilities, too. The lightning-like speed of modern war demands dependable communications under all circumstances and conditions. Therefore, it devolves upon all Signal Corps officers to furnish our combat forces with that superior kind of signal equipment and facilities which will materially aid in winning smashing victories over our foe.

Wholehearted support and teamwork will do that job. Nothing short of this effort will be worthy of your skill, patriotism and energy. Rigid discipline, irrepressible cheerfulness in the face of trying conditions, keen intelligence and physical stamina are prerequisites at all times.

You have been carefully chosen for outstanding characteristics and leadership. I know you will accept this challenge and will acquit yourself in a manner to bring credit upon the entire Army.

In keeping with the spirit of to-day's ceremonies, I am happy to be able to share with you the presence of an eminent guest, a gentleman who is high in the councils of the War Department. He brings to you an important message direct from our distinguished Secretary of War, the Honorable Henry L. Stimson. I esteem it a high privilege to introduce to you Honorable Harvey Hollister Bundy, special assistant to the Secretary of War.

Mr. Bundy conveyed a message from the Secretary of War in which the students were congratulated and reminded that they were charged with responsibility of the utmost importance in matters to which he was giving his constant personal attention; that they were in a branch of the Army by which this war might be lost but can and will be won. He finished by saying:

This is a tough war. You will serve under strain by night and by day; your financial rewards will be modest; you will be in danger, and some of you will die in your country's service. But you will have a satisfaction that only comes to those who lead the soldier's life and have the soldier's faith. Those of us who have never served in uniform will always regret that we are not of your brotherhood. You who risk your lives in battle have something added to your stature that others will never know.

Good luck and Godspeed.

Only in a nation such as ours is it possible to develop many thousand first-class radio operators. We are more fortunate than the other nations of the world because the American boy has a technical, humanistic and mechanical background. He has facility, resourcefulness and adaptability for things of mechanical nature. You have the material. Your country needs you. Can we expect to find you "In the Services"?

Ohm's Law in Rhyme

BY EILEEN V. CORRIDAN

Member of AWVS Radio Class,
New York City

*The law that Mr. Ohm discovered
You'll find right here completely covered.
To learn how much a circuit's got
Of current, volts, resistance, watt,
Just take the two of these you know
And figure out the others, so:*

What's what in watts you soon will spy
By multiplying E by I .
Or, knowing I and R , you'll see
 I squared times R the watts will be.

So, since with watts we've come thus far,
We'll try again with E and R .
Divide by R the square of E ;
The quotient is the watts there be.

Now, E with ease we want to get,
So don't give up that Ohm's Law yet.
It's I times R , and plain to see
The product of the two is E .

But now take care — look out — go slow —
Suppose it's watts and R you know!
First, R times watts — then you must take
Their products' square root, E to make.

What now? Well, given watts and I
You'll find that E without a sigh.
Division is the key to it;
 I into watts — it ought to fit.

Now, up pops I — where did it go?
Divide the E by R — you'll know!
With watts and R upon the table
Divide by R if you are able.

But — this will surely make you cry —
The square root of the quotient's I .
If after this your mind is sound,
There's one more way that I is found.

With watts and E within your bean,
Divide by E and I is seen.
Oh, boy, the end is now in sight.
There's only R with which to fight.

With E on hand, and also W ,
Find R — the job won't trouble you.
Divide by watts the square of E
And that is R , as you will see.

With watts and I beneath your nose
Just find the R , and then we'll close.
Divide the watts by the square of I
And there's Ohm's Law as easy as π .

Power Tuning for the Amateur Transmitter

A Variable Frequency System with Motor Drive

BY HENRY E. RICE, JR.,* W9YZH/1

WHEN a tiny puppy wags his tail at you, what is your first reaction? You stoop down and pat him — right? Power tuning is very much like that. You watch a motor turn a variable condenser and hear a signal “do a Dagwood” across the band a couple of times. The puppy has wagged his tail! You will begin to wonder instinctively how to put the signal where you want it. Although this writing can be little more than a comparatively non-technical introduction to the subject, a few details of one complete system which is believed to be readily applicable to amateur transmitter design may help you in thinking about that ultra-ultra rig you’re going to put on the air when and if.

Power tuning of radio equipment is a special form of automatic frequency control in which the capacity of a condenser or the inductance of a coil (or both together) may be varied by some

* Sudbury Center, Mass.

means other than manually. The two most commonly used sources of power are electric motors and magnetic step switches. The basic requirement of any system to be used for ordinary communications purposes is essentially that it must be capable of starting at the will of the operator and of stopping at some pre-determined frequency, the time element being a matter of seconds. The additional equipment should not lower the reliability standard of the particular service involved.

Requirements for Amateur Application

The basic requirement stated above holds good for amateur transmitters; the nature of amateur operation rules out the use of anything other than hand tuning with reasonable bandspread for receivers. Our reliability needs, except in the case of emergency equipment where any form of power tuning would be inane, are certainly moderate enough to permit the whirring of motors and the clacking of relays — if you happen to enjoy that sort of thing! The only absolute requirement for frequency change in an amateur station is that the frequency of the emitted signal be kept within the band limits. Thus, any power-driven mechanism employed must ensure that an audible or visible check be made by the operator before power reaches the antenna. For that reason extreme speed of frequency change is of doubtful value, and, if not attempted, our mechanical problem becomes just so much easier.

It must be reported that there is not a great deal of published material available dealing specifically with

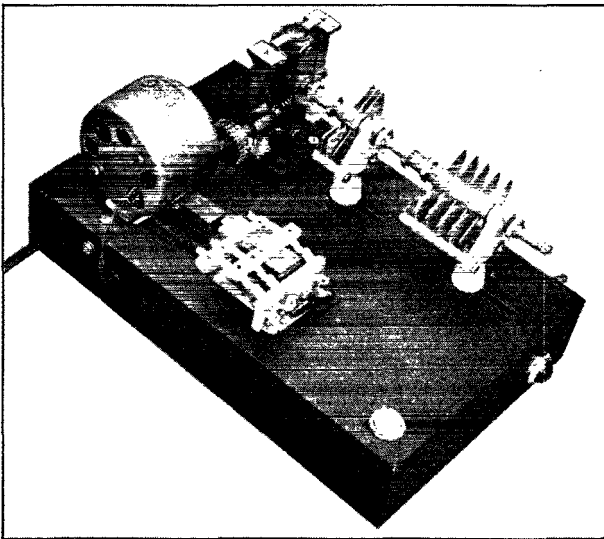

An experimental motor-control arrangement, showing a Tinkertoy motor in a “floppy motor clutch” arrangement used to drive ganged oscillator and amplifier condensers. When the control circuit is manually energized through the push-button switch the motor, mounted on a hinged bearing, pulls itself magnetically against a piece of soft iron, engaging the gears which operate the Millen dial drive. The condensers then turn until the automatic control circuit, which is tied in with the receiver a.v.c. system, opens when the oscillator is tuned to resonance with the receiver setting. The motor-start relay is shown in the foreground.

¹ Rider, John F., “Automatic Frequency Control Systems.”

Perrine, “More DX Per Dollar,” *QST*, Feb.; March, 1937.

Goodman, “Intra-Band Quick-Frequency Change for Transmitters,” *QST*, May, 1938.

Eitel and McCullough, “Auto-Resonator Transmitter,” *Radio*, June, 1939.

Mix, “Gang Tuning for the Multi-Stage Transmitter,” *QST*, June, 1938.

Linn, “Instant Band-Change with Push-Button Control,” *QST*, Feb., 1940.

Weber, “A. V. C. for C. W. Reception,” *QST*, January, 1941.

the general subject of power tuning of transmitters.¹ Because of this scarcity of information, it is the intent of this article to point out certain source material from which the amateur who is interested can acquire odds and ends of information. As pointed out in a recent *QST*

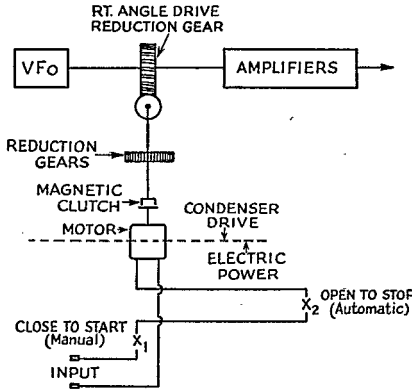

Fig. 1 — Block diagram of the automatic frequency control motor-drive unit. Right-angle drive reduction gear is Millen 10000 worm drive; second reduction gear is 2 to 1, giving 32:1 overall reduction or approximately 5 r.p.m. condenser rotation.

editorial, there are countless trade-in broadcast receivers which can be searched for tuning motors, magnetic clutches, reduction gears, relays and so on. Toy trains, motors for structural toys and phonograph winders are well worth investigating. One word of caution: the amateur on the prowl with that certain glint in his eye had best proceed cautiously in the matter of gear trains from decrepit old clocks! They might be valuable heirlooms.

At any rate, after a certain amount of reading and prowling it should be a relatively simple matter to compare the complexity of the various mechanical and electronic devices (if any) involved, and to decide what can or cannot be done with the tools at hand. The fact must be kept in mind that machinists are all very busy with priority orders just now. The days when a wishful look could wangle a complicated lathe set-up are gone for awhile! So let's confine our discussion to a system of motor tuning in which the mechanical angle is held to an absolute minimum.

All power-tuning systems may be classified into two distinct types, namely those which tune

to a number of preselected spot frequencies (6 to 20, or thereabouts) and those which give full coverage of a selected frequency range. The former, by far the better known of the two, implies the use of several crystals, and it is generally advisable to use paddler switching for this purpose wherever possible, specifically in all cases where the power of the stage involved is not excessive. It will be noted that the current trend in push-button tuning of broadcast receivers is toward the use of padders. Our spot-frequency problem is quite similar, at least in the low-power stages. Commercial transmitters have used power-driven channel selection in one form or another for a long time with satisfactory results, but its application to amateur equipment is definitely restricted by the complex nature of the mechanical selector device.

To avoid these complications there seems to be only one answer — to turn to the use of arrangements which permit continuous coverage of a selected frequency range. Is that bad? No, not by any means. The situation is comparable to the sad day when amateurs were restricted to wave lengths below 200 meters! This conclusion is not based on personal preference for the use of variable frequency control, but rather on experiments with the theory that the necessary control devices would be essentially electronic, and therefore easier for us to handle. This has proved to be correct, and it is interesting to note that the control circuit which follows is about the most elementary function of a triode tube.

A Practical System

The essential arrangement is shown by the block diagram, Fig. 1. In its simplest form, X_1 is a switch and X_2 the contacts (normally closed) of the control circuit relay. The motor starts (and the clutch engages) when X_1 is closed, and stops again (effectively, in that the power is shut off and the clutch releases) when the frequency of the v.f.o. coincides with the receiver setting. The system becomes fully automatic only when X_1 is replaced by push-button control of a motor-starting relay, an extra pair of contacts being wired in parallel to keep the motor running until the circuit breaker, X_2 , is actuated. A similarity to the familiar push-to-talk control will be evident at once.

The power of the motor to be used depends on the load presented by the bandsread condensers which it will have to turn. The requirement will

Modern design trends are toward achieving simplicity in operation — an object usually accomplished only through increased complexity in construction. Amateur radio is no exception, as witnessed by a comparison between modern gang-tuned v.f.o. transmitters and those of a few years ago. Now comes the proposition of completely automatic power-driven tuning. With the system here described the transmitter follows the receiver around the dial like — as W9YZH/1 hints — a well-trained puppy at the heels of its master.

never exceed a small fraction of a horsepower, and can perhaps be most conveniently expressed in power input as ranging from 20 to 100 watts. Gang-tuning is a prerequisite of this particular system, which means that the couplings and shaft alignment must be reasonably good if excessive drag is to be avoided. The clutch is purely a mechanical problem, and can be made in many forms.² It should be inserted where indicated on the block diagram (connected directly to the armature shaft) for greatest accuracy. It can never be omitted except in the case of a precision reversible system — which is something else again!

The tuning operation, which is initiated manually by the push-button switch, stops automatically when the v.f.o. is tuned exactly to resonance with the receiver setting. This is accomplished by the use of a sensitive relay actuated by a relay tube connected to the a.v.c. system in the receiver.

The circuit which controls X_2 is given as a part of the schematic diagram, Fig. 2. A 6C5 or 6J5 tube and a 1000-ohm resistor seem to be a convenient combination. Positive voltage from the receiver power supply is applied to the plate.

² The magnetic clutch is the heart of the mechanism, and must be constructed to work positively and smoothly. The arrangement here shown was tried because of its simplicity, but experimenters are urged to give thought to other systems, such as a sliding armature with dog or claw clutch, sliding gear operated by a solenoid, etc. Suggestions on alternative mechanisms are invited. — Editor.

The grid is tied directly to the source of a.v.c. voltage in the receiver. The cathode is biased to limit the current flow to about 5 to 8 ma. The particular relay used requires roughly 4 ma. for positive closure and opens when the current drops below 3 ma. As the fundamental of the signal from the local oscillator approaches the frequency to which the receiver is tuned, the rectified a.v.c. voltage potential at the grid becomes more negative, the plate current falls to zero almost instantaneously, and the relay opens.

With the receiver used in the original experiments (National 101X), the system doesn't work satisfactorily with the a.v.c. turned on. In fact, it doesn't work at all! It will not work with the b.f.o. on either, for that matter. The reasons are obvious, of course; the a.v.c. bucks itself and in the end there is not enough voltage to operate the relay tube, while the c.w. oscillator puts out enough signal to keep the circuit open all the time. With elaborate adjustment of the control circuit these complications might have been avoided, but it seemed simpler to provide a supplementary relay which automatically frustrates the a.v.c. and deranges the b.f.o. when the motor-drive circuit is functioning, as shown in Fig. 2.

It seems that the tube characteristic which applies here is grid-plate transconductance (g_m). Whatever it is, almost any triode seems to have plenty of it for our purpose! The accuracy of the system (the frequency difference between the

(Continued on page 76)

Fig. 2 — Schematic diagram of the complete motor-driven a.f.c. installation. Upper section is located at the operating position; lower section is motor-drive unit in transmitter. An 8-wire cable with octal plug and socket connects from the control circuit to the receiver; 3-wire cable with 4-pin miniature plug and socket connects to the motor-drive unit. Receiver cable connections are as follows:

- 1 and 2. Heater.
 3. A.v.c. voltage (source end of common grid filter).
 4. Common ground.
 5. B+.
 - 6 and 7. Connect in series with c.w. b.f.o. switch.
 8. A.v.c. voltage (supply end of common grid filter).
- D.c. relay — 5000-ohm sensitive relay.
C.w. and a.v.c. relay — Standard 115-volt a.c. relay, d.p.s.t.
Motor start-stop relay — 3-pole double-throw a.c. relay.
Tuning motor — 115-volt a.c. motor with internal gear reduction (Tinkertoy Series 39, 160 r.p.m., 20 watts max. input).

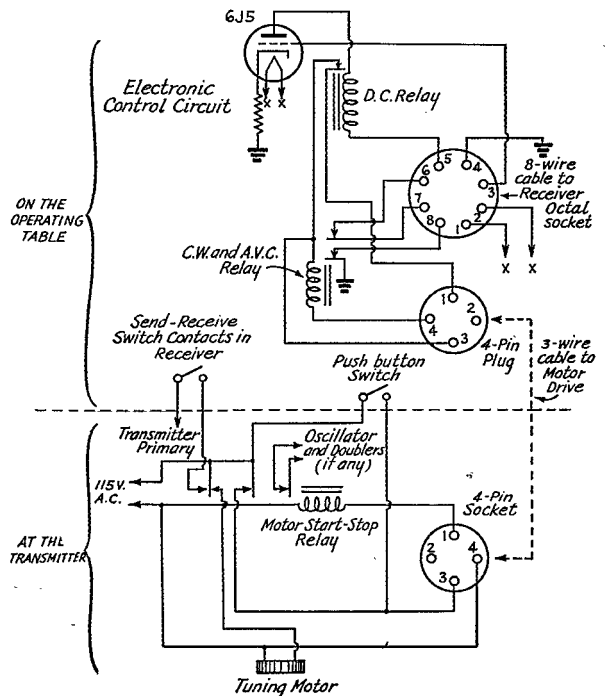

Visual Signalling

How to Read International Flag and Semaphore Codes

BY CLINTON B. DE SOTO,* WICBD

IMPORTANT though radio is in providing communication for the armed forces and between ships at sea, it is by no means the only form of signalling used. This fact has been discovered by many a young amateur who joined up with the Navy or the Signal Corps secure in the belief that because he knew radio he knew all there was to know about communications.

Actually, a knowledge of radiotelephone and c.w., even when supplemented with a smattering of wire telephone and telegraph, covers only a segment of the communicating methods in common use. It overlooks completely the highly-important field of visual signalling.

True, the smoke signals and signal horns that were used to transmit military intelligence in earlier times are no longer employed, but visual signals are still an important phase of the signalling art. In the many instances where use of radio is inadvisable or impractical — where radio silence must be preserved, where telephone wires cannot be strung, when shellfire has damaged other links — in such situations as these hand signalling is used as much or more in World War II as it ever was.

Who Needs to Know Visual Signalling

The purpose of this article is to supply some of the basic fundamentals of these direct methods of signalling. If you expect to enter signalling work in the Army or Navy — especially the latter — this is for you. If you are going into the Navy, a knowledge of visual signalling will be especially useful, because every Navy recruit is required to know semaphore — but the Signal Corps uses it, too.

Apart from the training angle, a knowledge of signalling procedure could mean the difference between life and death in any one of a number of situations. A soldier might have occasion to use it in case of shipwreck or aerial crash, for instance, signalling to shore or to other craft afloat or aloft.

Nor is potential use of visual signalling techniques limited to members of the naval or military establishments. If you are contemplating getting into marine operating, the information given here will be vital to you. Even on land, no one knows better than the radio amateur that circumstances can arise when all ordinary means of communication are made useless and only extraordinary

methods will serve. It's not only in fiction that the ex-Boy Scout finds himself in a tight spot and saves lives by his knowledge of semaphore and the Morse code; it happens in real life, too.

Far-fetched? Improbable? Listen. It all comes under the heading of preparedness. And the ham is the lad who is prepared — remember? It's because hams were prepared that they're able to do the unbelievably magnificent job they are doing to-day for the armed services — in industry and research — throughout the war effort. War itself was far-fetched and improbable when that preparedness began.

Hurricanes and floods and tornadoes are improbable, too. But they aren't *impossible*. And that's why we prepare for them. It isn't the expected event that becomes an emergency; it's the unexpected, the far-fetched, the improbable. And the more you know, the better equipped you are to handle the emergency when it comes, the better your chances for survival.

Visual signalling is one more element of knowledge that every trained communications man — amateur or professional — can well add to his equipment against the emergency need that may some day come.

Basic Methods

Apart from wire and wireless, there are five basic signalling methods involving the use of codes: (1) aural; (2) blinker; (3) wigwag; (4) semaphore, and (5) the international flag code.

The first three require little or no new knowledge on the part of the radio amateur, because they all involve use of the Continental code. Reading aural sound signals made by whistles, fog horns, sirens, etc., is no more difficult, for example, than reading ordinary c.w.

The use of blinker — sending code by flashing lights, either switching the beam off and on or, more often, interrupting it with a shutter — requires a bit of practice to adapt oneself to the use of another sense in transmitting the signal to the brain, but most hams can acquire a speed of 8 to 10 w.p.m. in a few hours — and that's the accepted standard. In fact, 12 w.p.m. is about the maximum encountered in practical blinker work. Now that amateurs are becoming interested in light-beam communication, an automatic upswing of interest in blinker seems a logical development.

The third method — wigwag — is a little

* Assistant Editor, QST.

tougher. It is seldom used these days except when nothing else will serve. Since wigwag is the only flag method based on the Continental code, it is just as well for amateurs to understand the basic principle, however. This principle is the dipping of a *single* flag or steady portable light to the *left* for a dot and to the *right* for a dash. These directions are from the position of the receiver; if you're sending they will be reversed, of course. Between dots and dashes the flag or light is held vertically above the head.

And that's all there is to it. Obviously, the wigwag method is slow and cumbersome, and for that reason is little used now except when nothing else will serve. If you can send more than a couple of words per minute with this system, you're good!

Semaphore

It was the need for a faster, better method that led to the development of the two-flag or semaphore method. This happened along about Napoleon's time, when shore-to-ship communication and inland telegraph relaying were accomplished by the use of fixed semaphore stations with tall masts and giant signalling arms.

Semaphore is now the most commonly-used system of visual signalling. It uses a code all its own, bearing no resemblance to the dot-and-dash code, and therefore one which must be learned quite anew. With practice, speeds up to 25 w.p.m. can be attained by semaphore, however, and this extra speed makes the extra effort involved in learning it worthwhile.

Semaphore signalling is usually done with a pair of identically-colored hand flags (portable

lights, signal arms, etc., are used on occasion) by which the message is spelled out in accordance with the basic alphabet shown in Fig. 1. There being no numerals or special characters other than those for "Attention" and "Break," all numbers and symbols are spelled out in full. Special meanings can, of course, be given certain letters by prearrangement, and code groups are often used to shorten transmission time. The standard letter symbols encountered in radio work are applied for this purpose. In fact, you can usually use radio abbreviations with any of the visual signalling methods and not be far wrong.

In signalling by semaphore the signalman first makes the "Attention" signal (waving both flags at arm's length). He does this until the receiving operator acknowledges with the letter "C." Then he proceeds to spell out the message. As each word is completed he drops his arm to the position shown for the "Break" signal. Each word is acknowledged by the receiving operator with the acknowledgment sign "C"; if no acknowledgment is received, the sending operator repeats the word. In addition to its use between words, the "Break" sign is also used between double letters; in this case, after completing the first letter the arms are dropped to the "Break" position and then immediately raised to form the repeated letter, without waiting for acknowledgment. The international code symbol "AR" is commonly used to indicate the end of a message.

International Flag Code

The final visual signalling method is the use of the international flags and pennants. This system is identified chiefly with the merchant

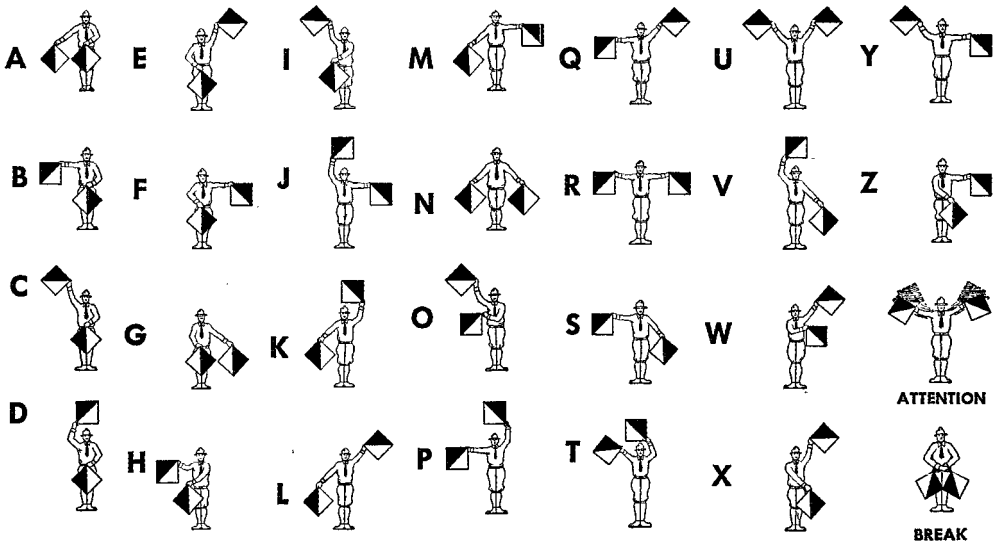















Fig. 1 — The Semaphore alphabet.

A Affirm		I am undergoing speed trial.
B Baker		I am taking on or discharging explosives.
C Cast		Yes (affirmative).
D Dog		Keep clear of me; I am maneuvering with difficulty.
E Easy		I am directing my course to starboard.
F Fox		I am disabled; communicate with me.
G George		I require a pilot.
H Hypo		I have a pilot on board.
I Int		I am directing my course to port.
J Jlg		I am going to send you a message by semaphore.
K King		You should stop your vessel instantly.
L Love		You should stop. I have something important to communicate.
M Mike		I have a doctor on board.













N Negat		No (negative).
O Option		Man overboard.
P Prep		(In harbor) All hands should come aboard; vessel is about to go to sea. (At sea) Your lights are out, or burning poorly.
Q Queen		My vessel is healthy, and I request free pratique.
R Roger		The way is off my vessel; you may feel your way past me.
S Sail		My engines are going full speed astern.
T Tare		Do not pass ahead of me.
U Unit		You are standing into danger.
V Victor		I require assistance.
W William		I require medical assistance.
X X-ray		Stop carrying out your intentions and watch for my signals.
Y Yoke		I am carrying mails.
Z Zed		(Used to call or address shore stations.)

Fig. 2 — International code flags and pennants.

marine and naval services, but it is also used in conjunction with aircraft, particularly those flying over water routes.

The International Flag Code is actually a dual-purpose system, in that each of the flags not only represents a letter or numeral but also has a special code significance of its own. Thus both plain-language messages and code groups can be transmitted. In practice, a comprehensive list of internationally-recognized abbreviations is used almost exclusively for actual communication; if word-by-word plain-language transmission of any length is required, the international code flag "J" is hoisted and the communication carried on in semaphore.

There are 26 letter flags in the International Code, 10 numeral flags (used in the text of messages), 3 substitute or repeater flags, 10 numeral pennants (used in calling) and several special pennants. These are shown in Figs. 2 and 4. In addition to their significance as characters of the alphabet used in spelling out coded or plain-language text, the letter flags each bear a special significance of their own when hoisted singly or in pairs. These code meanings are also shown in the tabulation, as they apply to the individual flags. Space precludes a detailed listing of the 2-flag symbols, but these may be obtained from official sources as discussed at the end of this article.

In the U. S. Navy each flag is identified by name as well as by letter, to reduce the possibility of error; these names are shown under each letter in Fig. 2. The letter "A" is given the name "Able" in the International Code, but the Navy calls it "Affirm." This is because in the International Code the symbol "C" means "affirmative" while in the Navy code "A" has the same meaning. The name "Int" for "I" is an abbreviation for "interrogatory," "Negat" for "negative," and "Prep" for "preparatory."

When using the flag code a message is spelled out by assembling the flags required for the necessary characters and attaching them in order to a halyard, which is then strung aloft. This is called a flag hoist. Obviously, the number of characters that can be sent in one message is somewhat limited, and brevity in composition is therefore essential. However, since it is the master of the craft who composes the messages, that won't ordinarily be your worry!

To avoid the necessity for carrying extra sets

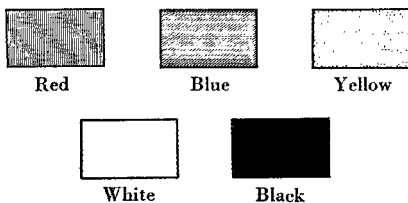

Fig. 3 — Color identification code.

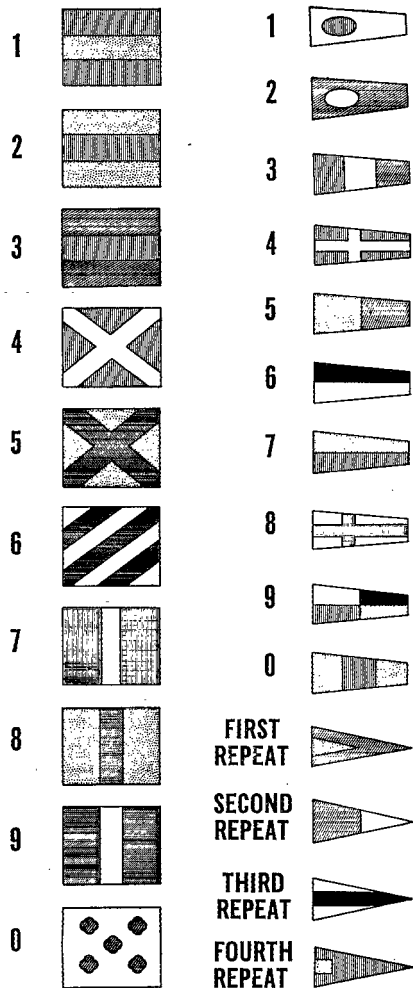

Fig. 4 — Numeral flags and pennants.

of flags, repeated letters are shown by the use of "repeater" or "substitute" pennants. The appearance of one of these pennants in a string of letter flags or pennants indicates that preceding characters are repeated. The first repeater pennant indicates that the top flag is repeated, the second repeater the next flag below it, and so on.

In order to reproduce the multi-colored signal flags in black-and-white, it has been necessary to adopt certain conventions to indicate the various colors (see Fig. 3). It should be emphasized that these are shown only for information, and it is not recommended that you attempt to use the flags as they appear here in practicing identification. It will probably only prove confusing when you attempt to identify actual flags. Instead, color the shaded areas with crayon or water-

(Continued on page 76)



OFF THE ULTRAHIGHS



CONDUCTED BY E. P. TILTON,* W1HDQ

For a while after the complete closedown of all amateur activity this department's correspondence dropped practically to zero, and no amount of digging on the part of your conductor seemed to produce any results in the way of interesting material. But recently things are looking up. We're beginning to become used to being a nation at war, and having been without our regular contacts we are just beginning to discover that the friendships we made over the air are really worth keeping up — even if we do have to QSO by means of pen or typewriter.

And war has made plenty of changes in our ranks already. A large percentage of the whole amateur fraternity is on the move, either in the various branches of the service or in civilian work pertaining to the war effort. Because u.h.f. enthusiasts generally are a clannish sort we think it will be of interest to record some of the shifts that have been made. Insofar as possible we shall try to make this department a clearinghouse of information as to new addresses, in order that correspondence may better serve to keep us in touch with one another during this period when a friendly letter now and then may mean so much to a fellow who has suddenly been shifted to some new assignment far from home and friends. Here is the latest dope on who is where:

Henry Wehrly, W1DLY, formerly of Gilbertville, Mass., comes to light in Prairie du Sac, Wisc., where he has gone to work at the Badger Ordnance Works. He sends us the first report of the year on reception of f.m. skip DX, having heard W43B, Paxton, Mass., W1XSN, Springfield, and W2XMN, Alpine, N. J., and several other weak signals, on April 16th between 6:30

* 329 Central St. Springfield, Mass.

and 8:30 P.M. Henry hopes to have an opportunity to look up some of the u.h.f. men in the region around Milwaukee before long. His address is Box 282, Prairie du Sac, Wisc.

"Big Ed" Remorenko, W3GUF, of Chester, Pa., is now an ensign and is stationed at the Philadelphia Navy Yard, but he doesn't expect to be there much longer.

W6OVK writes that W6PGO is a second lieutenant in the Signal Corps, stationed temporarily at Tucson. W6SLO is doing civilian radio installation work for the Navy. And a letter from Pvt. Clyde Criswell brings us up to date on the whereabouts of W6QLZ. Clyde writes from Wm. Beaumont Hospital, El Paso, but we haven't been able to find out whether this hospital business is an assignment or a confinement. He's hoping to get into the Signal Corps, but is wondering whether he will make it, in view of the fact that a friend of his who is the holder of a first-class ticket is learning to play the bugle!

Jerry Keefe, W9HAQ, Davenport, Iowa, gives us the low-down on several of the W9s who used to be heard on Five. Barney Miltner, W9IFB, is working in an aircraft factory in California. George Hanna, W9KZP, is an infantry sergeant and may have a commission by the time this appears in print. Jerome Keefe, the other half of the brother act at W9HAQ, is in the Signal Corps at Paine Field, Wash. Jerry reports that W9NFM, Solon, Iowa, has changed his ten-meter beam over to the proper length for the f.m. band, and is getting fine reception from stations around Chicago, about 240 miles away. W9HAQ took a trip up to see W9ZHB recently and found Ed the proud possessor of the "five-meter Oscar" from the U.H.F. Club of Chicago. We've had no

official confirmation of this from the Chicago club but we subscribe to their choice most heartily. Certainly no one in the whole Middle West area has done more to advance the cause of the ultrahighs than has W9ZHB. Which reminds us that the war probably prevented the first 56-Mc. WAS from being completed during this year. Ed was up to 42 or 43 states the last we heard!

Al Sear, formerly W1JNA, is now in San Juan, P. R. He was operating for a short time prior to Dec. 7th as K4IF0, having gone down there last summer on an FCC



The 12-element 56-Mc. array and businesslike layout of Jerry and Jerome Keefe, W9HAQ, Davenport, Iowa.

job. And if there are any others you haven't heard from for some time, they're probably in Washington, from what we hear from Mel Wilson, WIDEI.

Which brings us around to this business of observing and reporting the skip conditions noted during the summer on the f.m. band. Mel has been studying the distribution of f.m. stations over the country and is of the opinion that careful observation of the f.m. band in all parts of the country should provide a pretty fair picture of the prevalence of sporadic *E*. There is probably no point in the country where some f.m. signals would not be heard during a real opening. Thus far only two reports have been received — the WIDLY account already mentioned and a card from W8VUA/3 at Princeton, who reports that the last f.m. skip he heard was on Nov. 28th, when W45BR was logged between 8:15 and 9:30 p.m. As the sporadic *E* season is just about getting underway as this is being written, we hope to have a much larger list by next month.

With the advent of spring and with it that old feeling of DX in the air, some of us are just getting around to full realization of what it means to be off the air. We are just beginning to understand what a large part our hobby played in our lives, and we now look about for something to take its place. Of course all of us are plenty busy these days, and we understand that our first duty is to see that we are missing no opportunity for personal contribution to the war effort — but we still have some leisure time. What can we turn to in order to make the best and most interesting use of what free time we have in these hectic days?

We believe that we have come across an interesting pursuit which is directly allied with u.h.f. radio in the study of meteorology or, as it is now frequently called, aerology. A preliminary survey of the subject indicates that it fits in so nicely with our past work and would be of such value in any future u.h.f. efforts that this department might well devote at least part of its space each month to a consideration of amateur aerology, if interest in the subject warrants.

What is a temperature inversion? What causes one, when may it be expected, and where? Why is Southern California the scene of the country's most frequent and pronounced inversions? Can u.h.f. propagation conditions be gauged by watching cloud formations? What is ionization, of which we speak so glibly, and what is the latest accepted information regarding aurora? Why do some sections of the country show their most favorable u.h.f. conditions in the winter, others in spring or fall? These and many other questions have come up in our minds in connection with our work on the ultrahighs. What better time than now to get about finding the answers?

It may be something of a surprise to many to learn that our present knowledge of weather and allied phenomena is, some of it, very new. As

recently as 1934, when Ross Hull was formulating his temperature-inversion theory of u.h.f. wave propagation, high-altitude soundings and air-mass theories were just about well established in their present important place in the study of weather. Ross, always ahead of his time, was probably the first to visualize the potential value of point-to-point u.h.f. communication in the prediction of weather conditions — a potentiality which has never yet been fully exploited.

The recent ban on weather reports in newspapers or by radio has served to whet our interest in this weather business. There was a time not so long ago when there was very little in the way of readable material available on the subject, but books on weather are becoming more common on our book-store shelves. An example is the recent best-selling novel, "Storm," by George R. Stewart, the main theme of which is the work that goes on in a big-city Weather Bureau office. More strictly scientific but still interesting reading is "Weather and the Ocean of Air," by William H. Wenstrom, Major, U. S. Army, retired, and a former ham. Major Wenstrom draws from years of experience in the Army weather service in setting forth the fundamentals of our newly-developed knowledge of weather and the factors governing it. The means of establishing oneself as an amateur aerologist are detailed, and countless points in connection with aerology (many of which are directly related to various u.h.f. phenomena) are cleared up in an entertaining and instructive manner. We recommend it highly to anyone who has any real interest in finding out more about what is, to many of us, the most intriguing angle of u.h.f. work — analysis and prediction of the day-to-day variation in u.h.f. signals that come from beyond visual distances.

We know of several amateurs who have been dabbling in meteorology for years. We invite these fellows and others to send in information about their work along this line, together with any suggestions as to how a program combining our dual interest might be worked out.

Strays

In 1923, two youths in knee pants, one in Texas, the other in Colorado, made their first contact via ham radio. Throughout the years they have kept in close touch by both radio and correspondence. To-day they are both old timers, are married and have families. They will meet for the first time in eighteen years at this year's annual ARRL board meeting, for each now is the director for his division. They are none other than Wayland "Soupy" Groves, W5NW, of the West Gulf Division and Ray Stedman, W9CAA, of the Rocky Mountain Division.



HINTS AND KINKS FOR THE EXPERIMENTER



ELIMINATING GAS-DRIVEN-PLANT INTERFERENCE

K7ARG's reference to receiver noise from gas-engine-driven power installations on page 62 of *QST* for February indicates that many others may be having the same difficulty. It happens that I have had the job of eliminating noise generated by several plants, so perhaps I can suggest some effective relief.

The most important point is that of grounding the frame of the generator and one side of the output line. The ground lead should be short to be effective, otherwise grounding may actually increase the noise. A water pipe may be used if a short connection can be made near the point where the pipe enters the ground, otherwise a good separate ground should be provided.

The next step is to loosen the brush-holder locks and slowly shift the position of the brushes while checking for noise with the receiver. Usually a point will be found (almost always different from the factory setting) where there is a marked decrease in noise.

From this point on, if necessary, by-pass condensers from various brush holders to frame, as shown in Fig. 1, will bring the hash down to within 10 to 15 per cent of its original intensity, if not entirely eliminate it. Most of the remaining noise will be reduced still further if the high-power audio stages which manufacturers insist on hanging in their receivers are cut out and a pair of cans tied right into the second detector!

— *Herb Wallece, W8BQ.*

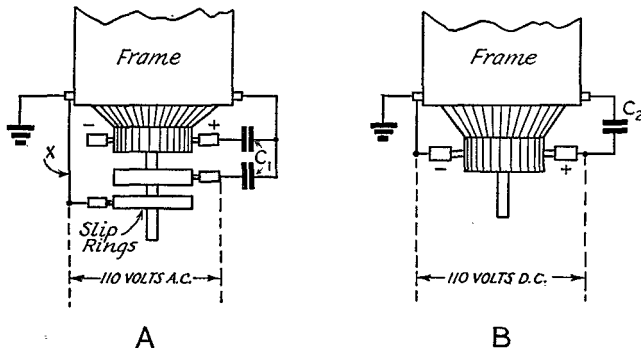

Fig. 1 — **W8BQ** indicates connections for eliminating interference from gas-driven generator plants. C_1 should be $1 \mu\text{fd.}$, 300 volts, paper, while C_2 may be $1 \mu\text{fd.}$ with a voltage rating of twice the d.c. output voltage of the generator. "X" indicates an added connection between the slip ring on the grounded side of the line and the generator frame.

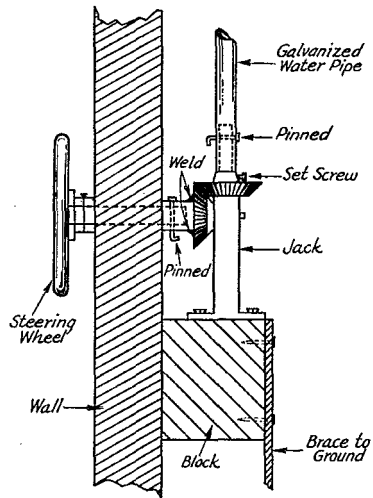

Fig. 2 — Inexpensive antenna rotating mechanism devised by **W9EMQ**. Details are given in the text.

LOW-COST BEAM-ROTATING MECHANISM

FIG. 2 shows a sketch of an inexpensive arrangement which I have been using to rotate a medium-weight directional antenna. A piece of $\frac{3}{4}$ -inch pipe is welded to the side gear of an old Ford Model-T-type jack, after the handle has been disconnected by driving out the pin which holds same to the frame. The pin which holds the gear on top is also driven out. This gear is then drilled and tapped with a small hole and a bolt is tightened down on the jack shaft to hold it securely against turning. A hole is also drilled through the jack shaft to match the one which is bored through the pipe mast and a pin or spike is inserted and clinched, so that the jack will drive the pipe.

This arrangement is mounted on a block of wood by screws through holes drilled in the foot of the jack, and the whole assembly is nailed to the side of the house. A half-inch hole is bored through the house wall and a piece of $\frac{1}{2}$ -inch rod is inserted

through this hole and into the piece of pipe welded on the jack side gear. A hole is drilled through both the rod and pipe and a nail or pin inserted to keep it from turning. On the inside of the house an automobile steering wheel is pinned to the rod. This makes a very neat and convenient way of rotating the beam.

Another similar mechanism built here has a drum screwed to the side gear and two or three turns of rope wrapped around it. The rope leads to a similar drum through the window sill which is turned by a handle on the inside drum.

A pointer or marker can be fastened to the steering wheel so that the direction of the beam may be determined. I have a small map mounted on the wall behind my steering wheel so that the pointer shows the direction in which the beam is pointed. I hope that this will help solve the problem of how to rotate a homemade beam, which is one of the biggest problems that must be dealt with in beam construction.

— H. Gordon Gwinn, W9EMQ.

HINTS ON WINDING COILS ON SMALL POLYSTYRENE FORMS

IN WINDING a coil of large wire on a small-diameter polystyrene or bakelite form, the process can be simplified by first winding the coil on a smaller-diameter form with a few more turns than is necessary. The coil is then removed from the small-diameter form and worked onto the larger form. Once it is properly in place it can be doped on the form, and the result is a firm coil which will not be as subject to change as one that is wound only for the finished diameter. This method also has the advantage that no holes in the coil form are necessary for fastening ends of wire. — Jack Hill, W9ZWW.

OPERATING A HALF-WAVE DOUBLET AT THE SECOND HARMONIC

FIG. 3 shows an effective arrangement which we used at W4GNQ for operating a half-wave doublet with low-impedance feed line at the second harmonic. All it requires is the addition of a single-wire feeder, insulated from the antenna and spaced from the low-impedance line by means of standard spacers. At the fundamental, the additional feeder is idle and the system performs in the usual manner as shown at A. To operate the system at the second harmonic, the two conductors of the low-impedance line are connected together to form one side of an open-wire line as shown at B. If the line and the added feeder are one-quarter wavelength long, no tuning apparatus will be

required. With longer lengths, series or parallel turning should be used, depending upon the length of the line.

At the harmonic, the two halves of the antenna operate out of phase, so the radiation pattern will be of the clover-leaf type as it would be if the antenna were fed at the end.

— Eugene Black, W2ESO, ex-W4GNQ.

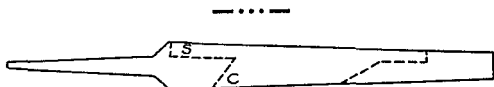

Fig. 4 — A hole cutter made from an old flat file. The steel may be cut readily with a hacksaw after heating.

HOMEMADE CIRCLE CUTTER

CIRCLE cutters for cutting holes up to 2 inches in diameter may be made quite readily from discarded flat files. The file should first be heated to a cherry red and allowed to cool slowly. This should soften the steel sufficiently to permit cutting it with a hacksaw.

The pattern of the cutter is shown in Fig. 4. Exact dimensions will depend upon the diameter of the hole desired. The end opposite the cutting end is shaped so that it may be clamped in the chuck of a carpenter's brace. The centering spindle, S, should be filed down to fit accurately a hole made by a drill of standard size, say 1/4-inch. It does not necessarily have to be round, however, so long as it will turn in the centering hole without undue play. The cutting edge, C, may be filed roughly to shape before hardening.

The hardening process consists merely of again heating the steel to a cherry-red color and immediately dousing it in water. I found that oil tempering made the steel too hard. It is advisable to temper only the cutting end back for a distance of an inch or so, since this prevents snapping off of the cutter up near the end held in the chuck.

After hardening, the cutting edge may be ground for proper cutting qualities. It is, of course, necessary to drill a hole to fit the cutter spindle at the center of the circle to be cut out.

— Robert B. Sayers, W8TUC.

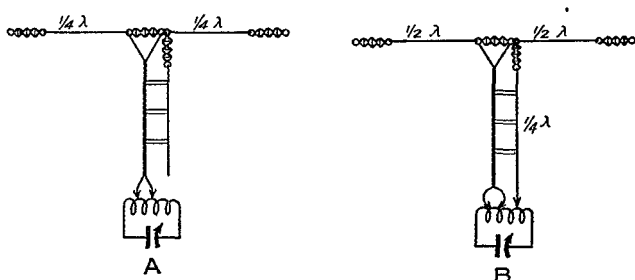

Fig. 3 — Scheme used by W2ESO for working a doublet antenna at the second harmonic. A shows the conventional arrangement for fundamental operation, while B shows the added feeder for harmonic operation.



CORRESPONDENCE FROM MEMBERS

The Publishers of *QST* assume no responsibility for statements made herein by correspondents.

RADIO IN THE ARMY

Somewhere in U. S. A.

Editor, *QST*:

. . . In my present position in the Army, I would say that what we need most is a lot of hams who can make a lousy, antiquated rig load up to a putrid antenna, and who can copy fifteen per through any noise from a military band to an anti-aircraft barrage. No kidding — the Army can teach a boy to copy 20 words per minute off of a tape sender, but the product of that system just can't sense code when the QRM is thick. . . .

It might interest you to hear a little about the station my platoon is now operating. We have the G.I. rig, which fits nicely into a 1½-ton panel truck and a 1-ton trailer. We also have a Meissner Signal Shifter, driving a pair of '10s at about 90 watts input, which works like a charm and doesn't take too much room. The Meissner belongs to my radio sergeant. We built the p.p. amplifier out of some junk parts we gathered in town here. The power supply for the final was built out of some junk left here in town by a National Guard infantry company now in Hawaii. One of their officers once had a p.p. '10 t.n.t. rig, which we found dismantled in a local armory. Were we delighted to find it! For a receiver, we have my Hallicrafters S-29, plus an old d.c. National SW-5. The antenna is a current-fed Zepp. Imagine how many hams would burn with envy if they knew someone in the Army was building and using ham rigs! As could be expected, the ARRL Handbook is always handy, and getting a bit dog-eared. . . .

Now, as to this matter of the government wanting ham gear. I don't know what they want it for, but I have an idea. So far as the Army in the field is concerned, ham equipment is not practical. The Signal Corps is standardizing all of its equipment so that there will be very few types of receivers issued, and very few types of transmitters. Many of the transmitters have components common to other transmitters — an admirable practice. In other words, the receiver out of a wrecked tank might be yanked out and put into a Flying Fortress by moving four snap fasteners and removing a power cable.

On the other hand, outside of the forces in the field, the Army has literally hundreds of fixed radio stations — some new, some with old equipment. Old Comet Pros, for example. . . . Can

you think of any better place for a ham's HRO or RME-70 or Super-Pro or SX-28 than in an air-base radio station, safeguarding the lives of several pilots with only radio communication to give them necessary orders? There is one place where good ham receivers would serve better than in a dust-covered shack. (Many an airplane radio operator is a ham, just like yourself.) There are lots of fixed stations whose transmitters could stand remodeling, too, and I don't doubt but what ham parts might do the job. You see, in a fixed station, it isn't quite so important that the screws and knobs be "of color prescribed by Army regulations." . . .

Now, that is just my idea of what might be done with a collection of ham parts. Far more important than the gathering of such small items is the devotion of *every* good commercially-designed and built receiver to war purposes. In my mind, it shouldn't be a question of whether or not a ham wants to *sell* his receiver to the government; the President has the right to confiscate it. If I had a top-notch receiver sitting around, I'd paint on the inside cover: "73 and good luck from W8 — ; CU when the war is won" — and let the Army use it for the duration. When I got the receiver back (if I did), it would mean much more to me than \$179.80 worth of beautiful parts. Don't you agree? Just what do you think has happened to all the HRO's in Europe? My guess is that they are very much in use — by our enemies.

At this point I'd better stop sounding off. I wish that you could see my radio equipment. Most of it is vehicular, and can be on the air instantaneously. The ops are equally handy with the key or with the tommy-guns, which give us a feeling of not being exactly helpless. . . .

We have here an HQ-120-X that was purchased out of training funds. You can bet your last defense stamp that it will go to hell and back with the outfit!

— Lt. —

EDITOR'S NOTE — In this and other cases where, for reasons of military regulation, members of our armed forces require the cloak of anonymity in reporting observations and expressing views, *QST* is glad to relax its policy against the printing of unsigned communications and therefore withholds the name of this correspondent.

NOW IS THE TIME . . .

Fort Bragg, N. C.

Editor, *QST*:

The League has long been expounding the importance of amateurs in the national effort. But not until I became a soldier myself could I realize just what our part is.

Uncle Sam needs radio operators immediately, and hams like myself must fill this need. Now is the time we are really appreciated, and our service now assures us that a wise government will restore our bands when the struggle is over.

Let me say a word of appreciation for *QST*. When it comes in every month, undiminished in size and full of timely articles, we know the amateur spirit is alive and will live, war or no war. If we stick to our guns, we'll be pounding brass and grumbling about QRM again.

— *Pvt. Leonard O. Hayden, W3IWS*

A CHANCE TO BE OF SERVICE

Kansas City, Kansas

Editor, *QST*:

Those of us at home who have to win the bread and butter for the rest of the family, the ones who have been living on borrowed time and the ones who cannot pass the physical exam — sure, we all want to help, too. We have our emergency rigs ready; we serve as air raid wardens, and we have taken the first-aid course.

But it seems to me that we are not doing a job that we could do and do very well. It is right down our alley, and we have the necessary equipment with which to do it.

These Axis U-boats have been doing a little too much damage to our merchant shipping for me to believe that it has all been just lucky contacts. They must be receiving information on ship sailings and destinations, and I am willing to bet my e.c.o. that it is by radio.

Why can't we spend a little time each day listening in on all the frequencies for stations that are phonies? Undoubtedly they use coded messages which presumably are sent on c.w., so it might be next to impossible for us to figure out what they are saying. But if the station happened to be located locally, which would be apparent by a loud signal and blocking effect on the receiver, and we knew that it was not a commercial station, it should be reported to the local FCC office or ARRL headquarters to be checked. The fellows who want to do a little more can build up some direction-finding equipment, and when a station is heard that cannot be identified and is not a local, send the bearings in to Headquarters. If several fellows had heard the station, taken bearings and sent them in, it should be possible to tell the location.

The agents may send the dope in a coded form by Western Union to a far inland location to be

rebroadcast on the high frequencies. Even we fellows who are located far inland might be in the same neighborhood with a fifth-column station. . . .

I know the FCC has listening posts all over the country, but there are a lot of frequencies to be covered and we can help. . . .

It sure would help to cinch our getting back on the air after this mess is over if some of us fellows at home could detect and locate some of the fifth-column stations. Quite often we read in the newspaper about the FBI raiding a fifth-column hide-out and finding radio transmitters, so we know that they have them and must be using them. Fellows, let's see if we can't help detect some of these stations.

— *Willard B. March, W9SPN*

OTHER CHANCES TO BE OF SERVICE

Box 721, Caldwell, Idaho

Editor, *QST*:

. . . In your "The Experimenter's Section" you could very well have a section for air-raid alarms. My experience has been that many cities are having difficulty obtaining sirens, etc. A glance at a "Graybar" catalog will prove that a considerable p.a. system could be built for the price of a siren. It could consist of a Class "B" output stage with a portion of the output fed back to the input through a series resonant circuit to about 800 or 900 cycles, with a resistor in series to stabilize it. There is a big demand for air raid alarms, and it seems to me that electronic alarms have possibilities — perhaps something besides a giant p.a. job.

Another possible opportunity for hams to serve is in the field of anti-sabotage devices. A few well placed mikes (per-mag dynamic speakers, etc.) with an amplifier can be made to do wonders for protection of water tanks and other vital installations. Perhaps the signals could be amplified and sent into a police station by carrier! Other devices are described in *Electronics* for February. Of course, these ideas border on the commercial, but many cities and towns would welcome help along this line. It is a chance for hams to be of service and make use of idle equipment, as well as picking up a little pin money now and then.

— *Ray Harland, W7FRA*

P.O.W.

W6CIS reports that George M. Conklin, W6BVL, of Oakland, Calif., was taken at Guam and is now being held as a prisoner of war in Japan.



OPERATING NEWS

F. E. HANDY, WIBDI, Communications Manager

GEORGE HART, WINJM, Asst. to the Coms. Mgr.

Radio Training Programs. The Honor Roll including the names of the many Clubs and Associations maintaining instruction programs speaks for itself testifying to the extensive continuing contribution of these groups to our war effort. Our monthly Honor Roll in *QST* constitutes a record of the groups voluntarily undertaking code or code-and-theory radio training. The annual survey of the status of ARRL's affiliated clubs has just been completed and shows that approximately two-thirds of the clubs reporting are engaged in patriotic and useful radio training work. Fully half the programs involve theory instruction. The majority of the instructors use the ARRL Outline for a Radio Course and the 17-lesson Code Instructors' mimeograph. The average course of instruction runs about 14 weeks, though some are planned to continue as long as twenty-four weeks. The number under instruction averages about 15 people per group although certain reports show instruction to as many as 125 people going forward. Classes usually meet either two or three times per week in sessions that are of two to four hours duration.

This war doesn't belong to a small group of us at home or in the services; it belongs to all of us. It is our duty and privilege to contribute to the national effort as we can. Thousands of amateurs are already in the services or filling vital jobs on the home front. Many more thousands of radio specialists are needed for every branch of the rapidly expanding military forces. Every radio instructor and every live club with a Training Program may be considered as serving a vital and necessary function. Radio knowledge must be passed along and extended and put to work to make it valuable to the nation or the individual.

Starting Local Courses. There should be available some guidance in radio training in each locality. Most live radio clubs have undertaken the necessary programs as above outlined. An individual and qualified amateur can follow the ARRL material and carry on radio training successfully even without club support as has been arranged in some cases. Every hour of pre-military training in radio is one less hour required under government training to fit a specialist for service. Time is of the essence. Every man who can be equipped to get into specialized civilian radio work will release a man for radio applications in the services. It is a great service to the individual expecting a call to the services to re-

ceive specialized training which will help him toward a rating. Radio clubs in many instances have found new club members and group interest enhanced through their war training programs.

Copies of a bulletin outlining procedure to follow in getting space for radio classes and a suggested initial publicity release to help contact those interested in instruction will be mailed by ARRL to anyone requesting such information. If you are in a position where you can get radio training arranged where none is now in progress, through a radio club or otherwise, please take the necessary steps. If you are in a position to help teach code or theory to a group in your spare time you should feel that you are fulfilling a patriotic purpose by so doing. Drop a line to ARRL asking for our suggestions on getting instruction started, for the theory-demonstration outline, or the helps for Code Instructors, when you are actually ready to go ahead and we can help.

Four Editions of *QST* in One. Starting with this issue *QST* will present the SCM reports of activities from various Sections and Divisions all in one single edition. The designations "eastern," "western," "central" and "southern" on the last inside cover page will be dropped. The former mechanical sectionalizing of *QST* permitted long local reports with plenty of space for general interest and technical articles. The new plan of getting "Activities" of all Sections in each issue, for the duration at least, will help those members in the services far from home to benefit from any home news in the SCM's reports. Those ARRL members who had *QST* forwarded from home instead of sent directly to their distant posts to make sure of getting the home information can safely give us changes-of-address without fear of getting the wrong edition in the future. With thousands of members in service this solves a problem becoming increasingly complex in distribution of *QST*. The change enables the Hq. to give better service to all members.

Send Individual Activities to SCMs by June 18th. Drop your SCM a line each mid-month. His address is given on page 4. Reports later than that date will be delayed in reaching *QST* since wartime censorship of technical publications licensed for export has made it necessary to advance the date when SCMs mail reports to West Hartford slightly. The reports of radio training plans, CAP and civilian defense programs, on experimental communication, etc., help keep us

Honor Roll

The American Radio Relay League War Training Program

Listing in this column depends on an initial report of the scope of training plans plus submission of reports each mid-month stating progress of the group and the continuance of code and/or theory classes. All Radio Clubs engaged in a program of defense radio training are eligible for the Honor Roll. Those groups listed with an asterisk teach both code and theory; those listed with two asterisks teach theory only. Others conduct only code classes.

Albuquerque Communications Club, Albuquerque, N. M.
 Allegheny Valley Radio Club, Verona, Pa.
 Amateur UHF Club, New York, N. Y.
 *American Women's Voluntary Services, New York, N. Y., St. Louis, Mo. (sponsored by YLRL).
 Caltech Radio Club, Pasadena, Calif.
 Central New York Radio Club, Syracuse, N. Y.
 *Central Oregon Radio Club, Bend, Ore.
 *Clinton Radio Club, McManus, La.
 *Dickson City High School Radio Club, Dickson City, Pa.
 *Dutchess County Sheriff's Emergency Radio Corps., Poughkeepsie, N. Y.
 East Texas State Teacher's College Amateur Radio Club, Commerce, Texas.
 Elgin Amateur Radio Defense Council, Elgin, Ill.
 **Federation of Long Island Radio Clubs, Jamaica, N. Y.
 *Field McKinley Memorial High School, Coffeyville, Kans.
 *Five Towns Defense Council, Cedarhurst, L. I., N. Y.
 Flood City Radio Club, Johnstown, Pa.
 Galveston Amateur Radio Club, Galveston, Texas.
 *Goshen Amateur Radio Club, Goshen, Ind.
 Green Bay Mike and Key Club, Green Bay, Wis.
 *Haverford High School Radio Club, Upper Darby, Pa.
 *Heart of America Radio Club, Kansas City, Mo.
 *Indianapolis Radio Club, Indianapolis, Ind.
 Joliet Amateur Radio Society, Joliet, Ill.
 Knoxville Radio Communication Club, Knoxville, Tenn.

Monroe County Radio Communications Association, Monroe, Mich.
 Mountaineer Amateur Radio Association, Fairmont, W. Va.
 Muskegon Area Amateur Radio Council, Muskegon, Mich.
 *Muskingum Amateur Radio Association, Zanesville, Ohio.
 National Radio Club, Chicago, Ill.
 Northern Minnesota Amateur Radio Association, Unit One, Bemidji, Minn.
 *Omaha Radio Defense Club, Omaha, Nebr.
 *The Peddie School Radio Club, Hightstown, N. J.
 *The Pennsylvania State College, State College, Pa.
 Pierre Amateur Radio Club, Pierre, So. Dak.
 Portland Amateur Wireless Association, Inc., Portland, Maine.
 Queen Anne Radio Club, Seattle, Wash.
 *Sedalia Amateur Radio Club, Sedalia, Mo.
 Sunrise Radio Club, Hollis, N. Y.
 *Union County Amateur Radio Association, Elizabeth, N. J.
 Union County Regional High School Code Club, Springfield, N. J.
 *Valley Radio Club, Spring Valley, N. Y.
 *Vashon Island Radio Club, Burton, Wash.
 *Wallingford Amateur Radio Association, Wallingford, Conn.
 Walnut Hills High School Radio Club, Cincinnati, Ohio.
 Wausau High School Radio Club, Wausau, Wis.
 *West Philadelphia Radio Association, Philadelphia, Pa.
 *W.P.A.-Park Department Recreation Radio Club, Fitchburg, Mass.

all informed and progressing together — so every amateur is urged to send a card to the SCM each month. Clubs and Coördinators should be especially on the alert to send SCMs information on their group projects for *QST* mention.

Civilian Defense Plans — Keep Ready. Still no news or Washington pronouncement of OCD-DCB plans for supplementary municipal defense-radio facilities! But it would be a mistake for amateurs to conclude that the plans have not been under study by the proper authorities. Even if the shape of regulations when finally drawn does not resemble the "reactivation" of amateur facilities as tried in December, we shall find no fault with a program that adequately permits the enlistment of amateur facilities and operators in civilian defense radio. ARRL urges Emergency Coördinators and AEC members to "keep ready."

When the right time comes there may yet be important work on this civilian front. No group of persons is inherently more ready to help. It is our belief that CDC plans ought to permit personnel selections to be made from those most qualified and ready in the ARRL Emergency Corps. Just because announcement has not yet come is no reason to give up hope for a suitable plan. Keep ready! Any new word for amateurs will be bulletined promptly to all members of the Emergency Corps.

Signal Flags this Field Day? This is the month when, traditionally, ARRL holds its Field Day tests for operators and emergency equipment. But business is decidedly not as usual. There's a war on! The way we can help contribute to our country's demands and needs must come first with each of us. All with radio skill must

find ways to use it to add to the strength of the nation.

For all who want to broaden their knowledge of signalling (which is a broader field than radio alone) we commend the article on wigwag, semaphore and the international flag code which appears elsewhere in this issue. Serious practice will take one a long way in new techniques. To become proficient in this sort of signalling is well worth some time. If you are properly situated to pursue the matter in your spare time, some backyard practice is suggested right away. Working in pairs, amateurs should call out characters as they are interpreted from the flags, impressing a bystander for "recorder" if necessary. With some experience you will wish to try for greater DX. Then we also suggest a planned trek to the usual FD location if you can make it on that third weekend of June. This will make a good outing for those of the group that can be rounded up; it will rouse afresh the memories of the last ARRL Field Day. Don't forget to give the signal-flag idea a Field Day workout!

— F. E. H.

ELECTION NOTICES

To all A.R.R.L. Members residing in the Sections listed below: (The list gives the Sections, closing date for nominating petitions for Section Manager, the name of the present incumbent and the date of expiration of his term of office.) This notice supersedes previous notices.

In cases where no valid nominating petitions have been received from A.R.R.L. members residing in the different Sections in response to our previous notices, the closing dates for receipt of nominating petitions are set ahead to the dates given herewith. In the absence of nominating petitions from Members of a Section, the incumbent continues to hold his official position and carry on the work of the Section subject, of course, to the filing of proper nominating petitions and the holding of an election by ballot or as may be necessary. Petitions must be in West Hartford on or before noon of the dates specified.

Due to resignations in the Missouri, Arizona, North Dakota and Northern Texas Sections, nominating petitions are hereby solicited for the office of Section Communications Manager in these Sections, and the closing date for receipt of nominations at A.R.R.L. Headquarters is herewith specified as noon, Monday, June 15, 1942.

Section	Closing Date	Present SCM	Present Term of Office Ends
Alabama	May 15, 1942	James F. Thompson	May 22, 1942
Virginia	May 15, 1942	Frank S. Anderson	May 27, 1942
Montana	June 1, 1942	R. Rex Roberts	Apr. 15, 1942
Alaska	June 1, 1942	James G. Sherry	June 14, 1942
Kentucky	June 15, 1942	Darrell A. Downard	Apr. 15, 1940
Hawaii	June 15, 1942	Francis T. Blatt	Feb. 28, 1941
New Mexico	June 15, 1942	Dr. Hilton W. Gillett	Apr. 15, 1941
Sacramento Valley	June 15, 1942	Vincent N. Feldhausen	June 15, 1941
Nevada	June 15, 1942	Edward W. Heim	Nov. 1, 1941
Oklahoma	June 15, 1942	R. W. Batten	Nov. 1, 1941
Eastern New York	June 15, 1942	Robert E. Haight	Nov. 1, 1941
Western New York	June 15, 1942	Fred Chichester	Dec. 6, 1941
Southern Texas	June 15, 1942	Horace E. Biddy	Dec. 23, 1941
Missouri	June 15, 1942	Robert C. Morwood (resigned)
Arizona	June 15, 1942	John K. Oliver (resigned)
North Dakota	June 15, 1942	Don Beaudine (resigned)
Northern Texas	June 15, 1942	George W. Smith (resigned)
Santa Clara V.	Aug. 3, 1942	Earl F. Sanderson	Aug. 15, 1942
Western Mass.	Aug. 3, 1942	William J. Barrett	Aug. 17, 1942
Ohio	Aug. 3, 1942	E. H. Gibbs	Aug. 17, 1942
Southern Minn.	Aug. 3, 1942	Millard L. Bender	Aug. 22, 1942
New Hampshire	Aug. 17, 1942	Mrs. Dorothy W. Evans	Sept. 1, 1942
Western Penna.	Sept. 1, 1942	Elmer Krall	Sept. 20, 1942

1. You are hereby notified that an election for an A.R.R.L. Section Communications Manager for the next two-year term

of office is about to be held in each of these Sections in accordance with the provisions of the By-Laws.

2. The elections will take place in the different Sections immediately after the closing date for receipt of nominating petitions as given opposite the different Sections. The Ballots mailed from Headquarters will list in alphabetical sequence the names of all eligible candidates nominated for the position by A.R.R.L. members residing in the Sections concerned. Ballots will be mailed to members as of the closing dates specified above, for receipt of nominating petitions.

3. Nominating petitions from the Sections named are hereby solicited. Five or more A.R.R.L. members residing in any Section have the privilege of nominating any member of the League as candidate for Section Manager. The following form for nomination is suggested:

Communications Manager, A.R.R.L. (Place and date)
38 La Salle Road, West Hartford, Conn.
We, the undersigned members of the A.R.R.L. residing in the Section of the Division hereby nominate as candidate for Section Communications Manager for this Section for the next two-year term of office.

(Five or more signatures of A.R.R.L. members are required.)
The candidates and five or more signers must be League members in good standing or the petition will be thrown out as invalid. Each candidate must have been a licensed amateur operator for at least two years and at all times, a member of the League for at least one continuous year, immediately prior to his nomination of the petition will likewise be invalidated. The complete name, address, and station call of the candidate should be included. All such petitions must be filed at the headquarters office of the League in West Hartford, Conn., by noon of the closing date given for receipt of nominating petitions. There is no limit to the number of petitions that may be filed, but no member shall sign more than one.

4. Members are urged to take initiative immediately filling petitions for officials of each Section listed above. This is your opportunity to put the man of your choice in office to carry on the work of the organization in your Section.

— F. E. Handy, Communications Manager

ELECTION RESULTS

Valid petitions nominating a single candidate as Section Manager were filed in a number of Sections, as provided in our Constitution and By-Laws, electing the following officials, the term of office starting on the date given.

San Joaquin Valley	Antone J. Silva, W6QDT	Feb. 2, 1942
Indiana	LeRoy T. Waggoner, W9YMV	Apr. 15, 1942
Colorado	Stephen L. Fitzpatrick, W9CNY	Apr. 15, 1942
San Diego	Richard Shanks, W6BZE	Apr. 15, 1942

In the Eastern Massachusetts Section of the New England Division, Mr. Frank L. Baker, Jr., W1ALF, and Mr. Carroll O. Peacor, W1GAG, were nominated. Mr. Baker received 233 votes and Mr. Peacor received 49 votes. Mr. Baker's term of office began April 2, 1942.

Meters Needed

MR. D. E. GASKILL of the Lockheed Aircraft Purchasing Department suggests that all owners of electrical meters of all kinds submit lists of such equipment. All aircraft engineering departments need electrical meters for design and test work, but with meter manufacturers overloaded with orders even the aircraft industry's high priority rating can't get deliveries quick enough to permit this vital part of our war effort to speed ahead. Give all details such as make, model, range, case style, condition and price. The aircraft producers are willing to pay fair market prices on any such meters they requisition. So turn in your meters, invest the extra cash in war bonds and deal a double blow to the Axis.

This is just a sample of the potential need for apparatus, and ARRL has filled this need by submitting a meter list from its Apparatus Bureau. There seems to be a need for more voltmeters. All amateurs are urged to list any or all commercially-built radio communications equipment by filling out the blank, page 17, April QST and sending to the Apparatus Bureau, ARRL headquarters.

BRIEFS

Having trouble getting enough equipment for those code-practice oscillators needed for your code classes? W9UXH, Dayton, Ky., writes that he obtained all kinds of old radios by advertising for donations in the local newspaper. Twenty-two old radios were obtained this way, and he had the students of his class tear them down and build code-practice oscillators under his direction. He reports that the small speakers in midget sets are more suitable for oscillators than the larger speakers because they produce a better tone as well as take up less space.



ATLANTIC DIVISION

MARYLAND-DELAWARE-DISTRICT OF COLUMBIA — SCM, Hermann E. Hobbs, W3CIZ — 2NJE has moved to Dover, Del., from Plainfield, N. J., and reports his presence. Welcome, OM. W3CDQ has been down with the flu. The Washington Radio Club is trying to provide instructors for classes in radio to start this summer at the YMCA. These classes will lead to a second class radiotelephone license and the requirements for prospective students include high school physics or previous radio service work.

SOUTHERN NEW JERSEY — SCM, Lester H. Allen, W3CCO — Ass't. SCM, W3ZL Regional Coördinator in charge of Emergency Coördination, W3BAQ, Emergency Coördinators: Atlantic City, W3EFM; Camden, W3KW; North Plainfield, W3CGU; Vineland, W3GMY; Somerville, W3EBC. W3ABS reports that his Radio School for the Hillsborough Defense Council is well under way and has 37 students enrolled. FFE is about to graduate from the University of Penna. and is anxious to get into the Signal Corps. GNM is now attending medical school at Fort Sam Houston. JJX has left to attend teletype school at Endicott, N. Y. GSR is stationed at Camp Claborne and is anxious to hear from the boys. HAZ has just completed a course in high speed radio transmission and is about to become a permanent instructor at Fort Monmouth. FXN, JIX, HHY and IFT are now in radiolocator training. HOU, who is operating aboard a sea-going ship, is studying math and radio. FXV is doing radio operating aboard an oil tanker and says he is still afloat. The South Jersey Radio Association had a very interesting meeting this month at which the Halli-crafter film "Skyrider" was shown. The boys gave a membership in ARRL and a copy of the new ARRL Handbook as kitty prizes. The Delaware Valley Radio Association is still conducting its lectures in radio under the able guidance of ARN. GNU is now employed as a civilian teacher at Fort Monmouth. JOL has completed his new radio room. EUH is overhauling the generator equipment of the Delaware Valley Radio Association. GCU is devoting his spare time these days in editing and writing the DVRA News. JNO is now employed at the new broadcast station in Trenton. GRW is operating on one of the tankers. Don't forget, fellows, to keep the notes and news coming as the boys in far off corners like to know what their old friends are doing. Until next month, 73.

WESTERN PENNSYLVANIA — SCM, E. A. Krall, W8CKO. Asst. SCM in charge of EC, W8AVY. TVA has a new SX24 and has joined the ARRL. FB, NWY, RIT, UTT, TTD and several radio repair men and teachers hold radio theory classes at Greensburg. PER reports that FPH and EVE are now RM2c. FPH is studying at Grove City College. NCJ has a dandy room for radio at his new location but has not yet set up the equipment. The Allegheny Valley Radio Club is conducting code classes at 533 Spruce St., Verona, Pa. RTV says classes are held Monday evenings from 7 to 10 p.m. RAT is attending air raid meetings and finds them interesting. QAN is with the Air Corps as an operator and wants to hear from all his old friends. His full address is Pvt. Wm. K. Thomas, Flight 125, Sqn. 303, Keesler Field, Miss. VYU is teaching a code class Tuesday and Thursday evenings at Greensburg. By the end of May she expects her scholars to be in the 13 w.p.m. class. Mac and TTD are studying the AARS cryptography course and progressing nicely. The following Greensburg hams are in service: TFL, QVP and SYU. QXT has a new junior op. RTU is an Ensign and will be stationed on one of our largest aircraft carriers. OVT is a member of the Civilian Air Patrol and doing nicely with his Taylorcraft. PX is an Air Raid Warden at Dormont, Pa. Coöperation from all ORS and OPS is requested to keep this monthly report going.

NEW ENGLAND DIVISION

CONNECTICUT — SCM, Edmund R. Fraser, W1KQY — W1FSH, EC and Secy. of the Manchester Radio Club, reports a code class being conducted by BAX and LMK Tuesday nights at the Trade School, attendance 40. ATH, Secy. of NHARA, reports two code classes started and in their third week. Monday night's class is conducted by KQY and IGT with 26 attending. Tuesday night's class is conducted by KDO and JQK with 25 in attendance. A special class of 5 YL's from the local Red Cross is to start April 27th. Lou Henriksen, Secy. of the Conn. Brasspounders Ass'n., reports a theory class being run Wednesday nights at the club rooms in Noroton Heights, attendance 30. Code instruction will be given at the conclusion of the present class. All above mentioned groups are using the ARRL form of instruction. BIH, EC of Torrington, reports Asst. EC KXB has a code class well under way. Two of his former students have received their operator's licenses. JQK, EC of Hamden, reports that code and theory classes held at the high school under the direction of FWB and MEF have been successfully completed. KKS has applied for a position with FCC. Harry Johnson, ex-SF, has received his operator's license. Our congrats. to JHN and his XYL on the birth of a second daughter. DDX and Jack Naughton, both members of NHARA in the Navy, recently met in Washington, D. C. VB, FSH, FMV, BYW, KQY and TD have all sent in applications for part time monitoring jobs. Let's keep up the interest for those in the services. If each club Secy and EC would contribute some information on the 16th of each month we could make this column more interesting.

MAINE — SCM, Ames R. Millett, W1BAV — WINVA is a new registrant for the AEC. KEZ has been appointed chairman of the radio section of the Civilian Defense unit in Millinocket. The boys in Millinocket and East Millinocket have organized a local radio club there and elected MDK as their president. The PAWA at Portland has just organized a couple of fine courses in code instruction and radio theory as prescribed by ARRL. An invitation was extended to the general public through the local paper. The ARRL prescribed course for code instruction is certainly a great job and is very valuable for club class work. EBM is now in the Army. LRL has received another boost and is now a Major. LOA was up for induction but was turned down by the board. MYS is working in Bangor at the local broadcast station. LOA, ex-AME, MVS, BAV and Lou Darling of the State Police radio, and Tom Barry of the Portland Police radio, were at the University of Maine for a week going through a course in radio measurements. CRP and LNI are still experimenting with the new types of transmission. LOA and BAV are working on wired wireless. GOJ and KOH have returned from Georgia and are looking for something to do in defense work. A good way to keep in touch with each other is through this column, so if you will just send along the dope we can put it in here and that way we can all keep together.

EASTERN MASSACHUSETTS — SCM, Frank L. Baker, Jr., W1ALP. I want to thank you for your confidence in me and hope that my efforts in the next two years will meet with your approval. A few more new ECs: MZR for Topsfield, IHA for Quincy. GYZ is now a Lt. (jg) in the Navy. We all wish to express our sympathy to Ruddy, MME, on the death of his xyl. BNJ is now working for the FCC. MBQ has his class A ticket. MBG made use of his 2 kw. generator when power went off, FB in a real emergency. GDY has a new TR-4. JLK was appointed communications officer for Easton Defense Council. MQX reports that MNS is in the Navy and NIC is now living in Roxbury. AWA is in charge of communications in his town and is holding code classes every Monday night. MEZ is at Fort Monmouth. DPD is teaching some women in the Motor Corps the code; he is also radio officer in Amesbury. MMD is in the Navy. LO and JEL have built new record amplifiers. BDM is building a new all-band rig. MON is moving to Randolph. John Doremus, 3EDA, is in charge of radio in this state for the Committee on Public Safety. He has been holding meetings in Lawrence, Newton, Boston and various other places. The meeting in Boston was well attended by hams from Athol, Worcester, Fitchburg, Lowell, Lawrence, Winthrop, Sharon, Quincy, Milton, etc. At this meeting equipment for

the various warning centers was given out and it looked like an old-time hamfest. The meeting at Newton was called for the ECs in region 5 and in Lawrence for region 4. To all ECs; if you find that you are going into the service, I would appreciate it if you would drop me a line and if you cannot continue as EC please suggest some one in your town. Remember the hams that are away from home would like to hear from you and about you, so let's not fail them. After this all news will have to be in my hands by the 19th of the month.

WESTERN MASSACHUSETTS — SCM, William J. Barrett, W1JAH — At a meeting of the Berkshire County hams at Pittsfield recently the proposed plans for OCD work in radio were outlined by Mr. Doremus, State Radio Communications Officer for the Mass. Committee on Public Safety. The plans as yet have not been formally approved by Washington, but all the objectionable features of the first reactivation seem to have been overcome. From this it would seem that we will still have a chance to take an active place in the C.D. setup. NKN dropped a line saying he was back in Naval Aviation as ARM2c. MKR and KZS are in the Army service. FNY was married recently and is now with FCC. ADF is home again after an operation at Boston hospital. EOB was married recently. How about dropping me a line the fifteenth of each month, fellows? Report your activities in other types of communication, club schools of instruction, etc.

NEW HAMPSHIRE — SCM, Mrs. Dorothy W. Evans, W1FTJ — HFO is now a radio engineer located at Southbridge, Mass. KLV is working in Baton Rouge, Louisiana. Your SCM wishes to call your attention to the various bulletins recently sent out by ARRL describing the opportunities now open to amateurs in the monitoring field. If you feel that you are qualified for this work, we strongly recommend that you get in touch with your SCM or direct with the League. How about some of you boys in the service writing in? I know that others will be glad to hear of you.

RHODE ISLAND — SCM, Clayton C. Gordon, W1HRC — The Westerly Radio Association held their annual open house in their new headquarters at the Old Town Hall Saturday evening, April 11 at 8 p.m. Naturally, it was a success. LDL was back in town on leave the other day and visited the P.R.A. He is teaching code for Uncle Sam in the Army.

VERMONT — SCM, Clifton G. Parker, W1KJG — MET has acquired an SX-24. GAN is scoutmaster of Boy Scout troop sponsored by the Lion's Club and JVS is very active in cub scouting programs. The Burlington Amateur Radio Club has submitted its application for affiliation. The Club is holding meetings each week, is building communications apparatus for civilian defense needs and the members generally are participating in civilian defense activities. Congratulations to GAE/7 who has a new operator in his family by the name of Mark Bowen Pratt. HLH is now Ensign and IQG is a petty officer in the Naval Volunteers, with MYS reported as a recent recruit. BJP and GNF still indulge in keying practice. AVP reports one 2½ meter transmitter-receiver and one five meter transmitter-receiver unit completed and is working with local authorities in defense arrangements. DQK is working on an amplifier for the Legion listening post in his area. JLF and his family, who have a fine daughter born February 16th, have recently moved to Springfield, Massachusetts, where he is in defense work. CBW has returned to this Section and is located at St. Johnsbury. LVI is on the Salvage Committee at St. Johnsbury. GQJ has been putting the finishing touches on his emergency-powered all-band outfit and has found time to experiment with modulation of light beams. JRU is now located at Windsor. KTB has been recalled to military service and is now at 56 Dudley Hall, Harvard University, where he is taking a course in electronics and cathode ray tubes. Your SCM will appreciate a line or card from you with news of the gang even though there is no traffic to report. Many addresses are changed in the recent months and the section files should be kept up-to-date. How about yours?

ROANOKE DIVISION

WEST VIRGINIA — SCM, Kenneth M. Zinn, W8JRL — W8KWI was home on a three day furlough from radiolocator training. For the benefit of Hobe's friends who

wish to write to him, his address is E.E. and R.M. school, University of Houston, Houston, Texas. BWK is radio repair man for the Navy. ASI and JKM have started a code class in Buckhannon sponsored by the M.A.R.A. Code classes in Elkins, Morgantown, Weston, Charleston and Huntington are progressing nicely. The code class in Clarksville sponsored by the M.A.R.A. graduated sixty-five persons at fifteen w.p.m. The second class starts immediately; also a radio theory class starts April 23rd. Thanks to MZD and BOK for their help with the recent code class. Charles Burner, ex-UHN, is a second lieutenant in the Signal Corps. NIY is now instructor in the N.Y.A. QFN and UFQ are very active in the southern part of the state enlisting the gang for AEC. Please do not forget to send your reports each month to your SCM, so we can keep the activities of our state before the gang, 73, Ken.

WEST GULF DIVISION

NORTHERN TEXAS — SCM, George Smith, W5HIP — Dallas is still continuing their code and theory class with excellent results. The "Three Brown Hams" from Electra report there will soon be "Four Brown Hams" up that way. It seems Mrs. Brown had too much competition from the two male members of the group, so now Miss Brown is on the way to getting her ticket. Uncle Sam needs radio men and now it's Radio Engineer Smith, W5HIP, attached to the San Antonio General Depot, Ft. Sam Houston, Texas. Here's to all of you. Thanks for the fine cooperation during our period as your SCM. We hope to see you soon on the air, 73, gang.

DELTA DIVISION

LOUISIANA — SCM, W. J. Wilkinson, Jr., W5DWW — ECs: W5HUY, I1H, GMR, HQY, INN, IVF, EVQ, I1H, HHV, FCG, IDA, HQE, BWZ, EB, BMM, DGB, HCV, IGQ, HBY, HOU and KOS. Some of the above have allowed their appointments to expire. Please forward your certificate to the SCM for endorsement. W5DGB is working as EC and says 73 to all. BFX is at Ft. Monmouth. DRC is "somewhere in Florida" as an Army op.

TENNESSEE — SCM, M. G. Hooper, W4DDJ — Four members of the Nashville Society of Licensed Amateurs have received code certificates. They are planning on conducting a technical discussion on chapters in the defense edition of the Handbook. Hub has built a home version of a super-het which he claims challenges the best. DDF is experimenting with wired wireless. The Nashville Amateur Radio Club is starting its code and theory classes this week with the outlook of an ever increasing group. J. A. Rogers, Jr., is in charge. The Knoxville Radio Communications Club with Mr. Mark Bowelle, Secretary, comes to the front with the section's newest radio club. We know you have been doing a swell job over there, Mark. Keep 'em going. Joe F. Denton, a former member of the NARC, and now with the U.S. Navy at New Orleans, was home for a week.

SOUTHEASTERN DIVISION

ALABAMA — Acting SCM, Lawrence J. Smyth, W4GBV — Had a letter from W4FYC who is at the Naval Base in Corpus Christi, Texas. He says there are so many hams there that he thinks he can make WAS in personal contacts. BOU/W8SBQ, former Alabama RM, is instructor at Ft. Belvoir. He is 1st. Lieutenant in U. S. Engineers. He and DGS have joined the Washington Radio Club. CMD is research engineer at Wright Field. DVJ, CPC, DHG and ex-SN are all at Ft. Monmouth. Ex-SN is 1st. Lt. AAD is a Navy radio engineer. FYC ran into GRA in New Orleans. Drop us a line, all of you Navy, Army and Marine hams, we are interested in where you are stationed and how you are getting along. Montgomery amateurs received their diplomas from the Defense Training School of Radio and have just started on their second course. Although the amateurs have not yet been called on for civilian defense, let's keep in readiness and let's not overlook the many things that we can do in the defense of our country. 73 — Larry.

WESTERN FLORIDA — SCM, Oscar Cederstrom, W4AXP — The highlight of the doings in the Section was

(Continued on page 68)



MAYBE you are trying out transmission on the "ultra-lows," maybe you are making filters, maybe you are putting together a code practice oscillator. For any of these projects you are likely to need low frequency inductances, so here are a few pointers.

Ordinary RF chokes and IF transformer coils work well in tuned circuits at frequencies well below 10,000 cycles. We have used a National IF transformer coil (designed for 175 KC) in a Colpitts oscillator with a tuning capacity of about .02 mfd (.03 and .05 mfd in series). With 125 volts on the plate of the 6J5, the output was about 35 volts and the frequency about 9600 cycles. It was a vigorous oscillator with excellent waveform, and is typical of the results that may be expected.

If an ordinary plate-to-grid transformer is driven by a pentode instead of a triode, it will be found that the frequency response is peaked. Typical results show a gain for one stage of 220 from 600 to 800 cycles, with the gain falling off rapidly at high and low frequencies. A 6J7 tube was used, and the transformer had a ratio of $1\frac{1}{2}$ to 1. This response is not unlike earphones, and does very well for a speech amplifier where reduction in background noise is desired. Details of the circuit were given in this page in *QST* for September 1939.

Although audio transformers can be tuned, the results are likely to prove disappointing because eddy currents in the laminations make the *Q* very low. Of course, a powdered iron core or a stack of thin laminations (.003" to .008" thick) will cause an enormous improvement — if you can get them. However, for many purposes high *Q* is not essential, even though it is desirable. We have made excellent filters where the inductances were merely coils from old relays stuffed with strips of lamination stock.

We have also made satisfactory oscillators and fair tuned amplifiers by adding a tuning condenser to an audio transformer primary. For this purpose, a plate-to-grid transformer usually has far too much inductance and it is better to use a line-to-line transformer. The latter transformer will have ample impedance to work out of a triode plate when tuned to parallel resonance.

Often it is necessary to determine the number of turns in a coil from the junk box. This can be done by winding a few turns on the outside of the coil and measuring the turns ratio. If you have suitable AC voltmeters, the coil can be rigged up as a transformer, provided that a core is available. It can also be done with DC milliammeters and without a core, by placing a small magnetic compass inside the coil, in the manner of a "tangent galvanometer." When the currents in the two windings are adjusted so that there is no deflection of the needle, the ampere-turns in each winding will be approximately equal. Neither method gives exact results, but they are a big help in experimental work.

RALPH HAWKINS



(Continued from page 56)

HINTS

TO



SERVICE MEN...

When you make out that bill for radio repairs, itemize your work, and list each Mallory part by name and type-number. Using these products, therefore, shows your customers that you do quality work and use quality parts. It earmarks your shop as first-class.

In these days, with no new radio-receiver production, more and more people are finding it advisable to have their present sets repaired, rebuilt, or modernized. Build prestige and profits by selling complete overhaul jobs. Do more than just "fix the trouble" . . . make the set play like new.

Keep 'em listening! And eliminate the annoyance and expense of no-charge reserivcing . . . insure the satisfaction of your customers by using Mallory Approved Precision Products.

P. R. MALLORY & CO., Inc.

INDIANAPOLIS

INDIANA

Cable Address — PELMALLO

Use

P. R. MALLORY & CO. INC.

MALLORY

APPROVED
PRECISION PRODUCTS

the Radio Service Men's meeting at Gulf Electric Supply Co. in Pensacola. Frank Langstroth of Hygrade Sylvania Corp. gave a very interesting talk on new radio developments. This meeting was well attended by the Pensacola hams and the information would have been of benefit to all hams and servicemen. Floyd G. Grice is one of our new ops and is looking forward to the day when he can get a station license and go on the air. Mangold, one of our Navy boys, is also the proud owner of a new operator's ticket. VR sold his Mac key to a prospective ham. GAM is now in Washington, D. C., at work for Uncle Sam. BOW is at work in Jacksonville as radio instructor and doing a fine job. BMH is keeping radios going as usual and still dreaming of that big CW job he is going to build. DAO is an Air Raid Warden. MS and AXF are staying with color movie photography. AXF has renewed her ticket. A lot of good fun and practice can be had by using two sets of keys and fones on a good oscillator. The OM and some of the hams working at the air station enjoy some good practice that way. You never know when you will be needed so keep your fist limber by doing consistent code practice. ECM has been doing some receiver building. Boys, the War may be on but that doesn't keep us from needing your reports. If you like to read about what the other fellow is doing, he may also enjoy reading about what you are doing. Best 73.

GEORGIA — SCM, William U. Hanks, W4AOB — Just received a letter from EDJ, who is raking the OM over the coals for no dope in QST from Georgia for the past two months. CBR is in Philadelphia and EEZ is in Jacksonville, both doing defense work. GZV is a sergeant in Home Guard at Waycross. FDJ with the coming of spring left the swamp and snakes for a couple days to visit Savannah. FMS and FOL are in Atlanta. WZ has gone to Jacksonville, DAA to Augusta. GQD is in the Navy. EWY, GIA and Georgia's most popular "unlicensed" ham, John "Doc" Pepper are still here to welcome wanderers. CRJ is teaching radio in vocational school. We sincerely believe that now is the time we should all stick by the ARRL, and we know of no better way to do this than to join the League immediately if we are not members at present. This procedure brings QST right to your home monthly, at less cost, and does infinitely more good than purchasing your copy on the news stand. Well, gang, this is the end of the news and thanks lots to FDJ for same. 73 — Bill.

WEST INDIES — SCM, Mario de la Torre, CM2OP — CO2DB assists the SCM with nice reports. CM2CT is using an HRO senior deluxe. CO2CL ascended to captain. CO6ZE is working fine on c.w. CO2HL, CO6DS and CO8VZ are with us again. CO6BB and CO8RQ got married. Congratulations, fellows. CO5FL, CO7AL and CO8GV are now on 'phone. CO5CR is using a 203A modulated by a pair of 830Bs. CO7AR and COSMC use "cocos." CO1AG installed a couple of 6L6Gs. CO2DL has a good doublet antenna. CO2BZ is testing on 'phone. CM5AH runs 40 watts input. CO5AJ uses an SX24 inhaler. YV3AA, from Valencia, Venezuela, is visiting Habana. CO2VC moved QTH. CO2GY chews the rag on 7 Mc. now. CM8BN and CM8ML are new hams. CO2CY is now using a T740 final. CO2FA wants a mike. CM1AE employs a couple of tens. CO6BC puts 250 watts on the air. All active hams have a corner in this section; drop me a card with your news for the month. 73.

DAKOTA DIVISION

SOUTH DAKOTA — SCM, Ernest C. Mohler, W9ADJ — The Sioux Falls Radio Club reports progress of classes in code: number attending beginner group, 63; number in advanced group, 19. Meetings Mon., Tues., Wed., Thur. and Friday, 7 to 10 p.m. The beginner group has attained a word speed of about 10 w.p.m. and advanced classes are working up to 24 w.p.m. Those who have ham tickets are working toward commercial tickets. The classes in theory have covered the fundamentals of radio, and are now working on vacuum tubes. Club meetings are held every other Tuesday, at Terrace Park Recreation Center. Membership of the club is turning over rapidly, classes acting as a feeder for membership. W9YOB reports heavy damage during recent snowstorm, with wires down all over the state — but no ham radio to the rescue this time. 73. — Clyde.

NORTHERN MINNESOTA — SCM, Armond D. Bratland, W9FUZ — Thanks fellows! It helps a lot to find

Select "Super Pro"

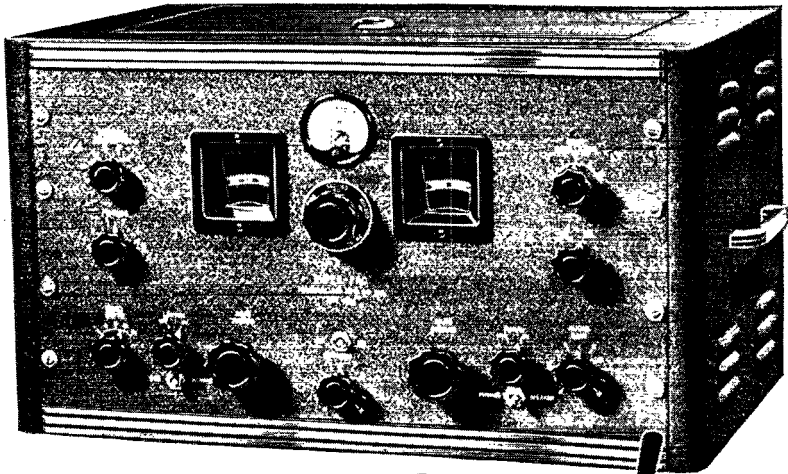

and Be Sure!

WHEN you choose a "Super-Pro", you are joining a large family of technicians and engineers who have consistently used and specified "Super-Pro" receivers for practically every type of communications service. This is your assurance that you are getting the finest receiver money can buy — for experts use the best. The new Series 200 "Super-Pro" has automatic noise limiting; five-point crystal selectivity with continuously variable I.F. band width, ranging from single signal to high quality broadcast; adjustable "S-Meter"; two T.R.F. stages, and just about everything required for either commercial or amateur service.

Export Dept.
100 Varick Street, New York City

HAMMARLUND

HAMMARLUND MFG. CO., INC. Q-6-42
460 W. 34th Street, New York City
Please send 16-page "Super-Pro" booklet
Name.....
Address.....
City..... State.....

TODAY'S

*War
Time*

EXPERIENCE

is building
tomorrow's

Greater Amateur Radio

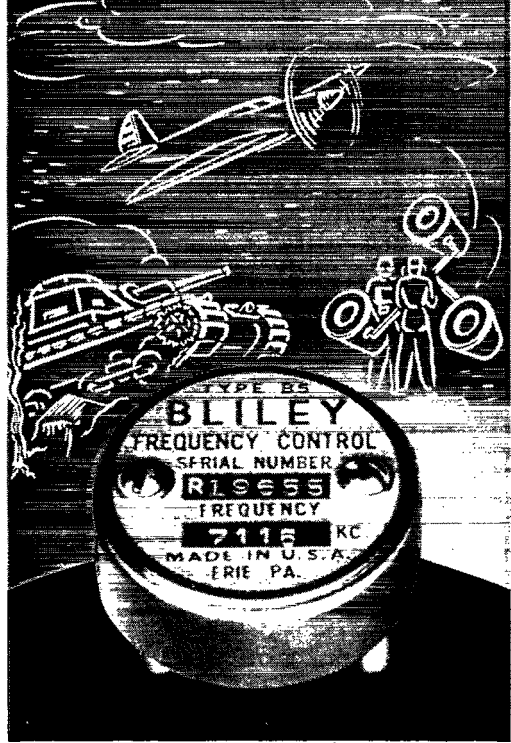

BLILEY ELECTRIC CO.
UNION STATION BUILDING ERIE, PA.

(Continued from page 58)

some reports in the mail. QCP has been examined for a special assignment of radio operating with F.C.C. DVG enlisted in radio branch Marines, awaiting call, and WNI is drifting in the same direction. TEF and NUI report from U. S. Coast Guard. OPA and DEJ tried out earth current communication. DX was only one block on voice. But rumor has it as a good scheme for bringing out the early angling worms. DEJ has a 2nd class telephone ticket. OOO is in Army. GNR was transferred to Dayton, Ohio. HQX is at McMinnville, Oregon. UHS is at Kent, Washington, working for Telephone Company. Division Director VVA sent out a request to all ARRL members of Dakota Division for any resolutions, suggestions or plans which should be brought up at the coming Board Meeting, and also urged that membership be kept strong. To that end we can all add our bit. The St. Paul Radio Club is presenting a series of radio code lessons which started Sunday April 26th at 9:30 A.M. over KSTP and will continue with one lesson a week at the same hour, covering approximately twenty consecutive Sunday periods. BHY, ZWW and "Dorothy" make up the team for the club and they work with several professionals furnished by the station. It's worth the effort to keep this monthly space in *QST*. If enough reports can be collected, the Section reports will continue, since they furnish the only source on news of former ham friends. There have been some encouraging reports this time, fellows and we are hoping that they will continue. 73 — Army.

CENTRAL DIVISION

ILLINOIS — SCM, Mrs. Carrie Jones, W9ILH — W9SG is stationed at Great Lakes. LF, GAO and ARN attended the Electric Show at U. of Ill. April 11. YCP is now on C.A.A. job in Chicago. BME has been transferred from Moline to a C.A.A. job in Ohio. GFW's home and 80-foot tower was totally destroyed in the recent tornado. FIN has been promoted to instructor for the Aircraft Radio Training School at Norfolk and JTX is to join him in June. PFR was home on a furlough recently. The Peoria Radio Club has purchased two 350-watt a.c. plants. JUA is attending radio school at Ft. Monmouth. The Ham Forum program at WLL has been discontinued. MNT is busy organizing the locals and building U.H.F. equipment. IHN paid ILH a short visit. On a trip home from oversea duty VKU met MAL in Brazil and they both thought there was something wrong with their eyes. There was quite a rag chew that night! NON of the Kankakee Club is with the Air Corps at Scott Field. TEU invested in an Abbott TR-4 and two DK3's for emergency work. FCW has been appointed Secretary of the Kankakee Radio Club by IBU, the President. IBU has been made a member of the County Defense Council.

INDIANA — SCM, LeRoy T. Waggoner, W9YMV — W9INL has a new receiver. MFD is located at Orlando Air Base at Orlando, Fla., and is now a Corporal. IUM says the Northeastern Indiana Radio Club is having interesting meetings with discussions on theory. FFM and IUM are building a 2 1/2-meter outfit. ELM recently completed a 500-watt rig. MDC is back to normal again after a recent illness. SVU is with the Signal Corps at Asbury Park, N. J. FVO, ZHS, WXG and BNF are attending the Naval Training School at the Utah State Agricultural College, Logan, Utah. GMJ is in war work at Indianapolis. JXX and MBV are working on a directional microphone for a listening post for the State Guard. ENJ visited the Indianapolis Radio Club recently and advised us that UZQ and EPR are based with him at New Orleans as aircraft radio operators. DNQ was inducted into the Army April 13th and hopes to get into radio work. TBM advises that the Fort Wayne Radio Club is conducting code and theory classes. NXU is flying in Florida, and is now in advanced training. EEE is radio technician with Pan American Airways. FXM says the code class at Richmond is progressing FB. SEO is with Uncle Sam's Navy at Great Lakes. AB has his low frequency inverter working and is looking for someone "on the lines." SVJ and WDV have been called to service, WDV for the second stretch! Good luck, fellows! CRZ, formerly of Mishawaka and now an Army lieutenant, is proud father of David Allen, born April 1st. Congratulations. Fellows, drop me a line with all the news from your locality. The Services are claiming many of our Emergency Coördinators throughout the state. If you do not have an EC in your community, volunteer for the job, or write recommending someone. Thanks for your past coöperation with me as Coördinator; I hope to enjoy it as your SCM. — Roy.

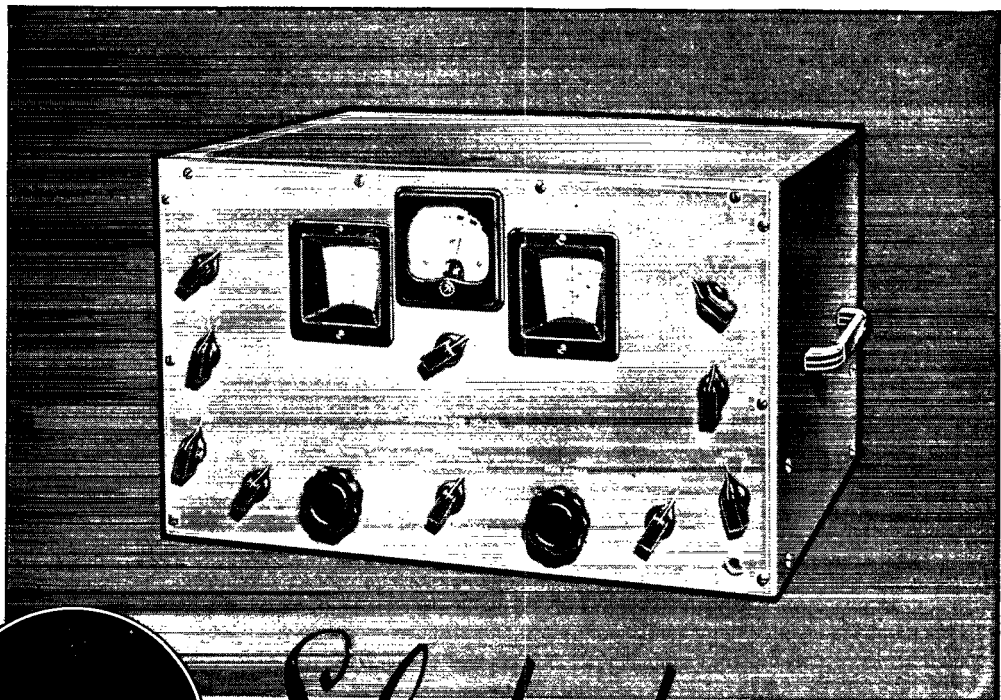

HQ-120-X

Selectivity "Plus" AND STABILITY

IN ever-increasing numbers, technicians are turning to the "HQ-120-X" because they find it to be everything they have ever hoped for in a medium-priced receiver. Loud praise from thousands who are already using "HQ-120-X" receivers was earned by pioneering on the part of Hammarlund engineers. They put into this receiver, features which operators could *really use*. Features which are rapidly changing the whole scheme of receiver design. And, today, the "HQ" is even better than ever because our engineers are ever alert to make the slightest improvement. In buying an "HQ-120-X" you do not get two or three year old engineering, but right up to the minute improvements.

Words can hardly express the quality of this fine receiver. To really appreciate its smooth performance, it is necessary to hear and operate it. By all means, visit your dealer and operate the "HQ" yourself, and experience "selectivity and stability plus."

SEND FOR DETAILS!

HAMMARLUND MFG. CO., Inc. Q-6-42
460 W. 34 St., N. Y. City

Please send 16-page "HQ" Booklet.

Name

Address

City State



Canadian Office:
41 West Ave. No., Hamilton

HAMMARLUND

EXPORT DEPARTMENT_100 VARICK ST., NEW YORK CITY

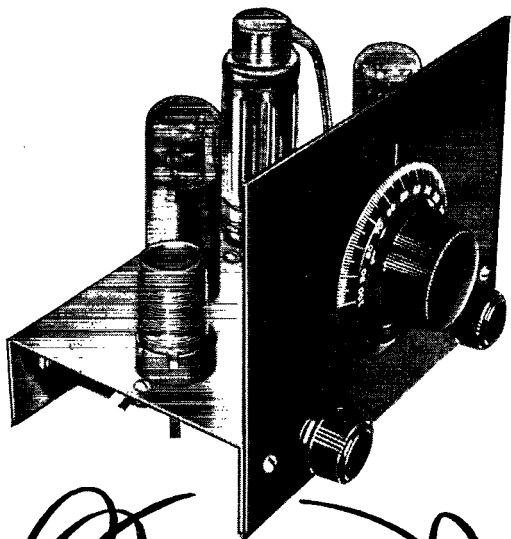

FOR
Defense

RADIO TRAINING

... use **MEISSNER KITS**

From a one tube kit to a three tube kit with "Add-One" features. These kits give the fundamentals of radio construction and are ideal for group teaching of assembly.

The Kits utilize the latest type of 1½ volt battery operated tubes, providing good performance with minimum battery drain. Each kit is supplied with a plug-in coil to cover the broadcast band, 200 to 545 meters; additional coils available to make a real "All-Wave" receiver.

Everything required for completion of the set is included (except batteries, tubes and headphones). The Pictorial Wiring Diagram included with each kit greatly simplifies the assembly.

One-tube battery receiver kits — \$5.50 list.

Two-tube battery receiver kits — \$6.75 list.

Three-tube battery receiver kits — \$8.50 list.

NEW! Kits are now available for AC-DC operation with the same progressive building operation. See your Meissner jobber.

Write for Complete New Catalog
Address Dept. QS-6

Meissner

MT. CARMEL, ILLINOIS

"PRECISION-BUILT
PRODUCTS"

(Continued from page 80)

MICHIGAN — SCM, Harold C. Bird, W8DPE — DAQ says club going strong on code classes and very QRL himself. SS announces the arrival of Kenneth Jr. on St. Patrick's Day. VDS wants to know why the gang doesn't form some kind of a club down there. Go after him, DARA gang. UKV has completed his 2½-meter rig and is going to rebuild his receiver for long wave reception. UCG reports the radio school sponsored by Muskegon Area Amateur Radio Council has 72 students. The instructors are UCG, DAQ, VQN, WAK and EXJ. The Jackson Radio Club reports meetings held every third Thursday. At the last meeting they decided to organize a defense radio training class. The Oakland County Radio Club is still holding code class meetings every Monday and Friday with students showing improvement since starting three months ago. The Detroit Club is still holding net operation around the table at each club meeting. About 37 members attend each meeting. The Greenville Radio Club is still holding code classes with good attendance. Code and theory classes are being organized at the Grand Rapids Radio Club. Anyone interested in a radio job contact your SCM. Have several attractive propositions to make to you young fellows. 83 — Hal.

WISCONSIN — SCM, Walter Wallace, W9EYH — W9RHS is serving in civilian capacity with the Army Air Corps at Lexington, Ky. Ex W9HSK, now W8WSI, is in Philadelphia and is supervisor of the Border Patrol radio station there. YVZ, formerly of LaCrosse, is now in Africa working for Pan American Airways. Richard Granke is a new ham in Stoddard. Likewise Robert Schultz in LaCrosse. UFX, instructor at the Naval Radio Training School at Madison reports that more full-time code instructors are needed. Applications should be sent to the Office of Director of Instruction. GPI and HWO are conducting code and theory class every Thursday night at the Shorewood High School with a present enrollment of 37 beginners and 14 in the advanced group. The Kenosha Kilocycle Club is now located in the Service Building in Southport Park. Plans are being made for the construction of aircraft detectors and the formulation of an efficient 2½-meter communication system. IJB and RQM, using wired wireless on a frequency of 150 kc., were heard at LED's. VHE is attending Kemper Military School in Missouri and hopes to get a commission as 2nd Lieutenant and then go to Fort Monmouth. MEE and YYL are attending radio school in Chicago. When finished they will be service men for the Air Corps. DND is operator at Army Corp Area Headquarters in Chicago. KCY persuaded his 76 to oscillate on one meter. GVL is about ready to give wired wireless a whirl. EYH received WAS endorsed for three bands. A shock to all who knew him was news of the death of Robert Guthrie, W9IHL, ex-W9EYU. Bob was drowned while surf boat riding in Hawaii. He was one of the 20-meter pioneer dx men and for the past several years had been a sea going commercial op. A real amateur, Bob had many friends for whom his passing is a tragic loss. 73 — Wally.

OHIO — SCM, E. H. Gibbs, W8AQ — Various club groups throughout the Section continue with their code and theory classes and regular meetings. Canton A.R.A. holds their classes 3 nights a week, have brought their first class of 25 members up to 16 wpm and have started a new class of 20 members. The Canton Club, at the suggestion of city officials, has filed for frequencies around 116 Mc. for an auxiliary police net. Congrats also to this club on their affiliation with ARRL. TGU, who is bed-ridden in Betesda Hospital, Zanesville, is teaching a class of about 35 in both theory and code 5 nights a week using the telephone lines between his hospital room and a nearby school. Nice going, Hal. The gang at Bellefontaine, with QOK, NAB and WUI, are giving instruction to two classes of about 20 members each. The code class at Piqua Radio Club is getting along FB after 6 weeks of activity and the club is building additional 112-Mc. equipment. The CARMARS of Toledo are 100% ARRL and are experimenting with city-wide wired wireless for emergency work. To date they have 5 rigs in operation and 30 more under construction. 73.

MIDWEST DIVISION

IOWA — Acting SCM, L. B. Vennard, W9PJR — W9FDL, EC Muscatine, has a large class in code meeting twice a week while VRD teaches the theory. CCY sends in a report from Jefferson Barracks, Mo., where he is a radio man in the Air Corps. FNT is ready to test his 2½-meter portable. SHY, WNL, GWD and OMF are expecting to get

TO STAY BEST . . . IT MUST BE EVER BETTER.

Ahead in the Past
This radical shape . . . plus unusual performance capabilities started the parade in 1934.

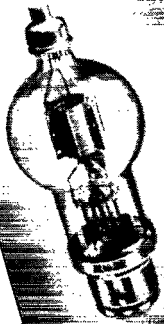

Ahead Today
The multiunit triode is today in fact what many thought could only exist in theory.

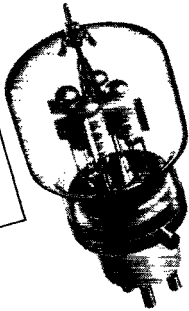

Ahead in the Future
Certain new achievements cannot be revealed. Others are in the making. Rest assured that Eimac is keeping ahead.

Everlastingly seeking improvements in the performance capabilities of the vacuum tube. That's the creed of the personnel in the Eimac shops. That's why you find Eimac tubes in the key sockets of practically every new development in the field of electronics, why communications men throughout the world have come to measure results in terms of the performance capabilities of Eimac tubes. This high standard of excellence was deliberately planned at Eimac . . . and is being deliberately maintained despite the rigors of wartime production.

You've found Eimac ahead in the past . . . they're ahead today . . . and you'll find them still ahead in the future

Follow the leaders to

Eimac TUBES

EITEL-McCULLOUGH, INC., SAN BRUNO, CALIFORNIA, U. S. A.

Export Agents: Frazer & Co., Ltd., 301 Clay Street, San Francisco, California, U. S. A.

EIMAC REPRESENTATIVES

California, Nevada
HERB BECKER, 1406 South Grand Ave., Los Angeles, Calif.
N. Y., N. J., Penn., Md., Del., Dist. of Col., Maine, N. H., R. I., Conn., Mass.
ADOLPH SCHWARTZ, 262 Grayson Place, Teaneck, New Jersey.

Wash., Ore., Idaho, Mont.
GENERAL SALES CO., Verner O. Jensen, 2605-07 Second Ave., Seattle, Wash.
Colo., Wyo., New Mexico, Arizona, Utah
RICHARD A. HYDE, 4253 Quitman St., Denver, Colo.

Chicago, Illinois, Wisconsin
G. G. RYAN, 549 W. Washington Blvd., Chicago, Ill.
N. Caro., S. Caro., Georgia, Tenn., Flor., Ala., Miss.
JAMES MILLAR, 316 Ninth St. N. E., Atlanta, Georgia.

Texas, La., Okla., Ark.
J. EARL SMITH, 2821 Live Oak St., Dallas, Texas.
Ohio, Mich., Ky., Ind., Minn., Mo., Kan., Neb., Iowa
PEEL SALES ENGINEERING CO., E. R. Peel, 154 E. Erie St., Chicago, Ill.

SPRAGUE KOOLOHMS

Meet "Impossible" Specifications

Koolohms' superior performance under adverse salt water immersion conditions has earned their approval for much military and naval equipment where average resistors were found inadequate. Enjoy the unique advantages created by Koolohms' distinctive feature — the ceramic insulation of the wire before it is wound. This improvement makes Koolohms smaller, sturdier, better protected. Koolohms are accurate! — and stay accurate.

KOOLOHM Progressive Winding

Koolohm ceramic insulated wire can be wound in high density patterned windings giving the electric equivalent of many layers of winding without high potential gradients. This permits much larger wire sizes with the resultant safety factor, and much higher resistance values in small space.

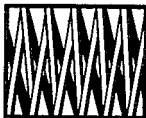

KOOLOHM Mounting Features

Most types are encased in a sturdy outer ceramic shell that allows quicker, easier, time and space saving mounting directly to metal or grounded parts with complete resistor circuit insulation.

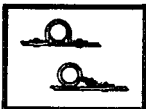

KOOLOHM Non-Inductive Resistors

Ceramic insulated wire permits perfect interleaved Ayrton-Perry windings, reducing inductance to practically negligible values, even at frequencies of the order of 60 mc. Distributed capacitance is very small.

Send Today For Catalog!

SPRAGUE SPECIALTIES COMPANY
(Resistor Division) North Adams, Mass.

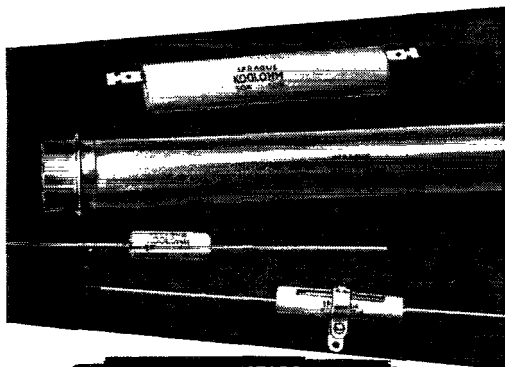

THE ONLY RESISTORS
WOUND WITH CERAMIC-
INSULATED WIRE!

(Continued from page 68)

their assignments to active service soon. The Burlington Radio Club gave a demonstration of the 1915 and 1941 radio transmitters and receivers. The demonstration seemed to be a great success and was very well received. Let's have a few reports each month, fellows. The SCM isn't a mind reader. CUL — Les.

KANSAS — SCM, Alvin B. Unruh, W9AWP — W9VWV works at Fort Leavenworth in a civilian status. IJK is in Washington, D. C. doing radio work for Uncle Sam. IVO is attending K. U. CWV is with the Corps of Engineers at Kansas City. OAQ is with field artillery at Fort Sill. TAE has been operating for Chicago and Southern Airways in Louisiana and Alabama. Major Thomas, W5DAY, formerly of Ft. Leavenworth, has been ordered to Wash., D. C. W9BGW, formerly of Ft. Leavenworth, is pounding brass at an undisclosed foreign location. VKJ is at Annapolis. OZN has been instructing Red Cross first aid classes and a civilian defense group. He reports a traffic total of 800 for period Nov. 15th—Dec. 7th. OUU reports that PV has a civil service job in Ohio, and that the following are taking ESMDT radio course: MDI, WPN, OQP, PV, NSZ and OUU. EC VBQ reports that GBA has gone East, probably to Washington, D. C. UTK is now a private at Orlando Air Base, Florida. VBQ is learning to use the mill and recovering from a case of mumps! DWC, new president of WARC, has been appointed to represent amateurs in the emergency communications committee of C.D. with LFB assisting. HNI edits "Sparks" in Sunday *Wichita Eagle*. JCY's father received his new ticket, with station side stamped "this side is void." FWY has accepted a civil service position at Omaha. YYW has been appointed communications officer for Wichita wing of Civil Aeronautics patrol. QFP visited friends on way to naval radio school in Washington. He has been serving aboard a destroyer in the Pacific. ODD is stationed in Iceland. MFH and WDD, former commanders of Wichita units of NCR, are in Hawaii. MFH is now a lieutenant, junior grade. OAJ and PLN drove to Florence to visit VJT.

MISSOURI — Acting SCM, Wm. G. Skinker, W9AEJ — Fellows, this column is now our only means of learning what some of our old pals are doing, and where. Let's make full use of it. GCL is settled down in St. Joe now. OUD had a visit from 8KCV. WIS is expecting either a Civil Service job or an Army uniform shortly. CKK is teaching school at Summerville. The St. Louis' Metropolitan Amateur Radio Club has received recognition as an ARRL affiliated club. FB, MARC! The St. Louis and St. Louis County gang are well organized now with a committee made of one elected representative of each police zone and county township, under the chairmanship of EKY. The committee is registering ability, availability, and equipment of all St. Louis hams for possible civilian defense communications. NSU is back in Mountain View, and is anxious to do some kind of radio work. NBB is keeping his fist in shape by practice on audio oscillators. He is looking for a radio job during the summer months. AXB and LTW work in the same store after school. QMD thinks Africa is swell. Keep on the good side of the natives, Bob! The Heart of America Radio Club of Kansas City is sponsoring code and theory classes Tues. and Wed. evenings with an average attendance of 50. Officers of the club are: pres., BLS; vice-pres., YJS and AHZ; secy., LBB; treas., SSG; sgt.-at-arms, TXG. 73, Bill.

NORTHWESTERN DIVISION

IDAHO — Acting SCM, Don D. Oberbillig, W7AVP — W7IQG enlisted in the Signal Corps. Second Air Force headquarters offered ham operators who could pass the combat radio operators physical examination good ratings. ABK is training CCC boys as radio ops at Camp McConnell, Boise. ZN is to assist Ada County defense in the communications division. BAR is now with the Navy Department as civilian radio technician. IGK is teaching a radio engineering extension course for U. of Idaho at Boise.

MONTANA — SCM, R. Rex Roberts, W7CPY — The Butte-Anaconda club is active with code classes, 12 in attendance. Special project at present is wired wireless. They proudly report, and rightly, 100% ARRL membership — FB fellows. Great Falls reports classes continue in defense training and code proficiency with attendance from 38 to 48. CC now instructing theory class and FGZ giving code instruction. HFZ reports 800-watt 2 1/4-meter rig complete with portable alternator ready for service. He is returning to college in June. Cliff Bunn is teaching radio service and repair course class to CCC enrollees at Miles City. Gang,

JOHNSON *for insulators*

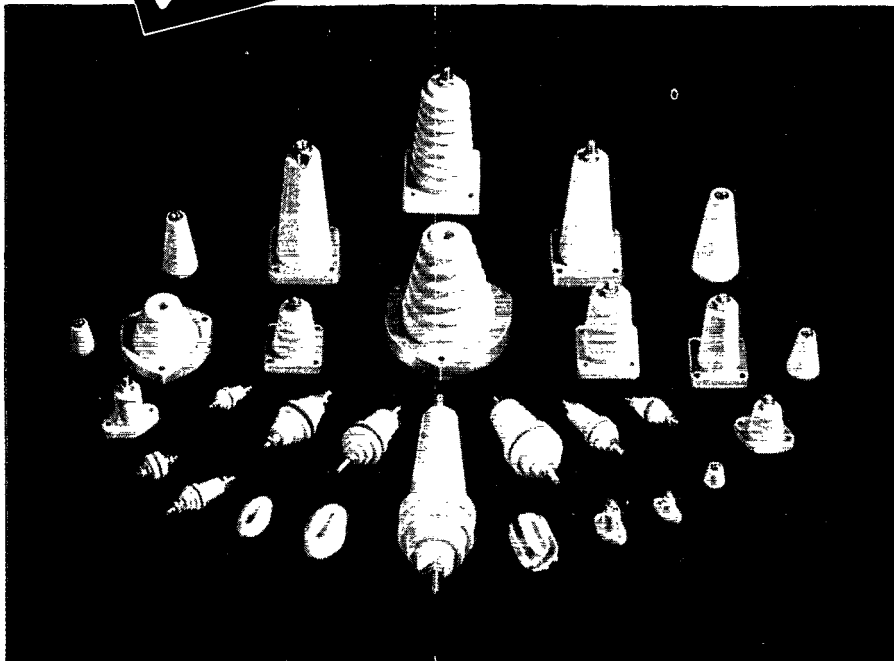

The famous Johnson insulator line is the most complete of any manufacturer. Designed by engineers for practical application, their quality, materials and excellence of workmanship are often imitated but never equalled. Nuts are carefully milled and heavily nickel plated, not cheap stamped unplated types. Studs have accurately cut threads held to a close tolerance and heavily plated. Inferior varieties use cheaper rolled threads that bind or strip easily. All Johnson insulators are made of the finest electrical porcelain or Steatite (depending on type) and are remarkably free from pin holes, impurities and imperfections. Substitutes are usually inferior porcelain or clay such as that used in dishes and pottery. Superior Johnson parts cost no more—why take chances?

Write us concerning your need. Johnson Engineers will recommend an insulator that will do the job better—often at a lower price. After all Johnson parts are GOOD parts. (Ask for Catalog 967J).



E. F. JOHNSON CO.

WASECA, MINNESOTA
EXPORT: 25 WARREN ST., NEW YORK, N. Y.

"MANUFACTURERS OF RADIO TRANSMITTING EQUIPMENT"

IN THESE TRYING DAYS
YOU CAN
DEPEND
ON
TERMINAL

Yes . . . now more than ever, the radio industry is looking to us for Parts and Electronic Equipment. The reason for this lies in our ability to supply much needed material with utmost speed and maximum efficiency.

The largest stock in our history is available to manufacturers, Government Agencies, and other organizations engaged in war work.

All Terminal salesmen are experienced radio men — not mere order takers. They are particularly well qualified to recommend the best available material to fill any gaps in your production requirements.

In other words, You Can Depend on Terminal — Your Most Reliable Source of Supply!

TERMINAL RADIO CORP.
85 CORTLANDT STREET
New York City • WOrth 2-4416

(Continued from page 64)

let's keep in touch with one another, drop your SCM a line (a penny card will do) telling him of your activities, or that of other hams, where they are, branch of service they are in, etc.

PACIFIC DIVISION

EAST BAY — SCM, Horace R. Greer, W6TI — ECs: W6OBJ, W6QDE, EC UHF: W6FKQ, Ass't. EC UHF W6OJU. Keeping up with the times, the East Bay Section of the ARRL at its regular meeting on Wednesday evening April 15th, 1942 at the Hotel Leamington, Oakland, California had "Navy Night." The Guest Speaker was Hap Current ex-AUE, Chief Electrician, USN, Retired. Some splendid talkies were shown on the bombing of Pearl Harbor, Marshall Islands and some general Navy pictures. A good time was had by the following who were on hand: AHG, OAO, NPL, UFD, NPO, UNG, CRF, HH, NPP, QAZ, RGQ, SFT, EY, HS, QMD, HGM, PYS, QDE, ZM, KTI, UDH, FKQ, LUS, OFX, TP, SEW, SHY, LGW, TI, JEE, ex-AUE Current, F. Oberhauser, D. Fulsaa, G. Mitchell, G. Wright, P. Wallace, B. Rossman, L. Kelsey, F. Pecka, R. Streib, H. Anderson, G. Stokes, W. Shaw, H. McElroy and G. Krecast. Everyone is invited to these meetings, and as your attendance is necessary to maintain interest, plan on being present the third Wednesday of every month. For your convenience we will be glad to take care of your renewals or new membership for ARRL. The following have been reported as being in the service. Navy: ONX, UFA, MLZ, RDA, IFF, BIP, KZF, LHH, IMU, NTU, SJQ, AHL, RZY. Army: LDD. This is a list only of those who have recently joined. The 2½-meter gang are all ready to go according to FKQ. Many of the gang are working for national defense. If you hear of any ham in the service, regardless of who he is, please let me or the ARRL know. 73 "TI."

SOUTHWESTERN DIVISION

LOS ANGELES — SCM, Ralph S. Click, W6MQM — Asst. SCM, W6QVV. This will be the last report you will have from me before the election of a new SCM. The job of SCM is one that has a lot of different angles and experiences to it and I leave it with a lot of fond memories. I have been fortunate in meeting a lot of fellows that I would not have known otherwise. In all it has been a grand experience and I would not have missed it. Whoever takes up the duties after July 1st will be working under a handicap due to no operation, however we all hope it will not be for long. I would like to ask the members of this Section, before I leave, to give the incoming SCM the whole-hearted cooperation that they have given me. SN reports he is still alive and has set up a clearinghouse for the gang for back issues of QST. Received a nice report from the Inglewood Club signed by RNN. They have been having trouble in the choice of meeting places but they have one now that will not fold up on them. It is in the banquet room of the Owl Drug Store at Market and Queen Streets. They meet on Fridays. ZCN adds to the report that they are still active, regular meetings still held, and experimental work is keeping them busy. PTR reports for the Santa Monica area of the AEC that the gang and equipment are still intact although there have been some losses to the military services. The gang is making plans to cooperate with the Santa Monica OCD. He is still teaching code to the women of the ambulance corps of Pasadena. OMQ and TRX are in the radio technician training course at Pasadena Junior College. KLN, JUH, FQJ and QQM are in electronics course at Cal. Tech. Well, that's the size of the reports for this month. I have bawled you fellows out for not sending reports in and I have been bawled out for not putting them in QST so this makes us even.

ARIZONA — Acting SCM, Gladden Elliott, W6MLL — Radio silence has not dampened radio enthusiasm in Arizona, if reports are a valid indication. The Tucson Short Wave Club reports a fine program of activity. A picnic was held early in April with 40 in attendance. A number of the fellows report activity with wired wireless. The club paid a visit to the Border Patrol Station, but reported they liked their own gear best. A meeting was held on April 28 at home of GS, club secy., with the XYLs serving refreshments. A visit was made to the power plant as part of the program. QWG lost out at Gallups Island but got his telegraph second and is somewhere on the Atlantic. TOZ and RXQ took their second class phone. REJ is taking an instructor's aviation course. RWW is a candidate for SCM and reports his

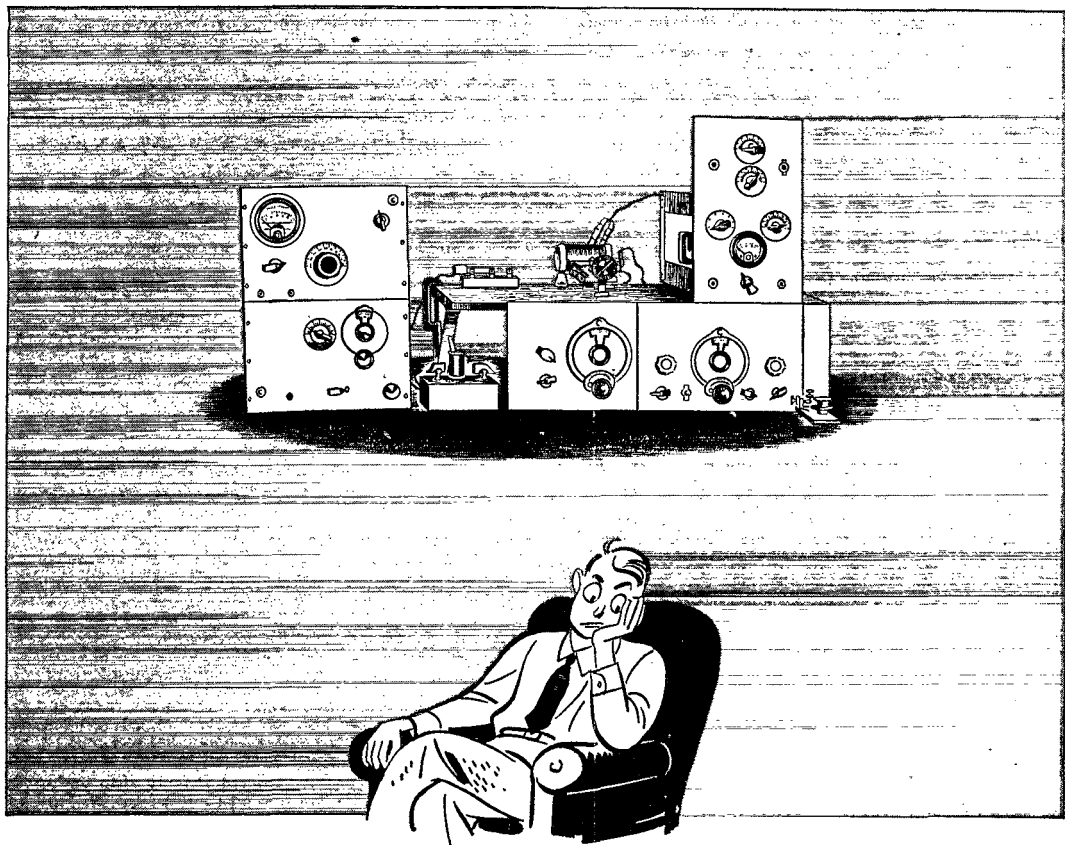

HE'S OFF THE AIR FOR A WHILE— BUT HE'LL BE BACK WITH A BETTER RIG!

YES, the rag-chewing was fun. But there was more to it than that. Tinkering with the rig, to squeeze out a little more performance. Cooking up new ideas... one or two of them found their way into plenty of other ham sets. Boning up on f. m. Coming through in emergencies... keeping communications open when flood or earthquakes wrecked the wire channels.

Things are different now, of course. The rag-chewing is over. But the amateur is still coming through in a pinch. Perhaps he's serving in the armed forces. He may be standing by to play his part in civilian defense. Perhaps his technical skill is helping to speed the production of urgently needed equipment.

And whatever he is doing, he is still tinkering—with his hands if he can get them on his gear, with his mind if he can't. He is still

working out new ideas—and out of the intensive research of today will come new and better equipment to help him carry them out.

He'll be back on the air some day—and back with a better rig. And when that day comes, *Isolantite's unusual combination of properties—high strength, dimensional precision, electrical efficiency, non-absorption of moisture—will again be helping him to get the most out of his rig.

ISOLANTITE

CERAMIC INSULATORS
ISOLANTITE INC., 233 BROADWAY, NEW YORK, N. Y.

*Registered trade-name for the products of Isolantite Inc.

NOW—a really high-powered RADIO ENGINEERING LIBRARY

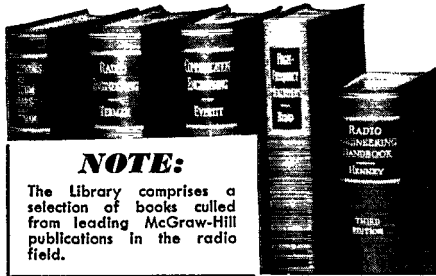

NOTE:

The library comprises a selection of books culled from leading McGraw-Hill publications in the radio field.

- ➔ especially selected by radio specialists of McGraw-Hill publications
- ➔ to give most complete, dependable coverage of facts needed by all whose fields are grounded on radio fundamentals
- ➔ available at a special price and terms

THESE books cover circuit phenomena, tube theory, networks, measurements, and other subjects—give specialized treatments of all fields of practical design and application. They are books of recognized position in the literature—books you will refer to and be referred to often. If you are a practical designer, researcher or engineer in any field based on radio, you want these books for the help they give in hundreds of problems throughout the whole field of radio engineering.

5 volumes, 3559 pages, 2558 illustrations

- Eastman's FUNDAMENTALS OF VACUUM TUBES, 2nd edition**
- Terman's RADIO ENGINEERING, 2nd edition**
- Everitt's COMMUNICATION ENGINEERING, 2nd edition**
- Hund's HIGH FREQUENCY MEASUREMENTS**
- Henney's RADIO ENGINEERING HANDBOOK, 3rd edition**

10 DAYS' FREE EXAMINATION

SPECIAL LOW PRICE

EASY TERMS

Special price under this offer less than books bought separately. Add these standard works to your library now; pay small monthly installments, while you use the books.

SEND THIS EXAMINATION COUPON

McGraw-Hill Book Co., 330 W. 42 St., N. Y.

Send me Radio Engineering Library for 10 days' examination on approval. In 10 days I will send \$3.00 plus few cents postage, and \$3.00 monthly till \$24.00 is paid, or return books postpaid. (We pay postage on orders accompanied by remittance of first installment.)

Name

Address

City and State

Position

Company.....QST 6-42

(Continued from page 66)

code classes are coming to a successful close. TIO passed away in March. TCQ reports he is busy with receivers and hearing devices. He says "if we can't build xmitters we can concentrate on receivers." He also reports interest in the QST plane spotter. MLL will have about a dozen ready to take their exams for a ticket by the end of May. KOL is really in up to his ears in radio. IYZ is developing into a traffic expert at Ft. Huachuca. RJN reports he is doing well at Camp Barkley, finished his preliminary training. NRP-MNH is copying cipher several hours a day to keep in practice. KSO reports he has visited RCA labs, National Union, and Western Electric in connection with his Washington, D. C., job. Missed connections with the Phoenix reports this month, but roundabout sources indicate they are still functioning as strong as ever. 73 — GC.

ROCKY MOUNTAIN DIVISION

COLORADO—Acting SCM, Orval Cunningham, W9KHQ — Congratulations are in order for CNL, our new SCM. Didn't get word in time to send dope to CNL for this report. Hope you don't think I'm too presumptuous. News items were more plentiful this month. YFJ has gone back to Michigan to teach radio. MOH is doing radio servicing. HGL is teaching radio in a defense course and QDC is trying out some new circuits which he hopes to use when we get back on the air. IDB is trying to get the other end of his light beam gadget working. CAA is busy getting prepared for the directors' meeting at Hartford. OLL is in the east, attending civilian radio school. CNL has wired wireless and earth current set-up ready to go, waiting for others within range. TFP is working on earth currents. 3JIN, ex-9VTK, is back in Denver permanently and will soon be working with both earth currents and wired wireless. The Radio Clubs of Denver are having trouble selling free code instruction classes to the school board and have come to the conclusion they will have to do it on their own. HWH has been inducted into the Army. GCM has been transferred from Grand Junction to Los Angeles. RGX still has his code class going and with the aid of TX is trying to give some instructions in fundamentals. CAW secured a position with Aircraft Radio Lab. at Dayton and is moving there as soon as he can be relieved of the postmastership at Summitville. PBW is radio operator on the SS Paul Luckenbach somewhere on the Atlantic. BBT is with the Army Signal Corps in Alaska. The new EC at Pueblo got on the job this month and advises UEL is teaching nite school at Centennial. TDR has been transferred to Kansas City as Regional Inspector for the CAA. WTN has been promoted from teletype maintenance to installation supervisor for the MST&T Co. ZJQ is in the Air Corps. ZNL is part-time op. for KGHF. WWB has departed for California to act as train dispatcher for the Southern Pacific RR. GHY is leaving for Washington, D. C., June 1st and will be with the Naval Research Lab. KKU, ex-FMG, is in Pennsylvania and planning a trip into Conn. While there he plans to call on ARRL Hq. JJU and husband, 3HTX, ex-9TTD, are now living in Richmond, Va. HCP is in San Antonio as Asst. Radio Engr. for the War Dept. YCD is now a sergeant and doing radio work in the Air Corps. EFP is working 10 hours a day for North American Aircraft and still manages to get in 4 hours a week in night school. DOA is in Chicago. EHC tells of difficulties in securing apartments near the new job, finally having to locate in Salt Lake City. EVT has secured a position at Camp Carson, working 6 days a week. I wish to express my appreciation for the cooperation and encouragement extended by all of you for the short time I acted as your SCM. I know you will continue this fine support of our new SCM. A last word; we need ECs in many localities of the state and suggest that if there is not one in your community, you take steps to have one appointed as soon as possible, then give him "all out" cooperation and assistance in getting organized. 73, Orval, W9KHQ.

UTAH-WYOMING — SCM, Henry L. Schroeder, W7GZG—A year ago we were all making FD plans! Seems as tho something is wrong when we aren't busy hauling out the camping equipment and making plans for new gear. From W6SID, an interesting letter after a long silence with the information that 60VC has been teaching a defense class in radio. 6CKI is still handling the radio dept. at the college in Ogden. Also reported in Ogden are W6's RIM, NPU, LLH, DTB, NKD, TMH, SYD, HYM, PCK, QAM, THU, SYH, W9's AFP, DSB, EHC, LJJ, WK, W7CKB and W4IVH. At the regular monthly meeting of the Shy-Wy Radio Club in Cheyenne on April 16th the first anniversary of the club's existence was marked by the

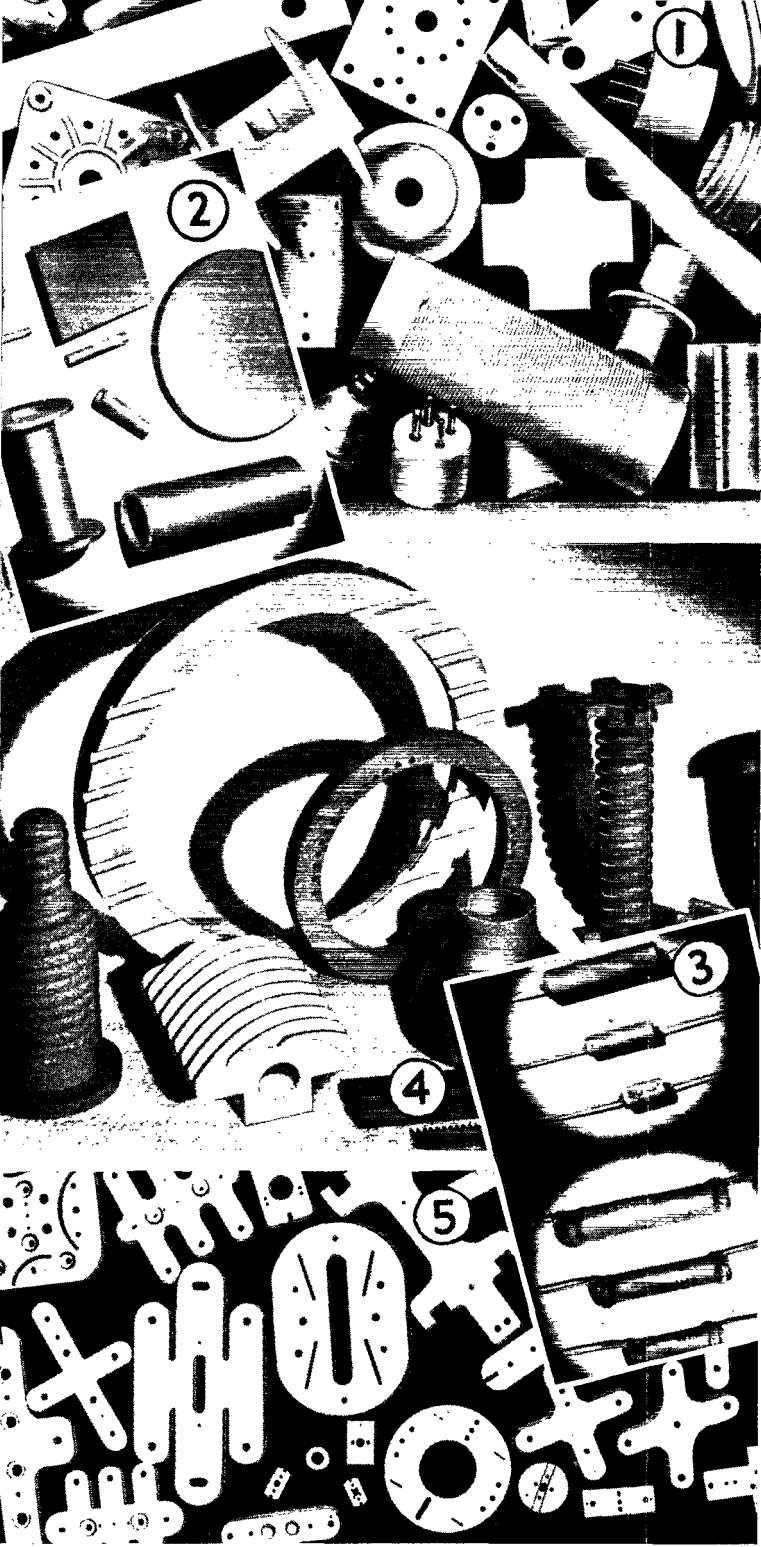

ALSiMAG

HIGH FREQUENCY
CERAMIC MATERIALS
FALL INTO **5** CLASSES

CLASS 1. AlSiMag 35 and 196, the low loss steatite ceramics for high and ultra-high frequency applications.

CLASS 2. AlSiMag 190, the material of exceptionally high dielectric constant.

CLASS 3. Special AlSiMag compositions with definite temperature coefficients of capacity. (Not offered for general use.)

CLASS 4. AlSiMag 72 and 202, materials with low temperature coefficient of expansion.

CLASS 5. AlSiMag 211, 222, 393 and Lava, for vacuum and cathode ray tube applications.

Complete physical characteristics of the more generally used AlSiMag and Lava bodies are detailed in Property Chart No. 416 which is sent free on request. The full range of physical characteristics of these bodies is not available from any other single source.

ALSiMAG

Trade Mark Reg. U.S. Pat. Off.

AMERICAN LAVA CORPORATION

CHATTANOOGA, TENNESSEE

CHICAGO • CLEVELAND • NEW YORK • ST. LOUIS • LOS ANGELES • SAN FRANCISCO • BOSTON • PHILADELPHIA • WASHINGTON, D. C.



Once upon a time we were answering such questions with an emphatic "YES."

Today, however, we're mighty proud to say, "Maybe."

For the past fifteen years we've been carrying full stocks of equipment of more than 80 of the country's leading radio equipment and parts manufacturers. Naturally, we accumulated a supply of almost everything.

ALL of it has NOT been sold.

So . . . if you are encountering difficulty in securing necessary components . . . call, wire, phone or write. We **MAY** have what you want.

★ **AMATEURS!** Our military services have need for some of the equipment that you may possess. Communications receivers, amplifiers, test equipment, etc. . . . are in demand. Write giving details and price desired.

CONVERT YOUR IDLE EQUIPMENT INTO WAR BONDS and STAMPS

W21JL • W21JA • W2PL • W2KWY

OUR *Best* VALUE IS OUR RECORD OF LOYAL SERVICE

HARVEY

Radio Company of New York

103 WEST 43rd STREET • NEW YORK, N. Y.

CABLE ADDRESS "HARADIO"

(Continued from page 68)

election of the following officers: 7HRM, president; 7CYN, vice president and activities manager; 7EJZ, secretary and treasurer. The club is now engaged in three code classes using the standard ARRL instructions. The total enrollment is 115. Two evening classes and one afternoon class are held weekly at present. Instructors are Harvey Robertson, Gail Davison, Frank Wolf, H. C. Avery, Charles Powles, Lizette Wolf and two non-amateurs — Mrs. Davison and Clifford Sullivan. An additional afternoon class is being organized in order to take care of the overflow. 7HDS has resigned her position as EC for Cheyenne. She turned in an excellent job for the year past. The EC position is now in the able hands of 7EVH, who has been assistant coordinator under 7HDS for the past year. The Shy-Wy Club has made arrangements for a big session with the Rocky Mountain Director, 9CAA, on May 1st. Meeting is scheduled for 8 p.m. at the U.S.O. Club, 2002 Capitol Ave., Cheyenne. On April 10th 9CAA met with the Salt Lake City club. He is scheduled to meet with Laramie, Wyo. amateurs on April 24th and the Casper, Wyo. club on May 2nd. From there he travels to West Hartford for the annual meeting of board. Code students in the classes being taught by the Laramie Club members are progressing rapidly. Several of the more apt pupils are already copying at 20 w.p.m. Tests will be announced shortly. Two new amateurs recently licensed at Laramie are Lester Watt and Neil Coghlan. They were not issued call letters due to the fact that station licenses have been suspended. At least one wired-wireless transmitter has been reported in Laramie. Seems to be more news now than when we were on the air. 73 and best luck. . . . — Hank-W7GZG.

The Month in Canada

QUEBEC—VE2

From Lin Morris, 2CO:

2BB is on duty overseas with the Navy. Belated congratulations to 2KX on his marriage. 3JI and 3HN have been working in Montreal for some time now, while 2HF is doing radio work in Toronto. 2CR writes that he has bought a house in the Queen City.

The gang will welcome the news that 2AR has recovered from a serious illness and is convalescing in England. 2NR is continuing his good work teaching code to Navy recruits. 2GE, recently commissioned as a 2nd Lt., is now on active service at the officers training centre at Brockville. Also on active service are 2GO and 2HO.

2BO is said to be in Florida — how's the heat, Geoff? 5TD oscillates at high frequency between Montreal and Ottawa. 2DR was home for a few days on furlough. 2JE is with Northern Electric. A recent addition to the gang at National Research Council is 2CS who just graduated from McGill in engineering. Seen but not heard: 2GA, 2BY, 2XM, 2HH, 2BF.

ONTARIO—VE3

From Len Mitchell, 3AZ:

From Oshawa comes word that 3QN is associated with Research Enterprises, Ltd., at Toronto, and that 3AZE is now with the Atlantic Ferry. This makes three Oshawa men with the latter organization, the others being 3SZ and 3AKB. We are sorry to hear that 3SZ has had scarlet fever and we extend to him our best wishes for a speedy recovery.

From Montreal comes word that 3KV recently figured in the news there when he demonstrated his ability to carry on with his job despite temptation, even when it came from high places. Jack is a Sergeant Instructor at No. 1 Wireless School, and was conducting a class in radio direction-finding when the door opened and His Excellency the Governor General of Canada, who was making an inspection of the school, entered, accompanied by a number of other high-ranking officials. The visitors did not interrupt the proceedings and Jack, ignoring the visitors, carried on with the lecture without a moment's hesitation. After about 10 minutes the visitors left without having interrupted class!

ALBERTA—VE4

From W. W. Butchart, 4LQ:

The NARC held a Social on the evening of March 18th which was a huge success. A swell turnout of mem-

Always

Specify
Centralab

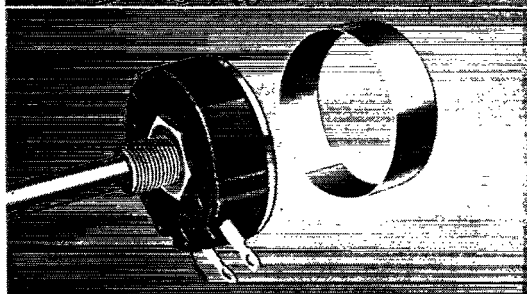

CONTROLS

Featuring the famous WALL TYPE resistor element which hugs the inner circumference of the black moulded bakelite case. Exclusive non-rubbing contact assures quiet smooth rotation and long life. Available in STANDARD, MID-GET AND ELF with or without switch cover.

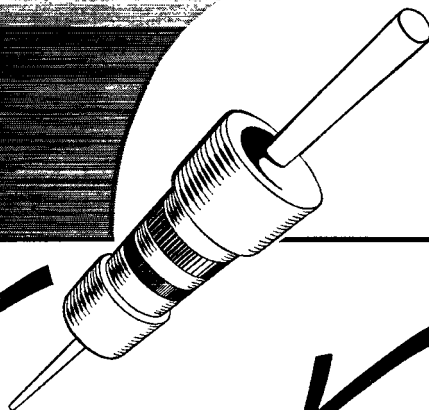

RESISTORS

Available in two types: RADIAL LEAD and AXIAL LEAD. Both feature a center core of resistance material, surrounded by a dense shock-proof ceramic providing strength and protection against humidity. Core and jacket are fired together at 2500 degrees F: into a single solid unit, hard and durable as stone.

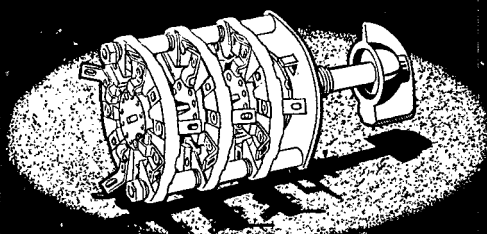

SWITCHES

Both selector and transmitter switches are available in an infinite number of combinations . . . ideal for high frequency circuits with minimum losses.

Most switches are supplied with an "adjustable stop" index . . . permitting the selection of from two to twenty-three positions.

CENTRALAB through every emergency continues to adhere to its policy of "performance plus" at all times.

The slogan "ALWAYS SPECIFY CENTRALAB" which has appeared in our advertising from the very inception of this name is as timely today as it was fifteen years ago.

Today as then . . . there is no substitute for **QUALITY**.

Write for Catalogue No. 23

CENTRALAB: Div. of Globe-Union Inc.
Milwaukee • Wisconsin

RADIO TRAINING



FOUNDED IN 1909

PORT ARTHUR COLLEGE, a non-profit-making educational institution, offers a practical radio operator's course. Each graduate receives two months' actual operating experience at the college's commercial broadcast station KPAC. This station is equipped with the latest type 1000 watt high fidelity RCA transmitter — 1250 kc. — directional antenna system. KPAC operates in new modern studios located on the campus.

Radio training at Port Arthur College is designed to qualify the graduate for employment as a broadcast engineer, combination operator-announcer in a studio, combination transradio press operator-announcer, studio control board operator, ground or flight radio operator in airline stations, marine operator on board ship, experimental and development work, radio beacons, government service, radio police patrol, seismograph, or secure a specialist rating in the U. S. Army, Navy, Air Corps and Marine Corps in National and Foreign service.

AUTHORIZED TO TEACH RCA TEXTS
COLLEGE LEVEL CURRICULUM
WOMEN STUDENTS ALSO ACCEPTED
If interested, write for Bulletin R

PORT ARTHUR COLLEGE
PORT ARTHUR (World-Known Port)
TEXAS

- **"Three-Way" Transmitter-Receiver for CD and Military Use**
Write for Circular CD
- **Radio Remote Control Equipment for Models and Industry**
1942 Edition of The Radio Control Instruction Manual, 25c postpaid
RADIO CONTROL HEADQUARTERS, INC.
P. O. Box 214 Deal, New Jersey

EASY TO LEARN CODE

It is easy and pleasant to learn or increase speed the modern way — with an **Instructograph Code Teacher**. Excellent for the beginner or advanced student. A quick and practical method. Available tapes from beginner's alphabet to typical messages on all subjects. Speed range 5 to 40 WPM. Always ready, no QRM, beats having someone send to you.

MACHINES FOR RENT OR SALE

The **Instructograph Code Teacher** literally takes the place of an operator-instructor and enables anyone to learn and master code without further assistance. Thousands have used and endorse the **Instructograph System**. Write today for full particulars and convenient payment and rental plans.

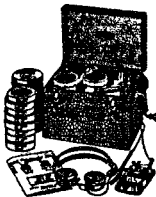

INSTRUCTOGRAPH COMPANY

4709 Sheridan Road, Chicago, Illinois
Representative for Canada:
Radio College of Canada, 54 Bloor St. West, Toronto

(Continued from page 70)

bers, friends and visiting hams brought the attendance nearly to the 50 mark. An amateur motion picture production was shown, along with several short subjects. Eats, dancing and singing rounded out the evening. Mickey, 4WY, and her OM motored up from Sylvan Lake to be present, and appeared to enjoy themselves to the utmost. 4AEN provided the dance records and 4LQ the sound system. 4ADW swings a wicked hoof on the dance floor. 4HJ featured in 4AKK's skit, "The Shooting of Dan McGrew." 4AEN, after lots of coaxing, got 4HF and his YL in on the circle two-step, and boys, that fellah HF sure can pick em! 4BW attended along with his XYL. Ted did a bit of missionary work recruiting for "E" Troop Cavalry Sigs. throughout the evening! And believe it or not, he hooked 4XF. It took the Social to get 4AEV and 4ANQ together. 4ALO was present to chaperone 4AEV.

The NARC has 4EA to thank for being able to get the films shown at the Social. Roy looked after the sound effects and musical accompaniment for the show while 4LQ handled the projector. 4AW, formerly of Calgary, and now with CATL, showed up with his XYL and met the boys. 4AEA seems to be thriving on his XYL's cooking. 4VJ was very pleased with the outcome of the Social and figures we should throw another shindig soon. 4WH, our worthy secretary-treasurer, worked hard as usual raking in the shekels. 4HM and his YF got out for the evening, and Chas. brought along his camera to grab off the odd picture, but he didn't get a chance to get to work. 4KK and his XYL came with the 4HMs. 4ATH's jalopy still gets around in high gear. Don't know what Stan will do when his tires get down to the fabric! 4XE was busy and arrived about 15 minutes late for the show.

4NU, believe it or not, is still talking 5 meters! 4AHQ built a garage for his car out of some of the Army big crates that Fairey Battles were shipped in. 4AHY's brother, with RCCS, was through Edmonton on the Army train that toured Canada. 4JP was a visitor in Edmonton during the week of April 5th. 4BW went to work on his staff at Radio Supply and was able to recruit the whole darn bunch in "E" Troop Signals. Nice work, Ted!

That's all for this time, gang, and if some of youse guys don't shoot in a bit of news this old column will have to fold up, in spite of all the favorable comments!

MAILBAG

We've had a lot of interesting mail from the VE membership here at Hq. this past month. Not the least interesting is the blast from Quebec's SCM, 2CO, which appears in the Correspondence section. Here are excerpts from some of the other letters received:

From Sgt. K. N. Brownell, at Coal Harbor, B. C.: "Just to-day I noticed your item in *QST* about wanting to know the whereabouts of amateurs, and knowing that Dad would write if he were here, I decided to write myself.

"Dad (James Harold Brownell, VE4BU) enlisted as a Flying Officer in the Royal Canadian Air Force in November, 1940. He went overseas in January '42. I'm afraid I can't tell you much about his work over there. . . . I've never seen him since he enlisted, as I was out on the West Coast here. . . . Although I am not an amateur myself, I sure am going to be when we win this scrap. I am a wireless operator in the RCAF, having learned it from my father. I joined up in November, 1939, and had it not been for this war I would have had my amateur license.

"I know another amateur who just lately joined in the RCAF as a radio technician. As yet he is under training and is just an AC2. He is Eddie Marcus, 4AJV. Dad got Eddie interested in the 'ham' game. Also, one of my friends up here is Phil Shepherd, 4HI. He is a wireless electrical mechanic. I would like to tell you more about our rigs and what we do up here on Active Service, Coastal Defense, but you know these censors — hil . . ."

And from a good friend in Calgary who prefers to have his name withheld: "Enclosed please find a clipping from the *High River Times* about LAC Clair Findlay. For a few months before the war started Clair operated a low-power rig at High River with the call 4AMN. Because of the short while he was on the air, and perhaps due to low power, Clair isn't very well known by his call. However, I believe he has made himself heard on the 4IN and 4ACF wavelengths. He is the second ham from the vicinity to prove himself with the joystick as the key, the other being 4ALO, who for the past while has been with Canadian Airways in Edmonton. 4AC is with the RCCS in Kingston.

Use It On
GLASS, METAL,
PLASTIC or WOOD

Shopfull of Tools

IN ONE AMAZING POWER-TOOL
WITH THOUSANDS OF USES



LASCO
ELECTRI-CRAFT
THE ELECTRIC POWER TOOL OF 1000 USES
for the Mechanic and Hobbyist

WHOLE SHOP FULL OF TOOLS ALL IN ONE COMPLETE WITH 35 ACCESSORIES

SAWING • GRINDING
CARVING • DRILLING
SANDING • POLISHING
ROUTING • ENGRAVING

MANUFACTURED BY LASCO PRODUCTS CORPORATION, NEWARK, N.J., U.S.A.

\$10.95

DELUXE ELECTRI-CRAFT

The only limit to the uses of this marvelous Electri-O-Tool is your own imagination! At least one job pops up every day that Electri-O-Tool will do faster and better! The handiest tool you ever saw to have around the house! For hobbyists, home craftsmen, mechanics—any one who uses tools in his work or hobby. Electri-O-Tool is as easy to use as a pen!

STANDARD ELECTRI-CRAFT \$9.45
(With 18 Accessories)

DELUXE ELECTRI-CRAFT

Factory List Price 26.75 **10.95**

COMPLETE KIT if bought separately

Factory List
Tool only 12.50
35 accessories 12.75
Steel Chest 1.50
Total 26.75

In addition to the power tool, and the sturdy steel chest, you get the following 35 accessories: 3/32" and 1/2" Collets, Wrench, 6 mounting grinding stones, 3 steel cutters, saw, 4 mandrels, 5 abrasion discs, felt buffer wheel, 3 rubber bonded polishing wheels, 3 brushes, wrapped wire cleaning & etching brush, dressing stone, muslin buffer.

QUANTITY LIMITED

MAIL ORDERS PROMPTLY FILLED

The RADIO SHACK
167 WASHINGTON ST., BOSTON, MASS., U.S.A.

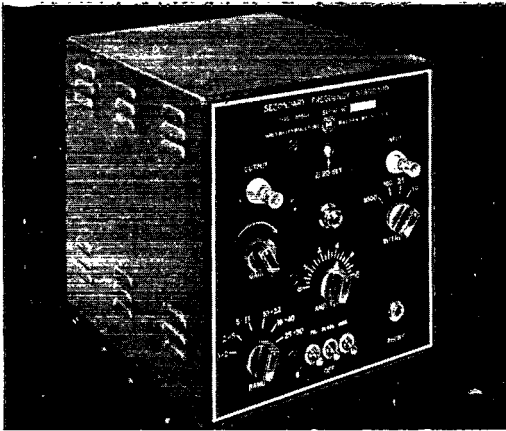

[A Precision Crystal — Secondary
FREQUENCY STANDARD

That Has Been "Designed for Application"

A precision frequency standard capable of being adjusted to WWV or some other primary standard and putting out uniformly accurate calibrating signals with 10, 25, 100, 1000 KC intervals. Uses the new GENERAL ELECTRIC No. 18A, 1000 KC crystal having a frequency temperature coefficient of less than one cycle /Mc/C°. The crystal is sealed in Helium in a standard metal tube envelope.

The self-contained AC power supply has VR150-30 voltage regulator tube.

In addition to oscillator, multivibrators, and harmonic amplifier, a built-in mixer with phone jack and gain control on panel is incorporated.

JAMES MILLEN
 150 EXCHANGE ST.



MFG. CO. INC.
 MALDEN, MASS.

*Kleinschmidt or
 Creed Perforators*

I would like to buy some, regardless of condition, because I can rebuild them. Will pay cash and a liberal price.

If you are interested in the finest of radio-telegraph apparatus—and no maybe about it—write for my latest catalog. Transmitters for schools, etc., ink recorders, auto heads, etc.

TED MCELROY

MCELROY MFG. CORP.

82 Brookline Avenue Boston, Mass.

(Continued from page 74)

"The best of luck to you in your drive to build up Canadian membership again. Although the hams were shut off before my license came through in '39, I will continue to support the A.R.R.L. as I want to use the privileges the League fights for after the war. I think everyone who is going after a ticket after the war should give the League their full support now, regardless of whether they were on the air before or not."

Sincere thanks, OM. The clipping referred to tells how 4AMN "brought honor to his home district" by winning the highest standing for all-around proficiency in his class of trainees. Judging from the report, the giving of the award was celebrated with suitable fanfare and recognition!

J. Stewart Houston, ex-4KJ, returns to the fold after a short lapse and supplies the following notes: ". . . I may say that almost all my ham acquaintances on this side of the line are now practicing their hobby in the RCAF or RC Navy or Army. Some, of course, like myself, are way over age and some of the youngsters in too low a category. 4ALS, a very clever and very keen man has been turned down owing to an unfortunate impediment in his speech. He is doing radio service for a large rural community. 4IM, with a bum foot, is TCA dispatcher at Regina. His brother Hughie is a sergeant instructor in wireless in an Ontario air school. 4ANM is a corp. in RCAF. . . ."

CU next month.

— C. B. D.

25 Years Ago

(Continued from page 26)

tion and whether the geography of his section is responsible for his poor results. He admits the illegal but not uncommon wavelength of 275 meters, but claims a "radiation" of 7.6 hot-wire amperes and insists that he knows how to tune a set. (P.S.: He didn't.) . . . He also claims that the trolley cars which pass in front of his station cause signals to swing, up as well as down:

There is a certain position of street cars at which signals are received at considerably more than normal strength, and then as the cars progress up the street, signals fade, frequently entirely out, and gradually come back again. I know it is the cars because I hear them coming at a certain point up the street, then signals increase, then fade, then the car passes, and then the signals swing back in. Last winter I had an aerial on the other side of the street a half dozen blocks down, and noted similar effects, this time on galena, proving that it was not some sort of induced potential which put a finer adjustment of voltage on the audion grid, etc., if such a theory would be admissible. These circumstances are extremely embarrassing. I have often heard a strange station, called, got an answer, and heard the response dwindle to nothing, and then realized that the car was passing and that the only reason I had heard him at all was because of the favorable condition originally caused by the car and then nullified as the car progressed. Now, wattel? Is it re-radiated radio energy from the trolley wire, the wave length of which is governed and changed by the circuit from trolley through car-motor to earth, producing alternately a favorable or unfavorable change from normal? Have you ever struck anything like this before, and can you explain it or suggest a remedy?

He also harangues the editor about an organized amateur attack on the problem of eliminating static and says:

You no doubt realize, as is clearly apparent to me, that in the amateurs of the United States is the greatest body of experimenters in existence. Many have ability and ample means to go into a thing exhaustively. I feel that almost any proposition that the amateur body as a whole bucks down to, can be worked out.

A promising lad; that. He seems to have a certain vision.

Where **POWER** is Vital...

DEPEND ON

Taylor

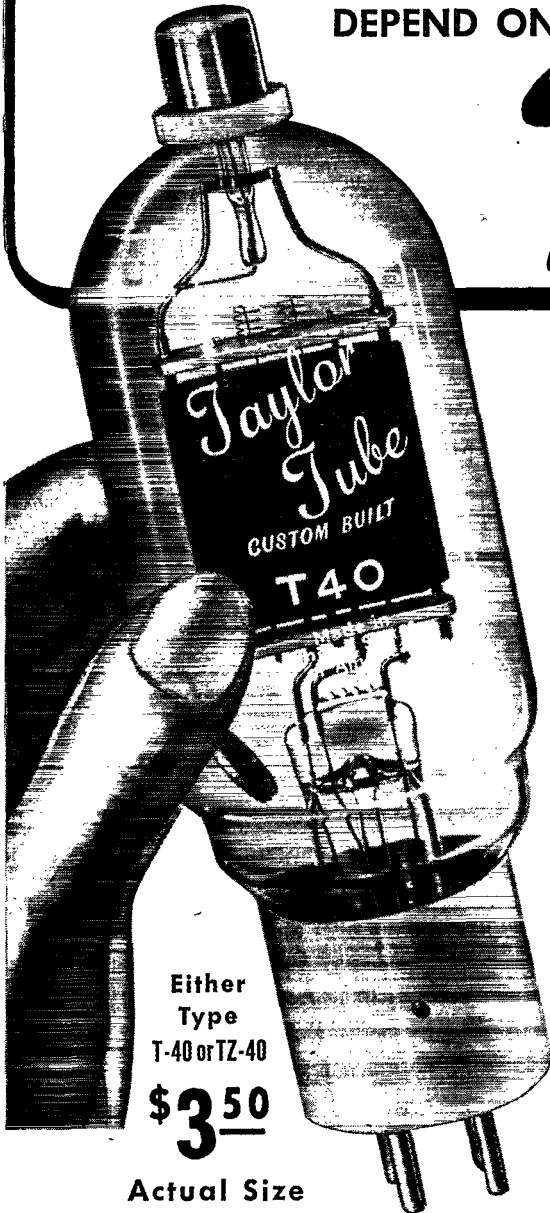

Either
Type
T-40 or TZ-40

\$3.50

Actual Size

Proved Dependability High Safety Factors

Every TAYLOR T-40 and TZ-40 type tube must pass a **1000% overload** test for gas before being offered to the user. No, the 1000% is not a typographical error — we mean **1000%**!

This *severe test* is your *assurance* against possible tube destruction in case of temporary overloads. It protects your investment and is your guarantee of *maximum service* and *long efficient tube life*.

TAYLOR has used every available means to squeeze "**More Watts Per Dollar**" into these tubes... you can depend on TAYLOR TUBES where sustained POWER is vital!

We sincerely believe that Taylor T-40 and TZ-40 type tubes are the best on the market in their class. Try them - - - prove it to yourself.

"MORE WATTS PER DOLLAR"

Taylor HEAVY **CUSTOM BUILT** DUTY **Tubes**

TAYLOR TUBES, INC., 2341 WABANSIA AVE., CHICAGO, ILLINOIS

GET YOUR RATING NOW!



Prepare for increased pay positions in the Army, Navy, Merchant Marine or Commercial Communications fields. There is a serious shortage of trained Radio code operators . . . you can prepare for one of these jobs without leaving your own home with the simplified Candler System. Over a quarter of a century of experience in training radio code operators. Write today and find out how easy it is to learn code now or improve code proficiency, and be prepared for the future. Mail a post card now . . . there's no obligation and no salesman will call!

A Free Book for You!

FREE 52-page BOOK OF FACTS contains inside advice and tips from the champions and world's fastest amateur and commercial operators. Get your copy of this free book now! Write today.



CANDLER SYSTEM CO.

Box 928, Dept. Q-6
DENVER, COLORADO

Visual Signalling

(Continued from page 45)

color in the indicated tones — or better yet, make yourself a separate set of identification cards showing the true colors for use in practice.¹

For Detailed Information

In the limited space available here it has been neither possible nor desirable to cover the whole subject of visual signalling and flag codes. After all, you only need to know the rudiments to start with — and they are covered here. However, those interested in obtaining fully detailed information, with complete lists of all the code symbols ordinarily used, are advised to secure a copy of the Hydrographic Office publication H. O. No. 87, "International Code of Signals (Vol. 1, Visual and Sound)," which may be obtained from the Hydrographic Office of the Navy Department at Washington, D. C., or any of its agencies in principal cities. The price is \$2.25.

¹ A complete set of colored "Signalcards," showing all international flags and pennants as well as the semaphore alphabet, is available from The Sunset Press, 1019 Tenth Ave., San Diego, Calif., for 50 cents postpaid. These cards are particularly useful for practice because the identification appears only on the back, facilitating memorization.

FILTER CONDENSERS 59¢ A PRE-WAR BARGAIN

AND UP

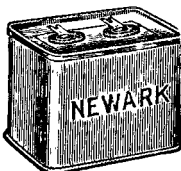

Oil Filled and Oil Impregnated condensers still available at pre-war prices! Real quality too. Guaranteed at Rated Voltage.

Mfd.	Volts DC	Size	Price
1	100	5 x 3 1/4 x 1 1/4	\$.59
2	2000	4 1/4 x 3 1/2 x 1 1/2	1.50
8	2000	5 x 3 1/2 x 3 1/2	2.75
8	3000	5 x 3 1/4 x 3 1/4	3.75

HURRY! ORDER YOURS NOW!

SAVE \$ On These High Voltage Power TRANSFORMERS

Guaranteed as illustrated. Made by a big transformer manufacturer.

No. 1549 — 300-0-300 — 100 Ma. 6.3 V.-3 amp; 5.0 V.-3 amp. \$1.95
 No. 4140 — 600-0-600 V. — 200 Ma. Filaments: 7.5 V.C.T.-3 — 5.0 V.C.T.-3 A. — 2.5 V.C.T.-10 A. Wt. 8 1/2 lbs. \$3.45
 No. 4240 — 600-0-600 V. — 200 M.A. Filaments: 6.3 V.-4 A. — 6.3 V.-3 A. — 5.0 V.-3 A. Wt. 8 1/2 lbs. \$3.45



Now is the Time to Show YOUR CALL LETTERS

Big Shadowed Decalcomanias 10¢ per set
 Nearly 2" high. Let folks in your town know you're a radio ham. Put your letters on your windshield, ham shack door, etc. Be sure to give your call letters and send dime.

ORDER YOUR NEEDS TODAY from Newark's big stock of **RADIO PARTS**. We have everything you need at the prices you want to pay. Full line **HALLICRAFTERS RECEIVERS** Now in Stock.

NEWARK ELECTRIC COMPANY
 323 W. Madison Street Dept. Q Chicago, Illinois

BARGAIN BOOK

Not only sets and parts but hundreds of general electrical items, tools, hard-to-get parts, etc. A regular encyclopedia of everyday needs.

FREE!

Power Tuning for the Amateur Transmitter

(Continued from page 41)

v.f.o. and the receiver after a frequency change has been completed) depends almost entirely on the sharpness of the resonance curve of the receiver, assuming of course that the clutch throws out without appreciable lag. It boils down to the fact that accuracy will be measured in kilocycles with the crystal filter phased out, and in cycles with the filter in operation. It is quite true that variables can be introduced into the control circuit, but is it logical to attempt to achieve accuracy from an inaccurate source? A broad selectivity curve is a form of inaccuracy. The magnitude of the input signal at the receiver has relatively little effect on the accuracy as long as it remains within reasonable limits, usually anywhere within the upper half of the r.f. gain control taper.

It has been found that the relays (a definite interaction cycle between the control relay and motor-starting relay is to be expected) tend to bounce when the signal strength is of sufficient intensity to block the receiver, and thus the system becomes balky about starting. When the signal strength is still further increased the bounce cycle becomes continuous and the system will not start at all. To counteract this, a stop-gap corrective measure (a receiving-antenna-disconnect relay wired in parallel with the tuning



TO the many of you who are now serving your Country in engineering and other technical radio positions, the high quality of Stancor Products is manifest in the devices in use for Uncle Sam.

Stancor still offers the only complete line of Transformers in the Industry and pledges a continuation of the Top Quality for which the name STANCOR is known.



COMPLETE CATALOG

24 pages of up-to-date listings, complete sales information and prices.

Data covers the industry's complete line of transformers and chokes for all practical applications. Packs both filtered and non-filtered types. Transmitter and amplifier kits. Ask today for your free copy of Catalog No. 140Q.

THERE'S A STANCOR JOBBER IN ALL PRINCIPAL TRADING AREAS



STANDARD TRANSFORMER

• CORPORATION •

1500 NORTH HALSTED STREET . . . CHICAGO



Let me send you
the popular
"ear" of the
amateur



HALLICRAFTERS

Discover for yourself why they are so popular. I have on hand *Hallcrafters* and other model receivers, ready for immediate delivery. Get 'em on my lowest 6% plan.

ARE YOU SET FOR 2½m?

Five models to choose from. Thousands of parts to build 'em from. Write for complete information and prices. (Leo W9GFQ)

FREE MAP OF U. S.
15c to cover postage and packing brings one to you.

FREE CATALOG

Fully illustrated. Everything in radio for the "ham" and service man. You should have one.

WHOLESALE RADIO LABORATORIES

746 West Broadway

Council Bluffs

Iowa

SICKLES COILS

ALL TYPES OF RF AND IF WINDINGS

Manufactured by

F. W. SICKLES COMPANY

P. O. Box 920

Springfield, Mass.

YOU CAN BE A

HIGH SPEED TYPIST!

It's easy!... Candler High-Speed Typing Course will help you make a better copy and to copy code at high speed. This system eliminates tiresome practice, gives surprising speed and technique.

Be master of touch-typing, speed and accuracy, easily and quickly without leaving your own home. Special price of \$6.85 to Amateurs and Operators for full course—24 simplified lessons.

Start now by sending full payment, only \$6.85 for complete Candler High-Speed Typing Course which is guaranteed to make you a better, faster typist, or send for FREE booklet which tells you the facts about this famous system, backed by over a quarter century of success.

CANDLER SYSTEM CO.

Box 928, Dept. TC Denver, Colorado

(Continued from page 76)

motor) can be used for experimental purposes. The final form of a motor-tuned transmitter would, of course, be expected to include adequate means of regulating the control signal, be the distance variable ten inches or ten miles.

Pointers

In this admittedly somewhat rambling discussion, a number of details have not yet been touched on. For the sake of brevity, these will be covered in a numbered list, as follows:

1) It is reasonable to assume that a substantial increase in tube life will result from the use of gang tuning (motor-driven or otherwise), because the stages will be resonated with each other once and for all at reduced plate voltage. A high percentage of all premature tube failures occur when a stage is off resonance (or have you been lucky?).

2) The theory of utilizing the regular station receiver as the frequency selector seems logical in that the receiver is truly the final say-so in the matter of frequency determination; at least, as far as we are concerned.

3) The control circuit will require only about 32 cubic inches of space when components of ordinary size are used. The necessary connections to the receiver should present no great problem (only a.c. and d.c. circuits being involved) although a person who is not reasonably familiar with receiver wiring would do well to have the schematic diagram available.

4) Motor tuning can be applied to any tube line-up. However, as is the case with all gang-tuning problems, the fewer stages the better.

5) The cost of the extra equipment for motor tuning of a medium-power transmitter will range from about \$12.00 up, although a comparison between the cost of motor tuning and single-dial control would mean that the price of one worm-drive unit (normally used in both cases) and the tuning dial can be subtracted from our estimate. Anyhow, there are so many possible arrangements that we'd best forget the whole thing before we begin to get really confused!

6) The motor may as well be run in one direction only. If the condensers have stops, cut them off before starting the motor! In case a worm-gear assembly having one ball thrust bearing and one tension bearing is used, it is best to drive in the direction which exerts pressure on the ball bearing. That may sound confusing, but it will make sense to anyone who gets that far.

7) The r.p.m. of the condenser shaft will normally vary from 2 to 10 or thereabouts, depending on the frequency change per degree of rotation.

8) If one decides to stay on say 7007.5 kc. indefinitely one just doesn't push the button. Complete dependability is a feature of this system; there are no dials, so it will really stay put.

It is quite impossible to make a general statement concerning the degree of accuracy which can be attained. Actually, the accuracy (even for

The lampshade microphone was designed to prevent "mike fright." This is an early scene at WGY, this year celebrating its 20th anniversary.



*Remember the Days
of the
Lampshade Mike?*



MORE watt-hours per dollar smaller, more compact tubes; longer life—what General Electric's 29 years in the tube business means to you today. Here are a few of the major advancements in tube design G-E engineers have contributed.

**THAT'S WHEN GENERAL ELECTRIC
COOLED TUBES WITH A
"MODEL T" RADIATOR***

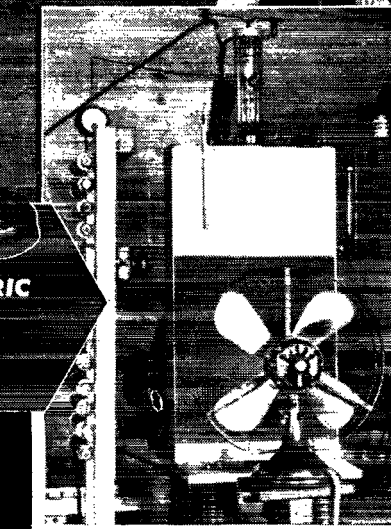
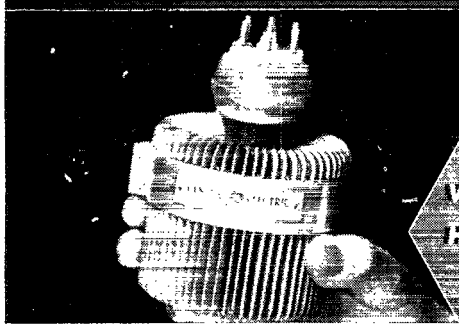

**WHAT A DIFFERENCE! TODAY,
HARDLY A HANDFUL GIVES
—1800 WATTS OUTPUT**

*Photo shows the first application of a water-cooled modulator—in WGY's 1922 transmitter.

- ★ **thoriated tungsten filaments**
- ★ **high-power, water-cooled tubes**
- ★ **hot-cathode, mercury-vapor rectifiers**
- ★ **the first accurate rectifier emission test**
- ★ **the screen-grid tube**
- ★ **metal tubes for receivers and industrial uses**

Today we are speeding the conquest of the ultra-highs with such tubes as the GL-880, GL-889, and GL-8002R. Bulletin GEA-3315C brings you the story on our complete line of tubes for all classes of service. *General Electric, Schenectady, New York.*

WGY today serves about one million radio families 24 hours a day. It was the *first* station in the Great Northeast; today it is the *foremost*.

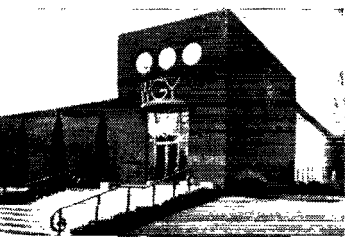

GENERAL ELECTRIC



161-3611-8850



CHECK HERE!

... if you want a BETTER radio job!

Technical ability is the only thing that stands between you and a better job. . . . CREI can prepare you NOW with just the training you need!

Yes, YOUR opportunity is here NOW! CREI home study courses are "made to order" for this opportunity and CREI

trained men are in demand throughout the radio industry. If the lack of sufficient technical training is your stumbling block . . . you can do something about it now — if you will. Your radio experience backed by CREI modern training will equip you to share in the better, good-paying jobs that await trained men now — and provide a secure career for the future. 5,000 professional radiomen can't be wrong — they're the men who have already turned to CREI for the advanced training they realize is necessary for success! We can help you — why not get the facts?

Write for Full Information and Catalog Now!

If you are a professional radioman and want to make more money—let us prove to you we have something you need to qualify for a better engineering job. To help us intelligently answer your inquiry—please state briefly your background of experience, education and present position.



Capitol Radio Engineering Institute

Home Study Courses in Practical Radio Engineering for Professional Self-Improvement

Dept. Q-6, 3224 16th St. N.W., Washington, D. C.

Contractors to the U. S. Signal Corps and U. S. Coast Guard
Producers of Well-trained Technical Radiomen for Industry

Attention!

RADIO AMATEURS

AND

ENGINEERS

When in Dayton, Ohio, make Standard Radio your headquarters

DISTRIBUTORS OF QUALITY

RADIO PARTS

AND

ELECTRONIC EQUIPMENT

STANDARD RADIO PARTS CO.

135 EAST SECOND STREET

DAYTON, OHIO

(Continued from page 78)

a given installation) cannot be expressed in cycles per second unless the frequency range is specified.

Summary

In summary, we have here the elements of a variable frequency transmitter which can be enclosed in a protective cabinet and placed at any convenient point. The send-receive switch and the push-to-tune button are all that must be within reach. We have something which should be fun to build and a pleasure to operate. We have a form of true single-dial frequency control. However, the really important fact is not what it is, but only that it is something else which is being tossed in our collective laps. The really important question is not what will it do, but what will we do with it?

A plain language article on science appearing in a recent issue of *Life* magazine contained this sentence: "It (Science) will exchange any number of theories . . . for the sake of a single, clearly established fact." We are not on the frontiers of science. Whether we are still on the threshold of development is debatable. We are surely about as near that point as any amateurs ever get. We have a lot of practical work to do right now, but there may be time for a little experimenting. For instance, this is by no means the only variable-frequency power-tuning system. There is at least one other, a bit more complicated perhaps, but capable of infinitely greater accuracy — if it works!

Experimenter's Section

(Continued from page 36)

to have one handy) as a reflector of aircraft noise. With the mike suspended at the focal point of a 35-foot pool, the gain is very pronounced.

Several warning posts report very satisfactory results with the unit described in March *QST*. If you know of anyone in your vicinity who is working with acoustic detectors, we'd like to hear about it.

PROJECT F

Supersonics

WE HAVE a list of several fellows interested in the possibility of communication by means of supersonic frequencies in air. They are considerably handicapped thus far, however, by the lack of suitable reference material for study. This group would appreciate hearing from anyone who knows of a source of literature on the subject.

Miscellaneous

By using an ordinary megaphone over a head-phone unit fed by a small audio oscillator,

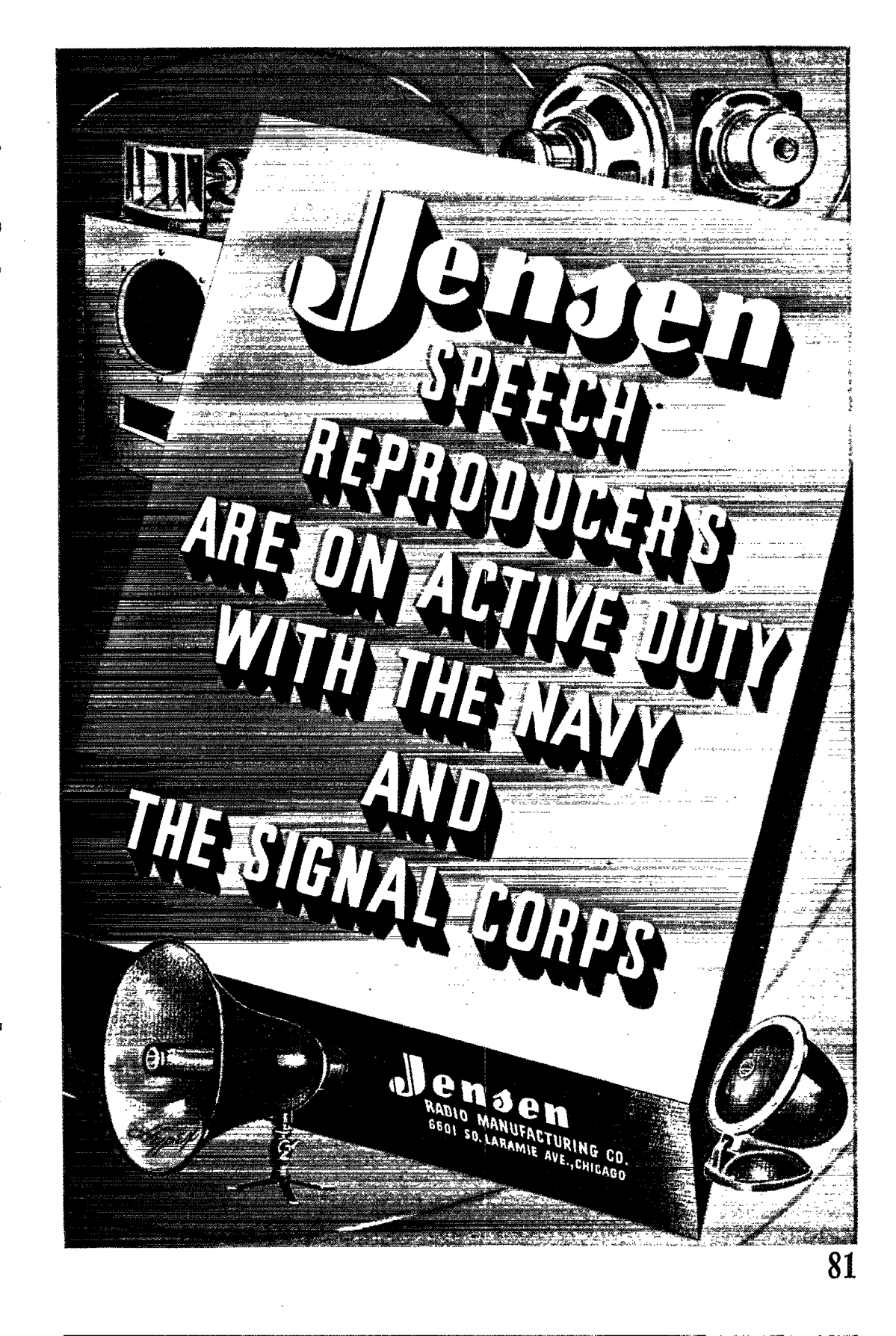

Jensen
SPEECH
REPRODUCERS
ARE ON ACTIVE DUTY
WITH THE NAVY
AND
THE SIGNAL CORPS

Jensen

RADIO MANUFACTURING CO.
6601 SO. LARAMIE AVE., CHICAGO

KLEINSCHMIDT OR CREED PERFORATORS

I would like to buy some, regardless of condition, because I can rebuild them. Will pay cash and a liberal price.

If you are interested in the finest of radio-telegraph apparatus—and no maybe about it—write for my latest catalog. Transmitters for schools, etc., ink recorders, auto heads, etc.



TED McELROY

McELROY MFG. CORP.

82 Brookline Avenue

Boston, Mass.

New... Handy



**UNIVERSAL
REPLACEMENT
Capacitors**

SOLAR MFG. CORP., Bayonne, N. J.

FASTEST WAY TO LEARN **CODE**

Easy, Fascinating — LEARN BY EAR to be a GOOD OP.

This New All Electric Master Teleplex Code Teaching Machine is exactly what thousands are looking for. No experience needed. Excellent for beginners — steps up WPM for ALL Ops. There is no guesswork with Master Teleplex, because it records your sending in visible dots and dashes by a brand new method on a specially prepared tape. You SEE and HEAR exactly how you are making your signals. You learn code the way you'll be using it—by SOUND. *That's why many schools teaching code use TELEPLEX.* Complete course included at no extra charge. Used by many schools and several governments for teaching code. Low cost, easy terms. MONEY BACK GUARANTEE. Send now for booklet Q-6, no obligation. Post card will do.

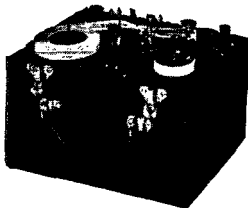

The "HAM" Special Standard Teleplex — a highly efficient code teacher using heavy specially prepared waxed paper tape, having two rows of perforations. Write for Free folder QT-6.

**TELEPLEX CO. 107 HUDSON STREET
JERSEY CITY, N. J.**

82

(Continued from page 80)

W9BAY has been able to conduct code practice between two buildings separated 150 feet. The signal is picked up by microphone at the receiving end and amplified by a unit similar to the one described for aircraft detection in March *QST*. The megaphone directivity is good enough so that the sound is barely detectable on the ground 15 feet below the transmitter.

—♦♦♦—

"If there is anyone on record as being interested, I would like to compare notes with him on the subject of reflection and focusing of infra-red rays. Think I've got something. I will travel a reasonable distance, if the cause warrants. . . ."

— W. E. Posey, *W4HEY*

228-A N. Main St., Greenville, S. C.

Course in Radio Fundamentals

(Continued from page 81)

rent decreases, the induced current will oppose the decrease — that is, it will tend to keep the current flowing.

These same effects take place in Coil 1 alone, but cannot be shown conveniently with simple apparatus. However, since both coils are in the same magnetic field it is easy to see that the same effects would be exhibited in both. On closing the circuit a current will be induced in Coil 1 which flows in the opposite direction to the battery current and exists only until the battery current reaches its steady value. The accompanying induced voltage is maximum at the instant of closing the circuit and is practically equal to but opposite in polarity to the battery voltage. It cannot exceed the battery voltage, of course, since a higher induced than applied voltage would mean that electrical energy was being supplied from the coil to the battery, which is obviously impossible. The amplitude of the induced voltage is greatest when the magnetic field is changing most rapidly, which is at the instant the circuit is closed, and decreases as the field builds up until finally it becomes zero when the field is no longer changing. On opening the circuit a voltage of opposite polarity is induced in the coil, and the current accompanying this induced voltage flows in the same direction as the battery current. Under these conditions the polarity of the induced voltage and that of the battery are the same, so that the bucking effect which exists on closing the circuit no longer is present. If the circuit is broken quickly the magnetic field will disappear very rapidly, and since the amplitude of the induced voltage increases with the rapidity of change in the magnetic field, the induced voltage may be very high — hundreds or thousands of times the battery voltage. The energy in the field likewise will have to be dissipated very rapidly, and it is used up in the spark which accompanies the breaking of the circuit. The property of storing energy in a magnetic field on closing the circuit and releasing it when the circuit is opened is called *inductance*. Since for a given current the field is stronger — that is, more energy is stored — with a larger number of turns, as shown in Exp. 4, and also with a core of high permeability, as shown by Exp. 5, the inductance is greater the greater the number of turns and the greater the permeability of the medium in which the field is set up.

If Coil 2 is in the same field, the voltage induced in it will be proportional to the voltage induced in Coil 1, to the ratio of its turns to the turns in Coil 1, and to the proportion of the total field set up by Coil 1 which bathes the turns of Coil 2. In the present case the coils are quite close together, hence are practically in the same field. Since Coil 2 has approximately twice the number of turns of Coil 1, the voltages induced in Coil 2 will be approximately twice those induced in Coil 1. These relationships can be shown in a qualitative way by the "finger test," even though measurement is impossible with this equipment. Disconnect the milliammeter, place two fingers of one hand across the terminals of Coil 2, and close the battery circuit through Coil 1. Since the induced voltage on "make" is quite small, the fingers feel no

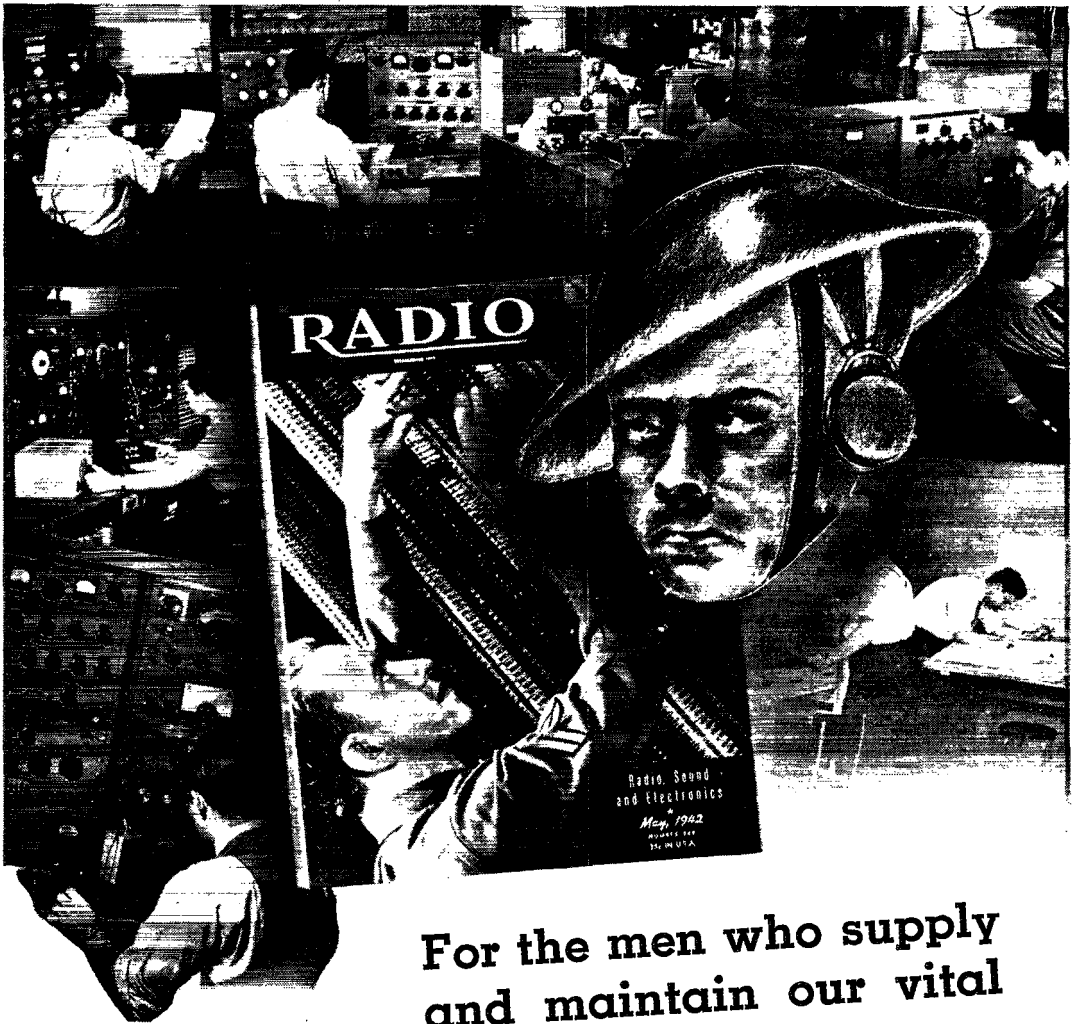

For the men who supply
and maintain our vital

RADIO COMMUNICATIONS

The editors of **RADIO** have only one interest: to keep our nation's rapidly increasing number of radio and electronic engineers and technicians supplied with important, practical engineering and design developments. That we will do, tempering our vigorous enthusiasm with mature, factual judgment.

*** The new *RADIO* will be larger in *SIZE* and *SCOPE*! * Current subscribers may extend their subscriptions for another year (\$2.50) or two years (\$4.50)! * New subscribers may take advantage of our *INTRODUCTORY* offer of *FIVE ISSUES* for only \$1.00!**

Rates quoted apply only within the United States of America

RADIO 1300 KENWOOD ROAD
Santa Barbara, California

WHAT TYPE OF RADIO INSTRUCTION DO YOU NEED?

new

1. A QUICK REVIEW

PRE-EXAMINATION TESTS FOR RADIO OPERATORS is the most comprehensive review ever offered. Shows what you know. Tells you what to study. Hundreds of questions. Separate set on each F.C.C. element (2 to 6). Used in conjunction with textbooks **RADIO OPERATING QUESTIONS AND ANSWERS** and **PRACTICAL RADIO COMMUNICATION**, it prepares you for license examinations in shortest possible time. Helps avoid failure. Very low cost. Send for circular 5Q on **QUICK RADIO REVIEW—TODAY.**

2. COMPLETE COURSE

Nilson's MASTER COURSE IN RADIO COMMUNICATION—fits you for job, advancement, or license examination. Best home-study course for the man who needs basic training. Covers entire field, same scope as resident school course. Low cost. Nilson graduates have high record of success on license examinations and on jobs. **FREE** circular 3-Q gives full information. Write **TODAY.**

NILSON RADIO SCHOOL, 51 East 42nd St., New York

IMMEDIATE CASH

for your—

RECEIVER • TRANSMITTER
TEST EQUIPMENT
METERS • TUBES
PARTS
ETC.

Send us a complete description of your equipment. Mention make, model, age, condition, "improvements," etc. If you have an approximate price in mind, state it. We will make a fair cash offer by return mail.

Hit 'em **TWO** ways—

- 1—Put your idle apparatus to work, for Victory!
- 2—Buy Victory Bonds with the cash we give you!

Send in your list today!

**HARRISON
RADIO CO.**

12 West Broadway • New York City

(Continued from page 82)

shock. On opening the circuit, however, there will be a distinct although quite harmless shock, showing that the induced voltage on "break" is quite high. Repeat with the fingers across the terminals of Coil 1; again nothing will be felt on "make," but a small shock will occur on "break." Since part of the energy is dissipated in the spark, it may be necessary to moisten the fingers to feel any effect at all in this second case. A better indication can be secured by holding one finger on the terminal at which the switching is done and keeping the battery wire in contact with the same finger while closing and opening the circuit. The induced voltage on "break" is obviously much larger than the battery voltage, which can give no shock itself, but is not as large as in Coil 2, which has a greater number of turns.

Silent Keys

It is with deep regret that we record the passing of these amateurs:

John H. Amis, W9CET, Topeka, Kans.

Edwin A. Darling, W1CRZ, W. Harwich, Mass.

William B. D. Gray, W1GKC, Thomaston, Me.

Robert B. Guthrie, W9IH, Milwaukee, Wis.

Andrew B. Hart, W5IXY, Cotton Valley, La.

Harry R. Houser, jr., W8WUJ, Altoona, Pa.

Sgt. Ivan Leslie Jones, ZL2RQ

H. Raymond Marple, W9RXX, Chicago, Ill.

D. B. Orwick, W8JZF, Toledo, Ohio

Harold F. Spencer, W2NGK, Brooklyn, N. Y.

Lloyd C. Tucker, W9IET, Ripon, Wis.

Optical Fundamentals

(Continued from page 81)

be illuminated by tangential light from the right. The longer the focal length of the lens, the better is this phenomenon shown. This scheme was first applied to the testing of telescopic mirrors by Foucault about 90 years ago. Its importance to us lies in the fact that it gives us a means of varying the amount of light passing through an optical system without changing the shape or size of the image—just what the doctor ordered.

We are all set now to put this dope together in a workable voice-modulated narrow beam. The elements are shown in Fig. 11. We have replaced the pinhole with a narrow slit illuminated by the lamp. The condensing lens focuses the slit on a second slit, one side of which is vibrated by a voice coil from a loudspeaker unit.² The experi-

² Somewhere in the speech amplifier system it will be necessary to put in a series condenser to reduce the low frequencies, otherwise the slit will overmodulate on the lows and produce distortion. The size of the condenser will depend on the impedance of the circuit in which it is used.



THE RADIO AMATEUR'S HANDBOOK

NAVY AVIATION SPECIALISTS
 The training division of the Bureau of Aeronautics of the Navy has openings for men with some college training (physics and electrical engineering preferred) plus a commercial or amateur radio license. Radio training and experience are absolutely necessary. They will be assigned to various stations.

ENLISTING IN THE SIGNAL CORPS
 The Signal Corps is the only branch of the Army in which, by showing your amateur or commercial radio operator's license to the recruiting officer, you may be assured of the radio work assignment.

ANTI-AIRCRAFT WAVEGUIDES
 The Anti-Aircraft Artillery Command of the East Coast is in severe need of radio operators for the defense of the coast. They will be assigned to various stations.

U.S.A. CALLING!

U.S.A. IN THE NAVY
 The letters U.S.A. for years have meant new horizons for the amateur. In the commercial and experimental world they have meant television and f.m. Today, in a world at war, U.S.A. is playing another part, a higher part, one that may decide the fate of the world.

NAVY COMMISSIONS FOR ENGINEERING STUDENTS
 Last month we reported that commissions in the Signal Corps are available for junior and senior students of engineering schools.

MORE SIGNAL CORPS COMMISSIONS
 Vacancies exist for the immediate appointment of a limited number of second lieutenants in the Signal Corps, for general duty.

ENGINEERING STUDENTS AS OFFICERS
 The Signal Corps offers commissions as second lieutenants to junior and senior students of engineering schools in the fields of electronic physics, up to and including the Ph.D. degree.

ELECTRONICS TRAINING
 That's the correct name for the new group called the Electronics Battalion of the Signal Corps. This is the most intensely intriguing and important of the new units, particularly those with ham licenses.

WAR DEPARTMENT OPERATIONS
 There is a continuing need for high-speed radio-equipped personnel for fixed service of the War Department. The Army is now offering \$165 per month for candidates for training in the various branches of the Signal Corps.

AND WOMEN, TOO!
 Technically-trained women, available for employment, are needed to communicate with the Army and Navy. They will be assigned to various stations.

YOUTH AND THE AIR
 That America needs amateurs in the air as well as on the air is the theme of a new campaign. The Navy is going to need 5000 more maintenance men with radio experience in the secret new work in the air.

**SPECIAL DEFENSE EDITION
 RADIO AMATEUR'S HANDBOOK**

PRICE ONE DOLLAR POSTPAID

American Radio Relay League, Inc., West Hartford, Connecticut

HIGHER - VOLTAGE Oil-Filled CAPACITORS

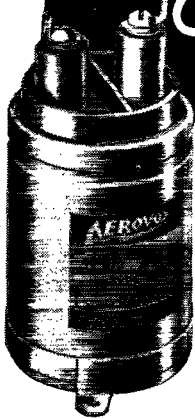

● Those higher-voltage requirements particularly in electronic applications such as cathode-ray circuits, are being met by the "12" Series Aerovox Hyvol Capacitors.

These oil-filled round-can units, with barrier-cap and removable pillar terminals, are available in voltages up to 7500 D.C.W. Conservative design—more paper dielectric than usually considered necessary—makes them the favorite choice for tough jobs.

Ask Our Jobber . . .

He'll gladly show you the Hyvol line of capacitors with its wide choice of types. Ask for latest catalog—or write us direct.

Exclusive Hyvol oil dielectric. Effective capacity maintained even at freezing temperatures.

Hermetically-sealed metal container.

Capacities from 2.0 mfd. at 2000 V. D.C.W. to 0.1 at 7500 V. D.C.W.



DUE TO THE TREMENDOUS DEMAND

for the new McElroy-Built Code Machine, which works on either AC or DC and on any cycles, we are compelled to standardize on these. We have about fifty of the older type which are in good order but work on 60 cycle AC only. At forty dollars each, they're a bargain. Complete with pullers. Send check or money order and we will ship promptly.

N. C. Ayers, 711 Boylston St., Boston, Mass.

Hams, Defense School Students and Gov't Men

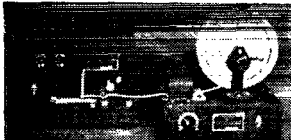

Ayers Automatic Code Machines Dept. Q-6, 711 Boylston Street, Boston, Mass.

are learning the code the right way, quickly and easily with the all electric Ayers machine. Built by Code Champion McElroy for our future champions. Largest selection of tapes in World available with each machine. Low monthly rental. Tapes for MacAutos, recording slip and special inks for sale.

**AMATEUR
CRYSTALS
EXCLUSIVELY**



**COMMERCIAL
SINCE
1934**

PETERSEN RADIO CO., Council Bluffs, Iowa

HARVEY RADIO LAB'S, Inc.
Manufacturers of
Radio Transmitters
ELECTRONIC APPARATUS
447 CONCORD AVENUE, CAMBRIDGE, MASS.

(Continued from page 84)

menter has unlimited opportunities here to display constructional ingenuity. Nice work is called for if the best results are to be obtained. A rough bench layout will give immediate results if the output light is fed to a photoelectric cell. This system is the basis of sound movies, the only difference being that the variable light is focused on a moving film.

To sum up, let's consider Fig. 12. We are back to our simple lens used to produce a more or less parallel beam. Now, we have a finite source of light of intensity I_S and diameter D_S placed a distance f from the lens. The beam is received at a distance d and the diameter of the received image of the source is D_I and has an intensity I_R . From the laws of optics and physics, we set down a few useful relations.

1. I_R varies directly as I_S , other things being equal.
2. I_R varies as A^2 , other things being equal.
3. I_R is independent of f , other things being equal.
4. I_R varies as $1/d^2$, other things being equal.
5. D_I varies with D_S , other things being equal.

From the above, it will be seen that increasing the power of the lamp by increasing the size but not the brightness of the filament only results in the production of a larger field at the receiving end and, unless the receiving lens or mirror is large enough to embrace all the light, no gain in sensitivity is secured—only an increase in spread, which is not useful. Only that light which can be picked up by the receiver is useful. Large aperture, short-focus lenses such as reading glasses are useful provided the receiver is large enough, but all considerations point to the use of large-aperture, long focal-length lenses (or mirrors) for the transmitter. For the receiver, aperture is the main requirement. The electrode on a photocell is large enough to permit the use of reflectors of the automobile headlight type or nickleplated sun-bowl heater reflectors, since the device is not being used as a visual telescope.

The main thing is to start experimenting with whatever lenses are at hand. Those with serious intentions will do well to acquire a copy of "Amateur Telescope Making," published by Scientific American Publishing Co., New York, N. Y. The writer possesses a homemade 10-inch reflector of 75-inch focus, and the beam from this, using a 2.5-volt flashlight lamp, is only 15 inches in diameter at a distance of one mile.

A Talkie-Walkie for Civilian Defense

(Continued from page 18)

should be able to see the filaments when lit. Leave the switch in the receive position. After the tubes have had a chance to warm up, the usual superregenerative hiss should be heard in the speaker. If it is not, vary the regeneration control C_3 until it is. If there is still no result, try

KENYON BRINGS IT THRU

KENYON is serving the Allied forces on the land . . . in the air . . . and under the sea.

Whether it's an airplane flying for war or peace . . . whether it's a ship at sea or a submarine signalling beneath . . . whether it's a broadcasting station bringing the news . . . or a long-distance telephone call announcing a birth or a death . . . Kenyon Transformers are on the job.

In the exigencies of war and along the by-ways of peace the efficiency and high fidelity of Kenyon Transformers are playing a part.

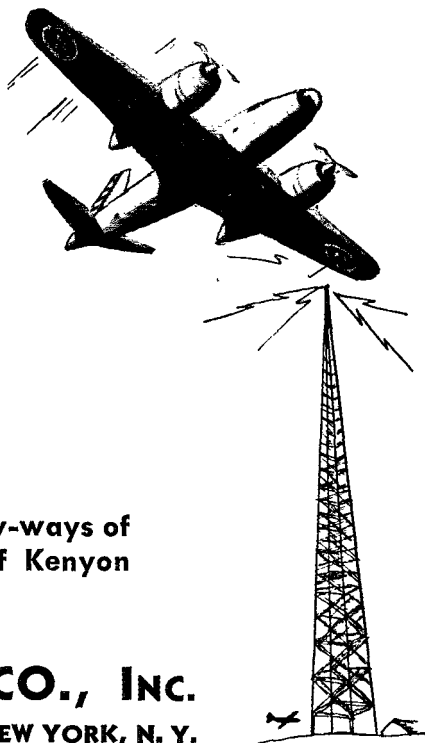

KENYON TRANSFORMER CO., INC.

840 BARRY STREET

NEW YORK, N. Y.

WE Have the World's Largest Stock of **Hallicrafters, Hammarlund, National, RME, Howard Communications Receivers**

Order from us for prompt delivery. **WE SPECIALIZE IN GOVERNMENT AND OTHER PRIORITY ORDERS AND SOLICIT SUCH BUYERS.** We give you better service and lowest prices.

Our stock of receivers is so large that we can sell to civilians. You can buy on our 6% terms financed by us. You can trade-in your radio. You get ten day trial.

We have a large stock of transmitters, Triplett meters, Thordarson, UTC, Stancor, and radio parts and supplies of all sorts. Send to us for any radio apparatus. Priority is not required.

Write, telephone, telegraph us anytime about any receiver, transmitter, parts. We are on the job 24 hours a day, 365 days a year. We also have a store at 2335 Westwood Blvd., West Los Angeles, Calif. Ted Henry, W6UOU, runs the California store. Bob Henry, W9ARA, runs the Butler, Missouri store.

HENRY RADIO SHOP, Butler, Missouri

"WORLD'S LARGEST DISTRIBUTOR OF COMMUNICATIONS RECEIVERS"

COMMERCIAL RADIO INSTITUTE

A radio training center for over twenty years. Well equipped. Excellent faculty. Practical resident courses in Radiotelegraphy, Broadcast, Servicing, Television, Aeronautical Drafting, Mathematics, Industrial and Studio Technique. Placement bureau. Day and evening classes now forming. Send for catalog. Dept. B.
38 WEST BIDDLE STREET, BALTIMORE, MARYLAND

RADIO TECHNOLOGY



RCA Institutes offer an intensive course of high standard embracing all phases of Radio and Television. Practical training with modern equipment at New York and Chicago Schools. Also specialized courses in Aviation Communications, Radio Servicing and Commercial Operating. Illustrated Catalog on request.

RCA INSTITUTES, INC. Dept. ST-42

A Radio Corporation of America Service

75 Varick St., New York 1154 Merchandise Mart, Chicago

PREPARE YOURSELF FOR A COMMERCIAL RADIO POSITION

through a Home Study Course, written for the man who has forgotten higher mathematics and who has had a non-technical education. This course qualifies you to pass the Federal Radio Telegraph and Telephone Examinations. An easily read, easily understood course. Moderate tuition fee. Write for particulars.

American Radio Institute, 1123 Broadway, N. Y.

LEARN RADIO • TELEVISION

60-page catalog on request. Oldest, largest and best equipped in New England. New classes now forming. Write for new catalog.

MASS. RADIO SCHOOL

18 Boylston Street Boston, Massachusetts

GOOD JOBS in RADIO for young men age 17 to 20

As older men leave for the Army, RADIO calls for recent high school graduates. Prepare now for jobs in Radio Engineering; Broadcasting; Marine Aviation, Police Radio; Servicing; Radio Manufacturing. Our streamlined courses give excellent preparation for Army and Navy Service. Expenses low. Write for free catalog.

THE DODGE TELEGRAPH & RADIO INSTITUTE

408-1 Monroe St., Valparaiso, Indiana

A. R. R. L. CALLING!

The American Radio Relay League invites correspondence from licensed women amateurs, and from licensed male amateurs who by reason of age or physical defects are not liable to military service, and who might be interested in joining its Headquarters Staff in West Hartford, Conn., for service for the duration as stenographers, clerks, secretaries, correspondents or technical writers. Please address the Secretary, stating technical and business schooling and experience.

(Continued from page 86)

changing the antenna tuning control C_1 . There should be a combination of the setting of C_1 and C_3 which will provide for even regeneration over the entire scale of C_2 . You may have to change the length of the antenna by sliding it up or down, but do that only as a last resort; whenever possible use the full length of from 72 to 96 inches, depending on the type of auto antenna you have purchased.

After the set has been made to function as a receiver, the transmitter can be tested. This is done in the usual manner with a neon bulb or with a current-squared galvanometer. The modulation should be up, and the indications should show it. Downward modulation is usually caused by insufficient "A" voltage at the filament of the 6G6G modulator. Incidentally, should the set function perfectly as a receiver but transmit only a bunch of squeals and whistles after it has been working satisfactorily for a while, it is a more or less sure sign that the $7\frac{1}{2}$ -volt battery is down, or exhausted. If it is down, remove the 4-ohm series resistor; if exhausted, replace with a new battery. In the latter case, don't forget to reinsert the 4-ohm dropping resistor! The 1.5-volt battery will outlast it by several days, and the "B" batteries will last the longest. The normal input to the oscillator is in the neighborhood of 3 watts, with an output of perhaps a watt or more. This will be found to be sufficient to operate the set over longer distances and from more congested districts than the usual type of 112-Mc. pack gear.

Conclusion

Until such time as the FCC relicenses us for defense work, it is against the law to do any transmitting. This unit has a powerful carrier and it should not be tested in the "transmit" position except into a dummy load such as a pilot bulb or a non-inductive resistor. Testing may, however, be done in a completely shielded room such as is to be found in any receiver factory, if the builder happens to have access to such a room. Except for that, there is no reason why the unit cannot be built and be in readiness for operation. Sure it is that it will do Trojan duty in any emergency. And the patriotic ham is the prepared ham.

KLEINSCHMIDT OR CREED PERFORATORS

I WOULD LIKE TO BUY SOME, REGARDLESS OF CONDITION, BECAUSE I CAN REBUILD THEM. WILL PAY CASH AND A LIBERAL PRICE

If you are interested in the finest of radio-telegraph apparatus—and no maybe about it—write for my latest catalog. Transmitters for schools, etc., ink recorders, auto heads, etc.

TED McELROY, McELROY MFG. CORP., 82 BROOKLINE AVE., BOSTON, MASS.

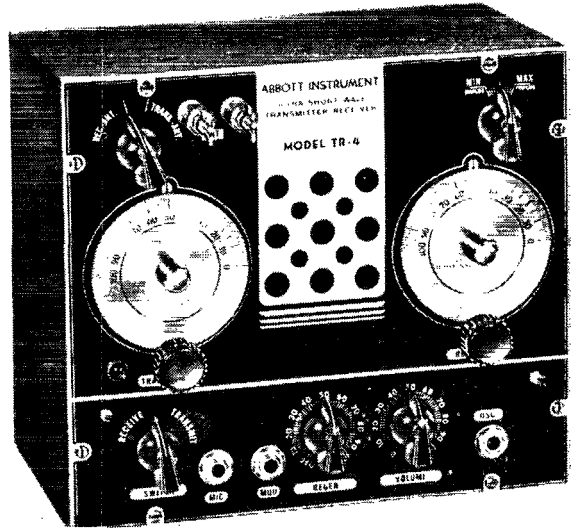

ABBOTT Ultra High Frequency *Transmitter-Receiver* units have been incorporated in emergency communications networks as standard equipment . . . and FB reports keep coming in from police auxiliary, as well as civilian and military services. Our engineering department may be able to assist in solving your particular problem, too.

ABBOTT **INSTRUMENT, INC.**

8 WEST 18 STREET • NEW YORK, N. Y.

Green Lights **AND AMBER**

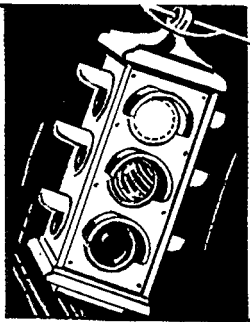

● Uncle Sam now has the right of way . . . the green light. Nothing is so important as speeding supplies through to where they are needed most. Everything else is subject to "amber light" warnings. Radio and phonograph parts manufacturers are still permitted to supply jobbers with replacement parts in order to keep present equipment operating. The Astatic Corporation is endeavoring to maintain this service to

jobbers insofar as it does not conflict with defense orders. For greatest efficiency and satisfaction, all parts replacements should be made with nationally known, trademarked and guaranteed products.

ASTATIC

SEE YOUR RADIO
PARTS JOBBER

THE ASTATIC CORPORATION

YOUNGSTOWN, OHIO

Licensed Under Brush
Development Co. Patents

In Canada
Canadian Astatic Ltd
Toronto, Ontario.

**"THAT'S MARTY ROYE!
HE GAVE HIS TEACHER AN
ECHOPHONE EC-1!"**



Echophone Model EC-1

6 tubes, 3 bands. Tunes from 550 kc. to 30 mc. Beat frequency oscillator. Bandsread logging scale. Self contained speaker. Electrical bandsread on all bands AC/DC. 115-125 volts. ECHOPHONE RADIO CO., 201 EAST 26TH STREET, CHICAGO, ILLINOIS

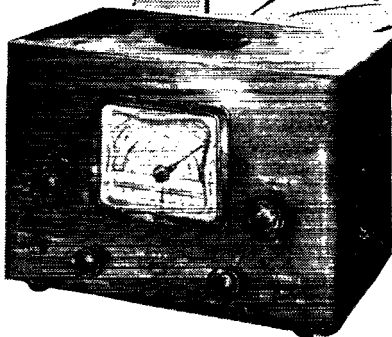

HAM-ADS

(1) Advertising shall pertain to radio and shall be of nature of interest to radio amateurs or experimenters in their pursuit of the art.

(2) No display of any character will be accepted, nor can any special typographical arrangement, such as all or part capital letters be used which would tend to make one advertisement stand out from the others.

(3) The Ham-Ad rate is 15¢ per word, except as noted in paragraph (6) below.

(4) Remittance in full must accompany copy. No cash or contract discount or agency commission will be allowed.

(5) Closing date for Ham-Ads is the 25th of the second month preceding publication date.

(6) A special rate of 7¢ per word will apply to advertising which, in our judgment, is obviously non-commercial in nature and is placed and signed by a member of the American Radio Relay League. Thus, advertising of bona fide surplus equipment owned, used and for sale by an individual or apparatus offered for exchange or advertising inquiring for special equipment, if by a member of the American Radio Relay League takes the 7¢ rate. An attempt to deal in apparatus in quantity for profit, even if by an individual, is commercial and all advertising by him takes the 15¢ rate. Provisions of paragraphs (1), (2), (4) and (5) apply to all advertising in this column regardless of which rate may apply.

Having made no investigation of the advertisers in the classified columns, the publishers of *QST* are unable to vouch for their integrity or for the grade or character of the products advertised

* * * * *

Gear is short. You can sell your old and extra gear through Ham-Ads.

* * * * *

QUARTZ—direct importers from Brazil of best quality pure quartz suitable for making piezo-electric crystals.

Diamond Drill Carbon Co., 719 World Bldg., New York City.

COMMERCIAL radio operators examination questions and answers. One dollar per element. G. C. Waller, W5ATV, 6540 Washington Blvd., Tulsa, Okla.

TELEPLEXES, instructographs bought, sold. Ryan's, Hannibal, Mo.

RADIO headquarters—tremendously large stock of receivers (over 200 on hand), transmitters—all sizes, transceivers—over five different models, radio parts of all kinds. Write to Leo, W9GFC, for that big bargain catalog and reconditioned receiver list today. Wholesale Radio Laboratories, Council Bluffs, Iowa.

QSL'S SWL'S. Theodore Forcher, 7708 Navajo, Philadelphia. **SELL**, in interest of national defense effort, commercial H.D. type components for high power xmitters or complete units. UTC, Thordarson, Eimac, Duncu, Weston, Triplet, etc. Perfect condition, little used. No junk. Box 703, Enid, Okla.

WANTED: radio operators for Merchant Marine, must have commercial license, wages \$225 to \$325 monthly. Radio Officers' Union, 265 West 14th St., New York, N. Y.

WANTED—high power R.F. & A.F. amp. instruments, pre-war Calbook, RME or NC receivers, instruments, etc. Age, make, size. W9NQO, Cedar Rapids, Iowa.

KLEINSCHMIDT or Creed perforators: I would like to buy some regardless of condition, because I can rebuild them. Will pay cash and will pay liberal price. Ted McElroy, 82 Brookline Ave., Boston, Mass.

WANTED—Howard 490, NC200, A.T.R. inverter type 6-RSA. State price and condition. 1214 10th St., Bremerton, Wash.

BOUND QST's 1921-1930. Perfect. Make offer. Also many back copies from 1923. Request list. Potter, 233 East Ave., Park Ridge, Ill.

WANTED Eimac Vacuum condensers, broadcast mica capacitors. New or used 828s, 804s, RK20As, 802s, 1603s, 872As, 892Rs, 8 to 15-amp. TC meters. Advise makes, condition and prices. Mims Radio Co., Box 504, Texarkana, Texas.

FOR sale—Weston #167 panel mount 150 watt scale wattmeter; 3 Weston #429 0-15 volt a.c. meters; #301 0-2500 volt d.c. meter; Weston #432 0-750/1500 watt, 115/230 volt wattmeter; Weston #433 0-150/300 voltmeter; assortment of 3" meters, Jewell, etc.; assortment transmitter and receiver condensers, high power filament transformers and chokes; 1/4" electric drill. W8DGV, 1145 Erieview Rd., Cleveland Heights, Ohio.

SELL SX-16 with speaker—\$65 and express charges. R. M. Allen, Box 81, Navy Yard, Charleston, S. C.

LICENSED operators, Vacancies. Broadcast studios and transmitters. Register now. No fee charged. Write or apply American Communications Assn., 1626 Arch St., Philadelphia, Pa.

WANTED—HRO, NC200, Super-Pro. Capt. Craig, Fort Stevens, Ore.

INTERESTED in motorcycle or what have you for following used equipment like new: 1100 volt power supply using Thordarson transformer, chokes, Echophone EC-1, N.R.I. multi-meter with oscillator, Triplet tube tester model 1512; and unused equipment: Airline 3 stage speech amplifier 6L6 pp output, Astatic T3 microphone with stand. All complete with tubes. Dick Campbell, Jr., W3IZF, Strasburg, Va.

WANTED: SX-24 or any other good receiver. Cash for bargain. Write W8WSC, Fred W. Rudolph, Stryker, Ohio.

SWL'S?—Samples? W8DED, Holland, Mich.

WANTED—813 tubes in good condition, will pay net price. W8FZN.

HRO, relay rack panel, black, serial T-147, coils 1.7 to 30 Mc., 5887 power supply, Brush BJ crystal headphones, Cinaudograph PM-8 speaker, complete equipment \$170 f.o.b. Hempstead, N. Y. Prefer sell to user for U. S. war application. T. M. Ferrill, Jr., 6 Clare Rd., E. Hempstead, N. Y.

SELL radio parts. Send stamped self-addressed envelope for list. W9SXS, Henry Heckert, Red Oak, Iowa.

WANTED used HRO's, SX28s, and other receivers. Also SOC-100 crystal units. Will pay cash. Wholesale Radio Labs., Council Bluffs, Iowa.

ATTENTION all hams: due to owner's enlistment, W2MQG is for sale. 150 watt transmitter, HRO and Browning F.M. receivers, Triplet modulation meter type 1969A, antenna tuner, Guthman frequency meter, complete public address system 2-3 ft. and 1-6 ft. deluxe steel cabinets. Also other equipment. Everything practically new. Gerstein, 1512 Townsend Ave., N. Y. C.

SWAP—National AGSX complete. Want Winchester 52 or Match Target Colt Woodsman. Charles Fiege, Laurelton, N. J.

AMERICAN-Japanese desires radio serviceman's job back East. W6SGA, Charles Mayeda, 2084 W. Mountain St., Glendale, Calif.

WANTED: used University PAH dynamic driver units (no horns) good condition. Hal Justice, Canton, N. C.

WE pay cash immediately for used communications receivers. Write, telephone, or telegraph description to us, Henry Radio Shop, Butler, Mo.

WE still have a large stock of communications receivers, transmitters, code teaching equipment, Vibroplexes, radio supplies of all sorts. You get lowest prices, best 6% terms (financed by us), ten day trial. Code machines rented. Your inquiries and orders invited. Henry Radio Shop, Butler, Mo., and 2335 Westwood Blvd., W. Los Angeles, Calif.

RECONDITIONED guaranteed communications receivers and transmitters. All makes and models cheap. Free trial. Terms. List free. Henry Radio Shop, Butler, Mo.

WANT to employ men who know crystal cutting and finishing. Write or telephone. Bob Henry, Butler, Mo.

CRYSTALS: general communication frequencies, high quality commercial units, meeting FCC requirements. New type E62 and E64 Seatite units now available, smaller and better. Suitable for 1600 to 10,000 kilocycle range. Sound advice: place your orders early and with priority whenever possible, regardless of your supplier. Eidson's, Temple, Texas (Phone 3901).

WANTED: Howard 650 preselector with loops new or used. Cash. Clayton Fyfe, W9STR, 1915 N. Adams St., Hutchinson, Kansas.

SELL quantity of RCA-954 Acorn tubes, excellent condition, \$2 each. HQ-120X with speaker, excellent condition, \$120. Dubilier condensers type PL 310-51, one .0002 mfd., one .0004 mfd., both 20,000 volt. Never used. Make offer. Joe Harms, R.F.D. 2, Plainfield, N. J.

WANTED RCA VA-22 or VA-15 record player. W9DWK, Jackson, Mo.

WANTED: deluxe Meissner ECO all coils, automatic key, will pay cash. Sell or trade new Thordarson 6-110, 25 watt amplifier, two 12" PM speakers, one RCA wood baffle, necessary cables. New RPC wattmeter \$9. Used Solar condenser checker \$15. New service parts universal, standard, 50% off. Write for list. W. L. Cornelius, 1123 McClellan St., Schenectady, N. Y.

FOR sale: transmitter 350-watts, designed and built by T.W.A. engineer, quality throughout. Nearly new Onan 110 volt a.c. 1000 watt power plant. Also SX-23. Make offer. L. Brasel, 210 West 46 Terrace, Kansas City, Mo.

KLEINSCHMIDT or Creed perforators: I would like to buy some regardless of condition, because I can rebuild them. Will pay cash and will pay liberal price. Ted McElroy, 82 Brookline Ave., Boston, Mass.

FOR sale—New NC200 with matching speaker. Immediate delivery. R. Yeager, 4034 Monroe, Chicago.

SELL HQ-120X, used six weeks, gray, C.O.D., securely packed in nice box, \$140 guaranteed. Jack Watt, Ontonagon, Mich.

THE 1942 RADIO AMATEUR'S HANDBOOK

MORE CONSTRUCTIONAL MATERIAL THAN EVER BEFORE

IN BUILDING THE 1942 EDITION the ARRL Headquarters staff designed a new, non-mathematical, simple yet thorough treatment of fundamentals to make the **HANDBOOK** even more useful in its growing role as a textbook for defense classes. Stripped to essentials, the new theory and design sections cover every subject encountered in practical radio communication, sectionalized by topics with abundant cross-referencing and fully indexed.

All this was achieved without sacrificing any of the constructional information on tested and proved gear which has always been the outstanding feature of the **HANDBOOK**. In fact, *the constructional chapters are given more space and contain more new designs in this edition than ever before.*

★ The new **HANDBOOK** is divided into two parts. The first section starts the reader with the basic electrical fundamentals, takes him through the principles of vacuum tubes and their operation, explains the methods of generating r.f. power, keying, modulation, radio reception, principles of wave propagation and antenna systems. The subject matter is keyed in such a way as to make ready reference possible throughout the book.

★ The second section is devoted to the building of practical amateur equipment. Constructional details are given for receivers from 1 to 7 tubes, including new ultra-simple receivers designed especially for the beginner. The greatly enlarged transmitter chapter now coordinates power supply and r.f. equipment, ten complete transmitters from 70 watts

to a kilowatt being described. The fifteen individual exciters and amplifiers range from the simplest oscillator to a push-pull kilowatt amplifier. The u.h.f. chapters also enlarged, place special emphasis on equipment for portable-mobile work. They include converters, superregenerative receivers using the newest tubes, crystal- and self-excited transmitters in several power ranges and a battery transceiver, as well as FM transmitting and receiving equipment. Other chapters contain an expanded treatment of measurements and measuring equipment, material on emergency and portable gear, workshop practice, operating procedure, F.C.C. regulations and miscellaneous tables and data. The vacuum-tube tables remain the most complete published anywhere, with over 50 new types added.

THEORY—CONSTRUCTION—OPERATING. *More than ever before, the new 1942 RADIO AMATEUR'S HANDBOOK is "the all-purpose volume on radio." Text, data book, operating manual—it is all these and more. As a text it is probably more used in radio schools and colleges than any other single volume. As a practical constructional handbook, it stands in a class alone. As an operating manual, it provides information available from no comparable source.*

Buckram Bound
\$2.50

\$1.00
POSTPAID

\$1.50 Outside
Continental U. S. A.

AMERICAN RADIO RELAY LEAGUE, INC., West Hartford, Connecticut

Your Nearby Dealer Is Your Best Friend

Your nearby dealer is entitled to your patronage. He is equipped with a knowledge and understanding of amateur radio. He is your logical source of advice and counsel on what equipment you should buy. His stock is complete. He can supply your needs without delay. His prices are fair and consistent with the high quality of the goods he carries. He is responsible to you and interested in you.

One of these dealers is probably in your city — Patronize him!

BALTIMORE, MARYLAND

Radio Electric Service Co.
3 N. Howard St.
Everything for the Amateur

KANSAS CITY, MISSOURI

Burstein-Applebee Company
1012-14 McGee Street
"Specialists" in supplies for the Amateur and Serviceman

BUFFALO, NEW YORK

Radio Equipment Corp.
326 Elm Street
W8PMC and W8NEL — Ham service and sound equipment

KANSAS CITY, MISSOURI

Radiolab
1515 Grand Avenue
Amateur Headquarters in Kansas City

BUFFALO, NEW YORK

Dymac, Inc.
1531 Main Street — Cor. Ferry — GA. 0252
One of the Largest Ham Supply Houses in Western New York

MILWAUKEE, WISCONSIN

Radio Parts Company, Inc.
538 West State Street
Complete stock Nationally Known products

CHICAGO, ILLINOIS

Allied Radio Corporation
833 West Jackson Blvd.

Complete standard lines always in stock—W9IBC, W9DDM, W9AUK, W9BWP, W9CKD, W9JFM, W9SFW, W9TXZ

NEW YORK, N. Y.

Harrison Radio Company
12 West Broadway
Harrison Has It! Phone WOrth 2-6276 for information or rush service

CHICAGO, ILLINOIS

Chicago Radio Apparatus Company
415 South Dearborn Street (Est. 1921)

W9RA and W9PST — Amateurs since 1909

OAKLAND, CALIFORNIA

W. D. Brill Company
198 10th Street
W6KLO — The House of Parts — W6FJX

DETROIT, MICHIGAN

Radio Specialties Company
325 E. Jefferson Avenue
Ham Supplies — National & Hammarlund Sets and Parts

PROVIDENCE, RHODE ISLAND

W. H. Edwards Company
85 Broadway
National, Hammarlund, Hallicrafter, Thordarson, Taylor, RCA

HARTFORD, CONNECTICUT

Radio Inspection Service Company
227 Asylum Street
What do you want? We have it. Radio exclusively

ST. LOUIS, MISSOURI

Van Sickle Radio Company
1113 Pine Street
Owned and Operated by Amateurs

YOU CAN BE SURE
WHEN YOU BUY FROM

QST

ADVERTISERS

“Advertising for *QST* is accepted only from firms who, in the publisher’s opinion, are of established integrity and whose products secure the approval of the technical staff of the American Radio Relay League.”

Quoted from QST’s advertising rate card.

Every conceivable need of a radio amateur can be supplied by the advertisers in QST. And you will know the product has the approval of the League’s technical staff

Index to Advertisers

	PAGE
Abbott Instrument, Inc.	89
Aerovox Corporation	86
American Lava Corporation	69
American Radio Institute	88
Astatic Corporation, The	89
Ayers, N. C.	86
Bliley Electric Company	60
Candler System Company	76, 78
Capitol Radio Engineering Institute	80
Cardwell Mfg. Corp., Allen D.	5
Centralab	71
Commercial Radio Institute	88
Dodge Telegraph & Radio Institute, The	88
Echophone Radio Company	90
Eitel-McCullough, Inc.	63
General Electric Company	79
Hallicrafters Company, The	1, 2
Hammarlund Mfg. Company, Inc.	59, 61
Harrison Radio Company	84
Harvey Radio Company	70
Harvey Radio Laboratories, Inc.	86
Henry Radio Shop	87
Instructograph Company	72
Isolantite, Inc.	67
Jensen Radio Mfg. Company	81
Johnson Company, E. F.	65
Kenyon Transformer Company, Inc.	87
Mallory & Company, Inc., P. R.	58
Massachusetts Radio School	88
McElroy Mfg. Corporation	74, 82, 88
McGraw-Hill Book Company, Inc.	68
Meissner Mfg. Company	62
Millen Mfg. Company, Inc., James	74
National Company, Inc.	Cov. 3, 57
Newark Electric Company	76
Nilson Radio School	84
Petersen Radio Company	86
Port Arthur College	72
RCA Institutes, Inc.	88
RCA Mfg. Company, Inc.	Cov. 4
Radio	83
Radio Control Headquarters, Inc.	72
Radio Shack, The	73
Sickles Company, F. W.	78
Solar Mfg. Corporation	82
Sprague Specialties Company	64
Standard Radio Parts Company	80
Standard Transformer Corporation	77
Taylor Tubes, Inc.	75
Teleplex Company	82
Terminal Radio Corp.	66
Thordarson Electric Mfg. Company	96
Triplett Elec. Instr. Company, The	95
United Transformer Company	Cov. 2
Wholesale Radio Laboratories	78
Yaxley	58

Pledge

TRIPLETT MEN AND WOMEN HAVE SIGNED THIS PLEDGE TO AMERICA'S VICTORY

The Nation needs us strong ... **I WILL KEEP FIT!**

Lost hours help our enemies. My working time is America's
time ... **I WILL TAKE NO "TIME-OFF"!**

Carelessness causes accidents. Accidents annually cost
enough man-hours to build 15,000 bombers ... **I
WILL BE CAREFUL!**

Some American soldier may die if indifference to the im-
portance of small jobs results in poor work ... **I WILL
KEEP MY INTEREST!**

The future welfare of America will rest upon the increased
knowledge which will emerge from present necessity
... **I WILL ADVANCE!**

These things I PLEDGE that our future
may be secure for Life, Work and Service

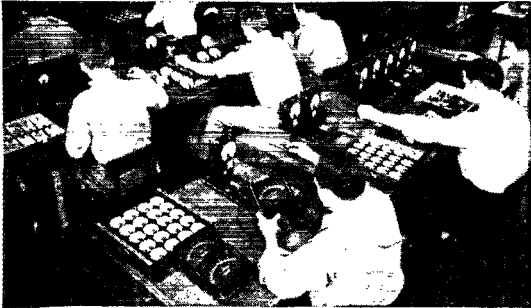

ACCURACY AS EVER

Despite the rush of present production there is no relaxation from rigid requirements of accuracy in calibration and inspection of fine Triplett instruments. No compromise is permitted to affect in the slightest those exacting standards which have become the international Hallmark for precision and quality.

TRIPLETT ELECTRICAL INSTRUMENT COMPANY

Bluffton, Ohio

THORDARSON

Quality Transformers



TRANSFORMERS
FOR ALL USES. ASK
FOR FREE CATALOG
NO. 400 F. X.

TRANSFORMER SPECIALISTS SINCE 1895

• Engineering skill, care and precision are built into the many types of Transformers manufactured by THORDARSON — Transformer Specialists Since 1895.

Any size — any type — any quantity
but only ONE quality

Thordarson Quality!

Consult us regarding your War
Production Problems.

THORDARSON

ELECTRIC MFG. CO.

500 WEST HURON STREET
CHICAGO, ILLINOIS, U. S. A.



WAITING FOR
LIBERTY CALL



NATIONAL COMPANY, MALDEN, MASS.



At 400 miles per hour

You'd Appreciate Metal Tubes!

A POWER DIVE in a pursuit plane is something to write home about! Your engines roar . . . the wind shrieks and screams . . . the air-speed indicator climbs past 300, 350, 400, toward terminal velocity. As you ease back on the stick to pull her out, enormous stresses wrench at the vitals of the plane — and at every piece of equipment inside!

Is it any wonder that both the Army and the Navy specify

metal tubes for military radio equipment —? Or that RCA is now turning out metal tubes at the fastest pace in our history—? For metal tubes combine extreme ruggedness with positive socket-contact (at the *pins*, where contact *should* be!) along with lower interelectrode - capacitances,

greater compactness, and efficient self-shielding. Only metal tubes can give the *advantages* of metal tubes!

With enormous quantities of RCA Metal Tubes going into equipment for the Democracies, you may experience difficulty or delay in the shipment of *your* orders for non-war purposes. Please be patient. For military equipment *comes first* . . . and military equipment needs *metal* tubes!



METAL TUBES