

QST

december, 1941

25 cents

35c in Canada

devoted entirely to

amateur radio

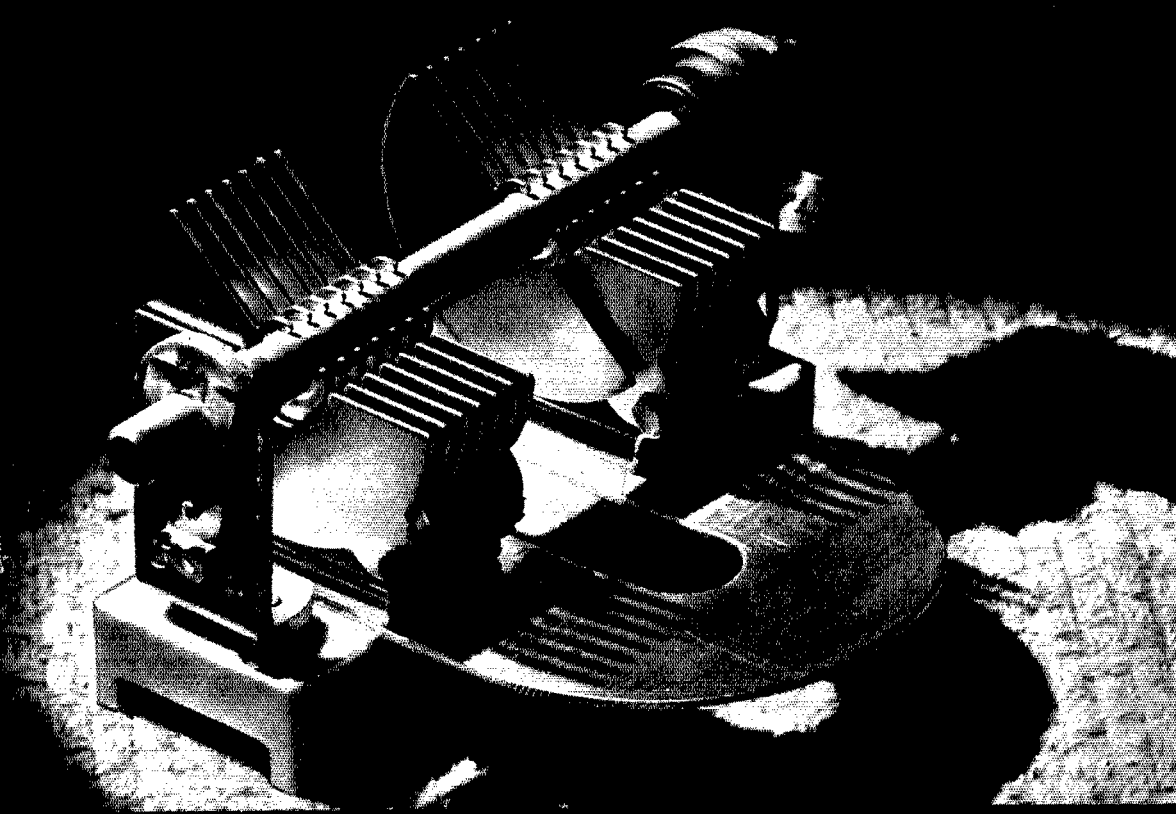

U.S. P. Corp. for Civilian Protection



Argus, Guardian

Watchful, hundred-eyed Argus, of mythological fame, had a principal role. He was guardian for the gods. Equally important in the radio field is the part played by another guardian—Collins inspection department. All-seeing as Argus, inspection's concern is the close surveillance of components and parts that go to make up a radio transmitter.

Inspection examines all units, its concern to see that all meet fully the rigid specifications demanded of them. With modern precision testing devices and up-to-date methods, Collins inspection department is our keeper of quality and your guardian of reliability in your Collins transmitter.

COLLINS RADIO COMPANY

CEDAR RAPIDS IOWA NEW YORK, N. Y. 11 WEST 42 ST.



The American Way..

Calls for the highest standard of quality. It is an American tradition to make everything better and to constantly improve the product. American traditions are closely adhered to at Hallicrafters and the yardstick of good American quality is rigidly applied for National Defense or for amateur equipment. Our two plants are devoted exclusively to the manufacture of short wave communications equipment for both amateurs and National Defense.



*Super Sky rider,
Model SX-28, 15
tubes, 6 bands,
covers 550 kc. to
42 mc. \$179.50.*

*Used by 33 Governments ** Sold in 89 Countries*

the hallicrafters co.
CHICAGO, U. S. A.

**The Skyrider Marine
always has**

"The Situation Well in Hand!"



With a Skyrider Marine you can have good reception well in hand. It is designed for Marine service in the range from 16.2 to 2150 meters (18 mc. to 110 kc.). Variable mica condensers are especially treated to maintain adjustment under continuous exposure to salt sea atmosphere. The mechanical bandspeed with separate dial provides easy logging. Calling and working frequencies lie in same band. 110 volt AC-DC operation — provision for 6 volt battery operation. Skyrider Marine (Model S-22R) complete with tubes and speaker \$74.50.

SEAL OF OFFICE



*On November 10, 1941,
the U.S. Marine Corps
celebrated their 166th
birthday.*

the hallicrafters co.

CHICAGO, U. S. A.

USED BY 33 GOVERNMENTS * * SOLD IN 89 COUNTRIES

DECEMBER 1941

VOLUME XXV

NUMBER 12



STAFF

Editorial

KENNETH B. WARNER, W1EH
Editor and Business Manager

CLARK C. RODIMON, W1SZ
Managing Editor

GEORGE GRAMMER, W1DF
Technical Editor

DONALD H. MIX, W1TS
BYRON GOODMAN, W1JPE
Assistant Technical Editors

EDWARD P. TILTON, W1HDQ
Contributing Editor, U.H.F.

VERNON CHAMBERS, W1JEQ
Technical Information Service

JAMES J. LAMB, W1AL
Research Engineer, A.R.R.L.

Advertising

F. CHEYNEY BEEBLEY, W1GS
Advertising Manager

Circulation

DAVID H. HOUGHTON
Circulation Manager

RALPH T. BEAUDIN, W1BAW
Asst. Circulation Manager



OFFICES

38 La Salle Road
West Hartford, Connecticut

Subscription rate in United States and Possessions, \$2.50 per year, postpaid; all other countries, \$3.00 per year, postpaid. Single copies, 25 cents. Foreign remittances should be by international postal or express money order or bank draft negotiable in the U. S. and for an equivalent amount in U. S. funds.

Entered as second-class matter May 29, 1919, at the post office at Hartford, Connecticut, under the Act of March 3, 1879. Acceptance for mailing at special rate of postage provided for in section 1103, Act of October 3, 1917, authorized September 9, 1922. Additional entry at Concord, N. H., authorized February 21, 1929, under the Act of February 28, 1925. Additional second-class entries to cover sectional editions authorized March 20, 1935.

Copyright 1941 by the American Radio Relay League, Inc. Title registered at United States Patent Office.

QST

devoted entirely to

AMATEUR RADIO

PUBLISHED, MONTHLY, AS ITS OFFICIAL ORGAN, BY THE AMERICAN RADIO RELAY LEAGUE, INC., AT WEST HARTFORD, CONN., U. S. A.; OFFICIAL ORGAN OF THE INTERNATIONAL AMATEUR RADIO UNION



CONTENTS

It Seems to Us	7
Our Cover	8
112-Megacycle Emergency Gear George Grammer, W1DF	9
A 112-Mc. Emergency Transmitter George Grammer, W1DF	14
Gallups Island Radio Club Puts on a Show	20
What the League Is Doing	22
QST, 25 Years Ago This Month	23
For the Junior Constructor Meter Shunts	24
U. S. A. Calling	26
RSGB News	28
Cutting Bias Supply Size and Cost J. D. Blich, W4IS	29
A Compact Receiver for 112 Mc. Vernon Chambers, W1JEQ	31
Ham Spirit Triumphs Over Handicaps	34
An Experimental 112-Mc. Receiver James W. Brannin, W60VK	36
One Shack — Nine Bands	39
A Modern Vacuum Tube Voltmeter for D.C., A.C. and R.F. Measurements Clinton B. DeSoto, W1CDB	40
Army-Amateur Radio System Activities	45
P.O.W.	46
Circulation Statement	46
Hints and Kinks for the Experimenter	
Amplifier Neutralizing With Safety—Folded Antenna for 160—	
Novel Substitute for Antenna Pulley—Hint on Improving an	
Unresponsive Bug—Tone Control by Negative Feed-back—	
Adjusting the Delta-Match System from the Ground	47
In the Services	50
On the Ultra-Highs E. P. Tilton, W1HDQ	52
Correspondence from Members	55
Operating News	56
Beginners' Code Practice	58
WIAW Operating Schedule	59
Brass Pounders' League	59
Trainee Traffic Stations	60
Sending Practice Schedules and Qualifying Runs	62
Arizona—New Mexico Flood Work	62
Book Reviews	80
Silent Keys	96
WWV Schedules	98
Hamads	103
QST's Index of Advertisers	106
QST Index for 1941	109

Section Communications Managers of the A.R.R.L. Communications Department

■ All appointments in the League's field organization are made by the proper S.C.M., elected by members in each Section listed. Mail your S.C.M. (on the 16th of each month) a postal covering your radio activities for the previous 30 days. Tell him your DX, plans for experimenting, results in 'phone and traffic. He is interested, whether you are an A.R.R.L. member or get your QST at the newsstands; he wants a report from every active ham. If interested and qualified for O.R.S., O.P.S. or other appointments he can tell you about them, too.

ATLANTIC DIVISION . . .

Eastern Pennsylvania . W3BES . Jerry Mathis, 6042 Master St., Philadelphia — Maryland-Delaware-District of Columbia . W3CIZ . Hermann E. Hobbs, 9701 Monroe St., Silver Spring P. O., Linden, Maryland — Southern New Jersey . W3CCO . Lester H. Allen, 704 Quinton Ave., Trenton — Western New York . W8PLA . Fred Chichester, Sonyea — Western Pennsylvania . W8CKO . E. A. Krall, 703 Broadway, East McKeesport.

CENTRAL DIVISION . . .

Illinois . W9ILH . Mrs. Carrie Jones, 2407 Central Ave., Alton — Indiana . W9AB . Harry B. Miller, 729 E. Lowell Ave., Mishawaka — Kentucky . W9ARU . Darrell A. Downard, 116 N. Longworth Ave., Louisville — Michigan . W8DPE . Harold C. Bird, R.F.D. 2, Pontiac — Ohio . W8BAQ . E. H. Gibbs, 405 Broad St., Wadsworth — Wisconsin . W9UIT . Aldrich C. Krone, 2702 So. 46th St., Milwaukee.

DAKOTA DIVISION . . .

North Dakota . W9RPJ . Don Beaudine, 512 14th St. S., Fargo — South Dakota . W9ADJ . E. C. Mohler, Box 149, Rapid City — Northern Minnesota . W9FUZ . Armond D. Bradford, Birchmont Rd., Bemidji — Southern Minnesota . W9YNQ . Millard L. Bender, 608 N. Huron Ave., Spring Valley.

DELTA DIVISION . . .

Arkansas . W5GNV . John R. Sanders, P. O. Box 1563, Little Rock — Louisiana . W5DWV . W. J. Wilkinson, Jr., Room 313, Jefferson Hotel, Shreveport — Mississippi . W5EGE . S. Benton Cain, 221 E. Monticello, Brookhaven — Tennessee . W4DDJ . M. G. Hooper, 4908 Georgia Ave., Nashville.

HUDSON DIVISION . . .

Eastern New York . W2LU . Robert E. Haight, 511 South Holmes St., Scotia — N. Y. C. & Long Island . W2AZV . E. L. Baunach, 102 Central Ave., Massapequa, L. I. — Northern New Jersey . W2LAN . Edward Gursky, Jr., 367 Van Winkle Ave., Hawthorne.

MIDWEST DIVISION . . .

Iowa . W9CTQ . Ray L. Martin, 209 Leffler St., West Burlington — Kansas . W9AWP . A. B. Unruh, 1617 S. Seneca St., Wichita — Missouri . W9QMD . Robert E. Morwood, 616 Delmar, Springfield — Nebraska . W9WKP . Garold Bennett, 214 East St., Hastings.

NEW ENGLAND DIVISION . . .

Connecticut . W1CTI . Frederick Ells, Jr., 19 Merrill Rd., Norwalk — Maine . W1BAV . Ames R. Millett, 37 Morning St., Portland — Eastern Massachusetts . W1ALP . Frank I. Baker, Jr., 91 Atlantic St., North Quincy — Western Massachusetts . W1IAH . William J. Barrett, 239 Columbia St., Adams — New Hampshire . W1FTJ . Mrs. Dorothy W. Evans, P. O. Box 312, Concord — Rhode Island . W1HRC . Clayton C. Gordon, 70 Columbia Ave., Gaspee, Plateau, Warwick — Vermont . W1KJG . Clifton G. Parker, Box 537, Morrisville.

NORTHWESTERN DIVISION . . .

Alaska . K7GNN . James G. Sherry, Chichagof — Idaho . W7CRL . Clifford A. Jessup, Post Office Dept., Moscow — Montana . W7CPY . Rex Roberts, Box 1088, Glendive — Oregon . W7GNJ . Carl Austin, 1137 Federal, Bend — Washington . W7EPB . Carl F. Hofmann, 4413 East E St., Tacoma.

PACIFIC DIVISION . . .

Hawaii . K6ETF . Francis T. Blatt, 837 16th Ave., Honolulu — Nevada . W6BIC . Edward W. Heim, 509 Claremont St., Reno — Santa Clara Valley . W6IUZ . Earl F. Sanderson, 101 Claremont Ave., San Jose — East Bay . W6TI . Horace R. Greer, 414 Fairmount Ave., Oakland — San Francisco . W6CIS . Kenneth E. Hughes, 209 Lincoln Way, San Francisco — Sacramento Valley . W6MDI . Vincent N. Feldhausen, 113 South Quincy St., McCloud — Philippines . KA1GR . George L. Rickard, Box 849, Manila — San Joaquin Valley* . W6PPO . H. S. Walling, Box 929, Fresno.

ROANOKE DIVISION . . .

North Carolina . W4CYB . W. J. Wortman, P. O. Box 566, Morganton — South Carolina . W4BQE/ANG . Ted Ferguson, 1213 College St., Columbia — Virginia . W3GWQ . Frank S. Anderson, Jr., 4703 New Kent Ave., Richmond — West Virginia . W8OXO . W. D. Tabler, 1004 So. Davis Ave., Elkins.

ROCKY MOUNTAIN DIVISION . . .

Colorado . W9EHC . Carl C. Drumeller, 606 E. 6th St., Pueblo, Colorado — Utah-Wyoming . W7GZG . Henry L. Schroeder, P. O. Box 731, Laramie, Wyoming.

SOUTHEASTERN DIVISION . . .

Alabama . W4DGS . James F. Thompson, Waucoma Apts., 12 Clanton Ave., Montgomery — Eastern Florida . W4PEI . Carl G. Schaaf, Lakeview Hotel, Clermont — Western Florida . W4AXP . Oscar Cederstrom, Second St. & Bruce Ave., De Funiak Springs — Georgia . W4AOB . William U. Hanks, 4 Hunter St. S.E., Atlanta — West Indies (Cuba) . CM2OP . Mario de la Torre, Escobar 110 (Altos), Habana, Cuba — (Puerto Rico-Virgin Islands) . K4KD . Everelt Mayer, 24 Lindberg St., Santurce, P. R.

SOUTHWESTERN DIVISION . . .

Los Angeles . W6MQM . Ralph S. Click, 1038 Milwaukee Ave., Los Angeles — Arizona . W6KOL . Kahn K. Oliver, Box 642, Nogales — San Diego . W6BKZ . Louis A. Cartwright, 7214 Fay St., La Jolla.

WEST GULF DIVISION . . .

Northern Texas* . W5EAV . R. E. Hughes, 1410 Ave. E. N.W., Childress — Oklahoma . W5GFT . Russell W. Battern, Box 290, Enid — Southern Texas . W5MN . Horace E. Biddy, 1746 Schley Ave., San Antonio — New Mexico . W5ENI . Dr. Hilton W. Gillett, Lovington.

MARITIME DIVISION . . .

Maritime . VE1DQ . A. M. Crowell, 69 Dublin St., Halifax, N. S.

ONTARIO DIVISION . . .

Ontario . VE3EF . Flying Officer Donald R. Gunn, care of Canadian Bank of Commerce, New Toronto, Ont.

QUEBEC DIVISION . . .

Quebec . VE2CO . Lindsey G. Morris, Apt. 6, 4510 Girouard Ave., N.D.G., Montreal, P.Q.

VANALTA DIVISION . . .

Alberta . VE4GE . C. S. Jamieson, 581 W. Riverside Drive, Drumheller, Alta. — British Columbia . VE5DD . C. O. I. Sawyer, 2634 West 31st Ave., Vancouver.

PRAIRIE DIVISION . . .

Manitoba . VE4AAW . A. W. Morley, 747 McMillan Ave., Winnipeg — Saskatchewan . VE4SY . Arthur Chesworth, 1071 4th Ave., N. W., Moose Jaw.

* Officials appointed to act until the membership of the Section choose permanent S.C.M.'s by nomination and election.

Centralab

The Quality Line

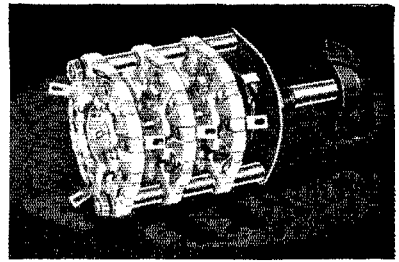

SELECTOR SWITCH

Available in an almost infinite variety of combinations . . . in bakelite or steatite . . . in single or multiple gang . . . from two to eleven positions on any one switch . . . also available for use in amateur transmitters.

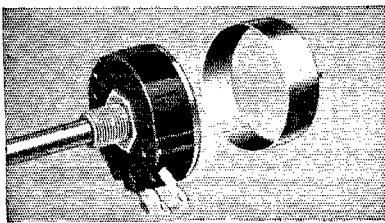

STANDARD RADIOHM

Wall type resistor. Exclusive non-rubbing contact band. 1 3/8" diameter x 9/16" deep. Available single, twin or triple, plain or tapped . . . with S.P.S.T., D.P.S.T. or S.P.D.T.

Hams, Servicemen, Experimenters and Manufacturers appreciate the utter dependability of Centralab products. Since 1922 more than a hundred million radio parts bespeak the universal acceptance accorded Centralab products. Send for catalog if your jobber cannot supply you.

CENTRALAB
Div. of Globe-Union Inc.
MILWAUKEE

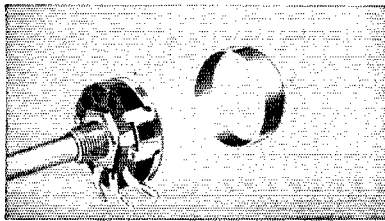

MIDGET RADIOHM

Companion to "standard" . . . small size but large control efficiency. Available single, dual or triple . . . plain or one, two or three taps . . . with S.P.S.T., S.P.D.T., or D.P.S.T. Moulded bakelite case, 1 1/8" diameter, 1/4" metal shaft 3 3/8" long.

WIRE WOUND RADIOHMS

In values from 2 to 10,000 ohms . . . insulated construction . . . 3 watts . . . universal shaft for all replacements . . . regular Radiohm switch covers may be attached . . . in linear curve only . . .

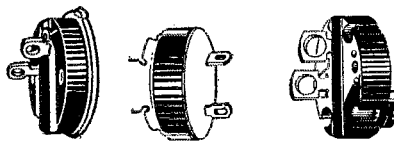

ATTACHABLE SWITCH COVERS

For standard and wirewound resistors (Radiohms) as well as Midget and Elf Radiohms . . . S.P.S.T. . . . S.P.D.T. . . . D.P.S.T. . . . four point . . . S.P.D.T. (operates at clockwise position) and S.P.S.T. with Dummy Lug.

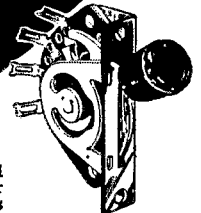

LEVER ACTION SWITCH

Used singly or in groups . . . for broadcasting, receiving, public address, test instruments and industrial uses. Available in any one of ten different combinations including positive and spring return action.

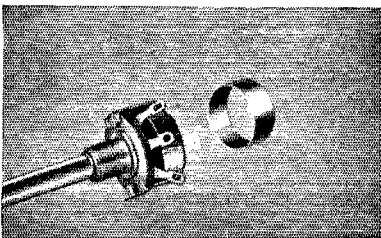

ELF RADIOHM

Smaller but also features the long, straight resistor strip. Available plain or tapped with S.P.S.T. switch . . . with or without dummy lug. Bakelite case 57/64" diameter, 17/32" deep (less switch) 25/32" deep with switch.

AXIAL LEAD RESISTORS

Body is insulated by inert ceramic jacket . . . proof against vibration and humidity . . . will withstand five times rated load without permanent change. In two sizes . . . RMA coded . . . 1/2 watt at 1/8" x 5/8" and 1 watt at 1/4" x 1" . . . Also supplied in conventional RADIAL LEAD Style . . . 1/2 watt - 1 watt or 2 watt.

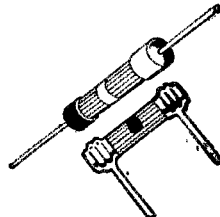

CERAMIC TRIMMER CONDENSER

where greater stability than ordinary types is required. Supplied with neg. temp. coefficient of .006 MMF/MMF/C°. With or without mounting brackets.



CERAMIC CAPACITOR

Small "special purpose" for h.f. circuits where temperature compensation, low power factor, or absolute permanence are important. 1000 V.D.C. leakage resistance more than 10,000 meg. Power factor less than 1%.

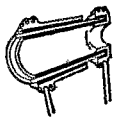

SEND FOR CATALOG NO. 23

THE AMERICAN RADIO RELAY LEAGUE

Directors

<i>President</i>	
GEORGE W. BAILEY	W1KH 74 Webster Road, Weston, Mass.
<i>Vice-President</i>	
CHARLES E. BLALACK	W6GG Box 35, Yuma, Ariz.
<i>Canadian General Manager</i>	
ALEX REID	VE2BE 169 Logan Ave., St. Lambert, P. Q.
<i>Atlantic Division</i>	
WALTER BRADLEY MARTIN	W3QV Box 612, Roslyn, Pa.
<i>Central Division</i>	
GOODWIN L. DOSLAND	W9TSN 10 No. Clark St., Chicago
<i>Dakota Division (Acting)</i>	
ADOLPHUS A. EMERSON	W9ITQ 5336 S. Elliott Ave., Minneapolis
<i>Delta Division</i>	
E. RAY ARLEDGE	W5SI P.O. Box 286, Pine Bluff, Ark.
<i>Hudson Division</i>	
ROBERT AKERIDGE KIRKMAN	W2DSY 920 Eighth Ave., Brooklyn
<i>Midwest Division</i>	
FLOYD E. NORWINE, JR.	W9EFC 7405 Hiawatha Ave., Richmond Heights, Mo.
<i>New England Division</i>	
PERCY C. NOBLE	W1BVR 37 Broad St., Westfield, Mass.
<i>Northwestern Division</i>	
KARL W. WEINGARTEN	W7BG 3219 N. 24th St., Tacoma, Wash.
<i>Pacific Division</i>	
J. L. McCARGAR	W6EY 66 Hamilton Pl., Oakland, Calif.
<i>Roanoke Division</i>	
H. L. CAVENESS	W4DW 2807 Vanderbilt Ave., Raleigh, N. C.
<i>Rocky Mountain Division</i>	
C. RAYMOND STEDMAN	W9CAA 925 So. Gaylord St., Denver
<i>Southeastern Division</i>	
WILLIAM C. SHELTON	W4ASR Box 652, Daytona Beach, Fla.
<i>Southwestern Division</i>	
JOHN E. BICKEL	W6BKY 801 E. California St., Whittier, Calif.
<i>West Gulf Division (Acting)</i>	
W. T. CASWELL, JR.	W5BB 1502 West Ave., Austin, Texas

THE AMERICAN RADIO RELAY LEAGUE, INC., is a non-commercial association of radio amateurs, bonded for the promotion of interest in amateur radio communication and experimentation, for the relaying of messages by radio, for the advancement of the radio art and of the public welfare, for the representation of the radio amateur in legislative matters, and for the maintenance of fraternalism and a high standard of conduct.

It is an incorporated association without capital stock, chartered under the laws of Connecticut. Its affairs are governed by a Board of Directors, elected every two years by the general membership. The officers are elected or appointed by the Directors. The League is non-commercial and no one commercially engaged in the manufacture, sale or rental of radio apparatus is eligible to membership on its board.

"Of, by and for the amateur," it numbers within its ranks practically every worth-while amateur in the nation and has a history of glorious achievement as the standard-bearer in amateur affairs.

Inquiries regarding membership are solicited. A bona fide interest in amateur radio is the only essential qualification; ownership of a transmitting station and knowledge of the code are not prerequisite. Correspondence should be addressed to the Secretary.



Past Presidents

HIRAM PERCY MAXIM, W1AW, 1914-1936
EUGENE C. WOODRUFF, W8CMP, 1936-1940

Officers

<i>President</i>	GEORGE W. BAILEY, W1KH Weston, Mass.
<i>Vice-President</i>	CHARLES E. BLALACK, W6GG Yuma, Ariz.
<i>Secretary</i>	KENNETH B. WARNER, W1EH West Hartford, Connecticut
<i>Communications Manager</i>	F. EDWARD HANDY, W1BDI West Hartford, Connecticut
<i>Acting Treasurer</i>	DAVID H. HOUGHTON West Hartford, Connecticut
<i>General Counsel</i>	PAUL M. SEGAL 1026 Woodward Building, Washington, D. C.

Address all general correspondence to the administrative headquarters at West Hartford, Connecticut.

"IT SEEMS TO US—"

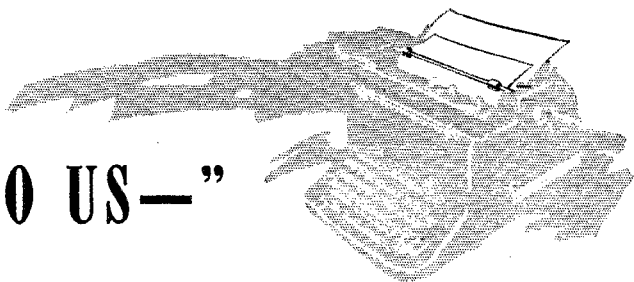

CONSERVING APPARATUS

WE HAD a scare last week when it was rumored that there were no more mercury-vapor rectifiers available. Inquiry at all the supply stores in the city showed only five tubes on hand of our favorite brand but no shortage of other perfectly useable makes. Nonetheless it made us stop and think. Imagine the shiny kilowatt rig standing idle for want of a couple of these inexpensive but indispensable little bottles! What on earth would we do? Go back to chemical rectifiers? We couldn't, because the aluminum wouldn't be available. Kenotrons? Where'd you get them? Sync rectifiers? Wrong kind of hash for our palate. No, we'd be on a spot "for want of a nail."

While this kind of thinking again emphasizes the desirability of salting away a few spare essentials, that at best would be a transitory remedy. There is a better solution: conservation.

It's overloading that ends the life of most amateur parts. Conversely, underloading vastly extends their lives — indefinitely. There is no blinking the fact that it's going to be hard, if not downright impossible, to get some components. When they go blooie under our customary overloads, there may be no replacement. We therefore propose that all amateurs who value their place on the air immediately reduce power, say to three-quarters or half of what they are using now. We don't believe there would be any detectable difference in signal strengths and we know that gear would last much longer — particularly tubes, and especially rectifiers. If you'll cut down on that plate voltage that now rips hunks out of filaments and electroplates it onto grids, you'll be just as happy and you'll stay on the air a whole lot longer. Tubes deserve particularly loving care. Keep your filament voltages exactly right. Warm up *plenty*. Avoid frequent cooling and reheating of filaments; if you're going to use the transmitter again within two hours it will be cheaper in the long run to leave the filaments on. Treat each item in your station as if you never expected to see another like it. You'll be glad you did.

LET'S USE 160!

AS WE write, there is every expectation that December 20th will see us moving out of 3800-3900 kc. as the first step in our temporary loan of frequencies to the War Department. Thus we are smack against the practical problem of whether or not we will make an effective use of the 1750-1900 frequencies which simultaneously are being cleared for exclusive c.w. use.

Despite the manifest advantages of the latter band, there seems considerable reluctance to make the move. All too few of our nets have signified their intention to shift bands. Particularly as concerns this first installment, the general tendency is just to "slide sideways" and crowd up a little more. Very probably that would be the proper solution if that were all there were to the program. But there are two more groups of frequencies to be given over later, and what then? We cannot share the optimism of those who expect that *they* will be able to work through the congestion even though the others can't. It might be true of an individual super-station; it will assuredly not be true of the average stations constituting a net. It is a matter of simple arithmetic to divide the number of known nets into the available band-width with the minimum workable separation both in kilocycles and in miles-before-duplication, and see "how many deep" the nets will be. Roughly, it works out that it is theoretically possible most of the time to accommodate all the trunk-lines and nets in the narrowed band of 3500-3650 if the evening hours can be accurately divided into thirds and provided there is no rag-chewing in the band by nontraffic stations (!). Time division will be essential, say into two-hour assignments beginning at 6 o'clock, 8 o'clock and 10 o'clock.

You say that will be jake if your net can get an 8 o'clock assignment? Ah, but only a third of the nets and trunklines can! Some of them, by sheer arithmetic, will have to work at 6 o'clock, which may be impossibly early for you, and some at 10, which may be inconveniently late for you. The point in all this, and the answer, is simply this: 160 beckons. There

is lots of room there and you can about pick your own operating time. Interference won't compare with 80. And signals will be notably better during much of the winter. There is no sense in suffering inconvenience on 80 when 160 will do the job better.

TYPEWRITER COPY

WHILE it is hopeless for one who can only typewrite at 20 words a minute to attempt to copy code at 25 per on the mill, many amateurs who are fast typists have been puzzled and rather discouraged over their inability to put down on the mill anything approaching their usual speed with a stick. They want pointers on mill copying.

Diligent inquiry shows no secrets about it. As with learning the code, it is mostly a case of practice and more practice. Even the service schools find that when students are first put on typewriters, their progress falls below normal for two weeks of daily practice, until gradually they learn to coordinate mill and code; and

then everlasting practice makes perfect. Two practical pointers continue to deserve emphasis:

1. Instructors seem to agree that the habit of copying two or three words behind aids greatly in coordinating.

2. It is best to practice at speeds well below your comfortable code speed. For instance, if 25 is comfortable for you with a stick, stay at about 15 on the mill until you have it licked cold. Then step it up only gradually, remembering that you can't do 19 until you can do 17.

Incidentally, most amateurs who are reasonably good on typewriter copy seem to be weak on numerals and punctuation marks — perhaps because we don't have too many of them in our work on the air. Hams who are building up mill speed would do well to include plenty of practice on numerals. NAA's weather reports, with the numerals averaging only half the w.p.m. of the letters, will show you up if you are weak in that department, and give you plenty of copy.

K. B. W.

OUR COVER

Gentlemen, you are looking at a high-stability 2½-meter tank. Shades of the old high-C days — it is the heart of the 112-Mc. emergency layout developed in the ARRL lab and described by W1DF. It is only the first in a series of intensely practical u.h.f. units now undergoing extensive tests. This is part of the League's "all out" effort to make hams positively indispensable in civilian protection plans in every community, all over the country.

Quist Quiz

Q. What happened to the Dixie Squinch Owl and his long missed Juice? — W2LUU

A. Can you help us on this one, Pop?

Q. Anyone looking at the last four issues of QST with the cartoon covers and not being familiar with our ham fraternity would think us all a bunch of screwballs or nitwits. (Or are we?) — W9WXS

A. Local opinions are variable on this one. Mail your expression to Quist Quiz and the most candid reply, in the judge's opinion, arriving before December 20th will receive a copy of the 1942 Handbook, cloth bound and suitably inscribed.

Strays

To eliminate instability due to mechanical vibration, use three gum-rubber erasers spread in a triangle under the base of the receiver or s.e.o. The art-gum type, selling for a nickel each, do a swell job. — H. W. S.

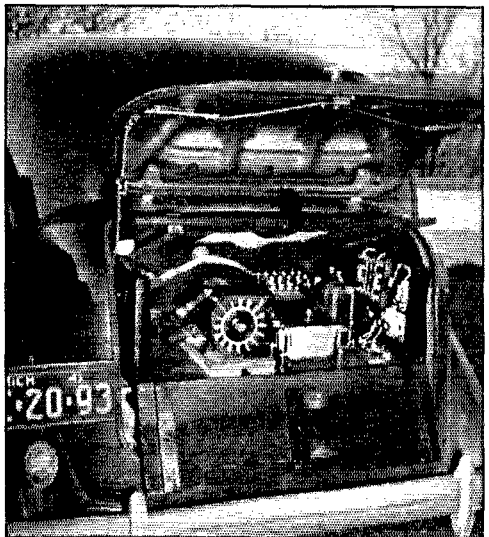

How many present-day hams have ever seen a spark transmitter in operation?

W8FX is creating considerable interest at ham gatherings with a unit shown above which he carries around in the trunk of his car. It includes the whole works from whining rotary to kick-back preventer.

112-Megacycle Emergency Gear

An Outline of Requirements and Recommendations on Standardization

BY GEORGE GRAMMER,* WIDF

In any comprehensive plan for amateur coöperation in local civilian defense communication, the apparatus will play an exceedingly important part. Simply having a 2½-meter set that works is not enough. The exigencies of emergency communication can best be met by forethought with respect to ease of installation, operating convenience, availability of replacement parts, and serviceability. This discussion of the problem lists the requirements which must be met; suggests standardization methods whereby the amateurs of a community can coördinate their equipment into a smooth-running communications system. Existing 112-Mc. gear now capable of vibrator-pack operation easily can be fitted into the general scheme.

THE requirements which must be met by emergency equipment naturally depend upon the conditions under which it must operate. Meeting such requirements is no new problem to amateurs, but it can stand — in fact, calls for — re-examination in the present instance. A nationally successful program must involve thousands of amateurs whose operating experience until now has been confined entirely to low-frequency bands. This immediately imposes a fundamental requisite: Any equipment for the purpose must be simple, easy to put together, and sure-fire in operation. Likewise it must be inexpensive, since high cost can only too effectively prevent the widespread coöperation which is essential to the success of the program. Simplicity and low cost constitute the framework which must embrace all our other requirements.

Beyond these, there are other obvious fundamentals; by definition, the equipment must be portable and must be capable of working from emergency power supply. Forecasting as well as we can the probable needs in civilian local defense communications, we interpret the term "portable" not to mean a complete station, ready to be picked up by a handle and carried off, but rather as a collection of apparatus which is easily movable and can be transferred to a new location, set up and put into operation with a minimum of delay. It does not have to be all in one piece; in fact, as we shall see later, it is preferable to adopt the opposite course and make the station in several separate, but intimately related, units. Weight is of relatively little importance; there is little likelihood that it will be excessive, since the power will be limited because of the necessity for operating from an emergency power supply. Likewise, there is no need to worry about mechanical shapes convenient for carrying. On the other hand, compact construction is de-

* Technical Editor.

sirable because the station should be adaptable to mobile as well as fixed-station operation; it should be possible to install it in a car without crowding out the passengers.

On the question of emergency power supply, all lines of thinking lead to the storage battery as the primary source, with the vibrator high-voltage supply for the plates of the tubes. Dry batteries are likely to be well up on the list of unavailables in the near future, we are informed, particularly the ones most useful for pack outfits; we simply daren't count on having them in an emergency. Nor can we count on gasoline-driven generators; those who have them are all set, of course, but they are too expensive for most of us — and most of us have to get into this set-up if we're going to make it click. But every automobile carries a primary power source in the form of its starting battery, and furthermore also supplies the means of keeping the battery charged. It is obviously logical to build our system around this universally-available power supply.

Only a limited amount of power can be taken from a 6-volt battery if the battery is to last for a reasonable operating period. This, together with the economic limitations, sets a ceiling to the transmitter power we can figure on having. We believe that the best basis on which to work is a vibrator supply of the type which has been most popular in amateur mobile installations, one rated at a load current of 100 milliamperes and an output voltage of 300, and regard these figures as the standard to which all apparatus designs should conform. The total power is available for either the transmitter or receiver, since the two need not be used simultaneously. This is a maximum power figure; the equipment need not be capable of handling more, but it *should* be capable of operating at reduced voltage in case a lower-power supply has to be used.

It is more than possible that less power *will*

have to be used. All indications are that the supply of ready-made vibrator-type units of this rating is far below the potential demand, with little chance of alleviating the condition in view of the existing priorities situation. We shall have to look into other ways and means. One possibility is the power unit in the automobile broadcast receiver; its output is generally lower than that of our "standard" supply, but some of the larger sets come close to the 30-watt level. It may be feasible to parallel low-current units to obtain higher output; if two units are reasonably well matched this should present no difficulties. Also, the replacement parts for car b.c. sets may solve the source-of-supply problem. This situation, as well as some other possibilities, is being looked into now and will be discussed in *QST* as soon as is practicable.

Although an independent power supply is a primary requisite, it is certainly only reasonable to use a.c. just as long as it comes out of the mains. Therefore an a.c. supply is definitely called for — not as an alternative to the storage battery unit but to go hand-in-hand with it. It should also furnish 100 ma. at 300 volts, a rather easy specification to meet with inexpensive components. With both supplies, the station is prepared to operate from a.c. just as long as the power line is functioning, but can be switched to the

d.c. supply with no change in operating conditions or power level when the necessity arises.

Components and Tubes

Many of us don't realize it, but there is already a shortage of parts, tubes and miscellaneous materials essential to the construction of radio equipment, and it's going to be more and more acute as time goes on. We shall have to use what we can get; not only that, we shall have to build or rebuild our present equipment on the basis of replacements that may be available in the future — not only available from dealers in amateur supplies but from music stores, department stores, service shops, or any of the other outlets for BCL supplies and repairs. That u.h.f. tube which graces the transmitter at present is no doubt a marvelous performer — but can you expect to get a replacement on a few minutes' notice if its filament should give up in an emergency a year from now? We can answer that quite simply: as things look now you can't afford to entertain any such expectation. There are only two ways out: keep a supply of spares on hand, or else build your outfit around the most popular tubes and components, those which are so firmly a part of the BCL picture that stocks can be expected to hold up. If you adopt the first, you may find that the things you need are hard to get right now. We

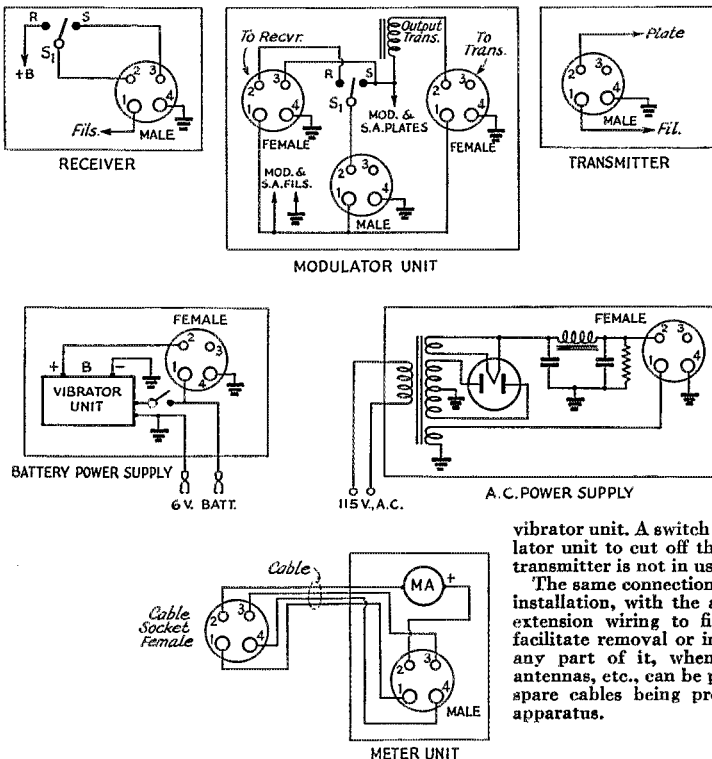

Fig. 1 — Interconnection and switching system for various units of the emergency station. Connections are made by means of cables provided with a plug at one end and a socket at the other. Four conductors are required in the cables; to minimize filament voltage drop the type of cable having two heavy conductors should be used, or pairs of wires in an ordinary six-wire cable can be connected in parallel to lower the resistance. It is convenient to make the cables about three feet long. A few extra ones can be used as extensions in case greater length is necessary.

The switch in the battery power supply makes it possible to keep tube filaments hot when the station is not required to be on the air, thereby saving the battery power normally going to the vibrator unit. A switch should be provided in the modulator unit to cut off the microphone battery when the transmitter is not in use.

The same connection scheme can be used in a mobile installation, with the addition of suitable control and extension wiring to fit individual layouts. This will facilitate removal or installation of the equipment, or any part of it, when necessary. The basic wiring, antennas, etc., can be permanently installed in the car, spare cables being provided for external use of the apparatus.

expect to base our plans on the second; after all, some sacrifice in efficiency is infinitely to be preferred to no performance at all.

Of course, some components need not be expected to fail. Comparatively little, short of smashing, can go wrong with a variable condenser or a coil or a binding post. The critical components are tubes, by-pass and filter condensers, resistors and the like, particularly tubes. A tube which can be found in ten thousand broadcast receivers is our best bet.

Reliability

Reliability means not only the ability of the equipment to operate without a hitch for long periods; we conceive it as including such things as ease of setting up the station, simplicity and convenience in operating — all those factors which go to make it possible to forget the equipment and concentrate on the business of communication, in itself a plenty big enough job when the stress of emergency is on. The range of the station is also part of this picture; it should be adequate for the demands to be made on it, but at the same time depends so much on local conditions that it is useless to try to set a lower or upper limit. The power output of our transmitters is going to be limited by the available power input, and also the possible efficiency that can be attained at 112 Mc. with the kind of tubes we may have to use; receiver sensitivity may likewise be limited. Probably more important than either is the character of the terrain over which the signals must travel and the goodness or poorness of the available locations for antennas. A reliable communications network must be built on the ground rather than on speculation, and this is a matter of meeting local needs and conditions — in other words, an organization job. The cardinal point is to make no impossible demands on low-power equipment, but to prepare adequately and well ahead of time so that enough stations are available to do whatever is necessary.

With the above as a basis, it becomes possible to talk details. Details are far from unimportant, because it is only by giving them adequate attention that the larger objectives can be reached. We visualize this thing as a community, rather than an individual, project, hence a certain amount of standardization is eminently desirable. The idea of a standard station for OCD coöperation, which could be duplicated by thousands of amateurs, was one to which we gave a good deal of thought. It has many attractive features, but when followed through too thoroughly also develops certain defects which in the end more than outweigh the advantages. It could not, for instance, readily make provision for including the many existing 112-Mc. stations which in the main meet the fundamental requirements. Nor could such a standard design avoid the "freezing" which accompanies standardization, and which

only too frequently precludes the possibility of future improvement. But most important of all, such standardization would necessarily involve the use of specific pieces of apparatus which, under present conditions, simply would not be available in sufficient quantity. Thus in the end it would defeat itself, by not taking cognizance of the fact that for all coöperating amateurs to equip themselves as quickly as possible it may, and probably will, be necessary to use almost anything and everything that may be available in the way of parts.

Performance Standards

Nevertheless, careful consideration of the complete standardization scheme not only leads to some useful ideas along more restricted standardization lines, but also indicates the outline of general performance requirements. In setting these up, we attempt to anticipate as much as possible the conditions with which operators will have to cope in an actual emergency, and to make all practicable provisions for simplicity and continuity of operation in the face of foreseeable breakdowns.

Primarily, of course, communication will be by 'phone. There should, however, be provision for modulated c.w. operation to take care of situations when the signal is too weak for good 'phone intelligibility, when interference is bad, or when high accuracy of transmission is needed with difficult text. Pure c.w. operation is out of the question with simple equipment at this frequency. With either 'phone or code, power is required for modulation, so that it is necessary to divide the available power between the transmitter and modulator. Something near a 50-50 division seems most practicable, but it is permissible to give somewhat more plate current to the oscillator and slightly less to the modulator. The latter, if built for high efficiency, will take less plate current idling than when running at full output, and since an appreciable plate-current increase will occur only on voice peaks, the maximum "talking" current can run slightly over 100 ma. without overload dangers. Thus it appears proper to assign 50 to 60 ma. to the transmitter and 40 to 50 ma. to the modulator from our standard 100-ma., 300-volt supply.

The transmitter frequency stability (or oscillator stability, since the allowable plate current hardly is great enough to make oscillator-amplifier construction practicable, aside from the considerations of simplicity) should be as high as possible. To some extent the requirements here depend upon the number of stations likely to be operating at one time; obviously the band can accommodate only so many stations of a specified channel width. With reasonably stable transmitters the determining factor in the interference problem is the selectivity of the receivers in use.

Thus, it is apparent that minimization of frequency modulation is an important part of the story, and (as usual) more to be desired than the utmost power output. Since the same measures which reduce frequency modulation also tend to minimize drift, the sharper transmitter also is more likely to be found on the same spot in the band after an idle period when the tube and circuit have a chance to cool off. From an operating standpoint reduction of drift is important, not only because it lessens the need for frequent retuning of the receiver, but also because it reduces the possibility of two transmitters drifting into each other and creating unnecessary interference.

Since the transmitter input will be of the order of 15 watts or slightly more, the modulator should provide an audio power output of 7 to 8 watts for complete modulation. For reasons of economy and availability the modulator should be designed to work from a single-button carbon microphone; there would be no objection to use of other kinds of microphones so long as provision is made for the carbon type. And here, it appears, we probably shall have to fall back on dry batteries for microphone current, in view of the likelihood of feedback troubles and hash pickup when expedients are used for taking the current from the "B" supply, or from the storage battery from which the vibrator supply operates. However, ordinary flashlight cells, which are available everywhere, will serve to supply the few volts and small current needed and, we hope, will continue to be obtainable from the corner store even should the special "A" and "B" units disappear from the scene.

Some form of superregenerative receiver is indicated of necessity, since this type of receiver is the only kind which will give sufficient sensitivity with constructional simplicity and a small number of tubes and other components. It lacks selectivity, but in many cases this may not be too great an operating disadvantage. It is conceivable, however, that the simultaneous operation of a considerable number of stations may be essential in larger communities, and in such cases something more elaborate than the simple superregenerator may be required, at least at key points such as net control stations. Some of the possible means of improving performance in this respect are being investigated, and the problem may not be insurmountable.

From a practical communications standpoint, the radiation from the superregenerative receiver is probably the most serious objection of all. Four or five radiating receivers standing by on a control station's frequency can only too easily break up communication — or if not completely ruin it, at least provide an annoying accompaniment of howls and squeals. If radiation cannot be completely eliminated, it must certainly be reduced to the point where interference is negligible even when the stations involved are separated by only

a short distance. This is a primary requirement of more importance than extreme sensitivity.

The transceiver has been a serious offender both in transmitter instability and receiver radiation, although neither of these need be an inherent transceiver fault. However, there are other reasons for preferring separate transmitters and receivers. It is easier to design separate units for suitable performance in their respective fields; the transceiver circuit has to be a compromise. The familiar habit of "walking through the band" when two transceivers get together does not go well with organized net communication, besides being a cause of stations getting in each other's way. Finally, there is not enough freedom in choosing frequencies; your transmitting frequency is performed the one on which you listened last, and while this might be tolerable in some cases it introduces a factor of inconvenience, to say the least, when one station is endeavoring to maintain communication with several others operating on different frequencies. Efficient network operation is based on knowing exactly where to look for the other fellow, not in playing an involuntary game of follow-the-leader up and down the spectrum.

Units and Interconnections

So much for the desirable electrical characteristics of the transmitter and receiver. They involve no new objectives which are not generally wished for by the present $2\frac{1}{2}$ -meter gang. In addition, there are electrical and mechanical requirements more or less peculiar to an emergency set-up. Broadly, these are simplicity and convenience in installation, operating and servicing. And at this point it is necessary to depart from generalities and get down to specific recommendations.

All points considered, it is desirable to split the station into units. This makes for simplicity of construction and ready interchangeability. The main divisions are transmitter, modulator (including the speech amplifier), receiver, and power supply. When the unit system is properly carried out, W2XXX's modulator will work perfectly with W2YYY's oscillator, and W2ZZZ's receiver or power supply will fit in neatly with either or both. The advantages of this system are obvious. Should a particular unit develop trouble in operation, a spare can be plugged in with a loss of but a few moments' time, and the defective gadget can be looked over and serviced without interrupting communication. Extra units can be built in preparation for just such a contingency, but the work — and cost — of making spares available can be spread among a group of amateurs by having one build a spare modulator, another an extra transmitter, and so on. With this system a few spare units can take care of a fairly good-sized communication system, since it is unlikely that all parts of a station would fail simultaneously, and when a spare is in use the replaced unit can be undergoing repairs.

Two things are essential if this system is to work out in practice. First, each unit must be designed to operate from the standard voltage and current. Second, the method of making power connections must be the same in all corresponding units. The latter point involves also a convenient method of making connections to avoid loss of time in either replacement or the initial setting up of the apparatus. The one which we have adopted is shown in Fig. 1; we urge it upon other amateurs as a method fully meeting the requirements as we see them now. There are six divisions: oscillator, modulator, receiver, a.c. power supply, vibrator power supply, and a meter unit for checking currents. The latter is useful, although not essential, in regular operation, but is needed for initial transmitter checking and adjustment. The point is that metering facilities are available, quickly and simply, but the meter itself is not tied up permanently in the equipment.

The system is based on the use of four-conductor cables, with four-prong sockets and plugs for quick and positive interconnection. Each cable has a plug at one end and a socket at the other. Suitable cable-type connectors are readily available, but even in the event that they are not, ordinary four-prong sockets and old tube bases readily can be adapted to the purpose. On the various units of the station, a socket (female) is used for *outgoing* power and a plug (male) for *incoming* power; thus there is no danger of shock nor any possibility of making wrong connections. The prong connections we have adopted as our standard are indicated on the diagram.

The general plan is that a cable runs from the power supply to the modulator, where the power is distributed to the transmitter and receiver. The modulator is provided with two outgoing sockets; the plus-“B” lead to the transmitter socket picks up the modulator audio output and carries it along with the d.c. to the transmitter when the cable is attached. On the receiver side, the fourth prong is used to provide duplicate send-receive switching at both modulator and receiver. The connections to the single-pole double-throw switches are shown in the appropriate units. With either switch in the “receive” position, the other may be used to switch the plate power back and forth. The cables, of course, simply carry through connections from plug prongs to corresponding socket prongs; all the cables are identical. The meter unit has a plug and a short length of cable with a socket connector at its end; a separate cable is unnecessary here since the meter will be used near the unit whose plate current is being measured. The whole system is quite simple and easily applied; it has the great advantage that no wiring has to be done when a station is installed, besides the feature of rapid replacement of units. The units themselves can be widely different in design internally, so long as the external connections are

standardized and the circuits are designed to work with the standardized currents and voltages. If less voltage is needed, as might be the case in a receiver, it can very easily be reduced to the appropriate value by suitable dropping resistors or voltage dividers.

Antenna Systems

The standardization might profitably also be carried out to antenna systems, since it is far better to get the fussing with antenna coupling and tuning out of the way before an emergency comes along than to have to do it in the stress of

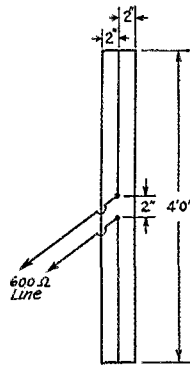

Fig. 2—Three-wire folded doublet antenna for matching a 600-ohm line. The three conductors are connected together at the ends as indicated. They may be of wire, rod or tubing, and can be mounted on stand-off insulators on a wooden support.

getting into operation. This standardization is in fact necessary if transmitters and receivers are to be completely interchangeable with a minimum of delay. Since it may not be possible to install the transmitter or receiver right at the antenna, these units ought to be designed for operation with a transmission line, and since the line lengths may vary considerably it is apparent that the line should be non-resonant. For cheapness, ease of construction and portability an open-wire line of approximately 600 ohms impedance represents a good choice, and its losses are reasonably low even in considerable lengths.

To make the line non-resonant for transmitting it is of course necessary to match it to the antenna. Matching stubs and similar devices can be employed, the design depending upon the type of antenna to be used. In practice, it is probable that a non-directive antenna will be preferred, and a simple three-wire folded doublet¹ arrangement which is suitable is shown in Fig. 2. This gives a 9-to-1 impedance step up at the line terminals, hence practically automatic matching to a 600-ohm line, assuming the normal doublet

(Continued on page 66)

¹ The principle of the folded doublet is described by P. S. Carter, "Simple Television Antennas," *RCA Review*, October, 1931.

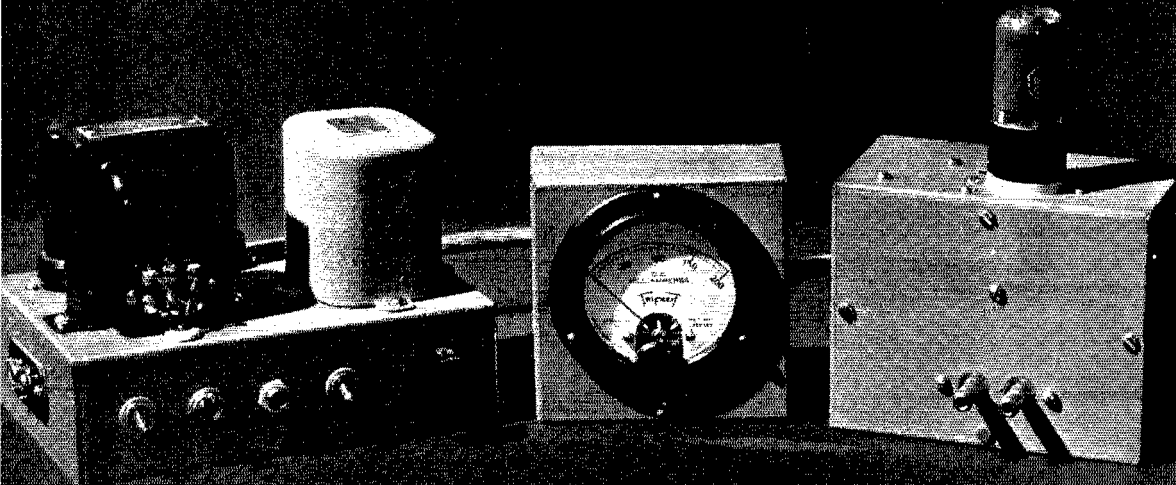

A 112-Mc. Emergency Transmitter

Transportable Oscillator and Modulator for Vibrator Plate Supply

BY GEORGE GRAMMER,* W1DF

THE two pieces of emergency equipment to be described have been designed to meet the specifications and standards outlined in another article in this issue.¹ It should be emphasized right at the start that the transmitter and modulator shown here do not by any means represent the only way in which such units can or should be constructed. Alternative designs not only are possible but undoubtedly will be necessary, for the simple reason that the existing supplies of any one type of component are limited and future deliveries are bound to be slow and uncertain.

The problem we set ourselves in constructing the transmitter was this: First, of course, the transmitting system, which includes the modulator, had to work from the 300-volt, 100-milliampere supply which is the basis of all our calculations. Of the total output current, 50 to 60 milliamperes would be available for the oscillator which performs would be the whole r.f. section of the transmitter. The transmitter we had in mind would use a tube or tubes to be found in practically any radio store (not just in amateur supply stores) in the country. We had no great hope of anything remarkable in the way of performance from any of these "bread-and-butter" tubes. Having determined which of the relatively few suitable types worked best, we then wanted to build an oscillator with as much frequency stability, particularly dynamic stability, as it was possible to get so that frequency modulation would be minimized. We felt that at least it

should be possible to improve considerably on the performance of the ordinary modulated oscillator in this respect, although just what order of stability would be possible was decidedly an open question.

At the same time we wanted the circuit to be as simple as possible, to use components we could reasonably expect to find at amateur supply houses, and to involve only construction which could be readily duplicated in the average amateur workshop. To a large extent this eliminated consideration of anything special in the way of low-loss tank circuits, since these are usually somewhat difficult to construct and call for hard-to-get materials. We wanted to avoid even the use of the popular linear circuits if possible, partly because copper tubing or pipe is not so easy to find these days, but chiefly because such circuits are awkward things to have in portable apparatus.

The results of an inquiry into the receiving tube situation, particularly those replacement types as likely to be found on music store shelves as in jobbers' warehouses, were rather disappointing; none of the types we expected would have the best possibilities were among the leaders in volume — or even near them. Of the volume group, only a few could be considered at all; the others, even in pairs, were not capable of carrying the plate current or dissipating the power — and we had no illusions that very much of the power put in would be coming out as r.f. Even at low frequencies an oscillator with any pretense to stability does not operate at high overall efficiency — 50% is a very good figure — and we were

* Technical Editor.

¹ Grammer, "112-Mc. Emergency Gear," this issue.

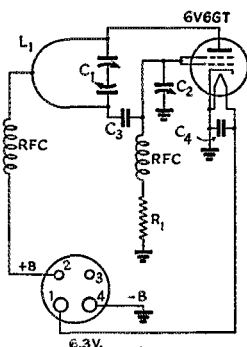

Fig. 1 — Oscillator circuit diagram.

- C₁ — 100 μ fd. per section (Hammarlund MCD-100-S or Millen 24100).
- C₂ — 3-30- μ fd. paddler (National M-30, Millen 28030, Hammarlund MEX, etc.).
- C₃ — 50- μ fd. midget mica.
- C₄ — 250- μ fd. midget mica.
- R₁ — 15,000 ohms, $\frac{1}{2}$ watt.
- L₁ — See Fig. 2.
- RFC — $\frac{1}{4}$ -inch winding of No. 28 d.s.c. on $\frac{1}{4}$ -inch polystyrene rod, no spacing between turns (Ohmite Z-1 chokes satisfactory).

trying to work at 112 megacycles with tubes designed for the audio region.

Yet oddly enough the tube we finally decided had made the best showing, after many tests with all kinds of receiving tubes of sufficient (and insufficient) power capabilities, in and out of the high-volume group, turned out to be one of the common ones — the 6V6GT. Used as a triode, with screen and plate connected together, it not only worked better than any of the others but had one important operating advantage which most of them lacked — it would run along under full input of 15 to 18 watts for hours on end with no upward-creeping plate current. The others, even those with higher plate dissipation ratings, could run only a relatively short time before the

plate current would start to climb, and once started there was nothing to do but shut down and wait for the tube to cool off.

And the old-fashioned high-C tank circuit proved to be the answer to the question of improving frequency stability — once the tank is made really high C. In the final circuit the tank condenser is a 100- μ fd.-per-section double unit, and nearly all the capacity is used. It is possible to get more power output by using less capacity, but only with the inevitable accompaniment of

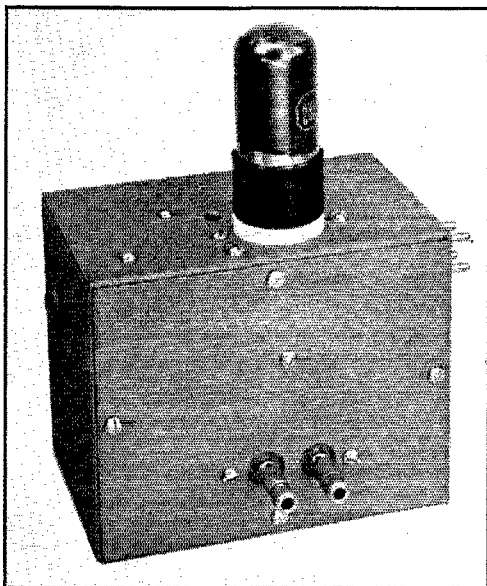

The oscillator is built in a small metal box, with only the tube, power plug and antenna posts on the outside. The small hole on the top just to the left of the tube is for adjustment of the excitation condenser. The grommetted hole on the left edge allows screwdriver adjustment of the tank condenser.

Here are the first of your Civilian Defense apparatus designs — a low-powered $\frac{2}{4}$ -meter oscillator of satisfactory stability and an accompanying modulator — as forecast in our November editorial. While obviously any satisfactory power supply can be used, we shall give you next month sister units for 6-volt and 115-volt sources. The first receiver design is nearly done and is coming up soon. Some recommendations on antennas and feeders are found in another article in this issue.

These apparatus designs are the first of a family of ARRL-recommended designs for OCD work. Since you can't build everything at once, and since speed may prove important, we are not waiting for the whole family to be assembled — we're presenting them as fast as they are ready. Each will comply with the fundamental considerations outlined in the article this month, "112-Mc. Emergency Gear," which you should read before studying this article.

For further background, see "The Amateur and National Defense," page 7, November, and the Operating News the past couple months. This country needs, in the hands of its amateurs, many thousands of movable self-powered u.h.f. stations for ham participation in civilian-protection work. You should equip yourself with some such apparatus, to be prepared to do a possibly vital communications job for your own home community. These designs, and their companions now in process, are intended to give you the needed help.

greatly increased wobble. The change in frequency with changes in plate voltage is somewhat difficult to measure accurately at 112 Mc., and even more difficult to interpret in terms of channel width when both amplitude and frequency modulation are taking place. Qualitatively, the effect can be evaluated by observing the distortion which occurs when the signal is passed through amplifiers of varying band width at the receiver. For this purpose we used a Hallcrafters S-27 receiver, which has a "sharp" i.f. channel with a band width of the order of 50 kc. at ten times down, and a "broad" channel intended for wide-band f.m. reception. Using amplitude-modulation reception, the quality of reproduction was equally good on either the sharp or broad i.f. positions with the tank-circuit L/C ratio finally used, indicating that the signal was not appreciably exceeding the band-width of the sharp channel. Ordinary modulated oscillators are obviously distorted (when understandable at all) even with the broad i.f.; better reception is obtained with f.m. detection, a certain indication that the carrier is being splattered around so much that proper a.m. detection can not take place.

The conditions under which a low-power oscillator must work are particularly unfavorable, since the greatest frequency change takes place at quite low voltages. As an illustration, measurements showed that the curve of frequency change versus plate voltage was fairly linear from well above the operating d.c. plate voltage (as high as it could safely be carried towards double plate voltage) down to the region of 100 volts or so; as the voltage was lowered still more the rate of change in frequency continually increased, becoming very high indeed near the minimum plate

voltage which would maintain oscillation. Depending upon the operating conditions, anywhere from 50% to 80% of the total frequency change occurred in the low plate-voltage region, which in practice would correspond to modulation (in the downward direction) above 75%. A small reduction in modulation percentage therefore makes a considerable change in the width of the channel occupied by the transmission. Also, 100% modulation really ought not be considered unless the oscillator is capable of maintaining oscillation right down to almost zero plate voltage. Few u.h.f. oscillators are capable of even approaching this condition, let alone maintaining linearity of output in the low plate-voltage region. The consequence is that the bad effects of overmodulation and the worst frequency modulation occur in the 75-100% modulation region.

Fortunately, however, the average voice modulation is below 75% even when the random peaks are 100% or over. Also fortunately, the additional sidebands caused by the higher modulation percentages are of relatively low amplitude since they occur at low instantaneous plate voltages. The splatter they cause is of noticeable proportions only when the signal is strong at the receiver, and with an oscillator of good stability will not extend outside the area in which the rush is suppressed by the carrier, in reception with a super-regenerative receiver. In addition, it is possible to use to advantage the lop-sided character of speech waves² by making the peaky side do the upward modulating, thus lowering the downward modulation percentage and keeping the splatter within bounds. By the simple process of observing the width of the signal, including splatter, then

² Grammer, "Lop-Sided Speech and Modulation," *QST*, February, 1940.

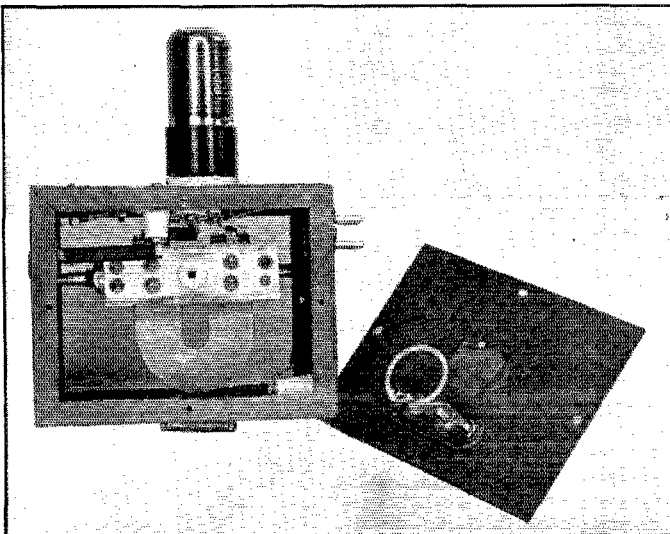

Looking into the oscillator from the antenna-terminal side. The grid choke is in the upper left corner, with its "hot" end supported by a small ceramic standoff. The plate choke is partly visible in the lower right corner; it is mounted endwise on a ceramic standoff. The 1-turn antenna coil can be seen mounted on the antenna terminals.

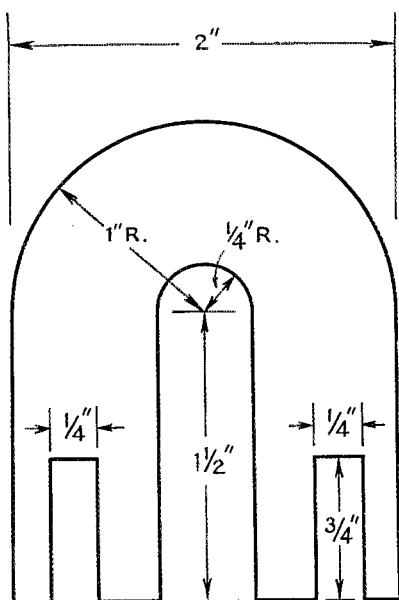

Fig. 2 — Tank inductance construction. This drawing is full size and may be used as a template.

reversing the connections of the output winding of the modulation transformer and observing the signal width again, it is possible to decide which polarity gives the best results in this respect.

The Oscillator Circuit

The oscillator circuit of Fig. 1 is down to bare essentials. Tuned cathode circuits, filament chokes and the like, seemingly helpful and often necessary in earlier versions, were gradually eliminated until it was finally found possible to dispense with them altogether with no loss of performance. The by-pass condenser across the heater proved sufficient to clean up a slight tendency toward r.f. in the filament wiring. The r.f. chokes are necessary but not especially critical as to dimensions. The grid condenser capacity specified was found to be optimum after considerable experimenting with variable values. The excitation control condenser, C_2 , proved to be an important addition to the circuit, improving both output and stability when properly set.

The tank circuit consists of the balanced condenser, C_1 and the U-shaped metal piece whose dimensions are given in Fig. 2. This "coil" was designed to have as much surface area as possible, thereby reducing resistance and losses, and also to provide the lowest possible contact resistance where it connects to the condenser. Original experiments were with inductances of copper tubing, but we were especially anxious to avoid the losses caused by concentration of current at condenser plates which become relatively large in high- C

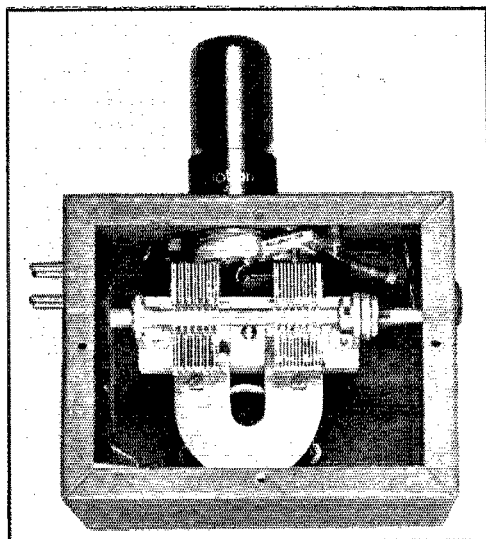

Inside the oscillator unit. The tube socket is placed so that the plate prong is directly above the left-hand tank condenser stator terminal, making an extremely short plate connection. The grid condenser forms the connection between the grid prong and the right-hand stator terminal. The positions occupied by the excitation condenser and grid leak are plainly shown in this view.

circuits,³ and it proved to be a difficult job to solder the tubing in such a way that it would make contact with all the stator plates. A blow-torch was needed to get sufficient heat, and when the joint became hot enough to make solder flow freely the stator assemblies tended to collapse.

The ends of the U-shaped inductance fit under the stator-plate assemblies, which in the types of condensers specified are provided with flat holding plates to which the individual condenser plates are soldered. The slots in the ends of the U allow the inductance to be slid in and out to adjust the L/C ratio over a small range. By this means the current to each individual plate almost always comes directly from the coil; there is little necessity for plate-to-plate r.f. current flow. To assemble the tank circuit the condenser must be dismounted from the base, and washers about the same thickness as the metal of the tank coil inserted between the base and the rotor supports, thereby raising the rotor to correspond to the increased height of the stators. It is not difficult to replace the stators so that the plate spacing is as uniform as it was originally. If the inductance is made exactly as specified the slotted ends should come within about $\frac{1}{16}$ th inch of the far side of the base to give the proper frequency range.

³ Peterson, "High-Q Tank Circuits for Ultra-High Frequencies," *QST*, September, 1939.

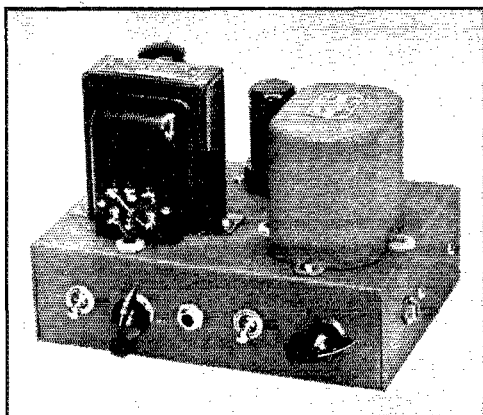

The modulator unit. The output transformer is at the left and driver transformer at the right. Controls along the front chassis edge are send-receive switch, phone-c.w. switch, key jack, microphone battery switch, and gain control. The microphone jack is on the right hand edge, around the corner from the gain control.

The inductance shown in the photographs was cut from a small piece of scrap sheet copper somewhat less than $\frac{1}{16}$ th inch thick. A duplicate inductance made of aluminum also worked well. The metal should have low resistance, although its thickness is of no importance except for mechanical stiffness. If brass or iron is used it should be copper or silver plated to a thickness of a few thousandths of an inch so that the thin layer in which the current flows will have minimum resistance.

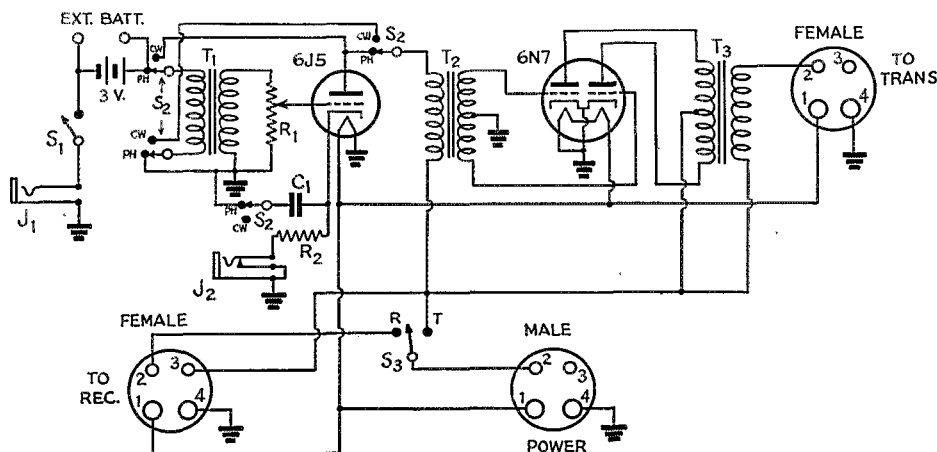

Fig. 3 — Modulator circuit diagram.

C₁ — 10- μ fd. electrolytic, 50 volts.
 R₁ — 0.5-megohm volume control.
 R₂ — 2000 ohms, 1 watt.
 T₁ — Single button microphone to grid transformer (Stancor A-4706 or equivalent).
 T₂ — Class-B driver, 6J5 to 6N7 (UTC S8 or equivalent).

T₃ — Class-B output, 6N7 to 5000-6000 ohms (Thoradson T19M13 or equivalent).
 J₁ — Open-circuit jack.
 J₂ — Closed-circuit jack.
 S₁ — S.p.s.t. toggle switch.
 S₂ — 4-pole double-throw rotary switch (Yaxley 3242J or equivalent).
 S₃ — S.p.d.t. toggle switch.

put to negligible proportions. For this reason the rotor-to-case capacity should be kept as low as possible — another reason for mounting the condenser on a stand-off insulator.

The plate voltage is fed to the tank circuit near the center of the U. It is not necessary to find the exact nodal point (although this can be done if a receiver which will give a c.w. beat note is available, by tapping a small screwdriver along the tank to find the spot which gives the least change in frequency) since the plate choke is effective in preventing r.f. leakage. The lead from the cathode to ground should be as short as possible and made of heavy wire, likewise the lead from the grounded filament pin. The same connection may be used for both, and also for the No. 1 pin.

Aside from the points discussed above, we have found only one constructional precaution necessary — the excitation condenser C_2 , should be mounted in such a way as to keep it as far as possible from the plate section of the tank condenser. In one version we had it between the two condenser sections, and the output was unaccountably below normal until the condenser was moved to its present position. The reason for this is not clear.

Oscillator Adjustment

The only adjustments to be made are to determine whether the frequency range is correct and to set the output coupling and excitation for maximum stability and output. The tank inductance will be properly adjusted when it is set (by sliding the ends in and out under the stator-plate assemblies) so that with the condenser at maximum capacity the frequency is between 111 and 112

megacycles. The frequency may be measured by using Lecher wires as outlined a few months ago.⁴ The output may be judged by connecting a dial light (150-ma. size or larger) to the output terminals, when varying the coupling and adjusting C_2 will readily show the optimum settings. The stability is more difficult to check unless a 112-Mc. superhet is available. However, the maximum stability is obtained when the capacity of C_2 is set at the largest value which will give good output, and it is advisable to adjust C_2 by first increasing its capacity to the point where the output drops off and then decreasing it just to the point where the output comes back to normal. As the capacity is decreased still more the output should decrease somewhat.

With normal operation the plate current, with load, should be between 50 and 60 milliamperes. The exact value will vary somewhat with individual tubes, and if it tends to be outside these limits it may be regulated by using a slightly different value of grid leak, larger values giving less plate current and vice versa. The current will drop a few milliamperes when the load is removed.

To adjust the coupling for working into a 600-ohm line, a 1-watt resistor of 500 or 600 ohms may be used as a load. To indicate current through the resistor a 60-ma. dial light may be connected in series with it. A 150-ma. lamp also may be used, but is a less convenient indicator since it glows only dimly. The coupling should be adjusted for maximum current.

⁴ "A Lecher-Wire System for U. H. Frequency Measurement," *QST*, October, 1941.

(Continued on page 68)

◆

Underneath the modulator chassis. The microphone transformer is mounted on the chassis edge alongside the microphone jack. The power plug and the two outgoing power sockets for the transmitter and receiver are mounted on the rear edge of the chassis (bottom edge in this view). Terminal strip for an external microphone battery is on the left-hand edge. The flashlight cell microphone battery is held in place by a metal strip; the cells are protected from accidental short-circuit by a piece of thin fiber or cardboard bent in a "U" to cover the terminals.

◆

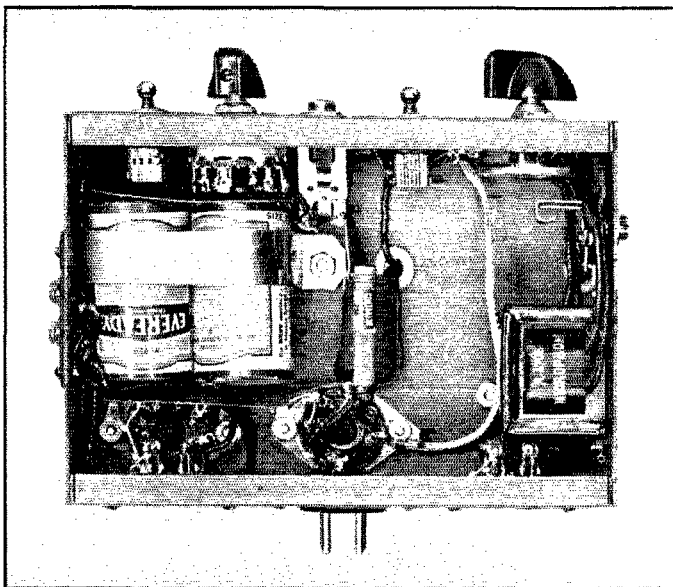



Taking it on the mill.

On the dock at Gallups Island.

Automatic tape code transmitter.

Hams study Maritime gear

Gallups Island Radio Club Puts on a Show

Maritime Service Radio School Exhibit Feature of New England Division Convention

BACK in the June, 1941, issue, *QST* carried an article announcing the establishment of a resident radio school at the U. S. Maritime Service Training Station at Gallups Island. So widespread was the interest in this announcement that numbers of amateurs took advantage of the opportunity to earn while learning radio operating under almost ideal conditions, and the school has proved itself a successful effort not only from the standpoint of the training presented but also of enrollment.

This is in the nature of a report on the project to date, occasioned by the successful participation of the school and the Gallups Island Radio Club in the New England Division ARRL Convention held in Boston, October 18th.

The Gallups Island participation in the convention was threefold, including (1) an inspection trip by the conventioners to the school, (2) an elaborate \$6000 exhibit occupying approximately 500 square feet near the main entrance to the ballroom, and (3) participation in the general convention activities by 61 members of the Gallups Island Radio Club.

At 10 A.M. the first trip to the school was made, the visitors proceeding to the dock by car, whereupon they were carried by the cutter, *Yeaton*, out to the Island. There they saw the equipment and methods described in the June *QST* article. This trip was a conspicuous convention highlight.

The two booths housing the Gallups Island

exhibit could accommodate approximately 50 persons, and they were filled to capacity throughout the day and night as the 1200 amateurs attending the convention crowded through. One booth contained a display of radio equipment such as is used in the Maritime Service, including a complete lifeboat transmitter and eight receivers, together with photographs of the school and a large colored chart depicting the various segments of the electromagnetic spectrum.

The other booth showed the system of code instruction and operating facilities provided at the school, in the form of a typical code table with eight operating positions. Complete operating facilities were provided, with automatic code transmitting equipment, radio receiver connections to the code tables, loud-speaker, etc.

Visiting New England Division hams were able to sit down at the operating positions and test their skill at copying on the "mill" from the automatic transmissions, as well as talking with each other through the inter-position circuits provided. A third channel constantly carried signals from the rack-mounted receiver which was continuously manned by an amateur operator. Hundreds of hams took advantage of these facilities, including no less than fifteen YL's.

Throughout the convention the Maritime Service uniforms of the G.I. Radio School students, distinguished by a white circled shield on the sleeve, were conspicuously present. They were to be seen



Maritime equipment display by the G.I. school at the New England Division ARRL Convention.

at all the meetings, at the long tables in the main ballroom allotted to the various amateur bands where the occupants of those bands congregated, and in the contests — particularly in the contests! Members of the G.I. club took prizes in everything from the liar's contest and baby bottle contest to the code receiving competition. To show the extent to which students come to Gallups Island from all over the country, the list of G. I. convention prize winners includes W6RWQ, W2KTR, W2MEM, W9OMU, W8VWN, W8VSF, and W9JLD.

Actually, the Gallups Island Radio Club includes calls from all districts, held by the 89 licensed amateur members enrolled at the time of writing. A recent check showed eight W1's, twelve W2's, eight W3's, six W4's, twelve W5's, seven W6's, three W7's, ten W8's and no less than twenty W9's.

The officers of the G.I. Radio Club are: Jared Smith, W3HDH, president; W. B. Marsh, W2KTR, chief operator; J. A. Jolly, W6RWI, vice-president; Vicent Peduto, W1MKL, *QST* correspondent; Bill Olson, W6RWQ, chief technical adviser; and Joseph Quinn, W9GZZ, secretary-treasurer.

Plans are now being made for the installation of an elaborate amateur station at the school for the use of the Radio Club, capable of operation on all the c.w. bands. Plenty of activity is anticipated when this station gets going, not only by the students but by the amateurs on the instruction staff of the school as well. Most of the latter have found themselves too busy to put up stations of their own since landing on the Island but they promise to give the club station a workout.

The membership of the club is naturally in a constant state of flux, with members graduating and new arrivals joining up. During a typical week a total of 26 of the 206 students under instruction were released, about a third of them going directly into the merchant marine. Thirty-



The Gallups Island Radio Club, a live and enthusiastic aggregation of hams representing every U. S. call-letter area. There are 83 of them in the picture.

two licensed operators were available for assignment. Those remaining were grouped in a total of six classes, averaging about 35 men each. Five such classes have already been graduated. New classes are begun every six or seven weeks.

Their activity at this convention showed that the hams taking the Gallups Island training course have lost none of their amateur spirit. They are training to become commercial operators in an atmosphere of strict Coast Guard discipline, but they are still hams at heart.

They'll be better hams for the training they are receiving, though — and better men, as well. They'll know a lot more about radio operating and technique than they did before, and on top of that they'll have learned lessons in discipline, self-reliance and manliness that will be invaluable to them in later life.

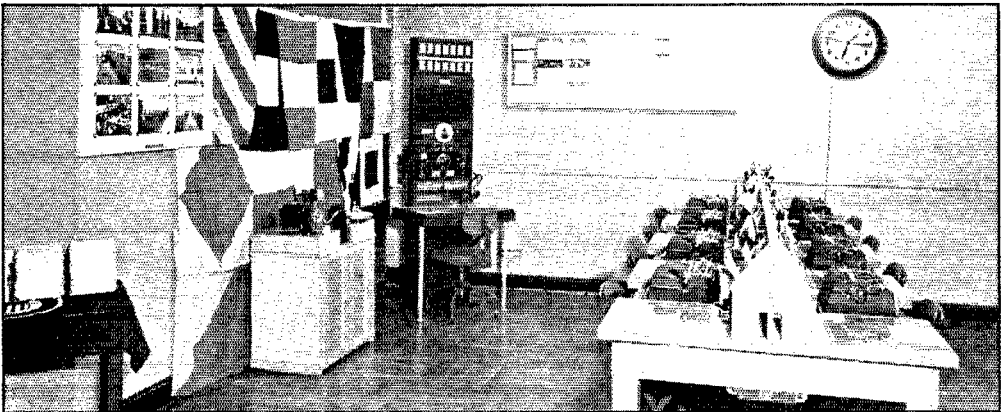

Code-instruction table set up in Gallups Island exhibit where conventioners tested code ability.

★ WHAT THE LEAGUE IS DOING ★

ELECTION NOTICE

To all members of the Southeastern Division:

You are hereby advised that no eligible candidate for Southeastern Division alternate director has been nominated under the recent call. By-Law 21 provides that if no eligible nominee be named, the procedure of soliciting and nominating is to be repeated. Pursuant to that by-law, you are again solicited to name a member of the Southeastern Division as a candidate for alternate director. See the original solicitation published at page 30 of September *QST* and page 21 of October *QST*, which remains in full effect except as to dates mentioned therein: nominating petitions must now be filed at the headquarters office of the League in West Hartford, Conn., by noon E.S.T. of the 20th day of January, 1942. Voting will take place between February 1 and March 20, 1942, on ballots to be mailed from the headquarters office the first week of February. The new alternate will take office as quickly as the result of the election can be determined after February 20, 1942, and will serve for the remainder of the 1942-1943 term.

You are urged to take the initiative and file nominating petitions.

For the Board of Directors:

K. B. WARNER,
Secretary

November 3, 1941

ELECTION RESULTS

DIRECTORS Arledge, Norwine, McCargar and Shelton have been declared reelected directors from their respective divisions without the need for balloting by their memberships, they being in each case the only eligible candidate named by their gangs in the autumn election of 1941. In both the Atlantic and Dakota Divisions balloting is now going on between a multiplicity of candidates for both director and alternate, and the Southeastern Division will have to approach again the job of selecting an alternate, but in the other four divisions balloting is not necessary. Here is the way it went:

DELTA

Mr. Arledge and W5CPV were both nominated, but the latter was found ineligible under the by-laws, leaving the election to Mr. Arledge. The Delta has a new alternate in the person of B. G. Lowery Smith, W4DEP, of Memphis. He was the only candidate named and was, therefore, de-

clared elected for 1942-1943. Mr. Smith, our former Tennessee SCM, is an RM and ORS and Tennessee SNCS for AARS. His business connection is with the Memphis light, gas and water facilities' accounting department.

MIDWEST

The Midwest nominated only W9EFC for reappointment as director, but it now has a new alternate. W9KEF was nominated for that post but was found ineligible under the by-laws, and W9OUD had the bad fortune to have her petition arrive at West Hartford too late. This left the field without balloting to William H. Graham, W9BNC, of Omaha. Bill Graham is a well-known newspaper man on the *Omaha World-Herald*, where he has been for twenty years. He has been Mr. Norwine's assistant director for Nebraska the last four or five years, so he knows the job well. He has held various offices in the radio clubs of Omaha and has been prominent in the management of conventions thrown in his city.

PACIFIC

The Pacific again nominated only W6EY for its director, so he carries on. Elbert J. Amarantes, W6FBW, continues as alternate without balloting, after the necessity of finding W6SG ineligible under the by-laws.

SOUTHEASTERN

W4ASR was reelected without balloting, being the only nominee. W4EBZ was named for alternate but, unfortunately, wasn't eligible as to continuity of membership. This leaving no candidate, it is necessary to advertise anew in the Southeastern, as will be found above in this department. As the former alternate, W4EV, is now out of the Division, it is hoped the boys will come forward immediately with new candidates.

OMISSION, BOARD MINUTES

AN OMISSION has been discovered in the minutes of the last meeting of the Board of Directors. See June *QST*, page 36, first column. Just above the second paragraph from the bottom, insert the following:

Moved, by Mr. Shelton, that, to stimulate experimentation in the radio control of models, the League sponsor a special license for the use of the 112-Mc. band or small portions thereof for this experimental work. But, after discussion, the motion was unanimously rejected.

ARE YOU LICENSED?

When joining the League or renewing your membership, it is important that you show whether you have an amateur license, either station or operator. Please state your call and/or the class of operator license held, that we may verify your classification.

MISCELLANY

THE number of amateurs continues to grow. New amateur operator licenses issued by FCC during 1941 have averaged 130 per week. League membership grows too and the number of membership copies of *QST* printed this month is an all-time high. . . . Many hams are getting tickets for not complying with the new rule on signing, which requires the use of the calls of both stations. The correct dope is on page 28 of August *QST*. . . . At ARRL hq we are trying to compile a roster of the amateurs serving in the defense effort. It will be useful in future years — perhaps you remember the resolution adopted on that subject by the Board at its last meeting. We are having great difficulty with this job; everybody is so busy. We get many lists from units where we have a good ham contact, perhaps in the person of the commanding officer himself, but we know they are only a small part of the whole. If you can do anything about this, by reporting yourself or your gang, please do so. We are interested in civilians serving as experts and laboratorians in the defense effort, as well as officers and enlisted men in the services. Our estimate, by the way, is that there are now about 10,000 amateurs serving in defense communications work. . . . Wouldn't it be a good idea if the War Department would permit the establishment of amateur stations at the new bases, to permit the personnel there to exchange messages with home through mainland amateurs?



THE first anniversary of *QST* is celebrated in December, 1916, with a 72-page issue, a three-colored cover and a raft of interesting advertisements.

There are several new "firsts." "Who's Who" is introduced, the first candidates being 2FH and 6PN. The first article by "Dr. Radio" appears, "Efficient Short Wave Transmitting," practical pointers on avoiding losses. Dr. Radio is a composite of Maxim and Tuska (and, later, Warner),

but this one seems to be pure Tuska. The first *QST* constructional article appears, describing the building of a short-wave regenerative receiver, based on the Godley articles of the summer and responsive to the feeling that amateurs need a separate tuner for waves below 600 meters. This article is destined to leave a powerful imprint upon amateur radio, being the first description of how the amateur could roll his own version of the new regenerative tuners that have recently appeared on the market. A single tuber, it has shellacked windings on cardboard tubes, variable antenna coupling, condenser control of regeneration, a tapped secondary but no secondary tuning condenser.

A.T.&T. has recently inaugurated coast-to-coast wire telephony, and Mr. Maxim proposes an attempt at a transcontinental relay, prophesying great honor to the amateurs who successfully handle the first relay message and its reply on the same night. Ranges are lengthening, shown not only in "Calls Heard" but by specific reports. 9IK and 5ED, 1100 miles apart, have worked for an hour, and 8NH has worked the same distance to a ship in the Gulf. 2LK on Long Island is handling traffic direct with 9IK, Chicago, but Trunkline Manager Hebert complains that this lure of DX interferes with the keeping of close-by schedules for reliable message-handling. J. C. Cooper, Jr., of Jacksonville (now vice-president of Pan American Airways) and W. T. Gravely (now W3BZ) are appointed district superintendents, and S. Kruse at Lawrence, Kansas, is local manager for the eastern end of Trunkline B, Portland-Cape Girardeau. 6EA reports the reception on galena of a Jap coast station on 3000 meters, a battleship in the Atlantic on 750 meters.

The League has decided that it cannot support itself on donations and the sale of callbooks, and has set dues at \$1 a year. (*QST* is separately owned.) The Old Man, with "Rotten Ground-Leads," gives point to the perpetual argument on where a ground begins and ends. The Marconi Company is suing the government for a million dollars, alleging violation of patents by Army and Navy stations. "New Apparatus" reports the appearance of the Paragon RA-6 tuner, the most famous ham receiver of all time. A San Antonio amateur has been arrested for deliberate interference with Fort Sam Houston. Charles A. Service, Jr., of Bala, Pa. (later to be vice-president, now W4IE), wins first prize in *QST*'s first subscription contest, a deForest detector. John M. Clayton, 5BV, serves notice that up to October 1st he permitted 5XO to use his call, and so cannot tell which reports relate to his own signals. "Mr. K. B. Warner of Cairo, Ill., has dismantled his set at 9JT and has entered into a partnership with 9FW. The relay work for that vicinity, including test messages, will be handled by Mr. Warner at 9FW henceforth."

• For the Junior Constructor — Meter Shunts

A Convenient Way of Cutting the Cost of Transmitter Metering

TO MOST of us, meters are expensive, but necessary, items which contribute nothing to the power output of the transmitter. To spread their usefulness as widely as possible, it is common practice to arrange the circuits so that one or two meters may be switched from circuit to circuit, thereby permitting them to do the work of several meters. The switching is usually done with a multitap switch or a system of plugs and jacks.

One of the difficulties which arises with this scheme of things is that the currents flowing in the various circuits to be checked vary so widely that it is impossible for a single meter to do a completely satisfactory job in all cases. For instance, a meter which will handle a plate-current range of 300 to 500 ma. for the final amplifier will be of hardly any practical use in checking the 3-ma. grid current of an 807 driver. This disadvantage may be almost completely overcome by selecting a meter with a sufficiently low scale to permit reading the lowest currents with reasonable accuracy and then placing multiplying shunts across the meter when the higher currents must be checked. As many shunts as desired may be made up with copper wire for a few cents each. It is much more sensible to purchase one meter of decent size and quality than to try to get along with several cheap meters of inferior quality.

The original meter range to be chosen had best depend upon the maximum range desired, allowing sufficient leeway so that the meter pin will

not bang up against the pin if the high-power stage happens to be detuned momentarily. Since a scale multiplication of 10 removes the necessity for mental calculations when the shunts are in use, meters with original scales of 10 ma., 25 ma., 30 ma., 50 ma. and 100 ma. should be purchased when the maximum currents to be checked are 100 ma., 250 ma., 300 ma. or 1000 ma., respectively. A current of 2 ma. may be read with quite good accuracy on a three-inch meter with a scale as high as 50 ma. In a pinch, even a 100-ma. meter may be used. However, if currents in excess of 500 ma. must be checked, along with small currents, a meter with a scale of 10 ma. may be provided with two shunts, one of ten times increasing the range to 100 ma. and one of 100 times increasing the range to 1000 ma.

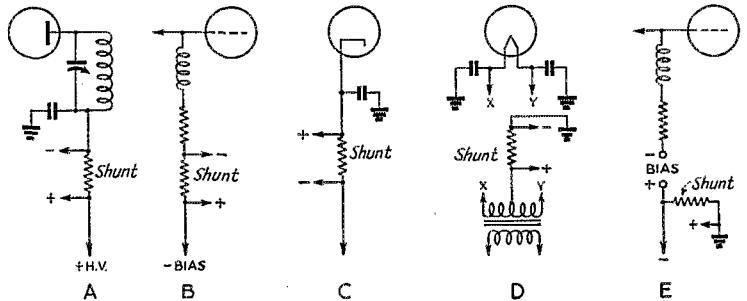

Fig. 2 — Circuits showing placement of shunts for metering various circuits. A — For reading plate current (high insulation required). B — For reading grid current (high insulation required if fixed bias over 200 volts). C — For reading cathode current. D — For reading cathode current with filament-type tube. E — For reading grid current (eliminating necessity for high insulation.)

Switching Systems

The usual meter-switching system involves the use of a two-pole, multicontact switch, as shown in Fig. 1A, although a simple d.p.d.t. switch may serve where only two circuits are considered, as shown at B. The meter terminals are simply connected between the two poles of the switch, while the shunts connect between corresponding pairs of contacts. If the shunts are connected in the high-voltage sides of the circuits, as shown in Fig. 2A and B, the switches must have good insulation to ground and between contacts. If they are connected in the ground circuits, as shown in Fig. 2C, D and E, ordinary low-voltage insulation will be satisfactory. The disadvantage of the connec-

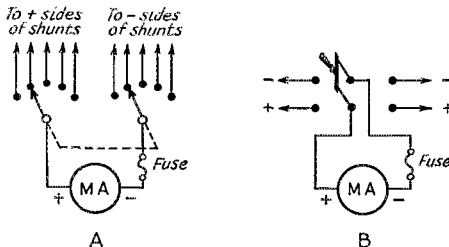
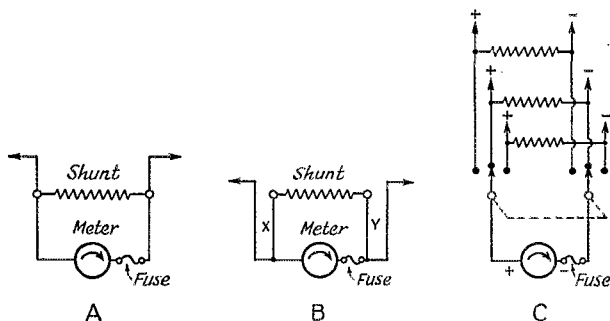

Fig. 1 — Methods of switching meter. A — Two-gang multitap switch for several circuits. B — Simple d.p.d.t. toggle switch for two circuits.

Fig. 4 — Right and wrong ways to connect meter shunt in circuit. *A* — Right. *B* — Wrong. *C* — In a switching system, the shunts and circuit connections are made directly at the switch terminals.



tions shown in *C* and *D* is that the meter reads total cathode current, which includes grid and screen currents as well as plate current. It is, therefore, necessary to make mental subtractions

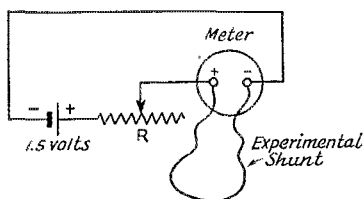

Fig. 3 — Set-up for adjusting copper-wire meter shunt.

of grid and screen currents in order to arrive at the true value of plate current. This will not often be considered a particular hardship if grid and screen circuits are also metered. Most modern medium- and low-power tubes operate at grid and screen voltages which will not exceed the breakdown-voltage ratings of ordinary tap switches.

One other disadvantage of low-voltage metering occurs in the case of filament-type tubes which require individual filament transformers for this type of metering. In many cases, only the tube or tubes in the final amplifier are filament type and, therefore, no difficulty will result.

Construction of Shunts

The action of meter shunts depends, of course, upon the principle that currents through two parallel resistances will divide in inverse proportion to the resistance of each branch. One of these resistances is represented by the internal resistance of the meter itself, while the other branch is the shunting resistance. Therefore, if we wish to wind a resistance which will multiply the original scale of the meter by ten, we shall want to shunt the meter with a resistance equal to one-ninth of the meter resistance. Then, when the shunt is placed across the meter, nine-tenths of the total current will flow through the shunting resistance, while one-tenth will flow through the meter itself. Thus, when the meter reads full scale, we shall know that the total current flowing

in the circuit is ten times that indicated by the meter.

For multiplications other than ten, the resistance of the shunt will always be equal to 1 divided by one less than the multiplier figure desired, times the resistance of the meter. A multiplier of three will require a resistance of 1, divided by 3 minus 1, or $\frac{1}{2}$ the meter resistance.

Meter resistances vary from about 3 ohms for the 10-ma. range to 0.3 ohm or less for the 100-ma. range. It is, therefore, perfectly feasible to wind the shunting resistances with ordinary copper magnet wire, since the maximum required for a multiplication of 10 will be $\frac{1}{3}$ ohm or less. Wire tables show the resistance per thousand feet for any size wire, as well as the current-carrying capacity. Since large windings are not required, it will be safe to select a wire one size smaller than that listed in the tables for 1000 c.m. per ampere. For ten-times shunts, No. 30 will do for a 10-ma. meter, No. 26 for a 25-ma. meter, No. 24 for a 50-ma. meter and No. 22 for a 100-ma. meter. No. 22 should also be used in the 100-times shunt for increasing the range of a 10-ma. meter to 1000 ma. Approximately 3 ft. of No. 30, 26 and 24, or about 2 ft. for No. 22 will be required for the ten-times shunts. The 100-times shunt for the 10-ma. meter will require less than 4 inches of No. 22. It is best, however, to start out with a somewhat longer length of wire.

Calibration

The shunt may be adjusted to the right value, of course, by connecting a meter with the desired scale in series with the shunted meter and adjusting the shunt to make the shunted meter read the same in a circuit. However, we are assuming that several extra meters are not available and the single meter may just as easily be calibrated against itself. To do this, the meter to be shunted should be connected in series with a 1.5-volt battery and a resistance of 150 ohms for the 10-ma. meter, 60 ohms for the 25-ma. meter, 30 ohms for the 50-ma. meter or 15 ohms for the 100-ma. meter. The circuit is shown in Fig. 3. A variable resistance is, of course, very convenient, but if

(Continued on page 74)



U. S. A. CALLING



REGISTRATIONS WANTED!

HONESTLY, fellows, you never saw anything like the call that exists to-day for qualified amateurs. On every hand there is a need for an immense number of radio people of almost every category. We are beleaguered with requests from innumerable quarters of the defense effort, sometimes for a particular kind of expert, sometimes for a dozen or a hundred or 2000 men at a clip for some special kind of a job — officer candidates, guys who know how to grind crystals, a soldering expert, an administrator who can coordinate all the so-and-so work at all the university labs, etc. Nothing surprises us any longer — except the small supply of names.

We can put any well-qualified amateur in the way of a good job. Uncle is calling, and as the defense gearing-up increases, it becomes more important for skilled amateurs who are open to a change in employment to let us know of their availability. All you ordinarily read about in this column are the quantity jobs, where scores of men are wanted. The individual jobs are a different story. Some of them are very good — up to \$4600, \$5000 or \$5200 for the right man, or ranks up to Major and Lt. Commander. He has to be good, of course — maybe a physicist, maybe a mathematician — but for many it will be a rung up the ladder, as well as first-hand acquaintance with new things that are nothing short of marvelous and which will be the basis for much of the new art of quieter days to come.

We want registrations, so that we can lead members to defense posts that are crying for smart hams. Wherever you fit in radio to-day, the chances are that we can help you to something more interesting and better-paying, and both of us will be helping Unk too. At the least, it won't hurt you to look over the offers. All we need is a little dope on your qualifications. See the questionnaire on the next page. If you're possibly available, **FILL IT OUT TO-DAY!**

ELECTRONICS TRAINING

THROUGH the cooperation of the U. S. Office of Education, the U. S. Signal Corps, the Massachusetts Institute of Technology, and forty selected colleges, a plan has been worked out by George W. Bailey, president of the ARRL, called the Electronics Training Plan. This plan provides for the special training of students in electronics and should furnish trained men next June who will be qualified for commissions in the Signal Corps and for positions in industry. Graduates with amateur radio licenses will be preferred.

Forty of the largest colleges in the country were invited, and all accepted, to send professors from their electrical engineering or physics departments to attend an intensive three-weeks' course, starting October 27th, at M.I.T., dealing with the subject of ultra-high frequencies. The instructors will return to their respective institutions and offer a similar, but more detailed, course to seniors enrolled in the electrical engineering and physics departments. Physical examinations will also be given those students interested in applying for a commission in the Signal Corps, so that when they graduate in June, they will be ready to be commissioned as second lieutenants immediately and go on active duty. Those who do not wish to accept a commission or who could not pass the physical examination will be ready to take positions with industrial firms.

The inspiration for such a plan and the hearty response of all concerned arose from the realization of the great need in this country for men with training and experience in ultra-high-frequency and cathode-ray activities.

NAVAL RESEARCH LABORATORIANS

THE Naval Research Laboratory is looking for additional personnel for its radio division. They need men who have sufficient radio experience and educational background to qualify for radio research and development work. Their activities are so broad that they cover all the various branches of the radio field — transmitters, receivers, antennas, wave propagation, electronics, direction finding, etc.

They need men all the way from smart hams to physicists — the types of jobs, required qualifications and salaries varying with the man. This is not cut and dried. It is on the basis of civil contracts, individually negotiated. NRL has always been an interesting place where the newer developments in the art are being worked out. Amateurs with special skill and engineers interested in development work could here find desirable berths, some of them with very good salaries. NRL has a comprehensive questionnaire for which applicants should write in filing application or soliciting further information. Address the radio division, Naval Research Laboratory, Anacostia Station, Washington, D. C.

SKILLED AMATEURS WANTED

NEVER before has the holder of an amateur radio license been in such demand, particularly if the amateur has had any college training in either electrical engineering or physics. Men

Registration of Personnel Availability

INSTRUCTIONS

1) Read the adjoining item on "Registrations Wanted." If interested, file this form immediately with ARRL, West Hartford, Conn. If you don't want to mutilate your copy of *QST*, make out your own form on letter-paper following this same style.

2) This registration replaces the one of last February, so far as personnel availability is concerned. If you registered then and are still interested in a new position, be certain to register again on this form.

3) Keep our personnel department advised of any change of address, and do this separately from any notifications to our circulation department.

4) Let us know if your situation changes so that you are no longer interested in changing employment.

5) Your story is told chiefly by your report of education and experience, so give complete details thereon.

Name..... Call.....

Address.....

Age..... Married?..... Dependents?..... Physical disability?.....

Present occupation.....

Education.....

.....

.....

.....

.....

.....

.....

Radio experience.....

.....

.....

.....

.....

.....

.....

.....

.....

.....

.....

.....

.....

.....

.....

.....

.....

.....

.....

.....

.....

.....

.....

.....

.....

.....

.....

For what kind of position do you wish to be considered:

Engineering

Operating

Manufacturing

Administration

Supervisory

Executive

Research

Hand equipment

Production superintendent

Design and development

Automatic

Crystal grinder

Testing, engineering

Radio mechanic

Drafting

.....

Other specialty:.....

Preference for location?..... Necessary salary \$.....

who have these qualifications are urgently needed to apply for reserve commissions in the Army and Navy and are also wanted for civilian defense jobs in the War and Navy Departments, with good salaries.

The positions under Civil Service involve work in Washington for at least a year on details connected with the radio-locator. If you have had sufficient radio training and experience, a college degree is not necessary for these Civil Service positions.

If you have an amateur radio license, do not let it lapse. Keep up your amateur activities; they may stand you in good stead.

If you do not hold a license and are studying electrical engineering or physics, the very best thing you can do is to work for a license. It will improve your chances for a good job.

Write to George W. Bailey, National Research Council, 2101 Constitution Avenue, Washington, D. C., for information regarding both the commissions and the civilian jobs, stating at the same time your qualifications.

INSTRUCTORS FOR ARMORED FORCE

THE Civil Service invites applications for radio-operating and radio-electrical instructors at the Armored Force School at Ft. Knox, Ky. Five grades ranging from \$2000 to \$4600, appointment generally at the junior grade but rapid promotion possible. Instructors plan courses, prepare text material, conduct classes—operation and maintenance of mobile armored-combat equipment.

Shop or technical experience, including some as shop foreman or responsible instructor, is necessary. For seniors, two additional years supervising others. Technical education may be substituted for some of the basic requirement of experience. No written test. Particulars and forms from Civil Service secretary at any first- or second-class post office or from the commission itself at Washington. (See first paragraph, p. 28, November *QST*.)

RSGB News

WE find amongst our W and VE members great interest in the progress of the affairs of the Radio Society of Great Britain under war-time conditions. We have had great pleasure in reporting recently the excellent progress of RSGB, but we believe we can now do it much more interestingly by reproducing the editorial of Secretary-Editor John Clarricoats, G6CL, from the September number of *The T. & R. Bulletin*. It is swell news, which will cheer and inspire everyone:

TWO SEPTEMBERS

With World War Number Two entering its third year, it seems an appropriate moment to reflect awhile on the way

the Society has stood up to war conditions. Two years ago this week, the Council met, and after the most careful consideration decided that the work of the Society should be continued. Following the meeting, a special message was addressed to every member through the medium of this *Journal*. The message opened with these words:

"War or no war, it is our intention to carry on the work of the Society to the very best of our ability. The pillars on which the Society stands must not be allowed to crumble or decay, for it is essential that when peace returns the organisation must be strong and virile, fully prepared to safeguard the interests of its members."

"An important factor is to keep THE T. & R. BULLETIN in existence, and this we shall do with the co-operation of our many advertisers who have promised their support. That its size must be reduced will be obvious to all, but we shall continue to publish articles and news of general interest. Topical information will be welcomed, as will personal letters from our members in the services. We hope THE BULLETIN will, more than ever, become the connecting link between our members everywhere."

Little did we think, when that message was written, that two years hence we should be electing new members at a rate far in excess of any peak pre-war period, or that more advertising space would be booked per issue than at any corresponding period before the war, or that 22,000 copies of the Society's Handbook would have been sold in the two intervening years, or that Society meetings would be flourishing throughout the country. Yet these things, and many others have come to pass.

At the outbreak of war the finances of the Society were sound, as the result of wise administration on the part of Council, but is there one among us who would have dared to suggest that in September, 1941, the Society would be able to record a credit balance *three times greater* than in September, 1939? Yet such is the case.

This amazing progress has not been brought about by a miracle, or by luck. Several factors are responsible. First, members, especially those on active service, appreciative of the fact that a strong Society is essential, have introduced its work to their colleagues. Second, this *Journal* has provided a link between old and new members. The Service features in particular have been appreciated, as have the special series of Mathematics articles, and the *Vade-mecum* contributions. Third, our advertisers have rallied to our side in a manner which no member will ever forget.

Fourth, our *Handbook* has demonstrated to countless thousands of non-members what can be done, by an amateur organisation, to provide sound technical information without frills. Last but not least Headquarters has been able to effect economies, by operating in the suburbs of London with a minimum of staff.

These factors are chiefly responsible for our remarkable progress, but others have contributed. For example, Council, whose duty it is to direct the activities of the Society, has met without fail every month, often during air raids. That they will continue so to do is certain, for the work of the Society must and shall go on.

The time is not yet ripe to refer to post-war operating facilities, but the membership may rest assured that no stone will be left unturned in the task of establishing broad principles.

Let us hope that before another year has passed Peace will have returned and with it those familiar sounds, "Dah, Dit, Dit-dit-dit, Dah."

— J. C.

Strays

Since someone is always borrowing my copy of *The Radio Amateur's Handbook*, I keep a copy of the Spanish edition around the shack just to see the expressions which result when the book is opened by the unsuspecting borrower. Hi!

— W6ITH.

Cutting Bias Supply Size and Cost

BY J. D. BLITCH,* W4IS

Some pointers on minimizing the cost of a protective bias supply, together with an unorthodox but effective circuit for biasing Class-B modulators.

SOME four years ago the writer undertook the construction of a kilowatt 'phone transmitter, encountering no problems until it was found that there was no room in the 7½-foot cabinet for another panel to accommodate a heavy, well-regulated bias supply. To make a long story short a supply was worked out that met the requirements for space and was about fifty pounds lighter. It has performed nicely ever since — and at a good saving in cost.

The schematic diagram, Fig. 1, reveals the solution. At first glance it might appear that the dynamic characteristics of such a supply would not fill the bill, but the oscilloscope gives a normal trapezoid, so far as the writer can tell, at 100% modulation.

The voltages across the bias supply, on the

Fig. 1 — The combination bias supply used by W4IS. The operating bias voltages are obtained by rectified grid-current flow through R_1 and R_2 . The supply furnishes protective bias only.

- C_1 — 8- μ fd. 450-volt electrolytic.
- C_2 — 30- μ fd. 450-volt electrolytic.
- C_3 — 1- μ fd. 1000-volt paper.
- R_1, R_2 — 5000-ohm adjustable, 50-watt.
- L — 8 henrys, 100 ma.
- T_1 — Rated at 340 volts d.c. at load of 60 ma.

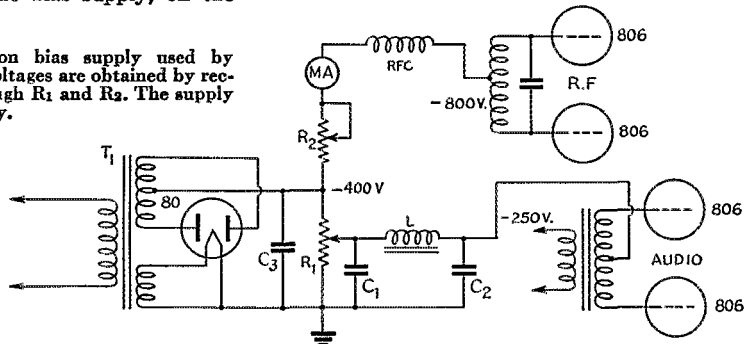

grids of the 806 r.f. tubes and on the modulator grids are shown on the diagram. These are measured values under operating conditions. The point to note is that the 400 volts developed across the resistor R_1 under operating conditions is in excess of the peak output of the bias supply and in normal operation the voltage supplied by the transformer is thus completely overcome by the excess potential rectified by the grids of the 806 final tubes. Thus no current is taken from the supply under actual operating conditions, and it has become nothing more than a protective device which is ready to act immediately upon failure of the excitation on the final grids. That ex-

plains why the condenser C_3 is only 1 μ fd; as a matter of fact it may well be a mica capacitor of about 0.05 μ fd. since under operating conditions it is only useful in smoothing r.f. pulsations. In normal operation the final stage is driven to 80 or 85 milliamperes grid current and the voltage developed across the series resistors R_1 and R_2 is thus about 800 volts. R_2 is normally at maximum resistance and there is thus about 400 volts d.c. across R_1 . The Class-B grids require approximately 260 volts bias for normal operation and this is tapped off the resistor R_1 . The transformer, T_1 , actually used is rated to deliver 70 ma. and the unloaded output is something near 400 volts. This was too high to permit operation as described above, but 105 volts were available from an autotransformer already incorporated in the rig, so this reduced primary voltage was used in lieu of a transformer of lower output voltage. Under these conditions the 80 rectifier receives less than rated filament voltage, but this is not damaging to an oxide-coated filament and it was found that the emission was more than ample.

This brings us to a consideration of the dy-

amic performance of the modulator tubes. It is evident that the modulator grids are going to do some rectifying on their own account when driven positive. The resistance accounted for by the tapped portion of R_1 is roughly 3000 ohms, and inasmuch as this is in the Class-B grid circuit all the rules for Class-B bias would appear to be violated. Except for the brute force filter C_2LC_1 , this would be true, but this filter suffices to prevent any variation of the bias on either set of tubes within the period of an audio cycle. As a matter of fact the d.c. voltage across the portion of R_1 and ground does vary under modulation, but this variation is slow and in normal use does not, in any way that the writer can detect, affect the

* 43 E. Main St., Statesboro, Ga.

correct operation of the transmitter as judged on a three-inch 'scope. The modulators do not work hard in this layout, and it was found that the rise in modulator grid voltage on peaks was only about one fourth the rise that occurred when the transmitter was modulated by a continuous tone, 100% modulation being effected in both cases.

When the potentiometer, R_1 , is properly adjusted for normal operation, failure of the excitation will leave the r.f. tubes practically cut off. The modulators will draw a slightly excessive current but the bias is wholly sufficient to prevent damage to the tubes if R_1 is advanced or excitation restored in a minute or so.

Class-B Modulator Supply

With a remotely-controlled transmitter, or with carbon-plate modulator tubes which do not show a change in color when the dissipation is above normal, a separate bias supply for the modulator tubes would be desirable for complete protection, since the bias would be the same with or without excitation to the r.f. stage. It is not necessary to forego the use of a small, cheap supply. The diagram shown in Fig. 2-A is such a circuit. It is important to notice the differences between this circuit and the conventional bias supply shown at B. They explain why a light supply of this design can be superior to a heavy supply of wrong construction. The pi-section filter is primarily intended to keep the bias voltage at the

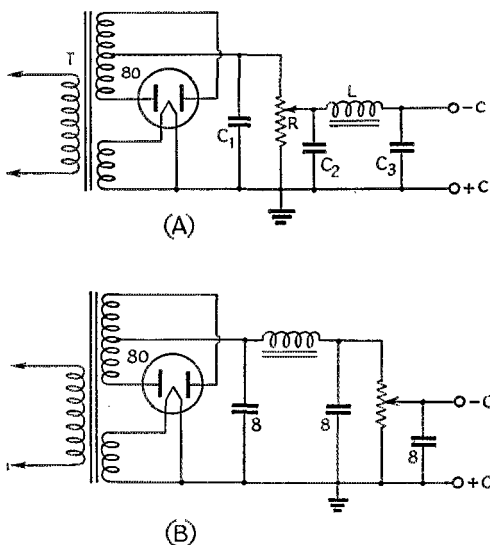

Fig. 2 — Recommended circuit for Class-B modulator bias supply (A) compared with conventional supply (B). C_1, C_2 — 8- μ fd. electrolytic. C_3 — 30- μ fd. electrolytic. R — Adjusted to cause rated output current of transformer to flow. L — 5 henrys, 120 ma. T — According to requirements; see text.

grids from varying during the period of an audio cycle. We may regard C_3 as the input condenser of the filter as viewed from the Class-B grids, and the filter should be regarded as serving the dual purpose of smoothing the pulsating d.c. current drawn by the grids and smoothing the d.c. output

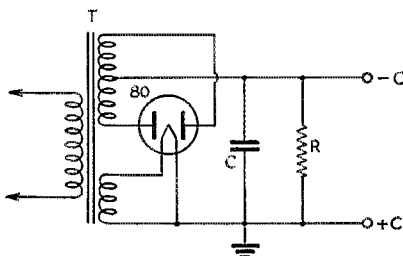

Fig. 3 — Protective bias supply for r.f. stages. C — 1 μ fd. or less, voltage rating greater than maximum operating bias. R — Grid leak for r.f. stage.

of the rectifier. Note that the choke does not carry the bleeder current. The smoothing is thus improved and a small choke is satisfactory for the purpose. The transformer, T , should supply a little more than the required operating bias. If an auto-transformer is incorporated for voltage regulation, the voltage supplied to T may be dropped a little and we may replace the voltage divider, R , with a fixed resistor; in this event C_1 and C_2 may be replaced by a single 16- μ fd. condenser. In either case R should be of a value to draw nearly the maximum current that the transformer is rated to deliver continuously. This individual bias supply, unlike the circuit of Fig. 1, does not appreciably drop the current flowing through the rectifier tube.

The time constant of the filter between the Class-B grids and the bias supply should be as large as it can be made conveniently. The filter should be of the "brute force" type; that is, effective at all audio frequencies.

Bias for R.F. Stages

Use of a bias supply principally for protective purposes is, of course, not a new idea — many of our bias supplies are operating in this way. It is the purpose here to show that they should be deliberately made to take no part in biasing the tube under normal operating conditions. Referring to Fig. 3, when we are considering the design of a bias supply for a single r.f. stage the first consideration is R . This should be made equal to grid-leak required for the stage. The second consideration is the necessary bias to protect a particular tube against excessive plate dissipation upon failure of its grid excitation. (For high- μ tubes the necessary bias may be low enough that a transformerless bias supply will suffice, or in the case of zero bias tubes no protective bias at all

(Continued on page 72)

A Compact Receiver for 112 Mc.

Receiving Equipment for the 2½-Meter Mobile Station

BY VERNON CHAMBERS,* WIJEQ

THE design and construction of the receiver usually presents the most difficult problem connected with a mobile station installation. Transmitters may be hidden out of sight in some convenient spot, but the receiver must be within reach of the operator at all times. Thus the set will probably be mounted in the vicinity of the car dashboard, and it becomes apparent that neatness is one requirement if the car's interior appearance is not to be spoiled. The receiver must be compact, because space is at a premium in the average modern automobile equipped with heater, windshield defroster, broadcast receiver, etc. Sufficient audio output for a loud-speaker is a "must" because of the inconvenience afforded by headphone operation. And last, but not least, is the importance of attaining adequate sensitivity as an aid in combatting the trying circumstances under which a car receiver must work. Satisfactory receiving locations are few and far between, and antennas are simple affairs always located within a few feet of the ground.

The receiver to be described conforms with the specifications set forth above. It is neat in appearance and requires a minimum of mounting space. Permanent-magnet speaker output is provided, and the sensitivity is equal to that of any superregenerative detector using an acorn tube. Cost? — approximately \$15.00 complete with tubes.

Circuit Details

Fig. 1 shows the circuit diagram of the receiver. A type 9002 tube is used in a "Minute-Man" detector circuit. C_1 is the main tuning condenser and C_2 serves as the padder and band-set capacity. The antenna is inductively coupled to the grid end of L_1 through a variable link. Plate voltage is brought to the tube through a tap on the center of L_1 . RFC_1 , RFC_2 and C_4 form a filter which prevents r.f. from entering the audio system. Regeneration is controlled by proper adjustment of R_3 .

The detector is transformer coupled to a 6J5 audio stage. This circuit uses R_7 as the gain control and operates with cathode bias. Resistance coupling is used from the 6J5 to a 6V6 power-amplifier. T_2 connects the output tube to the speaker. The tube and the speaker may be separated any reasonable distance when the actual mobile installation is being made. Cathode bias is also used with the 6V6.

* ARRL Technical Information Service.

The receiver described in this article is designed for use with the 112-Mc. mobile transmitter described in November *QST*. However, there is nothing about the receiver that confines its use entirely to mobile operation. In fact, its compact construction and good all-around performance suggest it as an excellent design for a general-purpose 2½-meter receiver.

Construction

The receiver is built in a metal box measuring 3 by 4 by 5 inches. The box is equipped with removable covers, and one of the covers serves as the panel. Construction of the set requires that the parts be laid out carefully; they will not fit into the box otherwise. We suggest that you proceed as follows:

Mounting holes for the National type A dial should be marked and drilled first. The dial shaft is centered between the bottom and top on the panel and is 1¼ inches in from the left edge. The dial assembly is now bolted in place, and the shaft of C_1 is temporarily slipped into the assembly

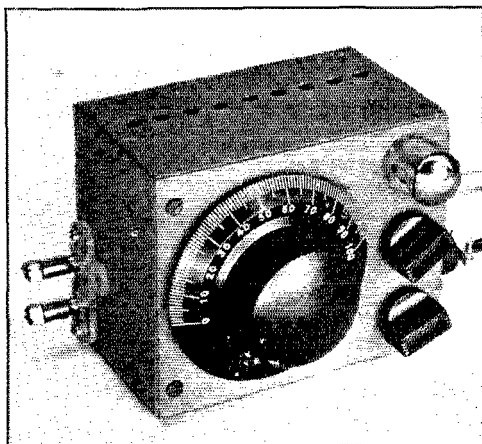

This front view shows how the tuning controls are arranged on the panel; the audio gain control is at the bottom right-hand corner. The pilot light is at the top right-hand corner. Antenna and input lead terminals are at the left and right ends respectively. The speaker cable runs out through the rear of the cabinet.

while mounting holes for the condenser are being marked. C_1 is then removed from the dial and holes for the variable resistors and the pilot light socket are drilled at the right end of the panel. The regeneration control is at the center of the line, and all three holes are $\frac{3}{4}$ -inch in from the left edge. Space restrictions demand that midget control be placed at the bottom of the panel. A hole is then drilled and tapped for the future mounting of RFC_2 —the choke may be seen in the photograph of the bottom of the detector assembly.

The bracket which supports the 9002 may now be cut and formed from a piece of thin metal stock. The photographs show the size and shape of this bracket. The extra plates are removed from C_1 and the bracket and the condenser are then mounted in place. $1\frac{3}{8}$ -inch spacers are used between the condenser frame and the panel. A flexible shaft coupler and a short length of polystyrene rod form the extension between the condenser shaft and the dial assembly. C_1 is mounted with the terminal lugs on the under side. The variable resistors, RFC_2 and the lamp socket can now be mounted in place. The metal

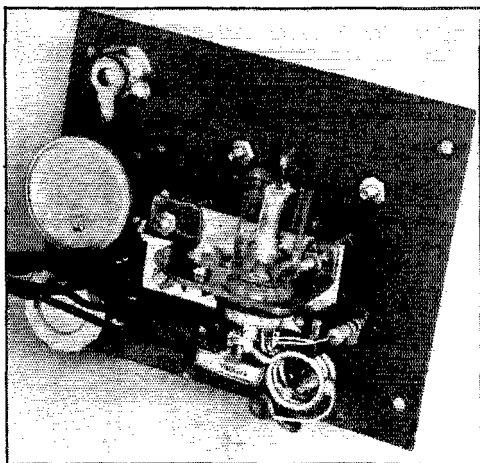

This photograph shows the shape of the small metal bracket which supports the 9002.

box has rolled-over lips along all open sides and these lips must be filed down at the front right end. The sections to be filed away are marked after the panel assembly has been held up against the front of the box.

The parts inside the box may now be mounted as shown in the photograph. T_1 mounts on the side wall between the two tube sockets. The input-plug socket is directly in front of the 6V6. C_6 and C_7 stand on end above the transformer and C_5 lies flat in front of the two electrolytic condensers. It will help a great deal if the socket connections are made before the sockets are mounted in the box. The antenna coupling link is soldered to the antenna terminals located at the left end of the case. The terminals and the link should be mounted after the detector assembly has been completed because this allows the link to be placed at a point where it lines up with the detector coil. Three lines of holes, one along the top of the case and two along the rear panel, should be drilled to provide ventilation inside the box; excessive heat caused by the tubes may damage the paper condensers.

The bottom view of the detector shows the placement of the r.f. circuit components. L_1 is mounted between the stator plate terminal of C_1 and pin No. 1 of the tube socket. C_2 is soldered directly across the terminals of C_1 . The grid condenser and resistor may be seen at the left of the metal bracket, and RFC_2 is screwed to the panel at the rear of C_2 . The leads of RFC_1 are connected between the center of the coil and one side of RFC_2 .

When the panel is screwed to the cabinet, the mounting position of the antenna terminals and link can be located. Holes, $\frac{1}{2}$ -inch in diameter, are also drilled in the side and bottom of the box. One of these is alongside the antenna terminals and the other is just below the adjustment screw

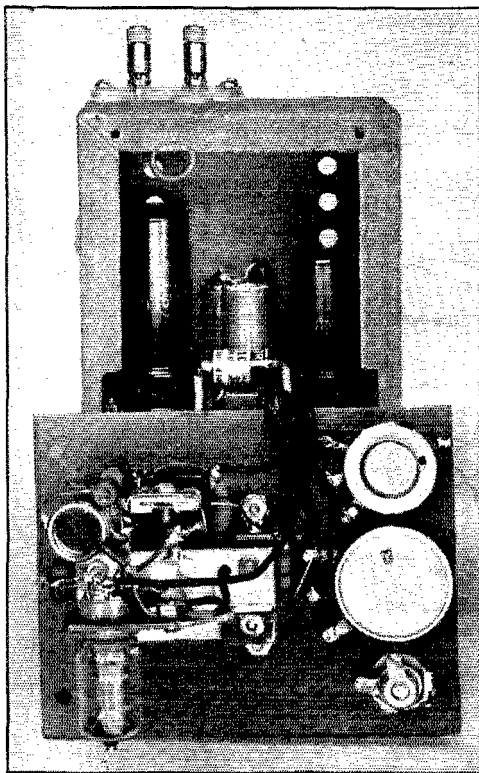

A bottom view of the detector assembly. The 6J5 at the right, and the 6V6 at the left, are mounted as far toward the rear of the case as possible.

of C_2 . This permits screwdriver adjustment of the link and the band-set condenser.

Power Supplies

The receiver, when used as a mobile unit, can be powered by the transmitter supply. A vibrator supply delivering 300 volts at 100 ma. is used with the set described. An a.c. supply might well be employed for testing or for fixed station work. This type of power pack should deliver 200 to 300 volts at 60 or 70 ma. The a.c. filament transformer must deliver 6.3 volts at 0.9 amp.

Testing

Considerable time and labor can be spared if the receiver is tested and lined up before it is mounted in the automobile. One of the supplies recommended above must be available for the text. The positive high-voltage lead and one side of the heater supply are to be connected to the two-prong plug. The negative high-voltage lead and one side of the heater supply must be connected to the receiver case. The power supply may now be turned on and, after a few seconds of warming up, the superregenerative hiss should become audible when the regeneration and gain controls are turned toward their maximum settings.

It is suggested that the receiver be lined up while coupled to an antenna similar in design to the one that will be used with the mobile installation. A change in loading alters the frequency range for a given setting of the band-set condenser and, unless conditions are to remain the same, it may be necessary to re-align the set after it is installed in the car. Coupling between the antenna and the detector is quite critical, and the detector will not superregenerate if the coupling

is too tight. The antenna loading effect will change from one end of the band to the other and, as a result, it is necessary to advance the regeneration control as the set is tuned toward the high end of the band. It is not a bad idea to make the

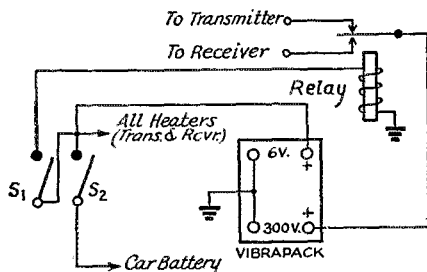

Fig. 2 — Wiring diagram of the control system.

Relay — S.p.d.t.

See November QST for other data.

antenna coupling adjustments with the regeneration control advanced to nearly full scale and with the set tuned to the high end of the band. Further data pertaining to the operation of this type of detector circuit is given in November QST.¹

The Mobile Installation

As we have said before, the receiver may be mounted anywhere within reach of the operator. This naturally means that it will be near the driver position. It is only necessary that the case be bonded to the car chassis in order that voltage return leads be completed. One of the photographs shows a recommended method of mount-

(Continued on page 49)

¹ Goodman, "Two U.H.F. Receivers Using the 9000 Series Tubes," QST, November, 1941.

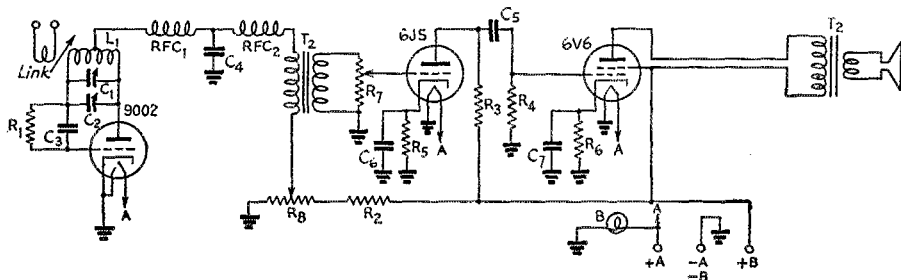

Fig. 1 — Wiring diagram of the mobile receiver.

- C_1 — 15- μ fd. midget variable with two stator and two rotor plates removed (National UM-15).
- C_2 — 3-30- μ fd. padder condenser (National M-30).
- C_3 — 50- μ fd. mica.
- C_4 — 0.003- μ fd. mica.
- C_5 — 0.01- μ fd. paper.
- C_6, C_7 — 10- μ fd. electrolytic, 50 volts.
- R_1 — 10 megohms, $\frac{1}{2}$ watt.
- R_2, R_3 — 0.1-megohm, $\frac{1}{2}$ watt.
- R_4 — 0.25-megohm, $\frac{1}{2}$ watt.
- R_5 — 2,500 ohms, $\frac{1}{2}$ watt.
- R_6 — 500 ohms, 1 watt.

- R_7 — 0.5-megohm midget volume control.
- R_8 — 50,000-ohm variable.
- RFC₁ — U.h.f. r.f. choke (Ohmite Z-1).
- RFC₂ — Low-frequency r.f. choke (Meissner 19-1995).
- T_1 — Plate to grid coupling transformer (Inca G-52).
- T_2 — Speaker transformer, 10,000-ohm primary, 4-ohm secondary (Jensen Z2362).
- Speaker — 5-inch type (Jensen ST-443).
- L_1 — 3 turns No. 12 wire, $\frac{1}{2}$ -inch diam., turns spaced diam. of wire.
- Link — 1 turn No. 12 wire, $\frac{3}{8}$ -inch diam.

Ham Spirit Triumphs Over Handicaps

Although Deaf, Dumb and Blind, Leo Sadowsky Passes Amateur Exam and Becomes W2OFU

THE other morning, the following "general information release" was received in the mail from the FCC:

The enthusiastic interest which radio holds for the amateur equals, if not transcends, that of any other hobby. Unlike some pursuits, there is no pecuniary motive for the radio amateur; he functions solely for his own entertainment and enlightenment. His ardor has built up an exemplary fraternal spirit which has contributed much to the advancement of radio in general. In flood, hurricane, or other localized emergency the "ham" can be depended upon to establish communication when wire service is temporarily disrupted. And from the patriotic amateur ranks Uncle Sam is now obtaining many operators and other technicians urgently needed for the national defense. In the theatrical profession the term "ham" is more or less derogatory, but among radio amateurs it is a coveted honor. Amateur licenses are eagerly sought, and proudly cherished. It is a personal distinction to be a "ham"!

Therefore, there was nothing singular that a Brooklyn youth was among the many who of late applied to the Commission for an amateur radio operator's license. But remarkable is the fact that this particular applicant is deaf, dumb, and blind! Stranger still is the fact that he qualified. Despite his handicaps, the youth took the prescribed written examination at the Commission's nearest field office. To 10 pages of questions and problems, he submitted 30 pages of answers written by himself on a Braille typewriter. In the practical tests the candidate demonstrated that he could "hear" radiotelegraph signals through vibrations produced by special devices. The result is that this aspiring 21-year-old is, according to Commission records, the first deaf, dumb and blind licensed amateur radio operator.



New York Daily Mirror Photo

Taking his amateur exam at the New York RI's office, Leo receives a final word of encouragement from Bob. Before him is the Braille typewriter on which he wrote his answers; the machine has a space bar and six keys which perforate characters in a sheet of heavy waxed paper. The over-sized cribbage board at the left is a "blind-man's adding machine"; by placing markers of different value in the various squares, Leo solved mathematical problems given in the exam.

Full of pride at this latest evidence of the indomitable ham spirit, we investigated. We found that the amateur who had accomplished this unbelievable feat is 21-year-old Leo Sadowsky of 482 Ashford St., Brooklyn, and that the call assigned him is W2OFU.

On top of that, we found that the man who taught Leo amateur radio is *himself blind!* He is Robert T. Gunderson, W2JIO, well-known amateur who got his own ticket at 15 and is now instructor in radio at the New York Institute for the Education of the Blind and also an instructor at the Radio Television Institute, New York.

It was about two years ago that Leo came to Bob Gunderson from the deaf-blind department of the Blind Institute and asked if he could learn radio. At first Bob told him this seemed an impossible accomplishment.

Leo had been born deaf. When he was two years old an accident destroyed the sight of his left eye. As he grew older the overburdened right eye (Leo was an omnivorous reader) also failed, and at sixteen he became totally blind.

However, Leo was determined, and finally Bob agreed to try to teach him radio.

Leo's first idea was simply to learn something of the mechanics of the science. "I asked him how he would be able to hear the radio signals," Bob related, "and he informed me that he would take my word when I told him that the receiver was working satisfactorily." He started with a crystal detector. By the time he was ready for his examination he had built a superhet complete with preselector.

"When I agreed to take Leo into the class," Bob said, "I permitted him to take only one hour a week, but he proved to be so appreciative and enlisted my sympathies so thoroughly that his time jumped to four hours at the end of a month. We devoted about one hour a week to lecture, another to code practice, and the rest to practical applications."

Leo learned the code by the use of a low-frequency buzzer, which produced vibrations that could be felt through the finger tips. He received his lectures throughout the course by means of the manual alphabet. You can realize just how much work it must have been to spell out each letter of each word into the boy's hands!

However, Leo's code speed steadily improved along with his knowledge of radio and electricity. To-day he is able to build and operate his own radio equipment, and he can copy at about fifteen or twenty words per minute.



Leo Sadowsky, W2OFU, deaf, dumb and blind radio amateur (seated) and his instructor, Robert Gunderson, W2JIO, also blind. Leo "hears" through the sensation produced by 60-cycle a.c. in the 'phones, keyed by a relay in the receiver output.

Leo's next desire was to get on the air. To make this possible Gunderson devised a translating device to be connected to a communications receiver. This "translator" consisted of a triode, biased to cut-off, with a high-impedance relay in its plate circuit. The triode was coupled to the power stage of the receiver. When a code signal was fed into this "translator," a low-frequency buzzer connected in series with the relay contacts converted the high-pitched code signals into a frequency Leo could feel.

"I knew now that Leo could operate his own transmitting and receiving equipment. However, a new obstacle soon presented itself," Bob recalled.

"After we had developed Leo's equipment, I made application to the FCC for Leo's amateur license. The reply was none too encouraging, for I was advised that according to the rules and regulations, the code test must be taken 'aurally' and since Leo was totally deaf, he could not qualify.

"I had spent two years in training this boy and I was not willing to give up quite so readily. Finding that it was useless to argue, I set to work on some new equipment. This time, instead of the low-pitched buzzer, the translating device operated a 60-cycle source of a.c., whose output was fed into a public address system. The output of this amplifier in turn operated a headset. I tried this new development out, and it worked perfectly after we had spent a week or two with it."

Gunderson then reapplied to the Commission and explained the operation of the new equipment. He argued that whether or not Leo could

hear was beside the point; he was taking the code with a pair of headphones on his ears and that was all that was required! This time the Commission permitted Leo to take the examination, and July 1st was set as the date.

On two of the hottest days of the summer Leo took the amateur exam under the supervision of Arthur Bachelor, chief radio inspector of the 2nd FCC District.

Giving the examination was a complicated procedure. Leo "speaks" in a variety of ways. He can communicate with his brother Sam by a visual wigwag system the boys devised when they were young, before Leo became blind. He talks with other blind people by touching fingers, having them simulate the shapes of the Braille characters with their hands. And now he can converse by code, either by having the other person tap his wrist with a finger or by "sound" through the sensation transmitted via his headphones.

Leo was first given the code test, the output of the code machine being fed to the "translator." Leo dictated the code word-for-word as he received it to his brother Sam, who wrote it down in longhand.

This part of the ordeal over, Bob Gunderson proceeded to transcribe the questions for the written examination into Braille. Leo then wrote his answers in Braille, and Bob rewrote them on the typewriter. All diagrams were given in word form.

Finally the test was completed. The examination papers were bundled up and sent to Washington. Days of painful waiting followed. Then on a Saturday morning a telegram came from the FCC announcing that Leo had passed.

Now Leo Sadowsky is on the air from his own amateur station, W2OFU. He operates on 80-meter c.w., and you can look for him there. Because of his double handicap, Leo's vocabulary is limited so that amateurs will have to be patient with him at first.

The transmitter at W2OFU is a 6L6 crystal oscillator, running at 25 watts input, working into an end-fed antenna. The receiver is an ACR-136, followed by the translator built for him by Gunderson. He tunes his transmitter by touching the tank circuit and adjusting for maximum r.f. burn!

According to PM, Leo heretofore spent much of his spare time in his brother Sam's garage, a few blocks away from the Sadowsky family's apartment. There he washed cars and changed tires, and once a day the two boys put on boxing gloves and had a five-minute workout, just to keep Leo fit.

Since W2OFU got on the air, however, we have the notion a few cars have gone unwashed and tires unchanged. Certainly Leo's world is now vastly expanded beyond the small circle of family and Braille books and typewriter and a few blind

(Continued on page 78)

An Experimental 112-Mc. Receiver

Overcoming the Faults of the Superregen Receiver

BY JAMES W. BRANNIN,* W6OVK

THE receiver to be described was built after considerable experimenting with superregenerative second detectors in superheterodyne receivers, and is offered as an answer to many of the problems confronting the fellows who haunt the frequencies above 112 Megacycles. High gain and sensitivity, ease of coupling to any and all types of antennas, no radiation, simplicity of alignment and comparative economy in construction are some of the features of this type of u.h.f. receiver. In the use of a superregenerative final detector it resembles the S.I.G. receiver described by the late Ross Hull¹, although in other respects it is a straight superhet arrangement. While it is not offered as the ultimate in its class, comparative tests show that it is far superior to the average "rush box." We believe that a receiver of this type might set new distance records if properly built and used on good high-gain beam antennas.

Probably most of the parts can be found in the average junk box; the front end is the only section where the best of parts are really necessary. This particular receiver was built with a separate power supply, mainly so that it could be operated from batteries in cases of emergency. The receiver consists of four main sections: r.f. stage, mixer and oscillator, intermediate frequency amplifier and superregenerative second detector and audio.

* Southern Pacific Telegraph Office, Tucson, Arizona.

¹ Hull, "A New Receiving System for the Ultra-High Frequencies," *QST*, November and December, 1935.

R.F. Amplifier

The r.f. stage uses one of the new midget u.h.f. tubes, a 9003. From all accounts the 9001 would do equally as well in this part of the receiver. The circuit for this stage was suggested by W6SLO. Battery bias (from small flashlight cells) is used so that a short cathode connection to ground can be obtained. The tube is mounted upside down along with the 1232 mixer and the 6C5 high frequency oscillator, to give very short leads in all of these circuits. No shielding is used in this stage nor in any part of the r.f. section. The r.f. stage oscillates a little with no antenna load, but settles down as soon as the antenna is connected. Perhaps the overall gain and sensitivity could be improved by the use of resonant lines instead of the 5 turn coil in the grid circuit of the r.f. stage, but antenna coupling was considered to be more of a problem in the case of lines and so far we have not tried them on this receiver.

Mixer and Oscillator Circuits

The 1232 mixer proved to be among the best of several types of tubes used experimentally, not necessarily from the standpoint of high gain but because of the ease of lining up and because the amount of injection voltage required is not critical. The mixer and oscillator circuits also were found by experiment to be the best for this type of tube. After many tests with other circuits a combination of cathode and grid-leak bias proved

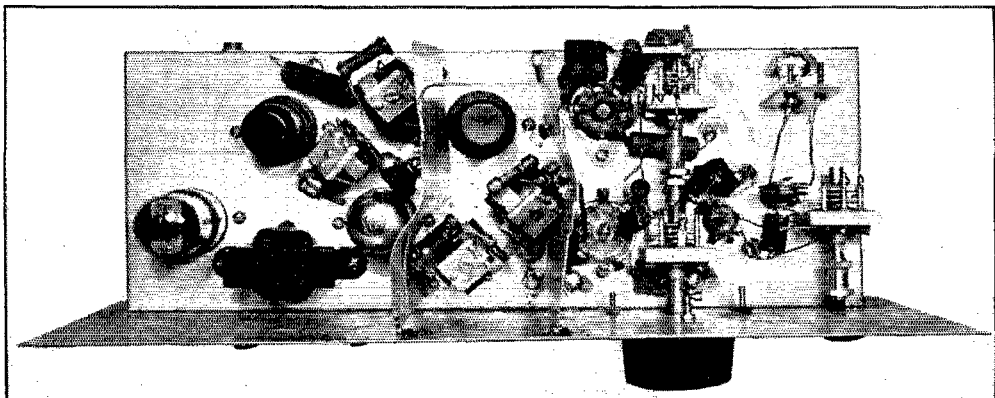

A plan view of the experimental 112-Mc. receiver at W6OVK. The i.f. amplifier is in the center section enclosed by the two baffle shields. The r.f. section is at the right; note the upside-down mounting of the tubes to secure short leads to the tuned circuits. The superregenerative second detector and the audio amplifier are to the left.

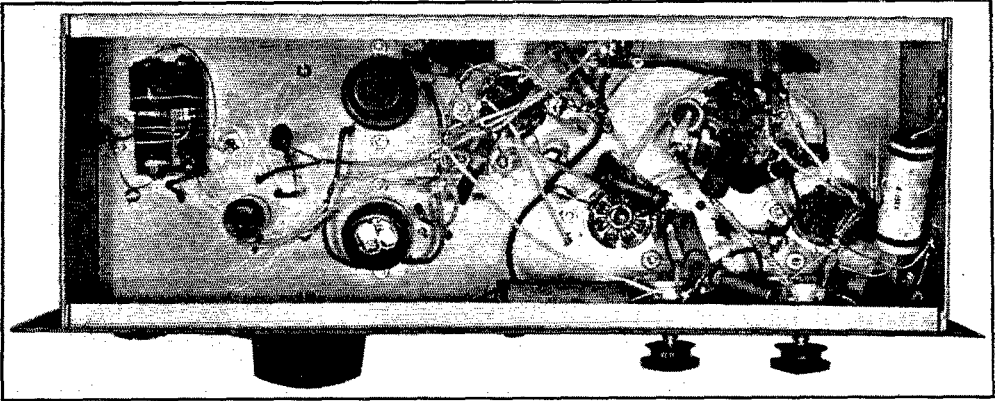

The r.f. tubes are in the left-hand part of this below-chassis view of the receiver. Only a few resistors and by-pass condensers are called for in the relatively simple below-chassis wiring in the i.f. and audio sections.

to be necessary for highest gain and sensitivity. Increasing the injection voltage seems to increase the gain, and it is, therefore, worth while to do a little experimenting with different amounts of coupling between the high-frequency oscillator and mixer. This coupling is obtained by forming a condenser of No. 20 bare wire, using two pieces $1\frac{1}{4}$ inches long spaced $1/32$ inch, cemented with polystyrene cement. The longer the wires the greater the coupling.

Very low C is recommended in the r.f. and mixer stage tuned circuits. High C is desirable in the high-frequency oscillator stage in order to stabilize this circuit as well as to help eliminate hum. There is very little ripple on the oscillator frequency and no hum can be observed on received signals. If the oscillator has a tendency to squeg (have a whole string of frequencies close together) adjustment of the cathode tap on L_2 to reduce feedback will eliminate it.

No dropping resistor is used in the plate circuit of the 6C5 high-frequency oscillator, the 150 volts from the voltage regulator being directly applied to the oscillator plate. This stabilizes the oscillator and minimizes pulling when the mixer grid circuit is tuned. These two stages of the receiver track very nicely simply by adjusting the position of the tap from the rotor of C_1 on the grid coil, L_1 . The band covers 60 per cent of the dial or a little more, and may be adjusted by tapping the rotor connection of C_2 up and down on the coil L_2 . A corresponding adjustment should be made to the tap on L_1 to maintain tracking.

I.F. Amplifier

The intermediate frequency amplifier circuit is conventional, using a 6SK7. The shield shown between the i.f. amplifier and the r.f. section, and also the shield between this stage and the superregenerative detector, were found necessary to help eliminate oscillation in the i.f. stage. The intermediate frequency is approximately 20,000

kc. and was selected on account of the better performance of the superregen detector at a comparatively high frequency and also to allow the high frequency oscillator to work at a fairly low frequency on the low side of the received signal. If this stage has a tendency to oscillate after the shields are put in place, resistors may be placed across the coils as shown in box in Fig. 1. This will, of course, broaden the i.f. stage and cut down slightly on the selectivity of the receiver. Alternatively, an i.f. gain control, inserted in the cathode circuit of the 6SK7, is suggested as a means of controlling oscillation without loss of selectivity. However, even with the resistance loading the selectivity of the receiver is much better than that obtained with straight 112-Mc. superregenerative detectors.

The i.f. transformers are of the "open air" type, and were built this way in order to allow some adjustment of coupling between the different coils. This helps in minimizing oscillation in the i.f. stage, as well as allowing adjustment for maximum input to the superregen second detector. Some pruning of all coils may be necessary to obtain resonance in these circuits. Fairly high C is recommended in the i.f. and second detector stages.

Detector and Audio

There is nothing out of the ordinary in the 7A4 superregen second detector and the audio

Here is a $2\frac{1}{2}$ -meter receiver which overcomes the major superregen defects and at the same time provides improved selectivity, gain and signal-to-noise ratio, while retaining the characteristic superregen a.v.c. action and ability to receive broad signals. It has proved itself at the receiving end of the 105-mile $2\frac{1}{2}$ -meter W6OVK-W6QLZ schedule in operation now for many months.

circuits. Some experimenting may be necessary to get the detector to go into superregeneration properly, in the way of changes in the size of the r.f. choke and grid leak. Any conventional superregen detector circuit will work, however.

The detector is loaded as heavily as is consistent with good superregen action, just as when coupling an antenna to the ordinary superregen detector on 112 Mc.

General

Voltage regulation is not absolutely necessary in the r.f. and i.f. sections of the receiver, but if the line voltage in the neighborhood varies con-

siderably then the use of a VR-150 in the power supply is strongly advocated. Higher voltage is used on the audio by applying the full voltage from the power supply without a dropping resistor.

The receiver shown in the photographs was built for efficiency rather than appearance. The chassis is 5½ by 16 inches and 2 inches deep. The panel is 18 by 7½ inches. The depth of the chassis is ample to take care of the upside down position of the r.f. tubes. The two shields are 26 gauge galvanized iron and are bent slightly to clear the adjacent parts. More elaborate shielding might be

(Continued on page 78)

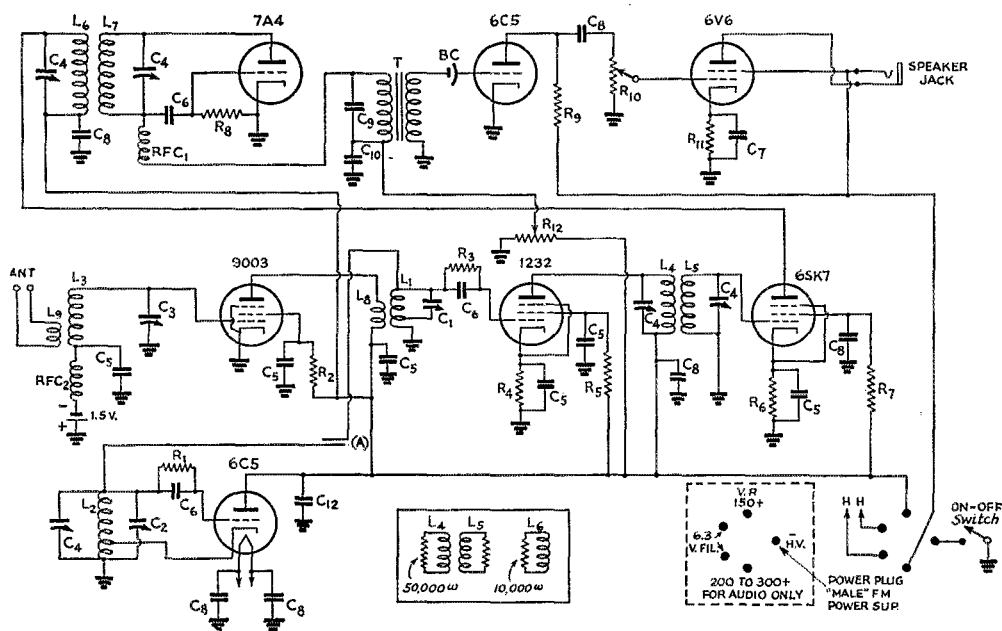

Fig. 1 — Circuit diagram of the receiver.

- | | | |
|----------------------------------------------------------------------------------------------|----------------------------------------------------------------------------------------------------------------------------------------------------------------------------------------------------------------------------------------------------------|------------------------------------------------------------------------|
| C ₁ , C ₂ , C ₃ — 1-10- μ fd. variable (Bud Tiny Mite). | R ₂ — 15,000 ohms, 1 watt. (If more than 150 volts is used larger size may be necessary here to give proper screen voltage to 9003.) | R ₈ — 1 to 4 megohms, ½ watt. |
| C ₄ — 5-35- μ fd. isolantite padder. | R ₃ — 4 megohms, ½ watt. | R ₉ — 50,000 ohms, 1 watt. |
| C ₅ — 500- μ fd. postage stamp mica. | R ₄ — 500 ohms, ½ watt. | R ₁₀ — 0.5 megohm potentiometer. |
| C ₆ — 100- μ fd. postage stamp mica. | R ₅ — 40,000 ohms, ½ watt. | R ₁₁ — 500 ohms, 5 watts. |
| C ₇ — 10- μ fd. paper, 25 volts. | R ₆ — 500 ohms, 2 watts. | R ₁₂ — 50,000 potentiometer. |
| C ₈ — 0.02- μ fd. paper, 400 volts. | R ₇ — 50,000 ohms, 1 watt. | RFC ₁ — 125-ma. receiving type choke with two pies removed. |
| C ₉ — 0.01- μ fd. paper, 400 volts. | | |
| C ₁₀ — 0.05- μ fd. paper, 400 volts. | | |
| R ₁ — 30,000 ohms, ½ watt. | | |
| RFC ₂ — 30 turns No. 28 cotton covered wire diameter ⅜-inch. | L ₈ — 3 turns No. 20, diameter just large enough to fit around outside of L ₁ . | |
| L ₁ — 2 turns diameter ⅜ inch, ⅜ inch long. | L ₉ — 3 turns No. 18, ½-inch diameter, space-wound, coupled to grounded end of L ₃ . | |
| L ₂ — 4 turns diameter ⅜ inch, ½ inch long. | T — Any ordinary audio transformer, preferably a 3 to 1 ratio. | |
| L ₃ — 5 turns diameter ⅜ inch, ½ inch long. | S — S.p.s.t. toggle. | |
| L ₄ — 9 turns No. 22 d.c.c. ⅜-inch diameter, close-wound. | BC — Bias cell, 1¼ volts. | |
| L ₅ — 7 turns No. 22 d.c.c. ⅜-inch diameter, close-wound. | Note: L ₄ and L ₅ are coupled with plus "B" end of L ₄ next to grounded end of L ₅ . L ₆ and L ₇ are coupled with plus "B" end of L ₅ next to plate end of L ₇ . | |
| L ₆ — 8 turns No. 22 d.c.c. ⅜-inch diameter, close-wound. | | |
| L ₇ — 8 turns No. 22 d.c.c. ⅜-inch diameter, close-wound. | | |

One Shack — Nine Bands

1.75 to 400 Mc. at W2TY



The $\frac{3}{4}$ -meter rig swinging from the rafters in the attic. Power and audio are supplied remotely through a four-wire cable from the operating room. The half-wave antenna is capacitively coupled.

WE DON'T doubt that other amateurs have worked all bands at one time or another, but we believe that W2TY is the first station to have permanently-installed and regularly-operated rigs for each of the nine bands assigned for amateur use from 160 to the three-quarter-meter band.

Contrary to what one might expect, the equipment for this unusual station is accommodated in the relatively small space afforded by one end of a medium-size room done off in the attic. The low-frequency transmitter is a 500-watt rack unit which covers the 1.75-, 3.5-, 7- and 14-Mc. bands. The three-stage r.f. portion consists of a 6L6 crystal oscillator, 803 buffer and HK354 final. Output-frequency crystals are used for each

band and the tank coils for the first two stages are switched. Plug-in coils are used in the final amplifier.

The modulator consists of a pair of ZB120's driven via a 500-ohm line by a pair of Class-A triodes and a three-stage speech amplifier at the operating position from a crystal mike. The rack also contains five power supplies, including a bias supply for the final. A 6L6 tube keyer is used in the screen circuit of the 803.

The transmitter for the 28- and 56-Mc. bands is constructed on the series of chassis in the open rack to the right of the operating desk. A 6J5 oscillator with a 28-Mc. crystal is followed by a 6L6 buffer-doubler which drives the push-pull 807 final. Changes between 28 and 56 Mc. are made by changing coils in the driver and final stages. The modulator unit for this transmitter consists of a 625A carbon mike, 56 speech amplifier, 56 Class-A driver and Class-B 46's. Four separate power supplies are provided to insure stability. A relaxation audio oscillator is built in for i.c.w. operation and the screens of the 807's are keyed for c.w. work.

For the 112- and 224-Mc. bands, a pair of HY75's in push-pull is used in self-excited oscillator with changeable tuned plate and filament lines with the grids at ground potential. The input on either band is 50 watts. Audio power for this unit is also obtained from the unit which supplies the 28-56-Mc. transmitter.

The transmitter for the 400-Mc. band is a "pole" oscillator in which a 316A "door knob" is used at 10-watts input. Half-wave open plate lines and a concentric cathode line are used. The

(Continued on page 86)

The shack at W2TY. The low-frequency transmitter is in the rack to the left which also contains audio equipment and power supplies. Transmitters covering 28 to 224 Mc. are in the open rack to the right. To the extreme right are the receivers for all frequencies except the 400-Mc. band. The "micro-wave" receiver with its directional antenna are to the extreme left.



A Modern Vacuum-Tube Voltmeter for D.C., A.C. and R.F. Measurements

BY CLINTON B. DE SOTO, WICBD*

To the typical amateur the words "vacuum-tube voltmeter" in the title of an article are a signal to turn the page. Any ham who has the slightest interest in experimental technique, particularly on the u.h.f., is advised to give this one at least a preliminary reading, however, for it describes a stable, dependable measuring instrument with 20 megohms input resistance on d.c. and with an r.f. probe usable up to the microwaves — all at a total parts cost of \$17.00 plus tubes and meter.

THE vacuum-tube voltmeter is a venerable device that has recently experienced a reincarnation in the radio servicing field after years of comparative disuse. You'll find it called by various new-fangled names to-day, but under the skin it is still the same old v.t.v.m. that always did have qualities no other measuring instrument could quite equal, but which was such a doggone nuisance to build and calibrate few of us ever bothered with one.

When broadcast receivers acquired critical a.v.c. and other circuits that couldn't stand the slightest bit of loading, however, some of the more competent servicemen began to realize that ordi-

* Assistant Secretary, ARRL.

nary instruments no longer were quite good enough. A few far-sighted manufacturers noted this problem and went to work on the traditional v.t.v.m. in an effort to get rid of the inconveniences that had always limited its popularity.

All in all, they succeeded pretty well. The modern vacuum-tube voltmeter is a considerable step forward in stability and general utility from its forerunners of a decade or so ago. In fact, as noted above, it does such a good job that the manufacturers gave it a variety of new names to avoid the stigma of its ancient heritage.

There is an old saying (or if there isn't, there should be) to the effect that what is a good instrument for the serviceman probably is a good instrument for the ham to have around the shack, too. We find the multi-range volt-ohm-milliammeter just as much a ham tool now as it is the serviceman's standby. There might be a little argument as to which popularized the economical and effective present-day oscilloscope, but no one can deny that both use it. In fact, the test equipment on the serviceman's bench and that in the ham shack is rather generally interchangeable. (For that matter, it often does double duty as both!)

The fundamental difference is that the ham usually likes to build his equipment rather than buy it ready-made. He does, that is, if he is the true experimenter — and if he isn't, he's not

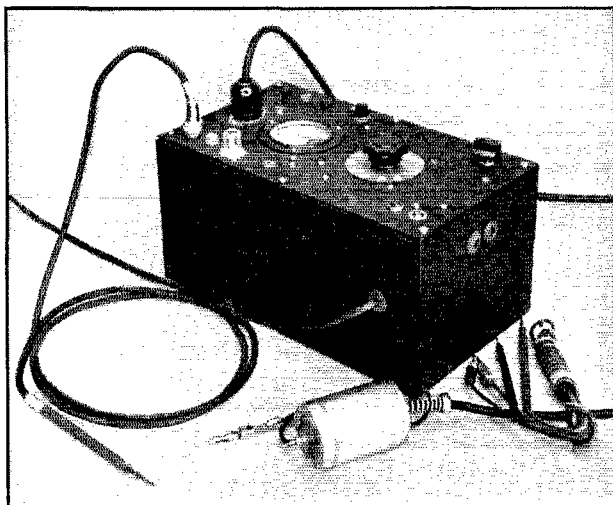

The modern rectifier-amplifier type vacuum-tube voltmeter with all accessories for various types of measurements. At front left is the d.c. isolating probe with its shielded cable. The acorn-tube diode-peak rectifier r.f. voltmeter head is in the center, and beside it the standard test leads for a.c. and audio measurements. Panel controls are: range switch, zero-setting control (knob at lower right), meter polarity-reversing switch and a.c. on-off switch (beneath pilot light, lower left).

likely to have much interest in elaborate measuring apparatus, anyway.

So this is a description of a vacuum-tube voltmeter — an electronic voltmeter, if you will — that can be built by the average ham at reasonable cost and is capable of doing most of the things the commercially-built jobs can do, including those designed for laboratory use and selling up in three figures (and which can't be bought even at those figures now, on account of priorities and such).

Fundamentally, the instrument is a balanced degenerative d.c. v.t.v.m. with self-contained power supply. When measuring a.c. this unit becomes a d.c. amplifier for an optional internal or external diode-peak rectifier, measuring the peak value of the a.c. voltage directly on the d.c. scale. As a d.c. meter it has five ranges from 1.5 to 150 volts, enabling accurate scale reading at almost any level, plus two auxiliary ranges of 1500 and 5000 volts. As an a.c. meter it also has five ranges from 1.5 to 150 volts.

The input resistance is approximately 20 megohms on the five low d.c. ranges and equivalent to 1000 ohms-per-volt on the two high ranges. On a.c. the input resistance varies with frequency, as will be discussed later; in the audio range it is effectively about 3 megohms. In other words, the resistance is in either case high enough to cause negligible loading of any circuit under measurement.

The D.C. Voltmeter

Referring to the circuit diagram of Fig. 1, the basic voltmeter using a 7N7 tube (equivalent to two 6J5's in one envelope) is the section at the upper right.

The operation of the balanced degenerative voltmeter circuit is best considered as two separate tubes. The upper triode (in Fig. 1) is the "voltmeter-triode," the lower the "balancing-triode." In analyzing the behavior of the circuit, the junctions of R_{18} , R_{19} , R_{20} and R_{25} , R_{28} , R_{29} and the grid of the balancing-triode can be considered at a common ("ground") potential.

Considering first the operation of the voltmeter triode alone, if a signal is applied to its grid plate current will increase, causing an increased voltage drop across its cathode resistor (R_{19}). This increased bias will tend to oppose the increase in plate current. The extent of this opposition (the amount of the increased voltage drop) depends on the value of the cathode resistor.

Thus the sensitivity of the meter in terms of plate current change vs. signal is determined by the cathode resistance; in fact, it is inversely proportional to the value of this resistance. If the resistance is sufficiently high, the plate current change is independent of tube characteristics and operating voltages, and is directly equal to the ratio of the signal voltage to the resistance.

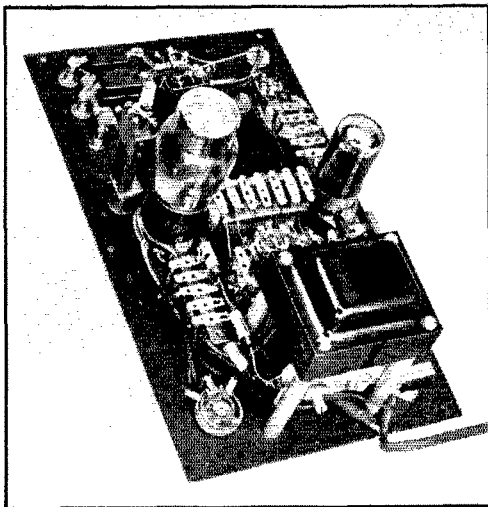

Inside the vacuum-tube voltmeter, showing how all parts are mounted on the panel for convenience in assembly and wiring. Resistor sub-assemblies are prepared on bakelite terminal strips before mounting. Polarity-reversing switch is at left near 80 rectifier tube, zero-setting potentiometer at bottom left. A.C. coupling and isolating condensers can be seen at top, alongside the 6H6 socket.

Because of this degenerative effect, it is possible to construct a highly-stable meter with a true linear scale that is not seriously affected by changes in supply voltages and does not need to be recalibrated when tubes are changed.

Turning now to the balancing triode, the function of this tube is to balance out the initial plate current of the voltmeter-triode, so that the meter reads only the plate-current change. The tubes are effectively connected in a bridge circuit including R_{21} , R_{22} , R_{23} . So long as both grids are at zero or "ground" potential, the tube resistances will be equal and the bridge will be balanced. In this condition no current will flow in the microammeter (M). When a voltage is applied to the voltmeter-triode grid, however, its plate resistance decreases. The bridge is then unbalanced, and the measure of this unbalance is indicated by the microammeter.

Thus far the circuit has been considered as though the voltage drop in the individual cathode resistors R_{19} and R_{20} were the only bias in the circuit. It has been stated that, if the cathode resistance were made high enough (50,000 ohms or more), a linear scale and a high order of stability would result. However, the use of so high a cathode resistance greatly reduces the sensitivity of the meter.

What looks like an unsatisfactory compromise can be avoided by making the individual cathode resistance of each triode sufficiently low to provide the required sensitivity and adding in series an additional high resistance common to both

tubes (R_{18}). If there is placed effectively in series with the grid returns another voltage (derived from the power-supply voltage-divider) exactly equal in value to the voltage drop in this common cathode resistance, the advantages of extreme degeneration can be obtained without undue loss of sensitivity, because any change in the supply voltages causing a change in the operating conditions of one triode will also cause an equal and opposite change in the other. This further equalizes the operating conditions of the voltmeter and improves the stability. The sensitivity is still controlled by the value of the individual cathode resistors.

Provided the two triodes and the associated resistors are identical in their characteristics, the initial balance of the bridge will be perfect and no

current will be indicated on the meter. In practice minor variations occur, however, and therefore an auxiliary balancing or zero-setting resistor is included (R_{22}).

To facilitate making the final adjustment to fit the range exactly to the meter scale, the cathode resistors are made slightly smaller than is required for a full-scale sensitivity of 1.5 volts with the 200- μ a. meter used, and a variable resistance (R_{24}) is connected in series with the meter as a range control to regulate its sensitivity.

A polarity-reversing switch for the meter with center "off" position is also provided (S_2). Either positive or negative d.c. voltages can be measured without shifting the input terminals simply by turning this switch. The "off" position is desirable for protecting the meter during the warm-up period.

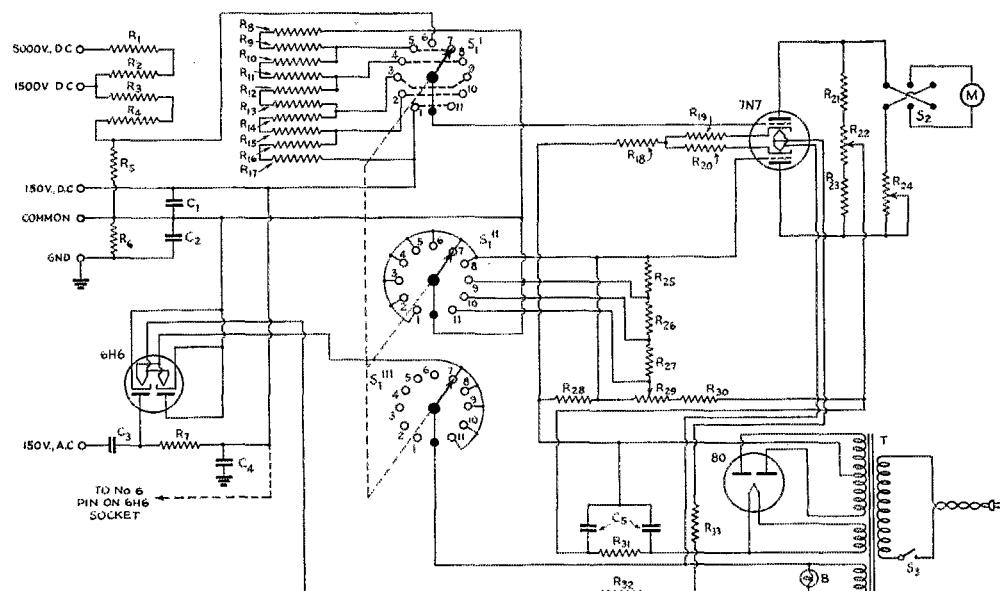
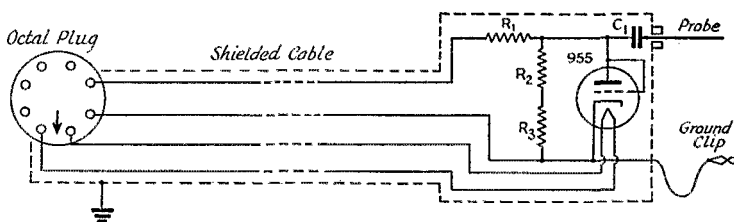

Fig. 1 — Circuit of the vacuum-tube voltmeter.

- C_1 — 0.01- μ fd. mica.
- C_2 — 0.05- μ fd. 600-volt paper.
- C_3 — 0.02- μ fd. mica (two 0.01- μ fd. in parallel).
- C_4 — 100- μ fd. mica.
- C_5 — Dual 8- μ fd. 450-volt electrolytic.
- R_1 — 3 megohms, 3-watt (three 1-megohm 1-watt in series).
- R_2 — 0.5 megohm, $\frac{1}{2}$ -watt.
- R_3, R_4 — 0.75 megohm, 1-watt.
- R_5 — 1500 ohms, $\frac{1}{2}$ -watt.
- R_6 — 10 megohms, $\frac{1}{2}$ -watt.
- R_7 — 1 megohm, $\frac{1}{2}$ -watt.
- R_8, R_9 — 0.1 megohm, $\frac{1}{2}$ -watt.
- R_{10}, R_{11} — 0.2 megohm, $\frac{1}{2}$ -watt.
- R_{12}, R_{13} — 0.7 megohm, $\frac{1}{2}$ -watt.
- R_{14}, R_{15} — 2 megohms, $\frac{1}{2}$ -watt.
- R_{16}, R_{17} — 7 megohms, $\frac{1}{2}$ -watt.
- R_{18} — 75,000 ohms, 1 watt.
- R_{19}, R_{20} — 2500 ohms, 1 watt (wire-wound).
- R_{21}, R_{23} — 10,000 ohms, $\frac{1}{2}$ -watt.
- R_{22}, R_{29} — 1000-ohm wire-wound potentiometer (Mallory-Yaxley C1MP).
- R_{24} — 5000-ohm wire-wound potentiometer (Mallory-Yaxley C5MP).
- R_{25} — 600 ohms, $\frac{1}{2}$ -watt.
- R_{26} — 2000 ohms, $\frac{1}{2}$ -watt.
- R_{27} — 60,000 ohms, $\frac{1}{2}$ -watt.
- R_{28} — 25,000 ohms, 5-watt (wire-wound).
- R_{30}, R_{31} — 10,000 ohms, 5-watt (wire-wound).
- R_{32} — 8.5 ohms, 1-watt (15-ohm BW-1 and 20-ohm BW- $\frac{1}{2}$ in parallel).
- R_{33} — 6 ohms, 2-watt (10- and 15-ohm BW-1 in parallel).
- S_1 — 11-pt. 3-gang rotary switch (Mallory-Yaxley 1231L).
- S_2 — D.p.d.t. switch with off position (Mallory-Yaxley 62).
- S_3 — S.p.s.t. on-off switch.
- M — 0-200 microammeter (Weston).
- B — 6-volt pilot light with jewel.
- T — 290-volt 40-ma. power transformer with 6.3-volt and 5-volt windings (Thordarson T-13R11).

Fig. 2 — Circuit of the separate r.f. voltmeter head.
 C_1 — 0.01- μ fd. mica.
 R_1 — 1 megohm, $\frac{1}{2}$ -watt.
 R_2, R_3 — 20 megohms, $\frac{1}{2}$ -watt.



Input Voltage Dividers

The full-scale sensitivity of the voltmeter alone as shown is 1.5 volts. For higher ranges an input voltage divider is required. In fact, there are two of them, one for the low ranges to 150 volts (R_8 - R_{17}) and the other for the 1500- and 5000-volt ranges (R_1 - R_4). A three-deck 11-position rotary switch is used to select the ranges. Points 1 through 5 correspond to the d.c. ranges of 1.5, 5, 15, 50 and 150 volts, point 6 is for the 1500- and 5000-volt d.c. ranges, and points 7 through 11 represent the 150, 50, 15, 5 and 1.5-volt a.c. ranges in order. The same input divider is used for both d.c. and a.c. ranges, opposite contact points being wired in parallel on the switch. When using the high-voltage d.c. ranges the switch is set on the 1500-volt position and the test leads transferred to the correct terminals.

R_6 and C_2 comprise an isolating circuit between the "common" terminal and the case, making it possible to measure voltages between two points both of which are above ground. The potential between "common" and ground should not be allowed to exceed 500 volts.

Because of the extremely high input resistance and sensitivity of the meter, the use of a shielded test probe with isolating resistor is desirable to minimize a.c. and r.f. pickup, as well as to avoid detuning of resonant circuits under measurement.

The Diode-Peak Rectifier

When a.c. voltage is to be measured the d.c. voltmeter just described is used to measure the crest of the alternating voltage as rectified by a 6H6 diode.

Referring to Fig. 1, when an a.c. voltage is applied between "common" and the terminal marked "150-v. A.C.," condenser C_3 is charged to a voltage almost exactly equal to the peak value of the applied voltage. In this state rectified d.c. flows through the diode only at the very peak of the cycle, provided the time constant of the diode circuit is large enough so the charge on C_3 does not diminish appreciably between cycles. Thus the effective resistance of the diode is very high and the shunting effect on the circuit being measured is small.

The voltage across the diode can be represented as a negative rectified d.c. voltage in series with the applied a.c., the d.c. voltage being approximately equal to the peak of the a.c. component. The a.c. component is removed by the filter cir-

cuit R_7 and C_1 . The d.c. component is discharged through the input divider (R_8 - R_{17}) and its value measured by the d.c. voltmeter.

In common with all diodes, the 6H6 has a slight residual electron flow from cathode to plate even when no a.c. is applied, causing a "contact potential" to be developed across the input divider. This residual current is minimized by reducing the heater voltage to the 6H6 (R_{32}), but it still causes a deflection on the meter. To compensate for this contact potential and avoid constant re-setting of the zero-setting control, positive bias from a tap on the voltage divider is switched in on the lower a.c. ranges through the second deck of the range switch (S_{11}^{II}). With the switch on the 1.5-volt range, the value of this compensating bias is set by the variable resistor (R_{29}) so that the meter reads zero. Since the input divider reduces the effective bias proportionately on the higher ranges, less compensating voltage is required. The correct ratios are obtained through the fixed divider R_{26} , R_{25} , R_{27} .

On the d.c. ranges the diode heater is disconnected by means of the third deck on the range switch (S_{11}^{III}), thus removing the source of the contact potential and therefore the need for compensation.

The 6H6 diode-peak rectifier is useful on frequencies throughout the audio range. It can be used on r.f. provided suitable precautions are taken, but this is not recommended. The upper frequency limit is set by the capacity and inductance of the input circuit and test leads.

The lower frequency limit is determined by the capacitance of the input condenser and the time constant of the capacity-resistance circuit associated with the diode. With the values shown the error is negligible down to 100 cycles or so. At 60 cycles the reading is about 5% low. If very low-frequency measurements are to be made with good accuracy, the value of C_3 should be increased to 0.1 μ fd. A low-leakage mica condenser must be used.

The power supply employs a conventional replacement-type transformer operated well below rating, with an 80-tube rectifier and a resistance-capacity filter. Series resistances in the heater circuits reduce the heater voltages; full emission is not required, and the lower temperature reduces grid current, improves stability and increases tube life. The resistances R_{23} , R_{29} and R_{30} constitute a bleeder and voltage divider.

Probe-Type R.F. Voltmeter Head

For r.f. measurements a separate voltmeter head was constructed, with a 6-ft. length of shielded cable terminating in an octal plug that replaces the 6H6 and provides input and power connections through its socket. This head contains another diode-peak rectifier, using an acorn 955 with grid and plate tied together. This tube is used because of its low interelement capacity and high input resistance at u.h.f. The circuit is shown in Fig. 2 and the construction in Fig. 3.

By keeping all leads extremely short and connecting the input condenser directly to a probe terminal mounted on the polystyrene insulator, both the input capacity and the inductance of the input loop are kept small. Because the input capacity is low (about 3 $\mu\text{mfd.}$) and the input resistance is low (about 3 megohms) and the input resistance of the acorn comparatively high, it is possible to use the meter for comparative measurements at frequencies up through the 224 Mc. band.

In making measurements at r.f. allowance must be made both for the resistance and the reactance of the diode input circuit. When the measurement is associated with a tuned circuit it is usually possible to tune out the shunt capacity, limiting the loading effect to the input resistance alone. As stated before, the value of this resistance will vary considerably, ranging from about 3 megohms at audio frequencies to approximately 1 megohm in the broadcast band and perhaps 50,000 ohms at 112 Mc.

When making measurements on non-resonant circuits the loading impedance can be considered as the effective value of the resistance and reactance in parallel. On the higher-frequency amateur bands the reactance is so much less than

the resistance that the impedance can be considered as the capacitive reactance of the input loop at the frequency in use. At very high frequencies this value will begin to rise again as the inductance becomes important near resonance (i.e., on 112 and 224 Mc.).

Construction

The unit is assembled on the panel of a 6 x 7 x 12-inch standard metal cabinet. This type of construction is not particularly compact, but does facilitate wiring and experimentation. There is a good deal of empty space in the cabinet; doubtless it would be a useful idea to cut out a section of the top end for a hinged door leading to an enclosed compartment where the r.f. probe and test leads could be stored when not in use.

The power transformer is supported on four tapped metal rods. A metal strip across two of these rods supports R_{24} and R_{29} , making these controls available for screw-driver adjustment through two holes in the bottom end of the case. These holes are insulated by $\frac{1}{2}$ -inch rubber grommets, since the shafts of the potentiometers have d.c. on them. Insulating washers are used in mounting the variable resistors, of course.

All of the other principal parts are mounted directly on the panel. The fixed resistors associated with the various circuits are first assembled on flat bakelite terminal strips, and pre-wired with connecting leads. These strips are then mounted in place and the leads run to the other circuits.

Ordinary bakelite-insulated tip jacks are used for the "ground," "common," "A.C." and "1500-v. D.C." terminals. The latter is given additional insulation by a pair of fibre washers.

(Continued on page 90)

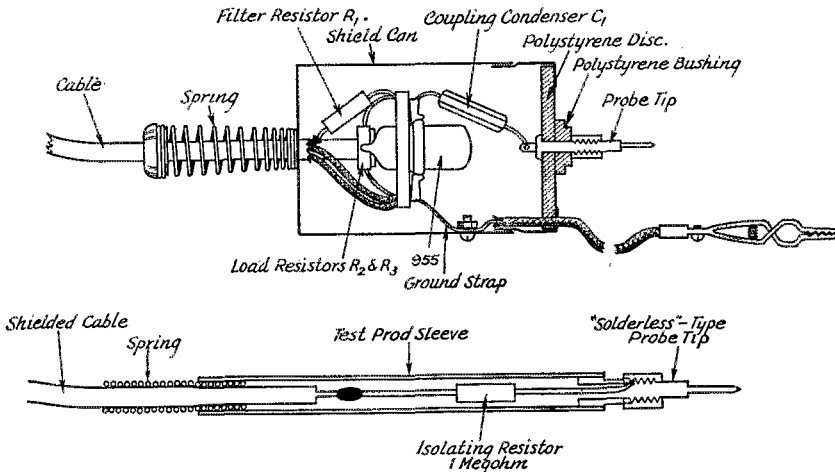

Fig. 3 — (Top) Showing construction of the 955 voltmeter head. Refer to text for details. (Bottom) Detail of the d.c. isolating probe.

ARMY-AMATEUR RADIO SYSTEM ACTIVITIES

War Department, Office of the Chief Signal Officer, Washington, D. C.

NEW CHIEF SIGNAL OFFICER

THE Signal Corps has a new head: Major General Dawson Olmstead was appointed Chief Signal Officer of the Army, effective October 24, 1941, succeeding Major General Joseph O. Mauborgne, retired. He is the twelfth CSO in the history of the Corps. His photograph and a biographical sketch appear on page 22 of October *QST*.

The part which Army-Amateur members will play in the civilian defense picture is being studied by the Office of Civilian Defense and the Defense Communications Board. The War Department is awaiting the completion of such studies before considering any changes in the Army-Amateur Radio System because the eventual determination of organization and responsibility for direction will be specified, in all likelihood, by the aforementioned agencies. Communication security requirements might possibly necessitate the closing of all radio stations (including those of the Army and Navy) the operations of which might be useful to the enemy for aircraft position finding, or as a source of information as to local conditions and activities. It is hoped that Army-Amateurs will continue to construct 112-Mc. and other ultra-high-frequency equipment for local u.h.f. nets to serve their communities and to tie in with existing AARS networks. However, too much dependence should not be placed on radio for civilian defense communication needs in time of emergency.

AMATEUR MESSAGE TRAFFIC

THE personal messages (third-party traffic) handled by AARS stations are increasing at a rapid rate. Messages to or from Army posts and camps make up the bulk of this expanding traffic. The work of relaying and delivering is putting a heavy burden on the comparatively few Army-Amateurs and other cooperating amateurs who are devoting much of their spare time to this public service.

As a means of expediting this traffic, with particular emphasis on speeding up the number that can be handled per hour, the ARRL Numbered Radiogram or fixed-text type of message has been adopted by the AARS. Stereotyped "form messages" were used by Army net stations last year to expedite the transmission of Christmas greeting messages, so that many Army-Amateurs should be familiar with the fixed-text type of radiogram. A supply of the "ARRL Numbered Radiograms" lists recently was distributed to corps area and

state net control stations. Additional copies may be procured without charge from ARRL Headquarters, West Hartford, Conn. The sender of a message should be asked to rephrase his text to conform to these fixed-text forms whenever possible. The abbreviation "ARL" will be used before the check to indicate that it is in the "ARRL Numbered Radiogram" series.

During the past several years the ever-increasing number of Christmas messages had been putting a heavy load on the operating personnel at Army NCS, WLM-W3USA, Washington, and other Army-Amateur stations, particularly those serving as relay stations. AARS nets are almost loaded to capacity at present with the large volume of service personnel radiograms. It is requested, therefore, that Christmas greeting messages, between points in the United States, not be routed over the AARS this year.

CODE SPEED CONTEST

THE annual code speed contest is scheduled tentatively for Monday, January 5th. In a manner similar to this year's contest, it is planned that Army-Amateur NCS, WLM-W3USA, will make automatic tape transmissions at speeds from 20 to 65 words per minute, in increments of 5 w.p.m., on 3497.5 and 6990 kc., starting at 10:00 p.m. E.S.T. It is hoped to arrange for similar transmissions from Ninth Corps Area NCS, WLW-W6NLL, Presidio of San Francisco, at 9:00 p.m., P.S.T., using a different text, that all amateurs in the United States may have an opportunity to receive these transmissions. This competition is open to all licensed amateurs. Participating amateurs should mail copies of the received text to their respective Corps Area Signal Officers for grading.

ANNUAL ARMISTICE DAY MESSAGE TEST

THE thirteenth annual Armistice Day Message Contest was held on Monday, November 10th. A message from the Chief Signal Officer was transmitted by net control station WLM-W3USA, on the special 3497.5- and 6990-kc. Army-Amateur frequencies, at 7:00 and 10:00 p.m. E.S.T. All Army-Amateur stations were to receive this message and submit copy to their respective Corps Area Signal Officers for scoring. The results will be announced later.

RESULTS OF FALL ZCB CONTEST

THE Ninth Corps Area Army-Amateurs added another one to their string of contest victories with the winning, by a large margin, of the Fall ZCB (Intercommunicating) Contest that

^a Corps Area	^b Membership 8-15-41	^c November Participating	^d Corps Area Points	^e C.A. Activity c/b	Final C.A. Score (d × e)
IX.....	402	280	2,733,677	69.7%	1,905,373
VII.....	205	98	1,826,875	47.8%	373,246
VI.....	282	125	1,743,941	44.4%	774,310
II.....	270	109	1,323,273	40.4%	534,602
III.....	147	60	1,139,437	40.7%	463,751
IV.....	339	110	1,329,681	32.4%	430,817
I.....	194	93	743,337	47.9%	356,058
V.....	203	61	1,076,430	30.1%	324,005
VIII.....	143	39	564,988	27.3%	154,242
Puerto Rico Dept.....	7	3	8,250	42.9%	3,539
TOTAL.....	2192	978		44.6%	

FALL ZCB CONTEST — CORPS AREA WINNERS

C.A.	Station	Contacts	Score	City
I.....	W1SC	106	141,480	Boston, Mass.
	W1KZS	59	63,720	Pittsfield, Mass.
	W1AZW	94	62,909	Pittsfield, Mass.
II.....	W2MLW	107	115,560	Elizabeth, N. J.
	W2SC	96	90,720	Governors Island, N. Y.
	W2MZB	66	86,400	Islip, L. I., N. Y.
III.....	W3OKC	106	285,120	Shamokin, Pa.
	W3EPV	55	118,800	Hagerstown, Md.
	W3SN	102	118,320	Baltimore, Md.
IV.....	W4GOG	63	166,140	Hialeah, Fla.
	W4BYF	75	162,000	Miami, Fla.
	W4JU	69	152,360	Jacksonville, Fla.
V.....	W3SLH	83	104,580	Cincinnati, Ohio
	W3PZA	83	93,375	Cleveland, Ohio
	W3HDL	74	89,910	Mansfield, Ohio
VI.....	W9DIR	107	298,530	Portage, Wisc.
	W9UQT	60	129,600	Bloomington, Ill.
	W8UFH	82	95,940	Detroit, Mich.
VII.....	W9OZN	95	239,400	Udall, Kansas
	W9KCO	90	121,500	Iowa City, Iowa
	W9BLK	66	121,440	Rapid City, S. Dak.
VIII.....	W3CEZ	59	138,060	Ponca City, Okla.
	W5HBQ	65	84,825	San Antonio, Texas
	W5CCL	38	48,640	Hammon, Okla.
IX.....	W6IOJ	124	312,480	No. Hollywood, Calif.
	W6LTA	107	279,270	North Fork, Calif.
	W6GEG	92	154,560	Fresno, Calif.
Puerto Rico.....	K4HEB	11	6,930	Santurce, Puerto Rico
	K4HHR	3	1,200	Ft. Buchanan, Puerto Rico
	K4KD	3	120	Santurce, Puerto Rico

was held on September 8th; 280 Army-Amateurs in the Ninth participated to roll up a score of 1,905,373 points. The Seventh was next, followed by the Sixth, with 873,246 and 774,310 points, respectively. The highest individual score was made by W6IOJ, North Hollywood, who worked 124 stations in 28 states, all nine corps areas and Alaska, to score 312,480. A total of 978 Army-Amateur members participated. Detailed results are shown above.

Lt. A. W. Lister, G5LG, Lichfield, Staffs.
A. C. Webb, G6WQ, Ilford, Essex (interned civilian).

CIRCULATION STATEMENT

PUBLISHER'S STATEMENT OF CIRCULATION AS GIVEN TO STANDARD RATE AND DATA SERVICE

This is to certify that the average circulation per issue of QST for the six months' period January 1st to and including June 30, 1941, was as follows:

Copies sold.....	41,514
Copies distributed free.....	511
Total.....	42,025

K. B. Warner, Business Manager
D. H. Houghton, Circulation Manager

Subscribed to and sworn before me on this 29th day of September, 1941
Alice V. Scanlan, Notary Public

P.O.W.

It is reported that the following amateurs are being held as prisoners of war:
Corp. D. W. Carr, G8UC, Maidstone, Kent.



HINTS AND KINKS FOR THE EXPERIMENTER



AMPLIFIER NEUTRALIZING WITH SAFETY

Fig. 1 shows an arrangement I have been using successfully for some time in neutralizing amplifiers equipped with link output coupling. A flashlight bulb is simply connected across the link and the neutralizing condensers adjusted for no indication, or minimum indication. This system has the advantages over the neon-bulb method that it does not unbalance the circuit and that it is entirely safe in operation.

If coupling to the output coil is variable, the most-sensitive bulb available should be used,

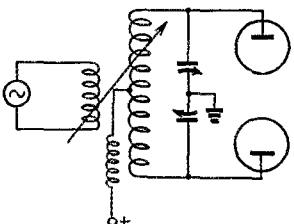

Fig. 1 — W8RBL uses a flashlight bulb connected to variable link for safe neutralizing.

starting with very loose coupling and increasing the coupling as the point of neutralization is approached. With fixed links, start with a less-sensitive bulb and finish up with the sensitive one. — R. E. Span, W8RBL.

FOLDED ANTENNA FOR 160

THE 160-meter 'phone station of W6QVP, fixed-portable at Merced, California, has had to handle a situation which confronts many amateurs operating on 160, namely, the lack of sufficient room for a good half-wave antenna. Faced with this difficulty, the usual response is to put up a piece of wire "about so long and so high," then worry about tuning equipment to make it resonate.

For this station, however, there are several definite reasons why a Marconi end-fed type was not looked on with favor. Some of them are: Too much b.c. interference; loss of power in antenna-tuning equipment; expense of purchasing new antenna-tuning apparatus (we had none so it would mean laying out cash); difficulty of being sure the power input was actually getting to the antenna and, finally, the main reason which was

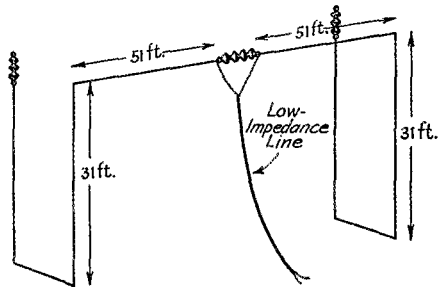

Fig. 2 — Good results have been obtained by W6QVP with this folded 160-meter doublet.

that with a Marconi the current node is at ground point, while with a doublet-type antenna it is at the center of the system. Hence, it was obvious that, lacking tuning equipment, having two b.c. receivers directly under the antenna and wanting the utmost efficiency for our 85 watts input, we turned to a doublet.

We have two 32-foot "two-by-three" poles, one on the house and the other 105 feet away on the garage. Fifty-one feet of the 239-foot overall antenna length is on each side of the center in horizontal position. Hence, we have a 102-foot flat top. At the top of each pole and raised or lowered right with the antenna, is a three-foot light-wood spreader with insulators on each end. A similar spreader is lightly nailed to the bottom of each pole. The antenna wire is led from the center of the top spreader insulator over to one end of that spreader, thence down 31 feet to the corresponding end of lower spreader, across it, then back to the opposite end of the top again as shown in Fig. 2. This consumes between 66 and 68 feet of antenna equally at each end in a typical approved balancing-out plan described in the ARRL Antenna Book. The theory is that the parallel sections on the ends partially balance out and thus reduce vertical radiation. All wire, of course, is insulated from the wood with glass insulators. Both house and garage here are a few feet above usual height, so our poles get up to about 47 or 48 feet above ground. This receiving location, however, is very bad with regard to noise, which should be taken into account in an appraisal of the following results.

For a period of less than two weeks, our log shows ten stations reporting Q5-S9 plus signals,

five Q5-S9, seven Q5-S8 or S8 to 9, seven Q5-S7 or S7 to 9, six Q5-S6 or above, one Q4-S5, one Q5-S5, and one Q3 to 4-S9 plus. Calls include eight in 7th call area, one in fifth area and one in third district. This last amateur we did not hear at all, but his report was relayed to us. We conclude, logically, that due to the very poor receiving location, our transmitter is undoubtedly working far beyond our receiving range.

— Earl M. Alcorn, W6QVP

NOVEL SUBSTITUTE FOR ANTENNA PULLEY

IN RUNNING through our files the other day for material for Hints and Kinks, we ran across a suggestion made by the late Fred Sutter which was typical of his will to simplify.

Knowing the difficulty with which broken antenna halyards are replaced in the usual pulley at

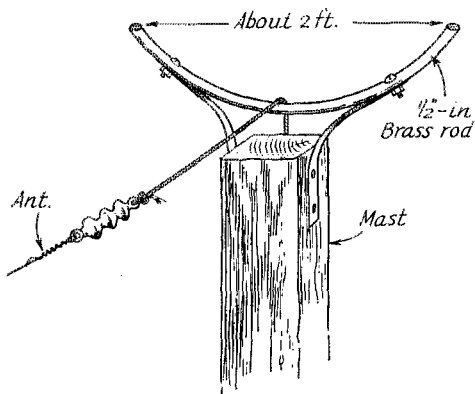

Fig. 3 — This gadget is much easier than a pulley to “rethread” when the rope breaks.

the top of the mast, he asked, “Why use a pulley?” A rope rides about as easily over the gadget shown in Fig. 3 as it does through a pulley with the usual antenna load. If the rope breaks, there is a fair chance that a fellow with a good arm can succeed in throwing a weighted line up over the top of the mast, after a little practice. The line can be used to haul the new halyards into place. If a strong arm is lacking, a kite or balloon with a light line may be flown near the top of the mast and maneuvered into a position which will permit dropping the line into the yoke.

HINT ON IMPROVING AN UNRESPONSIVE BUG

MANY of the bugs manufactured nowadays, particularly the less expensive ones, tend to be rather unresponsive at speeds less than thirty words per minute. Observation seems to indicate that this is often caused by an excessively-stiff main spring. As a result, it is often necessary to adjust the bug for excessive side swing, or else

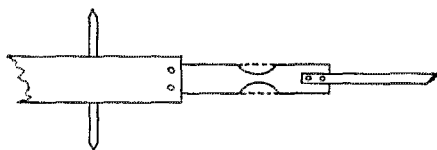

Fig. 4 — W9SCH finds that narrowing the width at the center of the vibrating spring makes most bugs more responsive.

run the dots too fast, to gain responsiveness. Since neither of these alternatives is conducive to the best sending, it has been found advisable to increase the flexibility of the main spring by decreasing its width at the point of vibration.

The complete arm assembly should be unfastened at the trunnions and removed in order to facilitate this operation. By means of a file, or by careful use of an emery wheel, a notch should be ground out of each side of the main spring as near to the supporting bar as possible as shown in Fig. 4. The notches should be semicircular rather than V-shaped, and enough metal removed to make the spring about one-half the normal width.

When the bug is reassembled, it will be found that its maximum dot speed is somewhat lower than formerly but that the action is much snappier at all useful speeds. Since most operators send between fifteen and thirty-five words per minute, the loss in maximum speed is more than compensated for by the increased “feel” and ease of action.

This kink has been applied successfully on Vibroplex, Speed-X’s and MacElroy keys with equal success, and the results have always amply repaid the effort expended.

— Charles Rockey, W9SCH.

TONE CONTROL BY NEGATIVE FEED-BACK

AN EXCEPTIONALLY wide range control, from high treble to deep bass, is obtained with the

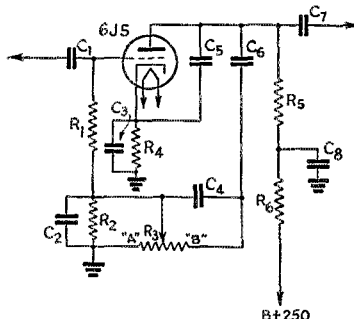

Fig. 5 — Circuit for wide-range tone variation.

- | | |
|-----------------------------------------------------------------------------------|------------------------------------------|
| C ₁ , C ₄ , C ₆ , C ₇ — 0.05 μ f. | R ₃ — 2-megohm potentiometer. |
| C ₂ — 0.006 μ f. | R ₄ — 3000 ohms. |
| C ₃ — 10 μ f. | R ₅ — 50,000 ohms. |
| C ₅ — 100 μ f. | R ₆ — 0.1 megohm. |
| C ₈ — 0.5 μ f. | |
| R ₁ , R ₂ — $\frac{1}{4}$ megohm. | |

circuit shown in Fig. 5. With the arm of the potentiometer at "A" the 250,000 grid resistance is shorted out and the 0.05 μ fd. plate condenser is connected as a by-pass to ground, giving maximum bass. With the arm at "B" the 0.05- μ fd. by-pass is high above ground and the feed-back voltage is maximum, with feed-back taking place only at low frequencies, due to the 0.006-grid shunt. The high audio frequencies are passed and the lows attenuated at "B." — *Willard Moody.*

— . . . —

ADJUSTING THE DELTA-MATCH SYSTEM FROM THE GROUND

THE problem of impedance matching between an antenna which is part of an array, and its feed line is often a hard one, because of the difficulty of computing or measuring the impedance at the points of connection to the antenna.

Since cut and try methods must be employed, it is advantageous to use a matching system which is continuously variable over a considerable range. The matching stub with its feed line tapped on at the proper point, and the "Y"-match seem to be the most flexible systems. Using either system, the approximate spot is chosen for tapping on and the taps are then varied until standing waves are eliminated from the feed line. Adjustment of the taps is often a tedious and physically difficult task, because adjustments must be made while the antenna is in the position in which it is to be operated.

The "Y"-match antenna can be adjusted in another manner which greatly simplifies the whole procedure and which should prove very valuable in making adjustments on beam antennas where the whole array is mounted so as to be accessible only with difficulty. The "Y" antenna, as shown in Fig. 6, can be thought of as a grounded quarter-wave antenna with a single-wire feed line. The portion to the left of the dotted line represents the image in the earth. The feed line is correctly terminated when the resistance presented to the feed line at point P_2 (assume a resonant wire) is equal to the characteristic impedance of the feed line. This resistance is a function of the length of the wire, L_1 , its characteristic impedance, and the impedance presented to it at P_1 . It has been customary to secure the correct resistance at P_2 by changing the position of P_1 , thus changing the load pre-

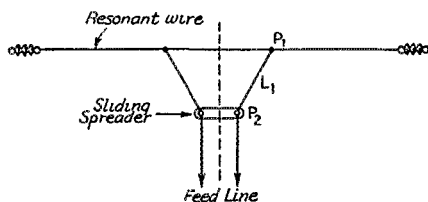

Fig. 6—Scheme suggested by W9RQG for making final adjustments of Delta feed from ground.

sented to P_1 , the length of L_1 , and the characteristic impedance of L_1 (by changing its average height above ground).

This same result can be achieved by moving the sliding spreader at P_2 , thus changing the length and impedance of L_1 . It is not possible to get as great a variation by this method as by moving the taps, but if the points of tapping are roughly correct, it should be possible to secure a match with reasonable movements of the spreader from its original position as determined from tables.

The system can be raised to its operating position and the spreader moved up or down by means of a long fish pole with a hook or clamp attached to its end. When the proper position is found, the spreader can be wired in place.

— *Victor H. Voss, W9RQG.*

A Compact Receiver for 112 Mc.

(Continued from page 33)

ing the receiver. In this case, the receiver is mounted firmly above the control box by means of two metal side supports and self-tapping screws. The speaker may be mounted behind the dashboard or in any other convenient place.

The receiver is turned on and off with the aid of the transmitter control box. Fig. 2 shows the revised wiring diagram of the control unit. The new circuit arrangement uses one of the switches to break or pass voltage to the receiver and transmitter filaments and to the vibrator supply primary. The relay winding is connected to the second switch and is wired so as to place voltage on the receiver with the switch in the closed position. Therefore, the relay switch should always be closed before the filament switch is closed; this prevents the transmitter from radiating during the warming-up period. The transmitter is placed in operation by opening the relay switch.

The transmitter previously described makes use of a half-wave antenna located at the rear of the car, and this naturally makes the use of one antenna rather impractical. The receiving antenna is, therefore, a separate affair mounted at the front of the automobile. It is the broadcast-receiver type and will extend to a full 6 feet ($\frac{3}{4}$ -wave at $2\frac{1}{2}$ meters). This allows a low-impedance feed line to be used between the base of the antenna and the receiver. We have a broadcast receiver in the car and switch the antenna from one set to the other whenever necessary.

Incidentally, some of the car antennas are equipped with a low-impedance feed line that may be used effectively with the 112-Mc. receiver. However, make sure that you don't get one of the lines which has an inner conductor made with a single strand of very fine wire. Feeders of this type are quite common — and inefficient.

IN THE SERVICES

IF THERE be those who are not yet convinced of the part played by the radio amateur in girding the country for defense, let them gaze in awe on the following names of 68 licensed amateur operators, every single one of whom is an instructor in radio, either engineering or operating, at the Air Corps Technical Schools, Scott Field, Ill. They are training the men who will be responsible for the communications system of our rapidly expanding air corps. Tech. Sgts. Gargan; Jones, 9FHT; Slough, 9NHS; Staff Sgts. Honeywell, W8UJY; Ronnermann, W2JEK; W. R. Otey; Ingalsbe, W9FEZ; Lawrence, W9QJL; Nolen, W5IUX; A. C. McGinnis; Sgts. Abrams, 6TXD; Specialny, W3HIX; Olson, W9TOH; Wolfe, W9KCB; Cpls. Sewall, W1KJV; Arseneau, W9GBM; Pfc. Bair, W8SJU; Greenwood; Martinsen, W9ZDA; Pvts. Horn, W7FTU; Aggers, W5ETT; Sabel, W9WLD; Miller, W8SPV; Meyer, 6SJE; Falconer; Wood, W1LVG; Frakes, W9FGL; Mael, W9WLH; Yohn, W8PWL; Funk, W9TUV; S. P. Jones, W9YED; W. M. Bell, W9FEG; Howard Stadermann, W9AHB; Paul Esmay, W9KJG; Jack Loomis, W5IVD; Stanley Benson, W9SXH; Francis Case, W9AQB; Arnold Resnik, W9SDF; Charles Sibley, W9PWL; Marshall Ingling, W9GGF; Hugh Winter, W9HID; M. Dean Post, W9LFG; Paul Smay; Paul McCallen, W9TL; Alvin Morgan, W5ILL; William Williams, W9UOD; Norbert Gamara, W6QYF; Colin Rae, W9STX; Max Morrison, W5FOC; Edwin Knowles, W9PYN; Lloyd Gipe, W9CZV; Samuel Oxman, W9KUC; Thomas Morse, W9AXY; William van de Kamp, W9CEB; Philip Bloom, W2FIB; Frederic Dickson, W9UIC; W. Earl Peterson, W8PPN; Jesse LeGrand, W9PCT; John Petty, W9NAT; Samuel Stiber; J. Stephen Anderson, W9UFE; Edmund Parsons, W9AWD; Samuel Sullivan,

W9SAB; Thomas Braidwood, W9TEB; H. W. Belles, W5FMU; Arthur Richards, W9ODJ; Richard Hamilton, W9DDJ; Elmer Pearson, W9OTS. We've named others in previous issues too.

SIGNAL CORPS

New members of Ft. Monmouth's electronics battalion are Lts. Gunn, 3GUZ, and Banan, 1LYG, the latter being commissioned after induction under selective service. In the Signal Corps Labs there we find Lts. Giacoletto, 9WKE; Heitman, 6PHP; and OM Young, 8TO, all doing development work. In the 1st Training Bn. is Pvt. Hein, 8LXE. At nearby Ft. Dix are Tech. Sgt. Giles, 3CYI, communications chief in the 157th F. A., and Lt. Clifford, 3CJJ, communications officer of the 114th Inf. Hq. Co. Lt. Ray, 8NWP, is assigned to the 58th Sig. Bn., Camp Forrest, Tenn.; Lt. Hoelze, 4HWF, to the 254th Sig. Construction Co., Camp Claiborne, La.; Lt. Branch, 4FWO, to the 8th Sig. Co. at Ft. Jackson, S. C.; and Lt. Krisberg, K4HDZ, to Hq. at San Juan, P. R. Cpl. Brands, 9YTV, is now on detached service in Iceland. Lt. Thompson, 4BRF, is radio officer of the Fourth Corps Area. Cpl. Frydlo, 8QQB, pounds brass at WYH, Hamilton Field, Cal. Cpl. Willard, 20JH, instructs in radio at Ft. Monmouth. Lt. Downing, 7ISQ, supervises the Kodiak Base of the Alaska Communications System.

Up in Clinton, Ontario, there is a radio school training English, Canadians and Americans. As is usual in such rapidly-organized schools, the various rooms bear temporary cardboard placards until the proper lettering can be made on the doors. The other night, just before mealtime, one of those placards bore just three words: "Ordinary Radiomen's Mess." As the "chow line" filed past, a number of them stopped before the sign to make a small notation. Next morning could be read the calls of 9PPY, 6QCC, 9BEV, 2KUV, 7EYT, 5IHU, K6PXI, K6DV, 3ABE, 3AMI, LAFI, 2LHD, K6OZG, 6BWE, 6HLR, 6QUM, 6OUH, 6NMZ, K6MIN, 3HTO, 2LBD, 4HEW, 3JRP, 1MLR, 5BLT, 3IGL, 2FQW, 4DNY, 6RET, VE3FB, 6LGZ, 2BYI, 1LUX, 6PVR, 3DDW, 9QHP, SHU, 7AOP, VE4HZ, VE4ANM, VE3AD, 5GEP, 7EST, 6FWJ, 2LQC, 6PKQ, 8BPE, 9RUZ, K6OAM, 6ODE, 6NQR, 6MFO, 3IZA, 4VM, 9BHK, 6NMC, 6QGH, 2LVP, 2NTP, 7IXX, 1AQW,

Here is the amateur portion of the radio class who graduated October 1st as radiomen, third class, from the Naval Training School at Los Angeles.

Front row (l. to r.): Sprecher, 6AOU; Mickey, 7IY; Hansen, 7IJK; Crosby, 6MCG; CRM Masiello, 6OQU; Forman, 7IMC; White, 6QEZ; Carpenter, 6MKX; Dunn, 6TCX. Center row: Jackson, 6JZF; Kilgore, 6KDW; Brown, 6TOH; Healy, 6QCR; Guyot, 6LIX; Stefens, 6IWS; Aznoe, 6PJV; Wulf, 6TCZ; Hickingbottom, 9QWZ; Fisher, 7BRP. Rear row: Thormahlen, 6TFQ; Peters, 7IWB; Rock, 7IGR; Vasquez, 6QOW; Pedler, 6UDO; Kamm, 6HWZ; Faust, 6TSSO; Carmean, 6PQE; Hauk, 6TXX. Not in the picture is RM3c Dippel, 6CXL.

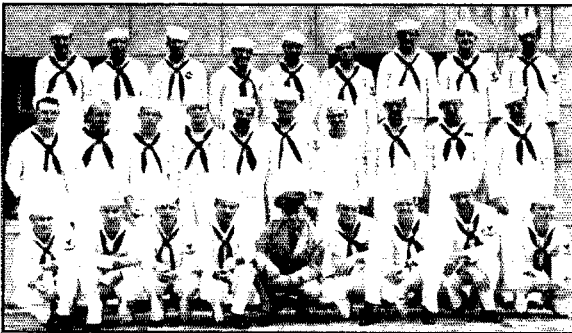



Nineteen of the 21 officers and enlisted men at NAI (Great Lakes, Ill.) have their own calls. They are (l. to r.): Ens. Ritzow, 9GDP; Lts. (jg) Asmann; Penhollow, 8SYH; RM2c Church, 9ZUO; RM3c Cunningham, 9WZA; RM2c Freye, 9WVO; RM3c Knickel, 9KAX; RM1c Abele, 9VUD; RM3c White, 9MMT; RM1c Bamberg, 9KCR; RM2c Mitchel, 9THE; Chief Telegraph Carr, 9KHZ; RM3c Ledbetter, 9WTT; CRM Bush, 9GUZ; RM3c Coulombe, 1MVG; CRM Lien, 9FYX; Lt. (jg) Hansen, 9FFD-NS; Lt. Comdr. Schnell, 9UZ; and Lt. (jg) Kessler, 9GYP. Cf Craft, 9ESW, was on leave and is not in the picture here.

CM8YB, 4HGG, K5AJ, K5AA, 5AUC, 6OZT, 9BLJ, 1LAO, 3BJE, G6QN, G2BHU, 9NHS, 9TAP, 3IZL, 9BLS, 9JFS. Most of them have since been transferred to other stations.

IT'S A SWELL WAR . . .

PVT. KENNETH GRIFFITHS, who closed down **WIKKY** to operate a "walkie-talkie" for Battery B, 84th F. A. Bn., certainly learned the horrors of death during the Army maneuvers in South Carolina. Last week while the Ninth Division was hammering the 44th, Griffiths was missing for twenty-four hours. Upon returning he confided that he had been captured twice and riddled to "death" the same number of times. Reclining on a truck seat to take a nap, he informed the N.C.O. that it would be useless to call him for battery duties, as an umpire had ruled him definitely a "dead soldier."

Half an hour later, however, when the "chow" whistle blew, **OM Griffiths** was noticed at the head of the line.

AIR CORPS

If we were able to hop from field to field with the speed of a P-40, we could find **Lt. Griffith, 4FUF**, at MacDill Field, Fla.; **Lts. Sexton, K4HWW**, and **Lingard, 9SST**, and **Sgt. Gabriel, K4GNM**, at Borinquen Field, P. R.; **Stg. Diehl, K6UGH**, and **Eilo, 9HCM**, at Wheeler Field, T. H.; **Lt. Lindner, 2JMU**, and **Sgt. Johnson, 4BYW**, at Maxwell Field, Ala.; **Lt. Dewey, 8PWJ**, at March Field, Cal.; **Lt. Coss, 8NEJ**, at Nichols Field, P. I.; **Staff Sgt. Michael, 1NQX**, at the Bangor, Maine, Air Base; **Pvt. Newton, 8VJP**, at Hq. 54th Pursuit Gp., Paine Field, Wash.; **Pvt. Hildreth, 6NRW**, of the 44th Sig. Platoon, Pendleton, Oregon, Air Base; **Cpl. Crum, 8GKD**, with the 854th Sig. Svc. Co., Tucson, Ariz.; and **Tinsley, 8HGC**, operating aboard a B-18.

In the 372nd school Sqdn. at Scott Field are **Sgt. Groves, 9NHO**; and **Pvts. Rehbein, 9TLK**, and **Hedrick, 8UFO**. Major Canterbury, 91MT, is assigned to the same field. Air Corps gunnery students **Beljan, 8SCW**; **Graff, 9NSE**; **Strobo, 9YKL**; and **9OOR** will soon be operating 8SCW/6 at Las Vegas, Nev. **Staff Sgt. Richardson, 8SUT**, is with the ferrying command at Bolling Field, D. C. **M. Sgt. Hinck, 9RXG**, is stationed at Lowry Field, Colo., with the 10th School Sqdn. **Sgt. Nolan, K5AD**, operates for the 25th Bomb. Sqdn., France Field, C. Z.

NAVY

LT. COMDR. SAM TOWNSEND, 8WY, in May left the broadcasting business and the presidency of **WKST** to become district communications officer for the Fourth Naval District, headquarters at Philadelphia. Active duty is not new to him, for as **8WY** and radio **NID** in Akron he supervised communication with the first trial flights of the dirigibles *Akron* and *Macon*. His present duties also include super-

vision of communications in the Philadelphia Navy Yard and the outlying radio stations in the district. **Comdr. Grimes**, of Los Angeles amateurdom, has taken over the D.C.O. job of the Eleventh Naval District, headquarters at San Diego. **Lt. Comdr. Fass, 6NZ**, is on duty in San Francisco. **Lt. Comdr. Catal, 9DTK**, left Milwaukee for active duty at the Air Station in Corpus Christi, Texas.

Radiomen of the *Albemarle* include **Bratton, 5HWI**; **Jones, 4GBC**; **Ryburn, 8RGK**; **Warren, 9TCN**; **DeCourt, 4HDM**; and **Blossom, 5AMG**. At Navy Radio, New York (NAH), we find, in the headquarters building, **Lt. (jg) Braue, 2HII**; **CRM Conrad, 2BHE**; **RM1cs Kirchoff, 2FAR**; **Kerr, 3CCC**; **Canino, 8ERZ**; **Cook, 8LOV**; **RM3cs Sternfeld, 2GIY** and **Berler, 2EPC**; at the material lab are **RM2cs Maciejko, 1GVV**, and **Vossberg, 1FKR**; at the transmitter station, **RM2cs Lawreynovicz, 1KYF**, and **Dee, 2FUO**. **RM1c Tobias, 6IIC**, is in charge of radio on the *Bittern*. Radiomen **Pickford, 6ISS**, and **Towler, 5BYV**, are stationed at the sub base in Coco Solo, C. Z. **RM3c Stewart** pounds brass on the *Williamson*. **Ens. Hathaway, 7BCV**, and **Lt. Emigh, 7BH**, are stationed at District Headquarters in Seattle.

Although **O'Keefe, 2KTS**, and **Geranis, 2NUD**, both lived in Brooklyn and within 100 feet of each other, it was only when they reported aboard the *Colorado* last March that they met for the first time. Other hams in the ship's materiel personnel are **Lt. (jg) Wood, 8AOZ**; **RM2c Webb, 6SHA**; and **CRE Czenkus, 6JZJ**. Radiomen on the *McKean* include **Crane, 9SQF**; **Chiles, 6ROI**; and **Sanders, 6ONG**; on the *Little* are **Tatarski, 6TJL**, and **Rex, 6QHM**; on the *Stringham*, **Hawkins, 6CUQ**; and **Kerr, 6RPO**. **OM Chiles** says the radio equipment is new and a pleasure to operate.

Not all the boys are on boats. **Seamen Dickey, 2HRD**, and **DuVall, 6QJZ**, are training at San Diego; **Radiomen Klehfoth, 9TWV**, and **Harrison, 1KYL**, at Noroton; **Schorn, 9GKW**, at San Francisco. **Lt. (jg) Veverka, 9CGS**, is with a detachment at Ft. Mills, P. I., and **Lt. Beall, 6BYV**, with one at Quito, Ecuador. **Ensigns Warren, 4EXJ**, and **Davis, 4GQ**, are assigned to the communications office at Charleston, S. C., navy yard. The gang at Newport, R. I., naval operating base include **CRM Baxter, 1AKE**; **Davies, 1AZG**; **Grace, 1EEP**; **Krynitzky, 1BFS**; **Baldwin, 1IKE**; **McArthur, 8MBA**, and **Somers, 1LVA**. **Lt. Comdr. T. R. Penypacker, 1VR**, is the C.O., assisted by **Lt. (jg) Stimpson, 1KL**, and **Ens. Hardman, 1CIK**. There are numerous Naval Air and Radio Stations dotting our coastline, with amateurs performing much of the communications work. We find **CRMs Boyd, 3JGG**, and **Barr, 8MLZ**, at Annapolis; **Estes, 4GKK**, at Jupiter, Fla.; **CRM Rand, 1PG**, at Quonset Point, R. I.; **Lt. Thomas, 7FEZ**, at Kodiak, Alaska; **RM3c Stellmaker, 9EUS**, at Miami; **Lt. Fenton, 4GGN**, at Pensacola; and **Jarrett, 3JEA**, at Cheltenham.



ON THE ULTRA HIGHS



CONDUCTED BY E. P. TILTON,* W1HDQ

You never can tell about Five Meters!"

With everyone looking for an aurora session around the middle of October (such a magnificent display as burst forth on Sept. 18th would surely have a sequel the following month) we get, instead, a couple of sporadic-E openings. Thus, with aurora DX in July and skip DX in October, has the band rudely broken up our nice picture of "what to expect, and when."

Most of the gang who operate principally on Five had given up their summer habit of watching conditions on Ten, and thus were caught completely unawares until they heard the few who never miss such things calling W4s and W9s. Here are a few reports:

October 20th:

W1DLY, Gilbertville, Mass., worked W9YKX; heard W4FBH.

W4FBH, Decatur, Ga., worked W2BYM and W2BQK; heard W2AMJ and W1HDQ.

W2BYM, Lakehurst, N. J., worked W4FBH, W9s FFV DYH NFM and YKX; heard W9UWL.

W9RFT, Waterloo, Iowa, heard W2BYM and several unidentified signals.

October 22nd:

W1DLY, W1AEP, W1QB, and W1LL worked W4DXP; heard W4EQM.

W4FBH worked W2BYM.

W2BYM worked W4FBH and W4DXP; heard W4EQM.

W1HDQ was asleep at the switch on both occasions!

Operating activities during October were somewhat overshadowed by the general awakening in the need for organization of our u.h.f. facilities for civilian defense. All of us who work the ultra-highs have long felt that organization along emergency lines was in order, but because of the general confusion of ideas as to what was needed, little in the way of definite planning has

been done until the last few weeks. Now, however, a communications plan is being drafted by the Office of Civilian Defense, in which a place inevitably will be made for amateur radio. At this writing the picture is not entirely clear, but one thing seems certain — there is a tremendous job ahead for u.h.f. men! *QST* will shortly carry the complete story (much has already been reported, and more in this issue) with suggestions as to gear, organization methods, and the jobs we may be called upon to do. Each month this column will report local organization work of u.h.f. nature. Here are a few examples of what is already being done:

Chicago — W9PNV has organized a net of fixed and mobile 112-Mc. stations, twelve members at present. Personal delivery of messages from a 3.5-Mc. c.w. net by 112-Mc. mobile stations is being tried.

Belmont, Mass. — W1AJW reports a complete inventory of amateur facilities. Appropriations for purchasing u.h.f. gear for amateur emergency use have already been made, and more are coming up.

Hartford, Conn. — 112-Mc. net under auspices of Connecticut State Police in operation each Monday night. Control, W1JJR, calls roll by towns in the area around Hartford. Practice messages are handled as a part of each drill.

Tucson, Ariz. — U.h.f. enthusiasts under direction of W6OVK mailing out literature to all active amateurs in Arizona, stressing need for development of emergency u.h.f. facilities. W6QLZ, Phoenix, reports quantity purchases of u.h.f. gear and much local interest in construction of same.

Springfield, Mass. — Local nets on 56, 112, and 28 Mc. being organized as adjuncts to police radio and police and fire signal systems. First test of 112-Mc. facilities Oct. 23rd, with W1GCR/1 operating from City Hall tower, contacting portable, mobile and fixed stations throughout Springfield area. 56-Mc. mobile group, comprising six stations at present, to work out Nov. 6th.

San Pedro, Cal. — W6ANN reports 112-Mc. emergency net operating each Monday night at 8 P.M. Nine stations included, to date, all using the same frequency for drill.

Meriden, Conn. — U.H.F. Amateur Emergency Ass'n, W1KJT, president, W1FYG, secretary, formed. First regular meeting at Conn. State Armory on Oct. 20th open to all local and out-of-town amateurs interested in increasing the value of u.h.f. emergency facilities.

And so it goes! The opportunity for u.h.f. service is limited only by the number of operators and available gear, it appears. If we are to do all that

* 329 Central St., Springfield, Mass.

Five-Meter Men gather at W9HAQ, Davenport, Iowa. Left to right, Jerry Keefe, W9HAQ; George Sperry, W9CBJ, Washburn, Ill.; Harold Wier, W9GFV, Lacon, Ill.; Bill Copeland, W9YKX, Woodbine, Iowa; Clair Brown, W9NFM, Solon, Iowa; and Jerome Keefe, W9HAQ.

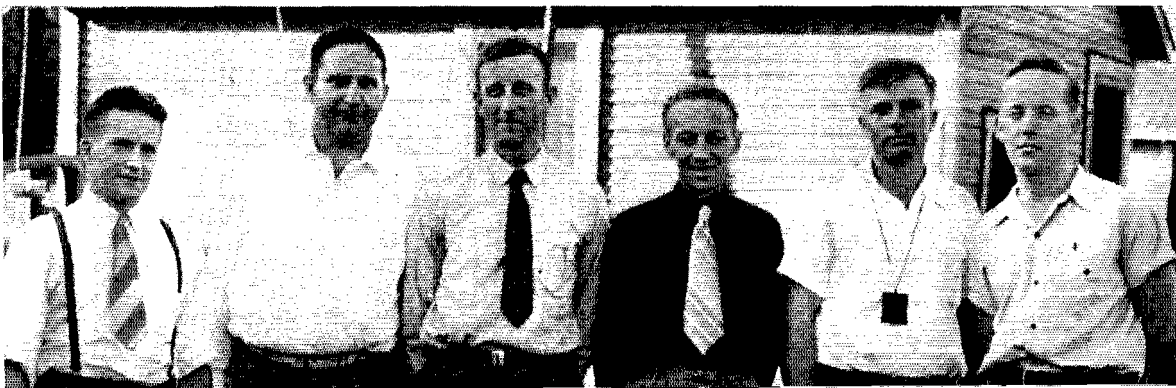

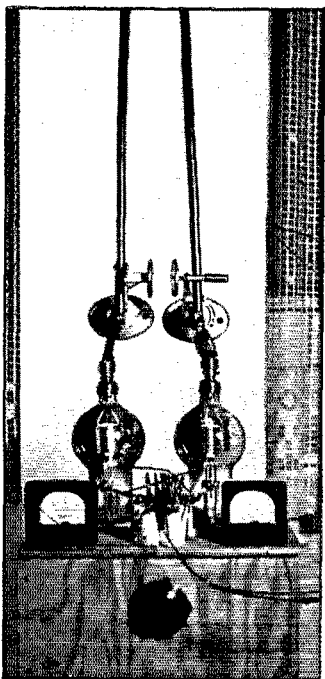

A pair of RK-63's with linear plate circuit take up to 1 Kw. The 56-Mc. final at W3HWN, Mechanicsburg, Penna.

we should, it is going to mean the "conversion" of many low-frequency men and the construction of scores of rigs in every sizable community. If your town has not already started, get the gang together at once. Survey available gear and prospects for construction of units for the job at hand. Get every local ham going on the job, and soon; and let us know about your plans and the progress you are making!

HERE AND THERE:

W1DJ, Winthrop, Mass., had a big night on Sept. 25th, working two long-looked-for stations in **W1MEP**, Glastenbury Mt., Vermont, and **W1MFK**, Portland, Maine, for the first time. He then went on to contact **W1BGA**, Pawtucket, R. I., **W1LSN**, Exeter, N. H., **W1FLQ**, Middletown, Conn., and several locals — making all New England States in one evening. In New England's hills, that is something! Arthur, long-time Western Union man, sends along a sheet from the W.U. organ, "Dots and Dashes," in which is reported the success of engineers in combatting the effects of magnetic storms on wire communication. Peaks as high as 480 volts were recorded on observer circuits during the magnetic storm of July 4th-5th, yet wire service was maintained almost without interruption. Well, so long as they don't find some way to stop the disturbances themselves it's all right with us!

W1MEP has a tough assignment. Chef's mountain is an ideal spot in summer but few will envy him, seven miles from the nearest highway, this winter. But things could be worse — he now has two storage batteries and the means to charge them. An **HY-75** is being installed in the famous flea-power rig and **W1MEP** will soon be heard with high power (8 to 10 watts) on 57,486, 114,972, and maybe, even (shh!) 28,742. Keep those frequencies in mind, gang —

contacts are going to mean a lot to that guy way up there, buried in some ten feet of snow, on Glastenbury Mountain, Vermont!

There may not be too many stations on Five on a given night, but just announce a "Horsetrader Shindig" and watch them flock to it! Even with a World Series for competition, 140 u.h.f. enthusiasts showed up at a Shindig in New York October 6th. **W4EDD**, **W3JSL**, **W1DEI/3**, **W3AWM**, and the Conklins came up from Washington; **W1QB** came all the way from Natick, Mass.; a fine group from Philadelphia; and, with practically all the gang from New York and Connecticut on deck, a fine time was had by all.

"The lingo is familiar but I can't place that call, **W3JSL**." Just another of those hams who have been drawn into the net at Washington — the former **W9ZJB**, whom some of you may know! Vince got "the works" at the Horsetrader Shindig, as the representative of about 40 new members who were initiated "by proxy."

Television has its uses, though it has kept quite a few five-meter men away from their rigs, of late. One of these is **W2AMJ**. It didn't take Frank long to get on Five when **W2BQK**, a near neighbor, blasted forth on the sound channel calling **W4FBH**!

W5AJG used to be missing from the 56-Mc. picture during the winter months, except for an occasional skip QSO; but this winter he is working **W5HTZ**, Cromwell, Okla., quite regularly. **W5s ATH** and **EYZ** are on in Ft. Worth again, and between these and **EHM**, **JCN/5**, and **JKM** (Mrs. **W5AJG**) out with the car rig. Leroy has managed to have contacts nearly every day.

W6ANN, San Pedro, Cal., works cross-band with **W6OIN** on 2½ regularly. Last fall, when the temperature inversions faded, **W6ANN** was unable to work into San Diego until the following spring. This year by using both bands and a variety of antennas they hope to keep this 100-mile circuit open.

DX openings are big events for die-hard u.h.f. enthusiasts who are isolated under normal conditions. **W8BKI**, Charleston, W. Va., got the thrill of his life in the aurora session of Sept. 18th. His contact with **W3HDJ**, Delanco, N. J., was the first **DX** QSO for **W8BKI** in nearly ten years of intermittent work on Five. In addition he logged the following: **W1s LLL NF**, **W2BYM**, **W3s OR AXU**, **W8s NSS CIR**, **FGV QQP NYD BPQ QXV QYD KKD**, and **W9RBK**. **W2XBS** on 55,750, and the (third) harmonic of **WKJ** were also heard.

A "first report" comes from **W9RFT**, Waterloo, Iowa. Vernon runs an **HK-54** at 180 watts, feeding a 3-element horizontal array 56 feet off ground. The receiver is a **DM36-SX25** combination. Contacts have been made with **W9s ARN**, **HAQ**, **SBU**, **YKX**, **NFM**, and **ZHB** all nice **DX**. **W9WIP**, also of Waterloo, is on and **W9OJD** near Mt. Auburn is getting set.

W9PK will have moved from Lyons to Downer's Grove by the time this appears in print. Jack had such good luck with his "W6QLZ Beam" that he is going to get it up at the new location right away. He also wants to get on 2½, but won't do it until he can have crystal control and a receiver capable of copying c.w. Object: aurora **DX** on 2½!

W9EGQ, Gary, Ind., was having receiver trouble during the aurora session of Sept. 18th. He got it straightened out the next day and hasn't heard a thing since! Herb will be on at least twice each week "even if I don't hear a sig until next spring!" He would like to arrange skeds with stations within his working radius.

W9ZHL, Terre Haute, Ind., reports that **W9KZD**, Ashland, Ill., and **W9HSB** at Springfield, Ill., have been working the Wabash Valley gang recently, despite the fact that both boys are running only about 30 watts input. **KZD's** antenna is 80 feet in the air, which is undoubtedly a help in covering this 145-mile hop with low power.

112 MC. AND UP:

THE fall of 1941 will stand out in the history of the development of the Ultra-Highs as the period in which occupants of the band, in the East, began to appreciate its potentialities. In this we were just about a year behind the West Coast gang. Formerly 2½ was considered to be little more than a substitute field for the use of the simple equip-

U.H.F. MARATHON

Call	Contacts Through October 15th				Score	States in 1941
	56	112	224	400		
W1BCT		78			428	3
W1DJ	125	99			1003	12
W1EHT	64				491	6
W1EKT	120				900	16
W1HDQ*	251	137	4		2869	29
W1KIJ	196	143			2725	26
W1LFI	30	172			900	7
W1LLL	162	102			1900	25
W1LMU	92	108			432	2
W1LXN		2			868	13
W1MBS		288			1142	3
W1MEP	52	9			580	10
W2ADW	1	163			1168	6
W2AMJ	191				1080	22
W2BYM	209	56			2161	29
W2COT	120	30			690	6
W2DZA		361			1384	6
W2FJQ	58	72			624	13
W2LAL	98	6			644	9
W2LXO		211			1295	5
W2MGU		193			804	4
W2MIV	56	228			938	9
W2MQF		114			455	2
W2OEN		171			928	6
W3ABS	59	1			220	5
W3ACC	100	26			746	15
W3AXC	30	6			148	6
W3AXU	139	20			1134	20
W3BZJ		268			1576	6
W3CGV	95	12			794	16
W3GJU	67	5			359	10
W3HOH	99	361			2031	13
W4FBH	67	5			721	17
W4FKN	34	12			322	12
W5AJG	152	2			1723	25
W6ANN	62	245			1879	14
W6IOJ	16	34	1	2	313	1
W6NCP		30			70	1
W6OVK	77	8			1665	23
W6QKM	4	91	1		368	1
W6QLZ	56	20			1039	16
W6RVL		180			632	1
W8CIR	115	10			1983	26
W8KJD	113	46			1600	21
W8KWL	26				412	14
W8MHM	4	27			221	1
W8QQS	68				848	19
W8RUE	56	15			584	11
W8TDJ	39	1			576	13
W8UUY		10			150	1
W9ARN	87				1219	23
W9BDD	88				1347	23
W9EGQ					72	9
W9LLM	92	39	1		1030	16
W9PK	106				1052	25
W9PNV		115			682	2
W9YKK	92				1362	26
W9BDD	74				1052	19

Eighth Period Winner: W3HOH, 351 points.

Ninth Period: W1KIJ, using F.M. on 2½, piled up 590 points for leading 9th-period report.

Calls of entrants not reporting for two consecutive months have been dropped. They will be re-listed upon receipt of further reports.

* Not eligible for award.

ment we once employed on Five; but recent experience points to the fact that, under conditions of temperature-inversion bending, stations come in louder (from points beyond the visual horizon) than do those on Five having comparable power and antenna equipment. During the warmer months, at least, it seems definitely easier for low power and simple equipment to negotiate the hops beyond 100 miles on 2½ than it ever was in the old days on Five. Conversely, it appears that the day-to-day communication on Five is more consistent; that is, the difference between a "good" night and a "poor" one is more pronounced on the higher frequency. It makes one wonder what will happen on 224 Mc. when we get around to exploring that field!

W1HXE, Lawrence, Mass., reports some nice low-power DX. Using a pair of 7A4's at 5 watts input and a simple Marconi antenna with his mobile setup, W1HXE contacted W2ADW from Holt's Hill in Andover, Mass., a distance of about 160 miles. This is unusual in that the

elevation of the hill in question is only 310 feet, while W2ADW is practically at sea level. W3HOH and about twenty W2's were heard.

One of the loudest sigs from W2 is that of W2OEN at Middletown, N. J. It is hard to believe that the S9-plus we hear over that 145 miles is being produced by an HY-75 at only nine watts! But then that 16-element beam may have something to do with it! Mid has worked numerous Rhode Island and Mass. stations, several at distances in excess of 200 miles! W3BZJ, Glenside, Pa., has found it easier to work Rhode Island on 2½ than on 5. Bob connected with WINBU, North Providence, 220 miles, and W1KOE, Wakefield, R. I., 205 miles, on Sept. 22nd.

W3CGV, Wilmington, Del., is now on 2½ with crystal control, and thus another "new state" is made available. Several of the gang now have seven states on 2½. A few have eight — is this the top?

In Atlanta, Ga., W4FKN, with the help of W4FWD, has got things started on 2½. W4s HZG, HRT, HDC, FVI, and FBH are now heard on the band. Most of the work is portable, from various hilltops and tall buildings. No DX beyond 15 miles or so has been worked but the boys are having a lot of fun, and the groundwork for future emergency operation is being laid. W4FKN has built a duplicate of the W1AIY 224-Mc. rig described in August QST and is waiting for some receivers to be built so he can get some 1½-meter contacts.

Activity in his neighborhood by a Defense Guard under the Direction of W6s FL and CEV has got W5AJG interested in 112 Mc. again. Leroy is going to put on a crystal-controlled rig, with a separate modulator, and let it run whenever he is operating on other bands. DX on 2½, too? W5s EYZ and ATH in Ft. Worth, and HTZ in Okla., are going to try 2½ also.

As "proof of the pudding" W6OVK sent your conductor a recording, in Tucson by W6PCB, of the signals of W6QLZ, Phoenix, as received over the 105-mile path on OVK's modified S.I.G. receiver. Comparison with a similar recording of QLZ's 56-Mc. sigs bears out Jim's claims for this receiver in no uncertain terms. Both sides of the 10-inch recording are "solid copy," and the signal-noise ratio is a revelation to those accustomed to the hiss level of the conventional superregen. A detailed description of this receiver appears elsewhere in this issue. A similar receiver is under construction for 224 Mc.

With hams flocking to Washington from all parts of the country, it is man-bites-dog news to report one who went the other way. After a year and a half in Washington as W3IYO, the former W6NCP got homesick for the California climate and scenery (Chambers of Commerce please note) so we find Beck, once more W6NCP, back in Whittier, Cal., with a new job and a fine u.h.f. location. As soon as the gear is all unpacked W6NCP will be going strong on 2½. A small transceiver and an indoor antenna are serving in the meantime.

W6QKM had a 10-foot antenna stolen from his car and is having trouble getting a replacement for it. Many manufacturers are discontinuing the longer types, due to scarcity of materials and reduced demand. Don has gear all set up for 224 Mc., including an HY-75 oscillator and 9002 receiver. These are equipped with separate arrays which can be taken apart and set up in portable locations. Anyone interested in setting a new 225-Mc. record? W6ANN has 100 watts to a

(Continued on page 66)

U.H.F. RECORDS

Two-way Work

- 56 Mc.: W1EYM-W6DNS, July 22nd, 1938 — 2500 miles.
- 112 Mc.: W2MPY 1-W1JFF, August 21, 1941 — 335 miles.
- 224 Mc.: W6IOJ/6-W6LFN/6, August 18, 1940 — 135 miles.
- 400 Mc.: W6IOJ/6-W6MYJ/6, September 14, 1941 — 60 miles.



CORRESPONDENCE FROM MEMBERS

The Publishers of *QST* assume no responsibility for statements made herein by correspondents.

CHEERS FOR B.C. EDITORIAL

RFD Box 67, E. Hampton, L. I.

Editor, *QST*:

Three cheers for you at *QST* and *Radio & Television Retailing* for your editorial on "Bum Superhets" which really was swell. I showed this to two BCL's whom I was QRMing on their "big" receivers, and it calmed them right down.

Here at W2MQB we even took one of these 1941 "big" receivers and set it up alongside my 1934 Philco and they saw for themselves. . . .

The unfairness of it all is that we hams are blamed for QRM when a bum-designed receiver is going out of its way to pick up our signals which are minding their own business.

— Donald A. Miller, W2MQB

HAMS AND EMPLOYMENT

Wilton, New Hampshire

Editor, *QST*:

Some months ago there were several letters in *QST* regarding the opportunities for hams in the professional field. It occurred to me that you might find my experiences along this line interesting.

In June 1940 I got my second-class radiotelegraph ticket and set out to find a use for it. United Fruit Company wasn't interested in green operators. Mackay Radio said to see the unions but wouldn't give any information as to where to find them or which one to find. At Radiomarine Corporation I got my name and specifications onto a card which was duly added to the bottom of a considerable stack of similar cards. Also at RCA I got the addresses of the two unions, CTU (Commercial Telegraphers Union, AFL) and ACA (American Communications Association, CIO). The chap who gave me the addresses very properly refused to recommend either union over the other. He merely said it wouldn't do any harm to see them.

ACA was in the same class as United Fruit; they had no jobs for beginners, and ham experience has no official standing. CTU was a little more encouraging. The representative took my name and specifications and said I would probably hear from him sooner or later.

For nearly six months after that I called on RMCA and CTU at odd intervals just to let them know I was still alive. Finally, in December, I got a card from CTU asking if I would take a relief trip on a trawler. I have been riding the trawlers ever since. The answer to the long wait is that no skipper wants to take a green op if he can avoid it, and, after all, I don't blame them now that I know what the op has to do. Just at present there seem to be plenty of jobs for men who have shown themselves to be competent and even for some who haven't. . . .

— Jon Ring, W1HXJ-exWVNZM-WOLC-WBEB-KJGJ

602 W. Callender St., Livingston, Mont.

Editor, *QST*:

. . . Lots of letters printed in *QST* about not being able to crash in, and lots of words passed around that all of *QST* agitation about jobs was bunk. I didn't have any trouble getting one. All I had to do was say "Yes" to the right one. Not all cream, of course, having to come all the way to Montana, but I said I wanted a job, didn't I? Well, if you really want one you take what you get — right? . . .

— Ernest Bracy, W1M0F-W1BFA

EDITOR'S NOTE. — The following letter comes from a well-known (and competent) ham who is now production manager for one of the top-ranking industrial electronic-appara-

tus manufacturing firms. His identity must be withheld, but no name is necessary to certify the merit in his charges.

Editor, *QST*:

. . . One thing that has come up I think may be of interest to you in view of some recent discussion in the Correspondence pages of *QST*. It concerns this business of the all-round usefulness of hams in commercial electronic work. I used to think that a good, all-round ham could be put to work on just about anything using vacuum tubes and be expected to "catch on" right away. Sad experience has not borne this out.

Over the past year I've had quite a number of fellows working at our plant who rated pretty high around here as hams. They simply haven't done well enough. My main complaint against them is that they don't want to do things the way we want them done. They are hired to wire a batch of amplifiers, and immediately they begin pointing out why the equipment is not properly designed; that is, not designed the way they would design it. Because, for commercial or defense reasons, we are unable to go into the reasons for doing things a certain way, they immediately get the idea that we don't know the answers and say so — sometimes to people they shouldn't.

Not enough hams know the most elementary theory. Ohm's Law is a closed book to most of them. Seems silly, but it is true. Why are they so resistant to new ideas? Many of the fellows we have hired here just don't want to learn. Some of them have joined defense classes only to drop out after two or three classes. This is not true of all of them, of course, but it is true of the majority.

I think, more and more, that if the educating influences in ham radio, *QST* for example, directed their influence more toward emphasizing and teaching fundamentals instead of pushing the cut and dried "how-to-make-it" type of article, the general technical level of American ham radio would be greatly improved in a short time. If your editorial effort pushed the importance of learning over the importance of simply gabbing on the air, I think we all would benefit. Your recent editorial, "Shortage of Materials," pleased me no end — for obvious reasons. Now follow it up with another, "Shortage of Brains."

GOT YOURS?

180 East 32nd st., Brooklyn, N. Y.

Editor, *QST*:

I've been on the air for about 8 years now and have been copying plenty of bug fists, commercial tape sending, press, army nets and what have you. Have never had any trouble copying solid in my head (yeah, that's solid too!), but last night really showed me up as a pretty poor copy specialist.

Was doing fine and figured the run was going to be a cinch at 35 w.p.m. until I tried to put it down on paper on the old mill. The certification of my copy will give you a better idea of what I mean. . . .

If my certificate comes through for more than 25 w.p.m. I'll be the most surprised guy in the world, and don't think I'm not going after that 35 sticker. You've offered a challenge to my ego up there at HQ, and as sure as there's soup in the antenna I'll get that endorsement yet.

If any of the gang hasn't yet tried to qualify for the award, don't avoid these transmissions because you think: "That's kid stuff. I've been copying better than 35 for years." Just try putting it down solid on paper and you'll find out the difference between copying on "gray matter" and copying on some of this white stuff they call paper.

— Charles R. Cross, W2FNI



OPERATING NEWS

F. E. HANDY, W1BDI, Communications Mgr.

J. A. MOSKEY, W1JMY, Asst. to the Coms. Mgr.

For Civilian Defense . . . Register Now, and Build u.h.f. Units. Every amateur owes it to himself and his institution of Amateur Radio to add his weight and support to the useful contributions amateur radio may make to the national emergency situation. Letters from hundreds of hams have indicated the desire to engage in amateur work dedicated to defense needs. Now, as indicated by last *QST*, we are going ahead in this. To our Code Proficiency Program and morale-building trainee-traffic work we add this important ability to perform in the event of civilian emergency.

In shaping our amateur radio for possible civilian defense needs we aren't starting from scratch, but will use all amateur facilities we have and extend them in the direction this problem requires. All ARRL programs are designed to develop the maximum value of amateur radio as an instrumentality of public usefulness. Each individual participation in "organized amateur radio" adds to those values that have kept amateur radio a going institution. Our organized *ARRL Emergency Corps* has for years been directed at preparedness for service in communications emergencies due to flood, hurricane, earthquake, etc. in normal times. These aims are being now supplemented by studies to fit Emergency Corps organization to *any civilian defense need* for radio communication. *Every* amateur licensee should be registered for civilian defense, registered in the ARRL Emergency Corps, a part of organized amateur radio! ARRL efforts at once include consideration of civilian defense problems. You are invited and urged to take an active part in civilian defense plans. *Register on ARRL blanks to-day, if you have not already done so!*

Civilian Defense Planning and Building. October ARRL bulletins outlining the League's initial civilian defense program have called upon ARRL Emergency Coördinators to contact the OCD's executive directors or local defense coördinators of their communities, (1) to ascertain the communications programs for each community, (2) to report concisely the status of amateur radio coverage of that locality, and (3) to arrange for supplementing wire service and messenger plans with planned disposition of amateur radio facilities, to be built up through Emergency Corps registrations, and practical tests and building programs. The 3500 amateurs registered in the Emergency Corps are on their toes and give us a fine start, but no less than *every* active amateur

should participate in civilian defense plans insofar as his equipment and operating time permits. Every reader with an amateur license has a place in the Emergency Corps, whether self-powered or not, whether u.h.f. or not, and of course you are even more able to fit in, if you have such equipment. Just fill out and return our Form 7 registration blanks for the Emergency Corps and civilian defense amateur radio availability, and we'll make you a part of the Corps and send more information about civilian defense. *If not already in the AEC, drop a radiogram or postal to Hq. to-day for the AEC¹ registration blanks.*

While awaiting civilian defense and emergency corps data, after returning said blanks, follow the suggestions in *QST* about *building u.h.f. sets and acquiring self-power*. All the needs point in the direction of use of frequencies with a reliable 7- to 10-mile range that can be used simultaneously by roof top watchers, roving rescue and demolition squads, for contact with first aid posts and repair crews, etc., in every city and town in the land without nationwide interference as would result on low frequency. See the suggestions for unit-construction of u.h.f. 112-Mc. rigs, self-powered units and a.c. supply, and standardized plug-on connections for our civilian defense equipments in this and following issues of *QST*. Our immediate civilian defense job is one of registration-and-building to make possible the fullest participation of amateurs in the civilian defense problems and tests of the near future.

Recommend Local Amateur Leaders to SCMs. Numerous club-recommended and group-recommended leaders for amateur emergency and civilian defense radio organizing for different local communities are now receiving appointment. In most cases they are made ARRL Coördinators by the appropriate Section Communications Managers. Wherever there is no local amateur leader representing us to civilian defense local offices this will request active amateurs to continue to suggest and recommend the best qualified local men to SCMs for early appointment! There is local amateur organizing to do, and our Oct. 7th bulletin will be sent to each such leader as appointed.

December 20th FCC Order Effective 3:00 A.M. EST. At that hour and date we amateurs

¹ You can also get ARRL Emergency Corps (Form 7) blanks from your SCM or EC or the nearest Western Union office. Don't delay in registering for the Emergency Corps and possible civilian defense amateur radio.

discontinue use of 3800-3900 kcs., loaning the frequencies for use of the government in the pilot training program, except for specified shared-amateur use in certain northern states in daytime (if no QRM is caused). Starting at this time also 7250-7300 kc. is authorized for radiotelephone (A-3) emission by amateurs holding all classes of operator licenses. A Class A ticket and station must still be held for any work in 75- or 20-meter 'phone bands. With other Dec. 20th changes radiotelephone (A-3) emission is prohibited from the 1800-1900 kc. frequencies in order to promote, permit, and encourage network and traffic activity to transfer at once from the congested and to-be-loaned 80-meter c.w. regions.

January 9th-10th-11th '42 Band-Opening W.A.S. Party Announced. There's no good reason why c.w. operators should not fill 1750-1900 kc. with useful traffic activity right away. There's no point either in awaiting the final FCC orders that loan all the c.w. frequencies above 3650 kc. in the 80-meter band. If you haven't done so before December 20th make that the date to use the General Traffic Period (6:30-8:00 p.m.) for a daily 160-meter work out. Crystals for 10-station 160-meter c.w. networks lined up by SCMs in accord with rules defining 160-m. ARRL nets are still available . . . drop your SCM a line and have him get you into such a group! But, of course, the whole net must be a going concern before the official recognition can be given. Help your SCM to make your Section one of the first with a complete 160-net a going thing.

A band-warming 160-meter W.A.S. Party is announced along the lines of the one we had last February for dates of Jan. 9th-11th inclusive. This is within a month of the December 20 Order and should enable many SCMs to contact capable amateurs to complete their 160-net memberships. Also the occasion will fully demonstrate the fine virtues of this band, which is enough reason for setting the annual activity ahead. Everybody, help open up 160! Make traffic skeds there — and take part in your Section-ARRL Net being organized on that band with SCM-planning to make it cover points for state-wide civilian defense part of the picture too.

5th Annual ARRL QSO Party tentatively set for February 7th-8th. During December and January we are not scheduling many general activities lest these compete with the u.h.f. building program. Plan to complete new workable 2½-meter u.h.f. equipment before February first. Make it a definite station building program for these two months. Every amateur station should be properly u.h.f.-equipped and able to take part in local civilian defense tests. Be ready . . . and expect to see u.h.f. as well as Code Proficiency credit factors turning up in coming activities as extra credits for those pulling their weight in the programs aimed at the national interest and the welfare of the amateur fraternity.

Flash . . . Code-Proficiency-Program Qualifying Runs to be sent from W9HCC in addition to W1AW. Arrangements just completed extend qualifying run coverage by adding the voluntary services of another well-equipped station experienced in sending code practice transmissions by Wheatstone perforated tape at pre-determined speed. Thanks to Mr. Sumner B. Young of W9HCC, amateurs interested in qualification, starting December 7th, may have a choice between additional W9HCC-frequencies and W1AW-frequencies for copying simultaneously-sent *qualifying* runs using duplicate tapes prepared by ARRL for transmission on qualifying dates. The next opportunities for qualifying for ARRL Code Proficiency certificates or endorsement stickers are as follows, and all participating are requested to indicate the station-and-frequency from which copy is submitted to enable us to gauge the increase in coverage of certain areas through the extended schedule.

<i>Dates Qualifying Runs</i>	<i>Time*</i>
Dec. 7	1:30 P.M. EST, 12:30 P.M. CST
Jan. 4	11:30 A.M. MST, 10:30 A.M. PST
Feb. 1	
Dec. 26	9:45 P.M. EST, 8:45 P.M. CST
Jan. 22	7:45 P.M. MST, 6:45 P.M. PST
Feb. 16	
W1AW-frequencies: 1761-3575-7150-14,254-28,510-58,968 kcs.	
W9HCC-frequencies: 3532-7058-14,312 kcs.	

Amateurs sending in copy of one of these stations for certification are requested to mark the particular *one minute of solid copy* that qualifies for endorsement or certification at a particular speed. Taking into account the rate of sending (5-character words and identifying spaces between them) 89, 119, 149, 179 or 209 correct and consecutive characters-and-spaces are required to "make" 15, 20, 25, 30, or 35 w.p.m. speeds. If you count less than the requisite amount of solid copy, send in 100% copy at the next lower speed and avoid receiving a failure card. To be acceptable for checking reception copies must be postmarked before the next qualifying run. If you haven't got your achievement award for Code Proficiency start working for it to-day. Every FCC-licensed amateur is eligible. — F. E. H.

* The starting time for information about qualifying runs is 1:30 p.m. and 9:45 p.m. EST, actual qualifying texts to be copied following this advance notice at 1:45 p.m. and 10:00 p.m. EST respectively.

BRIEFS

We still receive numerous inquiries from amateurs asking why they did not receive a card verifying their contact with KC4. Every QSL which was referred to us for handling has been sent to representatives of the expedition. For the information of those who desire to communicate directly with the KC4USA/B/C operators, we here list their respective mailing addresses: KC4USA — Clay Bailey, CRM USN, Chief Operator, U. S. Antarctic Service, C/O Navy Department, Washington, D. C.; KC4USB — Elmer L. Lamplugh, CRM, U. S. Naval Air Station, Corpus Christi, Texas; KC4USC — St. Sgt. Felix L. Ferranto, First Signal Company, U. S. Marine Base, Quantico, Va.

ARTICLE CONTEST

The article by Mr. Roy Corderman, W3ZD wins the CD article contest prize this month. *We invite entries for this monthly contest.* Regarding subject matter, we suggest that you tell about what activity you find most interesting in amateur radio. Here you will find an almost limitless variety of subjects. Perhaps you would like to write on working for code proficiency, Emergency Corps planning, traffic work, working in Section Nets, 'Phone and Telegraph operating procedures, holding a League appointment, working on radio club committees, organizing or running a radio club, the most interesting band or type of ham activity, or some other subject near to your heart.

Each month we will print the most interesting and valuable article received. Please mark your contribution "for the CD contest." Prize winners may select a bound *Handbook*, *QST* Binder and League Emblem, six logs, eight pads radiogram blanks, DX Map and three pads, or any other combination of ARRL supplies of equivalent value. Try your luck!

Don't Hide Your Light . . .

BY ROY C. CORDERMAN, W3ZD*

MANY centuries ago a wise man said, "Don't hide your light under a bushel." In other words, when you have done something tell the world about it.

As one looks about at those who get ahead and compares them with those who seem to stand still, one often asks, "How is it that John has gone ahead whereas Bill has not; I have always found that Bill knows more about things than John does." Notice that *you* have found it, Bill didn't tell you, you had to ask him.

And so it goes with ham radio. When you do something, tell it. Tell it in full, but stop there, when you have told it all, once, in the right place. When you enter a contest, report your results, good, bad or indifferent. If you don't, when you have done a good job, then the ones who have only done a mediocre job feel that they have been better than they really were and that isn't good for them. When you haven't done so well, report it too; it makes the fellow who has done a good job feel better, when he learns of the true strength of his competition. In any case the total score of all contestants is incomplete if you have not reported your score.

When you have developed a new circuit, a better arrangement of parts, a more efficient antenna, another way of doing something that makes the job or the play easier, tell about it. Our hobby only grows through spreading such information around. Your idea may be patentable; if so, tell it to a good patent attorney, and after you are proceeding to a patent, if you will tell about your idea in the right places, at the right time it will help you to sell it. When your idea is not patentable, tell the gang about it, so that all may benefit through the improvement born in your mind. Even though others improve upon your ideas and patent it to their own gain, don't cry about it, for it would have died had you not told it and the world would have had to wait for someone else to bring it forth again.

Now that civilian shortage threatens our advancement as well as our continued operation, we are going to have to originate some of our parts from the rough. Of course, we are not equipped to build tubes, but some ham may find a way to do without tubes. Should you find such a way, or even have an idea of such a way, and you are not able to go further with it, tell it to someone who can assist you in bringing the new way to life. Your country needs your idea, your fellow ham needs it, and all of humanity may benefit by it. If you can't write, tell it to someone who can.

* 4401 Leland St., Chevy Chase, Md.

When you have handled traffic through a local emergency, or when you have just stood by, keeping the channels clear, tell it to your local newspaper. If you consider it unimportant that the public hear about you, then remember it's good for ham radio, for the whole gang, to have your home folks know that ham radio serves or is ready to serve.

When you have participated in a contest, when you handle ordinary traffic, when you organize an emergency group, or develop records of emergency equipment, when you find a way to keep a better or simpler log, when you hook up a circuit that takes fewer parts or uses substitutes or does a better job, in short, if you have helped ham radio move ahead, put it down on paper where others can see it, or shout it from the housetop. Our good old game lives and grows through your telling it.

Beginners' Code Practice

THE following operators, working in the 1750-ke. band, have volunteered code practice for the benefit of beginning amateurs. *QST* will publish additional schedules as other amateurs volunteer their services. A mimeographed list of code practice stations and code-learning helps is available from ARRL Headquarters. Beginning amateurs are invited to send a postal for a copy.

W1MXT, Maine, 1950 kc., Tues., Thurs., Sat., 6:30-7:00 P.M. EST

W2NCC, New Jersey, 2000 kc., daily, except Sun., 10:30-11:00 P.M. EST

W3INH, Pennsylvania, 1790 kc., Fri., Sun., 6:30-7:00 P.M. EST

W5AT, Texas, 1923 kc., Mon., Tues., Wed., Thurs., 8:00-8:45 P.M. CST

W5EIB, Texas, 2028 kc., Mon., Thurs., 8:00-8:30 P.M. CST

W6APG, BKZ, CHV, DUP, NWG, Palomar Radio Club, Calif., 1900 kc., Mon. through Fri., 7:00 P.M. PST

W7IGZ, Washington, 1977 kc., Tues., Thurs., 2:00-4:00 P.M. PST

W8TQA, Michigan, 1787 kc., Mon. through Fri., 6:15-6:45 P.M. EST

W9BHY, Minnesota, 1910 kc., Mon., Tues., Wed., 6:00-7:00 P.M. CST

W9BSP, Kansas, 1903 kc., daily, 7:30-8:30 P.M. CST

W9ULO, Illinois, 1759 kc., Sun., Mon., 6:45-7:15 P.M. CDST

W9YMV, Indiana, 1940 kc., Mon., Thurs., 6:15-6:45 P.M. CST

— * * * —
WRUL, the station of the World-Wide Broadcasting foundation, announces that it is conducting code lessons every Monday night on 6.04 and 11.73 Mc. A beginners' session is held at 6:30-7:00 P.M. EST, and lessons for advanced students are sent at 10:15-10:45 P.M. EST. There is a registration fee of one dollar. Since WRUL is a non-commercial and non-profit organization, this fee covers merely the cost of printing and mailing the course material. Enrollment gives the student the privilege of having his weekly tests and his final examination corrected. Application for enrollment may be made by writing to World Radio University, Care University Club, Boston, Mass.

BRIEFS

NY4AD, operated at Guantanamo Bay, Cuba, for the past two years was shut down in September. The op, T. O. Moore, ex-W6OLD, has a few cards left and will send one to anybody who didn't receive theirs. Address is 1273 E. Avery St., Pensacola, Florida.

— * * * —
Roger Parnell, the feller who gave so many DX hounds a new country by working from Johnston Island as KE6SRA, is now located at New London, Conn., and wants the word passed around that he will send along a QSL to anyone worked who missed out on the cards sent from Johnston. Write him at U.S.S. *Semmes*, C/O Postmaster, New York City.

W1AW Operating Schedule

Effective November 25th

OPERATING-VISITING HOURS:

2:00 P.M.-2:00 A.M. EST daily, except Saturday-Sunday.
Saturday and Sunday-7:00 P.M.-1:00 A.M. EST.

Frequencies and Times

OFFICIAL BROADCAST SCHEDULE, sending addressed information to all radio amateurs.

C.W.: 1761-3575-7150-14,254-28,510-58,968 kc. (simultaneously).

Starting Times (P.M.)		Speeds (W.P.M.)								
EST	CST	MST	PST	M	T	W	Th	F	Sat	Sun
8:30	7:30	6:30	5:30	20	15	25	15	20	—	20
Midnight	11:00	10:00	9:00	15	25	15	20	15	15	—

'Phone: 1906, 3952, 14,237, 28,510, 58,968

All voice transmission marked * under "general operation" starts off a period of general ham contact on the given frequency. The operator, when sending OBC on more than one band, listens for replies on the frequency indicated after transmissions at the times marked *.

'PHONE:

Frequency	Time EST
1906 kc.	*6:30 P.M., 12:45 A.M.
3952 kc.	*9:15 P.M., 12:30 A.M.
14,237 kc.	2:30 P.M., *4:30 P.M.
28,510 kc.	*2:00 P.M., 8:00 P.M.
58,968 kc.	2:00 P.M., *6:00 P.M., 9:15 P.M., 12:30

CODE PRACTICE: Besides the OBS times and word-speeds given above, W1AW will adhere to a schedule for sending code practice transmissions at progressively increasing speeds (15 to 35 w.p.m. in 5 w.p.m. steps) daily except Friday, starting at 9:45 P.M. EST. The Proficiency Certificate Award qualifying runs, after a 15-minute advance notice at 9:45 P.M. EST, start at 10:00 P.M. EST, December 26th and January 22nd. Daytime runs for qualification, after preliminary call at 1:30 P.M. EST, start at 1:45 P.M. EST on December 7th and January 4th. Effective December 7th, W9HCC will transmit official qualifying runs on a similar schedule simultaneously on 3532, 7058 and 14,312 kc.

GENERAL OPERATION: Besides specific schedules in different bands, W1AW devotes the following periods, except Saturdays and Sundays, to GENERAL work in the following bands:

Time EST	Frequency
*2:00 P.M.-2:30 P.M.	28,510-kc. 'phone
3:30 P.M.-4:00 P.M.	7150-kc. c.w.
*4:30 P.M.-5:00 P.M.	14,237-kc. 'phone
*6:00 P.M.-6:30 P.M.	58,968-kc. 'phone
*6:30 P.M.-7:00 P.M.	1906-kc. 'phone
7:30 P.M.-8:00 P.M.	14,254-kc. c.w.
*9:15 P.M.-9:45 P.M.	3952-kc. 'phone
12:45 A.M.-1:15 A.M.	1906/1761-kc. 'phone/c.w.
1:15 A.M.-2:00 A.M.	3575-kc. c.w.

6:45 P.M.-7:30 P.M.: Schedules on 3500-kc. band.

9:45 P.M.-11:00 P.M.: Code Practice, all c.w. freqs.

11:00 P.M.-Midnight: National Trunk Line Net, NCS.

At other times, and on Saturdays and Sundays, operation is devoted to the most profitable use of bands for general contacts and to participation in special week-end operating activities. The station is not operated on legal national holidays.

W3BES, SCM of the E. Pa. Section was recently the proud poppa of a junior op whom he named Howard Allen Mathis!

Brass Pounders' League

(September 16-October 15)

Call	Orig.	Del.	Rel.	Extra Del. Credit	Total
W6FWJ	481	443	1942	426	3292
W7EBQ	216	347	1790	255	2608
W3FJU	131	53	1890	34	2108
W5FDR	214	263	1278	240	1995
W5OW	193	39	1228	208	1668
W4PL	22	98	1382	95	1597
W2SC	46	133	1177	55	1411
W6LUJ	327	491	96	485	1399
K7HZM	0	0	1339	0	1339
W9BNT	577	135	539	24	1275
W3BNT	63	103	1009	97	1272
W2LPJ	1024	37	83	102	1246
W9BNT*	550	118	511	28	1207
W9DIR	38	119	817	107	1081
W9OZN	9	2	1004	1	1016
W8INU	16	87	762	82	947
W9HHN	9	82	673	46	810
W8DAQ	2	57	664	57	780
W2BO	42	64	544	52	702
W5DNX	0	0	670	0	670
W5MN	50	92	442	80	664
W4DD	0	0	663	0	663
W5DWW	0	51	538	51	661
W91/A	344	127	46	118	635
W3CIZ	2	6	620	6	634
W4JR	8	70	478	65	621
W6IOX	20	32	524	30	606
W9IHL	14	72	486	31	603
W9QKL	14	66	516	4	600
W9MIN	43	17	517	9	586
W8CFL	7	28	528	17	586
W4AOB	14	49	457	49	569
W9BRD	35	84	366	73	558
W8JF	7	10	526	7	550
W8IGW	5	11	512	10	538
W2MNT	31	48	412	40	531
W8SAY	25	21	458	18	522
W9GFF	10	39	446	22	517
W6DH	51	88	331	43	513

MORE-THAN-ONE-OPERATOR STATIONS

Call	Orig.	Del.	Rel.	Extra Del. Credit	Total
K1IHR	1504	1290	120	998	3912
W3USA	154	114	2682	114	3064
W1AW	32	197	471	190	890

These stations "make" the B.P.L. with total of 500 or over. One hundred deliveries + Ex. Del. Credits also rate B.P.L. standing. The following one-operator stations make the B.P.L. on deliveries. Deliveries count.

W2KI, 230	W6KOL, 148	W8JHW, 110
W6BHV, 230	W8TZD, 140	W5CEZ, 108
W2DW, 219	W4GT, 126	W2CGG, 106
W3FGJ, 196	W1MIN, 124	W3GNY, 104
W5EGE, 188	W3JAS, 121	W6NRP, 104
W8UFH, 182	W2BGV, 117	W5BR, 102
W6ZX, 175	W1JCK, 115	W5DGU, 102
	W9PSP, 113	

A.A.R.S.

Call	Orig.	Del.	Rel.	Extra Del. Credit	Total
WLN (W2SC)	22	52	479	36	589

MORE-THAN-ONE-OPERATOR STATION

Call	Orig.	Del.	Rel.	Extra Del. Credit	Total
WLM (W3USA)	222	143	3210	143	3718

A total of 500 or more or 100 deliveries + Ex. D. Cr. will put you in line for a place in the B.P.L.

* Aug.-Sept.

Through oversight reports on the participation of several stations in the Red Cross/ARRL Preparedness Test failed to reach us for inclusion in the results published on page 57 of October QST. The following stations handled messages with totals as indicated: W9KEF, 175; W9FUZ, 23; W8PUN, 12; W1EHT, 10; W1EKT, W7FCG, 7; W1KBQ, W6KWI, 2; W1DDP, WIHUV, W1MDN, W1SI, 1. The

work of PAM W9KEF was particularly outstanding and his 3903-ke. net deserves much credit for its efficiency in handling messages from 57 of the 68 Red Cross chapters assigned.

ELECTION NOTICES

To all A. R. R. L. Members residing in the Sections listed below: (The list gives the Sections, closing date for receipt of nominating petitions for Section Manager, the name of the present incumbent and the date of expiration of his term of office.) This notice supersedes previous notices.

In cases where no valid nominating petitions have been received from A. R. R. L. members residing in the different Sections in response to our previous notices, the closing dates for receipt of nominating petitions are set ahead to the dates given herewith. In the absence of nominating petitions from Members of a Section, the incumbent continues to hold his official position and carry on the work of the Section subject, of course, to the filing of proper nominating petitions and the holding of an election by ballot or as may be necessary. Petitions must be in West Hartford on or before noon of the dates specified.

Due to a resignation in the San Joaquin Valley Section, nominating petitions are hereby solicited for the office of Section Communications Manager in this Section, and the closing date for receipt of nominations at A. R. R. L. Headquarters is herewith specified as noon, Monday, December 1, 1941.

Section	Closing Date	Present SCM	Present Term of Office Ends
W. New York	Nov. 17, 1941	Fred Chichester	Dec. 6, 1941
San Joaquin Valley	Dec. 1, 1941	Edwin A. Andress (resigned)
Philippines	Dec. 1, 1941	George L. Rickard	Oct. 15, 1938
Kentucky	Dec. 1, 1941	Darrell A. Downard	Apr. 15, 1940
New Mexico	Dec. 1, 1941	Dr. Hilton W. Gillett	Apr. 15, 1941
Sacramento Valley	Dec. 1, 1941	Vincent N. Feldhausen	June 15, 1941
Hawaii	Dec. 1, 1941	Francis T. Blatt	Feb. 28, 1941
Md.-Del.-D. C.	Dec. 1, 1941	Hermann E. Hobbs	Sept. 17, 1941
Wisconsin	Dec. 1, 1941	Aldrich C. Kropes	Dec. 18, 1941
Nevada	Dec. 15, 1941	Edward W. Heim	Nov. 1, 1941
Oklahoma	Dec. 15, 1941	R. W. Battern	Nov. 1, 1941
E. New York	Dec. 15, 1941	Robert E. Haight	Nov. 1, 1941
So. Texas	Dec. 15, 1941	Horace E. Biddy	Dec. 23, 1941
Louisiana	Dec. 15, 1941	W. J. Wilkinson, Jr.	Jan. 2, 1942
Eastern Mass.	Mar. 2, 1942	Frank L. Baker, Jr.	Mar. 11, 1942

1. You are hereby notified that an election for an A. R. R. L. Section Communications Manager for the next two-year term of office is about to be held in each of these Sections in accordance with the provisions of the By-Laws.

2. The elections will take place in the different Sections immediately after the closing date for receipt of nominating petitions as given opposite the different Sections. The Ballots mailed from Headquarters will list in alphabetical sequence the names of all eligible candidates nominated for the position by A. R. R. L. members residing in the Sections concerned. Ballots will be mailed to members as of the closing dates specified above, for receipt of nominating petitions.

3. Nominating petitions from the Sections named are hereby solicited. Five or more A. R. R. L. members residing in any Section have the privilege of nominating any member of the League as candidate for Section Manager. The following form for nomination is suggested:

(Place and date)

Communications Manager, A. R. R. L.
38 La Salle Road, West Hartford, Conn.
We, the undersigned members of the A. R. R. L. residing in the Section of the Division hereby nominate as candidate for Section Communications Manager for this Section for the next two-year term of office.

(Five or more signatures of A. R. R. L. members are required.)
The candidates and five or more signers must be League members in good standing or the petition will be thrown out as invalid. Each candidate must have been a licensed amateur operator for at least two years and similarly, a member of the League for at least one continuous year, immediately prior to his nomination or the petition will likewise be invalidated. The complete name, address, and station call of the candidate should be included. All such petitions must be filed at the headquarters office of the League in West Hartford, Conn., by noon of the closing date given for receipt of nominating petitions. There is no limit to the number of petitions that may be filed, but no member shall sign more than one.

4. Members are urged to take initiative immediately, filing petitions for the officials of each Section listed above. This is your opportunity to put the man of your choice in office to carry on the work of the organization in your Section.
— F. E. Handy, Communications Manager

ELECTION RESULTS

Valid petitions nominating a single candidate as Section Manager were filed in a number of Sections, as provided in our Constitution and By-Laws, electing the following officials, the term of office starting on the date given.

Western Florida	Oscar Cederstrom, W4AXP	Oct. 1, 1941
Eastern Florida	Carl G. Schaal, W4PEI	Oct. 15, 1941
Missouri	Robert C. Morwood, W9QMD	Oct. 19, 1941
West Virginia	Kenneth M. Zinn, W3JRL	Nov. 21, 1941



Meet the S.C.M.'s

BY DR. H. W. GILLETT, W5ENI

S.C.M. New Mexico has been active in amateur radio since 1928 when he obtained his first license. At present located in Lovington, N. M., he formerly held the call W2BWW and W8DMJ. W5ENI is RM, has been ORS for seven years and SCM for three years, holds WAS and A-1 Operator Club certificates. The station layout consists of a modified Harvey 200-R using 6A6-42-813 at 250 watts and the receiver is an RME-69. A gas-driven 110-volt a.c. generator is on hand to run a 6L6-807 rig and the regular station receiver in emergency. "Doc" works mostly on 3703 kc., though occasionally he drops down to 7- and 14-Mc. c.w. He is a member of the Army Amateur Radio System and holds the special call WLJI. His hobbies include chess, baseball and cryptography. Profession: Physician and surgeon.

Trainee Traffic Stations

THE following is a supplement to the list published on page 64 of October QST and page 60 of November QST. Drop a line or send a radiogram to the Communications Dept., giving your call, address, frequency, operator names, and traffic outlets.

K6SYM/K6 — Gerry Hobbs, Pearl Harbor, T. H., schedules W6FWJ and delivers all traffic received by mail.

K7IZK/K7 — Roy V. Williams, Fort Lewis, Washington, operates practically every day.

W5DGU — Theo W. Mozart, near Camp J. T. Robinson, Little Rock, Ark., operates daily on 3.5 Mc.

W6TTP — Frank M. Quiggins handles traffic for the Tucson Air Base.

W9HWW — Camp Robinson, Ark., schedules W9ZPQ and W9JXG at 4 p.m. CST on 7076 kc.

W3JPM — L. W. Buckalew, Jr., Fort George G. Meade, Maryland, will have ORS schedules and operate WLQB in AARS for long-haul traffic.

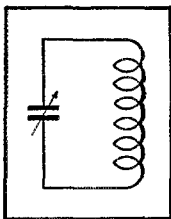

WE LIKE to put input ratings on our tanks as a guide to the amateur who is laying out a rig. The AR-16 coils with TMK condenser are rated at 50 watts plate input, and the 5-B-100 at 100 watts, for instance. These ratings were determined with care under normal operating conditions and are conservative. Occasionally one of these tanks will arc over or overheat, even though the rated input is not exceeded. This is not because the tank is faulty, nor is it due to optimistic ratings. The trouble is

that the rating does not tell the whole story.

The plate input to a stage is partly dissipated in heat in that stage. Some of the power is delivered to an external load. This is particularly true of the final, where about 35% of the input is dissipated by the plates, and maybe 5% by the tank. The remaining 60% is radiated elsewhere by the antenna, to the neighbor's gutter pipe, for instance. If the load is removed from the final, it is obvious that the tubes and tank can no longer handle the same input. No matter how efficient they are, all the input is converted to heat for there is nowhere else for it to go.

Disconnecting the load from the final amplifier may or may not cause trouble, as most hams know. There is always a large increase in RF voltage across the tank which increases the current and the heating. At the same time, the input decreases as shown by the dip in plate current, and becomes equal to the losses in the tank and at the plates. The voltage rise across the tank depends on so many variables that we will not give figures. The important thing is that it rises a lot and the prudent amateur will allow some margin of safety when designing the rig. Most hams have learned this from experience.

What many hams have not learned is that abnormal conditions can give the tank real punishment. Suppose the new final is connected to the new antenna, and the plate input is found to be much too low. In such a case, many amateurs will step up the plate input (by reducing bias, raising plate voltage, etc.) until the tubes draw the desired input. If the tank blows up at this point, almost everything is damned except the antenna which may not have been taking power from the tank. Next time adjust the final with a dummy antenna, to save equipment as well as QRM. Then connect the antenna. *If the input is too low, adjust the antenna.*

The same thing applies to exciters and buffers. Plenty of excitation is fine, but 50 watts input to a buffer that is supplying 5 watts is just punishing the buffer tank.

Of course, coils should be rated in watts dissipation, just as condensers are rated by peak voltage and tubes are rated by plate dissipation. Such a rating would save the manufacturer from occasional recriminations, but it would not be as convenient for most amateurs as the watts input rating. So we will stick to the latter rating and hope that this explanation will save misunderstanding.

CALVIN HADLOCK



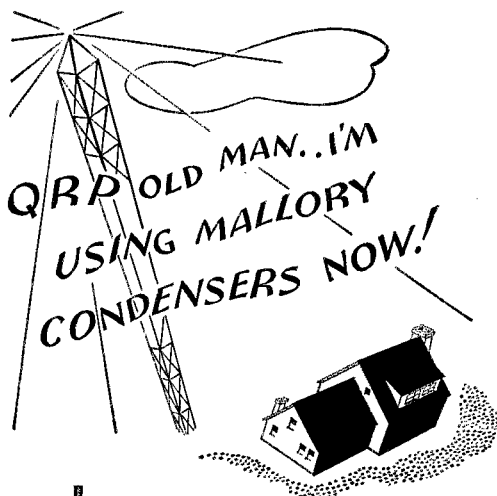

WELL maybe he's "slightly" over enthusiastic, but that's a natural condition when you use Mallory Condensers. Take Mallory condensers Type FP or BB for example. Both are made with Special High Ratio Anode Plate construction... the method that has led the way to startling compactness in condenser sizes and set up brand new standards for efficiency and long lived performance.

When you choose Mallory FP or BB type condensers you can go the whole distance in getting the capacity you need to do a real job. Smaller sizes make it unnecessary to cut corners on needed capacitance. Try Mallory in the set you are planning now!

MALLORY NOISE FILTERS

Use this proven way to eliminate man made static from nearby arcing electrical appliances. Mallory Noise Filters are inexpensive, easy to apply... and each is engineered for specific conditions. Write today for Form NF-100.

P. R. MALLORY & CO., Inc.
INDIANAPOLIS INDIANA
 Cable Address—Pelmallo

Use
P. R. MALLORY & CO. Inc.
MALLORY
 APPROVED
 PRECISION PRODUCTS

W1AW Sending Practice Subjects and Qualifying Runs

Daily-except-Friday W1AW Code Practice starts at 9:45 P.M. EST. Simultaneous transmission on: 1761, 3575, 7150, 14,254, 28,510, 58,960 Kc.

THE subjects given below will be followed each Sunday, Tuesday, and Thursday, November 18th to January 1st, and the text is identified to make sending practice available. To get sending help, hook up your own key and buzzer or audio oscillator, turn to the *QST* material, tune in W1AW, and attempt to send right in step with the tape signals. Adjust your spacing in the manner the received signal indicates necessary for improvement.

Date	Subject of Practice text from Nov. <i>QST</i>
*Nov. 18	YLRL, QRVI, p. 22.
Nov. 23	Evening Qualifying Run, 9:45 P.M. EST. Un-announced copy.
*Nov. 25	YLRL, QRVI, last par., p. 34.
*Nov. 27	A 56-Mc. Transmitter for Mobile Work, p. 50.
*Nov. 30	An Inexpensive Automatic Line-Voltage Regulator, p. 26.
Dec. 2	"It Seems to Us —", p. 7.
Dec. 4	"It Seems to Us —", first par., second col., p. 8.
Dec. 7	Daylight Qualifying Run, 1:30 P.M. EST. Un-announced copy. Also sent from W9HCC at same time on 3532-, 7058-, and 14312 kcs.
Dec. 7	Two U.H.F. Receivers Using the 9000 Series Tubes, p. 10.
Dec. 9	An Antenna Tuner for the Beginner, p. 18.
Dec. 11	A Soldier's Portable, p. 22.
Dec. 14	U.S.A. Calling, p. 28.
Dec. 16	More Meaning in Your Signal Reports, p. 30.
Dec. 18	A Mobile Transmitter for 2½ Meters, p. 36.
Dec. 21	Texas Hurricane Finds Hams Ready, p. 39.
Dec. 23	Vibrator Power Supplies, p. 44.
Dec. 26	Evening Qualifying Run, 9:45 P.M. EST. Un-announced copy. Also sent from W9HCC at same time on 3532, 7058 and 14312 kcs.
Dec. 28	Hints and Kinks, p. 52.
Dec. 30	A Coupling Unit for Continuous Antenna Rotation, p. 15.

* October, 1941, *QST*.

Arizona-New Mexico Flood Work

ON September 29th, the towns of Duncan, Arizona, and Virden, New Mexico, were isolated by flood of the Gila River.

The first report of conditions came shortly before 7 p.m. when W6QNC at Safford, a member of the ARRL 1.75-Mc. Section Net, came on the air and promptly contacted W6RLC, NCS at Jerome, and proceeded to outline the situation in the flood area. Despite the fact that regular weekly net drill is usually held at 8:15 p.m. on Monday, it was not more than a few minutes until several other members had checked in and an emergency net had been formed. W6TVU in Phoenix, the State capital, was among the first to check in and immediately contacted by telephone the State Highway Dept., Sheriff's Office, U. S. Weather Bureau, Red Cross and other State

24 hour SERVICE!

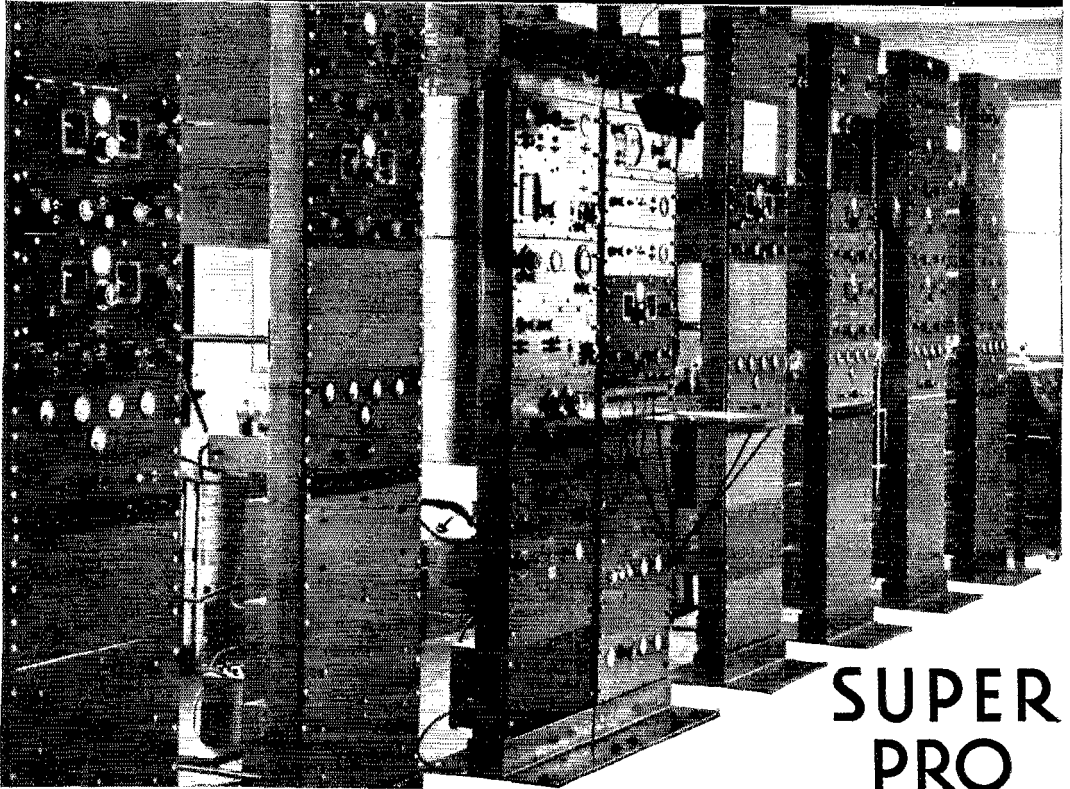

SUPER PRO

EVERY hour of the day and night, in all parts of the world, news pours through Super-Pro receivers at hundreds of words a minute. Many of these press receivers have been in service for 5 and 6 years, and are still giving trouble free performance. The new series 200 Super-Pro has all the outstanding features of the older models plus a number of improvements. Today, no matter what the requirement, you'll find the

Super-Pro has everything necessary to do a good job over a long period of time.

SEND FOR FREE BOOKLET!

HAMMARLUND MFG. CO., INC.
424 W. 33 Street, New York City

Q-12

Please send "Super-Pro" booklet

Name

Address

City.....State.....



HAMMARLUND MFG. CO., INC.

424-438 WEST 33rd ST., NEW YORK

CANADIAN OFFICE: 41 WEST AVE. NO., HAMILTON, ONTARIO



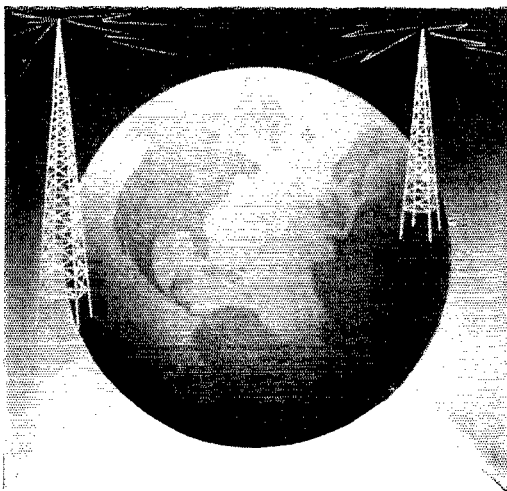

“ . . . AND WE HOPE
THERE WILL ALWAYS BE
A **KENYON** ”

One of the greatest reasons for Kenyon's leadership has been its consistency of quality and dependability. . . .

Day after day our many customers, the blue blood of the electrical industry, say to us, "We hope there will always be a Kenyon."

These companies by past experience and justified faith have come to rely heavily upon Kenyon products. We take that responsibility seriously . . . and to the best of our ability, there will always be a Kenyon.

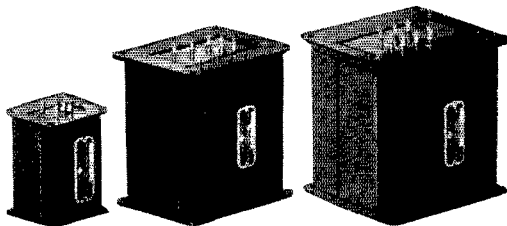

KENYON TRANSFORMER CO., Inc.

840 BARRY STREET

NEW YORK, N. Y.

Cable Address: "KENTRAN"—New York

officers and offices. Exchange of traffic between the various departments and their representatives in the flood area was then effected. Due to a freak skip in the early part of the evening, all communications between W6QNC in Safford and W6TVU in Phoenix were relayed by W6RLC and other stations in the northern part of the State.

Between transmissions on the frequency, practically all net stations checked in with offers to assist in handling traffic and in any other possible way. While the nature of traffic handled during the early part of the evening prevented many of the other net stations from taking active part, all assisted in maintaining a clear channel for emergency use and some outside-bound traffic was routed through them.

Shortly after 8 p.m., W5IAQ, Virden, was heard by a member station calling "CQ Emergency" on 1803 kc. and was immediately contacted by the NCS. W5IAQ was operating on emergency power from a 200-watt kc. generator driven by the fan belt on his car and opened up with a barrage of personal messages from the people of Virden, assuring friends and relatives at outside points that all was OK there. W5IAQ also assisted the U. S. Weather Bureau and other officials by keeping close watch on the Gila River as it flowed past Virden; in this way they were able to estimate the probable additional rise and fall of flood waters before they reached Duncan and other points farther down the river. Amateur radio, emergency-powered, served as the only means of outside contact during the better part of two days for the isolated resident of Virden.

W6ROD, assisted by other amateurs of the Pima Valley, assembled complete emergency-powered equipment early Monday night and proceeded by truck to Duncan. However, by the time they had arrived there the telephone crews, after working all day Monday, were finally able to clear one wire into Safford for emergency use and the urgent need for communication was no longer necessary. The amateurs laid aside their equipment temporarily to assist with other work that was perhaps more important.

ROD and his assistant set up their equipment and got on the air shortly after midnight to contact W6QNC and report that everything was OK there.

As NCS for the Arizona ARRL 1.75-Mc. Section Net and as 1.75-Mc. PAM, I would like to express my gratitude and appreciation to all members of the Arizona Net for their cooperation and to countless other amateurs outside the State who stood by during the entire emergency and assisted in keeping 1836 and 1803 kc. free from interference.

Among those taking part in the emergency, which was the first in Arizona since the organization of the 1.75-Mc. Net, were the following: W6RQX, W6SCK, W6TUW, W5IAQ, W6QNC, W6ROD, W6OZM, W6QJL, W6TYD, W6TVU, W6UAF (relief op at W6QNC), W6RLC, W6QDD and W6TRO.

One thing that was definitely shown by this emergency is that the development and maintenance of a net is well worth the time and

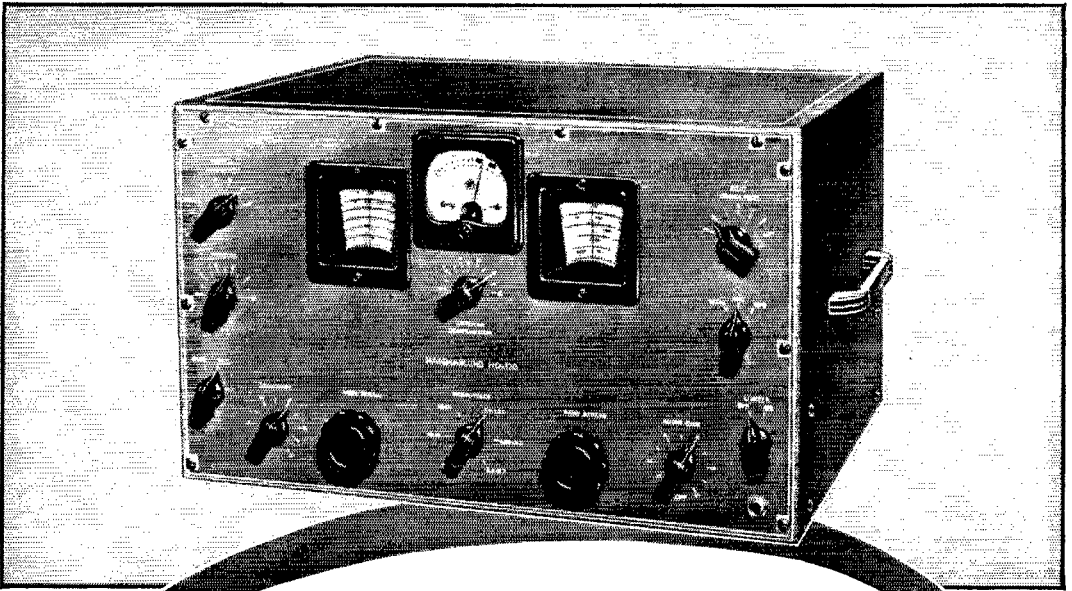

IDEAL!
for 40 meter
PHONE...



THE new 40-meter phone band is going to be crowded, and to get the most out of this new privilege it's going to require a receiver with a crystal filter designed for phone reception. Those who already own "HQ" receivers, will find themselves well prepared for this new phase of amateur radio. The six point selectivity of the "HQ" receiver covers a smooth range from 3 kc to better than

THE
HQ-120-X

100 cycles. Four degrees of selectivity are available for phone alone, and each is free of pulling, interlocking and spurious responses. A stable oscillator and tuning unit are just as important as a good filter. In the "HQ" a specially designed communications type tuning condenser, voltage regulation and temperature compensation all add up to give perfect 40-meter phone performance.

WRITE DEPT. Q-11 FOR "HQ" BOOKLET

H A M M A R L U N D

THE HAMMARLUND MFG. CO., INC., 424 WEST 33RD STREET, NEW YORK CITY, N.Y.

have fm now!

with a Meissner FM CONVERTER

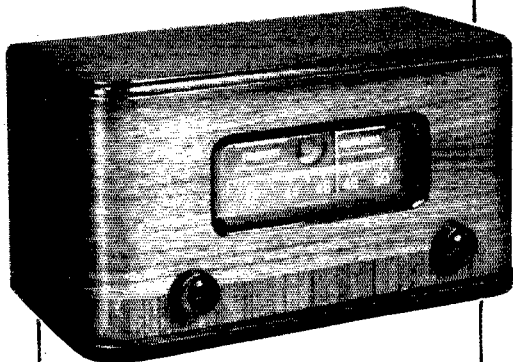

Why Wait!— You can have FM right now on any radio with a Meissner converter. Especially designed for FM reception, includes high-gain RF stage, mixer-oscillator, two stage IF channel, limiter, discriminator and second detector. The power output and quality of tone are limited only by the capabilities of the audio equipment in the regular receiver. Extremely simple to install — comes complete, ready to operate, with tubes, detailed instructions, circuit diagram and voltage chart. FM converter No. 9-1047 \$44.95 (list)

SIGNAL SHIFTER

Amateurs everywhere praise the Meissner Signal Shifter for its remarkable stability. Permits instant frequency change in any given band — right from the operating position!

Supplied complete, ready to operate,

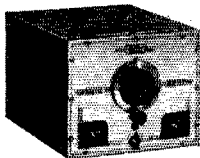

with tubes and set of 3 coils for any one amateur band, and with full instructions for installation and operation. Only \$52.25 net to the amateur.



MT. CARMEL, ILLINOIS

"PRECISION-BUILT PRODUCTS"

effort. Even though the Arizona 1.75-Mc. Net does cover a great portion of the State, membership is now needed more than ever in a great many of the larger cities such as Bisbee, Douglas, Yuma, Nogales, Flagstaff, Kingman, Prescott and others. We appeal to other Arizona amateurs to get on 1.75 Mc. in the needed districts. The frequency is 1836 kc. (1955 after change), the time 7 p.m. daily except Sunday, and the weekly drill is held at 8:15 p.m. on Monday.

— R. E. Lawrence, W6RLC, PAM 1.75 Mc.

112-Mc. Apparatus

(Continued from page 13)

impedance of 70 ohms. In addition, it has a broad resonance characteristic and is therefore well suited to working anywhere in the band.

To avoid the necessity for special switching or the use of low-capacity low-loss relays and auxiliary transmission lines, the use of separate antennas for transmission and reception is advisable when the equipment is used under emergency conditions and quick changeover is an important operating feature. These may be of the same type, but preferably should be erected at least a couple of wavelengths from each other to minimize pick-up and reradiation with accompanying directional effects. With two antennas, a single switch (the d.p.d.t. unit on either the receiver or modulator) provides all the send-receive switching necessary.

This, then, is the general outline of what the equipment ought to be designed to accomplish, and the specific means by which all the 112-Mc. emergency apparatus in a community can be coordinated to produce the maximum of emergency communication. If you have equipment capable of meeting the power supply specifications it is a simple matter to revamp it for interconnection and thereby fit it into the general picture, ready for service when the necessity comes. If you're an old hand on 2½, your pet circuits certainly can be worked into the general framework with ease. Finally, if you're an absolute novice at ultra-high frequencies, suitable equipment designs will be coming up right along in *QST*. We can make a place for ourselves in this civilian defense pattern if we prepare ourselves to do an adequate job — and then insist on the right to do it!

On the Ultra Highs

(Continued from page 54)

pair of 35TG's and an HY-615 receiver — just as a suggestion.

"They do it with mirrors, why not with u.h.f. signals?" Such is the reasoning of W5JGV, Hurley, New Mexico, who wonders if it would be possible to erect a 112-Mc. "mirror" up in the mountains at a point which is nearly a clear-vision shot into Tucson, Ariz.; and, by focusing his beam on this mirror-array, bend 2½-meter signals over the mountains into Tucson. There's one way to find out, but Wayne would like to know if it has ever been done.

In a 75-meter QSO with W8AKR, Breedsville, Mich., W9PNV, Riverside, Ill., had him listen on 2½, a cross-band QSO resulting. W8AKR also heard W9LLM, when Frank was testing with an antenna only three feet off ground! W9LLM, with W9ZZF, is out to promote some 224-Mc. activity in the Chicago Area. Frank has had to supply the receiver for cross-band contacts heretofore.



Vacuum Tube PERFORMANCE begins on Eimac's own MACHINES

Eimac tubes are different. Different in their outstandingly superior performance capabilities... the shapes of the bulbs... the rugged design and the materials used. They are the only tubes on the market which are unconditionally guaranteed against premature failures which result from gas released internally.

So exacting are the production requirements for Eimac tubes that the tools are specially made in the Eimac factory. The glass lathes... the vacuum pumps... there's many a "gadget" so unusual that procurement from a conventional tool maker is impossible.

Follow the leaders to

Eimac
TUBES

Eitel-McCullough, Inc.
San Bruno, Calif.

EIMAC REPRESENTATIVES

California, Nevada
HERB BECKER, 1530 W.
104th St., Los Angeles, Cal.

N. Y., N. J., Penn., Md., Del.,
Dist. of Col., Maine, N. H.,
R. I., Conn., Mass.

ADOLPH SCHWARTZ, 262
Grayson Place, Teaneck, New
Jersey.

Wash., Ore., Idaho, Mont.
GENERAL SALES CO.,
Verner O. Jensen, 2605-07
Second Ave., Seattle, Wash.

Colo., Wyo., New Mexico,
Arizona, Utah

RICHARD A. HYDE, 4253
Quitman St., Denver, Colo.

Chicago, Illinois, Wisconsin
G. G. RYAN, 549 W.
Washington Blvd., Chicago,
Ill.

N. Caro., S. Caro., Georgia,
Tenn., Flor., Ala., Miss.

JAMES MILLAR, 316 Ninth
St. N. E., Atlanta, Georgia.

Texas, La., Okla., Ark.
J. EARL SMITH, 2821 Live
Oak St., Dallas, Texas.

Ohio, Mich., Ky., Ind., Minn.,
Mo., Kan., Neb., Iowa

PEEL SALES ENGINEER-
ING CO., E. R. Peel, 154
E. Erie St., Chicago, Ill.

Export Agents: Frazar & Co., Ltd., 301 Clay Street, San Francisco

FOR THE FINAL!

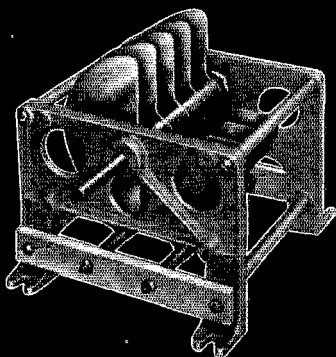

TML CONDENSER

Moisture-resistant Isolantite insulation, thick plates with rounded and polished edges, rigid cast aluminum end plates . . . every feature adds up to permanently high efficiency in the rig. Built in single and double stator models, in capacities from 50 to 500 mmf, and with voltage ratings of 7500, 10000, 15000 and 20000 volts.



Type N DIAL

The four-inch N Dial has an engine divided scale and vernier of solid nickel silver. The vernier is flush with the scale. The planetary drive has a ratio of 5 to 1, and is contained within the body of the dial.

R-175 CHOKE

Suitable for parallel feed as well as series feed in transmitters with plate supply up to 3000 volts modulated or 4000 volts unmodulated. The reactance of the R-175 is high throughout all amateur bands from 10 to 160 meters, inclusive.



NATIONAL COMPANY, INC.

MALDEN



MASS., U.S.A.

112-Mc. Transmitter

(Continued from page 19)

The Modulator

Except for the provision for modulated c.w. operation, the modulator is a quite conventional Class-B arrangement, using a 6N7 driven by a 6J5. Class-B is used because of its higher plate efficiency and relatively low idling plate current. Microphone and driver transformers are readily available from several manufacturers, and suitable output transformers also are obtainable. The oscillator load will be between 5000 and 6000 ohms, depending upon the plate current, and it will be sufficient to take the nearest value furnished by the transformer, using a plate-to-plate load of 8000 ohms for the 6N7. There is ample gain with the single speech amplifier stage for ordinary single-button microphones operated from a 3-volt battery.

Power input and output connections conform to the standards described elsewhere.¹ To give tone modulation for code transmission, the speech amplifier tube is made to oscillate. While oscillations can be produced by several circuit arrangements, the method shown in Fig. 3, in which the primary of the microphone transformer is connected as a tickler in series with the plate circuit, proved best in this instance both from the standpoint of satisfactory tone frequency and ample output for full modulation. A four-pole double-throw switch is necessary to change from 'phone to c.w., two poles being used to transfer the primary of T_1 , a third to close the plate circuit for 'phone, and the fourth to disconnect the cathode condenser for tone modulation. This last is essential for good keying (the speech amplifier tube is keyed in the cathode circuit) since it was found that the tone was chirpy and oscillations built up too slowly with the condenser in the circuit. On the other hand, the condenser increases the gain on 'phone, since the un-bypassed cathode resistor is degenerative. The c.w. tone pitch depends upon the value of the cathode resistor and the setting of the volume control, but with several microphone transformers tested falls in the optimum region (500 to 1000 cycles) with a 2000-ohm cathode resistor.

A separate switch is provided to cut the microphone battery whenever desired. The battery would normally be left on while receiving when communication is being carried on, but during stand-by periods it will be desirable to switch off the microphone current to prolong battery life. The same effect can be secured by pulling the microphone plug out of the jack, but the switch is more convenient. A battery of two flashlight cells connected in series is made a permanent part of the unit, since there is sufficient room to mount them underneath the chassis, but additional terminals are provided for an external battery should the internal one wear out during an emergency. To use an external battery it is necessary to snip one of the leads to the self-contained unit.

The microphone jack is mounted on the side of the chassis so the microphone plug and cord will be out of the way of the controls on the front. The key jack, which probably will get less use,

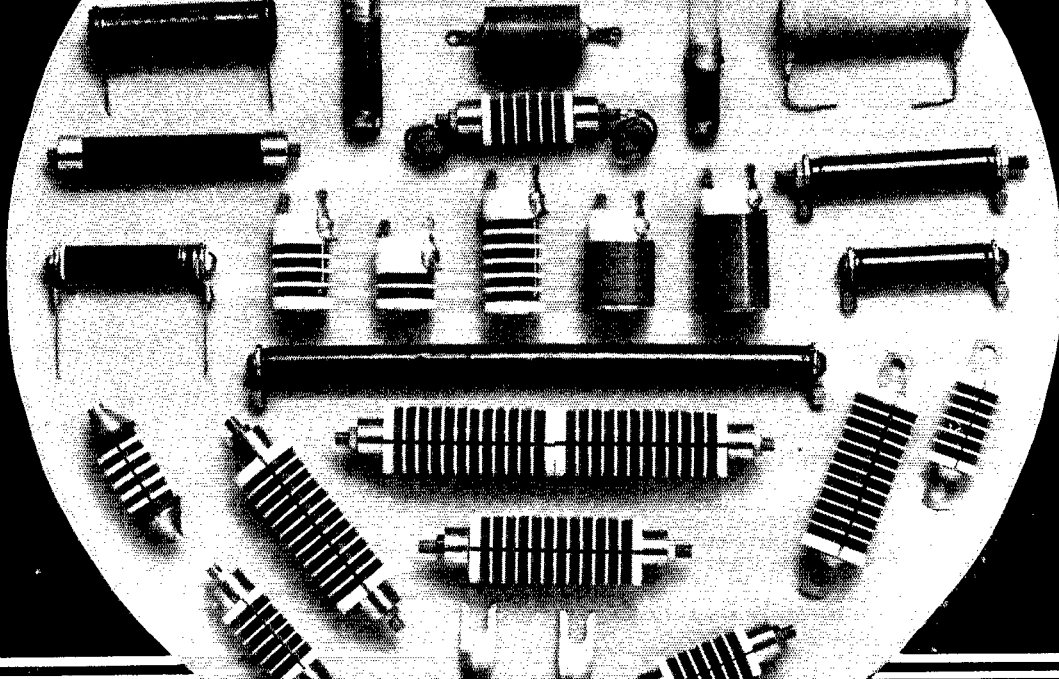

Photograph courtesy
Shallcross Mfg. Co.

ALSiMAG IS FAVORED...

BY LEADING MANUFACTURERS OF RESISTORS

Wire-wound resistors, no doubt, are the most accurate among the various types of resistors. They are used in electrical measuring instruments, electrical and radio testing equipment and other high grade electrical apparatus.

They are manufactured to cover a range resistance from .01 to 10,000,000 ohms and to be able to build such a large variety of resistors requires the use of various alloys such as manganin, copper nickel, nickel chromium, copper, iron, nickel and other special resistance alloys.

But for the forms on which these alloys are wound only one insulating material is required—ALSiMAG, the best grade of non-hygroscopic ceramic material available.

Its great mechanical strength and absolute rigidity assures permanence of calibration over a long period of time.

ALSiMAG ceramics are custom made to the specifications of resistor manufacturers. If you specify ALSiMAG, you get the best ceramic insulators on the market.

* * *

This group of stock resistors illustrated above and insulated with ALSiMAG is an example of the versatility of this insulation. Since ALSiMAG parts are accurately custom made to the specifications of the resistor manufacturer, they are always the size and shape best suited for the application.

This advertisement is one of a series designed to give you a better understanding of the advantages of ALSiMAG insulation. It is not a solicitation of business. Custom made ALSiMAG is sold direct to the manufacturers.

ALSiMAG

Trade Mark Reg. U. S. Pat. Off.

FROM CERAMIC HEADQUARTERS

AMERICAN LAVA CORPORATION • CHATTANOOGA • TENNESSEE
CHICAGO • CLEVELAND • NEW YORK • ST. LOUIS • LOS ANGELES • SAN FRANCISCO • BOSTON • PHILADELPHIA • WASHINGTON, D. C.

MODERNIZE
WITH THE
STANCOR
MODEL 69
TRANSMITTER



HIGHLIGHTS

- 60 Watts Phone and C. W.
- Quick Band Change 10-160 Meters
- Safety Provisions
- Antenna Tuner Included
- Compact Self-Contained
- Ease of Construction and Operation
- Inexpensive Accessories Required
- Novel Design

★ ★ ★

The model 69 transmitter incorporates many excellent features to make it the most versatile rig on the market. Rated at 60 watts amplifier power input, this crystal controlled, phone C. W. transmitter works on all bands from 1.7 to 30 mcs. and is compactly self-contained from the dual power supply to antenna tuning system in a commercial type grey cabinet measuring only 16" long x 9 1/2" high x 11" deep.

All controls are conveniently located for simplicity of adjustment and operation. A front door, equipped with safety interlocked switch, gives access inside for quick changing of crystal and coils which are standard plug-in units. A special 3", dual scale, illuminated meter is switched to provide important circuit current readings. Only six inexpensive tubes are required. Careful design makes for easy construction augmented by detailed instruction sheets and a supplied cabled harness which alone accomplishes most of the wiring.

The model 69 kit includes high quality components, cabinet, and meter.

NET KIT PRICE
(less accessories)..... **\$75.00**

Price subject to change without notice

ASK FOR DESCRIPTIVE BULLETIN No. 231



**STANDARD
TRANSFORMER**

• CORPORATION •
1500 NORTH HALSTED STREET . . . CHICAGO

is on the front. Since the modulator unit is small (the chassis is 5 by 7 by 2 inches) the send-receive switch was placed at the end of the line where it is easiest to handle. For the convenience of others who may be called upon to use the unit in an emergency the controls and outgoing power sockets ought to be plainly labelled. A bottom cover plate on the chassis is a desirable addition, to prevent damage to parts or wiring when the unit is being carried.

The plate current taken by the modulator and speech amplifier tubes is in the vicinity of 35 ma. with no excitation. Thus when the r.f. oscillator is added the current drain is just under the 100-ma. steady limit of the power supply. With a sine-wave signal, the total plate current taken at 100% modulation by both units is 125 milliamperes, but because of the well-known voice-power characteristics the maximum current need not rise above about 110 to 115 ma. for voice modulation. This does not represent an overload on the supply, since the current peaks are of short duration and hence the instantaneous current is supplied chiefly from the energy stored in the output condenser in the filter. When the keyed tone is used this is no longer true, but since the tone is applied intermittently the average increase in heating, which is the real measure of the overload, is inconsequential.

In tests with the plate voltage maintained constant under varying load, it was found that the oscillator plate current was substantially constant with modulation up to 100%, rising slightly with higher modulation. If the voltage regulation of the supply is not perfect the decrease in plate voltage with increased load current under modulation will cause the oscillator plate current to kick downward. A lamp dummy antenna will show normal upward modulation, however.

Basically, the transmitter is intended for short-range work under average conditions, since it is not expected that in an organized local communication network hops of more than a few miles will be necessary. In field tests, practically 100% communication has been maintained with a mobile station (using a superregenerative receiver) travelling over the well-populated area within a radius of four miles or so of League headquarters, using an antenna of the type described¹ and placed outside a window alongside the steel-frame building at a height of about 30 feet above ground. A transmission line about 40 feet long was used, with no tuning at the transmitter end other than adjustment of the coupling as described above. The terrain is about average, neither excessively hilly nor especially flat. Time has not permitted further exploration, at this writing, to see what the outermost limits would be. With fixed stations having more receiving-antenna height, much greater ranges are attainable, as would be expected, likewise additional power could have been made available for radiation by picking a more favorable location for the apparatus so that a shorter transmission line could be used. However, we were interested in seeing what was possible under unfavorable, rather than the most favorable, conditions.

Prepare for Civilian Defense



on 2½ METERS with the new ABBOTT TR-4 TRANSMITTER-RECEIVER

Designed for either fixed station operation or as a mobile unit in automobile, truck, boat or airplane . . . the TR-4 requires a 6 volt battery or 110 volt, 60 cycle A.C. power supply. Its separate receiver employs a Hytron HY-615 as a super-generative detector, while the transmitter utilizes a Hytron HY-75 as an ultra-high frequency oscillator. Operating at approximately 15 to 20 volts, the detector becomes extremely sensitive, and reduces receiver radiation to an absolute minimum.

The receiver portion of this Abbott TR-4 incorporates a specially designed circuit in addition to numerous mechanical refinements, including front of panel control variable inductive coupling, variable sensitivity control, audio volume control, etc. . . .

Absolute separation of transmitter and receiver sections eliminates the inconvenience of retuning when switching from SEND to RECEIVE during a contact. A ganged antenna send-receive switch is automatically operated when the single, master SEND-RECEIVE switch is operated, enabling the use of a common antenna for both the transmitter and the receiver. The 5 inch PM speaker is self-contained.

● FREQUENCY: 112 to 116 MC. ● RANGE: Varying from 5 to 75 miles, depending upon terrain. Contacts up to 150 miles have been completed in field tests. ● TUBES USED: One each of Hytron HY-615, Hytron HY-75, 7F7, 6V6 or 6L6. ● MICROPHONE: Any good single button microphone.

TR-4 Overall size 9" x 8" x 4½", less tubes and power supply, list price (subject to amateur discount) \$65.00

ABBOTT

INSTRUMENT, INC.

8 WEST 18 STREET • NEW YORK, N. Y.



MRT-3

High power (20 watts input), 2½ meter Transceiver for automobile, truck, boat or airplane. Simple to install and operate, with a satisfactory operating range of from 5 to 50 miles.

Less tubes and power supply. List \$49.00



DK-3

Unusually low priced, portable, 2½ meter Transceiver with special Variable Antenna Coupling. Incorporates only 2 inexpensive tubes. Effective range is from 2 to 30 miles.

Less batteries and tubes. List \$32.00

Here is Everything You Need to Know to be a Radio Amateur . . .

156 PAGES! OVER 100 PICTURES!

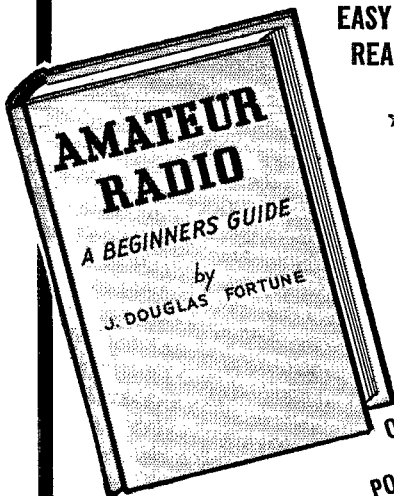

EASY TO
READ!

☆☆☆

☆☆☆ Takes you step-by-step through everything you need to know to be an amateur and have your own radio station. Written so anyone can easily follow the instructions, this textbook is a great help to the beginner or the full-fledged amateur.

☆☆☆ You can learn how to build your first transmitter and receiver—how to learn code—how to get your license—how to use your beginning equipment in building larger and more advanced rigs. Here is radio theory really made understandable.

Bound in cloth and stamped in gold. Obtain a copy from your Radio Parts Distributor, or write direct to THORDARSON.

THORDARSON

ELECTRIC MFG. CO.

500 West Huron Street, Chicago

"Transformer Specialists Since 1895"

ONLY
75c
POSTPAID

It appears, therefore, that satisfactory results can be secured without special u.h.f. tubes and apparatus, despite the fact that the resulting rather inefficient operation limits the power output to low values. The actual output of the oscillator to the transmission line is about one watt of r.f. By using a low- C tank circuit this can be increased to about 3 watts, an increase of about $4\frac{1}{2}$ db. or less than one average S point. However, the signal strength increase is not very marked in practice, since with the low- C tank the frequency modulation is so bad that f.m. detection has to be used on a superregenerative receiver—that is, the modulation disappears in the center of the region where the rush is pushed down by the carrier, and the signal appears in two spots off at the edges where the hiss is quite pronounced, even when the carrier alone is fairly strong. Thus the signal-to-noise ratio appears to be actually poorer with the higher power output.

Incidentally, it is very easy—and quite common—to overestimate power output from the brightness of lamp dummy antennas at some power levels. A 15-watt lamp gives a very satisfactory almost-white-colored glow at 3 watts, and casual observers invariably estimate the power to be as at least twice as much as it actually is. And the same type of lamp will show a discernible reddish glow with as little as one-half watt in its filament!

Cutting Bias Supply

(Continued from page 30)

will be needed.) The third consideration is the power transformer, if one is needed. It should in all cases be possible to use one that has low enough voltage to supply the minimum bias required and still permit the rectified grid current from the grid of the biased stage to cut it off entirely under operating conditions. Arithmetically this means that the operating grid voltage will, in nearly all cases involving r.f. tubes, be more than 1.4 times the required protective bias. If this condition is not met the input filter condenser should be 8 μ fd. or more.

The necessary minimum protective bias roughly will be something less than the value specified for Class-B audio operation with a given plate voltage. It will be considerably less than the cut-off bias given by the formula $E_c = E_p/\mu$. To figure it more closely first determine the maximum allowable plate current under conditions of no excitation. This will be equal to the rated plate dissipation divided by the plate voltage. Then look on the characteristic curves supplied with the tube and find the negative grid bias which permits this value of plate current to flow. As a factor of safety increase this bias voltage by ten per cent. The filter condenser, C , can be 1 μ fd or less and should have a voltage rating well above the maximum voltage that will appear across grid-leak R . This voltage is simply the product of the value of this resistance in ohms and the maximum grid current in amperes.

Last, choose a transformer that will supply the bias arrived at above. As an approximation, this



**"HAPPY DAYS!
A set of G-E tubes--Old Santa
must be a ham himself"**

IT'S possible for a sight like this to gladden *your* heart when you wake up Christmas morning. Just leave a marked copy of Bulletin GEA-3315C* about the house as a gentle reminder to the rest of the family.

Make sure you check that versatile performer, the GL-807. For your Class B modulator requirements put a big X beside the GL-809. If you're a low-power man who wants to step up a notch, check a pair of GL-810's.

General Electric offers to amateurs a

complete line of top performers, priced low—unsurpassed in value. A set of G-E tubes is just the ticket to make your Christmas complete.

And incidentally, make sure Santa stuffs a couple of Pyranol capacitors into your sock. They are so compact it will hold several. Bulletin GEA-2021B will give you complete dope, or write General Electric, Schenectady, N. Y.

**If you have mislaid our transmitting-tube bulletin, get another copy at your dealer's.*

10 heat treatments PROTECT TRIPLET PRECISION



In these and similar batteries of electric ovens every Triplett Instrument is subjected to scientific heat treating during several stages of the assembly process.

Pre-curing of molded parts and heat treatment of all assembled materials are precautions to eliminate strains and stresses which otherwise would develop after the instrument is in the hands of the user. This is one of the many Triplett methods of insuring your continued satisfaction with Triplett Precision Instruments and Testers. Accurate alignment for dependable performance is thus assured under all normal conditions and usage.

THE TRIPLET ELECTRICAL INSTRUMENT CO.

Buffton, Ohio

FASTEST WAY TO LEARN **CODE** Easy, Fascinating — LEARN BY EAR to be a GOOD OP.

This New All Electric Master Teleplex Code Teaching Machine is exactly what thousands are looking for. No experience needed. Excellent for beginners — steps up WPM for ALL Ops. There is no guesswork with Master Teleplex, because it records your sending in visible dots and dashes by a brand new method on a specially prepared tape. You SEE and HEAR exactly how you are making your signals. You learn code the way you'll be using it — by SOUND. *That's why many schools teaching code use TELEPLEX.* Complete course included at no extra charge. Used by many schools and several governments for teaching code. Low cost, easy terms. **MONEY BACK GUARANTEE.** Send now for booklet Q-12, no obligation. Post card will do.

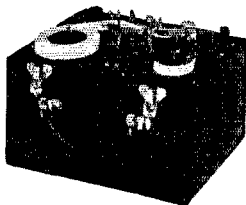

TELEPLEX CO. 107 HUDSON STREET
JERSEY CITY, N. J.

WANTED

COMPETENT ELECTRONICS MECHANIC

to build experimental electronic test equipment. Must be capable of complete layout, construction and test from a schematic diagram. Engineering background desirable but not essential. Apply by letter to Installation Department. Applications not solicited from persons now employed in aircraft manufacturing industry.

Pratt and Whitney Aircraft, East Hartford, Conn.

may be a transformer whose a.c. voltage, measured from the center tap to one side of the secondary, is approximately 80% of the required d.c. bias. The wattage rating of the transformer should be just sufficient to supply the current that it drives through grid-leak R under conditions of no excitation. A small transformer and an 80 rectifier should be adequate for any common pair of tubes. Low voltage transformers can be found in the category of speaker field supply transformers. If a compromise in the choice of voltage output is necessary, choose a unit delivering more than the required voltage.

If the above calculations are carried through reasonably well it may be expected that no current will be drawn from the bias supply under normal operating conditions. The supply cannot introduce hum into the grid circuit of the r.f. tubes, and is ready to protect them instantly upon the failure of the excitation.

Meter Shunts

(Continued from page 25)

one isn't obtainable, the resistance may be made up with a combination of 1-watt fixed resistors and some fine copper wire for fine adjustments. The idea is to adjust the resistance in the circuit until the meter just reads full scale.

When this has been done, our shunting wire, cut to approximate length, should be bared at each end and the ends pressed firmly against the meter terminals. This will cause the meter reading to drop. The length of the shunting wire should now be reduced in small steps until connecting it across the meter causes its reading to fall to one-tenth of full-scale reading (for a 10-times shunt). During the process, the full-scale adjustment should be checked frequently to make sure that the reading hasn't fallen off because of falling battery voltage with load. When the correct length of the shunt has been determined, it may be wound up in compact form on a match stick, strip of fiber or anything handy.

The adjustment of the 100-times shunt is done somewhat differently. In the first place, an accurate reading at $\frac{1}{100}$ of the original scale is impossible. Therefore, the adjustment should be made in connection with the 10-times shunt so that a check at $\frac{1}{10}$ scale will be permissible. With the meter shunted with the 10-times shunt, it should be placed in the test circuit of Fig. 3 and the circuit adjusted for full-scale reading (100 ma.). The 10-times shunt should then be removed and the 100-times shunt adjusted until it gives a meter reading of 1 ma. on the original 10-ma. scale. Special care should be taken to open the battery circuit each time before the shunt is removed to prevent damage to the meter. For most accurate results, the test should be made with the 100-times shunt soldered in place on the switch to be used, unsoldering each time a change in length must be made.

An alternative method is to have the 100-times shunt made up of a 10-times shunt and a lower-resistance shunt in parallel. The 10-times shunt is connected permanently to the switch terminals

PLAN NOW for YULETIDE FUN WITH A NEW RECEIVER!

**BUY NOW . . . Beat Rising Prices
. . . GET MORE for Your Money**



High Voltage Power TRANSFORMERS

Newark's larger volume of amateur business makes this unmatched value possible. Made by one of the largest transformer manufacturers. These husky transformers have a place in every Ham Rig. Guaranteed. As illustrated. Five Filament Types.



QUANTITIES LIMITED

No. 3004 — 350-0-350 . . . 150 Ma. 5 V.-3 amp; 5 V.-3 amp; 2 1/2 V.-3 amp; 2 1/2 V.-7 amp. **\$1.95**
 No. 1549 — 300-0-300 . . . 100 Ma. 6.3 V.-3 amp; 5.0 V.-3 amp. **\$1.95**
 No. 4140 — 600-0-600 V.—200 Ma. Filaments: 7.5 V.C.T.—3 A.—5.0 V.C.T.—3 A.—2.5 V.C.T.—10 A. Wt. 8 1/4 lbs. **\$3.45**
 No. 4240 — 600-0-600 V.—200 M.A. Filaments: 6.3 V.—4 A.—6.3 V.—3 A.—5.0 V.—3 A. Wt. 8 1/2 lbs. **\$3.45**

★ ★ ★ ★ ★
SPECIAL

**OIL FILLED — OIL IMPREGNATED
FILTER CONDENSERS**

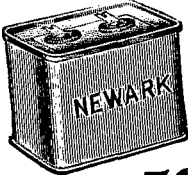

As Low as 59¢

Mfd.	DC	Volts	Size	Price
1	1000	5	x 3 3/4 x 1 3/4	\$.59
2	2000	4 1/2	x 3 3/4 x 1 3/4	1.50
3	2000	5	x 3 3/4 x 1 3/4	2.75
4	3000	5	x 3 3/4 x 3 3/4	3.75

The lowest price NEWARK has ever featured . . . on a condenser value that already has made thousands of friends for us! Quality-built by reliable maker. Guaranteed at rated voltage.

**NATIONAL NC 200
\$43.62 Down
\$17.34 per month for 8 months**
Cash Price \$174.50 Complete

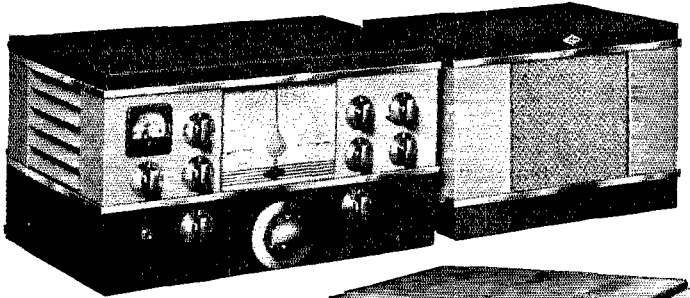

**HALLICRAFTERS SX 28 →
\$44.88 Down \$17.84 Per
Month for 8 Months**

Cash Price \$179.50 less speaker.
Regular PM23 Speaker in Metal Cabinet \$15.00.

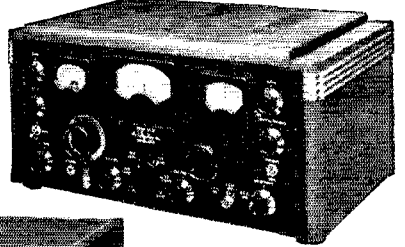

**HAMMARLUND HQ 120X
← \$42 Down**

Balance \$16.69 Per Month for 8 Months
Cash Price \$168.00 Complete
(Speaker Cabinet \$3.90)

**Have you seen our NEW CATALOG?
SEND FOR IT TODAY . . . Free!!**

The radio equipment "Book of the Year," 1942 edition, now ready! Over 3000 items, parts, supplies, accessories, receivers, P.A. systems, transmitters, etc. If interested in radio, sound recording, etc., YOU NEED THIS CATALOG! Send for it . . . NOW.

WHEN ORDERING any of the above receivers, be sure to include down payment and credit reference.

**LOOK! YOUR
CALL LETTERS
in Gold, 10¢**

Big shadowed decals, nearly 1/2" high. For ham shack door, windshield, etc. Be sure to give your call letters.

NEWARK Electric Company
323 W. MADISON ST.
Dept. Q CHICAGO, ILL.

RADIO TRAINING



FOUNDED IN 1909

PORT ARTHUR COLLEGE, a non-profit-making educational institution, offers a practical radio operator's course at the lowest tuition price in its history. Each radio graduate receives two months' actual operating experience at the college's commercial broadcasting station KPAC. This station is equipped with the latest type 1000 watt high fidelity RCA transmitter — 1250 kc. — directional antenna system. KPAC operates in new modern studios located on the campus.

The college has never advertised jobs or positions in lieu of education. Today it is well known there is a shortage of radio operators in every branch of radio; particularly flight and ground operators for airlines in America and South America — marine operators for ships traveling coastwise and foreign — geodetic-geographic research — broadcast stations — the Army and Navy — other positions in many departments of the United States Government. Therefore, we believe it is good common sense to mention that Port Arthur College is the sole radio school in America which owns a commercial broadcasting station with commercial advertising representatives in New York, Chicago, San Francisco, and many of America's leading cities, with active membership in the National Association of Broadcasters, and Broadcast Music Incorporated. Through these contacts the college receives from the broadcast industry alone more calls for radio operators than it is possible to supply.

AUTHORIZED TO TEACH RCA TEXTS

If interested, write for Bulletin R

PORT ARTHUR COLLEGE
PORT ARTHUR (World-Known Port)
TEXAS

CRYSTALS by HIPOWER

The Hipower Crystal Company, one of America's oldest and largest manufacturers of precision crystal units, is able to offer the amateur and manufacturer attractive prices because of their large production and the exclusive Hipower grinding process. Whatever your crystal need may be, Hipower can supply it. Write today for full information.

HIPOWER CRYSTAL CO.

Sales Division—205 W. Wacker Drive, Chicago
Factory—2035 Charleston Street, Chicago, Ill.

LEARN CODE THE WAY YOU'LL USE IT.— BY HEARING IT

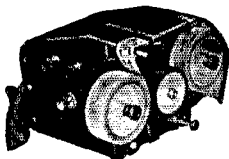

Type S = \$17.50

Sends from 4 to 40 words per minute. Higher speeds if desired. Complete with 10 rolls of double-perforated lesson tape of carefully selected and arranged matter for speediest results in learning code. Most compact and practical code teacher on market.

Type J = \$12.50

Sends 6 to 65 words per minute. Built-in tape perforator. Cut your own practice and message tapes. Complete with one roll of practice tape covering Alphabet, Numerals, Words to five letters; and 5 rolls of blank tape.

If your dealer can't supply you, write us

GARDINER-LEVERING CO. Haddon Heights
New Jersey, U. S. A.

and the test circuit adjusted for full-scale deflection (100 ma.). The 100-times shunt, connected across the 10-times shunt, is adjusted to give $\frac{1}{10}$ -scale reading. This will avoid the necessity for opening the test circuit each time for an adjustment of the 100-times shunt, although it requires the making of an additional 10-times shunt.

In either case, it will be found that the adjustment of the length of the wire in the 100-times shunt will be much more critical than that of the others, a fraction of an inch becoming important.

Connecting the Shunt in Circuit

Care should be taken, when connecting the meter with its shunt in the circuit, to make the circuit connections to the ends of the shunt, as shown in Fig. 4A and not to the meter terminals, as shown at B. With the circuit connected to the meter terminals, the lengths of leads X and Y will be added to the shunt, causing an error in the meter reading. This is normally taken care of automatically, since it is common practice to solder the shunts directly to the switch terminals and to make the circuit connections at these same terminals as shown in Fig. 2C.

Non-Multiplying Shunts

The switching system described requires that a shunt for the meter be provided even for the circuits in which no multiplication of the meter scale is desired. In the cases where it is desired to use the original meter scale, the shunting resistance is made so high that it has a negligible effect upon the reading of the meter. As stated previously, the maximum meter resistance will be about 3 ohms. A shunt of 50 ohms will cause an error in reading of about five per cent. Lower shunting resistances may be used with meters of lower resistances.

Meter Protection

One of the best investments an owner of a good meter can make is that of purchasing protective fuses to be connected in series with the meter, as shown in the diagrams. Very inexpensive fuses are obtainable and the $\frac{1}{10}$ - and $\frac{1}{4}$ -ampere sizes will give adequate protection for 10-ma. and 100-ma. meters. Selecting a fuse with a rating too close to the maximum reading of the meter (without shunt) will prove to be somewhat of a nuisance, since it will be apt to blow even on slight momentary overloads which will do a meter of good quality no particular harm. — D. H. M.

Ham Spirit Triumphs

(Continued from page 35)

friends; now he is in intimate contact with what must seem like the whole world.

An inspiring concept, that — the prospect of a normal and well-rounded life thus opened by the magic of amateur radio. Even more inspiring, however, is the demonstration of perseverance, ingenuity and indefatigable resolution exhibited by this young amateur and his mentor in the face of their combined handicaps. That's the kind of spirit America needs. — C. B. D.

Phasing Unit built to order for WTMJ, Milwaukee, Wisconsin. Dozens of similar units have been supplied by Johnson to other stations recently.

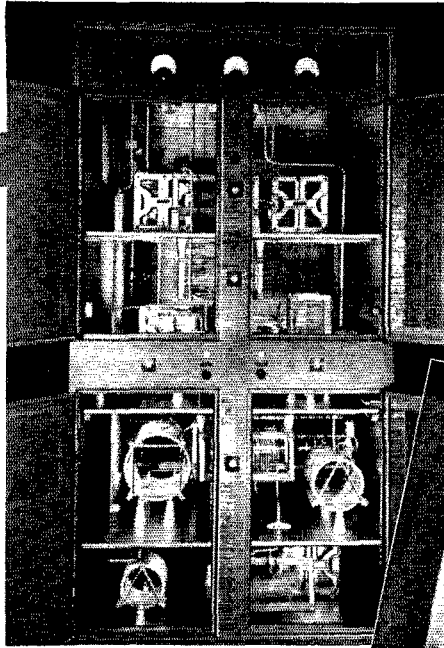

Antenna Coupling Unit for WTMJ. One such unit is required for each tower.

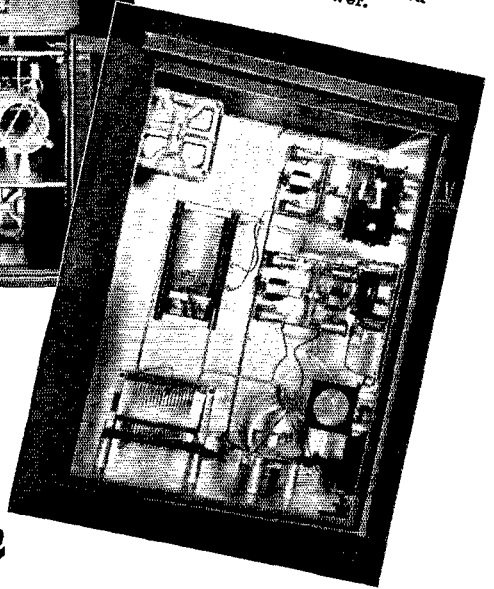

PRECISION ENGINEERING

at your service

Directional patterns of modern broadcast stations are determined by the phase relationship of the energy radiated and the placement of each tower in the system. To control the phase and power relationship a Phasing Unit is employed. A separate coupling unit for each tower is necessary to properly match the impedance of the tower to the transmission line. For years Johnson Engineers have specialized in designing and building such equipment.

ASK FOR CATALOG
967J



E. F. JOHNSON CO

WASECA, MINNESOTA

EXPORT: 25 WARREN ST., NEW YORK, N. Y.

"MANUFACTURERS OF RADIO TRANSMITTING EQUIPMENT"

Whatever Your Yardstick!

PRECISION INDUSTRIAL and LABORATORY TEST EQUIPMENT

Will readily measure up to highest standards of accuracy, performance and value.

Ranges to 1200 volts D.C. • 2400 volts A.C.
• 5 Megs • 600 MA and + 62 DB

All in **PRECISION**
Series 832-A
31 range AC-DC
compact circuit tester

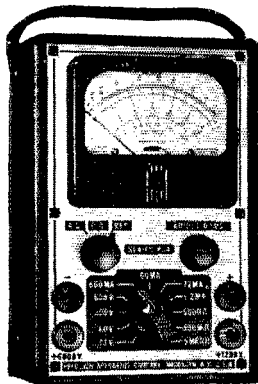

★ 6 D.C. voltage ranges to 1200 volts ★ 6 A.C. voltage ranges to 2400 volts ★ 4 D.C. current ranges to 600 MA ★ 3 Resistance ranges to 5 MEGS ★ 6 Decibel ranges to +62 DB ★ 6 Output ranges to 2400 volts ★ Easy reading 3" bakelite cased, wide faced 800 microampere meter
★ Each instrument individually calibrated to within 2% D.C. and 3% A.C. overall accuracy ★ Overall size only 7 x 4½ x 3 inches.

Tops in multi-tester value at only
\$16.95 net

Write for the new radio amateur, laboratory, industrial test equipment catalog No. 42-Q . . . just off the press

PRECISION TEST EQUIPMENT
Standard of Accuracy SEE THEM AT YOUR JOBBER
PRECISION APPARATUS COMPANY
647 Kent Avenue Brooklyn, New York
Export Div.: 458 Broadway, New York, U. S. A. — Cables: Morhanex

An Experimental 112-Mc. Receiver

(Continued from page 38)

an advantage; however, no signals of any kind have been picked up on the intermediate frequency so far. The main dial is a National velvet vernier. The small knob to the right tunes the single-section r.f. tuning condenser. The on-off switch is mounted in the bottom center of the panel. Audio volume is controlled by the 0.5 megohm potentiometer to the extreme left, and regeneration in the detector is controlled by the 50,000-ohm potentiometer between the audio control and on-off switch. Good mechanical line-up of the mixer and oscillator band-spread condensers is somewhat difficult with the average flexible coupling, so two metal couplings were used with a short piece of ¼-inch bakelite rod between them. The mixer-oscillator combination worked better when these two condenser shafts were insulated from each other. The i.f. transformers are wound on 1-inch pieces of ¾-inch bakelite tubing, mounted by means of small angle brackets to the chassis so that the coils may be swung back and forth for variable coupling. After the proper coupling is found they may be tightened down permanently.

Alignment

After the set is wired and checked, alignment should be comparatively simple, provided one has a 2½-meter station not too far away to help in checking. Harmonics from lower-frequency stations are very tricky to use and may cause a false calibration; for this reason they are not recommended at all. To begin with, the tubes are removed from the r.f. section (9003, 1232 and 6C5) and the set turned on. The superregenerative detector should be tuned to approximately 20,000 kc. by checking on another receiver or a wavemeter. After the detector is working properly, the coupling between L_6 and L_7 should be adjusted and at the same time L_7 should be tuned with the padder until the detector is loaded as much as possible while still getting smooth superregeneration. Then L_4 and L_5 are tuned, and when resonance is reached in each of these, tuning L_4 first, the superregen detector will be pulled slightly farther out of regeneration. Some readjustment in the coupling between L_6 and L_7 may be necessary at this time in order to keep the detector regenerating properly. The coupling between L_4 and L_5 should be kept at maximum (about ⅝ or ¾ inch) so long as no trouble is experienced with oscillation in the i.f. stage. After the i.f. alignment is completed, the tubes should be replaced in the r.f. section. A slight readjustment of the i.f. may be necessary after these tubes are replaced.

The antenna pick-up coil, L_9 , and the plate coil of the 9003, L_8 , should be constructed so that variable coupling is possible. In attempting to find the band, be sure that both coils are tightly coupled to their respective grid coils. Set the band spread dial at about mid-scale and tune the padder on L_2 until the 2½-meter station is located. After this, the coupling between L_9 and L_8 and

WHY NOT DO IT NOW!

Tomorrow may be too late, right now is the time to prepare yourself for an advanced position in the Army, Navy or commercial fields. Uncle Sam needs trained Radio Code Operators now! You can learn this fascinating work without leaving your own home. The Candler System shows you the easy, interesting way to Speed, Skill, and that amateur or commercial license in half the usual time. Waiting will not build your future. Write today!

Send for **FREE BOOK!**

Free **BOOK OF FACTS** for code students, Amateurs and Radio Operators. There is no obligation and no salesman will call. Get the inside advice. Send for your copy **TODAY!**

CANDLER SYSTEM CO.

Dept. Q-12 • Box 928
DENVER, COLORADO



Rough Going!

**TAYLOR TUBES
ARE BUILT
FOR IT**



In Uncle Sam's Armored Tank Forces or in an amateur's rig, TAYLOR TUBES are built to take the toughest kind of punishment and still deliver top performance with longer life.

Years of serving the knowing amateur and developing and manufacturing tubes to meet his exacting demands, has made this possible.

The HIGH SAFETY FACTORS, characteristic of all TAYLOR TUBES have long been the amateurs protection against unexpected tube failure and now more than ever they are the choice of thinking hams who are rebuilding or overhauling their rigs for amateur defense.

Whether it be on the low or high frequencies, a kilowatt or a low power rig you are planning, TAYLOR TUBES will give "MORE WATTS PER DOLLAR."

★

Of course, the requirements of our government must come FIRST—so, if your Distributor is unable to give you prompt service, we ask that you understand the situation. Taylor Tubes and their Distributors are doing their very best to continue the fine service they have always given.

"More Watts Per Dollar"

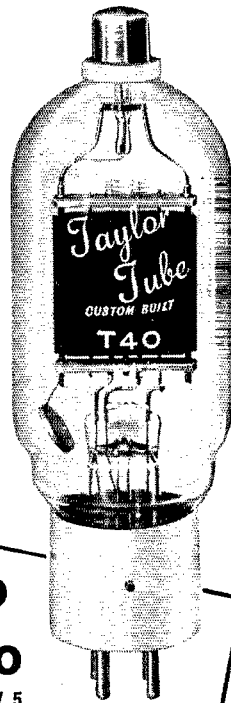

**T-40
and
TZ-40**

FIL. VOLTS . . . 7.5
FIL. CURRENT
AMPS. 2.5
D.C. PLATE
VOLTS . . . 1500
D.C. PLATE
CURRENT MA. . 150

\$ 3.50

Taylor HEAVY **CUSTOM BUILT** DUTY **Tubes**

TAYLOR TUBES, INC., 2341 WABANSIA AVE., CHICAGO, ILLINOIS

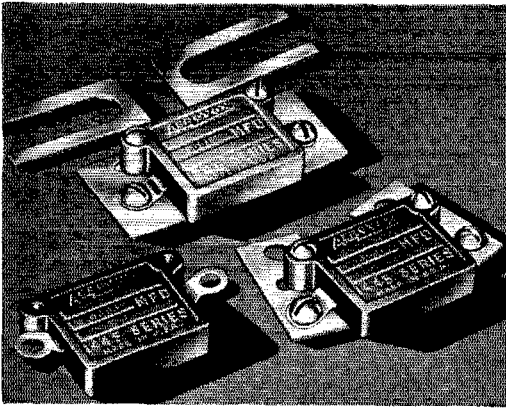

Some two dozen molded-in-bakelite types to choose from.

Meter-shunting capacitors with adjustable brackets. Wider choice of mountings, terminals, dimensions, voltages.

Capacitors also available in XM (yellow) low-loss bakelite for UHF work, at slight price increase.

Also stack-mounting; bakelite-case; cast-aluminum case, metal case and other extra-heavy-duty types heretofore available only on special order.

MICAS

When it comes to those more special mica capacitors, you can always depend on the Aerovox line because it provides a greater choice. Especially since Aerovox communication-type capacitors, heretofore made to order, are now generally available. Ask jobber for catalog. Or write us direct.



In Canada: AEROVOX CANADA LTD., Hamilton, Ont.
EXPORT: 100 Varick St., N. Y., Cable 'ARLAB'

SICKLES COILS

ALL TYPES OF RF AND IF WINDINGS

Manufactured by

F. W. SICKLES COMPANY

P. O. Box 920

Springfield, Mass.



EXPERIMENTAL RADIO

(4th Edition. 136 experiments.)

By R. R. Ramsey, Prof. of Physics, Ind. Univ. The experimenter's manual: Measurements, Tests, Calibrations, with ordinary radio and physical apparatus. "Measure and know."

FUNDAMENTALS OF RADIO

(2nd Edition. 426 pages, 430 figures.)

Modern radio explained with a minimum of mathematics. "You find it in Ramsey's." Experimental, \$2.75. Fundamentals, \$3.50 postpaid.

RAMSEY PUBLISHING CO. Bloomington Indiana

EASY TO LEARN CODE

It is easy and pleasant to learn or increase speed the modern way — with an Instructograph Code Teacher. Excellent for the beginner or advanced student. A quick and practical method. Available tapes from beginner's alphabet to typical messages on all subjects. Speed range 5 to 40 WPM. Always ready, no QRM, beats having someone send to you.

MACHINES FOR RENT OR SALE

The Instructograph Code Teacher literally takes the place of an operator-instructor and enables anyone to learn and master code without further assistance. Thousands have used and endorse the Instructograph System. Write today for full particulars and convenient payment and rental plans.



INSTRUCTOGRAPH COMPANY

4709 Sheridan Road, Chicago, Illinois

Representative for Canada

Radio College of Canada, 54 Bloor St. West, Toronto

between L_2 and L_1 may be adjusted for maximum gain and at the same time C_3 tuned to maximum signal strength. The mixer grid circuit should be resonated by squeezing the turns of L_1 closer together or pulling them farther apart.

C_3 was not ganged with C_1 and C_2 because many different types of antennas are being tried at my shack from time to time and separate tuning of the r.f. stage saves the trouble of realignment each time a new antenna is used. The r.f. stage tunes very broadly, requiring only about three settings to cover the whole band, one setting giving maximum gain over a range of 1200 to 1500 kilocycles. A slight increase in noise is noticed when tuning L_1 and C_3 through resonance with the superregen detector on the edge of regeneration. However, they should be peaked on a weak signal, if possible, to be certain of the maximum settings for each. In changing antennas, a slightly different coupling may be necessary between L_2 and L_3 .

I believe that this type of receiver is certainly well worth the time and trouble in building and that it will outperform any of the ordinary super-regens in use. Considerable credit should go to W6QLZ for his help in lining up this receiver, for he spent many evenings transmitting while the different stages were peaked and different adjustments and experiments were being made. QLZ is the only station with whom I have been able to make tests over any great distance. The path is 107 miles air line, and across three ore-filled mountain ranges, reaching heights of from three to five thousand feet. A 4-element horizontal beam 34 feet high was used to receive 6QLZ during all experiments. However, the receiver couples well to all types of antennas and feed systems.

★ BOOK REVIEWS ★

The Radiotron Designer's Handbook, by F. Langford Smith. Distributed in U. S. A. by RCA Manufacturing Co., Inc., Harrison, N. J. 365 pages, illustrated. Price, \$1.00.

Here is a case of the mountain coming to Mahomet. Mr. F. Langford Smith of the Amalgamated Wireless Valve Co. Pty. Ltd., RCA's *alter ego* in Australia, wrote a Handbook for his company which, to quote his Foreword, was "prepared expressly for the radio set designer, but will be found invaluable to all radio engineers, experimenters and service mechanics." It was indeed found invaluable, so much so that when the third edition was published in 1940 nearly 20,000 copies had to be printed to supply the demand. Now RCA has obtained permission to reproduce the volume by photolithograph and is distributing it in this country.

Supplied in stiff covers at moderate cost, *The Radiotron Designer's Handbook* will be useful to anyone interested in the fundamental principles of practical vacuum-tube circuit design. It is primarily a book of procedure: how to compute cathode and screen by-passes, calculating selectivity with the aid of universal design charts, the design of negative feedback circuits — these are but three of numerous practical problems which can readily be solved by reference to the formulae, tabular and narrative data and reference charts collected by Mr. Smith. A very useful dollar's worth for the engineer and technically-minded amateur.

— C. B. D.

JUST OUT!

NEW CATALOG 18

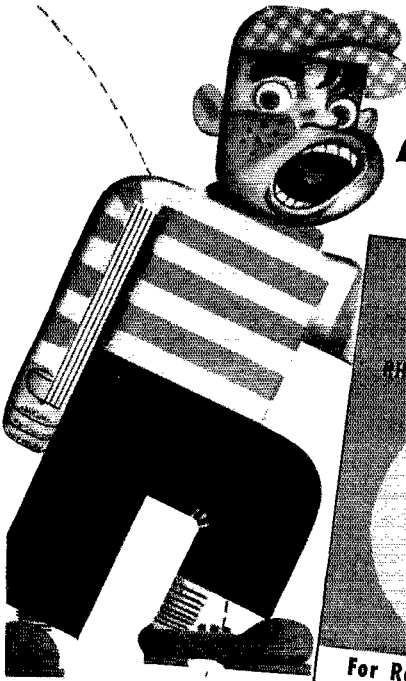

For Radio, Television, Sound, Electronic and Industrial Uses
CATALOG NUMBER 18

Be Right with
OHMITE

I N D E X

RHEOSTATS, Models H and J, Vitreous Enamelled.....	Page 2	FILAMENT DROPPING RESISTORS.....	Page
Vitreous Enamelled.....	3	CENTER-TAPPED RESISTORS.....	11
"DIVIDION" ADJUSTABLE RESISTORS 10, 25, 50 and 75 Watt Ratings, Vitreous Enamelled.....	4	TAP SWITCHES, Power Type, All-Ceramic.....	11
"DIVIDION" ADJUSTABLE RESISTORS 100, 150 and 200 Watt Ratings, Vitreous Enamelled.....	5	Models T11 and T12.....	11
FIXED RESISTORS, Vitreous Enamelled 25, 50, and 100 Watt Ratings.....	6	TAP SWITCHES, Power Type, All-Ceramic Models 312, 412 and 501.....	12
150 and 200 Watt Ratings.....	6	BAND CHANGE SWITCH BC-8.....	13
"BROWN DEVIL" RESISTORS, Vitreous Enamelled.....	7	CHOKES, Radio Frequency Plate.....	13
"WIREWATT" RESISTORS.....	7	CHOKES, Power Line.....	14
HERMETICALLY SEALED IN GLASS.....	8	PARASITIC SUPPRESSOR.....	14
NON-INDUCTIVE BUNNY ANTENNA RESISTORS.....	8	SOLDERING IRON CONTROL RHEOSTATS.....	14
NON-INDUCTIVE RESISTORS.....	8	DIALS AND KNOBS.....	15
"MILTEVOL" TAPPED RESISTORS, Vitreous Enamelled.....	9	LINK CONTROL.....	15
Vitreous Enamelled.....	9	MODEL TRAIN CONTROL RHEOSTATS.....	15
"RITEOHM" PRECISION RESISTORS.....	10	OHMITE OHM'S LAW CALCULATOR.....	15

ISSUED NOVEMBER 1942 All of the items listed in this catalog are carried in stock. The prices shown are list prices as noted and are subject to the usual trade discounts. Prices subject to change without notice.

OHMITE MANUFACTURING COMPANY
 4835 West Flournoy Street, Chicago, Illinois, U. S. A.
 All Telephones: AUStin 1070 • Cable Address: OHMITECO • Cable Code: 25

FREE
 for the asking!

FEATURES

Especially useful today! Gives complete up-to-date information on the wide range of Ohmite stock resistors, rheostats, chokes and switches used in all types of applications . . . Lists over a thousand stock items, including new developments . . . Gives descriptions, ratings and prices . . . Helps you select the right units for each job, easily, quickly. Get your copy of this handy new Catalog 18 now! It's FREE. *Send the Coupon today!*

OHMITE MANUFACTURING COMPANY
 4865 Flournoy Street, Chicago, U. S. A.

Send Free Catalog 18.

Name _____
 Address _____
 City _____ State _____

Be Right with **OHMITE**
 RHEOSTATS * RESISTORS * TAP SWITCHES

THE 1942

RADIO AMATEUR'S HANDBOOK

MORE CONSTRUCTIONAL MATERIAL THAN EVER BEFORE

IN BUILDING THE 1942 EDITION the ARRL Headquarters staff designed a new, non-mathematical, simple yet thorough treatment of fundamentals to make the **HANDBOOK** even more useful in its growing role as a textbook for defense classes. Stripped to essentials, the new theory and design sections cover every subject encountered in practical radio communication, sectionalized by topics with abundant cross-referencing and fully indexed. The new **HANDBOOK** is an ideal reference work as well as a logically-arranged study course.

All this was achieved without sacrificing any of the constructional information on tested and proved gear which has always been the outstanding feature of the **HANDBOOK**. In fact, *the constructional chapters are given more space and contain more new designs in this edition than ever before.*

★ The new **HANDBOOK** is divided into two parts. The first section starts the reader with the basic electrical fundamentals, takes him through the principles of vacuum tubes and their operation, explains the methods of generating r.f. power, keying, modulation, radio reception, principles of wave propagation and antenna systems. The subject matter is keyed in such a way as to make ready reference possible throughout the book.

★ The second section is devoted to the building of practical amateur equipment. Constructional details are given for receivers from 1 to 7 tubes, including new ultra-simple receivers designed especially for the beginner. The greatly enlarged transmitter chapter now coordinates power supply and r.f. equipment, ten complete transmitters from 70 watts

to a kilowatt being described. The fifteen individual exciters and amplifiers range from the simplest oscillator to a push-pull kilowatt amplifier. The u.h.f. chapters, also enlarged, place special emphasis on equipment for portable-mobile work. They include converters, superregenerative receivers using the newest tubes, crystal- and self-excited transmitters in several power ranges and a battery transceiver, as well as FM transmitting and receiving equipment. Other chapters contain an expanded treatment of measurements and measuring equipment, material on emergency and portable gear, workshop practice, operating procedure, F.C.C. regulations and miscellaneous tables and data. The vacuum-tube tables remain the most complete published anywhere, with over 50 new types added.

THEORY—CONSTRUCTION—OPERATING. *More than ever before, the new 1942 RADIO AMATEUR'S HANDBOOK is "the all-purpose volume on radio." Text, data book, operating manual—it is all these and more. As a text it is probably more used in radio schools and colleges than any other single volume. As a practical constructional handbook, it stands in a class alone. As an operating manual, it provides information available from no comparable source.*

Buckram Bound
\$2.50

\$1.00
POSTPAID

\$1.50 Outside
Continental U. S. A.

AMERICAN RADIO RELAY LEAGUE, INC., West Hartford, Connecticut

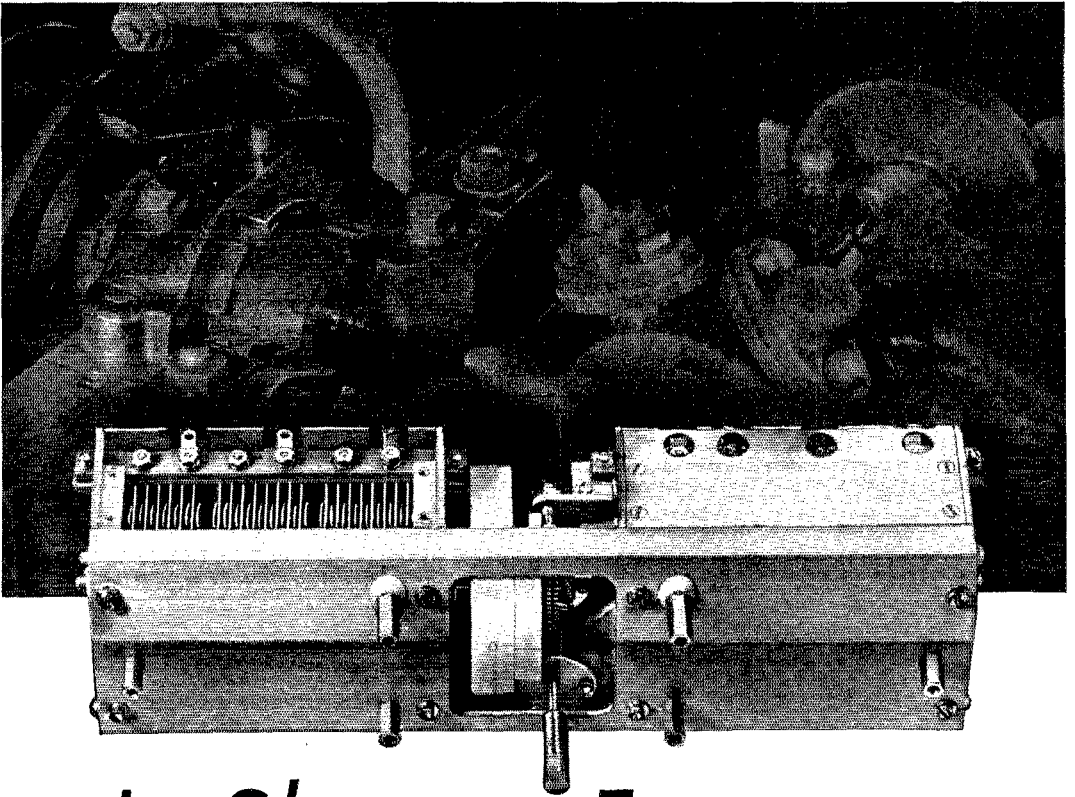

In Sharper Focus . . .

Current CARDWELL production schedules are set, and frankly, our output of standard types of condensers for commercial applications is necessarily, drastically curtailed.

Yet, out of the haze caused by the initial frantic rush of expanding defense requirements, material shortages and priorities ratings, has appeared a semblance of our production picture for the future.

The days of IMMEDIATE deliveries have passed! All orders other than those bearing urgency ratings cannot receive precedence.

By no means, does this condition imply that we cannot ever fill your orders. It suggests that YOU can facilitate production and delivery schedules by anticipating your requirements for the future and by securing and forwarding to us the assigned priorities extension certificates, whenever these are available.

***THE ALLEN D. CARDWELL
MANUFACTURING CORPORATION
83 PROSPECT STREET • BROOKLYN NEW YORK***

Station Activities



NEW ENGLAND DIVISION

CONNECTICUT — SCM, Frederick Ells, Jr., W1CTI — W1AW hits BPL with a bang. TD is busy with activities in West Haven. KQY has Nutmeg Net perking in fine style. LUH is a member of the Charter Oak Net that meets daily on 3950 kc. MBN is building emergency power equipment to use storage battery and vibrapack. EAO is acting as alternate for W1AW on Trunk N. ITI made several changes in his shack. DWP has a new Meissner Signal Shifter. KAT is on 28 Mc. with a new 3-element beam and 125 watts to 809's. At a recent meeting of the New Haven Amateur Radio Assn. the following officers were elected: Pres., KDO; Vice-Pres., TD; Secy., ATH; Treas., JQK; Directors, BYW, AGT, LTZ; Chief Opr., LTB. After three weeks of code practice at the club rooms, six of the boys are doing 11 w.p.m. BCG increased power to 500 watts and bought a straight key. Yep, he is going to teach the XYL the code. HYF-2NLQ is active on 3640 kc. 3AOH recently gave a very interesting talk on antennae and feeder systems to members of CBA.

Traffic: W1AW 890 (WLMK 8) TD 129 LOP 114 KQY 111 JQD 58 UE 51 BIH 45 LUH 35 MBN 33 KNV 30 EAO 27 CTI 18 FMV-ITI 8 NIW 6 DWP-GB 5 INF 43 JMY 27.

MAINE — SCM, Ames R. Millett, W1BAV — New PAM for Northern Maine is W1KZZ. New RM in this Section is BNS who transferred to this state from Vt. Red is a swell fellow and did credit to the Vt. Section. We are certainly lucky to have him with us. New OPS: IFZ, New ORS: DHD. KTN is now 2BVR in Schenectady, N. Y. AWZ moved to So. Paris from Fall River, Mass.; he used to be a Maine ham back in the days of spark and had a two-letter call. IIB is back with PTN and Hit and Bounce gangs at 8:30 every morning. The Androscoggin Radio Club are conducting classes every week and have about nine students interested. AUC is on c.w. as well as 3.9-Mc. 'phone. LIC is back at Camp Blanding after spending three months at radio school. Scotty has Class A now, and is very anxious to be back on the air and work some of the old gang. AI is spending most of his time operating on 3.9-Mc. 'phone and reports into the Sea Gull Net. GXY is back on the air for the winter and doing a swell job with new e.c.o. TD spends pretty near all radio time banging away at traffic handling and lining up his emergency set up for Augusta. KEA is back on 1.75-Mc. 'phone and 3.5-Mc. c.w. after about 25 years' absence. Nice going, Irving. GKJ finished building 112-Mc. receiver. The Northern Maine Net changed time to 5:45 p.m. EST. After a 100 per cent attendance all summer, GKC is obliged to drop out of NMN for the winter due to lack of time. The gang are sure going to miss you, Sloppy. HSO was visited recently by his son, ATE, who was home on leave from naval duties as Ensign. JAA compiled a very nifty listing of all Maine hams, cross-indexed by towns, that is very useful in routing traffic on NMN. They tell me LYW has hung a fluorescent tube on the far end of his antenna which terminates in a graveyard. It produces a very weird effect with a four-foot white light swinging back and forth as passersby increase their speed at night. MUY has a new 1.75-Mc. antenna up and improved signal strength. KVK is now living in Bangor and operating at WABI. MXN moved to So. Thomaston for the winter. MXQ has some swell out-of-state schedules for the NMN traffic on 1.75 Mc. MXT is building 112-Mc. equipment. NHI got his 70-footer up, with only one helper. NBK has a new rig running 812s, cathode modulated. NDV has a new Gross transmitter running 75 watts plate-modulated to 1'Z20s. KKZ has 250 watts to T40s. HLT is rebuilding to 812s. NKJ at Rockport is very active on 1.75 Mc. with Harvey 80T. Although Roland's ticket is new, he was new to ham radio when they started using rotary gaps! The NMN are still looking for Bangor outlet. Anyone interested, drop a card to KKZ and arrange a schedule to talk it over. The NYA Radio Club at Houlton was issued a license and plans to put on a couple hundred watts soon. This project was organized and is being instructed by NBK. GOJ, Chief RM of PTN, has appointed LYJ as acting manager for the net during his absence. MFK is on 56 Mc. and being heard regularly in Mass. The Portland gang are all working on u.h.f. gear. DZU has been doing a lot of 112 Mc. work along with CRP, LNI, KAD, EFR,

AWT, LOA and MBR. LOA has a new double extended zepp on 112 Mc. KAS, KSS, GVS, LOA and BAV were at the Boston Hamfest and had a swell time. The ultra highs seem to hold plenty of prospects for the future, so take it for what it's worth, gang.

Traffic: W1TO 31 GXY 28 AI 4 IIE 18 KKZ 19 IFZ 21 BNS 23 NGV 43 AUC 7 GOJ 126 DHD 30 BAV 53. AARS: W1AMR 42 CFO 95 EFR 44 FAP 148 FJP 19 GE 42 GHT 40 GVS 86 IJF 66 IST 30 IVV 4 KOU 140 LML 88 LKP 31 TO 26 DHD 3.

EASTERN MASSACHUSETTS — SCM, Frank L. Baker, Jr., W1ALP — The New England Convention and Boston Hamfest have come and gone. More than 1000 attended. The SCMs were present from Maine, N. H. and West Mass. Our Director, BVR and our Pres., KH, were there. New ECs: ATD, Brookline; UU, Beverly; COX, Lowell; KTG, Cambridge. Give them your support, gang. New OPS: COX, KVH, DA. New ORS: LRO. LBY is now EC for Marshfield and is busy with Fire Dept. We need two new ECs, one for Bristol and one for Plymouth Counties. What say, who will volunteer? If you know of any ham in this Section who is doing any traffic handling, we want their reports for this column. Write me or tell them and I will mail some monthly report cards. JGQ built transmitter for MXJ. His gang had first test for Civilian Defense, working portable-mobile with Red Cross. IUQ is back on 3.5 Mc. KKO left for Coast Guard training station. MPP and gang in Watertown had first net meeting and will have drills on the air. IWO is at Fort Knox. IID has new home-built a.m.-f.m. super for 112 Mc. IKW is working on 112-Mc. converter. AKD is mobile with m.o.p.a. on 112 Mc. KQN is back on 14 Mc. MDN is rebuilding, will be e.c.o. on 56 Mc. LXQ is busy on Defense organizations. NBM and NBI worked K6 on 28 Mc. NPE got KB4. CIB gets KA's on 14 Mc. each a.m. at 7. GOU says look for K7's soon on 28 Mc. LO, LRN, JEL all have 4-element beams atop cars for 112 Mc. KBL moved to Attleboro and is rebuilding for all bands. JJQ is back on 112 Mc. GIW is building and will be back on 28 Mc. and has new Sky Champ receiver. AGR is now Commanding Officer for C.A.R. at Norwood Airport. CRN is rebuilding. NNN and NKQ on with 112-Mc. portable rigs. AHP has MRT3 in his car. BOO's 112-Mc. equipment was set up as control in tower of County Court House during defense test. CCA rebuilt station on 7, 14, 28 and 112 Mc. BWW has new receiver and is active again after long silence. ACT, Fall River Amateur Radio Club station, is being dusted off and meetings held again every Thursday night. The following are spending a lot of time on Civilian Defense radio communications: CRN, BOO, JGL, FZU, CCA, AHP and NKQ. Just a suggestion: I think all clubs should let the time and meeting place of their club be known so that any ham in the service who may be staying near you can drop in for a visit. AAR is now Corps Area Net control CADC9 for 1.75-Mc. Net. Russ had QSO with W2GPO on L. L. N. Y., on 112 Mc. recently. MLK is manufacturing 14-Mc. rotary beams. NAV and XYL have a new YL jr. op. Congrats. KTE went to Burlington Hamfest and won a crystal. BAP is working on 112-Mc. rig. NKW is having fun on 112 Mc. HIL worked KA1JH. The cross-band contest between EC, OPS and ORS worked out fairly well in this Section. NF won first prize for emergency rig at New England Convention. Hams in Milton put on an Emergency test with portable rigs on 112 Mc. GAG is working on 56-Mc. rig. MJ is working on new modulator for 56 Mc. KIY in Melrose is now on 56 Mc. LPP is now in Clinton. CRW is moving to Derry, N. H., soon.

Traffic: W1JCK 307 (WLGV 45) BDU 282 BXC 160 AAR 181 MJK 108 KZT 86 BMO 80 LBY 30 MQT 25 NAV 21 KTE 19 MDV 16 BAP-JIS 6 MKN 4 EVJ-IXL 3 EKT-NKW-ALP 2 AKS 304 (WLG0 68) LWH 195 (WLGf 188) EHT 1 JSM 219 EMIG 184 GAG 5 MPP 8 BB 6. AARS North Shore 10 Fone Net: WIAGX 49 HWE 34 JFS 39 LVZ 94 MQE 7. 160-Meter Net: W1HIL 27 KYN 13 WS 15 BWJ 36 IEN 32 CCL 22 AAL 24 MEZ 23 LSA 73 EXU 20 KRR 1 MOJ 33 FVL 35 NPA 3 MLZ 7 IYU 38 MTQ 49. 2½-Meter Net: W1EYR 130 MQH 96 MMY 64 LWI 14 MBS 26 MON 210 MIG 22 MZJ 14 NBC 26 MPT 30 FIK 2 MWM 10 NBT 6. 80 CW Net: W1KCT 154 AHP 56 KB 38 EPE 208 FSL 142 KXU 116 MAN 12 NFZ 8 QA 1 TY 126.

WESTERN MASSACHUSETTS — SCM, William J. Barrett, W1JAH — WIBIV leads this month's scoring parade. Pres. is getting all set for emergency-powered 112-Mc. work in local emergency setup. MIM comes through with the first BPL of the season. Nice going, Lee. She is making a habit of conventions these days, having taken in

the Bridgeport, Burlington and Boston affairs. AZW is doing swell job with West Mass. AARS Net. AZW, BKG, HNE, FOI, MND, KIK, KZS, FZL, JAD, BVR, NKN, AUN and MVF were among those present at the N. E. Div. Convention. MJP and BXP are new ORS and GUF is new OPS. BNL says rig is about set for winter, after replacing battery bias with power supply. LVW is now in Army Air Corps. Ex-JXN, now 4-HMS, asks to be remembered to his old friends in West Mass. Ed is now pounding brass at sea. JAH enjoyed visits from BVR, SC, JMY and NMF during the month. A swell time was had by all at the N. E. Div. Convention at Boston. Many angles of interest in connection with our part in Civilian Defense, etc., were thoroughly discussed. The conclusions were clear: Each one of us should make himself an integral part of defense efforts in his community, particularly with regard to u.h.f. equipment, whether you have to beg, borrow, steal or build it. Every single ham should set as his goal the possession of self-powered u.h.f. equipment, plus, if feasible, self-powered low frequency gear. Those who don't like the idea of buying vibrapacks, etc., might look over the possibility of "borrowing" the necessary juice from the car radio. A switch in the heater supply to the car radio tubes will leave the power supply output available for your use. Let's go, gang, 73.

Traffic: WIBIV 279 (WLGJ 68) MIM 209 AZW 154 (WLGJ 73) IOR 147 (WLGJ 12) JAH 115 (WLGJ 9) MVF 93 NKN 83 FOI 80 BVR 70 (WLGJ 73) LGA 64 (WLGJ 10) KZS 60 NLL 53 BXP 48 AJ 38 MBT 36 MND 30 MKR 28 PNY 25 LHW-MJP 20 ICW-DUZ 17 ADF 15 JFA 13 JVV 11 MSR 7.

NEW HAMPSHIRE — SCM, Mrs. Dorothy W. Evans, WFTJ — WILSN has three-sided wooden tower up with topmast making Johnson Q 55 ft. high. BJB and JOG are working on 56-Mc. transmitter. COO completed crystal-controlled transmitter for operation on Mt. Washington just outside 116 Mc. KLV is new OBS. AOQ, NEI and 2ISQ/1 are new ORS. KLV recently wrote FB article for his local paper informing the general public just why and how they might receive short-wave signals on their BC sets. Good work, Hap, and fine article. BFA 7 is now located in Montana. We miss you on NHN, Ernie. JKH recently visited LSN and other hams at Hampton, N. H. GVJ has a new arrival at his shack. Congratulations! KKK is active in NH AARS. She recently attended Worcester Hamboree. MUW, together with MIM from Mass., went to the Burlington, Vt., hamfest. The girls report having a swell time up there. Norma now has received her 25 w.p.m. Code Proficiency Certificate. We think that's grand. She also attended New England Convention at Boston. BFT won third place in code contest at New England Convention. BITU recently visited the Manchester Radio Club, LVK, SC, JMY, MIM and MUW have formed a new net and, we understand, provide good code practice. NNZ, NNA, NOP and NKI are new hams in Manchester. 2ISQ/1 is now located at Hanover and has been checking in on the NH Net. We're glad to have you with us, Jack. NEI now has e.c.o. running about 25 watts input. Les is interested in cryptography. GEY is interested in 112 Mc. We would like to see even more u.h.f. activity here in this Section. AYH is now located in Amherst. Nashua boys now have a 112-Mc. Net for handling local traffic. They meet every Thursday night. MMG is considering signing up for radio school at Callup's Island. BHJ is working on a new concentrated beam for 56 Mc., with which he is in hopes of getting through to New York City. IVU is contemplating taking the final step. ICS is now working at WMUR. AVG received his commission as Ensign C-V (S) USNR and is reporting for duty at Noroton Radio School soon. HJI has new XYL and new QTH. He will soon be found on 14-Mc. phone once more from his new location. AVJ has a new NC200.

Traffic: WIGEY 60 MMG 48 JKH 33 IP 23 CEA 17 AOQ-BFT 16 LSN 3.

RHODE ISLAND — SCM, Clayton C. Gordon, WHRC — The Westerly Radio Club sent representatives to Providence to visit and confer with the P.R.A. committee on standardization of portable-emergency equipment, and have since appointed their own standardization committee consisting of W1MOK, MAE, AGJ, BDS, LZD. This effort, being connected with Local Defense, and at present emphasizing 112-Mc. equipment, has started a 112-Mc. boom in Westerly. APX moved to Westerly from Rangely Lakes and has joined the W.R.C. IEJ and Norman Husted are on the committee for the annual banquet and nominations. KRF is attending radio school in Boston and building e.c.o. in his spare time. MOK recently kept FB schedule with

KRQ/8 on 7 Mc. Several days later he found that he had worked with a 3.5-Mc. coil in final KCG and IEJ are known as the Swap Kings of Westerly, and are doing a land office business since parts started to get hard to get. Whatcha got, fellers? HJB is leading the parade in the P.R.A. with renewed effort to get the 112-Mc. Net working right up to snuff. He really went to town in his plea at the P.R.A. the other night for more 112-Mc. stations for his net. MEK has been working on JEZ's emergency rig and has it perking nicely on 3.9-Mc. phone now. NCD was relieved from duty in U. S. Army, Sept. 16th, and is active on 112 Mc., working MEK for 3.9/112-Mc. crossband QSO of 2 1/4 hours the other day. BFQ is active on 7 Mc. again. HRC made his annual pilgrimage to Vermont State Convention and ran into Everett Sunderland, who has completed his hitch in the Navy and is now with FCC. LCH wrote home from camp that the Army is agreeing with him and praised some of the gear he has seen that was built by National.

Traffic: W1MEK 19 MWK 12.

VERMONT — SCM, Clifton G. Parker, W1KJG — W1GQJ completed new buffer using parallel TZ40s covering 1.75 to 14 Mc. at inputs up to 250 watts, with fine results reported. Alex has T155 final for tough going. The season was off to a good start at the hamfest on the 4th, with good weather, good attendance, a fine program and a general good time. Twenty-three ARRL Club Code Proficiency Certificates were awarded. The Burlington Amateur Radio Club, sponsor of the convention, also has been busy installing the club station and recently received fine publicity in Vermont dailies with photos, etc. Newly elected officers for the current year are: Pres., GAN; Vice-Pres., KUY; Secy.-Treas., NLO. The club meets each Monday night at the club building, rear of 25 Bay View St., Burlington. 2HCB and XYL were recent visitors at AVP. Bill says the Vermont Phone Net is on each Sunday from 9:30 a.m. until noon. They would like to secure more general coverage in the Section, so let your PAM know where you can help. KJG has been assigned W1GU for AARS work. MZO reports work on portable units. NLJ is completing 250-watt rig. NAG is attending Northeastern, where he is taking E.E. course. KOO moved his outfit to Burlington. AD has been appointed RM for 1.75-Mc. activities and is working on 1.75-Mc. C.W. Net. Charles will appreciate hearing from others in the Section who can and will aid in getting more coverage for traffic. Your SCM has distributed application cards around the Section, and hopes the gang will get them back promptly. KTB has his rig on again from Lyndonville. AVP has been appointed OBS. BNS has resigned as RM for Eastern Vt. due to present work in Maine. Our Section roll now reads as follows: RMs: FSV, AD. ECs: JVS, KOO, MJU, AZV, AD, CBW, KJG. OBS: KTB, AVP. OPS: AVP (also PAM), GAN, AD, DQK, MCQ, CBW, GQJ. ORS: KOO, KTB, MJU, MLJ, KWB, MANU, CBW, NDL, GQJ, KJG. We still have plenty of opportunities to add to each list, particularly for Emergency Coordinator work. Your query by mail or air will be welcomed.

Traffic: W1GQJ 7 AVP 13 JVT 9 MZO 2 MMU 7 CBW 63 BLC 8 KJG 71. (Aug.-Sept.: W1GQJ 5.)

HUDSON DIVISION

EASTERN NEW YORK — SCM, Robert E. Haight, W2LU — KWG continues doing a swell job handling traffic. 8SFD reports via amateur radio, thanks to 2MXR. ACB, EC of Schenectady area, has emergency equipment in first-class condition. MHV sports new Meissner Deluxe Signal Shifter and SX16. NCG is getting out FB with just a signal shifter. EQD is a proud papa. Congrats, OM. FSD reports for AARS traffic handlers and says CMA of Scarsdale joined AARS. Your SCM at this writing extends his best wishes for the future success of the new SCM. As SCM I have enjoyed your cooperation and trust you will continue it. I am also leaving for active duty in the U.S.N. and hope I will have the pleasure of meeting many of the boys in the Service. 73 to all.

Traffic: W2KWG 143 8SFD 153 ACB 22 MHW 11 NCG 8 Aug.-Sept.: HTU 6 JQI 192 KCI 15 KWG 85 LRZ 42 NVB 68 SPSM 21 8QMR 53 8SFD 44 LLK 32 MSW 13 IJG 4 Sept.-Oct.: JQI 65 HTU 18 LRZ 37 KCI 21 NVB 192.

NEW YORK CITY & LONG ISLAND — SCM, Ed L. Baunach, W2AZV — W2LUY is out for ORS. HAE reports from Naval Training Station at R. I. EXR is home again after a 10,000 mile trip throughout the U. S. BFS is building his transmitter into his new shack. BGV increased power and is using 811 with 130 watts input. LPJ rebuilt rig using

(Continued on page 88)



A CREI Course is the Direct Course to a Secure Future in Radio!

CREI Spare-Time Training Can Prepare You Now for a Responsible, Well-Paid Position

Take a long-range view of your future in radio. Look past the present-day defense activity into the years that are ahead. The substantial engineering positions of the future will belong to the men who trained for them now.

Your opportunity is here today! Your own radio experience backed by CREI modern technical training can equip you with the ability and knowledge to acquire and hold a responsible, radio engineering position. The only difference between an \$1800 "short term" job today and a \$4000 "career" job tomorrow is your technical qualifications as an engineer. Don't waste another day in making your present job pay for your investment in your future.



Write for Details and Free Book Now

If you are a professional radioman and want to make more money—let us prove to you we have something you need to qualify for the better job opportunities that can be yours. To help us intelligently answer your inquiry—please state briefly your education, radio experience and present position.

Capitol Radio Engineering Institute
Dept. Q-12, 3224 16th St. N. W., Washington, D. C.

One Shack — Nine Bands

(Continued from page 39)

power from a 6L6 modulator and power for plate and filament are fed to it through a four-wire cable to the operating room.

A Hammarlund HQ120 is used for receiving on the four lowest frequency bands. A two-tube converter feeding into the HQ120 is used for the 28- and 56-Mc. bands. A super-regenerative receiver with a 955 acorn detector, plug-in coils and a two-stage audio amplifier is used for the 112- and 224-Mc. bands. A similar super-regen with quarter-wave tuned lines and a 6L6 amplifier is provided for the 400-Mc. band.

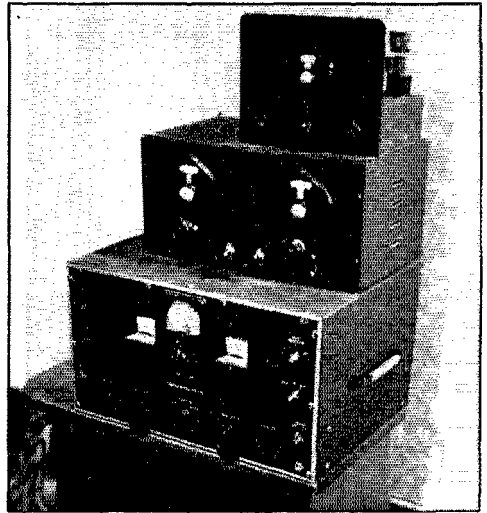

Receivers covering all but the $\frac{3}{4}$ -meter band. The HQ120 is used for the lower frequencies, a converter for the 28- and 56-Mc. bands and super-regens for the higher frequencies.

Five antennas are provided to take care of the various transmitters. For the lower frequencies there is a 135-ft. wire 50 ft. in the air. It is operated as a quarter-wave against ground for 160, half-wave end-fed on 80, full-wave on 40 and three half-waves on 20. The first few feet of the antenna are in the form of a short section of concentric line and a matching stub for 14 Mc.

A half-wave center-fed antenna with tuned feeders is used for 10. The same antenna is used as two half-waves in phase for 5. A half-wave vertical with tuned feeders is used for $2\frac{1}{2}$ meters. Indoor half-wave verticals are used with the $1\frac{1}{4}$ - and $\frac{3}{4}$ -meter rigs.

Receiving antennas are separate from those used for receiving. A small rotatable system is mounted on top of the $\frac{3}{4}$ -meter receiver.

Bill MacDonald, owner and operator of W2TY, is editor of *Radio and Television Retailing*, a trade magazine. His station is located at Hollis, L. I., N. Y.

— D. H. M.

BLACKOUT THE SHADOW!

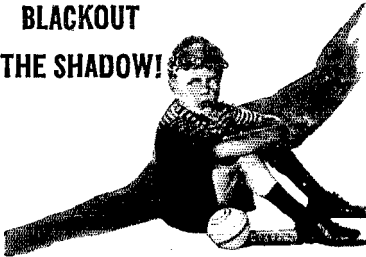

CLOSE to all of us is the threatening spectre of tuberculosis. No respecter of persons, it lurks in every corner, may strike at any moment. *More people between 15 and 45 die from tuberculosis than from any other disease.*

Yet tuberculosis can be driven from the face of the earth. Since 1907 your Local Tuberculosis Association has helped reduce the toll of tuberculosis by 75%!

By buying Christmas Seals you will help us complete the job—and make this a safer world for yourself and your loved ones.



Buy
**CHRISTMAS
SEALS**

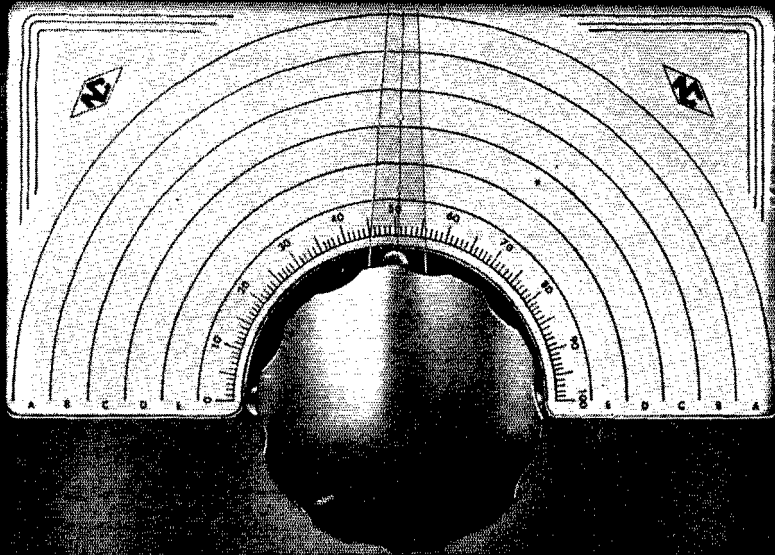

NATIONAL
COMPANY, Inc.
MALDEN, MASS.

NATIONAL ACN DIAL

- Dial bezel acts as drilling template
- Blank scales for direct calibration
- Index holes in pointer for pricking calibration points
- Scale removable without dismounting mechanism
- Uses "Velvet Vernier" Drive Unit
- Bezel can be drilled for switches or jacks.



It's no wonder you want an
ASTATIC MODEL D-104
MICROPHONE
for Christmas!

LIST PRICE \$22.50

*Complete with plug, connector
and 8-ft. cable. See your Radio
Parts Jobber or write for catalog.*

● Thousands of veteran amateurs have thrilled to the long, satisfactory and dependable service of this grand speech-range microphone. Model D-104 has definitely reduced feedback tendencies and does not gum up or overload when used for close talking applications. This is the first practical crystal microphone ever developed and today, after eight years in amateur service all over the world, is one of Astatic's most popular models.

ASTATIC

THE ASTATIC CORPORATION

YOUNGSTOWN, OHIO

Licensed Under Brush
Development Co. Patents

In Canada:
Canadian Astatic Ltd.
Toronto, Ontario

(Continued from page 86)

a 59 e.c.o. 6L6 doubler, TZ20 buffer, p.p. TZ40s. VG finally settled his antenna problem for 7-Mc. operation and is now looking for a schedule to handle trainee traffic. MWT is deserting 23 Mc. for 1.9 Mc. OAF worked his first W6 in California. DZH completed rack and panel job for 7 and 112 Mc. IHT installed intra-communication radio station on Yale campus. BO requests all 2nd C.A. AARS to make use of 7020 WLNZ daily at 1 p.m. for traffic anywhere. KTA is getting cooperation when AARS net comes on Monday night. LUY finished 300-watt rig. IOP is busy rebuilding. The boys are busy getting FJV going for defense communications. MZB received 35 w.p.m. sticker. BWC was control station for the 3.5 Mc.-c.w. AARS stations during the Nassau County blackout. NDQ maintained contact with IHP/2 and NFU/2 during emergency practice with the N. Y. State Guard on 112 Mc. Both EC and GP are on the A P Prunk line. BCS operates on 14265 kc. BGO, EC for Bronx County, is looking for stations with portable 112-Mc. equipment for the Emergency Net. All those interested should get in touch with him. DOG had good success with 112 Mc. during Suffolk County blackout. Stations on the east end of L. I. should contact him to help build up the net. EC, CET for Nassau County and RZ, 112 Mc. Asst. EC, did a fine job of lining up all towns on 112 Mc. and working LJJ at County Headquarters during the blackout. Every 112-Mc. station in Nassau County should register with CET to help in getting the net organized 100 per cent. The following stations are on the 3710 section net every night at 8:30 p.m.: MT, CKU, DW, GTZ, LBI, LGK, LR, MRL and MZB.

Traffic: W2SC 1411 (WLN 589) LPJ 1246 BO 702 BGV 337 KI 260 DW 299 MRL 71 MZB 71 LUY 61 AZV 49 AYJ 45 MWT 35 BWC 32 (WLN 17) NDQ 30 LGK 29 LR 26 BGO 22 EC 19 MT 22 CET 18 AV 11 RZ 10 CKU 8 DOG 7 BFS-GTZ-LBI-MSS-VG 4 BDS-KTA-ADW 3 OAF-UH 2 FF-NHD 1.

NORTHERN NEW JERSEY — SCM, Edward Gursky, Jr., W2LMN — PAM, W2LXI. RMS: 2CGG, HCO, IYQ. New appointments: RM, HCO; ORS, LFR. Section Net, 3630 kc., 8:45 to 9:30 p.m., daily (except Sunday). 2JYK received Class A and is now active on 14 Mc. FB is active on 112 Mc. MHB operates with e.c.o. on 1.75-Mc. 'phone. MRJ received 35 w.p.m. CP sticker. MRX has a new three element beam for 23 Mc. and is building e.c.o. and 200 watt final. At recent election of Tri-County Radio Assn. the following officers were elected: President, 2HNY; vice-pres., 3FKK; secy., 2NJE; treas., 2LYP. A newly organized AARS net meets on 2000 kc. daily at 12:30 p.m. HXI is proud owner of a new Super-Vibroplex. The Bloomfield Radio Club extends a hearty welcome to all hams. They are on the air with between 300 and 800 watts to 852's. HNA is active on 3.9-Mc. 'phone. Once again MLW took high honors for the second C.A. in the AARS ZCB contest. Frank also received the special call WLNC. The Irvington High School Radio Club, MTZ, is back on 7-Mc. c.w. and 1.75-Mc. 'phone. NWA is trustee and OAE, MRZ, LEU and NBL are staff operators of the station. JSE, MRZ, FDL and MKN are all active on 1.75-Mc. 'phone. JME has been getting in to New England and Penna. on 112 Mc. The gang in East Orange have formed the "East Orange Emergency Radio Club" with AGD, AKK, BCC, BIE, CIZ, CO, EGT, EJA, EJD, EMN, EOW, FAC, FL, GCE, GEL, GQN, HIJ, HQD, HUW, HXI, HYR, HYV, HZR, IBJ, IBO, IRE, JAF, JEZ, JGW, JH, KEH, KKQ, KXX, LII, LWO, MLP, MXO, ARI, CBH and prospective ham Fred Charles all pitching in. OGU is a newcomer in Rahway. MPS and LCA are instructors for the radio code and theory course of the North Newark Adult School. NOZ is the call of the Senior High School Radio Club of Long Branch. They have been active on 1.75 Mc. Among the active members are five YLs. Because a large number of their members are either in the services or tied up with night working hours, the North Newark Amateur Radio Club has decided to discontinue their weekly meetings and meet once a month instead. FSQ has been prompted to the rank of master sergeant in charge of communications for the 102nd Cavalry. The radio class of the Verona NYA Center has completed two mobile units for operation on the NYA frequency, 26,750 kc. A 100-watt and a 250-watt rig will be assembled by the students when the kits are received. OGG is ex-8VSR and is on 1.75-Mc. phone from Englewood. NZH built new e.c.o. QL is back on 7-Mc. c.w. once again. He just returned from Baton Rouge, La., with a new XYL.

Traffic: W2MNT 531 (WLNW 100) CGG 450 KSR 353 JUU 186 HXI 179 MLW 153 NCY 107 IYQ 68 (WLN 13) LAIN 57 EKU 54 IFR 31 NJE-OBG 28 MRX 16 NWA 13 MRJ 12 HZY 6 MIG 5 JHK 4 IZV 2 JC 1 (Aug.-Sept.): MWW 222 JUC 21 JKH 12 MNO 9.

ATLANTIC DIVISION

EASTERN PENNSYLVANIA — SCM, Jerry Mathis, W3BES — 3FJU's large total is due to being Corps Area NCS for two weeks. AOC is back in school again after 2½ years' absence. ABT of U. of P. is on once more. 3KJ has five schedules a week with KAICM and KAJJH on 14 Mc. 'phone. ADE is rebuilding. FXZ is acting as stand-in for AKB on her trunkline schedules. IKN has rig now working on 3.5, 7 and 14 Mc. DVC says: #@&*!!\$ the guy that cut down his antenna. From W3AQN York Co. E.C.: "The Asst. ECs on my committee are as follows: IQN, GES, HFG, GZZ, BXR, IPE and HKB. There is one for each band. We have 30 amateurs here." SRKZ is using a Meissner Signal Shifter on 3.5-, 7- and 14-Mc. c.w., suares quite a lot of traffic on the loose and gets a big kick out of handling trainee messages. AQN wants some Phila. stations to report into the E. Pa. Net. At present there are none. 8AKF is back on the air after 7 years' silence. He may be found on 3.5 or 7 Mc. with 100 watts to HY40. 3BRZ is working 1.75 Mc. and helped in aircraft spotters radio net in Lancaster County. NYA station, 8VYC, now schedules 3JJA, NYA at Harrisburg on 3800 kc. and will move to 3592 when FCC order becomes effective. SUQM is in charge and will gladly QSO the gang. 8WAS and 8VJA are now working 112 Mc. with 8UQM. On Sept. 20th members of the Lancaster Radio Transmitting Society provided emergency communication with four emergency powered stations for the Lancaster Civilian Air-Defense Service who furnished practice flights for the American Legion Aircraft Spotters Service in spotting tests. The entire program was a huge success with 24 local planes participating. A swell gossip letter of which I will quote parts came in recently from 8PTE of Towanda. "There are 5 hams in the town of 4100 population. 8BFF moved to a new QTH where he can put up 3.5-Mc. antenna and will be on 3.5 Mc. c.w. in the daytime due to night work. 8MFD works 3.5- and 7-Mc. c.w. 8PTE is on 3.5-Mc. c.w. only and has his 35 w.p.m. code ticket. 8PUZ is on 3.5-Mc. 'phone and c.w. 8TOD has another call, W8OVN, for his hunting shack 8 miles away and may be found on 3.5-Mc. c.w. and 1.75-Mc. 'phone." 3BES now has a brand new son and heir whose initials are H.A.M.

Traffic: W3FJU 2108 3AOC 366 8AQN 205 3BXE 126 SRKZ 122 3DXC 2 3HCT 21 8ATF 73 3KJ 9 3DR0 15 3ADE 28 3JBC 19 3FXZ 23 8OML 12 8UQM 29 3IXN 8 3GDI 36 3DVC 3 3AKB 66 3BES 36 3DMQ 1 3EWR-(WLQH 348).

MARYLAND-DELAWARE-DISTRICT OF COLUMBIA — SCM, Hermann E. Hobbs, W3CIZ — W3BWT Eppa W. Darne, Chief RM. Roy Corderman, Regional Coordinator Emer. Nets. Lt. Caskey, of the Md. State Guard, is interested in forming an Amateur Radio Net in cooperation with the Md. State Guard to operate for training purposes between 8:30 and 10:30 p.m. each week day. He will be pleased to hear from anyone interested no matter what type of rig or whatever the power. Address 5th Regt. Armory, Baltimore, Md. AQV moved to 428 Baltimore Ave. where receiving conditions are not as good as his former QTH. CGY is Asst. EC for u.h.f. for Wilmington, Del. BKZ/WLQK, the genial SNCS of the Md. AARS, has a secretary to help out with correspondence. CDQ took part in the CP contest and will be in the U.H.F. Test. DLC is now on 14-Mc. 'phone with 300 watts. FFN was inducted into the Army and is located at Camp Wheeler, Georgia. HUM reports the AP net going in good shape and plenty of traffic. HWJ schedules Va. 'phone net Sundays at 9:30 A.M. IEM is now at Hampden-Sydney College, where he and HAE are organizing a radio club with HAE's 150-watt rig and new HRO. JAS is QRL with Md.-D.C. AARS net every night. JFW has a nicely distributed bunch of 7-Mc. schedules. JHW is proud possessor of NC-200 receiver but doesn't have time to operate as much as he would like. JMC/3 is a new arrival and ORS from Phila., Pa. JOI is call of Baltimore Radio Club. GXO is on two year jaunt and left his 350-watt rig with the club which is now OPS and on the air. JOW is a new local ham. PV can be heard on the AARS net and occasionally on 14 Mc.

Traffic: W3AQV BKZ 118 BWT 1272 CIZ 634 DLC 16 FFN 1 HUM 129 JAS 292 JFW 50 JHW 16 JMC/3 32 JOI 6 PV 39 UF 77 USA 3064 (WLM 3718).

SOUTHERN NEW JERSEY — SCM, Lester H. Allen, W3CCO — Asst. SCM, W3ZI-Regional Coordinator in charge of Emergency Coordination, W3BAQ-RM's: 3BEI, ITU, ZI. PAM., 3EUI-Section Net Frequencies: OPS, 1980 kc. (Tues. and Thurs. 8 p.m.); ORS, 3700 Kc. (Tues., Thurs. and Sat. 8 p.m.). With the writing of this column we sum up the year's operating activities and look forward to greater things in 1942. Look back and ask yourself if you have done enough to help the section in the past year. If not, make plans and take an active part in all section events. During the past two months I have had several requests on the boundaries of our Section. For your convenience they are listed by counties: Atlantic, Burlington, Camden, Cape May, Cumberland, Gloucester, Hunterdon, Mercer, Morris, Salem, Somerset, Sussex and Warren. If you or your friends have never been mentioned in these columns and live in one of the above mentioned counties, your SCM will be glad to hear from you and mention what you have to offer. There are lots of openings for appointments in the above mentioned counties and some don't have as much as one representative. How about it, fellows? Let's try to get at least one appointment in all counties. After all, activity is what makes the wheels go around and help keep our Section on top. 3ITU, ASQ and BEI renewed OPS for another year. IPM, JNO and JOL were appointed OPS and are doing a swell job in the Section Phone Net. BWF is now OBS and OO. BYR moved to N. N. J. GIZ has RK38's on 28 Mc. running 500 watts and has a new oscilloscope. ZI has been traveling lately doing a lot of research work and reports has visited several amateurs during his spare time. TL is rebuilding to rack and panel. CMX is building new rig for 1.75-Mc. 'phone. IZT has been quite busy but still finds time to do a good job on the 'phone net. When not busy on the 3.5-Mc. c.w. nets, EWR will be found on 112 Mc. From all indications there is quite a lot of activity on 112 Mc. around Atlantic City. IDZ needs Oregon and Idaho to complete WAS on 1.75-Mc. 'phone. GNY is doing FB job on ORS net and is slowly climbing to the top. AVJ is still heard on ORS and AARS traffic nets. INF is active on ORS net only. AEJ is heard on 1.75-Mc. 'phone calling into OPS and Westmont nets. GZS is new OPS in Clarksboro and is heard regularly in Section Phone Net. JL is moving to new QTH. ASQ is building new high-frequency gear. ABS reports into OPS Net regularly and is seeking AARS c.w. net. JAV is new member of OPS Net on 56 Mc. JBU is considering AARS c.w. net. JAV is new member of OPS Net and is doing FB job from Hammonton. JOL is building a new power supply for power increase. GHR is operating portable from Greenbank. IWA and JL are experimenting on 112 Mc. HPX has 56 Mc. mobile equipment in his car. FSI left our section to accept a job in Panama. EWF reports from Jacksonville this month and says he enjoys reading all about the boys back home. The DVRA is making final plans for its 10th anniversary banquet and from all reports a good time is in store. The date is Nov. 22nd. Heartiest Christmas Greetings to all. 73.

Traffic: W8EWK 197 BZX 180 IDZ 106 GNY 129 AQ 86 OQ 85 HAZ 62 CCO 71 IZT 47 AVJ 47 HDW 89 INF 25 BEI 16 AEJ 12 GZS 11 HPX 10 ASQ 9 GHR 7 ABS 6 IFU 5 JBU 6 JAV 5 JOL 3.

WESTERN NEW YORK — SCM, Fred Chichester, W8PLA — Although there has been plenty of activity and a great deal of traffic handled in the section in the past month, news is scarce. W8CSE is monitoring 1780 kc, the new frequency, registered at ARRL Tuesday and Wednesday nights. He would like schedules with anyone working 1.75-Mc. c.w. DII's new rig will have 812s running 450 watts. TEP finished a 250-watt rig capable of working all bands, 'phone or c.w. USX needs five states for WAS. ELK joined AARS. Allegheny OPS are getting ready for 112-Mc. portable and defense work. BHK is operating 14-Mc. 'phone and 7-Mc. c.w. VEF won Miller Variarm at the Schenectady hamfest. KWS and HNN spent a week traveling through the New England states with a 112-Mc. rig in their car and worked about 50 stations. ETH, QLV and SUV have 112-Mc. stations on the air and are looking for some 50-mile DX contacts. BCU is working overtime to get his station on 112 Mc. DEB moved from camp to new QTH and has to start building a station. KYM started construction of a 112-Mc. receiver. Defense has taken another W. N. Y. ham. VLM has accepted a position with a Niagara Falls firm doing National Defense work. TBZ was home on leave from the Army. Sid is going to put a 7-Mc. rig on from his QTH at Camp Shelby, Miss., and would welcome QSOs with the gang. UTR is operating 1.75-Mc. 'phone and has FB sig.

STUV celebrated 15th wedding anniversary and has been in ham radio nearly all that time. The gang are looking for a card from QJG, who is now in the Navy. RKJ is now a War Dept. Inspector associated with the Aircraft Radio Laboratory. He is signing W8RKJ/3 from Towson, Md.

Traffic: W8AIE 7 AMO 9 AOR 13 BJO 141 BOA 20 BUN 15 CSE 54 DLU 11 DSS 30 DII 131 EUY 18 JIW 156 KBW 12 KWS 7 KXR 16 KYR 465 LLZ 9 MLM 14 MNW 4 MRA 11 MVB 20 MXC 12 PLA 399 RGH 198 RKM 218 RMR 11 RTX 236 SB 6 SBV 58 SFD 135 SXR 46 SZB 98 TDB 81 TEP 22 TUS 17 UHT 7 USX 15 UXT 114 VFG 35 VNQ 43 VQH 16 BAL 14 BLO 23.

WESTERN PENNSYLVANIA — SCM, E. A. Krall, W8CKO — Asst. SCM in charge of ORS activities, W8KWA — Asst. SCM for emergency Coordination, W8AVY, RM's: W8NQCJ, TOJ, KUN, W8WJR is new EC for high frequency communication in Allegheny County. KWA has been appointed Third Ca Radio Aide. MJK has been on the job and has a good report again. PER and TTD manage to keep the W. Pa. ORS Net going with their traffic. PX is still going strong on the 'phone traffic. His Weather Bureau Net is doing nice work. AIG still manages to handle some traffic. We hear IOH frequently but not on the net. AXD comes across as an old reliable from Smethport. RIT reports the first fall meeting of the Greensburg Amateur Radio Club was held at VYU's home. RAT and PJJ both have built e.c.o.'s and say they work FB. OFO, our former SCM, now has Meissner Signal Shifter. BOZ is anxious to participate in more OPS parties. OUIH is DNCs Pa.-4 AARS and CDG is his alternate as DNC2. CPE has authorization from the Pittsburgh Defense Council to assist in enlisting the aid of amateur operators to meet the needs of Air Raid Precaution Committee. 8SUS sends OBS every Wednesday before code practice at 3:30 p.m. The Horse Shoe Radio Club at Altoona is well organized for 112 Mc. work. Pittsburgh u.h.f. men are urged to contact EC WJK in order to organize a local net. We are asking for volunteers for a 1.75-Mc. ORS Traffic Net in W. Pa. We are badly in need of this net, fellows, so how about it? RM TOJ made the following report: "W. Pa. activity for month ending Sept. 16: Number of net sessions, 21; number of stations reporting, 180; number of stations per net session, 8.57; number of messages handled, 236; number of messages per net session 13.6. This report shows an 8% increase in the number of messages handled over previous period and an increase in number of stations reporting of 12.5%. Several of our ORS who fail to report for net activity, but are on the band consistently creating QRAM for regular ORS and AARS members are likely to have their certificates cancelled. Your SCM asks such station owners to operate in portions of the band where rag-chewing interference will not bother the regular net. All amateurs should endeavor to become net members in order to expedite handling the volume of traffic. ORS stations are the cream of amateur radio, for they are of real public service.

Traffic: W8KWA 399 CKO 391 NCJ 203 MJK 162 TOJ 187 PER 123 TTD 105 PX 41 HKU 11 AIG 8 IOH-RIT 6 AXD-RAT 5 OFO 4.

DELTA DIVISION

ARKANSAS — SCM, John R. Sanders, W5GNV, Asst. SCM, W5GED. The main news these days concerns the pending frequency changes and Civilian Defense organization. ARRL has offered free crystals to the first ten nets of ten members registering with them for 1.75-Mc. c.w. I have mentioned before the desirability of forming some state nets, particularly on 1.75 Mc. As yet I have only received a limited comment on the subject. Please express *your* opinion. It may not be too late yet to grab that offer. Also, there is a rush for u.h.f. organization in the centers of large population. The League has outlined a procedure for net formation and testing and the many uses such a net can have. The Ft. Smith gang are busy on this angle. The SCM has received a communication from the Relief Wings organization wanting amateurs with light weight self-powered equipment to cooperate with their flying members in this section, so that communication can quickly be transported to isolated sectors in time of emergency. Any good operator with the above requirements living near an airport and interested, please communicate with me. AEC membership is steadily growing. If you're not registered, drop the SCM a card for blanks. Registration is becoming more and more important. Every type of activity is gathering momentum these days. Keep your ears open, and especially watch for the Official Broadcasts.

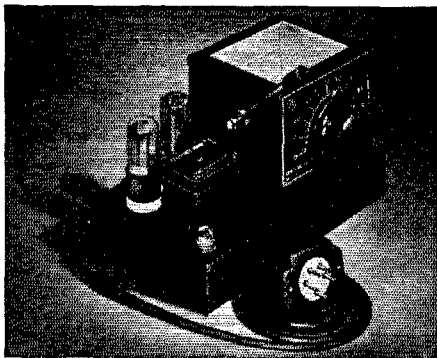

THE RICE-VARIARM

was described in detail in a comprehensive article by Henry E. Rice, Jr., in the January issue of QST. The Millen commercial models are:

No. 90700 has fundamental oscillator frequency range of from 3500 to 3650 Kc. "Convenient-to-change" taps on amplifier and link coils provide for output on 80 or 40.

No. 90701 is the same as No. 90700 except fundamental oscillator frequency range of from 1750 to 2000 Kc., providing for output on 160 or 80.

JAMES MILLEN
150 EXCHANGE ST.



MFG. CO. INC.
MALDEN, MASS.

RACKS ★ PANELS CHASSIS ★ CABINETS by PAR-METAL

"The Line of Beauty"

Ask the man who builds his own and he'll tell you that you can depend upon Par-Metal Parts to be of easy assembly, accurately machined and interchangeable almost at will. You'll learn, too, that they are streamlined, modern in every respect and handsomely finished for lasting beauty.

There are Par-Metal Parts for every job — from simple chassis to complete Sound Systems or Kilowatt Transmitters.

Our Catalog No. 41 describes and illustrates both our DeLuze and Standard Lines. Get a free copy at your jobber's or from us direct

PAR-METAL PRODUCTS CORP.
3262 49th St., Long Island City, N. Y.

Export Dept.: 100 Varick Street, New York, N. Y.

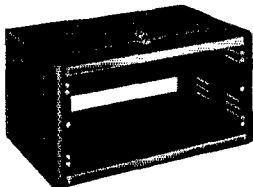

Modern Vacuum Tube Voltmeter

(Continued from page 44)

The 5000-volt terminal is a special safety terminal made by mounting a plain tip jack in an Amphenol 66-60B polystyrene feed-through bushing. The wall of the bushing provides a safety sleeve covering the end of the test lead connecting pin.

For the low-voltage d.c. input with its special shielded probe, a shielded single-conductor panel connector (Amphenol PC1M) is provided. A matching cable connector is attached to the 6-ft. length of shielded microphone cable which is used as the test lead. The probe is made from a standard test prod of the solderless type.

As shown in Fig. 3, one lead of a 1-megohm IRC BT- $\frac{1}{2}$ resistor is soldered to the inner conductor of the cable. The spring cord protector from an Amphenol MC connector fits both the microphone cable and the inside of the prod tightly. The cable is first drawn through this spring the required distance and the spring forced into the prod. The free end of the resistor is fastened in place through the hole in the tip.

As is also shown in Fig. 3, the 955-voltmeter head is assembled in a 2-in. shield can with a removable base (ICA 1539). The acorn socket (Hammarlund) is supported by two $1\frac{1}{4}$ -in. long mounting pillars made of $\frac{1}{4}$ -in. rod, the ends being tapped for 6-32 screws. The socket is completely wired, with the cable and all components including the coupling condenser and probe terminal tip in place, before final assembly in the can. The cable is then run through its outlet hole, with lugs soldered to the shielding braid held in place by the socket-mounting pillar screws.

The "base" of the shield carries the polystyrene disc insulator and bushing, attached with 6-32 screws. The probe insulator is a 2-in. disc of QuartzQ $\frac{1}{8}$ -in. thick, to which is cemented a National XP-6 polystyrene bushing. The probe tip, which is of the solderless type supplied with chuck and nut, is drawn up tight against the insulator through the clearance hole by the cap.

To reduce cable wear at the point where it enters the shield can, a spring protector taken from a standard appliance plug is attached to the can by means of a retaining fitting made from the mounting base of a National GS-1 insulator.

Components

Good quality parts must be used in the construction of the v.t.v.m. if it is to perform with accuracy and stability. This applies particularly to the fixed resistors. Wirewound units are used where available at reasonable cost.

The 7N7 plate and cathode resistors must be carefully matched to keep the circuit symmetrical. The exact values aren't important and 10% accuracy is satisfactory, but the resistors in each pair must have the same error. Wirewound cathode resistors are used for maximum stability.

Inexpensive metallized resistors (IRC BT) are used in the voltate dividers. Good accuracy can be achieved by matching them by pairs. A 1-megohm

Plug in a
BLILEY LD-2
CRYSTAL

and
forget about
it!

The Bliley LD2 Crystal Unit for 80 and 160 meters requires no constant supervision, no pampering, no finger crossing. Just plug it in your transmitter and forget it!

Whenever you wish to transmit, this highly active crystal will instantly snap into operation. Warm-up periods or prolonged transmissions will cause no concern because the drift is less than 4 cycles/mc./°C. And, you'll always know your frequency because each unit is accurately calibrated and guaranteed to be correct within .03% in your transmitter.

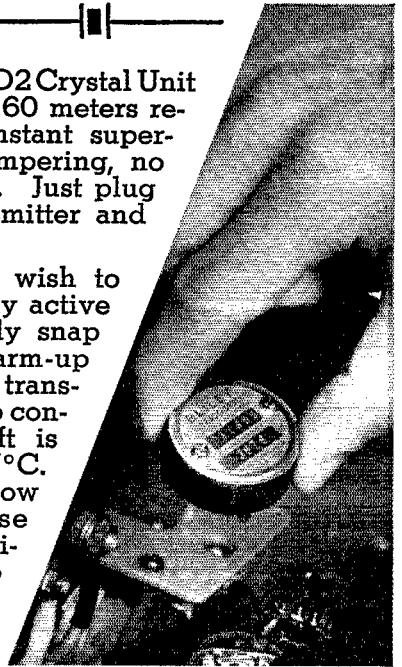

BLILEY LD-2 CRYSTAL UNIT

Equally Effective for

RADIO

CONTROL and
 COMMUNICATION

RCH Universal "Three-Way" Transmitters

Amateurs know that RCH National Championship equipment is tops in the radio control field. But now they are finding that it offers unique advantages for *communications* work, too.

You get complete flexibility for every portable-mobile or emergency need through the exclusive RCH "three-way" design. No. 221½ transmitters can be operated from a.c., batteries or vibrapack without changing anything but the tube. Uses 1J6G (135 volts), 6Z7G (180 volts), 6Y7G (250 volts), 6N7G (300 volts) interchangeably. Compact (only 2 x 3 x 8")—can be mounted anywhere. Balanced high-C, high-Q bandspread oscillator circuit for stability and efficiency. Sturdily built, reliable—a remarkable performer.

ALSO AVAILABLE—Receiver-Transmitter-Modulator combinations for 112 Mc. Unit-style assembly for maximum flexibility—can be installed with individual units located separately for mobile installations or assembled in one unit for portability. The ideal all-around u.h.f. station for defense emergency use. Ask your dealer about the No. 2211 assembly or write for data.

RCH Transmitters were used by Champion Jim Walker in winning the National Radio Control event in Chicago

JUST OUT—the New 1942 edition of *The Radio Control Instruction Manual*, 25¢.

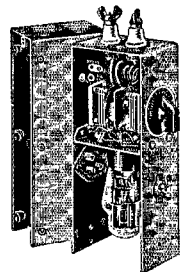

No. 221½
 (110-118 Mc.)
 \$12.50

No. 228 Modulator
 (616) \$12.50

RADIO CONTROL HEADQUARTERS

330 WEST 42ND STREET

NEW YORK CITY



MAKE THIS
the
MERRIEST XMAS
Ever
WITH A NEW
NATIONAL NC-45

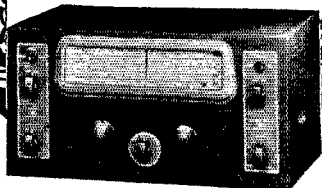

**A NEW 8 TUBE — 4 RANGE
COMMUNICATIONS RECEIVER**

- Series Valve Noise Limiter—Automatic
- Improved A.V.C. Circuit
- F.V. Dial with Separate Band Spr. Condenser
- Tone Control—CW Oscillator
- Four Range SW. 550 Kc. to 30 Mc.

Amateur Net Price—**\$57.50**
including speakers and tubes

IN STOCK!

AVAILABLE for IMMEDIATE DELIVERY

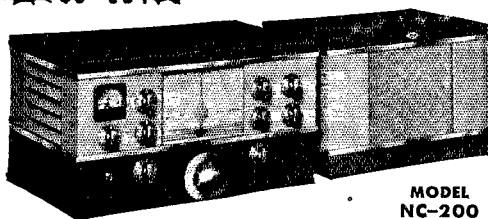

MODEL
NC-200

A LONG-TIME FAVORITE!

- One Microvolt Sensitivity
- Improved Xtal Filter 10000 to 1
- Stability, 3 parts in 100000
- Series Valve Noise Limiter
- Temperature Compensation
- 10 Independent Bands

Amateur Net Price—**\$159.50**
less speaker

OTHER MODELS IN STOCK — NOT ILLUSTRATED

NC-100A.....\$132.00 NC-101X.....\$141.90
NC-100XA.....\$156.75 HRO.....\$197.75

SEND FOR NEW 1942 NATIONAL CATALOG FREE

NEW YORK'S OLDEST "HAM" HOUSE

SUN RADIO CO.
212 Fulton Street, Dept. QE New York
Cable Address: SUNRADIO NEW YORK

precision resistor accurate to 1% costs several dollars, but by selecting two ½-megohm metallized resistors from a dealer's stock, one of which may be 4% high and the other 4% low, an accurate 1 megohm resistor can be had at a cost of twenty cents. The stability of the metallized resistors with voltage, temperature changes and aging is not equal to precision wirewound units, but it is adequate for ordinary use.

Speaking of stability, the leakage of insulating materials used in the meter becomes important when it is considered that the input resistance of the d.c. unit is 20 megohms. Ceramic insulation throughout would be desirable but would also be costly. The manufacturers use special wax-impregnated fibre switch wafers, etc., which are not readily available to the home constructor. However, the standard bakelite switch wafers have proved quite satisfactory in the present unit and no serious leakage has been observed even under conditions of high humidity.

The insulation of ordinary push-back wire is not to be trusted, however. Cambric-covered high-voltage wire is used in wiring the input circuits. Crystal microphone cable is used in the special shielded d.c. probe, while the cable for the r.f. voltmeter-head is made of rubber-covered wires with high insulation resistance.

One further note in relation to stability. While the meter is highly tolerant of plate-voltage supply changes, variations in heater temperature are undesirable, especially when making a.c. measurements. For this reason a primary-type voltage regulator (such as the UTC AR-1) would be a useful addition to a precision laboratory version of the instrument.

Calibration

Calibrating the vacuum-tube voltmeter still remains the hardest part of the job. Hard, that is, if one insists on a precise calibration. The difficulty is that the other measuring instruments customarily found around the amateur shack are not themselves sufficiently accurate to be of much help in making an accurate calibration.

It is seldom that the amateur has need for an absolute accuracy of better than about 5%, however. Comparative measurements are more important, anyway, and these can be made with good precision. Even with some calibration error the accuracy of a vacuum-tube voltmeter is usually better than that of other instruments because the circuit-loading error is minimized.

A sufficient degree of accuracy can be achieved simply by laying out a linear scale for the meter and setting the maximum meter-reading by the range control, using a d.c. source such as a dry cell or "B" battery checked by an ordinary d.c. voltmeter of 2% accuracy. One useful d.c. calibration source is a VR-150 voltage regulator tube. With exactly 30 ma. flowing through the tube the output voltage will be within 1% of 150 volts. Calibration on one range should hold with fair accuracy for all.

The same scale can be used to indicate peak a.c. voltage as well. However, for real accuracy on a.c., particularly at low frequencies and r.f.,

BUY ON EASY TERMS · MAIL ORDERS PROMPTLY FILLED · WRITE FOR FREE CATALOG

Answering National Defense Requirements DO YOUR PART

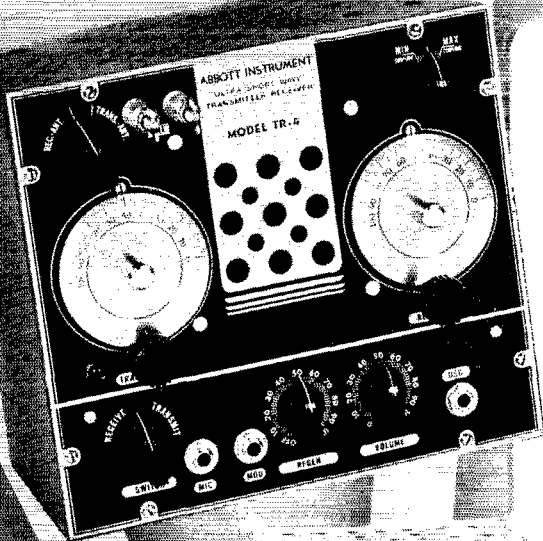

ABBOTT TR-4

2½ Meter Transmitter-Receiver. Designed to fill governmental, commercial, and amateur needs. This new, extremely compact, powerful unit incorporates latest of design and tested engineering principles. Separate receiver and separate transmitter. *Literature on request.*

PRICE \$38.22

ABBOTT MRT-3

20 watts input on the Abbott MRT-3 2½ meter transceiver gives you satisfactory operating range from 5 to 50 miles. A proven performer.

PRICE \$28.81

ABBOTT DK-3

Completely portable and battery operated. The DK-3, with variable antenna coupling and only two tubes, will enable you to carry on effective communications from 2 to 30 miles.

PRICE \$18.82

IMMEDIATE DELIVERY

On all

ABBOTT

2½ Meter Equipment

Both AC and vibrator power packs can be furnished out of stock. Do not delay. Get your 2½ meter equipment immediately.

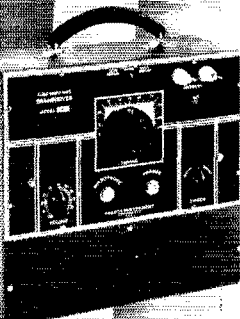
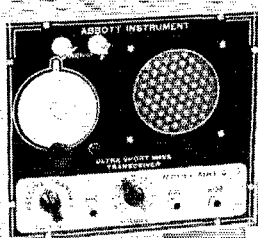

The RADIO SHACK
167 WASHINGTON ST., BOSTON, MASS., U.S.A.

GREENOHMS

for that extra
OVERLOAD FACTOR



10 to 200 watts. Any resistance. Fixed and adjustable. Note rugged mounting lugs, adjustable sliding band, general mechanical neatness.

● **Clarostat Greenohms** are now found in many commercial and highest-grade "ham" transmitters in continuous service. These familiar green cement-coated resistors have won an outstanding reputation for being tough. You can't go wrong when you take a tip from leading equipment builders! And remember, Greenohms cost no more.

Ask Our Jobber . . .

He'll gladly show you Clarostat Greenohms. Ask for latest literature. Or write to Clarostat Mfg. Co., Inc., 285-7 N. 6th St., Brooklyn, N. Y.



COMMERCIAL RADIO INSTITUTE

A radio training center for over twenty years. Well equipped. Excellent faculty. Practical resident courses in Radiotelegraphy, Broadcast, Servicing, Television, Aeronautical Drafting, Mathematics, Industrial and Studio technique. Placement bureau. Classes now forming for mid-year term February 9th. Send for catalog, Dept. B.

38 WEST BIDDLE STREET, BALTIMORE, MARYLAND

AMATEUR RADIO LICENSES

Day and Evening Classes in Code and Theory
HOME STUDY COURSES

Reasonable, Efficient and Thorough, Hundreds of
Licensed Students Now on the Air

American Radio Institute, 1123 Broadway, New York, N. Y.

Your OPPORTUNITY in Radio

Success depends on your training. Nilson's

MASTER COURSE IN RADIO COMMUNICATION for home study, provides up-to-date knowledge in technical radio for ■ Amateur operator who wants commercial license ■ Unlicensed, but employed radioman who wants license ■ Licensed operator who wants to increase technical knowledge. Send for circular No. 3.

NILSON RADIO SCHOOL, 51 East 42nd St., New York

RADIO TECHNOLOGY



RCA Institutes offer an intensive course of high standard embracing all phases of Radio and Television. Practical training with modern equipment at New York and Chicago Schools. Also specialized courses in Aviation Communications, Radio Servicing and Commercial Operating.

Illustrated Catalog on request.

RCA INSTITUTES, INC. Dept. ST-41

A Radio Corporation of America Service

75 Varick St., New York 1154 Merchandise Mart, Chicago

correction factors must be used. These can be derived from checks of the scale linearity when known voltages are applied. If a General Radio Variac is available, the 150-volt a.c. range can be checked from the 115-volt line. The Variac supplies an r.m.s. output voltage accurate to within 2% of dial reading when the input is exactly 115 volts. (NOTE: C_3 should be increased to 0.1 μ fd. when calibrating on 60-cycle a.c.)

In making these checks allowance must be made for the errors in common types of a.c. meters. The calibration of a moving-iron a.c. meter can be relied on only at 70% of full-scale, for example, and then only on very low frequencies such as 60 cycles. Many copper-oxide rectifier-type meters have a possible error due to temperature alone of 5%, in addition to which there is a frequency error. A typical high-quality single-range copper-oxide meter was found to read 15% high at 10,000 cycles, for example.

A.c. meters are ordinarily calibrated to read effective or r.m.s. values, while the vacuum-tube voltmeter reads the peak value. For a sine-wave voltage this is 1.41 times the r.m.s. value. It may be desired to provide a separate calibration in terms of r.m.s. values. Such a scale is useful, but it is to be relied on only when the voltage is a true sine-wave.

To avoid waveform error it is imperative that the a.c. source used in calibration be a true sine wave. On distorted waveforms the error in the reading may be as much as the percentage of harmonics in the wave. Odd harmonics will cause a reading that is too high. Even harmonics may cause either a high or low reading depending on polarity. If even harmonics are present, reversing the input connections (not the meter switch) will give two different readings. Averaging the two readings will result in an answer somewhat closer to the true value than either one alone.

This waveform error is accentuated at r.f. when measurements are being made on non-resonant circuits because the reactive portion of the input impedance changes for the various components of the voltage. At very high frequencies, where the harmonics approach the resonant frequency of the input loop, the resonant rise of impedance will also be different for the various voltage components. In this case even the peak reading will be

LEARN RADIO • TELEVISION

60-page catalog on request. Oldest, largest and best equipped in New England. New classes now forming. Write for new catalog.

MASS. RADIO SCHOOL

18 Boylston Street

Boston, Massachusetts

GOOD JOBS in RADIO for young men age 17 to 20

As older men leave for the army, Radio calls for high school graduates. So don't snap up just any temporary job! Train for \$150 to \$250 per month positions at school where the army has sent many men the past year. Next class starts Jan. 5. Write for free catalog now!

THE DODGE TELEGRAPH & RADIO INSTITUTE
408 Monroe St., Valparaiso, Indiana

Christmas Gift Suggestions

EACH YEAR an increasing number of individuals find that A.R.R.L. publications and supplies make excellent gifts. Let us help you with this age-old yearly problem. All prices are postpaid and we will enclose a gift-card in your name.

PUBLICATIONS:

How to Become a Radio Amateur \$.25

The standard elementary guide for the prospective radio amateur.

The Radio Amateur's License Manual25

This publication provides the most direct path to obtaining an amateur license.

Building an Amateur Radiotelephone Transmitter..... .25

An introduction into amateur radiotelephony written for the man who has a Class B or C license.

Hints & Kinks for The Radio Amateur50

A compilation of hundreds of good ideas for amateurs.

The A.R.R.L. Antenna Book.... .50

A comprehensive manual of antenna design and construction.

The Radio Amateur's Handbook 1.00

This publication includes the latest and best information on everything pertaining to amateur radio.

Two Hundred Meters and Down \$1.00

The story of amateur radio told in a spirited and dramatic fashion.

SUPPLIES:

Radiogram Forms per pad .20

For the delivery of radiograms, pads of 100 forms.

Log Book each .35
3 for 1.00

A record book providing space for all facts pertaining to transmission and reception.

Amateur Radio Map of the World 1.25
(Size 30 x 40)

A special map designed by A.R.R.L. for amateur operators.

QST Binder 1.50
Holds 12 issues of QST.

LIGHTNING CALCULATORS:

Type A - Inductance-Capacity.. 1.00

An extremely helpful device for the amateur who designs or builds equipment.

Type B - Ohm's Law 1.00

Especially helpful when power problems are confronted.

~~~~~  
A.R.R.L. MEMBERSHIP—QST SUBSCRIPTION... see page 104  
~~~~~

Please send items checked to.....

Send gift-card from.....

~~~~~  
AMERICAN RADIO RELAY LEAGUE, INC., W. HARTFORD, CONNECTICUT  
~~~~~

Go "2 1/2"

2 1/2 meter operation is really becoming "hot"! Not only is it low-cost . . . but it's the accepted band for local civilian defense emergency operation. Read K. B. Warner's editorial, November issue of QST.

New
ABBOTT
TR-4



TRANSMITTER-RECEIVER

This separate transmitter and receiver is designed specifically for 112 mc. operation . . . an emergency mobile or fixed station unit. The efficient receiver circuit, employing an HY-615, helps to reduce receiver radiation to a minimum. A powerful 20 watt output HY-75 is used in the separate transmitter with its own 6L6G modulator.

Net to amateurs	\$38.22
Complete complement of tubes, net	7.98
Abbott Mobile power supply, net	19.20
Abbott AC power supply, net	19.20
Universal Handset	5.88
Johnson 2 1/2 m. "Q" antenna, net	3.90

ABBOTT DK-3 TRANSCEIVER

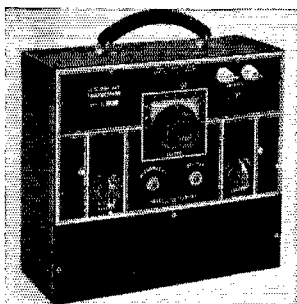

This battery operated "walkie-talkie" is a companion unit for the TR-4. Extremely low priced unit, providing communication from field to fixed station or automobile.

Net to amateurs	\$18.82
Complete complement of tubes, net	\$1.26
Batteries for DK-3, net	\$5.28

W21JL • W2LJA • W2PL • W2JKD • W2KWY

OUR *Best* VALUE IS OUR RECORD OF LOYAL SERVICE

HARVEY

Radio Company of New York

103 WEST 43rd STREET • NEW YORK, N. Y.

CABLE ADDRESS "HARADIO"

in error because of the drop between probe tip and diode plate.

The sum of the frequency errors below 30 Mc. can be regarded as negligible for general work, and the calibration will hold to considerably higher frequencies without serious error as far as comparative measurements are concerned. The absolute accuracy will, of course, be somewhat worse at very high frequencies. No facilities were available for determining the magnitude of this error, but indications are that up to 120 Mc., at least, the scale readings are sufficiently close to give a useful indication.

Silent Keys

It is with deep regret that we record the passing of these amateurs:

- Silas Blaine Artrip, W8SCL, Bluefield, W. Va.
- Virgil E. Blackman, W9ZGY, Louisville, Ky.
- Dr. Ruy de Moraes da Cunha e Costa, CT1SP, Lisbon, Portugal.
- John Cannon Dodds, W9OMH, Kansas City, Mo.
- Lindsey G. Doherty, W5CQV, Vivian, La.
- James Howard Emmerson, G8HA/GM8HA, Walton-on-Thames, Surrey, England.
- J. Gordon Kerr, GM8QD, Glasgow, Scotland.

WOULD YOU BELIEVE IT?

EDDIE CURRENT-
RAISED A PROTON
AS BIG AS A FOOT-
BALL BY FEEDING
IT VITAMINIZED LOP
LIVER OIL.

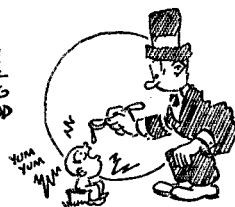

THE LATEST THING
IN HIGH FREQUENCY
INDUCTANCE IS THE
SILVER PLATED GRAPE-
VINE TWIZZLE.

PHIL PHLAPJACK,
W7POD, WORKED
NINE STATIONS
USING A GROUND-
DOWN HAILSTONE
BEFORE IT MELTED
AND WENT
OUT OF THE
BAND

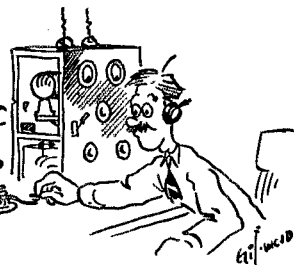

★ *It's* HARRISON *for*



NATIONAL and SERVICE!

PRICES?

No matter what happens to prices — here at Harrison our large scale purchasing and our tremendous stock enable us to continue to give you the lowest possible prices at all times.

It pays to buy from Harrison!

★ DELIVERY?

With production facilities already greatly overtaxed, deliveries are falling behind more every day. But, we anticipated this "Back-order Era" and placed protective orders many months ahead. Right now we have more receivers, parts, tubes, etc. *on hand* than at any time in our busy sixteen year history!

You get faster delivery from Harrison!

★ TRIAL?

When you buy anything from Harrison it has to be entirely satisfactory or you don't keep it. Try out your next receiver for ten days without charge or obligation by ordering it from us.

You get 100% cooperation from Harrison!

★ TRADE-IN?

By fair dealing we have built up the largest Reconditioned Receiver business in the world! We have a ready market for your old set, and that means we can give you the very best trade-in allowance. (We also buy receivers, transmitters, etc., for cash.)

You get the best "break" at Harrison!

★ TERMS?

Certainly! Charge Account or Easy Payment Plan. Buy your Receiver, transmitter, parts, etc., on our easier terms at lowest cost.

Your credit is good at Harrison!

★ GUARANTEE?

Everything is "guaranteed," but your best guarantee is the integrity of the person with whom you deal. Here at Harrison we go far beyond the standard warranty in order to please you!

You get a square deal from Harrison!

★ I'll be looking for your order!

73,

Bill Harrison, W2AVA

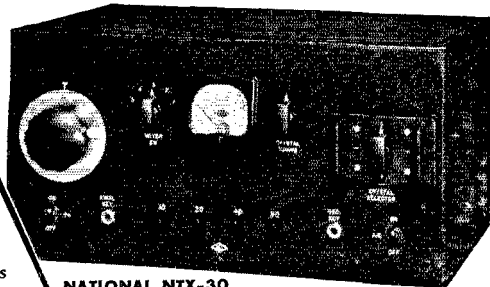

NATIONAL NTX-30

One of National's many versatile transmitter units. A completely self contained transmitter with an *output* of 30 watts on 10, 20, 40, and 80. Crystal and meter switching. Push button selection of exciter frequency. FB to drive a higher power final. With all coils and tubes, less crystals — table model — \$129.00.

Harrison has it — in stock!

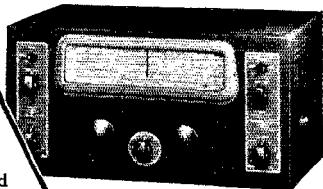

National's new, and improved, version of the well known NC-44. Eight tubes, noise limiter, better AVC, tone control, etc. Three models: AC, AC-DC, Battery. \$57.50, with speaker.

Harrison has it — in stock!

★ For anything you need — write to me — NOW!

NATIONAL HRO

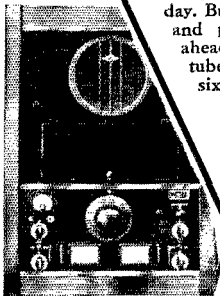

Tried and proven—the choice of Commercials, Governments, and discriminating Amateurs, everywhere. Write to me for the HRO booklet, or better yet, have me send you a receiver so *you* can see for yourself how good it is! Available in combination rack model (as shown) or in table models. \$197.70 and up.

Harrison has it — in stock!

The NC-200 is National's most popular receiver today! It offers high performance ability, up-to-the-minute features, and modern styling — at reasonable cost. Ask the man who owns one — and they'll soon be asking you. \$174.50 complete, with speaker.

Harrison has it — in stock!

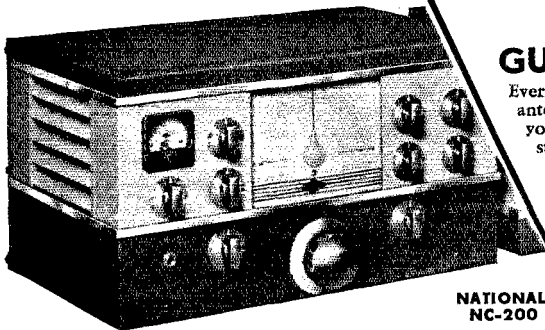

NATIONAL NC-200

HARRISON RADIO CO.

12 WEST BROADWAY • NEW YORK CITY

WOrth 2-6276

Decibels.....

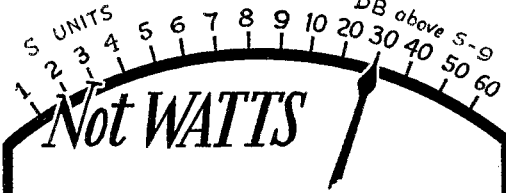

Input versus Output

Although output ratings are less spectacular than input ratings, it has been Hytron's policy to stress the watts obtainable from a given type of tube. Hytron believes the output yardstick interests the amateur, because he knows it is the output that determines the strength of his signals; it is the output that produces those precious decibels on the other fellow's "S" meter.

HYTRON LABORATORIES



A DIVISION OF THE
HYTRON CORP.
25 N. DERBY ST.
SALEM, MASS.

MANUFACTURERS OF RADIO TUBES SINCE 1921

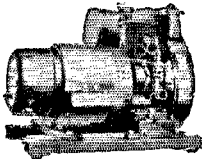

110-VOLTS A.C. Anytime Anywhere With KATOLIGHT PLANTS

Have special plant for operating portable radio receivers and transmitters. Close voltage regulation. *Filtered and Shielded.* 400 watt A.C., Amateur's price, \$76.50
Other sizes up to 10,000 watts. Also converters, AC and DC generators, and frequency changers.

"Ask your Jobber"
KATOLIGHT, 2 Elm St., Mankato, Minn.

AMATEUR



COMMERCIAL

TYPE PR-X IN
"ALSIMAG" HOLDER
40-80-160 M. BAND
ONLY.....

WRITE US
FOR PRICES

.....\$3.00

PETERSEN RADIO CO., Council Bluffs, Iowa

QUALITY ABOVE ALL

SOLAR

CAPACITORS

Write for Catalog
SOLAR MFG. CORP.
BAYONNE, N. J.

RADIO OPERATING QUESTIONS^N, ANSWERS

Nilson & Hornung's new edition covers all FCC commercial license exam elements. Standard handbook 20 years, \$2.50, postpaid. Money back if not satisfied and book returned in 10 days. Send check or money order . . . net cash. *Free circular on request.*



NILSON RADIO SCHOOL, 51 East 42nd St., New York

WWV Schedules

IMMEDIATELY after the standard frequency station WWV of the National Bureau of Standards was destroyed by fire November 6th last, a temporary transmitter was established in another building and partial service was begun. The service has now been extended, although still with temporary equipment. It is on the air continuously at all times, day and night, and carries the standard musical pitch and other features. The radio frequency is 5 megacycles per second.

The standard musical pitch carried by the broadcast is the frequency 440 cycles per second, corresponding to *A* above middle *C*. In addition there is a pulse every second, heard as a faint tick each second when listening to the 440 cycles. The pulse lasts 0.005 second, and provides an accurate time interval for purposes of physical measurements.

The 440-cycle tone is interrupted every five minutes for one minute in order to give the station announcement and to provide an interval for the checking of radio measurements based on the standard radio frequency. The announcement is the call letters (WWV) in telegraphic code.

The accuracy of the 5-megacycle frequency, and of the 440-cycle standard pitch as transmitted, is better than a part in 10,000,000. The time interval marked by the pulse every second is accurate to 0.000,01 second. The 1-minute, 4-minute, and 5-minute intervals marked by the beginning and ending of the announcement periods are accurate to a part in 10,000,000. The beginnings of the announcement periods are so synchronized with the basic time service of the U. S. Naval Observatory that they mark accurately the hour and the successive 5-minute periods; this adjustment does not have the extreme accuracy of the time intervals, but is within a small fraction of a second.

LICENSED RADIO AMATEUR WANTED

Excellent, permanent sales position available with large, well-established radio parts store in New York City for experienced, capable amateur. Should be technically familiar with all "ham" receivers, transmitters, parts, tubes, etc. and have pleasing personality. Resident of N. Y. C. or vicinity preferred. Write stating age, selling experience, education, salary, etc. Address—Box NY, c/o Advertising Dept. GST, West Hartford, Conn.

Hams, Defense School Students and Gov't Men

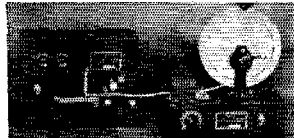

are learning the code the right way, quickly and easily with the all electric Ayers machine. Built by Code champion McElroy for our future champions. Largest selection of tapes in World available with each machine. Low monthly rental. Tapes for MacAuton, recording alip and special

Ayers Automatic Code Machines
Dept. Q-10, 711 Boylston Street, Boston, Mass. inks for sale.

HARVEY ELECTRONIC

RADIO LAB'S, Inc. APPARATUS

447 CONCORD AVENUE, CAMBRIDGE, MASS.

Where to buy it

A directory of suppliers who carry in stock the products of these dependable manufacturers.

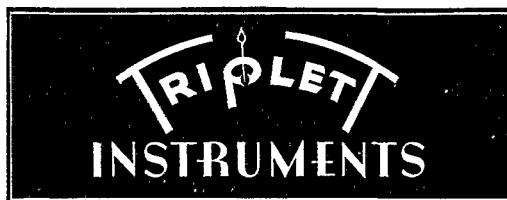

ALBANY, N. Y. Uncle Dave's Radio Shack 356 Broadway
ATLANTA, GEORGIA 265 Peachtree Street
 Radio Wire Television Inc.
BOMBAY, INDIA Eastern Electric & Engineering Company
BOSTON, MASS. Radio Shack 167 Washington Street
BOSTON, MASS. 110 Federal Street
 Radio Wire Television Inc.
BRIDGEPORT, CONN. Hatry & Young, Inc. 177 Cannon Street
BRONX, N. Y. 542 East Fordham Rd.
 Radio Wire Television Inc.
BUFFALO, N. Y. Dymac, Inc. 1531 Main Street
BUTLER, MISSOURI 211-215 N. Main Street
 Henry Radio Shop
CHICAGO, ILL. 833 W. Jackson Blvd.
 Allied Radio Corp.
CHICAGO, ILL. 901-911 W. Jackson Blvd.
 Radio Wire Television Inc.
CINCINNATI, OHIO 1103 Vine Street
 United Radio, Inc.
DETROIT, MICH. 325 E. Jefferson Ave.
 Radio Specialties Co.
DETROIT, MICHIGAN 11800 Woodward Ave.
 Radio Specialties Co.
HARTFORD, CONN. 227 Asylum Street
 Radio Inspection Service Company
HOUSTON, TEXAS 1021 Caroline Street
 R. C. & L. F. Hall
INDIANAPOLIS, INDIANA 34 West Ohio Street
 Van Sickle Radio Supply Co.
KANSAS CITY, MO. 1012 McGee Street
 Burstein-Applebee Company
LITTLE ROCK, ARKANSAS 409 W. 3rd Street
 Beem Radio Company
NEW HAVEN, CONN. 1172 Chapel Street
 Hatry & Young, Inc.
NEW YORK, N. Y. Harrison Radio Co. 12 West Broadway
NEW YORK, N. Y. 100 Sixth Ave.
 Radio Wire Television Inc.
NEWARK, N. J. 24 Central Ave.
 Radio Wire Television Inc.
READING, PENN. 404 Walnut Street
 George D. Barbey Company
SCRANTON, PENN. 519-21 Mulberry Street
 Scranton Radio & Television Supply Co.
WASHINGTON, D. C. 938 F Street, N. W.
 Sun Radio & Service Supply Co.
WATERBURY, CONN. 199 South Main Street
 Hatry & Young, Inc.

ALBANY, N. Y. Uncle Dave's Radio Shack 356 Broadway
ATLANTA, GEORGIA 265 Peachtree Street
 Radio Wire Television Inc.
BOSTON, MASS. Radio Shack 167 Washington Street
BOSTON, MASS. 110 Federal Street
 Radio Wire Television Inc.
BRIDGEPORT, CONN. Hatry & Young, Inc. 177 Cannon Street
BRONX, N. Y. 542 East Fordham Rd.
 Radio Wire Television Inc.
BUFFALO, N. Y. Dymac, Inc. 1531 Main Street
BUTLER, MISSOURI 211-215 N. Main Street
 Henry Radio Shop
CHICAGO, ILLINOIS 833 W. Jackson Blvd.
 Allied Radio Corp.
CHICAGO, ILL. 901-911 W. Jackson Blvd.
 Radio Wire Television Inc.
CINCINNATI, OHIO 1103 Vine Street
 United Radio, Inc.
HARTFORD, CONN. 203 Ann Street
 Hatry & Young, Inc.
LITTLE ROCK, ARKANSAS 409 W. 3rd Street
 Beem Radio Company
MINNEAPOLIS, MINNESOTA 1211 LaSalle Avenue
 Low Bonn Company
NEW HAVEN, CONN. 1172 Chapel Street
 Hatry & Young, Inc.
NEW YORK, N. Y. 100 Sixth Avenue
 Radio Wire Television Inc.
NEWARK, N. J. 24 Central Ave.
 Radio Wire Television Inc.
READING, PENN. 404 Walnut Street
 George D. Barbey Company
WASHINGTON, D. C. 938 F Street, N. W.
 Sun Radio & Service Supply Co.

Listings on this page do not necessarily imply endorsement by QST of the dealers or of other equipment sold by them.

ABBOTT 2½ METER TRANSMITTER-RECEIVER



THE NEW ABBOTT TR-4

Fills the needs of governmental and commercial services as well as advanced radio amateurs for an extremely compact, powerful single unit incorporating a separate transmitter and receiver. Negligible receiver radiation. Net price, less tubes and power supply **\$38.22**

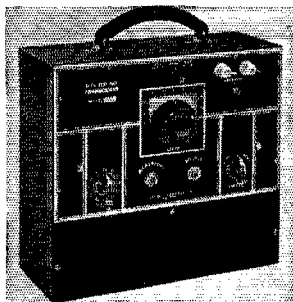

THE ABBOTT DK-3

Unusually low priced, portable 2½ meter Transceiver with special Variable Antenna Coupling. Incorporates only 2 inexpensive tubes. Effective range is from 2 to 30 miles. Net price, less accessories **\$18.82**

ABBOTT MRT-3. High power (20 watts input) 2½ meter Transceiver for automobile, truck, boat or airplane. Simple to install and operate, with satisfactory operating range of from 5 to 50 miles. Less tubes and power supply **\$28.81**

Send us your mail orders — we'll fill 'em!

TERMINAL *Radio Corp.*

68 West 45th St. • 80 Cortlandt St.
2 stores in NEW YORK CITY
Vanderbilt 6-5050 • Cable: TERMRADIO

QST

YEARLY BINDERS



Are We Right?

You should have at least two of them—one for your complete 1941 file of copies, and one for each 1942 issue as published.

With each Binder is furnished a sheet of gold and black gummed labels for years 1923 through 1942. The proper one can be cut from the sheet and pasted in the space provided for it on the back of the binder.

Price **\$1.50** postpaid

Available only in United States and Possessions

THE AMERICAN RADIO RELAY LEAGUE
West Hartford, Conn.

THIS YEAR *Say it WITH A Hallicrafters*

SUN OFFERS IMMEDIATE DELIVERY
FROM STOCK ON ALL RECEIVERS
BUY NOW—IN TIME FOR CHRISTMAS



SKY CHAMPION. 9 tubes, 4 bands, covers from 545 kc. to 44 mc. Has all the essential controls for good amateur reception. Inertia bandspread tuning, separate electrical bandspread. Battery-vibrapack DC operation. Amateur net price... **\$54.50**

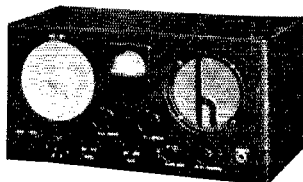

SKY BUDDY. Gives you superior performance at a moderate price. 6 tubes, 4 bands, continuous coverage 550 kc. to 44 mc., electrical bandspread, built-in 5" dynamic speaker, built-in line filter. Amateur net price... **\$32.50**

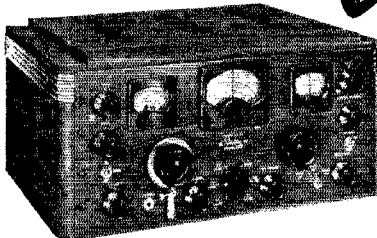

Super Skyrider (Model SX-28). Amateur net price (less speaker)... **\$179.50**

THE SUPER SKYRIDER. 15 tubes, 6 bands, covers from 550 kc. to 42 mc. Calibrated bandspread inertia controlled. 80-40-20-10 meter amateur bands calibrated, push-pull high fidelity audio output, band pass audio filter, adjustable noise limiter.

THE SUPER DEFIANT. 12 tubes, 4 bands, covers from 550 kc. to 42 mc., separate calibrated bandspread dial for 10-20-40- and 80 meter amateur bands provides frequency meter tuning. 110 volt 50-60 cycle AC operation. Complete with crystal and tubes.

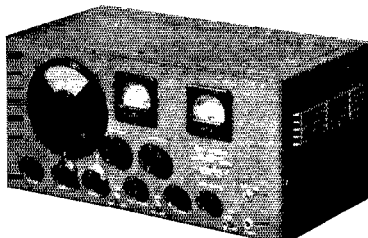

Super Defiant. Amateur net price... **\$94.50**

ALL RECEIVERS AVAILABLE ON EASY TERMS

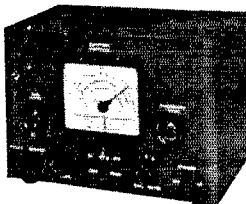

Amateur net price **\$24.50**



EC-1. 6 tubes, 3 bands, covers from 550 kc. to 30 mc. Electrical bandspread. Built-in speaker. AC-DC 115-125 volts.

EC-3. 10 tubes, 3 bands, covers from 550 kc. to 30 mc. Preselection on all bands. Separate 6" PM speaker. 115 volts AC-DC.

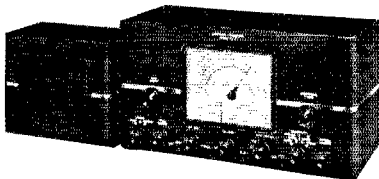

Amateur net price **\$39.50**

Send for Complete Descriptive Literature — Address Dept. QD

New York's Greatest Amateur Supply House



RADIO CO.

212 FULTON STREET, NEW YORK CITY
CABLE ADDRESS:
SUNRADIO — N. Y.
ESTABLISHED 1922

**HE BOUGHT AN
ECHOPHONE EC-1!**

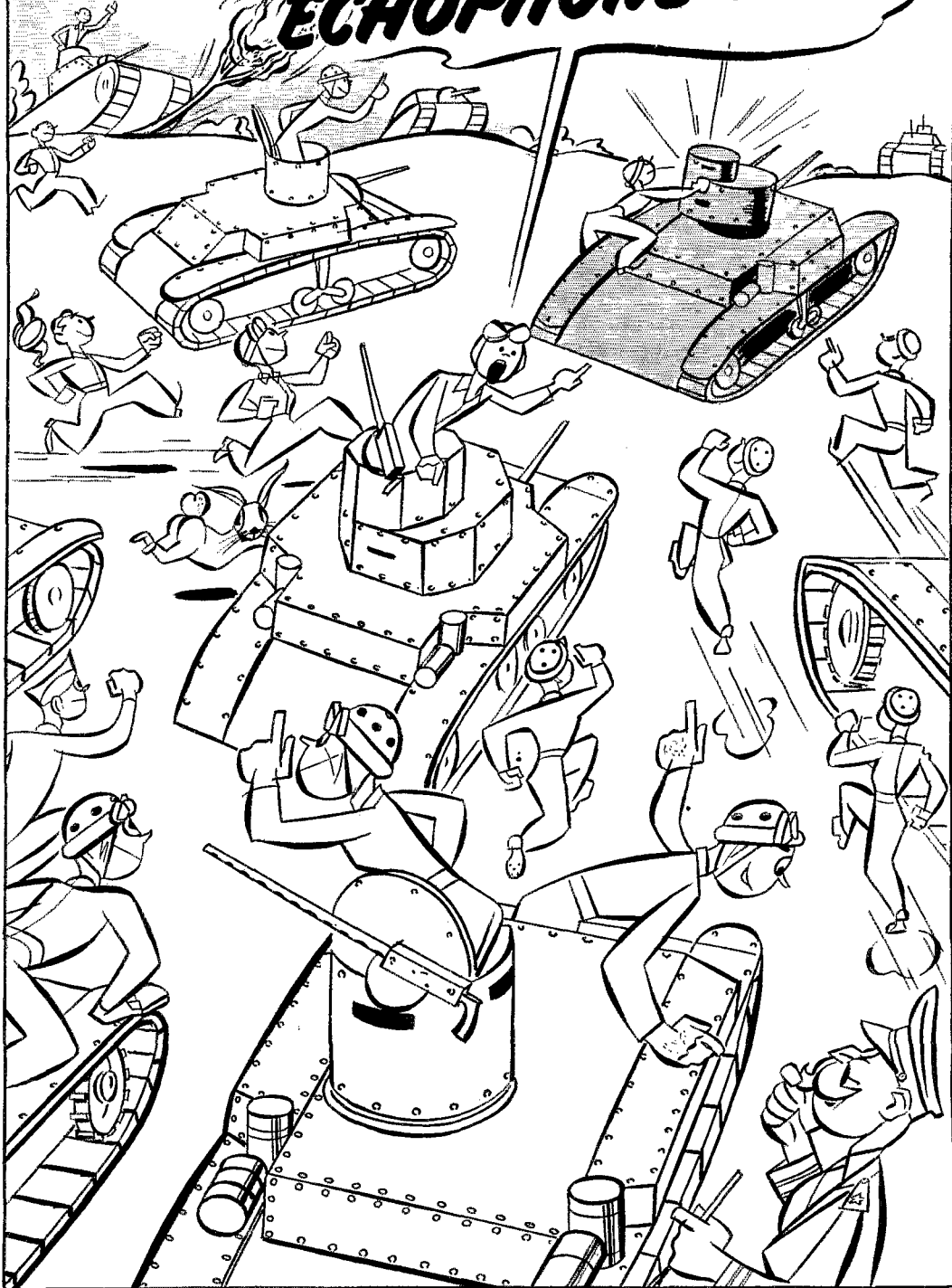

HAM-ADS

(1) Advertising shall pertain to radio and shall be of nature of interest to radio amateurs or experimenters in their pursuit of the art.

(2) No display of any character will be accepted, nor can any special typographical arrangement, such as all or part capital letters be used which would tend to make one advertisement stand out from the others.

(3) The Ham-Ad rate is 15¢ per word, except as noted in Paragraph (6) below.

(4) Remittance in full must accompany copy. No cash or contract discount or agency commission will be allowed.

(5) Closing date for Ham-Ads is the 25th of the second month preceding publication date.

(6) A special rate of 7¢ per word will apply to advertising which, in our judgment, is obviously non-commercial in nature and is placed and signed by a member of the American Radio Relay League. Thus, advertising of bona fide surplus equipment owned, used and for sale by an individual or apparatus offered for exchange or advertising inquiring for special equipment, if by a member of the American Radio Relay League takes the 7¢ rate. An attempt to deal in apparatus in quantity for profit, even if by an individual, is commercial and all advertising by him takes the 15¢ rate. Provisions of paragraphs (1), (2), (4) and (5) apply to all advertising in this column regardless of which rate may apply.

Having made no investigation of the advertisers in the classified columns, the publishers of QST are unable to vouch for their integrity or for the grade or character of the products advertised

* * * * *

Gear is short. You can sell your old and extra gear through Ham-Ads.

* * * * *

QUARTZ — direct importers from Brazil of best quality pure quartz suitable for making piezo-electric crystals.

Diamond Drill Carbon Co., 719 World Bldg., New York City.
QSL'S. Cartoons. Free samples. Theodore Porcher, 7708 Navajo, Philadelphia, Pa.

CALLBOOKS — Fall edition now on sale containing complete up-to-date list of radio hams throughout entire world. Single copies \$1.25. Canada and foreign \$1.35. Radio Amateur Call Book, 610 S. Dearborn, Chicago.

QSL'S — SWL's. 100 — 3 color — 75¢. Lapco, 344 W. 39th, Indianapolis, Ind.

COMMERCIAL radio operators examination questions and answers. One dollar per element. G. C. Waller, W5ATV, 6540 Washington Blvd., Tulsa, Okla.

QSL'S — Brownie, W3CJI, 1725 Frankfield Ave., Allentown, Pa.

TELEPLEXES, Instructographs bought, sold. Ryan's, Hannibal, Mo.

FOR SALE: new RCA transmitting tubes in original cartons at a bargain price, send stamp for list. Lowell Ecker, Sedan, Kansas.

QSL samples, prices on request. W2AEY, 383 Elmora, Elizabeth, N. J.

1000-WATT G.E. transformers 1100—2200—4400 volts each side c.t. Guaranteed \$13.50. Dawson, 5740 Woodrow, Detroit, Mich.
OLD QST's. Bought — sold — traded. 1916/41. W6SN.

METER and instrument repair and recalibration. Lowest cost consistent with good results. Braden Engineering Co., 3317 Kenmore, Dayton, Ohio.

QSL'S — SWL's — Fritz, 1213 Briargate, Joliet, Ill.

FOR SALE: two Eimac 100TH's and UTC filament transformer, never used, \$20. 300 watt fone, CW transmitter \$150, cost \$500. Foto and description Glen Katzenberger, Rt. 2, Box 929A, Bremerton, Wash.

WANTED: Grebe rovr models CR13-18. REL xmtrs same period. Cash or trade. W9WGT.

QSL'S. Finest. Maleco, 1805 St. Johns Place, Brooklyn, N. Y.

WANTED — large transmitting tubes, new or used. State prices and condition: 204A's, 852's, 250TH's, 150T's, 810's, etc. W4DPN.

WANT 500-watt CW complete, vicinity N. Y. C. No. junk. W2NCY.

FOR SALE — SX-18 Sky Challenger in original carton. Complete Hammarlund transmitter in Bud table rack 60 watts CW. All new equipment. Make offer. W3JAQ, Sparta, N. J.

SUPREME Diagonometer model 585 deluxe for sale. Cost \$95. Sell \$30. Ralph Hunter, Catskill, N. Y.

QSL'S? — SWL's? — Riley crystals? — QST subscriptions? — Patronize the ham. W8DED, Holland, Mich.

FOR SALE — 400-watt fone, CW rig 2 standard racks. Best parts used throughout. Eight Weston meters. Must be seen to appreciate. First \$300 takes. W2MVL, 206 Millburn Ave., Millburn, N. J.

SELL — QST'S 1928 thru 1940, also Proceeding IRE same years. Best offer. Don Duncan, 2115 Benderwirt, Rockford, Ill.

SWAP — Vibroplex, surplus new and used radio equipment for woodworking tools and machinery. W9FWT.

FOR SALE — 600 watt phone, 1000 watt CW transmitter in enclosed rack. Includes Thordaron preamplifier, Astatic D-104 microphone and bug key. All Thordaron transformers and heavy duty components. Remote control. Also Super-Pro. Best offer takes all. W2JOZ.

DISMANTLING 500-watt transmitter. Leading manufacturers' parts in new condition at half price. Stamp for list. W9VGS, 1305 EB, Hutchinson, Kansas.

SACRIFICE. 300 watt transmitter (whole or part), receiver, preselectors, accessories. W2JDI.

WANTED: all-band phone-CW medium power transmitter. W6QE.

FOR SALE — two hundred and fifty watt rack and panel transmitter; standard HRO receiver; ohm-voltmeter; galvanometer; dynatron and parts. Write W3CA, Box 2211, Roanoke, Va.

WANTED — television receiver, cash. W2IMT.

SELL — transmitter; 150 watt output, phone, CW; all bands; bargain \$135. Norman Pirkey, C & P Telephone Co., Roanoke, Va.

WANTED: Old 805 radio tubes. W7GRL.

NEW transmitting kits all phone and CW from 15 watts through 150 watts. Also new ECO unit for \$39.50. New 40 meter phone transmitter reasonable. Also plenty of 40 meter crystals. Write for details today. Leo, W9GFQ.

RECEIVERS — all types — new and reconditioned. Easy terms. Free trial. Send for big list and other specials. Get acquainted with Leo, W9GFQ.

TRANSMITTING headquarters on latest Stancor, Thordaron, and other kits — commercially wired at low cost. New 70 watt transmitter kits complete only \$35 — speech amplifier modulator up to 80 watts at \$29.50 — up to 150 watts \$49.50. New JT-30 mikes & stands \$5.95. Easy terms. Write Leo, W9GFQ, today.

LEO, W9GFQ, offers the hams more and a better deal always. Lowest terms without red tape on all new and used equipment. Free trial. Personalized service. Write for big free ham bargain catalog and used receiver list. Wholesale Radio Labs., Council Bluffs, Iowa.

CRYSTALS: famous P.R. mounted in the latest Ainsmag 35 holders — 40, 80 meter PR-X, 160 meter PR-Z \$3, 40, 80 meter PR-Z (low drift) \$3.50; 20 meter PR-20 \$4.50; unconditionally guaranteed. Immediate shipment. Quality blanks 70¢. Wholesale Radio Labs., Council Bluffs, Iowa. W9GFQ.

WANTED: Will pay cash for Mims Deluxe 3 element 20 meter antenna, HRO, and 2000 volt tubes. W9QOB, Columbia, Mo.

WILL trade AC light plant for oscilloscope with 3" screen suitable for checking 60 cycle wave form. Katolight, Mankato, Minn.

WANTED: Utah units 4 and 5 for cash. W9GVR, Mt. Vernon, Ill.

I WANT good used receivers. Am offering the best trade-in allowances on the West Coast. New National, Hallicrafter, Hammarlund, RME, Howard receivers in stock for immediate delivery on terms. Write or see Ted Henry, 2335 Westwood Blvd., W. Los Angeles, Calif.

WANTED: IP 501-A receiver. Advise price, condition. Walter Faries, Bala-Cynwyd, Pa.

SALE: 1-kw. fone-CW with AMC PP806 final PP805 modulator relay controlled built-in scope 16 Weston meters Far-Metal cabinet complete with speech amplifier remote control PI-tuner \$600. W3ME, 911 W. 37th St., Baltimore, Md.

WANTED: radio books — will trade law books. J. Drummond, 403 Rodriguez St., Watsonville, Calif.

MONITORS — CW, phone. Guaranteed. W2BCP.

SELL: Super Skyrider SX-16. Very good condition. Forty dollars cash. W1DBS, New Britain, Conn.

TRADE — Abbott MRT-3 complete with dynamotor for Deluxe Signal Shifter. W7BL, 1921 — 30th South, Seattle, Wash.

CRYSTALS: commercial or amateur, they are still available. Eidson commercial crystal units meet FCC requirements and complete satisfaction is guaranteed. A complete line is available, aircraft, police, marine, defense projects, etc., — send for catalog. For hams: those dependable T9 40 and 80 meter crystals still only \$1.60. T9 40 or 80 meter spot frequencies \$2.50 or \$3.60 with holder. Sold by: Teague Hardware Co., Montgomery, Ala.; Henry Radio Shop, Butler, Mo.; Frank Anzalone, 170 Jane St., Englewood, N. J.; Kerr Radio Shop, El Paso, Texas; Pemberton Labs., Ft. Wayne, Ind.; Distribuidora Fronteriza, Laredo, Texas; and Eidson's, Temple, Texas.

500 WATT phone transmitter real bargain at \$350. PP100TH amplifier and '03A modulators, all parts heavy duty. For details and photo write L. M. Whitehurst, 307 Wilcox St., Joliet, Ill. ALTERNATOR — 4.5 KVA — 240 volts 19 amp. 1 phase 60 cycles 1800 RPM. Two Bearing with self-contained overhung exciter. .250 kw. 32 v., weight approximately 350 lbs. Excellent condition — \$200. Pioneer 32 v. — 8 A. Engine generator, used about two hours — \$40. Also considerable recording equipment. G. Philip Stout, 324 Broadmoor Rd., Baltimore, Md.

HENRY Radio Shop has branch store 2335 Westwood Blvd., West Los Angeles, California, operated by Bob's brother Ted Henry. Western amateurs write Ted and get acquainted.

WRITE Bob Henry, W9ARA, for best deal on all amateur receivers, transmitters, kits, parts. Bob offers you largest trade-in allowance for your equipment; best terms (financed by Bob with no red tape); lowest prices; quickest delivery, ten day trial. Write Bob for anything. Tell what you want; what you have to trade in; what terms you want. You will get immediate personal attention. Henry Radio Shop, Butler, Mo.

RECONDITIONED guaranteed amateur receivers and transmitters. All makes and models cheap. Free trial. Terms. List free. Write. W9ARA, Butler, Mo.

WANTED — Creed automatic transmitter. Good condition; Give complete details. Batty, Noroton, Conn.

ANSWERS to radio problems — complete analysis, circuits designed, reasonable fees. Stuart and Coleman, Engineers and Radio Technicians, 327 Miffin St., Huntingdon, Pa.

RADIO engineer wanted: Interesting work on a national defense project for a technically trained man having experience in the design and operation of ultra-high-frequency radio apparatus. Write giving information covering education and experience. Salary arranged. All communications will be treated confidentially. Raytheon Mfg. Company, 190 Willow St., Waltham, Mass.

ARE you up-in-the-air about U.H.F. gear for your defense plans? Well, come on down long enough to study the Ultra High Frequency Chapters of the new 1942 Handbook.

WANTED: Used Hallicrafter 8-29. Sgt. Masters, Quarters 2052-D, Quantico, Va.

HALLICRAFTER Champion, Utah transmitter, accessories, \$60. Wilson, Box 1175, Macon, Ga.

GET INTO AVIATION RADIO

Use your hobby to qualify more quickly for a steady, well-paid position in the rapidly expanding Air Transport Industry.

Thorough training supervised by instructors released to Midland by major Airlines and directed by a Nine-Airline Advisory Board has placed our graduates on the job with all major Airlines and from coast-to-coast. Demand for Midland men far exceeds supply.

Investigate

Write for your copy of our profusely illustrated 58-page Catalogue and Training Outline. Get your name on our Midland News mailing list. No obligation.

MIDLAND RADIO and TELEVISION SCHOOLS, Inc.

Dept. Q-12, Power & Light Bldg., Kansas City, Mo.
(Contractors to the U.S. Army Signal Corps)

Be Santa Claus to Your Friends . . .



NOT FORGETTING THOSE IN THE SERVICE

Each year an increasing number of individuals find *QST* to be the ideal gift. A subscription present is unique, too. It serves as a monthly reminder of your thoughtfulness. A yearly subscription, including League membership, costs only \$2.50, little enough for the ones you have in mind. And . . . we'll send an appropriate gift-card conveying your Christmas Greetings at the proper time.

A Monthly Reminder of Your Thoughtfulness and Good Judgment

38 LA SALLE ROAD

QST

WEST HARTFORD, CONN.

Your Nearby Dealer Is Your Best Friend

Your nearby dealer is entitled to your patronage. He is equipped with a knowledge and understanding of amateur radio. He is your logical source of advice and counsel on what equipment you should buy. His stock is complete. He can supply your needs without delay. His prices are fair and consistent with the high quality of the goods he carries. He is responsible to you and interested in you.

One of these dealers is probably in your city — Patronize him!

ATLANTA, GEORGIA

Radio Wire Television Inc.
265 Peachtree Street
"The World's Largest Radio Supply House"

HOUSTON, TEXAS

R. C. & L. F. Hall
1021 Caroline Street (C 0721)
"Specialists in Amateur Supplies"

BALTIMORE, MARYLAND

Radio Electric Service Co.
3 N. Howard St.
Everything for the Amateur

NEWARK, N. J.

Radio Wire Television Inc.
24 Central Avenue
"The World's Largest Radio Supply House"

BOSTON, MASS.

Radio Wire Television Inc.
110 Federal Street
"The World's Largest Radio Supply House"

NEW YORK, N. Y.

Radio Wire Television Inc.
100 Sixth Avenue
"The World's Largest Radio Supply House"

BUFFALO, NEW YORK

Radio Equipment Corp.
326 Elm Street
W8PMC and W8NEL — Ham service and sound equipment

NEW YORK, N. Y.

Harrison Radio Company
12 West Broadway
Harrison Has It! Phone WOrth 2-6276 for information or rush service

BUFFALO, NEW YORK

Dymac, Inc.
1531 Main Street — Cor. Ferry — GA. 0252
One of the Largest Ham Supply Houses in Western New York

PHILADELPHIA, PENNSYLVANIA

Eugene G. Wile
10 S. Tenth Street
Complete Stock of Quality Merchandise

HARTFORD, CONNECTICUT

Radio Inspection Service Company
227 Asylum Street
What do you want? We have it. Radio exclusively!

PROVIDENCE, RHODE ISLAND

W. H. Edwards Company
85 Broadway
National, Hammarlund, Hallicrafter, Thordarson, Taylor, RCA

HARTFORD, CONNECTICUT

Hatry & Young, Inc.
203 Ann Street
Stores also in Bridgeport and New Haven

SCRANTON, PENNSYLVANIA

Scranton Radio & Television Supply Co.
519-521 Mulberry Street
Complete Stock of Quality Amateur Supplies

WATERBURY, CONNECTICUT

Hatry & Young, Inc.
199 South Main Street
Time Payments for Connecticut Hams

YOU CAN BE SURE
WHEN YOU BUY FROM

QST

ADVERTISERS

“Advertising for *QST* is accepted only from firms who, in the publisher’s opinion, are of established integrity and whose products secure the approval of the technical staff of the American Radio Relay League.”

Quoted from QST’s advertising rate card.

Every conceivable need of a radio amateur can be supplied by the advertisers in QST. And you will know the product has the approval of the League’s technical staff

Index to Advertisers

	PAGE
Abbott Instrument, Inc.....	71
Aerovox Corporation.....	80
American Lava Corporation.....	69
American Radio Institute.....	94
Astatic Corporation, The.....	87
Ayers, N. C.....	98
Biley Electric Company.....	91
Candler System Company.....	78
Capitol Radio Engineering Institute.....	86
Cardwell Mfg. Corp., Allen D.....	83
Centralab.....	5
Clarostat Mfg. Company.....	94
Collins Radio Company.....	Cov. 2
Commercial Radio Institute.....	94
Dodge Institute, The.....	94
Echophone Radio Company.....	102
Eitel-McCullough, Inc.....	67
Gardiner-Levering Company.....	76
General Electric Company.....	73
Hallicrafters Company, The.....	1, 2
Hammarlund Mfg. Company, Inc.....	63, 65
Harrison Radio Company.....	97
Harvey Radio Company.....	96
Harvey Radio Laboratories.....	98
Henry Radio Shop.....	107
Hipower Crystal Company.....	76
Hytronic Laboratories.....	98
Instructograph Company.....	80
Joinson Company, E. F.....	77
Kato Engineering Company.....	98
Kenyon Transformer Company, Inc.....	64
Mallory & Company, Inc., P. R.....	62
Massachusetts Radio School.....	94
Meissner Mfg. Company.....	66
Midland Radio & Television Schools, Inc.....	104
Millen Mfg. Company, Inc., James.....	90
National Company, Inc.....	Cov. 3, 61, 68, 87
Newark Electric Company.....	75
Nilson Radio School.....	94, 98
Ohmite Mfg. Company.....	81
Par-Metal Products Corp.....	90
Petersen Radio Company.....	98
Port Arthur College.....	76
Pratt & Whitney Aircraft.....	74
Precision Apparatus Company.....	78
RCA Institutes, Inc.....	94
RCA Mfg. Company, Inc.....	Cov. 4
Radio Control Headquarters, Inc.....	91
Radio Shack, The.....	93
Ramsey Publishing Company.....	80
Sickles Company, F. W.....	30
Solar Mfg. Corporation.....	98
Standard Radio Parts Company.....	96
Standard Transformer Corp.....	70
Sun Radio Company.....	92, 101
Taylor Tubes, Inc.....	79
Teleplex Company.....	74
Terminal Radio Corp.....	100
Thordarson Electric Mfg. Company.....	72
Triplet Elec. Instr. Company, The.....	74
United Transformer Corp.....	108
Wholesale Radio Laboratories.....	93
Vaxley.....	62



You Can't Beat
"Personal Service"

Everytime I get a repeat order with an added note of thanks for my "personal service" I know I am accomplishing my ambition to give every order, not only my personal attention but to see you are getting the best value for your money.

I can give you the lowest financing costs on any communications receiver because I personally finance my own low cost time payments, easy 6% terms, and I eliminate the "red tape."

You get prompt shipments from the world's largest stock of all makes and models of amateur communications receivers.

You can't lose with my 10 day free trial, low cost finance plan and the best trade-in value for your old communications receiver.

Drop me a line here at Butler — I'll see that you are 100% satisfied, and I will save you money!



*If you live in the western states, write my brother
Ted Henry*

HENRY RADIO SHOP

2335 Westwood Blvd., W. Los Angeles, Calif.



HENRY RADIO SHOP

WORLD'S LARGEST DISTRIBUTOR OF AMATEUR RECEIVERS

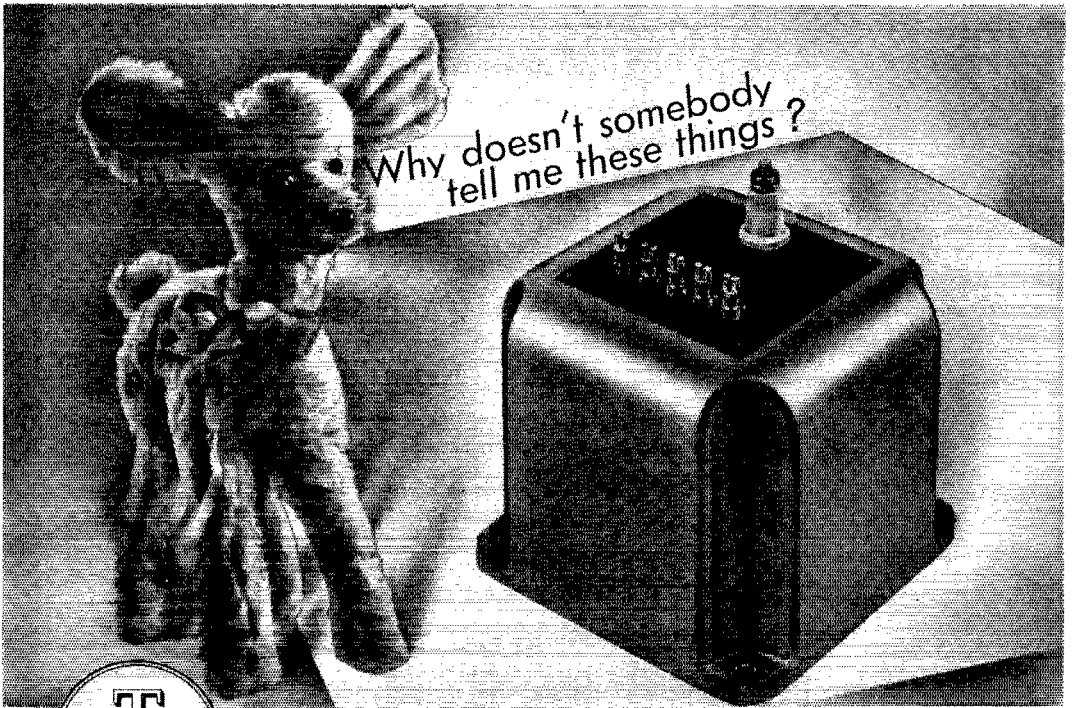

*is an ideal source for
transformers to specifications*

With improvements in materials, structural design, and production methods, UTC is producing, today, transformers which even a year ago would have been considered impossible.

As a typical example of such development is a transformer recently supplied to a customer for one cycle operation having the following characteristics:

- Primary impedance 10 ohms.
- Impedance ratio 75,000:1.
- Secondary inductance 250,000 Hys.
- Weight under 8 pounds.
- Self-resonant point above 7 cycles.

In addition to these difficult characteristics, this unit operates at - 160 DB signal level and hum shielding was developed to provide negligible hum pick-up to signal ratio.

MAY WE ASSIST YOU IN YOUR PROBLEM?

The same design experience and engineering ingenuity shown in the above example can be applied to your application. May we have an opportunity to cooperate?

UNITED TRANSFORMER CORP.

Write: COMMUNICATIONS DIV. ★ 150 VARICK ST. ★ NEW YORK, N. Y.
EXPORT DIVISION: 100 VARICK STREET NEW YORK, N. Y. CABLES: "ARLAB"

Index to Volume XXV—1941

AMATEUR RADIO STATIONS

W1LEA, W2WD, PY5BL, W1EOB, W9AS.... 44, Apr.
 W9JID, W7GGG, KA1NF.....73, 82, 83, May
 W1BLE, W5IRO, W6KUP, W3CPN..54, 66, 82, 84, July

ARMY AMATEUR RADIO SYSTEM

Major General Mauborgne Says..... 29, Sept.
 New Acting Chief Signal Officer..... 29, Oct.
 News.....47, Feb.; 42, Mar.; 43, Apr.; 29, May;
 55, June; 37, July; 27, Aug.; 56, Sept.; 53, Oct.; 51, Nov.

ANTENNAS

Adjusting Rotary Antenna Elements by Remote Control (H&K)..... 40, July
 Adjusting the Delta-Match System from the Ground (H&K)..... 49, Dec.
 Antennas for Domestic Work (Mix)..... 38, Sept.
 Antenna Tuner for the Beginner, An..... 18, Nov.
 Boosting the Antenna Height (H&K)..... 56, Apr.
 Coupling Unit for Continuous Antenna Rotation, A (Plotts)..... 15, Nov.
 Easy Way to Raise a Mast, An (H&K)..... 41, Jan.
 Feeder Tuning (H&K)..... 58, Oct.
 Folded Antenna for 160 (H&K)..... 47, Dec.
 Glass Tubing Feeder Spreaders (H&K)..... 46, Jan.; 40, July
 Hurricane-Proof Mast, A (Stewart)..... 12, Apr.
 Improving the Transmitting Loop (Green)..... 24, June
 Low Frequency Antenna for Emergencies..... 41, July
 Mast-Raising Kink (H&K)..... 56, Apr.
 Multi-Band End-Fed Antenna, A (H&K)..... 52, Nov.
 Notes on UHF Antenna Heights (Stiles)..... 38, July
 Novel Substitute for Antenna Pulley (H&K)..... 48, Dec.
 Self-Supporting Antenna Tower, A (Boatright)..... 18, Mar.
 Simple 28-Mc. Vertical Antenna (H&K)..... 40, Jan.
 Successful 56-Mc. Arrays (Tilton)..... 23, May
 Working the 80-Meter Zepp on 160 (H&K)..... 52, Nov.
 40-Meter Zepp on 160 (H&K)..... 59, Oct.

AWARDS

VWOA Award to W5FDR..... 37, July
 VWOA Honors Gen. Mauborgne..... 43, Apr.
 W9BSP is 1940 Paley Award Winner..... 26, July

BEGINNERS

Combination Code Practice Oscillator and Keying Monitor (H&K)..... 60, Sept.
 How to Build a Code Instruction Table..... 30, May
 New Code Practice Oscillator..... 48, June

BOOK REVIEWS

Amateur Radio Handbook (RSGB)..... 33, Jan.
 Getting Acquainted With Radio (Morgan);
 Television Broadcasting (Lohr); Understanding
 Radio (Watson)..... 36, Feb.
 Calling CQ (DeSoto)..... 68, May
 Vacuum-Tube Voltmeter (Rider); Make Radio
 Your Hobby (Stiening)..... 80, July
 I Live on Air (Schlechter); You're On the Air
 (Heyliger); How to Make Good Recordings... 82, July
 Radiotron Designers Handbook (Langford-Smith)..... 30, Dec.

CODE PROFICIENCY

After the Code Proficiency Certificate — What?
 (Handy)..... 29, Mar.
 Code Proficiency Notes, Statistics..... 58, June; 18, Jan.
 Code Proficiency Program Expanded (Handy)..... 40, May
 Get Your Code Proficiency Award..... 42, Oct.
 Secrets of Good Sending (Battey)..... 35, Sept.; 43, Oct.
 This Business of Code (Huntoon)..... 48, Feb.
 Typewriter Copy..... 8, Dec.

COMMUNICATIONS DEPARTMENT

Affiliated Club Honor Roll.....70, Apr.; 90, Nov.
 Boost Your Code — Start Traffic (Handy).... 54, Apr.
 Correction on Checking Messages..... 64, Sept.
 Elections, SCM.....62, Feb.; 68, Apr.; 68, June;
 56, Aug.; 68, Oct.
 Handle Your Traffic on 160 (Grammer)..... 11, Sept.
 Meet the SCM's.....W2AZV, W7GNJ, 47, Jan.;
 W5MN, 56, Feb.; W3CCO, 61, Mar.; W1ALP, W7CPY,
 64, Apr.; W4DWW, 48, May; CM2OP, 70, June; W4DGS,
 45, July; W5GNV, 65, Sept.; W5ENI, 60, Dec.
 Opportunity — Through Registration..... 25, Feb.
 RCC..... 70, Mar.
 Traffic Fun — A Defense Job for Every Amateur..... 30, Mar.
 Trainee Traffic Grows (Handy)..... 33, Aug.
 Warning — Message Handlers and Rag Chewers 59, Nov.

CONTESTS

(See also, "U.H.F. — Tests")

AARS Code Speed Contest (Results)..... 29, May
 ARRL Member Party, Fourth Annual
 (Announcement)..... 34, Jan.
 (High Scores)..... 68, Mar.
 (Results)..... 46, Aug.
 Addendum, 1939 DX Competition..... 47, May
 Battery-Powered Equipment Test (Announce-
 ment)..... 46, Oct.
 Code Proficiency Frolic..... 48, Sept.
 Field Day, Ninth ARRL (Announcement)..... 26, June
 (High Scores)..... 37, Aug.
 Navy Day (1940)..... 36, Feb.
 (1941)..... 40, Oct.
 ORS/OPS Parties (October, 1940)..... 50, Jan.
 (April, 1941)..... 46, July
 (July, 1941)..... 72, Oct.
 Red Cross Test (Announcements).....36, Mar.; 48, Apr.
 (Results)..... 57, Oct.
 Sweepstakes, Eleventh (1940) ARRL
 (High Scores)..... 54, Jan.
 (Results)..... 49, June
 (Correction)..... 45, July
 Sweepstakes, Twelfth (1941) ARRL (Announce-
 ment)..... 47, Nov.
 1.8- and 28-Mc. WAS Parties (Announcement)
 (High Scores).... 70, Apr.
 (Results)..... 54, Sept.

CONVENTIONS

Connecticut State Convention..... 29, Sept.
 Delta Division Convention..... 66, May
 New England Division Convention..... 8, Oct.
 Midwest Division Convention..... 8, Oct.
 Northwestern Division Convention..... 48, Aug.
 Oklahoma State Convention..... 47, Oct.
 Pacific Division Convention..... 72, Nov.
 Radio Interference Conference..... 28, May
 Roanoke Division Convention..... 66, July
 Rocky Mountain Division Convention..... 8, Aug.
 Southwestern Division Convention..... 31, Sept.
 Vermont State Convention..... 31, Sept.
 West Gulf Division Convention..... 102, Sept.

EDITORIALS

Amateur and National Defense, The..... 7, Nov.
 Bum Superhets..... 7, Oct.
 Call to 'phone Men, A..... 7, Mar.
 Clippings..... 7, July
 Conserving Apparatus..... 7, Dec.
 Defense Communications Board, The..... 7, Feb.
 Exit Heterodynes..... 8, June
 Frita..... 7, July; 8, 22, Aug.

How to Write an Editorial	6, Apr.
I.A.R.U. Societies, The	7, Jan.
Keeping Above Suspicion	7, June
Let's Use 160	7, Dec.
Ourselves	7, June
Our Contribution to National Defense	7, Sept.
Radiolocator	7, Aug.
Shortage of Materials	7, Oct.
Typewriter Copy	8, Dec.

EMERGENCY AND RELIEF WORK

AEC in South Dakota Fire	68, Feb.
Amateurs Provide Red Cross with Communications on Inauguration Day (Reed)	25, Mar.
Amateur Radio Provides Communication for Poughkeepsie Regatta	64, Oct.
Cheyenne Emergency	66, June
Maine Snowstorm	78, July
Mexican Amateurs in Colima Earthquake (Medina)	22, July
Michigan Emergency Council Formed	50, May
Minnesota Emergency Nets Reviewed by Officials	58, Nov.
Minnesota Snowstorm (Fritchard)	39, Jan.; 62, Mar.
Radio Amateurs Help in Michigan Gale	46, Jan.
Radio Club Receives Generator	58, Nov.
Texas Hurricane Finds Hams Ready	39, Nov.
Texas Ice Storm	39, Jan.; 49, Mar.

EXPEDITIONS

Around the World with the Yankee (Spalding)	9, Oct.
U. S. Antarctic Service Expresses Appreciation	17, Nov.

FEATURES AND FICTION

Gallups Island Radio Club Puts on a Show	20, Dec.
Ham Forum at WILL	8, June
Ham Haven (Beardsley)	28, Sept.
Hamming on Howland Island (Lieson)	9, Apr.
Ham Spirit Triumphs Over Handicaps (DeSoto)	34, Dec.
Putting Dynamic Prognostication to Work (Rapp)	30, Apr.
QST Visits Gallups Island	9, June
Radio at the National Model Airplane Meet (DeSoto)	15, Sept.
Signal Corps Radio School	9, Aug.
YLRL—QRV (Bien)	32, Oct.

FREQUENCY CALIBRATION

Decade Calibrator, The (Jeffrey)	23, Oct.
Lecher Wire System for U.H.F. Frequency Measurement, A	18, Oct.
Sensitive Absorption Wavemeter, A	19, July
50-, 100- and 1000-kc. Oscillator for Band Edge Spotting, A	32, Sept.

FREQUENCY MODULATION

(See also, "U.H.F. Apparatus")

Band Width and Readability in Frequency Modulation (Crosby)	26, Mar.
Some Thoughts on Amateur F.M. Reception (Grammer)	9, Mar.

HINTS AND KINKS

January, page 40	
Simple 28-Mc. Vertical Antenna (Hecht)	
Oscillator Keying Circuit for Click Elimination (Smith)	
An Easy Way to Raise a Mast (Snyder)	
E.C.O. Coupling Circuit (Clemens)	
Glass Tubing Feeder Spreaders (Sutter)	
February, page 50	
A Simple Break-In Keying System with Keying Monitor (Crouse)	
Your Receiver or Audio Amplifier as an Intercommunicating System (Hummel)	
Crystal Switch (Gray)	
Increasing Resistor Power Rating (Blanchard)	
March, page 55	
'Phone Monitor Using Infinite-Impedance Detector (Montgomery)	
A Card Index for Your QSO's (Utterback)	

Improved Voltage Regulation with VR Tubes (Dubofsky)	
Simple Tone Modulation for U.H.F. Transmitters (Seibert)	
Automatic Overload Protection for 807 and Other Tubes (Fancboner)	
April, page 56	
Filament-Transformer Kink (Nelson)	
Boosting the Antenna Height (Shields)	
Mast-Raising Kink (Hidley)	
A Kink for the Work Bench (Bohn)	
Cutting Square Holes (Davis)	
Push-to-Talk Without Fixed Bias (Welch)	
Keying Monitor (Wagner)	
May, page 42	
Warning to Users of Transformerless-Powered Equipment	
Single-Switch Change-Over Systems	
Something New in Side Swipers (Livingston)	
June, page 56	
Balanced Inductive Coupling for U.H.F. (Mix)	
Hints on Drilling Tubing and Rod (Chambers)	
Simplified I.C.W. Operation (Ziniuk)	
Soldering Tip for Tight Places (Warner)	
Operation from Three-Wire Power Lines (Villard)	
July, page 40	
Adjusting Rotary-Antenna Elements by Remote Control (Hentz)	
Light for the Workbench (Warner)	
Re Transformerless Supplies	
Low-Frequency Antenna for Emergencies (Edgar)	
Another Glass-Tubing Feeder Spreader (Huntington)	
System for Break-In and Keying Monitoring (Rosenberg)	
August, page 47	
A Simple Filter for Elimination of B.C.I. (Pearson)	
The SW-3 as a Preselector (Seltzer)	
Connecting Dissimilar Plate Transformers in Series (Wheaton)	
Hints on Improving the FB-7 Receiver (Rockey)	
September, page 58	
Adapting the 6L6 Grid-Plate Oscillator for Fundamental and Harmonic Operation (Preston)	
Repunching Socket Holes with Accuracy (Moseley)	
Audio Attenuator for NC100 and 101 Receivers (Hill)	
Simple Treatment for B.C.I. (Plotts)	
Higher Voltage from Pole Transformers (Carter)	
Operating Kink for Superhet Receivers (Nelson)	
Another Single-Switch Control System (Zelle)	
Combination Code-Practice Oscillator and Keying Monitor (Lattig)	
October, page 58	
Feeder Tuning (Hill)	
Speech Amplifier or Modulator as Audio Oscillator for I.C.W. (Silver)	
Frequency Equalizer for Crystal Mikes (Frenkel)	
40-Meter Zepp on 160 (Skinker)	
Interference from AC-DC Receivers (Smith)	
November, page 52	
Working the 80-Meter Zepp on 160	
Resistance-Capacity Audio Oscillator for Monitoring Keying (Gilliam)	
A Multiband End-Fed Antenna (Seaton)	
Cheap Filament Rheostat (Leemon)	
Variable Crystal Frequency with an 815 Locked Oscillator (Robbins)	
Boosting Transformer Voltage (Smith)	
Improved Voltage Regulation for the Oscillator (Stone)	
December, page 47	
Amplifier Neutralization with Safety (Span)	
Folded Antenna for 160 (Alcorn)	
Novel Substitute for Antenna Pulley	
Hint on Improving an Unresponsive Bug (Rockey)	
Tone Control by Negative Feedback (Moody)	
Adjusting the Delta-Match System from the Ground (Voss)	
I.A.R.U. NEWS	
I.A.R.U. Societies, The	7, Jan.
Notes	54, Mar.; 60, June; 50, Nov.
R.S.G.B. News	28, Dec.
INTERFERENCE	
Bum Superhets	7, Oct.
Interference from AC-DC Receivers (H&K)	59, Oct.

Local Boy Makes Noise (Wesman).....	43, Mar.
Simple Filter for Elimination of B.C.I. (H&K).	47, Aug.
Simple Treatment for B.C.I. (H&K).....	59, Sept.

KEYING

Combination Code Practice Oscillator and Keying Monitor (H&K).....	60, Sept.
Hint on Improving an Unresponsive Bug (H&K)	48, Dec.
Keying Monitors (Mix).....	15, Jan.
Keying the Crystal Oscillator (Goodman).....	10, May
Oscillator Keying Circuit for Click Elimination (H&K).....	40, Jan.
Resistance-Capacity Audio Oscillator for Monitoring Keying (H&K).....	52, Nov.
Simple Break-In Keying System with Keying Monitor (H&K).....	50, Feb.
Some Thoughts on Keying (Goodman).....	17, Apr.
Something New in Side Swipers (H&K).....	43, May
System for Break-In and Keying Monitoring (H&K).....	41, July
Tube Keying (Goodman).....	30, June

METERS AND MEASUREMENTS

Amateur Application of the Wien Bridge, An (Caywood).....	22, Jan.
Automatic Direction Finding (Gibbons).....	48, Oct.
Meter Shunts (Mix).....	24, Dec.
Modern Vacuum-Tube Voltmeter for AC, DC and R.F. Measurements (DeSoto).....	40, Dec.
Optimum Q and Impedance of R.F. Inductors (Naslund).....	28, July
Wide Range Vacuum-Tube Voltmeter, A (Kelley).....	32, Feb.

MISCELLANEOUS

Beware — High Voltage.....	74, Feb.
Card Index for Your QSO's (H&K).....	55, Mar.
Cutting Square Holes (H&K).....	57, Apr.
Eugene, Ore., Vocational School.....	56, Jan.
Hints on Drilling Tubing and Rod (H&K).....	57, June
Kink for the Work Bench, A (H&K).....	57, Apr.
Light for the Work Bench (H&K).....	40, July
Repunching Socket Holes with Accuracy (H&K)	58, Sept.
QSL Hobby, The (Horizny).....	62, Apr.
Shock — What To Do If (Erickson).....	63, Sept.
Soldering Tip for Tight Places (H&K).....	57, June

MONITORS

(See also, "Keying")

Keying Monitors (Mix).....	15, Jan.
'Phone Monitor Using Infinite Impedance Detector (H&K).....	55, Mar.

NAVAL COMMUNICATIONS RESERVE

Navy Day, 1940.....	36, Feb.
Navy Day, 1941.....	40, Oct.
Notes.....	48, Mar.; 50, Apr.
N.C.R. Abolished.....	34, June

OBITUARY

Hebert, A. A.....	7, May
Little, D. H.....	33, May
Silent Keys.....	25, Jan.; 21, Mar.; 60, May; 59, June; 15, July; 22, Aug.; 53, Sept.; 86, Oct.; 74, Nov.

OPERATING PRACTICES

(See also, "Code Proficiency")

Getting Into Real Operating (Bakeman).....	60, Mar.
Let's Improve Our Fists (Katzner).....	66, June
Log Keeping (Miles).....	46, May
Notes on Receiver Usage (Martin).....	52, Aug.
On the Use of "SK" (Warner).....	66, Feb.
On Using Q Sigs (Smith).....	64, Sept.
QTC1 (Castner).....	55, Feb.
Self-Training Hints for Voice Operators (Handy)	30, Feb.
Some Do's and Don't's for 'Phone Hams (Nelson).....	63, Oct.
Speed vs. Accuracy (Nebel).....	57, Nov.
Traffic Handling (Daehler).....	44, July

POWER SUPPLIES

Boosting Transformer Voltage (H&K).....	54, Nov.
Cheap Filament Rheostat (H&K).....	52, Nov.
Connecting Dissimilar Plate Transformers in Series (H&K).....	48, Aug.
Filament Transformer Kink (H&K).....	56, Apr.
Higher Voltage from Pole Transformers (H&K)	59, Sept.
Improved Voltage Regulation with VR Tubes (H&K).....	56, Mar.
Improved Voltage Regulation in the Oscillator (H&K).....	54, Nov.
Increasing Resistor Power Rating (H&K).....	51, Feb.
Inexpensive Automatic Line Voltage Regulator (Taylor).....	26, Oct.
Modulator and Power Supply for the Inexpensive 56-Mc. Transmitter, A (Chambers).....	18, Aug.
Operation from Three-Wire Power Lines (H&K)	57, June
Single-Switch Changeover Systems (H&K).....	42, May
Vibrator Power Supplies (Goodman).....	44, Nov.
Warning To Users of Transformerless-Powered Equipment (H&K).....	42, May

PROPAGATION

Five Meter Wave Paths (Wilson).....	23, Aug.; 23, Sept.
Predictions of Useful Distances for Amateur Radio Communication (January, February, March).....	32, Jan.
(April, May, June).....	46, Apr.
(July, August, September).....	24, July
(October, November, December).....	41, Oct.

RADIOTELEPHONY

(See also, "U.H.F. — Apparatus")

Flea-Power AC/DC 'Phone (Chambers).....	22, Mar.
Frequency Equalizer for Crystal Mikes (H&K).....	58, Oct.
More Meaning in Your Signal Reports (Taylor).....	30, Nov.
'Phone Monitor Using Infinite Impedance Detector (H&K).....	55, Mar.
Push to Talk (H&K).....	57, Apr.
Some Notes on Fidelity (Brooks).....	20, Jan.

RECEIVING

Audio Attenuator for NC100 Receivers (H&K).....	58, Sept.
A.V.C. for C.W. Reception (Weber).....	26, Jan.
Dual-Diversity Preselector (Bartlett).....	37, Apr.
Hints on Improving the FB-7 Receiver (H&K).....	48, Aug.
More Meaning in Your Signal Reports (Taylor).....	30, Nov.
Operating Kink for Superhet Receivers (H&K).....	59, Sept.
Practical Design of Mixer Circuits (Hammond)	38, Feb.
Selectable Single Side-Band Receiving System (McLaughlin).....	16, June
Some Notes on Fidelity (Brooks).....	20, Jan.
SW-3 as a Preselector (H&K).....	47, Aug.
Tone Control by Negative Feedback (H&K).....	48, Dec.
Two-Tube Superhet, A.....	12, Feb.

REGULATIONS

American Morse.....	20, Mar.
Applying for Renewals.....	27, May
Army Maneuvers.....	20, Oct.
Calling and Signing.....	28, Aug.
Changes in 10-Meter Band.....	28, Aug.
Citizenship Showing.....	21, Oct.
Class A Continued.....	20, Oct.
Easy Renewals for Service Men.....	29, Aug.
Examination Points.....	31, Sept.
Extension for Renewal Applications.....	21, Nov.
FCC Disciplinary Actions.....	64, Mar.
FCC Notes.....	34, June
I.C.W. on 160.....	23, Feb.
Moving into a Class B Circle.....	29, Aug.
Our Contribution to National Defense.....	7, Sept.
Proof of Use Waived.....	22, Feb.
Remote Control.....	28, Aug.
Renewing and Modifying.....	22, Apr.
Renewing Licenses.....	31, Sept.
Temporary Changes in Location.....	28, Aug.
Transfer of Frequencies Postponed.....	20, Oct.
Warning — Amateur Traffic Must Not Disclose Ship Locations.....	33, Nov.
Washington Notes.....	18, Jan.
Working Army Stations.....	21, Nov.

TRANSMITTING — GENERAL

Amplifier Neutralization with Safety (H&K) . . .	47, Dec.
Automatic Overload Protection of Tubes (H&K)	57, Mar.
Frequency-Halving Oscillators (Goodman and Bubb)	46, Sept.
Handle Your Traffic on 160 (Grammer)	11, Sept.
Why Not Parallel Feed? (Ferrill)	30, Jan.

TRANSMITTING — CRYSTAL AND E.C.O.

(See also, "Keying")

Adapting the 6L6 Oscillator for Fundamental and Harmonic Operation (H&K)	53, Sept.
Crystal Switch (H&K)	51, Feb.
E.C.O. Coupling Circuit (H&K)	42, Jan.
Frequency-Halving Oscillators (Goodman and Bubb)	46, Sept.
Gang-Tuned V.F.O., A (Goodman)	14, Mar.
Improved Electron-Coupled Oscillator, An (Metcalf)	14, May
Low-C Electron-Coupled Oscillator, A (Seiler) . .	26, Nov.
Let's Talk E.C.O. (Stiles and Blair)	14, Aug.
Variable Crystal Frequency with an 815 Locked Oscillator (H&K)	53, Nov.
"Variarm 150," The (Rice)	8, Jan.

TRANSMITTERS — PORTABLE AND LOW POWER

Compact Portable-Emergency Transmitter, A (Chambers)	24, Apr.
Emergency Transmitter Design Considerations (Read and Stiles)	36, May
Flea-Power AC/DC Phone (Chambers)	22, Mar.
Fool-Proof Rig for 80 and 40 Meters (Mix)	20, June
(Correction)	8, July
Further Developments in the Fool-Proof Rig (Mix)	30, Aug.
Pocket-Size Complete Transmitters (Hayes, Lawrence)	12, Jan.
Portable-Emergency Transmitter for Vibrator Power Supply, A (Roberts)	32, Apr.
QSL-25, The (Sutter)	40, Apr.
Soldier's Portable, A (Roof)	22, Nov.
Transmitter Frequency-Control Unit with Three-Band Output (Shuart)	45, June
Versatile Portable-Emergency Transmitter (Hadlock)	9, July

TRANSMITTERS — MEDIUM AND HIGH POWER

Apartment-Size 100 Watt Transmitter (Woehr) .	12, July
Inexpensive Two-Stage Three-Band Transmitter, A (Chambers)	16, Feb.
Push-Pull 809's in a Low-Frequency Transmitter (Mix)	32, Mar.
Short on Space, OM? (Huntoon)	38, Mar.
80-Watt All-Band Transmitter or Exciter, An (Goodman)	15, Oct.

TUBES

826, 1625, 1626, 866A	30, Feb.
384	82, Feb.
7V7, 12SF7, 6SG7	98, Apr.
6SF7, 12SF7, 6SN7GT, 45Z3, 3Q4	80, May
6AH7GT, 12AH7GT	74, June
8005, 8001, Z-225	86, July
5Y3, 12SL7GT	49, Aug.
HY65, HY67	90, Sept.
6SL7GT, 1631, 1632, 1633, 1634	100, Sept.

ULTRA-HIGH-FREQUENCIES — APPARATUS

112-Mc. Emergency Gear (Grammer)	9, Dec.
112-Mc. Emergency Transmitter, A (Grammer)	14, Dec.
Balanced Inductive Coupling for U.H.F. (H&K)	58, June
"Bugless" 5-Meter Transmitter, A (Barrett and Melton)	14, Apr.
Compact Receiver for 112 Mc., A (Chambers) . .	31, Dec.
Compact 56-Mc. Converter, A (Goodman)	3, Feb.
Experimental 112-Mc. Receiver, An (Brannin)	36, Dec.
Inexpensive 56-Mc. Exciter or Transmitter, An (Chambers)	13, June
Inexpensive 112-Mc. M.O.P.A., An (Johnson) .	12, Aug.
Lecher Wire System for U.H. Frequency Measurement, A	18, Oct.
Low-Powered 112-Mc. Transmitter-Receiver, A (Goodman)	20, May
Mobile Transmitter for 2½ Meters, A (Chambers)	36, Nov.
Modulator and Power Supply for the Inexpensive 56-Mc. Transmitter, A (Chambers)	18, Aug.
New Miniature U.H.F. Receiving Tubes in a 56- and 112-Mc. Converter, The (Grammer) . .	18, Sept.
Simple Tone Modulation for U.H.F. Transmitters (H&K)	56, Mar.
Simple 5- and 10-Meter Transmitter (Thompson)	20, Feb.
Simplified I.C.W. Operation (H&K)	57, June
Two U.H.F. Receivers Using the 9000 Series Tubes (Goodman)	10, Nov.
U.H.F. Superhet Design for Improved Performance in Audio and Video Reception (Griffin) . .	27, Feb.; 27, Apr.
56-Mc. Transmitter for Mobile Work, A (Goodman and Bubb)	50, Oct.
227-Mc. Rig at WIAIY, The	38, Aug.

ULTRA-HIGH-FREQUENCIES — TESTS

Aurora DX, March, 1941	47, Apr.; 28, May
On the Ultra-Highs	36, Jan.; 44, Feb.; 50, Mar.; 51, Apr.; 33, May; 42, June; 34, July; 42, Aug.; 50, Sept.; 54, Oct.; 40, Nov.; 52, Dec.
U.H.F. Contests, Fifth	29, Jan.
Sixth	49, Apr.
Seventh	36, Apr.
Eighth	45, Aug.; 60, Nov.
Ninth	43, Nov.
U.H.F. Marathon for 1941 (Handy)	24, Jan.

WHAT THE LEAGUE IS DOING

Acting Directors	34, June
Amateur Examinations in 1941	24, Feb.
Amateur Licensing	29, Aug.
Army Questionnaire	22, Feb. 22, Apr.
Board Meeting, Agenda	27, May
Minutes	34, June
C.C.C. Instructorships	23, Apr.
Code Proficiency Statistics	18, Jan.
Defense Communications Board, The	7, Feb.; 22, Feb.; 20, Mar.; 22, Apr.; 29, Aug.
Easy Renewals for Service Men	29, Aug.
Election Notices	19, Jan.; 30, Sept.; 21, Oct.; 22, Dec.
Election Results	22, Feb.; 20, Mar.; 22, Dec.
Executive Committee Meetings	18, July
Financial Statements, 18, Jan.; 23, Apr.; 13, July; 21, Oct.	
League Field Day Authorized!	27, May
Let George Do It	21, Nov.
Miscellany	20, Mar.; 28, May; 22, Dec.
New ARRL Treasurer	17, July
New Membership Rules	18, July
Our Contribution to National Defense	7, Sept.
Radio in the Draft Army	19, Jan.
Policing Our Bands	21, Nov.
Service Records Wanted	18, Jan.; 20, Mar.
Washington Notes	18, Jan.

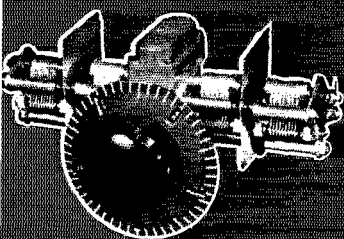
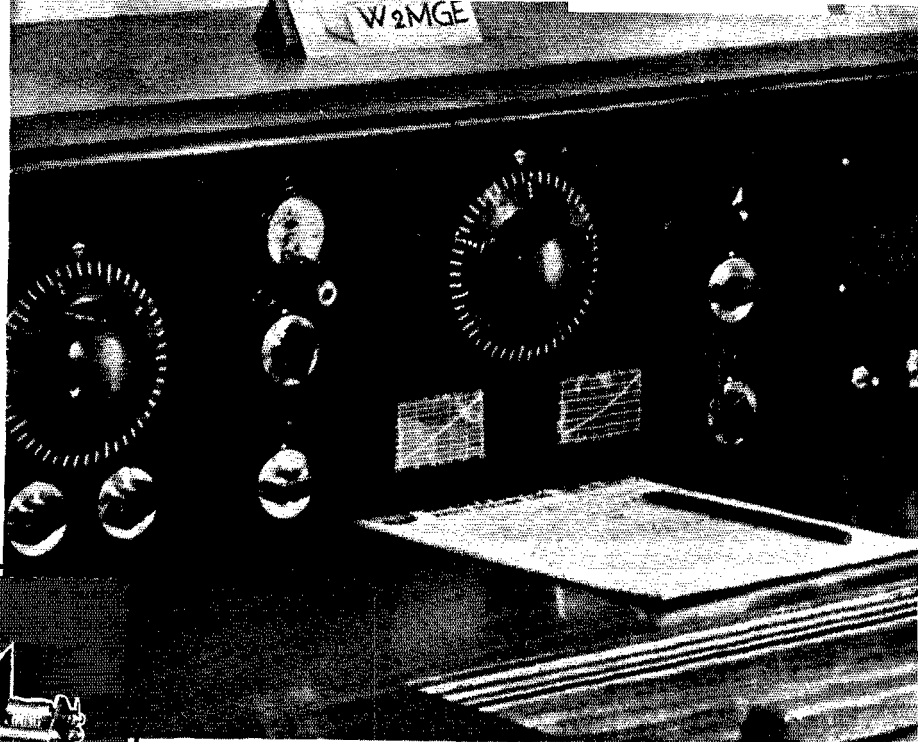

TUNING EYE -
W2MGE -
 Accurate for precise tuning
 of broadcast stations and
 other communication stations.

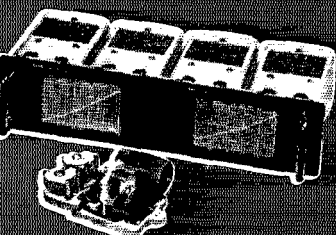

BANKED TUBE-IN-CASE
 All stages of protection for tubes
 against vibration, shock and
 temperature extremes.

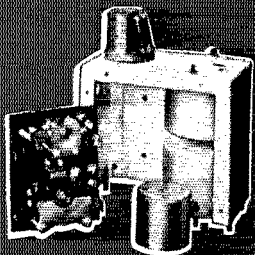

WIDE RANGE CONTROL -
 Wide range of volume and
 tuning controls for maximum
 flexibility of use and performance.

HRO

Wherever the choice of a communication receiver is based on proven performance, the HRO is a logical selection. For the HRO is cleanly designed for crack operators, free from superfluous tubes or details, yet including everything that can aid the user's skill. The HRO combines ease of operation with brilliant performance and superb reliability.

NATIONAL COMPANY, INC., MALDEN, MASS., U. S. A.

Typical of RCA Tube values is the RCA-8005 Transmitting Triode de luxe, priced at only \$7 net. Designed for use as a radio frequency amplifier and class B modulator, this tube is capable of handling 300 watts (ICAS) input at 5 meters!

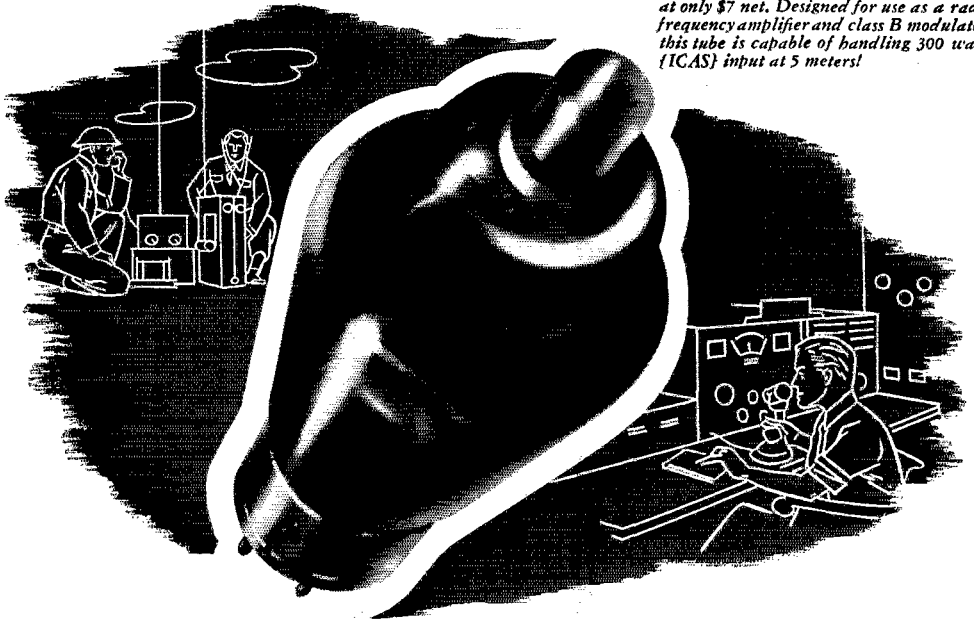

PRODUCTION FOR DEFENSE ... COOPERATION FOR ALL!

Defense production with RCA gets first call—and always will. Suffice to say that a tremendous quantity of RCA Transmitting Tubes is being supplied for a wide variety of defense needs. Meanwhile, although the 1941 total of RCA Transmitting Tubes supplied through our regular distribution channels will exceed that of last year, there is a scarcity of certain types.

We know you will understand that this is unavoidable. We know, too, that we can count on your cooperation during these trying times—just as we want our countless friends in amateur Radio to know that they can count on ours.

RCA Transmitting Tube quality is being rigidly maintained. RCA publications will be kept strictly up-to-date. Ham Tips will be continued. New data and construction material will be supplied. Inquiries about RCA Tubes and their applications will be answered promptly. Above all, research and development work is continuing as never before.

Thus, although it may not always be possible to supply the tubes you want during the National Emergency, RCA is still on the job to help wherever and whenever it can!



TRANSMITTING TUBES

RCA MANUFACTURING CO., Inc., Camden, N. J.

A Service of The Radio Corporation of America • For Canadian prices write to RCA Victor Company Limited, Montreal