

QST



April, 1941
25 cents
35c in Canada

devoted entirely to

amateur radio



... a group of low-powered, high frequency transmitters having several features in common.

All models have up to ten quick change Autotune frequencies. A1, A2, and A3 types of emission are available throughout the series. The rated power output is from 150 to 500 watts. Any of Collins standard remote control arrangements can be employed.

This 16 Series together with Collins 231 Series forms a closely related group of seven transmitters with rated power outputs from 150 to 3000 watts.

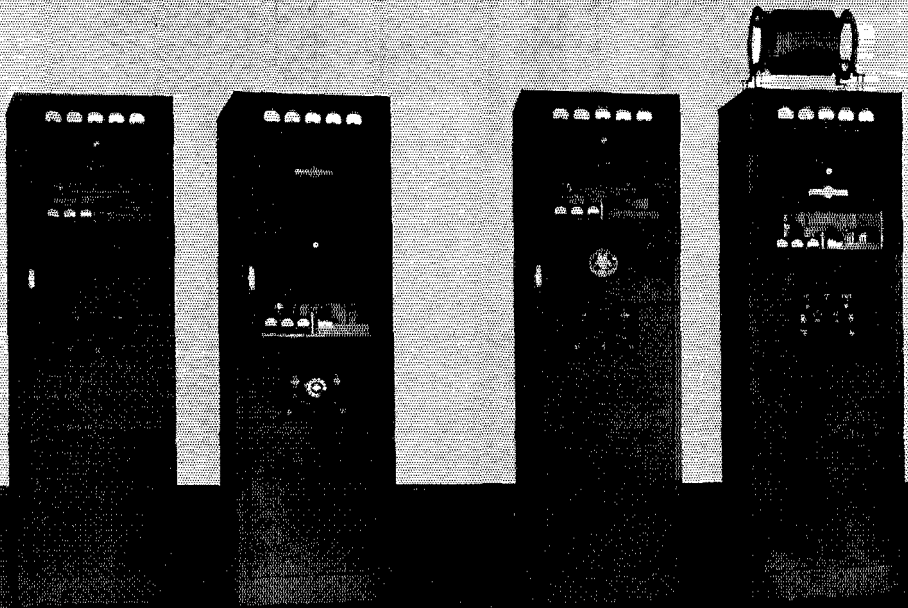

COLLINS RADIO COMPANY

TOP QUALITY

Communications Performance



ENGINEERED to a high degree of perfection. The SX-28 offers every worthwhile feature necessary to top quality communications performance. 15 tubes, two stages preselection, calibrated bandspread inertia controlled, micrometer scale tuning inertia controlled, tone and AC on-off, beat frequency oscillator, AF gain, RF gain, crystal phasing, adjustable noise limi-

ter, send-receive switch, AVC-BFO switch, bass boost switch, phono jack, 80/40/20/10 meter amateur bands calibrated, wide angle "S" meter, band pass audio filter, improved signal to image and noise ratio, push-pull high fidelity audio output, 6 step wide range variable selectivity, improved headphone output. Model XS-28 with crystal and tubes \$159.50.

the hallicrafters co.

CHICAGO, U. S. A

USED BY 35 GOVERNMENTS

SOLD IN 89 COUNTRIES

Take it With You Wherever You Go!

THE Sky-Traveler (Model S-29) is a portable designed to communications receiver tolerances. You can take it with you wherever you go, or use it at home. Operates on 110 volts AC or DC or from its self-contained batteries. Frequency coverage from 542 kc. to 30.5 mc. on 4 bands. Telescope antenna with high gain coupling circuit provides truly remarkable reception throughout the tuning range. Electrical band-spread. Automatic noise limiter. Battery life prolonged through a self-contained charging circuit. RF stage used on all bands. Sensitivity below two microvolts on all bands. Permeability tuned RF and IF circuits. Weight including batteries 18 lbs. The Sky-Traveler (Model S-29) \$59.50.

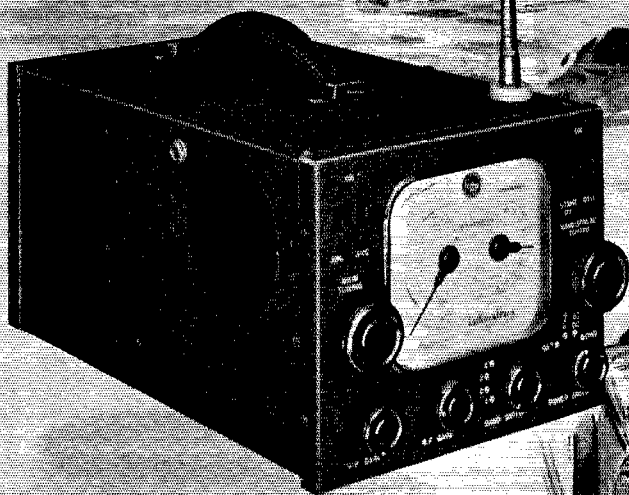

the hallicrafters co.
CHICAGO, U. S. A.
USED BY 33 GOVERNMENTS
SOLD IN 89 COUNTRIES

APRIL 1941

VOLUME XXV

NUMBER 4



STAFF

Editorial

KENNETH B. WARNER, W1BX
Editor and Business Manager

CLARK C. RODIMON, W1SZ
Managing Editor

GEORGE GRAMMER, W1DF
Technical Editor

DONALD H. MITZ, W1TS
BYRON GOODMAN, W1JPE
Assistant Technical Editors

EDWARD P. TILTON, W1BDQ
Contributing Editor, U.H.F.

VERNON CHAMBERS, W1JEG
Technical Information Service

JAMES J. LAMB, W1AL
Research Engineer, A.R.E.L.

Advertising

F. CHEYNEY BEEBLEY, W1GS
Advertising Manager

Circulation

DAVID H. HOUGHTON
Circulation Manager

RALPH T. BEAUDIN, W1BAW
Asst. Circulation Manager



OFFICES

88 La Salle Road
West Hartford, Connecticut

Subscription rate in United States and Possessions, \$2.50 per year, postpaid; all other countries, \$5.00 per year, postpaid. Single copies, 25 cents. Foreign remittances should be by international postal or express money order or bank draft negotiable in the U. S. and for an equivalent amount in U. S. funds.

Entered as second-class matter May 29, 1919, at the post office at Hartford, Connecticut, under the Act of March 3, 1879. Acceptance for mailing at special rate of postage provided for in section 1103, Act of October 3, 1917, authorized September 9, 1922. Additional entry at Concord, N. H., authorized February 21, 1929, under the Act of February 28, 1925. Additional second-class entries to cover sectional editions authorized March 29, 1935.

Copyright 1941 by the American Radio Relay League, Inc. Title registered at United States Patent Office.

QST

devoted entirely to

AMATEUR RADIO

PUBLISHED, MONTHLY, AS ITS OFFICIAL ORGAN, BY THE AMERICAN RADIO RELAY LEAGUE, INC., AT WEST HARTFORD, CONN., U. S. A.:
OFFICIAL ORGAN OF THE INTERNATIONAL AMATEUR RADIO UNION



CONTENTS

Editorial	7
Silent Keys	8
Hamming on Howland Island <i>Robert Lieson, W1KFFV, ex-KF6SJJ</i>	9
A Hurricane-Proof Mast <i>Guy A. Stewart, Jr., W2JRC</i>	12
A "Bugless" 5-Meter Transmitter <i>J. C. Melton, W3NT, and M. W. Barrett, W3RZ</i>	14
Some Thoughts on Keying <i>Byron Goodman, W1JPE</i>	17
What the League Is Doing	22
For the Junior Constructor A Compact Portable Emergency Transmitter <i>Vernon Chambers, W1JEQ</i>	24
U.H.F. Superhet Design for Improved Performance in Audio and Video Reception <i>Dana A. Griffin, W2AOE</i>	27
Putting Dynamic Prognostication to Work <i>Larson E. Rapp, W1OU</i>	30
A Portable Emergency Transmitter for Vibrator Power Supply <i>Walter van B. Roberts, W3CHO</i>	32
April 26th-27th — 7th U.H.F. Contest	36
A Dual-Diversity Preselector <i>Forrest A. Bartlett, W6OWT</i>	37
The "QSL-25" <i>Fred Sutter, W8QBW, W8QDK</i>	40
WWV Schedules	42
Army-Amateur Radio System Activities	43
Ham Shacks <i>W1LEA, W2WD, W1EOB, W9AS, PY5BL</i>	44
Predictions of Useful Distances for Amateur Radio Communication in April, May and June, 1941	46
Red Cross Schedules	48
Naval Communication Reserve Notes	50
On the Ultra Highs <i>E. P. Tilton, W1HDQ</i>	51
Boost Your Code — Start Traffic <i>F. E. Handy, W1BDI</i>	54
QST, 25 Years Ago This Month	55
Hints and Kinks <i>Filament-Transformer Kink — Boosting the Antenna Height — Mast Raising Kink — A Kink for the Workbench — Cutting Square Holes</i>	56
Results, 6th U.H.F. Contest and Relay <i>James R. Buckler, W9NFL/I</i>	59
Correspondence From Members	60
Operating News	61
Hamfest Schedule	62
A.R.R.L. Affiliated Club Honor Roll	70
New Receiving Tubes <i>7V7, 12SG7, 6SG7</i>	98
Ham Ads	107
QST's Index of Advertisers	110

Section Communications Managers of the A.R.R.L. Communications Department

All appointments in the League's field organization are made by the proper S.C.M., elected by members in each Section listed. Mail your S.C.M. (on the 16th of each month) a postal covering your radio activities for the previous 30 days. Tell him your DX, plans for experimenting, results in phone and traffic. He is interested, whether you are an A.R.R.L. member or get your QST at the newsstands; he wants a report from every active ham. If interested and qualified for O.R.S., O.P.S. or other appointments he can tell you about them, too.

ATLANTIC DIVISION			
Eastern Pennsylvania Maryland-Delaware-District of Columbia Southern New Jersey Western New York Western Pennsylvania	W3BES W3CIZ W3CCO W8PLA W8CKO	Jerry Mathis Hermann E. Hobbs Lester H. Allen Fred Chichester E. A. Krall	6042 Master St. 9701 Monroe St. Silver Spring P.O. 704 Quinton Ave. 703 Broadway Philadelphia Linden, Maryland Trenton Sonyea East McKeesport
CENTRAL DIVISION			
Illinois Indiana Kentucky Michigan Ohio Wisconsin	W9ILH W9AB W9ARU W9DPE W8AQ W9UIT	Mrs. Carrie Jones Harry B. Miller Darrell A. Downard Harold C. Bird E. H. Gibbs Aldrich C. Krones	2407 Central Ave. 729 E. Lowell Ave. 116 N. Longworth Ave. R.F.D. 2 405 Broad St. 2702 So. 46th St. Alton Mishawaka Louisville Pontiac Wadsworth Milwaukee
DAKOTA DIVISION			
North Dakota South Dakota Northern Minnesota Southern Minnesota	W9WWL W9ADJ W9IGZ W9YNQ	Anton C. Theodos E. C. Mohler Edwin L. Wicklund Millard L. Bender	Box 444 Box 149 R.F.D. 3 608 N. Huron Ave. Williston Rapid City Kensington Spring Valley
DELTA DIVISION			
Arkansas Louisiana Mississippi Tennessee	W5GNV W5DWW W5EGE W4DDJ	John R. Sanders W. T. Wilkinson, Jr. S. Benton Cain M. G. Hooper	P. O. Box 1563 Room 313, Jefferson Hotel 221 E. Monticello 4908 Georgia Ave. Little Rock Shreveport Brookhaven Nashville
HUDSON DIVISION			
Eastern New York N. Y. C. & Long Island Northern New Jersey	W2LU W2AZV W2LMN	Robert E. Haight E. L. Baunach Edward Gursky, Jr.	511 South Holmes St. 102 Central Ave. 367 Van Winkle Ave. Scotia Massapequa, L. I. Hawthorne
MIDWEST DIVISION			
Iowa Kansas Missouri Nebraska*	W9PIR W9AWP W9OUD W9WKP	L. B. Vennard A. B. Unruh Miss Letha Allendorf Garold Bennett	1113 So. 9th St. 1617 S. Seneca St. 1015 W. 3rd St. 704 12th St. Burlington Wichita Joplin Auburn
NEW ENGLAND DIVISION			
Connecticut Maine Eastern Massachusetts Western Massachusetts New Hampshire Rhode Island Vermont	W1CTI W1IIE W1ALP W1IAH W1IFTI W1HRC W1KJG	Frederick Ellis, Jr. H. W. Castner Frank S. Baker, Jr. William J. Barrett Mrs. Dorothy W. Evans Clayton C. Gordon Clifton G. Parker	19 Merrill Rd. 147 Church 171 Colby Road 239 Columbia St. 163 South Main St. 70 Columbia Ave., Gaspee Box 537 Norwalk Damariscotta North Quincy Adams Concord Plateau, Warwick Morrisville
NORTHWESTERN DIVISION			
Alaska Idaho Montana Oregon Washington	K7GNN W7CRL W7CPY W7GNI W7FCG	James G. Sherry Clifford A. Jessup Rex Roberts Carl Austin W. Beale	Post Office Dept. Box 1038 1137 Federal R. 4, School Ave. Chicagof Moscow Glendive Bend Walla Walla
PACIFIC DIVISION			
Hawaii Nevada Santa Clara Valley East Bay San Francisco Sacramento Valley Philippines San Joaquin Valley	K6ETF W6BIC W6UJZ W6TTI W6CJS W6MDI KA1GR W6KUT	Francis T. Blatt Edward W. Heim Earl F. Sanderson Horace R. Greer Kenneth Hughes Vincent N. Feldhausen George L. Rickard Edwin A. Andress	837 16th Ave. 509 Claremont St. 101 Claremont Ave. 414 Fairmount Ave. 209 Lincoln Way 113 South Quincy St. Box 849 2921 North Van Ness Blvd. Honolulu Reno San Jose Oakland San Francisco McCloud Manila Fresno
ROANOKE DIVISION			
North Carolina South Carolina Virginia West Virginia	W4CYB W4BOE/ANG W4GWO W8OXO	W. J. Wortman Ted Ferguson Frank S. Anderson, Jr. W. D. Tabler	P. O. Box 566 1213 College St. 4703 New Kent Ave. 1004 So. Davis Ave. Morganton Columbia Richmond Elkins
ROCKY MOUNTAIN DIVISION			
Colorado Utah-Wyoming	W9EHC W7ZGG	Carl C. Drumeller Henry L. Schroeder	224 Colorado Ave., Apt. 3 P. O. Box 731 Pueblo Laramie, Wyoming
SOUTHEASTERN DIVISION			
Alabama Eastern Florida Western Florida Georgia West Indies (Cuba-Puerto Rico- Virgin Islands)	W4DGS W4PEI W4AXP W4AOB CM2OP	James F. Thompson Carl G. Schaal Oscar Cederstrom William U. Hanks Mario de la Torre	12 Clanton Ave. Waucoma Apts. Lakeview Hotel Second St. & Bruce Ave. 4 Hunter St., S.E. Escobar 110 (Altos) Montgomery Clermont De Funiak Springs Atlanta Habana, Cuba
SOUTHWESTERN DIVISION			
Los Angeles Arizona San Diego	W6MQM W6KGI W6BKZ	Ralph S. Click John K. Oliver Louis A. Cartwright	1038 Milwaukee Ave. Box 642 370 Nautilus Los Angeles Nogales La Jolla
WEST GULF DIVISION			
Northern Texas * Oklahoma Southern Texas New Mexico	W5EAV W5GFT W5MNI W5ENI	R. E. Hughes Russell W. Battern Horace E. Biddy Dr. Hilton W. Gillett	1410 Ave. E, N.W. Box 290 1746 Schley Ave. Childress Enid San Antonio Lovington
MARITIME DIVISION			
Maritime	VE1DQ	A. M. Crowell	69 Dublin St. Halifax, N. S.
ONTARIO DIVISION			
Ontario	VE3EF	Flying Officer Donald R. Gunn	% Canadian Bank of Commerce New Toronto, Ont.
QUEBEC DIVISION			
Quebec	VE2CO	Lindsey G. Morris	Apt. 6, 4510 Girouard Ave., N.D.G. Montreal, P. Q.
VANALTA DIVISION			
Alberta British Columbia	VE4GE VE5DD	C. S. Jamieson C. O. I. Sawyer	581 W. Riverside Drive 2634 West 31st Ave. Drumheller, Alta. Vancouver
PRAIRIE DIVISION			
Manitoba Saskatchewan	VE4AAW VE4SY	A. W. Morley Arthur Chesworth	747 McMillan Ave. 1071 4th Ave., N. W. Winnipeg Moose Jaw

* Officials appointed to act until the membership of the Section choose permanent S.C.M.s by nomination and election.

HERE'S THE NEW Jensen "Speech Master" REPRODUCER

FOR DESK, WALL OR PANEL MOUNTING

ATTRACTIVE streamlined appearance, versatile utility, and exceptional acoustic performance are capably combined in the new JENSEN "Speech Master"—designed especially for highly effective speech reproduction at moderate levels. Efficient, fully-enclosed PM structure. Rugged moving system. Internal provision for transformer mounting.

Desk Type . . . complete with base . . . "tilt" adjustment . . . for desk or wall mounting . . . List Price \$9.95.

Panel Type . . . for rack or cabinet assemblies . . . List Price \$8.10.

Bulletin 106 gives complete details.

*Especially Designed for
Radiophone Communication*

Airline—Police
Aviation—Commercial

Intercommunication
One-Way & Talk-Back

Paging Systems
Low-Level Stations

Public Address
Low-Level Extensions

Jensen
6601 SOUTH LARAMIE AVENUE • CHICAGO
CABLE ADDRESS: JERAD, CHICAGO
R E P R O D U C E R S

THE AMERICAN RADIO RELAY LEAGUE

Directors

President
GEORGE W. BAILEY W1KH
74 Webster Road, Weston, Mass.

Vice-President
CHARLES E. BLALACK W6GG
Box 55, Yuma, Ariz.

Canadian General Manager
ALEX REID VE2BE
169 Logan Ave., St. Lambert, P. Q.

Atlantic Division
WALTER BRADLEY MARTIN W3QV
Box 612, Roslyn, Pa.

Central Division
GOODWIN L. DOSLAND W9TSN
10 No. Clark St., Chicago

Dakota Division
FRED W. YOUNG W9MZN
1333 North 12th Street, Fargo, North Dakota

Delta Division
E. RAY ARLEDGE W5SI
P.O. Box 286, Pine Bluff, Ark.

Hudson Division
ROBERT AKERIDGE KIRKMAN W2DSY
920 Eighth Ave., Brooklyn

Midwest Division
FLOYD E. NORWINE, JR. W9EFC
7405 Hlawatha Ave., Richmond Heights, Mo.

New England Division
PERCY C. NOBLE W1BVR
37 Broad St., Westfield, Mass.

Northwestern Division
KARL W. WEINGARTEN W7BG
3219 N. 24th St., Tacoma, Wash.

Pacific Division
J. L. McCARGAR W6EY
66 Hamilton Pl., Oakland, Calif.

Roanoke Division
H. L. CAVENESS W4DW
2607 Vanderbilt Ave., Raleigh, N. C.

Rocky Mountain Division
C. RAYMOND STEDMAN W9CAA
925 So. Gaylord St., Denver

Southeastern Division
WILLIAM C. SHELTON W4ASR
Box 652, Daytona Beach, Fla.

Southwestern Division
JOHN E. BICKEL W6BKY
501 E. California St., Whittier, Calif.

West Gulf Division
WILLIAM A. GREEN W5BKH
301 Ross St., Abilene, Texas

THE AMERICAN RADIO RELAY LEAGUE, INC., is a non-commercial association of radio amateurs, bonded for the promotion of interest in amateur radio communication and experimentation, for the relaying of messages by radio, for the advancement of the radio art and of the public welfare, for the representation of the radio amateur in legislative matters, and for the maintenance of fraternalism and a high standard of conduct.

It is an incorporated association without capital stock, chartered under the laws of Connecticut. Its affairs are governed by a Board of Directors, elected every two years by the general membership. The officers are elected or appointed by the Directors. The League is non-commercial and no one commercially engaged in the manufacture, sale or rental of radio apparatus is eligible to membership on its board.

"Of, by and for the amateur," it numbers within its ranks practically every worth-while amateur in the nation and has a history of glorious achievement as the standard-bearer in amateur affairs.

Inquiries regarding membership are solicited. A bona fide interest in amateur radio is the only essential qualification; ownership of a transmitting station and knowledge of the code are not prerequisite. Correspondence should be addressed to the Secretary.



Past Presidents

HIRAM PERCY MAXIM, 1914-1936
EUGENE C. WOODRUFF, 1936-1940

Officers

President GEORGE W. BAILEY, W1KH
Weston, Mass.

Vice-President CHARLES E. BLALACK, W6GG
Altadena, Calif.

Secretary KENNETH B. WARNER, W1EH
West Hartford, Connecticut

Treasurer ARTHUR A. HEBERT, W1ES
West Hartford, Connecticut

Communications Mgr. F. EDWARD HANDY, W1BDI
West Hartford, Connecticut

General Counsel PAUL M. SEGAL
1026 Woodward Building, Washington, D. C.

Address all general correspondence to the administrative headquarters at West Hartford, Connecticut.

"IT SEEMS TO US—"

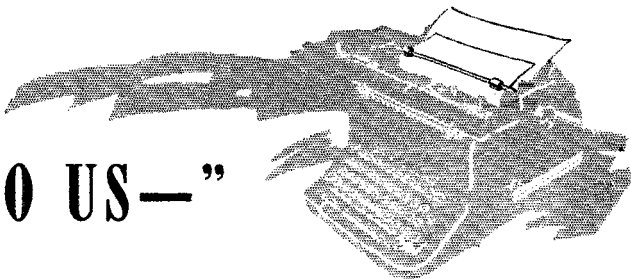

HOW TO WRITE AN EDITORIAL

WE'VE been staring at this cursed sheet of blank paper for nigh on to an hour, wondering what to write about. Some days you just can't make a Muse. Maybe it's the weather — it's a beautiful golden day outside our window and we suddenly remembered golf, for the first time in months. Songbirds are reported as far north as Washington and it won't be long before somebody up here spots a robin. Ah, spring! Offices shouldn't have windows. We must get on with the job.

"The camera addict can go around snapping pictures all his lifetime without invading the prerogatives of another human being. The model-builder can build a thousand OO-gage railroad cars and not a soul need know of his existence. Even the motorcyclist on a Sunday afternoon spin is only utilizing one track of a road created impartially for the use of every citizen. But the transmitting radio amateur can't shoot so much as a watt into the air without some significant part of the world being affected."

Nice sentences, contributed by deSoto as a possible theme for an editorial. They would be all right if we know where to go from there. But we don't; not to-day. We look over the old notes:

"To many of us our day-by-day pursuit of amateur radio has become such a commonplace and accepted activity that we are not always fully aware that it is the world's most extraordinary hobby." Get in something here about superficial comparisons with other hobbies. "Unlike all others, it is the only one where a high order of social and technical responsibility is a requisite." Better clean up that sentence first. But where's the impulse to moralize on a topic like that on a day as immorally gaudy as this one?

We dig into our tattered Idea Folder. Tripe, mostly. A note solemnly asserting that the Worcester courthouse doorway bears the motto, "Obedience to law is liberty." Can't remember to-day just why we thought that was worth filing; it had something to do with the value of restraint by free men. . . . A

reminder to tell you again what you get for A.R.R.L. membership. "The old story is always valuable," the note says. True, but must we write it to-day? Two rejected drafts of complete editorials, held for hard times, but now thoroughly dated. . . . A scribbled memo paraphrasing something apparently cribbed from another magazine; all it says is, ". . . Get a suspension from the F.C.C. and go out of amateur radio the same way that Balaam rode from Jerusalem to Jericho." We recall the general idea from our Sunday-school days, but how do we use it this month? . . . Old speeches: "Fellow amateurs of the Radio Club of Cuba: It is a happy privilege to be here amongst you in Cuba, and I must thank you deeply for receiving me with that warmth which everywhere characterizes the true radio amateur." We remember why we thought that worth saving. It's a very real thing, that warmth of amateur feeling, as we know from visiting many foreign countries to attend international conferences. Some day, when a kindly Muse will sit upon our knee and dish out inspiration, we aim to get out a real piece on the subject. Meanwhile this weather would only make us tiresome.

Well, then, what about something on how the amateur, alone of all services, does not have to get a construction permit and prove that his individual station will be in the public interest, convenience and necessity, because our League has established that fact for the whole institution of amateur radio? It's a good thought, worth a ponderous Warner editorial, but can you take it to-day? No; it's spring.

We ransack our mind. Must be something in these many recent Washington trips to talk about. . . . Trouble is that so much of it is confidential national-defense stuff. We'd love to be able to cut loose with something on the amazing development of microwave technique, but we can't. We'd like to be able to tell you about the work of the defense communications board but this is truly national defense and every person participating in the work has taken an oath that he will not even disclose the subjects that have been under consideration. It's pretty tough on us to be able only to

mumble vague generalities about a proper appreciation of the amateur's value and about interesting plans that may later be announced. The only thing we can say plainly is not to worry; Uncle Sam isn't going off half-cocked on the amateur question. When the story is written some day it will be a good one. But it won't fill *this* month's page.

It seems to us that it should be interesting to speculate on the reasons why certain outstanding technical developments have never yet found a real acceptance in amateur radio technique. For instance, how many of those clever electronic keys do you suppose have been built by hams? And Jim Lamb's heterotone — do you ever hear of it any more? And 'phone break-in and volume compression? And even that versatile confection, extended variable-frequency crystal control, is rarely men-

tioned. We might, in fact, point at the whole broad field of newer u.h.f. developments, particularly frequency-modulation and television, with a passing glance at amateur facsimile, and suggest —

How's that, Miss Schmalz? The weather report, you say? Fair and warmer, we suppose; let's hear it! "Cloudy to-night, moderate to heavy snow to-night and to-morrow, colder to-morrow?" Impossible. You're sure?

What a pity we're not writing this to-morrow — maybe *QST* could have an editorial. But Roddy, the M.E., says he can't wait any longer for copy. . . . Blizzard, eh? No robins and no golf this week-end. Oh, well, maybe there'll be some nice temperature inversions somewhere this evening, and a bit of aurora, and a hot time on Five!

K. B. W.

Calls Heard

W2HNH, Jack Najork, RM3C, U.S.N.

Heard at Culebra, Virgin Islands, Jan. 27 to Feb. 2, 1941
3.5-Mc. c.w.

W1AJL BAV BIG CQN FRZ IHI IPC INF JNM KJG
K00 KXB LGH LSK LWA MJE MMN MZE
W2BCR BWC CGG FNY HHW HXI KWG LRZ LYG
MEI MHW MSF NAK
W3BEI BSB BZX DMM ELN EMN FDQ FDX FYP
GHD GKO GXU HOF IAM IFS IXZ
W4BIR CPE CZL DXF EDQ ENA FCF FMI HEE KK
W5DNE IRF IVA
W8ABZ/3 AIW CSE EHA JZN KZO MTE NGC QBE
RHM RQJ RVH TZP UZN VCL VMR
W9BNF DXX GCL HGK HUV IFX LQF LXJ MLW
QUZ QVL QYG QZU SKN UYD
KF6QM/Q/5

Joe Hassett, RM3C, U.S.N.

Heard at Pearl Harbor, T. H., on Feb. 21, 1941
3.5-Mc. c.w.

W1AW
W5FAB
W6BWX LHM
W7AVR CJO FLT
W8AIZ
W9OMZ ZUA

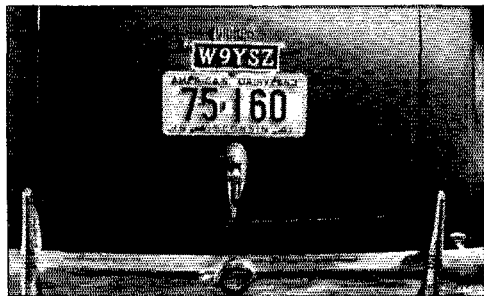

Speaking of license-plate numbers . . .

FLASH

On March 11th the F.C.C. authorized portable operation for all participants in A.R.R.L.'s annual Field Day, which is to be held June 7th-8th. Full details in next issue.

OUR COVER

Yes, this has something to do with ham radio — it's the quarter-wave tower that shouts W3KL to the brethren around 1880 kc. This 127' self-supporting electrically-welded 3-ton radiator rests on a 24-ton concrete base and can be seen at Lakeside Park, Bridgeton, New Jersey. Our thanks to Dr. A. C. Whitaker, Jr., for this shot.

Silent Keys

It is with deep regret that we record the passing of these amateurs:

Pvt. Everett Applegate, W9NED, Canon City, Colo.

Blakely Cross, ex-W8ANX, Gloversville, N. Y.

Elmer Davis, W8BUX, Buffalo, New York

G. O. Marsh, G2GM, London, England

Charles Hall Martin, W9GGI, Webster Groves, Mo.

Sub. Lt. Lewis Scholefield, G5SO-EP5SO, Birmingham, England

William Samuel Sneed, W4DZZ, Winston-Salem, N. C.

Frederick C. Sutter, W8QBW-W8QDK, Grosse Pointe, Mich.

What DX-minded amateur hasn't pondered over the advantages of being the only station in some out-of-the-way place where the prefix is different and the QRN is nil? However, most of them never get a chance to do anything about it, so they should be interested in this story of a ham who had the chance and did do something about it.

Hamming on Howland Island

The Story of KF6SJJ

BY ROBERT LIESON,* W1KFV,
EX-KF6SJJ

I WAS loafing around the hangars at Honolulu's Hickam Field one afternoon, trying to decide whether life with the Air Corps was as exciting as I'd thought it would be when I joined up back in Massachusetts. One of the boys happened to remark that the Department of Interior was looking for able-bodied young fellows like myself to help colonize Howland Island. It seemed he had applied for one of the jobs, but had been turned down. He told me where the office was, and I went there and filed my application.

When I think back on it now, I really didn't have any very clear idea of what I was letting myself in for. I realized vaguely that Howland Island was a spot in mid-Pacific just a few miles north of the equator, and I knew that Uncle Sam had planted a few colonists there to stake our claim of possession, or something. But all that

* 17 Litchfield St., Springfield, Mass.

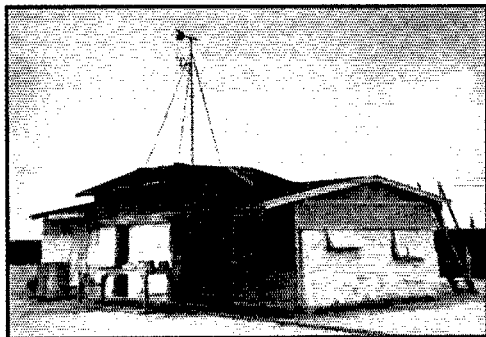

The kitchen also served to support the weather vane and anemometer.

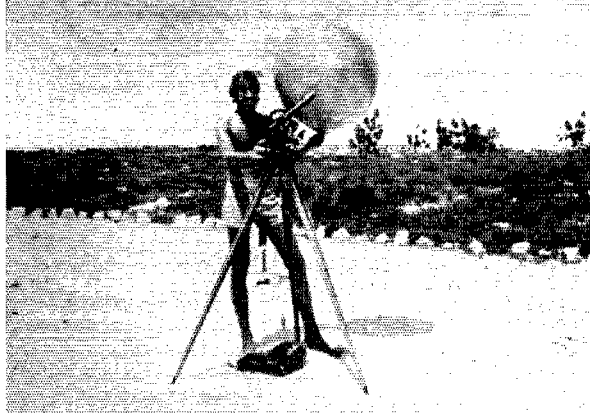

KF6SJJ, complete with beard and tan, about to send up the balloon for a check on wind conditions.

didn't seem very important. The thing that counted with me was that I was going to have a chance for radio work such as almost any ham would give an arm for. While at Honolulu in the Air Corps I had heard KF6JEG often on 20 meters and wondered many times how it would feel to be on a small island and have DX in my own call letters when going on the air.

Here was my chance. I had been operating K6SJJ in Honolulu, and when I decided to take the job with the Department of Interior as radio operator and weather observer I put in for a KF6 prefix.

The Coast Guard boat left Honolulu for Howland Island on March 4th. There were two other lads, replacing two of the four colonists stationed on the Island, and myself. The trip from Hawaii — an 1800-mile voyage to the southwest — was calm and uneventful. I spent most of the time wondering what the Island was going to be like.

On the fourth morning about 1 A.M. a very small strip of land was sighted. Everyone went to the bow of the boat. I could hardly convince myself that this was really the spot I had been waiting to see. Howland Island is shaped like a bean and is one and one-half miles long and about three-quarters of a mile wide. It is a coral formation, with an average elevation about 18 feet above sea level. There are a few ironwood trees; low weeds comprise all the vegetation. Palm trees and shrubbery have been transplanted and are now growing well. From the boat it seemed impossible that human beings could live on such a small island.

The small boats were lowered and we made our way to the Island. As we got near shore we sighted the four colonists, their arms swinging, and heard their shouts of joy. After all the supplies were landed we loaded the boats with the empty gas drums and said farewell to the two boys who had been on the Island for the past year.

I was then shown the radio room. It was one-half of the main government house. The other half comprised the living and sleeping quarters for the colonists. The beds were in one room and the radio equipment was set up in the other,

which also served as the library and reading room.

The first job was setting up the new transmitter, which consisted of a 6L6G oscillator and 811 amplifier. The previous rig — an obsolete piece of old Army gear with a 47 crystal, 10 buffer and p.p. 211 final, all pretty well worn out — was pulled

out and the new outfit hooked up. After the last wire was connected I tied the antenna on. The old neon bulb lighted and a contact was made with the Coast Guard boat. After checking once more to make sure that we would be all right they weighed anchor, and soon we were glimpsing our last contact with the outer world until July, four months away.

When the last of the supplies were stowed away and we finished eating, I gave thought to going on 20 meters. The transmitter was designed to work on 7161 kc., but it happened that the general coverage coils provided for the SW-3 just missed the 40-meter band. Since all our government schedules were with the Canton Island station on 8100 kc., this didn't matter for regular work, but it did wash out hamming on 40 meters.

The 20-meter band could be heard, however, — even though it represented only about a quarter of an inch on the dial — and I set about putting the transmitter on that band. After taking a look around the shack I sure wished I could visit a radio store for about an hour. There wasn't any wire for cabling the power leads, even, and the antenna feeders were separated with wooden spreaders.

After considerable cutting and trying, however, I got a coil to work on 20 and called my first CQ. The band seemed dead, but finally I heard a

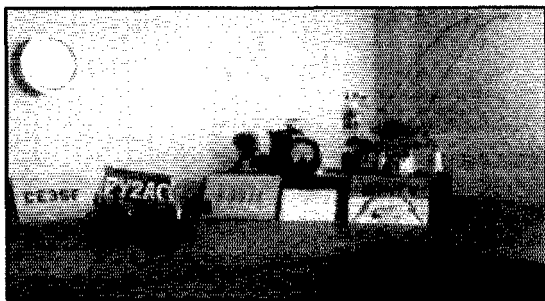

The 6L6-811 rig that was used at KF6SJJ was built in Honolulu by K6BAZ. Power was piped in from the generator house ten yards away.

The next morning I inspected the dynamotor and started charging the batteries used to supply power for the rig. The dynamotor was about five years old and looked as though it had been operating in water for about half that time. Boy, how that dynamotor did swallow up the juice!

During my first term at the Island I wasn't able to do as much hamming as I liked. This was because of the lack of batteries and the necessity for constant charging. Another complication was the automobile radio set that had been brought along. Only one outfit could be used at a time, and since I was the only one who got much kick out of the ham contacts, we spent a good deal of time listening to the mainland b.c. stations.

Perhaps I should explain something of the setup on the Island at this point. Our job there was to make weather observations at six-hour intervals — 6 A.M., noon, 6 P.M. and midnight. After the observations were taken they were coded and I would send them to Canton Island to be relayed to the weather bureau at Honolulu. Pan-American Airways, which of course had a station at Canton, also used the weather data in connection with the clipper flights from Honolulu to Canton Island.

The rest of the time we spent fishing and swimming — and sleeping. At night we'd listen to the auto set, read, or play various games that

chirpy signal calling me. It turned out to be a Japanese ham. Reports were exchanged, and after a brief contact I sent out a "QRZ?" To this another J came back and again reports were exchanged. This was the first foreign DX I had ever worked; when I was in the States I had never gone after DX or used high power.



Howland Island is made up of these buildings — and sand! From left to right: kitchen and food storage house, rain collection shed, government house (sleeping quarters and radio station), tool room and generator house, and hydrogen shack.

had come along in the supplies. We didn't shave and ordinarily wore little or no clothing. In fact, the place looked like nothing more or less than a House of David's nudist camp!

That was during the first "term." (A term is four months — the interval between the boat trips.) During the second term I was able to

get in quite a bit more hamming. I can remember how eagerly I waited for the time for the next boat to come, and when July finally arrived the days just wouldn't seem to go by fast enough. At last the boat was sighted, and on it came a 300-watt a.c. generator and a 750-volt power supply. And with the supplies was plenty of extra gasoline!

As soon as everything was unloaded and set up, the power supply was connected. The transmitter fired up in beautiful style, and I tested with the boat until we saw it slip over the horizon.

There was a little local QRM along about then. Every "boat time" meant a general cleaning up around the camp, and once a year the house was painted. After a week of cleaning up in the camp — with a few interludes of tuning the rig and getting acquainted with the new generator — I put up a four-wavelength "V" antenna pointed toward Canton Island, SSE of Howland. At last I was getting ready for some of the hamming I had promised myself when I started out on this party.

After that I was on the air almost every minute of the time the band was open. This was normally from about 4 to 8 P.M. Howland time, during which time the Pacific Coast and some W5's and W7's came through, and again at 11 P.M. to 2 or 3 A.M. when W9's and the U. S. East Coast were in. With the a.c. generator I could keep the rig on the air continuously and work break-in,



Drinking water was collected on the roof of this shed and fed into drums through a trough.

with no worry about charging batteries. During August and September I had the rig on the air every day. Whenever the band sounded open I'd call CQ. The receiver was rather erratic by this time, and often when the band sounded dead a little banging on the set or tilting the table would raise an S4 signal to S7 or 8.

All in all between five and six hundred W's were worked, some of them many times. Schedules were kept with W1AVK and W1CQR in my home town. What a thrill when I heard my mother's voice over W1AVK! They used 'phone and made other 'phone schedules with various hams. When I got back to Honolulu I received about twenty s.w.l. reports stating that my voice sounded good and quality was clear. Since I had used c.w. exclusively, this puzzled me until I figured out that they must have heard other stations repeating messages and talking with me, so they figured I was also on 'phone at the other end!

All in all it was a pretty good existence, particularly from the ham standpoint. When I got too homesick I'd contact W1CQR and send a flock of messages and answer all his questions. In between times I'd fish or read or eat or sleep. There was plenty of each. The fish were mostly a sort of Hawaiian tuna, big and good eating. There were plenty of lobster; we'd go out at night when the tide was low and catch ten or twelve, eating what we wanted and discarding the rest.

When it came to eating we generally did ourselves pretty well. Except for the fish and lobster, just about all the food we had was brought down by the Coast Guard boat, but the supplies were generous and had plenty of variety — canned

(Continued on page 26)



This is what is meant by a desert island — looking north along the west shore of Howland Island.

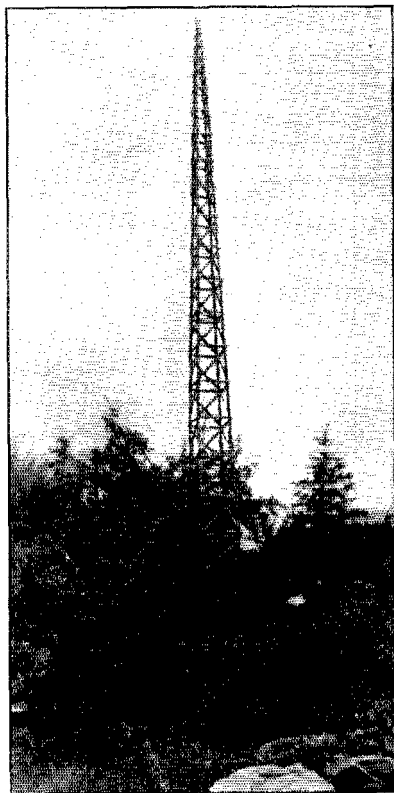

A mast that can take it! Easy to build and erect, and readily can be taken down when repainting is necessary.

THIS is not the story of just another mast. It is a story of a hurricane-proof mast; the story of a mast that can take it and has taken it as other masts all around were toppling and crashing to the ground. And this mast, believe it or don't, was constructed with new material at a cost of \$9.75, U. S. coin.

Along about June, 1937, a year after I had gone back on the air after a lapse of 19 years following the first World War, I became interested in something upon which to hang an antenna that would be better than a 50-(or-more)-year-old elm nearby that, had for the first year back, sufficed. The elm was all right but it was tall and slender and swayed wildly in the wind at times, and I frequently found my sky-wire on the ground.

Not being an engineer I didn't know much about designing the mast I had in mind. So after a lot of thought and rough sketches of what I wanted I rummaged around in the attic to find some old mechanical and structural engineering books that had been used by an uncle while attending West Virginia University a quarter century before. I studied what I found about

* 86 Highland Ave., Tuckahoe, N. Y.

A Hurricane-Proof Mast

An Inexpensive Self-Supporting 48-Footer

BY GUY A. STEWART, JR.,* W2JRG

towers and bridges and then laid out my dream mast on paper, carefully drawing it to scale.

I carefully estimated the number of running feet of lumber I needed and set off in high spirits to a local lumber yard. Here I purchased 14 pieces of clear pine, each 16 feet long, of what I was told was six-quarter by three, but which, in language I could understand, was an inch and a half by three. Then I purchased 300 feet of furring strips; very rough lumber with one side partially dressed. This is more commonly known as "one by two."

Next, I purchased 75 carriage bolts, two and a half inches long and a half inch in diameter. When I finished these purchases I found I had spent \$9.40 of my good, hard-earned cash. The final purchase was 35 cents worth of two-inch wire nails. Thus, the total cost of the material for my hurricane-proof mast had come to \$9.75. Here in Westchester County, where I live, the cost of building material is probably the highest in the whole country, so the price of the material elsewhere would undoubtedly have been much less. Possibly as low as \$7 or \$7.50.

Next, assisted only by my 10-year-old son, I built my mast. It took us just nine hours to complete it. First, we laid out the four side pieces; three 16-foot lengths of the "one by three" pine. The odd pieces were cut into four parts and tapered. The 16-foot lengths were then bolted together using the four-foot pieces to eliminate overlapping of the longer sections. The method used is shown in sketch *D*. This gave me four pieces each 48 feet long.

Incidentally, before going any further, let's be honest about this cost business. I invested \$3 in pure white lead and another \$3 in the best outside paint I could buy. As the side pieces were assembled a liberal coat of white lead was applied where wood was laid against wood. The bolts, with iron washers, were drawn up very tight; as tight as possible.

Then two of these side pieces were laid on the ground and the base width of 4 feet (outside measurement) was observed. No attention was paid to the angle of taper to the top until after the first cross piece was nailed on at one and a half feet from the bottom. Here again white lead was used where wood met wood.

Next, with the aid of a borrowed carpenter's roofing square and a long piece of cord, the proper taper of the side pieces was determined. The sides

were just to meet at the top with the exact four-foot width at the bottom maintained.

This step was followed by making the now fixed side pieces permanently rigid with another cross piece. The second piece was nailed two feet above the first. From there on each subsequent piece was nailed on with spacing each time reduced one inch. In other words the first cross piece was 18 inches from the bottom; the second 24 inches above; the third 23 inches above the second; the fourth 22 inches above the third and so on until the 32-foot level was reached. From there on to the 40-foot level the spacing was reduced by two inches each time. Above 40 feet the spacing was reduced by three inches each time to the top. This gave the mast a better appearance.

When this was finished we nailed on the pieces that cross at an angle between each of the horizontal cross pieces. We finally had two finished sides and turned them on edge. After carefully measuring the bottom width to keep the base four feet wide, we went halfway up the third side with

No untried sky-hook, this. It's been up through four winters, survived the 1938 hurricane and a sleet storm that took out plenty of other structures. Withal, it's light enough to be handled by two men and the material cost is less than ten dollars!

our cross and angle pieces. By this time the mast was sufficiently rigid to permit turning the whole thing over and completing the fourth side.

Next, the mast was turned over again and the third side completed to the top. The two sides were then bolted together at the top with carriage bolts as shown in *E*. The final construction step was to nail on three internal cross braces. These were installed at the ten-, twenty- and thirty-foot levels as shown in sketch *F*. Nine hours after starting we were finished. Incidentally, we found

(Continued on page 74)

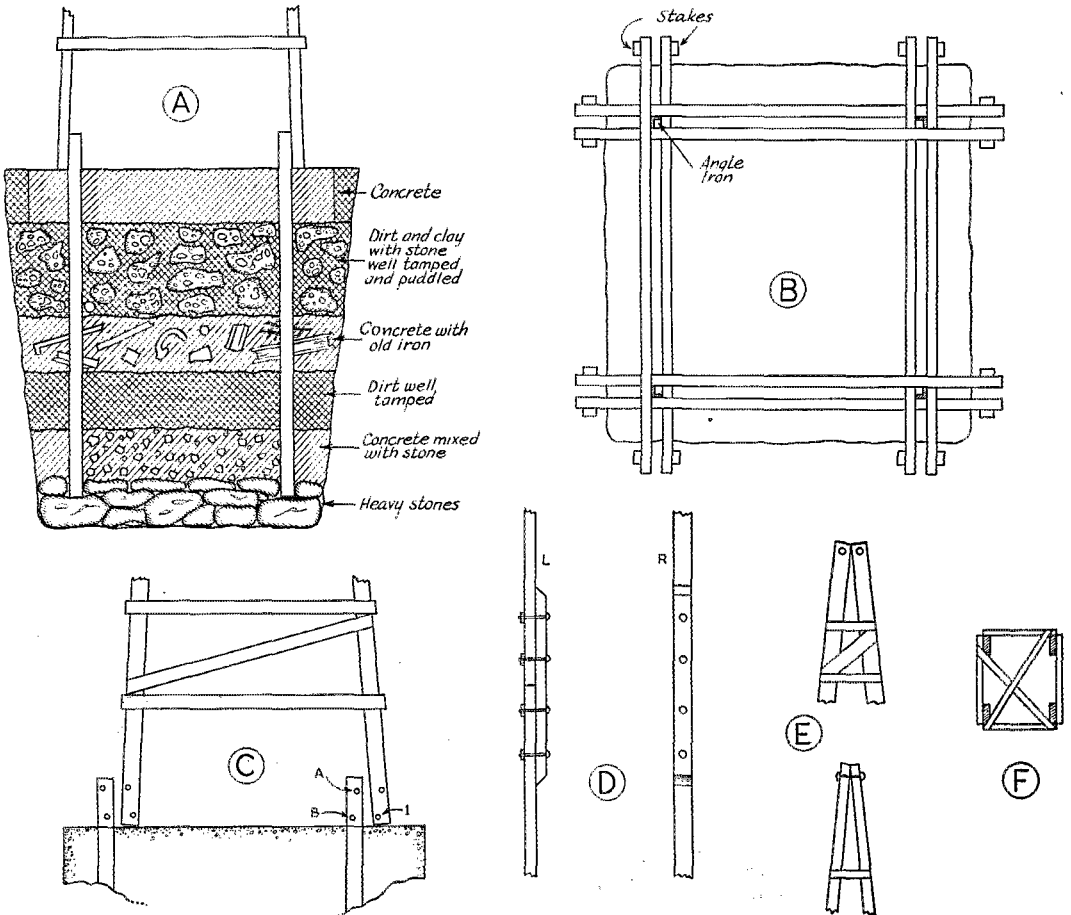

Fig. 1 — Mast construction details.

A "Bugless" 5-Meter Transmitter

Getting Better Efficiency from the U.H.F. Layout

BY J. C. MELTON,* W3NT, AND M. W. BARRETT,** W3RZ

THE high-frequency transmitter described here is the result of about three months of experimental work and "bug" extermination — and let us assure you right here that 5 meters is thoroughly infested with the little fellows that cause so much trouble. However, they were eliminated one by one, and we feel that if the circuit and mechanical placement of parts are followed closely in duplicating the outfit the results will be more than gratifying.

An analysis of the circuit diagram will reveal nothing radically new. A deliberate attempt was made to keep the design as simple as possible with elimination of all "trick" circuits which, when they do work, are fine. When they don't, which is most of the time, they are the cause of many a budding five-meter fan's sending in a call for the goofy wagon. Several features have been incorporated which we feel have contributed in a large measure to the fine performance of the rig. Instead of mounting the sockets directly on the chassis, they were supported on home-made hard rubber pillars about an inch and a half high. This brought the socket prongs on an even plane with the tuning tanks and resulted in ultra-short

high-frequency leads. Also, the various by-pass condensers can be grouped in an upright position around the sockets. By this mounting the condenser itself acts as the lead, with no wire whatsoever in the circuit.

No attempt was made to bring all ground leads to a central point. Instead, each ground lead was soldered directly to the chassis at the closest possible point to the by-pass condenser.

Home-made inductances are mounted directly on the tuning condensers. Experimental work with manufactured plug-in coils showed that considerable loss resulted because of the longer leads necessary from the tuning condenser to the coil socket, thence up to the coil.

Mud sockets are *out* except for the oscillator. Even the ceramic type with a metal mounting ring was not entirely satisfactory because the ring, being insulated from the chassis, was found to be very "hot" with r.f. Bringing a ground lead from the chassis to the ring seemed to have a detrimental effect, so an all-ceramic socket was substituted in the final.

Not wishing to tie up for 5 meters alone two power supplies which could be used elsewhere, the following method of connecting them quickly was devised: The two power supplies (500 and 1000 volts) were built up on separate chassis, the total length of the two being the same as that of

* Asst. Radio Material Officer, Norfolk Navy Yard, Portsmouth, Va. (Mail address: 1117 Cambridge Crescent, Norfolk.

** 117 Oakdale Terrace, Suffolk, Va.

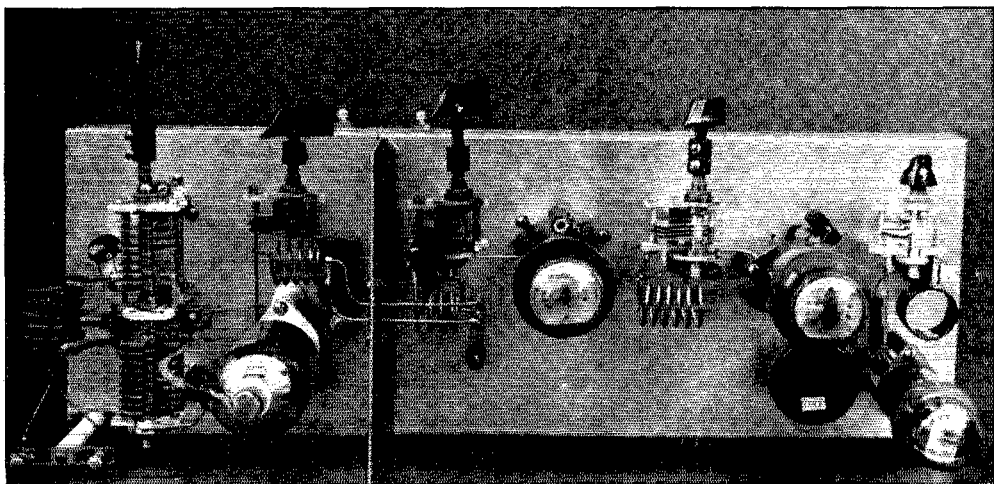

The simplicity of the chassis layout is evident in this plan view. Nearly all the parts and all the r.f. wiring are above chassis.

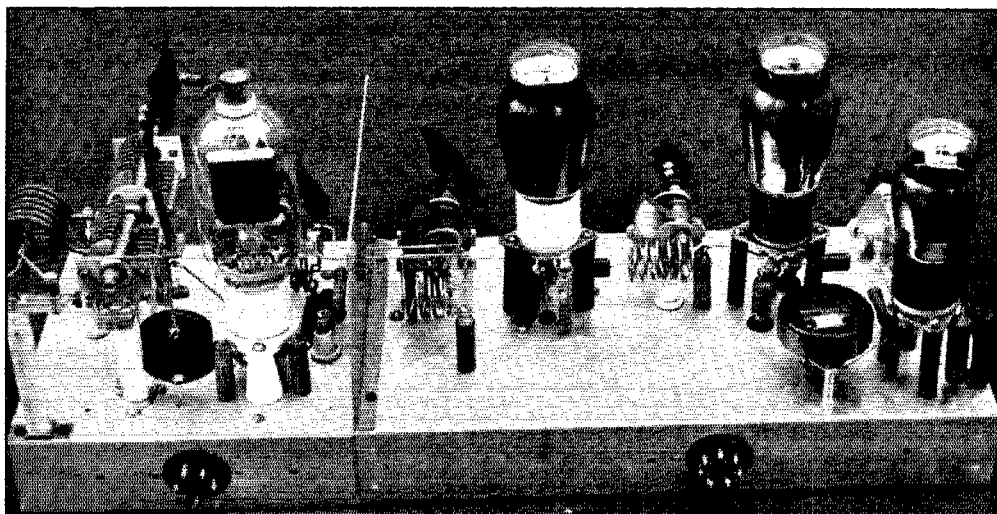

The W3NT-W3RZ 56-megacycle transmitter is built on two chassis joined end-to-end, the final amplifier being a separate unit. This view, from the rear, shows the method of mounting the tubes and also the power-supply plugs which fit into corresponding sockets on a power-supply chassis.

the r.f. portion of the rig. A 7-prong socket was mounted on the 500-volt supply and a 5-prong socket on the 1000-volt supply. Corresponding plugs on the rear of the r.f. chassis enabled it to be backed up to the supply chassis, the plugs fitting into the sockets and making all filament, plate and control switch connections, without cables. Of course the entire rig, power supply and all, may be mounted on a single chassis if desired.

Circuit Notes

The circuit starts with a 6V6G tetrode crystal oscillator operating in the 7-Mc. band. The oscillator is capacity coupled to a 6L6G quadrupler with output on 28 Mc. This stage is capacity coupled to a T21, which has proved to be excellent for doubling to 56 Mc. These three circuits comprise the driver portion of the rig and are mounted on a 7- by 13-inch chassis. If a low-power set for field work is desired this driver and the 500-volt supply can be operated independently of the final.

Various frequency-multiplying oscillators were tried but finally were discarded in favor of the straight tetrode oscillator. Twenty-meter crystals with a quadrupler stage to five were also tried

but with little success; besides, 20-meter pieces of glass cost money. The quadrupler circuit needs to be driven rather hard to get sufficient output to excite the doubler, and the tetrode oscillator met this requirement in a manner impossible with a frequency-multiplying circuit.

The final, mounted on a 7 by 7 inch chassis, consists of a single 1Z40 operating in a purely conventional amplifier circuit. No doubt the pushpull boys will throw up their hands in holy horror at attempting a single-ended stage at the ultra-high frequencies. Well, push-pullers, several of your pet circuits were tried out and they just didn't work for us. We have never had any trouble getting the single 1Z40 to put out plenty of soup, and neutralizing is a matter of seconds. From observing the action of the push-pull circuits we have come to the conclusion that unless the circuit is *exactly* balanced trouble will result. As balance is extremely critical at the ultra-highs it is with much difficulty that a push-pull final is made to operate satisfactorily.¹

In the final, the plate tank coil and tuning condenser are mounted on ceramic pillars about three inches high. This makes the plate lead short and allows the neutralizing condenser to be mounted underneath with a very short lead to the grid.

R.f. chokes of the so-called 5-meter variety were found to be resonant and produced more "fire"

¹ No doubt many u.h.f. constructors would be eager to argue the question of push-pull vs. single-ended. It seems a fact, nevertheless, that neutralizing difficulties are encountered, probably because of the length of neutralizing leads required in many layouts. The authors solve this problem by practically eliminating the leads in the neutralizing circuit. — Ed.

The fact that this transmitter inspired the construction of two other similar rigs which performed with equal success should be sufficient recommendation. An inexpensive tube line-up, and construction which incorporates some good ideas for u.h.f. work.

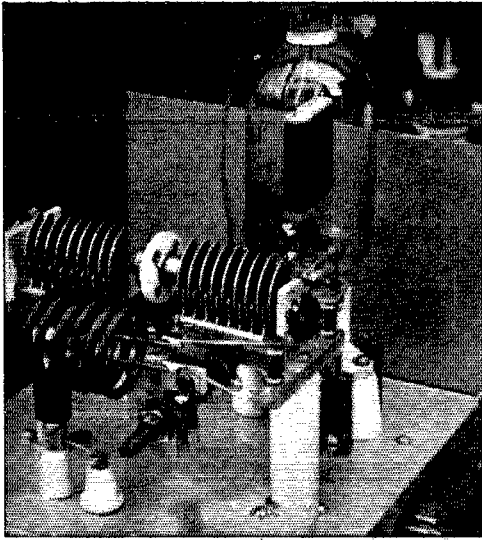

A close-up of the final amplifier, showing how the neutralizing condenser is mounted. Short leads contribute to trouble-free neutralizing.

on the dead end than they did on the live end. Standard 2.5-mh. chokes were used throughout except in the grid circuit of the final, where a 5-meter choke was used to prevent resonance with the plate.

The final is link-coupled to the driver by means

of a line spaced about one-half inch. Twisted pair was found to be unsatisfactory even over a short distance, as it heated and produced considerable loss.

One of the most important considerations is the L/C ratio in the 10- and 5-meter tuning tanks, especially in the latter. A coil was made up for 5 meters which resonated with the tuning condenser about one quarter meshed. Then the turns of the coil were spread until the condenser was three quarters in, with a marked increase in output. Reducing the inductance further and increasing the capacity resulted in a drop in output. Apparently the coils should be resonated with about three-quarters full capacity in circuit. Incidentally, one of the most troublesome things in the construction is to get the coils to resonate properly, and a simple wavemeter with flashlight bulb indicator will prove invaluable. Coils were wound and connected into the circuit before an attempt was made to resonate them, as any slight change in the circuit will greatly affect the overall inductance and throw the coil off. Also the driver plate tank will no doubt have to be readjusted when it is link coupled to the final, since the link may affect the inductance of the coil sufficiently to throw the tuning beyond the range of the condenser.

At the time construction was started, two other local amateurs were experimenting with 5-meter rigs with little success. After our rig was found to perform so well these two others copied

(Continued on page 58)

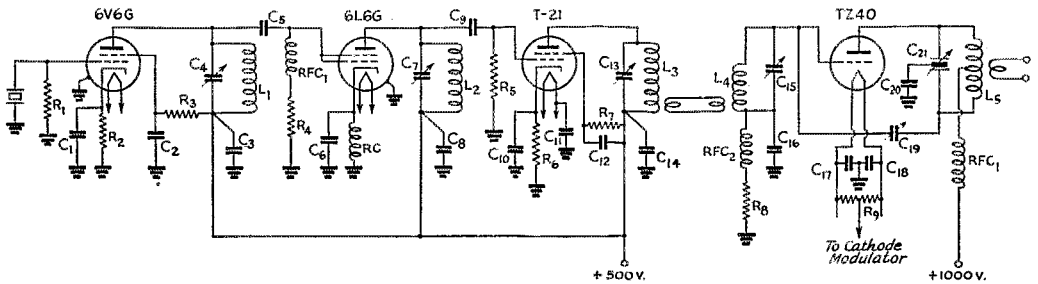

Fig. 1 — Circuit diagram of the 56-Mc. transmitter.

- C₁ — 0.01- μ fd. paper.
- C₂, C₃ — 0.005- μ fd. mica.
- C₄ — 35- μ fd. variable.
- C₅ — 0.0003- μ fd. mica.
- C₆ — 0.005- μ fd. mica.
- C₇ — 50- μ fd. variable, ceramic insulation.
- C₈, C₉ — 0.001- μ fd. mica.
- C₁₀, C₁₁, C₁₂ — 0.002- μ fd. mica.
- C₁₃ — 15- μ fd. variable, 0.07-inch spacing, ceramic insulation.
- C₁₄ — 0.001- μ fd. mica.
- C₁₅ — 15- μ fd. variable, ceramic insulation.
- C₁₆ — 0.001- μ fd. paper.
- C₁₇, C₁₈ — 0.01- μ fd. paper.
- C₁₉ — 15- μ fd. "triple spaced," ceramic insulation.
- C₂₀ — 0.005- μ fd. mica.
- C₂₁ — 30 μ fd. per section, 0.07-inch spacing, ceramic insulation.
- R₁ — 25,000 ohms, 1-watt.
- R₂ — 400 ohms, 10-watt.

- R₃ — 0.1 megohm, 1-watt.
- R₄ — 25,000 ohms, 10-watt.
- R₅ — 0.15 megohm, 2-watt.
- R₆ — 600 ohms, 10-watt.
- R₇ — 30,000 ohms, 10-watt.
- R₈ — 5000 ohms, 10-watt.
- R₉ — 20 ohms, center-tapped.
- L₁ — 20 turns No. 18 enam., close-wound, outside diameter $1\frac{1}{8}$ -inch.
- L₂ — 6 turns No. 12, outside diameter 1 inch, spaced to make coil length $1\frac{1}{4}$ inches.
- L₃ — 3 turns No. 12, o.d. 1 inch, length 1 inch. Link 3 turns No. 14, o.d. $\frac{5}{8}$ inch, length $\frac{3}{8}$ inch.
- L₄ — 4 turns No. 12, o.d. 1 inch, length 1 inch. Link same as L₃.
- L₅ — 6 turns No. 8 or $\frac{1}{8}$ -inch copper tubing, o.d. $1\frac{1}{8}$ inches, length $1\frac{1}{16}$ inches. Link 1 turn No. 14, o.d. $\frac{1}{2}$ inch.
- RFC₁ — 2.5-mh. r.f. choke.
- RFC₂ — 0.2-mh. solenoid.

Some Thoughts on Keying

Using the Oscilloscope to Study Keying Characteristics

BY BYRON GOODMAN,* W1JPE

If there is any one common weakness in most of the amateur c.w. transmitters it is in the keying. This story is designed to show some of the things that take place when a transmitter is keyed, and it offers a few suggestions on a procedure for checking the keying characteristics of transmitters. Although an oscilloscope was used to obtain the illustrations for this article, it is not absolutely essential, and a good receiver is all the check equipment necessary. This story deals with the keying of amplifiers and self-excited oscillators—a later story will treat crystal oscillators and grid-block keying.

AT FIRST glance, a c.w. transmitter should present no more problem than the building of a generator of r.f. energy of a single frequency and a high-speed switch (key) for turning it on and off. As a matter of fact, once the r.f. generator is built, it is much easier to modulate it with voice frequencies than it is to turn it completely on and off at keying speeds without introducing unwanted by-products in the form of clicks. If break-in operation is to be used, requiring that all sources of r.f. energy be turned "off" between characters, the problem of frequency stability (chirps) can be introduced as well. In voice work, a "good" signal is one that reproduces the voice

without introducing extra components, such as harmonics and spurious signals, that are not in the original voice signal. But what is the measure of a good c.w. signal?

The F.C.C. regulations tell us that "spurious radiations from an amateur transmitter shall be reduced or eliminated in accordance with good engineering practice and shall not be of sufficient intensity to cause interference on receiving sets of modern design which are tuned outside the frequency band of emission normally required for the type of emission employed." The regulations continue and define "spurious radiations," including in their definition "key clicks, and other transient effects." The final statement affecting c.w. work reads, "The frequency of emission shall be as constant as the state of the art permits."

Let's consider that last regulation first. A three- or four-stage crystal-controlled transmitter keyed in the final stage should have no frequency change at all with keying, providing the line regulation isn't so bad that it varies the oscillator plate voltage over a wide range. But most amateurs, particularly on the lower frequencies where traffic is handled, want to work break-in, which practically dictates that oscillator keying be used. Unfortunately, every keyed oscillator is not free from "chirps." During the instant that the oscillator is started (or stopped), the frequency does not always remain constant, with the result that the signal chirps. What, then, shall be the standard for "chirpless" oscillator keying? We suggest that the standard be such that, listening on the 28-Mc. band to a harmonic of the keyed

* Asst. Technical Editor, QST.

Fig. 1—Circuit diagram of the apparatus used for the oscillographic study of keying characteristics.

- C₁—Resonant with L₁ to frequency of transmitter.
- C₂, C₃—0.01- μ fd. paper.
- C₄—0.1- μ fd. paper.
- C₅—1.0- μ fd. paper.
- C₆—0.002- μ fd. mica.
- R₁, R₂—0.1-megohm, 1-watt.
- R₃—0.1-megohm, 10-watt.
- RFC—Hash-filter choke.
- Relay—Low-current s.p.s.t. relay.

The audio oscillator should be capable of good output at 20 cycles, and the oscilloscope should have a horizontal sweep frequency down to 15 or 20 cycles if amateur-speed keying is to be observed.

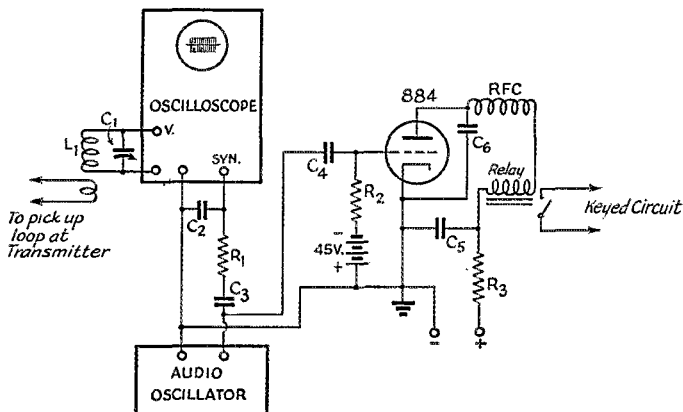

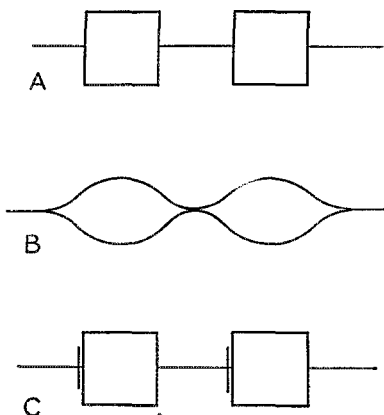

Fig. 2 — An ideal oscillogram of perfectly-shaped dots (no lag anywhere in the circuit) is shown at A. This type of signal has clicks of the worst possible type.

The signal shown at B is a representation of two dots being sent at the same speed as at A, but with a minimum amount of clicks. The B signal, however, would be too "soft" and very difficult to copy.

The sketch at C shows how the oscillogram looks of a signal with "bounce" on make, caused by poor adjustment of a bug key or relay. The click caused by bounce is often masked when sufficient lag is introduced.

oscillator, with the signal tuned in at a low beat note (30 or 40 cycles), the operator is not ashamed of any chirp he may hear. This applies to the operator whose work is confined to the 3.5- or 7-Mc. bands as well as to those operating on higher frequencies. A signal can have considerable chirp that will not be apparent when tuned in at a high beat note (1000 or more cycles) on the fundamental. However, the combination of listening to a low beat note coupled with the accentuation of the chirp through frequency multiplication will show up any chirp — providing, of course, that a stable receiver is used to monitor the signal. The r.f. gain control should be turned as low as possible and the audio control should be turned up when making the test. Overloading of a receiver will often cause an apparent chirp, and the test can best be made with the antenna removed from the receiver or, in the case of a high-powered transmitter, with the receiver antenna terminals shorted. It isn't enough to take someone else's word for it that you have no chirp — make the test yourself. You might ask someone who doesn't even know what a chirp is, or someone who needs a QSL from your state.

Checking Keying on the 'Scope

Although the better commercial stations have been using oscilloscopes for checking keying for a number of years, the subject seems to have been neglected in the amateur field. Not all 'scopes are satisfactory, but any that has an internal horizontal sweep oscillator capable of going down to 15 or 20 cycles is splendid for amateur work. Older 'scopes can have their sweep oscillators

modified by the addition of additional capacity to the sweep oscillator circuit in the lowest range.

For an oscillographic study of keying, it is necessary to have a key that will make a string of continuous dots (and/or dashes). An ordinary bug key is satisfactory but only for short spurts, but an electronic bug should do beautifully. We started out by making a motor-driven keyer, but it was difficult to keep the motor at a sufficiently constant speed, and we ended up with a form of electronic bug that was triggered by an audio oscillator. The circuit is shown in Fig. 1. This system has the advantage that the 'scope can be locked in with the audio oscillator, as is the keyer tube, resulting in a steady pattern on the 'scope. In order to center the dot on the screen of the 'scope, a phase-shifting circuit is necessary between the audio oscillator, and R_1 and C_2 make up this circuit. C_3 is simply an isolating condenser. The 45-volt battery introduces some delay in the keyer circuit and gives dots and spaces of approximately equal length. Removing the battery and shorting the grid of the 884 to ground through R_2 gives characters that are not quite dash length but which are close enough. R_3 and C_5 in the plate circuit are proportioned to have a time constant that will give best operation of the relay over the operating range. In practice, the keyer will follow the audio oscillator from about 15 to 45 cycles, corresponding to keying speeds of from 40 to 120 w.p.m. The slower speed was used in all of the tests, as being more representative of amateur practice. RFC and C_6 were found necessary to kill some "hash" that was coming from the 884 and interfering in the receiver with our search for spurious frequencies off the signal.

The advantage of a steady "dotter" is that the transmitter can be keyed at a constant rate, allowing an oscillogram of the output to be held steady on the screen of the 'scope. Small changes can then be made in the key-click filter or other parts of the circuit and the effect can be easily seen. Listening to the signal at the same time ties in the visual pattern with any clicks that are being generated.

Key Clicks

When we started to examine the keying characteristics of some of the transmitters around the laboratory, we had hoped to end up with a universal formula that could be applied to any trans-

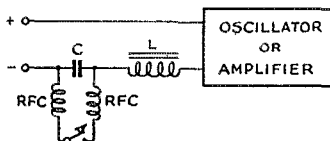

Fig. 3 — The general form of negative high-voltage keying, as used for all of the pictures in this story. Making the value of L larger introduces more lag to the start of the character, and increasing the value of C increases the lag (or "tail") at the end of the character.

mitter for the removal of clicks. There may be some such formula but it won't appear in this story, simply because we were unable to find it. However, several factors influencing key clicks were found, and they are of sufficient interest to merit passing along. There is apparently, however, no substitute for a patient adjustment and examination of one's own transmitter.

Key clicks are undesirable from several standpoints. If the clicks are bad enough, they will interfere with neighboring BCL sets. Even if they aren't that bad, they will make the signal unpleasant to listen to on the air. A click that can be heard when the receiver is tuned off the frequency of the signal is not necessary for communication and serves only to cause interference.

Before going further it might be well to review the reason for clicks. A c.w. signal can be assumed to be the same as a 'phone signal except that, instead of being modulated by a few sinusoidal waves and their harmonics, it is modulated by a rectangular wave as in Fig. 2-A. If it were modulated by a sinusoidal wave of single frequency, as in Fig. 2-B, the only sidebands resulting would be removed from the carrier frequency by an amount equal to the modulation frequency. A keying speed of 50 w.p.m., sending sinusoidal dots, would give sidebands removed only 20 cycles either side of the carrier. However, if harmonics were present in the modulation, the sidebands would extend out as far as the frequency of the highest sideband. This is exactly the same as in voice modulation, where the sidebands extend out as far as the highest voice frequency that is present. There is, however, a tremendous difference between sinusoidal dots and the rectangular ones shown in Fig. 2-A. It can be shown mathematically (by Fourier analysis) that a pure rectangular waveform would contain harmonics of the keying frequency up to infinity, so our carrier modulated by rectangular dots would have sidebands covering the entire spectrum. Actually the really high-order harmonics are lost through the selectivity of tuned circuits and because of their small amplitude, but there is still enough energy in the low-order harmonics¹ to extend the sidebands considerably. Another way of looking at it is to remember that whenever a pulse of current has a steep front (or back), high frequencies are bound to occur. This is the reason that whenever an electrical switch is turned on and off a click is heard in a nearby radio — the steep front of the current rushing through the wire generates harmonics that extend up into the radio-frequency end of the spectrum. Conversely, if the pulse can be slowed down through a click filter (lag circuit), the highest-order harmonics do not exist, or it might be said that they have been filtered out.

The first cause of clicks, then, is the sudden rush of current through the keying circuit, or the

¹ For a rectangular waveform, the amplitude of the energy in the sidebands varies inversely as the frequency.

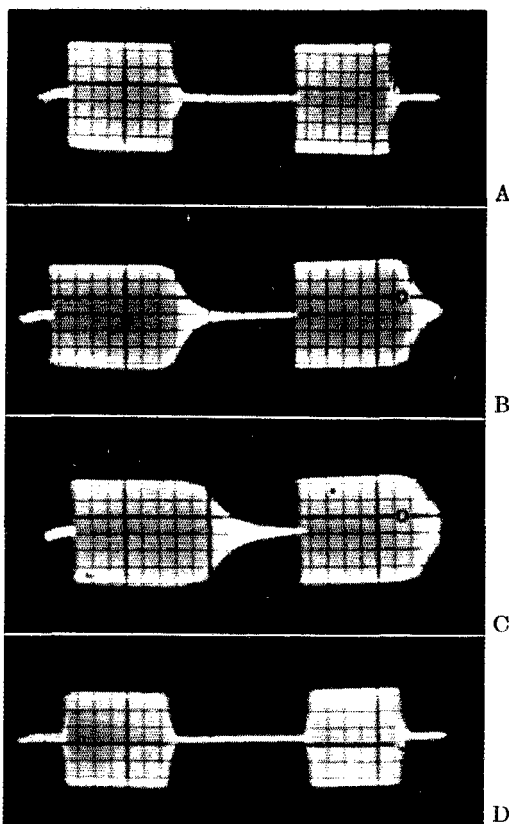

Fig. 4—A group of oscillograms of a self-excited oscillator keyed in the negative power lead. The oscillator draws 2.8 ma. at 150 volts and is followed by two Class-A amplifier stages. The left-hand side of the character is "make," and the right-hand side is "break." The black lines are part of the 'scope face.

A — No filter. The slight tail is due to r.f. by-pass condensers in the oscillator. In its ideal form this picture would resemble Fig. 2-A. It has clicks on both make and break.

B — 0.05 μ fd. added across key. The make characteristic remains the same, but a tail is added on break. This represents the optimum lag at the speed of the picture (50 w.p.m.). At slower speeds more tail could be tolerated. Clicks on make, none on break.

C — 0.1 μ fd. across key. Slightly more than optimum tail, but the signal is perfectly readable. Clicks on make, none on break.

D — 30 henrys in series with key. The make characteristic is rounded slightly, the break characteristic remains as in 4-A. Very slight click on make and break.

one that is commonly associated with a spark at the key. This click can sometimes be heard in nearby BC receivers in exactly the same way that a click is heard when an electrical appliance is turned on or off. Its cure is the most straightforward of any and consists simply of using r.f. chokes right at the key. The small 2.5-mh. r.f. chokes are quite satisfactory if the keyed circuit carries no more than the current rating of the

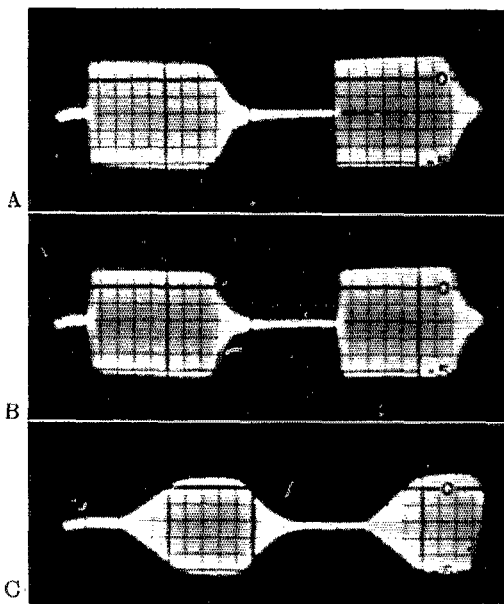

Fig. 5 — Oscillograms of oscillator keying using complete key filters.

A — 15 henrys and 0.05 μ fd. This represents slightly less than optimum filter on make and optimum on break. The keying is satisfactory, but the click on make is heavier than necessary.

B — 30 henrys and 0.05 μ fd. Optimum keying characteristic — very slight click on make, practically none on break.

C — 300 henrys and 0.05 μ fd. No clicks on make or break, but the lag on make is excessive. Difficult to copy — sounds too "soft."

chokes, but larger ones must be used if the current is higher, as in the case of primary keying. No condenser should be used across the key contacts — any capacity in the circuit should be placed across the circuit at the ends of the chokes away from the key. The chokes do not remove all clicks, but they are essential to every keyed circuit.

It is obvious that to be effective the r.f. chokes must be placed right at the key, otherwise there will be enough radiation from the leads to cause interference.

Another cause of clicks that is not so well-known but which the 'scope showed up on several different occasions is the "bounce" of a relay or a bug dot lever on "make." Because this is not a constant sort of click, it was not possible to get a picture of it, but it looks like the drawing of Fig. 2-C. The only check for this type of click outside of an oscilloscope is to listen to a steady string of dots and to try and detect clicks of varying intensity on "make." Another check for bounce of a bug key dot lever is to switch over to straight hand key sending — if the clicks disappear it indicates bounce at the bug dot contacts. However, with a proper amount of lag in the circuit (to be described later), the click caused by

bouncing contacts is usually greatly reduced or eliminated.

Oscillator Keying

One thing that became apparent almost at once when testing the keying of a self-excited oscillator was that cathode (or center-tap, whichever you prefer to call it) keying was not very easy to filter. Various values of inductance and capacity in the circuit didn't have as much effect in modifying the characteristic as was to be expected. When negative high-voltage keying was used, this trouble disappeared, and the inductances and capacities had the effects that were desired. The answer probably lies in the fact that cathode (or center-tap) keying, since it is a combination of plate and grid keying, has too many interlocking factors present. The value of capacity and leak in the grid circuit have an effect on the time constant as well as do the inductance and capacity introduced in the key circuit, and it is difficult to know just what is going on. On the other hand, straight plate keying (in the negative high-voltage lead) allows much more straightforward adjustment of keying, although there is likely to be more spark at the key when high-power circuits are keyed.

The adjustment of a plate-keyed circuit is not difficult at all. The signal should be tuned in at a reasonable level, with the r.f. gain control backed off and the antenna disconnected if necessary, and then the b.f.o. should be turned off. (Don't make the check with the a.v.c. on.) When the key is pressed and then released, a click will be heard at "make" and one at "break." Inductance added to the circuit will reduce the click at "make," and capacity added to the circuit will reduce the click at "break." Their positions in the circuit are shown in Fig. 3. A low-current high-voltage circuit will require more inductance and less capacity than will a high-current low-voltage circuit.

A logical question at this point is "How do I know when I have the right amount of filter?" Tests on the ears of the gang around HQ indicated that they all liked to listen to signals that were a little more "solid" on make than on break, which means that for good copying a signal cannot stand as much lag at the start of a character as at the end. Oscillograms showed that dots could have enough "tail" to run into the next dot (see Fig. 4-C) without becoming too difficult to copy, whereas putting that much lag at the front of the dot made it difficult and almost unpleasant to copy. The conclusion was reached, therefore, that the filter can be adjusted to the point where there is only a slight click on make and practically none on break, and the signal will be good for clean copy up to about 50 w.p.m.

Amplifiers or self-excited oscillators keyed in the plate lead very definitely require some inductance in the circuit if clicks are to be eliminated. A 400-volt circuit drawing 60 or 70 ma. will re-

quire but little inductance to be quite effective, and the primary of an old filament or small plate transformer will often do the trick. On the other hand, a 400-volt circuit drawing only 10 or 15 ma. may require up to 30 henrys inductance. The

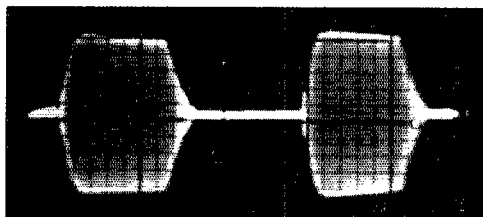

Fig. 7 — Negative power lead keying of amplifier with optimum key filter. The amplifier operated at 70 ma. at 400 volts, and the filter was the primary of a small filament transformer and 0.5 μ f. There is slightly more lag on make than necessary.

high-current circuit will stand up to 0.5 μ f. or so for elimination of clicks on "break," while the low-current one needs only 0.05 or 0.1 μ f. The "make" doesn't want to be too soft, but there should be no clicks when the receiver is tuned off the signal.

When the clicks have been reduced to a satisfactory value, a harmonic of the signal should be listened to, with the b.f.o. turned on, in order to check that no chirps have been introduced. If chirps are present it indicates that the oscillator isn't stable enough. This article is not designed to cover the question of oscillator stability, but a self-excited job can often be improved by the use of a higher-*C* (lower-*L*) tank circuit, lighter loading, readjustment of the feedback through change in grid condensers and tickler adjustment, or a higher value of grid leak. An oscillator that runs at high current requires a higher-*C* tank than a low-current one for the same order of stability, and it is advisable to run the oscillator at as low current as possible.

Effects of the Amplifier

Unfortunately, a well-keyed oscillator is not always insurance that the output signal will be good after it has gone through several amplifier stages. Usual practice is to bias the stages following a keyed oscillator (or amplifier) to cut-off or more. Since no self-respecting 'phone station would follow a modulated stage by anything but a carefully-adjusted Class-B amplifier, it is not surprising that the stages following a keyed stage (which can be anything from Class B to Class Q) do not exactly reproduce the waveform of the keyed signal. It isn't quite as bad as it may be made out here, but it is a fact that the lag introduced to the oscillator or other keyed stage isn't always reproduced in the same fashion in the output signal.

Two simple things can be done to reduce the effects of the amplifiers. The better the voltage regulation of the power supplies feeding the amplifiers, the better will be the output signal. In several cases it was found that the power supplies, aside from having only mediocre voltage characteristics, did not have sufficient output filter

(Continued on page 78)

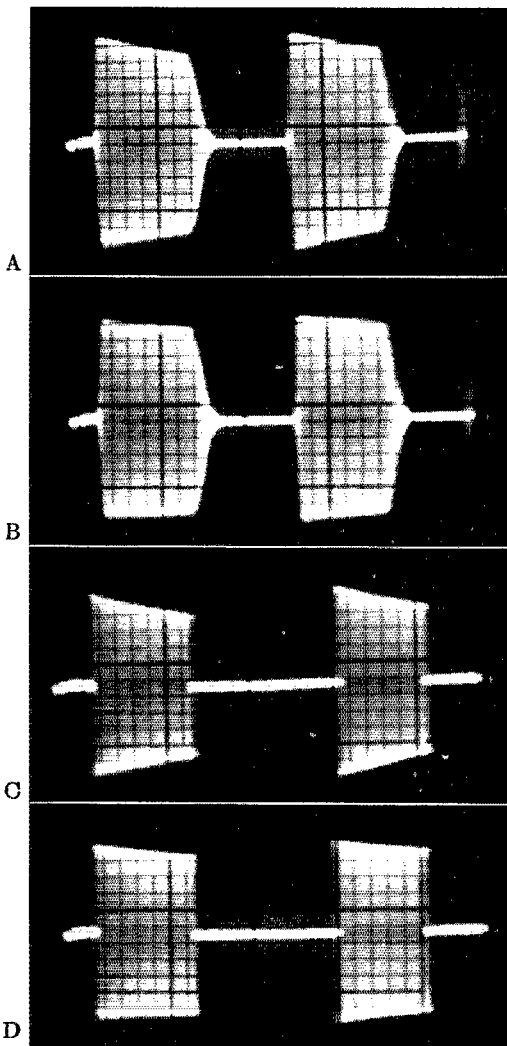

Fig. 6 — Effects of adding an amplifier.

A — Oscillator keyed as in 5-B, amplifier biased to cut-off. Insufficient output capacity in amplifier power supply accounts for wedge shape of characteristic. Clicks slightly stronger than 5-B.

B — Same as 6-A, but with output capacity of power-supply filter doubled. Wedge shape is reduced somewhat. Clicks reduced over 6-A, but still more than 5-B.

C — Amplifier keyed in negative power lead, no key filter, and power supply filter output capacity same as 6-A.

D — Same as C, but with additional output capacity in power supply. Both C and D have bad clicks because no keying filter — they are included to show the effect of insufficient output capacity on shape of characteristic.

★ WHAT THE LEAGUE IS DOING ★

RENEWING AND MODIFYING

AT THE urgent request of A.R.R.L., the F.C.C. issued its Order No. 76-A, effective March 1st, extending all expiring amateur licenses as long as September 30th (if it takes the Commission that long to act upon them), provided proper application for renewal and citizenship showing are filed. The earlier order extended to April 1st those licenses expiring before March 1st but did not cover March expirations. The licensing section is still behind in its work because of the pile-up they got when citizenships were ordered proved, and there was even question whether pending renewals could be got out by April. The new order covers the old one and reaches back to last summer. If you have filed citizenship showing and if you file (or have filed) renewal application in accordance with the regulations, you may continue operating until the end of September or until you hear from F.C.C. to the contrary. The new order provides:

“ . . . That all amateur radio station and amateur radio operator licenses which by their terms have expired or will expire during the period July 1, 1940, to September 30, 1941, inclusive, and for which applications for renewal have not been granted or denied prior to the effective date hereof, BE, AND THEY ARE HEREBY, EXTENDED, in respect to each such license until such further action as the Commission may take upon application for renewal or otherwise, but in no event beyond September 30, 1941; PROVIDED, HOWEVER, That this extension is granted only to such amateur licenses as have submitted or do submit a proper application for renewal in accordance with the Rules and Regulations of the Commission and have complied or do comply with the requirements of Commission Order No. 75; PROVIDED FURTHER, That this extension shall not apply to licenses whose licenses have been or, prior to September 30, 1941, may be revoked, suspended or designated for hearing.”

More good news, also as a result of League representations: Remember that the time during which you may operate at a new permanent address while awaiting applied-for modification was recently raised from 60 days to 4 months? That was a temporary change, supposed to revert back to 60 days on May 1st. But on March 4th the F.C.C. amended Sec. 12.93a of our regs to read permanently 4 months. That prevents a lot of trouble around the first of May and eliminates much of the confusion between 12.93a and 12.93b.

ARMY QUESTIONNAIRE

WITH the cooperation of A.A.R.S. members, every amateur is receiving from the War Department two copies of a questionnaire which he is asked to fill out and return promptly. The object is to give the Army data in connection

with defense matters, for purely statistical purposes, and the Chief Signal Officer states that the return of the questionnaire does not obligate the amateur in any way nor constitute a form of registration.

We hope that all amateurs will be disposed to cooperate. We can perhaps help with some further information we have received from the Army in response to some questions we asked about the form. In general it is plain sailing but the suggestions below, bearing the same numbers as the questions on the forms, may help you when you sit down to fill them out:

3. Include your street address, P.O. box number, etc.

5. In this or similar questions, where the boxes are numbered, it is sufficient just to put a check mark or “x” in the appropriate box.

9. It is suggested that no person under 18 years of age or over 45 regard himself as physically fit for military service, regardless of his estimate of his physical fitness.

10. This question was primarily designed to ascertain the “limited service” capabilities of amateurs not physically fit for active military service.

14. No need to answer unless an affirmative answer is made to Question 13.

19. Include service in the National Guard (when not in Federal service) under the heading of “reserve.”

21. This space may be used for answering the longer questions, such as 12 or 19. If the space is still insufficient, an additional sheet may be attached.

DEFENSE COMMUNICATIONS

THE Defense Communications Board's amateur committee has had long meetings every week or two, with intensive preparatory work in between, and has been making good progress. The Board has issued no statement touching upon amateur radio. Meanwhile, in numerous states, state defense committees are being appointed by the governors and are including communications in their plans. While most states will want amateur help, and while we will all want to help our own state, we foresee the probability of confusion here, because communications are a national matter, particularly in time of military emergency. We imagine that any plans made now will have to be reconciled later with the decisions of the D.C.B. Amateurs collaborating with the state organizations should bear this in mind in laying plans.

FINANCIAL STATEMENT

THE fourth quarter of last year, with the appearance of the new edition of the *Handbook*, was an excellent one in the League's business affairs, resulting in a gain of over \$7000. For the information of members, the operating statement is here published, by order of the Board:

STATEMENT OF REVENUE AND EXPENSES, EXCLUSIVE OF EXPENDITURES CHARGED TO APPROPRIATIONS, FOR THE THREE MONTHS ENDED DECEMBER 31, 1940

REVENUES	
Membership dues	\$17,682.81
Advertising sales, <i>QST</i>	21,844.49
Advertising sales, Handbook	6,078.75
Newsdealer sales, <i>QST</i>	11,071.66
Handbook sales	22,827.36
Spanish edition Handbook revenues	43.00
Booklet sales	4,238.29
Calculator sales	467.43
Membership supplies sales	2,588.19
Interest earned	487.02
Cash discounts received	249.38
Bad debts recovered	77.15
	\$87,655.53
<i>Deduct:</i>	
Returns and allowances	\$ 2,930.63
Cash discounts allowed	569.19
Exchange and collection charges	120.85
<i>Add: increase in reserve for newsdealer returns of QST</i>	646.39
	4,267.06
Net Revenues	\$83,388.47
EXPENSES	
Publication expenses, <i>QST</i>	\$16,493.22
Publication expenses, Handbook	19,221.58
Publication expenses, booklets	1,494.94
Publication expenses, calculators	215.56
Spanish edition Handbook expenses	27.00
Salaries	25,788.26
Membership supplies expenses	1,668.80
Postage	1,650.39
Office supplies and printing	2,033.45
Travel expenses, business	1,319.40
Travel expenses, contact	36.89
<i>QST</i> forwarding expenses	991.38
Telephone and telegraph	696.30
General expenses	1,276.94
Insurance	58.40
Rent, light and heat	1,150.83
General Counsel expenses	267.44
Communications Dept. field expenses	121.25
Headquarters Station expenses	300.68
Bad debts charged off	155.04
Provision for depreciation of:	
Furniture and equipment	307.63
Headquarters Station	448.89
	75,724.27
Total Expenses	75,724.27
Net Gain before expenditures against appropriations	\$ 7,664.20

C.C.C. INSTRUCTORSHIPS

THE Civilian Conservation Corps expects to open thirty or more radio schools at some of their camps around the country, beginning in mid-April, and are in need of many instructors.

While amateur experience alone will not qualify a man for one of these positions, there are doubtless many of our readers who will be interested. Candidates must have had at least five years of radio experience, including the servicing or designing of transmitters and receivers, but for four of these years may substitute college electrical or communications engineering training or broad engineering experience. They must have a working knowledge of radio theory and practice with particular emphasis on troubleshooting and maintenance; must possess or be able to obtain both classes of second-grade commercial licenses; in particular, must be able to prepare and deliver lectures and conduct classes in an effective manner. The objective of the six months' course they will teach will be to turn out radio technicians and operators capable of obtaining second-class licenses. Instructors must live at a camp and be on constant call; the work schedule is 44 hours per week. The pay is \$2000 per year. Interested applicants should secure forms and further particulars by writing direct to H. L. Caravati, Assistant Director, C.C.C., New Post Office Department Building, Washington.

The names of those who previously expressed interest in this subject to A.R.R.L. headquarters have been turned over to the C.C.C., which has sent them forms. Some of these people will be offered instructorships. Those who registered with us can ascertain their status by direct inquiry of Mr. Caravati.

MISCELLANY

WHILE there is no legal prohibition against the use of code or cipher by amateurs in domestic communication, it goes without saying that secret language arouses suspicion these days and that amateurs should confine themselves to plain language. That has been part of our voluntary code since the beginning of the European trouble. . . . At the request of the League, the Department of State is making representations intended to relieve us of the improper interference of a B.B.C. station operating on about 7150 kc., and of the Papeete station FZP on i.c.w. near 14,200 kc. . . . F.C.C. has decided that amateur stations must possess special authority to work expeditions that are on the high seas in American vessels. Four stations, including W1AW, have been so authorized to communicate with WCFT, the *Yankee*. The KC4 stations are OK to work. . . . The Z calls used by the A.A.R.S. and N.C.R. are "restricted"; they are available only for authorized use by the members of these nets and may not be published or divulged to others. . . . F.C.C.'s appropriation for the next fiscal year, now on the way through Congress, totals about 4¼ million dollars, divided about half for normal activities and half for national-defense activities.

• For the Junior Constructor —

A Compact Portable Emergency Transmitter

Low-Power from Battery or Vibrator Pack Supplies

BY VERNON CHAMBERS,* W1JEQ

THIS inexpensive c.w. transmitter incorporates nothing new in the way of circuit development, but it does employ several features which simplify portable operation. Its power requirements are conveniently attained and it is adaptable for use with simple antennas. The compactness and light weight make it ideal for automobile installations. It may function as the control stage for the fixed station transmitter until called upon for emergency or field duty. The complete cost, including everything from tube to cabinet, is less than twelve dollars.

Fig. 1 shows the circuit diagram of the transmitter. A grid-plate oscillator works into a coupling network rather than the usual parallel tuned tank. This feature does away with a separate antenna tuner and permits operation with several types of antennas. A switch is used to short out a section of the coil for 7-Mc. work. It is also used to select the best value of inductance for any setting of the coupling network; more about this later. The use of parallel plate feed isolates the tuning condensers from positive voltage.

* A.R.R.L. Technical Information Service.

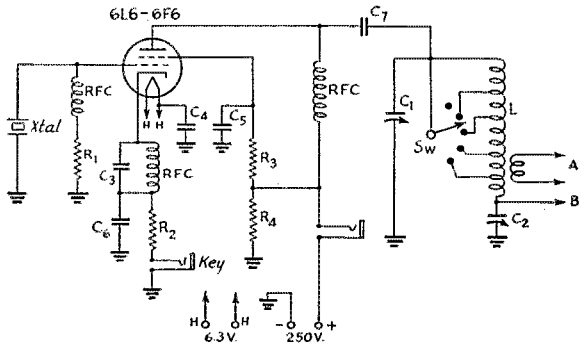

Fig. 1 — Wiring diagram of the portable transmitter.

- C₁ — 140- μ fd. variable (Hammarlund MC-140-S).
- C₂ — 325- μ fd. variable (Hammarlund MC-325-M).
- C₃ — 100- μ fd. mica.
- C₄, C₅, C₆ — 0.01- μ fd., 400-volt paper.
- C₇ — 0.002- μ fd. mica.
- R₁ — 0.1 megohm, 1-watt.
- R₂ — 400 ohm, 2-watt.
- R₃ — 15,000 ohm, 1-watt.
- R₄ — 50,000 ohm, 1-watt.
- RFC — 2.5-mh. r.f. chokes (National R-100).
- Sw — One circuit, five contact, selector switch (Yaxley 3215J).
- L — 43 turns No. 18 d.c.c., close-wound on 1½-inch diam. form. Tapped at the 7, 14, 28 and 35th turns. Link wound around bottom (see text).

Cathode keying is employed. The 6L6 and the 6F6 perform equally well in the circuit, both giving the same amount of output with a 200-250 volt supply.

Construction

A sloping-panel cabinet houses the unit. The base dimensions of the case are 7 by 7¼ by 6½ inches. A four-prong socket, for input lead connections, is mounted on the rear wall of the housing. Three feed-through insulators are spaced across the top section and serve as antenna terminals.

The commercial chassis deck is 5¾ inches wide by 5½ inches deep. It is mounted by means of a 1½-inch section bent down along the front edge. Lips ½-inch wide are bent down along the sides.

Assembly of the transmitter will be simplified if mounting holes for the chassis components are made first. The top view shows the actual placement of the parts. C₂, at the lower right hand corner of the chassis, has its mounting holes ⅜ inch in from the right-hand edge. The tube socket

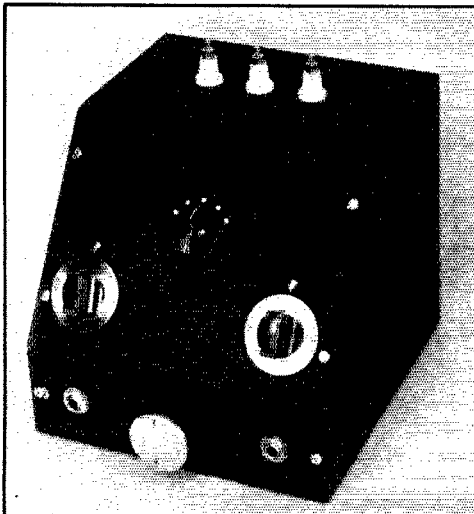

A panel view of the portable transmitter. Two of the insulators at the top are for doublet antenna connection and the third, at the left, is for single-wire radiators.

◆

A view of the parts arrangement above the chassis. Ball-and-socket shaft couplings permit the condensers to be mounted on the base and the dials on the sloping panel.

◆

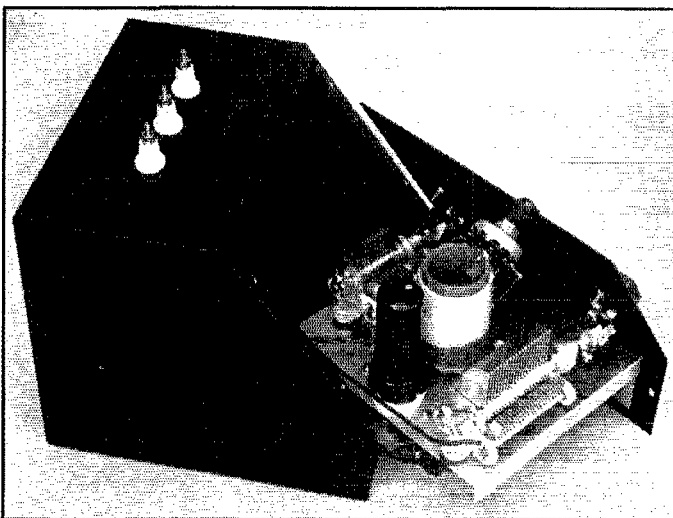

is at the rear center while the coil is centered $2\frac{3}{8}$ inches in from the rear edge. A $\frac{1}{8}$ -inch hole should be drilled where the coil is to be centered. The mounting holes for C_1 (at the opposite end of the chassis to C_2) are $\frac{5}{8}$ inch in from the edge; the rear hole is $1\frac{1}{4}$ inches in from the back edge.

Holes for the jacks and the crystal holder next should be drilled in the panel. The panel view shows the crystal holder located at the center of the vertical panel section. The meter jack is to the left and the key jack to the right, each being $1\frac{1}{8}$ inches in from their respective side edges. The panel holes should now be scribed on the supporting member of the chassis. Later, when the holes are drilled, the crystal holder and the jacks will clamp the chassis and the panel firmly together.

It will be wise to get the coil made up before proceeding further. The form has all of the prongs cut off flush with the bottom and the top is sliced off just below the flared out part, the remaining part of the form then being $2\frac{3}{8}$ inches long. A hole for a $6/32$ machine screw is drilled and tapped at the center of the form's base. Holes are drilled at the top and bottom of the form so that machine screws and soldering lugs may be used to terminate the ends of the winding.

Before the parts are mounted on the chassis the condenser shafts should be cut down to a length of $\frac{1}{4}$ inch; this permits the use of the flexible shaft couplers which send the shaft extensions up toward the sloping panel. All chassis parts may then be mounted and the panel and chassis tem-

porarily fastened together. The panel holes for the shaft extensions should be marked and drilled. Switch *Sw* is centered $2\frac{1}{4}$ inches from the top of the panel.

Wiring needs but little explanation. The stator side of C_1 is connected to the top of the coil and the stator of C_2 connects to the bottom. Four of the switch contacts are joined to the coil taps; one of the switch contacts is not used inasmuch as the switch has no "off" position. Below-base wiring may be seen in one of the photographs. A shielded lead runs between the grid prong of the tube socket and the crystal holder; the shield is grounded. Other connections need no special care, but should be no longer than necessary.

Power Supplies

If the transmitter is to be operated from the b.c. receiver vibrator pack, it is necessary to "get inside" the set so that the positive lead can be brought out. A s.p.d.t. switch should be connected in the lead so that the supply output can be switched conveniently from the receiver to the transmitter. It will be wise to visit the radio dealer who sold the set in order to secure the supply diagram. We have not attempted to cover the various circuits because they are too numerous to treat. Access to most of the sets is easily attained and, as a rule, an output of 200-250 volts at 50 ma. can be expected.

The layout, with either type tube, may be operated with a.c. supplies. Nothing need be changed for 250-volt work. However, R_2 and R_4 should have two-watt ratings and R_3 should be a 10-watt job if the 6L6 is to be run at 400 volts.

Batteries may be used as the power source, also. Large size "B" blocks will allow several hundred hours of intermittent operation. A 6-volt storage battery is used for the filament supply.

It's worth any ham's while to have a low-power emergency transmitter when it can be built as simply and inexpensively as this circuit. The high voltage can be supplied by the power pack in an automobile b.c. receiver.

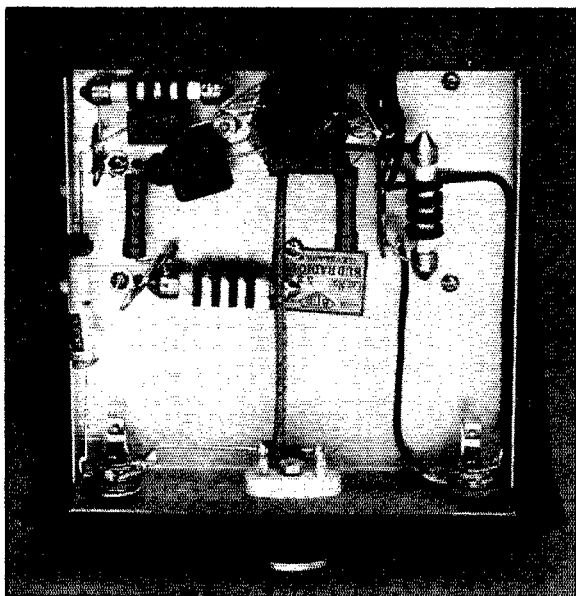

The parts and wiring below the base.

Adjustments

To make the first tests, the supply is connected to the rig and key and meter leads are plugged in the jacks. A crystal is placed in the holder and the supply turned on. Assuming that a 200-250 volt supply is used, the meter will read (with the key open) 3 or 4 ma. which is the current

Hamming on Howland Island

(Continued from page 11)

fruit and juices, cereal, powdered or canned milk, ham, bacon, prepared biscuit powder, canned meats, including hot dogs and sausages, corned beef, canned stew, etc., etc. One of the colonists had formerly been a baker, and once a week or so he'd bake bread and cakes. We even had fresh eggs — tern eggs, about half the size of ordinary hen's eggs. Rain water for drinking was collected in drums and stored away until needed. The water was kept cold in a kerosene refrigerator. The temperature on Howland is fairly constant, running from 85 to 90 in the daytime and cooling off to from 78 to 82 at night. The heat in the daytime didn't bother us much, however, because we wore no clothes and there was usually a slight breeze from the east. It rains about twice a week, heavily but for only about an hour. Once a month or so it would drizzle all day, preventing our taking a balloon reading because the instrument would get wet.

The library was well stocked with magazines and books of all descriptions. Each time the boat landed it would bring the previous term's quota

drawn by the screen voltage-divider. With the key closed, the current will rise to 30 or 35 ma. C_2 is set at maximum capacity and C_2 is rotated until resonance is indicated by a dip in the plate current. If an 80-meter crystal is used during the test, the entire coil should be in the circuit; about $\frac{1}{2}$ of the coil should be used with a forty-meter crystal. The unloaded resonance plate current will be around 10 ma.

Proper adjustment of the network will allow almost any type of antenna to be loaded. Low impedance lines will be matched with C_2 set toward maximum capacity. High impedances are matched with C_2 set well toward minimum capacity. In either case the condenser should be adjusted for best loading. The low-impedance antennas should be link coupled to the coil by means of a few turns of wire wound around the bottom of the coil as indicated by "A" in Fig. 1. Single wire radiators are attached at the point marked "B". If Zepp feeders are used,

one feeder should be connected at "B" and the other grounded. All types of antennas will load the transmitter up to approximately 25 ma. If it is difficult to load to this value it is best to try the

(Continued on page 90)

of popular magazines, as well as complete files of the two Honolulu newspapers for the four months preceding.

The second term passed very quickly, it seemed, and almost before I knew it October came and the boat was due again. I decided that I had had enough of the Island life and sent a message saying that I wanted to go back to the good old U.S.A. I packed up my things, and the morning the boat was due I was up at five o'clock. Much as I had enjoyed my stay on Howland, I can tell you it was one of the happiest moments of my life when I saw the boat coming over the horizon.

When the ship landed, KF6OWR and K6SBM came ashore. KF6OWR was to take my place on Howland and K6SBM was scheduled to go on to Jarvis with KF6JEG. Thus the unbroken succession of hams on Howland — beginning with K6BAZ and including K6JEG and K6OWR, whom I replaced — was carried on.

I could hardly wait until the ship got started on the voyage back to civilization. A few days later I saw Honolulu again — and it looked about ten times as big as when I first viewed it after coming from the States. In Honolulu I answered letters, mailed out a QSL for every QSO, and went swimming until the time for my boat back home. I was satisfied to be a plain, ordinary W1 again. I had worked DX and *been* DX — and what more could any ham ask?

U.H.F. Superhet Design for Improved Performance in Audio and Video Reception

Part II—Kinescope Circuits, Power Supplies, Test and Adjustment*

BY DANA A. GRIFFIN,** W2A0E

ONCE the wiring of the television receiver is completed, the next step is the important one of test and alignment. The first check should be that of the low voltage power supply using the 5Y3 tube. (Leave the 5U4's out.) Following through the circuit, check the voltage of all plates and screens that are supposed to be supplied from the 300-volt source. The video circuit voltages will read quite low in most cases due to the use of high plate resistances. This should not cause any worry, however.

The first thing to align is the i.f. amplifier. Connect the input of a two-stage audio amplifier with output meter to the coupling condenser that connects between the video amplifier and the 906 grid. Set the test oscillator on 12.5 Mc. and connect to the grid of the last i.f. tube. Adjust the tuning screws on top of the second i.f. transformer for maximum output with the mutual coupling condenser underneath the i.f. transformers screwed up tight (not forced) and then backed off one-quarter turn. Next put the signal on the first i.f. grid, and align the second i.f. transformer. Then do the same thing for the first i.f. transformer with the signal input to the first detector grid. Gain of the test oscillator of course should be reduced as progress is made towards the front of the receiver.

Next tune the oscillator back and forth either side of this "center" frequency of 12.5 Mc. The voltage output should be at least 50% of the maximum at 12.0 and 13.0 megacycles. A substantial amount of tube noise will be heard in comparison to that noticed in an ordinary receiver. This is due to the broad-band characteristic of the amplifier and should cause no alarm. If regeneration is present, however, as the result of faulty by-passing or long leads, a very large amount of tube noise will be heard, and the band width obtained will not be as great as that specified. Often the shifting of a by-pass from one ground point to another on the same tube socket will make a difference. Regeneration must be eliminated in the i.f. amplifier if good results are to be obtained.

Few test oscillators go to 112 Mc., but harmonics from 56 Mc. can be employed. By connecting the test oscillator to the grid of the r.f.

stage, the oscillator and detector circuits (r.f. plate circuit) can be quickly aligned. Set the oscillator to 56 Mc. Turn the condensers to nearly full capacity and adjust the oscillator trimmer until the signal is heard. Check the circuits for tracking the other end of the band and make corrections by adjusting the turns spacing of the plate coil or bending the condenser plates. A flat response over the band can easily be obtained. The r.f. stage grid does not require any alignment if the dimensions given are followed. We should now be able to hear any 112-Mc. 'phone hams who may be on the air in the vicinity. In fact, before proceeding further it is a good idea to play with the "radio" part of the set to get the feel of it, before going ahead with the video circuits. The antenna input circuit is arranged so that it may be coupled to an untuned line, or series or parallel tuned feeders may be used. Find out which system works best on your antenna with local 'phone hams. Close antenna coupling is desirable to reduce the Q of the grid circuit and thus minimize regeneration.

The next step is to check the vertical and horizontal oscillators. This can most readily be done by connecting the vertical plates of an oscilloscope to the grids of the scanning amplifier tube. If the sweep frequency of the oscilloscope is set for 30 cycles, a single saw-tooth pattern will be observed if the scope is connected to the vertical section of the 6F8. If a saw-tooth is not obtained, the oscillator should be carefully checked. Connect a temporary lead from the plus 300 volts to the bottom of the plate load resistors of the 6F8G. Connect the 'scope to the plate of this tube and the saw-tooth will be seen in enlarged

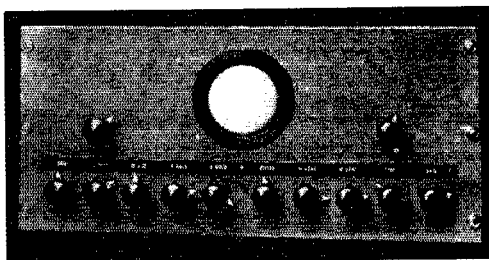

Panel view of the complete rack-mounting receiver.

* Part I of this article appeared in February QST.

** 742 Central Street, Plainfield, N. J.

form if this tube is working properly, with the saw-tooth inverted from the first position due to the phase reversal going through the tube. The

horizontal oscillator pulses also can be checked in exactly the same manner with the sweep frequency raised to 3600 cycles if a single pulse is to

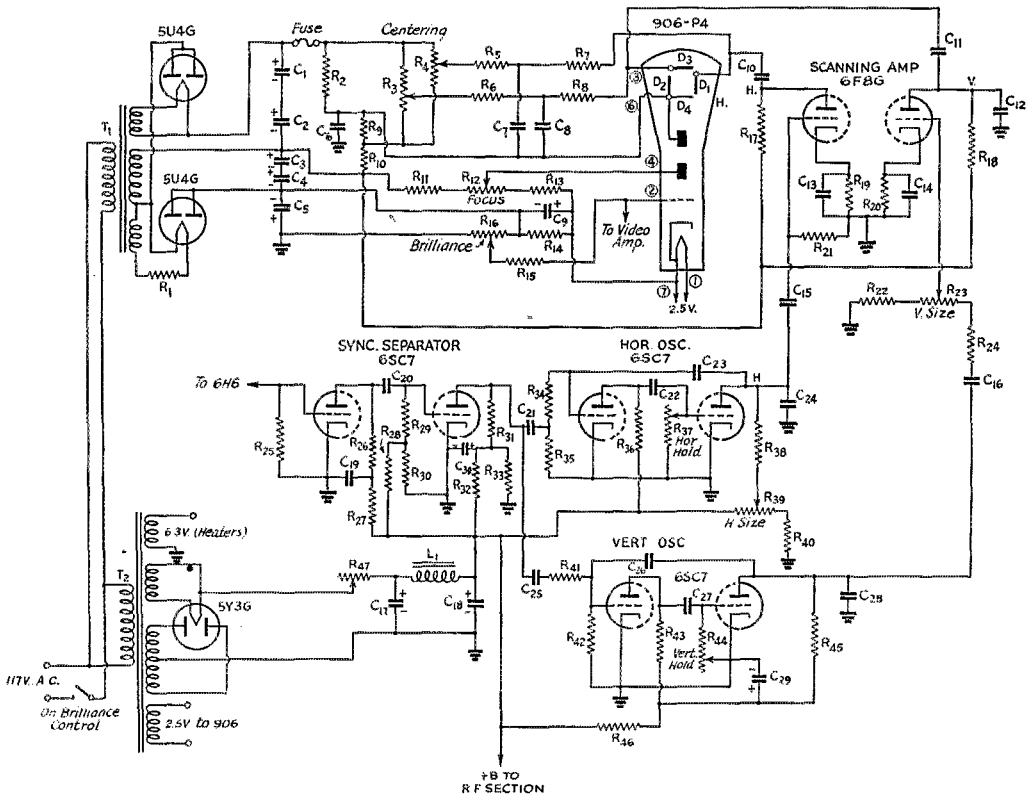

Fig. 3 — Scanning and Kinescope circuits with power supplies.

- | | | | |
|---|---|---|--|
| R ₁ — 1-ohm, 10-w., with slider. | R ₁₃ — 500,000-ohm, ½-w. | R ₂₆ — 20,000-ohm, ½-w. | R ₃₈ — 1-meg., ½-w. |
| R ₂ — 200,000-ohm, ½-w. | R ₁₄ — 70,000-ohm, ½-w. | R ₂₇ — 100,000-ohm, ½-w. | R ₃₉ — 250,000-ohm pot. |
| R ₃ , R ₄ — 1-meg. pots. | R ₁₅ — 5-meg., ½-w. | R ₂₈ — 1-meg., ½-w. | R ₄₀ — 100,000-ohm, ½-w. |
| R ₅ , R ₆ — 500,000-ohm, ½-w. | R ₁₆ — 20,000-ohm pot. | R ₂₉ — 10-meg., ½-w. | R ₄₁ — 250,000-ohm, ½-w. |
| R ₇ — 3-meg., ½-w. | R ₁₇ — 250,000-ohm, 1-w. | R ₃₀ — 500,000-ohm, ½-w. | R ₄₂ — 50,000-ohm, ½-w. |
| R ₈ — 5-meg., ½-w. | R ₁₈ — 500,000-ohm, ½-w. | R ₃₁ — 20,000-ohm, ½-w. | R ₄₃ — 200,000-ohm, ½-w. |
| R ₉ — 250,000-ohm, ½-w. | R ₁₉ — 5000-ohm, ½-w. | R ₃₂ — 500,000-ohm, ½-w. | R ₄₄ — 1-meg. pot. |
| R ₁₀ — 2-meg., ½-w. | R ₂₀ — 15,000-ohm, ½-w. | R ₃₃ — 10,000-ohm, ½-w. | R ₄₅ — 1-meg., ½-w. |
| R ₁₁ — 100,000-ohm, ½-w. | R ₂₁ — 2-meg., ½-w. | R ₃₄ — 10,000-ohm, ½-w. | R ₄₆ — 20,000-ohm, ½-w. |
| R ₁₂ — 250,000-ohm pot. | R ₂₂ — 2-meg., ½-w. | R ₃₅ — 500-ohm, ½-w. | R ₄₇ — 750-ohm, 10-w., with slider |
| C ₁ , C ₂ — 4-μfd., 450-v. electrolytic. | R ₂₃ — 1-meg. pot. | R ₃₆ — 200,000-ohm, ½-w. | (All resistors are I.R.C.) |
| C ₃ , C ₄ — 20-μfd., 450-v. | R ₂₄ — 500,000-ohm, ½-w. | R ₃₇ — 1-meg. pot. | |
| C ₅ — 4-μfd., 450-v. | R ₂₅ — 10-meg., ½-w. | | |
| C ₆ — 0.1-μfd. paper, 1600-v. | C ₁₃ — 5-μfd., 25-v. electrolytic. | C ₂₁ — 0.003-μfd. mica. | C ₃₀ — 8-μfd., 450-v. electrolytic. |
| C ₇ , C ₈ — 0.1-μfd., 200-v. | C ₁₄ — 50-μfd., 25-v. electrolytic. | C ₂₂ — 500-μfd. mica. | (All fixed capacitors are Cornell-Dubilier.) |
| C ₉ — 4-μfd., 450-v. electrolytic. | C ₁₅ — 0.01-μfd. mica. | C ₂₃ — 250-μfd. mica. | T ₁ — Stancor 6010 Transformer. |
| C ₁₀ — 0.005-μfd. mica, 2500-v. test. | C ₁₆ — 0.25-μfd., 600-v. paper. | C ₂₄ — 0.001-μfd. mica. | T ₂ — Stancor 6294 Transformer. |
| C ₁₁ — 0.1-μfd., 1000-v. paper. | C ₁₇ , C ₁₈ — 20-μfd., 450-v. electrolytic. | C ₂₅ — 0.01-μfd., 600-v. paper. | L ₁ — Stancor C 1421 Choke. |
| C ₁₂ — 0.01-μfd. mica, 2500-v. test. (May be omitted.) | C ₁₉ — 8-μfd., 450-v. electrolytic. | C ₂₆ — 0.006-μfd. mica. | Fuse — 7.5-ma. video Littelfuse and mounting. |
| | C ₂₀ — 0.25-μfd., 600-v. paper. | C ₂₇ — 0.02-μfd., 600-v. paper. | |
| | | C ₂₈ — 0.25-μfd., 600-v. paper. | |
| | | C ₂₉ — 20-μfd., 450-v. electrolytic. | |

be observed. This is hardly necessary, however, as two or three wave forms can be readily observed.

The final test is that of the high-voltage supply and the Kinescope itself. The circuit of the high-voltage bleeder string and its associated components should be very carefully checked for errors, as it is quite easy to make them in this circuit if you are not familiar with 'scope circuits. Next the rectifiers can be put in their sockets and the power applied. The brilliance control should be advanced part way, and a broad ribbon of fine horizontal lines interspersed with broader return-trace lines will be seen on the Kinescope screen. The tube socket of the Kinescope should be located so that the pattern is exactly horizontal. Then the centering controls should be adjusted to put the pattern in the center of the screen and the size controls set to make the pattern occupy nearly the whole face of the tube. The size is affected somewhat by the position of the "hold" or frequency locking controls. Final adjustment is made when the picture is received. Adjustment of the focusing control will blur the lines either side of the correct focus position. The finest, cleanest line is the thing to be worked for with this control.

As the hold controls are shifted, the pattern on the screen will go through many fascinating changes. Again a few minutes should be taken to play with these controls in order to get the "feel" of them. The approximate rough adjustment of the hold controls is $\frac{3}{4}$ of the way on. If they are turned on full, oscillation will stop, and a broad line will result. Or a bright spot will occur if both are turned to this point simultaneously. This should be avoided as it is likely to burn the screen just as it may burn if the sweep oscillators are disabled with the brilliance control turned up.

With a pair of 'phones plugged into the monitoring jack, preliminary tuning for the picture is started. The brilliance control, by the way, should not be set too high. The picture can be identified aurally by the interrupted 3600-cycle tone, the 30-cycle pulses sounding like a superimposed motor-boating. The screen will change its pattern materially at the same time. Tune in for maximum volume and then remove the 'phones. The screen will be streaked with much brighter and darker streaks than usual with plenty of signal input. Next the hold controls should be carefully turned. Then snap — and there is your picture. Make fine adjustment of the brilliance and focus controls for best detail and of the i.f. gain for best contrast and you are well started on a new and thrilling chapter of amateur radio. By chance the vertical oscillator may lock in at 15 or 60 cycles in which case you will see pieces of picture sliced horizontally. If the horizontal sweep is too fast or too slow the picture will bend sideways at the top or divide vertically. It is easy to correct this trouble quickly. The final knob settings for the proper adjustment should be marked for future reference.

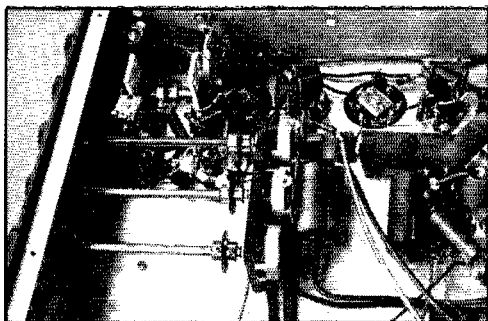

Close-up of the acorn first-detector and u.h.f. oscillator section underneath the chassis.

We quickly learn from experience that the tuned circuits must be tuned to resonance for best results, and that the setting of the gain is quite important. Too much signal will cause too black "blacks" plus distortion. Too little will cause a loss of contrast in which the blacks become pale grays, with return-trace lines showing at very low level. As we receive less signal input from a more distant transmitter, the gain naturally must be advanced. The set noise then comes up and, of course, modulates the picture through the video amplifier, causing graininess or a salt-and-pepper effect on the picture. Noise, particularly ignition noise, also modulates the horizontal oscillator *via* the sync separator, causing sidewise displacement of the lines. This, then, is the limit beyond which we cannot hope to go, just as in an audio receiver signals below the noise level are hard to read. However, field tests indicate pretty clearly that we can expect a substantial area of coverage with good pictures even in a metropolitan locality. Bearing in mind the fact that only 20-odd watts have been used with relatively low-gain bi-directional antennas, the prospect of future progress with higher power and better radiating systems is bright indeed.

While amateur television activity is increasing in various widely separated areas, the Hudson division has been the scene of the greatest operating activity to date, largely because of the outstanding performance of the W2USA-W2DKJ two-way circuit. While the New York World's Fair is now a thing of the past, New Yorkers will be pleased to know that W2DKJ will remain on the air for an indefinite period. The writer, too, expects to be on with a transmitter by the time this is published and several other rigs are on the way. Therefore, the New York area in particular is assured of continued activity in the newest and most fascinating of amateur activities.

Strays

W4PL's log and traffic file for 1940 was kept on a mill. It totalled 830 letter-size pages of single-spaced type!

Putting Dynamic Prognostication to Work

An Efficient, Compact, Flexible and Versatile Unit of Extreme Simplicity

BY LARSON E. RAPP, W1OU

The worth of this manuscript was immediately apparent to the editors when the story was first submitted for publication, and it was hurriedly scheduled for the very next issue of *QST*. There is no doubt that it should have a far-reaching effect on contemporary transmitter theory and design.

MANY developments in amateur radio are the result of insidious experimentation or residual cut-and-try methods, while fewer and more outstanding ones are the end results of logical and clear-cut thinking. The unit to be described in this story should not be confused with either, because both methods were used to develop it.

The general trend towards simplification and versatility in amateur gear, along with compactness and efficiency, was the incentive for the author to follow the same general line of reasoning. Old methods were first discarded and then later brought into use, proving beyond a shadow of a doubt that if anything new was to be developed, the older reasoning must be eliminated. This was done by first building a breadboard model.

Circuit Development

Since most units in present practice employ at least three stages, the breadboard model was built with provision for a transmitter of at least three stages. The use of anything but beam-power tubes was never considered, not even for a minute, since the beam tubes are generally acknowledged to be the most efficient tube (from an economy and power-efficiency standpoint)

available. Low-loss insulation was used throughout, and all shields were made of silver-plated copper. It was found later that the shields were unnecessary, so any experimenter verifying the results can save considerable money by dispensing with the shields from the start.

Although it has been said that grid neutralization makes a stage easier to drive than one with plate neutralization, it was found in these experiments that *no* neutralization made the stages still easier to drive, and neutralization was eliminated in all but the driver stage, which was later discarded. The elimination of neutralization should not be confused with the introduction of regeneration, as some authors have failed to point out.

With the elimination of neutralization and the consequent reduction in driving-power requirements, it was possible to eliminate the driver stage, leaving only the oscillator and final amplifier stages. The power from the crystal oscillator, although adequate to drive the final amplifier in an orthodox way, was not satisfactory from a dynamic standpoint, so it was decided to try regeneration through the screen circuit of the final amplifier, a method that has been wilfully neglected for years. To our great surprise, it was found that the screen feedback, through the capacity between the screen grid and control grid, not only gave the necessary regeneration and lowered drive requirements but also acted as a control-grid neutralizing circuit, resulting in high stability of the amplifier except at several points well outside the resonant frequency. This effect was found to be negligible when the stage was loaded. The grid-screen capacity of a metal 6L6 is too low for best results, but four out of five 6L6G's were found to be just right.

As a by-product of this lowered driving-power

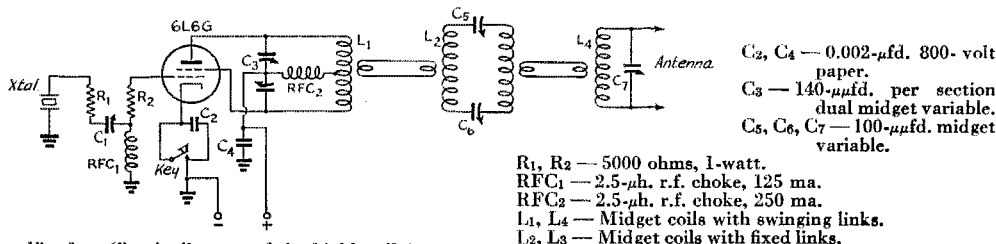

Fig. 1 — Circuit diagram of the highly-efficient one-stage transmitter.

C1 — 35- μ fd. midget variable.

C2, C4 — 0.002- μ fd. 800-volt paper.
C3 — 140- μ fd. per section dual midget variable.
C5, C6, C7 — 100- μ fd. midget variable.

R1, R2 — 5000 ohms, 1-watt.
RFC1 — 2.5- μ h. r.f. choke, 125 ma.
RFC2 — 2.5- μ h. r.f. choke, 250 ma.
L1, L4 — Midget coils with swinging links.
L2, L3 — Midget coils with fixed links.

When operating on any particular band, L1 and L4 are coils designed for that band and L2 and L3 are coils for the next higher-frequency band.

requirement, it was found possible to eliminate the crystal oscillator stage entirely, leaving only the crystal in the circuit for frequency control. Resistance coupling was employed between the crystal and the final amplifier stage, through the use of an inverted π -section filter. As can be seen in Fig. 1, R_1 and R_2 are the shunt elements of the filter and C_1 is the series element. RFC_1 is simply a d.c. return to ground and can be eliminated if the stage works better that way. Ours wouldn't work at all that way, and the choke was retained. The value of C_1 is adjusted for maximum drive with minimum crystal heating.

The next step in the development of the circuit was the antenna coupling, the bugaboo of most high-efficiency installations. Link coupling was found to be the most efficient, confirming the findings of other experimenters, so it was decided to try "double" link coupling. This was found to be a great improvement, and it is surprising that it hasn't been used before this. The final circuit, as shown in Fig. 1, results in no coupling back from the antenna to the transmitter when C_5 and C_6 are properly balanced, and consequently a swinging antenna has no effect on the transmitter frequency.

Keying was the next problem to be attacked and, after trying all circuits and discarding them, the symmetrical circuit shown in Fig. 1 was evolved. Apparently the symmetry of the circuit gives a very good waveform, and the resultant "click" (sometimes called "thump") is almost negligible. Possibly by using a twin beam-power tube having separate cathode connections, a split-stator condenser for $C2$ and a twin key could be used for perfect symmetry and consequent perfect keying.¹

The rest of the circuit is conventional and represents present practice.

Construction

The finished model, shown in the photographs, represents several innovations in amateur practice. Some months back a conductive, or "low-resistance," rubber was announced secretly to the trade. This would make an ideal chassis material, since it combines shock-absorbing characteristics with extreme flexibility. However, since it is not yet available through regular channels, we went to the next best thing and built the chassis of semi-stiff cardboard covered on the underside with tin foil. Copper foil would be better but it was not available at the time. Cardboard has the virtue that it can be easily drilled, requiring nothing more than an ice pick and a pair of manicure scissors to work it. Although it is not as flexible as rubber, it is readily bent and can be

¹ — Mr. Rapp is slightly in error here. It is not necessary to have a completely symmetrical waveform for perfect keying, as long as the well-known relation $C_2 = \frac{E}{R} \left(1 - e^{-\frac{Rt}{L}} \right)$ is satisfied. — Ed.

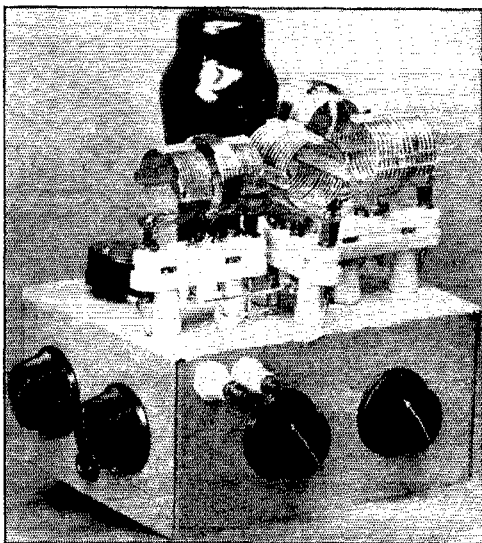

A compact transmitter of high efficiency and simplicity. The tuning controls at the front are crystal coupling and antenna output, with the key jack mounted between. The knobs on the side by the antenna terminals control the antenna coupling condensers, and the plate tuning condenser is turned by a knob on the far side in back of the tube.

Note the simple construction of the chassis which is made from cardboard fastened by wire staples and glue. The underside is covered with tin foil.

glued or pasted together. Minor mistakes in the placement of holes can be easily corrected.

As can be seen from the photographs, the finished model is rather compact. This could have been carried further, except for the odd shapes of some of the components. However, the air spaces between some of the pieces of gear are not really necessary, since the high efficiency of the unit results in very little heat being radiated, most of it staying within the tube where it is more available. Purists who worry about mounting the coils so close to each other can be assured that the incidental neutralizing between control and screen grid, together with the tight coupling possible through the "double link" system, results in practically no external field.

Tuning

Tuning is more or less conventional, except that care must be exercised in tuning with no load. The high coupling efficiency of the unit results in a minimum plate current at resonance of about 0.9 ma. at 7 Mc. This is too low a value to show on the 0-250 milliammeter that should be used in the circuit, so you'll have to take our word for it.

As the antenna coupling is critical, with two tuned circuits and the double link coupling, two hands should be used for tuning, particularly for beginners. With 900 volts on the plate, the normal

(Continued on page 94)

A Portable Emergency Transmitter for Vibrator Power Supply

Crystal and V.F. Control with C.W. or 'Phone

BY WALTER VAN B. ROBERTS,* W3CHO

A thoroughly practical emergency outfit incorporating a number of novel circuit features. Designed to operate within the limits of the ordinary 300-volt 100-milliamperere vibrator power supply.

A PORTABLE emergency transmitter designed primarily for operation in the lower-frequency bands from a low-powered source, such as a vibrator plate power supply, is a piece of equipment that may at any time be of real public service by virtue of its ability to operate without any other source of power than an ordinary automobile storage battery. Many such little rigs have been described from time to time, but there are almost as many opinions as to what features are desirable in these transmitters as there are potential users, so without further apology an arrangement will be described which meets the ideas of the writer and may be helpful to others in carrying out their own ideas.

In tabulating desired features one of the first decided upon was that it should operate either crystal or self-controlled, as a known crystal frequency is convenient in that it is always accurately reproducible without careful setting of any control, and is a frequency on which the sta-

* Patent Department, Radio Corp. of America, New York City.

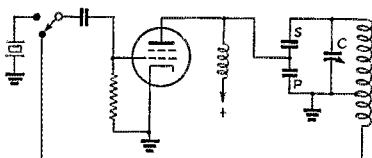

Figs. 1 and 2 — The basic circuit (top) and the simplified version (bottom).

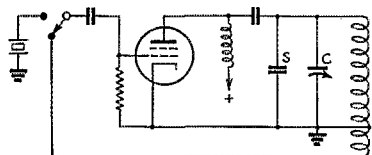

tion can usually be found. On the other hand, it is also convenient, especially in the case of a low-powered transmitter, to be able to shift frequency to avoid interference and to be able to break in on a contact between two other stations.

Accordingly, a circuit was developed which, while extremely simple, provides conventional operation as a crystal oscillator and also stable oscillation when self-controlled, requires a minimum total number of circuit elements, and is very simply switched from one condition to the other.

Another feature that was desired was band switching. Plug-in coils would have been slightly simpler but it was felt that the trouble of arranging for switching would be well justified in the

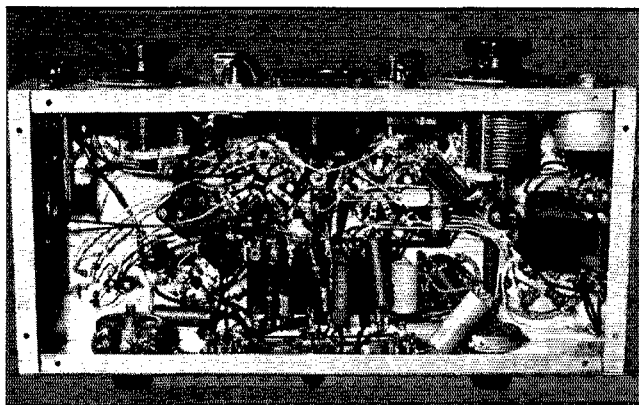

A view of the bottom of the transmitter. The potentiometer for carbon microphone voltage, the audio gain control and the modulator cathode switch are on the rear edge of the chassis. Note the shield around the crystal microphone jack in the lower right corner.

This portable emergency c.w.-phone transmitter works from a vibrator plate supply, operates either with crystal control or a self-controlled oscillator. The chassis is 7 by 15 by 3 inches.

The oscillator section is at the left, amplifier at the right, with the modulation equipment at the rear center. All coils are enclosed in shield cans. Controls along the front chassis edge, from left to right, are crystal switch and key jack, oscillator tuning control, oscillator (above) and final cathode switches, cathode-current milliammeter, neutralizing control, stand-by (plate-voltage) switch, amplifier tuning control, and jacks for the two types of microphones.

Switches for changing bands are on top of the chassis in the center foreground, on either side of the neon-bulb over-modulation indicator.

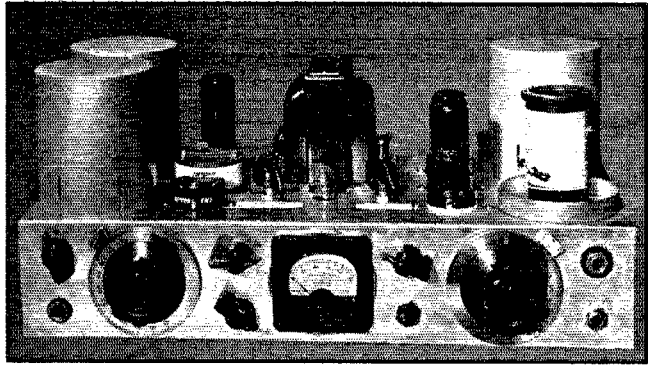

long run. However, the transmitter was not intended for operation ordinarily in more than two bands and a compromise was adopted which combines the complete flexibility of plug-in coils with the quick band-change of the switching type. This compromise consisted in supplying two complete sets of plug-in coils with switches to shift from one to the other. Thus, plugging in any two sets of coils, quick switching between them is provided and the wiring is much less complicated than if switching between a large number of bands is attempted.

Other minor features of the transmitter will appear in connection with the description of the complete circuit.

The Oscillator

Referring particularly to the oscillator, which is the most unusual part of the rig, Fig. 1 shows the schematic circuit and arrangement for switching from self-controlled oscillation to crystal control. When operating crystal control the circuit will be seen to be the usual crystal oscillator employing a tuned plate circuit, except that the plate is tapped part-way down the tuned circuit. In the self-controlled position the oscillator follows the principles laid down for good stability in the writer's article in the April, 1940, issue of the *RCA Review*.¹ In this article it was shown that if the effective input capacity of the oscillator tube is subject to a certain amount of variation as a result of such causes as varying supply volt-

¹ W. van B. Roberts, "The Limits of Inherent Frequency Stability," *RCA Review*, April, 1940.

age (for example, voltage regulation that produces chirpy keying) and if the output circuit of the tube is subject also to variations in capacity, then for a given strength of oscillation the frequency stability will be best when the input and output electrodes of the tube are so coupled to the resonant circuit that the voltages impressed on these electrodes are proportioned inversely as the amount of variability in the respective capacities. It is also important to make both voltages as small as possible consistent with a desired strength of oscillation.

The circuit of Fig. 1 is the same as the circuit described in the article referred to except that the input and output electrodes of the tube are reversed, which results in making possible a very simple switching arrangement for changing from crystal to self-control. In this circuit condensers *S* and *P* may be so chosen as to provide both a suitable amount of bandspread and also a desired amount of reduction of the alternating voltage on the plate. The number of turns in the grid coil, of course, determines the alternating voltage on the grid. Experimentation with this circuit, however, led to the conclusion that the simplified circuit of Fig. 2 is stable enough for all practical purposes, especially if a fairly large capacity tuning condenser is used. As a matter of fact, as the tuning capacity is made larger and larger in Fig. 1 it becomes necessary to move the plate tap farther and farther up until finally Fig. 1 turns into Fig. 2 automatically. No sufficiently complete experiments have been made to determine the optimum value of the tuning capacity

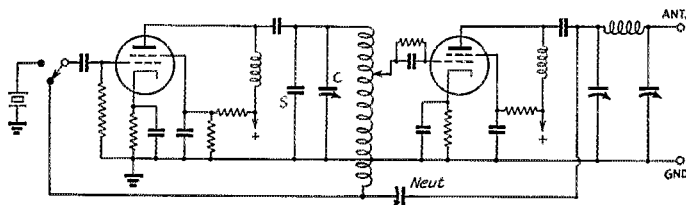

Fig. 3 — Fundamental circuit from which the practical version of Fig. 4 is derived.

used in Fig. 2, but satisfactory results are obtained with a variable condenser of 100 $\mu\text{fd.}$ in parallel with a fixed condenser of about 300 $\mu\text{fd.}$, which results in approximately the required bandspread on the lower frequency bands. (*Warning:* Some fixed condensers give a chirpy note on keying. Use an air condenser for comparison when looking for a suitable fixed one.)

With these constants it was found that about

two turns on the grid coil would produce approximately the same strength of oscillation as was obtained when operating under crystal control. It will be seen that the grid alternating voltage is very much less than the plate alternating voltage, and this is as it should be because the effective plate capacity is not nearly so susceptible to variations as the effective grid capacity.

Fig. 3 shows an oscillator of the type shown in

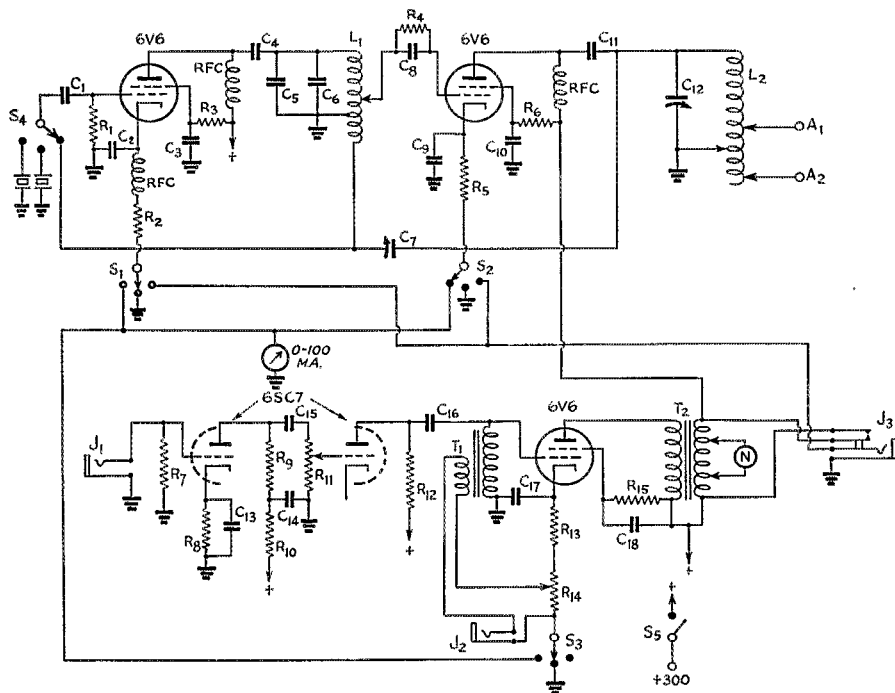

Fig. 4 — The emergency transmitter circuit, complete with modulator. Either crystal or carbon microphones may be used.

- C₁ — 100- $\mu\text{fd.}$ mica.
- C₂ — 0.1- $\mu\text{fd.}$ paper.
- C₃ — 0.01- $\mu\text{fd.}$ paper.
- C₄ — 500- $\mu\text{fd.}$ mica.
- C₅ — 300- $\mu\text{fd.}$ low-drift mica.
- C₆ — 100- $\mu\text{fd.}$ variable.
- C₇ — 15- $\mu\text{fd.}$ variable.
- C₈ — 30- $\mu\text{fd.}$ mica.
- C₉ — 0.1- $\mu\text{fd.}$ paper.
- C₁₀, C₁₁ — 0.002- $\mu\text{fd.}$ mica.
- C₁₂ — 200- $\mu\text{fd.}$ variable.
- C₁₃ — 25- $\mu\text{fd.}$, 25-volt electrolytic.
- C₁₄ — 4- $\mu\text{fd.}$, 450-volt electrolytic.
- C₁₅, C₁₆ — 0.01- $\mu\text{fd.}$ paper.
- C₁₇ — 25- $\mu\text{fd.}$, 25-volt electrolytic.
- C₁₈ — 10- $\mu\text{fd.}$, 50-volt electrolytic.
- R₁ — 50,000 ohms, 1-watt.
- R₂ — 400 ohms, 1-watt.
- R₃ — 0.1-megohm, 1-watt.
- R₄ — 20,000 ohms, 1-watt.
- R₅ — 400 ohms, 2-watt.
- R₆ — 25,000 ohms, 2-watt.
- R₇ — 2 megohms, $\frac{1}{2}$ -watt.
- R₈ — 2000 ohms, $\frac{1}{2}$ -watt.
- R₉, R₁₀ — 0.25-megohm, $\frac{1}{2}$ -watt.
- R₁₁ — 1-megohm volume control.
- R₁₂ — 0.25-megohm, $\frac{1}{2}$ -watt.

- R₁₃ — 170 ohms, 1-watt.
- R₁₄ — 200-ohm wire-wound potentiometer.
- R₁₅ — 22,000 ohms, 2-watt.
- L₁ — 1.75 Mc.: 33 turns No. 24, length $1\frac{3}{8}$ inches, tapped 17th turn from bottom; grid coil two extra turns at bottom of coil.
- 3.5 Mc.: 16 turns No. 18 d.c.c., length $1\frac{1}{4}$ inches, tapped 9th turn from bottom; grid coil two extra turns at bottom of coil.
- L₂ — 1.75 Mc.: 44 turns No. 20 d.c.c., length $1\frac{7}{8}$ inches; tapped 1, 2, 3, 4, 5, 7, 9, 13, 19, 25 and 31 turns from bottom.
- 3.5 Mc.: 31 turns No. 18 d.c.c., length $1\frac{5}{8}$ inches; tapped 1, 2, 3, 4, 6, 9, 11, 16, 21 and 26 turns from bottom.
- T₁ — Single-button microphone transformer (Thordarson T-86A02).
- T₂ — Modulation transformer, variable ratio, adjusted to match 10,000-ohm load to 8500 ohms required by 6V6 (Thordarson T-19M13).
- N — $\frac{1}{4}$ -watt neon bulb.
- J₁, J₂ — Open-circuit jack.
- J₃ — Circuit-closing jack.
- S₁, S₂, S₃, S₄ — Single-pole 3-position switch (Centralab 1461)
- S₅ — S.p.s.t. toggle.
- RFC — 2.5-mh. r.f. choke.

Fig. 2 followed by an amplifier. In addition to the further circuit details shown in the oscillator, it will be seen that advantage is taken of the oscillator grid coil to permit grid side neutralization of the amplifier tube by way of condenser "Neut." This type of neutralization leaves the choice of amplifier plate circuit completely free so that a matching network may be used in place of the conventional tank as shown. With a 6V6 amplifier the neutralizing capacity is only a few μmfd . Theoretically it might be preferable to connect the lower side of condenser *S* to the grid end of the grid coil rather than to ground as shown. It may be noted at this point that the shunt feed used in both tubes has several advantages. For one thing, it keeps high voltage off the neutralizing condenser, tuning condensers and antenna, and for another it permits the amplifier grid leak to be shunted directly across the grid condenser so that there are no losses due to r.f. voltage across the leak.

The Practical Circuit

Fig. 4 is a complete circuit diagram of the transmitter shown in the photo, as actually built and used, with the exception that the band-switching arrangements are not shown in this figure. In view of what has gone before, only a few scattered comments on Fig. 4 will be required. It will be seen that there is no bleeder resistor between the oscillator screen and ground. It was found that the oscillator stability was good enough without any bleeder and every effort was made to keep down the total current drain required of the vibrator power supply. Each cathode circuit may be switched either to ground or to the meter. Either the oscillator or amplifier cathode circuit, or both, may be switched to the keying jack, *J*₃. This jack is provided with an auxiliary pair of contacts that are pushed together when a plug is inserted in the jack, and these contacts are connected across the secondary of the modulation transformer so as automatically to short this out for c.w. operation. When operating c.w. the audio

tubes may be removed, or the cathode circuit of the modulator tube may be switched to the unused switch point to avoid the unnecessary flow of space current.

For portable operation a single-button carbon microphone may be plugged into jack *J*₂ so that only one type of tube is used throughout. For use in the home station the twin-triode tube 6SC7 may be placed in its socket and a crystal microphone inserted in jack *J*₁. No switching is required in changing from one type of microphone to the other. A tiny quarter-watt neon lamp *N* is tapped across enough turns of the modulation transformer so that it flashes on voltage peaks corresponding to overmodulation.

In order to be able to work into a low-impedance antenna and to avoid any readjustment of antenna coupling upon switching between bands, a somewhat different amplifier plate circuit is used than the matching network shown in Fig. 3. The arrangement of Fig. 4 permits the output terminals *A*₁ and *A*₂ to be tapped a small distance on either side of the ground tap on the plate coil, so as to match a balanced transmission line, or one of them may be connected to ground and the other one suitably tapped for a concentric line or low-impedance antenna, or moved up the coil to match antennas of increasing impedance. To provide a sufficient number of tap points on the coil a small hump was made in the wire at each of the first six turns, and thereafter at increasing intervals. When using fairly heavy wire these humps do not straighten themselves out under a light winding tension, and after the coil is completed they may be pinched into a sharp projection which tightens up the winding and can be easily soldered to hold together to form a point of contact for a miniature Fahnstock or other type of clip. Finally, a small but appreciated incidental feature is that the four coil shields make excellent supports for the rig when upside down!

The band-switching arrangement employed is shown in Fig. 5, in which the circles represent the

(Continued on page 88)

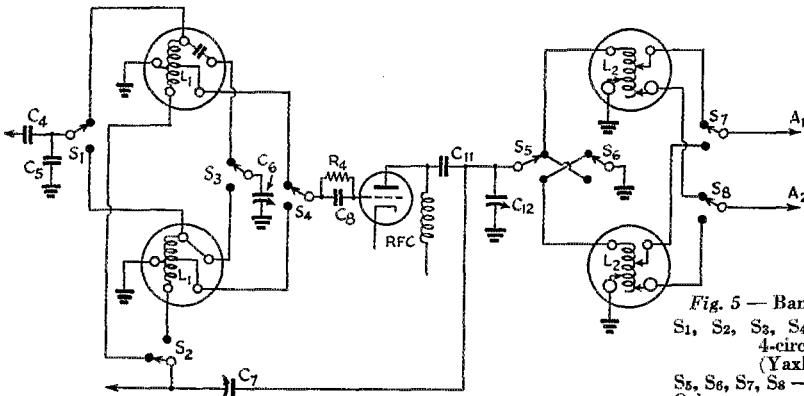

Fig. 5 — Band-switching circuit.

*S*₁, *S*₂, *S*₃, *S*₄ — Combined in one 4-circuit, 2-position switch (Yaxley 1312-L).

*S*₅, *S*₆, *S*₇, *S*₈ — Same.

Other components same as in Fig. 4.

April 26th-27th—7th U.H.F. Contest

Multipliers Credit Multi-Band Work, Use of C.W., and Field Operation; WIAW Will Be In It

It's TIME for the Spring u.h.f. Activity. Here's a chance to roll up your first big bunch of points for the 1941 Marathon! You will work some brand-new u.h.f. stations and new states, perhaps. Start short test messages to go across country as far as possible *entirely by u.h.f.*! The Contest is week-end fun in its own right, with a separate scoring plan all its own. The report of individual work and contest results will appear in *QST*. Certificate recognition (awards) by the League are available to participants. If you can work on 56, 112, 224 or 448 Mc., plan to get into the u.h.f. game to the full April 26th and 27th. Enjoy the operating fun. Report results to A.R.R.L. for credit!

The Contest Period, April 26th (Saturday), 3 P.M. local time to April 27th (Sunday), 7:59 P.M. local time.

Scoring of the Contacts: List all different stations worked in the contest period, and besides the calls show the *location* of the stations obtained as you work them for the claimed points. In a given band, a fixed or portable station may be worked but *once* for contact credit regardless of location. Contact points depend on the transmitter frequency of the station for which the claim is entered, and the distance covered, in line with the table below:

Distance of Station Worked	Number of Points Score, for Contacts Using Transmitter on		
	56-60 Mc.	112-116 Mc.	Above 224 Mc.
Under 25 Miles	1	2	10
25 to 75 Miles	2	4	20
75 to 275 Miles	5	10	50
Over 250 Miles	10	20	100

Scoring Message Credits: To the contact points computed as above add points for message copies submitted. *If these show handling data*, the call of the station *from which* message was received, call of station *to which* the message was sent by radio, time and date of acknowledgments of receipt between stations, the claim to points will be allowed. The call of the reporting amateur should be on each message for identification.

Send messages to those known active or *likely* to be active on u.h.f. in the contest. *For originating* and sending a test message of approximately five to ten words, specifically addressed or "to any amateur" in remote sections of the country and submitting copy with handling data (but one such message per station will be credited)—10 points.

For relaying such messages away from the starting point toward destination and submitting full copies (1 for receiving by radio, 2 for relay onward)—3 points. Reply messages relayed,

with copies submitted, also count as just explained, but for originating stations, but—1 point.

Multipliers: Points may be multiplied in turn by multipliers designed to credit (a) ability to use more than one ultra-high frequency band; (b) ability to use c.w. or m.c.w. as well as A-3 (voice) emission; (c) ability to work from field locations under portable designation.

(a) If one or more contacts are made, with contestants transmitter fundamental on 56-, 112-, 224-, or 448-Mc. assignments, the sum of scoring points may be multiplied by the number of such bands on which work is thus demonstrated (*not to exceed four*).

(b) Those contact points specifically made with the transmitter using c.w. or m.c.w., and those message points similarly made, may be multiplied by *two* before other multipliers are applied. C.w. aids identification at distant points and this also credits demonstration of ability in its use.

(c) Stations under portable indicator, may multiply all points made while actually operating portable or portable mobile by *two*.

— —

If cross-band work occurs, consider the band your *transmitter* is on as the band on which the contact is counted in your report. If your transmitter is on c.w. and the man contacted uses voice, you report your work for c.w. credit; he reports his as 'phone. Answering questions: A buzzer keyed in front of a mike will produce an m.c.w. transmission. If during a contact a message is transmitted using c.w. or m.c.w., *both* contact and message credit may receive the multiplier (b). If all operation is in a portable status and using c.w. or m.c.w., it is convenient to use multipliers *after* all the contact and message points have been added. If part of the work is in a portable status, or only part use was made of c.w., then only those parts of the total score may be given the appropriate multiplier of course.

After you get your test message off, the aim is to work as many as possible, and push other test communications on their way in a responsible manner.

If you transmit in different u.h.f. bands, the same station may be worked more than once to count in the contact score.

Be sure we get your report, with claimed score and message copies, promptly. Marathon forms must not be used in reporting results of the Relay.

— F. E. H.

A Dual-Diversity Preselector

Reduced Fading of C.W. Signals by Diversity Reception

BY FORREST A. BARTLETT,* W6OWP

SEVERAL excellent articles on diversity receiving systems have appeared in *QST*. All of these discussions, however, have treated the subject with respect to its application to radiotelephone work. This follows logically since the standard system of diversity reception does not readily lend itself to general use by the c.w. man. In the following paragraphs, the writer describes a unit which may be used with any short-wave receiver to provide dual-diversity telegraph reception. The results to be expected may not be quite as spectacular as those achieved in diversity 'phone reception, but the reduction of fading does go a long way toward improving operating efficiency. Hollow and fluttery signals which might otherwise be uncopyable often may be brought to 100% readability. For receiving installations making use of tape recording apparatus, the circuit offers a remarkably effective yet inexpensive solution to the problem of fading signals.

It is generally agreed that short-wave signals arriving at a given receiving point normally travel over several separate paths — paths that are constantly shifting in accordance with changes in the ionized reflecting layers above the earth. Since the total distance of each path varies, the time required for a signal to cover its own route to the receiving point will differ slightly from the time required for the same signal arriving over another

Here is a story that should interest everyone interested in improved high-frequency c.w. reception. W6OWP shows how a simple double preselector can be added ahead of any communications receiver to allow diversity reception of c.w. signals, without requiring any changes in the receiver itself.

route. A difference in phase is thus introduced which may either reinforce or tend to nullify the energy impressed on the receiver input. It is this condition which causes the rapid fading accompanying high-frequency signals. The foregoing takes into account the conditions existing at a single receiving installation. If another identical receiver and antenna were set up at a distance from the first point, it would be found that when signals arriving out-of-phase caused perhaps complete cancellation in one receiver, there would, at the same moment, be no fading in the second receiver. Conversely, the periods of maximum signal strength would not occur at the same instant in both receivers. It is this peculiarity of short-wave transmissions that forms the basis for most diversity set-ups.

The distance between the two antennas has an important bearing on the diversity action. The diversity effect is quite noticeable, however, when

* KGER News Bureau, 600 Knickerbocker Bldg., Los Angeles, Calif.

◆

The dual-diversity preselector, shown from an angle that gives a good idea of the placement of parts. The two grid circuit coils are housed in the shields to the left of the chassis, and the plate coil shield can be seen at the center front. The audio-oscillator phase-inverter section occupies the right front corner, with the power supply to the rear. Antenna inputs and the output link are attached through standard jacks. The individual band-change toggle switches can be seen under their respective coils.

◆

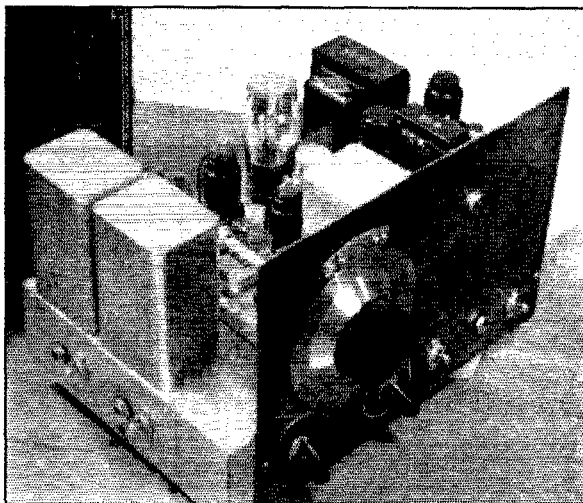

the spacing is only on the order of one wavelength at the received frequency. Where space is at a premium, improved results are obtained when the two antennas used favor signals arriving at different angles with respect to the horizontal or in different planes of polarization.

It should be emphasized that separate receivers as well as antennas were considered in the above observations. Coupling two spaced antennas into a single receiver has only the effect of increasing the possible paths the signal may travel in reaching the receiver input — with a resulting increase in possible out-of-phase conditions. This very likely will aggravate fading rather than improve the overall average signal level.

In two receivers each coupled to its own antenna, the signal phase differences existing at the respective receiver inputs will be carried through the entire r.f. portion of each receiver and are not removed until final rectification of the r.f. carrier. The rectified signals of the two receivers may then be fed into a single audio system and, in the case of radiotelephone work, a diversity arrangement is set up. The complete installations described in *QST* comprise separate r.f., i.f. and second-detector systems with a single high-frequency oscillator and audio amplifier.

In c.w. work, however, standard treatment is not so simple. This follows because a beat oscillator cannot be used to provide an audible beat note. Phase differences existing between signals in the r.f. channels of the diversity receiver would be present in the audio beat note outputs of the two second detectors. Any effort to combine the two audio signals would result in the same effect as though the two antennas used were coupled directly to a single receiver.

Various means of meeting this problem have been advanced. In commercial practice, the rectified and combined carrier energy from the two detectors is used to key a tone circuit. Other suggestions vary from the use of "split headphones" and heterotone modulation of the incoming signals to the use of separate, isolated beat oscillators producing beats of different audio frequencies. None of these solutions are really satisfactory from a general-usage point of view, and the amount of equipment required overshadows the advantages of telegraph diversity reception except for specialized instances.

Viewing the problem from another standpoint, it was reasoned that with some means of alternately coupling first one and then the other antenna to a single receiver at a suitable rapid rate, the receiver output would be proportional to the loudest signal present at any instant in either antenna. The difficulties introduced by phase relationships between signals in the two antennas would not be an influencing factor since at any given instant, only one antenna actually would be supplying signal energy to the receiver. This is the principle of the diversity unit herein described.

Two r.f. stages, each coupled to a separate antenna, are set up. The input circuits of the two stages are well isolated but the plate circuit is common, with its output link-coupled to the receiver input. An audio oscillator followed by a phase-inversion stage furnishes out-of-phase switching voltage of suitable frequency. This voltage is applied to the individual r.f. tubes in such a manner as to alternately make the first and then the second tube operative — but never both at the same time. Thus the receiver will always be coupled, through an r.f. stage, to one of the two antennas. The complete circuit diagram is shown in Fig. 1.

The input circuits of the two r.f. tubes are conventional. Components are arranged for symmetrical wiring to facilitate alignment of the tuned circuits. The common plate circuit is shunted to permit grounding of C_3 . The coils are tapped and a switch is used to provide coverage of a fairly wide band of frequencies. Inasmuch as few users of a unit of this type have abundant antenna space available, provision has been incorporated for covering only two bands. The unit under discussion covers the range from approximately 16,000 to 6900 kc.

The trimmer across C_3 is controlled from the front panel since it will be found that the plate circuit will not track over a wide frequency range. The tubes used are 6L7's — chosen because of the favorable dual-control characteristic afforded by their No. 3 or "injection" grid.

At this point, it may be mentioned briefly that a three-position switch is provided to permit use of either r.f. channel separately as a straight pre-selector stage or the two together operating as a diversity coupling stage. Further use of this switch in practical operation will be taken up in a later paragraph.

When operating diversity, the No. 3 grids of the 6L7's are biased to block operation of the tubes except on the positive half of the audio switching voltage supplies from the circuit comprising a 6C5 audio oscillator and 6C5 phase inverter. The audio voltage existing on the plates of the 6C5's will be 180 degrees out of phase. This voltage is taken from the divider resistors R_1 and R_2 and applied to the No. 3 grids of the 6L7's.

Since each r.f. tube is made operative only on the positive halves of the audio voltage impressed on its respective No. 3 grid and since there is a 180-degree phase difference between the two grids, then it follows that only one tube will be operative at any given instant. Signals present in the input circuit of either r.f. tube will be amplified and appear in the plate circuit during portions of the audio cycle when that tube is operating. If signals are present in one input but absent in the other, the signal in the plate or output circuit will be modulated at the oscillator frequency. If signals of equal amplitude exist in the input

of both r.f. tubes, then the signal in the output will be modulated at double the oscillator frequency.

In practice, it has been found that the r.f. energy fed to the receiver is approximately proportional to the loudest signal existing in either antenna. The effect of fading in one antenna with a steady signal in the other is only to change the modulation frequency of the r.f. energy delivered to the receiver, and consequently the tone of the signals heard in the receiver output. The resulting modulated c.w. effect is a very pleasing one to most c.w. operators.

An oscillator of the stabilized feedback type was chosen to generate the audio switching voltage. This circuit provides a substantially pure tone output. Harmonics have a detrimental effect on general operation and should be eliminated as far as possible. The phase-inversion circuit is

straightforward. An audio by-pass condenser of suitable value may be needed from plate to ground if too much harmonic content is present.

An alternative method for obtaining the necessary out-of-phase switching method would be to feed the audio oscillator to an amplifier stage which had a "single plate to push-pull grids" transformer in its output. While the writer has not applied this circuit in practice, it nevertheless seems to be a logical arrangement. The separate amplifier tube would be necessary to isolate the output transformer from the transformer used for feedback.

The exact frequency of the voltage produced by the oscillator is not critical. However, it must be kept in mind that the incoming signals will be modulated as mentioned previously. Sidebands generated by this modulation will, of course,

(Continued on page 80)

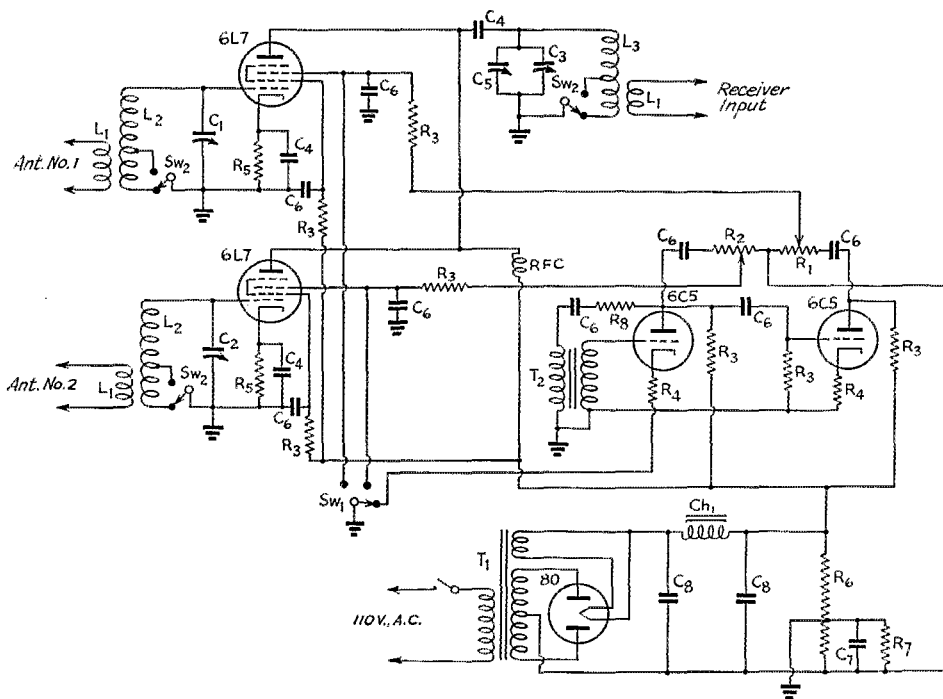

Fig. 1 — Circuit diagram of the dual-diversity pre-selector for c.w. reception.

- C₁, C₂, C₃ — 140- μ fd. tuning condensers, ganged.
- C₅ — 30- μ fd. trimmer condenser.
- C₄ — 0.001- μ fd. paper.
- C₆ — 0.01- μ fd. paper.
- C₇ — 0.1- μ fd. paper.
- C₈ — 10- μ fd. electrolytic.
- R₁, R₂ — 50,000-ohm potentiometers.
- R₃ — 50,000 ohms.
- R₄ — 2000 ohms.
- R₅ — 500 ohms.
- R₆ — 50,000 ohms, 25-watt.
- R₇ — 1000 ohms.
- R₈ — 5000 ohms.

- All resistors 1-watt unless otherwise mentioned.
- T₁ — Power supply transformer.
- T₂ — Audio transformer.
- Ch₁ — Power supply filter choke.
- RFC — 2.5-mh. r.f. choke.
- Sw₁ — Three-position s.p. rotary switch.
- Sw₂ — S.p.d.t. toggle switch.
- L₁ — Four turns, untapped.
- L₂ — 10 turns, tapped 4 from bottom.
- L₃ — 7½ turns, tapped 3½ from bottom.

The coils are all wound with No. 26 d.c.c. on small forms, approximately 1¼ inches in diameter. The range covered by the coils is 16 to 6.9 Mc., in two steps.

This is the last of the "QSL" transmitters. On February 23rd W8QBW joined the ranks of Silent Keys, succumbing following an operation necessitated by a severe illness.

We find it difficult to associate the idea of death with Fred Sutter. The youthfulness of his outlook was in no way dimmed by his seventy-odd years; no better testimony of this is to be found than in his *QST* descriptions of the post-card size transmitters it was his delight to devise. We knew him, through correspondence, for several years without suspecting that he was not so young in years as in spirit. His writings were motivated by a desire to be helpful to the younger generation, particularly those whose resources were limited. There is no better expression of the true amateur spirit.

This article, written shortly before his illness, is a typical QBW story. It has the breeziness, the little touches of humor, the good common sense, which characterized all of the series. It shows, better than we could tell, why he will be missed by those who knew and read him. If anything so exuberantly cheerful can serve as an epitaph, let it so stand. *Vale, W8QBW!*

The "QSL-25"

The 6L6G Goes Conservative

BY FRED SUTTER, W8QBW-QDK

Our reporter called upon 6L6G and that tough water-front character said: "Sure, I joined de Union — why should I work so hard when all dese other tubes are taking life easy? Dis guy 8QBW — look what he done to me. Here I been putting out 40 watts, 50 watts and then 60 watts — and fer all I know maybe he will gyp me into putting out a k.w. It ain't fair — I kin take it and like it but I tink dere are plenty of mugs dat want me to git a break — I'm gonna see me mouth-piece."

Well! Perhaps he is right. So here we go with a little rig with full 25 watts output and fewer parts — no voltage divider, no dropping resistor, no

screen condenser and no meter. But as we have pointed out before, the tube does the work and the more parts and gadgets we can leave out, the better chance the watts have of getting aboard the antenna and going places. Now 25 watts output is not to be sneezed at! Here at W8QBW and 8QDK the "Portable Five"¹ with only 5 watts output has worked 30 states so far and all W districts except the 6th. I thought once I had hooked a West Coast station, but he turned out to be a bootlegger — the rat! Although he may have been on the West Coast at that. So I claim that 25 watts is any man's money's worth.

¹ Sutter, "The 'Portable Five,'" *QST*, December, 1939.

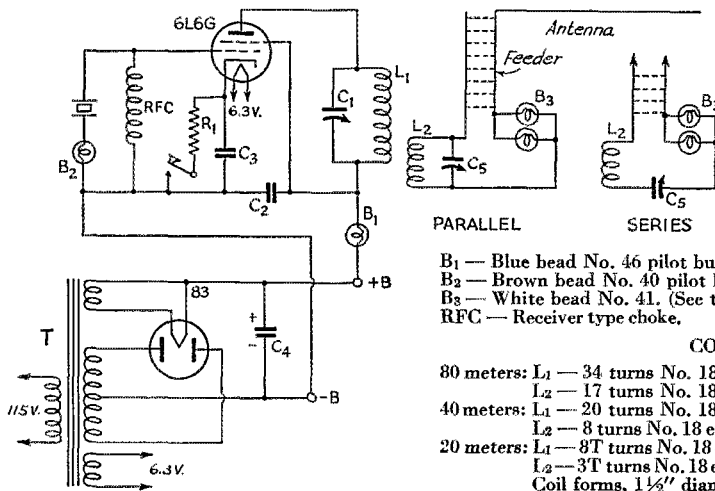

Fig. 1 — Complete transmitter and antenna system.

T — 700-v. c.t., 120-ma., 5-v. and 6.3-v. (Thoradson T13R14).

C₁ — Hammarlund Star Midget, 100- μ fd.

C₂, C₃ — 0.01 paper tubular, 600-volt.

C₄ — 20- μ fd. electrolytic, 450-volt working.

C₅ — About 350- μ fd. receiver type variable.

B₁ — Blue head No. 46 pilot bulb.
 B₂ — Brown head No. 40 pilot bulb.
 B₃ — White head No. 4L. (See text.)
 RFC — Receiver type choke.

COILS

80 meters: L₁ — 34 turns No. 18 enameled, close-wound.
 L₂ — 17 turns No. 18 enameled, close-wound.
 40 meters: L₁ — 20 turns No. 18 enameled, close-wound.
 L₂ — 8 turns No. 18 enameled, close-wound.
 20 meters: L₁ — 8T turns No. 18 enameled, 3/16" center-to-center.
 L₂ — 3T turns No. 18 enameled, 3/16" center-to-center.
 Coil forms, 1 1/2" diameter.

This rig is self-contained, the transmitter and power supply being all on a chassis $3\frac{3}{4}$ by 7 inches. The total weight is 6 lbs. 11 oz. and the cost is \$5.85 not including tubes or crystal, which most fellows already own. You will see in front the plate condenser knob and plate current bulb. At the left are the feed-throughs for the antenna feeders, the key terminals being at the rear. On top are the transformer, the 6L6G (bless his heart!) and the '83, the coil, crystal and crystal current bulb. It is urged that specifications be followed exactly. There must be literally hundreds of these various "QSL" rigs in use, and I have heard of very few disappointments that could not be traced to "changes" or "improvements," very adverse local conditions or nondescript antenna arrangements. Make all the changes you want to, of course — have a good time! *But* don't throw any pop-bottles at the umpire, in case.

Antennas

Usually when a writer describes his little pet he fails to mention antennas or says, lightly, "see *Handbook*," or mentions a random piece of wire and a tuner. It seems to me that the fellows want (and need) something more than that, and it seems also that there is a tendency on the part of the newer amateurs, at least, to stick up a random antenna, a random feeder system, perhaps an antenna "tuner" also random and then find on their hands some rather random results. Now, I don't like random things nor do I like antenna tuners. Perhaps what I am about to say may be thresh-

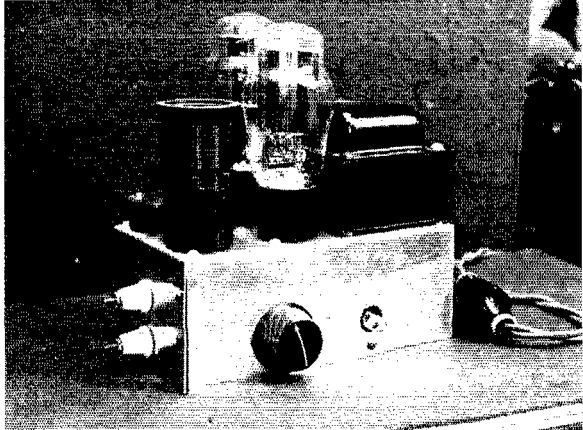

The QSL-25 is complete on a small folded aluminum chassis, the folding and drilling template for which is given in Fig. 2.

ing last year's straw. But this is not written for experts who know everything anyway.

I suggest to the builder of this or any other rig, that he start *at the antenna*. Most any amateur will tell you that a few watts in a top-notch antenna are better than ten times that power in a haywire sky hook. So at risk of stirring up the animals I am going to urge the use of the good old end-fed Zepp. Of course, if it is handier you can feed it at the center. If you have room make it about 135 feet long — an 80-meter half wave (or 40-meter full wave or a 20-meter two wave) — it will work on all three bands. Your crystals should be in fairly close harmonic relationship — for example, 3550 kc., 7150 kc. and 14,300 kc. — and the antenna cut for 3550 kc. if that is the frequency you select.

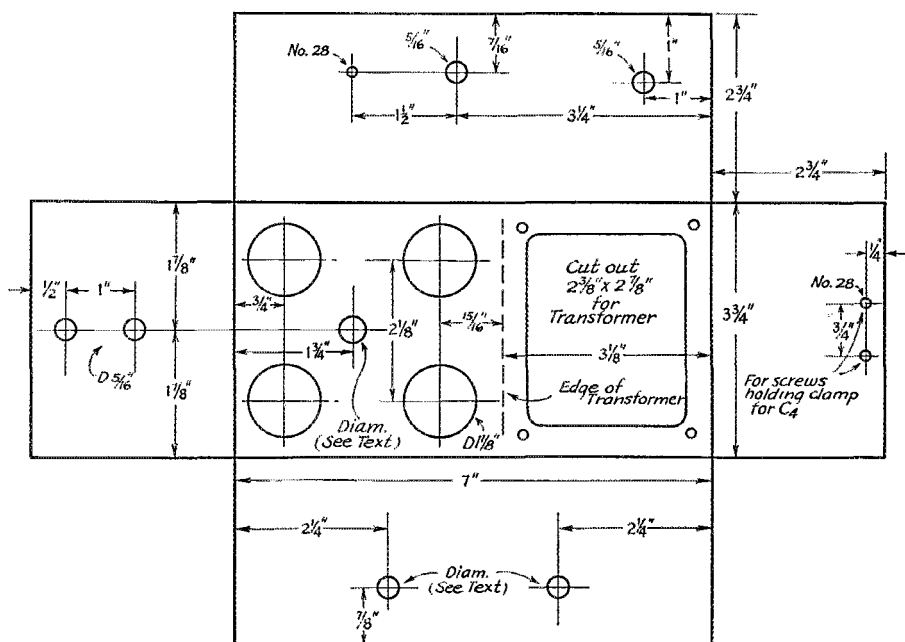

Fig. 2 — Drilling template for the 25-watt transmitter.

$$\text{Length in feet} = \frac{468,000}{\text{kilocycles}}$$

or 132 feet for 3550 kc.

If you simply don't have room for an 80-meter half-wave antenna, then put up one for 40 meters. Very few homes indeed cannot spread a 66-foot wire somehow or other.

Feeders

Here is where we *do* find random lengths! The old saying is, "If they don't tune one way they will the other," which is not strictly true nor is it the whole story. The copy-book rule is to make the feeders a quarter-wavelength or a multiple — which leaves out the little matter of feeder current at the transmitter end. It is desirable that the feeder current at the point of measurement, which is usually at or close to L_2 , should be a reasonable amount so as to be readily indicated by the pilot bulb or bulbs. If series tuning is used, which will be the case if the feeders are one quarter-wave long (66 feet in the above example) the feeder current at or close to L_2 will be at a maximum. If the output is 50 or 60 watts this current may run up close to 2 amperes. Now if the above system is operated on 40 meters, instead of 80, the feeder is then two quarter-waves long and parallel tuning will be used, and the feeder current will be a minimum, maybe not over a few hundredths of an ampere. If used on 20 meters the feeders are then four quarter-waves and again parallel tuning is used, and very low current observed.

I suggest, therefore, that the feeder length be such as to give a fair amount of current on either series or parallel tuning. This means that the feeders should be a little less or a little more than one quarter-wave. The length can readily be determined by cut-and-try till you have a satisfactory current value at the point of measurement for the band or bands you propose to work. By "satisfactory current value" I mean current sufficient to light up one or more pilot bulbs — say the No. 41 white bead or No. 46 blue bead, etc.,² — these being in the live feeder as shown in the diagram.

About all that is left to say is that L_2 should be wound with such a number of turns that a receiver-type condenser, C_5 , of about 350- μ fd. capacity will tune the feeders. In general if L_2 has about $\frac{1}{2}$ or $\frac{1}{3}$ the number of turns that L_1 has it will be satisfactory. If these suggestions are adopted you will have no trouble with feeder tuning and getting the antenna to "load," which sometimes stumps the beginner and leads him to blame the transmitter for his dilemma.

General

A few "musts" should be pointed out. The plate condenser C_1 must be insulated from the

² Sutter, "What, No Meters?", *QST*, October, 1938.

chassis. This may be accomplished by means of a bit of bakelite, but a simpler way is to use a soft rubber grommet which will insulate the condenser and hold it firmly in place when the nut is screwed up snugly. The socket for B_1 must also be insulated from the chassis and this had best be done by using a Yaxley 304CH socket or an ARH Co. No. 1761, which have insulated mounting brackets. The bracket of the 304CH should be bent straight, and in either case the bracket should be drilled for a mounting screw which should be long enough so that the shell of the socket and the base of the pilot bulb do not extend beyond the chassis. The B -lead should run to the socket lug which feeds the *center contact*. If this is done there is no chance of getting "bitten" at this point.

The socket for B_2 can also be mounted with the same size of rubber grommet as was used for condenser C_1 . If the grommet is a shade larger than the socket, cut the hole for the grommet a bit small and this will pinch it up to a snug fit. It is customary to install B_2 between the crystal and B — rather than between the grid and the crystal.

The key posts on the rear apron of the chassis consist of a ground screw on the chassis and a feed-through. R_1 runs from cathode to the feed-through. The chassis dimensions are based on the use of MIP sockets ("molded-in-plate") and these should be used.

The feeders here at 8QBW are 80-meter quarter-wave and the coils specified in Fig. 1 tune as follows:

80 meters	— series tuning
40 "	— parallel tuning
20 "	— " "

These windings may or may not be what you require but will serve as a starter. L_1 should have such a number of turns that it will tune with C_1 about $\frac{1}{4}$ to $\frac{1}{2}$ in mesh, and the figures given should be correct. As stated before, L_2 should have from $\frac{1}{3}$ to $\frac{1}{2}$ the turns of L_1 so as to tune the feeders with C_5 at about $\frac{1}{2}$ capacity.

WWV Schedules

DURING construction work on the new standard frequency station of the Bureau of Standards, the old schedule of transmissions has been discontinued. At present a 1-kw. transmitter is broadcasting continuously on 5000 kc. from 10 A.M. to midnight, E.S.T., every day except Sunday, using c.w. only. Telegraphic announcement of the call letters WWV is given every 20 minutes. Accuracy of the transmissions is better than one part in ten million.

A considerably enlarged service is contemplated when the new station is completed. Details will be given in *QST* as soon as available.



ARMY-AMATEUR RADIO SYSTEM ACTIVITIES

V.W.O.A. HONORS GENERAL MAUBORGNE

THE Marconi Memorial Medal of Service was awarded to Major General J. O. Mauborgne, Chief Signal Officer of the Army, by the Veteran Wireless Operators Association at the annual banquet which was held at the Hotel Astor, New York, on the night of February 11th. As General Mauborgne was unable to be present, the award was made by William J. McGonigle, W2ASN, president of the V.W.O.A., to Colonel John C. Moore, Signal Officer First Army, who represented him at the affair.

General Mauborgne's amateur radio experience dates back to 1898, when he first used coherers. Later, in 1912, he installed a small spark transmitter on an army observation airplane for the first test of aircraft radio control of artillery fire. While in the Philippines in 1914 he conducted, for the first time in Army history, two-way communication between plane and ground, using a pocket-size receiving set which he had developed. During the World War, General Mauborgne (then a lieutenant-colonel) was head of the engineering and research division of the Signal Corps and was largely responsible for the development of all Army radio, wire, and cipher equipment. He has been serving as Chief Signal Officer since 1937 and is a staunch supporter of the American radio amateur.



Major General J. O. Mauborgne, U.S.A.



Richard E. Nebel, W2DBQ-WLNB

A Scroll of Honor was also awarded by the V.W.O.A. to Richard E. Nebel, W2DBQ-WLNB, Second Corps Area Radio Aide, for his national-defense services despite his physical handicap. Dick Nebel obtained his first license in 1931 and also joined the A.A.R.S. the same year as a district net station. He has been District NCS, State NCS, and State Radio Aide. On November 1, 1940, he was appointed radio aide to the Signal Officer, Second Corps Area, by Colonel Clyde Simpson, Corps Area Signal Officer, to take over the work formerly handled by Major David Talley, W2PF. Although completely paralyzed in both legs as a result of infantile paralysis when a child, Dick is doing his bit toward national defense. In addition he is active as an A.R.R.L. route manager, official observer, and emergency coordinator.

WAR—AMATEUR SCHEDULES

THE number of amateur stations that have worked WAR now exceeds 750, and they will soon receive the new WAR QSL card. Because of increasing traffic in the War Department net it has been necessary to make slight changes in the schedules and to shift one WAR frequency from 4025 kc. to 4020 kc., effective March 1st. The revised schedules are:

Days	E.S.T., p.m.	Amateur Band Monitored	WAR Frequency
Tues. & Wed.	7:00- 7:45	3500-3900 kc. (c.w.)	4020 kc.
Tues. & Wed.	7:45- 8:00	3900-4000 kc. (phone)	4020 kc.
Saturday	7:00- 8:30	3500-3900 kc. (c.w.)	4020 kc.
Saturday	8:30- 9:00	3900-4000 kc. (phone)	4020 kc.
Mon. to Sat.	9:00-10:00	7000-7300 kc. (c.w.)	6990 kc.

(Continued on page 100)

HAM SHACKS

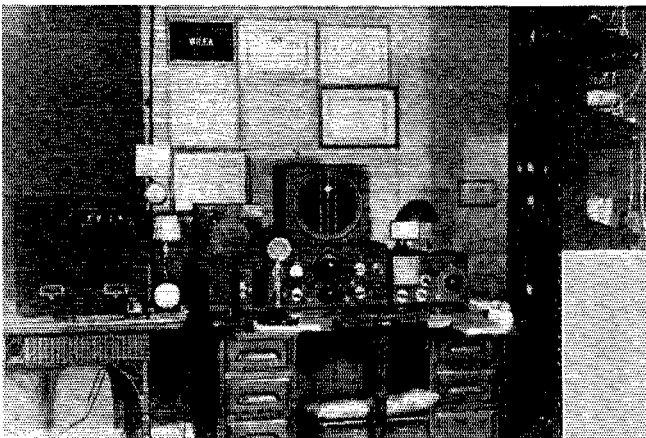

*Left—W1EA,
Lawrence, Mass.*



*Below—W9AS,
Newton, Iowa*



◆
Below—W2WD, Long Island, N. Y.
◆

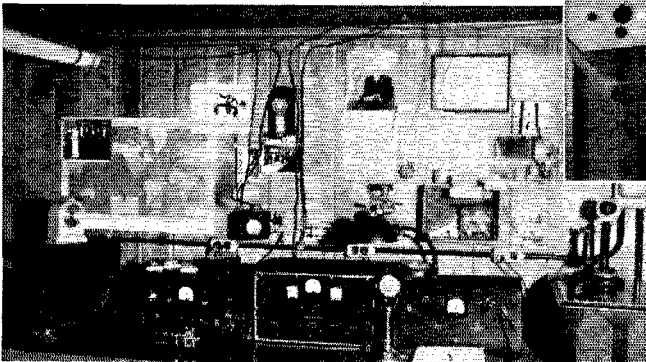

◆
Below—PY5BL, Brazil
◆

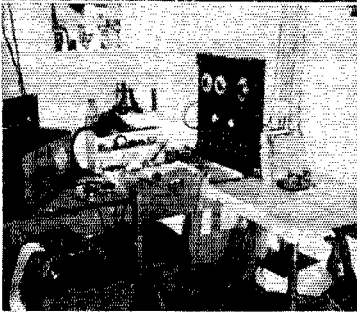

*Above—W1EOB, Springfield,
Mass.*

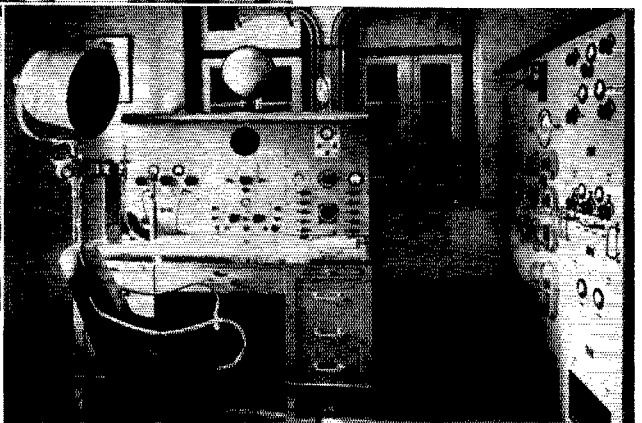

WILEA

THE transmitter is built up in the popular rack-and-panel style. In the exciter, which occupies the third section from the top, a 6L6G crystal oscillator and HY61 buffer drive a 35T. The output of this unit is link-coupled to the final in the next section above, which consists of a pair of 35T's in push-pull, running at 500 watts input. The antenna-tuning equipment is placed in the section at the top of the rack. By the use of plug-in coils, the transmitter may be used on 40, 20 or 10.

The audio equipment consists of a National NSA speech amplifier following the Astatic D104 mike. A low-impedance line connects the output of the speech amplifier to the input of the modulator in the transmitter rack below the exciter unit. A pair of TZ40's is used to modulate the final amplifier.

Not shown in the photograph is another rig using a pair of 35T's for 2½-meter work which is operated at 200 watts input. The TZ40 modulator is used for this rig also.

A National 101X is used on the lower frequencies, while a "1-10" is used for u.h.f. reception. A National oscilloscope is used for modulation checks.

A 33-foot horizontal doublet is used for 7-, 14- and 28-Mc. work. For 2½, a half-wave vertical antenna is used.

Raymond Lasonde, who presides at the controls, has made WAS and has worked 36 countries. He has also worked 18 different stations on 2½. He is an A.R.R.L. Assistant Emergency Coördinator. WILEA will be heard most frequently on 40 c.w. and 2½ 'phone.

W2WD

STAN McMINN is a well-known figure in amateur circles around New York City. His call has been a familiar one since the days when he was distinguished by possessing one of the first crystal-controlled transmitters in W2 land. Having had his experience with high-power rigs, Mac has now returned to low power where he says most of the thrills are these days — besides, he gets away from BC interference.

The shack is located in a sealed-off portion of the basement. Everything is arranged for maximum convenience in shifting from one band to another. The transmitter is a National NTX-30 with NSM modulator. Four separate half-wave antennas are provided for the 10-, 20-, 40- and 80-meter bands. Each is fed with a low-impedance cable so that it is necessary only to push the band switch in the transmitter panel and plug in another transmission line in the jack in the antenna-meter box to shift from one band to another. The receiver is the Hammarlund HQ-120X.

Mac is Editor of "Automotive Merchandising," an automotive trade paper and is always glad to contact hams in the trade. He will usually be found on c.w. on 3888 kc.

W1EOB

ONE of the leading traffic handlers in the Western Massachusetts Section is Vic Paounoff, whose station, W1EOB, is located at Springfield. He's almost always well up in the running in domestic contests, finishing first for his section in the Sweepstakes for the last three years. The station is Alternate Control for the First Corps Area A.A.R.S., Alternate State Net Control for Western Massachusetts and ORS of long standing.

The station is a compact arrangement which fits into a corner of the bedroom which any contest man ought to find rather convenient. The receiver on the left end of the operating table is an SX-9. The unit on top of it is a home-made regenerative preselector.

The transmitter is in the little rack to the right. An 802 e.c.o. drives an RK47 final with a normal input of 100 watts. All bands from 1.7 to 28 Mc. are covered. The single antenna is a 3.5-Mc. half-wave affair with single-wire feed.

The collection of badges on the wall furnishes proof that Vic's face is a familiar one at most ham gatherings in the vicinity. Although he'll be found most frequently on 80, he is active on the higher frequencies, even to the extent of working a little DX now and then.

W9AS

JOHAN MATTHEWS is a survivor from the days of Ford squeak-boxes and crashing rotaries. He wore out the calls 9LK and 9DZW years ago and is now working hard on W9AS, which seems to be standing up well, nevertheless.

The latest rig in the enclosed rack consists of an NTX-30 push-button exciter driving a single HF100 at 250 watts input. The final is plate-modulated by Class-B ZB120's driven by a Collins 7C speech-amplifier and driver from a dynamic mike.

A National CRO oscilloscope is used for checking 'phone transmissions. The receiver is the RME69 with DB20 preselector.

A two-element rotary is used on 28 Mc., while a half-wave doublet is used for 14-Mc. work. A single-wire-fed 3.5-Mc. half-wave antenna is provided for 7- and 3.5-Mc. work. John says he spends about 95 per cent of his time on the air on 'phone.

PY5BL

ONE of the neatest amateur installations we have seen is PY5BL, the station of C. Owen Bossemeyer, an American residing in Brazil. The operating table is arranged for a maximum of convenience. The panel at the back of the operating table is divided into three sections of rack width. The section at the left contains the speech amplifier and power supply, while the section at the center is occupied by the RME69, the DB20 preselector and a rack-mounting speaker. The section at the right contains a clock, modulation monitor and controls for the transmitter. These include a voltmeter and line-voltage control. At the left-hand end of the table is a bracket holding a second loud-speaker and an extension arm for the Turner microphone. A fluorescent lamp across the top of the panel assembly provides illumination.

The transmitter, an assembly of Utah units, is mounted behind the panel at the right. A 6L6G crystal oscillator is followed by a pair of 807's which drives the push-pull T55 final. A pair of 203Z's is used in the modulator. The central section is devoted to various relays and circuit breakers, while the rear section is available for future expansion. A fluorescent lamp is used to illuminate these panels also. All power wiring is done with heavy "BX" flexible cable.

A Mims double three-element rotary is used for 14- and 28-Mc. work.

Mr. Bossemeyer is general manager for the Parana Light and Power Co. He has resided in Brazil for over 11 years.

Strays

According to a newspaper clipping sent in by VE5HL, "a device has been invented that is asserted to age hams with electricity in seven weeks, instead of the months required to smoke-cure them."

Instability in the h.f. oscillator of my Sky Buddy at frequencies above 10 Mc. was cured by substituting a 6J8G for the 6K8 mixer tube. Now I get T9 signals on the 14-Mc. band instead of T4.

— K7GBF.



Predictions of Useful Distances for Amateur Radio Communication in April, May, and June 1941

National Bureau of Standards, Washington, D. C.*

THESE predictions are for maximum and minimum useful distance ranges in the five amateur frequency bands regularly useful for long-distance sky-wave transmission during April, May, and June 1941. They are based on ionosphere observations and field intensity measure-

* Report prepared by N. Smith.

ments made at Washington. For a discussion of sky-wave transmission see Letter Circular 614 of the National Bureau of Standards, "Radio transmission and the ionosphere," and Letter Circular 615, "Distance ranges of radio waves."

The use of the charts in the present article was explained in the article in the September 1940 issue of *QST*, page 26, entitled "Predictions of useful distances for amateur communication." Slight changes have been made in the charts this

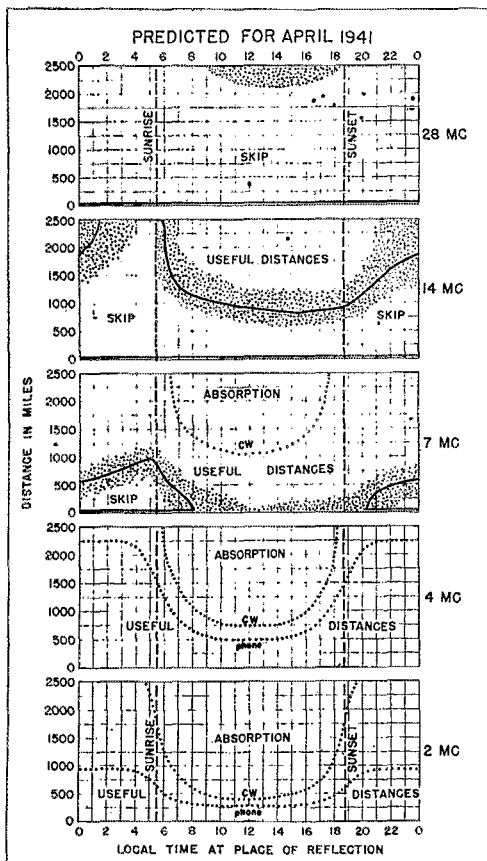

Fig. 1 — Useful distances for radio wave propagation via the regular layers of the ionosphere, predicted for April 1941. The 56-Mc. band will be useful only for local transmission (optical and quasi-optical paths).

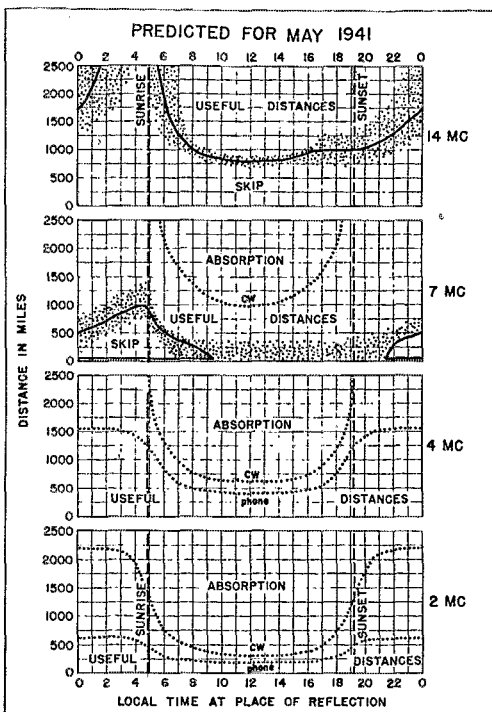

Fig. 2 — Useful distances for radio wave propagation via the regular layers of the ionosphere, predicted for May 1941. The 28-Mc. and 56-Mc. bands will be useful only for local transmission (optical and quasi-optical paths) except on irregular occasions when "sporadic-E" transmission may occur at these frequencies over distances of 800 miles or more. At these times the skip distance on 14 Mc. will be unusually short.

time. The solid lines representing skip distances are supplemented by dotted shaded areas. The solid lines show the average skip distances during each month, and the shaded areas show the probable limits of variation. For example, at 18 o'clock on a day in May the average skip distance for 14 Mc. will be 1000 miles. The skip distance will almost always be greater than 750 miles and almost never be greater than 1250 miles.

The dotted curves marking the maximum distance range as limited by wave-absorption in the ionosphere are labeled "phone" or "c.w." This is because a greater field intensity is needed for good 'phone reception than for good c.w. reception. These curves are based on 100 watts radiated power, both for 'phone and c.w. Higher-powered transmitters can transmit to distances greater than shown by the dotted curves; lower-powered transmitters to distances not as great. For example, to produce a good c.w. signal at the distance shown by the "'phone" curves would require a power of only 2 watts; to produce a good 'phone signal at the distance shown by the "c.w." curves would require a power of 8 kw.

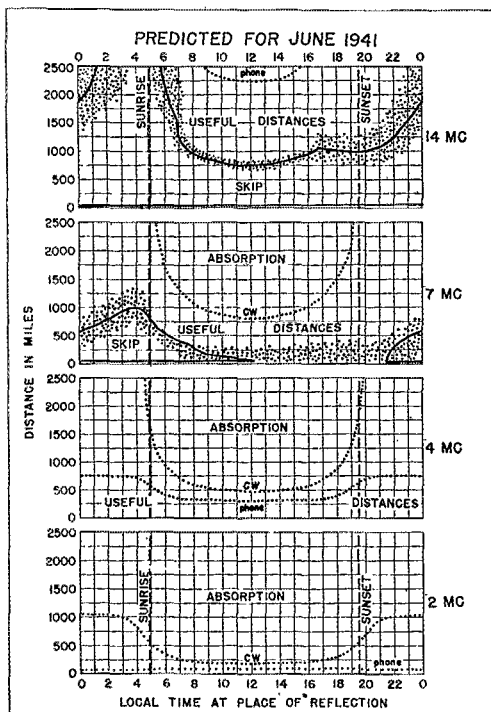

Fig. 3 — Useful distances for radio wave propagation via the regular layers of the ionosphere, predicted for June 1941. The 28-Mc. and 56-Mc. bands will be useful only for local transmission (optical and quasi-optical paths) except on frequent irregular occasions when sporadic-E transmission may occur at these frequencies over distances of 800 miles or more. At these times the skip distance on 14 Mc. will be unusually short.

During April the average skip distance on 28 Mc. will be greater than 2500 miles, but there will be days when this frequency band will be useful for distances as indicated by the shaded area. Ionosphere storms are likely during this month and may at times cause extreme variations from the values shown.

Propagation conditions during May and June will be characterized by longer skip distances, greater sky-wave absorption during the day, and, especially during June, increased static intensity, both day and night. During May and June there will be periods, especially in the morning, late afternoon and evening, when 28 Mc. and at times even 56 Mc. may be transmitted over distances of 800 miles or more. This effect is known as "sporadic-E transmission" and very rarely occurs for distances shorter than 400 miles on 28 Mc. or 800 miles on 56 Mc. At these times the skip distance on 14 Mc. may become zero. Sporadic-E transmission is irregular and unpredictable in detail, but is usually most prevalent from May through August at the latitude of Washington.

AURORA DX ARRIVES ON SCHEDULE!

FOLLOWING the trend observed in past years, the recurrence of periods of Aurora refraction of 56-Mc. signals on a cycle of approximately 28-day intervals during February, March, and April, found many of the old hands watching for a chance at this eerie business during early March. They were rewarded on Saturday, March 1st.

During the early afternoon, 28 Mc. showed that wavy North-South skip which usually presages Aurora refraction on Five. Around 3:30, a definite flutter showed on Ten, and things began to happen on Five shortly after. All this happened too late to permit complete reporting of the affair, so we present, with sincere thanks to those who sent us the dope immediately, the lists of stations heard and worked by some of the fellows who were active:

WILSN, Exeter, N. H. Heard W1's LLL AEP, W2AMJ, W3's CUD ABS, W8's CIR PK.

W1AEP, Springfield, Mass. Worked W3ABS, W8CIR; heard W3's GUF CUD, W1's JLI HXP LSN, W8's QQP PK.

W1LLL, Hartford, Conn. Worked W3ABS, W8CIR; heard W8PK.

W1HDQ, Wilbraham, Mass. Worked W8's CIR PK; heard W8's FGV QQP PKJ.

W2AMJ, Bergenfield, N. J. Worked W8's PKJ FGV QQP CIR; heard W1JLI.

W3ACC, Neshanic Station, N. J. Worked W8CIR; heard W8FGV.

W8PK, East Bloomfield, N. Y. Worked W3ABS, W1's JLI HDQ, W8's CIR PKJ; heard W1's LLL AEP, W2AMJ.

Terrific fading, occasional distortion of 'phone signals, and a few instances of visible aurora during the first week of March indicate that much work, as yet unreported, may have taken place. All the work mentioned above was accomplished on c.w., the only type of emission that will get anywhere during these times. So get some fixed bias on that final and dig out the old key — you'll be wanting to pound some brass again around the last of March and the first of April!

— W1HDQ

Help in Red Cross-A.R.R.L. Test—April 4th, 5th, 6th

**All Out Test of Amateur Facility Planned—5 p.m. April 4th Zero
Hour—Thousands of Messages to Start—Help Relay Them—
Organized Receiving Centers Ready—Do Your Part
for Success of Red Cross Test**

PRiority! Every active amateur is asked to assist to make the Preparedness Test of Amateur Facilities a success. All amateurs are asked to give priority to the emergency test traffic on April 4th, 5th, and 6th in order that as good a showing as possible be made.

The test is dedicated to perfecting the ability of our institution (Amateur Radio) to serve the Red Cross at any time by proper handling of recorded message traffic on our amateur frequencies. The test is designed to perfect liaisons between each of the 3700 Red Cross chapters and the amateur radio service representative, the Emergency Coördinator, who would be called upon for radio service (as the local amateur organizer) in the event of emergency. In the event of any type of emergency requiring relief measures messages might be filed for one of the three big regional offices of the American Red Cross just as in this test. There would not be as many hundreds of messages for the same points as in this test, but the Red Cross messages in a major emergency might have to compete with as much other radio correspondence and interference. We have an annual June activity dedicated to emergency *equipment* tests; this is a test of the entire *personnel* of amateur radio . . . of the *operating or message handling* ability of amateurs to get every last message to its destination from the most remote Red Cross Chapter wherever it may be in the continental United States.

All amateur bands may be used, as mentioned in the advance announcement last month. The low-frequency bands that would be subject to F.C.C. restriction against other-than-relief traffic in a real emergency are the ones to use in this test. Major David Talley, A.A.R.S. Liaison Officer, has advised that A.A.R.S. will be pleased to cooperate. A.A.R.S. cooperation is most welcome. Since this is purely a test of *amateur* frequency capabilities and in order not to compete with special receiving center plans established for this relay, we are requesting that all the Red Cross messages handled on the dates of the test be handled *on amateur frequencies only* without recourse to special government frequencies that may be available to some participants.

Each A.R.R.L. Coördinator will obtain a separate message from each Red Cross Chapter for which he is responsible, and will designate a starting station, preferably one using 80-, 40-, and 160-meter bands (although all bands *can* be used and will be covered), to release the message at the zero hour. None of the messages will be over 15 words. Each will be addressed to one of the three Red Cross offices. Scores and hundreds of messages will be on the air at once. The point of the test is to assure DELIVERIES of accurate transcriptions of the messages that were filed to the Red Cross officials to whom they were addressed. Delivering the messages will be taken care of by A.R.R.L. Directors and Affiliated Radio Clubs that are setting up message receiving centers to function the three days of the relay in their respective cities. The RADIO RELAYING of the messages from the originating points to destinations is the responsibility of the amateur fraternity. *All amateur networks and all individual amateur operators are asked to assist in making the Red Cross Test fully successful.*

Before the starting time the starting stations will have checked their traffic carefully to make sure it is in standard message form and that the correct word count has been placed on the message. (See article on drafting and message form elsewhere in this issue.) As soon as possible after 5 p.m. Friday, April 4th, starting stations will try to get their messages on the way to Washington or St. Louis or San Francisco. Obviously it will take the stations at those places some hours to clear even the near-by states. All amateurs who know how to relay a message are asked to handle messages, to receive and forward them to destination, to help outlying stations.

To take part: Get on the air and help if you are in a position to relay from remote or weak stations. Stand by to keep channels clear if you are not. All amateurs getting a message on their hook will be expected to accept full responsibility for that message. *See the job through* by sticking on the air until you have put it to destination or to a station that will in turn take full responsibility for relaying or delivery.

Report your part in the test the Monday following. A card or letter to A.R.R.L. listing in

tabular form where you got a message and whom you gave it to and noting any unusual incidents of the operating activity will help us to credit all work in QST. Each participating reporting station will get a Special Souvenir Acknowledgment Card as a memento of the occasion of the Red Cross A.R.R.L. Facilities Test, and a permanent proof of this participation.

Review last QST for details and operating suggestions for aiding accurate handling, getting around QRM and the like. If you get a message on the hook and your transmitter tubes burn out don't give up . . . try to file the message for immediate relay with another local. The messages are all important to the Red Cross. The information received will play a definite part in the Red Cross plans for the coming weeks, and for planning use of emergency communications in actual emergency. Deliveries count!

Advance Organization at Receiving Centers. A thorough and coordinated organization of planned watches at the three receiving centers is progressing well as we go to press a month before the activity. The stations manned will continue to scour the bands for calls throughout the three days of the Red Cross Test, April 4, 5 P.M. to April 6, 11:59 P.M. local time. There will be other helping stations that can take your traffic, but to give added assurance here is a list of "delivery" stations pledged in advance to be looking for inbound messages from any part of their Red Cross areas:

CQ DC . . . for Washington, D. C., Stations¹

<i>3.5 Mc.</i>	<i>7 Mc.</i>	<i>W3HQX (eco)</i>
W3ECP 3503-	W3ESO 7007	<i>14 Mc.</i>
W3GKP 3517	W9IVL/3 7020	W3IEE 14326
W3BWT 3548	W3IBS 7020	<i>28 Mc.</i>
W3ZD 3557	W3ESO 7021	W3HVS 29008
W3GKP 3560	W3HMX 7122	28580
W3EEN 3625	W3IPX 7145	Captains:
W3ECP 3630	W3CJR 7160	W3DK, W3WU
W3BWT 3790	W3CDQ 7220	W3CVO, W3CIZ
W3EEN 3806	W3EYX 7270	W3IBS
3910 'Phone	W3CJR 7290	W3EEN
W3ZD		

WANTED — EMERGENCY COÖRDINATORS

The aim for several months past has been to expand the Emergency Corps and to appoint an amateur spokesman, a qualified A.R.R.L. Emergency Coördinator for each one of the 3700 Red Cross Chapter jurisdictions of our country.

Do you know if the Section Manager has appointed a League member as such an organizer and spokesman for the amateur service in your locality? Such a Coördinator may be made a member of the Red Cross' Sub-committee on Transportation and Communication. If there is an opening, if you would do your best to register and plan the use of all local amateur radio facilities in line with the League Plan, drop a line to your S.C.M. (see page 4 for address) right away.

Each Washington district is under a "captain." Many additional stations will be enlisted in the receiving effort, to cover all amateur bands, by the time this appears in print. All stations will be operated as much as possible during the whole period of the Preparedness Red Cross Test.

W1AW will set aside all regular schedules Friday, April 4th, devoting all its facilities to collection of Washington bound traffic (in busy hours) for QSP (relay) to Washington stations on schedule at hours when general work is lightest. On April 5th and 6th as much time as possible will be spent in the Red Cross Test. W1AW will observe its times to clear Trunk Lines and the periods of General Operation (see list in Operating News section) for clearing Washington bound Red Cross traffic from each named band.

CQ ST. LOUIS . . . for St. Louis Stations¹

<i>1.8 Mc.</i>	<i>W9ZVJ</i>	<i>W9EKY</i>
W9DUD	<i>3.9 Mc.</i>	W9BPN
W9HVC	W9ZK	W9DZG
<i>3.5 Mc.</i>	W9EFC	W9DLB
W9RCQ	W9KEF**	W9AEJ
W9EKY	W9DUD	W9GHD
W9DJG	W9HVC	W9LTW
W9DLB	W9HJL	W9AXB
W9EFC	W9FIZ	<i>14 Mc.</i>
W9JTG	W9NDP	W9AUB
W9KEI	W9THB	('Phone)
W9PUV	<i>7 Mc.</i>	W9YRX
W9RKN	W9BEU	W9BEU
W9TBU	W9BMU	W9PW
W9GHD	W9EOW	W9BGE
W9KIK	W9AUB	W9EZX
W9AEJ*	W9RCQ	

* The Route Manager of the Mo. Net on 3755 kcs. invites calls and traffic for St. Louis delivery. Net stations will cover the band looking for calls of stations with traffic.

** Clearing the Mo. Emergency Net on 3903 kcs. including: W9QQI (NCS), W9NOY, W9CCU, W9TGN, W9FLD, W9TYZ, W9NIP, W9VMI, W9PUA, W9TYZ, W9CZI, W9PYK, W9XG, W9IMZ, W9ZIG, W9ZHY, W9WFK, W9HKW, W9HGB/W9YQJ, W9BRN, W9LTY, W9LVA, W9HVW, W9OCO, W9ZJG, W9MNN, W9CHE, W9SRE, W9MQD, W9LBM, W9FSZ, W9OMG.

Relief operators will man many of the stations in the above tabulation continuously. More stations also were to report schedules after these QST forms closed.

CQ SF . . . for San Francisco Stations¹

C.W. and 'Phone, all bands:

W6AAU	W6EY	W6OSY
W6AEX	W6HB	W6PFM
W6BEZ	W6IMA	W6QVQ
W6BGY	W6NZG	W6OMX
W6DDO	W6NZJ	W6VX
W6DSV	W6OMC	W6ZF
W6EHS	W6JGN	

3.9 Mc.

W6ADM (plus several receiving stations)

This Emergency Communication Test should make an active and interesting weekend of operating, a veritable traffic jamboree for all participating. If you have a station, you are urged to take part following the principles given in the March and this April QST announcement. Here's to luck and success in the Test.

— F. E. H.

¹ Or answers from other station that will offer reliable QSP (relay) of traffic to that point during the period of the test.



NAVAL COMMUNICATION RESERVE NOTES

Director of Naval Communications Receives "Medal of Service"

REAR ADMIRAL LEIGH NOYES, U. S. Navy, Director of Naval Communications, was presented the Medal of Service of the Veteran Wireless Operators Association on February 11th

In his acceptance speech, Admiral Noyes said in part, "It is a symbol of the interest and co-operation of your association in national defense. . . . Yours is indeed an association of veterans. . . . Many of your members received their first training and experience in military service. . . . Some of your members have been called into active service during the present emergency . . . many of you hold key positions in the radio industry. You are performing a service to your Government as valuable as military service itself. You in the industry and we in Government are aware of the task which confronts us. This is no casual problem! It will tax all of our capabilities! . . . Our national safety demands it and I know that you, the Veteran Wireless Operators Association, will make its full contribution!"

These words of Admiral Noyes have a great significance for the amateur radio operator since the amateur of to-day is the veteran of to-morrow. Already is the amateur found in the Army, the Navy and the radio industry — a task confronts him. His problem is to prepare himself to assist in the national defense — and he will make his full contribution.

Admiral Noyes knows the value of communication by radio through early association and experience. He was born at St. Johnsbury, Vermont, December 15, 1885, and was appointed to the Naval Academy in 1902 from Vermont. He was the first communication officer of the Navy Department, serving in 1915-1916, and in 1916 was appointed flag secretary and fleet communication officer on the staff of the Commander-in-Chief, Atlantic Fleet, Admiral Henry T. Mayo. While on the staff of Admiral Mayo he inspected the communication facilities of all U. S. naval forces in Europe, during 1917 and 1918. From September, 1920, until June, 1922, he served as Atlantic Coast Communication Superintendent, Office of Naval Communications. He established for the Navy Department for the first time a central communication service system, fitted to handle all messages whether by wire, radio or cable with great saving in time. On June 24, 1939, he was ordered to duty as Director Naval Communications in the Office of the Chief of Naval Opera-



Rear Admiral Leigh Noyes, U.S.N.

tions. He was promoted to his present grade July 1, 1939.

In addition to the Navy Cross, Rear Admiral Noyes has received the Victory Medal, Atlantic Fleet Clasp — U.S.S. *Pennsylvania*, and Decoration of the Order of St. Stanislaus, by the Government of Russia. He received letters of commendation for the rescue of survivors of the U.S.S. *Macon*, off the coast of California, February 12, 1935, while in command of the U.S.S. *Richmond*, and for directing the U.S.S. *Lexington's* search for Amelia Earhart in 1937.

Strays

Oil-mileage stickers used at automobile service stations make good markers for terminals, etc. They will stick to almost any surface and leave no mark when they are removed. — *W8OBZ*.

Oiled-silk refrigerator-bowl covers make good dust covers for microphones. — *W8IBG*.

By running a $\frac{1}{4}$ - or $\frac{1}{2}$ -inch lucite rod through the panel to a point close to a transmitting tube it is possible to tell whether or not the tube plate is showing color, since the end of the rod will show color also. All except the ends of the rod should be covered with some material which shields the light. — *W9DB*.



ON THE ULTRA HIGHS



CONDUCTED BY E. P. TILTON,* W1HDQ

IF ANY doubt exists that activity on Five has shown a healthy increase in the last year, the reports for the first period of the 1941 Marathon provide proof. The greater participation can be explained by the more widespread knowledge of the contest — the 1940 edition was introduced with little fanfare — but what is more important is the number of contacts made thus far. Dig out your April, 1940, *QST* and make a few comparisons.

Particularly heartening is the development of interest in parts of W6 and W9. At this stage of the game last year, fellows outside the area near the Great Lakes and up and down the Atlantic seaboard were fortunate if they could find more than one other station to work. All of which means that Five is now well established as a national proposition — and its popularity is growing daily. So if you are one of those who has had an urge to try Five, but have hesitated to take the leap for fear that there'd be no one for company, get started right away. There's just about time to get that rig perking and that beam up before the DX season swings into its spring opening!

February, true to expectations, offered a recurrence of "aurora DX." And, as in every instance in the past, many DX opportunities were missed because most of the gang simply did not know what it was all about. W8NOR, North Tonawanda, N. Y., heard at least a dozen carriers of 'phone stations — all unintelligible — appearing suddenly around 9 p.m., Feb. 5th. Several c.w. CQ's brought no response until W2KLLZ, Johnsonville, N. Y., was worked, followed shortly by W2AMJ. W1LLL, Hartford, was the only other c.w. signal heard, in a band full of fuzzy modulated carriers. W1HXP, Newton, Mass., worked W8CIR, Aliquippa, Pa., and heard W8NOR and W2AMJ. W1LSN reports hearing W8CIR, W8NOR and W2AMJ, as did W1DA. W1LLL and W1AEP both heard W8NOR.

W8NOR found the band open the next evening, Feb. 6th, between 7 and 8 p.m., when W8SLU, Auburn, Mich., was contacted. All this work is in that difficult range between 200 and 500 miles. Aurora refraction represents a chance to make contacts with states and over distances which cannot be worked by any other medium. And just about all it takes to work it is a key and a wide-awake attitude toward band conditions! By the time this appears in print, there will very likely have been a recurrence of this phenomenon in early March, and if this season follows last year's lead there will be another opportunity during the first week of April.

February provided just a smattering of sporadic-E DX, too. Catching most of the band napping, things popped open for W1-W9 work around 4:25 p.m., Feb. 15th. The ever-present W1LLL was the only one we know of who was quick enough to catch this one. Brownie worked W9KEW, Union, Ill., while your conductor was changing bands, having been given brief warning by the sudden outburst of W8 and W9 sigs on Ten. A contact between W6OVK and W5VV was reported on Feb. 1st. On the 14th, the band was open for Tucson again, W6OVK and W6SLO both working W5HTZ and W5AFX of Oklahoma City.

HERE AND THERE:

THE "New England Net" is one of the reasons why activity is picking up around Boston on Five. With W1DJ, Winthrop, Mass., as control station, a rapid-fire roll-call is made each Thursday night at 8 p.m. No lengthy conversations — the list is too long for this now — just a round-up of the active stations so each can find out who is on and where to find the others. Stations are called according to frequency, with the list starting at alternate ends of the band from week to week. While the net is semi-local in character, the roundup occasionally includes stations in Western Massachusetts and Connecticut when conditions permit.

From W1ELP at Harvard's University of Geographical Exploration, we learn that a fine topographical map, "Landforms of the United States," by Erwin Raisz, is now available. With work on Five over distances in excess of 200 miles becoming increasingly common, it is of considerable interest to examine the nature of the terrain over which these hops are made. The Geodetic Survey maps are fine for studying local features, but for a country-wide picture, the map referred to above is one of the best we've seen. It may be obtained from Dr. Raisz at the Institute, 2 Divinity Ave., Cambridge, Mass. Prices: single copy, 50 cents; 10 copies, 35 cents each; 25 copies, 25 cents each.

Several years ago, W1AEP, Springfield, Mass., took a fling at Five. Chellis was not too favorably impressed then. The boys didn't give his crystal-controlled rig much of a tumble — and he never did get used to that super-regen rush. But it's all very different, now, and you'll find W1AEP on 56.8 Mc. every afternoon and evening, knocking them off with 200 watts to a T-125 and a variety of beams. Chellis, who gets out of work at 3 p.m., is looking forward to the day when he can tell W1LLL that the band was open before Brownie got in on it. He'll have to get up early and stay up late to pull any fast ones on that guy in Hartford!

The band boasts at least two YL operators. You've heard about Bernie May, W5JKM, but be on the lookout for W2FHJ, also. Viola has been on Five quite consistently for two years, making plenty of noise around 56.8 Mc. An acorn converter ahead of a new SX-28 does a fine job on the receiving end at W2FHJ.

"/3, Washington, D. C.," is quite the fashion these days. One of the latest is none other than W9BNX/3. "You can work all districts — with a whistle — around these streets," Bill reports. He's found a good house — quite a feat, we're told, in that area — on the highest ground available. What's the altitude for, Bill?

Good news from Louisiana: W5ML, Oil City, reports that he works W5DXB and W5CQV of Vivian, nightly except Saturday, from 7 to 8 p.m. W5ZS and W5AKI will soon be

* 329 Central St., Springfield, Mass.

on, as will W5EEL and W5IOP of Shreveport. For Louisiana on Five, watch for the following:

W5CQV, Vivian,	58,010,	25 watts
W5DXB, Vivian,	58,088,	60 watts
W5ML, Oil City,	57,080,	100 watts
W5AKI, Oil City,	58,800,	250 watts
W5ZS, Dixie,		200 watts

And in Drew, Miss., W5JDR is wondering about his chances of getting in some contacts on Five. With his state one of the few from which signals on Five have never been heard, he should do plenty of business during band openings, and possibly the Louisiana gang could be worked if test schedules were arranged.

Around Los Angeles, W6QG reports at least ten active stations on Five. These include PTJ, IKH, IOJ, AVR, LQX, IFQ, ANN, LYN, MYJ, CLH, and QG. W6ANN received the dope on the famous W6QLZ 4-element beam. With the advent of more stations in this area, California-Arizona work should be possible frequently during the spring and summer months, and occasionally throughout the year. Harmonics from California stations working on Ten are heard frequently by W6OVK, W6QLZ, and others in Arizona.

W6QLZ continues daily skeds with W6OVK. This 100-mile-plus circuit has never failed since the erection of horizontal beams at both ends last November. W6PQG, Benson, Ariz., has been hearing Clyde during these skeds occasionally. This is a real achievement — a hop of around 150 miles — over country which is even rougher than that between Phoenix and Tucson. W6OVK and W6PQG have been working regularly, with PQG transmitting on 40 and listening on Five. W6QIN dropped in at Tucson to visit W6OVK just in time to find the band breaking open for W5 on the 14th. Ray was duly impressed by this demonstration, and also by the performance of Jim's crystal rig and converter for 2½.

W3HJQ/5 is now located in Albuquerque, N. M. Frank is running daily skeds with the Arizona gang. That's optimism for you — it's a mere 325 miles of mountainous country to Phoenix and Tucson! Nothing tried, nothing gained. Frank is working on the local gang, too, and expects to have W5IZQ on shortly. Via 28 Mc., W5ICD of Hurley, N. M., reports that he will be going on Five soon. It appears that

New Mexico will definitely be on the five-meter map this spring and summer.

W6QLZ has always had a tough time with his line voltage. The power generated on the ranch had an annoying way of dropping off to about 70 volts or so just at the wrong time, so Clyde has arranged to have lines run up by the local power company. This cost a pretty penny, but Clyde says it will be worth it to know that he will not have to worry about having to go off the air every time the pump starts up. And besides, that ranch power was 25-cycle, and it put a terrible ripple in Clyde's 2½-meter carrier, making it tough to copy on W6OVK's converter.

Up in Montana, W7GBI has some five-meter prospects lined up, with W7BYQ and W7CYP of Glendive promising to be on the band in time for the DX this spring. GBI will be running around 500 watts to a 250TH, and watching the band for any chance of working out to those W5's and 9's who are after that W7 contact. Watch that band closely in July. Bud, and maybe you'll have a W1, 2, 3, or 8 for your trouble, too. To date, only W5, 6, and 9 have worked W7 on Five, and not too many of these.

Wanted: K6's who will make a real effort to work across to the Coast on Five. K6MNV's second harmonic was heard last year by W6QLZ, and distances equal to this have been covered over land, so it appears that a contact between K6 and W6 or W7 should not be too difficult. But it will take some consistent effort on the part of a few K6's — or some phenomenally good luck! K6FSF has promised to be on, and we understand that schedules are being arranged with K6OQE by W6's BPT, HKO, GAQ, and TBK.

W9AB, sending in his first Marathon report, says that things in Northern Indiana are looking up. Harry and W9WDV are on in Mishawaka, and in Fort Wayne, W9's QCY, ODW, UJE, UUN, and YQV are active. W9QCY works into Indianapolis, about 100 miles, regularly. W9NYY, South Bend, is working on a 500-watt rig. The Fort Wayne gang are "between the devil and the deep blue sea" on the matter of polarization, being halfway in between the irreconcilable advocates of both types.

W9ZHL, Terre Haute, reports a new one there, W9YXT. At Evansville, W9HGJ and W9UIA are making the 100-mile hop north to Terre Haute. This looks like the beginning of a nice north-south relay circuit up to Detroit and Kalamazoo, Mich. W9ANH says he hears that stations are coming on in Vincennes and Bicknell, Ind. Henry suggests that if fellows who are trying to get on Five (or those who are on but have no local activity) would make themselves known to the fellows who are now on regularly, it might be possible to work out their difficulties and promote more activity on the band.

The twice-weekly schedules of W9YKX and W9ZJB continue to be successful, and now YKX is working W9NFM at Solon, Iowa, a distance of 235 miles, on regular schedule, 8:30 p.m. nightly. This is the longest distance over which, to our knowledge, communication has been maintained on 56 Mc. other than at irregular intervals. Though the country is essentially flat, and therefore favorable, 235 miles is a real hop in any country. Horizontal beams are used in all this work. Bill reports a contact with W9HAQ at Davenport on Jan. 24th. This is clear across the state of Iowa, a distance of 260 miles. During this QSO, YKX was heard in Zeoring, Ill., by W9ZHB, some 335 miles away! What will happen next summer when things get good?

If the April 25th-26th Relay doesn't make history, it won't be the fault of the Middle West boys. W9ZJB sent his mobile rig to W9PKD at Salina, Kansas. It will be used to drive a pair of T-20's at about 100 watts on 57,350. Salina is 160 miles or so from W9ZJB and should be workable readily, either direct or via W9VWU at Topeka. From W9PKD it is only a matter of 70 miles to W9QPK at Russell — and then if only some of those Colorado boys would get going again!

112 MC. AND UP:

JUST a few hours too late to make last month's issue as last-minute news, came a wire from Arizona, which tells its own story:

TUCSON, ARIZ., FEB. 6, 1941.
JUST WITNESSED CROSS-BAND CONTACT, 6QLZ

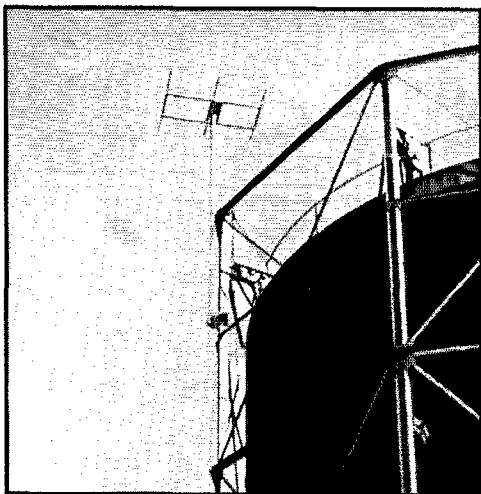

How does he get away with it? W9CNJ, Robinson, Ill., has his 3-element "Q" array mounted at the top of a gas storage tank, 95 feet above ground. Rotating device is a revamped chain hoist. Photograph by W9BDL and W9GTS.

ON 2½ AND 60VK ON 5. TWO-WAY PROMISED SOON. MOUNTAINS HIGH AS EVER.

6PCB

Yes, they make it on 2½, too! Using a variety of transmitters, including a concentric-line oscillator and a crystal-controlled rig, the signals of W6QLZ are now heard regularly by W6OVK on his converter and 3-element horizontal beam; 105 miles over mountainous country on 2½!

W3BYF has forsaken Five for 2½, along with W3BZJ. Pres has a 6V6 crystal oscillator on 14 Mc., a 6A6 and 6L6

U.H.F. RECORDS

Two-Way Work

- 56 Mc.: W1EYM-W6DNS, July 22, 1938 — 2500 miles.
- 112 Mc.: W6BJJ/6-W6KIN/6, July 4, 1940 — 255 miles.
- 224 Mc.: W6IOJ/6-W6LFN/6, Aug. 18, 1940 — 135 miles.
- 400 Mc.: W6IOJ/6-W6LFN/6, Jan. 28, 1941 — 20 miles.

1941 U.H.F. MARATHON

(Incomplete summary of first reporting period, Jan. 16th-Feb. 15th)

Call	Contacts Through Feb. 15th				Score	States in 1941
	56	112	224	400		
W1AEP	14				70	3
W1BBM			1		10	1
W1DJI	51				134	4
W1EHT	26				83	2
W1EKT	34				105	2
W1HDQ ¹	56	13	1		346	7
W1IJJ	23	14			176	4
W1JAX	9				25	2
W1KIJ	14				62	3
W1LLI	24				122	4
W1LSN	29				102*	2
W1MBS		72			194*	1
W1NBU		23			73	2
W2ADW	1	6			30	2
W2AMJ	43				189	7
W2BYM	13				42	4
W2COT	9				16	2
W2DZA		55			163	3
W2FJQ	20	2			22	7
W2LAL	38				108	3
W2LXO		22			65	2
W2MGU		37			128	3
W2MEU	27				75	4
W2MQF		14			37	2
W3ABS	22				59	4
W3ACC	29				94	6
W3AXU	11	11			56	3
W3BYF		4			14	1
W3BZJ		23			110	3
W3CGV	34	1			122	4
W3FSM		2			4	1
W3IIS	15				69	4
W5FSC	1				1	1
W5VV	1				10	1
W6ANN	12	21			160	1
W6IOJ	10	9	1	1	116	1
W6OVK	9	1			97	3
W6QC	9				41	1
W6QLZ	5	2			70	1
W6RVL		48			159	1
W8CIR	18				133	5
W8KID	7	18			76	1
W8RUE	14				49	3
W9AB	2				4	1
W9ANH	7				67	2
W9ARN	15				112	3
W9BDL	11				110	3
W9PNV		33			118	2
W9RGH	14				84	3
W9VHG	19	4			79	2
W9YKX	5				88	2
W9ZHL	11				82	2
W9ZJB	5				22	2

¹ Not eligible for award.

* Looks like tops for first period.

Note to Contestants: Repeat contacts, for special activity credit, need not be listed in monthly report. Be sure to retain your log, however, as this may be required as evidence.

as doublers and an 815 final on 112,080 running 65 watts input. "Get them Kansas City and St. Louis boys stirred up," says Pres, "as 3BZJ and I have a buck on who works the first W9 on 2½ — so there'd better be someone out there to work!"

W1IJJ, Madison, Conn., says he calls CQ each day at 12:15 P.M. Many of the boys who are working nights will welcome this chance for some daytime activity. Owen has crystal control, p.p. HK-24's, on 113,920. He reports activity brisk around Bridgeport, with W1's ASO MRF MWV CLH CPL and JMI being heard at Madison. CLH is another night worker who checks the band nightly 11:30 to midnight. There is quite a bit doing out on the far end of Long Island now, with W2ADW, W2LUD and W2KPB working across the Sound. W2LXQ is operating from Fisher's Island.

W1JP says that W1EJB has formed the "Southern New England 2½-Meter Emergency Net" in the area around Providence, R. I. Nearly all the thirty or more stations take part in a workout each Sunday at 11:30 A.M. Practice messages are exchanged and relayed to stations who cannot hear each other. In Providence, too, is the "Four Minute Club," with a roundtable held each Monday night at 8:30 under the guidance of W1NDQ.

Note that we have a new 400-Mc. record. W6IOJ and W6LFN made it 20 miles on Jan. 28th. On Feb. 2nd, tests were made over a 112-mile path (that Los Angeles-San Diego business, again) at 5-minute intervals on 112, 224, and 400 Mc. The same power, 5 watts, was used on all frequencies — and the signal got through on 400 Mc. only! No contact was made at this time, but you can expect it anytime now. Incidentally, we think that W6IOJ's 400-Mc. receiver (described in *Radio* last month) is one of the neatest bits of gear we've seen described in many a day. It should have possibilities for 1½, too.

The "Centimeter Net" is functioning again. With W1's AIY, Wolcott; HEDF, Elmwood; and KIJ, Bristol, Conn., and your conductor now set for operation on both 56 and 224 Mc., some very interesting workouts are taking place each Saturday evening. Anyone with gear for 1½, transmitting or receiving, is invited to take part.

Sometime back we mentioned that u.h.f. mobile kit is great stuff for keeping the family satisfied without missing doings on the band. Zella Harris (Mrs. W6RVL) says she concurs in this. She and Al have had some really fine outings — including the time Al left the coils at home, and the time he forgot the tent!

Strays

A choke consisting of about 15 turns of No. 12 or 14 wire, wound to fit over the cap of my 866's, eliminated r.f. in my rectifier. The inductance of the choke may be varied to a certain extent by sliding the coil up or down on the cap, thereby short-circuiting a portion of the coil. — W6SUD.

A rather odd QSO took place when W9OLD worked W9NEW. It looks like the F.C.C. made a mistake in issuing the calls, since NEW is 43 years of age, while OLD is only 18. — W9OLD.

Boost Your Code—Start Traffic

BY F. E. HANDY,* WIBDI

HAMS — GET IN THIS!

Amateur Radio Traffic from Uncle Sam's Trainees is already on the air. It will increase. It is an amateur radio job to help the morale of our soldiers and sailors. Your assistance, please. It is amateur radio self-training to keep every amateur frequency busy with the traffic.

Get in touch with your S.C.M. to get into a net or to accept an organizing post as explained on page 30 of March *QST*. Handle messages in proper form. Get in trim as an operator. Complete all messages with handling data. Report to your S.C.M. to earn O.R.S. appointment!

MAKE your first aim real code proficiency. Get so you too can take it on a mill. For practical experience in handling communications go for traffic handling in a big way. It is a stepping stone to top rank in operating; it is a sure road to higher code proficiency." The quoted remarks were our concluding words in last month's article suggesting the direction for our work to take when acquiring one's Code Proficiency Certificate. This month we promised to tell something about using our code ability to handle messages. Learning to handle messages may be compared to learning to swim. Few people learn about swimming from a correspondence course! The way to learn is by noting the principles and then actually handling some messages. For message handling principles study of the Operating a Station Chapter in the A.R.R.L. Handbook is recommended. Actually to get the principles of message handling down pat, you must "learn by doing." Quite likely you will find that handling recorded traffic will give you a new thrill and a new feeling of responsibility, if you have never gotten into this fascinating part of amateur radio before.

As a starter, you may wish to follow the advice (of last month) that you handle ten messages in proper form over the air. Try to send some messages for relay beyond the station immediately contacted to see if you can get any answers. Originate some traffic. Whether you write all ten messages to your own distant amateur friends or invite the family and neighbors to assist in your initial entry into message handling work, you must aim to do everything from start to finish correctly. ACCURACY is the first and last aim for reliability must come first.

* Communications Manager, A.R.R.L.

Drafting Messages

Before we can send a message it must be placed in proper form. In drafting messages ambiguity must be avoided. Make every message started both clear and suitably brief. Give it an adequate or preferably more-than-adequate address, so it can be delivered. In writing out a message, or assisting others to do so, it must be made plain that the *reliability* of conveying the thought, the *speed* of handling, and in amateur radio the voluntary effort of the handling operators to put your message through, all depend on the careful phrasing of the text. Choice of wording helps to avoid garbles when messages must be relayed through several stations. "Apparent importance" is a factor in getting operator cooperation, especially if the message wanders outside organized amateur radio traffic operator groups.

Every amateur of course considers it his duty to learn as much as possible about the use of radio in communication. From the purely selfish standpoint he stands to profit, of course, since training may help to fit him for a pay job to his liking in connection with the national defense program. Drafting requires a certain skill of its own to achieve complete understanding with a maximum degree of conciseness.

Message origination involves responsibility, since the Communications Act makes one responsible for a station log and message files. The secrecy of communications section (605) is important. Addressed communications must be considered inviolate. Such information is subject to release to unauthorized parties *only* by an originator or addressee. Amateurs may accept no compensation for use of their stations to communicate. Sec. 326 of the Act requires refusal of any communications containing obscene, profane or indecent language. In these troubled times the A.R.R.L. code of precautions makes it also necessary to scrutinize traffic from strangers to avoid handling matter relating to the war or of possible military significance. In accepting already drafted messages or refusing them, a licensee must comply with the legal and common sense precautions that protect him and his amateur radio.

Once a message is originated it *must be sent as drafted*. Operators may not properly alter or change message texts in transit without authority from the originator.

Message Form

Even in this short article we want to include the form that is standard in drafting amateur radio-grams so you will be able to send complete mes-

sages. At some later date we'll hope to review the names of the parts and explain each in some detail. The parts and the order of transmitting them are as follows:

- | | |
|-----------------------|---------------|
| (a) Number | (f) Date |
| (b) Station of Origin | (g) Address |
| (c) Check | (h) Text |
| (d) Place of Origin | (i) Signature |
| (e) Time filed | |

Example:

(a) NR 1 (b) W9QAK (c) CK 7 (d) Northville S. Dak. (e) 5R40 PM (f) April 4 (g) Mr. Wm. M. Baxter, Jr., Midwest Area Red Cross Office, St. Louis, Mo. BT (h) REFERENCE LETTER FIFTH RECORD ME IN AFFIRMATIVE BT (i) John Doe

Numbers that identify messages in operator exchanges, receiving, etc., are assigned at the originating station from a consecutive number list or "number sheet," such as that which you will find in every A.R.R.L. log book for your convenience. In amateur work the number given a message stays with it regardless of the number of times relayed by intermediate stations. The booklet "Operating an Amateur Radio Station" explains all the parts of a message in detail, and will be sent gratis to League members (10¢ to others). Word count is explained in the operating chapter in the Handbook, pages 430-436, also. Unless you run into something out of the ordinary, it may be enough to know that the check includes a count for each "dictionary" word in the text of the message. Figures and punctuation may be spelled out for accuracy. In counting figures a group of five digits or less counts as a word. Amateur calls sent as a group now count as one word. Standard message form helps each operator to know what is coming next so his writing falls into place neatly on the message blank.

The *Radio Amateur's Handbook* is a complete manual and includes the valuable operating information every amateur wants and which you will not find in competitive publications. Study your subject. The fundamentals of good message work will come quickly if you will make yourself familiar with the abbreviations and methods of getting fills, and put into practice on the air examples of the traffic you read about so you can meet the situations that come up. It is all quite simple. Only an attempt to cover the finer points requires treatment at length.

(Continued on page 90)



The big news in our April, 1916, issue was the report of the Washington's Birthday relay, by 9XE, who managed it from Davenport, Iowa. A message from the commanding officer of the Rock Island arsenal was transmitted from

9XE and relayed by amateurs all over the country to the governors of their states. It is reported that for the first time in amateur history the air was silent at 11 P.M. as the message started, and then the gang went to work. The message reached the West Coast in 55 minutes, the East Coast in an hour, New Orleans and the Canadian border in 20 minutes. The participants included many famous names of that day and some that are well known in amateur circles to-day, including K. B. Warner, then 9JT in Illinois, and A. A. Hebert, the League's treasurer. The text of this message is worth quoting to-day:

A DEMOCRACY REQUIRES THAT A PEOPLE WHO GOVERN AND EDUCATE THEMSELVES SHOULD BE SO ARMED AND DISCIPLINED THAT THEY CAN PROTECT THEMSELVES.

Hiram Percy Maxim's idea for relay organization is taking hold in great shape. M. B. West, the famous 8AEZ, offers coöperation and helpful suggestions. Mondays and Thursdays are to be relay nights, when the entire country will be lined up for messages. "Big things will now be happening in the A.R.R.L. . . . New records for receiving and sending will be surely made. All of those with poor insulation, unsoldered joints and doubtful tuners want to get busy and fix things up p.d.q." The League announces the appointment of A. A. Hebert, 2ZH, of Nutley, N. J., as manager of Trunk Lines C and D; and of R. H. G. Mathews, 9IK of Chicago, for Trunk Lines A and E.

Hebert has written a technical article, "The Sending Set": how to tell when you have the right number of Leyden jars and the right gap speed, how to make pancake O.T., and a warning against having your h.v. wiring parallel to the house wiring, lest you blow the meter and set the house afire. . . . Another article describes the mica-diaphragm "amplifying receivers," the headphones later to be manufactured by Baldwin. The article is by their Philadelphia inventor, Thomas Appelby, and an advertisement in the same issue shows the price of the 'phones to be \$24!

The deForest tubular Type T audion is announced at \$5.50, the first vacuum tube available without buying the whole instrument or returning a burn-out tube. An abortive offering of the Audiotron is also made, but its price is \$6.50, and it is not to be heard from again for many months.

Amongst the amateur stations described is that of Orrin E. Dunlap, of Niagara Falls, he who is later to be radio editor of the *New York Times* and now a big-shot in RCA publicity. Amongst new members joining the League are Edward G. Raser, 3NG, now W3ZI in Trenton; and Frank M. Corlett, 5ZC of Dallas, later to serve many years on the League's Board as director of the West Gulf Division.



HINTS AND KINKS FOR THE EXPERIMENTER



FILAMENT-TRANSFORMER KINK

HERE is a kink which may come in useful in an emergency. Sometimes a ham has a filament transformer delivering 5 volts or some other voltage and has need for one delivering 6.3 volts. A simple solution is to take a small core and wind an autotransformer on it, the autotransformer to operate from the 5-volt transformer (or whatever the available voltage happens to be).

The diagram of the autotransformer is shown in Fig. 1-A. Make the 5-volt section about 3 turns per volt and then add more turns, tapping off at about every two turns.

The idea has the merit of extreme simplicity, since few turns are required and no particular attention has to be paid to insulation. An autotransformer can be wound up in a few minutes. The wire should be of sufficient size to carry the required current and the amount of power drawn from the autotransformer should not exceed the rating of the transformer from which it is operating.

Another variation of this idea is shown in Fig. 1-B in which a home-wound transformer is de-

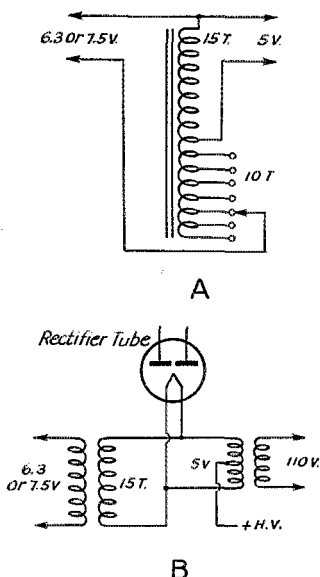

Fig. 1 — Details of simple transformers suggested by N8FU. A — Autotransformer. B — Isolating transformer.

signed to operate from the filament transformer supplying a rectifier. Isolation between rectifier and other filaments is thus obtained. Here the insulation must be sufficient to withstand the voltage at which the rectifier is operating and the rectifier transformer must have a rating capable of handling the extra power drawn from the homemade transformer. — *J. C. Nelson, N8FU.*

BOOSTING THE ANTENNA HEIGHT

SOMETIMES in changing antennas around, it may be necessary to get a little more height at one end or both ends to clear some obstruction.

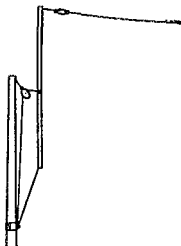

Fig. 2 — Scheme for boosting antenna height used by W5AJJ.

A scheme which I have found very useful is sketched in Fig. 2. A ring of heavy wire is attached to the bottom of the new section and the regular halyard is attached at a point farther up which will give the section good support. If a new set of guy wires is attached to the top of the new section, an appreciable increase in height is obtainable.

The spur idea suggested by VE4KN in Hints and Kinks for June, 1940, should work well in this case to anchor the bottom of the top section and take the strain off the halyard, especially if a second ring is added near the point where the halyard is attached.

— *Bernard S. Shields, W5AJJ.*

MAST-RAISING KINK

IN THE various mast-raising schemes suggested from time to time, we often see a ladder put to use, usually as a sort of gin pole. In erecting

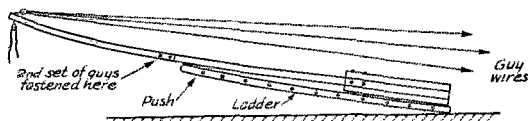

Fig. 3 — W2JAW uses a ladder to brace a light mast while it is being erected.

a mast of moderate height made of light material, such as the popular "A"-type mast made of "two-by-two's," the ladder can often be used to advantage in the manner shown in Fig. 3. Here the ladder is used to prop up the mast to keep it from bending to the breaking point when it is pulled up with the guy wires. The ladder, rather than the mast itself is "ginned" up. Of course, careful timing between those handling the gin pole and those pulling on the guy wires is required, but I have put up a 50-foot stick in half an hour without any trouble. It is essential that the part extending beyond the ladder be kept bent up by proper tension of the guys.

— Robert Hidley, W2JAW.

A KINK FOR THE WORK BENCH

How many times have you wished for a third hand when you're trying to solder some small object? The sketch of Fig. 4 shows one simple way of providing that third hand. Take a

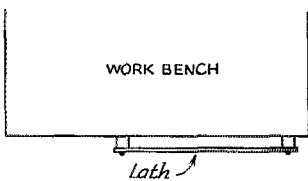

Fig. 4 — Convenient "third hand" for work bench for holding small objects suggested by W2LRT.

six-foot strip of one-inch by one-quarter-inch strip or a long lath and fasten it to the front edge of the work bench as shown. The strip should be spaced out from the bench about one-quarter inch at each end with spacing blocks of wood.

Now, when we have some small object we wish to be held, we can wedge it in between the lath and the edge of the bench. The center of the strip can be bowed out somewhat and the object can be slid toward one end until it is held firmly.

— Lewis C. Bohn, W2LRT.

CUTTING SQUARE HOLES

Fig. 5-B shows how a lot of filing can be avoided in cutting a square hole in a chassis.

The usual practice is to drill half-inch holes at opposite corners of the rectangle to be cut out and start sawing with the hacksaw immediately. This results in a long sweeping cut from the center of the hole before the saw can be brought along the line marking the side of the rectangle. If time is taken to do a little filing around the holes before the hacksaw is started, the saw can be started on the line and the sides will then require only smoothing up with the file.

Fig. 5-A shows how a simple holder for a hacksaw blade may be made in case the regular frame cannot be used. — Harold S. Davis, W8EOY.

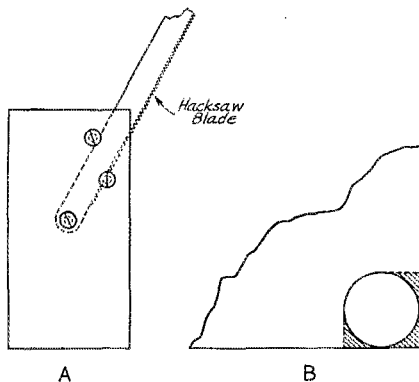

Fig. 5 — Showing how W8EOY avoids a lot of filing in cutting rectangular holes in a chassis.

PUSH-TO-TALK WITHOUT FIXED BIAS

I HAVE had the problem of providing a push-to-talk arrangement which was complicated by my unwillingness to use fixed bias on the Class-C stages and more than one relay. The arrangement I am using is probably not original; however, it is providing rapid push-to-talk, and I am passing it on hoping that it may be of use to some of the rest of the boys.

Briefly, the system shown in Fig. 6 consists of a sensitive relay connected with the coil in the buffer grid circuit and the contacts, arranged to close when energized, connected in series with the Class-C power-supply primaries. A key or push-button is also provided in the negative high-voltage lead of the oscillator.

The action is such that the relay only closes and puts power on the Class-C plates when there is excitation from the oscillator. Should it fail to start or stop after it has once started, the Class-C tubes will be protected even without fixed bias on the grids.

I hope that this arrangement may be of some use to those who don't want to use a lot of relays

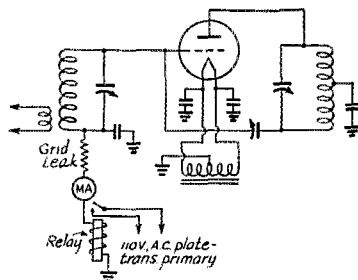

Fig. 6 — W1LRU's scheme for push-to-talk without fixed bias. The relay used is the Utah R.A.C. 110. Connected in the grid return circuit of the buffer stage, the relay opens the primaries of the plate transformers which supply the amplifier stages when excitation is removed.

and relay batteries and who do not want the added complication and expense of a bias supply for the Class-C stages.

— *Nicholas A. Welch, W1LRU.*

KEYING MONITOR

THE new 117-volt filament tubes can conveniently be applied to many amateur uses for there are no dropping resistors nor transformers for the filament circuit. The keying monitor shown is a practicable application of the new 117L7GT. It consists of an ordinary "growler" or audio oscillator which uses one-half of the tube while the other half rectifies a small portion of the radio-frequency output of the transmitter to act as the "B" supply for the "growler."

This circuit was developed to feed in parallel into the headphones which are connected at all times to the receiver. If the headphones are not to be used in conjunction with the receiver, C_1 can be increased to 0.01 μf d. which will give an increase in volume. On the particular receiver in use a ground hum could be distinctly heard until C_1 was reduced to a small value. The pickup link consists of two turns of well-insulated wire, about 3 inches in diameter, connected to the monitor by a twisted pair. The amount of power used is very small, which allows the pickup link to be coupled to almost any tank coil—very loose coupling on high power. The grid leak, R_1 , is a variable resistor to adjust the tone. This is the only adjustment necessary since changing bands or varying the operated frequency has no effect.

Other types of monitors were tried but were either noisy in b.c. sets when coupled to the receiver, needed adjustment for change in frequency, or too complicated. This monitor is completely free from b.c. interference, needs no adjustment when frequency is changed, is very compact and easy to build.

— *C. Ray Wagner, W2FEN.*

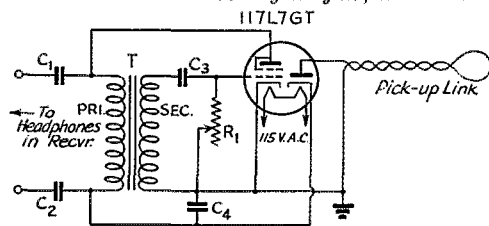

Fig. 7 — "Powerless" keying monitor used at W2FEN. Plate voltage for the audio oscillator is obtained by picking up a small amount of r.f. from the output stage and rectifying.

R_1 — 0.1-megohm, variable.

C_1 — 250- μf d., mica.

C_2, C_3 — 0.01- μf d. paper.

C_4 — 0.1- μf d. paper.

T — Audio transformer.



W6IWU's name is George R. Stray.

A "Bugless" 5-Meter Transmitter

(Continued from page 16)

our driver exactly, with success equalling ours. However they still stuck to push-pull finals which refused to neutralize. Finally one of the pair installed a single 812 and has since had excellent results. Just a few days ago the remaining push-puller gave up and is busily installing a single-ended stage. The fact that not one but three rigs, built by different parties, have all been successful speaks for itself.

As to antennas, we have found that a simple horizontal half-wave antenna is entirely satisfactory. This is coupled to the transmitter through a matched transmission line with a spacing of two inches. No doubt a coaxial cable would be better but us poor folks just can't afford that stuff.

The transmitter is successfully modulated by a cathode-modulator unit employing two 6L6 tubes in the last stage. No trouble whatsoever was

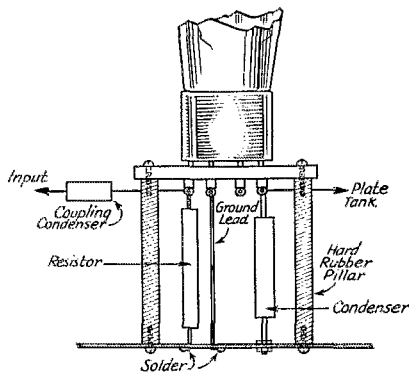

SOCKET ELEVATION

Fig. 2 — Method of mounting sockets and wiring.

experienced in getting upward modulation, nor were any special provisions (such as variable grid bias in the final) made other than placing a center-tap resistor across the filament of the final, connecting the center tap to the modulator and letting her go.

As indicated in the diagram, the plate voltage on the first three stages is 500 volts. Plate currents run as follows under normal conditions: 6V6, 45 ma.; 6L6, 60 ma.; T21, 90 ma. The TZ40 takes about 125 ma. at 1100 volts, depending upon the antenna loading; the plate dissipation is somewhat excessive at the higher current so the input is generally kept at a lower figure. The plate efficiency and output will of course depend upon the audio power available for modulation; with 30 watts of audio and 135 watts input to the TZ40 the output should be about 80 watts and the plate dissipation not too far above rated. More audio power will permit greater plate efficiency and hence more input and output.

Results, Sixth U.H.F. Contest and Relay

JAMES R. BUCKLER, JR., * W9NFL/1

SCORES, SIXTH U.H.F. CONTEST AND RELAY

(Figures represent score, number of stations worked and number of states worked. Letters indicate band or bands used. A for 56, B for 112 and C for 224 Mc.)

W3HOH	4164-53-6-AB	W2SQ	120-13-2-B
W3BZJ	3120-38-5-AB	W8BHY/8	120-4-1-A
W1HDQ	1488-14-4-AB	W2NDJ	119-24-2-B
W1IJ	1040-13-4-AB	W1JDV	118-22-2-A
W2DZA	834-33-3-AB	W3HTF	116-14-2-B
W8CIR	712-11-4-A	W1LSN	96-18-2-A
W6OFU	666-12-1-ABC	W1HUV	84-27-2-A
W2HYJ	624-34-3-AB	W9PNV	80-14-2-A
W2NKO	596-40-4-B	W1EHT	70-12-2-A
W8KQC	396-12-3-A	W2MQF	60-8-2-B
W1DJ	306-28-3-A	W6QLZ	60-3-1-A
W1EKT	294-29-3-A	W9BDL	58-5-2-A
W2LAU	282-35-2-B	W1DID	56-16-2-A
W8QDU	276-15-3-AB	W1MDN	51-13-2-A
W9VHG	267-9-3-A	W8RUE	50-6-2-A
W2LAL	264-15-3-A	W1LPF	44-9-2-A
W8CVQ	243-5-3-A	W8SPY/8	44-7-1-A
W8GU	192-5-3-A	W6OVK	30-2-1-A
W9ARN	153-6-3-A	W6GBN	15-1-1-A
W2MIV	138-27-2-B	W3ABS	6-4-1-A
W2MWA	130-18-2-B		

THE December U.H.F. Contest and Relay was featured by a high degree of c.w. and m.c.w. activity. Encouraged by an extra multiplier for code operation, many of the fellows used this method for handling all or a large part of their traffic. Comments from some points indicated that relays would have been unsuccessful with any other means.

Another highlight was the extension of the East Coast-Middle West route in a westerly direction. W9HAQ, Davenport, Iowa, originated a message which was relayed all the way to W1HDQ, the longest route yet traversed by a message on u.h.f. bands without the aid of skip-DX. Other messages from W9ARN, W9WIV and W9VHG also passed along the same route which was: W9ZHB-W9VHG-W8CVQ-W8KQC-W8CIR-W8BHY/8-W3BKB-W3CUD-W3HOH-W1KTF-W1HDQ. Much of the credit for the success of this route is due W8BHY/8, who, at a time when few of the gang cared to operate in the field with portables, set up at the vital Blue Knob Mountain location which so effectively bridges the gap between eastern and western Pennsylvania.

In the scoring, top place went easily to W3HOH, Bernardsville, N. J., who worked 53 stations in six states to run up a score of 4164 points. Ken Kingsbury, operating on both 56 and 112 Mc., made liberal use of c.w. and m.c.w. in handling forty-five messages during the contest period. In second place comes W3BZJ, Glenside, Pa., with

* Communications Dept.

38 stations worked in five states, scoring 3120 points. W1HDQ worked 14 stations in four states to score 1488 points for third place. To the West goes credit for the only station reporting operation on three bands during the December contest. W6OFU made contacts on 56, 112 and 224 Mc. from various portable-mobile locations to score 666 points.

Although there were numerous occurrences of skip-DX during December, none appeared during the contest period. No such help was needed by those who had carefully planned in advance the routes to be used and who had, in previous tests, proved the reliability of these routes.

The following routes each carried a message to its destination. Asterisks mark those routes by which a reply was returned to the originating station.

W1LSN-W1JDV-W1HDQ-W1IJ-W1KTF-W3HOH-W2LAL-W2DZA; W1HUV-W1QB-W1DJ-W1HDQ*; W1EHT-W1DJ-W1QB-W1HDQ; W2MQS-W2LAU-W3HOH-W1IJ-W1HDQ; W2MIV-W2LAU-W3HOH-W3BZJ; W2VL-W2LAU-W3HOH; W2DZA-W2LAU-W3HOH-W3BZJ; W2LAL-W3HOH-W3BZJ; W2FUV-W3HOH-W3BZJ; W2HIK-W2DZA-W2LAL-W1KTF-W1HDQ; W2ILK-W2LAL-W2AMJ-W1KTF-W1HDQ; W2MIG-W2LAU-W2LYP; W3HOH-W3BKB-W8BHY/8; W3FED-W3BZJ-W3HOH-W1IJ-W1HDQ; W3BKB-W3HOH-W2LAL-W2KKE; W3BKB-W8BHY/8-W8CIR-W8GU; W8HUV-W3HTF-W3IUF*; W6GBN-W6QLZ-W6OVK*; W6GBN-W6QLZ-W6SLO*; W6QUK-W6OFU-W6QG; W8QDU-W8KQC-W8GU-W8CIR-W8BHY/8-W3BKB-W3GNA-W3HOH-W2LAL-W1KTF; W8RUE-W8BHY/8-W3BKB-W3CGV-W3HOH-W1HDQ; W8CIR-W8BHY/8-W3BKB-W3CGV-W3HOH-W1HDQ-W1QB-W1DJ-W1LSN-W1JDV; W8BHY/8-W3BKB-W3HOH; W8SPY/8-W8CIR-W8BHY/8-W3BKB-W3ACC-W3HOH-W1IJ-W1HDQ-W1QB-W1DJ-W1LSN; W8GU-W8KQC-W8QDU; W9TQR-W9PNV-W9OFV; W9RLA-W9PNV-W9OFV; W9VHG-W8CVQ-W8KQC-W8GU-W8CIR-W8BHY/8-W3BKB-W3GNA-W3HOH-W2LAL-W1KTF-W1HDQ.

Due to the lack of relay points in some sections and because changing conditions cut off established routes at times, some messages did not reach their destinations by the close of the con-

(Continued on page 72)

Strays

An example of the reverence with which one of our members regards his QSL cards from America was revealed to me the other day. On noticing the gaps on his wall where cards were once pasted, I asked him what he had done with them. He replied, "They have been packed away in a suitcase with my best suit of clothes in case we have to get out of the house quickly."

— G6NF, President, R.S.G.B.



CORRESPONDENCE FROM MEMBERS

The Publishers of *QST* assume no responsibility for statements made herein by correspondents.

SELLING YOURSELF TO THE JOB

612 West Joppa Rd., Towson, Md.

Editor, *QST*:

One thing that has been brought out by the letter from "Strictly Ham" and some of the replies is the fact that most of the writers do not seem to realize that there is a right and wrong way to get a job — whether in radio or in any other line of business.

They forget that the relationship between employer and employee is a strictly business relationship. The employer is buying two things — *time* and *capability to handle a certain job*, NOT time and capability to handle many things. The point where most hams, and others, too, fall down is in not making clear the fact that they are able to do *the job in question*.

Often they count on the statement that they are "hams" to cover this. But it doesn't. Unless the employer is a ham himself he doesn't really know that a ham actually is capable. Often he feels that most hams are young squirts who "fool around" with radio tubes as a hobby. . . .

The ham, or anyone seeking a job, should find out what type of work is demanded in the job for which he is applying. And he should spend all his efforts showing how he can fill that job. The rest of his experience might just as well be forgotten for all the interest it will get.

If, for example, the job in view is that of a tester, the statement "ham, no experience" is almost enough to end the interview. But if the applicant explains that for so many years he has been building and testing receivers, transmitters, frequency measuring devices, at home, with poor equipment — if he explains that he alone has kept an entire transmitting and receiving station in operation through his ability to find and repair troubles in his equipment — here's something that a man wishing to employ a tester can understand, can use to justify his hope that the man will be able to handle the job. . . .

Of course, if you are applying for a job as a commercial c.w. operator, with necessary licenses, the story is entirely different. Your testing ability becomes of little importance. Then you talk operating speed, message-handling experience on the ham bands, your record of accuracy, your ability on the mill, and all that part of hamming which applies to the particular job in question. . . .

Getting a job is like selling merchandise. You have to match your abilities to the job in question. And it's surprising how, when you can produce just such a match, the requirements of college degrees, special training and other such high qualifications will melt away! After all, an employer uses these only to be sure that the applicant is qualified. If you can prove it another way, the results, as far as he is concerned, are the same.

So before you apply for a job — in radio or any other field — do this. Sit down and write down on a piece of paper all the requirements of that job. Then, alongside of each write the particular experience you have had which helps you qualify. Memorize this — and talk these facts and little else.

Such arguments as, "Sure, I've never operated commercially, but how many of the boys from the schools have sat down at midnight with a three-tube bopper and taken 28 from the coast on the mill. Stick me in front of a real receiver and you'll see how much traffic I'll take." Or, "Listen, those fellows from the schools can line up i.f. transformers. But how many of them have kept a receiver running with nothing more than a screwdriver and a broadcast signal — running well enough, by the way, to work in the crowded hambands. Give me some real equipment, and I'll show you lining up that is lining up!"

Sell yourself by any legitimate means at hand. But *Do it*. If you can't get an interview, write all this on the application form, or on a piece of paper and stick it on. That alone will get you attention.

Remember — man-power, like merchandise, has to be sold. *Sell it!*

— Frank E. Lyon, W3HAL/WLQA

PAN-AMERICAN JOBS

South Duxbury, Mass.

Editor, *QST*:

Wayne P. Paschal, Acting Secretary, American Communications Association, C.I.O. Marine Division Local Two, is unjustified in his reference to Pan-American Airways in February *QST*.

Apprentice operators are started at \$100 a month. However, they do not, as Mr. Paschal would have you believe, go to work on clipper ships at this time. Pan-American pays them \$100 a month to study their procedure and spends hundreds of dollars in training these men. If paying a man \$100 a month to go to school is not fair, what is?

At the end of six months if the apprentice operator's progress is satisfactory he becomes an operator and receives a raise. These raises follow periodically during a man's tenure with Pan-American. Pan-American flight officers (radio operators, to you) work approximately every other day. Is this slavery? . . .

I was one of those operators who failed with Pan American. I believe that I was treated with the utmost fairness and my failure was due to inexperience, not any personal feeling. Furthermore, I have talked and lived with many of the PAA radio operators and I have yet to meet one who had anything but praise for the fairness with which they are treated — according to their merits, not due to like or dislike on the part of their superiors.

— Winslow P. Freeman, W1HDV

QST OVERSEAS

Randolph Macon Academy, Front Royal, Va.

Editor, *QST*:

Reading over the correspondence addressed to *QST*, I was very hard struck over the letter written by W2CSS containing the letter of PAÖGE to him.

I should imagine that there are many more European hams in the same position in regard to financial matters. I ask that A.R.R.L. members do their little part in this war by extending *QST*'s subscription to every one of the helpless OM's in war-torn Europe. We are luckily born in a country where by the grace of God we have a government that will permit amateur radio activity. Let's not have the reputation fall upon American hams that America is only interested in its pocketbook. Why not see if we could have the A.R.R.L. take a sympathetic attitude toward European hams?

My suggestion to *QST* is for the A.R.R.L. to support a fund to carry on subscriptions for the European hams — the money to be paid back at a later date, that is, if and when Europe ever pulls itself out of its mad war. I myself would be more than glad to contribute to this fund, and I am sure many other hams have the feeling that they would like to

(Continued on page 104)



F. E. HANDY, WIBDI, Communications Mgr.

J. A. MOSKEY, WIJMY, Asst. to the Coms. Mgr.

Warning — Observe F.C.C. Order No. 72. Since last June 4th, U. S. radio amateurs have been prohibited from engaging in foreign communications. All amateurs are again cautioned to avoid any violations of Order No. 72 which forbids amateur communication with any or all points outside the continental United States and its possessions. In the last few months reports have been received indicating D4ARR, HR1AT and several Cuban and other foreign stations actively calling unwary U. S. amateurs. At least one CM/CO — disguised himself as a K4 to get answers to calls, which didn't in any manner lessen the fact of a violation of F.C.C. order, or the fact that a few W — amateurs have failed to appreciate that Cuba is indeed a foreign country. This paragraph is merely to say that the duty is incumbent on all licensees *to be watchful*. Work with foreign points is strictly unlawful and will not be tolerated. Close governmental surveillance is maintained. Avoid trouble by strict observance of Order No. 72.

Classify Traffic — in Monthly Reports to S.C.M. Traffic handled under a government (non-amateur) call, on a non-amateur-band frequency, should *not* be counted in amateur band traffic totals reported to Section Managers, but should be classified separately. Both the amateur total, and the "Army" and "Navy" totals may be sent to your A.R.R.L. Section Manager, who invites these reports on the 16th of each month covering your activity in operating a station for the previous 30 days for *QST* mention.

The policy expressed in the above has been in effect for several years. It means that our records of annual performance, our reports to the Board of Directors, refer to the use radio amateurs make of their amateur frequency bands in terms of message handling. From the standpoint of the individual amateur not affiliated with A.A.R.S. or N.C.R., it means that in the national traffic picture (which is something of a competitive scramble) he is on an even footing with every other user of amateur frequencies. For the chap who has a special government frequency on which A.A.R.S. or N.C.R. traffic for training may be exchanged, there is separate provision for a report of what was handled exclusively on the other-than-amateur-band frequencies for those who want to report this additional information. A glance at the B.P.L. or totals after the Station Activity reports will show the break-down or classification of traffic totals by what is handled under amateur calls, and under government calls

where such is reported. Every individual operator is on his honor to report for a call only what was handled *using that call*. The matter is explained here for the benefit of the many newly reporting amateurs now turning to "traffic" as a fascinating field of interest, accomplishment and self-training in OPERATING ABILITY.

Red Cross — A.R.R.L. Test, April 4th, 5th, 6th. The "zero hour" for starting thousands of messages from as many Red Cross Chapters containing radio reports to each regional headquarters of the Red Cross will be Friday, April 4th, at 5 P.M. A.R.R.L. Emergency Coördinators will have each carried out a duty and responsibility in contacting the local representatives of the Red Cross, and designating the starting station for each particular message.

This test is one of amateurs and amateur frequencies. *Every licensed amateur* is invited to play a constructive part in making the test fully successful. Scores of stations at the receiving cities will be looking for the calls "CQ DC," "CQ St. Louis," or "CQ SF" that stations with messages will use. How can you help? Even if you are not one of the starting or receiving stations, you can help RELAY Red Cross messages to destination. On the 4th, 5th, and 6th give PRIORITY to the test traffic. Place it above any other amateur radio activity short of a real emergency. Stand by to keep a channel clear; help hook up distant stations with those at delivery points; receive and forward by radio (relay) toward destinations; keep circuits as clear as possible, so messages may go through smoothly and accurately with as few repeats and delays as possible. Cut your own transmission to bare essentials of *message handling* in the busy Friday evening hours. Listen long and carefully for calls from the furthest corners of the continental United States in order to get in *every* message from *every* state. Know your procedure. (See the operating booklet or Operating Chapter of the *Radio Amateur's Handbook*.) DO YOUR INDIVIDUAL PART to make this Red Cross test of amateur radio emergency communication facilities a success. Report what messages you handled, what other assistance you rendered to make the Red Cross Preparedness Test a success, by a memo to A.R.R.L. promptly after this interesting week end has become history.

WIAW Code Practice and Qualification Runs. *Code practice* runs start at 9:15 P.M. CST, daily except Friday. The next *qualifying* runs (after March 21st run) are as indicated below, and

follow transmissions at the usual practice time, the *qualification* copy starting at 9:30 P.M. CST:

April 17th, Thursday	July 20th, Sunday
May 14th, Wednesday	Aug. 18th, Monday
June 17th, Tuesday	Sept. 20th, Saturday

Underline the full minute of perfect copy that you believe qualifies you at any speed. State on copy if you are working for a first certificate or an endorsement sticker. For our information, mention if you copied on mill or by pencil. Attach a statement that you copied by ear without aid except typewriter or pencil. We want to give every U. S. A. licensee a certificate recognition of his code ability. Look for W1AW on the frequency that comes in best at your location: 1762, 3825, 7280, 14253, 28510, or 58970 kcs. Get more code practice on the 7:30 P.M. and 11:00 P.M. CST tape-sent official messages to "all radio amateurs." Start after your Code Proficiency Award Certificate to-day! Mark dates of qualifying runs on your calendar, and send in what you copy those dates!

Learn Mill Copy. It is plenty important! We spouted off on this subject starting on page 29 of March *QST*, so we'll hold off any further lengthy remarks. We want to remind everybody that *press* is mighty good stuff to use for some daily practice in getting everything down on the mill the first time. See the schedules given on page 57 of February 1941 *QST* for this. Some serious practice makes the difference between being an *operator* and being a *putterer* — almost exactly the difference between really being able to hold down a communications circuit and being just an onlooker when real doings start! Build knowledge of procedure and also transmitting code speed through traffic work. Start by getting an A.R.R.L. Code Award at *any* speed (either pencil or typewriter — no distinction made in certificates), but don't stop until you can take ten on a line with the mill!

— F. E. H.

Hamfest Schedule

April 26th, at Framingham, Mass.: The Ninth Annual Hamfest of the Framingham Radio Club will be held Saturday, April 26th, at the Kendall Hotel, Framingham, Mass. This affair has always featured unusually good food, splendid speakers, and, of course, the opportunity to meet those amateurs whom you have long wanted to talk with in person. The atmosphere will be a military one with special attention given to those amateurs called into service. The registration fee is \$2.00. Tickets may be secured in advance, or further information may be obtained

from Ed. Parson, W1BWJ, 29 Pitt St., Natick, Mass.

March 28th, at Queens Village, L. I., N. Y.: The Federation of Long Island Radio Clubs will hold its Seventh Annual Hamfest on Friday evening, March 28, 1941, at Community Hall, 212-35 Jamaica Avenue, Queens Village, L. I., N. Y. It will be a stag affair and there will be plenty of fun and ham spirit in the air. The time is 8:30 P.M. Admission: \$.50.

ARTICLE CONTEST

The article by Mr. Walter Horizny, W2KVL, wins the C.D. article contest prize this month. We invite entries for this monthly contest. Regarding subject matter, we suggest that you tell about what activity you find most interesting in amateur radio. Here you will find an almost limitless variety of subjects. Perhaps you would like to write on working for code proficiency, Emergency Corps planning, traffic work, working in Section Nets, Phone and Telegraph operating procedures, holding a League appointment, working on radio club committees, organizing or running a radio club, the most interesting band or type of ham activity, or some other subject near to your heart.

Each month we will print the most interesting and valuable article received. Please mark your contribution "for the C.D. contest." Prize winners may select a bound *Handbook*, *QST* Binder and League Emblem, six logs, eight pads radiogram blanks, DX Map and three pads, or any other combination of A.R.R.L. supplies of equivalent value. Try your luck!

The QSL Hobby!

BY WALTER HORIZNY, W2KVL*

You will recall how impatiently you waited for the letter carrier to bring the first QSL card which now has an exalted place on the wall, or in the album. Subsequent cards which came were also welcomed and were accorded the same hospitality. Soon came the well-remembered and cherished day when, after many enjoyable and pleasurable contacts with your fraternal brothers, you received cards from the forty-eight states of the Union and cards from the six continents of the world. Aye, and since that day you have gleefully displayed on your QSL cards the letters WAS, WAC! And on the wall of your shack are the esteemed WAS and WAC certificates now roosting with a newcomer, the Code Proficiency Certificate! But, let us not reminisce any longer, and get to what is my fixed objective in writing this piece.

Surely, you have seen a stamp collector's album, where on the pages are printed — or, simulated, if you wish — pictures upon which the stamp collector places the genuine stamps. Have you ever thought that the entries in your station log are to the simulated stamps as the QSL's are to the real stamps? There is no difference, you'll agree, yet, how would the stamp collector feel if he had nothing but a bunch of insignificant and cold-looking pictures? Give him some stamps — real stamps — and watch his gloom disappear and a broad, gleaming, smile lighten his face. And

* 503 East 6th Street, New York, N. Y.

Use the General Traffic Period (6:30-8:00 P.M.). It will make for Effective Amateur Results.

so it is with amateur radio operators. Acknowledgment cards, unlike log entries, reflect the personality of the ham; they impart life and interest among the amateurs, and, most of all, they bring back pleasant memories of past and colorful events, of history, never to be recorded.

Proud is the ham who can display his variegated, multi-hued wall paper of QSL cards — of cards from far off lands, of cards from the city in which he resides. QSL cards lend enchantment. They turn the ugliest and darkest cellar into the most pleasant and gay shack.

Such are the reasons why amateurs have, are, and always will exchange QSL cards. Yet, there are quite a few amateurs who do not QSL for one reason or another — good or bad.

Lack of time, due to other and more important duties, is one reason why some amateurs do not answer QSL cards. Surely, the time needed to fill out one card does not even compare with the time necessary, for example, to read the daily paper, to chew the rag on the air, or to experiment with the rig. Certainly, any ham with some intelligence can so manage his time so that he can answer the QSL cards, singly, or collectively.

For some hams, economics play an important rôle in deciding whether or not they QSL. But do you not think that if a ham can afford a transmitter, a receiver, and other incidental things which go into the making of an amateur station, that he can afford to have cards printed? Surely, if he can afford nothing better than a one-color card, or perhaps a hand written postal card, it is a QSL in the fullest meaning of the word. Whether a card is one-colored, multi-colored, or just a neatly handwritten card, it is welcomed, I assure you, by all.

Another group of hams, which I have reserved for last, and for whom I have little respect, are those who just plainly refuse to QSL, not because they lack time, or the money with which to purchase cards, but because after being in the game for a while and collecting all the cards they want, they do not see the sense in swapping cards any more. "I have quite a few cards from that state . . . have my WAS. Why should I QSL?" they say. That reason is certainly not uncommon, and it is for those hams, and such reasoning, that I, and the likes of me, despise such hams. Amateur radio was not built on such poor foundations as greediness, lack of insight, and non-coöperation.

Amateur radio is not a hobby of one person, but of many. Its keyword is *coöperation*, its rule, the Golden Rule. Just as you must have team work in dancing, baseball, football, or band, so it is with amateur radio.

It is *your* hobby; why not make it more interesting, more pleasant, by revitalizing its co-related hobby — the exchange of QSL cards?

BRIEFS

W9QZU, Hillsboro, Ill., is conducting code practice for the benefit of beginning amateurs daily from 6 to 7 P.M. C.S.T. on 1810 kc. This schedule is not effective on the following dates: March 10th, 11th, 12th, 20th, 21st, 22nd, 23rd; April 7th, 8th, 9th, 17th, 18th, 19th, 20th; May 5th, 6th, 7th.

The San Mateo, Calif., Junior College Radio Club conducted a rather novel experiment at a recent meeting. All commercial power was switched off at the club station, W6YU, and the members proceeded building a transmitter and getting on the air totally with emergency equipment. Using candle heat for soldering, a 35T crystal oscillator was wired up. Power for this rig was supplied by five 6-volt car batteries which ran two 350-volt dynamotors with their outputs in series. The antenna was a 100-foot piece of wire, 10 feet high, at the far end and running into the basement shack at the transmitter. A battery-powered SW-3 was used for receiving. W7BOC in Washington and W6RMM in California were raised. Candles and lanterns provided light. The gang say it was the most fun they have had at a meeting yet, and recommend the idea very highly to other clubs who are looking for something different in the way of a meeting program.

Brass Pounders' League

(January 16th-February 15th)

Call	Orig.	Del.	Rel.	Extra Del. Credit	Total
W4FJR	0	200	2000	180	2380
W4PL	6	44	2079	34	2163
W9INU	9	97	1894	92	2092
W3BWT	83	144	1375	132	1734
W3CKO	24	54	1427	48	1553
W4AOB	15	97	1177	41	1330
W9OIL	72	133	952	131	1288
W6LUI	227	479	36	477	1219
W5FDR	271	184	498	161	1114
W6ROZ	47	42	952	31	1072
W6PCB*	127	165	606	152	1050
W3AOC	74	74	810	55	1013
W3EML*	35	67	814	61	977
W3CIZ	23	58	822	47	950
W8JW	157	259	218	191	925
W7EBQ	31	77	694	60	862
W9OZN	17	3	822	3	845
W9ILH	16	64	712	24	816
W8DAQ	27	24	718	22	791
W2HXH	23	69	616	56	764
W2MTY	56	112	482	60	710
W4FDT	13	15	656	14	698
W6DH	53	106	442	86	687
W6PCB	70	104	398	99	671
W4AXP	13	2	644	1	660
W8TGU	64	26	502	8	600
W4EVJ	0	0	584	0	584
W8SJE	6	10	544	5	565
W5CEZ	22	107	413	8	550
W9JMG	42	20	475	9	546
W8UNH	26	33	452	21	532
W9OUD	32	52	409	22	515
W6CFN	0	0	511	0	511
W5MNN	38	101	296	71	506

MORE-THAN-ONE-OPERATOR STATIONS

Call	Orig.	Del.	Rel.	Extra Del. Credit	Total
W4DUG	2964	0	0	0	2964
K4IHR	932	863	12	836	2643
W5OW	168	133	1056	49	1406
W1AW	73	157	474	154	858
W4FCU/GFO	5	15	603	8	631

These stations "make" the B.P.L. with total of 500 or over. One hundred deliveries+Ex. Del. Credits also rate B.P.L. standing. The following one-operator stations make the B.P.L. on deliveries. Deliveries count.

W6SPB, 248	W5AAJ, 131	W2MNT, 107
W5GFT, 245	W2CGG, 130	W6NRP, 106
W3HRS, 237	W6ZX, 125	W6RGQ, 106
K7DIS, 214	W2BNU, 122	W9AEJ, 106
W9VBQ, 167	W9YYA, 118	W5CDU, 104
W6RBQ, 150	W1BAV, 113	W3BXE, 102
W7APS, 146	W5DDJ, 113	W3BZE, 102
W5DWW, 145	W9MRQ, 112	More-than-one-opr.
W4DXF, 136	W6PIV, 111	W5CEB, 224
W8KWA, 136	W8PAF*, 110	K4IHO, 136

A.A.R.S.

Call	Orig.	Del.	Rel.	Extra Del. Credit	Total
WLMW (W9QIL)	67	108	507	101	783

MORE-THAN-ONE-OPERATOR STATIONS

Call	Orig.	Del.	Rel.	Extra Del. Credit	Total
WLM (W3CXL)	290	211	3095	211	3807

A total of 500 or more or 100 deliveries+Ex. D. Cr. will put you in line for a place in the B.P.L.

* Dec.-Jan.

The Gulf Coast Storm Net

Amateurs located near the Gulf of Mexico are asked by the Galveston Amateur Radio Club to participate in an emergency network they are sponsoring, called the Gulf Coast Storm Net. Established in 1933, the net was controlled by W5DIG but, with increased activity, one control station

was found inadequate, and divisional operating has been instituted. At present two divisions are operating, the South Texas and the La.-Miss. divisions. W5DIG is N.C.S. of the former and W5IKP of the latter. Two or three more divisions of the net are needed to provide good coastal coverage, one taking in Alabama, Georgia and Florida, another South Florida, and a third Southwest Texas. Organization work on these is now in progress and the cooperation of gulf coast amateurs is solicited. For details write to Wm. Scharpwinkel, W5BTX, Chairman, G.C.S.N., c/o the Galveston Amateur Radio Club, 2021½ Avenue B, Galveston, Texas.

Amateur License Suspended

The Federal Communications Commission on February 25, 1941, adopted an order suspending the amateur radio operator license of Robert B. Caris, East Orange, N. J., for the remainder of the license term, because the licensee is alleged to have transmitted obscene and indecent language by radio, while engaged in the operation of amateur radio station W2HXL, in violation of Section 326 of the Communications Act. In addition to the suspension, the Commission also revoked the amateur radio station license of W2HXL.

U. S. Army Signal Corps Urges Amateurs To Join New Radio Intelligence Unit

Col. Lloyd B. Magruder, Second Corps Area Recruiting Officer, announced Feb. 21st that the First Radio Intelligence Company, a newly formed unit of the U. S. Army Signal Corps, stationed at Fort Monmouth, N. J., has openings available to amateur operators and those interested in or having special skill in short-wave radio operation. Since the radio intelligence company is such a new group, Col. Magruder stated that there would be a large number of non-commissioned officer ratings for communications specialists.

Meet the S.C.M.'s



Frank L. Baker, Jr., W1ALP

S.C.M., Eastern Mass., was bitten by the radio bug in 1923, and secured his ticket the following year. All his operating is confined to brasspounding on the 3.5- and 7-Mc. bands, with 3545 and 7181 kc. the most used frequencies. The rig is a 6L6-RK39, and the receiver an RME-70. W1ALP is a past O.R.S., and takes a keen interest in organization work. Under his direction, much has been accomplished in perfecting the Eastern Massachusetts A.E.C. setup. He is a member of the South Shore Amateur Radio Club and has held office

as its President and Secretary; he has done considerable work during past years as a member of the Boston Hamfest Committee, having served in the capacity of Chairman, Vice-Chairman and Secretary. When not busy with Section affairs, S.C.M. Baker's favorite forms of recreation are bowling during the winter months and horseshow pitching in the summer; he is also interested in baseball and hockey. His occupation: Purchasing Agent for the Boston Safe Deposit and Trust Co.



R. Rex Roberts, W7CPY

In addition to his office of S.C.M. for Montana, W7CPY is O.P.S., P.A.M., Alternate Director in the Northwestern Division and a member of the A.A.R.S. He has been a licensed amateur for nine years and was an experimenter as far back as 1912, when, he says, "I sent signals clear across—a BIG room." His present transmitter is a home-built panel-type, crystal-controlled job with bandswitching in all but the final stage, and employs beam tubes throughout. Normal input power is 150-200 watts. Power supplies are in a separate unit cabled to the transmitter proper, and the entire layout is designed for safety. High voltage can be applied only while the operator is in front of the operating table. The station receiver is an SX-17. S.C.M. Roberts operates with both 'phone and c.w. on all bands from 1.75 to 28 Mc., but claims 3.9 Mc. as his favorite. A Code Proficiency Certificate for 20 w.p.m. is held. High-speed photography is another hobby he enjoys, and his favorite sport is dry fly fishing. The Mountain States Tel. and Tel. Co. employs him as its Glendive, Montana, Manager.

DX Notes

ALMOST in the same mail this month we learn o two fellows who have completed five-band contacts with a Porto Rican station. W8JW claims his as the first, having worked K4KD on 1.75 Mc. recently; a low-power man, he used at no time more than 20 watts to accomplish the feat. W3BES made contact with K4DTH on a fifth band, also using 1.75 Mc. . . . W6KW worked KC4USB two-way on 3.9-Mc. 'phone, the only station to do so with Little America. . . . From W1LMB via Mass. S.C.M., W1ALP, we receive the following: XU8AM is in the States, and will send a card to anybody who didn't receive theirs. His address is: W. H. Wood, 616 Greenwood Ave., Takoma Park, Washington, D. C. . . . W9MFD worked KB6GJX on 7190 kc. He says the Guam op is trying for W.A.S. . . . In between qso's W6QKB squeezed in K7HBJ (7220), K4KD (7225), NY1AE (7200), KB6GJX (7080), and KC4USB (7075). . . . W8JMP received a qsl from XU1A, who was supposed to have been in Ningsia, Mongolia, but the card gives no dope on the qth. . . . KB6GJX advises that KB6VV is unknown

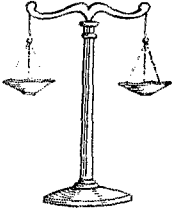

FOR many years, we have been urging prospective buyers of communications receivers to make a competitive test of available receivers before deciding on any. This is the only prudent way to buy, because with anything that costs as much as a good receiver, you want to be right the first time.

A good laboratory signal generator will tell you just about everything you want to know — sensitivity, selectivity, signal-to-noise ratio, image suppression, freedom from dead spots, and so on. However, it is often impossible to borrow such a signal generator and the amateur must use simpler equipment. As a matter of fact, a surprising amount of information on a receiver can be obtained with no equipment except a good antenna. Most of the tests which we shall describe take only a few moments and could be done on a dealer's counter. However, most dealers will let you take the receivers home for a more thorough test, and we strongly advise doing so if possible.

At all events, here are the tests that you can make. They will indicate sensitivity, shielding, gain, RF stage efficiency, dead spots, and other items of interest to the buyer.

First of all, we suggest that you check on the receiver's shielding. This is important, particularly in the power supply. If signals are picked up from the power lines and elsewhere, it is a safe bet that noise will be picked up, too. This will nullify many of the advantages of a good antenna. For instance, a directional antenna helps in reception by rejecting noise from directions other than that in which it is aimed. Also, in districts where there is a lot of man-made static, a high antenna "in the clear" with balanced transmission line will hold noise to a minimum. But in either case, a well-shielded receiver is essential. The test is very simple — just disconnect the antenna and turn up the receiver gain. If the receiver picks up any signal, the shielding is imperfect. If it is dead the shielding is OK.

Next try the set with an antenna. This should be a good one, for two reasons. With a poor antenna the set with the worst shielding gives the best results. Only a good antenna will give a fair test of weak signal response on distant stations. The second reason is because of impedance match. Well designed communications receivers usually have an input impedance below 500 ohms, so that they will match the usual transmission line or lead-in found in amateur stations.

Low-priced receivers are more apt to have high impedance input. Such being the case, make your test with your own antenna, the one that you intend to operate with. This will show which receiver works best in your station, which is what you really want to know.

Try the receivers on weak signals from distant stations, noting the signal-to-noise ratio as well as weak-signal response. Try the crystal filter. Watch for frequency drift. In checking these points, we wish to caution you on one thing. Familiarity with a receiver makes a great deal of difference in the results. If you are used to operating a certain National receiver, for instance, you may think that the others are second-rate just because you have not learned how to get the best out of them. And vice versa. For a fair test (and a lot of fun!) try to make a hamfest out of it. For each receiver that you have on test, invite a ham who is an expert on that particular model. It should be a memorable evening.

This is all we have space for this month. Simple tests for images, receiver noise, dead spots, and RF efficiency will be described next month.

JACK IVERS



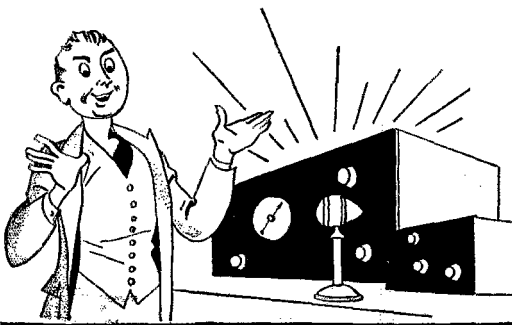

P. R. MALLORY & CO. INC.

NOTHING LIKE MALLORY
HARDWARE FOR DOLLING
UP A RIG... AND FOR
GREATER CONVENIENCE TOO!

DIAL AND PANEL LIGHTS



Avoid run down batteries, or increased power bills by using Mallory-Yaxley Pilot Lights and Jewels as indicators. They will keep you "informed" at all times, and enhance the appearance of your rig.

KNOBS, NUTS, WASHERS



Most of the popular types of washers, nuts, knobs and other small radio hardware are supplied by Mallory. High quality... beautifully finished. They are true Mallory products.

JACKS AND PLUGS

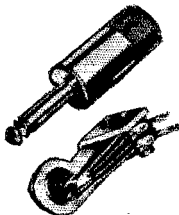

Two-way phone plug No. 75N, with shielded nickel shell. Other types—three-way, tie cord, etc.—in both bakelite and nickel shells.

Junior Jack No. 704—springs are parallel to panel for compactness—thirteen combinations available in this type.

P. R. MALLORY & CO., Inc.
INDIANAPOLIS INDIANA
 Cable Address—PELMAILLO

Use

P. R. MALLORY & CO. INC.

MALLORY

APPROVED
 PRECISION PRODUCTS

out there and is believed to be a foreign bootlegger. . . . W9OKM reports working KB6OCL at 12:45 a.m. C.S.T. on 3.5 Mc. Mebbe so, but we strongly suspect it was a bootlegger. At any rate, those who pretend to know say it was the wrong time of day for such happenings. . . . W9ANJ passes along the info' that KF6JEG/KG6 will soon be signing KG6SBM on Jarvis, and that those who missed KD4GYM may still be able to snag Swan Island if they keep an ear open for KD4HHS, who will be on soon. . . . W9BQZ sends us a list, including K4CM, K4HEB, KD4GYM, K6CGK and K5AG. . . . K6OLU worked KF6OWR (7160) and KF6JEG/KG6 (14,190 'phone), and says the former is active nightly from 9 to 11 p.m. P.S.T., the latter at 4 p.m. P.S.T. He also reports K6SBM/KG6 active occasionally on 7180 at 10:30 p.m. P.S.T. There are, he says, no stations doing business from Midway or Wake at present. . . . The KA's have broken out on 14-Mc. 'phone, according to W6ITH, whose list includes KA1CM (14,100 and 14,160), KA1AC (14,125), KA1RX (14,175), KA1BB (14,250). . . . Reg says KA1CM reports KAJJH, 1CW, 1AC, 1GC, 1RX, 7FS, and 4LH all active. KA1AN is on with 12 watts, and gets through at times. 28 Mc. has again opened up for W's out there after being dead since last December; the band is open from 7 to 10 a.m., Manila Time, and 1CM is on Sunday mornings his time. . . . W9VEL hooked KA1HR on approximately 7040 kc.

WIAW Operating Schedule

(Effective until April 27, when all times given below become D.S.T.)

OPERATING-VISITING HOURS:

3:00 P.M.—3:00 A.M. E.S.T. daily, except Saturday-Sunday
 Saturday — 8:30 P.M.—2:30 A.M. E.S.T.
 Sunday — 7:00 P.M.—1:00 A.M. E.S.T.

OFFICIAL BROADCAST SCHEDULE (for sending addressed information to all radio amateurs).

Frequencies

C.W.: 1761-3825-7280-14,254-28,510 kcs. (simultaneously)

	Starting Times (P.M.)				Speeds (W.P.M.)						
E.S.T.	C.S.T.	M.S.T.	P.S.T.	M	T	W	Th	F	Sat	Sun	
3:30	7:30	6:30	5:30	20	15	25	15	20	—	20	
Midnight	11:00	10:00	9:00	15	25	15	20	15	15	—	

PHONE: 1806, 3950.5, 14,237, 28,510 kcs.

Each code transmission will be followed in turn by voice transmission on each of the above frequencies.

CODE PRACTICE:

Besides the O.B.S. times and word speeds given above, WIAW will adhere to a schedule for sending code practice transmissions at progressively increasing speeds (15 to 35 w.p.m. in 5 w.p.m. steps) daily except Friday, starting at 10:15 p.m. E.S.T. Proficiency Certificate Award qualifying runs start 15 minutes later than practice schedules on a date announced for each month. (Feb. 21st, Mar. 21st, Apr. 17th.)

GENERAL OPERATION:

Besides specific schedules in different bands, WIAW devotes the following periods, except Saturday and Sundays, to GENERAL work in the following bands:

Time E.S.T.	Frequency
4:00 P.M.—4:30 P.M.	28,510-kc. 'phone/c.w.
4:30 P.M.—5:00 P.M.	14,237-kc. 'phone
6:00 P.M.—6:30 P.M.	14,237-kc. 'phone
6:30 P.M.—7:00 P.M.	14,253-kc. c.w.
8:00 P.M.—8:30 P.M.	14,253-kc. c.w.
9:15 P.M.—9:45 P.M.	3950-kc. 'phone
12:45 A.M.—1:15 A.M.	1806/1760-kc. 'phone/c.w.
1:15 A.M.—2:00 A.M.	3825-kc. c.w.
2:00 A.M.—3:00 A.M.	7280-kc. c.w.

7:00 P.M.—8:00 P.M.: Schedules on 3500-kc. band
 10:15 P.M.—11:00 P.M.: Code Practice, all c.w. freqs.
 11:00 P.M.—Midnight: National Trunk Line Net N.C.S.

At other times, and on Saturdays and Sundays, operation is devoted to the most profitable use of bands for general contacts and to participation in special week-end operating activities. The station is not operated on legal national holidays.

LONG TIME NO C?



Then follow Now-Hum-Low's example, OM,
and change to **G-E PYRANOL** capacitors

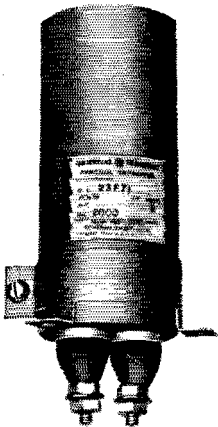

This compact unit provides 2
mfd at 2000 volts, Amateur
net, only \$3.00

Now-Hum-Low pushes a bulging kilowatt into his GL-810's on 80 and 20. But there was a time when he couldn't. The reason? His filter capacitors weren't up to snuff.

"No C—no volt," was his analysis—so he promptly rectified the difficulty by installing G-E Pyranols.

Like many another ham, Now-Hum-Low found an amazing improvement in performance—a big saving in space—easy mounting—and a 10 per cent safety factor in the voltage rating.

Take your cue from this sagacious oriental—you'll be tickled with the results. Your G-E dealer will be glad to give you the dope on the complete line of G-E Pyranol capacitors—or write for free bulletin, No. GEA-2021B. General Electric, Schenectady, N. Y.

NEED TUBES? Try G.E.'s and measure the difference!

GENERAL ELECTRIC

407-5-5700-6625

Your best buy

IN

FREQUENCY CONTROL

WHEN you purchase vital equipment for your station, you are really buying performance. Details of design and construction are of little interest as long as the equipment effectively does the job for which it is intended. If expected performance cannot be realized, your investment is a loss.

Consider quartz crystals. They may be just pieces of ground quartz but they should be precision frequency control devices. Properly manufactured crystals will have a single accurately calibrated frequency of oscillation and will function without pampering. They will snap into oscillation instantly, follow keying faithfully, and will operate reliably over extended periods of rigorous service.

No matter what type of product you purchase, your best buy will be controlled by performance and reliability. Bliley Crystals are deliberately made to be your best buy—and they are just that!

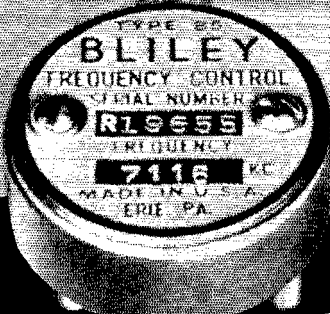

BLILEY CRYSTAL UNITS

ELECTION NOTICES

To all A.R.R.L. Members residing in the Sections listed below:

(The list gives the Sections, closing date for receipt of nominating petitions for Section Manager, the name of the present incumbent and the date of expiration of his term of office.) This notice supersedes previous notices.

In cases where no valid nominating petitions have been received from A.R.R.L. members residing in the different Sections in response to our previous notices, the closing dates for receipt of nominating petitions are set ahead to the dates given herewith. In the absence of nominating petitions from Members of a Section, the incumbent continues to hold his official position and carry on the work of the Section subject, of course, to the filing of proper nominating petitions and the holding of an election by ballot or as may be necessary. Petitions must be in West Hartford on or before noon of the dates specified.

Due to a resignation in the Washington Section, nominating petitions are hereby solicited for the office of Section Communications Manager in this Section, and the closing date for receipt of nominations at A.R.R.L. Headquarters is herewith specified as noon, Tuesday, April 15, 1941.

Section	Closing Date	Present SCM	Present Term of Office Ends
Philippines	Apr. 1, 1941	George L. Rickard	Oct. 15, 1938
Alberta *	Apr. 1, 1941	C. S. Jamieson	Feb. 18, 1940
Kentucky	Apr. 1, 1941	Darrell A. Downard	Apr. 15, 1940
Maritime *	Apr. 1, 1941	Arthur M. Crowell	June 15, 1940
Quebec *	Apr. 1, 1941	Lindsay G. Morris	Dec. 14, 1940
San Joaquin Valley	Apr. 1, 1941	Edwin A. Andress	Feb. 15, 1941
Vermont	Apr. 1, 1941	Clifton G. Parker	Feb. 15, 1941
Western Florida	[Apr. 1, 1941	Oscar Cederstrom	Apr. 15, 1941
Rhode Island	Apr. 1, 1941	Clayton C. Gordon	Apr. 15, 1941
New Mexico	Apr. 1, 1941	Dr. Hilton W. Gillett	Apr. 15, 1941
Washington	Apr. 15, 1941	W. Beale (resigned)
Hawaii	Apr. 15, 1941	Francis T. Blatt	Feb. 23, 1941
Maine	May 15, 1941	H. W. Castner	June 7, 1941
No. Minnesota	June 2, 1941	Edwin Wicklund	June 15, 1941
No. Texas	June 2, 1941	Lee Hughes	June 15, 1941
Sacramento Valley	June 2, 1941	Vincent N. Feldhausen	June 15, 1941
North Dakota	June 2, 1941	Anton C. Theodos	June 14, 1941
So. New Jersey	June 16, 1941	Lester H. Allen	June 22, 1941
Iowa	June 16, 1941	L. B. Vennard	July 3, 1941
San Francisco	June 16, 1941	Kenneth E. Hughes	July 5, 1941

* In Canadian sections nominating petitions for Section Managers must be addressed to Canadian General Manager, Alex Reid, 169 Logan Ave., St. Lambert, Quebec. To be valid such petitions must be filed with him on or before the closing dates named.

1. You are hereby notified that an election for an A.R.R.L. Section Communications Manager for the next two-year term of office is about to be held in each of these Sections in accordance with the provisions of the By-Laws.

2. The elections will take place in the different Sections immediately after the closing date for receipt of nominating petitions as given opposite the different Sections. The Ballots mailed from Headquarters will list in alphabetical sequence the names of all eligible candidates nominated for the position by A.R.R.L. members residing in the Sections concerned. Ballots will be mailed to members as of the closing dates specified above, for receipt of nominating petitions.

3. Nominating petitions from the Sections named are hereby solicited. Five or more A.R.R.L. members residing in any Section have the privilege of nominating any member of the League as candidate for Section Manager. The following form for nomination is suggested:

(Place and date)

Communications Manager, A.R.R.L.
38 La Salle Road, West Hartford, Conn.

We, the undersigned members of the A.R.R.L. residing in the Section of the Division hereby nominate as candidate for Section Communications Manager for this Section for the next two-year term of office.

(Five or more signatures of A.R.R.L. members are required.) The candidates and five or more signers must be League members in good standing or the petition will be thrown out as invalid. Each candidate must have been a licensed amateur operator for at least two years and similarly, a member of the League for at least one continuous year, immediately prior to his nomination or the petition will likewise be invalidated. The complete name, address, and station call of the candidate should be included. All such petitions must be filed at the headquarters office of the League in West Hartford, Conn., by noon of the closing date given for receipt of nominating petitions. There is no limit to the number of petitions that may be filed, but no member shall sign more than one.

4. Members are urged to take initiative immediately, filing petitions for the officials for each Section listed above. This is your opportunity to put the man of your choice in office to carry on the work of the organization in your Section.

— F. E. Handy, Communications Manager

ELECTION RESULTS

Valid petitions nominating a single candidate as Section Manager were filed in a number of Sections, as provided in our Constitution and By-Laws, electing the following officials, the term of office starting on the date given.

West Indies	Mario de la Torre, CM20P	Dec. 16, 1940
Arizona	John K. Oliver, W6KOL	Dec. 16, 1940
Michigan	Harold C. Bird, W8DFE	Feb. 3, 1941
Mississippi	B. Benton Cain, W8DFE	Feb. 3, 1941
Arkansas	John R. Sanders, W5GNV	Feb. 15, 1941

Engineering

in every PART!

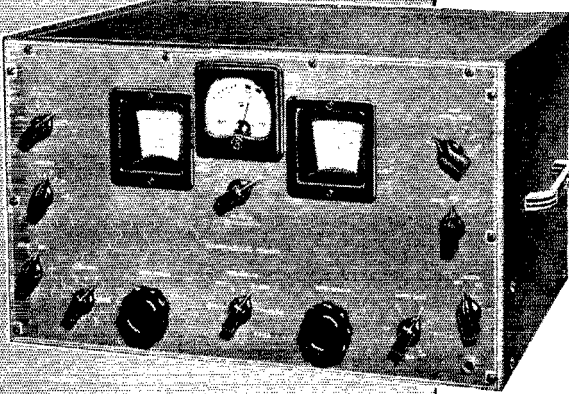

HQ-120-X

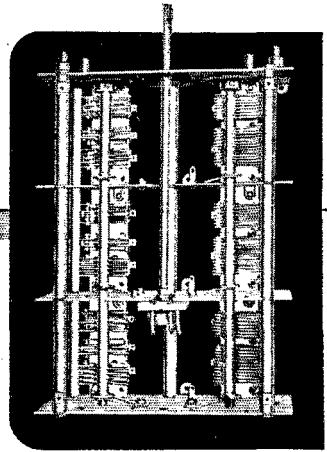

THERE'S a lot more to a radio receiver than meets the eye. Careful planning of the original design and thorough engineering of the parts which make up the receiver are of extreme importance, but can only be appreciated after considerable experience with the receiver. It usually takes two or three months to find out whether or not a mistake has been made in the selection of a product, and then it is too late. You can get some idea of the hidden values in the "HQ" by consulting present owners and surveying the used receiver market. You will find the "HQ" stays sold. Also, the many outstanding features such as variable selectivity crystal filter, calibrated band spread, and antenna compensator are original Hammarlund developments. These were planned and engineered into the original design. The more critical you are in selecting a receiver, the more likely you are to choose an "HQ-120-X."

IMPORTANT!

UNTIL recently, the "HQ" has been available in standard black cabinet and panel. Gray models were available at a slight increase in cost. Standard models will, henceforth, be finished in gray, and black models will be available only on order. There will be no extra charge for either the black or the gray.

Our technical department will be glad to answer any questions you may desire to ask regarding the "HQ-120-X." Also, write for 16-page booklet containing complete technical data.

Canadian Office: 41 West Avenue, North, Hamilton, Ontario



HAMMARLUND MFG. CO., INC.

424-438 WEST 33rd ST., NEW YORK



EXPORT OFFICE: 100 VARICK STREET, NEW YORK CITY

NOW WE'RE DEALING IN "FUTURES"

When normal conditions return, we will be proud to offer the **CARDWELL Precision Capacitor**

Type No. 3-860

For use in frequency checking devices

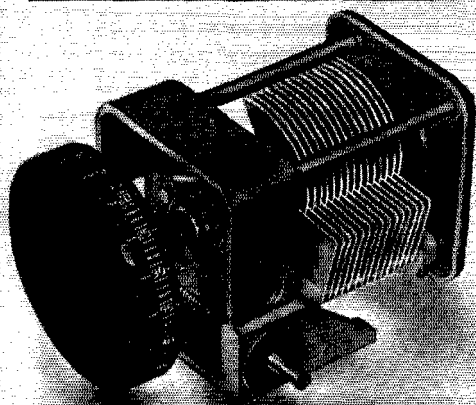

FEATURES

- Low temperature coefficient of expansion provided by use of INVAR
- Minimum frequency variation over extreme temperature ranges
- Negligible back lash
- Has 100 to 1 precision worm gear drive, to which 100 division crank operated dial may be attached, which, with vernier index, can give 50,000 readable divisions for 180° rotation.
- Ball bearings
- Alsimag No. 196 insulation
- Straight line frequency when used to cover a 2 to 1 frequency range. Maximum capacity is 228 mmf.

**THE ALLEN D. CARDWELL
MANUFACTURING CORPORATION**
83 PROSPECT STREET • BROOKLYN NEW YORK

A.R.R.L. AFFILIATED CLUB HONOR ROLL

The list below was compiled by analysis of a questionnaire returned in response to a year-end club survey.

All members of these are A.R.R.L. Members

Asheville Amateur Radio Club, Asheville, N. C.
 Amateur Radio Club of Savannah, Savannah, Ga.
 Amateur Radio Transmitting Society, Louisville, Ky.
 Associated Amateur Radio Operators of Denver, Colo.
 Azalea City Wireless Club, Palatka, Fla.
 Binghamton Amateur Radio Association, Binghamton, N. Y.
 Chippewa QRR Club, Chippewa Falls, Wis.
 Delaware Valley Radio Association, Trenton, N. J.
 Dells Region Radio Club, Portage, Wis.
 Frankford Radio Club, Philadelphia, Pa.
 Garden City Radio Club, Garden City, L. I., N. Y.
 Helix Amateur Radio Club, San Diego, Calif.
 Inter-City Amateur Radio Club, Irvington, N. J.
 Iowa-Illinois Amateur Radio Club, Burlington, Iowa
 Montgomery Amateur Radio Club, Montgomery, Ala.
 M. A. K. Amateur Radio Association, West Somerville, Mass.
 Norfolk County Radio Association, Norwood, Mass.
 Northwest Amateur Radio Club, Des Plaines, Ill.
 Northeast Nebraska Radio Club, Pender, Nebr.
 O. B. P., Chapter No. 1, St. Louis, Mo.
 Order of Brass Pounders, Chapter No. 3, Kansas City, Mo.
 Palomar Radio Club, La Jolla, Calif.
 St. Louis Amateur Radio Club, St. Louis, Mo.
 The T9 Club, Beverly, Mass.
 The L/C Club of New Jersey, Jersey City, N. J.
 Wichita Amateur Radio Club, Wichita, Kansas
 York Radio Club, Elmhurst, Ill.
 York Road Radio Club, Glenside, Pa.
 The 56-Mc. Minutemen, Winchester, Mass.

High Scores, 1.75-Mc. W.A.S. Party

THE Third Annual A.R.R.L. 1.75-Mc. W.A.S. Party follows suit with most of this season's operating activities by breaking all past records. Interest was at an extremely high pitch, and many stations were active that ordinarily confine their operating almost exclusively to higher frequencies. Scores received are higher by far than those of the previous two parties, and great strides were made by those working toward the W.A.S. certificate. Of the claimed scores received to date, W9JJD's is especially outstanding. He reports a total of 86,880 points amassed by working 352 stations (133 more than the station leading in number of contacts last year) in 48 states!!! The performance of W6AM, from the standpoint of stations worked — 340 — is also notable. W9ZVT came pretty close to W.A.S. by working 47 states. Final analysis of results will be completed for publication in a future issue of QST. Meanwhile, we present a tabulation of some high-claimed scores. The figures shown below represent score, stations worked, and states worked.

W9JJD	86880-852-48	W9BBS	37000-175-40
W9WGL	68625-295-45	W1LOP	34365-227-29
W6AM	64750-340-37	W9KLC	31570-154-41
W9DJA	63360-278-44	W9LNC	31450-175-34
W9RQM	56745-281-39	W9ZVT	29845-127-47
W6SPX	56700-315-36	W3CRW	28985-177-31
W1TS	55125-305-35	W3CWG	27440-186-28
W4FLS	53020-241-44	W8WQ	24850-155-32
W9ROQ	41780-199-44	W2MIG	23490-152-29
W8KWI	40740-184-42	W8MTO	22880-133-32
W4GWV	40530-193-42	W9UTL	22500-140-30
W9KOH	40280-212-38	W2LXI	21700-145-28
W1JHV	38400-256-30	W2KVE	21000-130-30
W3IMY	37260-207-36	W9GWL	20600-103-40

(Continued on page 78)

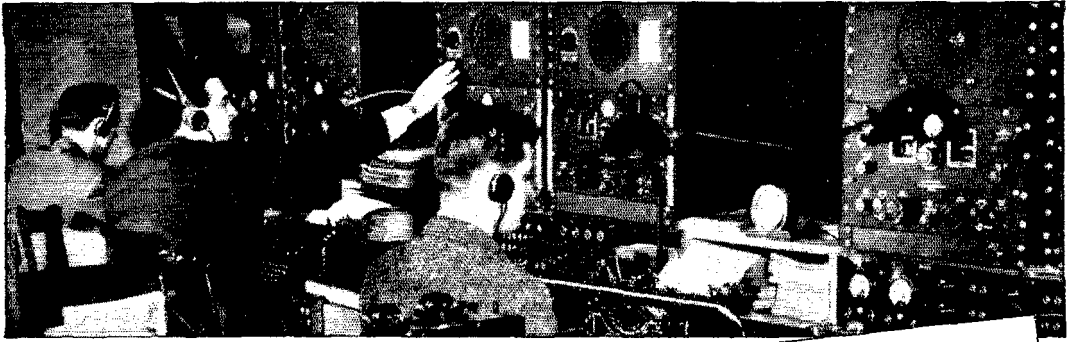
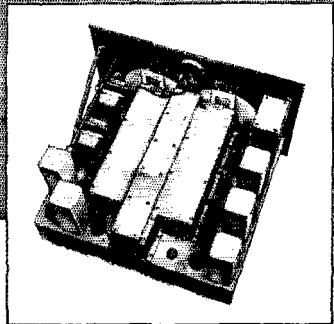
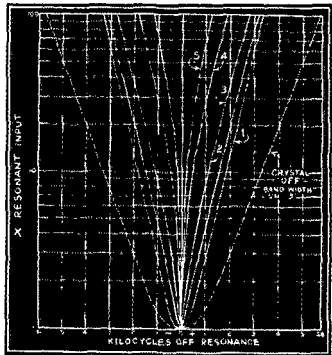

Photo courtesy
New York Herald Tribune

The SUPER PRO AT WORK!



THROUGHOUT the entire world "Super-Pro" receivers are carrying news dispatches and important diplomatic messages with unflinching accuracy. The New York Herald Tribune radio installation (illustrated above) includes four "Super-Pro's." Mr. Wolff, chief operator, reports that high speed automatic Asiatic transmissions are copied on schedule with complete success. The extreme flexibility of the "Super-Pro" makes it ideal for such installations where it may be required to copy automatic tape sending one minute and some important international diplomatic radiophone broadcast the next. The Series 200 "Super-Pro" has variable crystal selectivity, variable I.F. band width, noise limiter, calibrated "S" Meter, and everything else the skilled operator needs.



Send for 16-page Super-Pro booklet

At Right: VARIABLE CRYSTAL FILTER SELECTIVITY CURVES ➤



HAMMARLUND MFG. CO., INC.
424-438 WEST 33rd ST., NEW YORK



CANADIAN OFFICE: 41 WEST AVE. NO., HAMILTON, ONTARIO

Why fire up your
Kilowatt Rig...

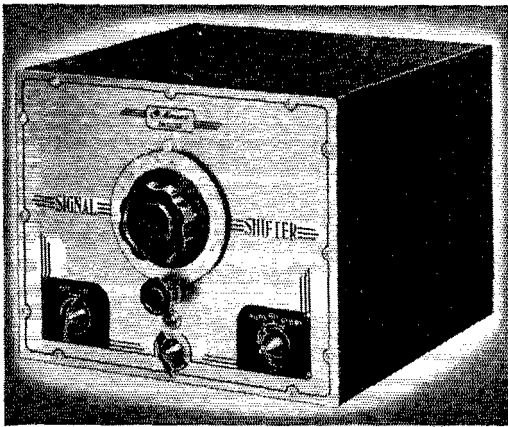

when the Meissner
SIGNAL SHIFTER
will get the same results?

With DX out of the picture for the present, it may surprise you to hear that the Meissner Signal Shifter—with 7½ watts output—is actually running rings around some of the "big boys"!

Originally designed merely as the best variable-frequency exciter that we knew how to make, the ability of the Signal Shifter as a transmitter in its own right was soon discovered. Its crystal-pure note, unflinching adherence to frequency adjustment, PLUS the all-important faculty of being able to place that signal in the RIGHT spot on the band, very shortly proved that super-power was NOT a necessity for consistent contacts in the U.S.A.

Coast-to-coast contacts have been made with such regularity as to make them commonplace—using only the Signal Shifter as a transmitter! W-A-S certificates have been issued to hams with no other transmitting equipment than this versatile exciter unit! Why not get into the "low-power" field and find out for yourself what new thrills await you there—with only 7½ watts, CW?

DON'T DELAY—GET YOURS TODAY!

See your Meissner Distributor at once or write for further details to the address below—now!

Write for Free Amateur Catalog!

Dept. Q-4



W9BRD	20100-134-30	W7HAZ	13500-125-20
W5IKP	19685-119-33	W1KLV	12870-107-22
W9JOL	19040-112-34	W8OKC	12750- 92-25
W8IWM	18620-123-23	W8MON	12480- 96-26
W9MUX	18450-113-30	W9HUV	12480- 86-26
W2JKH	18000-140-24	W7GNJ	12285-107-21
W9HHR	16800-105-32	W8ROX	11845- 93-23
W8PBX	16660-119-23	W1KYT	11700-107-20
W1EJK	15985-129-23	W9GLU	11520- 86-24
W9MBI	15400-110-28	W2KCC	11500-105-20
W1LTB	13875-101-25	W4AFQ	11440- 78-26
W3BXE	13875-101-25	W8JUM	11400- 85-24
W8FGX	13680-104-24	W2JWK	11000-100-22

HAMS INVITED TO WORK NAA!

Where? 5865 kc.
When? 8 to 9 P.M. E.S.T.
(if you use 3500-3900 kc. band)
9 to 10 P.M. E.S.T.
(if you use 7000-7300 kc. band)
Monday, Tuesday, Wednesday, Friday

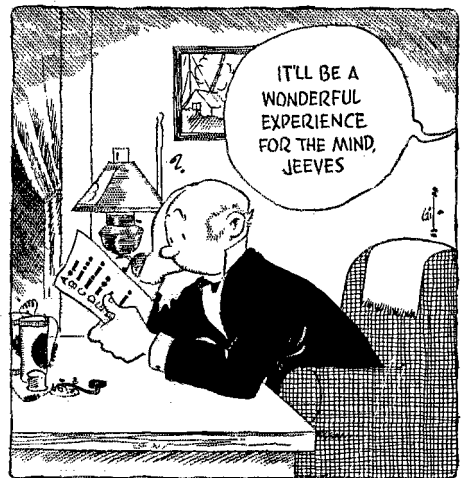

JEEVES

Results U.H.F. Contest

(Continued from page 59)

test. For the benefit of the originators, the points to which such messages were traced are listed below:

Starting Station	Traced To	Starting Station	Traced To
W1LSN.....	W3CGV	W2ILK.....	W3ACR
W1HDQ.....	W3GNA	W2LST.....	W3HFY
W1BJB.....	W3GNA	W2HYJ.....	W3ASJ
W1DID.....	W3GNA	W2LAU.....	W1HXP
W1QB.....	W3GNA	W2MQF.....	W2AIH
W1JDV.....	W3HFY	W2LNT.....	W9ZHB
W1HDQ.....	W9BDD	W3FTR.....	W1KTF
W1LJ.....	W9ZHB	W3BKB.....	W9BDD
W1EKT.....	W2AMJ	W8CIR.....	W1LSN
W1MDN.....	W2AQA	W8BHY/8.....	W8CVQ
W1BJB.....	W1KTF	W9BDD.....	W2LAL
W1KTF.....	W2AMJ	W9NFM.....	W2LAL
W1MWU.....	W1QB	W9ANH.....	W2LAL
W1LFF.....	W1LSN	W9IZQ.....	W8GU
W1LFL.....	W1LSN	W9ZHB.....	W8CIR
W2MWA.....	W3CGV	W9CBJ.....	W8CIR
W2KKE.....	W3CGV	W9YLV.....	W8CIR
W2HRA.....	W3CGV	W9IZQ.....	W9BDD
W2MWN.....	W3HPX		

W6KW John R. Griggs

2-WAY, 75 Meter Phone
Contact with KC4USB

...and a regular schedule week-
in, week-out with the Antarctic
Expedition . . .

That's W6KW using

Eimac
TUBES

Operating table
showing No. 1 and
No. 2 transmitter

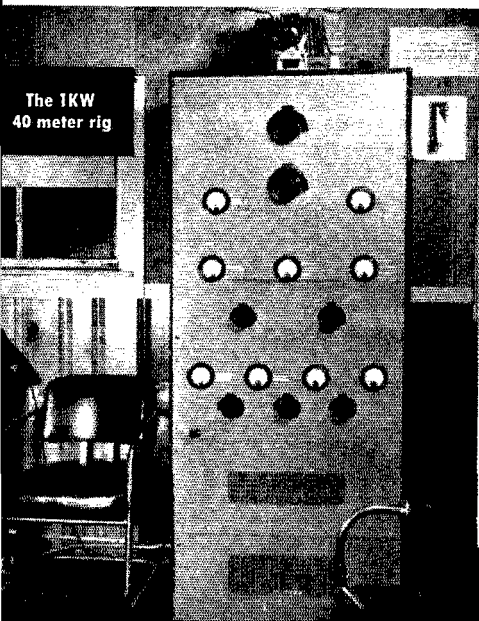

3 TRANSMITTERS in operation at W6KW — All **Eimac** Equipped

"Communication with the Antarctic Expedition Stations KC4USA-B on a week-in, week-out, schedule during good or bad seasons, demanded the utmost from the vacuum tubes. That's why Eimac Tubes were chosen . . . and they delivered nobly. I think they are the most dependable tubes available." So says, John R. Griggs owner and operator of amateur station W6KW. Griggs has set something of a record with his 2-way 75 meter phone contact . . . over 7400 miles distance.

Letters and statements like this and others from the world's leading radio amateurs and engineers should mean much to you. These are not mere claims, they are the results obtained in actual service. The ever increasing list of top radio men who are adopting Eimac Tubes is proof enough that... In the field of Electronics the overwhelming swing is to Eimac Tubes.

*Get complete information from the nearest representative
or write direct to the factory.*

EITEL-McCULLOUGH, INC.

San Bruno, California

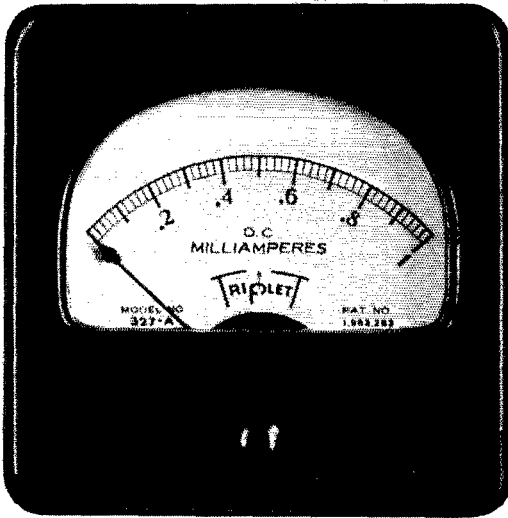

PRECISION INSTRUMENTS FOR EVERY REQUIREMENT

Round, Square, Fan or Twin Cases in 22 Styles

Model 327-A — One of Triplet's 22 panel instrument case styles. These precision electrical measuring instruments are provided in round, square, fan and twin cases — 2", 3", 4", 5", 6" and 7". A complete line of portable instruments for exacting measurements also is offered. In Triplet's entire line are instruments for every electrical measuring, indicating or control purpose.

- ★ D.C. Instruments are the D'Arsonval type with an extra light moving coil; time-proven magnets with pole pieces aligned to permanent precision accuracy; trussed metal bar bridges.
- ★ A.C. Instruments are the movable double iron repulsion type; with interchangeable coils.
- ★ Electro-dynamometer type instruments — a new line with developments assuring extreme accuracy and ruggedness. Wattmeters, voltmeters or ammeters.
- ★ Instrument relays — standard or special designs for electrified control purposes.
- ★ Instruments for special industrial applications — pyrometers, differential relays, directional locators, and a host of others.

All have two genuine sapphire jewel bearings and every refinement marking the most approved instrument building practice.

Write for Catalog! Section 254, Harmon Avenue

THE TRIPLET ELECTRICAL INSTRUMENT CO.
Bluffton, Ohio

A Hurricane-Proof Mast

(Continued from page 15)

it expeditious to cut the cross and angle pieces to size after they had been nailed on.

Now this mast was designed (we hoped) to be a guyless mast, so the next problem was anchorage. Work up to this point, I discovered, had been child's play. The tough part of the job, the sweat producing kind, was ahead. After determining just where the mast was to sit, we dug a hole. So easy to say but a week's job to do, with plenty of help from the 10-year-old son and some of his neighborhood chums. (They were paid off with soft drinks and quarters.)

The hole was dug about six feet wide and six feet deep. I'd hate to be a grave digger. What a life! Here, when you hit clay after going down about two feet, the going gets tough and the last four feet were mean. At the end of the sixth day the hole was completed.

In the meantime we had scouted around and found, at the town incinerator, four pieces of angle iron. These were all six feet long or more. The iron was about two and a half inches wide.

Three had to be cut down with a hack saw to six foot six inches. Then a floor of heavy flat stones was placed at the bottom of our hole. The angle irons were then set in place by the method shown in sketch B, using some of the remaining furring strip (there was plenty left out of the 300 feet purchased), and the angle irons very carefully placed so that they would fit just inside the four pieces at the base. The distance was measured about ten times just to be absolutely certain it was right. A lot depended upon this measurement being correct. At the time the hack saw was used to cut the angle irons two holes were drilled in each piece as shown in sketch C. This was also very important, as you shall see. The top hole was drilled one and a half inches from the end of the angle iron and a half inch off center to the left. The second hole was drilled three inches below and a half inch off center to the right.

Now, getting back to where the irons were carefully set, we then mixed a very cheap mixture of cement, sifted dirt and a little sand. Only a half bag of cement was used. This mixture, by adding a lot of small stones, was made to fill the hole by about one foot. This was permitted to set over night. The next day, using some of the dirt taken from the hole, which seemed to be all over the place (my, what a lot of dirt can come out of a little six by six by six hole!), we filled in another foot. This was well tamped by a piece of two by four and some jumping with my 195 pounds. Then some more cheap, poor grade concrete was mixed, still using sifted dirt and very little sand. This was poured in and mixed with it was any and all kinds of old iron that could be found (aided and assisted by the aforementioned neighbors' children) and it included an old tire rim, some rusty sad irons, pieces of old pipe, parts of an old bed and so forth. The next level, a two-foot one, was filled in with more dirt and clay and plenty of large stones. This was well tamped and puddled with water from the garden hose, bring-

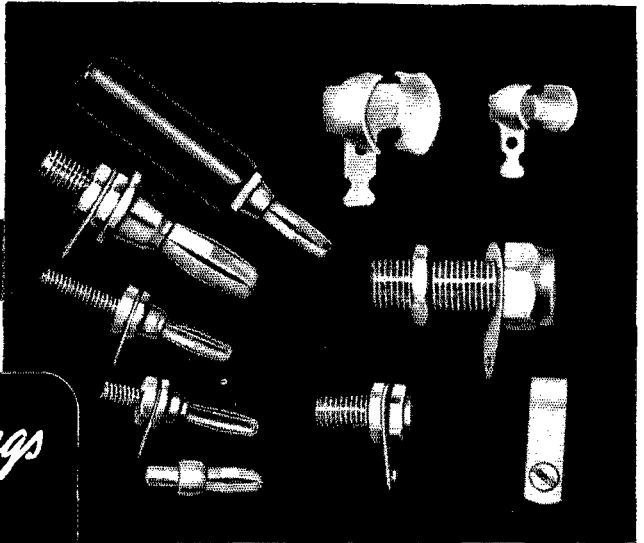
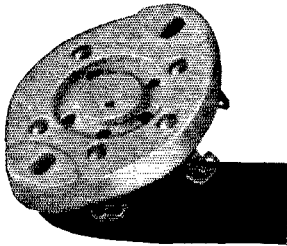
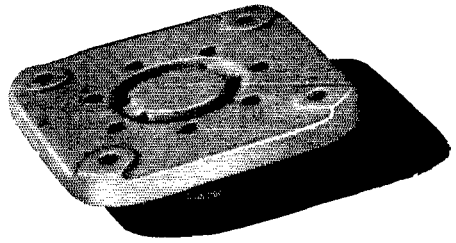
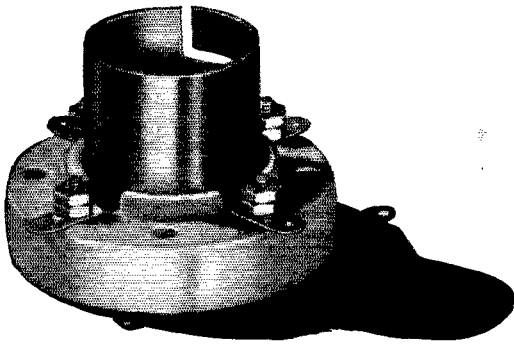

*It's the little things
that count for*

NATIONAL DEFENSE



Just a few of the many parts being furnished by the thousands for National Defense. Parts to meet exacting Government specifications as to material, dimensions, and plating. However, JOHNSON'S contribution has been made possible through plant expansion and increased personnel not by robbing old friends. Deliveries are being made to our old customers as usual. **The new Johnson-Bassett Antenna Handbook is ready at your favorite Jobbers, only 25c.**

Catalog 966J free on request.



E. F. JOHNSON CO

WASECA, MINNESOTA

EXPORT: 25 WARREN ST., NEW YORK, N. Y.

"MANUFACTURERS OF RADIO TRANSMITTING EQUIPMENT"

NATIONAL SOCKETS

XC SERIES SOCKETS

Any Type List \$.60



National wafer sockets have exceptionally good contacts with high current capacity together with low loss Isolantite insulation. All types have a locating groove to make tube insertion easy, with the exception of the Octal socket which has a central locating hole.

CIR SERIES SOCKETS

Any Type List \$.40

Type CIR Sockets feature low-loss isolantite or steatite insulation, a contact that grips the tube prong for its entire length, and a metal ring for six position mounting. The sockets are supplied with two metal stand-offs.



XM-50 List \$1.75

A heavy duty metal shell socket for tubes having the Jumbo 4-pin base ("fifty watters").

JX-50 List \$1.20

Without Standoff Insulators

JX-50S List \$1.50

With Standoff Insulators

A low-loss wafer socket for the 8 13 and other tubes having the Giant 7-pin Base.

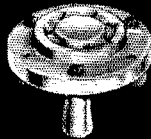

XCA

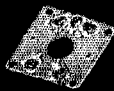

XMA



XM-10



JX-100

A COMPLETE LINE

National's line of sockets is complete. It includes compact sockets for acorn tubes, one of which has built-in bypass condensers. It includes husky sockets for tubes like the 803 and RK-28. You will find the socket you need in the National Catalogue No. 400.

NATIONAL

MALDEN



COMPANY

MASS.

ing our filled hole up to within one foot of the normal ground level.

The final foot was done in a workmanlike manner. Good concrete was made; a 3-to-1 mixture of cement and sand. The top was floated to a fine finish. This finished top was made in a 5-by 5-foot form made of some old sheathing boards. When this was set hard, about three days later, we were ready to raise our mast.

Oh, I almost forgot, in between times work was being done on the base, the mast was painted. Two coats of very good paint, with a day's drying between, were applied. Three days elapsed and then we applied the final outside coat.

Now comes the really interesting part. We carried the mast (it's light enough for two men to carry around easily) up to the base. Holes were then drilled in the mast feet, one in each back leg. These were the only holes drilled at this time. It was easy to bolt the two back legs of the mast to the two back angle irons which, of course, projected up above the concrete base. It was found we had a perfect hinge. It was a simple matter for my pal, W2VJ, myself and a couple of boys, who really were not needed, to push up the mast with the aid of a borrowed block and tackle which was anchored to a nearby apple tree. Thus we had a mast nearly 50 feet high that could be raised and lowered at will for painting and other reasons with a minimum of effort.

After getting the mast upright holes were drilled to correspond with the lower holes on the front legs and angle irons. The mast was loosely bolted here and the rear bolts removed, permitting the four legs to rest on the base. The other holes needed were then drilled, using the holes in the angle irons as guides, and the mast was held permanently in place by using just eight half-inch bolts. Very simple.

The mast was erected in September, 1937. It had no guy wires. During September, 1938, that hurricane that roared up out of the south and hit the north Atlantic seaboard hit us here. It toppled trees, telephone and lighting service poles, knocked over garages and felled a 100-foot steel police radio tower a quarter of a mile away. We are located on the crest of a high flat plateau and felt the fury of that blow.

But, by the dawn's early light, our mast was still up and so was our antenna. However, we noticed that the whole thing was slightly, oh so slightly, off plumb. The whole base had been moved by that hurricane, so great was its fury. We decided to put on guy wires. They were put on last year. I really don't think anything could be worse than that hurricane that the mast apparently withstood with ease, and don't think the guy wires were needed, but they are on now.

And last winter a sleet storm, the worst in the history of this part of the country, struck here. The elm mentioned earlier, that had withstood storms for 50 years, went with hundreds and hundreds of other trees that were torn to pieces. The top of the police tower fell again. The community was without power for 40 hours, so great was the destruction by this two-inch coating of

G R A P H I T E



DOES NOT FUSE

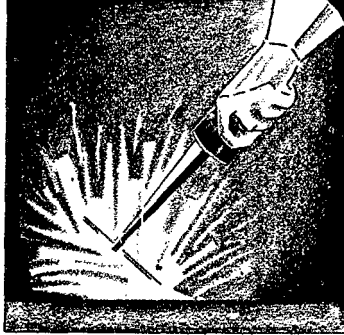

DISSIPATES HEAT

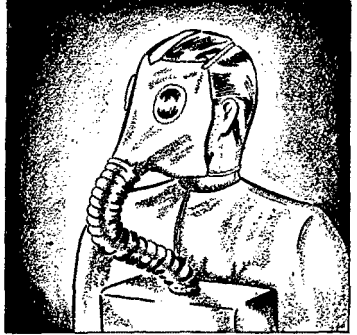

ABSORBS GASES

for Tube Power and Life

SPEER GRAPHITE ANODES

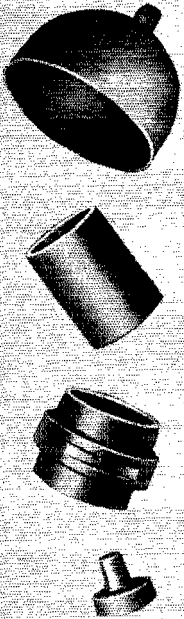

With SPEER Graphite Anodes, transmission and power tubes have longer service life because the anodes cannot be damaged by overloading. They will not warp, fuse, soften or blow.

With SPEER Graphite Anodes, tubes handle more power because their relative heat dissipating value exceeds that of all other anode materials.

SPEER Graphite Anodes tend to absorb gases given off by other elements.

For tube life and power, use tubes with SPEER Graphite Anodes. List of tube makers and Anode Data Book sent on request.

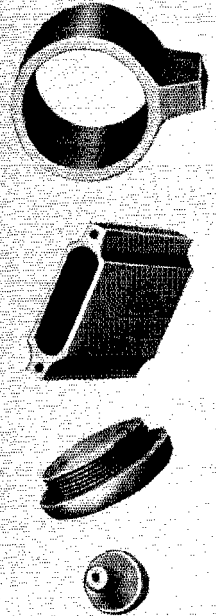

SPEER CARBON CO.
ST. MARYS, PA.



NATIONAL RF CHOKES

The R-175 Choke is suitable for parallel feed as well as series feed in transmitters with plate supply up to 3000 volts modulated or 4000 volts unmodulated. Unlike conventional chokes, the reactance of the R-175 is high throughout the 10 and 20 meter bands as well as the 40, 80 and 160 meter bands. Inductance $225\mu\text{h}$, distributed capacity 0.6 mmf, DC resistance 6 ohms, DC current 800 ma, voltage breakdown to base 12,500 volts. R-175 Choke, Net Price \$1.65

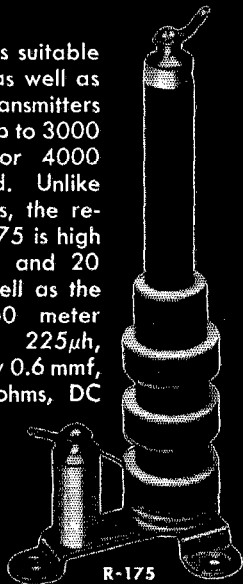

R-175

R-152

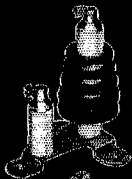

For the 80 and 160 meter bands. Inductance 4 mh, DC resistance 10 ohms, DC current 600 ma. R-152 Choke, Net Price \$1.35

For the 20, 40 and 80 meter bands. Inductance 1 mh, DC resistance 6 ohms, DC current 600 ma. R-154 Choke, Net Price \$1.35

The R-154U (not illustrated) is the same as the R-154 but omits the third mounting foot. R-154U Choke, Net Price \$1.05



R-154

R-100U

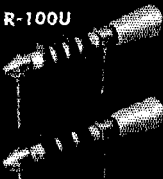

R-300U

RF chokes R-100U and R-300U are compact and efficient units for low power equipment, arranged for mounting on a removable standoff or by pigtailed. Either model, Net Price \$.36. Similar models without standoff are \$.30 Net each.

NATIONAL
MALDEN



COMPANY
MASS.

ice — but the hurricane-proof mast easily weathered it. Hams all around me lost their antennas and I lost a 60-foot three-inch pipe grounded J and a 5-meter Johnson Q in the sleet storm, but not a thing happened to my good old hurricane-proof mast.

And, I've climbed to the top of that mast — as have several others — and I weigh nearly 200 pounds!

So, that's the story of a mast — a mast that can withstand a hurricane; can be erected by two men; constructed in nine hours by a man and a small boy.

Some Thoughts on Keying

(Continued from page 81)

capacity, resulting in effects as shown in the photographs in Fig. 6. While this distorted shape was responsible for only a very slight increase in clicks, it is not a particularly desirable condition for one seeking the best he can obtain in keying. Additional capacity added to the output of the filter helped the condition considerably.

The other desirable operating condition for amplifiers following a keyed stage is that they be fix-biased only as high as is necessary to bring the "key-up" plate current down to a value low enough so that the plate rating of the tubes won't be exceeded. This allows some plate current to be drawn when the key is up and puts the amplifier in a favorable condition to show up any fundamental or parasitic oscillations that may be present. The amplifier can apparently be regenerative to some extent on the fundamental frequency without adversely affecting the keying characteristic, but the lowered bias suggested above will reduce the amount of regeneration that can be tolerated in an amplifier.

Operating the amplifier stages with a minimum of fixed bias has another definite advantage that is important to good keying in many instances. Many signals are afflicted with key clicks that do not extend regularly and steadily either side but which appear at spaced intervals from the signal, often removed by several hundred kilocycles. This is the type of click one hears in one part of the band and then has to tune halfway across the band before finding the signal causing the clicks, with click-free intervals in between. These clicks are caused by low-frequency parasitic oscillations that occur in the amplifier stages of the transmitter at the instant the signal is building up. They often disappear when the excitation reaches a value high enough to take complete control of the stage, but sometimes they will persist as rough keyed signals. High fixed bias on an amplifier stage will usually prevent these parasitic oscillations from occurring when the key is "up," but the application of excitation shifts the operating point of the amplifier (for the parasitic oscillation as well) and allows the oscillation to take place over part or all of the "key-down" period. Any amplifier following a keyed stage should be thoroughly checked for parasitic oscillations if good keying is to be obtained into the antenna.

Taylor

EACH TUBE IS CUSTOM BUILT TO GIVE "More Watts Per Dollar"

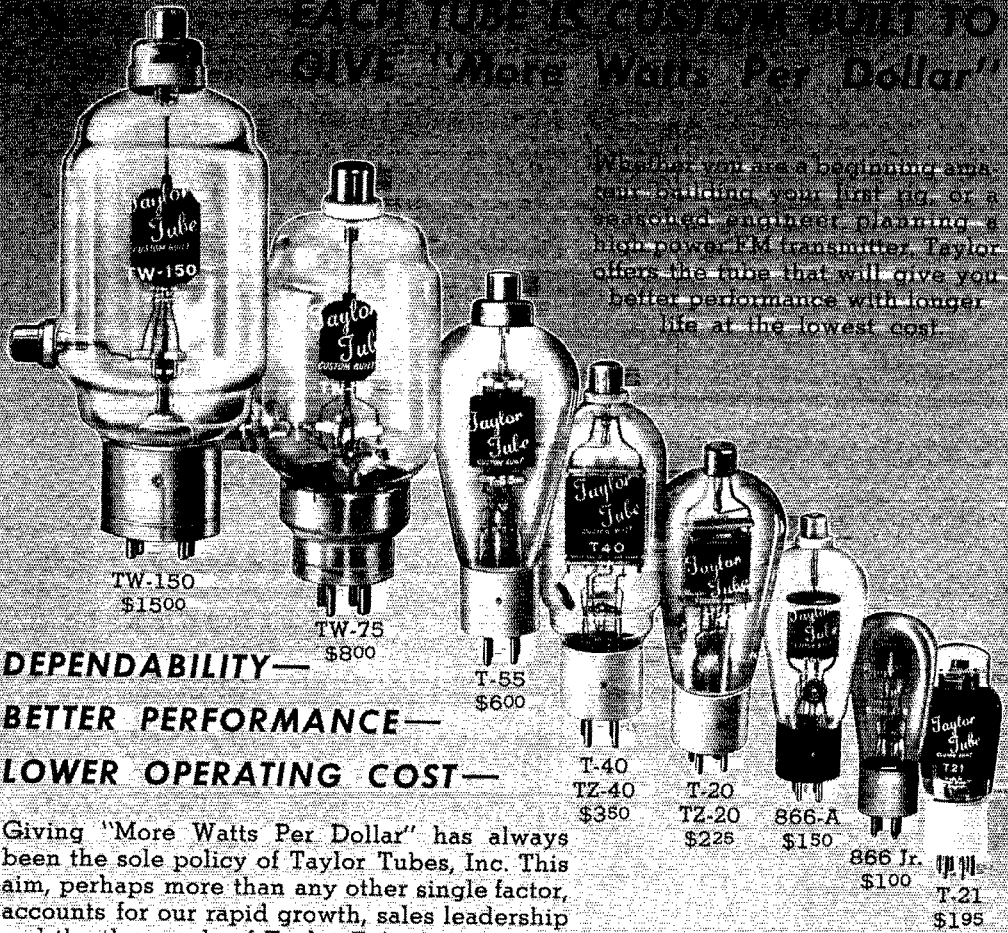

Whether you are a beginning amateur building your first rig, or a seasoned experimenter planning a high-power FM transmitter, Taylor offers the tube that will give you better performance with longer life at the lowest cost.

TW-150
\$1500

TW-75
\$800

T-55
\$600

T-40
TZ-40
\$350

T-20
TZ-20
\$225

866-A
\$150

866 Jr.
\$100

T-21
\$195

DEPENDABILITY—
BETTER PERFORMANCE—
LOWER OPERATING COST—

Giving "More Watts Per Dollar" has always been the sole policy of Taylor Tubes, Inc. This aim, perhaps more than any other single factor, accounts for our rapid growth, sales leadership and the thousands of Taylor Tube boosters.

OTHER TAYLOR TUBES

2032	T 200	814	303C
822	T 125	HD203A	TF100
203A	872A	841SW	830B
211	875A	756	825
211C	249B	HD211C	838
845	204A	HD203C	805

"More Watts Per Dollar"

Taylor Manual

Contains full operating information and ratings of all Taylor Tubes, plus 48 pages of up-to-the-minute transmitting data. It's FREE for the asking at your distributors, or send five cents in stamps to Taylor Tubes, Inc., to cover cost of mailing.

Taylor HEAVY **CUSTOM BUILT** DUTY **Tubes**

TAYLOR TUBES, INC., 2341 WABANSIA AVE., CHICAGO, ILL.

EXTRA CAPACITOR VALUE
IN CORNELL-DUBILIER'S

HIDDEN EXTRAS

ALL CAPACITORS are not alike. Hidden extras distinguish C-D's. Longer life, finer performance, added dependability lie hidden in the ingredients of every Cornell-Dubilier capacitor. You pay no more for this extra value, yet it cannot be matched, anywhere... just as the thirty-one years of Cornell-Dubilier experience that put it there cannot be matched. Get more for your capacitor dollar — specify C-D's.
send for new catalog no. 185a

GET THESE ADVANTAGES
AT NO EXTRA COST IN C-D
DYKANOL CAPACITORS

TYPE TJU

- dykanol impregnated and filled
- stand 10% continuous overload
- universal mounting bracket
- heavy duty pillar type terminals
- hermetically sealed

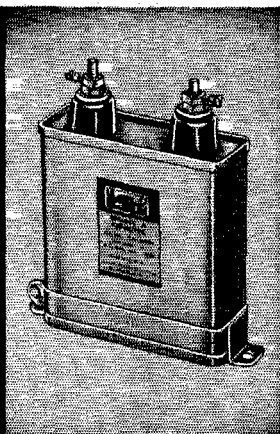

Get the extras

AND YOU GET THE
TOPS IN CAPACITOR
PERFORMANCE!



CORNELL-DUBILIER
ELECTRIC CORPORATION

1013 HAMILTON BLVD. • SO. PLAINFIELD, N. J.

Another detriment to good keying is too much arcing of the key at "break." This causes a heavy click on the end of each character which is, however, easily cured by the addition of capacity across the key (but outside the r.f. chokes). There may still be a spark at the key, but it breaks very rapidly and doesn't form an arc. An easy check for arcing at the key is to hold the key down and then release it slowly. If an arc forms at the key as it is opened and can be drawn out for any appreciable distance, steps should be taken to correct the condition. If additional capacity in the key filter doesn't help, it is probably best to look around for another circuit to key.

Summary

It has been possible to touch on only a few points connected with keying. Next month we hope to present the results of an investigation of crystal-oscillator and grid-block keying. In the meantime, a summary of tests that can be made on any c.w. transmitter might be in order.

1. Check for clicks by listening to the signal on a stable receiver with the gain reduced (possibly the antenna disconnected) and with the b.f.o. turned off. Slow dashes will immediately show if serious clicks are occurring on make and/or break.

2. R.f. chokes right at the key will remove clicks of the type heard in nearby receivers when an electrical appliance is turned on and off.

3. A c.w. signal can stand much more lag on break than it can on make. No click on break and only a slight click on make will usually give an excellent keying characteristic.

4. Check the frequency stability by listening with a low beat note to a harmonic on the highest frequency your stable receiver is capable of tuning to, even if you never operate higher than 3.5 or 7 Mc.

5. Be critical. The other fellow is always too lenient with his criticism.

Dual-Diversity Preselector

(Continued from page 39)

tend to broaden the signal heard in the receiver. A fairly low frequency is thus indicated. On the other hand, the higher audio frequencies produce a somewhat more pleasing signal in the receiver output. A frequency on the order of 300 to 400 cycles per second seems a suitable compromise since the tone modulation of received signals will be double this value when equally strong signals are present in each antenna.

Because of this modulation of incoming signals, this unit cannot be used for *diversity* 'phone reception. However, where an operator wishes to receive radiophone signals as well as c.w., a switching arrangement has been incorporated which allows use of either r.f. channel individually as a single-stage preselector. In addition to permitting "straight through" operation for 'phone reception, this switch is often advantageous in c.w. work when conditions of interference require maximum selectivity. Switching from "diversity"



For Every Need
in **EVERY** Emergency



AXIAL LEAD RESISTORS
 TYPE 710 — size 1/8" x 5/8" rated 1/2 watt
 TYPE 714 — size 1/4" x 1" rated 1 watt

Centralab AXIAL LEAD RESISTORS

Under water... in the air... under ground... on every "front" these famous resistors are proving their fitness in routine as well as emergency work.

Due to more exacting conditions in the industry... the vogue of smaller plastic models; there is an even greater need for resistors that are both small in size and positively insulated. Centralab AXIAL LEAD resistors are designed to fit into limited space without danger of shorting. Moulded bakelite CAPS through which the end leads protrude... complete the positive insulation afforded by the non-conducting ceramic jacket. Will withstand five times rated load without permanent change.

For further information ask your jobber or write for Bulletin No. 806.

CENTRALAB: Div. of Globe-Union Inc.
 900 E. KEEFE AVE. • MILWAUKEE, WISCONSIN

Builders of the famous
 CENTRALAB VOLUME CONTROLS...
 SWITCHES CERAMIC CAPACITORS...

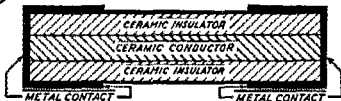

Magnified cross section shows center core of resistance material surrounded by a non conducting shock proof ceramic.

Both core and jacket are fired together at 2500 degrees F. into a solid unit—hard and durable as stone and impervious to moisture. Pure copper spray at extreme ends gives positive electrical and mechanical contact.

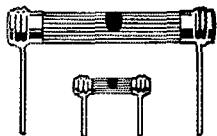

RADIAL LEAD RESISTORS

The radial leads where attached to the body of the resistor are uninsulated... making these resistors 90% insulated... in every other respect the electrical characteristics are the same as the AXIAL Lead units.

TYPE 310 — size 1/2" x 5/8" Rated 1/2 watt
 TYPE 314 — size 3/4" x 1" Rated 1 watt
 TYPE 316 — size 1" x 1 3/4" Rated 2 watts

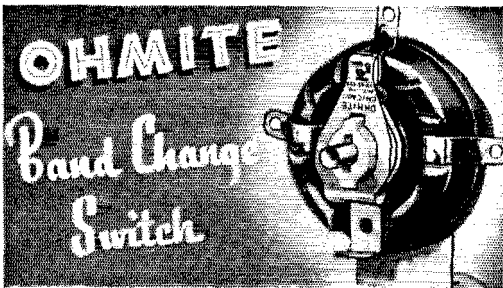

For Rigs Up to 1 K.W.

Just a turn of the knob — and you have instant, easy change from one frequency to another with really low loss efficiency! Band changing may be provided in all stages of the transmitter and “ganged” for complete front-of-panel control! At your Jobber.

Send 10c in coin for new
Ohmite Ohm's Law Calculator
OHMITE MANUFACTURING CO.
4853 Flournoy Street, Chicago, U.S.A.

Be Right with **OHMITE**
RHEOSTATS • RESISTORS • TAP SWITCHES

RADIO OPERATING QUESTIONS AND ANSWERS

Nilson & Hornung's new edition covers all FCC commercial license exam elements. Standard handbook 20 years. \$2.50, postpaid. Money back if not satisfied and book returned in 10 days. Send check or money order . . . not cash. *Free circular on request.*



NILSON RADIO SCHOOL, 51 East 42nd St., New York

LEARN RADIO • TELEVISION

60-page catalog on request. Oldest, largest and best equipped in New England. New classes now forming. Write for new catalog.

MASS. RADIO SCHOOL
18 Boylston Street Boston, Massachusetts

“The American Radio Relay League — and What It Means to You”

is the title of a new little booklet which we will be glad to mail free on request. Designed to tell prospective members what they should know about the League, it will be likewise interesting and informative to members.

The American Radio Relay League
West Hartford, Connecticut

to either r.f. channel automatically cuts off the audio oscillator and the negative blocking voltage to the 6L7's, but does not affect the tuning in any way.

In placing the unit in operation, suitable antennas are connected to the two r.f. inputs and the output link is attached to the receiver antenna terminals. The only preliminary adjustments are the setting of the blocking-bias tap on the power supply bleeder and the adjustment of resistors R_1 and R_2 to provide the proper audio signal voltage on the No. 3 grids of the 6L7's. The former is made by first throwing the switch to “diversity” and removing the audio oscillator tube. Then, with a strong steady carrier tuned in, the bias tap is set at the point where the applied negative voltage blocks operation of the 6L7's. The oscillator tube may now be replaced and adjustment of R_1 and R_2 made as follows:

Remove the antenna from r.f. channel No. 1 and adjust R_2 to the minimum value that will permit operation without decrease in signal strength as heard in the receiver output. The antenna may now be replaced to channel No. 1 and disconnected from channel No. 2. R_1 is next adjusted the same as above. Replace the antenna to channel No. 2 and the unit is ready for use. The resistor adjustments once properly made require no further attention.

No particular mention need be made with respect to receiver operation since it is unaltered by use of the diversity pre-selector. The latter is tuned in a manner exactly the same as if it were a standard external r.f. stage.

If, when operating “diversity,” distinct side-band frequencies appear above and below the desired signal on the receiver dial, harmonic content in the audio oscillator output is indicated. The only satisfactory solution is to improve the waveform of the oscillator-phase inverter circuit output. This difficulty was not encountered in the particular circuit shown.

Considerable space could be devoted to the description of suitable diversity antenna systems. In all cases, however, the exact system used will depend on the space available. Wherever possible, two identical antennas spaced at least one wavelength apart should be used. If space will not permit such an installation, antennas of different types may be used. For example, a system which has worked out very satisfactorily in practice makes use of two doublets, one of which is erected horizontally, the other at right angles to the first but slanted at about 45 degrees in the direction from which reception is desired. The ends of the two antennas are less than a quarter-wave distant, yet the diversity effect is fairly well defined.

Where a vertical antenna is operated in conjunction with one in the horizontal plane, results are often discouraging. It has been found that, on the higher frequencies in particular, there are periods of time lasting in some cases for days when the average signal level in the vertical antenna is 10 to 15 db. below that in the horizontal antenna. For best results with a unit of the type described, the average signal level in both antennas should be the same.

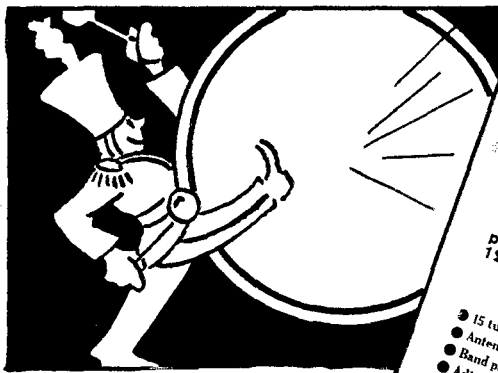

Sky Champion S20R

Buy It the Easy Newark Way

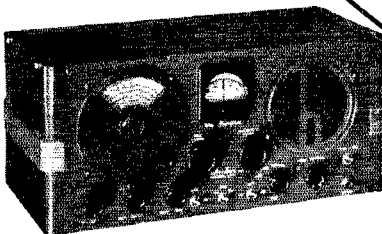

\$4.95 down \$5.90 per month
EIGHT MONTHS TO PAY!

Sensitivity, selectivity, and all-around quality performance you'd expect only in a high priced receiver... yet Hallicrafters give it to you for only \$49.50! Has all the essential controls for good amateur reception. Complete with tubes and speaker. Nothing else to buy. Cash price... **\$49.50**

★ ★ ★ ★

HIGH VOLTAGE POWER TRANSFORMERS

One of America's largest transformer builders made these... and NEWARK's immense amateur radio business enabled us to get them for you at a price! We guarantee every one. Real "huskies" they are, and just the thing for your Ham rig!



Choice of Two Filament Types
 No. 4140 — 600-0-600 V. — 200 Ma. Filaments: 7.5 V.C.T.-3A. — 5.0 V.C.T.-3A. — 2.5 V.C.T.-10 A. Wt. 8 1/2 lbs. **\$2.85**
 No. 4240 — 600-0-600 V. — 200 M.A. Filaments: 6.3 V.-4 A. — 6.3 V.-3 A. — 5.0 V.-3 A. Wt. 8 1/2 lbs. **\$2.85**

ANOTHER SALES LEADER!

Just the thing for the Osc. Power Supply, Speech Amplifier and many other services. Same style as illustrated above. Wt. 8 lbs.
 350-0-350 Volts — 150 MA. 5 V. at 3 A.; 5 V. at 3 A.; 2.5 V. at 3 A.; 2.5 V. at 7 A.
 No. 3004.....**\$1.69**

JOIN THE "PARADE" TO NEWARK
 for your hallicrafters SX-28

★
\$15.95
 DOWN...
 and
\$12.68
 per month for
 12 months...



- ★
- 15 tubes
- Antenna trimmer
- Band pass audio filter
- Adjustable noise limiter
- 2 stages of preselection
- Micrometer scale main tuning
- Machine tool, grey wrinkle government specifications.
- SX 28 complete, less speaker, cash price..... **\$159.50**
- Calibrated bandspread on 10-20-40-80
- Six bands for most satisfactory L/C ratio
- 6-step wide range variable selectivity
- Push-pull high fidelity audio steel cabinet. Designed to
- Regular FM 23 speaker in metal cabinet..... **\$12.00**
- Hallicrafters Jensen bass-reflex enclosure 30" high, 19" deep, 22 1/2" wide..... **\$20.50**
- Hallicrafters Jensen bass-reflex enclosure 23 1/2" high, 10 1/2" deep, 17 1/2" wide..... **\$19.50**

Hallicrafters S-29

PORTABLE COMMUNICATIONS RECEIVER

\$59.50 Complete with Tubes, Battery and Speaker. **\$5.95**
 Down — \$7.10 per Month for 8 Months

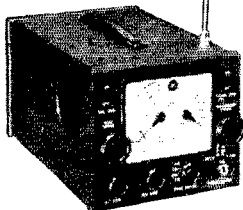

Hallicrafter's Universal Portable Receiver — take it with you — use it at home. Operates on either 110 volts AC or DC or from self-contained batteries. Tunes from 542 kc. to 30.5 mc. (553 to 9.85 meters). Self-contained antenna. One stage preselection on all bands. Electrical bandspreading.

ORDER YOUR HALLICRAFTERS SET ON NEWARK'S EASY TERMS . . . Today!

Pick out the receiver you want, and write or print your order plainly. Write name and address plainly, enclose down payment and credit reference. We ship immediately upon credit approval. You pay balance plus carrying charges, in equal monthly payments. Any Hallicrafters receiver may be purchased this easy way if you order it from NEWARK!

➔ We also have the new **ECHOPHONE EC2** and **EC3** in Stock

SEND AT ONCE FOR THIS FREE BOOK!

This book belongs in every "ham" shack, ready for instant reference. Helps you plan your new rigs, figure costs, learn sizes and specifications before you start construction. NEWARK's most complete amateur radio parts and equipment guide . . . contains many more items than we've ever put between the covers of any catalog. Thousands of bargains, sets, parts, accessories, supplies, of best known makes. Hundreds of illustrations. WRITE FOR YOUR FREE COPY NOW.

NEWARK Electric Company
 323 W. MADISON ST.
 Dept. Q CHICAGO, ILL.

Station Activities



CONNECTICUT QSO PARTY

April 12th-13th

All Connecticut amateurs are invited to take part in a QSO party to be held Saturday, April 12th, from 6 p.m. to midnight and from noon to 10 p.m., Sunday, April 13th. 'Phone, c.w., or a combination of both may be used on any band or bands. Count two points for each QSO. Multiply contact points by the number of towns/cities worked (Post Office designations). Exchange QTH's and nicknames. Ten points before multiplier may be claimed if registration in the A.E.C. accompanies your log. The necessary blanks may be secured from A.R.E.L.L. Headquarters. If you're already registered in the Emergency Corps, the extra credit may also be claimed. Prizes will be awarded for the highest total score, for the highest c.w. score, and for the highest 'phone score. Each participant will be eligible for one prize only. In addition, all who take part will be eligible for a prize to be awarded by means of a hat drawing. Send all logs to S.C.M., WICTI, no later than April 30th. Good luck to all!

NEW ENGLAND DIVISION

CONNECTICUT — SCM, Frederick Ellis, Jr., WICTI — Nutmeg Net, 3640 kc., 6:45 p.m., daily except Sunday. KKS took a vacation from traffic, and MGC took over his schedules. Bill made 50 QSO's and worked 17 states in the 1.75-Mc. W.A.S. Contest. CTI B.P.L.'d on deliveries. TD reported for GB. KFN and GRU, former chief operators, are at Fort Monmouth working at the Squire Labs. KAT has a 28-Mc. beam most ready to be put up. BQL is RM1c on the U.S.S. *Sapphire*, just starting active duty. HNO was ordered to duty at Key West, Fla. AZT is another N.C.R. lad now in the Navy. ADW is at Norfolk making the BPL at the rate of 200 messages a day for Uncle Sam! KAA and MEC are at the Brooklyn Navy Yard instead of pounding brass at home. P.A.M. EAO was down with the flu during the last O.P.S. and A.R.R.L. Party, but listened to the local gang on a midget broadcast receiver in bed. JPE is active on 56 Mc. LOP was appointed O.P.S. and O.R.S. DWP has joined the State Police Net being formed by W1ANN. LQK spends most of his time with the N.C.R. DGG is spending 3 weeks in Florida. JXP is working on a U.H.F. Net. EER has weekly schedules with K4FKC and K4EZR. The Hartford County Amateur Radio Association has been issued WINEM and has a new 1/2 kw. ready to go on the air. JFN is working on a new swamp antenna, but is being held up as the swamp is flooded and frozen! Notice to all Conn. O.R.S.: Watch your procedure. Use AR, K and VA properly. Sign your call every ten minutes as required by F.C.C. regulations. When relaying a message, send the whole message and include all of the preamble. Don't omit part of the preamble just because a previous message was similar. Sign your call when you call a station. Everybody can't guess your call by your fist and note! Let's all try to set a good example by doing things right.

Traffic: W1AW 858 KKS 258 CTI 193 2T 135 JQD 84 LVQ 80 KQY 43 KAT 36 BDI 27 JHM 9 EAO 8 FMV 6 GB-DWP-I-QK 2.

MAINE — SCM, H. W. Castner, W1LE — New O.R.S.: W1EUL, BTY, GKC. New O.P.S.: EUL, LKA, TO. New E.C.'s: EUL, BTY, GKC. New O.B.S.: FPS/1. The Rockland boys had a fine little hamfest Feb. 6th. RU was master of ceremonies, and a very unusual QSO with Boston was demonstrated. Old "QTC 1" Rip. W1EJS to you, gave a short talk and W1FZW spoke briefly. W1FPS/1 is a proud father. BGZ has gone back to sea. LNI has a new e.c.o. and uses 112 Mc.; he plans on 56 Mc. for portable mobile in the spring. BGU has moved to Canada. LHA is working in Miami and says it is fb. The P.A.W.A. had a W.A.S. contest in Feb. on 3.5 Mc. BTY is building up a

swell emergency net along the Saco River. The Quoddy Village Club is reorganized, and LIP writes that they will have two transmitters on soon. MINI is on 1.8-Mc. 'phone. LAP is in the Army, headed for Hawaii. GHT has moved to new QTH. LML has new Variam e.c.o. and new receiver. The Skowhegan boys have the club going again, and LKA is Pres.; MEV, Vice-Pres.; FEE, Secy.-Treas.; MQD, Activities Manager. MQH has the new N.Y.A. project in Bangor going fine. They will have a 40-watt 'phone-c.w. rig and new receiver. The boys on the project will assemble the transmitter. They will soon organize a club. FQ, LEV, LLQ, AWY, MLX left for active duty in the Army. LEV will take a rig with him, and wants schedules from Camp Blanding, Fla., on 28-Mc. 'phone and 14-Mc. and 7-Mc. c.w. MFU is a youth worker at Bangor N.Y.A. BLF has a new 28-Mc. 'phone. CGV has separate rigs on 14- and 28-Mc. 'phone. HNS has a new 1.8-Mc. 'phone. PQ has new HF100 final. AKR and FNL are doing some work in f.m. LBX has a fine new direction indicator for his rotary beam antenna. AID, BLF, CBV, CWB, FNL, HTZ, LBX, LEV and MWH are on 28-Mc. 'phone and, when the band folds up, they have a fine local round-table. MT has been made Lieut. jg in the N.C.R. BTA has left duty in Maine and has been transferred to Hawaii. EMR has a fine daughter that just arrived. VF was called to active duty, but is waiting a waiver on some "bicuspid" specifications. ALO has gone into the Navy. Many of the boys in Sanford Unit No. 3 N.C.R. are in the service. KVK is having a grand time on 3.9-Mc. 'phone. LWO has had a schedule with W8MCF, with only two misses in a year. The Sea Gull Net continues to be most interesting and worth while. We stand ready to help anyone with information of any kind, and many of the boys are asking for help on traffic handling. We're sending out a large amount of material. After you get these helpful booklets, please read them. We're having a lot of questions heaved at us that are answered in the book. We hear old BWR on the air over near Concord, N. H., signing, W1MRO/1. LML says he is itching to take a whack at the Pine Tree Net. That would be fine, Leo. We have a lot of interest and activity on the net, and several new members are getting ready to come in including DTS and MID. If you think there is more than one way to get a message across, ask IBR and MID and DTS. These boys, including LKP, have taken the matter seriously, and they have made great improvement. I'd bank on 'em anywhere. I will offer to send anyone a sample message in absolutely correct form, who will ask for it. If you want to get 'em over and do it accurately and quickly, there's only one way, fellows. The sooner we get it straight, the better. If you hear the control station on the Pine Tree Net say, "CQ PTN QTC?" and you can get on the frequency of 3597, just give us a blast and we would be more than pleased to handle any traffic for you. RU is about ready to work on 112 Mc. along with FZW, FZD and EJS. KTT is using a little 1.8-Mc. 'phone job that RU got together, and it sure sounds fine. IFZ is about ready to join the gang on 1.8-Mc. 'phone. That 1.8-Mc. outfit around Rockland is really something. INW will soon be on the air from Boothbay Harbor. The boys at OR have a new receiver, and have been on a lot lately. KEZ has been on 1.8-Mc. 'phone all winter. HSD has a new rig, and will be on just as soon as he gets up a sky wire. His final is an RK-20. We hear Flo and Pete batting it out on Trunk C down there in Augusta, Ga. The old signal sure comes up this way fine. EEY has a fine emergency plan for his vicinity and is carrying on practice drills. GXY is sure doing a fine job with BNG for the boys in the service from Bath. IKE has the change of address all fixed, and is now batting it out from Bates College with an 89 plus signal. We are delighted to state that the old veteran, TO, is now O.P.S. NCG has left Bridgton C.C.C. The S.C.M. contacted many of the gang on 1.8 Mc. from W9GKC. For the benefit of all concerned, let me again explain that all reports to the S.C.M. should be mailed between the 16th and 18th so that they can be included in my report which must leave promptly on the 20th of each month.

Traffic: W1IEE 94 EBY 3 GKJ 21 LKP 60 BNG 5 EUL 4 LOA 42 LNI 9 GXY 28 KTT 11 CMO 23 GMD 18 BAV 262 EJS 122 LYK-IKE 13 IBR 21 BTY 65 LKA 11 MFK 10 FBZ 22 LML 192. A.A.R.S.: W1AMR 50 CFO 60 EFR 64 FAP 105 GE 21 GHT 10 GVS 172 LIF 87 KOU 190 KTN 74.

EASTERN MASSACHUSETTS — SCM, Frank L. Baker, Jr., W1ALP — The best news this month is the number of new Emergency Coordinators for the following cities and towns: CTR, Framingham; EVJ, Nantucket

County; BAP, Wrentham; DMF, Wenham; MQV, Chelmsford; AKS, Salem; FWS, Milton; RP, Westwood; AGR, Norwood; FJN, Scituate; CCL, Cohasset; JMJ, Dukes County; IBF, Danvers; MTV, Needham. DTP and I want to thank you all for your interest and cooperation in helping in this work. All hams in these towns get in touch with these fellows to see what you can do to help. We have also appointed new P.A.M.'s for the following 'phone bands: EKT, 56 Mc.; AIQO, 28 Mc.; KTE, 3.5 Mc. You 'phone boys should give them your support. GAG is the Chief P.A.M. Brockton Radio Club held its annual banquet, with a turkey and chop suey supper, prizes, dancing, etc., at the Mohawk Lodge which is run by KBM. GOU has a qsl from KB4HBX. QW is now in the Navy, aboard the U.S.S. *St. Augustine*. Good luck, Wes, KH, EKT and LSA are now O.P.S. LZW is new O.B.S. on 112 Mc. Framingham Radio Club are working on their Annual Hamfest, scheduled for some time in April. Save your pennies, gang, for another swell turkey supper and a nice time. HXE says all the Emergency Corps up his way are getting 112-Mc. transceivers. HA is working on a high-power rig for 1.75 Mc. EPE has been appointed new State Radio Aide for East. Mass. A.A.R.S. Welcome to three old-timers, AVA, AHI and DXR, who are back on again. MDN enjoyed the 1.75-Mc. W.A.S. Contest. HIL is working on a rig for 1.75 Mc. EVJ has an emergency transmitter and is going to build a receiver. LMB is on 112 Mc. for a while. LEU is working N.H. each nite on 28 Mc. LN is now at Fort Monmouth, N. J., as a Radio Engineer in the Sig. Corps. AAL has applied for O.P.S. KWD is on with 250 watts. LNE is on 28 Mc. again. BDM and MME are on 112 Mc. AHD has left for China, and will be on 28 Mc. MJ is interested in 3.5-Mc. c.w. MZE is looking for traffic on 3.5-Mc. c.w. BDU is looking for traffic on 14-Mc. c.w. LAO is in Cuba with the N.C.R. MYO has a new 3-element beam. MQO and LO have schedules with LDR/5. LEU has a new 8X28. MGQ has new e.c.o. FHW is back on 28 Mc. JNK has a new 3-element beam. The Parkway Radio Ass'n is getting ready for their annual banquet. HOB is all set now for 1.75 through 14 Mc. MQO's rig blew up, but he is on again. WV worked 43 sections in the A.R.R.L. Party. He had a visit from GM3HX. He wants local hams for Mass. State Guard. HPT and ATD have signed up. HUV has 250-watt rig on the Farmer's Net with a real antenna, and was in the N.H. QSO Party. ALP also worked a few in this party. New stations are coming on 56 Mc. every week. I want to thank the A.A.R.S. men who are sending traffic reports to me for this column. Take a look at them below! Remember, gang, this is your space, and it is open to all hams in this Section. Send me a card or message, or look for me on 3.5-Mc. c.w. on or before the 18th of each month. NBQ is a new ham in Roxbury and is on 7 and 3.5 Mc. Welcome to NFK, a new ham in Cambridge on 112 Mc. BDU has taken over the job of Chief Route Manager for this Section. All O.R.S. and traffic men please cooperate and give him your suggestions. Let's build up this Section's traffic totals, and be up among the leading sections of the country, where we used to be. If you don't pick up any traffic on the air, originate some! JXU is back from Kansas, and is at Camp Edwards on Cape Cod. GAG has a rig going on 7 Mc. MME applied for O.P.S. MMM and MTQ applied for O.R.S. QD's 112-Mc. A.A.R.S. net is quite active; he wants more traffic going to the 1.75-Mc. A.A.R.S. Net.

Traffic: W1AKS 275 BDU 254 EMG 78 HWE 76 BMO 27 MKN 12 HA 10 MQO-KTE 6 LBH 5 BB 4 ALP-NAS 2 AAR 136 KXU 83 LBV 62 AAL 43 EHT 7 MME 2 FSL 143 FWQ 38 LYG 43 MDU 13 JCK 127 (WLG 65) KZT 44 IXL 6. A.A.R.S. Members: W1AHP 154 LSA 24 IYU 121 MNW 16 MOJ 36 DKS 19 LVD 41 KYN 18 MTF 8 FVL 14 CCL 21 KCT 87 JSM 282 LPX 1 MAN 14 LWH 318 EPE 223 AYN 31 BHL 24 EYR 112 IYN 2 KAL 8 LWI 56 MBS 45 MIF 39 MMY 11 MON 336 MQH 43 NBT 28 QD 123 LVZ 56 KMQ 27 JFS 45 AGX 20. (Dec.-Jan.: W1KZT 48 HA 24.)

WESTERN MASSACHUSETTS — SCM, William J. Barrett, W1JAH — W1BIV runs up a nice total in the first month at new qth. BKG has a new final perking. SZ is rebuilding. BVR is awaiting a new HQ 120X. LUA keeps busy with A.A.R.S. schedules. AJ has a new NC-200. BNL has 6L6-807 on the air and is adding RK20; regenerative i.f. is being added to the receiver. KRX took in the A.R.R.L. Party, and is getting started on a code proficiency certificate. The only states KJO missed east of the Miss. River in the A.R.R.L. Party were Vt. and W. Mass. KZU built a new band-switching crystal/e.c.o. exciter. Very few

replies or expressions of interest were received after the last appeal for members to revive our West. Mass. O.R.S. Net. How about it? The A.A.R.S. in our Section is thriving, and there seems to be no reason why we could not also have a successful A.R.R.L. Net. Don't let code speed deter you. MIM is new O.R.S. Please try to get reports in on time so they can be sent to arrive at A.R.R.L. on the 20th.

Traffic: W1BIV 295 (WLG 74) JAH 126 (WLG 63) AZW 98 FOI 92 BKG 90 (WLG 35) LUA 77 KZS 22 MYZ 23 BVR 20 (WLG 97) JWV 14 ADF-MBT 13 MSR 12 KUW 11 HWB 10 AJ-LJW 9 BXF-IIP 8 DUZ 7 MJP 6 IJL 4.

NEW HAMPSHIRE — SCM, Mrs. Dorothy W. Evans, W1FTJ — In spite of an oversight regarding the date of our New Hampshire QSO Party, our contest went over with a bang and was apparently a huge success. To date your S.C.M. has received 56 reports, and they are still coming in by each mail. The bands seemed to be quite active for this party, and many report having worked a lot of the old-timers who hadn't been heard of for some time. It was good to hear and work so many New Hampshire stations, and it was nice also to have so many out-of-state hams join us in our fun. We are planning on making this an annual or semi-annual event, and the S.C.M. would appreciate comments from New Hampshire hams about this. The next issue of QST will have the dope on the final scores. There were some nice ones and a lot of competition. NEI is a new ham in Laconia. He held his first QSO on February 9th, and was so excited he says he could hardly hold the pencil! The New Hampshire Net is operating nightly, as per usual, under the guidance of IP, since BFT has been called to active duty with the U. S. Navy. New officers of the Manchester Radio Club are: IVU, Pres.; CMR, Vice-Pres.; MUW, Secy.; HFO, Treas.; MDP, Ass't. Treas. MXL/1 is now located in Laconia and is checking in nightly on New Hampshire Net. HFO expects to have a pair of 811's running 250-300 watts by next month. The gang at Berlin is getting interested in f.m., now that W1XER is on regularly. AP, engineer at XER, says the wind the other day was 130 w.p.h. and blew his pipe out of his pocket while he was walking from station to powerhouse! IVE and LLP had to put their antennas back up after the same wind. KP'D has a Meissner Signal Shifter and is replacing the final with an RK49. He hopes to be able to drive a pair of 813's at 800 watts directly!! KKQ is helping to organize a class of yI's in Milford sponsored by N.Y.A. Leora is teaching the gals their dots and dashes. MMG is now using an NC81X. BJF now has another yI jr. operator. FB, Walt. KLV is new O.R.S. LSN is new O.P.S. at Exeter. JBA is on the U.S.S. *Tennessee*.

Traffic: W1FFL 311 KIN 167 GEY 151 MOF 107 FX 38 GMM 87 ANS 80 JDP 67 IP 51 MMG 49 KKQ 37 IDY 33 JGI 23 MLO 21 KMH 18 HGV 15 JKH 13 GDE-HFO 12 AXL 11 GVJ 10 CMR 9 ITF 8 KBU 6 CEA 3.

RHODE ISLAND — SCM, Clayton C. Gordon, W1HRC — The big event for this month seems to have been the R.I. QSO Party, and is my face red! Realizing that either a stack of good old rocks a mile high or a v.f.o. are almost a necessity in a contest nowadays, your S.C.M. spent several shekles and lots of time on his e.c.o. trying to bring it up to snuff. The thing grounded against the mike stand and burned up the transformer and grid coil about an hour before contest time. Was sort of burned up myself along with the rig. But from reports, guess everybody else was on. There is considerable action stirring to make it a monthly get-acquainted affair, which is one darned fine thought. Many old-timers who haven't dusted off the key for years took part in this contest. KRQ has a job in the weather station at Glens Falls, N. Y. Bill has long been one of the most active hams in his locality, and was one of the starters of the Westerly Radio Club. He was always on hand to help the boys get their rigs going, and always gave a new ham or a prospective ham an eager helping hand. He will be remembered for his excellent work during the hurricane, and has several citations for his efforts. A 7-Mc. round table is held every Monday at 8 p.m., consisting of LZD, KRQ, MAE, MVL and MOK. The purpose is to increase code speed and operating technique, and the boys say they would be glad to hear from others who would like to get in on it. IZD, MAE, MVL, MOK, KRQ, INN and BOS are all on 1.75-Mc. 'phone. March 6th, the P.R.A. started its code and theory school for this year. HJB is controlling the 112-Mc. Southern New England Emergency Net which operates at 11 a.m. on Sunday mornings with NBU, NDQ, MNC, LYE, NBH, NDM and KKE active.

(Continued on page 88)

A Portable Emergency Set

(Continued from page 85)

Announcing!!

NEW ABBOTT DK-3

Portable battery 2½ M. transceiver with inductive antenna coupling variable from front of panel permitting maximum transfer of power in the transmit. position and additional tuning refinements in the receiver position.

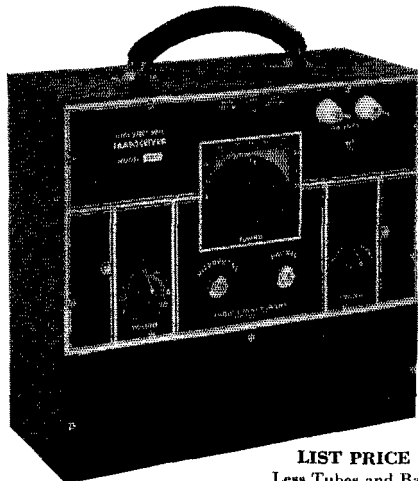

LIST PRICE \$29.50
Less Tubes and Batteries

40% DISCOUNT TO AMATEURS

THE ABBOTT DK-3 functions as a completely self-contained 112 Mc. radiophone transmitter and receiver. Its extremely compact size makes it desirable and convenient to use in a car, plane, boat, or carried for portable work. Range will vary between 2 to 30 miles depending on the terrain. Ideal as an emergency communications unit. Exceptional results have been obtained.

Specifications:

CASE: Size 11" long x 11" high x 4½" wide, grey wrinkle finish, heavy leather handle. All batteries are self-contained in case. Back is removable, making easily accessible, the batteries and tubes.
FREQUENCY: Covers 112-116 mc. (Amateur 2.5 meter band).

BATTERY REQUIREMENTS: Three 45 volt B batteries like Eveready No. 482 or Burgess M30 and four 1½ volt batteries like Burgess 4 PH or Eveready No. 742.

TUBES: One 6J5GT, one 6GGG.
SHIPPING WEIGHT: 11 pounds.

SEE IT AT YOUR FAVORITE DEALER

Write for bulletin

ABBOTT INSTRUMENT, INC.

51 Vesey Street

New York City

FULLILL YOUR AMBITION

Train yourself at home for that technical radio job or promotion you want. Study under personal direction of A. R. Nilson — for twenty years expert author-instructor. Three up-to-the-minute, low-cost, home-study technical radio courses:

1. Essentials of Radio Communication
2. Advanced Radiotelegraphy
3. Broadcast Operating

will help you succeed in your job or on license examinations
FREE BOOKLET "What the Modern Radioman Must Know" describes these courses in detail. Send for your copy now!

NILSON RADIO SCHOOL

51 East 42nd St., New York, N. Y.



sockets and the parts inside the circles are the plug-in coils. The four single-pole double-throw switches indicated by S_1 to S_4 , are really a single four-circuit two-position switch. Likewise, the switches S_5 to S_8 form another unitary switch. If anybody is too lazy to turn two switches he is at liberty to gang them together, but then he cannot operate the amplifier tube as a doubler. In Fig. 5 it will be noted that the plug-in oscillator coil in one of the sockets has its upper end connected through a fixed condenser to the tuning condenser terminal while this condenser is replaced by a straight connection in the other socket. Actually this fixed condenser is not used except where it is desired to reduce the coverage to a lesser value than will completely cover the 160- and 80-meter bands. For example, if the rig were to be operated on 40 meters a condenser at this point would be mounted inside the 40-meter coil form, its capacity being so chosen as to make the oscillator tuning range just 7 to 7.3 megacycles.

This transmitter was designed to operate on a standard vibrator power supply giving a maximum of 100 ma. at 300 volts. In normal operation the amplifier draws 30 ma. and the oscillator 10 ma., more or less, and the modulator tube about 40 ma. This is sufficiently within the vibrator rating to permit simultaneous operation of a small receiver using headphones to avoid the use of a high-current output tube. It is really surprising how well such a low-powered rig can get out when conditions are right, even when the supply voltage is reduced to only 250 volts and the power input to the final correspondingly reduced to about 7 watts.

In designing this transmitter the question arose whether it would not be possible to get more output from the 30 watts available from the vibrator by putting most of this 30 watts into the final and grid-modulating this stage, which would require very little power for the modulating system. Apparently there is little to choose between the two systems so far as output is concerned, but a tube of greater plate dissipation than the 6V6 would have had to be used with grid modulation and it was thought desirable to have all of the tubes of the same type if possible.

Regardless of the particular arrangements employed, the writer believes that it is something almost approaching a public duty for every amateur to have on hand an emergency transmitter and receiver, so designed as to be capable of complete operation at all times independently of alternating power supply, and this means in the case of most of us that there should be no batteries relied upon that cannot be quickly obtained in an emergency. The actual use of such an outfit is, in addition, a lot more fun than can be realized by anyone who has not tried it, and even those who scorn low power can utilize the rig by arranging the r.f. and a.f. portions to serve normally as exciter and preamplifier for the high-power transmitter.

★ ★ ★ ★ ★ ★

The radio amateur's handbook

THE STANDARD MANUAL OF AMATEUR
RADIO COMMUNICATION



1941

PUBLISHED BY THE
AMERICAN RADIO
RELAY LEAGUE

\$1 IN CONTINEN-
TAL U. S. A.



The Handbook tells the things which are needed for a comprehensive understanding of Amateur Radio. From the story of how Amateur Radio started through an outline of its wide scope of the present — from suggestions on how to learn the code through explanations of traffic-handling procedure and good operating practices — from electrical and radio fundamentals through the design, construction, and operation of amateur equipment — this book covers the subject thoroughly. It includes the latest and the best information on everything in Amateur Radio.

\$1 postpaid in Continental U.S.A.

\$1.50 elsewhere

Buckram bound edition, \$2.50

American Radio Relay League, West Hartford, Conn.

(Continued from page 85)

JP has new Class B 809. QR is keeping a Sunday A.M. schedule with LYK. EOF is working nights every other week, but gets on P.R.A. Net and during the daytime when he can. LYE is working in the P.R.A. Net, P.C.N., and the S.N.E. 2½-Meter Net. He runs 50 watts to an HK24 modulated oscillator on 112 Mc., and the antenna is an extended double zepp. KZN closed down Feb. 15th, but expects to be on from Camp Blanding, Fla. JEZ is taking the second half of Prof. Tompkins Electronics Course at Brown. His new emergency rig is 6L6-6L6 crystal/e.c.o. and 6SJ7-6C5-6N7-6N7 modulator. This makes two complete emergency-powered rigs for Walter, and puts him up as E.C. FUB is mixing up 802 e.c.o., 7C5 dblr, 7C5 dblr, 815 pp amp, for 112 Mc. NDM is on 1.75-Mc. 'phone with pp 809's, and on 112 Mc. with pp. HK-24's. LCS is enjoying some fine dx on 3.5 Mc. DDD is extremely active on 112 Mc., with his new receiver a great success. JP told the P.R.A. about 112-Mc. antennas at a recent meeting. He was just getting the boys all set to build Yagi beams when a fire broke out in the Freight Depot at Union Station. The third alarm broke up the meeting and left poor JP cold. MDW schedules W2MIY and W1LWA. LWA has been active on 3.5 and 1.75 Mc. and worked K4DTH at 6 p.m. He also worked the West Coast between 7 and 10 p.m. The N.A.A.R.O. as a whole visited Brockton where KCS gave an interesting talk on f.m. MQF has joined the club, and is on 1.75-Mc. 'phone and 3.5 c.w. with an HK-54 and 100 watts. KYP is on 3.5 Mc. with 807 final. NEH is a new ham on 3.5-Mc. c.w. and 112-Mc. 'phone. KYK is now on 112 Mc. MJL has a new W.E. rack, and they say the rig is a "swell looker." BBN has a new e.c.o. exciter. NCX is an ex-K5AA op. and is now on 3.5-Mc. c.w. MO is leaving the Section for the West. He will be missed by the gang, and they look forward to hooking up when he is a W6. MRV has a new Stancor 20P on 3.5 and 7 Mc. GBO is on 1.75-Mc. 'phone. That winds up another jerky jernul, boys, and it certainly does your S.C.M. good to see so many of you taking active part in our activities. See you next month. 73.

Traffic: W1LWA 197 LDL 127 (WLGK 5) HRC 47 HJB-LYE 22 KZN 18 EOF 9 QR 5 JP 4 MWY 1.

VERMONT — SCM, Clifton G. Parker, W1KJG — BJP is active on 3.9-Mc. 'phone and visited TJ, BLC, DQK and JZF. HXC at Beecher's Falls is heard on 1.75-Mc. 'phone. AYP is busy with plans for a 3.9-Mc. 'Phone Net; Vermonters frequently heard Sunday mornings include AYP, EMQ, TJ, CBW and BJP. FSV is now working for Plant Department of Central Vt. Public Service Co. KUY is settled in his new home, which is complete with radio room in basement. KJG was visited by JRU, MLJ and KUY. JRU operates with a remote control system, and has a special "ventilated" desk for his receiving position. KUY is now at Barre, and busy completing 400-watt rig. MMV has a 28-Mc. 'phone nearly completed. MCQ is rapidly ironing out difficulties with his 500-watt 'phone unit, and is active on the air. LTW is now heard on c.w. MLJ has been busy moving to new QTH at Barre. Ex-IQG plans to go to Schenectady for ticket early in March. Officers elected by Burlington Amateur Radio Club are: HLL, Pres.; JVS, Vice-Pres.; Burt Dean, Secy.-Treas. This club has been very active this season with very good programs on amateur activities, and has instituted a course in amateur radio as outlined by A.R.R.L. Instruction covering various phases of the course is being given by HLL, JVS, LWN, LVP and MET. LWN has moved to Burlington where he has a position at WCAX recently held by BZS. GAE has moved to Burlington, and is busy getting his station on the air. MJU and MMV are working on the old WDEV transmitter which they have acquired, and are getting it ready for 1.75-Mc. 'phone and c.w. AEA is back on 1.75 Mc., has installed a new 260-foot antenna and started a T-20 final unit. CBW is active on the Vt. A.A.R.S. Net. KJR has had night duty at shop, and is absent from usual traffic activities, but can be heard on the air during the day. JLF is back on 1.75-Mc. 'phone and heard frequently on week-ends. JVS has been appointed S.N.C.S. 4 for Vt. A.A.R.S. AD has completed a 913 oscilloscope unit, and is anxious for Vermont contacts on 1780 kc. Amateur activities in the Barre-Montpelier area are rapidly on the increase, and amateurs there are formulating plans for a radio club to take in the general territory around those cities. We welcome two new amateurs to our Section; NDB, Harold Spaulding, of Barre, and NDL, Gerald Benedict, of Montpelier. NDB has been appointed O.R.S. These last mentioned stations

will give Vermont badly needed traffic outlets for the capital area.

Traffic: W1AD 48 JVT 15 FSV 109 KJG 34 JRU 36 AEA 7 JVS 15.

HUDSON DIVISION

EASTERN NEW YORK — SCM, Robert E. Haight, W2LU — KWG is pounding out traffic on 3742 and 3510 kes. LSD, King Station of the F.T.S. boys, reports a nice total. SZJ is working on 3.9-Mc. 'phone with a new National 600-watt rig. ACB reports new Trunk Line N operating through to Chicago. JRG is on 2018 kc. with 10 watts. NIY is heard on 3700 and 3530 kc. LLU completed a new 6-tube receiver per Nov. 1940 QST which perks fb.

Traffic: W2KVG 150 LSD 119 SZ-ACB 13 JRG 11 NIY 8 MIY 710.

NORTHERN NEW JERSEY — SCM, Edward Gursky, Jr., W2LNM — R.M.'s: 2BZJ, 2CGG, 2HXI, 2IYQ. P.A.M.: 2LXI. Section Net frequencies: 3630 and 7070 kes. New appointments: O.P.S.: JMC. O.R.S.: ANW, E.C.: Belleville, JUJ; Clifton, HFN; Jersey City, BNU; Newark, KRA; Red Bank, AER; Rutherford, ANW; Somerville, 3EBC; Westfield, HNY. KEG is moving to Fairlawn. MNG needs Nevada for W.A.S. MUA has a new e.c.o. NDY has a new two-element beam. NLN has a new receiver. FWT, the Clifton Radio Club, had a fire, but all equipment was saved. MFF moved to Garfield, and will soon be on 28-Mc. 'phone. KTM and NKN are both building new rigs. MMT would like to form a net of members of the "Junior Order of United American Mechanics." HPE is at Floyd Bennet Field with the N.C.R. CVF is passing the cigars. He's the proud papa of a yl. KSR has applied for membership in the A.A.R.S. FYO is back on 3.9-Mc. 'phone with 350 watts input. JMC is rebuilding, and will be on 112 Mc. soon. KOQ and LHI are students at Stephens Institute. LWZ built three 54-foot masts for the Livingston Amateur Radio Club. CHM is back on the air after five years; he's using an 809 on 1.75 Mc. KOG is on 1.75 Mc. C'II has applied for O.P.S. appointment. MNT was appointed N. C. 3 of the N. J. 40 A.A.R.S. Net and received the special call WLMW. MAX received the special call WLMN. CGG received a nice write-up in one of the local newspapers for the fine work he's been doing to keep the members of the 102nd Essex Troop Cavalry, now located at Fort Jackson, S. C., in touch with home. MRJ has an 809 and other equipment he would like to trade for a bug. KP has been doing a lot of experimenting with 112-Mc. meter receivers. JME lost one element of his beam in the sleet storm. LYP has been working some nice dx on 112 Mc. BNU has been getting a lot of traffic from the Florida Fair. MHJ received appointment as an active A.A.R.S. He keeps weekly schedules with his brother, MHK, who is working portable from W4. NDL is an ex-op of K6QUJ and would like to get in touch with some of the fellows who used to schedule Joe Slizen at K6QUJ. ISU enlisted for three years at Fort Monmouth. The Bloomfield Radio Club is rebuilding their rig and will soon have about 800 watts on 3.5, 7 and 14 Mc. CMZ, president of the club, is active on 3.5-Mc. c.w. HZY was reinstated as O.R.S. HLC is getting back on the air after a long lay-off. NPV is the new call of the N.Y.A. station at Verona. FZV is building 112-Mc. equipment. CNO is rebuilding and getting a new receiver. The members of the N. J. 1.75-Mc. Net held a meeting at the home of KXT to discuss their spring activities. AHN, DAC, EMN, GYY, KXT and MKN were present.

Traffic: W2 HXI 764 MNT 459 (WLNW 46) CGG 430 BNU 210 MHJ 201 LMN 155 (WLNK 99) MNO 96 MAX 53 (WLNM 12) JUJ 50 MRJ 11 CJX-HZY 6 KSR 5 IZV 3 IYQ 108 HCO 36.

ATLANTIC DIVISION

EASTERN PENNSYLVANIA — SCM, Jerry Mathis, W3BES — W3GKO has been assigned WLQQ. 3AOC landed his W.A.S. after trying ten years. BXE has an NC101X and has 100 watts on 1.75, 3.5, 7 and 14 Mc.; he was active in the A.R.R.L. R.M. and 1.75-Mc. W.A.S. Parties. AKB purchased a genemotor at the York Road Radio Club auction, and is rebuilding an emergency-powered rig. Eastern Penna O.R.S. should join the E. Pa. Net and receive the fb bulletin they publish. 8ATF put down 35 w.p.m. with pencil on the December 17th run from W1AW. 8EU received his E. Pa. Section Net Certificate;

he wants a schedule with Seranton. 3FJU is handling some fb traffic with the E. Pa. A.A.R.S. Net on 3.9-Mc. 'phone. SASW left for the Army Feb. 3rd, so we lose him for a year. "Happy Landings," or the equivalent in Anti-tank parlance. 3GYK has a new NC200. 3GAG (Phila. Wireless Assn.) is ready to go on 3.5-, 7- and 14-Mc. c.w. with a 1/2-kw. band-switching rig. GYK represents the Phila. Wireless Assn. in cooperation with the new Emergency Coordinator, BYS. They will buy a gas-driven generator this summer. GYK has 3rd-class specialist rating in the A.A.R.S. A.A.R.S. PA1 Net is going strong. DXC is looking for 7-Mc. daytime schedules. 3DRO, 3HCT and 8ATF report via radio. 3BES worked K4DTH on 1.75 Mc. to complete a Five Band TOC. Several of the local gang have FB TOC with that gentleman. 3HQE is on active duty at the Navy Yard. GQW is the E.C.'s contact man for the Frankford Radio Club. New officers at the Yeoman Amateur Radio Assn. are: Pres., FTQ; Secy., INV. The club is running a contest on 7 Mc. for their members. HUS is a member of the F.T.S. and is looking for traffic. 8OCK wants to become O.R.S. 3FPC, 3GKR and 3HMO were blasting away on 'phone in the 1.75-Mc. W.A.S. Contest. 3HFE attended the Red Cross disaster meeting in Jenkintown. W8SNZ has new QTH in Lehighton. 8GV is building an e.c.o. à la Don Mix. The Reading Radio Club is a hustling bunch, and had a big celebration on their first anniversary. Club officers are: Stanton L. Blatt, Pres.; Russell W. Fredericks, Secy.; H. Clifford Weidner, Treas. 3FXZ had a busy month participating in the Y.L.R.L., F.T.S., O.R.S., A.R.R.L. Parties, and worked K4USB. 3CQQ got his W.A.S. ticket after seven years, and copied 35 w.p.m. from WIAW with pen and ink on first attempt, worked WAR and NAA. During our recent blizzard, the members of the E. Pa. Net stood by and kept hourly schedules reporting for Western Union. The wires were heavily loaded with ice, and it was feared that service would be interrupted. W. U. was prepared to rely on the net for communication. Fortunately, after maintaining watch from the evening of Jan. 24th till morning of Jan 25th, wire chief W3CKB deemed the danger over. Participating were 3AQN, 3ASW, 3BXE and 8ATF.

Traffic: W3GKO 1553 (WLQQ 39) 3AOC 1013 3BXE 320 3AKB 277 3HRS 270 3AQN 190 8ATF 176 8EU 127 3FML 121 3FJU 69 8ASW 54 3GYK 52 3ADE 32 3HCT 30 8O ML26 3DRO 20 3EEW 12 3BES 6. (Dec.-Jan.: W3EML 977 8PAF 176 3EHH 35 3INH 16 3DXC 22 3FJU 5.)

MARYLAND-DELAWARE-DISTRICT OF COLUMBIA — SCM, Hermann E. Hobbs, W3CIZ — Eppa W. Darne, Chief R.M., 3BWT. Roy Corderman, Reg. Coördinator, 3ZD. Harold A. Kemp, Coördinator for Balto and vicinity. Wilfred A. Thompson, Coördinator, Cumberland, Md., and vicinity. Oscar W. B. Reed, Coördinator, D. C. and vicinity. The "Argument Radio Club" meets twice a month, and has about 20 members. 3AED and W3WJ are going strong on 56 Mc. AXP is stationed at Maxwell Field, and now has his wings and commission as 2nd Lieut. DRD is looking for schedules west and south. FIZ was recently appointed 3rd C.A. Alt. N.C.S. with the A.A.R.S. call WLQC. FTD is now on 14-Mc. 'phone. PPK expects to be on 3.9- and 14-Mc. 'phone shortly. EQK finally contacted Ariz. for his W.A.S. on 14-Mc. 'phone. FE is waiting for his A.A.R.S. Net crystal; when it arrives, he will join the gang in the spot frequency drills. HAL confines most of his activities to c.w. for the present. 10G/3, Chesapeake City, Md., is a new member of the A.A.R.S. 'Phone Net. JTT/3 has started construction of a heterodyne exciter. New Officers Baltimore Amateur Radio Ass'n are: EEI, Pres. and Communications Mgr.; GRT, Vice-Pres.; DWX, Secy.; GXO, Treas.; DWC and Chas. Reddick, Directors. DWX has been rebuilding.

Traffic: W3BKZ 56 BWT 1734 CDQ 16 CIZ 950 DRD 46 EIZ 74 EQK 6 FE 7 HAL 46 IIS 55 JCT 38 NF 78 OZ 60 CXL (WLM 3807).

SOUTHERN NEW JERSEY — SCM, Lester H. Allen, W3CCO — Ass't S.C.M. and A.A.R.S. Liaison R.M., Ed. G. Raser, W3ZI — Regional Coördinator in charge of Emergency Coördination, Ted Toretti, W3BAQ — R.M.'s: W3BEL, W3BYR, W3ITU — P.A.M.: Bill Hannah, W3EUL. Section Net frequencies: O.P.S.: 1980 kc. (Each Thursday at 8 p.m.); O.R.S.: 3700 kc. (each Tuesday, Thursday and Saturday at 8 p.m.); O.R.S.: 7280 kc. (each Monday, Wednesday and Friday at 8 p.m.). We always have openings for any who are interested in traffic work on either 'phone or c.w. If you care more for checking frequencies or bad notes, there is the Official Observer appointment. If

you have a station which has good coverage, and neither of the above-mentioned appointments appeal to you, we have the Official Broadcast Station appointment whereby you can give your brother hams the latest information direct from A.R.R.L. Headquarters. Regardless of your personal likes or dislikes, we have a place for you in our Section. It is up to you to let me know of your desires. As S.C.M. I would like to hear from all who read our column. A penny post card will do. Your thoughts will be appreciated and a great asset in preparing this column monthly. W3HYT and W3FXV are new O.R.S. for our Section. AVJ, IFT and EFM had their O.R.S. certificates endorsed for another year. HDJ has his O.P.S. endorsed for the coming year. ISY returned to Trenton for a few days after sailing the briny deep for 2 months. HKO is touring the State of Wyoming, giving lectures on the 2nd Byrd Expedition. ARN is now doing research work for Western Electric at Fort Monmouth. BAQ, BWF, HAZ and IOK are running neck and neck in Delaware Valley Radio Association QSO Contest. GEV lost his 3-element beam in the last ice storm. W3ELV/3 wishes to inform the Section he has a direct outlet to Fort Dix, for traffic. BZX brings in the usual fine traffic score this month and takes honors as high man. INF is now residing in Camden. VE is with the 112th F.A. at Fort Bragg, North Carolina, and is all set for all previously arranged schedules. Sam also advises he has applied for a W4 call. GCU is new member of the Delaware Valley Radio Association. W2ADH/3 is operating at Lawrenceville. CKY is now in Trenton and working 14 Mc. ZI keeps his A.A.R.S. schedules at W2NPV which is the new call at N.Y.A. Center No. 4. GNU/2 is active from the N.Y.A. Center No. 4 at Verona. N. J. COT has been recommended for O.R.S. HDW is N.C. 2 for the 7-Mc. A.A.R.S. Net and expects to join the S.N.J. The Delaware Valley Radio Association deserves a word of praise for its outstanding work with W3AQ. The gang has had its station in all A.A.R.L. contests, works as Net Control Station for the O.P.S. Net each Thursday evening, and recently helped to locate a man and wife on the way to Florida, to advise them of a death in their family. The boys still find time to plug all the latest O.B.S. messages from Hq. Thanks, fellows, for helping the Section. The S.N.J. O.P.S. Net was recently congratulated on its fine operation by the N.C.S. of the Eastern Massachusetts Army Net. The recent ice storm took down GCU's antenna. AEJ, CWG, IMY and AQ were plugging mighty hard in the recent 1.75-Mc. W.A.S. Contest. A.B.S. has just completed his new transmitter and is all set to go. HOJ is on the U.S.S. *New York* as RM3C. HRJ decided to try ham radio once again, and is on 7 Mc. Likewise, INS has again returned to the airways. IFT has decided to stay on 3.5-Mc. c.w. FMR has just finished building a 3-element rotary for 14 Mc.; Elmer was a recent visitor at AQ. LUS is a prospect for O.P.S. IDZ is working the West Coast consistently on 1.75-Mc. 'phone. BEI is interested in selling his 3-inch oscillograph. HAZ is still actively engaged in A.A.R.S. and S.N.J. O.R.S. details. GMY, our O.R.S. N.C.S., has decided to give 1.75-Mc. 'phone a try, and expects to be on shortly. EWK has qualified for 25-w.p.m. Code Proficiency Certificate. DNU has promised to rejoin the League so that he can qualify for an O.R.S. endorsement. CCO is rebuilding 2000-volt power supply, and expects to return to the 28-Mc. band presently. ITU has contacted 41 states on 1.75-Mc. 'phone using W3AQ. JAG is new call in Trenton. BAQ was appointed chairman of the Field Day Committee for the D.V.R.A. GRW is experimenting with a new type of oscillator. Might I again mention that we would like to have more members in the O.P.S. and O.R.S. groups? If you are not already a member, why not look into this? Also, don't forget the monthly reports concerning your activities and those of your friends. Until next month, 73.

Traffic: W3BYR 182 (WLVN 100) HAZ 135 DNU 105 IFT 102 IDZ 67 ZI 65 EUH 60 AVJ 53 AQ 50 ASQ 40 ITU-HLV 39 GMY 37 FMR 36 EWK 33 AEJ 31 HYT 27 HDW 22 GCU 15 BEL-ACC 8 ABS 5 CCO 4.

WESTERN NEW YORK — SCM, Fred Chichester, W8PLA — JIW breaks all records for the Section with a traffic score of 925. SZB has been on the sick list. FFU is celebrating the arrival of a Jr. op and his Class A ticket at the same time. RZV is back on 1.75 Mc. FYC jumps from 1.75 to 56 Mc. LLN is installing a m.c. in his speech amplifier. RVM received his Class A ticket. The N.Y.A.

(Continued on page 38)

RADIO TRAINING



PORT ARTHUR COLLEGE — not privately owned, not operated for profit, a college built and endowed by the late capitalist-philanthropist, John W. Gates — offers the most thorough practical Radio training in America. P. A. C. owns Radio Station KPAC, which is equipped with the very latest type 1000-Watt high fidelity RCA transmitter, operating on 1220 kc. with directional antenna system. The Radio training covers thoroughly Airways, Press, Announcing, Teletype, Typewriting, Laboratory and practical experience at KPAC transmitter, control room and studios. Announcing is an optional part of this training; nevertheless a number of students annually make successful announcers.

Port Arthur College pioneered the teaching of radio with its first classes in 1909, and for thirty-one years has maintained an active Employment Bureau that is successful in placing graduates in airways, broadcast and marine radio industries.

*If interested in details about the Radio Course,
write for Bulletin R*

PORT ARTHUR COLLEGE
PORT ARTHUR (World-Known Port)
TEXAS

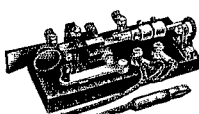

TELEGRAPH SPEED KEYS

Radio Type in Kits — \$2.89
Send Card for Complete Information

ELECTRIC SPECIALTY MFG. COMPANY
Box 645, Cedar Rapids, Iowa

ONAN ELECTRIC PLANTS

OVER 40 STOCK MODELS — 350 TO 10,000 WATTS

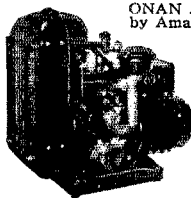

ONAN A. C. ELECTRIC PLANTS are used by Amateurs ALL OVER THE WORLD for Emergency Power during shut-down caused by Hurricanes, Floods and Sleet Storms. AMATEUR RADIO CLUBS participating in recent Field Day scored High with ONAN Powered Equipment.

ONAN PLANTS used in Radio and Electrical Work, operate Radio Transmitters and Receivers, Telephonic Communication Systems, News and Advertising Cars, Lights, All Appliances.

NEW MODELS — Any Voltage — Any Frequency Air or Water-Cooled — Any Starting Method, Gasoline, Natural Gas, Oil or Diesel Powered. Write for Complete Details.

D. W. ONAN & SONS

348 Royalston Avenue

Minneapolis, Minnesota

A Compact Portable Emergency Transmitter

(Continued from page 26)

switch at several different positions on the coil at this will allow different capacity settings to be compared for performance. Overloading will affect the keying and the signal should therefore be monitored while the tests are being made.

Boost Your Code — Start Traffic

(Continued from page 65)

In receiving traffic: Don't guess at anything. Be sure you have what was sent, if you are copying a message directed to your station. Don't copy ahead. Insist on hearing it *before* you put it on the blank. Learn how to "break" the transmitting station or to start him off from a word just by repeating that last word received correctly just as soon as he is copying you! Get accustomed to taking messages on paper, and soon you will be able to make them neater, to add the trick of sliding blanks into the mill just as you take others out, etc. Don't receipt at all until you have *all necessary fills*. Learn to abbreviate operator conversation to a minimum. An R to show a receipt, a K for "Go ahead," is as useful as a lot of remarks that say the same thing. Spend your time operating and getting fills. Gassing about the signal strength and readability is usually wasted time when the progress on completing a recorded message will tell you all of that story minus any guesswork or flattery. Get to the message without too much preliminary talk. See the message through and ragchew later.

The message isn't a complete message for files until it has been serviced or had the "handling data" added. Handling data includes the entry of date, time, and station call on the traffic. By the *time* we refer to the "time of receipt" which is the time of official transfer of responsibility for that particular message!

In sending traffic: Think of the receiving operator. Give him time to adjust his copy to his message blank. In sending, repeat the number and check, adjusting speed to the copying ability of the operator with whom you are paired. Difficult names, and addresses in particular should be transmitted clearly. Do not run words or numbers together. Proper spacing of characters and timing of transmission with slower speeds for difficult sections will save yourself time and insure accuracy. Set the text off with BT as illustrated, and show the end of transmission of a message with AR.

Use "QSL?" if you didn't hear the operator's receipt for your message. Used in the affirmative it means the same as "R." Followed by IMI it means, "Can you give me acknowledgment of receipt?" . . . and when you get to be a real dyed-in-the-wool traffic man this doesn't mean anything about QSL cards. Here's wishing all readers our very best in making themselves keen and alert communication operators, the only kind our country needs to-day.



Stack-mounting mica capacitors in five sizes.

Other heavy-duty mica capacitors in cast-aluminum cases and in bakelite cases.

New plug-in electrolytics for ready testing and replacement, in continuously-operated equipment.

Still greater choice of oil-filled capacitors, up to 7500 v. D.C.W.

Commercial Grade...

● Heretofore made to order for Government and commercial communication companies, these stack-mounting mica capacitors, as well as other commercial-grade types of mica, oil-filled, paper and electrolytic capacitors, are now available to you. ● Ask your Aerovox jobber about these commercial-grade capacitors. Or write direct.



Regular as OLD FAITHFUL



Type 966A
\$1.50



Type 966
\$1.20

UNITED RECTIFIERS

Year after year United Rectifiers have been giving faithful, dependable performance. They are the endurance criterion of today.

- TWO TYPES TO CHOOSE FROM**—Unshielded and shielded—each has specific advantages.
 - GREAT SAVING IN TIME DELAY**—10 seconds initial or routine—this quality of the 966 places it in a class by itself.
 - FULLY SHIELDED CONSTRUCTION**—For certain applications where shielding is important, type 966A is the uncompromised solution.
 - NO EXCESS MERCURY**—966 and 966A have measured mercury content, preventing harmful amalgams and costly time delay.
 - LONG AND SATISFACTORY LIFE**—is not merely predicted, it is a matter of history.
- Also similar qualities in larger types 972, 972A and 975A.

UNITED ELECTRONICS COMPANY

47 SPRING STREET

NEWARK, NEW JERSEY

NEW 1941 PATENTED JEWEL MOVEMENT

DE LUXE GENUINE

VIBROPLEX

World's Finest Semi-Automatic Key

Send for
FREE
Catalog

The smartest looking, smoothest action, easiest to operate "Bug" Vibroplex has ever produced. Has Patented Jewel Movement found only in De Luxe Vibroplex Keys. Precision construction including DIE CUT contact and main spring. Highly polished chromium base and machine parts, colorful green silk cord and wedge. Large contacts. An outstanding key in smartness, signal quality, speed and ease of operation, users say. Vibroplex keys give quality performance—insist on Vibroplex. Accept no substitute. Three De Luxe models—Lightning Bug, Original and Blue Racer. Each is equipped with Patented Jewel Movement. The finest semi-automatic keys money can buy. Order yours NOW! Money order or registered mail. Write for catalog of other Vibroplex keys priced from \$9.95 to \$19.50.

THE VIBROPLEX CO., Inc.
832 Broadway New York, N. Y.

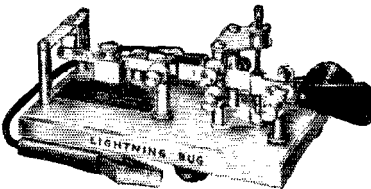

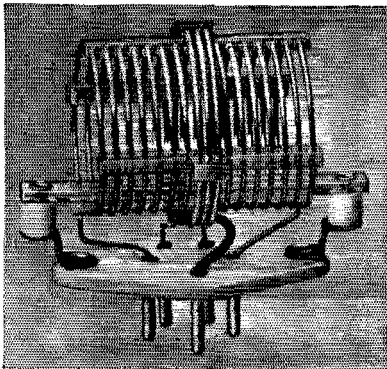

Amateur net
\$1.00 each

MORE EFFICIENCY IN LESS SPACE

B&W 75-WATT "JUNIORS" are designed to provide optimum performance in many types of 75-watt applications. Particularly suited for crowded layouts, portables and other limited-space rigs, "Juniors" are actually more rugged and efficient than most larger, more bulky coils of comparable rating. The economical answer to 75-watt inductor problems, B&W "Juniors" deliver the ultimate in efficiency in a minimum of space. Your jobber will be glad to show you — or write for details.

BARKER & WILLIAMSON

Radio Manufacturing Engineers • ARDMORE, PENNSYLVANIA



CREI Graduates, As a Group, Are The HIGHEST PAID in the Industry!

CREI Provides Advanced Practical Engineering Training for Professional Radiomen to Qualify for Better Jobs in Every Branch of the Industry

● The success of CREI men in every branch of radio should prove an incentive to investigate thoroughly the opportunities that await you through CREI training in Practical Radio Engineering. We are not interested in bringing "beginners" into the industry, but WE ARE interested in helping professional radiomen NOW in radio to advance to better-paying jobs. More than 5,000 students and graduates prove we are doing it — surveys show that CREI men, as a group, are the HIGHEST PAID! New opportunities for trained men are being created constantly. Now is the time for you to advance yourself with advanced practical training.

Write for Details and Free Book Now!

If you are a professional radioman and want to make more money — let us prove to you we have something you need to qualify for job opportunities that can be yours. To help us intelligently answer your inquiry, please state briefly your education, radio experience and present position.



Capitol Radio Engineering Institute

Dept. Q-4

3224 16th St. N. W., Washington, D. C.

(Continued from page 89)

Radio Club for Lewis County has signed up 50 members. TEP and RVM lost their skywires in a storm. UNY reports the St. Lawrence Valley Net going fine with TEP as N.C.S. TC is celebrating his 30th year in ham radio. He is still active on 7-Mc. c.w. He also became the proud papa of a YL recently. VLN is a new Rochester call. Warren Wheeler, of the WHAM transmitter staff, received the call W8VOX. He is on 3.5 Mc. DFN won the annual R.A.R.A. QSO Party for the second time in three years. NCM joined the U.S.N.R. Twenty hams and their xyl's were present at a farewell party for OQC on Feb. 15th. He leaves for a U.S.N.R. radio school in Connecticut very soon. A joint meeting of K.B.T. and R.A.W.N.Y. were held Feb. 21st at Hotel Statler, Buffalo. Guest speaker was Mr. Clinton DeSoto from A.A.R.S. Hq. K.B.T. Club is sponsoring a net contest on 3590 kc. for the purpose of training operators in the Buffalo area. The net is under the direction of PCN, R.M. for Buffalo. At present there are 20 stations in the net which is being conducted with A.R.R.L. procedure and signals. The club is planning to have an Army signal officer speak before one of their March meetings. The Niagara Falls Radio Club is sponsoring experimental activity on the ultra-high frequencies, under the direction of Osten Lidbury. A transmitter is being completed for 14, 23, 56 and 112 Mc. for this work. New editors of the K.B.T. Club paper, "Q.R.M.," are NNP and NVJ. The Buffalo State Teachers' College is giving a radio course to draftees designed to prepare them with radio theory and operation so they may specialize in the Army. This work is under the direction of UMY. The Buffalo Mike and Key Club is undergoing reorganization. PCN now works 7 Mc. with 100 watts. EKM is planning a low-power rig for all bands. ELF is building a television receiver. QZP is working into K.B.T. Net with 30 watts. SJV is very active on 1.75-, 3.5- and 7-Mc. c.w. with a new rig. NNP is showing signs of becoming a traffic man. RRL is now on 2022 kc. UUD is doing fine work on 3.5-Mc. c.w. with his 80P. QEE has a flea-power 6L6 rig on 1.75 Mc. LQC has a new all-band rig with pp T20's. OMD has a new exciter and is now A.A.R.S. PHB has completed a new rig for 1.75 and 3.5 Mc. VOC is a new ham on 7 Mc. from Spencer. W.N.Y. has a new net operating between 1775 and 1780 kc. with SMH and CSE active. OSH is quite active on 3.5 Mc. ELK is rebuilding to 300 watts. Rochester now has a W2 and W7 working portable there. The contest held recently by the Sidney Radio Club was won by VEF; the prize was a new crystal. V3F is on 1.75-Mc. 'phone and 3.5-Mc. c.w. TEW and LUR are on 3.9-Mc. 'phone occasionally. The Sidney Club has an emergency transmitter practically finished. It is a complete unit with provision for 6-volt d.c. or 110-volt a.c. input. Permanent meeting rooms of the club are at TQH's home. MNY is on 75-meter fone with 150 watts. JPP is running higher power on 1.75-Mc. 'phone. Results of the W.N.Y. QSO Party will appear in the next issue of QST. The Central New York Radio Club and the N.Y.A. Radio Club of Syracuse have combined and meet regularly at the N.Y.A. club rooms in South Clinton. TJK has worked 41 states on 3.5 Mc. with 45 watts and is after W.A.S. on that band.

Traffic: W8JIW 925 OMD 51 'AQE 68 SBV 157 SMI 91 PLA 139 PCN 251 FCG 187 BJO 135 RKM 305 UPJ 50 UNY 6 RVM 16 SFD 147 RZX 10 EBR 11 BHK 23.

WESTERN PENNSYLVANIA — SCM, E. A. Krall, W8CKO — Ass't S.C.M. in charge of O.R.S., W8KWA — Ass't S.C.M. in charge of Emergency Coordination, W8AVY — RM. SNCJ. Beth XYL at NCJ has made her third consecutive copy of the Navy Day message. NCJ is now running a pair of RK20's with 250 watts for R.C. cooperation. ETD is building a battery-powered portable job. RAT suggests a 14-Mc. club to meet on the air once a week. BWP is a new O.O. UAW is rebuilding. BK is sporting a new microphone. AME has moved to Detroit. USV expects to have to carry a lightning rod when he gets near his new HP transmitter. BOZ has been experimenting with hf transmitters. NDE still schedules KWA. RNO sports a rebuilt rig. McKEESPORT is active with plenty of 1.75-Mc. stations. AVY reports that Pittsburgh has no EC. How about an active amateur taking over? UWZ continues his good work as O.R.S. The Horse Shoe Radio Club of Altoona gets out a nice bulletin. ASE has a 35 w.p.m. Code Proficiency Certificate. KYD possesses a new Sky Buddy. EYY and ROA are active. Major Dutton and Ensign Sutterfield gave in-

(Continued on page 90)

BUY ON EASY TERMS · MAIL ORDERS PROMPTLY FILLED · WRITE FOR FREE CATALOG

NEVER BEFORE *Such Values in Communications Receivers*

Echophone Model EC-3

ELECTRICAL CHARACTERISTICS

- crystal filter
- variable selectivity
- automatic noise limiter
- calibrated band spread
- preselection all bands
- fly wheel tuning
- separate 6-inch PM speaker

- two-stage amplifier
- CW monitor

The EC-3 operates on either 115 V AC or DC

This latest model EC-3 Echophone is priced to suit your pocketbook. To the best of our knowledge never before has a 10-tube receiver with three bands, covering from 545 KC to 30.5 MC, ever been available to the amateur at such a price.

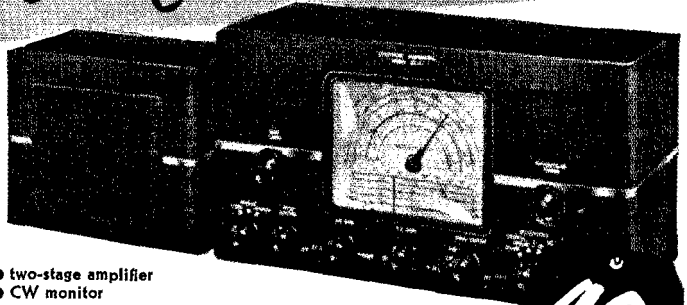

\$49.95
\$4.95 down

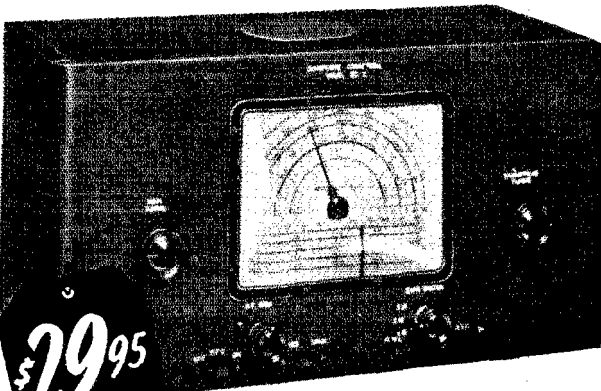

\$29.95
\$4.95 down

Echophone Model EC-2

ELECTRICAL CHARACTERISTICS

- 8 tubes
- preselection on all bands
- calibrated band spread
- automatic noise limiter
- coverage 545 KC to 30.5 MC
- 5-inch PM dynamic speaker

Operates on 115 V AC or DC current

To those who do not require crystal operation, we believe that this new Echophone model EC-2 will solve many of the problems that arise in the purchase of a communications receiver. Again, we believe that this model represents in its price class tremendous value, and a solution to your problem when it comes to purchasing a receiver for your amateur station, for home or your boat.

Echophone Model EC-1

ELECTRICAL CHARACTERISTICS

- tuning range 545 KC to 30.5 MC
- electrical band spread
- tuning dial calibrated in megacycles
- separate logging scale
- built in PM dynamic speaker
- standby switch
- beat frequency oscillator
- automatic volume control

For use on 115 V AC or DC current

\$19.95
\$3.95 down

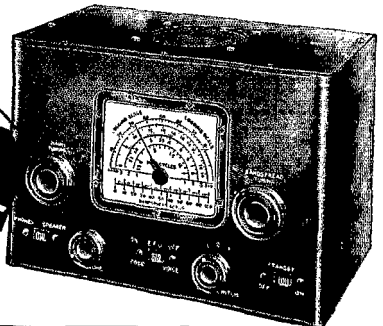

The RADIO SHACK
167 WASHINGTON ST., BOSTON, MASS., U.S.A.

Janette

ROTARY CONVERTERS

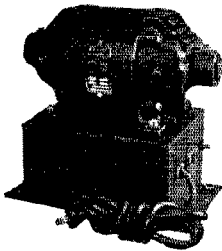

Janette Converters were the ORIGINAL machines designed and built especially for radio apparatus.

These machines progressed with the industry and have made record for economical, reliable, trouble-free operation that today Janette and quality products are synonymous.

such an outstanding reliable, trouble-free operation that today Janette and quality products are synonymous. **WARNING:** Janette converters are being imitated — be sure Janette is stamped on the name plate. Dynamotors, generators and motor-generators are also available.

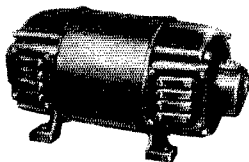

MAY WE SEND LITERATURE?

Janette Manufacturing Company

556-558 West Monroe Street Chicago, Ill. U. S. A.

ELECTRIC POWER ANYWHERE

with
BLUE DIAMOND POWER PLANTS

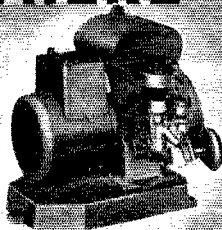

Pincor Hi-power Blue Diamond power plants provide a PORTABLE electric generator of high output ratings. Available in various models to meet any requirements: 450 watts 110 volts, 60 cycles A.C. PLUS — 6, 12, or 32 volts D.C. in various wattages; for charging batteries; for direct operation of electric lights or appliances. Sturdy, light weight, easily portable for use anywhere. Send for complete information today.

PIONEER GEN-E-MOTOR CORP.

CHICAGO, ILLINOIS

Export Address: 25 WARREN ST., N. Y., N. Y.

Cable: SIMONTRICE, New York

PINCOR Products

FOR AIRCRAFT • SOUND • POWER SUPPLY USES

Dynamic Prognostication

(Continued from page 81)

current will run around 240 ma., for several seconds.

The measured efficiency, with a new 6L6G in the socket and 700 volts on the plate, was 94.3 per cent from crystal to antenna. This includes the screen current which contributes no power to the antenna, so it can be seen that the efficiency is quite high. If it later becomes possible to manufacture a triode with beam-power advantages, the screen power will be eliminated and the efficiency boosted still higher.

Performance and Versatility

It had been hoped that the unit would be versatile enough to be used in several ways. Actually, it can be used for reception by plugging in a pair of headphones where the key normally goes. Since the plate current passes through the cathode circuit, a plate detector is formed and, by unbalancing C_5 or C_6 (but not both), energy can get from the antenna into the plate circuit to allow the tube to function as a plate detector. The current through the cathode circuit is high, however, and a coupling transformer should be used, to avoid burning out the headphones. It must be confessed that the unit is not as efficient a receiver as it is a transmitter, and no real DX was heard during several nights of listening on the 7- and 14-Mc. bands. This may be caused by the inadvertent band-pass effect of the antenna coupling system, or some other reason beyond our control. It is, however, a condition that we hope will clear up in the very near future.

~~Strays~~

The magnet from an old meter placed at the spot where a hole is to be drilled in the chassis will keep the chips from falling to the floor. A home-made electromagnet will work even better. — W8OSI.

W9QLC tells what direction his beam antenna is pointed by using a large mirror adjusted to the right angle just outside his shack window. By painting the rotating portion white, it shows up very nicely in darkness.

W2EXQ has automobile license-plate number FB73K.

Having a message for the N.H. Net, I turned on the receiver and tuned to the frequency of W1GMM. The first thing I heard was, "CQ de W2GMM." — WHITE.

Changed my keying leads of ordinary wire to 20 ft. of shielded mike wire and cleared up b.c. interference entirely. Cannot hear the rig on b.c. receiver in the same house. — W6SUD.

Heard a W9 calling like this: "CQ CQ CQ Urgent de NVER." Careful listening disclosed that he wanted Denver! — W3QP.

Have you tried *Dunking?*

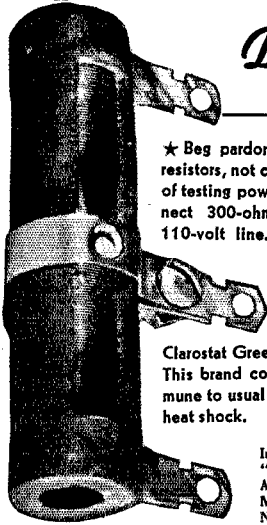

★ Beg pardon, but we are referring to power resistors, not crullers. Dunking is simplest means of testing power resistors for performance. Connect 300-ohm 10-watt unit directly across 110-volt line. When red hot, dunk in cold water. Repeat several times.

Now examine the coating. In most cases it will be cracked, chipped, flaked. Not so with a Clarostat Greenohm (inorganic cement coated). This brand comes through unimpaired. It's immune to usual humidity, heavy overload, severe heat shock.

Insist on Clarostat Greenohms for your next "rig." 10 to 200 watts. Fixed and adjustable. Ask jobber for data — or write Clarostat Mfg. Co., Inc., 281-7 N. 6th St., Brooklyn, N. Y.



Now Making Delivery

INCA

Midget Transformers

For Portable Radio and Sound Equipment, Aircraft, Police, Mobile and Portable-Mobile

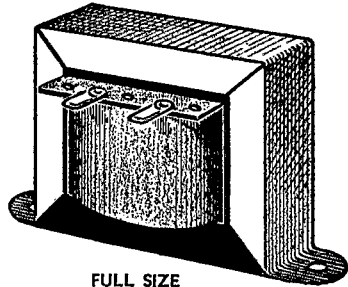

FULL SIZE

Dimensions: Height 1 1/8", length 1 5/16", width 1". Weighs ONLY two and one quarter ounces.

CLIMATITE TREATED, assuring protection against the most rigorous weather conditions.

ONLY INCA transformers have CLIMATITE treatment.

TYPE NO.		LIST PRICE
I-42.	Single button mike to single or PP grids.....	\$1.65
I-43.	Double button mike or line to single or PP grids.....	1.75
G-52.	10,000 ohm plate to one or two grids.....	1.65
I-45.	Single button mike and plate (2 primaries) to grid.....	1.80
L-48.	Class B input, IG4G to IG6Gs or similar.....	1.60
L-47.	Class B input, IE4G or similar to PP grids.....	1.60
F-64.	Output, tube to voice coil.....	1.50
F-65.	Output, tube to line or phones.....	1.50
N-37.	Modulation-Class B, 10,000 ohms to 5,000, 8,000 or 10,000 ohms.....	1.50
D-92.	Choke 6 h., 35 ma., 180 ohms.....	1.25

At your nearest Inca Jobber or

**PHELPS DODGE
COPPER PRODUCTS CORPORATION**

Inca Manufacturing Division

2375 East 27th St.

Los Angeles, Calif.

★ PAR-METAL ★ PAR-METAL

Par-Metal

Does Things to the Job

Just as a beautiful painting needs the right frame to set it off — so, too, does the job you build need Par-Metal Racks, Panels, Chassis and Cabinets to give it the true professional touch. Many engineers and amateurs have learned from experience that Par-Metal assures outstanding streamlined beauty, modern appearance, handsome finish and keen hardware not to mention the accuracy to which all parts are machined for easy assembly!

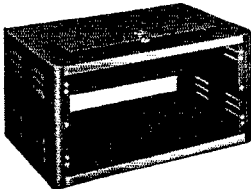

Chassis • Cabinets
Racks • Panels

in both Standard and De Luxe Models are described and illustrated in Catalog No. 40. Free at your dealers or direct from us.

PAR-METAL PRODUCTS CORP.

3262 49th St., Long Island City, N. Y.

Export Dept.: 100 Varick St., New York, N. Y.

★ PAR-METAL ★ PAR-METAL

Only One Wife!

MANY times a day we are asked the question: "Why does Kenyon not manufacture other types of equipment usually associated with the Transformer business?" Our answer has been and always will be the same.

For over 15 years our entire efforts have been concentrated on the manufacture of one thing only — transformers. It's our first and only love! Thus with only one objective and with the resources and skill of our entire staff applied toward that objective — a better product has been the result.

We have earned the highest respect of the customers we serve for they are secure in the knowledge *that we do not compete with them*, nor cast envious eyes upon what rightfully is theirs.

Yes — our marriage to Transformers is permanent . . . for better or for worse . . . **BUT PERMANENT!**

KENYON
TRANSFORMER CO., INC.
840 BARRY STREET NEW YORK, N. Y.

(Continued from page 88)

teresting talks before six hundred hams at the Pittsburgh Hamfest. Clint DeSoto of Hq. and Director Brad Martin also were on the program. The A.A.R.S. gang had a get-together dinner prior to the hamfest. We need some O.R.S. in Erie and all over southwestern Penna. WQ turns in a good report, even though he is bedridden. CKO regrets that he cannot operate with the W. Pa. Net each night. However, he gets on when he can and handles considerable traffic in other nets. Again the S.C.M. is serving warning to all O.R.S. and O.P.S. to send in their monthly reports. Otherwise, there are going to be some wholesale cancellations. We are soon to be confronted with numerous messages from the boys who will be in training; therefore, let each of us do our part and make the W. Pa. Section of the A.R.R.L. 100 per cent traffic. Even the 'phone stations can do their part, as proven by the Pa. 75 A.A.R.S. Net. This net is conducted by AJA as N.C.S. We would like to see more of the gang come out for O.P.S. appointments and find out what traffic handling can do for them. Let's make the 'phone bands in our Section hum with traffic. CDG has joined the PA4 A.A.R.S. Net. GJM is interested in starting a 1.75-Mc. A.A.R.S. 'Phone Net in W. Pa. KQA pounds brass on the W. Pa. Traffic Net quite consistently. PX handles the most traffic. FCO still tries to make 28 Mc. percolate whether conditions are good or bad. ONW gets on the air occasionally to rag-chew. BTQ takes his appointment as O.P.S. quite seriously. OKK does his bit on the net every night he possibly can. JSU seems to be doing nicely in his new shack. HKU in Warren is a good steady O.R.S.

Traffic: W8NCJ 391 KWA 358 MJK 188 CKO 130 JSU 89 WQ 82 CNP 81 PX 75 TOJ 51 ETD 26 IOH 16 PER 15 RNO 11 RAT 9 NDE 7 BWP-AVY 3 TTD 1 AXD 2.

DELTA DIVISION

ARKANSAS — SCM, John R. Sanders, W5GNV — FWJ has accepted membership in the Emergency Planning Committee. HMU had an 809 go west, and expects to come back on with more power. HWS has registered his equipment in the A.E.C. HYQ is a member of the A.E.C. and is still working on a modulator for his 7 watts. ISA/5, operating 1.75-Mc. 'phone from Truman, has enrolled in A.E.C.; power at present is 30 watts. DYS is running 100 watts on 1.75-Mc. 'phone. HUX, who has been N.C.S. of the 1.75-Mc. A.A.R.S. 'Phone Net, has been ill and is going to a hospital in Colorado Springs. He'll be missed by the 1.75-Mc. 'phone gang, and we wish him fast recovery. Members of the Army 'Phone Net will look to B. J. Rand, GED, for leadership while HUX is away. HAE is rebuilding and expects to be back on 3.9-Mc. 'phone soon with a medium-power layout. GHJ has an FB signal on 1.75 Mc. again after absence due to 3.9-Mc. 'phone work. HSQ and IXC have registered in the Emergency Powered Div. of the A.E.C. ISX is another station who enrolled in the A.E.C. IIZ and ILL, both of Batesville, are on 1.75 Mc. with fb 'phone signals. ICE is at Camp Robinson, Little Rock, with the 153rd Inf. National Guard. IHC operates on 1817 kc. with 100 watts. HWW is working portable at Camp Robinson and is quite busy with traffic. ICJ is on the West Coast for a year with the Army. Best of luck, OM. IXC left for Naval School at Charleston, and is missed very much. HUX will spend a couple of months restoring health at Colorado Springs and will sure be missed on the A.A.R.S. 'Phone Net. Ex-HNO and xyl visited FPU and GED while in L.R. He is now W9NHO. EKD/5 is now located in Little Rock and has recently completed a Stancor 10-P. IYW has increased power. IXC visited GED. IGM is back in Little Rock after working several months with U. S. Engineers. L.R. welcomes him with open arms.

Traffic: W5GED 9 IHC 11.

LOUISIANA — SCM, W. J. Wilkinson, Jr., W5DWW — JFR is on with an 85-watt c.w. 'phone rig. DEL is building a new shack. BSR has a pair T740's. IYL is working 7 and 14 Mc. IYG is on 'phone from Lake Charles. HHV plans power increase to 600 watts. JHG worked K6GOM with 25 watts on 7 Mc. JHP, JGO and JFS are all active in Baton Rouge. BMM is new E.C. in Plain Dealing. HNW was appointed P.A.M., and is working hard. WVY is a newcomer to Monroe. JCV moved to Pittsburg. DXL has said "I do," and now has an XYL. Congratulations. NI and IIH helped put on a show in Bastrop to aid financing of Delta Division Convention. CNG has moved to Lafayette. IIG has returned home to Monroe. GMR is back on fone. HUZ visits O.V.A.R.C. regularly.

Aces Up

WITH THOUSANDS
THROUGHOUT
THE AMATEUR WORLD

EXPERIENCED "HAMS" TO SERVE YOU

★ W2JEH ★ W2DXC ★ W2LFV ★ W2CLH ★ W2IOP ★ W2JZH

SUN OFFERS THE
FAIREST SQUAREST
DEAL IN THE LAND

•
INIMITABLE
PERSONAL SERVICE

•
EASIEST PAYMENT
TERMS

•
MOST GENEROUS
TRADE-IN ALLOWANCES

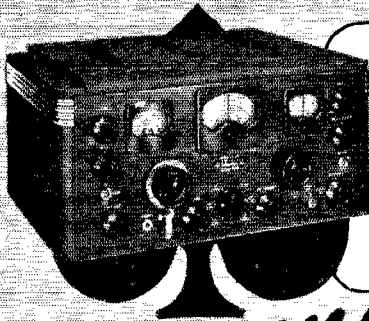

MODEL SX-28

Here is top quality performance. 15 tubes, 2 stages pre-selection, calibrated band-spread inertia controlled, 80, 40, 20 and 10 meter amateur bands calibrated. Model SX-28 with crystal and tubes..... \$159.50

Winners All!

THE NEW 1941
HALLICRAFTERS
TAKE TOP HONORS
WITH "HAMS" EVERYWHERE

SEE and HEAR THEM
AT SUN!

Mail Orders
Filled

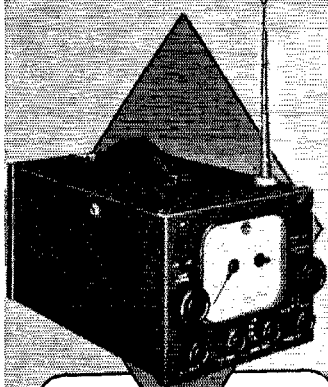

MODEL S-29

Portable designed to communications receiver tolerances. Take it with you wherever you go. Operates on 110/125 volts AC or DC or from self-contained batteries. Model S-29 \$59.50

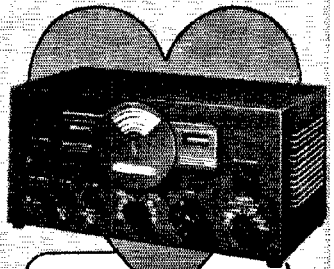

MODEL SX-25

Tunes from 540 kc. to 49 mc. in 4 bands. 12 tubes, separate calibrated bandspread dial for 10/20/40/80 meter amateur bands. 110 volt 50-60 cycle A.C. Model SX-25 with speaker, crystal and tubes..... \$99.50



SKY CHAMPION

One of the best values ever offered in the communications field. 9 tubes, 4 bands, tunes from 540 kc. to 44 mc., all the essential controls for good amateur reception. Sky Champion (Model S-20R)..... \$49.50

New York's Greatest Radio Supply House



RADIO CO.

212 FULTON STREET, NEW YORK CITY
CABLE ADDRESS:
SUNRADIO — N. Y.
ESTABLISHED 1922

DO IT NOW!

Find out how easily you can learn RADIO CODE without leaving your own home with the Candler System. Expert radio operators are always in demand, there is a promising career in the Navy, Army or commercial Communications field open to the expert radio operator. The U. S. Navy alone has asked for 5400 radio operators. You can prepare easily and quickly with the Candler System, the system selected by the U. S. Naval Reserve in the ninth district for training radio operators. The Candler System is a **SPECIALIZED TRAINING** backed by over a quarter of a century of success.

Get this FREE book!

Send a postcard today for the new Candler Book of Facts. It tells you the inside story on how to build a fascinating career. **WRITE TODAY!** Of course there is no obligation.



CANDLER SYSTEM CO.

Dept. Q-4
Asheville, N. C., U. S. A.

RADIO CONTROL

Lightweight, reliable, guaranteed — the only complete line of radio control equipment for models. Ask your dealer or send 10c for illustrated Instruction Manual.

RADIO CONTROL HEADQUARTERS, INC.
330 West 42nd Street New York City

No. 211 Flyweight Receiver, \$8.75

Piezo-Electric Crystals Exclusively

Quality crystals of all practical frequencies supplied SINCE 1925. Prices quoted upon receipt of your specifications.

Our Pledge: **QUALITY FIRST**

SCIENTIFIC RADIO SERVICE

"The Crystal Specialists Since 1925" University Park, Hyattsville, Md.

EASY TO LEARN CODE

It is easy and pleasant to learn the modern way — with an **Instructograph Code Teacher**. Ideal for the beginner or advanced student. Many tapes available ranging from alphabet for beginners to typical messages on all subjects. Speed range 5 to 40 WPM. Always ready, no QRM, beats having someone send to you.

FOR SALE OR RENT

STANDARD with 10 tapes and book of instructions, A.C. motor.....\$24.50
With spring-wound motor.....\$18.50
JUNIOR with 5 tapes and book of instructions (not rented).....\$12.00

RENTAL Standard with 10 tapes and book of instructions \$3.00 first month, \$2.25 each additional month. References or \$10 deposit required. All rental payments may be applied on the purchase price should you decide to buy the equipment.

Write for details today

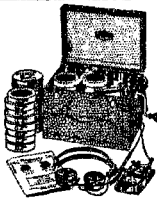

INSTRUCTOGRAPH COMPANY

Dept. Q, 4701 Sheridan Road, Chicago, Illinois
Representative for Canada:
Radio College of Canada, 54 Bloor St. West, Toronto

Strays

The aluminum cans which come with 35-mm. film make good shields for microphone jacks. — **W2KJY**.

Of interest to hams who are interested in direction finding is the booklet "Instructions for the Operation and Calibration of Radio Direction-Finder Equipment" — Chapter 30 of M.E.I. — which may be obtained from the Superintendent of Documents, Washington, D. C., for five cents. — **W9PQM**.

New Receiving Tubes

HYGRADE SYLVANIA announces a new receiving pentode amplifier, the type 7V7, whose characteristics feature, it is claimed, the highest transconductance, combined with the lowest grid-plate capacity possible for practical application of a tube of its type.

TYPE 7V7

Heater voltage.....	7
Heater current.....	0.48 amp.
Direct interelectrode capacitances:	
P-G.....	0.004 μ fd.*
Input.....	9.5 μ fd.
Output.....	6.5 μ fd.

Typical operating data:

Plate voltage.....	300	300 volts
Screen supply voltage †.....	150	300 volts
Screen series resistor.....		40,000 ohms
Suppressor voltage.....	0	0
Cathode bias resistor.....	160 min.	160 min. ohms
Plate resistance.....	0.3	0.3 meg.
Mutual conductance.....	5800	5800 μ mhos.
Plate current.....	9.6	9.6 ma.
Screen current.....	3.9	3.9 ma.
Grid voltage for cathode-current cutoff.....	-6	-14 volts

* With RMA M8-308 shield connected to cathode.

† When a screen supply voltage in excess of 150 is used, a series resistor must be used to limit the voltage at the screen to 150 volts when the plate current is at its rated value of 9.6 ma.

The two conditions given above represent operation with fixed screen supply and with series screen resistor respectively. The second set of conditions gives an extended cut-off characteristic.

The base is of the loktal type. Connections are as follows:

1 — Heater 2 — Plate 3 — Screen 4 — Suppressor
5 — Shield 6 — Grid 7 — Cathode 8 — Heater

NEW U.H.F. RECEIVING PENTODE

R.C.A. announces a new metal r.f. pentode amplifier tube whose performance at the ultra-high frequencies should more closely approach that of the acorn tube. The 12SG7 has a 12.6-volt heater, while the 6SG7 operates at 6.3 volts. Otherwise the characteristics of the two types are identical. They feature high transconductance, very low grid-plate capacitance and two separate cathode terminals. Because of these features, these tubes offer new facilities for improving the stage gain of receivers, particularly those designed to operate at the higher frequencies. The use of two cathode leads permits greater isolation of input and output circuits through

FOR PEAK PERFORMANCE PICK ASTATIC PRODUCTS

RIGID INSPECTION TESTS

Assure Astatic Product Operating Efficiency

Volume production has not been permitted to interfere with Astatic's golden rule of "quality first." All Astatic Crystal Products . . . including Microphones, Pickups, Recording Heads and Cartridges . . . are carefully tested to meet Astatic's exacting requirements before being shipped. That's why the name "Astatic"

has become synonymous with such phrases as "dependable performance" and "sturdy construction." Consider these points when making replacements or modernizing your present broadcast, public address, amateur or electrical phonograph equipment. See your Radio Paris Jobber or write for complete Astatic Catalog.

MODEL JT-30-TT

This popular crystal microphone now comes equipped with wood handle and interlocking metal base. When desired, wood handle may be removed and microphone used on floor stands threaded $\frac{3}{8}$ "-27. Standard equipment also includes concentric cable connector, 25-ft. rubber covered, single wire, shielded cable and spring cable connector.

LIST PRICE
\$16.50



ASTATIC MICROPHONE

IN CANADA, CANADIAN
ASTATIC Ltd., TORONTO, ONT.

YOUNGSTOWN
OHIO

Laboratory, Inc.

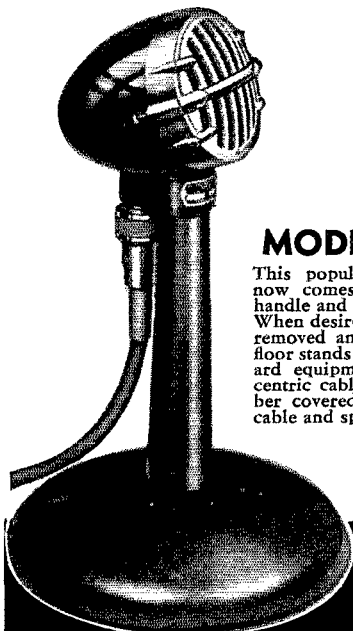

ASTATIC CRYSTAL PRODUCTS LICENSED UNDER
BRUSH DEVELOPMENT CO. PATENTS

AMATEUR RADIO LICENSES

Day and Evening Classes in Code and Theory
HOME STUDY COURSES

Reasonable, Efficient and Thorough, Hundreds of
Licensed Students Now on the Air

American Radio Institute, 1123 Broadway, New York, N. Y.



★ FREE TO AMATEURS ★

who write us their call letters and tell us what type of recording equipment they are now using. National will mail a sample of its new QSL disc, paper coated, 6 1/4 in., records on both sides. Widely used by amateurs to confirm QSO's. 1941 catalog now ready. Contains complete line of blank discs, cutting and playback needles, recorders and communications receivers.

NATIONAL RECORDING SUPPLY CO.
1065 VINE ST. HOLLYWOOD, CAL.

FASTEST WAY TO LEARN CODE

Easy, Fascinating—LEARN BY EAR to
be a GOOD OP.

The New All Electric Master Teleplex Code Teaching Machine is exactly what thousands are looking for. No experience needed. Excellent for beginners—steps up WPM for ALL Ops. There is no guesswork with Master Teleplex, because it records your sending in visible dots and dashes. You SEE and HEAR exactly how you are making your signals. You learn code the way you'll be using it—by SOUND. That's why schools teaching code use TELEPLEX. Complete course included at no extra charge. Used by many schools and several governments for teaching code. Low cost, easy terms. MONEY BACK GUARANTEE. Send now for booklet Q-4, no obligation. Post card will do.



The "Ham" Special TELEPLEX CO. Standard Teleplex — a highly efficient code teacher using heavy specially prepared waxed paper tape, having two rows of perforations. Write for Free folder QT-4.
107 HUDSON ST. JERSEY CITY, N. J.
In Canada write, CANADIAN ELECTRONIC INSTITUTE, TORONTO, ONT.

GENERAL COMMUNICATIONS CRYSTALS HOLDERS AND OVENS

Precision Made by *Bliley*

WRITE FOR CATALOG G-11

BLILEY ELECTRIC CO., ERIE, PA.

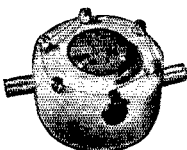
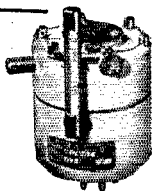

TO HELP You GET STARTED IN AMATEUR RADIO

How to Become a Radio Amateur

Universally recognized as the standard elementary guide for the prospective amateur, *How to Become a Radio Amateur* features equipment which, although simple in construction, conforms in every detail to present practices. The apparatus is of a thoroughly practical type capable of giving long and satisfactory service — while at the same time it can be built at a minimum of expense. The design is such that a high degree of flexibility is secured, making the various units fit into the more elaborate station layouts which inevitably result as the amateur progresses. Complete operating instructions and references to sources of detailed information on licensing procedure are given, as well as a highly absorbing narrative account of just what amateur radio is and does.

25¢

POSTPAID ANYWHERE
(NO STAMPS, PLEASE)

The Radio Amateur's License Manual

Before you can operate an amateur transmitter, you must have a government license and an officially assigned call. These cost nothing — but you must be able to pass the examination. The examinations are based on the multiple-choice type of questions. The "License Manual" has been written to make it as easy as possible for the individual to acquire the necessary knowledge to pass the examination with flying colors. Whether you are going up for your Class C, B or your Class A ticket, "The License Manual" will provide the most direct path to getting that ticket. If you are one of the thousands who always wants a "License Manual" around the shack for ready reference for amateur regulations, it will please you to know that the regulations are very thoroughly indexed.

25¢

POSTPAID ANYWHERE
(NO STAMPS, PLEASE)

AMERICAN RADIO
RELAY LEAGUE
WEST HARTFORD, CONNECTICUT

elimination of the coupling inductance of a common cathode return. As a result, the input conductance can be maintained at a low value at high frequencies. The single-ended metal construction with short internal leads is a practical consideration in obtaining high gain with stability.

Characteristics — 6SG7 — 12SG7

Heater voltage (12SG7).....	12.6		
(6SG7).....	6.3		
Heater current (12SG7).....	0.15	amp.	
(6SG7).....	0.3	amp.	
Direct interelectrode capacitances:			
G-P.....	0.003	μfd.	
Input.....	8.5	μfd.	
Output.....	7.0	μfd.	
Typical operating data:			
Plate voltage.....	100	250	250
Screen voltage.....	100	125	150
Grid voltage.....	- 1	- 1	- 2.5
Suppressor.....	Connected to shell internally		
Plate resistance, approx.	0.25	0.9	1 + meg.
Transconductance.....	4100	4700	4000 μmhos.
Grid voltage (approx.) for transconductance of 40 μmhos.....	- 11.5	- 14	- 17.5
Plate current.....	8.2	11.8	9.2 ma.
Screen current.....	3.2	4.4	3.4 ma

Pin Connections

1 — Shell	2 — Heater	3 — Cathode	4 — Grid
5 — Cathode	6 — Screen	7 — Heater	8 — Plate

A.A.R.S. Activities

(Continued from page 45)

ANNUAL CODE SPEED CONTEST

COMPLETE results of the annual code speed contest, which was held on February 10th, are not yet available. It is hoped to announce the complete scores and winners in the next issue of *QST*. In this connection, W. B. Hollis, W5FDR-WLJR, Houston, Texas, a member of the Eighth Corps Area A.A.R.S. net, made a good copy at the 55, 60, and 65 w.p.m. speeds, although he was confined to bed by illness.

ARMY QUESTIONNAIRE

ALL AMATEUR radio operators will soon receive the War Department questionnaire, WD OCSigO Form No. 170. It is hoped that they will promptly fill out and return the questionnaire, in duplicate, to their respective corps area signal officers in order that the required data will be available to the War Department as soon as possible. Many army amateurs will cooperate with their corps area signal officers by assisting in the addressing and mailing of these questionnaires to the amateurs in their respective corps areas.

MEMBERSHIP

A.A.R.S. MEMBERSHIP is increasing slowly but surely in all corps areas. This is an indication that amateurs realize the value of close affiliation with the War Department. It should be stated, however, that membership in the Army Amateur Radio System does not carry any assurance whatsoever that such amateur radio stations will be permitted to continue operations in the event of

AIRLINES NEED RADIO MEN

The knowledge and experience of Amateur Radio Operators has been responsible in a large measure for the outstanding record established by Midland Schools. Following is a brief resume of that record:

★ After an inspection of approximately 143 radio schools, Midland is one of three chosen by the U. S. Army Signal Corps to provide enlisted men with three months' radio training. ★ Recognition by the Air Transport and Radio Industries. ★ Airline instructors secured from major Airlines. ★ Training directed by a 9-Airline Advisory Board. ★ Graduates employed in more than 32 states, at more than 50 airports, and by all major Airlines. ★ Demand for qualified graduates exceeds the supply.

WRITE US TODAY

Midland Schools specialize in training men for positions as Airline Radio Operators and Radio Maintenance Men, with more than \$40,000.00 in equipment available for training. Write us today for a copy of our new 58-page catalog and training outline, containing photos and information provided by Airlines and aircraft manufacturers. No obligation.

Listen in on the Midland Grad circuit, 7225 kc.,
CQ call, "CQ—MR."

MIDLAND RADIO

AND TELEVISION SCHOOLS INC.

Dept. Q-2, 29th Floor

Power & Light Bldg.

Kansas City, Missouri

YOUR INQUIRIES INVITED!

YOU need assistance in getting the right receiver for your use, and I can help you. I can make it to your advantage to buy from me. Here are five good reasons why it will pay you to write me before you buy.

1. YOU GET specialized personal attention of genuine value that you can't expect to get from other jobbers.
2. YOU GET prompt shipment from the world's largest stock of all makes and models of amateur communications receivers.
3. YOU GET easy 6% terms which I finance myself so you have less cost — no red tape — quicker delivery. Write me for terms.
4. YOU GET best trade-in for your receiver. Describe it and I will tell you its trade-in value. Pay the balance on my 6% terms.
5. YOU GET ten-day free trial. You don't buy unless you are satisfied.

So write me and I will help you get the best receiver and will cooperate with you to see that you are 100% satisfied. Your inquiries invited.

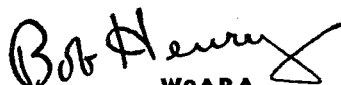
• 
W9ARA

HENRY RADIO SHOP

BUTLER
MISSOURI

the suspension of all amateur radio activities during a national emergency. Complete information and application blanks on the A.A.R.S. may be obtained by any interested amateur from the signal officer in his respective corps area as per the following list:

Corps Areas	Amateur Call Areas
Signal Officer, First Corps Area, Army Base, Boston, Mass.	The First Corps Area and the 1st call area coincide.
Signal Officer, Second Corps Area, Governors Island, N. Y.	The Second Corps Area includes all of the 2d call area; Delaware and New Jersey from the 3d call area; and New York from the 8th call area.
Signal Officer, Third Corps Area, Post Office Building, Baltimore, Md.	The Third Corps Area includes all of the 3d call area except Delaware and New Jersey; and Pennsylvania from the 8th call area.
Signal Officer, Fourth Corps Area, Post Office Building, Atlanta, Ga.	The Fourth Corps Area includes all of the 4th call area; Louisiana and Mississippi from the 5th call area.
Signal Officer, Fifth Corps Area, Fort Hayes, Columbus, Ohio.	The Fifth Corps Area includes Ohio and West Virginia from the 8th call area; Indiana and Kentucky from the 9th call area.
Signal Officer, Sixth Corps Area, U. S. Post Office Bldg., Chicago, Ill.	The Sixth Corps Area includes Michigan from the 8th call area; Michigan, Illinois and Wisconsin from the 9th call area.
Signal Officer, Seventh Corps Area, Federal Office Building, Omaha, Neb.	The Seventh Corps Area includes Arkansas from the 5th call area; all except Indiana, Kentucky, Michigan, Illinois, Wisconsin and Colorado from the 9th call area.
Signal Officer, Eighth Corps Area, Fort Sam Houston, Texas.	The Eighth Corps Area includes the 5th call area except Louisiana, Mississippi, and Arkansas; Arizona from the 6th call area; and Colorado from the 9th call area.
Signal Officer, Ninth Corps Area, Presidio of San Francisco, Calif.	The Ninth Corps Area includes all of the 6th call area except Arizona, and all of the 7th call area.

SPECIAL FREQUENCY OPERATIONS

UNDER the above title, reference was made in March *QST* to various WL-nets to which amateurs might wish to listen, and their schedules were shown in a table on page 42. The frequency of 6900 kc. shown in that table should read 6980 kc.

EXPERIENCE SPEAKS

THOSE steel broom or utility cabinets sold in department and household-furnishing stores ought to make much less expensive transmitter enclosures. They are usually 20 or 21 inches wide and up to 66 inches high. An opening 17½ inches wide may be cut in the back with a hacksaw or acetylene knife and the edges backed up with iron or wood strip for mounting standard rack panels. A good husky one of "streamline" design usually costs less than ten dollars.

Where to buy it

A directory of suppliers who carry in stock the products of these dependable manufacturers.

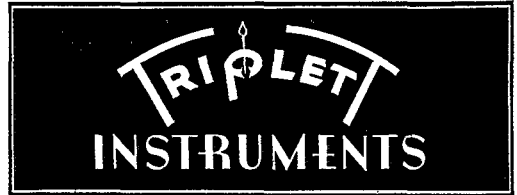
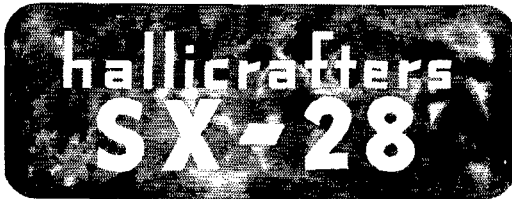

ALBANY, N. Y. Uncle Dave's Radio Shack 356 Broadway
 ATLANTA, GEORGIA Radio Wire Television Inc. 265 Peachtree Street
 BOMBAY, INDIA Eastern Electric & Engineering Company
 BOSTON, MASS. Radio Shack 167 Washington Street
 BOSTON, MASS. Radio Wire Television Inc. 110 Federal Street
 BRIDGEPORT, CONN. Hatry & Young, Inc. 177 Cannon Street
 BRONX, N. Y. Radio Wire Television Inc. 542 East Fordham Rd.
 BUTLER, MISSOURI Henry Radio Shop 211-215 N. Main Street
 CHICAGO, ILL. Allied Radio Corp. 833 W. Jackson Blvd.
 CHICAGO, ILL. Radio Wire Television Inc. 901-911 W. Jackson Blvd.
 CINCINNATI, OHIO United Radio, Inc. 1103 Vine Street
 DETROIT, MICH. Radio Specialties Co. 325 E. Jefferson Ave.
 DETROIT, MICHIGAN Radio Specialties Co. 11800 Woodward Ave.
 HARTFORD, CONNECTICUT Radio Inspection Service Company 227 Asylum Street
 HOUSTON, TEXAS R. C. & L. F. Hall 1021 Caroline Street
 INDIANAPOLIS, INDIANA Van Sickle Radio Supply Co. 34 West Ohio Street
 JAMAICA, L. I. Radio Wire Television Inc. 90-08 166th Street
 KANSAS CITY, MO. Burstein-Applebee Company 1012 McGee Street
 LITTLE ROCK, ARKANSAS Beem Radio Company 409 W. 3rd Street
 NEW HAVEN, CONN. Hatry & Young, Inc. 1172 Chapel Street
 NEW YORK, N. Y. Harrison Radio Co. 12 West Broadway
 NEW YORK, N. Y. Radio Wire Television Inc. 100 Sixth Ave.
 NEWARK, N. J. Radio Wire Television Inc. 24 Central Ave.
 READING, PENN. George D. Barbey Company 404 Walnut Street
 SCRANTON, PENN. Scranton Radio & Television Supply Co. 519-21 Mulberry Street
 WASHINGTON, D. C. Sun Radio & Service Supply Co. 938 F Street, N. W.

ALBANY, N. Y. Uncle Dave's Radio Shack 356 Broadway
 ATLANTA, GEORGIA Radio Wire Television Inc. 265 Peachtree Street
 BOSTON, MASS. Radio Shack 167 Washington Street
 BOSTON, MASS. Radio Wire Television Inc. 110 Federal Street
 BRIDGEPORT, CONN. Hatry & Young, Inc. 177 Cannon Street
 BRONX, N. Y. Radio Wire Television Inc. 542 East Fordham Rd.
 BUTLER, MISSOURI Henry Radio Shop 211-215 N. Main Street
 CHICAGO, ILLINOIS Allied Radio Corp. 833 W. Jackson Blvd.
 CHICAGO, ILL. Radio Wire Television Inc. 901-911 W. Jackson Blvd.
 CINCINNATI, OHIO United Radio, Inc. 1103 Vine Street
 HARTFORD, CONN. Hatry & Young, Inc. 203 Ann Street
 JAMAICA, L. I. Radio Wire Television Inc. 90-08 166th Street
 LITTLE ROCK, ARKANSAS Beem Radio Company 409 W. 3rd Street
 MINNEAPOLIS, MINNESOTA Low Bonn Company 1211 LaSalle Avenue
 NEW HAVEN, CONN. Hatry & Young, Inc. 1172 Chapel Street
 NEW YORK, N. Y. Radio Wire Television Inc. 100 Sixth Avenue
 NEWARK, N. J. Radio Wire Television Inc. 24 Central Ave.
 READING, PENN. George D. Barbey Company 404 Walnut Street
 SCRANTON, PENN. Scranton Radio & Television Supply Co. 519-21 Mulberry Street
 WASHINGTON, D. C. Sun Radio & Service Supply Co. 938 F Street, N. W.

Listings on this page do not necessarily imply endorsement by QST of the dealers or of other equipment sold by them.



HARVEY'S
Headquarters for
RECORDING
EQUIPMENT

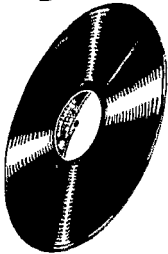

audiorecords

Complete stocks of all sizes, aluminum and bond base; for professional use up to 16 inches, for "home" recording up to 12 inches.

audiorecord chip chaser



A handy accessory for brushing the thread from the cutter. Fits any machine or turntable—no adjustments. Professional appearance.

For 12" turntable, list.....\$4.50
For 16" turntable, list.....5.25

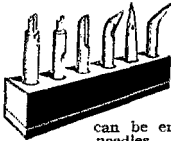

audiopoints

The quality of the recording is dependent, to a great degree, upon the proper cutting needle. Audiopoints are "tops." Reproduction can be enhanced with "matched" playback needles.

Sapphire, Stellite or steel stylus list from 25c to \$6.25 each
Shadowgraphed playback needles list as low as (per 100) 60c

HOW TO MAKE GOOD RECORDINGS

A profusely illustrated book, covering every phase of instantaneous disc recording from choosing the equipment and operating hints to dramatization for fun.....\$1.25



★ Scores of other accessories as well as complete equipment and assemblies.

W21JL ■ W21JA ■ W2KWY ■ W2JKD ■ W2PL

OUR *Best* VALUE IS OUR RECORD OF LOYAL SERVICE

HARVEY

Radio Company of New York

103 WEST 43rd STREET • NEW YORK, N. Y.

CABLE ADDRESS: "HARADIO"

Correspondence

(Continued from page 80)

help their fellow hams out. I would welcome the chance to take on the responsibility of paying for one or two subscription fees for any helpless OM such as PAØGE. So what say?

—Thomas L. Schmidt, W1MXD/3

MATHEMATICAL SELECTIVITY

7509 Boyer St., Mt. Airy, Philadelphia, Pa.

Editor, *QST*:

After reading the letter by W9LQE (p. 100, March '41) I wrote him a thing or two! An interesting sideline was the mathematical phase of his super-selectivity proposal. Assuming 10-cycle channels per proposal, and 6 seconds for listening on each channel for an answer to CQ, it would take 10 minutes to cover the first kc. If you covered, say, 100 kc., which is a fair amount, it would take almost 17 hours! And for the whole 80-meter band more than 3½ days!

Something tells me there are difficulties in his idea other than those of manufacturing. HI!

—Alan P. Buffington, W3EEW

MAKE IT CONSTRUCTIVE

8 N. Main St., Clintonville, Wis.

Editor, *QST*:

I've never written a letter for the correspondence section of *QST*, and I wouldn't be writing this if I didn't think my criticism was constructive. . . .

I've read all the letters that have been written by other hams published in the Correspondence section, and have picked up many ideas and have heard many arguments pro and con. I admire the person that voices his opinions and stays on the constructive side whether he be right or wrong. But sour is the taste in my mouth when I read the stuff that I figure comes under the heading of "gripe." It's true that the letters are similar to a radio program, and that if a person doesn't like it he doesn't have to listen. But as long as the person who wrote the article exerted the energy to sit down and write the letter and spend the money on ink, paper, stamp and the effort to trot over to the post-office, then why in heck couldn't he have put one more ounce of pressure on the pen and end his article with what he might figure is a way of correcting the fault, or give some thought as to remedying the situation, rather than just run down what the other person has to say? I can plainly understand why the editors of *QST* insert the line, "The Publishers of *QST* assume no responsibility, etc."

I have been as careful as can be in writing this so as not to create an impression that I myself am a "griper." I do not have any particular articles or letters in mind and have no intention of running someone down for something that is their very sacred opinion (an American institution, by the way), but rather to offer the suggestion that these other fellows please keep their criticism as constructive as possible. . . .

—C. L. Graf, W9NSE

CRYSTALS by HIPOWER

The Hipower Crystal Company, one of America's oldest and largest manufacturers of precision crystal units, is able to offer the amateur and manufacturer attractive prices because of their large production and the exclusive Hipower grinding process. Whatever your crystal need may be, Hipower can supply it. Write today for full information.

HIPOWER CRYSTAL CO.

Sales Division—205 W. Wacker Drive, Chicago

Factory—2035 Charleston Street, Chicago, Ill.

RADIO

ENGINEERING, broadcasting, aviation and radio telegraphy and telephony, policeradio, servicing, marine accounting taught thoroughly. 48 weeks' engineering course, equivalent to three years of college radio work. School established 1874. All expenses low. Catalog free.

DODGE'S INSTITUTE, Day Street, Valparaiso, Indiana

TERMINAL

YOUR RELIABLE RADIO SUPPLY HOUSE

We are one of the largest distributors of radio equipment in the country. Naturally, you can expect us to carry everything in radio — and we do!

At our counters you will always enjoy lowest prices, quality merchandise, good humor, and the technical understanding of the salesmen who serve you.

Special **MEISSNER** COMPLETE F-M RECEIVER

12 tubes, complete with high fidelity audio and hi-fi P.M. speaker. 6 watts output, tone control and beautiful two-tone walnut cabinet. **\$34.95**
Reg. \$58.31 — now.....

WEBSTER Recorder Chassis

Make recording of your QSO's! Webster recording chassis, utilizing crystal cutting head, crystal pick-up, motor and recording assembly now costs only..... **\$20.28**
A super-superior value!

NEW! Type ACN NATIONAL DIAL

Here is a new Velvet Vernier Dial that permits your own calibrating! Scale removable without dismounting mechanism.
Net price..... **\$2.70**

Other new National dials and net prices are types: NY—\$4.80, O—90c, K—90c, L—\$1.50, M—\$1.50. Ask us for complete National catalog.

BATEMAN RECORDING MACHINES AND EQUIPMENT

We carry the complete line of recorders and recording mechanisms by BATEMAN, manufacturers of quality, low-priced recording apparatus. Their portable professional 12" recorder costs **\$132**

GARDINER-LEVERING

Automatic Code Senders
Type S — Most compact and practical. With 10 rolls lesson tape..... **\$17.50**
Type J — Sends 6 to 65 wpm. Built-in tape perforator.
With tapes..... **\$12.50**

MEISSNER Signal Shifter

Variable frequency exciter of remarkable stability delivering approx. 7.5 watts on 14, 7, 3.5 and 1.7 mc bands. Instant fre-

quency changes in any given band. Complete with tubes and 20 meter coils. Cabinet in black or gray. Net **\$46.55**

New! Millen **RICE-VARIARM**

A good ECO at a low price. Low Drift • Vibration Immune • No Hand Capacity • Chirpless Keying • Good Bandsread. **\$29.50**
Complete.....

ECHOPHONE RECEIVERS

All Models In Stock
See last month's QST for data of two new fb Echophone receivers. Priced at \$29.95 and \$49.95. EC-I model at \$19.50 is a best seller!

TERMINAL RADIO CORP.

68 WEST 45th ST. & 80 CORTLANDT ST. in NEW YORK, N.Y.

Mail Orders Filled

Open evenings till 8

Vanderbilt 6-5050

3 BIGGEST BUYS in COMMUNICATIONS RECEIVERS

Try and beat all these amazing features at this sensationally low price. Tunes from 545 kc. to 30.5 mc. (550 to 9.85 meters) on 3 bands. Electrical bandspread on all bands. 6 tubes. Self-contained speaker. AC/DC-115-125 volts. (Model EC-1.) A real communications receiver for only

\$19.95

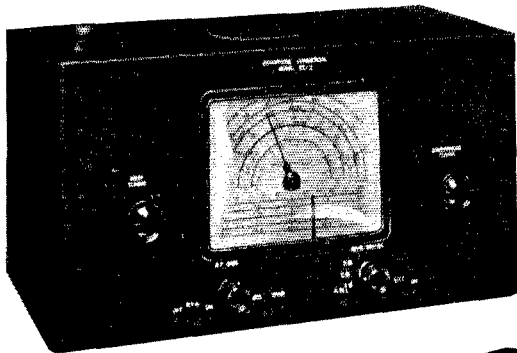

Up to the minute communications receiver performance. 8 tubes; 3 bands; covers 545 to 2100 kc.—2.1 to 8.1 mc.—7.9 to 30.5 mc.; self-contained 5" PM dynamic speaker; preselection on all bands; calibrated bandspread scale on 80/40/20/10 meter amateur bands; automatic noise limiter; electrical bandspread at all frequencies in the tuning range; operates on 115 volts AC/DC. (Model EC-2.) Never before have you been offered these outstanding communications features for only

\$29.95

Here's your opportunity to have all these communications features at this remarkably low price. Crystal filter (four position variable selectivity); calibrated bandspread; automatic noise limiter; preselection on all bands; 2 stage IF amplifier; fly-wheel tuning; separate 6" PM speaker; CW monitor; 10 tubes; 3 bands; covers 545 to 2100 kc.—2.1 to 8.1 mc.—7.9 to 30.5 mc.; electrical bandspread. Operates on 115 volts AC/DC. (Model EC-3.) Now at this incredibly low price of

\$49.95

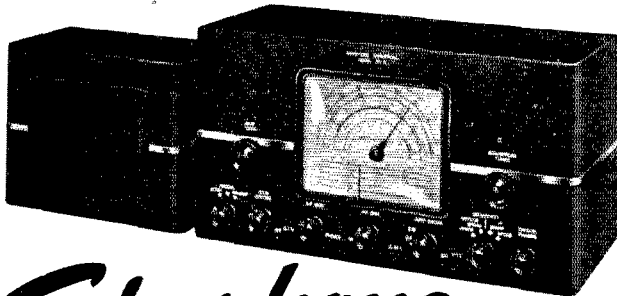

Echophone
COMMERCIAL

"The Ears of the World"

Echophone Radio Co. • 201 East 26th Street, Chicago, U. S. A.

HAM-ADS

(1) Advertising shall pertain to radio and shall be of nature of interest to radio amateurs or experimenters in their pursuit of the art.

(2) No display of any character will be accepted, nor can any special typographical arrangement, such as all or part capital letters be used which would tend to make one advertisement stand out from the others.

(3) The Ham-Ad rate is 15¢ per word, except as noted in paragraph (6) below.

(4) Remittance in full must accompany copy. No cash or contract discount or agency commission will be allowed.

(5) Closing date for Ham-Ads is the 25th of the second month preceding publication date.

(6) A special rate of 7¢ per word will apply to advertising which, in our judgment, is obviously non-commercial in nature and is placed and signed by a member of the American Radio Relay League. Thus, advertising of bona fide surplus equipment owned, used and for sale by an individual or apparatus offered for exchange or advertising inquiring for special equipment, if by a member of the American Radio Relay League takes the 7¢ rate. An attempt to deal in apparatus in quantity for profit, even if by an individual, is commercial and all advertising by him takes the 15¢ rate. Provisions of paragraphs (1), (2), (4) and (5) apply to all advertising in this column regardless of which rate may apply.

Having made no investigation of the advertisers in the classified columns, the publishers of *QST* are unable to vouch for their integrity or for the grade or character of the products advertised

QUARTZ — direct importers from Brazil of best quality pure quartz suitable for making piezo-electric crystals. Diamond Drill Carbon Co., 719 World Bldg., New York City.

QSL'S, Maps, Cartoons. Free samples. Theodore Porcher, 7708 Navajo, Philadelphia, Pa.

USED receivers, Bargains. Cash only. No trades. Price list 3¢. W3DQ, Wilmington, Del.

CALLBOOKS — Spring edition now on sale containing complete up-to-date list of radio hams throughout entire world. Also world prefix map, and new time conversion chart. Single copies \$1.25. Canada and foreign \$1.35. Radio Amateur Call Book, 610 S. Dearborn, Chicago.

CRYSTALS, mounted, 80-160 medium drift \$1.25, 40 — \$1.50; low drift 40-80-160, \$2.25. No Y's. R9 Crystals, 338 Murray Ave., Arnold, Pa.

MAC Auto code machines, low monthly rental, 50,000 words practice tapes. For those who own MacAutos, tapes for Macs, recording ink and blank tapes for sale. Write C. M. Ayers, 711 Boylston St., Boston, Mass. Tel. GRAnite 7189-W.

COMMERCIAL radio operators examination questions and answers. One dollar per element. G. C. Waller, W5ATV, 6540 Washington Blvd., Tulsa, Okla.

CRYSTALS: police, marine, aircraft. C-W Mfg. Co., 1170 Esperanza, Los Angeles.

1000 watt G.E. transformers 1100-2200-4400 volts each side c.t. Guaranteed \$13.50. Dawson, 5740 Woodrow, Detroit, Mich.

QSL'S — W2AEY, 338 Elmora, Elizabeth, N. J.

BATTERY model RME-69, noise silencer, crystal, \$70. Changeable to a.c. W9VQC, Virgil, S. Dak.

QUARTZ crystals — importers of highest quality tested for twinning suitable for cutting piezo-electric crystals. Donald M. Murray Co., 38 Pearl St., N. Y.

QSL'S — Brownie, W3CJL, 1725 Frankensfield Ave., Allentown, Pa.

CRYSTALS in plug-in heat dissipating holders. Guaranteed good oscillators, 160-M 80M AT \$1.25; 40X \$1.65. 80M vari-frequency (5 kilocycle variance) complete \$2.95. State frequency desired. C.O.D.'s accepted. Pacific Crystals, Box 6679, E. Los Angeles Branch, Calif.

LEO, W9GFQ, offers the hams more and a better deal always. Lowest terms, no red tape (as finance own paper) on all new and used equipment. Free trial, personalized service. Write for 124-page bargain catalog and get acquainted. Wholesale Radio Laboratories, Council Bluffs, Iowa.

TRANSMITTING headquarters on latest Stancor Thordarson & other kits — commercially wired at low cost. New 70 watt transmitter kits complete only \$35 — speech amplifier modulator up to 80 watts \$25 — up to 150 watts \$49.50. Easy terms. Write Leo, W9GFQ, today.

CRYSTALS: famous P.R., mounted in latest Alsmag 35 holders — 40, 80 meter P.R.-X, 160 meter PR-Z, \$3; 40, 80 meter PR-Z (low drift), \$3.50; 20-meter PR-20, \$4.50; unconditionally guaranteed. Immediate shipment. Quality blanks, 65¢. Wholesale Radio Labs., Council Bluffs, Iowa, W9GFQ.

RACK-panel xmtr — 500 watts phone, 750 watts CW, 100TH's in final, ZB120's in modulator. Each stage metered separately, with all tubes. Will be sold to highest bidder. Make an offer. W4EZP, 149 Barksdale Drive, N.E., Atlanta, Ga.

WANTED: manufacturers late communications receiver, also test equipment. Cash or trade. Jensen, 330 Aberdeen, Rochester, N. Y.

HAMMARLUND HQ-120X gray finish, complete with speaker and cabinet. Operated very few hours. Equal to new in every respect. \$100. Francis Maida, 959 W. 10th, Erie, Pa.

SELL: NC-101X like new. New CHT 2500 volt 1625 watt plate supply complete. Any reasonable offer. W9YOP.

PANELS ½ steel, baked wrinkle finish, racks, brackets — write for circular. W9EPO, 3358 N. 45th St., Milwaukee, Wis.

SELLING — low power transmitter \$15, steel relay rack \$10. K.W. power supply \$25 and high voltage variable condensers \$4 each. W6OFQ, San Mateo, Calif.

UTAH Jr. transmitter complete, \$12. W3IBX, 4627 Briarcliff, Baltimore, Md.

QSL'S? — SWL'S? Service. No cheap trash. America's finest QSL's. Samples? W8DED, Holland, Mich. Crystals? Biley (circular free); Callbooks \$1.25; A.R.R.L. supplies, QST, Radio subscriptions appreciated. W8DED.

BEST offer takes Utah 100W transmitter, Utah 500W amplifier kit, Utah antenna kit, all tubes all meters except RF, two 20 meter crystals, Skyrider SX9. H. O. Link, 614 Glenolden Ave., Baltimore, Md.

KILOWATT phone, all bands, \$300. W7BL, 1921-30th So., Seattle, Washington.

PICK your values — 100 assorted half one watt insulated resistors \$2.95 — your QSL gets list used receivers. Technical Equipment Co., 135 Liberty St., New York, N. Y.

500 watt, 20 meter phone xmtr in rack. Will sell cheap, leaving city. W8QIH, Cincinnati, Ohio.

TRADE new and used transmitting parts for woodworking machinery, or what have you? W4AWQ, 7126 3rd Ave., So., Birmingham, Ala.

SELL QST 1929 to 1936 complete. W2ASM.

QSL'S. Finest, Free samples. Maleco, 1805 St. Johns Place, Brooklyn, N. Y.

WANTED — National FBXA and commercial IP501 receiver. W8ARH.

SELL Esco M.G. 500 v. 100 w. W2BNK.

WANTED: transmitter Collins 30J, or Hallicrafters (400 watt), RME-99. Arnold Badt, Benton Harbor, Mich.

COMPLETE 1 K.W. xmtr for sale. Custom and commercially built switching arrangement for 600 watts input including network and accessories for 20 meter operation. Can be used on other frequencies. Pictures and specifications upon request. Reasonably priced. W2JEH, N. Y. C.

WRITE Bob Henry, W9ARA, for best deal on all amateur receivers, transmitters, kits, parts. You get best terms (financed by myself); big trade-in; personal cooperation; lowest prices. NC-200's and all other National, Hallicrafter, RME, Echo-phone, Howard, RCA receivers positively in stock for immediate delivery. Special bargain prices on several models of new receivers. Write. Bob Henry, Butler, Mo.

RECONDITIONED guaranteed amateur receivers and transmitters. All makes and models. Lowest prices. Free trial. Terms. List free. Write. Bob Henry, Butler, Mo.

WILL swap HRO Sr. complete for 16mm. sound projector in good condition or for highest cash offer. Write for large bargain list. W2HTP.

CRYSTALS — in plug-in holders. 160M-80M AT, \$1. 40X, \$1.35. Complete 80M vari-frequency, \$2.75. C.O.D.'s O.K. State frequency. Coppel, W6JEB, 344 So. Fetterly, Los Angeles.

SELL National HRO Sr. with Communications Laboratory adjustable noise limiter, \$98 cash. W2CUZ, Whittemore, Briggs Ave., Yonkers, N. Y.

EMERGENCY, portable, 20 watt Class B modulator transmitter, four tube Super, complete portable or home station. Also 350 watt gas generator. W2GKX.

SALE — HRO complete — \$87.50. W3KJ.

DETROITERS: new deal on amateur equipment. Terms, trades, personal service. Reconditioned receivers our specialty. Sky-Buddy \$12; Howard 430 \$15. W9KEH-8, Radio Supply & Engineering, 7667 Grand River, Detroit.

CASH for 1250 or 1500 volt 500 mil power supply, 300 or 500 watt modulation transformer, Thordarson speech amplifier kit. W8FOV.

WANTED: an Excelsior press 6 x 10 or larger. All letters or cards answered. Anthony A. Huber, Patton, Pa.

CRYSTALS: three blanks \$1; QSO Crystals, Indiana, Pa.

QUESTION? About radio? Write William D. Hayes, Box 1433-E, Oakland, Calif.

QSL'S. New designs. Free samples to hams. W2FJE, 101 Hanson Place, Brooklyn, N. Y.

CRYSTALS: Marine 2198, 2638, 2670, 2738, low-drift AT cut, .025% accuracy, mounted standard holder, \$5.50 Ham. Crystals, 1104 Lincoln Place, Brooklyn, New York.

COMPLETE station 100T 800 watt CW, 'phone transmitter Enclosed relay rack, 6 Triplett, 3 Jewell meters, Beautiful work. A real buy. Communications type receiver, tuning meter. Write for complete inventory, prices. Ruth Friedman, 91 Ft. Washington Ave., N. Y. C., Apt. 63.

CRYSTALS; commercial or amateur: Send for catalog of Eidson's complete line of low drift units for commercial services such as marine, police and aircraft, at attractive prices. Amateurs: for best results use T9 crystals—fine for fono or high-speed CW. Fully guaranteed. 40, 80, and 160 meter bands \$1.60, spot frequencies \$2 postpaid. T9 ceramic holder \$1. C.O.D.'s accepted. Sold by: Pemberton Labs., Ft. Wayne, Ind.; Kerr's Radio Shop, El Paso, Texas; Frank Anzalone, 375 W. 46th, N. Y. C.; Henry Radio Shop, Butler, Mo.; Frank Mayer Co., Corpus Christi, Texas; Radio Atlas, Tampico, Mexico; and Eidson's, Temple, Texas.

RECEIVERS—New Howard 460's with crystal in original carton, \$59.95. New factory reconditioned SX-23's, \$79.50. Reconditioned types, all makes, lowest terms. Write for free list. Leo, W9GFQ.

WHEATSTONE tape automatic transmitters. Also new parts for Creed automatic transmitters. Probor Instruments, 99 Rogers Ave., Brooklyn, N. Y.

QST'S 1925—1934 fairly complete. Trade for SW3 coils, crystals or what have you? WICTC, Woodmont, Conn.

RACKS—\$8.25. SchAAF, 4741 Byron, Chicago.

QSL'S, SWL'S. 100—3 color—75¢. Lapco, 344 W. 39th, Indianapolis, Ind.

RECEIVERS—New and reconditioned. For better values send for list. Easiest terms. Square deal. Bill Harrison, W2AVA, 12 W. Broadway, N. Y. C.

FOR SALE. QST, 1924-38, 105 copies. Best offer. Clarence Anderson, Page, N. Dak.

COMET-Pro wanted. W7GQ.

SELL new hundred watt fono complete in steel cabinet. Also Sky Buddy. Write for details. Cash only. W9ULJ.

COLLINS 30FXC 250 watts fono CW, coils 160, 80, 40, 20, new tubes, perfect, photo, \$400. W2LVZ.

RADIO TECHNOLOGY



RCA Institutes offer an intensive course of high standard embracing all phases of Radio and Television, Practical training with modern equipment at New York and Chicago Schools. Also specialized courses in Aviation Communications, Radio Servicing and Commercial Operating.

Illustrated Catalog on request.

RCA INSTITUTES, INC. Dept. ST-41

A Radio Corporation of America Service

75 Varick St., New York 1154 Merchandise Mart, Chicago

LEARN CODE THE WAY YOU'LL USE IT—BY HEARING IT

Type S - \$17.50

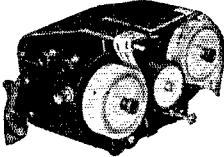

Sends from 4 to 60 words per minute. Higher speeds if desired. Complete with 10 rolls of double-perforated lesson tape of carefully selected and arranged matter for speediest results in learning code. Most compact and practical code teacher on market.

Type J - \$12.50

Sends 6 to 65 words per minute. Built-in tape perforator. Cut your own practice and message tapes. Complete with one roll of practice tape covering Alphabet, Numerals, Words to five letters; and 5 rolls of blank tape.

If your dealer can't supply you, write us

GARDINER-LEVERING CO. Haddon Heights, New Jersey, U. S. A.

SICKLES COILS

ALL TYPES OF RF AND IF WINDINGS

Manufactured by

F. W. SICKLES COMPANY

P. O. Box 920

Springfield, Mass.

SHURE "STRATOLINER" High Priced Features at Low Cost!

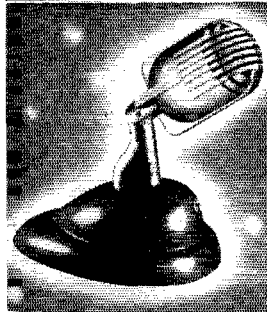

You get *all* these features in the Shure "Stratoliner" Crystal Microphone:

- ★ Special Speech Characteristic
- ★ High Output Level
- ★ Built-in R.F. filter protects against burnouts
- ★ Swivel Head
- ★ Striking Two-Tone Design
- ★ Built-in Cable Connector

Model 708SH—Crystal Microphone without desk mount. 7 ft. shielded cable. List Price..... **\$17.50**

Model 708S—Same, complete with Model S36A Iridescent Gray Desk Mount. 7 ft. shielded cable. List Price..... **\$20.50**

See Your Jobber— or write today for Catalog 153Q.

Shure Patents pending. Licensed under Patents of the Brush Development Company



TOPS in MULTI-TESTER VALUES

"PRECISION" Series 872

Automatic Push-Button AC-DC Multi-Range Tester

29 RANGES including **3000 volts AC & DC**

★ **LARGEST METER** (3 1/4" actual width) ever provided in such a compact instrument. ★ **RANGES** ● 6 DC and 5 AC voltage ranges to 3000 volts ● 5 DC current ranges to 1200MA ● 3 OHMMETER ranges to 5 MEGS; up to 500M ohms on internal battery ● 6 DB RANGES (-10 to +64 DB) ● 5 OUTPUT ranges to 3000 volts.

★ IT'S "PRECISION" BUILT! 1 1/2 wire wound bobbins and matched metalized multipliers.

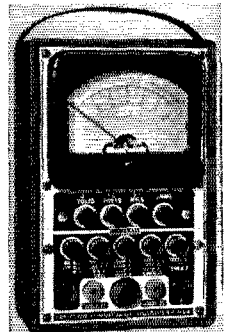

COMPARE THIS "PRECISION" VALUE at only **\$17.95 net**

This is only one of the more than 40 models comprising the complete "Precision" line of dynamic mutual conductance tube testers, combination set testers, multi-range testers, signal generators, etc. Prices start as low as \$14.95.

Ask for the PRECISION TEST EQUIPMENT 1941 CATALOG

PRECISION TEST EQUIPMENT
Standard of Accuracy SEE THEM AT YOUR JOBBER

PRECISION APPARATUS COMPANY

647 Kent Avenue

Brooklyn, New York

Export Div.: 458 Broadway, New York, U. S. A. — Cables: Morhanex

Your Nearby Dealer Is Your Best Friend

Your nearby dealer is entitled to your patronage. He is equipped with a knowledge and understanding of amateur radio. He is your logical source of advice and counsel on what equipment you should buy. His stock is complete. He can supply your needs without delay. His prices are fair and consistent with the high quality of the goods he carries. He is responsible to you and interested in you.

One of these dealers is probably in your city — Patronize him!

ATLANTA, GEORGIA

Radio Wire Television Inc.
265 Peachtree Street
"The World's Largest Radio Supply House"

JAMAICA, L. I., NEW YORK

Radio Wire Television Inc.
90-08 166th Street (Merrick Road)
"The World's Largest Radio Supply House"

BALTIMORE, MARYLAND

Radio Electric Service Co.
3 N. Howard St.
Everything for the Amateur

MONTREAL, CANADA

Canadian Electrical Supply Co., Ltd.
285 Craig Street West
Largest Distributors of Radio Parts & Testers in British Empire

BOSTON, MASS.

Radio Wire Television Inc.
110 Federal Street
"The World's Largest Radio Supply House"

NEWARK, N. J.

Radio Wire Television Inc.
24 Central Avenue
"The World's Largest Radio Supply House"

BRONX, NEW YORK

Radio Wire Television Inc.
542 East Fordham Road
"The World's Largest Radio Supply House"

NEW YORK, N. Y.

Radio Wire Television Inc.
100 Sixth Avenue
"The World's Largest Radio Supply House"

BUFFALO, NEW YORK

Radio Equipment Corp.
326 Elm Street
W8PMC and W8NEL — Ham, service and sound equipment

NEW YORK, N. Y.

Harrison Radio Company
12 West Broadway
Harrison Has It! Phone WOorth 2-6276 for information or rush service

BUFFALO, NEW YORK

Dymac Radio
1531 Main Street — Cor. Ferry
Owned and operated by Hams for Hams GA. 0252

PHILADELPHIA, PENNSYLVANIA

Eugene G. Wile
10 S. Tenth Street
Complete Stock of Quality Merchandise

HARTFORD, CONNECTICUT

Radio Inspection Service Company
227 Asylum Street
What do you want? We have it. Radio exclusively

PROVIDENCE, RHODE ISLAND

W. H. Edwards Company
85 Broadway
National, Hammarlund, Hallicrafter, Thordarson, Taylor, RCA

HARTFORD, CONNECTICUT

Hatry & Young, Inc.
203 Ann Street
Stores also in Bridgeport and New Haven

RICHMOND, VIRGINIA

The Arnold Company
Broad at Harrison St.
W3EQQ — "The Virginia Ham Headquarters" — W3FBL

HOUSTON, TEXAS

R. C. & L. F. Hall
1021 Caroline Street (C 0721)
"Specialists in Amateur Supplies"

SCRANTON, PENNSYLVANIA

Scranton Radio & Television Supply Co.
519-521 Mulberry Street
Complete Stock of Quality Amateur Supplies

YOU CAN BE SURE
WHEN YOU BUY FROM

QST

ADVERTISERS

“Advertising for *QST* is accepted only from firms who, in the publisher’s opinion, are of established integrity and whose products secure the approval of the technical staff of the American Radio Relay League.”

Quoted from QST’s advertising rate card.

Every conceivable need of a radio amateur can be supplied by the advertisers in QST. And you will know the product has the approval of the League’s technical staff

Index to Advertisers

	PAGE
Abbott Instrument, Inc.	86
Aerovox Corporation.	91
American Radio Institute.	99
Astatic Microphone Laboratory, Inc.	99
Barker & Williamson.	92
Bliley Electric Company.	68, 99
Candler System Company.	98
Capitol Radio Engineering Institute.	92
Cardwell Mfg. Corp., Allen D.	70
Centralab.	81
Clarostat Mfg. Company, Inc.	95
Collins Radio Company.	Cov. 2
Cornell-Dubilier Electric Corp.	80
Dodge’s Institute.	104
Echophone Radio Corp.	106
Eitel-McCullough, Inc.	73
Electric Specialty Mfg. Company.	90
Gardiner-Levering Company.	108
General Electric Company.	67
Hallcrafters Company.	1, 2
Hammarlund Mfg. Company, Inc.	69, 71
Harrison Radio Company.	101
Harvey Radio Company.	104
Henry Radio Shop.	102
Hipower Crystal Company.	104
Instructograph Company, The.	98
Janette Mfg. Company.	94
Jensen Radio Mfg. Company.	5
Johnson Company, E. F.	75
Kenyon Transformer Company, Inc.	96
Mallory & Company, Inc., P. R.	66
Massachusetts Radio School.	82
Meissner Mfg. Company, Inc.	72
Midland Radio & Television Schools, Inc.	102
Millen Mfg. Company, Inc., James.	111
National Company, Inc.	Cov. 3, 65, 76, 78
National Recording Supply Company.	99
Newark Electric Company.	83
Nilson Radio School.	82, 86
Ohmite Mfg. Company, Inc.	82
Onan & Sons, D. W.	90
Par-Metal Products Corp.	95
Phelps Dodge Copper Products Corp.	95
Pioneer Gen-B-Motor Corp.	94
Port Arthur College.	90
Precision Apparatus Corp.	108
RCA Institutes, Inc.	108
RCA Mfg. Company, Inc.	Cov. 4
Radio Control Headquarters.	98
Radio Parts Distributing Company.	105
Radio Shack, The.	93
Scientific Radio Service.	98
Shure Brothers.	108
Sickles Company, F. W.	108
Solar Mfg. Corporation.	99
Speer Carbon Company.	77
Sun Radio Company.	97
Taylor Tubes, Inc.	79
Teleplex Company.	99
Terminal Radio Corp.	105
Thordarson Electric Mfg. Company.	111
Triplet Elec. Instrument Company, Inc.	74
United Electronics Company.	91
United Transformer Corp.	112
Vibroplex Company, Inc., The.	91
Wholesale Radio Laboratories.	100
Yaxley.	64



FOR A.E.C. DUTY

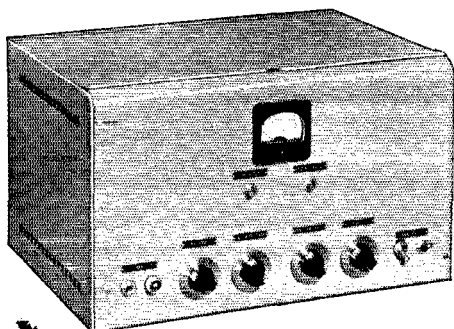

THORDARSON 12 WATT UNIVERSAL TRANSMITTER

The ideal portable unit for emergency services. Circuit changes from 115 volt A.C. to 6 volt D.C. are accomplished by merely inserting the proper power plug—no changes in wiring are necessary. Designed for phone and CW operation on all amateur bands from 160 to 10 meters. Nominal power input for phone operation is 12 watts when operated from a battery supply. Higher inputs may be obtained when operated on A.C. Doubling may be accomplished in either the crystal oscillator or final amplifier stage. An antenna matching network provides coupling to all type radiators. High gain audio system gives full modulation when using a crystal mike.

Kit including all parts, except accessories, available from your local Thordarson Distributor. Ask for kit T-22K13, list price \$72.50. Fully described in bulletin SD464 — FREE.

THORDARSON

ELEC. MFG. CO.

500 WEST HURON STREET
CHICAGO, ILLINOIS, U.S.A.

TRANSFORMER SPECIALISTS SINCE 1895

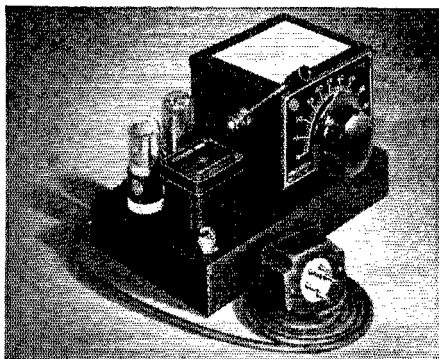

The RICE-VARIARM

• A New Type of Eco •

- A GOOD ECO AT A LOW PRICE
- LOW DRIFT — Less than 0.06% from cold start. Most drift in first 10 minutes.
- VIBRATION IMMUNE — Shock mounted oscillator section; sturdy construction.
- NO HAND CAPACITY
- CHIRPLESS KEYING — Constant load on power supply.
- GOOD BAND SPREAD — 100 dial divisions from 3500 to 3650 kc. "Variarm" vernier tuning.
- COMPLETE — Vibrationless power supply, three tubes, output coupling units.



The Rice-Variarm was described in detail in a comprehensive article by Henry E. Rice, Jr., in the January issue of *QST*. The Millen commercial models are:

No. 90700 has fundamental oscillator frequency range of from 3500 to 3650 Kc. "Convenient-to-change" taps on amplifier and link coils provide for output on 80 or 40.

No. 90701 is the same as No. 90700 except fundamental oscillator frequency range of from 1750 to 2000 Kc., providing for output on 160 or 80.

Either model complete with GE tubes, ready to use, only \$29.50 net at your dealer's

JAMES MILLEN
150 EXCHANGE ST.



MFG. CO. INC.
MALDEN, MASS.



Recognized Quality

The quality of UTC products is well illustrated by the leaders of American industry who have chosen them for use in their equipment.

The UTC research laboratories are doing continuous research and development on special units to fit specific customers' requirements.

May we assist you on your problem?

UNITED TRANSFORMER CORP.

Write: COMMUNICATIONS DIV. ★ 150 VARICK ST. ★ NEW YORK, N. Y.
 EXPORT DIVISION: 100 VARICK STREET NEW YORK, N. Y. CABLES: "ARLAB"

QST for April, 1941, EASTERN Edition

PRINTED IN U. S. A.
 RUMFORD PRESS
 CONCORD, N. H.

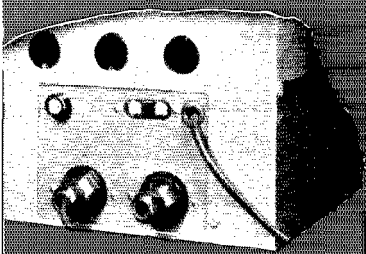

PORTABLE OR
AC OPERATION

TEN
COIL
RANGES

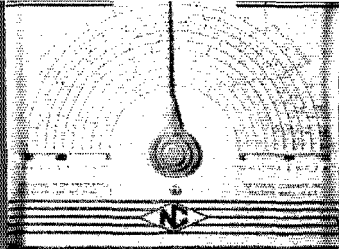

MOVABLE COIL
TUNING SYSTEM

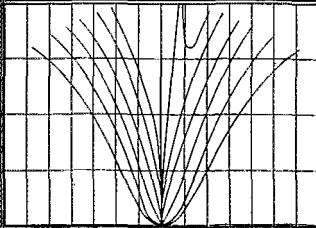

WIDE RANGE
CRYSTAL FILTER



The NC-200 has

TEN COIL RANGES

The NC-200 has ten calibrated coil ranges. Six of these ranges provide continuous coverage from 490 KC to 30 MC. The remaining four ranges cover the 10, 20, 40, and 80 meter bands, each band being spread over the major portion of the dial scale.

WIDE RANGE CRYSTAL FILTER

An improved wide range crystal filter is used in the NC-200. Selectivity is adjustable in six steps corresponding to bandwidths from 200 to 7600 cycles. The phasing circuit provides rejection ratios as high as 10000 to 1 when the interfering signal is only a few hundred cycles from the desired signal.

MOVABLE COIL TUNING SYSTEM

RF and oscillator coils, together with their associated padding condensers, are completely enclosed in separate pockets in a heavy cast aluminum shield. This shield moves bodily on a track, bringing the desired coils into operating position directly below the tubes and condenser, and taking the unused coils out of the way.

PORTABLE OR AC OPERATION

Typical of the refinement of detail in the NC-200 is the provision for operating standard AC models on batteries for emergency or portable use. All that is necessary is to plug in a battery cable in place of the dummy plug supplied with the receiver. This makes all necessary connections, and leaves the speaker and standby switch in operation. The B-supply filter is left in the circuit to assist in filtering vibrator and dynamotor B-power units.

— and low
price!

Best of all, the NC-200 sells for a very low price in spite of its many exclusive features. Complete with 10" speaker in a cabinet to match the receiver, with tubes and ready to run, the net price is only

\$147.50

At your dealer's!

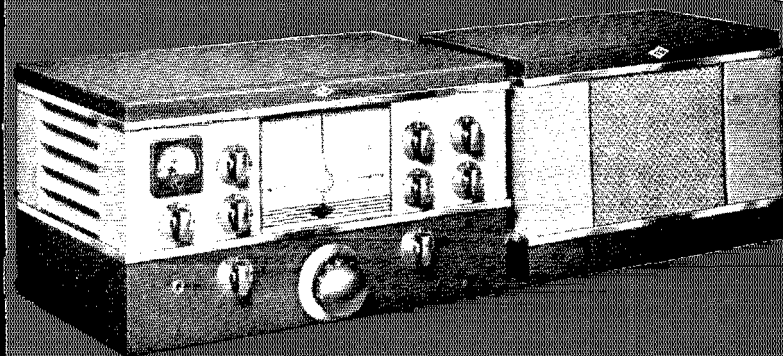

NATIONAL
COMPANY
MALDEN, MASS.

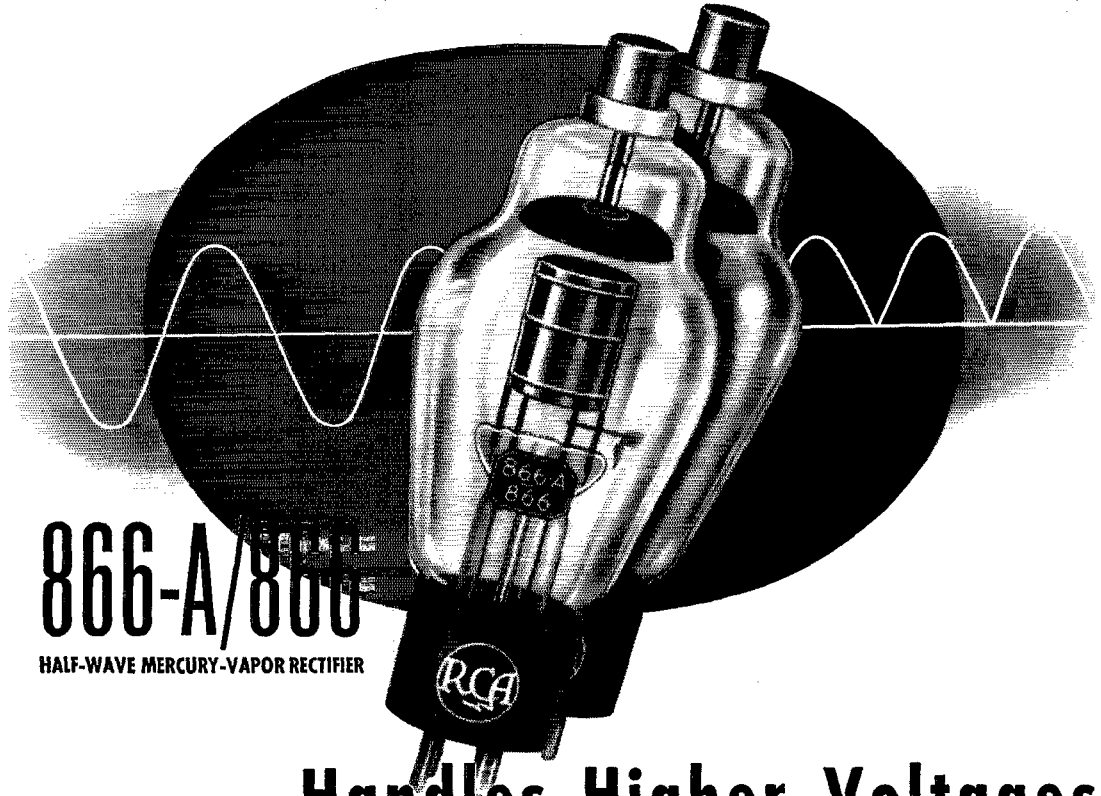

866-A/866

HALF-WAVE MERCURY-VAPOR RECTIFIER

Handles Higher Voltages ..Lasts Longer..Costs Less

\$1.50

Amateur Net

RATINGS

Filament Voltage (A-C)	2.5 volts
Filament Current	5.0 amperes
Peak Inverse Voltage	
Up to 150 cycles per second	10,000 max. volts
Up to 1,000 cycles per second	5,000 max. volts
Peak Plate Current	1.0 max. ampere
Average Plate Current	0.25 max. ampere
Tube Voltage Drop (approx.)	15 volts

In the few months the RCA 866-A/866 has been on the market, more than 9,000 of these tubes have been sold! There is no better evidence that here is another RCA winner—a sensational performer at an equally sensational low price.

This new tube supercedes the 866 and 866-A and may be used in equipment designed for these types. It combines the low starting voltage of the 866 with the ability of the 866-A to withstand a high peak inverse voltage—and, in addition, gives *plus* performance all along the line. It handles higher voltage at lower initial cost—and, equally important, it has amazingly long life achieved by virtue of a new filament. This filament is made of a new material having great emission capabilities. Edgewise-wound “ribbon” construction assures great mechanical strength, at the same time providing more emitting area for the same filament power.

Important among the tube's other features is the special filament shield designed so as to make practical a very low starting voltage. A ceramic cap insulator and a new dome-top bulb minimize danger from bulb cracks caused by corona discharge and resultant electrolysis.

THE RCA PHOTOTUBE BOOK IS HERE !

This comprehensive new booklet on Phototube theory, design and operation should prove both interesting and helpful. Free copy on request to Commercial Engineering Section, RCA Manufacturing Co., Inc., Harrison, N. J. Ask for the RCA Phototube Book.

Ask your RCA Amateur Equipment jobber for copies of the January and Feb.-March issues of RCA Ham Tips containing details on design of rectifier systems and filter systems applicable to the RCA 866-A/866.

