

QST

march, 1941

25 cents

35c in Canada

devoted entirely to

amateur radio

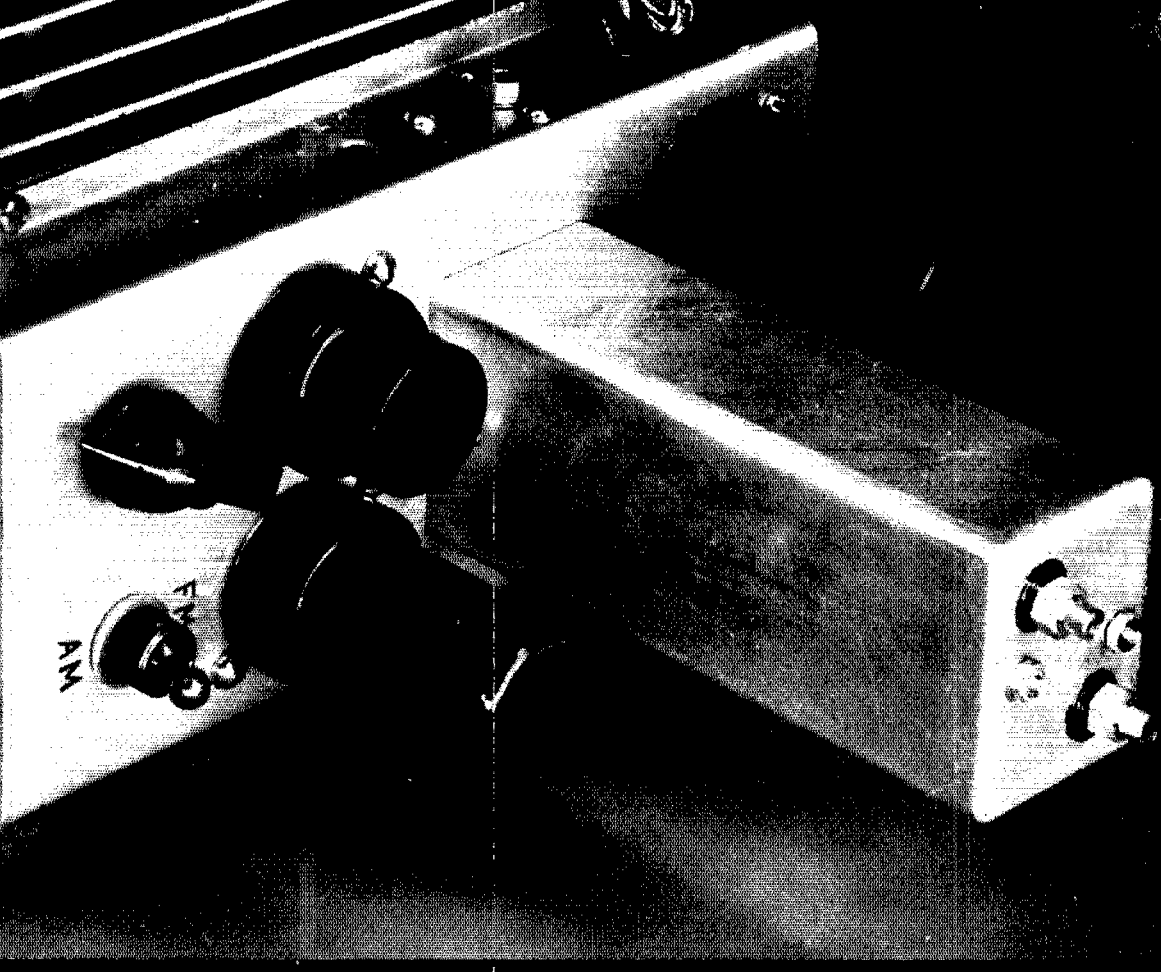

In This Issue - New Ideas in V. F. O. Design

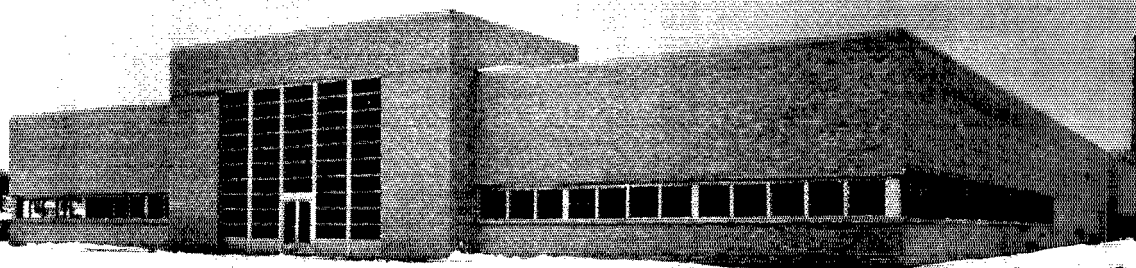

By the time you read this we will be installed and working in our new factory and office building. Used in conjunction with our other plant, we now have over 50,000 additional square feet of floor space in which to expand. Several novel features of the place may be of interest to you. Of the wide-span truss construction, floor space is practically unobstructed and there is plenty of flexibility to enlarge certain departments.

The building is lighted by one thousand fluorescent tubes with the single exception of a narrow band of double glazed sash across one end of the offices and the plate glass over the entrance to admit daylight to the lobby and corridors.

Year-round control of temperature and humidity is achieved by a modern air-conditioning system which effectively offsets the vicissitudes of the Iowa climate. Oil-fired boilers, 60 tons of machinery controlling 25 G.P.M. of 54° F well-water and 60,000 C.F.M. of air circulation accomplishes this result.

Extensive use of "Flexi-power" duct throughout the machine assembly and test departments provides the ultimate in power outlet convenience.

Ideal field test conditions are found on the twenty-six acre tract surrounding the building.

Collins is proud of its new home, the first completely "controlled conditions" plant west of the Mississippi and certainly one of the finest equipped radio factories.

The address remains the same, Cedar Rapids, Iowa; New York office is still 11 West 42 Street, New York, N. Y.



COLLINS RADIO COMPANY

NEW FM/AM

TUNES TO 165 MC



Covers FM Relay Frequencies*

NOW you can get an FM-AM communications receiver that even covers the FM relay frequencies! Model S-27B operates on 3 bands: 36 to 60 mc; 56 to 94 mc; 92 to 165 mc. Switch changing from FM to AM reception. RF amplifier 1st detector and oscillator are high frequency Acorn Tubes. High gain 1852 tubes in Iron Core IF stages. Push-pull high fidelity audio amplifier uses beam power tubes. Controls are: RF gain control; bandswitch; antenna trimmer; IF selectivity control;

volume control; beat oscillator pitch control; tone control with bass boost position; S-meter and Vernier Tuning Scale; AVC on-off switch; standby switch; phone jack; amplitude or frequency modulation operation switch. 15 tubes. 110 volt 50-60 cycle AC. (Available for 25 to 133 cycles, 110 to 250 volts. Price upon application.) Dimensions: 19" long, 9" high, 14" deep. Model S-27B. FM/AM Receiver complete with tubes. \$195.00.

*158-162 mc

the hallicrafters co.

CHICAGO, U. S. A.

USED BY 33 GOVERNMENTS • SOLD IN 89 COUNTRIES

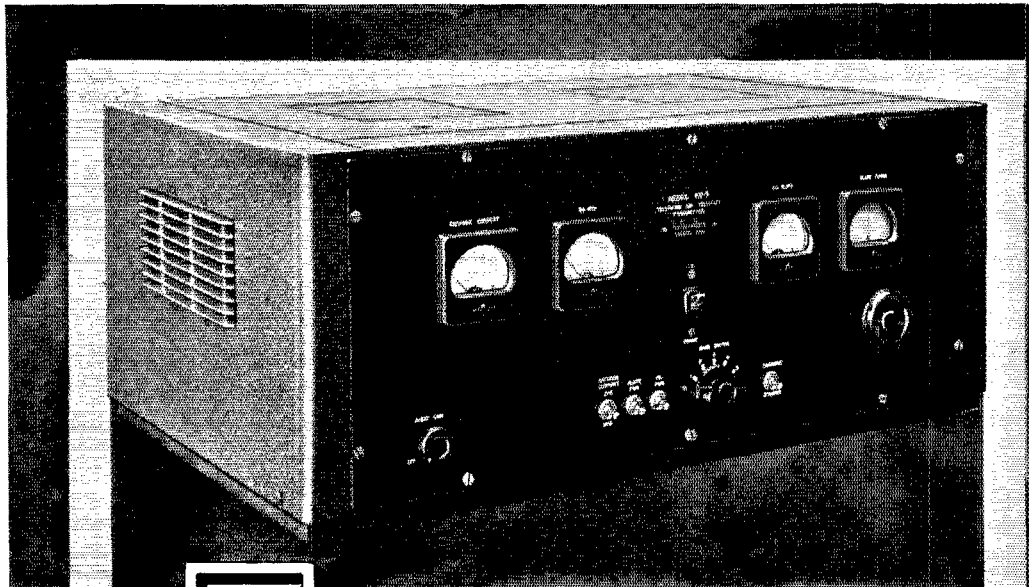

5 Frequency Phone & CW

**100 WATTS ON C.W.
75 WATTS ON PHONE**

MODEL HT-9—a 5-frequency phone and CW unit, rated at 100 watts on CW and 75 watts on phone (carrier output). Coils available for all bands from 1.7 to 30 mc. Exciter coils for 5 bands can be plugged in, pretuned, and left in the transmitter. 14 tubes. Operates on 110 volts, 50-60 cycles AC.

Model HT-6 (illustrated below) gives you exacting transmitter performance. Gives an output of 25 watts on most bands. Frequency range is 1.7 mc. to 60 mc. Coils for any 3 bands may be plugged in, pretuned and then control switched at will. 8 tubes. Operates on 110 volts, 50-60 cycles AC.

the hallicrafters co.

CHICAGO, U. S. A.

USED BY 33 GOVERNMENTS • SOLD IN 29 COUNTRIES

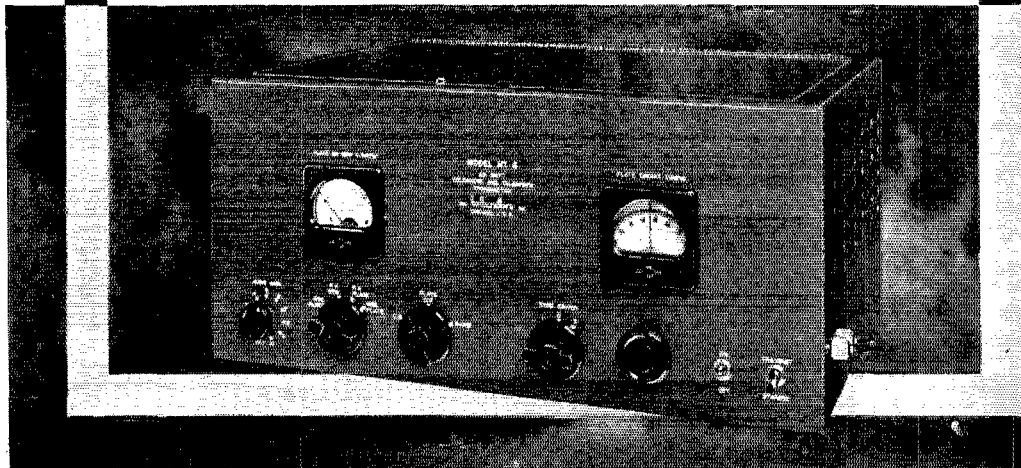

MARCH 1941

VOLUME XXV

NUMBER 3



STAFF

Editorial

KENNETH B. WARNER, W1EB
Editor and Business Manager

CLARK C. RODIMON, W1BZ
Managing Editor

GEORGE GRAMMER, W1DF
Technical Editor

DONALD H. MIX, W1TS
BYRON GOODMAN, W1JPE
Assistant Technical Editors

EDW. P. TILTON, W1EDQ
Contributing Editor, U.H.F.

VERNON CHAMBERS, W1JEQ
Technical Information Service

JAMES J. LAMB, W1AL
Research Engineer, A.R.R.L.

Advertising

F. CHEYNEY BEEKLEY, W1GS
Advertising Manager

CHARLES BRUNELLE
Asst. Advertising Manager

Circulation

DAVID H. HOUGHTON
Circulation Manager

RALPH T. BEAUDIN, W1BAW
Asst. Circulation Manager



OFFICES

38 La Salle Road
West Hartford, Connecticut

Subscription rate in United States and Possessions, \$2.50 per year, postpaid; all other countries, \$3.00 per year, postpaid. Single copies, 25 cents. Foreign remittances should be by international postal or express money order or bank draft negotiable in the U. S. and for an equivalent amount in U. S. funds.

Entered as second-class matter May 29, 1919, at the post office at Hartford, Connecticut, under the Act of March 3, 1879. Acceptance for mailing at special rate of postage provided for in section 1103, Act of October 3, 1917, authorized September 9, 1922. Additional entry at Concord, N. H., authorized February 21, 1929, under the Act of February 28, 1925. Additional second-class entries to cover sectional editions authorized March 20, 1935.

Copyright 1941 by the American Radio Relay League, Inc. Title registered at United States Patent Office.

QST

devoted entirely to

AMATEUR RADIO

PUBLISHED, MONTHLY, AS ITS OFFICIAL ORGAN, BY THE AMERICAN RADIO RELAY LEAGUE, INC., AT WEST HARTFORD, CONN., U. S. A.; OFFICIAL ORGAN OF THE INTERNATIONAL AMATEUR RADIO UNION



CONTENTS

Editorial	7
Calls Heard	8
Some Thoughts on Amateur F.M. Reception <i>George Grammer, W1DF</i>	9
A Gang-Tuned V.F.O. <i>Byron Goodman, W1JPE</i>	14
A Self-Supporting Antenna Tower <i>J. D. Boatright, W9JWC</i>	18
What the League Is Doing	20
Book Review	21
Silent Keys	21
Flea-Power A.C./D.C. 'Phone <i>Vernon Chambers, W1JEQ</i>	22
Amateurs Provide Red Cross With Communications on Inaugural Day <i>Oscar W. B. Reed, Jr., W3FPQ</i>	25
Band-Width and Readability in Frequency Modulation <i>Murray G. Crosby, W2CSY</i>	26
After the Code Certificate — What? <i>F. E. Handy, W1BDI</i>	29
Traffic Fun — A Defense Job for Every Amateur	30
Push-Pull 809's in a Low-Frequency Transmitter <i>Don H. Mix, W1TS</i>	32
Red Cross to Test Amateur Radio's Emergency Communications Facilities <i>F. E. Handy, W1BDI</i>	36
Short on Space, OM? <i>John Huntoon, W1LVQ</i>	38
Army-Amateur Radio System Activities	42
Local Boy Makes Noise <i>Chester Wesman, W9PFR</i>	43
Naval Communication Reserve Notes	48
Further Reports on Texas Ice Storm Emergency Work	49
On the Ultra Highs <i>E. P. Tilton, W1HDQ</i>	50
I.A.R.U. News	54
Hints and Kinks <i>Phone Monitor Using Infinite Impedance Detector — A Card Index for Your QSO's — Improved Voltage Regulation With VR Tubes — Simple Tone Modulation for U.H.F. Transmitters — Automatic Overload Protection 807 and Other Tubes</i>	55
In QST 25 Years Ago This Month	57
Correspondence From Members	58
Operating News	59
Hamads	107
QST's Index of Advertisers	110

Section Communications Managers of the A.R.R.L. Communications Department

All appointments in the League's field organization are made by the proper S.C.M., elected by members in each Section listed. Mail your S.C.M. (on the 16th of each month) a postal covering your radio activities for the previous 30 days. Tell him your DX, plans for experimenting, results in phone and traffic. He is interested, whether you are an A.R.R.L. member or get your *QST* at the newsstands; he wants a report from every active ham. If interested and qualified for O.R.S., O.P.S. or other appointments he can tell you about them, too.

ATLANTIC DIVISION				
Eastern Pennsylvania Maryland-Delaware-District of Columbia Southern New Jersey Western New York Western Pennsylvania	W3BES W3CIZ W3CCO W8PLA W8CKO	Jerry Mathis Hermann E. Hobbs Lester H. Allen Fred Clchester E. A. Krall	6042 Master St. 9701 Monroe St. Silver Spring P.O. 704 Quinlan Ave. 703 Broadway	Philadelphia Linden, Maryland Trenton Sonyea East McKeesport
CENTRAL DIVISION				
Illinois Indiana Kentucky Michigan Ohio Wisconsin	W9I1H W9AB W9ARU W8DPE W8AQ W9UIT	Mrs. Carrie Jones Harry B. Miller Darrell A. Downard Harold C. Bird E. H. Gibbs Aldrich C. Krones	2407 Central Ave. 729 E. Lowell Ave. 116 N. Longworth Ave. R.F.D. 2 405 Broad St. 2702 So. 46th St.	Alton Mishawaka Louisville Pontiac Wadsworth Milwaukee
DAKOTA DIVISION				
North Dakota South Dakota Northern Minnesota Southern Minnesota	W9WWL W9ADJ W9IGZ W9VNO	Anton C. Theodos E. C. Mohler Edwin L. Wicklund Millard L. Bender	Box 444 Box 149 R.F.D. 3 608 N. Huron Ave.	Williston Rapid City Kensington Spring Valley
DELTA DIVISION				
Arkansas Louisiana Mississippi Tennessee	W5ABI W5DWW W5EWD W4DDJ	H. E. Velte W. J. Wilkinson, Jr. Jewell W. Cole M. G. Hooper	4415 West 12th St. Room 313, Jefferson Hotel % City of McComb Water Dept. 4908 Georgia Ave.	Little Rock Shreveport McComb City Nashville
HUDSON DIVISION				
Eastern New York N. Y. C. & Long Island Northern New Jersey	W2LU W2AZV W2LMN	Robert E. Haight E. L. Baunach Edward Gursky, Jr.	511 South Holmes St. 102 Central Ave. 367 Van Winkle Ave.	Scotia Massapequa, L. I. Hawthorne
MIDWEST DIVISION				
Iowa Kansas Missouri Nebraska*	W9PIR W9AWP W9OUD W9WKP	L. B. Vennard A. B. Unruh Miss Lathia Allendorf Garold Bennett	1113 So. 9th St. 1617 S. Seneca St. 1015 W. 3rd St. 704 12th St.	Burlington Wichita Joplin Auburn
NEW ENGLAND DIVISION				
Connecticut Maine Eastern Massachusetts Western Massachusetts New Hampshire Rhode Island Vermont	W1CTI W1IIE W1ALP W1JAH W1EFT W1HRC W1KJG	Frederick Ellis, Jr. H. W. Castner Frank L. Baker, Jr. William J. Barrett Miss Dorothy W. Evans Clayton C. Gordon Clifton G. Parker	19 Merrill Rd. 147 Church 21 Colby Road 239 Columbia St. 163 South Main St. 70 Columbia Ave., Gaspee Box 537	Norwalk Damariscotta North Quincy Adams Concord Piscataway Warwick Morrisville
NORTHWESTERN DIVISION				
Alaska Idaho Montana Oregon Washington	K7GNN W7CRL W7CPY W7GNI W7FCG	James G. Sherry Clifford A. Jessup Rex Roberts Carl Austin W. Beale	Post Office Dept. Box 1088 1137 Federal R. 4, School Ave.	Chichagof Moscow Glenlive Bend Walla Walla
PACIFIC DIVISION				
Hawaii Nevada Santa Clara Valley East Bay San Francisco Sacramento Valley Philippines San Joaquin Valley	K6ETF W6BIC W6IUZ W6TI W6CIS W6MDI KA1GR W6KUT	Francis T. Blatt Edward W. Heim Earl F. Sanderson Horace R. Greer Kenneth E. Hughes Vincent W. Eldhusen George L. Rickard Edwin A. Address	837 16th Ave. 509 Claremont St. 101 Claremont Ave. 414 Fairmount Ave. 209 Lincoln Way 113 South Quincy St. Box 849 2921 North Van Ness Blvd.	Honolulu Reno San Jose Oakland San Francisco McClees Mania Fresno
ROANOKE DIVISION				
North Carolina South Carolina Virginia West Virginia	W4CYE W4BOE/ANG W3GWO W8OXO	W. J. Wortman Fed Ferguson Frank S. Anderson, Jr. W. D. Tabler	P. O. Box 566 1213 College St. 4703 New Kent Ave. 1004 So. Davis Ave.	Morganton Columbia Richmond Elkins
ROCKY MOUNTAIN DIVISION				
Colorado Utah-Wyoming	W9EHC W7GZG	Carl C. Drumeller Henry L. Schroeder	274 Colorado Ave., Apt. 3 P. O. Box 731	Pueblo Laramie, Wyoming
SOUTHEASTERN DIVISION				
Alabama Eastern Florida Western Florida Georgia West Indies (Cuba-Puerto Rico- Virgin Islands)	W4DGS W4PEL W4AXP W4AOB CM2OP	James F. Thompson Carl G. Schaal Oscar Cederstrom William U. Hanks Mario de la Torre	12 Clanton Ave. Waucoma Apts. Lakeview Hotel Second St. & Bruce Ave. 4 Hunter St., S.E. Escobar 110 (Aitoe)	Montgomery Clermont De Funiak Springs Atlanta Habana, Cuba
SOUTHWESTERN DIVISION				
Los Angeles Arizona* San Diego	W6MOM W6KOL W6BKZ	Ralph S. Chick John K. Oliver Louis A. Cartwright	1038 Milwaukee Ave. Box 642 370 Nautilus	Los Angeles Nogales La Jolla
WEST GULF DIVISION				
Northern Texas* Oklahoma Southern Texas New Mexico	W5EAV W5GFT W5MNI W5ENI	R. E. Hughes Russell W. Battern Horace E. Biddy Dr. Hilton W. Gillett	1410 Ave. E, N.W. Box 290 1746 Schley Ave.	Childress Enid San Antonio Lovington
MARITIME DIVISION				
Maritime	VE1DQ	A. M. Crowell	69 Dublin St.	Halifax, N. S.
ONTARIO DIVISION				
Ontario	VE3EF	Flying Officer Donald R. Gunn	% Canadian Bank of Commerce	New Toronto, Ont.
QUEBEC DIVISION				
Quebec	VE2CO	Lindsay G. Morris	Apt. 6, 4510 Girouard Ave., N.D.G.	Montreal, P. Q.
VANALTA DIVISION				
Alberta British Columbia	VE4GE VE5DD	C. S. Jamieson C. O. L. Sawyer	581 W. Riverside Drive 2634 West 31st Ave.	Drumheller, Alta. Vancouver
PRAIRIE DIVISION				
Manitoba Saskatchewan	VE4AAW VE4SY	A. W. Morley Arthur Chesworth	747 McMillan Ave. 1071 4th Ave., N. W.	Winnipeg Moosajaw

* Officials appointed to act until the membership of the Section choose permanent S.C.M.s by nomination and election.



Complete
NET
only
\$10⁵⁶



PORTABLE

Always THE RIGHT
REPLACEMENT CONTROL
WITH THIS Centralab
PORTABLE

Adashaft Kit

You name the set and it's a hundred to one that you can do a replacement job right out of our PORTABLE Adashaft Kit . . . mighty good business sense . . . owning one of these kits . . . The strong steel case is 12" x 5" x 1 1/2" . . . you can even carry it in your coat pocket (note Old Man Centralab above) and you pay for the controls only . . . we give you the case "FREE".

Any shaft and control can be combined in a moment without special tools. Yet the RESULT is just as STRONG and RELIABLE as a ONE PIECE SHAFT.

Then replace the controls from your jobbers stock as they are used. Buy that ADASHAFT KIT today . . . you need it.

CENTRALAB Div. of Globe-Union Inc., Milwaukee
Cable Address—Centralab

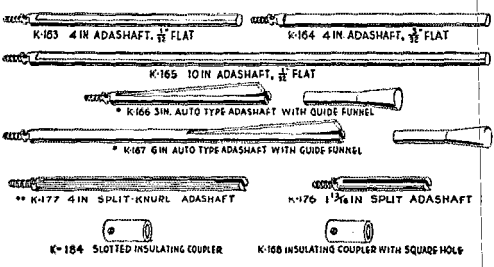
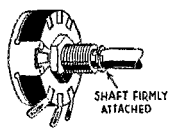
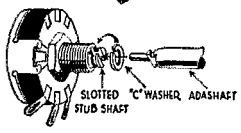

INCLUDED IN THIS ADASHAFT KIT
ARE THE FOLLOWING CONTROLS:

1 EACH OF	OHMS	CURVE
10,000	ohms	3
25,000	ohms	3
50,000	ohms	6
250,000	ohms	6
500,000	ohms	6
1 MEG	ohms	6
2 MEG	ohms	6
3 MEG	ohms	6
250,000	ohms	tapped
500,000	ohms	tapped
1 MEG	ohms	tapped
2 MEG	ohms	tapped

SHAFTS

3	K163
2	K164
1	K165
1	K166
1	K167
1	K176
3	K177

COUPLERS

1	K184
1	K168

SWITCH COVERS

5	K155 SPST
1	K157 DPST

Centralab

THE AMERICAN RADIO RELAY LEAGUE

Directors

President
GEORGE W. BAILEY, W1KH
74 Webster Road, Weston, Mass.

Vice-President
CHARLES E. BLALACK, W6GG
1700 Foothill Blvd., Altadena, Calif.

Canadian General Manager
ALEX REID, VE2BE
169 Logan Ave., St. Lambert, P. Q.

Atlantic Division
WALTER BRADLEY MARTIN, W3QV
Box 612, Roslyn, Pa.

Central Division
GOODWIN L. DOSLAND, W9TSN
10 No. Clark St., Chicago

Dakota Division
FRED W. YOUNG, W9MZN
1333 North 12th Street, Fargo, North Dakota

Delta Division
E. RAY ARLEDGE, W5SI
P.O. Box 286, Pine Bluff, Ark.

Hudson Division
ROBERT AKERIDGE KIRKMAN, W2DSY
920 Eighth Ave., Brooklyn

Midwest Division
FLOYD E. NORWINE, JR., W9EFC
7405 Hlawatha Ave., Richmond Heights, Mo.

New England Division
PERCY C. NOBLE, W1BVR
37 Broad St., Westfield, Mass.

Northeastern Division
KARL W. WEINGARTEN, W7BG
3219 N. 24th St., Tacoma, Wash.

Pacific Division
J. L. McCARGAR, W6EY
66 Hamilton Pl., Oakland, Calif.

Roanoke Division
H. L. CAVENESS, W4DW
2607 Vanderbilt Ave., Raleigh, N. C.

Rocky Mountain Division
C. RAYMOND STEDMAN, W0CAA
925 So. Gaylord St., Denver

Southeastern Division
WILLIAM C. SHELTON, W4ASR
Box 652, Daytona Beach, Fla.

Southwestern Division
JOHN E. BICKEL, W6BKY
301 E. California St., Whittier, Calif.

West Gulf Division
WILLIAM A. GREEN, W5BKH
801 Ross St., Abilene, Texas

THE AMERICAN RADIO RELAY LEAGUE, INC., is a non-commercial association of radio amateurs, bonded for the promotion of interest in amateur radio communication and experimentation, for the relaying of messages by radio, for the advancement of the radio art and of the public welfare, for the representation of the radio amateur in legislative matters, and for the maintenance of fraternalism and a high standard of conduct.

It is an incorporated association without capital stock, chartered under the laws of Connecticut. Its affairs are governed by a Board of Directors, elected every two years by the general membership. The officers are elected or appointed by the Directors. The League is non-commercial and no one commercially engaged in the manufacture, sale or rental of radio apparatus is eligible to membership on its board.

"Of, by and for the amateur," it numbers within its ranks practically every worth-while amateur in the nation and has a history of glorious achievement as the standard-bearer in amateur affairs.

Inquiries regarding membership are solicited. A bona fide interest in amateur radio is the only essential qualification; ownership of a transmitting station and knowledge of the code are not prerequisite. Correspondence should be addressed to the Secretary.



Past Presidents

HIRAM PERCY MAXIM, 1914-1936
EUGENE C. WOODRUFF, 1936-1940

Officers

- President*..... GEORGE W. BAILEY, W1KH
Weston, Mass.
- Vice-President*..... CHARLES E. BLALACK, W6GG
Altadena, Calif.
- Secretary*..... KENNETH B. WARNER, W1EH
West Hartford, Connecticut
- Treasurer*..... ARTHUR A. HERBERT, W1ES
West Hartford, Connecticut
- Communications Mgr.*..... F. EDWARD HANDY, W1BDI
West Hartford, Connecticut

General Counsel..... PAUL M. SEGAL
1026 Woodward Building, Washington, D. C.

Address all general correspondence to the administrative headquarters at West Hartford, Connecticut.

"IT SEEMS TO US—"

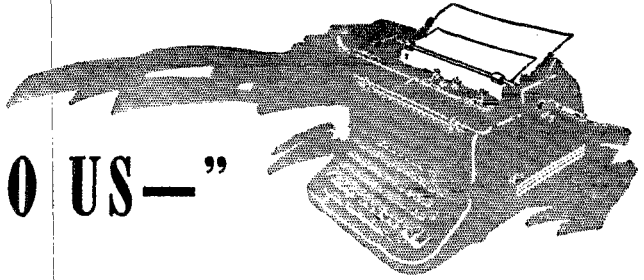

A CALL TO 'PHONE MEN

WE'VE all had a lot of fun in amateur radio together. We've been on spark and a.c.c.w. and i.c.w. and finally c.w. A lot of us have gone on to 'phone, and some of us work 'phone exclusively. In the process, we've let a lot of loose ends come into existence and it seems to us that we ought to sit down now and talk things over. The whole nation is gearing itself up for a job and we radio amateurs want to be able to help. While superficially it won't be so free and easy as it has in the past, it's still going to be lots of fun. There will be places in this work for 'phone men and their stations, and a leading 'phone amateur is one of the League's regional advisers in the defense planning. But in the meanwhile we ought to start picking up those loose ends and getting ready.

What we're going to say doesn't apply to all 'phone men. We know many notable exceptions to our complaints. We have in mind, too, the many splendid performances of which 'phone has delivered itself in emergencies, and we recollect that the 'phone men beat the c.w. men in one of the 'Phone-vs.-C.W. transcon relays. But, speaking in general terms, we are impressed by the fact that there is practically no evidence that the radiotelephone amateur is contributing to national preparedness in the way the c.w. man is. We'd like to see something done about this condition.

We believe the patriotism of 'phone amateurs to be as good as that of telegraph men; of course we do. We believe their technical knowledge, on the whole, to be much better. But whereas much of the c.w. world has buckled down to improving operator proficiency in the knowledge of possible defense needs ahead, the average all-'phone man is not employing his station in a way that makes increases in his proficiency, except perhaps in technical matters, and he continues to neglect his code.

The first requirement in building a 'phone transmitter is a good c.w. end; the modulating equipment is an appendix. In the same fashion, the basic requirement for the amateur license is code knowledge. Just as the 'phone station represents equipment that must be capable of doing a good transmitting job on both c.w. and

'phone, so does the 'phone operator assume a double-barreled responsibility to master operating technique in both fields. It is not correct to say that there are two separate kinds of amateur radio, c.w. and 'phone. There is one basic kind, common to all, which is telegraphy; and some of us build a cupola on that structure, which is telephony. That is borne out by the licensing arrangement, which provides no exclusive frequencies for 'phone but allots all the c.w. frequencies to every amateur and requires every applicant to know c.w. Everyone concerned has the right to expect that every amateur, even though he elects to operate almost exclusively on 'phone, possesses at least that minimum code ability which was his entrance requirement to the game.

But you and we know that that is not the fact in practice. The bulk of 'phone operation is done by fellows who are also competent c.w. operators, dividing their time between the two branches of the art. However, the *habitual* 'phone operator is all too likely not to be able to read even his own call unless it is slowed down to seven or eight words a minute — he has forgotten his code by neglecting it. This situation should not continue at such a time as this. The 'phone man must also be a qualified c.w. operator. We see no reason why he should abandon his microphone; we do not even suggest it. But here and now we do remind habitual voice ops of their basic responsibility, and we point out to them that they must prepare to pull their share of the c.w. load. We call upon them to spend some of their time on c.w.; to get themselves back quickly to minimum expectations; and to go beyond that point and build up their telegraphing proficiency to something useful, precisely the same as the men are doing who have no speech ends.

And that is only half the story. 'Phone men should also so shape their *voice* operating that it constitutes training for possible vital tasks that lie ahead. The lone-wolf individualism of 'phone has worked against progress in this field in the past; we must find a solution somewhere now. True, there are some 'phone nets, particularly for emergencies, but on the average they drill only once a week and have no particular

procedure. There are also a few "social" nets of competent old-timers who have grown up through every branch of ham radio and who would unquestionably give a good account of themselves in any emergency. There are some good A.A.R.S. 'phone nets. But, by and large, voice operating is just aimless gassing and it does a sorry job when it comes to handling communications for other parties because it has had no training in that respect. Most 'phone men for years have shunned every effort of the League to interest them in practicing procedure, in developing organized operation in nets or trunklines, in acquiring the skill necessary to handle third-party communications with accuracy and despatch. They have said it sounded too much like work, not enough like fun. It is a pity, because voice operation is inherently faster and more flexible than c.w., and great things *could* be done with it. We point out, for example, that the League has never been able to round up enough *organized* voice operation to support a single 'phone trunkline. 'Phone men have been unwilling to engage in teamwork; 'phone's flexibility and individuality have been simultaneously its blessing and its weakness. Perhaps now, with a national emergency staring us in the face, 'phone men will be willing to devote some of their activity to lines that will improve 'phone performance ability. Is it too much to hope? Are there 'phone amateurs who are now interested in organized operation that will show that voice can do a defense job too? If they will step forward in sufficient numbers, the League will provide organization and direction. A post card to the Communications Manager will show your willingness and will bring you data. Meanwhile the January issue of the Communications Department's RM/PAM bul-

letin is specially devoted to network organizing and maintenance, and your local S.C.M. or 'Phone Activities Manager can supply helpful information. In fact, they're calling for help right now.

So the second part of the story is that 'phone operators, to earn their salt, must learn to do a useful job for the nation, the same as c.w. They should learn now to operate in nets, how to handle third-party traffic, how to copy a voice message fast and accurately, how to read it so the other fellow can get it, how to get fills without an instant's delay, how to keep their records, how to employ universal phonetics almost unconsciously. In other words, their job is to develop and master a technique for moving traffic by voice, so that a message from A to B may get to B in jig time and read the way it did when it left A. If this sounds like a dreary job, our modulation isn't deep enough: it can be grand fun and sport, believe us. And we're lucky enough today to have something to do that is useful and still is fun. That's the kind of work the League wants to organize.

If we have sounded harsh in some of the foregoing it is because we perceive a certain urgency. If we are critical it is only because we know that 'phone has the potentialities of doing a splendid job for national defense. As a matter of fact, voice men have it within their reach to make of themselves the most valuable class of amateurs in the country: men basically competent in radiotelegraphy, possessing also a special technique for handling by voice the jobs that are best adapted to that mode, and who, by reason of their double activity, are the best-qualified technically. We appeal to them to get going on that job!

K. B. W.

★ CALLS HEARD ★

ZD2H/G2QN, Art. Tomlinson, Posts and Telegraphs, Kano, N. Nigeria

500 miles S. E. Timbuktu

Heard between Nov. 1-18, 1940

3.5-Mc. band

W1AW LTB MEK RY
W3DBY HXI
W3EFH
W4BPD
W8ALP LEC UBT YA
W9YWQ

4-Mc. 'phone

W3EWW FQP

7-Mc. band

W1AW BBN KYS LMR LWI MKR MLJ MNK QX QZ
W2AEY AGW EGO IRQ/2 LTP LWP LZR MLO MLW
NGP

W3ACV BES BXI CQU CSN DAJ GHK GOW HEO IEN
ITW IUD QT
W4BTB FFN FIJ GXB IO
W5AFV CXQ HRA IRL ISM IZC
W6BAM DPW MYJ QAP QOJ TAW
W8BUF GCA GYL JYJ LGQ NDC NDS NHV OPH
RIW/8 RVI SBW SCJ SYN TDN
W9AGB AGZ AWP BCS BQE CQS KKT KPC MFJ NII
QVA RSR UAZ ZTU ZWR
K5AY

HB9CZ, Hans Baeni, Engelbergstrasse 24, Olten, Switzerland

28-Mc. 'phones heard between Oct. 13-17, 1940

W1AAT CCZ DBE DEY EZS FMQ HQR KGR KYS
KZU LEU LMB LPA LTG MCW MSU NBR ON
W2ADH AJF BLC BMT FJQ JFR LIR LPW LXY MHA
MYR NBY ST
W3AWL CFS GRO GSX IJU
W4BB BNN ECV EZK FUM PU
W5CV DMQ HLQ HOC IRU JSU
W6GAQ LWN OHC
W8FCO GWR ISR RBN RK ROB UKA
W9FGR HAJ JBH TWU ULJ

Some Thoughts on Amateur F.M. Reception

An Inexpensive Adapter for Use with Communications Superhets

BY GEORGE GRAMMER,* W1DF

Signposts seem to point to narrow-band frequency-modulation as the eventual ham system. Dictated primarily by the necessity for adequate receiver selectivity in congested districts, it also opens the way to low-cost reception through utilization of existing a.m. superhet receivers. The clinching argument is the fact that weak-signal reception is better with narrow-band f.m. than with either wide-band f.m. or conventional amplitude modulation.

AMATEUR use of frequency modulation has been disappointingly small, in view of the potentialities of the system for improving communication. Since frequency-modulating a transmitter by means of the reactance modulator is simple, it hardly seems that transmitting difficulties could be the reason. Indeed, the transmitting side is rather attractive because audio equipment reduces to vanishing dimensions. We are left, therefore, to choose between two possibilities — either hams are shy of learning new techniques, or else f.m. reception is too involved or too expensive for the ordinary amateur.

As a matter of pride we refuse to accept the former explanation, preferring to put it squarely up to the receiver. It can't be denied that f.m. reception has looked rather formidable, especially to the ham who thinks of u.h.f. reception in terms of the superregenerator. Nor do the prospects of simplifying it look too promising at the moment, since simplicity and the requirements for good f.m. reception do not go hand in hand. Aside from the intricacies of limiters and discriminators, fundamentally this is because f.m. reception requires lots of r.f. (and i.f.) gain. In an f.m. receiver sufficient amplification should be provided to secure amplitude limiting so that noise impulses will be incapable of causing interference except by frequency modulation.¹ For weak-signal reception, the amplification should be great enough to give limiting on any signal capable of pushing itself above the level

of noise inherent to the first stage of the receiver. Since practical limiter circuits do not level off with inputs of less than three or four volts while the set noise is of the order of a microvolt or so, a gain of several million is a primary requisite. It isn't done with one or two tubes — yet.

In amateur work the problem of interference between stations is likely to be serious if the receiver is designed for wide-band reception. An amplitude-modulated signal falling within the pass-band of an f.m. receiver will behave much like noise covering the same frequency spectrum; that is, it will produce an audio output the magnitude of which depends upon how far the carrier is from the center of the pass band. With the carrier centered the audio output will be negligible, but when the carrier is off at either edge of the band the signal will ride through only too well. The effective selectivity of the receiver, then, is just about what one would expect from any set having a broad i.f. characteristic.

What Kind of Receiver?

A superhet receiver is the only type which will provide both high gain and high selectivity. The ordinary super may not even be good

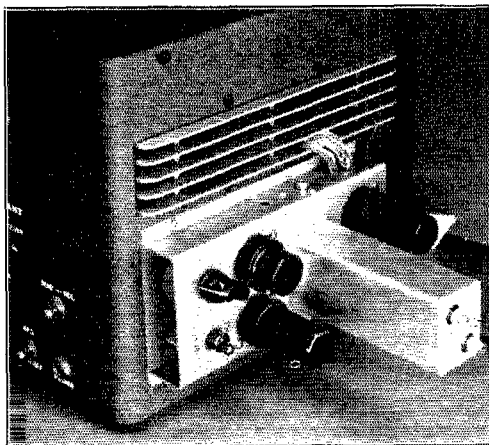

An adapter to convert a communications receiver to narrow-band f.m. reception, installed on the side of the receiver cabinet. No changes are needed in the receiver except to insert an adapter plug in place of the second-detector tube, and to tap a few milliamperes from the "B" supply.

* Technical Editor, *QST*.

¹ The process by which the transition from amplitude to frequency modulation takes place is explained in the article by D. C. Hierath, "Noise Reflection in Frequency Modulation," *QST*, December, 1940.

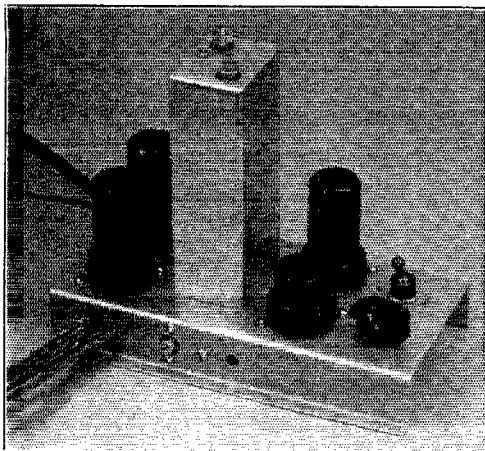

A close-up view of the adapter unit. The i.f. voltage comes in through the larger shielded lead at the left. The tube in the left foreground is the 6SQ7 diode-triode removed from the receiver. Behind it is the 6SJ7 first limiter; the second limiter, also a 6SJ7, is to the right of the transformer. The 6H6 is the discriminator. The adjustment shaft of the trimmer C_1 projects through the wall of the chassis; C_2 is reached through the small hole to the right of C_1 .

enough. It has recently been pointed out by J. A. Worcester² that for broadcast reception the requisite gain cannot be obtained with stability in the normal superhet stage line-up, so it is necessary to go to a double super to secure sufficient amplification of weak signals. This, however, is on the basis of a 4.3-Mc. intermediate frequency and includes some safety factors necessary in the production of manufactured receivers. For amateur reception the double super may not be a strict necessity, but its other well-known advantages for u.h.f. work make it desirable. Nevertheless, by one system or the other the necessary gain can be secured, provided enough amplifier stages are used.

The selectivity question presents a different problem. Here we have to decide how much unselectivity can be tolerated. If, for instance, we decide that a deviation ratio of five is desirable and we set our upper audio-frequency limit at 4000 cycles the deviation will be 20 kc., requiring a pass-band of 40 kc. in the receiver. If we could get an ideal selectivity curve with a 40-kc. flat-top and infinitely steep sides (which we can't), we should still be faced with the fact that any stations within 20 kc. on either side of the desired carrier will cause interference. In practice the conditions are much worse because the i.f. will not cut off sharply at the edges, and strong signals well out of the nominal pass-band will still interfere. Com-

²J. A. Worcester, "Recent Improvements in F.M. Receiver Design," paper presented at the IRE-RMA Rochester Fall Meeting, November, 1940.

pared to the selectivity we're used to in the ordinary communications superhet, this is pretty poor performance and not at all satisfactory if there are many stations operating.

But suppose the selectivity we want is the kind we're used to in our ordinary supers. Necessarily this eliminates the possibility of using wide-band frequency modulation. The i.f. of a regular superhet is barely wide enough to accommodate amplitude modulation sidebands, and certainly could not be expected to handle a large deviation ratio based on any reasonable upper audio-frequency limit. Fig. 1 shows a typical receiver selectivity curve, with A and B designating points 4000 cycles off resonance on either side. On the low side the response is down to 6 per cent of its value at resonance and on the high side down to 10 per cent. Without some means of flattening off the top of the curve, we could not possibly handle even a deviation ratio of 1 for an upper frequency limit of 4000 cycles.

The question immediately arises as to whether any of the benefits of f.m. could be secured with the band confined within narrow

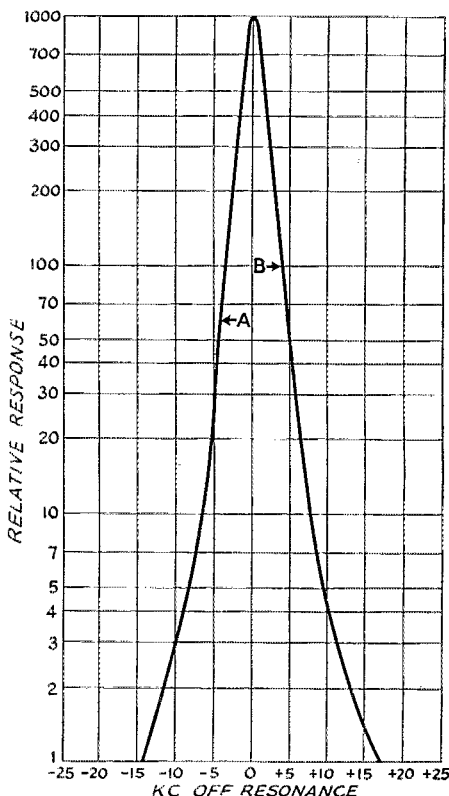

Fig. 1—Typical superhet selectivity characteristic, i.f. 465 kc.

limits. With impulse noise, or with other types of noise when the carrier is stronger than the noise, the signal-to-noise ratio becomes poorer as the deviation ratio is made smaller.^{3, 4} The existence of a cross-over point or threshold where this general relation is no longer true as the carrier strength is decreased has been pointed out⁴ and it is this weak-signal region which is particularly interesting to amateurs. An answer to the question has been provided by the recent work by Murray Crosby reported elsewhere in this issue⁵ and fortunately it is favorable to narrow-band f.m. The important thing is that on the basis of noise generated in the receiver, which is the ultimate limit to weak-signal reception, it is possible to read a weaker signal on f.m. than on a.m. when the f.m. deviation ratio is 1. The reduction of impulse-type noise such as most "man-made static"

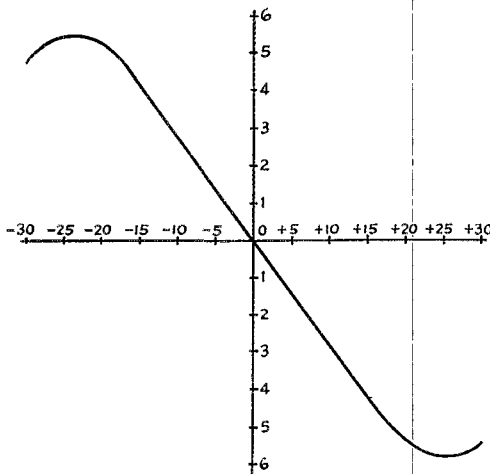

Fig. 2—Operating characteristic of discriminator. Abscissas, deviation in kc. from center frequency; ordinates, relative output voltage. Constant-amplitude r.f. input to discriminator.

is not as good with narrow-band as with wide-band f.m. but, as Crosby points out, should still equal the best type of amplitude noise-silencer.⁶ The band-width required by this type of frequency modulation is of the

³ E. H. Armstrong, "A New Method of Reducing Disturbances in Radio Signalling by a System of Frequency Modulation," Proc. I.R.E., May, 1936.

⁴ M. C. Crosby, "Frequency Modulation Noise Characteristics," Proc. I.R.E., April, 1937.

⁵ M. C. Crosby, "Band-Width and Readability in Frequency Modulation," QST, March, 1941.

⁶ Except for the difference in time duration of a noise pulse after it has travelled through a selective i.f. amplifier to reach the limiter-discriminator, where the silencing action takes place, as compared to its duration at the first i.f. stage, where the Lamb silencer usually is installed.

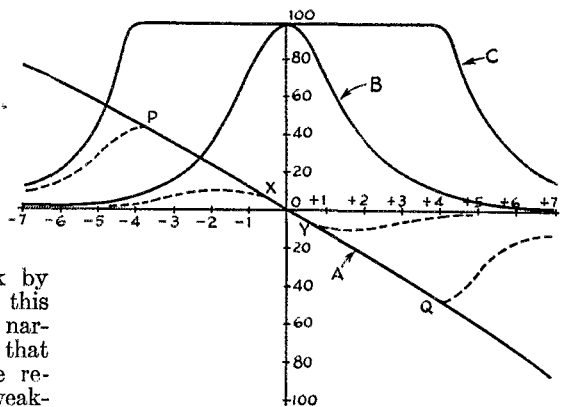

Fig. 3—How the effective discriminator characteristic is changed by selectivity of the circuits preceding it, in the absence of amplitude limiting. Conditions with full limiting also are shown. Horizontal axis, deviation in kc. from center frequency; vertical axis, for curves B (no limiting) and C (full limiting) per cent response compared to center frequency; for curve A (discriminator characteristic) response in arbitrary units.

same order as for amplitude modulation; the same receiver may be used for both, with no sacrifice of performance in either system. An additional advantage is that the f.m. transmitter takes up negligibly more room in the spectrum than a normal a.m. transmitter.

Narrow-Band Reception

On this basis we can use a receiver design which, up to the limiter, is quite conventional—comparable, in fact, to a standard super plus a u.h.f. converter, a combination which is in use at a great many u.h.f. stations. That being the case, why not simply build a gadget which will convert such a combination to f.m. reception? It ought to be relatively simple and cheap to do, and might tempt a good many hams to try f.m. reception—hams who would otherwise be unwilling to face the cost and complications of a complete f.m. receiver.

Such an adapter was built up—views of it are shown in the various photographs—and its performance has been up to expectations. Careful tests have shown that, through set noise alone, a carrier strength which will give a readable signal on narrow-band f.m. leaves 100 per cent amplitude modulation buried in the noise. About 6 db more carrier is necessary to bring the a.m. signal up to the same readability. The conditions under which these tests were made were, as a matter of fact, unfavorable to f.m. reception, and there is reason to expect that even better results could be secured. The explanation for this requires consideration of Figs. 2 and 3.

Fig. 2 shows the operating characteristic of the discriminator used in the adapter, taken

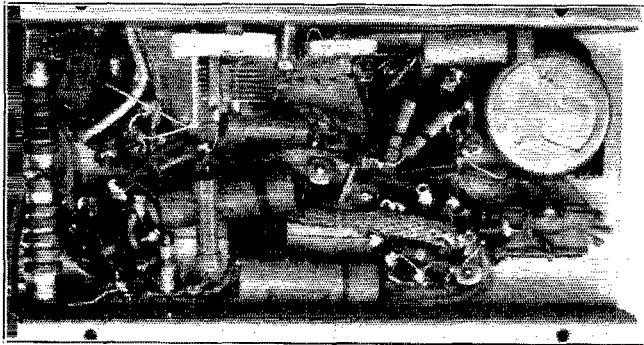

In this below-chassis view, the socket for the 6SQ7 is in the upper left corner, with the first limiter socket just below it. The two series chokes forming the shunt inductance in the i.f. circuit are along the left edge. Wiring is crowded, but i.f. leads are kept as short as possible. Rubber-covered pair runs out the lower left corner to the filament transformer.

with constant-amplitude r.f. input. The discriminator transformer is one designed for 15-kc. deviation; the peaks are considerably farther apart than is necessary for our purposes, but the principal effect of this separation is simply to reduce the possible audio output. In Fig. 3 the center portion of the characteristic has been plotted on an enlarged scale, the practically straight-line curve marked *A*. Curve *B* is a plot, on a percentage basis, of the typical selectivity curve of Fig. 1. If the response is as indicated—i.e., there is no amplitude limiting in the receiver—the resultant effective discriminator characteristic will be as shown by the dashed line close to the horizontal axis, since as the frequency deviates from the center the amplitude of the signal reaching the discriminator is lowered. The straight-line portion of the curve is restricted to the small section between *X* and *Y*, so that distortionless reception can be secured only when the maximum deviation does not exceed about 500 cycles. Greater deviations than this will swing out over the curved dashed lines, causing considerable harmonic distortion in the audio output. The permissible deviation ratio in this case is only 0.125, assuming a 4000-cycle upper limit, and this, as Crosby points out, is equivalent to a reduction in modulation percentage.

When the signal becomes strong enough to cause limiting over the complete 8-kc. channel a different picture results. Assuming a perfect limiter, the response curve (input to the discriminator) will take the form of curve *C* and the corresponding effective discriminator characteristic will be straight between points *P* and *Q*, dropping off at higher deviations than 4 kc. as shown by the dashed curves originating at those points. In this case we get full modulation and the system is working under the conditions always assumed in discussions of frequency modulation; that is, the signal is completely-amplitude-limited over the whole bandwidth of the transmission. With a peaked selectivity curve such as that of Fig. 1, the flat top

can be secured only when the signal amplitude is such that at 4 kc. off resonance it is still strong enough to saturate the limiter. This requires a signal 20 to 25 db stronger than one just sufficient to cause limiting at the center of the pass-band.

In the actual receiving set-up, the weak signal was well below the strength which caused limiting. It was, therefore, contending with conditions represented by the *X-Y* curve in Fig. 3. A signal which was strong enough to cause limiting out to the edges of the channel was not by any means "weak" when tuned in at the center. A tabulation of observations in terms of "S"-meter readings tells the story:

- S3 — Set noise alone, with 56-Mc. converter working.
- S3½ — Minimum carrier strength (tuned at resonance) for readable f.m. signal. A.m. signal buried in noise at this signal strength.
- S4¼ — Carrier strength at which limiting begins.
- S4½ — Carrier strength for a.m. signal of same readability as f.m. signal at S3½. F.m. signal well above noise at this strength.
- S9 — Carrier strength necessary to cause limiting over 8-kc. channel.

It was determined by calibration that over the range considered each "S" step was 6 db within rather close limits.

The conditions were unfavorable to f.m. from another standpoint. On the amplitude-modulated signal, the noise output follows the i.f. selectivity curve, *B* in Fig. 3, dropping off rapidly at the higher audio frequencies. The f.m. noise, on the other hand, has considerably greater intensity at the higher frequencies, and will extend well beyond the audio range of the modulation. To compare the two systems properly, a low-pass filter should be used in the audio system to cut off at the upper modulation-frequency limit, in this case assumed as 4000 cycles. No such filter was used in the audio system in these tests.

The F.M. Adapter Circuit

The circuit of the f.m. adapter is shown in Fig. 4. The unit has been designed so that changes in the receiver with which it is used can be kept to a minimum; as a matter of fact, no changes at all were needed in our particular case. In any superhet the second detector socket is the point where i.f. and audio meet, so it is readily possible to lead the former out and the latter back in with a minimum of disturbance to the receiver. The general idea is that the f.m. limiter is connected in parallel with the normal a.m. detector of the receiver; the f.m. channel is then completed by the discriminator circuit from which the audio output is obtained, and the output of either detector is switched as desired to the first audio stage in the receiver. Since the a.m. detector is always working, the a.v.c. circuit is not affected and the operation of the receiver is perfectly normal. Probably most sets these days use a combination diode-triode as the second detector, as in this case, but the kind of circuit or tube is of no particular consequence.

In the adapter shown, the various connections to the receiver are made by means of an octal plug which replaces the 6SQ7 second detector tube. The i.f. voltage, which appears at the diode plate connection, should be fed to the adapter through a low-capacity shielded lead. We found it satisfactory to run an ordinary piece of push-back wire through a piece of quarter-inch diameter spaghetti tubing, covering the latter with shield braid. The audio grid

lead, marked *G* in Fig. 4, also should be shielded to prevent hum. The cathode and plate leads need not be shielded, although shielding will do no harm.

Among the unusual features of the f.m. circuit is a cascade limiter using two 6SJ7's. A single-tube limiter will not give good limiting over a wide range of input voltages because different magnitudes of input voltages require different grid-circuit constants. Furthermore, the grid leak and condenser which give good limiting on steady signals have too great a time constant to handle impulse noises satisfactorily. By using two limiters, the first can be designed to take care of impulse noise with considerable, although imperfect, limiting on carrier voltages, while the second is designed for handling the reduced range of carrier variation passed on by the first tube.²

Untuned coupling is used between the two limiter stages. The constants specified have been found satisfactory in practice, giving limiting at rather low input levels along with ample gain without danger of self-oscillation.

The discriminator circuit is familiar except for C_5 , which is used to balance the extra plate-to-ground capacity of the lower diode. It has been shown⁷ that good capacity balance in the discriminator is essential if best suppression of impulse noise is to be secured. C_5 is simply

⁷ V. D. Landon, "A Study of Impulsive Noises in Frequency Modulation Receivers," paper presented at the IRE-RMA Rochester Fall Meeting, November, 1940.

(Continued on page 70)

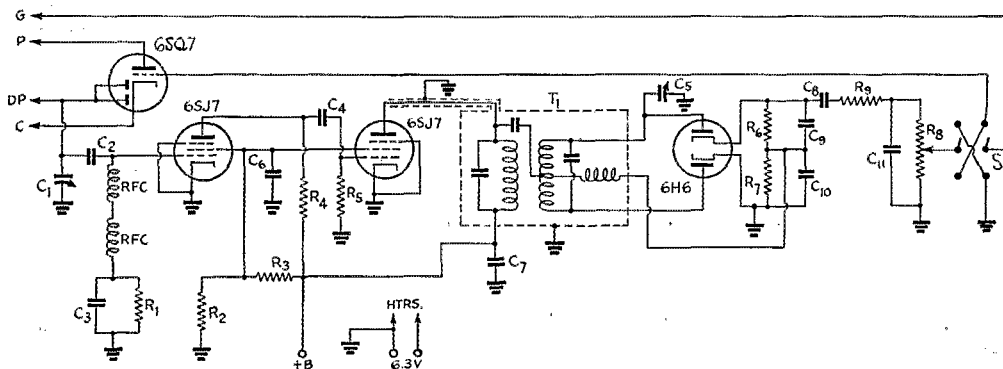

Fig. 4 — Circuit diagram of the f.m. adapter.

C_1 — 50- μ fd. air trimmer (Hammarlund APC-50).

C_2 — 500- μ fd. mica.

C_3 — 100- μ fd. mica.

C_4 — 250- μ fd. mica.

C_5 — 3-30- μ fd. trimmer (National M-30).

C_6, C_7 — 0.1- μ fd. paper.

C_8 — 0.01- μ fd. paper.

C_9, C_{10} — 100- μ fd. mica.

C_{11} — 50- μ fd. mica.

R_1 — 50,000 ohms, $\frac{1}{2}$ -watt.

R_2 — 3000 ohms, 1-watt.

R_3 — 70,000 ohms, 1-watt.

R_4 — 4000 ohms, $\frac{1}{2}$ -watt.

R_5 — 0.2 megohm, $\frac{1}{2}$ -watt.

R_6, R_7 — 0.1 megohm, $\frac{1}{2}$ -watt.

R_8 — 0.5 megohm volume control.

R_9 — 50,000 ohms, $\frac{1}{2}$ -watt.

T_1 — 456-ke. discriminator transformer (including coupling condenser and i.f. choke) (Millen 60457).

S_1 — D.p.d.t. toggle switch.

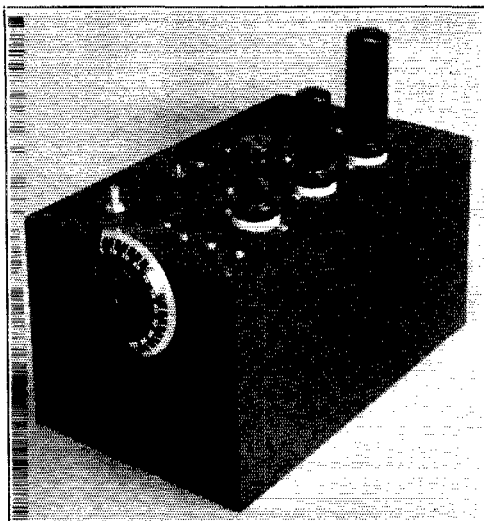

The v.f.o. is built in a 6- by 7- by 12-inch metal box. A panel could be added if desired, but there doesn't seem to be much reason for one.

SO MANY types of variable-frequency oscillators have been described in the past several years that it might seem presumptuous to tell about another unless it were radically different. The v.f.o. of this article is hardly "radically different," but it does incorporate a few features that might be interesting to past and potential builders of variable-frequency control units. The appearance of the unit is slightly unorthodox, but that is a result of trying to make the construction simple and leaving off any unnecessary parts.

Circuit Considerations

The advantages claimed for an e.c.o. are the electronic isolation afforded by the circuit and the compensating effect for changes in supply voltage when the screen and plate voltages (and cathode tap) are correctly proportioned. There is, however, the disadvantage that the cathode of the e.c.o. is above ground for r.f., resulting in putting the heater-cathode capacity across part of the tuned circuit, and this requires special precautions to minimize the harmful effects. On the other hand, the claimed advantages of the e.c.o. can be obtained by using two tubes instead of one and a regulator tube in the power supply, and at the same time an oscillator circuit with a grounded cathode can be used, thus eliminating the disadvantage of the e.c.o.

As can be seen from the wiring diagram in Fig. 1, a 6J5 triode oscillator is used in the tuned-plate grid-tickler circuit, operating on

* Assistant Technical Editor.

Whether you already have a v.f.o. or are just looking for ideas on one, you will be interested in this description of a unit that incorporates several thoughts for improving performance by reducing drift and reaction. It doesn't deliver more than 6 or 8 watts, but that should be sufficient to drive any beam-power tube that might be used to start out the transmitter line-up.

A Gang-Tuned V.F.O.

Variations on the E.C.O. Theme

BY BYRON GOODMAN,* WIJPE

160 meters and keyed in the cathode circuit. The plate and grid by-pass condensers are returned to the cathode instead of to ground to minimize the possibility of stray r.f. in the key leads. The oscillator is followed by a 6V6 amplifier tuned to twice the frequency of the oscillator, the excitation being capacity coupled from the grid of the oscillator. The combination of the oscillator and amplifier forms, in effect, an e.c.o. with the cathode grounded. The 6V6 is cathode-biased high enough so that no grid current flows, and hence there is no load on the oscillator. The high bias on the 6V6 results in considerably more output on the second harmonic than would be obtained if the 6V6 were biased for straight Class-A operation. A high value of grid leak in the oscillator holds the plate current of the oscillator to a low value (3 ma. at 150 volts), which keeps the heating and consequent drift negligible.

The oscillator operates in the 1750- to 2000-kc. range, and the plate circuit of the 6V6 is gang-tuned to cover 3500-4000 kc. The oscillator uses, of course, a high-*C* tank circuit for good dynamic stability and to minimize tube and circuit variations, but the use of a high-*C* plate circuit in the 6V6 amplifier is unconventional. This 80-meter circuit uses over 400 $\mu\text{fd.}$ of padding capacity, on the theory that changes in the input capacity of the following stage will have less effect on the 6V6 plate circuit and hence less effect on the oscillator frequency. The reaction is further reduced by using a low value of grid leak on the 6L6 output stage following the 6V6, since this grid leak is across the 6V6 plate tank and tends to lower the *Q* by loading the circuit. Further to isolate the output of the v.f.o. from the oscillator, the 6L6 output stage is neutralized.

Low temperature-coefficient condensers are used in the oscillator circuit, in the tank circuit and in the grid circuit. The use of a low-coefficient condenser in the grid circuit was found helpful in cutting down some drift that showed up.

Construction

The v.f.o. is built in a 6- by 7- by 12-inch Parmetal box, with all of the gear except the dial, power-supply socket, key and output connectors and an interstage shield mounted on one of the removable 7- by 12-inch faces. This construction makes it a simple matter to wire the unit and to get at it for testing and servicing. The tubes sit on top of this panel and the rest of the parts are mounted underneath, giving adequate ventilation for the tubes and allowing the rest of the parts to remain at a reasonably constant temperature.

The three ganged condensers are mounted on a strip of bakelite with flat-headed screws sunk in the bakelite so that the condensers won't ground to the chassis. The bakelite is drilled and tapped for screws that hold it to the top plate of the cabinet. The oscillator trimmer condenser, C_2 , is insulated from the cabinet by using fiber washers on the shaft bushing, and the output padding condenser, C_7 , is insulated by mounting it on a strip of bakelite in similar fashion to the three ganged condensers. The buffer padding condenser has an insulated adjustment screw and can be mounted directly to the metal without extra insulation.

The oscillator coil is wound on a 1-inch diameter bakelite form, supported $\frac{1}{2}$ inch above the metal on a brass pillar. A 2-inch diameter shield can (ICA No. 1539) is used around the coil, and the leads from the coil are

brought out through holes in the sides of the bottom plate of the shield can. The leads are brought out through short lengths of spaghetti tubing that keep the leads rigid. The buffer coil is wound on a $\frac{3}{4}$ -inch diameter polystyrene form supported $\frac{1}{2}$ inch above the metal on a brass pillar. The output coil is a manufactured unit used in low-power exciters, and it is supported on a plug-in strip provided for such coils, simply as a convenience and not because the coil is changed after once having been adjusted. The plug-in strip is mounted higher than usual above the metal by using two small stand-off insulators fastened together (by a headless screw) instead of the usual one insulator.

All of the r.f. wiring is done with No. 14 wire or the leads from the various components, and all of the components are tied down on tie-points wherever necessary for additional rigidity. Every effort was made to eliminate "floppy" wiring and consequent microphonic effects. The keying lead is run through shielded wire as an extra precaution against r.f. in this circuit, although it is well-filtered at the oscillator through C_{13} , C_{14} and the r.f. choke.

It was found impossible to neutralize completely the 6L6 until the shield was placed between L_3 and the output padding condenser, C_7 , but with this shield in place the stage could be neutralized very nicely. The shield mounts on the side of the cabinet and is not fastened to the removable plate.

Tuning and Adjustment

The easiest procedure in putting the unit into operation is to adjust it stage by stage. The first step is to plug in tubes in the oscillator and buffer stages and adjust the turns on the oscillator coil L_1 for correct coverage. This can be checked readily by listening to the

◆
A view of the underside of the unit shows the placement of parts. The shield partition is fastened to the side of the can and is not fastened to the removable top plate on which most of the gear is mounted. Two strips of wood, used to brace the sides of the box and reduce microphonic effects, have been removed for the photograph.

The shield can at the left houses the oscillator coil. The split-stator output padding condenser at the right is adjusted during testing through a hole in the cabinet.

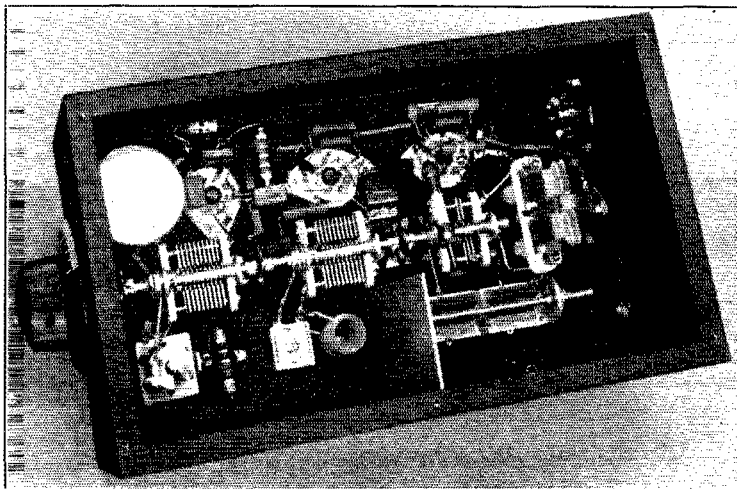

signal on a calibrated receiver. The coil was adjusted in this unit until the range 1750-2000 kc. covered from 5 to 95 on the dial, giving a maximum amount of bandspread. The frequency checks should be made with the shield over the oscillator coil, since the shield affects the inductance of the coil. When the coil has been adjusted, the turns can be fastened by coil cement. The tickler winding will probably need no adjustment, since the excitation can be adjusted to some extent by changing the capacity of the grid condenser, C_{11} , a larger capacity permitting more feedback.

With no plate or screen voltage on the 6L6 output stage, a 6L6 should be plugged in and a low-range (0-5 or 0-10) milliammeter connected in the circuit between R_5 and ground to measure grid current to the 6L6 and to check the tracking of the 6V6 plate circuit. Setting the oscillator to the high-frequency end of its range, tune the buffer padder, C_5 , to resonance as indicated by the grid current to the 6L6. The current should run around 2 or 3 ma., with 300 volts on the 6V6 plate and 150 volts on the oscillator plate. Now turn the tuning dial to the low-frequency end of the range — if the grid current to the 6L6 stays very nearly constant the oscillator and buffer are tracking.

However, the chances are that the two circuits won't track at the first attempt, so note which way the buffer padding condenser must be turned again to bring the buffer plate circuit into resonance. If capacity must be added, the buffer coil has too few turns, and if the capacity must be reduced it indicates that there are too many turns on L_2 . It is best, of course, to start with two or three extra turns and remove them one at a time until the two circuits track. It is a simple matter and, after the circuits track, the coil can be fastened to the form by judicious spotting with polystyrene cement.

The final coil is made to track in much the same way, using a 10- or 15-watt lamp connected to the output terminals for the indicator. Don't expect the lamp to light up to full brilliancy, because the 6L6 is not working as a Class-C amplifier and delivers only about 6 or 8 watts. However, the turns should be removed one at a time from the coil until the output is uniform over the entire range. It was found necessary to remove one plate from the tuning condenser, C_6 , since the stage wouldn't quite track with 5 plates in the condenser. If the padding condenser, C_7 , had slightly more capacity or if we hadn't been trying to get maximum bandspread, it would have been

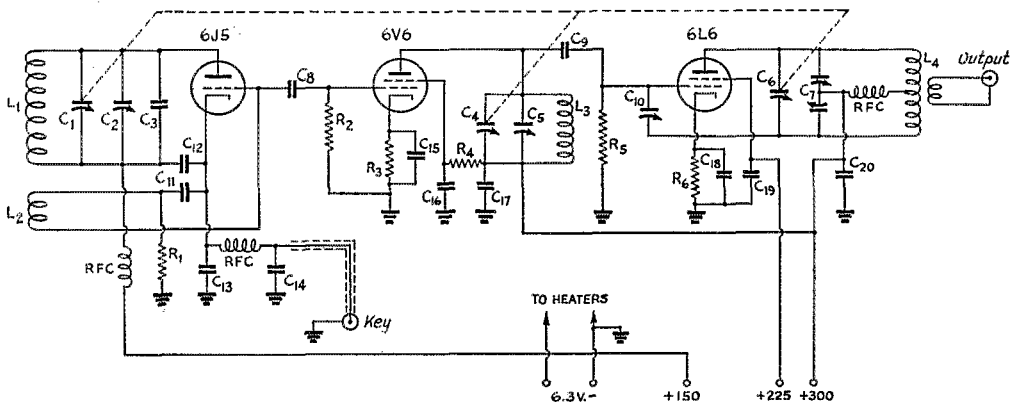

Fig. 1 — Circuit diagram of the triode v.f.o.

- C_1, C_4 — 140- μ fd., variable (Hammarlund MC-140-S).
- C_2 — 140- μ fd. midget variable (Hammarlund HF-140).
- C_3 — 350- μ fd. low-drift mica (Aerovox or Cornell-Dubilier).
- C_5 — 560- μ fd. adjustable mica padding condenser (Mallory CTX956).
- C_6 — 30- μ fd. variable (Hammarlund MC-35-S with one stator plate removed).
- C_7 — 140- μ fd. per section variable (Hammarlund HFD-140).
- C_8 — 100- μ fd. mica.
- C_9 — 250- μ fd. mica.
- C_{10} — Low-capacity neutralizing condenser (National NC-600).
- C_{11} — 250- μ fd. low-drift mica (Aerovox or Cornell-Dubilier).
- C_{12} through C_{20} — 0.005- μ fd. mica.

- R_1 — 50,000 ohms.
- R_2 — 0.15 megohm, $\frac{1}{2}$ -watt.
- R_3 — 1200 ohms.
- R_4 — 15,000 ohms.
- R_5 — 20,000 ohms.
- R_6 — 300 ohms.

- All resistors 1-watt unless otherwise mentioned.
- RFC — 2.5-mh. r.f. choke (Coto CI-11).
- L_1 — 32 turns No. 24 d.c.c. closewound.
- L_2 — 15 turns No. 28 d.s.c. closewound, $\frac{1}{8}$ inch from L_1 . L_1 and L_2 wound on 1-inch diameter bakelite form (Millen 45000).
- L_3 — 15 turns No. 24 d.c.c. closewound on $\frac{3}{4}$ -inch diam. form (National PRF-2).
- L_4 — 35 turns No. 24 bare, wound 32 turns/inch $1\frac{1}{2}$ " diam. (National AR16-80S with 9 turns removed). Link is 10 turns.

possible to make the stage track without modifying the condenser. However, it is a simple task to remove one stator plate from the condenser by twisting it off with a pair of long-nosed pliers.

When all of the stages are tracking, the output stage should be neutralized. This is best done by adjusting the neutralizing condenser, C_{10} , until tuning the dual-section padding condenser through resonance shows a minimum amount of reaction on the frequency of the oscillator. By listening to the signal at zero beat on 14 or 28 Mc., it is possible to detect small changes in the frequency and hence do a good job of setting the neutralizing condenser. This particular unit neutralized with the set-screw of the neutralizing condenser set at about $\frac{7}{8}$ -inch out, but the exact setting will be modified somewhat by the stray capacities throughout the circuit and minor changes in wire placement.

Power Supply and Keying

Fig. 2 shows the suggested values of resistors for obtaining the proper voltages from a 300-volt supply. The total drain to the v.f.o. and voltage divider will run around 100 ma.

The total current to the unit will not vary much with the key up or down, and consequently the VR tube doesn't have as much work to do as it might. The 6V6 and 6L6 stages do not draw excessive current with the key up because of the self-biasing in the cathode circuits.

One of the main points of interest to us was the keying characteristic that could be obtained from the unit. With no lag in the cathode circuit other than that introduced by the by-pass condensers and r.f. chokes, the keying characteristic was perfect as indicated on an oscilloscope. There were no surges, such as might be introduced by regeneration in the buffer and output stages. Listening to the harmonic on 28 Mc. beating against a crystal harmonic, no trace of a chirp could be detected. However, the signal had some clicks when listening to it. These clicks are the inescapable result of turning the signal on and off too fast, as indicated by the steep front and end of the signal as viewed on the 'scope, and do not extend outside the audible beat range of the signal as do clicks introduced by a parasitic oscillation or a frequency change under keying. Fortunately, however, they are reduced somewhat when the unit is connected to a transmitter (that has no parasitic oscillations or regeneration), and it takes only a small amount of filter at the key to round off the sharp corners of the characteristic and give practically clickless keying. The filter we used consisted of a filament transformer primary in series with the key lead and a 1.0-

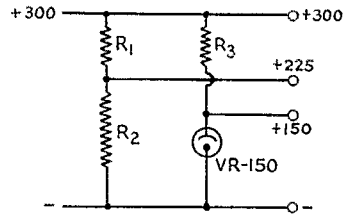

Fig. 2 — The voltage divider and regulator circuit for the v.f.o. power supply.

R_1 — 3000 ohms. R_3 — 5000 ohms.
 R_2 — 15,000 ohms.

All resistors are 10-watt wirewound.

μ fd. condenser in series with a 10,000-ohm variable resistor across the key. The resistor was adjusted until the clicks were at a minimum. The oscillator does give very positive keying, however, and will handle any speed used on the amateur bands with bug or tape sending.

The oscillator showed some microphonic tendencies until the box was cross-braced by two strips of $\frac{3}{4}$ -inch square wood held to the sides by screws in the ends of the strips. It was then possible to pound the table to a reasonable extent without affecting the frequency of the oscillator, since the "drum" effect of the cabinet was eliminated. Mounting the unit on a rubber pad will eliminate any microphonics introduced by pounding a key alongside the v.f.o.

The drift of the oscillator was checked by listening to its harmonic beating against the harmonic of a low-drift crystal on 28 Mc., and the drift on 28 Mc. was less than 1000 cycles in 3 minutes, with most of it occurring in the first minute. This was considered to be satisfactory, since crystals running hard will often drift more than that. The output of the oscillator will increase with lower values of grid leak and higher values of grid condenser, with consequent greater drive to and output from the 6L6 output tube, but the drift of the oscillator will also increase under these conditions. The values given in Fig. 1 represent a compromise between drift and output, but it would appear to be smart to sacrifice output for low drift at any time.

The performance of this unit is not to be considered unique for this particular one, but simply demonstrates what can be obtained from any v.f.o. with a reasonable amount of care. The use of a high-C low-Q buffer tank plus a neutralized output stage should do much to help a v.f.o. suffering from chirps and other reaction from the transmitter, and running the oscillator itself at a low input will do much to reduce drift. The use of zero-coefficient condensers in this unit might reduce

(Continued on page 74)



W9JWC and his mast take a rest at the 20-foot level.

A Self-Supporting Antenna Tower

A 70-Foot Antenna Mast for Fifteen Dollars

BY J. D. BOATRIGHT,* W9JWC

Here is a description of an antenna tower that may help to solve some of your construction problems. After reading the story, you may not be interested in going up to the full 70 feet, but you can't go wrong with a 50-footer.

ALONG with most other amateurs, I have always wanted to own a tower from which to hang any type of antenna that I might want. My funds being limited, I knew that it was out of the question to purchase a ready-made structure of steel.

Early last summer I visited one of the local lumber companies and inquired if they had any designs or plans for the construction of a high tower of wood. They had none, and so I was forced to draw up my own plans and to design the tower myself. Not being an engineer and knowing nothing about the stresses and strains in a structure of this kind, I just had to trust to luck that the tower would stand after it was built. Of course I intended to guy it, but even so I was plenty uncertain about it.

The plans were first drawn to scale on paper, using a 7-foot triangle for the base and making the height of the tower 70 feet. This looked to be in about the right proportions (see Fig. 1-A). The cross braces were then drawn in, relatively close together near the bottom of the structure where the sides are far apart and then a little farther apart where the sides get closer together. Since 2 by 2's are fairly cheap, I decided to build the whole tower, cross braces and all, out of them, and several hundred feet of them were ordered from the lumber yard.

Construction

A triangle measuring 7 feet on a side was laid out on the ground about 2 feet from the back of the house, and a stake was placed at each corner. At the points marked by the stakes, 3-foot deep

holes were dug for sinking the base supports. The supports were made from three old bed rails that were picked up at a local junk yard, although any pieces of steel angle bar could be used. Three holes were drilled about a foot apart at one end of each of the rails, and the other ends of the rails were placed in the holes in the ground. The tops of the rails were leveled and the rails made vertical in the holes, and then the holes were filled with concrete. When the concrete had set, holes were drilled in three of the 16-foot lengths of 2 by 2 to correspond to the holes in the bed rails,

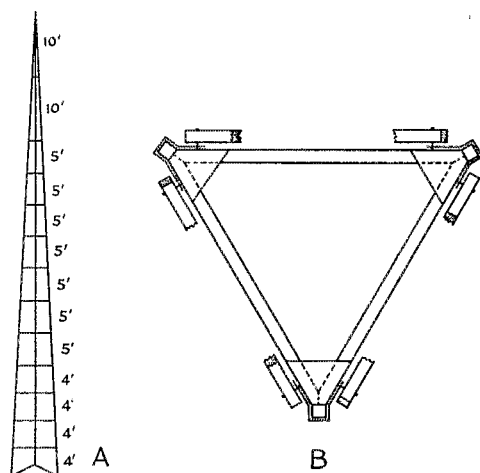

Fig. 1—The spacing of the various sections of the mast (A) and a plan view of one section (B), showing how the horizontal members butt into the vertical members.

* 628 N. Prospect Street, Colorado Springs, Colo.

and the three 2 by 2's were bolted to the supports.

The cross braces, I decided, should be constructed on the ground and then carried up and bolted in place. I cut three pieces of 2 by 2 seven feet long and laid them on the ground in the shape of an equilateral triangle. Using a triangle, the ends were cut to match each other with a 30 degree cut. A local tinsmith made up a lot of iron triangles for me, and I bolted them to each corner, putting two bolts through each end of each 2 by 2. The result was a strong and rigid triangle of the correct length on each side to mount in between the three uprights, just above the point where the bed rails joined the uprights. With a shaped piece of strap iron (which conformed to the shape of the 2 by 2 and wrapped around it, and then extended far enough to bolt to the sides of the triangle), I bolted the first triangle in place.

Taking the top triangle as 0 feet on a side and

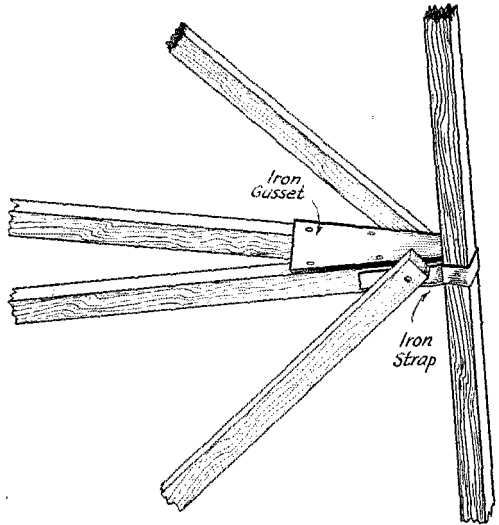
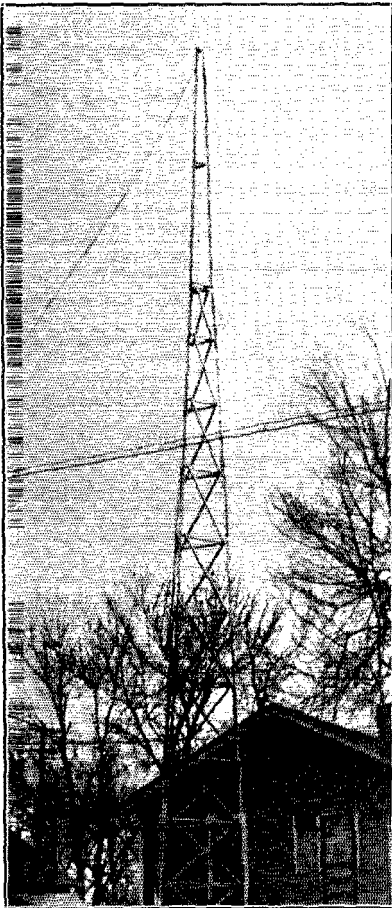

Fig. 2 --- Corner detail of the mast, showing the iron strap used to hold the horizontal members to the side piece and the gusset plate that gives additional strength to the horizontal members. The diagonal braces are fastened to the corner by bolts running through the horizontal members.



A self-supporting 70-foot mast, built at W9JWC for less than \$15.

the bottom triangle as 7 feet on a side, I figured the middle triangle as $3\frac{1}{2}$ feet on a side and so on, and thus I computed the length of the side of each triangle. I then constructed the second triangle and bolted it in place. I put them 4 feet apart and used the previously placed one to stand on while putting the next one in place. After putting four in place, the structure was beginning to get wobbly. It was at that point that I decided to put on cross angle braces instead of guying the tower.

I started at the bottom again and, taking the bolts out of the shaped iron braces one by one and replacing them with longer bolts so that they would accommodate two thicknesses of 2 by 2 instead of one, I placed 2 by 2 angle braces all around the bottom and then climbed up on that and did the same all the way up. After this extra bracing was accomplished, I found the 16-foot section just about as solid at the top as at the bottom.

About $2\frac{1}{2}$ feet above the fourth triangle was the end of the 16-foot uprights. A 2 by 2 five feet long was bolted in place on each upright, half protruding above the top of the uprights, and then the next 16-foot long 2 by 2's were hoisted hand under hand and balanced in place on top of the lower pieces and then bolted to the splicing 2 by 2's. Then, on up to the top of this structure, I slowly made my way (placing a triangle in place, then down after another 2 by 2 and the saw, brace and bit, and the bolts and nuts, and back up again,

(Continued on page 76)

★ WHAT THE LEAGUE IS DOING ★

DEFENSE COMMUNICATIONS BOARD

THE committees of the D.C.B. held their first meetings on January 6th. After a general meeting in which the work was explained, the individual committees held their initial organization meetings. In the case of the Amateur Radio Committee, George W. Bailey, W1KH, the president of A.R.R.L., was elected the chairman and F.C.C. Assistant Chief Engineer E. M. Webster was chosen secretary.

All the D.C.B. committees are now hard at work and will be for some months. Because the work relates to the employment of communications in the aid of the Army and Navy, there will be no publicity except that released by the D.C.B. chairman. However, it can be said that the work of the Amateur Radio Committee is characterized by a proper appreciation of the potentialities of the amateur. Out of this work, eventually, will come plans and announcements of great interest. In the meanwhile the officers and regional advisers of A.R.R.L., who are representing amateurs, will be much occupied for the next few months to come.

AMERICAN MORSE

FROM time to time we are asked whether the American Morse code may be used in the amateur bands. F.C.C. has no objection, provided it does not lead to confusion. They have

ruled that all call letters must be transmitted in the International Code and, of course, their examinations are all conducted in that code, but there is no objection to the use of American Morse in the body of communications.

SERVICE RECORDS WANTED

PLEASE see page 18 of January *QST*. The League wants to compile statistics on the contributions made by radio amateurs to the present national effort. All amateurs serving in radio work with the military forces of the United States are asked to register that fact by means of a *post card* to A.R.R.L. at West Hartford. Please give the following information:

- (1) Are you a Selective Service conscript, a volunteer, or a reservist on active duty?
- (2) For how long a term are you serving?
- (3) Is your service in the Army, Navy or the Marine Corps?
- (4) To what outfit or organization are you assigned?
- (5) Location; where is your organization stationed?
- (6) What rank or rating do you hold?
- (7) What is your present radio duty assignment?
- (8) Were you previously a member of N.C.R. or A.A.R.S.?
- (9) Give your name and your *home call*.

NAA DISMANTLED

SADLY the Navy announces that it is taking down the famous three towers of NAA at Arlington, familiar landmarks in Washington's skyline since 1912. With the exception of a very



© Broadcasting

The Defense Communications Board's Committees assembled in Washington for their first general meeting January 6th. In the first row, center, may be seen A.R.R.L.'s representatives, President George W. Bailey and Secretary K. B. Warner. Next to them is Lt. Comdr. John L. Reinartz, U.S.N.R., who represents the Navy on the Amateur Radio Committee.

few low-powered transmitters, the work of NAA is being transferred to Annapolis, NSS. Thus ends one of the pioneer high-power stations of the world.

PHYSICAL CONDITION

A NAVY personnel officer, himself an amateur, told us the other day that there is a disconcerting number of rejections for physical reasons amongst the amateur reservists who are being called up. Underweight, no chest expansion, bad teeth, flat feet, and what not. He says we run far worse than the average.

We discussed this subject in our editorial for October, 1938, and if you have the issue handy, we suggest that you take it down and read it. The average ham is immoderate and unbalanced in his pursuit of the game; he doesn't get enough sleep or exercise, he smokes too much, he works too hard at radio and keeps himself under strain too long at a time. This is no time for us to be caught that way. We urge you, gang, to give some thought to these things, to practice moderation, and to perceive the desirability of keeping yourselves in proper physical shape.

MISCELLANY

AMATEUR licensing has continued to gain slowly and is now generally satisfactory. . . . The Army Air Corps seeks candidates for its Squadron Communications Officers' school at Scott Field, Belleville, Illinois. Nine months' course in cadet status, ending in commission as second lieutenant, Air Corps Reserve, and active duty. Candidates must be college graduates with some knowledge of electricity or radio, unmarried, 20 to 26 years of age, excellent health. Applications direct to the Chief of the Air Corps, Washington. . . . We hear that something similar in the Signal Corps will be announced soon. . . . Chairman Fly of F.C.C. gave us some nice publicity recently. He says the Commission is encouraging amateur activity in the United States and remarked that the ban against international communication has not hurt our progress, citing that our numbers continue to grow nicely. He lauded our work in times of disaster and storm and pointed at our value as a reserve of trained personnel.

NORTHWESTERN ALTERNATE

AFTER advertising again for nominations for alternate of the Northwestern Division, three petitions were received. One, for Ivan E. Anderson, W7AUP, arrived after the closing hour and had to be rejected. The incumbent, W. N. Wintler, W7IKL, was nominated, but unfortunately had to be rejected as a candidate because of an accidental lapse in his League membership in 1939. There remained one eligible candidate, R. Rex Roberts, W7CPY, our S.C.M. for Montana. Mr. Roberts was thereupon declared elected

without balloting by the membership and immediately took office. He is by occupation the manager of the Mountain States Telephone Company at Glendive, Mont.

★ BOOK REVIEW ★

The Meter at Work, by John F. Rider.
Published by John F. Rider, 404 Fourth Ave.,
New York City. 152 pages, 138 illustrations.
Price, \$1.25.

This latest of the Rider series is, as are his other volumes, written for the serviceman, but its information is sufficiently generalized to be useful to all radio people. It starts with elementary magnetism and goes right on through with a detailed description of how various meter movements function, how they are used, how to get the most from the meters one now owns, and how to go about selecting new ones.

"The Meter at Work" features a novel physical make-up, in that the inside pages are split. Each section turns separately. The top third contains the illustrations, the lower two-thirds the text. Thus the text pages can be turned without disturbing the illustrations, eliminating the annoying necessity of having to turn pages back and forth in referring to illustrations while reading the text matter describing them.

— C. B. D.

Silent Keys

It is with deep regret that we record the passing of these amateurs:

Prof. A. C. Carson, W4MN, Columbia, S. C.

Earl Carter, W6PSF, Grass Valley, Calif.
Frank Cizek, Jr., W2MPJ, Astoria, New York

Maurice H. Clarke, ex-W8VO, Rochester, N. Y.

M. O. Davis, W9CDE, La Junta, Colorado
Bradford A. Durfee, W1MGZ, West Springfield, Mass.

Orris R. Grissom, W6DYL, El Monte, Calif.

Adolph H. Kloss, W2LYV, Irvington, N. J.

Lewis Kocum, W9KQC, Anoka, Nebraska
George E. Lantz, Jr., W5FVZ, Ft. Worth, Texas

Thomas H. Lokken, W9CE, Ishpeming, Mich.

Richard Naylor, ex-W6GVA, San Diego, Calif.

Charles E. Perry, W9ASV, Joplin, Missouri
Joseph G. Separk, W4FQE, Gastonia, N. C.

Hubert S. Smith, W8QKD, East Akron, Ohio

Marguerite L. Thomas, W6NMV, Chandler, Ariz.

• For the Junior Constructor — Flea-Power A.C./D.C. 'Phone

A Few Watts on 160 Meters for Local Rag-Chewing

BY VERNON CHAMBERS,* WIJEQ

A good many beginners — and others, too — whose primary interest is in c.w. operation often get the urge to put out a few watts on 160-meter 'phone for local rag-chewing. Many c.w. transmitters are not particularly adaptable to the purpose, and the cost of a suitable modulator often is a deterring factor. The little set described here has no pretensions as to power, but it does use pretty nearly the minimum number of parts for a rig conforming to the regulations. A transformerless power supply and 110-volt tubes are the answer.

Everything considered, there seems to be ample justification for a transmitter of this type. It is compact to a degree permitting simple and rapid construction and it is complete even to the extent of including the power supply and an antenna tuner. The tube complement does away with a power transformer, filament transformers and a separate rectifier tube, and voltage-dropping resistors are eliminated because all tubes have identical plate and screen voltages.

* Technical Information Service.

Because the power input is limited to 4 or 5 watts, it is possible to employ inexpensive low-voltage components. Also because of the low power a one-tube audio system can be used; that would only be the beginning if the modulator were called upon to supply audio for an amplifier running at 20 or 30 watts. Furthermore, several accessories important to a c.w. rig may be omitted so long as the design is centered on 'phone operation. Actually, the parts for the transmitter may be purchased new for as little as \$13.50, including such things as panel, knobs, terminal strips, wire, etc. The complete set of tubes may be obtained for \$3.81.

The R.F. Circuits

The circuit diagram of Fig. 1 shows a Tri-tet oscillator capacity coupled to a single-ended amplifier. Each stage uses the tetrode section of a type 117L7GT tube. The Tri-tet circuit was selected because it has the feature of buffering action attributable to electron coupling between the crystal and output circuits. This buffering action is an important consideration in a modulated transmitter employing only two stages because it does much to prevent frequency modulation by isolating the crystal and modulated-amplifier circuits. The plate tank of the Tri-tet may be used for excitation control because its tuning is practically independent of the rest of the circuit. Thus, the tank may be adjusted to deliver to the amplifier the amount of excitation giving optimum performance. This is a convenient method of control when compared with the system requiring a coil tap which must be placed experimentally. It also permits compensation for various degrees of output from different types of crystals. The screen of the tube operates at the same voltage as the plate and is by-passed by the same condenser used in the plate circuit. The usual cathode resistor and condenser are eliminated because they are unnecessary so long as the oscillator is not keyed. Fixed tuning in the cathode tank circuit reduces the cost of the cathode condenser and eliminates a control.

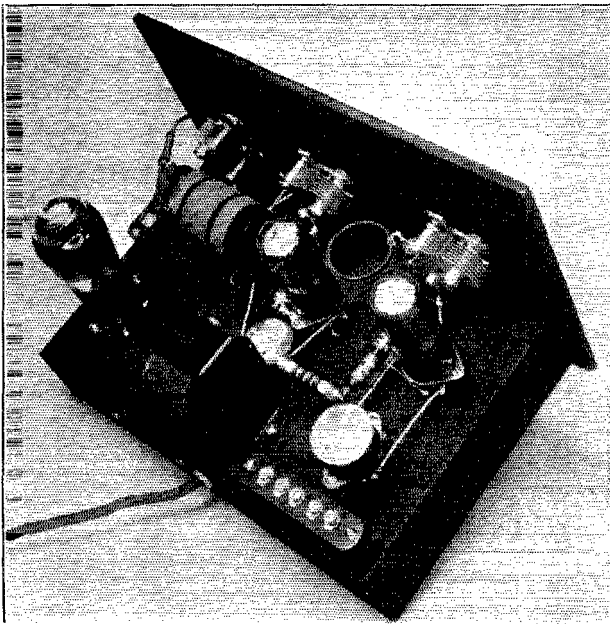

This rear view of the transmitter shows that most of the parts are above the chassis where they are easily mounted and wired.

The amplifier tube is connected as a triode. This causes a decrease in the audio power requirements because the screen grid does not have to be modulated; the input to the amplifier would be greater if the tube were connected as a tetrode because the screen would consume power and, as a result, more audio would be required to modulate the increased d.c. input. Plate neutralization is employed, using a neutralizing coil, L_4 , which provides the out-of-phase voltage which is fed back to the grid through C_{13} . This method of neutralization allows the use of a single-section tank condenser without subjecting the circuit to effects caused by hand capacity since it is possible to by-pass the rotor side of C_2 to ground. The amplifier, because of its strictly 'phone classification, operates with automatic bias. This results because the oscillator and amplifier function as one unit and excitation will be on the final at all times. Without excitation there would be no bias and the plate current would soar.

The antenna tuner, consisting of C_3 and L_5 , is designed to function with a 100-foot antenna. A radiator of this length was selected rather than one measuring a quarter or half wave because 100-foot rolls of wire are readily available and can be easily installed in most locations. The antenna loading coil is equipped with several taps so that parallel tuning can be used throughout the band; the taps allow the proper LC ratio to be selected for any frequency in the band. An untapped coil can not be used because the antenna capacity of several hundred $\mu\text{fd.}$ shunts the tuned circuit and thus increases the effective capacity considerably. The C of the circuit is therefore so high that only a small coil is required. This small coil would not cover the whole band with only a 140- $\mu\text{fd.}$ variable capacity to work with and, as a result, the tapped coil is used so that the appropriate inductance may be chosen at will.

Audio and Power Supply Circuits

The 25B6G audio tube operates as a Class-A amplifier. A single-button microphone is used in the input circuit. Plate power for the modulator (and for the r.f. amplifier) is fed through the modulation choke, L_6 , which has a high impedance for audio frequencies. The 15-volt bias which the 25B6G requires for Class-A operation is obtained by means of the cathode resistor, R_3 . The resistance section of the linecord is used to drop the line voltage to a value appropriate for the 25B6G heaters.

The diode sections of the 117L7GT tubes are placed in parallel to form a half-wave rectifier power supply. A condenser-input filter is used so that the d.c. output voltage will be as high as possible. A single filter choke was found to be adequate for good filtering, providing that sufficient filter capacity was employed. It is for this reason that 40- $\mu\text{fd.}$ filter condensers are

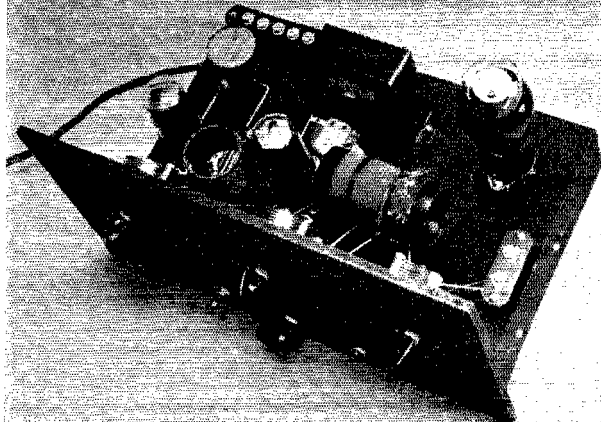

The "on-off" switch, the gain control and the microphone jack are along the bottom edge of the panel.

suggested. There is only one connection to the 110-volt line. This type of connection was used so that the chassis could be grounded.¹ With a double line connection there is danger of short-circuiting the a.c. line if the plug is incorrectly inserted. Of course, with a single connection it is necessary that the active prong of the plug be inserted in the ungrounded side of the line socket. The plate supply will deliver 100 volts at a load of 150 ma.

Construction

The rear-view photograph shows a majority of the parts mounted on top of a chassis measuring 7 by 11 by 2 inches. C_1 , C_2 and C_3 mount on the 7- by 12-inch panel, running in that order from right to left. L_2 is supported by heavy leads soldered directly to C_1 . The oscillator tube and the crystal are along the right edge of the chassis.

A terminal strip for the meter and ground connections, the power-supply filter choke, and the audio tube are all mounted along the rear edge of the base. The form which supports L_3 , L_4 and L_5 is at the rear of C_2 and C_3 ; the neutralizing winding is at the right end and the antenna coil at the left end. The antenna terminal strip is at the left end of the base and the amplifier tube is to the right of its plate coil. C_{13} , the neutralizing condenser, is mounted on a stand-off insulator located between the amplifier tube and the filter choke. A National TPB bushing runs through the base at a point below the center of the amplifier coil and plate voltage is carried to the final through this bushing. The amplifier plate by-pass condenser, the two grid leaks, the grid choke and the filament by-pass condensers, complete the list of components mounted above the base.

The terminal strips, sockets and the amplifier coil are all mounted on $\frac{3}{4}$ -inch pillars. Holes $\frac{1}{2}$ inch in diameter are drilled beneath the centers of the three tube sockets. A $\frac{1}{8}$ -inch hole is drilled below each of the lugs which form the terminal strip at the rear of the base. This type of construction was employed so as to eliminate the

¹ Simple Transformerless Duplex Bias Supply, p. 48, QST, November 1940.

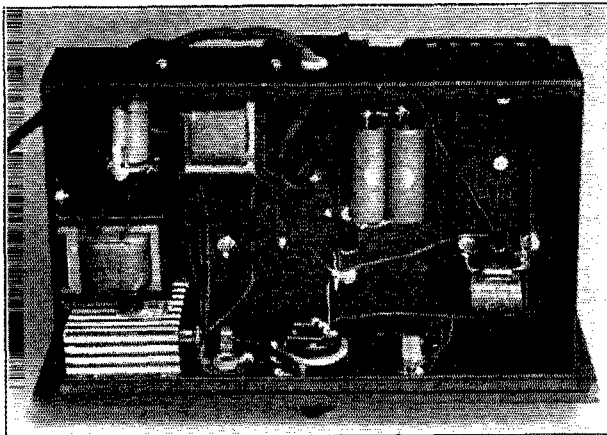

A bottom view of the 'phone transmitter

drilling of large holes essential in sub-base mounting.

The bottom-view photograph shows the microphone battery at the upper right-hand corner. L_6 is bolted to the right wall of the chassis and the

wires fed through these holes serve as terminals for the ends of the winding and as the mounting supports.

L_3 , L_4 , and L_5 are wound on a piece of $1\frac{1}{2}$ -inch

(Continued on page 78)

microphone transformer is mounted on the rear wall. The 25B6G cathode condenser and resistor are to the right of T_1 and the filter condensers are to the left. L_1 and C_4 are connected in parallel and are supported by a lug strip located below the oscillator tube socket. The 290-ohm linecord enters the chassis through a hole drilled in the rear wall.

L_1 is a self-supporting coil wound with 58 turns of No. 28 d.s.c. wire on a diameter of $\frac{3}{4}$ inch. The construction of this coil is similar to that described on page 17 of *QST*, February, 1941.

L_2 consists of 40 turns of No. 24 d.s.c. wire wound on a piece of $1\frac{1}{2}$ -inch bakelite tube. At each end of the form two small holes are drilled parallel with the edge, and heavy

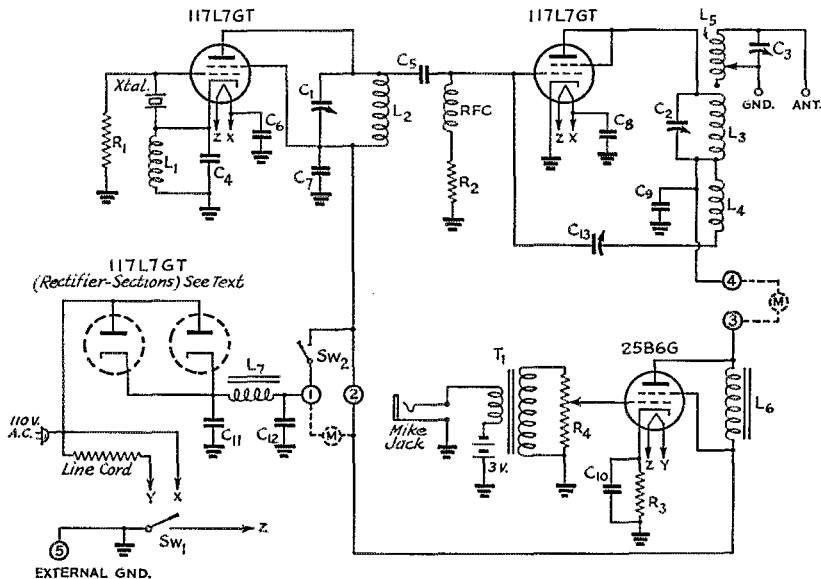

Fig. 1 — Circuit of the low-power 'phone transmitter

- C_1 , C_2 , C_3 — 140- μ fd. variable (National EX-140).
- C_4 , C_5 — 100- μ fd. mica.
- C_6 , C_7 , C_8 — 0.01- μ fd. paper.
- C_9 — 0.005 μ fd.
- C_{10} — 25- μ fd., 25-volt paper electrolytic.
- C_{11} , C_{12} — 40- μ fd., 150-volt paper electrolytic.
- C_{13} — 25-70- μ fd. trimmer.

- R_1 — 50,000 ohms, $\frac{1}{2}$ -watt.
- R_2 — 1000 ohms, 1-watt.
- R_3 — 300 ohms, $\frac{1}{2}$ -watt.
- R_4 — 500,000-ohm pot.
- RFC — 2.5-mh. r.f. choke.
- Sw₁ — S.p.s.t. switch (mounted on R_4).
- Sw₂ — S.p.s.t. toggle switch.
- Linecord — 290 ohms (Ohmite C-290).

- Battery — 3 volts (Burgess 3A2).
- Jack — Open circuit mike jack.
- T_1 — Single-button microphone transformer (Thordarson T-86A02).
- L_5 — 6-henry, 80-ma. choke (Thordarson T-57C51).
- L_7 — 8-henry, 150-ma. filter choke (Thordarson T-13C30).

Amateurs Provide Red Cross With Communications on Inauguration Day

Washington Radio Club Uses 2½ Meters for Emergency Work

BY OSCAR W. B. REED, JR.,* W3FPO

Members of the Washington Radio Club established a 2½-meter network covering the city as a unit of the Disaster Service of the American Red Cross for the inauguration of President Roosevelt on January 20th. So comprehensive was the planning for this system and so effective the results that it received widespread official commendation.

THIS year the Red Cross, increasingly aware of the need for public service in time of emergency, modeled their usual First Aid Service at public parades along the lines of a complete disaster service. The occasion of the president's inauguration and inaugural parade provided an excellent opportunity to test this disaster service.

Shortly after Christmas, through Roy C. Corderman, W3ZD, Vice-Chairman of the Communications Committee of the District Chapter of the Red Cross and A.R.R.L. Regional Emergency Coördinator, the Washington Radio Club was invited to provide communications for ten field first-aid stations. Calling on those registered in the emergency corps of the A.R.R.L. and other sources of available emergency equipment, the club set out under the leadership of its emergency coördinators to do the job.

Ten field tents located between the White House and the Capitol served as the First Aid

*7601 NW 16th St. Washington, D. C. Emergency Coördinator for Washington and vicinity.

Stations. To make each of these units capable of communicating with the District Headquarters building, the nerve center of the entire organization, required the use of self-powered radio units at each location.

At the first conference called, members of the club decided that the 2½-meter band was the most satisfactory due to present restrictions regarding use of portable equipment. At this time it was discovered that enough 2½-meter 'phone apparatus was individually available to do the job. As ever, at the last minute additional equipment was developed and used. Improvements in existing equipment was also the rule.

The Master Control station at the District Chapter Building, where a.c. power was available, made excellent use of the crystal-controlled transmitter of W3ING, running about 65 watts input to a pair of HK-24's on 115.2 Mc. In addition to the field radio stations located in the tents, two mobile units were also used. These two units, containing Red Cross personnel as well as the radio operators, served as liaison for all fixed units. Carrying supplies of additional emergency equipment, these units were called upon several times to replenish emergency power sources and provide an additional flexible message service.

Six of the field stations used storage-battery and Vibrapack power sources while the remainder depended upon dry-battery supply. Where dry batteries were used, communications equipment consisted of transceivers. In the other cases

(Continued on page 82)



Left — First-aid tent with u.h.f. link. Note the pole supporting antenna which may be seen between the group and tent. Right — Control station W3ING, set up at Red Cross Headquarters.

Band-Width and Readability in Frequency Modulation*

Effect of Channel Width on Weak-Signal Reception

BY MURRAY G. CROSBY,** W2CSY

ONE of the first questions which arises when frequency modulation is chosen for a communication system is that of the band width or amount of frequency deviation to be used. Among the many factors which affect the choice of band

modulation system, the system is not working at its best efficiency. As will be shown here, when the primary object is the transmission of intelligence, the maximum distance will be covered when the band width is made the minimum possible.

The reason for this superiority of a system using low frequency deviation over one using high frequency deviation, when maximum distance is the consideration, can best be shown by a study of the curves of Figs. 1 and 2. These curves compare the peak and root-mean-square signal-to-noise ratio characteristics of two frequency modulation systems having maximum frequency deviations¹ of 6 and 20 kilocycles, respectively. The curves were taken by varying the carrier strength of the frequency-modulated signal generator and measuring the signal-to-noise ratio at the output of each receiver for the full frequency deviation that each receiver was capable of handling. The radio-frequency input circuit of the two receivers was common so that both receivers were on an

¹"Deviation" in this paper refers to the amount of frequency shift to one side of the carrier.

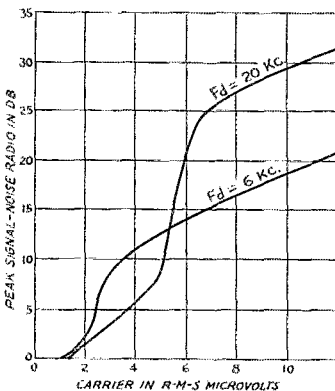

Fig. 1 — Peak signal-to-noise ratio characteristics for frequency-modulation systems using maximum frequency deviations, F_d , of 20 and 6 kilocycles, respectively. The audio band-width was 5 kilocycles. The noise was internal receiver noise and the signal-to-noise ratios were measured on an oscilloscope.

width is the subject of quality or readability of signal required. It is the purpose of this article to consider that subject and to attempt to show the relationship between band width and readability.

When the term readability is mentioned, consideration is limited to types of service in which the primary object of the system is the bare transfer of intelligence. This confines the consideration to services where the desire is to transmit voice the maximum distance with full readability. For, while a high signal-to-noise ratio is desirable in the reception of voice, increasing the ratio above a certain value does not improve the readability. Consequently if the high signal-to-noise ratio is obtained at the expense of the ability to receive weaker signals, which is the case when the band width is made too wide in a frequency

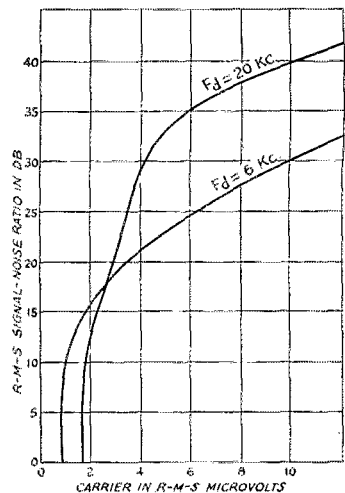

Fig. 2 — Root-mean-square signal-to-noise ratio characteristics for the same systems used for Fig. 1. The signal-to-noise ratios were measured on a rectifier-type meter.

* Also in *RCA Review*, January (first quarter) issue.

** RCA Communications, Inc., Riverhead, N. Y.

Of prime interest to u.h.f. men, this article, by an authority in the f.m. field, describes the results of an investigation of the effect of f.m. band-width on readability. Using the same band-width as normally employed in a.m. work, weaker signals can be read with frequency modulation than amplitude modulation.

equal basis so far as carrier strength and input noise were concerned. The noise consisted of the thermal agitation and tube hiss within the receiver. For the curves of Fig. 1, the signal and noise in the receiver output were measured by means of an oscilloscope which indicates peak voltages. For those of Fig. 2, an ordinary rectifier-type meter was used so that root-mean-square signal-to-noise ratios were obtained.

From these curves, it can be seen that for carriers below a certain value, the low-deviation system produces a greater signal-to-noise ratio and is therefore more capable of "reaching down" into the noise to receive a signal. It will be noted that both systems give a signal-to-noise ratio which is approximately proportional to the carrier strength down to a certain carrier strength. Below that strength there is a rather sudden drop-off in signal-to-noise ratio. This drop-off is due to a phenomenon which is peculiar to a frequency-modulation system² and which is called the "improvement threshold" effect. Any frequency modulation system has an improvement threshold above which the frequency modulation gain or improvement is realized and below which the signal becomes submerged in the noise. The threshold occurs when the peak voltage of the carrier is equal to the peak voltage of the noise in the intermediate-frequency channel of the receiver. The full frequency modulation improvement is not realized until the carrier is about twice as strong as the noise.

It will be noted that the improvement threshold of the wider system of Figs. 1 and 2 occurs at a

² Murray G. Crosby, "Frequency Modulation Noise Characteristics," Proc. of I.R.E., Vol. 25, No. 4, April, 1937.

stronger carrier strength than that for the narrower system. Hence, other things being equal, the wider system requires more transmitter power to produce a signal which will be above the threshold. The reason for this will be apparent when it is realized that the wider receiver must have a wider intermediate-frequency channel which inherently accepts a wider spectrum of the noise. The wider spectrum of noise has a larger peak voltage so that the improvement threshold for the wide system occurs at a higher carrier strength. Thus the threshold for the wider system of Fig. 1 occurs at a carrier strength which is about twice the corresponding strength for the narrower system.

The difference between the shapes of the curves of Figs. 1 and 2 is due to differences in crest factor (the ratio between the peak and root-mean-square voltage) of the noise. For carrier strengths above the improvement threshold, the crest factor is constant at a ratio of about 4.5. When the carrier is on the improvement threshold, the crest factor is higher by an amount which depends upon the deviation ratio (the ratio between the maximum frequency deviation and the maximum audio frequency of the system) of the frequency-modulation receiver. This increase in crest factor is caused by the fact that the higher peaks of the noise approach equality with the carrier so that these peaks are at the threshold while the lower peaks produce a carrier-to-noise ratio which is above the threshold. When the peak voltages of the carrier and noise approach equality, the effective frequency variation of the resultant wave rises to very high values and the stronger of the two voltages assumes control of the receiver. Thus, if the noise is stronger than the signal the noise assumes control and depresses the signal. Hence as the carrier is lowered towards the threshold, the effective frequency deviation of the noise rises until the higher peaks begin punching holes in the signal. As the carrier is weakened still further, the weaker noise peaks also punch holes in the signal so that it is submerged in the noise. The point at which the highest peaks of the noise just begin to reach equality with the carrier peak voltage, produces a "sputtering" type of noise which changes the character of tube hiss or

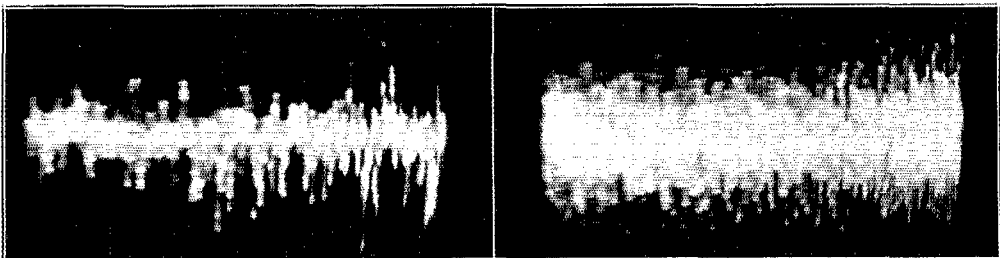

Fig. 3 — Oscillograms of internal receiver noise appearing at the frequency modulation receiver output. A (left) is with carrier-to-noise ratio at the threshold or "sputtering point." B is with carrier-to-noise ratio above the threshold.

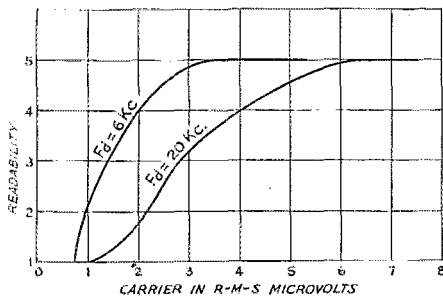

Fig. 4 — Readability comparison of frequency modulation systems using frequency deviations of 20 and 6 kilocycles, respectively. The a.f. of both receivers cut off at 5 kilocycles. The ordinates are plotted in the readability scale of the RST system, as follows:

- 1 — Unreadable.
- 2 — Barely readable, occasional words distinguishable.
- 3 — Readable with considerable difficulty.
- 4 — Readable with practically no difficulty.
- 5 — Perfectly readable.

thermal agitation so that the improvement threshold is easily recognized. Figs. 3A and B show the wave form of the noise at the threshold (which has been called the "sputter point") and above the threshold respectively.

When the noise is ignition or similar man-made noise the situation is similar to that shown by the peak signal-noise ratio curves of Fig. 1. In addition, the frequency-modulation receiver has inherent to it a noise-silencing action which is at least as effective if not better than the best amplitude-modulation noise silencer. This noise-silencing action is self-adjusting and is automatically adjusted for best operation as soon as the signal is tuned in. More detailed description of this action is considered elsewhere.^{2,3}

Listening Tests

With the signal-to-noise ratio characteristics as described above, it can be seen that the answer to the question regarding the relative readability obtainable with systems using different maximum frequency deviations depends upon the magnitude of signal-to-noise ratio required for a given readability. For instance, taking the curves of Fig. 1, if readability is obtainable on the narrower system for the signal strengths which are below the threshold of the wider system, the narrower system will have a range of superiority in readability of weaker signals. As will be seen from the following curves, practically full readability is obtained right down to the improvement threshold of the narrower system. With the wider system, full readability is not obtainable until the signal is strong enough to reach the threshold of the wider system.

In order to determine the actual difference in

³ Murray G. Crosby, "The Service Range of Frequency Modulation," *RCA Review*, Vol. 4, No. 3, January, 1940.

signal readability for systems using different frequency deviations, a listening test was conducted on the two frequency-modulation systems which were used for Figs. 1 and 2. A 5-kilocycle low-pass filter was inserted in the audio output of both receivers so that one had a deviation ratio of 1.2 and the other 4. The noise consisted of the thermal agitation and tube hiss originating in the radio-frequency circuits.

The curves of Fig. 4 show the results of the listening tests. Readability numbers of the RST system are plotted against microvolt output of the frequency-modulated signal generator. The points for the curves were taken from the averaged readings of three separate observers, namely, A. M. Braaten, R. E. Schock, and the writer.

It is obvious from these tests that the narrower system is capable of "dipping down" deeper in the noise to receive a signal. For equal readability on the two systems, it appears that the system with a deviation ratio of 1.2 will receive a signal about one-half as strong as that possible with the system having a deviation ratio of 4. Hence the minimum readable signal strength decreases approximately in proportion to the square-root of the ratio of the two deviation ratios. In the particular case of the systems used for Fig. 4, changing the deviation ratio of the system from 4 to 1.2 is equivalent to an increase in power of about 4 times, so far as readability is concerned.

The curves of Fig. 5 were taken in the same manner as those of Fig. 4, but the two systems compared were the narrower frequency-modulation system of Figs. 1 and 2 and its equivalent amplitude-modulation system. The maximum frequency deviation of the frequency-modulation system was 6 kilocycles and the audio band was 5 kilocycles. It can be seen that the narrower frequency-modulation system gives a readability which is always greater than that obtained on the amplitude-modulation system.

It is apparent from these tests that the optimum frequency deviation for a frequency-modu-

(Continued on page 86)

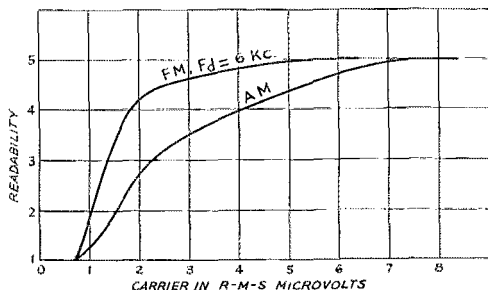

Fig. 5 — Readability comparison of a frequency-modulation system and its equivalent amplitude-modulation system. Maximum frequency deviation = 6 kilocycles. Audio band = 5 kilocycles.

After the Code Proficiency Certificate — What?

BY F. E. HANDY,* WIBDI

THOUSANDS of amateurs have now qualified for one of A.R.R.L.'s Code Proficiency Awards. Thousands of others are still starting on the road. There is hardly any slackening of the monthly pace! The certificate based on qualification from WIAW runs is now recognized as fulfilling part of the code speed requirements in the new civil service examination for "Under communications operators."

We invite every F.C.C. amateur license holder to get in the swim and get that League certification that comes from having gone upward one or more notches from the initial license requirement set by Uncle Sam. We're as happy to issue a 15 w.p.m. certificate as for higher speed. The idea is to spread the good word, and keep the program going until EVERY SINGLE HAM has done his bit to get the recognition due him — and his bit to make amateur radio more secure for us all — by showing interest in the thing that the government sets great store by which is nothing less than OPERATOR PROFICIENCY. To everybody now holding a code award we say, "Congratulations, you've done your part well. Please try this month to get one local radio friend to send in his try at *whatever* he can do. Thanks."

More power to all those who have gone upward and still are advancing their personal proficiency in the program, and to all who aim to make themselves real communication operator experts whether they have started on the program or not. The A.R.R.L. 20-25-30-35 w.p.m. stickers are

* Communications Manager, A.R.R.L.

available for recognition of each advance from your first certified speed. This short article is for the sole purpose of offering two small suggestions to those aiming at consistent progress. In a nutshell the goal of top proficiency can be attained by

- (1) Cultivation of ability to copy on a typewriter.
- (2) Building general procedure ability and code speed through traffic work.

Making Mill Copy

From two sources that we regard as reliable we have it impressed on us that the Trained Operator today *must* be able to copy on a mill. Sixty per cent of our letters from League members are typewritten, which proves amateurs have the machines available — so why not get so we can all put "ten on a line" with a mill instead of by hand? They are making portable typewriters even for the planes today! Everywhere you go you will find writing machines. A friend writes from his first assignment, "We have about 25 or 30 of the gang here and every one of them can take it on the mill. Makes a fellow feel funny if he cannot copy that way. From my short experience it is essential to have a chance in the services that every man be able to put the stuff down on a mill." Agreed then that we must learn *not only* to handle code well, but to put it down on a typewriter!

Suggestion one for learning to make mill copy is a simple one. You have heard it before. Practice

(Continued on page 90)

The A.R.R.L. Code Proficiency Certificate is available to every United States licensed amateur. The program aims to recognize your code ability. WIAW practice transmissions are scheduled daily except Friday starting at 9:15 P.M. C.S.T. on 1761, 3825, 7280, 14,253 and 28,510 kc. These will help you add to your ability to read code the knack of copying code. Now is the time to prepare for the next official qualifying run from WIAW which will take place Friday, March 21st, at 9:30 P.M. C.S.T. Aim to get your certificate or endorsement sticker for higher speed on that date.



Traffic Fun—A Defense Job for Every Amateur

IN THE January field organization bulletin of the League we requested every Section Manager, Route Manager, and Phone Activities Manager to see in connection with the many cantonments, camps, and training schools now being filled, that a personal contact be made with the officer in charge, or his representative to explain amateur radio facilities and arrange if possible for collection and origination of traffic from such points. This spells opportunity to all amateurs looking for traffic to aid personal operating ability. It is a chance for us amateurs to prove our value to the nation, handling third party messages that would otherwise never be sent perhaps but which have a distinct and great value in morale building both for volunteers and conscripts and for the friends and families at home! All such League representatives are requested to appoint a qualified spokesman to do this contact job if unable for any reason to do it in person. It will be necessary to explain amateur radio, our unguaranteed uncompensated, non-competitive service, our operator building through traffic training, our desire to be of service, in getting understanding cooperation from proper post officials. Do not offer more than can be performed. If any bottle-necks develop SCM's and Hq. will work out methods or organization to assist handling if we are advised.

It must be explained that any amateur message service does not compete with wire services, since there are no charges and can be no guarantee. Help your S.C.M. make this contact if you can. Even though a commander may not desire or be able to have an amateur station in his camp he ought to be interested in putting a box for amateur message collections in the recreation quarters with a suitably typed explanation of use of the facilities and the possible results.

This year we have urged upon each net and trunk liner the importance of exchange schedules and work in the General Traffic Period between

remote sections. This is accomplished by reliance on one or more members of a net for specified kinds of interconnecting schedules or general work. For the third month we emphasize in *QST* the importance of making fullest use of the General Traffic Period for message exchanges on every amateur frequency and mode of operation. The General Traffic Period and the proper cooperation of every licensed amateur, and use of directional CQ's, should expedite moving any and all traffic between or to the proper sections of the country. The delivery problem is taken care of best by the thorough coverage of Sections by local nets that include all larger cities. In all these A.R.R.L. nets the stations each accept responsibility for delivery to any nearby points not directly represented by radio stations.

WHAT TO DO

For those accepting this defense opportunity, and we hope every amateur will, here is an outline of the best way to get in on the fun.

If near a camp, cantonment, or training school:

1. Ask your SCM if you may represent him in making arrangements to bring about the origination of amateur radio traffic from the trainees.
2. If successfully arranged, take the following steps to see such traffic well started:
 - (a) Make prompt pickups on a schedule.
 - (b) Complete arrangements with local amateurs:
 - (1) To share any traffic load, to feed all traffic to proper points they schedule.
 - (2) To get traffic into existing lines and nets that give best service between desired areas.
 - (3) To arrange long hops such as their facilities provide for points where a lot of traffic is consistently expected to be sent.
 - (c) Urge all local amateurs to make practical use of the General Traffic Period for all bands and distances to move traffic not fitting into existing network plans.

If not near trainee centers:

1. Get on and use the General Traffic Period to grab anything coming your way — and to help relay.
2. Listen for directional CQs. Help relay to or toward destinations by schedules, nets, or otherwise.
3. Netters: Make your nets more useful by using the G.T.P. for all net stations to get

HAMS — GET IN THIS!

Amateur Radio Traffic from Uncle Sam's Trainees is already on the air. It will increase. It is an amateur radio job to help the morale of our soldiers and sailors. Your assistance, please. It is amateur radio self-training to keep every amateur frequency busy with the traffic.

Study the Outline of "What to Do" and put the principles into operation in your daily amateur operation. Get in touch with your S.C.M. to get into a net or to accept an organizing post as explained at the end of the outline.

traffic on and off the net, so *your coverage* is available to those *outside* the nets.

ALL Member-Amateurs:

Aid your S.C.M., R.M., and P.A.M. in their current expansion of delivery networks (explained in their bulletin of December 12th last).

Organizers are needed for additional town-to-town networks in many A.R.R.L. Sections. The S.C.M.¹ will appreciate volunteers for P.A.M. or R.M. until the posts at his disposal are filled. These officials have authority to initiate activities in their groups, and are specifically charged with getting an effective network in operation on a particular amateur band.

What organized delivery and inter-connecting town-to-town defensive networks does a fully organized A.R.R.L. Section have?

Route Manager sponsored:

- A 3.5-Mc. c.w. net.
- A 1.75-Mc. c.w.² net.
- A 7 Mc. c.w. net.

'Phone Activities Manager sponsored:

- A 1.8-Mc. 'phone net.
- A 3.9-Mc. 'phone net.
- 56- and 112-Mc. 'phone² nets.

Nets in general consist of up to 15 or 20 stations, usually working close to a common frequency. When over 20 stations and communities are connected in one net, two 3.5-Mc. Section Nets will be authorized. A January 22nd bulletin on "Network Organizing" contains complete outlines for starting and operating nets including procedure suggestions for operating use in both 'phone and c.w. nets. This will be sent *only* to R.M. and P.A.M. officials as we receive their appointments from their S.C.M.

All amateurs are asked to help build up organized amateur radio operation, which plays a vital part in this defense and self-training project. All amateurs who are members can become O.R.S., O.P.S., or R.M.s/P.A.M.s where vacancies are to be filled. All amateurs, *members or not* can earn a beautiful Section Net certificate by three months' successful participation in net training and operating in R.M. and P.A.M. sponsored nets. Send a postal to your S.C.M.³ to-day stating your interest in having your station part of the Section Net, so he can put you in touch with the proper R.M.-P.A.M.

One of our main talking points for use of frequencies "in the public interest" lies in our operator *training value*. Operators cannot be made in laboratories and workshops, though equipment can be developed and tested there. Knowl-

¹ See March 1940 *QST*, or send a card to A.R.R.L. for advice on existing net organization.

² Where activity and interest warrants and volunteers make possible.

³ See page 4 for addresses of all S.C.M.

Use the General Traffic Period

AID TO MOVING TRAFFIC

TRY IT! The General Traffic Period will make for effective amateur results in the traffic line.

The daily period 6:30-8:00 p.m. (your local time) has been designated the "General Traffic Period." All organized networks and official appointees are requested to work general during this period. In this manner operators who are unable to maintain regular schedules or whose operating time is limited may get on the air from 6:30-8:00 p.m. and clear their traffic through O.R.S. and T.L.S. who keep schedules on established traffic routes. Make use of this period daily to further delivery of traffic and dependability of service. *Directional CQs will also be found useful during this period.*

For 7- and 3.5- and 1.8-Mc. band operators the local time designation 6:30-8:00 p.m. will enable traffic-training minded hams to swap messages over north-south strips of territory within their time zones and perhaps extending a zone each way.

14- and 28-Mc. band operations (and longer hops on 7 Mc.) can be taken care of by making a selective use of the designated period. That is, let us assume we are in San Francisco and have a message for New York. We know that 8:00 p.m. New York time is 5:00 p.m. locally, so we get on the air with our 14-Mc. transmitter and tune for New York stations, starting at 3:30 p.m. and continuing until 5:00 p.m.

edge of fundamental theory, and code foundation are big assets of the amateur. Traffic and training are synonymous words. There is to us nothing more fascinating in amateur radio than the ability to convey intelligence past the person we can talk to directly through handling recorded traffic. Also there is no better way to train ourselves than to handle traffic . . . no better use of our frequencies!

Every one of us who is an amateur ought to be very familiar with the technique of handling recorded messages. It makes no difference whether we use c.w. or voice transmission, the ability of either the individual or the fraternity to point with pride at *communicating ability* inherent in the individual depends a lot on his knowledge of what to do with recorded communications. Skill is obtained by practice. Learning through doing is the essence of our amateur radio. Traffic is one of the very best roads to gaining keenness,

(Continued on page 86)

Push-Pull 809's in a Low-Frequency Transmitter

Inexpensive Two-Stage Rig for the 1.75- and 3.5-Mc. Bands

BY DON MIX,* WITS

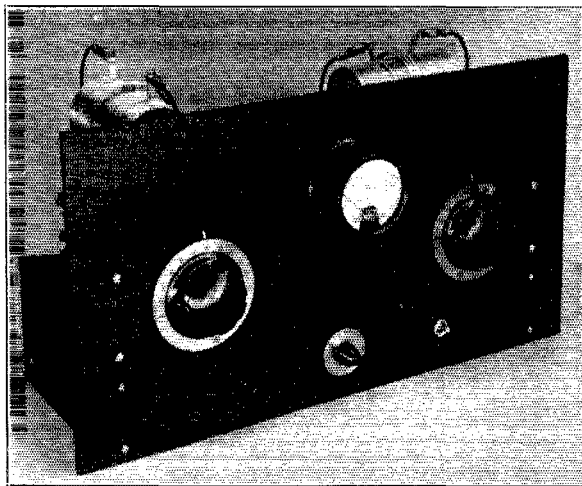

Front view of the two-band, low-frequency transmitter. The rack panel is 10½ inches by 19 inches.

MANY logical arguments have been set forth in favor of the multiband transmitter. For anyone who wants maximum power output on several bands at a minimum cost, a more practical arrangement is yet to be found.

However, the multiband transmitter does not represent the most economical design for the ham who wants to get on the air with the smallest investment and who has no particular desire to flit from band to band. Even though cost may not be important, there are other factors, such as restrictions in space for either transmitter or antenna, desire for simplification in construction and adjustment or plain lack of interest in more than one or two bands which make the multiband transmitter undesirable, or at least unnecessary.

For those who confine operation to the higher frequencies, greater efficiency and economies in space and cost will result if high-capacity tank condensers and other large components required for the lower frequencies can be eliminated. On the other hand, anyone who is interested in the lower-frequency bands only can also save considerable space and

expense and avoid unnecessary circuit complications by building his transmitter for these frequencies alone. Also, where cost is of no consideration, even multiband operation is most satisfactorily accomplished by the use of separate transmitters for each band.

The transmitter shown in the photographs is an example of what can be done in the way of simplification of circuit and conservation of space when the design may be confined to cover the two lowest-frequency bands, namely the 1.75- and 3.5-Mc. bands. A transmitter of equivalent power rating, following the usual form of multiband design would normally require three rack units, whereas the 200-watt single unit shown in the photographs requires no crowding of components to include the antenna tuner.

As the diagram of Fig. 1 shows, the circuit consists simply of a 6L6 Tri-tet oscillator driving a pair of 809's in push-pull. Since only the two bands are to be covered, no coil changing is required in the transmitter. The oscillator components may be mounted underneath the chassis where they will be well shielded from the amplifier plate circuit and close to the grid terminals. Changes from one band to the other are made simply by swinging the tank condenser between points near minimum and maximum capacities. A switch is provided to short-circuit the cathode tank circuit, reverting to the tetrode circuit in case c.w. operation with a 3.5-Mc. crystal is desired. The 50- μ fd. mica condenser, C_{15} , is used to compensate for the output capacity of the 6L6 across the opposite half of the tank circuit to balance up the grid-driving voltages.

The tank coils in the amplifier and antenna tuner are likewise permanently mounted. Change from 1.75 to 3.5 Mc. is accomplished by an arrangement of clips by which turns of the tank coils may be short-circuited. A simple system of clips also makes it possible to change from series to parallel tuning in the antenna tuner.

* Asst. Technical Editor, QST.

Why build an all-band transmitter if you operate in only one or two bands? For the ham who wants to get on the air with medium power at a minimum of expense and trouble, the economy and simplicity of this rig are well worth considering.

The single milliammeter with a scale of 200 ma. may be switched to read oscillator plate current, amplifier grid current or amplifier plate current. With the switch in the latter position, a multiplying shunt is connected in parallel with the meter to give a 400-ma. scale.

Parasitic Elimination

The high-pervance tubes which have come into general amateur use in the past year or two are reducing the problem of fulfilling driver-power requirements, but the same characteristics which make low excitation requirements possible are also largely responsible for the more frequent appearance of parasitic oscillations. From our experience with several recent amplifiers, it seems probable that parasitic-suppression devices are bound to become necessary components in all amplifier circuits. This is particularly true in regard to push-pull amplifiers.

When this amplifier was first put into operation, its performance was normal in most respects with excitation applied. The plate efficiency was somewhat below normal, however, and when excitation was removed, the amplifier went immediately into self-oscillation at a frequency in the vicinity of 250 kc. Investigation showed that the low-frequency oscillation was caused by resonant tanks in grid and plate circuits formed by the grid and plate r.f. chokes and capacities shunting them. Since the tank coils L_2 and L_3 offer no appreciable impedance to frequencies of this order, the plates and grids are effectively in parallel, with the two sections of C_3 in parallel connected across the plate r.f. choke in the plate circuit, and the grid chokes shunted by the coupling capacities C_6 and C_7 . This is a type of oscillation which is bound to be set up in any similar amplifier employing capacity coupling and the usual split-stator neutralizing circuit. An oscillation of this type may be misinterpreted as oscillation at the operating frequency caused by imperfect neutralization.

The most obvious remedy — that of eliminating the plate choke entirely — is not a satisfactory answer, since the plate tank circuit then consists of two uninterrupted portions which may make it impossible to find a neutralizing adjustment which will hold over a wide frequency range. Two-point resonance is also often observed with this connection. If a sufficiently high value of grid-leak resistance may be used, enough losses are usually introduced in the low-frequency oscillatory circuit of the grid to prevent the oscillation. However, most of the commonly used tubes are of the high- μ variety, requiring a low order of grid-leak resistance. The most satisfactory method of suppression seems to be detuning of the plate circuit by an alteration in the size of the inductance of RFC_2 , although the amount of detuning required seems to be considerable because of the broad resonance characteristic of the grid tank. Since series feed is used, it is not important that RFC_2 be a choke effective at the operating frequency. The size of this winding is determined by the amount of inductance necessary to form a sufficient impedance to break up the common connection between the center of the coil and the condenser rotors. At the same time, the resonant frequency of RFC_2 , shunted by the sections of C_3 in parallel, should be well removed from the resonant frequency of the circuit formed by one of the grid chokes shunted by one of the coupling condensers. In this case, it was necessary to go to a very small inductance.

Elimination of the low-frequency parasitic unmasked another at the ultra-high frequencies — this in spite of the fact that most leads are short and that there is considerable differ-

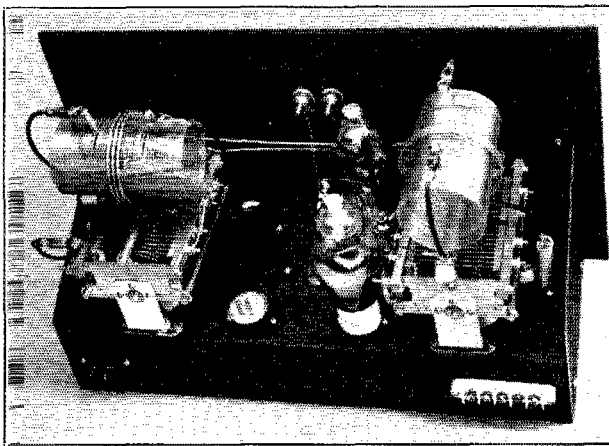

Rear view of two-hand transmitter. The chassis is 7 inches by 3 inches by 17 inches. The plate tank is to the right and the antenna tuner to the left. The two neutralizing condensers are centrally located between the two tubes.

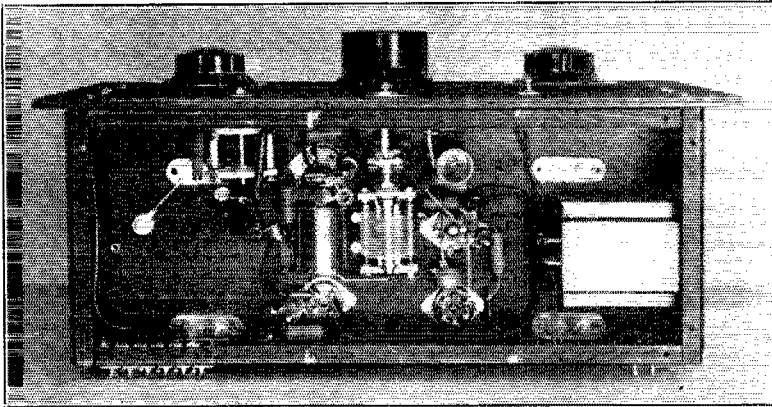

Bottom view of the low-frequency transmitter. The vertical coil to the right of the oscillator plate tank condenser is L_1 , the horizontal coil to the left is L_2 , which is permanently mounted on small cone insulators. The u.h.f. parasitic chokes are at each end of the coil.

ence in the lengths of grid and plate leads. While this oscillation was not easily started, once set off by a keying surge of the application of plate power, it would develop to vicious proportions. It does not appear that a great deal can be done in the way of arrangement of components to reduce the tendency toward this type of parasitic. One of the most effective measures that can be taken is the insertion of a u.h.f. trap tank circuit in either grid or plate leads of the tubes. When the amplifier is to be operated at frequencies of 14 Mc. and higher, the tuned circuit is recommended in preference to the simple parasitic choke because of losses introduced at the operating frequency when the choke alone is used. However, when the operating frequency is confined to the lower frequencies, as in this case, the simple parasitic choke will be entirely satisfactory.

Construction

The photographs show the general arrangement of components both above and below the chassis. The two large tank condensers are mounted with their centers $3\frac{1}{4}$ inches from either end of the chassis. Both must be insulated from the chassis. This is accomplished by supporting the condensers on metal brackets $1\frac{3}{8}$ inches wide which, in turn, are drilled at the base to fit the center holes of National FWB terminal strips. One of these strips is used above and another below the chassis at each end of the condenser after drilling half-inch holes and flattening the projections on the under strip with a file to fit the thickness of the chassis material. Large-size insulating couplings are used on each shaft and the panel-bearing units are grounded to the chassis.

The B & W coils are minus the plug mounting bars. The one for the amplifier plate circuit is insulated from the small mounting brackets, fastened to the condenser frame, by a pair of $\frac{5}{8}$ -inch cone insulators. A connection is made at the center of the coil for the high voltage.

Another FWB strip is fastened to the front end plate of each condenser with a spacer to form a means of anchoring the link line which runs the length of the chassis close to the panel.

The antenna tank coil is mounted at right angles to the plate coil by forming a pair of simple supports of No. 12 wire. Through one of the wire supports, a direct connection is made between the rear stator of C_{14} and one end of the coil. The other support is insulated from the opposite stator by $\frac{5}{8}$ -inch cone insulators screwed onto the stator studs.

Adjustable-tap connections are made with Johnson coil clips which may be clamped permanently in place, once the correct positions have been determined. Turns are short-circuited by making connection to these clips with spring clips.

The grounding condenser, C_{13} , is connected between the chassis and the front end plate of C_2 . A small feed-through insulator at one side of the plate tank condenser furnishes a connection for the high-voltage line and a mounting for the self-supporting coil RFC_2 .

Underneath, the oscillator plate tank condenser, C_2 , is mounted in the center of the chassis on a pair of FWB strips which fit the condenser mounting holes. A small insulated flexible shaft coupling is required. On one side of the condenser, the crystal socket, the 6L6 socket and the cathode coil, L_1 , are mounted in line. The form for the latter is spaced about a half-inch from the chassis with a spacer. On the other side are the sockets for the amplifier tubes and the oscillator plate tank coil, L_2 . The meter switch and the switch for short-circuiting the cathode coil are placed either side of the control for C_2 . The filament transformer is fastened to one end of the chassis, midway between the two antenna-condenser mounting strips.

Small components are mounted in available spaces close to the terminals to which they are to be connected. Upright-mounting r.f.

chokes are especially convenient in arriving at a compact arrangement. The two u.h.f. parasitic chokes are self-supporting and are connected between the ends of L_2 and the coupling condensers. The meter-shunting resistances are connected directly across the switch terminals. The multiplying shunt, R_6 , is wound with copper wire on a fibre form, its length being adjusted by trial until a full-scale reading is reduced to half scale.

A meter designed for mounting on the front of the panel was selected to permit shielding, in case a metal panel is used, and to conserve space in the rear. It is important from an angle of safety that the metal case of the meter be grounded to the chassis. Feed-through bushings for the terminals by which the meter is mounted are made by cutting an FWB strip in half and enlarging the holes slightly.

Wiring

The components are so arranged that wiring becomes almost automatic. Power wiring, done

first, is kept down close to the chassis. High-voltage cable is used for the 1000-volt circuits and No. 14 bus wire for the r.f. circuits. Holes lined with rubber grommets are provided for bringing the high-voltage leads up through the chassis to the meter terminals and for making connections with rigid wire between the lower terminals of the neutralizing condensers and the amplifier-tube grid terminals. Fibre lug strips will be found handy for making anchorages at one or two points.

Tuning

The unit is designed primarily for c.w. or 'phone operation with 160-meter crystals. 80-meter crystals may also be used by short-circuiting the cathode winding, but only c.w. operation is recommended in the absence of Tri tet buffering action. Two power supplies are required. The one for the oscillator should deliver 450 volts at 100 ma., while the one for the amplifier should have secondary taps

(Continued on page 96)

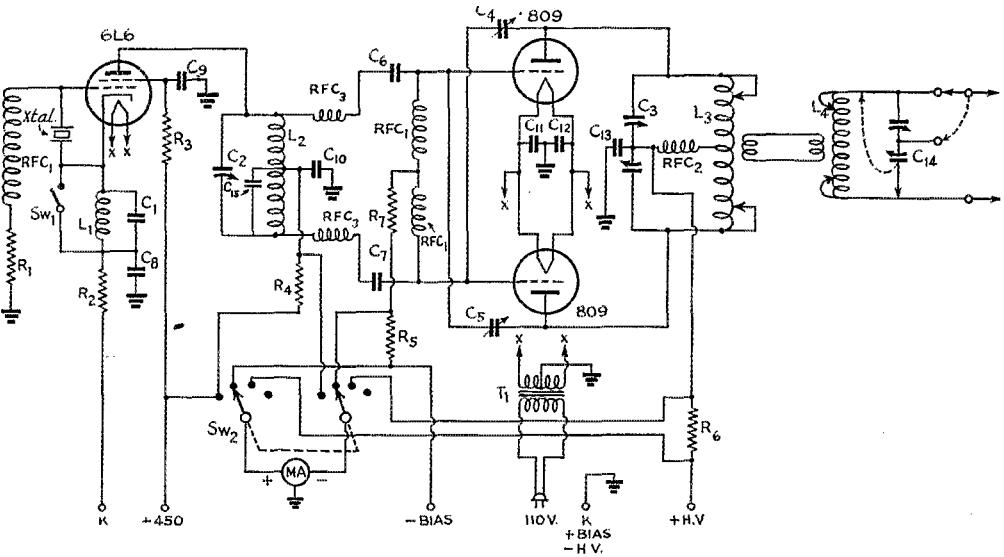

Fig. 1 — Circuit diagram of the 200-watt, two-band transmitter.

- C_1 — 100 μ fd., mica.
- C_2 — 250 μ fd., variable (National STH-250).
- C_3 — 200 μ fd. per section, 0.07-inch spacing (Cardwell XT-210-PD).
- C_4, C_5 — Neutralizing condensers (Millen 15003).
- C_6, C_7 — 100 μ fd., mica.
- $C_8, C_9, C_{10}, C_{11}, C_{12}$ — 0.01 μ fd.
- C_{13} — 0.001 μ fd., mica, 5000 volts test.
- C_{14} — 200 μ fd. per section, 0.07-inch spacing (Cardwell XT-210-PD).
- C_{15} — 50 μ fd., mica.
- MA — Projection-type milliammeter, 0-200 ma. scale (Triplett Model 324).
- R_1 — 50,000 ohms, 1-watt.
- R_2 — 200 ohms, 10-watt.
- R_3 — 25,000 ohms, 10-watt.
- R_4, R_5 — 50 ohms, 1-watt.

- R_6 — Meter shunt for 400-ma. range. (See text.)
- R_7 — 800 ohms, 10-watt.
- RFC₁ — 2.5-mh. r.f. choke.
- RFC₂ — 15 turns No. 12, 1/2-inch diam., 2 inches long.
- RFC₃ — 20 turns No. 20, close-wound, 3/4-inch diam.
- T₁ — Filament transformer, 6.3 volts, 6 amps. (Kenyon T387).
- L_1 — 40 turns No. 24 d.s.c., 1-inch diam., close-wound.
- L_2 — 50 turns, 1 1/4-inch diam., 1 3/8-inch long (National AR-80-C, unmounted, no link, 2 turns removed from each end), 50 uhy. inductance.
- L_3 — 54 turns No. 16, 2 1/2 inches diam., 4 1/2 inches long, tapped 10 turns from each end for 3.5 Mc. (B & W) 160TA, unmounted, 80 uhy. inductance.
- L_4 — Same as L_3 , taps adjusted as required.

Red Cross to Test Amateur Radio's Emergency Communications Facilities — Get Ready Now

Coming—a Nationwide A.R.R.L. Preparedness Test of Emergency Communications for the American Red Cross . . . Be Ready to Do Your Part . . . Test to Start April 4th

BY F. E. HANDY,* WIBDI

EVERY licensed amateur can participate in this Preparedness Test! Messages from 3700 Red Cross chapters containing information of importance to the Red Cross will be started from amateur stations each directed to one of the three big regional offices of the Red Cross as a test on this date in early April! A.R.R.L. Emergency Coordinators, the local spokesmen and organizers for amateur radio will arrange efficiently for starting those messages through Emergency Corps stations or others to be designated by them. After that *any licensed amateur* is eligible to take and receipt for such a message by radio, provided he will further the relaying and reliable handling of that message to the Red Cross office to which it is addressed. In Washington, St. Louis and San Francisco affiliated club organizations of the A.R.R.L. are establishing receiving centers. Their member-stations will be on every amateur band and cover every part thereof on the lookout for the messages. Every amateur who reads this notice is invited and urged to participate. Every *QST* reader with a station is asked to help relay the messages to the receiving centers with all care as to accuracy and as speedy handling as possible.

Radio amateurs are more or less familiar with message relays in which each state sends a message to Washington or in which League officials send messages to Hartford from all points. However, the prospect of the expeditious handling of over three thousands of messages is something that means A.R.R.L. must depend on *every* amateur to be in there doing his part. There will be more traffic than a few specialists can handle, and these messages will be coming from *all over* some on high and some on low frequency, some on 'phone as well as c.w. The majority of the traffic will be on the 3500 and the 7000 kc. amateur bands to judge from the course of previous tests, but with ample traffic to go around for all bands. This advance notice is to ask every amateur:

(1) To have his station ready.

- (2) To send a postal for emergency corps forms if not previously registered in the A.E.C.
- (3) To look in next *QST* for the further announcement with the frequencies of those stations on the receiving end at Washington, St. Louis and San Francisco.
- (4) To take part April 4th-6th.

This should be the biggest simultaneous test of amateur facilities of all time. It is an important job for the welfare of amateur radio, the Red Cross and the nation served by these institutions. It is an opportunity to demonstrate amateur radio more than a hobby. It is a chance to perfect and demonstrate *your own* ability to handle actual message traffic in written recorded form and by radio. The messages filed will each be individually worded. Each will go to a specific address. Messages will be limited to 15 words in the text. The summary of the contents of those messages will be of current importance to the Red Cross. There will be *something doing* every minute of this activity. Get in on the fun!

The test is dedicated to perfecting the ability of our institution (Amateur Radio) to serve the Red Cross at any time, in the event of earthquake, hurricane, fire, flood or defense emergency facing part or all of our country. The activity will help establish local contacts and perfect understandings between local Red Cross officials and amateurs who would be called on in case of actual emergency.

The receiving centers are organized to have stations watching different band sectors spaced all through the amateur bands. They will try to cover all bands as thoroughly as possible as long as they can dig out any messages the Friday, and even Saturday and Sunday of the traffic test. Attempt will be made to get all messages started promptly on April 4th. This does *not* mean that starting stations should attempt to send every message *direct* in one hop. Amateurs can assist best by individual relaying toward the message centers as well as by handling direct, and it is de-

* Communications Manager, A.R.R.L.

sired that every amateur have a chance to accept responsibility for at least one message. All amateurs getting a message on the hook will be expected to take full responsibility for that message and see the job through by sticking until it goes through by radio to another who can deliver or in turn take full responsibility for relaying toward destination.

CQ Wash'n, CQ St. Louis, or CQ S.F. will be the directional call used by every amateur who has a message on the hook for one of those places. Receiving center stations and some out-post stations that assist the message centers by taking traffic at busy hours that it may be cleared in the wee sma' hours after the peak operating rush will look for such calls. The program will be to keep trying, to keep relaying, to keep scouring the bands for any stray messages to be relayed to the proper Red Cross regional office, until *every last message started is in the bag*. The Red Cross is sending special letters to all its chapters asking reply by amateur radio on this date. The local amateur service representatives, A.R.R.L. Emergency Coördinators, are to arrange for proper starting of each message. *The rest of us* have the job of relaying them to their destinations safely and accurately.

In relaying remember that the race is not all to the swift, but to the intelligent operator who adjusts his speed to the man he is working with. A steady 15 w.p.m. following the principles outlined in "QTC1" (see page 55, February *QST*) will require fewer repeats and consequently be better all around than sloppier high speed operation. The Red Cross is aiming at 100 per cent chapter response. Our aim is "nothing short of 100 per cent relaying and delivery." C.w. is recommended for recorded communications work, and written out delivered messages are what the Red Cross is looking for. The delivery organizations make ample provision for 'phone coverage for incoming messages, however — enough to take care of every voice station operator!

In any traffic handling by 'phone, speak distinctly, grouping words by short phrases and sentences for clarity, emphasizing consonants like f, v, s, or z that might be lost or confused in a background. Speed of speaking should be guided by the accurate "writing down" speed of the receiving operator, who must *not* receipt until necessary fills have been got. Since a comparatively small volume of traffic always congests 'phone band frequencies (and there are always some grippers who place a lengthy rag chew or personal amusement above any test in the public interest — yes, sometimes even in real emergencies!) we have a suggestion to avoid possible delay, interference from side bands, arguments, etc! The intelligent thing, *to make best use of all channels* (and it is also the intelligent solution in actual emergency) is to put that transmitter on a c.w. frequency where full advantage of crystal filter

WANTED—EMERGENCY COÖRDINATORS

The aim for several months past has been to expand the Emergency Corps and to appoint an amateur spokesman, a qualified A.R.R.L. Emergency Coördinator for each one of the 3700 Red Cross Chapter jurisdictions of our country.

Do you know if the Section Manager has appointed a League member as such an organizer and spokesman for the amateur service in your locality? Such a Coördinator may be made a member of the Red Cross' Sub-committee on Transportation and Communication. If there is an opening, if you would do your best to register and plan the use of all local amateur radio facilities in line with the League Plan, drop a line to your S.C.M. (see page 4 for address) right away.

selectivity can put you through *any* kind of a mess. *Then* buzz the stations on the receiving end. No harm in warming up the basic code ability everybody has for this worthy purpose of getting the traffic through, too. Another idea for the voice station stuck with a message and a band full of QRM is to wait the QRM out. The wee small hours will bring relief and a chance to get through on 'phone if you care to demonstrate that it can be done that way. For anyone who hollers "interference" a swift change to c.w. telegraphy will bring a real relief. That will help clear up at least one of those all-too-few 6 kc.-required channels in the voice bands for somebody else, too.

Whatever you do plan to get in this test. Help the messages through. Stand-by to help put them across. Keep the circuits orderly and work coöperatively both using c.w. and 'phone. The relaying job is of such a size that on Friday April 4th at least all the low frequency bands are likely to have a capacity load of real messages. All amateurs are asked to give priority to the emergency test traffic, in order that as good a showing as possible be made. **DELIVERIES COUNT!**

Between now and April 4th:

1. Get registered in the Emergency Corps. A message or card to A.R.R.L. will bring forms if you are not one of the 3000 now part of the Corps. You can get the blanks at the nearest Western Union office, too. It's not necessary to be a League member to join A.R.R.L.'s Emergency Corps.
2. Handle ten messages, in proper form, with other stations over the air — just to get in trim. Originate some and invite answers. Put the handling data on 'em. Try some to be relayed *beyond* the station you work and see if you can stir up an answer-by-radio.
3. Practice makes perfect. Aim to have A.R.R.L.'s Code Proficiency Certificate. Don't stop there. Get in on the fun in efficient *communication work*. Get in traffic handling. Pretend April 4th is going to be an all out emergency. Could you do a job on relaying and transcribing traffic perfectly? Can you copy on a mill? Can you improve station or operating in any way in 30 days? **BE READY. . . TAKE PART ON APRIL 4TH IN THE RED CROSS EMERGENCY PREPAREDNESS TEST.**

Does the XYL believe that she took you for worse instead of better each time she passes the conglomeration of equipment spread over the "radio" corner in your apartment? Or, if still in single blessedness, do you continually hear from the head of the house about the amount of room you take up? Or perhaps the national defense program has given you an out-of-town job and you are currently staying in less spacious quarters than before. If any of these cases parallel yours, you'll be interested in reading how one ham solved the space problem without sacrificing either convenience or economy.

Not long ago I had the experience of being transferred a thousand miles away from home and faced with the necessity of keeping all my earthly possessions within the space of one room, eight by fourteen. My first thought after arrival was to write home and ask that my amateur radio junk (literally and figuratively) be sent to me. But upon arrival of the 1/2-kw. rack-and-panel job my self-appointed guardian, W1JPE,

* Assistant Secretary, A.R.R.L.



Wire screening of the power supply and bleeder resistor is well shown in this rear view of the transmitter installation, as well as the power connections between the units. The inverted 866 rectifiers are between the lower front panel and the power transformer.

Short on Space, OM?

A Transmitter Design for the Apartment Dweller

BY JOHN HUNTOON,* W1LWQ

took me to task. "Why stick a huge thing like that in your room?", he asked. "Design and build a rig which will go with the room."

"With lace curtains to match the color scheme?", I snickered.

"Listen, OF,¹" he ordered, "I mean one which fits the room — small, compact, etc."

After shedding a few tears over the thought of losing the "big rig" I began to realize what Uncle By said was probably true — it *was* an ungainly thing for a room the size of mine. It seemed to be a question of discarding the old transmitter layout, or dismantling the bed and sleeping on the floor. Possibly I am different than most amateurs, for I preferred the comfortable sleep. So I began casting (or perhaps the word is "floundering") about for ideas for a new rig in accordance with W1JPE's edict.

Back at W9KJY, a small typewriter stand on roller casters had been used to accommodate the receiver. Its convenience won so much favor that I already had ideas on its possibilities as a transmitter housing. So the problem of a small, compact and movable "rack" was solved. Such a table sells for about two-bucks-fifty at almost any office supply store. If interested, be sure you get one with L-beam uprights for ease in mounting the transmitter rather than the tubular frame.

In revamping the typewriter table to accommodate the transmitter, cross braces near the bottom were removed and in their place was mounted a double thickness of 1/4-inch Presdwood. This was used merely because it happened to be available; sheet metal or wood, of sufficient thickness to provide proper support for the components, would be just as satisfactory.

On the under side of this main shelf is mounted the 1500-volt power supply for the final stage. (Since the power supply is of standard design, its circuit diagram has not been appended to this description.) Perhaps the thought of 866 rectifier tubes in inverted mounting will cause some raised eyebrows, since the tubes' manufacturers seem to shudder at the thought. Having learned of a couple of other amateurs who use the same type of mounting, however, I decided to give it a try. When a dummy load drew about 300 watts at 2000 volts from a pair of rectifiers so mounted for a period of two hours, with no apparent harmful

¹ Old Fuss.

effects, I was convinced. The transmitter described was "on the air" during the League Member Party for operating periods as long as ten hours. The tubes do not seem to heat excessively, even though only average ventilation space is provided for them. It should be noted that this service is somewhat below the tubes' capabilities, however, and this paragraph should not be construed as a blanket recommendation for inverted mounting of any and all rectifiers.

A piece of crackle-finish Presdwood, cut to shape, is mounted as a front lower panel and supports the final plate current meter. The latter, in order to facilitate reading from the operator's sitting position, is mounted on an angle to the perpendicular by means of bushings between the meter and the panel on the lower two of the three mounting holes. On the back and two sides of that part of the lower frame housing the power supply is mounted a wire mesh screening — to keep out a careless operator's foot as well as the inquisitive family cat. Known as "hardware cloth," this material comes in a tinned or galvanized finish, and for the particular application in question was given a coat of black lacquer.

The transmitter proper consists of a 6N7G, one section being used as a Pierce oscillator and the second, when desired, as a doubler, a 6L6G driver stage and a TZ-40 final amplifier. A power supply mounted on the transmitter chassis provides necessary power for all but the final stage. The chassis, of electrical alloy, was formed by the dealer from whom it was purchased to conform to the size of the typewriter table — leaving, of course, sufficient leeway for its easy removal. Different designs of typewriter tables would doubtless call for different size chassis, and in many cases the builder would no doubt find a standard manufactured chassis available to meet his size requirements. This particular one is 11" by 14", and 3" high.

Front panel controls, from left to right across the lower panel, are: Crystal selector switch, doubler plate tuning condenser, driver plate tuning condenser, meter switch and B-power switch. Just above the latter is the final tank tuning control. The two knobs above and to the left control the antenna-tuning section which is the usual coupling scheme, identical to Fig. 1049 of the 1941 *Handbook*. The B-switch, of the double-pole single-throw variety, controls the delivery of primary power to the two plate transformers, connection to the high-voltage power unit being made through the plug and socket which can be seen just to the right of the power transformer in the rear view of the chassis. The ground connection between the two units is similarly made through this plug, while the positive high voltage is delivered to the final stage through a safety coupling.

The doubler coil socket, between the oscillator and driver tubes, allows insertion of a switching

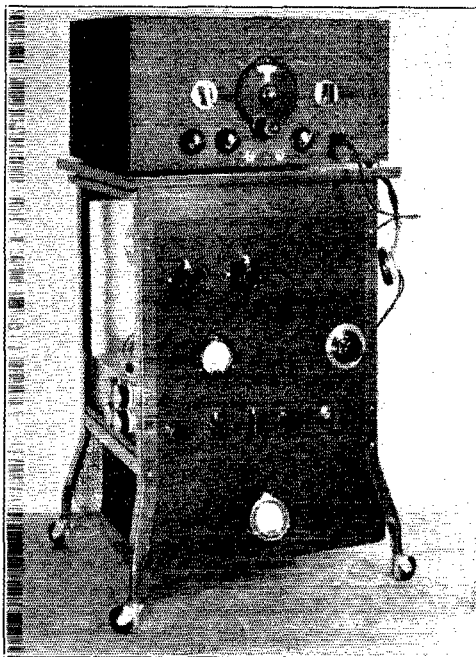

Mounting the transmitter in a typewriter stand, the receiver atop it, results in this complete station on casters.

plug with a coupling condenser when output is desired at the crystal fundamental frequency, or by inserting an appropriate coil with additional switching connections in the base (as shown in the diagram) the doubler stage may be cut in. The two large pin jacks of the driver coil socket are used for coil connections, so that the same coils are interchangeable between doubler and driver stages.

Although not neutralized, the driver stage gives no trouble when working directly from the Pierce oscillator. When the doubler stage is in use, however, and a tuned circuit (the doubler tank) is introduced into the driver grid section, the driver stage must be used as a frequency multiplier rather than operating straight through.

The transmitter is used principally on 80 and 40 meters. When working "straight through" on any one band, crystals at that frequency or of the next lower frequency band may be switched in or out indiscriminately, since the driver behaves nicely either as a straight amplifier or doubler, and of course there is no change necessary in the oscillator circuit constants since the crystal itself is the resonant circuit. For 160 meters additional capacity must be added across the final plate condenser, since the latter just reaches the low-frequency ends of the other bands when at maximum capacity. Since the final tank condenser rotor is at d.c. plate potential, the condenser is

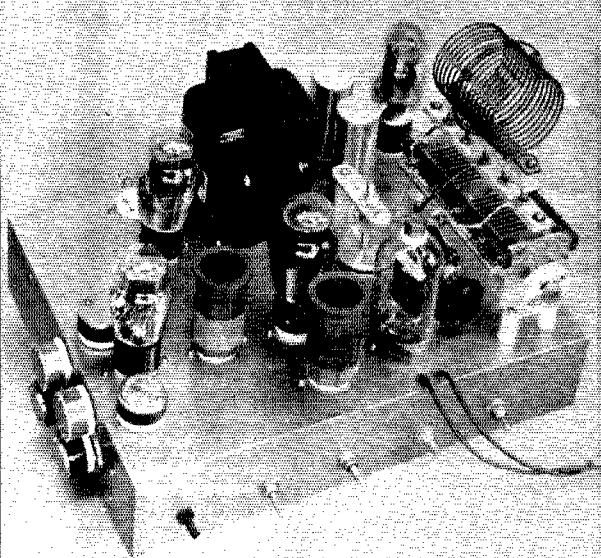

The transmitter chassis. Two leads at the lower right are connected to the meter on the transmitter panel.

mounted on suitable insulators; these particular ones are standoffs which were stripped of their metal fittings.

The transmitter employs tube keying of the oscillator. Cathode bias is provided for the 6L6G, which keeps its plate current from skyrocketing when the key is up. The final tube, of the zero-bias variety, has its grid return to ground instead of to a bias supply; the plate current without excitation is about 35 mils, a safe value. The simplest of several possible keying circuits is used, since it requires no blocking voltage. A separate filament winding is needed for the keyer tube, of course. In this connection it might be pointed out that the conglomeration of filament transformers, as will be seen from the under view of the transmitter chassis, resulted because they happened to be already available. A constructor wishing to duplicate this equipment would do well to secure a single filament transformer (or possibly two) providing all the necessary filament windings.

A word about the Pierce oscillator: If the driver tank condenser happens to be tuned somewhat on the minimum-capacity side of resonance, it will tend to act as a crystal oscillator itself, taking command of the particular crystal which happens to be in the circuit, independently of the 6N7G. Tuning said tank slightly to the high-capacity side of resonance will eliminate this tendency. Alternatively, a half-dozen or so turns could be wound at the "cold" end of each coil used in the driver stage, the outer lead introduced to the 6L6 grid through a small condenser (the center lead to ground) to provide sufficient neutralization. The 6L6G has no inclination to oscillate by itself — it is merely that sometimes it becomes putty in the hands of Madame Xtal.

The bleeder resistor is mounted on the outside of the chassis for ventilation. As a means of pro-

tection, a small rectangular piece of the previously-mentioned "hardware cloth" is soldered to a frame of bus wire of appropriate size, which is then bolted to the back of the chassis as a guard against accidental contact. The resistor is mounted on feed-through bushing insulators, and the oscillator plate and buffer screen voltage tap is also brought through an appropriate bushing.

The typewriter stand in which the transmitter is housed also serves as a table for the receiver. A small sliding shelf provides additional table space and can be used for callbook and logbook, or for the key itself. For the latter purpose it would not be too comfortable, however, and the builder should plan on confiscating the family secretary for writing space and for the key during periods of operation. One might think that such a location for the receiver would not provide ease of operation; it should be pointed out that the set-up is primarily for a particular service — traffic handling and net operation, all on predetermined frequencies and schedules — and for that purpose it is excellent. As a matter of fact, I previously used such a stand for my receiver in preference to putting it on the large operating table available. Even in general operation, such as ORS parties, its convenience is more than adequate. But for the DX man as an example (if DX men are ever examples) this installation might have to be augmented by a support for the operator's hand doing the tuning. The stand appears to be able to take it; at least, there is plenty of weight on this one, with no apparent harmful

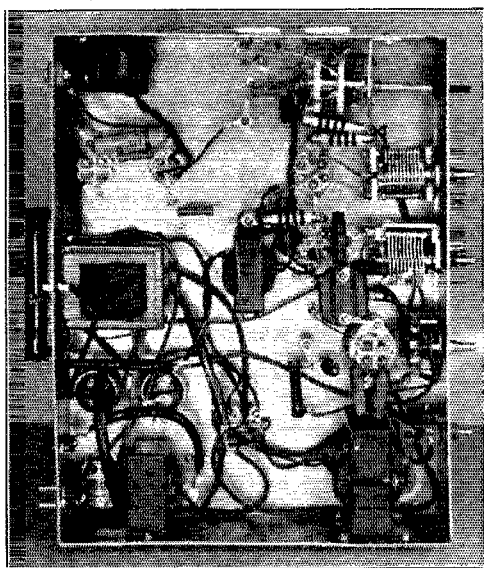

Underneath the chassis. The shaft of the crystal switch, at the upper right, was lengthened for this installation by a bakelite insulated coupling.

effects. With a power supply mounted so near the floor, the center of gravity is sufficiently low even with a receiver atop the table to avert any possible upset should it be carelessly bumped.

Here is a complete station on roller casters, minus only key and antenna. It can be kept in a closet or in an out-of-the-way corner when not in

use. A writing desk or table, normally part of the household furniture, can be used as an operating table for key and log when the operator wishes to go on the air, and the transmitter merely rolled out alongside it. All in all, this type of construction provides at least one solution for the amateur without much space.

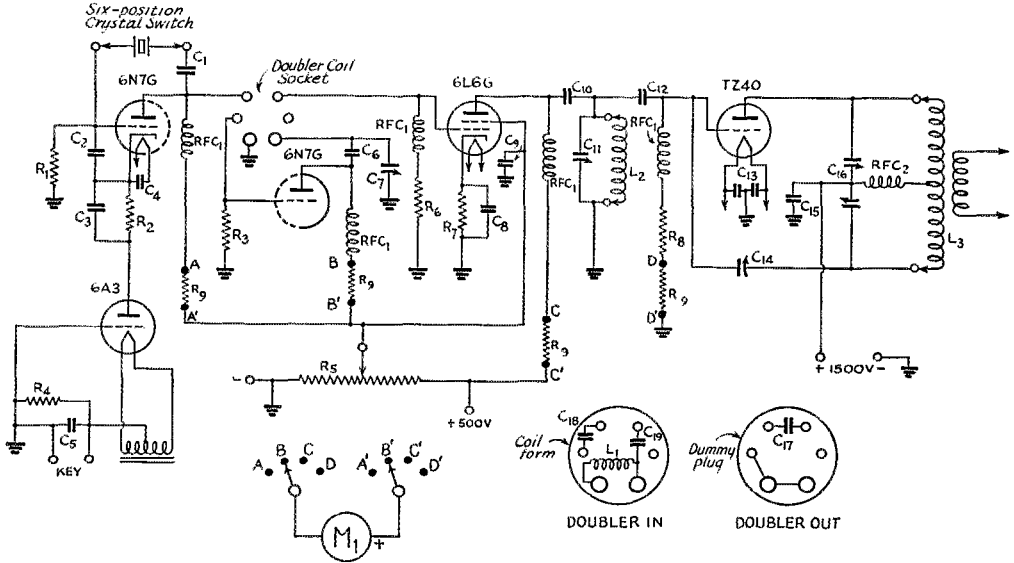

- C₁, C₉ — 0.002- μ fd. mica.
- C₂, C₁₈, C₁₉ — 100- μ fd. mica.
- C₈ — 0.001- μ fd. mica.
- C₄, C₈, C₁₃ — 0.01- μ fd. paper.
- C₅ — 0.25- μ fd. paper.
- C₆, C₁₀ — 0.002- μ fd. mica.
- C₇, C₁₁ — 100- μ fd. variable (National ST-100).
- C₁₂ — 0.0001- μ fd. mica.
- C₁₄ — 1-7- μ fd. neutralizing condenser (Cardwell ADN).
- C₁₅ — 0.002- μ fd. mica, 2000-volt.
- C₁₆ — 100 μ fd. per section variable (Cardwell MT-100-GD).

- C₁₇ — 50- μ fd. mica.
- R₁ — 100,000 ohms, $\frac{1}{2}$ -watt.
- R₂ — 2,000 ohms, $\frac{1}{2}$ -watt.
- R₃ — 25,000 ohms, $\frac{1}{2}$ -watt.
- R₄ — 10,000 ohms $\frac{1}{2}$ -watt.
- R₅ — 25,000-ohm bleeder, 50-watt.
- R₆ — 2,000 ohms, $\frac{1}{2}$ -watt.
- R₇ — 400 ohms, 10-watt.
- R₈ — 2,000 ohms, 10-watt.
- R₉ — 25 ohms, $\frac{1}{2}$ -watt.
- RFC₁ — R.f. choke (National R-100).

- RFC₂ — R.f. choke (Hammarlund Ch-500).
- L₁, L₂ — On six-prong coil forms, 1 $\frac{1}{2}$ inches diameter. 80 meters: 30 turns No. 18 d.c.c., close wound. 40 meters: 17 turns No. 18 d.c.c., spaced to occupy 1 $\frac{1}{4}$ inches. 20 meters: 7 turns No. 16 enameled, spaced to occupy $\frac{1}{8}$ inch.
- L₃ — Barker & Williamson BXL series.
- M₁ — 0-100-d.c. milliammeter.

Strays

W9QDF and some of the other fellows in St. Paul have been mystifying the gang recently with a new abbreviation, 78. Generated as a compound of 73 and 88, they say it means "Best of everything," and is designed to save the energy now required to say the best of this and the best of that. Hi!

A battle-scarred table top can be made better than new by covering it with a sheet of tempered Presdwood, obtainable at most lumber yards. Its surface is good looking, easy to clean and makes a good writing surface. Mine cost 67 cents.

— W7HAL.

W4MY wants to know if his grandfather's neutralization papers will help in establishing his citizenship. — W4FWD.

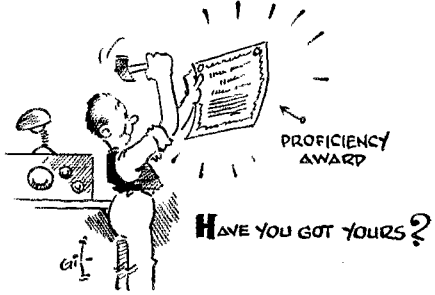



ARMY-AMATEUR RADIO SYSTEM ACTIVITIES

THE WAR-amateur contacts continue to interest many amateurs. WAR has contacted more than 500 amateur stations up to late January despite poor radio conditions on the 40- and 80-meter bands. It is expected that the new WAR QSL cards will be available this month for mailing to all working WAR. The following schedules are observed for amateur contacts:

TUESDAYS, WEDNESDAYS, THURSDAYS, AND FRIDAYS

E.S.T., p.m.	Amateur Band	WAR Frequency
7:00-7:45.....	3500-3900 kc. (c.w.)	4025 kc.
7:45-8:00.....	3900-4000 kc. (phone)	4025 kc.
9:00-10:00.....	7000-7300 kc. (c.w.)	6990 kc.

Comments or suggestions concerning these schedules are invited from interested radio amateurs.

COMMUNICATION OPERATORS WANTED FOR WAR DEPARTMENT RADIO NET STATIONS

THERE are a number of vacancies in the War Department Radio Net stations throughout the United States, for qualified radio operators desiring to become communication operators. The requirements are high-school education; touch-typing ability of at least 50 words per minute; ability to send and receive clear English text in the International Morse Code at 30 w.p.m. and five-letter code groups at 20 w.p.m. The pay for this "Under-Communication Operator's" grade is \$1440 per annum. These student operators will be given instruction in reading siphon-recorded tape so that they may be advanced to the grade of "Junior Communication Operator" at an annual salary of \$1620 when they are able to read the

recorded tape at 50 w.p.m. and to operate the tape perforators at 50 w.p.m. Men who have been actively engaged in the operation of amateur radio stations for the past three years and who possess the other qualifications are eligible for these positions. *The A.R.R.L. Code Proficiency Certificate will be recognized as fulfilling the 30 w.p.m. clear-text requirement.*

All applicants must pass a Civil Service examination embodying the aforementioned requirements. Interested Army Amateurs and other radio operators can apply to the War Department Message Center, Washington, or to their respective corps area signal officers for further information and application forms.

ARMY-AMATEUR NET CALLS

TO ASSIST the F.C.C. monitoring stations in their surveillance of the amateur bands, Army-Amateur stations will use the procedure signal "ZCAA" preceding state-net or other net calls when operating on amateur frequencies during drill periods or net schedules.

ANNUAL CODE SPEED CONTEST

THE Annual Code Speed Contest occurred February 10th. Automatic tape transmissions were sent by WLM, Washington, at speeds from 20 to 60 words per minute, in increments of 5 w.p.m., starting at 10:00 p.m., E.S.T. on both the 3497.5 kc. and 6990 kc. special frequencies. Similar transmissions starting at 9:00 p.m. P.S.T., but using different text, were made by WLW, San Francisco, for the benefit of Army Amateurs in the states west of the Mississippi.

The Veterans Wireless Operators Association

(Continued on page 55)

NET IN OPERATION

E.S.T., p.m.	3497.5 kc.	Call Signs	6990 kc.	Call Signs
5:30-6:00.....	1st Corps Area	WLG-	Army Net	WLM-
6:00-6:30.....	3rd Corps Area	WLQ-	8th Corps Area	WLJ-
6:30-7:00.....	5th Corps Area	WLH-	Army Net	WLM-
7:00-7:30.....	ZCVA - General Broadcast Message to all Army Amateurs on Monday nights. Army Net period on other nights.			
7:30-8:30.....	2nd Corps Area	WLN-	Army Net	WLM-
8:30-9:00.....	6th Corps Area	WLT-	8th Corps Area	WLJ-
9:00-9:30.....	7th Corps Area	WLU-	WAR-Amateur Contacts	
9:30-10:00.....	Army Net to all Corps Areas			
10:00-11:00.....	Army Net to all Corps Areas			
11:00-12:00 M....	9th Corps Area	WLV-, WLY-	ZCVA Broadcast message on Monday nights. Army Net to various Corps Areas and Hawaii	WLM, WLXA-

You'll enjoy reading this article — and get some good pointers as well. And not only technical pointers; the other aspects are important, too. The moral — there's a happy ending if you'll work for it!

Local Boy Makes Noise

A Saga of B.C.I. and Its Cure

BY CHESTER WESMAN,* WØPFR

THIS is the tearful tale of the b.c.i. interference caused by a 400-watt 20-meter 'phone, and what was done about it socially, legally, and technically. Fellows have told me on the air that they had b.c.i., but that their cases were hopeless and so they either operated in defiance of their neighbors' complaints or curtailed their own operating pleasure. Let me go on record as saying that both are needless, and that the old saw about "all cases of b.c. interference can be cured" is no baloney.

To make my position clear it is necessary for me to state at the outset that my investigation was conducted at the request of the F.C.C. as the result of a complaint that was filed against me. This is not as bad as it sounds and, although it is to be avoided, in my case it was a blessing in disguise. Let any of the brethren who think their b.c.i. troubles insurmountable because of strained diplomatic relations lend an ear and take heart.

The action was taken by my own particular "worst enemy" who approached me one fine day and told me that my voice was all over his broadcast dial. (I had just increased power from 100 watts to 400.) Trying hard to keep from socking him on the jaw, I smilingly informed him that I was overjoyed to receive this information (oh, yeah?) and that I would be glad to perform the necessary work on his receiver to eliminate the interfering signal. He insisted that I do something to my "thing up there." You know how much fun it is to explain the technical aspects of b.c.i. to a b.c.i. They all seem to think you're lying about your transmitter being okay. (You'd better be sure it is!) I actually thought I was getting some place with this guy, though. He finally agreed that I could have his receiver to work on for a couple of days, and that he would consult with the family and let me know when they could best do without it. It was necessary in my case to do all the testing of b.c. sets right in my station as there was no one to operate the rig while I tested at the b.c.i.'s location. So I set calmly back and waited for him to give me the go-ahead signal. It never came.

The next thing I knew I had a form letter from the F.C.C. advising me that Soandso was the complainant and I was the amateur. This was hard to believe. I looked at the date line on the letter. Five and a half days had elapsed between the time I talked to the b.c.i. and the time

the F.C.C. wrote me the little invitation. Then the information began to come in. Soandso had sworn that he'd never let me lay a hand on *his* radio. Soandso had declared publicly and often that he was going to run me off the air. I was a public nuisance. My neighbor informed me that Soandso had visited him and told him to keep a lookout through the window as the cop was coming over to "run me off the air." Other people imparted to me the information that Soandso had been around town soliciting signatures on a petition requesting my removal from the ether waves.

And that is why I say the action taken against me was a blessing in disguise. The next thing Mr. Soandso knew, he was the recipient of a form letter from the F.C.C. advising him that he must not assume the amateur was at fault, and that he must cooperate with me. He must have been terribly disappointed at this, especially after spreading the word that I was going to receive "a letter from Washington" which would put an end to my hamming, pronto.

The F.C.C. was on my side. I had been ready, willing, and able; now Mr. Soandso was being compelled to cooperate with me.

I spent a lot of time running back and forth between Mr. Soandso's house and the station, and wasted a lot of air trying to tell Mr. Soandso's mother (who was baking cookies in the kitchen) how to disconnect the antenna for a test and, later, how to tune a wave trap while I made test transmissions. She said the wave trap made me louder. I stated that this was the extent to which testing could go without my taking the receiver

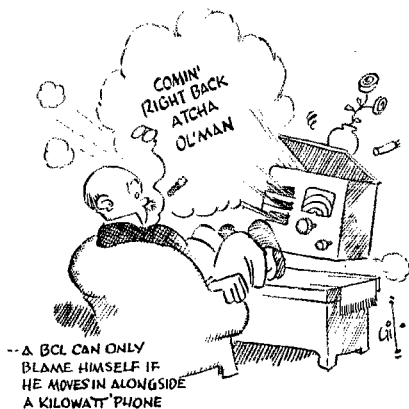

* Melrose, Minnesota.

home with me. Or, if she did not desire me to work on her receiver, I would be glad to make test transmissions while the local serviceman performed the operation. She didn't know. She'd have to talk it over with her "men folks". She said I should come over at seven that evening and see them. I did; but they weren't there. I tried again. They had just left. I tried again. No soap.

I finally cornered them at dinner time. The family discreetly withdrew, leaving me alone with Mr. Soandso and his father.

Then we had it, hot and heavy.

I was told in no uncertain terms that they didn't have to go through all this fuss and expense just to hear a radio program. They'd take it to the city council. (I knew that he had already done this and had been turned down.) Mr. Soandso informed me that he had sent in a petition that practically the whole town had signed and my dismissal from the air was but a matter of days. Also many other individual letters of complaint were now pouring into the offices of the F.C.C. "If I wanted to get mean about it," he said, "I could fix it so you wouldn't have your old radio any more!"

I stated that all that was necessary was to permit me to work on his radio for a day or two and I would eliminate the trouble. His father didn't want to miss his programs. He was worried about the line in the F.C.C.'s form letter which has to do with power supply work having to comply with the National Fire Underwriters' Code. Besides, I never did know anything about radio or why didn't I fix the trouble right where it started? I said they could use my b.c. receiver while I worked on theirs. Mr. Soandso asked if it worked. When I replied in the affirmative, he stated that, then, he'd keep my set if his didn't work when I brought it back. His father said yeah, how about that? What if it didn't work when I brought it back? I assured them it would work.

I brought them my b.c. receiver and took theirs to the station. My Mom was then drafted into the service, and to her goes plenty of credit for dropping household duties at a moment's notice

to come time after time to the mike and furnish modulation for my tests.

The Culprit

This receiver was a Philco model 96. It had three r.f. stages using 24's, a 27 detector, 27 audio, 45's in the output. Interference reported was all over the dial. Jerking the r.f. tubes left the interfering signal unchanged. However, Mr Soandso's mother had told me that disconnecting the antenna eliminated the interference. How could the antenna be responsible for the pickup if the removal of three r.f. stages did nothing to cut out the signal? This is a good point to remember, and the way it happens is this: the antenna brings the interfering signal into the set, but once inside, the interference is effective at a point different from that which goes to work on the b.c. frequencies. In this instance the 27 detector was the culprit. The grid and plate of the 27 were tied together and it acted as a rectifier for any r.f. that the three stages of 24's selected from the air and fed into it. The 24's, however, had nothing to do with my 20-meter signal as they were tuned to b.c. channels. But the detector was untuned and rectified anything that came along, which happened to be me. Placing my hand near the bulb of the 27 indicated that there was plenty of pickup to be had in this fashion. This tube is semi-shielded as it is, but I put a complete shield over it. The combined grid and plate of that detector was extremely sensitive to my r.f. To cut out any of my signal that was coming in via the wire which led to this point an ordinary 2½-millihenry r.f. choke was placed in series with it immediately adjacent to the tube socket. Tests in the station showed that this choke cut the r.f. pickup tremendously, but many wires were still sensitive to my signal. Although the choke cut out most of what had formerly arrived through the direct connection of the wire, there was still a great deal of pickup in the wiring which was in a position to transfer it through capacity to the grid and plate prongs of the tube. All wires near the tube socket were replaced with shielded wire and the improvement was very decided. It was noticed that an increase in signal strength could be obtained by grasping the speaker cable or putting a test lead near the speaker frame. This was also found to be transferred by capacity between wires in the set. Shielding all wires that led from the speaker socket cured this. It was found necessary to shield the 2½-mh. r.f. choke, and even the inch of wire that tied the grid and plate of the 27 together was replaced with shielded wire. The r.f. choke was shielded by first wrapping with friction tape and then with several layers of foil from an old condenser, connecting a wire securely to the inner folds of foil to furnish a good ground for the shield.

At this point the receiver was picking up so little signal from the 400-watt transmitter only

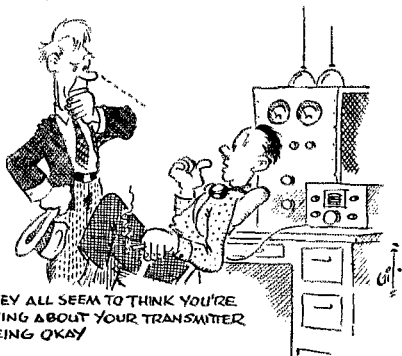

THEY ALL SEEM TO THINK YOU'RE LYING ABOUT YOUR TRANSMITTER BEING OKAY

six feet away that it could be operated over the entire b.c. band without interference to any program, although the modulation could still be heard faintly between stations. Inasmuch as the b.c.l. lived half a block distant, I decided that it would be okay.

Further tests with the receiver in its home location brought the report that the modulation was still faintly audible at several points on the dial. I thought that if everything was as it should be at the b.c.l.'s house there should be no pickup. Previous tests had shown that there was no signal entering from the a.c. mains, so I decided to inspect the antenna system. It proved to be the guilty party. Whoever had installed the antenna had put up a 75-foot stretch of wire with a glass insulator at each end, and the wire which supported the near end proved to be the lead-in wire itself. The antenna and lead-in wires were on opposite sides of the insulator, and there was no connection between them. Because of this, the receiver picked up b.c. frequencies better with the antenna post connected to the ground wire and, just to do something with the other wire, which was the lead-in, the b.c.l. had connected it to the chassis ground. This procedure made the chassis hot with respect to my signal, and all the shielding in the set was rather ineffective in keeping out the 20-meter r.f. So I got a ladder and clambered up on top of the house to connect the antenna with the lead-in wire. This done, it was possible to get plenty of b.c. signal pickup with the antenna, and the chassis could now be connected to actual ground.

Tests with this set-up brought the report that absolutely nothing could be heard of the 20-meter 'phone signal from W9PFR, even with my input boosted to 500 watts and my beam directly on the b.c.l. antenna. My dealings with Mr. Soandso were ended.

One of "Those Things"

Case No. 2 was that of a "bargain superhet." The make is immaterial because there was nothing distinctive about it. This b.c.l. reported spot tuning which, of course, is due to components of the receiver's oscillator beating with components of the transmitted signal to produce resultant frequencies within the tuning range of the b.c. receiver. This receiver had no preselection; the antenna worked directly into the converter tube, which was unshielded. The first step was to shield the converter to prevent the signal from acting directly on the elements inside the tube. Next, to keep any 20-meter r.f. from entering via the antenna and becoming effective at the converter grid, a small homemade r.f. choke was inserted in series with the grid lead directly adjacent to the tube cap. The construction of this r.f. choke will vary with the circuit to which it is applied and the frequency which it is designed to eliminate. In this particular circuit, a



2½-mh. r.f. choke threw the circuit so far out of line that all you could hear were howls and squawks. The choke which finally did the business without affecting the b.c. operation of the receiver was one made of 200 turns of fine wire wound around a piece of No. 14 copper wire, which was removed after the winding. The effect which the insertion of this choke had on the receiver when operated next to the transmitter was to reduce the strength of the spurious responses from the low end of the b.c. band up to about 900 kc. There were still a couple of honeys from there on up. But when taken to the b.c.l.'s location, which is fifty feet from the rig, there was absolutely no sign of spot tuning. Finished? No, not yet. Now that the S9-plus spots were gone, something else, which had gone unnoticed before, showed me that I wasn't finished. My modulation was now about S2 over the entire band, unaffected by the volume control setting or tuning of the variable condenser. The guilty critter here was the 75 second detector, which had an open wire grid lead and an unshielded tube top. Another choke was put next to this grid the same as the converter tube, and shields added. The grid lead to the i.f. amplifier was also shielded. This made everything hunky-dory.

An Antique —

Case No. 3 was an RCA Radiola 33 Model AR 784. This receiver uses three 26's in the r.f. stages, a grid-leak detector with a 27, a 26 first audio and a 71-A output. Signal from W9PFR reported all over b.c. dial, unaffected by position of volume control or tuning condenser setting. Removing the 26's left the interfering signal unchanged. The point at which the 20-meter field was becoming effective was the grid of the 27 detector. Some of the energy was entering the tube directly, because of lack of shielding; some of it was entering the circuit directly via the open wiring in the detector grid circuit; and some of it got into the grid circuit by capacity from the antenna lead which comes into one side of the chassis and crosses way over to the other side to connect to the first r.f. stage grid. This long antenna lead was replaced with shielded wire.

The detector tube was shielded, and a small homemade r.f. choke inserted in the grid circuit. Each of these steps caused a reduction in the 20-meter pickup and at this point the interference level was so low that I returned the receiver to the b.c.l. location. A test brought the report that my modulation was faintly audible at two sharply tuned spots on the dial. The b.c.l. insisted he had no use for either of these places, and that the performance of the receiver was entirely satisfactory.

— And a Phony

Case No. 4. Personal relationships enter into this one. This receiver belonged to the household of which Mr. Soandso's girl friend was a member. Mr. Soandso reported the case to me during the argument I had with him and his father. He told me that I came in all over the dial and completely drowned out every single b.c. station. Upon calling at the residence and inquiring as to the type and intensity of the interference, Mrs. X informed me that she couldn't say because she had never heard me. Miss X said she didn't know where I came in or how loud I was because it was her brother's programs I interfered with. Her brother said he couldn't tell me how loud I was or where I came in because he didn't know anything about radio. I smelled a rodent, but I kept my trap shut.

I took the receiver, an Apcx 31-B, back to the station and set it on the floor at the base of the rig. I plugged into an outlet which is tapped into the special BX cable which runs directly from my transmitter to the watt-hour meter and connected the antenna post of the receiver to a feeder which runs up to a pair of collinear half waves in phase suspended 33 feet from the vertical W8JK rotary to which the rig was tied. The transmitter was then operated at full input. The receiver worked without the slightest trace of interference over the entire broadcast band.

This receiver has a shield can which encloses three 24 r.f. stages and a 27 detector. I removed the top of this can and tapped a four-foot test lead onto each of the r.f. grids in succession, but there was still no sign of my modulation. I placed my hand around the detector tube to provide body capacity pickup, but still no interference. Since the X residence is over a block away, this caused me no end of dubiety.

Knowing that if there were any pickup in a receiver of this type, the place where it would most likely be effective would be the detector grid, I inserted a 2½ mh. r.f. choke in series with the detector grid lead, directly at the grid connection of the socket. I returned the receiver to the X home and transmitted a test. Upon returning I was informed by Mrs. X that she had listened carefully over the entire band and had found no trace of my signal.

Routine

Case No. 5. This receiver was a Philco Model 511. It had 26's in the r.f. and a 27 detector. A test at the station showed absolutely no signal pickup and the same procedure was gone through with this set as in case number four, including the insertion of an r.f. choke at the detector grid. Upon returning it to the b.c.l. location and transmitting a test, it was reported that my voice was still all over the dial but very faint. A shield was placed around the 27 detector and this eliminated the interference entirely.

A Misinterpretation

Case No. 6. In order to make this case plain, it is necessary to state here that, upon reception of the F.C.C.'s form letter, I submitted notice of test transmissions to the local paper and invited the public to listen at certain times to determine whether I was interfering with their reception of programs.

This receiver was in a convent better than four blocks away. The sister who saw me on my visit there stated that she was unfamiliar with the interference, but that they could hear my voice clearly at one point on the dial. This was a super-heterodyne type with exposed grid leads and unshielded coils. It had a short-wave switch which extended the tuning range of the receiver to 6 megacycles. There was no preselection and the antenna worked directly into the converter. As the type of interference described indicated a beat frequency within the broadcast range, a high-frequency choke was placed in the grid lead of the converter tube directly at the tube cap and several open grid leads in the i.f. and r.f. sections of the receiver were replaced with shielded wire.

Returning the receiver to the convent, I arrived just as a group of sisters were congregating in the room. I informed them that they would have no further interference from my voice on their receiver. There was a great deal of surprise at this remark, and I was at a loss to understand it until several of the sisters stated that they wanted to listen to me, but that it was the other interference I created which they wished me to eliminate. Inasmuch as my a.c. line to the transmitter is well filtered and is a grounded BX cable, and my signal is clean, and the convent is slightly over four blocks from W9PFR, I did not understand what they meant by "other interference." I inquired further and learned that it was not a noise which I caused that was objectionable, but the fact that ever since the notice of my tests appeared in the local paper, they had been unable to receive any broadcast stations except one or two very faintly at one end of the dial. It occurred to me that they may have inadvertently thrown the short-wave switch, and that the b.c. stations which they had heard were those operating in the extended b.c. band above 1500 kilocycles. Much

questioning upheld this theory. They didn't know that they had a short-wave switch on the receiver and, having thrown the switch to a band which, on this particular receiver, was almost perfectly blank, they connected the notice in the paper with the lack of stations on their receiver, and assumed that I was the cause of it. I very carefully explained the short-wave dial to them and transmitted a test to determine the effectiveness of the steps I had taken to eliminate reception of any spurious beat frequencies. As a result of this test transmission, the sisters advised me that they could not hear me anywhere on either the broadcast band or the short-wave band. They requested me to remove whatever I had put in their receiver, as they desired to listen to my signal. I did this, and the receiver was restored to its original condition.

Retrospect

Actually diving in and cleaning up the b.c.l. trouble turned out to be a lot simpler than I had expected. Mr. Soandso, angry because the Commission's procedure denied him anonymity, told wild tales of how widespread my interference was, and how many complaints had been made against me. I visited some of the people who he said were bothered by my transmitter and discovered that the majority of cases were pure fiction. Household devices caused a lot of interference, as well as near by high-tension wires and telegraph lines. The latter give a perfect imitation of a kilowatt c.w. rig being keyed in the final B-plus lead with no click filter. The city electrical superintendent told me that he had received numerous complaints about my transmitter and said that he would estimate the affected receivers as being two out of three sets for a radius of two blocks. He advised me that the best thing was to lay low for a little while and let them cool down, as it would be impossible to fix all the receivers that I was bothering.

To anyone who is confronted with a similar proposition all I can say is, don't let it scare you. I went on the air for seven evenings requesting the

public to notify me of interference, and four of these evenings were publicized on the front page of the local paper. Do you know how many answers I received to these tests? One! And that was the case at the convent, which I mentioned. *Not one case of interference showed up as a result of these tests.* But don't think they didn't do any good. They showed a great many people that the noise they had attributed to me was in reality something else.

In applying the remedy to any given receiver, here are a few short-cuts that will save you lots of worry.

If the interference is untunable, you know right off the bat you're not coming in on a carrier and that the pickup stage is on the other side of the receiver's selective system. In a t.r.f. set the troublemaker is almost always the grid of the detector. A choke and a tube shield as described in Cases 1, 3, 4 and 5 will usually fix this. To find the pickup points in any receiver take a test lead a couple of feet long and touch the outside connections of each tube under suspicion. The second you hit a point that needs attention your transmitter signal will come up. Having found a point of pickup, the next thing to do is to find the point at which that pickup becomes effective. For example, you might discover that touching your test lead to the plate of a tube increases your signal strength. Try taking this tube out and touching your test lead to the same plate clip on the empty socket. If you obtain the same increase in the interference level, you know that, although picked up in one stage, the signal is effective in the grid circuit of the following stage. If the circuit which shows pickup doesn't strike you as being one which could cause trouble, look for open wiring in more sensitive circuits running close by. Perhaps there is capacitive coupling. This is not as far-fetched as you may think. In case number one I shielded eight wires which had nothing to do with the circuit that was causing the trouble. They just happened to run close by and were a cause of considerable interference pickup.

If the volume of your interfering signal is not affected by the volume-control setting, you know that you are coming in on the other side of it. To determine the effectiveness of an r.f. choke in cutting out interference, touch each side of it with a test lead. The cold side should show little or no pickup, while the hot side will be the same as without the choke. There are many cases where a good 2½-mh. choke will work to perfection; but there are places where they will kill the b.c. signals as well as your own. When it is necessary to wind your own chokes, wind a lot with about ten turns difference between them. Then, with the rig going full blast, substitute one for the other as fast as you can so your memory doesn't play tricks on you. In Case No. 3, chokes with ten turns more or ten turns less than the value finally

(Continued on page 104)

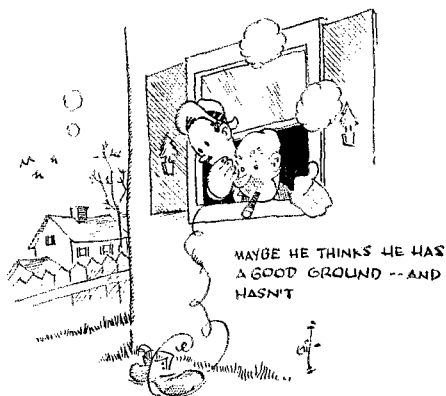

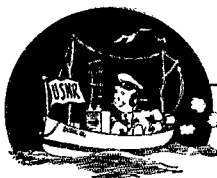

NAVAL COMMUNICATION RESERVE NOTES

DURING the past year it was recognized that impending defense demands were going to create a shortage of trained radiomen in the Navy. In consequence, V-3 volunteers from the N.C.R. were given a month's training course and active duty with the fleet.

As the summer months passed it became apparent that an additional training program was required if these reservists, many of whom were enlisted directly into ratings from civilian life, were to be sufficiently well-equipped for active duty. In consequence, the Bureau of Navigation called upon various naval districts to establish schools for the detailed training of radiomen in their areas.

Amateurs have always played an important part in N.C.R. work, and they are to be found in considerable numbers in the schools which have been established in response to this need. In January *QST* the roster of the school at Noroton was given (page 58); this month we take pride in presenting the amateur contingents at two additional naval reserve training schools.

Indianapolis Naval Radio School Well Supplied with Hams

WHEN the Navy decided it needed several schools for the training of radiomen, the staff at Great Lakes responded with a plan to establish a Naval Reserve Radio School at the Indianapolis Naval Armory.



Radio Hams attached to the Naval Reserve Radio School, Third Naval Reserve Area, Indianapolis — Officers, Instructors and Students.

In operation since September, this school is of particular interest because of the high amateur content of the staff — as evidenced by the accompanying photograph.

Lieut. Commander Boyd Phelps, C-V(S), USNR, N9BP/GH9C, of Minneapolis, is executive officer at the school. "Beep" is well-known throughout amateur circles. Lieut. E. H. Schubert, C-V(S), USNR, N8ALW/AX9B, of Cincinnati, is instructor in procedure, and has proved himself well qualified. The theory course is capably handled by Lieut. (jg) L. W. Sieck, C-V(S), USNR, W9IND, of St. Louis. A number of other amateur reservists are on active duty at the school.

In addition to the 240 radio operators receiving training and a group studying (and working!) at being cooks, the Indianapolis establishment includes a Yeoman School accommodating 50 V-3 men in quarterly classes. This is headed by none other than Lieut. (jg) G. L. Dosland, C-V(S), USNR, N9TSN/DA9C, of Chicago. "Dos" is, of course, the newly elected A.R.R.L. Central Division director.

Hams in Majority in San Diego Communications Class

THE V-3 men in the Communications Class at the U. S. Naval Training School Station at San Diego in January are also largely amateurs or ex-amateurs. These men completed a five-

First row, l. to r.: Lieut. L. W. Sieck, W9IND; Lieut. E. H. Schubert, W8ALW; Lieut. Commander Boyd Phelps, W9BP; Lieut. G. L. Dosland (A.R.R.L. Central Division director), W9TSN; Lieut. Beeman, KA1OZ.

Second row, l. to r.: George Ayers, RM2c, W9FXV; D. C. Ballard, RM3c, W9LFC; E. C. Michaelis, RM3c, W9DUI; W. H. Dettinger, RM3c, W8NXN; J. O. Sumner, RM3c, W9UXT; J. A. Hughes, RM3c, W9CBD; Joe Takacs, RM2c, W8NHO; J. C. Nicholson, RM1c, W8VP.

Third row, l. to r.: E. M. Hansell, RM2c, W9ODD; E. S. Glasel, RM3c, W9FCZ; E. Bartholemew, RM3c, W9IMS; J. F. O'Shea, RM3c, W8JZH; W. S. Bvers, RM3c, W8TYG; G. E. Jones, RM3c, W8SIO; F. J. Wasem, RM3c, W9QZH.

Top row, l. to r.: R. N. Higgins, RM3c, W9LRD; E. E. Burden, RM3c, W9GRY; J. B. Naugle, jr., RM3c, W9QIH; B. R. Shonebarger, RM3c, W8TAR; R. L. Long, RM3c, W8STU; N. J. Kelly, RM3c, W9JWN.

Bottom: Robo, K9, Mascot lc.

Communication Class, U. S. Naval Training Station, San Diego, Calif.

First row, l. to r.: W7GTK; no call; Clark, Master-at-arms; C. A. Mattson, Chief Radio Electrician (director of the school); W6KQY; no call.

Second row, l. to r.: W7BYK; W7CNI; W6IYU; ex-W6H DU; W7GDW; W8QT; W9CFG; W7JP.

Third row, l. to r.: ex-W7ADL; no call; no call; W7DGY; W6MMO; no call; W7WC; W7GKN; W6DXY.

Fourth row, l. to r.: W9UBV, W6SAB, ex-W8CCR, W8DMK, W8BKB, W9TFO.

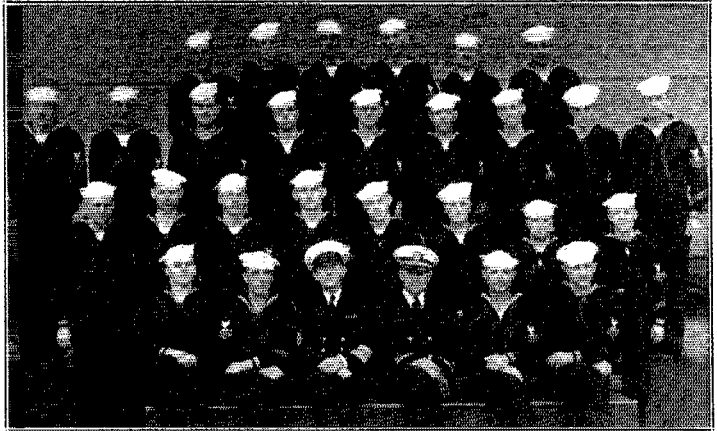

weeks' intensive training course in January, and are scheduled to take up active duty with the fleet. Although the actual orders are not known, of course, it is expected that most of them will go to Pearl Harbor. We are grateful to W8DMK for the attached photograph.

Further Report on Texas Ice Storm Emergency Work

"THE Texas weatherman seldom does things by halves," according to Division Director Bill Green, W5BKH. The November QRR situation — briefly reported in January *QST* — bears him out. After four days of near-record downpours floods raged through most of Texas. In the Panhandle of Texas, western Oklahoma and eastern New Mexico the temperature hovered near freezing. Rain fell, but froze the instant it touched trees, roads, buildings — and wires.



Tex Smith, W5CYX, at the controls, and Fred Trotter, W5IRU at the mill of W5CYX which was located in downtown Amarillo at the offices of the Amarillo News-Globe. Power was available at the start of the emergency, but later failed. An 800-watt, 110-volt-a.c. plant was then pressed into service to continue operation on 1997 kc.

The result was severe disruption of wire services carrying power and communications. Airlines were grounded; trains were all stopped or inched along without benefit of dispatcher. Throughout an area the size of New England the normal facilities of life were helpless.

Center of the icelocked region and hardest hit was the city of Amarillo, Texas. Of this beleaguered community one newspaper dispatch said, "Amarillo has spoken only intermittently with the outside world by short-wave radio since a growing sheath of ice mantled the area."

W5HYT handled the first traffic of an emergency nature from the city, working on ten meters with W3CBT. But his power soon failed, and W5IRU took up the work. When power failed at W5IRU's home, W5WX took over. In twenty minutes his power, too, was gone, and he and W5CHG moved downtown to the Amarillo Electric Company's office, where they put a rig on 160-meter 'phone. With the help of W5HYF (Mrs. W5CHG), they started handling traffic with W5FUA, W5DER and others.

In the meantime W5CYX was striving to get his rig set up at the Amarillo *Globe-News* office, where power was still available. Succeeding, he worked W5DAM at Dallas, as reported in January *QST*. Through this circuit on 1997 kc. a total of 256 messages were relayed over a three-day period. W5IRU pitched in to help W5CYX. W4JFF did a bang-up job of policing the circuit frequency. W5MR, W5AAN, W5CJJ, W5IEO, W5PH, W5DAD, W5DER, W5GBX, W5HVZ, W5IQN, W5FSQ and W5GB cooperated at various times in relaying and/or policing for this circuit.

W5ECL, with the able assistance of W5AVM and W5AZQ, did a remarkable job on 75 meters, handling hundreds of messages for Western Union and other public service agencies. WU representatives crowded W5ECL's location in "droves," according to W5CYX, who also re-

(Continued on page 108)



ON THE ULTRA HIGHS



CONDUCTED BY E. P. TILTON,* W1HDQ

WHAT does it take to do outstanding work on the Ultra-Highs? High power? A lot of costly and complicated gear? A home on a mountain top, within working range of New York City? A look at the layouts of some of the leaders in the 1940 U.H.F. Marathon, first long-term u.h.f. contest to receive nation-wide attention, should provide an answer.

Let us start with W5AJG, Dallas. It may be something of a shock to many of our high-power boys to learn that the national high in the Marathon for 1940 was made with 40 watts input to a pair of 801's! With contacts on Five confined almost entirely to skip DX, Leroy W. May, Jr., worked 166 different stations in 25 states and all nine call areas! The important factor here was a thorough-going knowledge of the band, the result of years of careful observation of the peculiarities of Five in relation to other easily-observable signs. We feel reasonably safe in stating that Leroy was active during as high a percentage of the total possible "openings" as any operator in the country. His winning of first place in the 1940 Marathon should offer encouragement to anyone who must be confined to low power. High-powered operating is much more important!

A number of other high-scoring stations offer similar proof of the value of heads-up operating. W3BZJ, Glenside, Pa., in second place, has never run more than 125 watts input to his T-40's; yet he has 25 states on Five in 1940 and a mighty list of contacts on 112 Mc. W6QLZ,

* 329 Central St., Springfield, Mass.

Phoenix, Ariz., remote from most of the areas of dense u.h.f. population, made contact with 62 different stations in 19 states. In addition, Clyde smashed all previous conceptions of the possibilities of Five for long-haul work by knocking off 12 stations in that "impossible" over-1500-mile classification. The rig? A single HK-54 at about 150 watts! But it might have been anything — for it was the operator and the antenna which were responsible.

While the effects of the approaching low period in the 11-year sunspot cycle are showing very definitely in the early closings of Ten and Twenty for normal skip work (*F-2* layer), it appears that sporadic-*E* (short skip) is on the increase. There has been enough activity on Ten at all times since 1935 so that observations of conditions on that band would not be greatly affected by lack of active stations in certain areas. In 1935-36, at the height of long-range conditions on 28 Mc., short skip was very rare except for a short period in the summer months. Thus far this winter, short skip has shown up on Ten more frequently than in any previous winter season since the band first became populated sufficiently for this sort of thing to be noticed. During late December and in January, Five has been open for skip work more frequently than ever before in winter-time, with contacts reported by stations in all call areas. DX was reported on December 24th, 25th, 26th, 27th, 30th, January 1st, 8th, 13th, 14th, and 16th.

From the foregoing it appears that there is

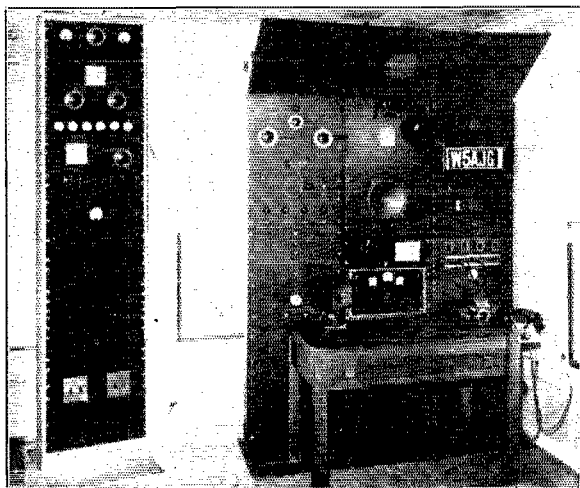

The neat layout of Leroy W. May, Jr., W5AJG, Dallas, Texas, winner of first place in the U.H.F. Marathon of 1940. The rack at the left contains a 400-watt all-band rig. Grouped around the operating position are the 40-watt rig for Five, 30-watt 112-Mc. rig, 30-watt 160-meter 'phone, speech equipment, automatic sender, etc. Receivers include a DM-36, HQ-120 combination and a super-regen for 2½. Room is 12' x 14', lined with sound-absorbent material, with all inter-bay wiring under the floor.

Second place in the Marathon was taken by W3BZJ, Glenside, Pa. Active since 1920, with u.h.f. experience dating back to 1926, R. W. Elmer runs 125 watts to T-40's on 56 and 112 Mc. Receiver is a Hallicrafter S-27. The paper Bob is reading must have April 1st as its publication date!



little relation between the occurrence of sporadic E DX and the 11-year cycle, and that we may look forward to an increase, if anything, in the amount of DX to be worked on Five in 1941. The persistent feeling that there is some definite system to the occurrence of u.h.f. skip DX — that it may some day be possible to predict, with considerable accuracy, the “good” dates for DX — is commanding the attention of many who regard this work as much more than just a round of friendly contacts. Though present conceptions are all very hazy, many of us feel that there exists some relation between skip DX and certain cycles within the solar system. Like long-range weather forecasting, its reliability is yet to be proven. The relations between weather and skip DX are too consistent to be passed off as mere coincidence. One does not, apparently, cause the other; but it may well be that both are the result of a common cause. With increased activity on all u.h.f. bands, the country over, careful observation of the vagaries of the Ultra-Highs may well shed some light on these fascinating theories in 1941.

HERE AND THERE:

MT. WASHINGTON. New Hampshire, with one exception the highest spot in the entire country east of the Mississippi River, is once again the scene of operation of a station on Five. W1AP, employed on the summit, finds it not all it might be, however. For one thing there's the 1-kw. WIXER, operating with f.m. on 43.9 Mc. taking out considerable slices of the band at several points. Enough of the band is left clear so that plenty of contacts can be made, however, and our route from Maine to as far south as the boys in Washington, D. C., can push it is now assured. And how would you like to put up beams in a location which holds the record for the whole of North America for low temperature (60 degrees below zero) and high wind velocity (231 miles per hour)? W1AP plans to stay with it, however, and it will be of considerable interest to see what can be done from this famous spot under modern conditions on Five.

W1ELP, Cambridge, Mass., using f.m. exclusively, missed the Eastern Massachusetts section award in the Marathon by a narrow margin, but he did manage to amass quite a list of “firsts,” including the first two-way contacts with f.m. on both 56 and 112 Mc., and first skip-DX work with f.m. Bill managed to get 97 operators to look above 58.5 Mc. during 1940.

Doc. Walsh, W2BW, has a “pink elephant” pocket charm which is attaining quite a reputation as a harbinger

of DX on Five. On January 1st, Doc. demonstrated the elephant's remarkable properties by opening the band up for W3HOH while 1941 was only a few hours old. That Ken was unable to get all the DX on the band was explained by Doc. on the grounds that the pink elephant had just come from a tough night!

Enthusiastic response to the Maine-to-Florida network idea has been received from W3CYW at Richmond and W3BZ at Danville, Va. Both of these fellows are looking for prospects to help them bridge the gap between Washington, D. C., and the North Carolina line. W3DBC used to work the boys in Richmond quite consistently, but none of the other Washington stations has been able to make the grade to date except on rare occasions. W3RL is now working in Washington but will be at Herndon over each weekend and has promised to be active on both Five and 2½ whenever possible.

We have mentioned the persistence of W5AJG in watching for every sign of an opening on Five. Leroy watches Ten and the various commercial services in between Ten and Five, and now has the various police operators, including W5DAS of the Highland Park Police, reporting anything unusual on their u.h.f. channels. And now Mrs. May has gone and got herself a ticket! She has long monitored the band for Leroy while he was at work and is a dyed-in-the-wool u.h.f. enthusiast. The W5JKM-W5AJG combination should be a tough one to beat in 1941!

The success of the W6QLZ-OVK schedule in covering the mountainous country between Phoenix and Tucson, Ariz., has boosted the activity on Five in that area. These boys have been at it for more than two months without a single miss and are making converts almost daily. W6GBN, Estrella, recently got up a 4-element horizontal beam and now works both W6OVK and W6QLZ. The distance to Tucson is 92 miles, air-line, with rough mountainous country all the way. Tommy is a telegraph operator at a “water stop” in one of the most desolate and uninhabited parts of Arizona. There is no power there and W6GBN relies on a 32-volt plant for his rig, which is a 6L6 e.c.o. (14–28 Mc.) followed by another 6L6 doubler to Five. The receiver is a single 6KSGT converter working into a three-tube home-made “blooper.” If this sort of gear can be made to cover 100-mile mountainous paths in Arizona, what is wrong with some of the gang in the East who never seem to be able to work out more than twenty or thirty miles? Those boys have got antennas out there! They also have receivers. W6SLO has a concentric-line preselector using a 1232, and W6OVK and W6QLZ are using 1232's with fine results also. Clyde has revamped his Skyriver 5–10, incorporating two stages of 1232 r.f. Since this recent change he is able to hear W6OVK with his antenna switch open. W6QLZ heard W4EDD S-9 on January 14th between 7:30 and 8 P.M. but has still been unable to get Robbie to hear him for that long-awaited W4-W6 QSO.

Not much is yet heard of activity in California on Five. The Arizona gang heard strong harmonics from several 28-Mc. stations in Northern California during January, but W6BPT, Santa Clara, was the only station heard on Five. W6BPT was contacted by W6SLO and W6OVK on the

14th. W6ANN, San Pedro, writes that he will soon be on with an 808 in the final, running 125 watts.

W8RUE reports the formation of the "Greater Pittsburgh Five-Meter Club, with W8's OMY, RNP, OKU, TFT, NTB, and RUE as charter members. A meeting is held on the air each Saturday night at 11:30 p.m. They are on the lookout for stations within working range of Pittsburgh at this time, or at any other time by arrangement. For further particulars address Ted Fabian, W8RUE, 3036 Churchview, Pittsburgh, Pa.

Here is another fine example of daily work over extended local paths. Since December 11th, W9YKX, Woodbine, Iowa, and W9ZJB, Gasland, Mo., have been working without a miss. Both are using 3-element $\frac{1}{4}$ -wave spaced beams, horizontal. The rig at W9YKX runs 200 watts to a pair of 808's. A converter employing a concentric-line tuned 954 and 6K3 is used for receiving. Bill reports a contact with W9NFM of Solon, Iowa, on January 11th, a distance of 235 miles. The distance to W9ZJB is just over 200. With W9NFM and W9HAQ working the Illinois gang and W9ZJB working W9VWU, the prospects for some new relay records look good for the next U.E.F. Relay, which is scheduled for April 26th and 27th. W9YKX reports W9TTL in Mapleton and W9FZN at Dunlap working each noon and evening. Schedules are in the works for a try with W9ZQC in Brookings, S. Dak., some 200 miles to the north.

New states are in prospect for this coming spring and summer season. W7IFL, Cheyenne, Wyo., visiting W1KOY, Glastonbury, Conn. (Johnnie was W1MHM of that town not long ago), reports that he is all set on Five and trying to stir up local interest. For Wyoming on Five, watch 57,104 and 57,142 for W7IFL. And we hear W7ACD talking Five on 28 Mc. — there's Idaho for you.

W9ANE, Terre Haute, Ind., reports that activity has held up well through the winter season, picking up a few new converts meanwhile. Regulars include W9's ANH, ZHL, BDL, AQQ, QCY, and UIA, with OMR and CNJ as recent converts. All use the 3-element horizontal "Q" beams made popular by W9ZHB, W9CNI, Robinson, Ill., has his mounted on the framework of a gas storage tank, 95 feet above ground. (Mad scramble follows as hams rush to nearest gas company for antenna permits.)

W9ZEB is all set in his new cabin shack, with the new all-position beam alongside. Ed really got going during the January 1st opening and worked just about every station that was on the air in the East. It is rumored that Ed is going to get his mother to handle the mail route. He will then reduce his quota of sleep to six hours and spend the other eighteen hours watching for DX on Five!

Space does not permit a complete listing of all the skip DX worked during the last month. We wish, however, to express our appreciation to the following for their detailed accounts of DX heard and worked: W1's LLL, IHA;

W2FJQ; W3's HOH, GUF, GNA; W5's DXB (Louisiana), AJG, VV; W6's BPT, QLZ, OVK, SLO; W8's RUE, RTW; W9's ANH, ARN. DX reports for January exceed those of any previous winter month in this department's experience. Though it is not always possible to print these reports in detail, it is important that we know as much as possible about all openings for skip DX in all parts of the country. These are retained for use by anyone interested in studying this intriguing phenomenon.

112 MC. AND UP:

ONE surprise in the 1940 Marathon was the fine showing of several stations operating exclusively on 112 Mc. Al Harris, W6RVL, must have really covered his territory to get those 191 contacts for 523 points! Reflecting the excellent DX work by the California W6's on $2\frac{1}{2}$ is the total of eleven contacts in that select "over-75-miles" group. Nice work, Bud!

Second place in national scoring was won by Stanley F. Brigham, W1MBS, of West Roxbury, Mass. With ten watts input to a 76 oscillator, Stan wound up with 175 contacts and a score of 401 points. This was enough to top the work of any of the five-meter gang in Eastern New England, so Stan gets the award for leading the Eastern Massachusetts section for the year. W1MBS has been able to work out, too, having been heard in Hartford, nearly 100 miles away, along with several other stations in the Boston area, all of whom were running 100 watts or more.

Bob Elmer, W3BZJ, Glenside, Pa., has given up operating on Five in order to devote more time to work on 112 Mc. He is revamping his final in order to run crystal-control on $2\frac{1}{2}$. Bob worked 95 different stations on $2\frac{1}{2}$ in 1940 and is serving notice that he is going to win the national award for 112 Mc. in 1941. He has the unique record of having worked four call areas on $2\frac{1}{2}$. If we could have heard him at Wilbraham, he would have tied W2DZA for states worked on $2\frac{1}{2}$, too.

A concentrated effort on $2\frac{1}{2}$ by W3HOH, Bernardsville, N. J., put Ken over the 100-contact mark for 1940, and won him plenty of wall paper in the Marathon. Ken was leader in scoring in October, November, and December, and was the winner of the Southern New Jersey section award, as well. Like W3BZJ, he missed a tie with W2DZA for the States-worked award by the inability of W1HDQ to hear his frantic calls for Massachusetts on $2\frac{1}{2}$!

W8UKS writes of interesting doings in the vicinity of Cleveland, on both $2\frac{1}{2}$ and $1\frac{1}{2}$. Sam has a multi-stage rig on both bands, starting with a Signal Shifter on 20, followed by a T-21 quadrupler, HK-24 doubler, and a pair of HK-24's in the final for $2\frac{1}{2}$. To get to $1\frac{1}{2}$, a pair of HK-54's are operated in "push-push"! The receiver is an f.m.-a.m. superhet for $2\frac{1}{2}$. An acorn converter using a harmonic oscillator provides reception on $1\frac{1}{2}$. The gang have gotten together to provide activity on Tuesday nights, from 8 p.m.



Al Harris, W6RVL, tuning up the 15-watt mobile rig which was an important factor in his winning of first place in the 112-Mc. division of the 1940 Marathon. Rig uses a pair of HY-615's, with lines in plate circuit. Receiver is a National One-Ten. Contacts have been made up to 170 miles using the extended double zepp mounted on the side of the truck.

1940 U.H.F. MARATHON

(Final Summary)

DECEMBER WINNER

W3HOH, Bernardsville, N. J., 100 points

Call	Contacts for Year			Cumulative States in 1940
	66	112	#24	
W1ATY	25		3	70
W1BCT		10		22
*W1CGY	52			138
W1CLH	72			264
W1CUC	28	6		53
W1DJ	108			174
W1EHT	68			101
W1EKT	121			319
W1ELP	97			359
W1GJZ	118			485
W1HDF	81	12	4	91
*W1HDD	214	63	1	1487
W1HXP				
W1JJR	110	4	3	588
W1JLK	90	28		205
*W1JP	1	39		3
*W1KIJ	252	7	5	1348
W1KVQ		68		146
W1LLL	151			851
W1LPP	65			134
*W1LSN	63			149
*W1MBS		175		53
*W2ADW	19	43		214
*W2AMJ	194			886
W2BYM	47	7		255
W2BZB	32	115		314
W2COT	128			316
W2DZA		148		358
W2GHV	122			590
W2LAL	112	2		246
W2LXO		131		300
W3BYF	58			314
*W3BZJ	220	95		1456
*W3CGY	80			237
W3CYY	20			162
W3DI	92			464
W3EHS	22	15	1	101
W3FJ	15			103
W3FSM	1	60	1	132
W3FK	37	23		107
*W3RHL	228	102		1006
*W3RL	70	1		563
*W4FBH	82			738
*W5AJG	166	8	7	1986
*W5VY	59			682
W6BQR		60		128
W6IOJ	8	95	4	393
W6OVK	23			234
*W6QG	24	4	2	136
*W6QLZ	62	3		1085
*W6RVL	1	191		3
W8MHHM	32	15	1	113
W8NKJ	53	23		397
*W8QDU	117	60	2	853
W8QQS	63			540
*W8RUE	81	16		340
W8SN		21		42
W8TQ	25			181
*W9ARN	84			713
*W9VWU	43			405
*W9ZJB	134	1		1359

The above list contains only those contestants sending in four or more reports. Three or less were received from the following: W1's EJU BYR JAX JIS JTG KH KHN KJG KME KSO LCG LFD LFI LFS LQX LZV *MFP MMB PI; W2's CTR OAX JND RNY LBN MLL MO YK; W3's AC AWM AWS GMZ HS; W4's ELZ EQK; *W5FYF; W6's KIJ MKS NCP OWX PGO QNU SLO SNU SNT; *W7GJS; W8's AGU BJG *PKJ RKE; W9's *ASO BJV DQH VHG.

* High scorer for year in A.R.R.L. Section, Certificate Winner.

MONTHLY CERTIFICATE WINNERS

January: W2MO, 241; February: W3QDU, 141; March: W3BZJ, 221; April: W6RVL, 86; May: W5AJG, 590; June: W9ZJB, 696; July: W6QLZ, 730; August: W1KIJ, 115; September: W2DZA, 68; October: W3HOH, 146; November: W3HOH, 59; December: W3HOH, 100.

MEDALION AWARD WINNERS

National High Score, 56 Mc.: W5AJG, 1909 points. (Includes extra credit, see Rule 7.)
 National High Score, 112 Mc.: W6RVL, 523 points.
 National High Score, 224 Mc. and up: W6IOJ, 90 points.
 States Worked in 1940, 56 Mc.: W9ZJB, 27.
 States Worked in 1940, 112 Mc.: W2DZA, 5.
 States Worked in 1940, 224 Mc.: W1ATY, W1HDF, W1KIJ, 2 each.

¹ Frequency modulation used exclusively at W1ELP — special credit added.
² Not eligible for award.

on. Prior to this, many new prospects for activity on the u.h.f. bands have been lost because they had to spend too much time listening before hearing any signals. Other stations using crystal-control on 1½ in the Cleveland area include W8MAP and W8IPU. W8VJE and W8ML are building multi-stage rigs for 2½. Others on 2½ include W8's GTE, CI, RRA, UTC, BGF, and SJT.

W1BBM, North Harwich, Mass. (Cape Cod), is working on 224 Mc. from Scargo Hill, Dennis. Bates uses an HY-75 modulated with a 6V6 and an acorn super-regen detector. He is interested in making schedules for 224-Mc. tests with stations in Boston and Providence.

W1JJP, Providence, reports about 20 stations now going strong on 2½. Jack says all the boys complain that the gang up around Boston can be heard quite frequently but seldom can be worked because they never turn their beams down that way.

We hear rumors of reception of the 112-Mc. sigs of W1IS of Wollaston, Mass., in Fort Dearborn, Mich. Can anyone tell us more about this one? Perhaps its in the class of the persistent rumor of reception of W1HDD in Texas!

Out in Reno, W6CW has practically the entire ham population of the town on 2½. W6's ONU, FUG, BYR, QAY, BIC, QKV, CW, and W6 find low-powered 2½ meter gear very handy for saving wear and tear on the telephone. Local work of this sort is great stuff for fostering a friendly spirit among the hams of any sizable community.

The fine work of the Arizona gang on Five is now in the process of being duplicated on 2½. W6QLZ has a 16-element turnstile array and is smacking an S-9-plus signal over the mountains to W6GBN. Clyde has been running crystal-control on both 2½ and 1½ but is now building a concentric-line m.o.p.a. which which he hopes to get to 400 Mc. W6OVK has an HK-24 doubler dishing out 30 watts on 114 Mc. but thus far has only the local government monitoring station to test with! Jim was unable to get satisfactory performance from the HK-24 until he put in 1000 ohms of cathode bias. The little '24 now takes up to 110 watts input without undue heating, and the efficiency appears to be comparable to doublers on the lower frequencies. The next step is schedules with W6QLZ, and then on to 1½!

W2LBK, Richmond Hill, L. I., has a pair of HK-24's running as a push-push doubler to 113.5 Mc. Joe also found cathode bias to be the answer to efficient doubling to 2½. He uses filament chokes and a 200-ohm resistor from the center-tap of the filament transformer to ground. Excitation is furnished by a TZ-40 doubling to 56 Mc., following the regular 20-10-meter rig which starts off on 3.5 Mc. with e.c.o. The output circuit of the 24's is series tuned. Unloaded plate current is down to 25 ma. at 1000 volts.

A. A. R. S. Activities

(Continued from page 42)

will present a Marconi Memorial Award to the winning Army-Amateur member (amateurs who by profession are government or commercial radio operators are not eligible for this award).

SPECIAL FREQUENCY OPERATIONS

CERTAIN Army Amateurs serving as radio aides, net-control stations or alternate net-control stations are authorized to operate on the special 3497.5 and 6990 kc. Army-Amateur frequencies using four-letter call signs beginning with "WL." Operations on these special frequencies are on a time-division basis by Army and corps area nets. Amateur operators may be interested in listening to the drills, traffic handling and other activities on these special frequencies as a further means of improving their code proficiency. The summary of these daily operations is shown on page 42.

(Continued on page 102)

★ I. A. R. U. NEWS ★

Devoted to the interests and activities of the

INTERNATIONAL AMATEUR RADIO UNION

Headquarters Society: THE AMERICAN RADIO RELAY LEAGUE, West Hartford, Conn.

MEMBER SOCIETIES

American Radio Relay League
Asociatia Amatorilor Romani de Unde
Scurte
Associazione Radioteleca Italiana
Brazilian Amateur Radio Society
Canadian Section A.R.R.L.
Ceskoslovenski Amatérni Vysilaci
Deutscher Amateur Sende-und-Empfangs
Dienst
Eesti Raadio Amatooride Ühing
Experimental Radio Society of Egypt
Experimenterende Danske Radioamatorer
Federation des Emetteurs Belges
Irish Radio Transmitters Society
日本アマチュア無線聯盟 Japan

Lietuvos Trumpjuju Bangu Radio Megeju
Draugija
Liga Colombiana de Radio Aficionados
Liga Mexicana de Radio Experimentadores
Magyar Rövidhullámú Amatőrök Országos
Egyesülete
Manchoukuo Amateur Radio League
Nederlandsche Vereeniging voor interna-
tionaal Radioamateurisme
Nederlandsch-Indische Vereeniging Voor
Internationaal Radioamateurisme
Newfoundland Amateur Radio Association
New Zealand Association of Radio Trans-
mitters
Norsk Radio Relæ Liga

Polski Zwiasek Krotkofalowcow
Radio Club Argentino
Radio Club de Cuba
Radio Club Venezolano
Radio Society of Great Britain
Rede dos Emissores Portugueses
Reseau des Emetteurs Francais
Reseau luxembourgeois des Ama-
teurs d'Ondes Courtes
South African Radio Relay League
Somon Radioamatööriühito r.y.
Sveriges Sändareamätöber
Unión de Radioemisores Españoles
Union Schweiz Kurzwellen Amateur
Wireless Institute of Australia

CUBA

AN "Auxiliary Corps of Radio Amateurs," a volunteer emergency reserve of licensed amateur operators, is being formed in Cuba as a result of presidential decree No. 3278. Similar to the W's Army Amateur Radio System, the new corps will, under the sponsorship of the ministry of communications, constitute a reserve of trained personnel and equipment for use in any disaster or emergency which threatens the country's welfare. All Cuban amateur licensees are being solicited for membership in the organization, and a directory will be published shortly containing a list of members, their code speed, equipment available, past service, and the like.

The proclamation reads, in part: "It is an established point that the radio amateurs of the Republic of Cuba generally possess attributes of ability, efficiency and honesty, and have collaborated with the authorities in the national interest, handling meteorological reports and other useful information in cases of floods, earthquakes and other public calamities; this demonstrates that it is a wise policy to foster and stimulate such valiant service. . . ."

DENMARK

ALTHOUGH amateur equipment is under government seal and storage, E.D.R. is carrying on all other normal work and, according to Secretary Helmer Fogedgaard, is "still going strong"! "OZ," the society's official organ, makes its appearance regularly each month and in normal size. Says Mr. Fogedgaard, "amateur radio in this country has a very strong position, and the amateurs are faithful to their organization. We have preserved our optimism for a good future for amateur radio."

At the society's annual meeting on September

29th, delegates were privileged to take part in a hidden transmitter hunt. By special permission of the government, two officers manned the "secret" station while members tracked it down.

The only sad note is the society's report that it has not been able to contact either of its brother organizations in Norway or Sweden.

BRAZIL

PYIJ corrects our statement in November *QST* and says that Brazilian amateurs were never prohibited from contacting foreign stations, but rather from contacting amateurs in belligerent countries, and this restriction still exists.

SALVADOR

FOR many years YSIFM had been the only licensed amateur in Salvador. Aspirants for amateur licenses, interested only in 'phone communication, would not take the trouble to learn the code.

About a year ago several influential persons wishing amateur licenses secured permission from the government to operate — and they promptly went on 'phone, despite YSIFM's warnings. It was not long before they ran into many difficulties such as broadcast interference as well as trespassing on government frequencies and handling non-amateur communications. So, on last October, all such operators were called before the authorities and told that their permits were cancelled. Rumor now has it that the government is setting up more stringent regulations under which amateurs may again be licensed.

ARGENTINA

POINTING out the desirability of a reserve of amateurs, an army officer writing in the

(Continued on page 102)



HINTS AND KINKS FOR THE EXPERIMENTER

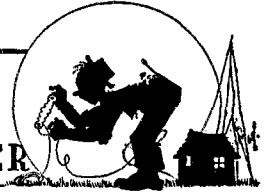

'PHONE MONITOR USING INFINITE-IMPEDANCE DETECTOR

GEORGE MONTGOMERY, W8IKE, describes a simple 'phone monitor which is enjoying considerable popularity among the hams of Western Pennsylvania. The monitor makes use of two triodes, one as an infinite-impedance detector and the other as an audio amplifier. In addition to the feature that the detector will handle high-percentage modulation without distortion and, therefore, comes the nearest to telling the operator what his signal sounds like at a distant receiver, the following advantages are claimed:

Wide-range frequency response.

Can be used on any band from 4 Mc. to 56 Mc.

Single adjustment.

Suitable for use with crystal headphones.

The unit is designed to operate from the receiver power supply. Small by-pass condensers are used in the detector circuit for high fidelity. The resistor, R_3 , in the plus-B lead provides additional filtering.

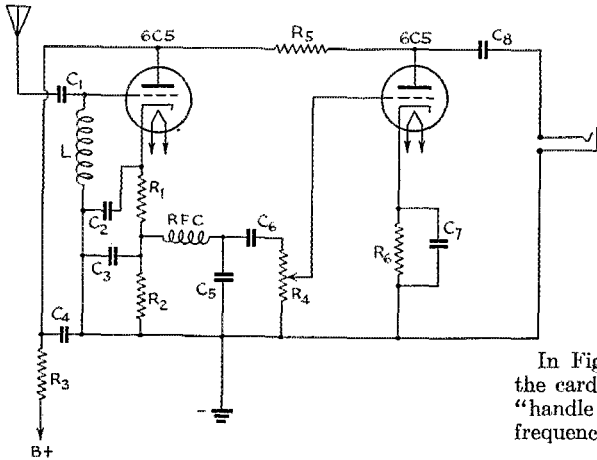

Fig. 1—Circuit diagram of 'phone monitor using infinite-impedance detector as described by W8IKE.

- C_1, C_2, C_3 — 100 $\mu\text{fd.}$, mica. R_1 — 50,000 ohms.
 C_4 — 8 $\mu\text{fd.}$ R_2 — 0.1 meg.
 C_5 — 50 $\mu\text{fd.}$ R_3 — 10,000 ohms.
 C_6 — 0.05 $\mu\text{fd.}$ R_4 — 0.5 meg. variable.
 C_7 — 10 $\mu\text{fd.}$ R_5 — 0.1 meg.
 C_8 — 0.1 $\mu\text{fd.}$ R_6 — 2000 ohms.

RFC — 2.5-mh. r.f. choke.

L — 25 turns No. 24 d.c.c., close-wound, 1½ in. diam.

With the audio volume control, R_4 , at maximum setting, the length of the pick-up antenna is adjusted for a satisfactory signal strength on the band on which the signal seems to be weakest. When this length has been determined, the volume control is adjusted for signals on the other bands to bring them down to the desired strength.

The same arrangement has been used successfully with a single double triode with separate cathodes, such as the 6C8 or 6F8.

A CARD INDEX FOR YOUR QSO'S

THE practical value of a card index file for recording all QSO's is becoming more generally recognized, but there are still those who feel inclined to associate the idea with a lot of hard work and drudgery.

First, let's banish this impression. If a workable system can be developed it is soon found that very little extra effort is required and *no* extra time, because the cards may easily be filled out during the QSO and, since this system takes care of a lot of the information usually recorded in the log, perhaps we may say there is even no extra *work* involved!

The cards, 3" by 5", ruled on one side, may be obtained in any dime store for 10 cents per hundred. Some hams just starting out may wish to use the small wooden recipe-index boxes, but it is advisable to get a regular file cabinet that will hold 1000 cards. These cabinets may be stacked one upon the other and locked together. They cost about \$1.50 each in office-supply stores.

In Fig. 2, is shown a typical example of how the cards are filled out. Note that just under the "handle" is where we record the other fellow's frequency or the term "ECO" if that is the case.

1909 ROYER ST.		
W3EEW-	PHILADELPHIA, PA.	ALAN.
QSL P.S.	ANNL-QMS-OQ-	ECO
4955-4962		

Fig. 2 — Sample of index QSO card used by W9FB.

The second line is reserved for the kind of information shown, "ARRL — ORS —" etc. Also note "QSL R.S.," this means "received" or "sent." The "total QSO" number is also listed on the face of each card. A new number is added for each QSO. About 75 numbers may be recorded on the face of each card.

All personal information is recorded on the back of the card. It might read something like this, "-- Age 34 (1940), married, 12 kids, works for the Hiram Hayseed Hogwash Co., ham since '27, rig 6L6 x osc, 25-w. 3-tube blooper. Likes hunting, fishing and gooseberry pie. --." Do you think you would have any trouble remembering the former QSO with that fellow if you had those remarks to freshen your memory?

Now, we find that we must place the cards in the file alphabetically. Likewise, it will be necessary to prepare marking tabs to indicate the location of the cards for each district. The dime store sells these too, but since they are marked "A" to "Z," it is necessary to reverse them and mark them "W3," "W5," "W9," "VE," "ZL," etc. It is a good idea to prepare at least one blank marker for each drawer. This is used to mark the place from which a card has been removed so that its location may be readily ascertained when again it is to be returned.

Since we have so much information on the cards, it is no longer necessary to put the QTH and other dope in our log. This suggests the use of a simplified log sheet. Those who wish to make their own logs, will find that a 25-cent "cash" book will serve very well, requiring the addition of only a few vertical lines and the filling in of the heading on each page. For those who prefer using A.R.R.L. logs, some modifications in the system may suggest themselves.

In conclusion, it may be stated safely that once this system is put into use, no wide awake ham would consider parting with it. Here at W9FB, the index idea was started the first of 1936. At present it has grown until it now includes over 1900 cards covering over 5000 QSO's. Some have been marked "deceased" across the face after seeing such calls listed in "Silent Keys." Indeed, one can spend an interesting hour browsing through a file of this kind.

Some who may have read this article may exclaim, "Now that's a swell idea, I think I'll start an index some day, maybe, perhaps —." But the fellow who dashes out and buys his first hundred cards at once and gets started will be the one to strut around a year hence, wondering how he ever managed without it. — Amos Utterback, W9FB.

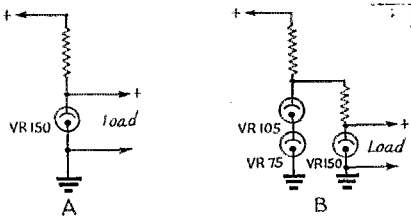

Fig. 3 — Voltage regulating circuits. A — Usual form. B — Cascaded form used by W1IJP to improve regulation.

IMPROVED VOLTAGE REGULATION WITH VR TUBES

DURING the course of making measurements of small intensities and variations in light with a photo-electric cell and vacuum-tube amplifier, Harry Dubofsky, W1IJP, encountered the necessity for a voltage supply of exceptionally good regulation for the amplifier. He reports some interesting observations in connection with the use of VR gaseous regulator tubes.

The original supply was of good design with a choke-input filter. A single VR150 was connected at the output of the supply in the conventional manner shown in Fig. 3A. The use of the VR tube resulted in an improvement in voltage regulation of the order of seven to eight times.

Desiring still greater improvement, three VR tubes were arranged as shown in Fig. 3B. This arrangement resulted in an improvement in regulation of three times, meaning a total improvement of more than twenty times over the regulation of the supply without the regulator tubes.

Such a combination should be of value in supplies for heterodyne frequency meters and other laboratory oscillators as well as in conjunction with variable-frequency oscillators for transmitters and other applications requiring a high degree of voltage regulation.

SIMPLE TONE MODULATION FOR U.H.F. TRANSMITTERS

C. B. SEIBERT, W8SPY/TDJ, describes a simple system of tone modulation which he has

Fig. 4 — Arrangement for using neon-hull oscillator for tone modulation.

- C₁ — 0.003 μ fd., paper.
- C₂ — 0.01 μ fd., paper.
- R₁ — 0.5 meg., 1/2-watt.
- N — Neon pilot lamp No. 5122.
- T₁ — Double-button carbon mike input transformer in existing speech amplifier.
- T₂ — Single-button carbon mike transformer, operated as stepdown transformer.

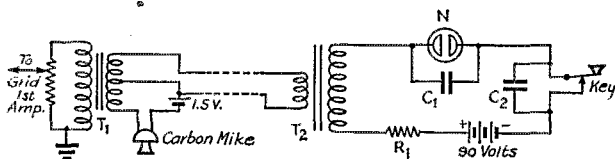

has been using with his u.h.f. transmitter with success for some time.

The circuit diagram is shown in Fig. 4. A relaxation oscillator employing a neon bulb is used as the tone source. This is coupled into the first audio tube of the modulator via the mike transformer. The most convenient feature of the arrangement is that no switching is necessary to operate either microphone or oscillator.

The oscillator is one which has been used for some time as a code practice set with a pair of magnetic headphones in place of T_2 . While standard neon glow lamps of the one-half or one-

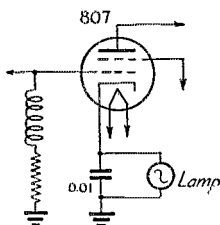

Fig. 5 — Cathode lamp for protecting 807 as used by W9BPS.

quarter-watt variety may be used, the values of C_1 and R_1 may have to be changed somewhat to obtain the desired tone. The resistor in the base of such lamps should be removed.

AUTOMATIC OVERLOAD PROTECTION 807 AND OTHER TUBES

I HAVE been using a trick here at W9BPS with such success that I feel sure that others would be glad to know about it. My rig is a small affair ending up with an 807 in the final. I key the final and use plain grid-leak bias, since I have found that any amount of cathode resistance which will give the tube any degree of protection during adjustments or in case of failure of excitation limits the power output more than I like.

However, after losing one 807 and almost losing another, I cast about for some answer to the problem. I finally hit upon the idea of using an ordinary low-power lamp bulb as a cathode resistor. The resistance of such a bulb when cold or at low temperature is quite low, of the order of 50 to 100 ohms, while the resistance of a 15-watt lamp will increase to 600 or 700 ohms when at normal brilliance. The result was perfect! With normal plate current flowing, the filament shows just a perceptible glow, but as the current increases above normal, the glow increases in brightness. With excitation removed entirely, the plate does not show color. Thus, not only does the lamp protect the tube effectively by automatically increasing the bias with high plate current, but the lamp gives a visual warning. — *H. A. Fanckboner, W9BPS.*

BY THE time its fourth issue was produced in March, 1916, *QST* had reached 32 pages and had begun to resemble a real magazine. The leading technical article was "Practical Pointers on the Audion," by A. B. Cole, the deForest sales manager. This was expert inside dope on the adjustment of the audion, correcting troubles and exploding fallacies. It was a badly-needed article, the editor pointing out that, although the best relay stations used audion bulbs, 90% of the amateurs of the day did not know how to get good results from them.

The second instalment of Maxim's article on "Practical Relaying" appeared — the article that was to bring forth the volunteers and the further suggestions that established the League's trunk lines. It seems surprising that in these faraway years there could have been any yearning after "good old days," but Lloyd Manuel had an article called "Thoughts of the Good Old Palmy Days," describing still earlier efforts with coherers, Leyden jars, etc. If memory serves us, it was Manuel who was later to become "The Young Squirt" and engage in monthly battle with "The Old Man" in our pages.

In this issue W. B. Pope, old-timer of Athens, Ga., reported being heard over 700 miles, while *QST* hailed 8ZI as one of the League's best stations, having worked 900 miles with 880 watts input. George Readio of 1ON, Springfield, now the well-known Grandpa Snazzy of WIAZ, reported having heard the 9XE Washington's Birthday relay message starting at Davenport, and by the time it had echoed down the relay lanes as far as Wheeling, West Virginia, he had the text solid! Amongst new members admitted to the League this month were L. C. Young, 9PC, now in Naval Research; Mark Biser, 3CY, now chief instructor at the Capitol Radio Engineering Institute; J. O. Smith, 2LK, later to be the League's first traffic manager, now with RCA and still experimenting; and Mrs. Charles Candler, 8NH, who became perhaps the best-known amateur before the War. Harold Bowen, now WIDQ, was reported elected secretary of the Fall River Amateur Wireless Association.

In the ham-ads that month you could have swapped a bicycle for a complete spark-coil station. Two hams wanted to sell their 2000-ohm E. I. Company 'phones cheap, probably having encountered the rumor that their impedance was due to the use of resistance wire. The deForest Company advertised in this issue for the first time, offering one-tube audion detectors on a cabinet in two models at \$14 and \$25. And the same issue carried the first advertisement of William B. Duck Co., advertising their new No. 9 320-page catalog.

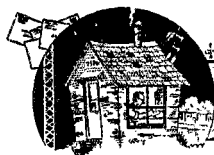

CORRESPONDENCE FROM MEMBERS

The Publishers of *QST* assume no responsibility for statements made herein by correspondents.

AND NOW THE COAST GUARD

Coast Guard Cutter *Tulip*, Staten Island Base, N. Y.
Editor, *QST*:

After sitting back and reading many editorials and letters concerning Army and Navy radio, I decided it was time someone said a few words in favor of the United States Coast Guard.

The Coast Guard, contrary to many mistaken ideas, is one of the military forces of the United States. In times of peace it serves as a sea-going police force, always ready to assist in the protection and saving of life and property at sea, and in the enforcement of all federal maritime laws falling under its jurisdiction. In time of war, national emergency, or when the president shall so direct, it becomes an active part of the Navy, its personnel being so trained that the amalgamation is accomplished with a minimum of effort or operating changes.

At present the Coast Guard, alone with all other rapidly expanding units of National Defense, is finding an ever-increasing need of trained radiomen. If you hold an amateur or commercial ticket and are seeking enlistment in the service, you should give the Coast Guard more than just a passing thought, for its opportunities are numerous.

For the first two or three months after enlisting you will be given a basic course in seamanship, after which you will be sent to one of the two radio schools maintained by the Coast Guard at New London, Conn., and Curtis Bay, Md. There you will receive a four-month course which includes touch typewriting, operating procedure, and an acquaintance with equipment you will work with out in the "field." Upon graduation you will hold the rate of radioman third class, and are on your own to work for higher promotions thereafter. Would you like to see service in San Juan, Honolulu, or Alaska? Just now requests from radiomen are being taken for assignments in these districts. Perhaps you have had previous flight training and would like to get into aviation radio. Here too the opportunity presents itself, for there are many air stations and aircraft forming a vital part of the Coast Guard. As a "ham" you have no doubt toyed with the idea of becoming a commercial operator on an ocean-going vessel. Then see that you get into the cutter service. On board one of these units you will stand a split 'phone watch on two frequencies: the Coast Guard working frequency and the commercial ship calling frequency (500 kc.). On the Coast Guard frequency you will handle routine traffic between various units ashore and afloat, and you will monitor the 500-kc. commercial frequency for distress cases, or other information whereby the Coast Guard may render assistance in its protection of life and property at sea. Once you are assigned to one of the cutters it'll not be long before you yourself take part in an actual or potential distress or assistance case involving radio.

The Coast Guard has long held an enviable recognition for its radio operators, and will continue to do so for a long time to come. So step in and do your part for National Defense through enlistment in the United States Coast Guard, and it will do its part for you in training and through its reputation.

— Jack C. Nygard, W2J CZ, RM2C

SWEEPSTAKES AND W8DK

Editor, *QST*:

North Berwick, Maine

I challenge W8DK's letter published in January *QST*. If he thinks the recent S.S. Contest was "child's play," I suggest he immediately make preparations to enter the next

annual S.S. Contest and play with the children. It might be good relaxation. If my 46 states, 61 sections, and 321 contacts accomplished with 40 hours of hard work was just child's play, then I wonder what W8DK would call a man's size job. . . .

The communications contests of the A.R.R.L. do more toward making good operators out of us than any other of our fine programs. Entrance into these contests equips us with much experience in copying signals through QRM, speeding up general operation, and particularly aids new men (who for various reasons are not members of traffic nets) to get a dose of fast and efficient operating.

When W8DK goes so far as to call the exchange of groups "meaningless numbers" he fails to consider that this drill work is only symbolic and could easily be converted into traffic, coded messages, etc., as might become necessary in the course of national preservation. S.S. contests bring all sections on the air and only through this great annual get-together do we realize the possibilities of amateur radio communication. . . .

There are various activities connected with amateur radio and it is easy to become so engrossed in one that we think it is only this activity that is worthwhile. However, when we stop to analyze the merits of other activities and actually participate in them we then realize that the A.R.R.L. promotes these various programs because they all are worthwhile enterprises. Any operator who takes part in all the major activities, traffic nets, DX contests, S.S. contests, code proficiency programs, ultra-high frequency work, etc. (or as many of them as he can), will find his knowledge much broader and his operating ability greatly improved. . . .

— Ernest L. Bracy, Jr., W1BFA/W1MOF

902 East 11th St., Pueblo, Colo.

Editor, *QST*:

I just finished the letter written by Mr. Grolz and published in January *QST*. My blood was certainly boiling by the time I finished it. I do not understand how he can say that the S.S. and O.P.S. parties serve no useful purpose. I have entered the last four S.S. contests and can truthfully say that my operating ability has been greatly increased by each one. And he says that these parties are no fun — I get more fun out of the S.S. than any other phase of the old amateur game I have run across since I've had my ticket. They must be fun or else the thousand or more who entered the last one are "goofy." . . .

He says we have more serious business at hand. There is no business more serious than that of making good operators out of amateurs. The S.S. Contest is the best thing I know of for making good operators.

His recommendation that these contests be held on the higher frequency bands — 2½, 5 and 10 meters — is foolish. The purpose of these contests is to develop operators and not experimenting with higher frequencies.

If these contests were held each weekend instead of just on two weekends each year, Mr. Grolz might have a kick coming. . . .

— F. F. Müller, W9WTV

Editor's Note. — H. L. Baker, W9FIN, Alan P. Buffington, W3EEW, Esther L. Davis, W9EFW, Lionel H. Orpin, W6GQW, Loyd W. Sherman, W3CDY, and W. J. White, ex-VE1EX, also were (in the words of W5GQW) "righteously indignant at the heresy promulgated by W8DK" in his *QST* letter.

(Continued on page 100)



F. E. HANDY, WIBDI, Communications Mgr.

J. A. MOSKEY, W1JMY, Asst. to the Coms. Mgr.

Home Guard Basis? In February *QST* (page 25) a blank was printed to sound out the basis for possible emergency operations of certain selected amateur stations for *home defense* contingencies. Every amateur not eligible for military service due to dependents, age, disability, etc., who would be available was asked to say so. It would no doubt require special authorization by proper authority for operators remaining at home in an actual declared war to permit such operations. But in the event of a major or extended emergency, the special enlistment of such operators might well constitute a practical and needed service that could be made possible by amateurs. This notice is a reminder to any who missed the request for an expression of interest that we should like your response. Frankly, we don't want anyone to give us information who wouldn't be able or willing to assist around the home town by some volunteer radio operating for defense. A.R.R.L. promises no immediate radio activity. The idea of planning for *possible* groups of this nature requires advance knowledge of numbers and facilities. Is there or is there not a basis for planning ways in which amateurs might best provide home-guard communications? *Unless you are* designated for military training or otherwise unavailable in a few months, please fill out that blank. *If* you would be glad to volunteer either your operating services or amateur equipment with yourself as operator, provided you were properly authorized, please let us hear from you. Use the blank from last *QST* or copy the essential information if we haven't heard from you already. Thanks for any help on this.

June Field Day Plans. We regret that we cannot give you a positive advance notice of the A.R.R.L. Field Day. Tentatively June 7th-8th is set for the time. You see we want to ask F.C.C. to give us a special extension of regulations for testing emergency equipment afield for the F.D. period. Under present national emergency conditions it is not practical to ask the F.C.C. to make commitments too far in advance. But count on the F.D. Get your plans in order. Start some week-end tests of new self-powered gear as permitted under Orders 73 and 73-A, just as soon as the weather permits. The Field Day has topped every other League activity in reported participation in recent years. Plan to make it the best yet this June. More via W1AW official message as soon as we have official word.

Starting Time. A good start has been made in emphasizing our self-training proclivities in the Code Award program. This is the time also for every amateur to get started in a program to use his frequencies and station for something additional to rag-chewing. Whatever kind of a station you have make this a starting time to get into organized amateur radio. Every ham should at least pull his own weight in those things that add to the collective performance of amateur "in the public interest." Just extreme care to avoid violating F.C.C. regulations and orders isn't enough. Get started in a positive useful program now!

For all who haven't one—start after your Code Proficiency Award (any old speed) to-day. See the news on the coming Red Cross Preparedness Test elsewhere in this issue. Note the chance for handling morale building messages *in the interest of defense* soon. Start handling messages. Be part of all that's going forward. Does your station's record for the last six months strongly show work "in the public interest convenience and necessity," or is the operation a purely selfish activity? If your station work makes you a more proficient operator than you were six months ago, or your traffic has served someone else or advanced the game, or you have taken part in organized A.R.R.L. activities, then you have a good answer. Whatever our present standing, let us go forward. How is your ability to copy on a mill? Message handling come to you as second nature? If you are not *too* good now is a good starting time to use amateur radio to add to individual and collective amateur radio stature. Start now.

W1AW Code Proficiency Runs. 1762-3825-7280-14253-28510-58970 kc. transmitters are used simultaneously. *Code practice* runs start at 9:15 P.M. CST, daily except Friday. The next *qualifying* runs (after Feb. 21st run) are as indicated below, and follow transmissions at the usual practice time, the *qualification* copy starting at 9:30 P.M. CST:

March 21st, Friday	June 17th, Tuesday
April 17th, Thursday	July 20th, Sunday
May 14th, Wednesday	Aug. 18th, Monday

Underline the full minute of perfect copy that you believe qualifies you at any speed. State on copy if you are working for a first certificate or an endorsement sticker. For our information, mention if you copied on mill or by pencil. The certificate you will receive does not show any distinc-

Use the General Traffic Period (6:30-8:00 P.M.). It will make for Effective Amateur Results.

tion, since not all hams have typewriters . . . but your knowledge of your extra ability is enough to make it worth while to you. Attach a statement that you copied by ear without aid except typewriter or pencil. We want to give every U. S. A. licensee a certificate recognition of his ability. It's an achievement! Two in every five active amateurs probably now has a Proficiency Certificate. Got yours?

— F. E. H.

Coming Activities

28-Mc. W.A.S. Party — March 7th-8th-9th (Starts 6 p.m. EST, Friday).

W1AW Code Proficiency Qualifying Run — March 21st (Fri.), 9:30 p.m. CST.

Red Cross Preparedness Test — April 4th.

W1AW Code Proficiency Qualifying Run — April 17th (Thurs.), 9:30 p.m. CST.

7th U.E.F. Contest — April 26th-27th.

ARTICLE CONTEST

The article by Mr. Delbert Bakeman, W9HKX, wins the C.D. article contest prize this month. We invite entries for this monthly contest. Regarding subject matter, we suggest that you tell about what activity you find most interesting in amateur radio. Here you will find an almost limitless variety of subjects. Perhaps you would like to write on working for code proficiency, Emergency Corps planning, traffic work, working in Section Nets, 'Phone and Telegraph operating procedures, holding a League appointment, working on radio club committees, organizing or running a radio club, the most interesting band or type of ham activity, or some other subject near to your heart.

Each month we will print the most interesting and valuable article received. Please mark your contribution "for the C.D. contest." Prize winners may select a bound *Handbook*, *QST* Binder and League Emblem, six logs, eight pads radiogram blanks, DX Map and three pads, or any other combination of A.R.R.L. supplies of equivalent value. Try your luck!

Getting Into Real Operating

BY DELBERT BAKEMAN, W9HKX*

IF ANY old timer who has been in ham radio and everything connected with it for years has begun to read this humble article he had better quit right now, for if not he will have to struggle through the ravings of a ham-sick beginner. The very life of amateur radio lies in its extra activities. I started out, as most hams do, with a flea-power transmitter and a low-priced receiver. The transmitter never did work right, and I finally built up a rig of the forty-watt class and, upon finding that it worked, decided that in my financial condition it would have to continue to work for quite some time. Eighty became boring so I dropped down to forty and got a real thrill. Then it disappeared and I began to look around for something else to take up by interest. I did get a cheap bug for some reason (certainly not a good one) and practiced a little on it before the long inactive summer set in.

Finally the fall came with returning interest in radio. I took one look at my past operating record, shuddered, and settled down to work to make something of my station and my

other self, my ham self. I rebuilt my station, this time for operating, not for looks. Then I studied a little theory, and to my surprise found it fun and interesting instead of what I had expected. Then the foundation having been laid I began to look around to see how I could blossom out with my low power and poor operating.

Now we come to the center of the whole matter. What can a beginning amateur in a situation such as mine, which I consider average, do to come to enjoy and benefit from all the benefits that amateur radio has to offer. Some turn to 'phone work and avoid code work, but since this is usually either financially impossible, or there is a preference for code work, many amateurs stay with c.w., which has the advantage of giving self-training in operating.

Looking about I came upon the A.A.R.S. or the Army Net and decided to try the pastime of message handling, enjoyed by so many. It is an excellent activity that offers pleasure almost the year around. It also develops code speed and procedure efficiency which in turn makes good operators, which are so important to our country in these troubled times. I found that any licensed amateur could join, and I promptly did so, but a low code speed and greenness in operating and procedure curtailed my interest. Code speed is a bottleneck to any activity, so I vowed to lick it. Finding no fellow sufferer to work with, I began to copy the nightly message from W1AW and soon found my code speed mounting rapidly. The A.R.R.L. Code Proficiency runs are a lot of fun to copy and give tangible proof that you can copy code at any certain speed. I also began to try to copy on the mill, but soon decided that both typing and code would have to be improved before trying to perform both at the same time, so I put the typewriter away for future reference.

However, any old timer will tell you that copying on the mill is important, so it's an excellent thing to work on. I even dusted off the bug and put in a little more practice on it. Finally I got up nerve enough to use it and found that QSO's speeded up in any manner vastly increased in interest. Ideas could be exchanged faster and, because of that, more personal and interesting talks resulted. Also the self-satisfaction you get from playing along with the fast boys themselves gives you a satisfaction that more than compensates for the hard work you have put in on the code. So, if the guy can take it down, let that old key smoke a little!

Now comes the task of learning procedure, and here is where another activity comes in. I was fortunate in having the Annual A.R.R.L. Sweepstakes come just at the right time, but if you aren't so lucky some other contest might take its place. However, the contests offer not only experience, but also thrills galore. If you go into the contest to really see what you can do, you are bound to make new records for your station and meet many new fellows. A contest is the real test of your operating ability, and a real challenge to any operator! You don't need a lot of power to run up a good score either. Just time your operating periods so you avoid the bad QRM and the points will roll in faster than you thought possible.

Then comes another very important part of amateur radio, its social activities. By this I mean conventions, club meetings, roundtables, and the like. You have all heard of the brotherly love among all hams and probably you have had a taste of it, but if you want a meal of it, go to the next convention that comes your way. I guarantee that you will have a lot of fun meeting all the boys you have talked with over the air and then remembering how you had imagined they might look; and then you just talk radio in general. And by the way, here's another reason for studying your theory, for if you don't know it, and a little more besides, you will be just naturally left out of a lot of the conversation at any place where hams get together. At some League conventions one can be initiated into the all high order of the Wouff Hong, the secret society of the A.R.R.L. If there isn't a live radio club where you live, it's a shame, for that means also an excellent chance to get acquainted with the local hams and to do things as a group. A.R.R.L. Field Days especially offer excellent opportunities for club work. These get together will also develop self confidence in meeting strangers, for when two hams get together there is always something to talk about!

These are but a few of the activities which as an amateur

* 617 Ohio, South West, Huron, S. Dak.

you can indulge in. They are not only fun in themselves, but develop your knowledge and operating ability, and, last but not by any means least, they will increase two fold your interest in ham radio which in turn will spur you to still greater heights as an all-around amateur.

There is a future in radio you know and the extra activities will make learning to be a good radio man a lot of fun. Try it! Get in on the fun!

--- --- ---
BRIEFS

From Dow B. Summers, W9KOH, of Unionville, Mo., comes this report:

"We had a terrible sleet storm here on December 14th. Monday morning the Bell line and Western Union could not get out of town. A local grocery man came to the house and said, 'Can you talk to Des Moines?' I told him I didn't know. My antenna was down but I thought I could load the feeders on my 10-meter beam and get out that way.

"Well, the feeders took a load and I called CQ Des Moines. W9AG in Ottumwa came back to me. They could not get out by land line either but he said if it was important he would call the police radio. They took my message, sent it in — and the grocery man had his 12 dozen milk bottles delivered that evening by truck.

"That gave me an idea. All lines in Missouri and Iowa were down (I understand the storm cost Bell Company \$50,000 dollars). I told W9AG to tell the Macon, Mo., police station I would check their frequency for any traffic and they could check mine. I was then referred to W9OQI in Jefferson City but he could not hear me. He could hear W9SRE in Brookfield, Mo., though, and we could work cross-band fine. I handled traffic here all day. . . .

"I think this police station hook up between amateurs and hams a wonderful thing. They nearly all have amateur stations separate from the police stations themselves to handle weather and traffic. I know we do in Missouri, anyhow. The official amateur here is W9OQI at Jefferson City and they keep in touch with Macon."

W9KOH has something there, all right. The police radio boys are also, in large proportion, hams. In fact, we are informed by the journal of the Association of Police Communication Officers that police departments generally not only encourage their operators to maintain ham rigs on the side, but also often provide space and facilities for a ham shack in the building where the police transmitter is located, for emergency and morale purposes.

Such a set-up makes for close and friendly cooperation between two of the most vital and extensive radio services — amateur and police radio.

**High-Speed Radio Equipment Operators
 Wanted for National Defense Work**

To meet the urgent need for high-speed radio equipment operators for the National Defense Program, the United States Civil Service Commission has announced that it will accept applications to fill these positions until further notice. Qualified persons are urged to send their applications to the Commission's Washington office at once. A large number of vacancies will be filled in defense establishments.

One year of experience as radio operator in commercial or Government communications work (not radio broadcasting) is required. Although training in radio operation at a service school may be substituted for this experience, all applicants must have had three months' experience in the operation of high-speed radio communication equipment such as transcribing to typewriter syphon recorder tape, and transmitting messages by hand or bug. The entrance salary is \$1620 a year.

Further information and application forms may be obtained from the Secretary of the Board of U. S. Civil Service Examiners at any first or second-class post office, or from the U. S. Civil Service Commission, Washington, D. C.

--- --- ---
 The Civil Service Commission also announces openings for Engineering Draftsmen, with an option in radio drafting. High school education except for substituted drafting experience is required. Applicants must also show paid drafting-room experience, or completion of a drafting course in a

school specializing in drafting, or college engineering; in addition they must show drafting experience in radio. Completion of study in engineering in a school above high-school grade may be substituted for a part of the drafting training or experience. Competitors will not be required to take a written test, but will be rated on their education and experience as shown in their applications, and on corroborative evidence.

--- --- ---
New Members—O.M.R.C.

A list of new members of "The Old Man Radio Club" is received from W1JIS. This group is made up of radio amateurs fifty years of age or older. April QST (page 84), June QST (page 86) and December QST (page 100) of last year contain previous listings of O.M.R.C. A list of new members, with ages indicated, follows: W1HUV 79; W9OMZ 76; W9BJA 74; W2IB 67; W6QFY, W9QJZ 66; PY5AG, W9ZAK 64; W3HYX 63; W3HXB, W7GUX, W8PJB 62; W3BZ, W6ON 61; W5EZZK, W6BDP, W8UGR, W8YS 60; VE3IB, W6TBK, W7KO 59; W4CXA, W5AMZ, W5JCS, W6SNE 58; W8GET 57; W4PL, W6DLA, W6GS, W6QJJ, W7IGM 56; W6EOP, W9HKL, W9KXJ 54; W2DCM, W2MIE, W6FOD, W6SQC, W7DP, W9VJH 52; W1MTP, W5IZW, W6RBJ, W6RKC, W8SBV, W9NKW, W9ZGK 51; W1ZE, W8CD 50; W7FMN.

--- --- ---
 W9VKF has been Southern Minnesota winner in the A.R.R.L. Sweepstakes each year since he received his ticket in September, 1935. He also won the Section award in the first three A.R.R.L. Parties. A record that's hard to beat, we'd say!

--- --- ---
 The Rag Chewers' Club now numbers more than 5000 members.



Meet the S.C.M.'s

W3CCO

Lester H. Allen, S.C.M., Southern New Jersey, received his first ticket in 1928. His very businesslike station is heard on all bands from 1.75 to 28 Mc., but the most used frequency is 29,000-kc. 'phone. The main transmitter runs 1 kw. to a pair of 250TH's modulated by another pair of 250TH's in Class B. A smaller rig with 812 final is available for stand-by use and can be powered from the 500-watt, 110-volt-a.c. gas-driven emergency plant. Receiving equipment consists of a Breting 14-AX and a Hallicrafters 7. S.C.M. Allen is president of the Delaware Valley Radio Association, A1-Op, R.C.C., ex-P.A.M., holds a Public Service Certificate, and has a W.A.S. award endorsed for contacts with all states on 'phone. Outside the shack his hobbies are motorboating and traveling, and he indulges in a bit of tennis and baseball now and then. He's a member of the Board of Council of Rider College, and is Sales Manager for Warren Balderson Company, distributors of broadcast receivers.

Northwest Sleet, Snow and Wind Storm

ONE of the worst storms in the memory of its oldest inhabitants swept through the Northwest last Nov. 11th and 12th. All highways were blocked, many for several days. Transportation was at a standstill in most localities, while power lines were down in many places, and many towns were entirely isolated. Sleet and wind tore out miles of telephone and telegraph lines. Amateur radio was in many cases the only means of communication. Trains were lost on the prairies while hundreds of automobiles were stalled on the highways. Hardest hit were western South Dakota, southern Minnesota and Wisconsin.

Again amateur radio served, bringing order out of chaos. Most of the traffic was handled on the 3.9-Mc. 'phone band. When skip entered in, much of it was diverted to 1.75-Mc. 'phone. The c.w. boys also did a great job, and those not active in message handling constantly searched the band for calls from the isolated areas. Special credit must go to those who monitored and policed the channels on which most of the work was done.

On the morning of the 11th there was a light rain turning to sleet about noon, soon followed by a bitterly cold wind. Conditions rapidly became worse as the snow began piling up in drifts. Emergency calls began coming through. W9BJV at Watertown, S. Dak., contacted MYX at Sioux Falls, informed him that Watertown was practically isolated, and proceeded to give him about 1000 words of press. From that time on, BJV was one of the key stations, handling all manner of important traffic including the dispatching of trains for the Chicago and N.W.R.R. and the Milwaukee & St. Louis R.R., as well as numerous individual messages. Schedules were kept and many stations took a part in maintaining contact with towns in South Dakota. One of these was CYX of Tracy, Minn., division point for the Chicago & N. W. CYX took dispatch orders from the R.R. operator and gave them to BJV who, in turn, 'phoned them to Huron. The C. & N. W. had no contact with Huron for two days except through CYX. One hundred and sixty-two messages were handled by this station.

Others who handled traffic with Watertown were NNO and BPK, who were in on the emergency in short order. OTE did a splendid job, as did KCX, OCF, WAS, CGK and others. In the midst of his traffic handling, BRK had his antenna blown down, but in true ham spirit went out in the blizzard and got it up again in short order. Part of the time he was on with emergency power. He also handled traffic to and from Albert Lea, Minn., which was isolated, and kept in contact with VVA at Willmar and UTR at St. Cloud. RHT was very active and deserves a lot of credit for his fine work in message handling and in locating lost persons.

WAS gave KHND, the State police station at Redwood Falls, contact with its central office through St. Paul and Minneapolis amateurs, as well as maintaining contact with Watertown and Brookings, S. Dak. KHND was also monitored by BJV during the storm so that an outlet could be maintained in case of failure of the amateur circuit. CRO was the operator at KNHD.

BN-DH at Minneapolis handled traffic for the power companies for four days, establishing new contacts with stations other than those included in their regular daily schedules. These included OKS, CYX, AN, GKO, WAS, ZXX, NIW, VVA, UTR, FSD, and JVP who handled a total of 83 messages. Some fine work was done by these amateurs.

OTE was especially busy on 3.9-Mc. 'phone, handling a great many messages, sometimes under difficult conditions. His wife took many messages over the 'phone and acted as assistant. QMR established contact from Farmington early in the emergency with BCT of St. Paul and some 75 radiograms were transmitted by these stations over a period of two days. When BCT's power supply went out, HCC of Minneapolis took over until BCT came back on the air. Much of this traffic was for the State Highway Department and aided them materially in routing plows on the roads. Other messages dealt with storm-bound parties in the vicinity as well as those relating to bus service and other modes

of transportation. HCC took over the duty of monitoring the 3.5-Mc. band and maintaining schedules with BHY, the State Coördinator. Others active on the Minnesota Emergency Net and should be credited with active monitoring on the net frequencies and the entire band were BBL, HFF, KFF, CVH, DNY, ITQ, CYX, CGK, ICU, and GKP.

ZVWV drove through almost impassable roads to operate BHY's station while BHY spent most of his time answering the 'phone and taking messages from frantic persons who had heard the broadcast over KSTP to the effect that the amateurs were in contact with some fourteen isolated towns, and would take any emergency messages. ZMQ assisted greatly in helping to organize the 3.9- and 1.75-Mc. 'phone nets. WCCO announced on the news broadcast that ZMQ would take emergency traffic for isolated towns, and as a result he was swamped with traffic. Again we felt indebted to the ladies, as the XYL's plunged into the job of helping the OM's.

The organization of the 1.75-Mc. 'phone band into a working unit can largely be credited to the efforts of KGY, who worked with ZMQ. KGY carried on all day and far into the night when conditions finally prevented continuance until the following day. Five states were lined up and took storm traffic via this set-up. Among those who took part were YLZ, CJS, KMH, LON, CYX, ORE, JBX, KOH, JCF, BXW, ICQ, LIL and NFM.

With an incomplete report available on the part that was played by many, it is difficult to give due credit to all. We again learned much, and hope that if we are again called on we shall benefit from the lessons learned. Once again we were reminded of the fact that "it can happen here." No doubt many were unable to serve due to lack of emergency equipment. We hope that these may find their way clear to build such a rig before the next emergency arrives.

To those who showed again the emergency communication value of amateur radio, we express our thanks for a job well done. We also thank those who cooperated in remaining off the air so that the job could be done effectively.

—A. E. Swanberg, W9BHY,
State Coördinator, Northern Minn.

A.R.R.L. Code Practice Stations

THE following amateur stations are transmitting code practice in the 1750-kc. band on regular schedules for the benefit of beginning amateurs:

Station	Frequency	Days	Hours
W4BPD S. C.	1945 kc.	Sun., Wed., Fri.	7:45-8:30 P.M. E.S.T.
W4FSW Ala.	1881 kc.	M-T-W-T-F-S	7:00-8:00 P.M. C.S.T.
W5TG/ Texas	2045 kc.	M-T-W-T-F	8:00-9:00 P.M. C.S.T.
W6QJH Nev.	1775 kc.	M-T-W-T-F-S	7:00-7:30 P.M. P.S.T.
W6SVH Calif.	1909 kc.	Tues., Thurs., Sat.	6:16 A.M. P.S.T.
W7DPU Wash.	1958 kc.	M-T-W-T-F	5:30-6:30 P.M. P.S.T.
W7IGZ Wash.	1978 kc.	Tues., Thurs.	2:00-4:00 P.M. P.S.T.
W8FFK Ohio	1805 kc.	Tues.	7:00 P.M. E.S.T.
W8NQS Mich.	1984 kc.	M-T-W-T-F	8:00-8:25 A.M. E.S.T.
W8QBU N. Y.	1878 kc.	Wednesdays	7:30-8:00 P.M. E.S.T.
W8SES W. Va.	1878 kc.	W-T-F-Sun.	8:00-9:00 P.M. E.S.T.
W9BB Nebr.	1660 kc.	M-T-W-T-F-S	7:15-8:15 P.M. C.S.T.
W9BQL Ill.	1920 kc.	M-T-W-T-F-S	6:30-7:30 P.M. C.S.T.
W9BSP Kans.	1903 kc.	Daily	7:30-8:30 P.M. C.S.T.
W9CEQ Ill.	1943 kc.	M-T-W-T-F	5:30-6:30 P.M. C.S.T.
W9CXQ/ Ind.	1965 kc.	Mon., Fri.	10-10:30 P.M. C.S.T.
BFG			
W9DYG Nebr.	2040 kc.	Daily	7:00-7:30 P.M. C.S.T.
W9NAA Ind.	1875 kc.	M-T-W-T-F	6:30-7:30 P.M. C.S.T.
W9TVS Nebr.	1900 kc.	Nightly except Sun.
W9YMV Ind.	1880 kc.	Thursdays	7:00-7:30 P.M. C.S.T.
K6PAH Hawaii	1976 kc.	M-T-W-T-F	8:15-9:15 P.M. H.S.T.

* Schedule effective starting March 10th.

(Continued on page 64)

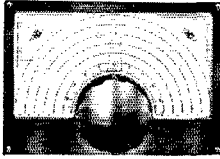

ON PAGE 118 of this year's Handbook you will see a dial that is not quite like anything that has been put on amateur gear before. It appears there because the fellow who was building that seven-tube superhet needed a practical direct-reading dial to finish the job right.

We set out to make him one. What he wanted, of course, was a dial that could be provided with direct-reading scales without resorting to factory methods. So we went through the process of calibrating a direct-reading dial, step-by-step, and kept on redesigning the dial until the steps were easy. This resulted in a rather unusual dial, as we can show by telling how it is used.

First of all, a dial must be mounted. It is difficult to cut large, queer-shaped holes in metal panels without a punch press, so we put the dial on the front of the panel with only a few small holes required. To save laying out these holes, the dial bezel is made rugged enough to serve as a drilling template.

The next step is calibration. This should be done after all adjustments have been made, and the equipment is in operation. So with everything assembled except the transparent cover over the dial scales, calibration begins. Each time a calibration point is determined, a hole is pricked in the scale with a sewing needle through one of the small holes in the sweep pointer. These holes are there for just that purpose, and they insure that the points will be accurately transferred to the scale.

The final step is inking-in the scale. Since loosening any setscrews or similar disassembly would destroy the calibration, the dial has been designed so that the scale can be slipped out by removing two small screws at the top of the bezel, without disturbing the dial mechanism in any way. When finished, the scale is replaced, this time with the protecting cover over it. The two screws hold it in place, and the job is done.

At this point you will probably say, "OK, it's easy enough to calibrate, but how good a dial is it when it is done?" That is not hard to answer. Its full-vision scales are patterned after the NC-100A's. It gets its knob from the HRO. And mechanically, it uses the guts of the Type A Dial, which for sixteen years has been winning compliments for its smoothness and freedom from backlash. We know you like these features separately, and we are sure you will like them in combination.

This business of taking a lot of time-tried parts to make a new product has another advantage, too. It eliminates most of the tooling, resulting in a remarkably low price for a quality dial.

Such is the new ACN Dial. We hope you like it. You will find it advertised for the first time on Page 75 of this issue, where it occupies a place of honor.

W. A. READY



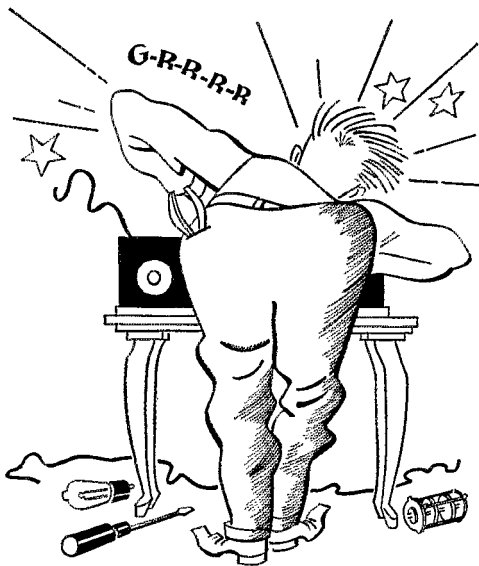

STOP CUSSING . . . START USING MALLORY CONDENSERS

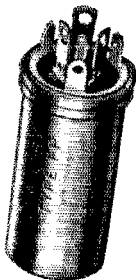

Developed by Mallory, Fabricated Plate Condensers offer smaller sizes without sacrificing safety or efficiency. Low R. F. Impedance, surge proof construction and improved sealing against humidity and heat are among the many outstanding advantages. Literally millions of FP Condensers are in use as original equipment and they have set up unequalled performance records. Remember . . . only Mallory makes FP Condensers for replacement and experimental work. Try them now!

● NOISE FILTERS

Don't let your DX reception be spoiled by man-made static originating from nearby arcing electrical appliances. Elimination of it is simple and inexpensive with Mallory Noise Filters. A type for every condition. Easily applied. Write for Form NF-100.

P. R. MALLORY & CO., Inc.
INDIANAPOLIS INDIANA
Cable Address—Pelmallo

Use
P. R. MALLORY & CO. Inc.
MALLORY
APPROVED
PRECISION PRODUCTS

F.C.C. Disciplinary Actions

THE Federal Communications Commission's Huntington, W. Va., office, acting in cooperation with the local United States Marshal, apprehended in early January at Hubbell, in that state, a youth who is alleged to have engaged in unlicensed broadcasting which caused interference to authorized radio programs. Using the non-existent call letter WBBQ, this offender transmitted entertainment which "collided" with regular services. Amateurs, particularly, complained of the resultant interference. The illegal station, which used a transmitter of approximately 25 watts and a steel vertical radiator, was located by means of the Commission's new direction-finding equipment. The operator has been charged with violation of Sections 301 and 313 of the Communications Act.

The amateur radio operator license with Class B privileges of Allan Walter Lorenzen, Long Beach, Calif., was suspended on January 14, 1941, for violation of the provisions of the Communications Act and the Rules and Regulations of the Commission Governing Amateur Radio Stations and Operators.

The F.C.C. in early January suspended the amateur radio operator license with Class B privileges of Norman Donald Sather, Minneapolis, Minn., for a period of six months, because the licensee while engaged in the operation of radio station W9ISH used his station for broadcasting entertainment, addressed radio communications to the general public and solicited telephone calls from radio listeners, and made transmissions to points equipped only with receiving apparatus, all in violation of Commission rules.

The amateur radio operator license, with Class A privileges, of Cyril A. Strehlow, St. Paul, Minn., was suspended in early January because the licensee while engaged in the operation of radio station W9OCF made transmissions to points equipped only with receiving apparatus by talking directly to all listeners and solicited telephone responses from them, used station for broadcasting entertainment, and permitted the emission of the unmodulated radio carrier wave thereof for extended periods of time when the station was not in actual communication with other radio stations, all in violation of the Commission's rules.

The Commission in early January adopted an order suspending the radio operator license with Class B privileges of Joseph Peter Pauly for a period of one year, because he impersonated another person at the Commission's Field Office in Chicago, in an attempt to obtain an operator and station license by fraudulent means, in violation of the Communications Act.

Add father and son schedules: W6PU, Albany, Calif., works his son W3INI, Baltimore, Md. From December 27, 1939 to December 27, 1940, schedules were kept on 229 days. Of these, 5 qso's were incomplete due to poor conditions; the remaining 224 were good solid contacts ranging in time from twenty minutes to an hour and three quarters. 200 watts c.w. is used at each end of the circuit.

November 7, 1940 (the same day the Narrows Bridge went out), at 4:19 p.m., the cable between Vashon Island and Tacoma, Wash., broke, leaving the island without telephone communication to the mainland, and KVI's transmitter without a program line. W7CYC, who works at the Vashon b.c. station, went home after going off duty and tuned up his rig on 3.9-Mc. 'phone. He called CQ Seattle or Tacoma at 9:09 p.m. and raised W7OS in Tacoma. Contact was carried on until 12:23 a.m. the next morning. The telephone operator on the island was informed of the hook-up and told that any important or emergency messages would gladly be handled. There was no traffic from the 'phone company. However, a couple of KVI's announcers came to W7OS's shack, Ernie Estes, W7AND, went to W7CYC, and KVI's program and engineering problems were discussed and planned for the following day. The telephone company had the cable repaired by the following morning, November 9th.

W8ROA, Secretary-Treasurer of the Horseshoe Radio Club of Altoona, Pa., writes to say he is interested in swapping bulletins with other clubs around the country. He's a shut-in and has plenty of time to answer all correspondence from other amateur radio groups. The basic thought behind obtaining such bulletins is that, in so doing, new ideas for programs and keeping up interest may be gathered. Watsa, club secretaries? It sounds like a good idea to us.

FOR *high speed...* **TRAFFIC!**

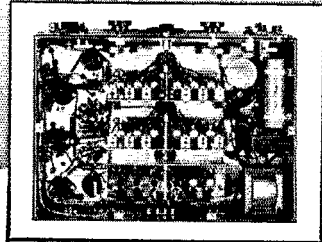
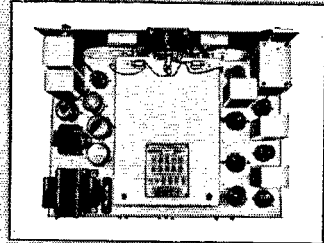
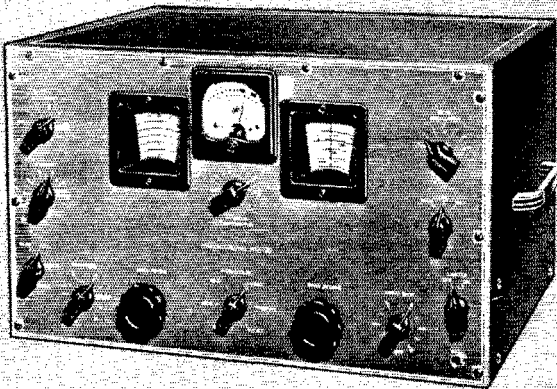

Use an **HQ-120-X**

FOR obvious reasons, the amateur is vitally interested in improving his ability to copy code and handle traffic. Success in this direction depends on two primary factors — personal ability and quality of equipment. The "HQ-120-X" receiver has been designed by engineers who think along commercial lines. Therefore, it has an inborn commercial quality. The amateur today requires a commercial type receiver every bit as much as a man who gets paid for copying. The amateur, as a matter of fact, has an even more difficult job because of heavy QRM. So, don't take

chances; use an "HQ-120-X" and your battle with high speed code and traffic will be more than half won.

SEND FOR FREE BOOKLET!

HAMMARLUND MFG. CO., INC.
424 W. 33 Street, New York City

Q-3

Please send "HQ-120-X" booklet

Name

Address

City State



HAMMARLUND MFG. CO., INC.
424-438 WEST 33rd ST., NEW YORK



EXPORT OFFICE: 100 VARICK STREET, NEW YORK CITY

OHMITE

**PARTS add new Life to
the Heart of your Rig**



★ Add pep and efficiency with these dependable Ohmite parts. They're proved right on the toughest jobs in every climate. Get them at your Jobber.

Dividohm Resistors—easily adjusted to resistance you need. **Brown Devils**—10 and 20 watt resistors for voltage dropping, bias units, bleeders, etc. **R.F. Plate Chokes**—to avoid fundamental or harmonic resonance in the amateur bands. **Parasitic Suppressor**—to prevent u.h.f. parasitic oscillations. **Center-Tapped Resistors**—used across tube filaments to provide an electrical center for the grid and plate returns.

Send 10¢ in coin for handy new
Ohmite Ohm's Law Calculator

OHMITE MANUFACTURING COMPANY
4865 Flournoy Street Chicago, U.S.A.

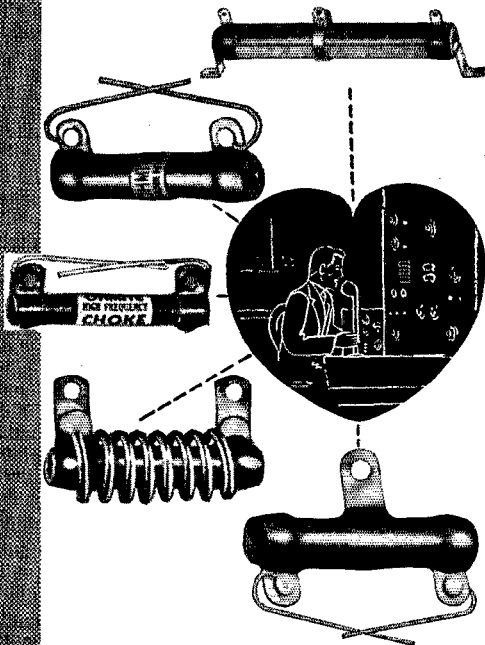

Be Right with **OHMITE**
RHEOSTATS • RESISTORS • TAP SWITCHES

Brass Pounders' League

(December 16th-January 15th)

Call	Orig.	Del.	Rel.	Extra Del. Credit	Total
W6LUJ	388	879	151	877	2295
W3GKO	44	62	2031	46	2183
W6DH	97	326	1162	321	1906
W6QKB	55	69	1227	36	1387
W5FDR	93	302	684	280	1359
W3AOC	68	99	1056	96	1319
W9ILH	30	130	1050	47	1257
W3BWT	134	116	892	105	1247
W6IOX	21	27	1082	27	1157
W6ROZ	45	66	970	58	1139
W2HXL	41	104	852	86	1083
W8DAQ	15	39	871	35	960
W7EBQ	48	93	716	81	938
W3CIZ	23	112	673	102	910
W5MNM	60	132	600	113	905
W9NBX	37	87	719	32	875
W1KKS	128	38	668	11	845
W9DUX	103	82	566	60	811
W9IU	123	51	548	38	760
W8NCJ	20	72	604	63	759
W3NF	7	26	694	26	753
W2SC	35	115	502	87	739
W8SAY	17	15	694	11	737
W5CEZ	18	120	543	17	698
W9OZM	51	8	620	4	683
W2MIY	43	57	465	104	669
W9ZTU	60	44	528	31	663
W8TGU	18	20	592	16	646
W5BN	20	46	534	42	642
W9JMG	117	8	485	2	612
W1MEC	28	110	348	104	590
W1MGC	106	27	440	13	586
W9ABE	0	5	568	1	574
W9TTJ	46	140	258	121	565
W9NSU	12	3	534	3	552
W2CGG	14	80	390	67	551
W8PCN	48	76	368	51	543
W9EKQ	9	10	506	16	541
W9QMD	14	12	498	8	532
W9OUD	29	81	382	32	524
W8CJL	14	23	468	17	522
W5DDJ	4	78	426	10	518
W1GOJ/4	30	44	411	29	514
W3EEW	56	57	362	33	508

MORE-THAN-ONE-OPERATOR STATIONS

Call	Orig.	Del.	Rel.	Extra Del. Credit	Total
KAIHR	2170	858	0	832	3860
W5OW	177	98	1682	59	2016
W1AW	109	129	682	124	1044
W8TTX	111	140	264	112	627
KAIHQ	281	54	274	0	609
W4FCU/GFO	10	20	468	16	514

These stations "make" the B.P.L. with total of 500 or over. One hundred deliveries+Ex. Del. Credits also rate B.P.L. standing. The following one-operator stations make the B.P.L. on deliveries. Deliveries count.

W2KI, 338	W6ZX, 154	W9MRQ, 113
W6SPB, 274	W5IQN, 152	W8SCW, 111
W6SN, 273	W8KWA, 149	W3AQN, 110
W7APS, 267	W3HRS, 138	W1KIN, 109
W8JIW, 252	W9YZE, 136	W2EC, 108
W2MRL, 227	W2DW, 132	W6MYT, 108
W6RBQ, 204	W3BXE, 130	W1KYQ, 106
W5GFT, 186	W2MNT, 127	W5AUL, 103
W6RGQ, 186	W6ZM, 127	W5FVY, 102
W9VBQ, 183	W6CMN, 126	W9WWL, 101
W5DVQ, 180	W1BAY, 123	W2MIY*, 100
W6EJA, 172	W8FFK, 121	More-than-one-opr.
W9QG, 159	W9SEB, 118	W5CEB/S, 111
W1FFL, 157	W1KCT, 113	

A.A.R.S.

Call	Orig.	Del.	Rel.	Extra Del. Credit	Total
WLMW (W9QL)	84	70	797	60	1011
WLN (W2SC)	93	157	492	116	858

WLYG (W7EBQ) made the B.P.L. on 112 deliveries.

MORE-THAN-ONE-OPERATOR STATIONS

Call	Orig.	Del.	Rel.	Extra Del. Credit	Total
WLM (W3CXL)	281	190	4510	118	5099

A total of 500 or more or 100 deliveries+Ex. D. Cr. will put you in line for a place in the B.P.L.

*Nov.-Dec.



Super Pro

SERIES
200

for the Tough jobs!

THE illustration above shows "Bob" and "Mabel" Beebe operating W7HXU, one of their two fine amateur stations. "Bob" has his own station, W7IGM, at his place of business. Both stations use "Super-Pro" receivers. Here is what "Bob" writes: "We have, beyond doubt, the world's worst receiving location, bar none, including three 26,000 volt transmission lines exactly 35 feet from the transmitter, and when the old-timers saw what we were blundering into, we were assured that 'It could not be done', and actually were out looking for a new home with suitable reception when someone suggested Hammarlund 'Super-Pro'. The 'Super-Pro' changed the situation completely and when the band is open, Mabel works 'em."

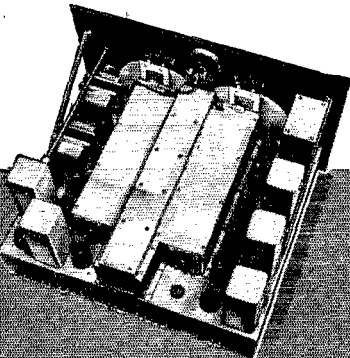

YES — for the tough jobs you'll find the "Super-Pro" can't be beat. It is built for 24-hour a day service under practically all conditions. To enjoy really fine reception, use a "Super-Pro". Your local jobber will be glad to arrange a demonstration. See him today. For complete technical information, including curves and diagrams, mail coupon below.

Q-3

HAMMARLUND MFG. CO., Inc.
424 West 33rd St., New York City
Please send 16 page "SP" booklet.

Name.....
Address.....
City..... State.....

HAMMARLUND

KENYON

STANDS OUT

We are passing through a period in our country's history when nothing must be left to chance . . . when Dependability is the keystone upon which the success of Defense rests.

For many years Kenyon Transformers have well earned a reputation for Dependability — a reputation which has been taken for granted. But in times like these the stature of the name Kenyon grows in importance for a new, a more significant shade of meaning has been given to Dependability.

Our engineering department will be glad to consult with you — whether you are a manufacturer of important defense equipment or whether you are an amateur seeking really dependable transformers for your transmitter. Catalog upon request.

KENYON TRANSFORMER CO., INC.

840 BARRY ST. NEW YORK, N. Y.

DX Notes

NO DOUBT some were disappointed to learn last month that W1JPE was discontinuing his very popular "How's DX?" However, until conditions warrant running the column again, we'll pass along anything of interest. ♪

G5LY writes to say that of 70 qsl's sent out confirming contacts with W's, he received only one reply. How about it fellows? A card to our friends across the pond means a great deal these days! . . . W8PQQ recently received cards from KF6SJJ, KE6SRA and KC6CBN. . . . On January 15th W9CVL worked KF6JEG/KG6 on Jarvis, who is off the air at present because he has to conserve fuel for Government schedules. . . . CVL also reports many excellent contacts with K6BZD, who is 10,000 feet up in the air on Haleakala Crater, Maui, and runs 4 watts to a pair of 30's and uses a 400-foot-long wire antenna. . . . ZD2H requires cards from Vermont, Nevada, Utah, Idaho, Oregon, Washington and South Dakota, and says he'd be pleased to exchange qsl's with stations he has worked in those states. . . . W6QL advises that KD4GYM will leave Swan Island about the end of February. It is understood that there will be another chap relieving him who will probably be on the air down there. Both W6QL and W6ONQ have been holding traffic schedules with KD4GYM. . . . Tommy Wimbush, ex-G2TW, SU2TW, ZC6CC, would like to hear from some of his old "W" friends. His address is Sgt. T. B. Wimbush, No. 31, S.F.T.S., Collins Bay, Kingston, Ontario, Canada. He insists, by the way, that he qsl'd *all* contacts.

High Scores, A.R.R.L. Party

THE Fourth Annual A.R.R.L. Member Party (January 18th-19th) brought forth widespread participation in what has become one of amateur radio's most popular and enjoyable operating activities. Since the party was scheduled later in the month than usual this year, there hasn't been much time for scores to come in. However, already stacks of logs have arrived and they continue to pour in each day. Those that have come in indicate that the records of previous affairs have been smashed to "smithereens." As this copy goes to our printer, the following "claimed scores" are at hand. We'll present the official results with a list of winners in July QST. The figures following the calls below represent score, members worked and sections worked.

W9FS	56974-442-61	W3CRW	27324-228-54
W1TS	50264-387-61	W8GD	26884-234-52
W3DGM	44840-355-59	W9VOQ	26400-215-55
W9RQM	41400-320-60	W6BAM	25704-227-51
W9PKW	41382-338-57	W9NDA	25493-216-53
W6PCE	40560-315-60	W9QMD	25312-201-56
W9DIR	39424-327-56	W9GFF	25092-221-51
W8KUN	38280-305-58	W9BBS	24804-209-53
W5KC	38000-309-57	W9KBL	24000-216-50
W3IWM	36288-299-56	W4FIJ	23976-197-54
W5FZD/5	33110-275-55	W4BSJ	23618-216-49
W5DBR	31376-272-53	W2JKH	23260-240-42
W9GBJ	31350-260-55	W8SCW	22984-221-52
W2EQS	30793-268-53	W9ZWR	22278-212-47
W1BIH	30240-256-54	W6QKB	22200-197-50
W9QFS	30195-251-55	W1KXU	21642-194-49
W3EML	29590-270-55	W8OKC	21604-224-44
W3BXE	29500-270-50	W8RMT	21008-177-52
W9GKS	29376-241-56	W4BYF	20265-205-45
W9AEB	27500-225-55	W8KO	20246-166-53
W3HUM	27400-251-50	W2EWD	20102-194-46
W2HXI	27342-254-49	W8ROX	20102-195-46

W1IIE, S.C.M. of the Maine Section, tells of a unique early morning traffic schedule maintained by members of the Hit and Bounce Net. Late in the evening W5MN in San Antonio, Texas, collects traffic from KA, K6, K7, W6 and W7. At 3 A.M. P.S.T., he works W3CIZ, W2CGG, W1BDU and W1IIE. He then transmits all messages on the hook while each of the other fellows copy preambles and addresses. When W1IIE, for instance, notes that a message is for his Section, he continues to copy the text and the rest merely copy for check. After completing the transmission of all traffic, W5MN checks with each station to make certain that each message has been copied in the Section to which addressed. The system works very efficiently and has provided some very fine service over long hops.

K6NYD

(Now W4HGN in
Pensacola, Florida)

One of the best known Amateurs of the Hawaiian Islands uses Eimac 250T's

"When and IF replacement becomes necessary,
Eimac 250T's will again be my choice" . . .
Says Lieut. A. W. Greenlee, U. S. N.

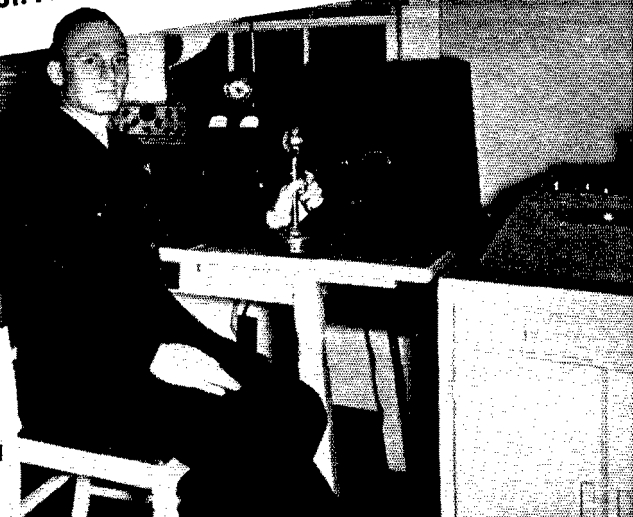

DX is no longer permitted but the past record of K6NYD is still impressive. On fone: 87 countries worked with 78 confirmed. On CW: 108 worked with 86 confirmations. K6NYD has been using Eimac 250T's in his final amplifier since 1937 and says they are extremely dependable. Prize feat with his "rig" was the regular schedule maintained with the evasive AC4YN . . . once on fone with the "AC" on CW. Lieut. Greenlee says: "In spite of more than 2500 hours service, my 250T's still neutralize perfectly and appear to have full filament emission."

Outstanding performance like this and long dependable service without a let down is typical of the results being obtained by amateurs who use Eimac tubes. Make no mistake about it, you can benefit greatly by the experiences of the worlds leading radio men, most of whom use Eimac tubes.

Be sure you buy tubes on the basis of facts . . . not on promises. Get full information today. See the nearest Eimac representative or write direct to the factory.

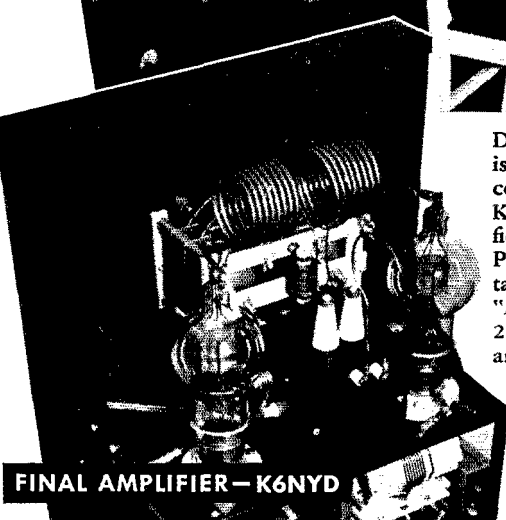

FINAL AMPLIFIER - K6NYD

**3 ELEMENT ROTARY
ANTENNA - K6NYD**

Eimac TUBES

Eitel-McCullough, Inc. • San Bruno, Calif.

HIDDEN EXTRAS

at no extra cost

THE BASIC REASON FOR CORNELL-DUBILIER LEADERSHIP

EXTERNALLY, the best and poorest capacitors may look alike. Internally, and in service rendered, they differ vastly. Cornell-Dubilier Dykanol Filter Capacitors are not merely well designed and constructed. They contain those valuable HIDDEN EXTRAS — Extra Stamina, Extra Dependability and Extra Long Life. That's the reason for their superior performance! That is why there are more C-D Capacitors in use today than any other make.

EXTRA VALUE FEATURES

YOU GET IN C-D

FILTER CAPACITORS TYPE TQ

- Vacuum Impregnated—5000 megohms per mil.
- Stand 10% continuous overload.
- Low power-factor.
- Hermetically sealed.
- Unaffected by temperatures up to 200° F.
- Impregnated and filled with non-inflammable Dykanol.

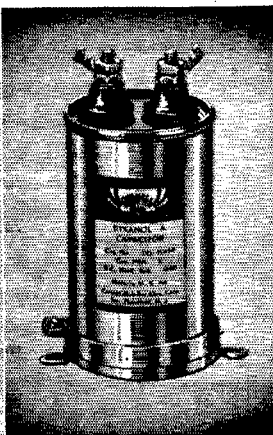

WHEN THE BEST IS A "MUST"
Specify C-D's CAPACITORS YOU CAN TRUST
 Capacitor Specialists for 31 years.



CORNELL-DUBILIER
 ELECTRIC CORPORATION
 1013 HAMILTON BLVD. • SO. PLAINFIELD, N. J.

The Rag Chewers' Club

THE Rag Chewers' Club is designed to encourage friendly contacts and discourage the "Hello-Goodbye" type of QSO. Its purpose is to bond together operators interested in honest-to-goodness rag chewing over the air. Membership certificates are available. Follow the rules here outlined and make your station eligible to sign "RCC." Present club members are urged to sign "RCC" after each call, so that those wishing to join may identify you and take steps to get "initiated."

How to Get In: (1) Chew the rag with a member of the club for at least a solid half hour. This does not mean a half hour spent in trying to get a message over through bad QRM or QRN, but a solid half hour of conversation or message handling. (2) Report the conversation by card to The Rag Chewers' Club, A.R.R.L., Communications Department, West Hartford, Connecticut, and ask the member station you talk with to do the same. When both reports are received you will be sent a membership certificate entitling you to all the privileges of a Rag Chewer.

How to Stay In: (1) Be a conversationalist on the air instead of one of those tongue-tied infants who don't know any words except "cuagn" or "cul" or "QRU" or "nil." Talk to the fellows you work and get to know them. (2) Operate your station in accordance with the radio laws and A.R.R.L. practice. (3) Observe rules of courtesy on the air. (4) Sign "RCC" after each call so that others may know you can talk as well as call.

How to Get Out: (1) Call a fellow and then say something like, "W1 nil hr OM cul 73 . . . -.", (2) Call anybody if you are so dumb that you can't make some conversation. (3) Fail to QSP promptly a single message — either by radio or by mail. (4) Call CQ more than five times without signing, or call lengthy CQ's without listening for answers.

— . . . —

The Delta 75 Phone Net

The Delta 75 Phone Net is made up of 3.9-Mc. radio-telephone operators in Mississippi and Louisiana interested in banding together for the purpose of establishing a form of communication to supplement the regular facilities within the two states. The net was organized and has functioned for the past two years under the direction of Captain Dobbins, W5FSI, formerly of Camp Beauregard in Alexandria, La. Captain Dobbins having been called into active duty, S.S. Arrighi, W5AXS, of Baton Rouge, La., is carrying on the work as net control station. Twenty-one stations are active each Sunday morning at 8:00 A.M. on a spot frequency of 3905 kc. Each member has been asked to make contact with a station in his locality on the 1.75-Mc. band in order to increase the number of available outlets. Most of the stations in the net have small emergency rigs, or have them under construction.

Amateur F.M. Receiver

(Continued from page 15)

adjusted by trial to make the discriminator characteristic as symmetrical as possible.

To insure that the last i.f. circuit in the receiver can be tuned to the proper frequency when the additional capacity of the limiter and adapter leads is shunted across it (and also to avoid the necessity for touching the trimmer in the receiver) the input circuit has a shunt inductance consisting of two r.f. chokes in series as shown in the diagram. This reduces the total inductance in the circuit so that an additional shunt capacity, C_1 , is needed to bring the transformer back to resonance. The net effect of this is that the adapter may be plugged in and the i.f. circuit resonated simply by adjusting C_1 .

The d.p.d.t. switch, S_1 , connects the audio

NEVER BEFORE!

\$49⁹⁵

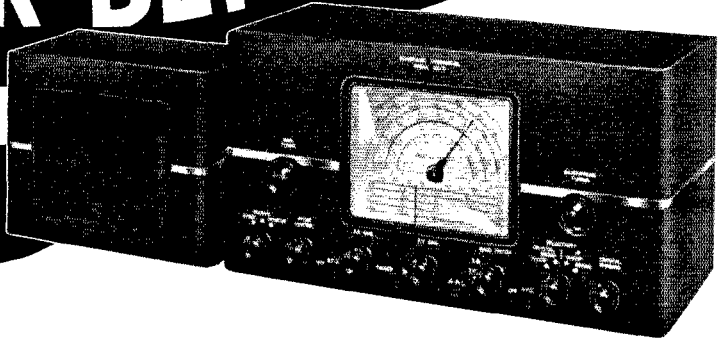

- Crystal filter (four-position variable selectivity).
- Calibrated bandspread.
- Automatic noise limiter.
- Preselection all bands
- Two stage IF amplifier
- Fly-wheel tuning
- Separate 6-inch PM speaker
- CW Monitor.

10 Tubes, three bands, covers 545 to 2100 kc.—2.1 to 8.1 mc.—7.9 to 30.5 mc. Electrical bandspread operated by fly-wheel tuning available at all frequencies in the

tuning range. Operates on 115 volts alternate current or direct current. Available also for operation on higher voltages with resistance cord.

NEVER BEFORE!

\$29⁹⁵



- Preselection on all bands
- Calibrated bandspread
- Automatic noise limiter.

8 Tubes, 3 bands, covers 545 to 2100 kc.—2.1 to 8.1 mc.—7.9 to 30.5 mc. 5" PM dynamic speaker mounted in cabinet. Calibrated bandspread scale on 80/40/20/10 meter amateur bands.

Electrical bandspread at all frequencies in the tuning range. Operates on 115 volts alternate current or direct current. Available also for operation on higher voltages with resistance cord.

Echophone COMMERCIAL

"The Ears of the World"

Echophone Radio Co. • 201 East 26th Street, Chicago, U. S. A.

A Specialized Relay FOR EVERY PURPOSE

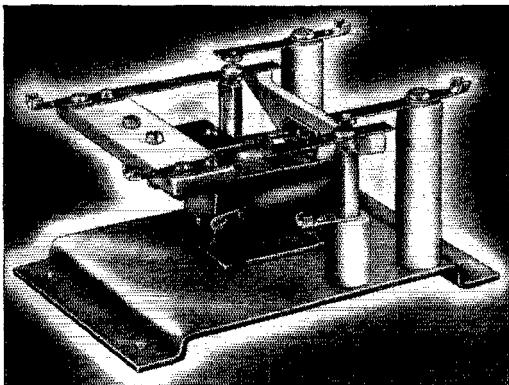

ANTENNA CHANGE-OVER RELAY

Fast—Positive—SILENT! For any type antenna—any frequency up to 60 mc—highest grade ceramic insulation. Straight-thru feed for transmission lines—oversize contacts handle a full KW! Operates on 110 volts AC; steel base and other metal parts chromium plated.

No. 28-1004 Antenna Relay, DPDT, Net Price, \$4.20

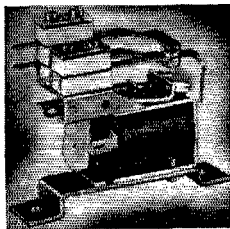

R-F RELAYS

Wherever high-frequency circuits require reliable switching. Large stick-proof contacts—Alsmag 196 insulation. For 110-volt AC operation; will fill every need!

No. 28-1001 DPDT \$3.30
No. 28-1002 SPDT \$2.40

POWER RELAY

Unusually sturdy, ruggedly built to handle heavy currents at low frequencies. Extra-large double contact system will safely break 20 amps. Operates on 110-v. AC.

No. 28-1003 SPST, Net \$2.70

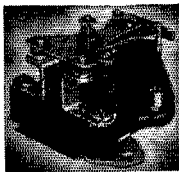

KEYING RELAY

Fast action—operates on 5 to 15 volts AC. Self-cleaning contacts will break up to 1500 volts! Laminated bakelite insulation; ultra-compact. Has adjustable tension spring.

No. 28-1000 SPST, Net \$2.10

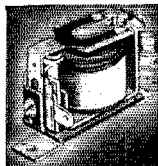

Write Today for Free Amateur Catalog!

Dept. Q-3



grid to either detector and simultaneously grounds the one not in use. Switching from f.m. to a.m. is, therefore, quite rapid and involves only audio circuits. Crosstalk between the two systems is inconsequential compared to the average level of audio output.

Heaters are not shown in the diagram, but are supplied from a small 6.3-volt transformer. It would be possible to take heater power from the receiver through the adapter plug, but it was felt that the extra drain of three additional tubes might be inadvisable. "B" requirements are very small and can be supplied by the receiver. In this case the connection was simply made to the plus-"B" side of the "S" meter, a readily accessible terminal.

In the case of other types of second detectors — a triode, for instance — some slight modifications may be necessary, but it should not be difficult to carry out the same general plan. With the triode detector the changeover switch could be put in the plate circuit, using a blocking condenser (0.1 μ fd. or so) to prevent grounding the plate supply through the plate load resistor.

The unit shown in the photographs is constructed on an aluminum channel 7 inches long and $3\frac{1}{4}$ inches wide, with 1-inch sides. Flanges are provided on the bottom for fastening to the side of the receiver case with self-tapping screws. There is no room to spare underneath, and a slightly deeper and wider chassis would be advisable. The layout is such as to give short leads in the limiter and discriminator circuits so the r.f. can be kept where it belongs. It was found necessary to shield the plate lead from the second limiter tube to the discriminator transformer to avoid feedback.

Lining up the discriminator is the most "touchy" part of the job of getting the unit into operation. The general method has already been described,⁸ and requires the use of a steady signal source at intermediate frequency, with a microammeter for measuring the current in the discriminator load resistors for really accurate work. Good alignment by ear is difficult, so if the necessary instruments aren't on hand they should be borrowed, if possible. It is hoped that some other types of circuits now under investigation will prove more amenable to alignment with instruments the ordinary amateur is likely to have. The center of the discriminator characteristic (zero rectified output) should line up exactly with the peak of the receiver's i.f. amplifier. It is easy to see why this is necessary by referring to Fig. 3 and imagining curve *B* shifted slightly to the left or right; the resultant effective discriminator curve without limiting would be highly unsymmetrical with respect to the zero point and the noise suppression would be correspondingly poor.

Although it may not be actually necessary to touch the i.f. in the receiver, a realignment often is worthwhile. It should be carried out

⁸ G. Grammer and B. Goodman, "Wide Band Frequency Modulation in Amateur Communication," *QST*, Jan., 1940.

Salute!

The Wonder Tubes T-40 and TZ-40

THIS MONTH MARKS
THEIR 3rd ANNIVERSARY

Taylor Wonder Tubes, T-40 and TZ-40 have continued a steady rise in popularity since their zoom to fame three years ago when first announced. Many challengers have appeared in the \$3.50 price class but T-40's and TZ-40's remain acknowledged leaders in sales, performance and value.

There is no better proof of leadership and genuine value than the fact that sales of T-40's and TZ-40's have increased to the point where it has become necessary to install additional production equipment. The demand from thousands of exacting amateurs, who have recognized the outstanding value of these Wonder Tubes, accounts for the sale of over 30,000 to date.

Characteristics

Filament Volts	7.5
Filament Current, Amps	2.5
D.C. Plate Volts	1500
D.C. Plate Current, MA.	150
Plate Dissipation, Watts	40
Safety Factor, Watts	260

"More Watts Per Dollar"

Taylor HEAVY **CUSTOM BUILT** DUTY Tubes

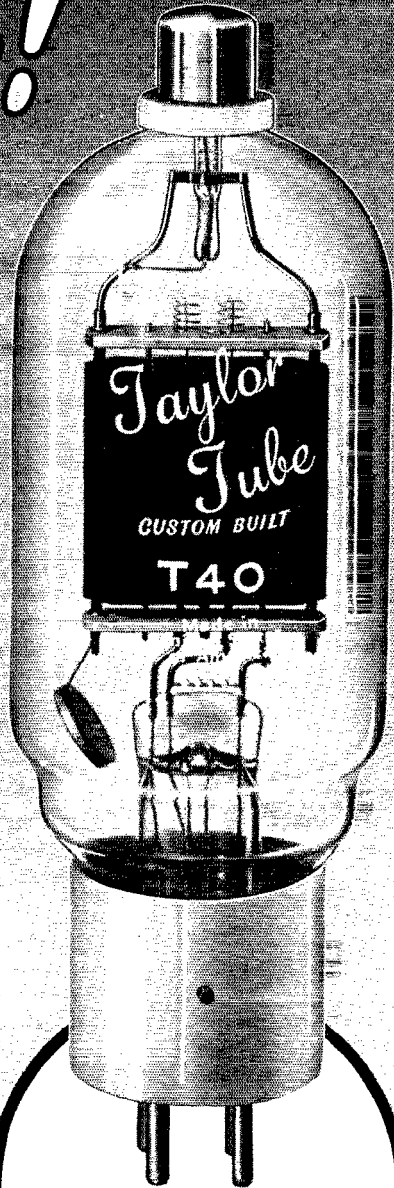

ACTUAL
SIZE

Only **3.50**

TAYLOR TUBES, INC., 2341 WABANSIA AVE., CHICAGO, ILL.

QUALITY ABOVE ALL!
SOLAR
CAPACITORS

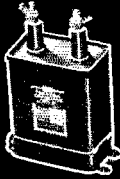

**XL
 TRANSOIL**
 For
 Permanent
 Filters

**XD, XC
 TRANSOIL**
 for Filters
 and Bypass



**XA, XH
 MICA**
 Oscillator
 Tank Circuits

**XR, XS
 MICA**
 Tank Circuits,
 R. F. Bypass

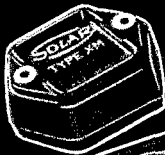
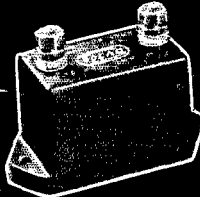

**XM, XQ
 MICA**
 Coupling, Blocking
 R. F. Bypass



**MH, MW
 MT, MO
 MICA**
 Low-voltage

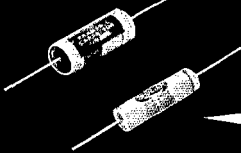
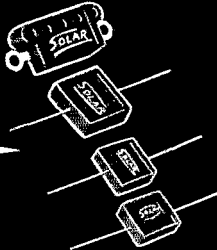

**XT
 OIL TUBULAR**
 S
 Wax-Molded
 Paper Tubular

Catalog Free Upon Request

SOLAR MFG. CORP., Bayonne, N. J.

just as though the f.m. adapter were not there. A final check can be made by detuning the test signal 3 to 4 kc. from resonance on each side to see if the "S" meter reading is the same on the channel limits. If there is much difference it can be corrected by a slight touching-up of the first i.f. transformer. The crystal phasing control usually will serve for this job.

Since there is some loss in the shunt i.f. circuit in the adapter as well as an additional load on the last i.f. transformer when the limiter is in parallel with the regular diode rectifier, a slight overall loss in gain can be expected with the adapter as compared to the receiver in its original condition. It is not really serious, however.

The receiver operation with the adapter switch in the amplitude-modulation position is normal in every respect, and the presence of the adapter can be ignored. For frequency-modulation reception the switch is simply thrown to the f.m. position and the carrier tuned for minimum noise. This point should coincide with maximum reading on the "S" meter. If the deviation of the incoming signal is too great the distortion will be noticeable, but this can be corrected by asking the transmitting operator to cut down his audio gain. If the receiver has a "broad i.f." position it will often help to switch to that position when the swing is too great for narrow-band reception. However, the noise reduction is better on weak signals with the narrow band. It may also help, on extremely weak signals, to cut out the a.v.c. when receiving an f.m. signal.

Where the u.h.f. converter-communications super-het combination is already in use, the adapter offers an economical and quite effective means of getting narrow-band amateur f.m. reception. The higher the overall gain in the converter-receiver the better it will operate, since limiting will take place at lower signal levels. But even without limiting, f.m. is still able to show superiority over a.m. if reasonable care is used in aligning the receiver.

Gang-Tuned V.F.O.

(Continued from page 17)

the drift still further, but keeping the unit at fairly constant temperature (as this does automatically) will do much to overcome temperature effects.

No attempt was made to obtain a maximum amount of power from the unit, since the output is adequate to drive a pentode or beam-power tube of any type, a logical choice for the first tube in the transmitter to follow. Further, provision for output only on the 3.5-Mc. band was incorporated because a large majority of transmitters are designed to start from a crystal or excitation on that band.

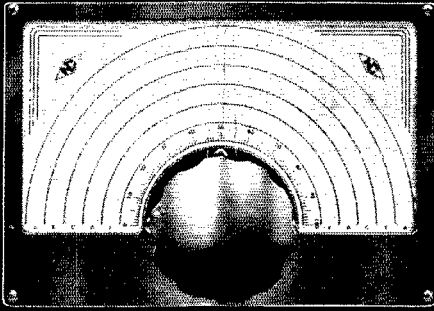

New! TYPE ACN
DO YOUR OWN CALIBRATING

- Dial bezel acts as drilling template.
- Blank scales for direct calibration.
- Index holes in pointer for pricking calibration points.
- Scale removable without dismantling mechanism.
- Employs Velvet Vernier Drive Unit.
- Amateur Net Price \$2.70.

NEW
DIALS

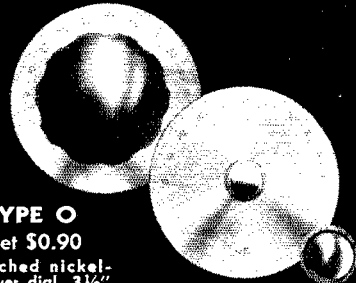

TYPE O
 Net \$0.90
 Etched nickel-silver dial, 3 1/2" Dia. Insulated from shaft.

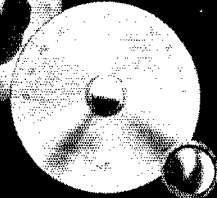

TYPE K
 Net \$0.90
 Etched nickel-silver dial, 3 1/2" Dia. Vernier drive.

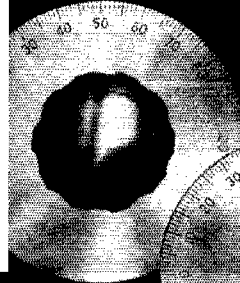

TYPE L
 Net \$1.50
 Etched nickel-silver dial, 5" Dia. Insulated from shaft.

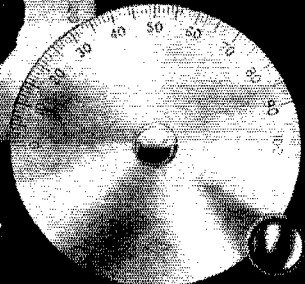

TYPE M
 Net \$1.50
 Etched nickel-silver dial, 5" Dia. Vernier drive.

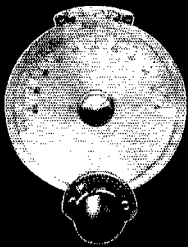

TYPE NY
 The four-inch NY Dial has an engine divided scale and vernier of solid nickel silver. The vernier is flush with the scale. The variable ratio drive is unusually powerful at all settings. 2, 3, 4 or 5 scale. Fits 1/4" shaft.
 NY Dial Net \$4.80

PATENT

No. 1744675 No. 1653875
 No. 1656532 No. 1751658
 No. 1813766 No. 1989529

—And, of course, the old favorites

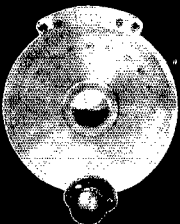

NW Dial



N Dial

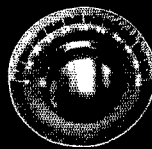

A Dial



B Dial



BM Dial



R Dial

NATIONAL COMPANY



MALDEN, MASS.

TO HELP *You* GET STARTED IN AMATEUR RADIO

How to Become a Radio Amateur

Universally recognized as the standard elementary guide for the prospective amateur, *How to Become a Radio Amateur* features equipment which, although simple in construction, conforms in every detail to present practices. The apparatus is of a thoroughly practical type capable of giving long and satisfactory service — while at the same time it can be built at a minimum of expense. The design is such that a high degree of flexibility is secured, making the various units fit into the more elaborate station layouts which inevitably result as the amateur progresses. Complete operating instructions and references to sources of detailed information on licensing procedure are given, as well as a highly absorbing narrative account of just what amateur radio is and does.

25¢

POSTPAID ANYWHERE

The Radio Amateur's License Manual

Before you can operate an amateur transmitter, you must have a government license and an officially assigned call. These cost nothing — but you must be able to pass the examination. The examinations are based on the multiple-choice type of questions. The "License Manual" has been written to make it as easy as possible for the individual to acquire the necessary knowledge to pass the examination with flying colors. Whether you are going up for your Class C, B or your Class A ticket, "The License Manual" will provide the most direct path to getting that ticket. If you are one of the thousands who always wants a "License Manual" around the shack for ready reference for amateur regulations, it will please you to know that the regulations are very thoroughly indexed.

25¢

POSTPAID ANYWHERE

AMERICAN RADIO
RELAY LEAGUE
WEST HARTFORD, CONNECTICUT

Self-Supporting Tower

(Continued from page 18)

sawing the angle brace to fit, drilling it and bolting it in place), and so on up to the height of 50 feet. Each time I gained new height, I wondered at my sanity, climbing up that high with nothing but a 2 by 2 structure under me. However, as I went higher and higher, I gradually got used to the height.

At 50 feet I decided to stop. I had a platform triangle on top that measured $1\frac{1}{2}$ feet on a side¹ that would make a swell mounting for a rotatable beam, and I didn't know how I was ever going to get the remaining 20 feet on top of what I already had. It was impossible to go any higher by the same method I had been using, since there wasn't enough room to work in, any way I looked at it.

At this point I decided that the remaining 20 feet would have to be constructed on the ground and then carried up and put in place. This was easier said than done, as I found out later.

I built the last section on the ground and painted it and put the halyard in place while the putting was good. It was 20 feet long, a triangle for one end that matched the one at the top of the tower, and for the peak I put in a small triangle 4 inches on a side to hang the pulley from. Half-way along another triangle was used to brace it, and it was ready to be put in place.

Twenty feet long, weighing a hundred pounds, ungainly as you can imagine, the problem of setting it in place just about floored me. It lay in the back yard for two weeks before I hit on a plan for raising it.

I first fastened a 15-foot 2 by 2 to one leg at the top of the tower, sticking up in the air 10 feet above the top. I put a rope through a pulley at the top of this pole and fastened one end to the midsection of the structure to be raised. However, the 2 by 2 would not take the weight of the structure, so I used it to steady the structure while I hoisted it with a separate block and tackle fastened to a rung on a false structure protruding 5 feet below the bottom of the last section which I was raising. The pulley for this block and tackle was fastened to the top of the 50-foot tower and we were all ready to go. The reason for the false structure at the bottom of the piece to be raised was to give enough clearance for the double pulley tackle and so that the piece could be actually raised up and set down on the top of the tower.

I took my position at the top of the tower and tied myself to the side of it. A friend kept the middle section as nearly straight as he could from below. Another slowly pulled on the main hoisting block and tackle, and slowly the tip came up even with me. I had previously prepared three pieces of heavy strap iron with which to bolt this last section in place. They were up there with me with the bolts, ready to be put in place.

As the tip came up even with me, I took hold of it and guided it on up as the two friends kept

¹ According to our calculations, the platform 50 feet up would be 2 feet on a side. Perhaps it looked smaller to W9JWC at the time. — Ed.

GL-813

Gives You *Commercial* Performance with *Ham* Economy!

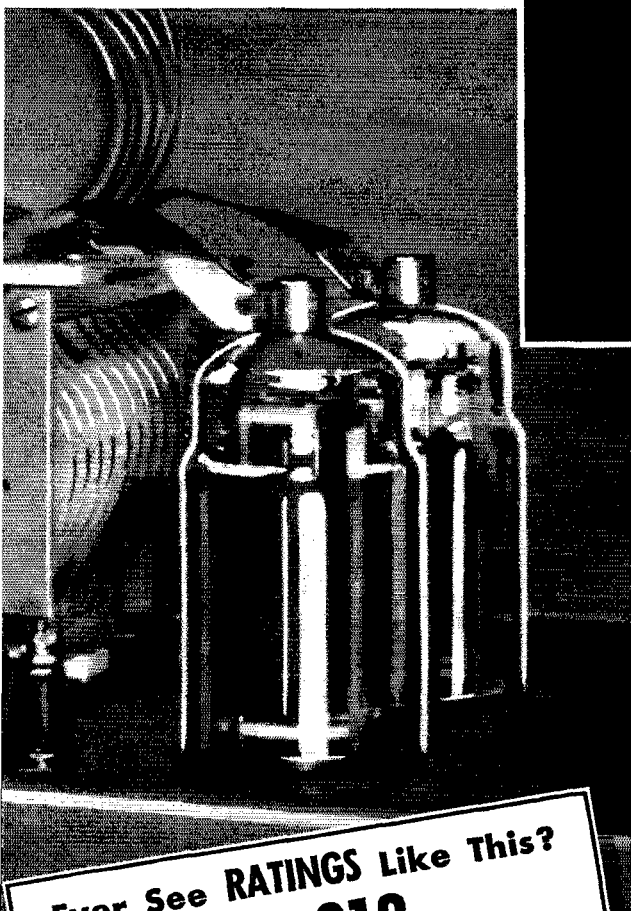

Ever See RATINGS Like This?
GL-813

Fil. Volts.....10 Fil. Amp.....5

	Class B Phone	Class C Phone	Class C Telegraph
Plate Volts.....	2000	1600	2000
Plate Milliamp.....	75	150	180
Driving Power, watts.....	0	1.2	0.5
Input, watts.....	150	240	360

Only \$22.00

From low power to high power in one stage—that's the GL-813, OM. Here's a mighty midget that will make the old skywire really sweat. With just half a watt driving power you can use an input of 360 watts on cw—even at 30 mc. Bandswitching is a natural. GL-813 eliminates intermediate stages, requires no neutralizing, and is a fine frequency multiplier.

Saves both space and spondulics.*
And for dependability you can't do better.

These are the reasons G-E engineers chose GL-813's for the final in the new G-E 250-watt emergency FM transmitter for 30 to 40-mc service (shown at left) . . . and why amateur and commercial users alike are getting real results from this versatile tube.

See GL-813's at your G-E dealer's— and for all your tube needs, *buy G.E. and measure the difference!* General Electric, Schenectady, N. Y.

*We mean you'll be money ahead.

NEED RECTIFIERS?

**Get the New
GL-866A/866**

The full rating of the GL-866A at the price of the GL-866. Replaces both types. Your G-E dealer has it.

Only \$1.50

GENERAL  ELECTRIC

RADIO TRAINING



PORT ARTHUR COLLEGE—not privately owned, not operated for profit, a college built and endowed by the late capitalist-philanthropist, John W. Gates—offers the most thorough practical Radio training in America. P. A. C. owns Radio Station KPAC, which is equipped with the very latest type 1000-Watt high fidelity RCA transmitter, operating on 1220 kc. with directional antenna system. The college is authorized to teach RCA texts. Additional equipment consists of the latest type Marine and Airways Transmitter installation complete; SOS Automatic Alarm; Marine Direction Finder, two-way Television Transmitter and Receiver; Trans-radio Press Receiving Equipment; laboratory facilities where every phase of practical radio assembly technique is taught. Students assemble composite transmitters, audio amplifiers, RF amplifiers, etc. The Radio training covers thoroughly Airways, Press, Announcing, Teletype, Typewriting, Laboratory and practical experience at KPAC transmitter, control room and studios. Announcing is an optional part of this training; nevertheless a number of students annually make successful announcers.

Port Arthur College pioneered the teaching of radio with its first classes in 1909, and for thirty-one years has maintained an active Employment Bureau that is successful in placing graduates in airways, broadcast and marine radio industries.

If interested in details about the Radio Course, write for Bulletin R

PORT ARTHUR COLLEGE
PORT ARTHUR (World-Known Port)
TEXAS

pulling on their ropes. After many "just abouts," I pushed the base over in place. Now I had to work fast. It was quite unstable in this position and I was afraid it was going to topple over any minute, as it was trying its best to get away from me.

The steadying pole was bolted to the corner that didn't have the false structure bolted to it and, since I couldn't loosen that pole at this time, I had to steady the section with one hand and disengage the false structure from one corner before I could fasten the section to the tower in any way. After much hoping-to-heck it wouldn't fall, I finally got it secured in place and it's still there, but I don't think I would have the nerve to go through that again to get it down! The whole structure was then painted with aluminum paint which makes it look like steel.

It took about two months to complete this tower, working on it evenings after work and all day Sundays. The total cost including hardware was about fifteen dollars. The whole tower was built without any ladders or aids other than the tower itself, and no guy wires support it in any way. It has withstood some of the strongest winds that we have here, and if you don't think the wind blows in a mild climate like this, just climb with me to the 50-foot level on a calm day and see for yourself how different it is up that high!

For two months I used it for a 66-foot vertical radiator for forty meters and it worked out very nicely. Since then I have had to change it to an inverted V on eighty for TL AP, and if and when I get around to working the ultra highs I think it will do nicely as a beam holder.

Low-Power A. C./D. C. Phone

(Continued from page 24)

diameter tube which has a length of 3 inches. All windings are closewound with No. 24 d.s.c. wire. L_3 consists of 39 turns wound at the center of the form. L_4 and L_5 each have a 20-turn winding wound in the same direction as L_3 . A $\frac{1}{8}$ -inch space is left between each coil. There are 7 taps on the antenna coil, 2 turns apart starting from the outer end of the winding. Heavy wire terminals similar to those on the oscillator coil are used for making connections to the coils.

Testing and Operation

The power supply should be tested first. Sw_1 is closed and Sw_2 is open during this check. A voltmeter will show the supply output to be approximately 150 volts if the line voltage is up to normal. Next, a 150- or 200-ma. meter is connected between terminals 1 and 2 and the lead from the bottom of L_5 is broken so that plate voltage may be applied to the oscillator tube alone. A crystal is now plugged in the crystal socket, and if a low-range milliammeter is available it may be connected in series with the amplifier grid leak; the meter is not a necessity but it does simplify the tuning up procedure. With the plate voltage applied to the oscillator

LEARN CODE THE WAY YOU'LL USE IT—BY HEARING IT

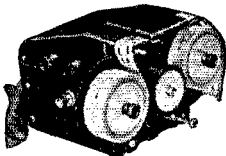

Type S - \$17.50

Sends from 4 to 60 words per minute. Higher speeds if desired. Complete with 10 rolls of double-perforated lesson tape of carefully selected and arranged matter for speediest results in learning code. Most compact and practical code teacher on market.

Type J - \$12.50

Sends 6 to 65 words per minute. Built-in tape perforator. Cut your own practice and message tapes. Complete with one roll of practice tape covering Alphabet, Numerals, Words to five letters; and 5 rolls of blank tape.

If your dealer can't supply you, write us

GARDINER-LEVERING CO. Haddon Heights
 New Jersey, U. S. A.

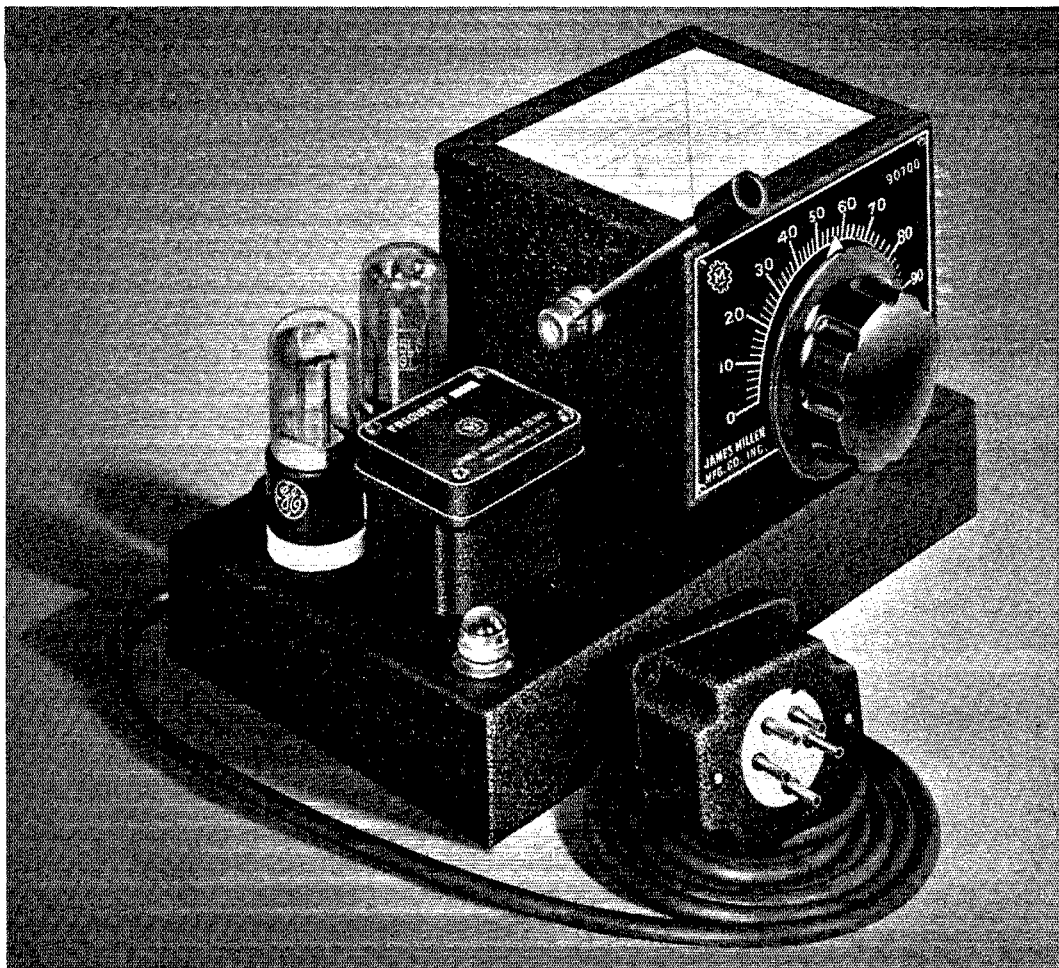

The RICE-VARIARM

— A New Type of ECO —

The Rice-Variarm was described in detail in a comprehensive article by Henry E. Rice, Jr., in the January issue of *QST*. The Millen commercial models are:

No. 90700 has fundamental oscillator frequency range of from 3500 to 3650 Kc. "Convenient-to-change" taps on amplifier and link coils provide for output on 80 or 40.

No. 90701 is the same as No. 90700 except fundamental oscillator frequency range of from 1750 to 2000 Kc., providing for output on 160 or 80.

Either model complete with GE tubes, ready to use, only \$29.50 net at your dealer's

- **A GOOD ECO AT A LOW PRICE**
- **LOW DRIFT** — Less than 0.06% from cold start. Most drift in first 10 minutes.
- **VIBRATION IMMUNE** — Shock mounted oscillator section, sturdy construction.
- **NO HAND CAPACITY**
- **CHIRPLESS KEYING** — Constant load on power supply.
- **GOOD BAND SPREAD** — 100 dial divisions from 3500 to 3650 kc. "Variarm" vernier tuning (only on 90700 model).
- **COMPLETE** — Vibrationless power supply, three tubes, output coupling units.

Modern Parts

for Modern Circuits

JAMES MILLEN
150 EXCHANGE ST



MFG. CO. INC.
MALDEN, MASS.

Pick your own ELECTROLYTIC



● With over two dozen different types of Aerovox electrolytics to choose from, you can select that type best fitted to your job. You don't have to substitute or improvise or juggle, as you would with a more limited choice.

And while you're picking out that type, be sure to consider those Aerovox heavy-duty large-can electrolytics which pack the stuff for longest trouble-free service. They cost less in the long run.

Ask Your Jobber . . .

Ask for copy of the new 1941 catalog, which contains the most extensive listings of all types of electrolytics. Or write us direct.



tube the plate current should be approximately 30 or 35 ma.; this value will decrease when the load on the plate supply is increased by the amplifier and audio tubes. C_1 should now be tuned until the grid meter gives a reading of 10 ma.

The voltage lead to the audio circuit is now connected. If the meter connected between terminals No. 1 and No. 2 shows the 25B6G plate current to be 45 or 50 ma. it may be assumed that the circuit is in order.

Neutralization of the amplifier is next in line. Terminals 3 and 4 are left open so that plate voltage will not reach the tube, and the antenna circuit should be open so there will be no load on the tank circuit. With the oscillator turned on, C_2 is rotated through resonance as indicated by a dip in the grid current. C_{13} is then adjusted so that the plate condenser can be swung through resonance without affecting the grid current. Nearly full capacity at C_{13} will be required.

The meter should now be moved from terminals 1 and 2 to terminals 3 and 4. Sw_2 , used as the on-off switch during normal operation, should now be closed. The off-resonance plate current of the amplifier should be 60 or 70 ma. with the condenser set at the low-capacity side; the current at the high-capacity side will be somewhat lower because the circuit does not tune very far off resonance. The plate tank is now tuned to resonance, when the plate current should fall to 15 or 30 ma. The 100-foot antenna is connected to the antenna terminal and a lead is connected between the antenna ground terminal and the chassis. The antenna coil tap is now adjusted until the tuner will load the final amplifier to 40 or 45 mils. It is not recommended that the tube be loaded up past this plate current value. Finally, the oscillator tuning condenser should be reset to bring the amplifier grid current back to 10 ma., since the grid current will drop when the amplifier is in operation.

The gain control, R_4 , is turned up after the microphone has been connected in the circuit. The amplifier plate current should kick upward slightly with loud speech, but in actual operation the kick should be kept to a minimum to prevent distortion. Remove the microphone plug from the jack when the unit is not in operation, as this prevents unnecessary current drain from the battery.

A last, but not necessary, check of the transmitter operation may be made with a voltmeter. The meter should show 100 volts at the oscillator circuit and the same at the 25B6G screen grid. The audio and amplifier tube plates should receive approximately 90 volts. This drop in voltage is caused by the 138-ohm d.c. resistance of L_6 . These readings are expected only with normal line voltage and a full load on the supply.



Are You Playing

"BLIND MAN'S BUFF"



With Your Future?

Are you, like so many other professional radiomen, aimlessly groping for the door to opportunity? Thousands of ambitious radiomen have been set on the right course with the help of CREI advanced technical training. Our records show that CREI graduates as a group are among the highest paid in radio — and that 69% (by actual survey) enjoy salary increases during or immediately after their training! The well-written text plus the personalized training provides a proven formula for more rapid advancement. Why not investigate what CREI training in Practical Radio Engineering can do for you?

Write for Facts Today

Let us send you our interesting booklet, together with personal recommendations for your advancement in radio. To help us intelligently answer your inquiry, please state briefly your education, radio experience and present position, also whether interested in home study or residence training.



Capitol Radio Engineering Institute

Dept. Q-3

3224 16th St. N. W., Washington, D. C.

W4HER and W4AIT both live in Greensboro, N. C., and both are named Homer Apple. W4HER lives on Sterling St., while W4AIT lives on Silver Ave. — W4CYB.

It's HARRISON for hallicrafters!

All models in stock

for immediate delivery —



Free ten-day trial

to convince yourself how good
these new receivers are! —

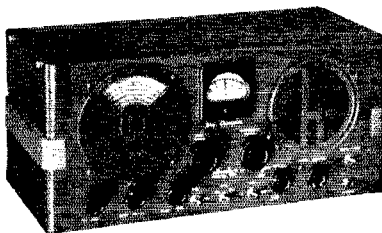

**Highest trade-in
allowances**

plus a 100% square deal!



Easiest Terms

10% down —

My personal cooperation

to see that you are entirely
satisfied —

I guarantee you

the best deal!

Order your new receiver
today — from me!

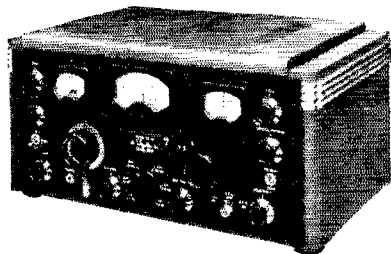

73,

Bill Harrison,

W2AVA

P.S. Send for my list of new and reconditioned receivers

HARRISON RADIO CO.

12 WEST BROADWAY • NEW YORK CITY

WOrth 2-6276

CARDWELL CONDENSERS

For Universal Application

FLEXIBLE TYPES EXTRA RUGGED MIDGET TYPES

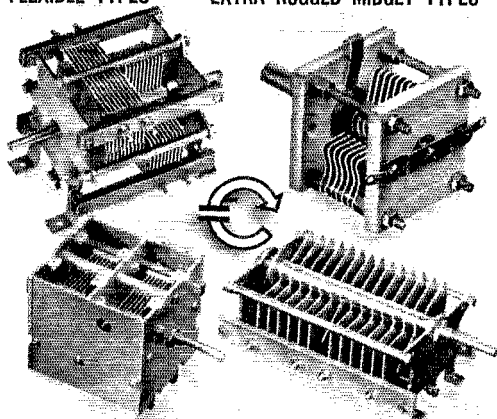

SPECIAL DESIGNS STOCK CONDENSERS

THE ALLEN D. CARDWELL
MANUFACTURING CORPORATION
 83 PROSPECT STREET • BROOKLYN NEW YORK

DAVEN

POPULAR PRICED ATTENUATORS

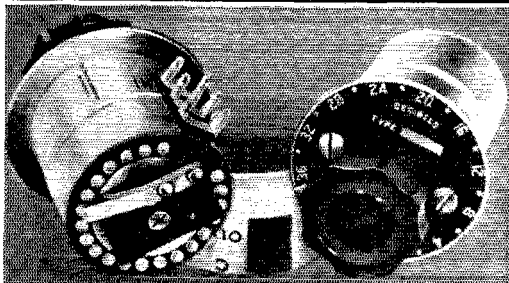

Compact low impedance mixing and gain controls for use in portable amplifiers, broadcast equipment and public address systems . . . similar in construction to our larger and costlier units . . . are specifically designed for popular priced systems.

Literature upon request

THE DAVEN COMPANY
 158 SUMMIT STREET • NEWARK, N. J.

Red Cross Communication

(Continued from page 25)

separate transmitter and receiver units were used at each location. In general the transceiver-equipped stations were those placed nearest the master control station. The remaining stations of somewhat higher power were along the farther end of the two-mile radius of coverage required.

On the hour and half hour, whenever the flow of traffic would permit, W3ING, the master control, transmitted a time check which also served as a frequency check for all stations. This frequency was used as the receiving frequency of all field stations forming the net. On the quarter hours W8SVW/3, using a grid-line controlled oscillator, transmitted a time check on 114 megacycles, which reference frequency was used as a transmitting frequency by all other net stations. In this manner any frequency drift in equipment at the individual stations was accounted for and corrected.

Initially it was required that field stations communicate solely with the net control and never with each other. On rehearsals held for two weekends prior to Monday, January 20th, this rule was followed. On Inauguration Day it was periodically relaxed, however, to allow relaying from the most distant station due to reception difficulties.

Messages originated were accepted only on the signed authority of the Red Cross station commander. In every case these messages were type-written copies bearing the signature of the executive officer in command of the station. Operators were not allowed to originate personal messages or information on their own authority. In cases of necessity the operator first requested authority to transmit. In this manner the net control station retained the initiative at all times with the result that there was very little confusion. Form messages authorized in advance with particular information filling given gaps were used in about 30% of the traffic handled. In a period of operation of seven hours between 8:30 A.M. and 3:30 P.M., 509 messages were originated, received and delivered.

The Red Cross Field Stations functioned smoothly. Some 235 persons were treated along the inaugural parade route and about fifty of them were sent to the hospital in ambulances. Messages relayed by radio stations included requests for misplaced supplies, additional personnel, information on injury cases, and "lost child" registration. A temperature of 28 degrees provided sufficient operating hardship to test the mettle of all services concerned.

From nine until ten o'clock in the morning all Red Cross Field Stations were inspected by a party led by Rear Admiral Rossiter, U.S.N. Ret., of the Red Cross, under whose direction the Red Cross participation in the inauguration took place. This group included Lieut. E. K. Jett, chief engineer of the Federal Communications Commission, and several members of the Defense Communications Board. All members expressed

(Continued on page 88)

YOU GET ALL

WITH THORDARSON "SPLATTER CHOKES"

- 1... ELIMINATES "SPLATTER"
- 2... PERMITS HIGHER PERCENTAGE OF MODULATION
- 3... GIVES SHARPER PHONE SIGNAL



THORDARSON "splatter" chokes are designed to eliminate side band splatter caused by over-driven modulators and audio distortion. If a transmitter is modulated by a 3000 cycle signal the band width occupied by the transmitter is 6000 cycles. However, if the 3000 cycle signal has an appreciable amount of third harmonic distortion the band width occupied by the transmitter is 18,000 cycles. A THORDARSON "SPLATTER" CHOKE PLACED BETWEEN THE MODULATOR

AND THE CLASS "C" STAGE WILL ELIMINATE ALL BOTHERSOME SIDE BAND SPLATTER CAUSED BY AUDIO DISTORTION.

Type	Max. Current DC	Volts Insulation	List Price
T-15C30	150	3000	\$3.25
T-15C31	300	5000	4.50
T-15C32	500	7500	5.25

Ask for complete engineering bulletin S0474 — FREE

DEPT. B

THORDARSON

500 W. HURON STREET

ELEC. MFG. CO.

CHICAGO, ILLINOIS

Transformer Specialists Since 1895

Station Activities



NEW ENGLAND DIVISION

CONNECTICUT — SCM, Frederick Ellis, Jr., WICTI — KFN is back from the field and working on Police Radio in New Haven. BDI keeps busy with N.C.R. work and is constructing a new loop to go with his portable receiver. MEC was called to active duty at the Brooklyn Navy Yard. Best of luck to you, Bill. BHM is again active on 3.5 Mc. and has a nice e.c.o. signal. Both EAO and LQK report working WAR and NAA on the first attempt. JRP is on 7 Mc. with 150-watts input to a pair of 812's and would like to contact any old ship or commercial operators and talk over the good old daze. Officers and directors for 1941 were elected at the annual meeting of the Connecticut Brass Pounders' Association, W1CBA, January 9th. The new Pres. is Cedric Root, W1BCG; Vice-Pres., Fred A. Ellis, Jr., WICTI; Secy., Edward Phillips; Treas., Stanley Shepherd. Directors: Justin Foster, W2AH; Louis Henriksen and Charles Simpson. GC is now working at WDRC in Hartford. BRA says this is no kind of weather in which to climb 30-foot poles to adjust 28-Mc. beams! 3640 kc. is the meeting place of the Connecticut traffic pushers. The Nutmeg Net meets at 6:45 P.M. and the A.A.R.S. net at 7:30 P.M. "Practice makes Perfect." Join a net and increase your operating ability.

Traffic: W1AW 1044 (WLANK 14) KKS 845 MEC 590 MGC 586 K9B TD 152 UE 135 ITI 117 CTI 105 KFN 93 ES 42 BDI-LVQ 40 BCG 36 KAT 34 KSJ 16 BEM 14 EAO-IJQK 5 CSY 1.

ALL MAINE QSO PARTY

Sponsored by W1YA

March 1st and 2nd, noon to 8 P.M. 1 point per contact; 2 points for cross-band contacts; 2 points for 'phone-c.w. contacts. Multiply total score by number of towns and cities worked. Single operator stations multiply score by 1½. Stations working W1YA multiply total score by ten. Separate prizes for 'phone and c.w. divisions. One contact by your station on 'phone will classify you under the 'phone division. Only 1 QSO with the same station will count, but, if more, you may select the one netting the most points. No student or employee of the U. of M. is eligible for prizes. Logs competing for prizes must be in hands of W1YA, U. of M. Radio Society, no later than March 10th, 1941 and must include date, time, RST reports, and QTH of stations worked.

MAINE — SCM, H. W. Casner, W1HE — LHA is with the Pan. Am. Airways at Miami. New officers of the P.A.W.A. are: GHT, Pres.; MBR, Vice-Pres.; GKJ, Secy.; CRP, Treas.; LNI, Chief Operator. Anyone around Portland should join this swell outfit. AI has increased power to 200 watts and it sure sounds fine here, Olin. AUC has left for Florida on the annual vacation. We have a number of new A.R.R.L. members lately. A lot of the boys are finding out what a fine job A.R.R.L. does for us and their membership is real material. Thanks, MGP was on 3.9-Mc. 'phone at home over Xmas. EJS, KTT and BTY are new members of the P.T.N. Be sure to watch carefully for the "phonies" on 14 Mc. and 7 Mc. signing K4. They're mostly "D" stations and if you innocently QSO one, you're on the spot!! LIP is going to the N.Y.A. at Quoddy and hopes to be on from MII. LYV has gone with the Coast Guard. MNI will be about the only ham around Woodland left on 1.75-Mc. 'phone when the other ones leave for service. FBJ is back from Florida. BAD is active again. LYK is still right on the job. LML is still piling up those traffic totals. KAS has ordered a new HRO. W1FPS/1 is at Boothbay Harbor and on the air. LKP is sure becoming a real traffic op. He has determined to master it and I say he's OK now. Your kind of determination is sure to do it, Johnny. Somebody gave me a "hum steer." CFO is still in charge of the Maine

A.A.R.S. with KOU assisting. The Sea Gull Net on 3960 kc. has continued to increase and there are now over 30 members. The gang meets at 5:15 P.M. Monday through Friday and they're a swell bunch and have a definitely interesting net for 3.9-Mc. 'phone. Your S.C.M. addresses them on 3597 c.w. each Monday night. The Knox county hams are buzzing with activity and cooperation. RU is planning a hamfest in Rockland about the first week in February and there should be a real turnout. Xmas traffic was sure heavy and we can chalk up a lot of credit for the boys with this fine public service. INW has renewed membership and official appointments and is on when time will permit. We're mighty sorry to lose Jack, HSE. He has gone to Miami to work on boats with his father. I have just learned of an amateur service during the hurricane of a few years ago. It seems that LHX and his wife handled nearly 400 messages and stayed up three days and nights with hardly any sleep and never said a word about it. We had a fine letter from FV who is teaching radio in the Portland High School Vocational Dept. He is teaching a class in commercial operating and there is much interest. GXY is still maintaining the schedule with BNG to transfer messages from the boys in the service with Company "D" to their home folks. We should all look around and inquire of the public if they have any sons or fathers in the service, and offer them the facilities of amateur radio by suggesting messages. BTY is understood to be building a 250-watt final using two TZ-40's. KYT is getting all steamed up about the All Maine QSO Party and says whoever plans to win had better be ready with all they have as he is going to offer some stiff competition. To make a good impression and further the cause of amateur radio, we urge every amateur to originate some messages. Contact the public in your vicinity and find some way to get these messages to the Pine Tree Net. This is a splendid public service and the existing nets are very reliable. We also can QSP into the Sea Gull Net on 3960 kc. which consists of more than 30 'phone stations. This is a splendid layout all through and Maine can justly be proud of its fine amateur organization. Information on any of these fine groups will be cheerfully given by your S.C.M. and we welcome any of the boys who would be interested. Did you ever think how easy it would be to turn these trained nets over to home defense or some other vital need if the occasion arose? Would you want to be untrained if needed? No, I do not think so. Any inquiry will receive immediate answer and no strings attached. New R.M.: INW. New O.R.S.: KTT, INW. New P.A.M.: AUC. New O.P.S.: KTT, CMO, GKJ.

Traffic: W1HE 228 AUC 16 LYK 29 LKP 56 AI-KYT 3 LYJ 41 MFK 19 IBR 37 EJS 81 GKJ 6 GMD 32 GXY 64 CMO 7 BTY 22 KTT 9 VF 4 BNG 19 EUL 3 BAV 314. A.A.R.S.: W1AMR 110 CFO 37 EFR 24 PAP 227 GE 37 GHT 20 GVS 151 LJE 75 IST 48 KOU 176 KTN 110 LAP 56 LML 204.

EASTERN MASSACHUSETTS — SCM, Frank L. Baker, Jr., W1ALP — I am sorry to have to announce the resignation of HXE as R.E.C. for this Section. Paul is now working for the Navy. He deserves a lot of credit for the fine job he has done, and we all wish him good luck. JJY is now a 2nd Lieut. in the Army and will be gone for one year. Good luck to you, Bud. DTP, Bill Lawrence, 30 Rural Ave., Medford, is our new R.E.C. In the future write him, E.C.'s. MDM had a good time in the u.h.f. contest and will be on 3.5-Mc. c.w. LBH is rebuilding his rig. LZW is on 28-Mc. 'phone. LKT is on 7 Mc. AOZ and LLV moved to Wakefield. We welcome NAS, a new ham. Hi Q Club of Lynn is looking for a new club room. They are running a contest for the most active member. NBI is putting up a beam for 28 Mc. LMB is back on 28 Mc. with 30 watts. The T9 Club is having a contest in building portable transmitters for emergency work. FB. How about other clubs doing the same thing? The Brockton Radio Club held its annual election and the new officers are: Pres., LWI; Vice-Pres., MON; Secy., KEF; Treas., IZB; Activities Manager, MQH; Tech. Adviser, DKD. KH has a television transmitter going on 115-513 kc. and it works. NBM, new ham in Mattapan, is on 28-Mc. 'phone. KRJ in Milton is also on 28 Mc. MBE and LVN want all the hams down on Cape Cod to register in the Emergency Corps. What say, gang. MXS is new ham in Cambridge. Welcome, Tom. MLK applied for O.P.S. IN is on 56-Mc. and 3.5-Mc. 'phone/c.w. AAR has a new MRT3 mobile rig in his car. WI works the West Coast every morn between 2 and 4 A.M., and will be on 'phone soon. LO is back on again with a new 3-element beam. MGQ has a new e.c.o. for Xmas. KH is keeping schedules with LDR/5 at Camp Hulen. LO also has schedules with him on Sunday. EHT is building a new 60-watt modulator and a 200-watt final for

56 Mc. G4IP was guest speaker at a meeting of the 56-Mc. Minutemen and WIZO at KH's; he told about being torpedoed on his first run as op. AAL is now on 1.75 Mc. The A.E.N. net is active each Thursday night on 112 Mc. with PI as control. We still need more Emergency Coordinators for a lot of cities and towns in this Section, gang. If you are willing to help out, please write to me or DTP. Don't wait to be asked or have to be urged. We need all the help we can get.

Traffic: **WIJSM** 442 AKS 328 LWH 427 BDU 301 EPIE 268 (WLGS 8) JCK 243 (WLGW 90) KCT 158 AAR 150 KXU 129 FSL 127 WI 62 LVD 67 HWE 60 FWQ 59 LYG 50 AGX 35 MDU 18 MQO 17 LO 10 KH-BMO-LZW 8 MDN 3 LBH-ALP 2 EHT-DTP 1 AAL 38 KTE 6. 112-Mc. A.A.R.S. Net: **WIAAR** 7 BHL 4 EYR 30 KAL 11 LKT 2 LSR 15 LWI 4 MBS 1 MIF 3 MON 194 MQH 38 NBT 2 QD 26. (Nov.-Dec.: **WIAKS** 340 HA 33 HLL 9.)

WESTERN MASSACHUSETTS — SCM, William J. Barrett, **W1JAH** — Traffic through the Xmas season seemed rather light this year. Prent, AZW, leads the parade this month, the result of plenty of scouting around for random traffic in addition to his A.A.R.S. schedules. JAH has been spending most of his time trying to dig up new members for A.A.R.S. net, the only active net in our midst at present. As yet there has been only one reply to my request for members interested in trying to revive a Western Mass. A.A.R.L. net. Among the new men in A.A.R.S. this month are MYZ, MSR, JWV, MJP, IIP, IJL, with AJ and BXF on the prospect list. FOI is new n.c.s. of the A.A.R.S. 'phone net, and is also acting as liaison between the 'phone and c.w. nets. Phone stations who are interested in handling voice traffic are urged to get in touch with either FOI or myself for further dope on the A.A.R.S. 'phone net which drills on 1830 kc. KZS got his 35 w.p.m. sticker from A.R.R.L. Nice going, Ernie. BKG schedules his brother, MWE, in addition to A.A.R.S. LJF turns in a nice total. LUA is doing a fine job as S.N.C. 4 for W.M.S. As you all know by now, BVR is our Director again, starting the third term season. Congrats, Perce. AJ has a new NC200 ordered, and is interested in A.A.R.S. IIP is on the air from Greenfield where he is operator at WHAI. MJP is doing a fine job handling traffic in A.A.R.S. net, his first experience in organized traffic handling. KZU reports JMF and MYZ active on 112 Mc. and JMF about to leave for the U. of Florida. If the writeup savors too much of A.A.R.S., it is mainly because all but one of the reports this month were from an active traffic handler who is in A.A.R.S. How about some activity from the rest of the members in the Section? After all, the news in this column must come from the reports sent in. 73.

Traffic: **W1AZW** 184 JAH 169 (WLGH 11) FOI 97 KZS 126 BKG 118 (WLCG 48) LJF 117 LUA 87 BVR 81 (WLQ 139) AJ 13 IJL 8 MJP 10 IIP 11.

NEW HAMPSHIRE — SCM, Mrs. Dorothy W. Evans, **W1FTJ** — The Nashua Mike and Key Club held their third annual banquet on January 18th at the "Brick House" outside of Nashua. A most enjoyable time was had with about 42 members and friends of the club members present. A turkey banquet was followed by speakers, prize drawing and then dancing. KKK had charge of the decorations and entertainment and she certainly did a fine job. The club is to be congratulated on the grand get-together. LVK is on the air once more on all bands. IJB is to be found now on 3.9-Mc. 'phone. KMH is new O.P.S. LCD has been quite ill. ICS is doing well on his new job with the F.C.C. MOF/BFA and IP are new O.B.S. stations. KXY is now located in New Hampshire. IP is new net control station for the New Hampshire net and GMM is alternate. KPD has a new junior op named Charges Quentin Gilbert. Note well first two initials. AP is on Mt. Washington as engineer of the new Yankee network f.m. station and is currently on 112 and 56 Mc., as well as on 39.6 Mc. as XOY. He expects to be on other bands shortly. JZS has moved to Bath, Maine, and is employed at the shipyards there. Ex-IXS is back from the Panama Canal Zone where he held K5AP. IVE got a Class "A" ticket but doesn't plan to expand operations just now. MOF/BFA has been appointed Emergency Coördinator for Dover. EDN is on 3.5-Mc. c.w. JNC is building a new exciter unit. JJD has now joined EDN, FTJ and LIN in working for BFT/DMD. AWU and BFT/DMD are now on active duty with the U. S. Navy. The newly formed Granite State Net with AUY as control station meets weekly Sunday mornings on about 3920 kc. In case of emergency, they have arranged connection with the State of Maine network and are endeavoring to get a hook-up with the Vermont network.

Traffic: **W1KIN** 346 FFL/WLGB/282 JDP 155 IDY 127

BFT 127 GMM 110 FX 79 MOF/BFA 94 GEY 66 ANS 61 IP 58 MMG 53 JGI 43 MLO 29 HXJ 28 JKH 24 JDV 20 HGV 19 EAL 15 FTJ 13 HFO 10 ITF 10 KBU 2.

RHODE ISLAND — SCM, Clayton C. Gordon, **W1HRC** — The Westerly Radio Club elected LZD, Pres.; KRQ, Vice-Pres.; MOK, Secy.; David Shaw, Treas., and AGJ, IEJ, MVL, as Board of Directors for 1941. INN, LZD, MAE and BDS are on 1.75-Mc. 'phone. MOK is building a 1.75-Mc. 'phone rig. KRQ is using cathode modulation on 3.9 Mc. KRF is on 7-Mc. c.w. KCG is silent in the presence of a YL who is in town (aren't we all!). Cy Ashworth and John Marshall are heading up a committee to train a squad of the members who have no tickets as yet to use blinker in case of emergency. KCS is in business for himself and doing lots of f.m. work. MJL worked his first W7 in Seattle, Wash. LWA has started a little activity going in the form of a net on 3535 kc. This is to be a R. I. net and all hams interested should get in touch with Ray. He worked NAA and WAR and is also on 1.75-Mc. c.w. IRF in Newport is tying into the new R. I. 3535 kc. net. BVI is on 1.75-Mc. 'phone. NDM is George Long of Lakewood who received his ticket just the other day; he promptly hopped on 160 'phone before the ink got dry. Some of the gang will remember Doc Nichols who used to show up at the P.R.A. with ARK now and then. He is now W3JAY on 7-Mc. c.w. in Philadelphia and has worked some of the boys. The P.R.A. held its annual election as usual and elected LCS, Pres.; HJB, Vice-Pres.; LYE, Secy.; KKE, Treas.; LDL and FUB, Directors. The P.R.A. coöperated with the Y.M.C.A. in their Annual Open House by setting up a 112-Mc. rig in the main Y.M.C.A. building and accepting traffic from visitors, which was relayed to INM in the Club Rooms, and eventually found its way into the A.A.R.S. nets. Other apparatus was on display. JXA was chairman of the committee. NBU, NBH, MZU and NCD are new hams in Providence. GJZ/1 is now in Conimicut. HRC visited BVR in Westfield and got acquainted with his new duties as Alternate Director. JP bought a crystal mike and found that plugging it into plate circuit jack didn't work out the way they planned it at the factory.

Traffic: **W1HRC** 64 LWA 239.

VERMONT — SCM, Clifton G. Parker, **W1KJG** — JVS spent the holidays in Delaware and took his Class "A" at Philadelphia. MOI of Manchester, N. H., an old-timer from the days of spark, visited at Burlington and attended club activities there. Capt. Jim Wilson, **W1KXY**, has been transferred and his new QTH will be 24 Fifield Street, Nashua. N. H. KTB/1 is now living at 15 Church St., Essex Jct., but anticipates new assignment outside our Section. HLB has been busy rebuilding his rig and plans to be on the air very shortly. The Burlington Amateur Radio Club is very busy with activities and programs. The last meeting featured a demonstration and lecture by Jean Holden on public address systems. The February meeting is to be held at the Fleming Museum in conjunction with the Vt. ranch of A.E.E.L. Western Electric and Hallicrafters' movies will be shown. JRU is active as tie-in with N. H. A.R.R.L. net. QQ reports fine results with his new signal shifter. KJG is at Montpelier during week days. The Emergency Coördinators' project in connection with the American Red Cross is scheduled for April. We need stations to coöperate in many of our Vermont communities where Chapters are located. If we have Coördinators in every town where these branches are located, we will then have about 50% coverage as there are many communities not having amateur stations. Please drop your S.C.M. a card advising if you can reasonably cover those towns near you having Red Cross branches in which there is no amateur station.

Traffic: **W1JVT** 8 JRU 19 FSV 172 KJG 140.

ATLANTIC DIVISION

EASTERN PENNSYLVANIA — SCM, Jerry Mathis, **W3BES** — W3CKO has a new schedule with NY4AE, the temporary Marine base at Guantanamo Bay. A.A.R.S. still wants members in Chester and Bucks counties, according to AOC. EEW reports building a high power 112-Mc. experimental station at Drexel Inst. SASW is getting ready to go into Federal service with Co. A 105th Anti-tank Btn. 3HRS lost his fine schedule with WIMEC who is on active duty with the Navy. AQN says "If you guys don't have time for tfe, look at this: work 5 days a week 8 hrs. each, report twice daily for Eastern Penna. Net, report for A.A.R.S. drills, hold two other daily schedules and go to night school."

(Continued on page 88)



DYNAMOTORS

SMALL MOTORS

HIGH FREQUENCY CONVERTERS

POWER PLANTS

Satisfied SAY
THOUSANDS OF PINCOR CONVERTER USERS

Where uninterrupted operation of such A.C. electrical equipment as gaseous signs, power amplifiers, motors, radios, musical instruments, etc. depend upon your converters, play safe by using Pincor Rotary Converters. They give thousands of hours of trouble-free service, even under the most adverse conditions.

Available with or without filter for converting 6, 12, 24, 115, 220 or special voltages D.C. to 110 or 220 volts A.C. 40 to 3000 KVA. Quiet, smooth, light weight and compact. Send for NEW complete catalog today.

PIONEER GEN-E-MOTOR CORPORATION
 CHICAGO, ILLINOIS
 Cable: SIMONTRICE New York

PINCOR Products
 FOR AIRCRAFT • SOUND • POWER SUPPLY USES

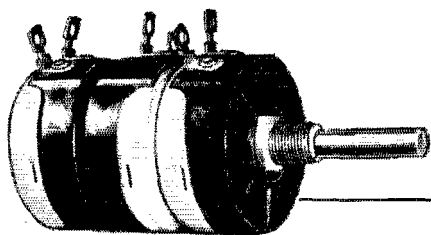

WIRE-WOUND
Controls

- ★ For applications requiring dependable, precise rheostats or potentiometers, simply insist on Clarostat Wire-Wound Controls. Such controls are found in the finest instruments, in broadcast control rooms, in commercial and top-flight "ham" equipment. ★ Single units, linear, from 1 to 400,000 ohms; tapered, 10 to 50,000 ohms. Wattage ratings 1.5 watts to 25 watts. ★ Also available in dual and triple units as L-pads, mixers, T-pads and other precise controls.
- ★ Ask your local jobber for these Clarostat Wire-Wound Controls. Ask for latest data. Or write Clarostat Mfg. Co., Inc., 285-7 N. 6th St., Brooklyn, N. Y.



(Continued from page 82)

particular interest in the work being done by the radio personnel, and their operations were the subject of much favorable comment. Those participating were W3ZD, FPQ, ING, EIS, EYX, FVD, IUZ, AWS, EJB, BKZ, GQM, IVC, HIQ, IUW, IUX, GKP, IVB, GAD, IEE, W8SVW/3, John Vestraci, Lynn Wilson, Dick Gillen, Terry Crabill.

This complete Emergency Disaster Service which received a critical test during the inauguration is now envisioned by Red Cross officials as a model for the nation.

Frequency Modulation

(Continued from page 28)

lation system designed to obtain maximum distance for full readability is that which corresponds to a deviation ratio of one. Such a system produces very nearly the same intermediate-frequency and audio channel widths as the corresponding amplitude-modulation system. To use a deviation ratio less than one would impair the efficiency without a compensating benefit in reduction of band-width, since it would be equivalent to an amplitude-modulation system which employed a modulation percentage less than 100.

The results of other listening tests³ conducted by the writer have indicated that the use of pre-emphasis and de-emphasis, as used in the present broadcast frequency-modulation systems, is of doubtful value when the object is the mere transmission of intelligibility instead of the enjoyment of a high-fidelity program. The peculiar triangular nature of the noise spectrum in the output of a frequency-modulation receiver is apparently more tolerable than the same noise spectrum after it has been made practically flat by the de-emphasis circuit. The results of the averaged observations of three observers showed that about 8 decibels more noise could be tolerated with the triangular frequency-modulation noise than with the rectangular amplitude-modulation noise. That is to say that when the intelligibility of voice is being received through fluctuation noise like tube hiss or thermal agitation, the same intelligibility may be received with 8 decibels more noise of the triangular characteristic obtained from the output of a frequency-modulation receiver than with the flat or rectangular noise characteristic obtained from the output of an amplitude-modulation receiver. This advantage is lost when pre-emphasis and de-emphasis are used because the triangular noise spectrum is converted to a rectangular spectrum.

Stays

One of W5IFR's neighbors came to him with the following:

"I have never used an outside antenna with my h.c. set, although I believe it would help bring the music in much better, but before putting one up, I thought I would ask you if it would interfere with your station. If it would, I will leave it like it always has been." !!!!

And some say b.c.l.'s are belligerent!—W5IGW.

WE'RE IN THE ARMY NOW...

AND who isn't in the 'army' for national defense? Regulars, National Guardsmen, conscripts, manufacturers, taxpayers and amateurs are all pulling together for the good old U. S. A.

We, at BLILEY, are in the 'army' too. Great numbers of quartz crystals are required for military purposes and it is up to us to cooperate wholeheartedly. We're behind national defense 100% and are gearing our production facilities accordingly. Our present motto is: Dig in!

Yet, we are not forgetting those who have been loyal to us—the radio amateurs. Production of amateur crystals is being continued at the best possible rate but some sacrifices must be made. Spot-frequency crystals, ten-meter crystals and variable-frequency crystals involve time consuming operations by highly skilled craftsmen. In some instances, deliveries may be slow. We sincerely want to provide fast service but the choice will not always be ours.

If your requirements cannot be met by selecting stock crystals, we will, as always, do everything possible for you. Be patient, however, if it takes a little time. National defense comes first—there can be no alternative.

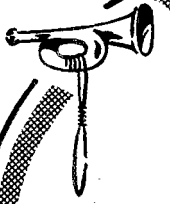

WORK
ORDER

RUSH

ORDER
PRIORITY
AI

RUSH

PRODUCTION
SCHEDULE

RUSH

ORDER
RUSH

RUSH



BLILEY ELECTRIC CO.

UNION STATION BUILDING

ERIE, PA.

(Continued from page 85)

8BQ designed and built an e.c.o. for 8EU. 8RNW swindled SVK out of his Sky Champ. 8ATF is definitely on 3.9-Mc. 'phone since December and is handling some fine traffic. 3EON is showing signs of life. 3GET wants "in" on the E. Pa. Traffic Net. The usual Post Office Xmas rush kept SOML off the air; he will be on with a new rig soon. 8UQM worked W7GTD at midnight on 3.5 Mc., using just his Signal Shifter. 8QEW received his 25 w.p.m. code proficiency ticket and his 30 w.p.m. endorsement. 3GOW has a fine e.c.o. going now. 3BES leads 3KT in the Frankford Radio Club W.A.S. Contest 45 to 44. 3HFE is building an emergency mobile for 112 and 224 Mc. 3HCT is back on again now. 3KT has a new qth across the street. 3HSG says there are 32 active 1.75-Mc. 'phones in the City of Phila. 3GHM did a bit of pounding in the A.R.R.L. O.R.S. Party. 3FLH reports "Music dealers competing successfully with radio dealers for my buck and a half monthly allowance." The Yeardon Radio Ass'n is holding a contest on 7 Mc. among its members. The losers have to treat the winning team to refreshments according to W3INV. Secy. 3FPK has the 25 w.p.m. ticket and is working on the 30. 3KJ got his new tower up and will be on soon. 3ADZ is out at Grand Island with the F.C.C. He hopes to be on the air from there soon.

Traffic: W3GKO 2183 3AOC 1319 3EEW 508 3BXE 440 SASW 353 3AKB 303 3HRS 232 3AQN 169 8EU 145 8ATF 142 3EON 76 3GET 61 3IAY 36 3DR0 21 8OML 20 8UQM 16 3FXZ 14 8QEW 6 3GOW 5 8SNZ 3 8GV-3BES 5 3HFE-3HCT 3 3KT-3HSG 2 3GHM 1.

MARYLAND-DELAWARE-DISTRICT OF COLUMBIA — SCM, Hermann E. Hobbs, W3CIZ — Eppa W. Darne, Chief RM, 3NWT, Roy Corderman, Reg. Coördinator, W3ZD, Oscar W. B. Reed, Coördinator D C, W3FPQ. AED and WJ are building 56-Mc. rigs. BAK reports quite a few 14-Mc. QSO's. CDQ holds a W.A.S. certificate and has returned from a trip to Miami and the Bahamas. BKZ, GXU, and ECP are fixed for local work on 112 Mc. and at the time of the inaugural parade in conjunction with the local Red Cross were kept QRL with parade orders. EIZ is QRL with his C.R.E.I. course. EQK is O.B.S. for Baltimore and vicinity on 1900, 3950, and 14,174 kcs. 'phone. FTD will soon be on 14 and 28 Mc. with a new rig. EQK is now on 14-Mc. 'phone and is still looking for Arizona for W.A.S. FE is back in the game after an absence of five years. HAL is on 'phone Sundays and Mondays, on c.w. the rest of the week and L.O. for A.A.R.S. with the call WLQO. HUM reports a busy holiday season on the A-P Trunk. IIS has finished his 500-watt rigs and is active on 3.9, 14 and 28 Mc. with fine results. Ed reports a new wrinkle for chassis construction. He found that his chassis was acting as a sounding board when mounted; having a cover for the bottom, he stuffed the space with rock wool. This dampens the vibrations to the point where it is unnoticeable. For details QSO him direct on either 'phone or c.w. IVT spent the holidays in Chicago. He has been transferred to Ft. Monmouth, N. J., for further instruction. He has been an active member of the A-P TL. We have enjoyed his short stay with us and hope he comes back at the completion of his six weeks' course. 73 George, and best of luck. 8JTT and 8NEL are with us for the present.

Traffic: W3BWT 1247 BKZ 121 CDG 3 CIZ 910 DRD 54 ECP 63 EIZ 163 EKZ 20 EQK 18 FE 16 HAL 91 HUM 401 IIS 18 IVT 69 8JTT/3 4 NF 753 OZ 62 CXL (WLM 5099).

SOUTHERN NEW JERSEY — SCM, Lester H. Allen, W3CCO — Ass't SCM and AARS Liaison R.M., Ed. G. Raser. W3ZI — Regional Coördinator in charge of Emergency Coördination, Ted Toretti, W3BAQ — R.M.'s: 3BEI, 3BYR, 3ITU — P.A.M.'s, Bill Hannah, W3EUH; Section Net Frequencies, ORS 3700 & 7280, OPS 1980 kcs. As a reminder, the Southern New Jersey Section QSO Party comes off March 2, 1941. It is hoped that a good attendance will be on hand. Scoring, etc., will be as announced last month. 3FXV will be in charge instead of 3HOJ as previously announced, since Walt has been called by the N.C.R. As you will note in the heading, a new O.R.S. net frequency appears for 7 Mc. Due to the many requests for an organized traffic net on 7 Mc., it has been decided to start this one immediately. It will be led by W3HLV. Anyone interested in joining is urged to write or radio your S.C.M. for applications, inasmuch as everyone is talking National Defense these days I might mention that we can use a few more appointees for Official 'Phone and Official Relay Stations in our Section, due to the increase in traffic these days. A few more stations added to the Net will relieve some of the boys who are being overworked. IDP

is much improved and is back on 1.75-Mc. 'phone after his short visit to the hospital. HEO has returned to, 7 Mc. again. HOJ is on a Naval cruise. FMR suggests that each O.P.S. appointee give the N.C.S. a list of towns he can cover by his local telephone, just in case there is some rush traffic. Elmer still contacts 9CAC daily on 14,200 kcs. IOK worked WAR and NAA. He expects to rebuild the transmitter to 250 watts and is going to try 112 Mc. ASW is active on the OPS Net and as O.B.S. EWK received his Code Proficiency Certificate for 20 w.p.m. INF expects to move soon. IMY built a lazy H antenna for 28 Mc. and is having fair results. GHR complains that deliveries are bad on his various originated messages. Mac suggests that we get some sort of contact with Phillipsburg for traffic going to Easton, Bethlehem and Allentown, Penn. We sure could use someone up in that vicinity. ACC is still looking for 56 Mc. to open up and reports he gets on 3.9 Mc. occasionally. ABS is rebuilding his 1-kw. rig and putting new B & W coils in the final; he hopes this will cure his troubles. The Southern New Jersey Radio Association held its annual election and the following are the officers for the coming year: 3FDF, President; 3DAJ, Vice-Pres.; 3GPU, Treasurer; 3GHJ, Corresponding Secy.; 3EWF, Secretary; 3KW, 3GVN, 3FEY, 3GVT, 3FBZ, 3GFL, 3FBH, Directors. Anyone wishing to correspond with the organization may write in care of Fred Green, W3EWF, 300-9th Avenue, Haddon Heights, N. J. ISY is doing an fh job on the SS Seminole. "WNCX." Fritz wishes to be remembered to the gang. VE has left Trenton and now can be contacted at Fort Bragg, North Carolina, working portable. CCC has been called to active duty by the N.C.R. and will be posted on Long Island. Eddie expects to be working portable very soon. Until next month, 73.

Traffic: W3BZX 373 CCC 51 HAZ 185 DNU 118 BYR 98 (WLVN 24) HLV 85 ZI 72 AVJ 68 OZ 47 IDZ 41 IFT 41 AQ 37 GRW 30 VE-FMR 26 BEI 24 AEJ-IOK 19 CCO 16 ITU-ASQ 15 EWK-INF 14 HPX 10 FXV 8 IHO 6 IMY 5 GHR 4 ACC 3 ABS 2.

WESTERN NEW YORK — SCM, Fred Chichester, W8PLA — R.M.'s: BJO, CSE, DSS, FCG, PCN, P.A.M.'s: CGU, RVM, UNY. PCN leads the Section this month in traffic handling. He makes the B.P.L. SZB, a new E.C. in the Section, is building a portable for emergency work. RTX has just put in a 250TH final and runs from 800 to 1000 watts on 1.75 and 28-Mc. 'phone. VJP, a new ham in Lakeport, is building a new rig for c.w. with 200 watts. ABN has rebuilt his c.w. rig and is getting out nicely with 125 watts. The Utica Radio Club has suspended meetings temporarily and the activity has been taken over by the Utica N.Y.A. Radio Club. K.B.T. Club will be up with the winners in the next Field Day. Nets are now being formed to educate operators and equipment is being made ready for tests. NWH has started work on a new transmitter. OMD, now O.R.A. and A.A.R.S., is one of Buffalo's proud traffic men. He is rebuilding his exciter to make it more flexible. QZP is modeling a smaller and more powerful transmitter. RV advises that samples of facsimile transmissions may be had by requesting same, enclosing self-addressed stamped envelope. AAU is helping relieve W.N.Y. of Rochester traffic through a schedule with KYR. Where are all the Rochester traffic men? W.N.Y. needs outlets to Jamestown, Niagara Falls, and Syracuse badly. Write your S.C.M. for information if interested. DXE is on 14-Mc. 'phone from new QTH. UXL is looking for early birds around 1910 kc. every a.m. UVY wants to contact some DX station who has not also worked UXL. ROX is working 28 Mc. with a vertical antenna. UBR is now on 1.75 Mc. UHI received an NC101X for Christmas. Maybe now he will try traffic seriously. UXH is building for 1.75, 3.5 and 7 Mc. with an 852 final. MBZ is holding contests on 1.75-Mc. 'phone. OWE expects to be on the air by spring. OWT also expects to get on soon working 1.75 and 7 Mc. OWL is getting out fine on 1.75-Mc. 'phone in the early morning. HVE now operates 1.75-Mc. c.w. with a 6L6 final. JTT/3 reports into the W.N.Y. Net quite frequently from Washington, D. C., where he is working. KYR requests more cooperation in her emergency corps program. So far ten stations have applied. Let's all help her, fellows. UXT is trying to schedule his cousin 9CQK. KYR, NTK and PLA have taken their tricks as acting N.C.S. in the Army Net. MOI is back on 3.5-Mc. c.w. — ex-8GJO is planning on getting a ticket again. UVF is the station at the Batavia School for the Blind. RMR is handling plenty of traffic in the F.T.S. HQG is back on 3.5-Mc. c.w. He and CDK are working on 112-Mc. rigs. MPN, of the N.C.R., has been called to active duty at Floyd Bennett Field. SFD is now active A.A.R.S. JTW,

NNJ and SZB are new Emergency Coördinators in the Section.

Traffic: W8AOR 92 CSE 54 DSS 34 FCG 306 JIW 954 KYR 53 OMD 9 PCN 543 PLA 145 RKM 340 RVM 10 SMI 92 SBV 68 SFD 220 TEP 10 UPJ 70.

WESTERN PENNSYLVANIA — SCM, E. A. Krall, W8CKO — Ass't SCM Emergency Coördinator W8AVY — Ass't SCM ORS activities W8KWA — Chief RM, W8NCJ. NCJ says any ham having traffic to move should take advantage of net facilities. PER received a new receiver for Xmas. QBK recently received a commission as ensign in the N.C.R. and was called to active duty Jan. 8th. KUN resigned as R.M. as he is unable to devote sufficient time to activities. PX and KBJ both came across the nice totals of messages handled on 3.9-Mc. 'phone. TOJ has a new Signal Shifter from XYL Santa. SWT also received a Signal Shifter. RIS still knocks them off on 28 Mc. Our sympathy to RNP and family on the death of father. GKH and MGV are now on 3.9-Mc. 'phone. ESR is working for the N.Y.A. Radio Department. CIR has a new SX28. Mon-Yough Key and Fone Club are organized to assist newcomers in getting their licenses. UST and VJY obtained their licenses with the club's assistance. A 1.75-Mc. 'phone net has been started in McKeesport and promises to be successful. NCJ reports that the most consistent members of the W. Pa. Net are: HKU, IOH, KWA, MJK, OKK, PER, RBO, TOJ and himself. Less active members are: DDC, GBC, JSU, KRY, KUN and YA. QDV has gone to Detroit to join the Coast Guard. QOD moved from Charleroi to Kittinging, Pa. BTQ is an active O.P.S. CDG has built an e.c.o. which promises to outperform any crystal for stability. The Pa. 75 A.A.R.S. 'Phone Net continues to operate with as great precision as the c.w. nets. BHN keeps the net on its toes. AJA has been appointed as D.N.G.S. Pa. 75 and PX D.N.C.2. NOJ replaces AQJ as E.C. at Erie, Pa. All O.R.S. and O.P.S. are requested to send in their monthly reports. Failure to do so may lead to cancellation of your appointment. NCJ and KWA make B.P.L. this month. To make this column more interesting, any amateur in the W. Pa. Section who has an appointment of any kind should feel obligated to send in a report.

Traffic: W8NCJ 759 KWA 288 CKO 113 CMP 78 BHN 76 JSU 64 BTQ 60 MJK 54 ETD 46 KBJ 44 RNO 40 PER 39 SFV 26 KRY 24 KUN-OKK 22 RNH 22 PX 20 TOJ 17 NDS 18 TTD 14 RAT 13 HKU 12 NDE 9 IOH 7 RAU-RIS 4.

HUDSON DIVISION

EASTERN NEW YORK — SCM, Robert E. Haight, W2LU — MIY enjoyed a visit from W1MDV. Dot is doing a swell job as State Radio Aide in A.A.R.S. KWG is back from recruiting duty in N.Y.C. Welcome home, John. LSD is handling messages for the Army boys at Larchmont Barracks. MHW has a new 616-809 rig running 65 watts which works FB. The R.P.I. boys are planning to go on 112 Mc. soon. JRG reports JRG and family visit HJM and family at party; HTG-FWK and 2GNS with YL's also attend. MEC joined the A.E.C. and new ham local W8DJR. MEC rec QSL's from Philippines. NIY manages to get on for N.C.R. drills with a nice signal. LLU rebuilt his 8-tube super to conform to the revamped circuit in Nov., 1940 QST. It works FB. KFB reports operating almost entirely on 3.9-Mc. 'phone and occasionally on 1.75 Mc. KFB installed e.c.o. and gets 10 per cent results from every call. ACB is back on the air from his new home and E.C. activities are under full swing.

Traffic: W2MIY 669 KWG 189 MHW 21 LSD 117 SZ 12 JRG 8 MEC 1 (Nov.-Dec. MIY 476).

NEW YORK CITY AND LONG ISLAND — SCM, Ed. L. Baumach, W2AZY — After being off since 1930, BIV is now O.R.S. again. MHD sends in his first report and is out for deliveries. DW is out for a big traffic total. MRL makes the B.P.L. on deliveries. MNF started off the new year by handling traffic and is on 7 Mc. every night from 7:00 p.m. to midnight. ITX reports from Ocala, Fla. and will be traveling out west for the rest of the year with the General Motors Previews of Progress. EOT is now at Fort Slocum in the regular Army. KGD and LQP are at the Coast Guard Radio school at New London, Conn. LGK finally found his cousin ex-2AUL, now ICZ, after eighteen years. EC reports that the A.P. Net has outlets to most Corps Area nets and state nets for the handling of traffic for the boys who are away, and can also take traffic for K5 and K6 on 3630 every night at 9:30 p.m. E.S.T. MT and SC run high traffic totals. IXQ is on 1.75 Mc. from his new QTH in N.Y.C. JGB is us-

Robert A. Kirkman, Director of the Hudson Division A.R.R.L. advises that the Board of Education of the City of New York has an emergency training program for national defense and will accept applications from a limited number of men interested in training as radio operators. Trainees must be resident of New York City. Classes are held in five boroughs. Further details may be secured by contacting Mr. Sam Harper, Trade Advisor, Radio Board of Education Building, Room 1010, 110 Livingston St., Brooklyn, N. Y. Please mention A.R.R.L. if you are interested and write to this agency.

ing new 28-Mc. beam. FNJ's kw rig is completed. JGB is interested in O.P.S. INF finished his new signal shifter using 2A5's. KYV gets out on 1.75-Mc. 'phone using 1½ watts input to a midget A.C.-D.C. job. CCD is on all bands using his new e.c.o. job. JIN is building his new superhet and exciter for good stable schedules. VG was off due to blown 866's and a cracked xtal. DOG was operating with only one 866 on 3929-ke. 'phone and did not notice any difference. LBI is now the trustee for the City College Radio Club station, W2HJ. MRV is using his new e.c.o. with good results. BGO has a new xtal rig and new antenna to go with it. BCS sends in his first report. LOQ moved to Berea, Ohio. AZV is busy breaking in two newcomers. CHK spent the past month in N.Y.C. moving a b.c. station. W1KTF is vacationing in Honolulu and schedules IYX from K6MVF on 28,540 kc. HGH graduated from Cornell and is now on 28 Mc. with a pair of 812's. AOA is out of the hospital after a narrow escape from the grim reaper. GPO and IYX (one block apart and both on 28 Mc.) find that the splatter suppressor cuts out all local splatter. EYS's regular operating frequency is 7055 kc. DBQ is looking for any stations in Brooklyn who are interested in the A.E.C. MT can be heard on the Section every night at 8:30 p.m. on 3710 kc. All stations with traffic for the Section should call him.

Traffic: W2SC 739 (WLN 858) MRL 461 BO 458 MT 441 KI 395 DW 226 EC 138 FAQ 133 DBQ 119 LPJ 94 MRV 67 AZV 54 MHD 41 AV 38 LGK 37 JIN 18 CET-CHK 17 IYX-AA 14 BGO-CET 13 CTN 11 INF-FLD 10 KYV-BYL 9 ADW 8 CCD-DLR 7 LYC-DOG 6 BCS 5 NHD 4 AZM 3 HGO-KWB-LBI 2 LID-ELK 1.

NORTHERN NEW JERSEY — SCM, Edward Gursky, Jr., W2LMN — RMs: BZJ, CGG, HMJ, HXI, IYQ-PAM LXI. Section net Frequencies: 3630, 7070 kc. New appointments: O.R.S., BNU; PAM LXI. More promptness is urged in getting monthly traffic reports to the S.C.M. in time to appear in QST. Reports should be mailed as soon after the 15th of each month as possible. The Long Branch Senior High School now has its own station. The call is W2NOZ and they operate on 1.75-Mc. 'phone after 3 p.m. The Jersey Shore Amateur Radio Association is organizing an emergency net. CZJ is now in the N.C.R. KXT reports plenty of activity on 112 Mc. around Plainfield. HXI had over a thousand total this month and wants a new receiver so he can hear more traffic! MNT is now N.C. 3 of the N. J. 40 A.A.R.S. Net. MRX will be on 28 Mc. 'phone shortly. MRK put the finishing touches on his new rig. He now works 3.5, 7, 14 and 28 Mc. JRU has his eye on a 35 w.p.m. endorsement for his Code Proficiency Certificate. JKH rebuilt his rig and it's now in a five-foot rack. In a recently held election of the Inter-city Amateur Radio Club the following officers were elected: HAO, Pres.; ex-9A10 Vice-Pres.; FDL, Treas.; EWM, Sec. JQA is now a married man. GDK, GBY, FSQ and IMJ are in the communications platoon of the Headquarters troop, 102nd Cavalry. The third annual Ten Meter Round Up was held in Kearny and was a big success. CIY has been called for active duty by the Navy. JMC has applied for O.P.S. MRJ has done likewise for O.R.S. The 40 meter net is gradually getting larger attendance but can still use more members. Anyone interested get in touch with George Lange, W2IYQ. HCO spent the holidays in the sunny South. MWW and MLW are active on 3.5-Mc. c.w. Many fellows report receiving their "Code Proficiency" award. HAVE YOU?

Traffic: W2HEXI 1083 CGG 551 MNT 475 JUU 209 IYQ 186 MNO 174 LMN 149 (WLN 167) MHJ 116 MAX 77 BZJ 50 (WLN 50) HCO 52 JUC 33 BNU 27 NDL 17 LXI 13 KSR 7 MRJ 5 IZV 4 MRX 3 MRK 2 (Nov.-Dec. HCO 54 LXI 8).

VOLTS? OHMS? MILS? DECIBELS? AMPERES?
Here's The Answer!

PRECISION Series 844-34 RANGE
AC-DC VOLT-OHM-DECIBEL-MILLIAMMETER

Designed to meet the exacting requirements of Amateur, Laboratory, Industrial, Television and Radio.

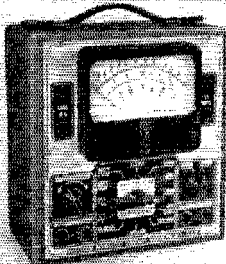

- 6000 VOLTS
- 10 MEGOHMS
- 12 AMPERES
- 1,000 ohms per volt AC & DC
- ★ 6 AC and DC voltage ranges to 6000 volts
- ★ 6 current ranges to 12 AMPS
- ★ 4 resistance ranges to 10 MEGS
- ★ SIX DB ranges from -12 to +70 DB.
- ★ SIX output ranges to 6000 volts
- ★ 4 $\frac{7}{8}$ " 400 microampere easy reading meter
- ★ 1% wire-wound bobbins and matched metallized multipliers
- 2% DC and 3% AC overall accuracy.

Series 844L (Illustrated) in hardwood walnut finished carrying case (7 $\frac{1}{2}$ x 8 $\frac{1}{4}$ x 4) less batteries and test leads. **\$22.95**

More than 40 models in the PRECISION 1941 LINE . . . 15 Mutual Conductance Type Tube Testers and Set Testers, 16 Multi-Range Testers, Signal Generators, etc. . . . See them at your local distributor . . .

Ask for the PRECISION TEST EQUIPMENT 1941 CATALOG

PRECISION TEST EQUIPMENT
Standard of Accuracy SEE THEM AT YOUR JOBBER
PRECISION APPARATUS COMPANY
 647 Kent Avenue Brooklyn, New York
 Export Div.: 458 Broadway, New York, U. S. A. — Cables: Morhanex

Janette

ROTARY CONVERTERS

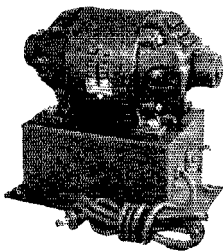

Janette Converters were the ORIGINAL machines designed and built especially for radio apparatus.

These machines progressed with the industry and have made record for economical, operation that today Janette and quality products are synonymous.

such an outstanding reliable, trouble-free Janette and quality products are synonymous.

WARNING: Janette converters are being imitated — be sure Janette is stamped on the name plate. Dynamotors, generators and motor-generators are also available.

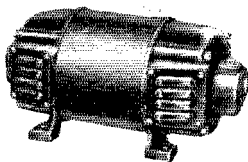

MAY WE SEND LITERATURE?

Janette Manufacturing Company
 556-558 West Monroe Street Chicago, Ill. U. S. A.

After Code Proficiency

(Continued from page 29)

makes perfect. In other words, get a mill in your operating position by hook or crook and use it regularly. At the N.C.R. Radio Schools touch typing is taught at the same time code proficiency is advanced. Letter writing will aid typing speed and keep it above your code speed and the companies give charts and tips on learning typing for the asking. If you have the rudiments of the typing (and apparently most hams use typewriters already) it is just a matter of slipping the cans on one's head and learning to coordinate faster and faster so that the words put themselves down on the paper as they come along. The 'phones will help shut out any noise the typewriter keys make. Pick a good commercial-strength signal. The W1AW transmissions come in daily except Friday on each amateur band and may be useful. See page 57 of February *QST* for a big bunch of press schedules that will fit almost any practice problem. The typewriter keys may jam up at first, but they will soon behave. You will find indeed that even 25 and 30 w.p.m. transmission requires only a slow measured cadence in typing, slower than a lot of letter writing you already do on your machine, we warrant.

Read what we say on "copying behind" (p. 45, January, 1941, *QST*). All that applies particularly in learning to write it down on a mill. Don't be afraid that you cannot copy code on a typewriter. Just try it, and keep with it, using some regular press or code practice transmissions to give you a steady source of signals. Once you begin to coordinate, and the brain directs a sequence of finger operations so you don't have to hunt around the keyboard, you only need a mite of "copying behind" ability. Then you will begin to put word groups down "automatically" while the brain is storing up the next train of code modulation that in a moment will turn into another typing sequence. Two words can convey the needs in learning how to take it on a mill:

- (1) Coördination. (2) Practice.

Force yourself to copy a little behind the incoming signals. Don't worry about missing anything. Make the subconscious mind accustom itself to digging up the images of words for translation into cold type a short while after the transmitting operator has sent the characters. The mind develops a sort of automatic response. The ears-and-brain, the intelligence department, then another department of brain-eyes-hands all correlated into a finely working whole does the job. These faculties work together after we give them practice. Ability to copy on a mill may come slowly at first but you will be surprised how soon your friends will marvel at what you can do! The ability to make mill copy is very worth while. We heard a broadcast announcement of a new opening for code men who could run teletypewriters and put down code on a mill just while writing these lines!

Don't try to do it all in one day. A reasonable practice period every day or two is best. Each period is a stepping stone to better correlation of the faculties, higher confidence and real ability.

The COLONEL'S LADY and JUDY O'GRADY Are NOT Sisters Under Their Skins!

1. A glass tube, continuously drawn with utmost precision to the size of a small pencil lead, is the beginning of an IRC Type BT Insulated Resistor.

2. The tube with a coating of Metallized type resistance material permanently bonded to its outer surface, and stabilized by a baking process.

3. Special leads for easy soldering have enclosed, positive contact to element which cannot open. Insertion of leads *inside* the element tube aids rapid heat dissipation, drawing heat out of the resistor.



A finished 1-watt unit. Element is completely sealed by molded insulating phenolic. Moisture cannot enter. No possibility of grounding. Leads anchored *inside* insulation cannot turn or pull loose.

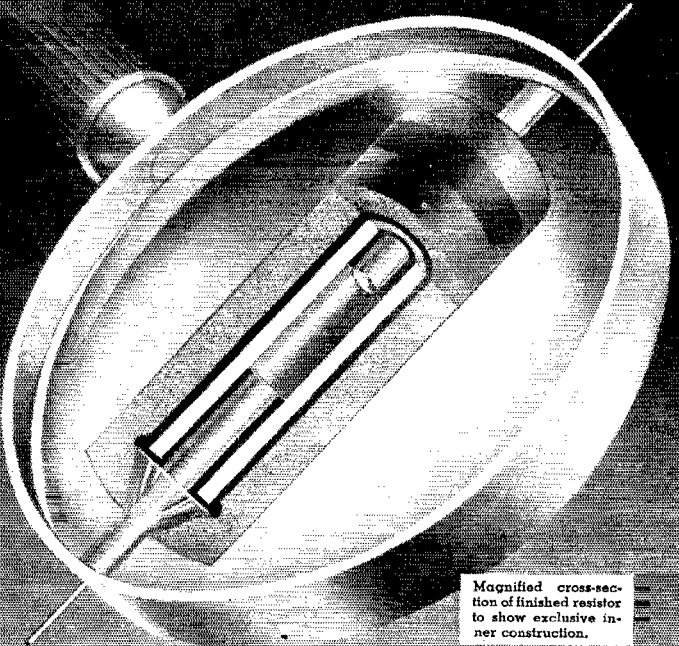

Magnified cross-section of finished resistor to show exclusive inner construction.

Flattering and widespread imitation following IRC's development of the Insulated Resistor with its obvious advantages as compared with old-style, non-insulated units has resulted in such uniformity of appearance that it is difficult to distinguish one make from another. *This similarity, however, is only skin deep—only as deep as the insulation.*

What lies beneath is of the utmost importance from the standpoint of performance. The outside insulation is important only because it protects the inside resistance element, prevents shorting and facilitates rapid and economical assembly. Not this protection *but* what it protects is the final determining factor of quality—and it is *underneath* this insulation that insulated resistor similarity ends.

As an outstanding example, the IRC type BT insulated resistors, comprising the unique "Metallized" filament element and specially developed insulating phenolic covering, have humidity characteristics hitherto unobtainable. More than 10 cycles of alternate two hour immersions in 100°C. and 0°C. salt solution followed by two hour loadings at normal rating result in an average change in resistance value of less than 10%.

In connection with the present defense program such performance is essential for dependable communication equipment but it is also obviously very important for all commercial applications.

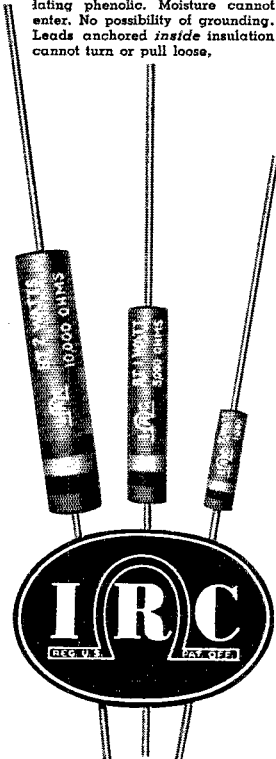

TYPE BT INSULATED RESISTORS

INTERNATIONAL RESISTANCE CO., 401 N. BROAD ST., PHILA.

A HAM'S PARADISE



Engineer, beginner, old-timer, "ham" and SWL alike (and a few YL's, too) — you'll find them all here at SUN "chewing the rag" with our highly competent, trained technical staff. From far and wide they come — to buy, to look, to listen and swap tall tales about the good old days gone by and the good days still to come. Man and boy they've been coming to us since 1922 for their every radio requirement. There must be a reason!

Why Not Try Us, Too?

IT'S SUN'S Plus-Perfect PERSONAL SERVICE that MAKES the DIFFERENCE!

FOR THE FIRST TIME! VERTROD NOISE-REDUCING COMMUNICATIONS ANTENNA

At long last! A real noise-reducing antenna system that covers the entire broadcast and short-wave bands. Range 500 Kc. to 60 Mc. Specially peaked for 10, 20 and 40 meter operation. 9 ft. rust-proof, solid duraluminum rod.

AMATEUR NET..... **\$7.06**

Write for illustrated literature

IN STOCK! MILLEN ECO VARIARM

Ready for immediate delivery — this complete, self-powered ECO unit with all coils and tubes, as described in January QST by W9YZH. Offers low drift, good band spread.

AMATEUR NET..... **\$29.50**

WE CARRY A COMPLETE LINE OF R.C.A. Air-Cooled PENTODES

Type	Fil. Volts	Max. Plate Volts	Max. Plate Input Volts	AMATEUR NET
813	10.0	2000	360	\$22.00
814	10.0	1500	225	\$17.50
815	6.3	500	75	\$4.50

Write for latest R.C.A. X'Mitting Tube Guide — Form IP2994

IT'S FREE!

TIME PAYMENTS • TRADE-INS

New York's Oldest "Ham" House
W2JEH•W2DXC•W2LFV•W2CLH•W2IOP•W2JZH

RADIO CO.

212 Fulton Street, Dept. ST New York

Cable Address: SUNRADIO NEW YORK

Taking ten words on the line is fairly simple once our ability to put copy down is sufficient. This is just an extension of the "copying behind" thesis to the point where we have time enough to scan the copy as it goes on paper. After the first five words are on a line hit the space bar of the typewriter an extra whack or two before putting down the next five. It is amazing how easy this method of logging copy makes it for us to check up on the group count before we receipt for a message.

Handle Traffic for Accuracy and Procedure Gains

Recently we reviewed results of a certain competition for code copying ability. We found that with all classes of amateurs competing and some of the runs purposely made through artificial interference, it was the man with traffic experience that was able to turn in the *best* copy. Why? Because he was more familiar with making written copy than those interested in rag chews or DX who also entered. His habit of correlation of faculties was so cultivated that most of his response was automatic. He was thus able to concentrate the *extra* little bit on the "difficult" signal. This made his ability to get down accurate copy greater.

Handling traffic involves not only receiving (writing down) of an address text and signature, but the preamble and check must be accurate. Procedure for getting fills, general practices for time saving and accuracy, the development of fine points in character and word spacing, sending that takes into consideration the receiving operator's problems and difficulties — all these are called for and developed by TRAFFIC HANDLING.

For years the League has recognized that relaying traffic was not only a whale of a lot of fun, but the best operator training for radio amateurs. The Brass Pounders' League exists to give prominence to the most consistent traffic handlers. The A.A.R.S. too recognizes the training in procedure and general ability through traffic work. Its nets make traffic the big thing. A limited circle can be reached by radio with the best of equipment. The *message*, however, can carry on *beyond* the two operators on a circuit, conveying and bringing back ideas. The miracle of accurate exchange of information at distances is made possible by the message, always transcribed and recorded. So to those seeking to become top notch operators we suggest first going after one of our Proficiency Certificates and then getting into traffic work as thoroughly as possible in order to reap the benefits in terms of code speed, procedure and all around accuracy that will come to you from your traffic handling.

"How do I get started in traffic handling?" do you ask? The first step is to examine the message form. Write out a message or two, just to show yourself how it is done correctly. Page 432 of the Radio Amateur's Handbook can be consulted¹, or the booklet Operating on Amateur Radio Station will be sent gratis to League Members who request it. With the correct makeup of a message in view one may next work some brother amateurs and surprise them by sending a message

BE SURE TO
SEE THE *New*

HOWARD

\$29⁹⁵ and \$39⁹⁵ Receivers

with TUNED R.F. STAGE on all Bands!

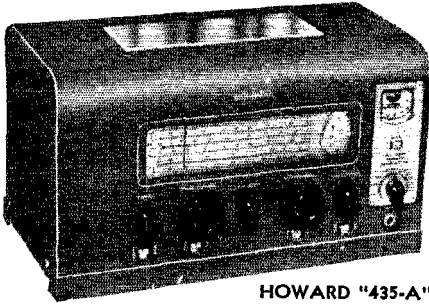

HOWARD "435-A"

MODEL "435-A" — 7 TUBES — \$29⁹⁵

The efficient Tuned R.F. Stage on all four bands, with 3-gang tuning condenser, provides improved selectivity, better signal to noise and image ratios and greatly increased sensitivity. 340° band spread dial with 8" coverage assures accurate logging. Has electrical band spread, BFO, AVC, iron core I.F. transformers, 6½" Howard-Jensen speaker, copper plated chassis, etc. Tunes from 540 KC to 43 MC (556 to 7 meters). Howard Progressive Series Plan provides factory conversions to higher performance receivers at any time. Sturdy steel cabinet is finished in gray wrinkle enamel. With Carrier Level Meter as shown — \$12.00 extra.

MODEL "436-A" — 8 TUBES — \$39⁹⁵

All features of Model "435-A" above are included in this new 8-tube communications receiver, plus an efficient automatic noise limiter and the famous Howard Inertia Tuning Controls. May be converted at any time to Model "437-A" — 9-tube receiver.

MODEL "437-A" — 9 TUBES — \$54⁵⁰

Incorporates all of the features of Models "435-A" and "436-A", plus an additional stage of I.F. and Crystal Phasing Control to eliminate unwanted signals when crystal is installed. Model "437-A" is the final receiver in the Howard Progressive Series and through the use of the finest components and the latest engineering improvements provides an exceptionally high degree of sensitivity, selectivity and stability. Cabinet, tuning range and basic construction is identical to Models "435-A" and "436-A". Model "437-A" complete with crystal — \$62.00. With carrier Level Meter as shown — \$12.00 extra.



HOWARD "437-A"

MODEL "490" — 14 TUBES

With Crystal 10" Speaker \$149⁵⁰

One of the finest self contained professional type communication receivers. Has two tuned R.F. stages, calibrated band spread, air tuned I.F. transformers, variable I.F. selectivity, temperature compensated oscillator, split stator tuning condensers, variable audio fidelity, automatic noise limiter and 8 watts of push-pull audio. Provides super sharp tuning or broad fidelity for reception of music. The Howard "490" is the result of years of engineering and development — the specifications tell their own performance story.

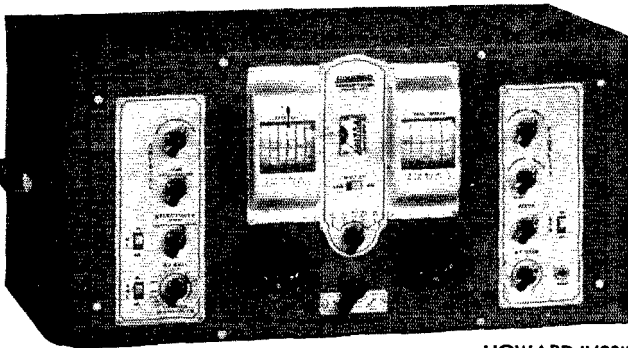

HOWARD "490"

AMERICA'S OLDEST RADIO MANUFACTURER (Export and Pacific Prices Higher)

HOWARD RADIO COMPANY

1731-35 Belmont Ave.,

Chicago, Illinois

Cable Address: HOWARDCO., U. S. A.

New

EFFICIENCY

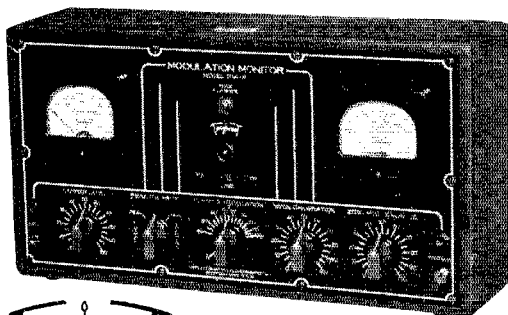

TRIPLET

MODEL 1696-A

You've solved your problem of getting maximum efficiency from your transmitter when you invest in a Model 1696-A Modulation Monitor. . . . A new monitor with improved shielding. . . . Just the unit for 10-meter bands. Plug it into your AC line — make simple coupling to the transmitter output and the monitor shows:

- Carrier Reference Level ● Per cent of Modulation ● Instantaneous Neon Flasher (no inertia) indicates when per cent of modulation has exceeded your predetermined setting. Setting can be from 40 to 120 per cent.

Helps comply with FCC regulations. Has two RED DOT Lifetime Guaranteed Triplett Instruments. Modernistic metal case. Model 1696-A — Amateur Net Price. . . . \$34.84

Also available as a rack panel mounting unit

For More Information — Write Section 253, Harmon Avenue

THE TRIPLET ELECTRICAL INSTRUMENT CO.
Bluffton, Ohio

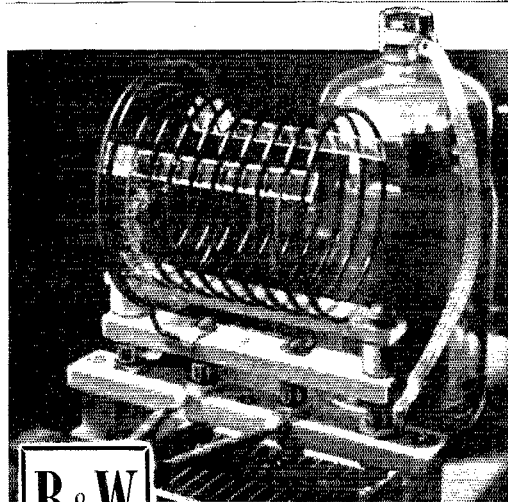

B&W

PERFORMANCE

Speaks Louder Than Words!

TYPE B and BL
(100 watt rating)

Type B is the straight coil, center tapped. Type BL (illustrated) is available center or end linked. Both types from 10 to 100 meters; priced from \$1.00 to \$2.50 net.

An actual test of any B&W Air Inductor in your own rig will offer proof of efficient performance a hundred times more convincing than anything we could say about them. Especially is this true of B&W Types B and BL, those neat, compact 100-watt coils that are usually "just the thing" for most any 100-watt job.

When you buy B's and BL's you get good looks, mechanical strength, unusual versatility, real economy and efficiency — in short, one of the smartest buys in plus performance you'll ever make! Try 'em — YOU be the judge!

BARKER & WILLIAMSON

Radio Manufacturing Engineers • ARDMORE, PENNSYLVANIA

to them or to a third friend both of you know. Messages to other amateurs are a natural means of exchanging comment and maintaining friendships. Handling messages brings prestige as well as fun and proficiency. To get into the game and get all the benefits you should not stop with one or two practice messages. You must aim to hook up with other amateurs who are interested in traffic handling to get all the benefits.

In working amateurs shoot a message along and see if they can take it! Ask if they could keep a schedule and handle a few each way. Spend some time tuning the band and looking for a station north-south-east-and-west of your location who will keep a schedule. Hook up with operators of about your own speed who would also like to develop their ability and have some traffic fun. Point out that your proposal is not only fun, but good operator training, of possible potential defense value as a radio circuit. Every organized system of schedules at any rate will add to the public interest inherent in the amateur station license authorization . . . for both stations of a circuit or for all participating.

Next month we hope to start a series of articles that will tell something about forming messages, what their different parts are for, a check and so on.

Aspire to traffic handling. Report your traffic to the S.C.M. for the previous 30 days on the 16th of each month. With your third traffic report ask him about qualifying for O.R.S. (Official Relay Station) appointment so he will send you an application blank. Get the name of the R.M. or P.A.M. who organizes nets in your Section from the S.C.M. Like everything else don't expect too much of traffic handling until you have learned the ropes. It is most effective if you know how to use it. It is ineffective if you try to give your messages to operators who are irresponsible or have no proper interest or are uninformed of the various nets and routes and traffic stations. Study of the calls at the end of each part of Station Activities will show you stations that are reliable, stations that are handling traffic. Aim to be one of them! Most of them work on 3.5- or 7-Mc. bands but a reliable operator for a schedule is of course on whatever band you find him! A directional CQ naming the direction and town you want will help move traffic intelligently. Use the General Traffic Period (explained in QST for the last three months). Best of all, get yourself some schedules with traffic stations and keep them faithfully. If you have never been in the traffic end of the game you will find new pleasure in this work. Traffic, like all other activities, will return dividends to you in proportion to your own effort. We suggest traffic handling as the sure road to the higher code proficiency awards. Keep at it after you graduate at 35 w.p.m. and you will go still farther. Make your first aim real code proficiency. Get so you too can take it on a mill. For practical experience in handling communications go for traffic handling in a big way. It is a stepping stone to top rank in operating; it is a sure road to higher code proficiency.

¹ See *About Ham Message Handling*, p. 40, August, 1935, QST.

NEW NATIONAL NC-200

The All 'round Communication Receiver

NOW in stock for immediate delivery
ON EASY TERMS!

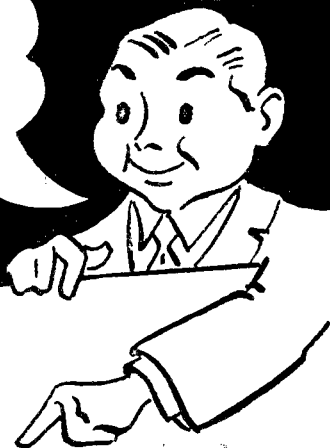

YOUR CALL LETTERS IN GOLD . . . 10c

Put these big shadowed decalcomania letters on your Ham Shack door, auto window, etc. Nearly 2" high. Send dime for yours today. Be sure to give call letters.

FREE . . . a book every Ham should have BIG NEW CATALOG

Just out . . . with many more items than we've ever put between the covers of any catalog. Thousands of bargains, sets, parts, accessories, supplies, of best known makes. Hundreds of illustrations. "Ham" shack, beams in every "ham" shack, ready for instant reference. Helps you plan your new rigs, figure costs, learn sizes and specifications before you start construction.

HOW TO ORDER

Send down payment and credit references with your order. We ship immediately upon credit approval. You pay balance plus 6% carrying charge in equal monthly payments of \$5 or more.

Six general coverage ranges, and four uniform amateur band spread ranges, all with definite, accurate calibration. Look up recent NATIONAL ads in *QST* for full details of this set, and order from NEWARK today.

Complete with 10" speaker in cabinet to match, cash price \$147.50. **\$14.75 DOWN**

\$11.73 per month for 12 months

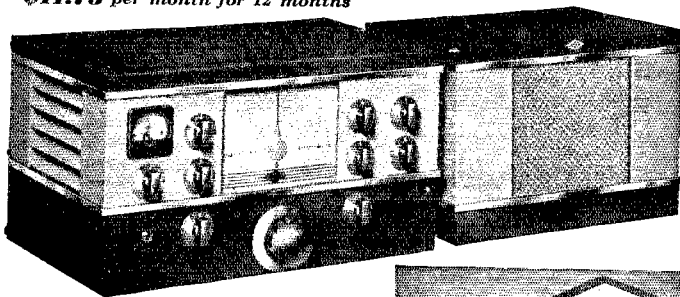

ECO VARIARM!

MILLEN MODEL 90700

An economical, stable ECO exciter, just as described in January *QST* (p. 81), and advertised by James Millen. Order it along with any receiver, or with \$20 worth of other accessories, and you can pay on easy terms. We ship promptly. Order now. Cash price **\$29.50**



OIL FILLED — OIL IMPREGNATED FILTER CONDENSERS

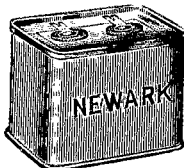

AS LOW AS **59c**

Thousands now in use by "hams" who are still wondering how we can sell such dependable quality condensers at such low prices.

No compromise with quality. Made by a leading manufacturer and **GUARANTEED** at rated voltages.

Mfd.	Volts DC.	Size	Price
1	1000	5 x 3 1/2 x 1 1/2	\$.59
2	1500	Misc.	.99
4.4	1500	5 x 3 1/2 x 1 1/2	1.50
2	2000	4 7/8 x 3 1/2 x 1 1/2	1.50
8	2000	5 x 3 1/2 x 3 1/2	2.75
4	3000	5 x 3 1/2 x 3 1/2	3.75

HIGH VOLTAGE POWER TRANSFORMERS



Newark's larger volume of amateur business makes this unmatched value possible. Made by one of the largest transformer manufacturers. These husky transformers have a place in every Ham Rig. Guaranteed. As illustrated.

Choice of Two Filament Types

No. 4140 — 600-0-600 V. — 200 Ma. Filaments: 7.5 V.C.T.-3A. — 3.0 V.C. T.-3A. — 2.5 V.C.T.-10 A. Wt. 8 1/2 lbs.	\$2.85
No. 4240 — 600-0-600 V. — 200 M.A. Filaments: 6.3 V.-4 A. — 6.3 V.-3 A. — 5.0 V.-3 A. Wt. 8 1/2 lbs.	\$2.85

NEWARK

Electric Company

323 W. MADISON ST.
Dept. Q CHICAGO, ILL.

If it has ANYTHING
to do with Code Practising,
HARVEY has it ...



GARDINER-LEVERING

TYPE "J"

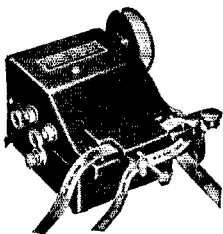

Double-purpose instrument—code teacher and automatic sender. Sends from 6 to 70 words per minute. Built-in tape perforator. Cut your own code-practice tapes and message tapes. Complete with already cut practice tape and 5 rolls of blank tape. Repeats calls and messages indefinitely. Length of messages practically unlimited. **\$12.50 net**

TYPE "S"

Sends from 4 to 60 words per minute. Higher speeds if desired. Complete with 10 rolls of double-perforated lesson tape of carefully selected and arranged matter for speediest results in learning code. Most compact and practical code teacher on market. **\$17.50 net**

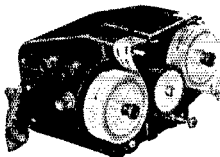

BUD

Code Practice Oscillator and Keying Monitor.
Ideal for code schools. **\$7.95 net**

SIGNAL

Code Practice Set consisting of a Buzzer and Key. Mounted on a wooden base and completely wired, including a detailed instruction booklet. **\$1.98 net**

W2IIL · W2LJA · W2KWY · W2JKD · W2PL

OUR *Best* VALUE IS OUR RECORD OF LOYAL SERVICE

HARVEY

Radio Company of New York

103 WEST 43rd STREET · NEW YORK, N. Y.

CABLE ADDRESS: "HARADIO"

Traffic Fun

(Continued from page 51)

to learning the highest operating technique. Every amateur can help extend the collective ability, the prestige of the fraternity and our *raison d'être* by a more general handling of messages using both c.w. and voice making use of all frequency bands! Beyond this lies a widening field of traffic-training opportunity. There are numbers of cantonments and camps and training schools and more to be established! The boys away from home require personal contact with home to help them maintain high morale. Every amateur and appointee near these groups is requested to constitute himself a point for friendly contact and traffic origination.

— F. E. H.

Push-Pull 809's

(Continued from page 35)

for 750 and 100 volts, 250 ma., if both 'phone and c.w. operation at maximum rated input is contemplated. A fixed biasing voltage of 20 to 25 volts will be required to cut off plate current at 1000 volts and this bias is assumed in determining the recommended value of resistance for the grid leak.

Plate voltage should not be applied to the amplifier until the oscillator has been tuned and the amplifier neutralized. An active crystal will oscillate with C_2 set at any position. Off resonance, the oscillator plate current should run in the neighborhood of 100 ma. Two dips in plate current will be found over the range of the condenser. The one near maximum capacity indicates resonance at the crystal fundamental and the one near minimum capacity indicates the second harmonic of the crystal frequency. At minimum dip the plate current should run between 80 and 90 ma. By switching the meter to the second position, it will be found that readings of grid current are obtained at each of these resonance points.

With C_2 adjusted for maximum grid current at the fundamental, the amplifier should be neutralized by adjusting both neutralizing condensers in small steps, keeping their capacities equal at all times. A check on the neutralizing adjustment may be made by any of the usual methods, such as test with a neon bulb touched to one end of the plate tank coil, which should not glow at any point in the range of the amplifier tank condenser, except possibly at minimum capacity. Another test is that of observing the grid-current reading. When the amplifier is completely neutralized, swinging the amplifier tank condenser through its range should cause no change in grid current. When not neutralized, the grid current will show a sharp dip when the plate tank condenser is tuned through resonance.

Plate voltage may now be applied to the amplifier and the plate circuit tuned to resonance. It is advisable to make preliminary adjustments at reduced plate voltage. Voltage

The beaten path still leads to . . .

FIVE YEARS' LEADERSHIP IS YOUR BEST GUARANTEE OF QUALITY

United Rectifiers long ago met the highest rating and life claims that are made today. The following points hold these famous tubes in an exclusive class:

- **TWO TYPES TO CHOOSE FROM**—Unshielded and shielded—each has specific advantages
- **GREAT SAVING IN TIME DELAY**—10 seconds initial or routine—this quality of the 966 places it in a class by itself
- **FULLY SHIELDED CONSTRUCTION**—For certain applications where shielding is important, type 966-A is the *uncompromised solution*
- **NO EXCESS MERCURY**—966 and 966-A have measured mercury content, preventing harmful amalgams and costly time delay
- **LONG AND SATISFACTORY LIFE**—is not merely predicted, it is a matter of history.

UNITED RECTIFIERS



TYPE 966A

PRICE \$**1.50**



TYPE 966

PRICE \$**1.20**

Ratings	Both Types
Filament volts	2.5
Filament amps.	5.0
Peak inverse voltage.....	10,000
Peak plate current.....	1.0 ampere
Average plate current	.25 ampere

UNITED ELECTRONICS COMPANY

42 SPRING STREET



NEWARK, NEW JERSEY

LEARN CODE

the way you'll be using it
by SOUND



The best way to learn to read code is by listening to code. The best way to learn to send code is by hearing your own sending repeated back to you. With the new All-Electric Master Teleplex Code Teaching Machine, you learn code the natural, easy, fascinating way.

Only instrument ever produced which records your sending in visible dots and dashes — then SENDS BACK your own key work at any speed you desire. That's why practically every school teaching code uses TELEPLEX. We furnish complete course, lend you All-Electric Master Teleplex, give you personal instruction with a MONEY BACK GUARANTEE — all at a surprisingly low cost per month. Write today for FREE catalog Q. 3. No obligation.

“HAM”
SPECIAL

Standard Teleplex — a highly efficient code teacher using heavy specially prepared waxed paper tape, having two rows of perforations. Write for Free folder “Q.T.3.”

TELEPLEX CO., 67-69 Park Place, New York

In Canada, Write

Canadian Electronic Institute, Toronto, Ontario

RADIO

ENGINEERING, broadcasting, aviation and radio telegraphy and telephony, Morse telegraphy and railway accounting taught thoroughly. 48 weeks' engineering course, equivalent to three years of college radio work. School established 1874. All expenses low. Catalog free.

DODGE'S INSTITUTE, Day Street, Valparaiso, Indiana

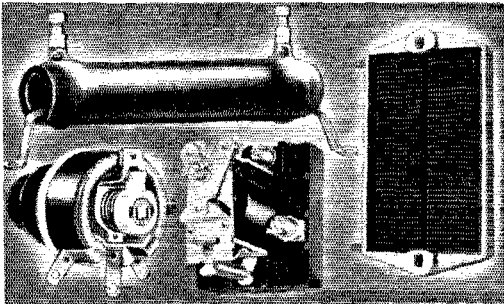

Relays • Resistors • Rheostats

The oldest and most complete line on the market for service and amateur use. Proven dependability and conservative ratings. You are not experimenting when you install Ward Leonard items . . . you know they are right.

WARD LEONARD ELECTRIC COMPANY

41 South Street, Mount Vernon, N. Y.

Please send me Circular 507 covering Relays, Resistors and Rheostats.

Name

Street

City and State

Call Signal

may readily be reduced by connecting a 150- or 200-watt lamp in series with the primary winding of the plate transformer. Minimum amplifier plate current (with the meter in the third position) as the plate tank circuit is tuned will indicate resonance. The value of plate current at the minimum will depend somewhat upon the setting of the antenna tank condenser but, by keeping the antenna circuit tuned well away from resonance, a reading of less than 50 ma. should be obtained.

Tests should now be made to make certain that the oscillator will key satisfactorily. If the crystal does not pick up readily, a slight re-tuning of C_2 should remedy the trouble.

Tuning the transmitter for 80-meter output is now a simple matter of tuning the oscillator to the resonance dip near the minimum of C_2 , placing the short-circuiting clips on L_3 and tuning C_3 for resonance. The shift from one band to another should take but a few seconds.

The adjustment of the antenna tank circuit will depend upon the type of antenna which is to be used and the length of the feeders. If parallel tuning is required, the free stator of the condenser C_{14} will be clipped to the free end of the coil and the feeders connected one to each of the condenser stators. If series tuning is required, the two stators are clipped together and one feeder clipped to the rotor and one to the stator as indicated in Fig. 1. Changes in inductance, as required, may be made by moving the Johnson screw clips. Once their positions have been determined, they are clamped in place and the short-circuiting connections made by means of the spring clips.

The amplifier may be loaded up until the total plate current reaches 200 ma. for either 'phone or c.w. operation. Plate voltage should be limited to 750 for the former type of operation. When loaded to rated plate current, the grid current should not fall below 60 ma. If the plate of one amplifier tube shows color, while the other remains cool, it is an indication that the excitation is unbalanced which would call for an adjustment of C_{15} . If the plate of the tube whose grid is connected to the same end of L_2 as the plate of the 6L6 shows color, the capacity of C_{15} should be increased, while color in the other amplifier tube would require a reduction in capacity. In any case, the value will not be critical within 10 or 20 $\mu\text{mfd.}$ and the value of C_{15} specified should be satisfactory in most cases.

The 60-ma. dial lamp shown in the photograph of the bottom of the chassis is connected between the crystal and the cathode of the 6L6 and may be used as a fuse against excessively-high crystal current under extraordinary circumstances. Ordinarily, however, crystal current will not be excessive under any adjustment.

Power output at 750 volts should run 100 watts or better, while 150 watts or more will be normal for c.w. operation at 1000 volts.



THIS IS A PHOTO OF HALLICRAFTER SETS IN STOCK AT W9ARA

Write me about type of receiver you want. I will help you get the right receiver and will cooperate with you to see that you are 100% satisfied. Ask for technical information about any receivers.

YOU get ten days free trial — you don't buy unless you are satisfied.

YOU buy on 6% terms financed by myself with less cost — more convenience — quicker delivery. Transaction is entirely between us. Write me for terms.

YOU get big trade-in for your receiver — describe it and I will tell you its value — you can pay the balance on my 6% terms. Don't trade until you get my offer.

YOU get prompt shipment from the world's most complete stock of amateur receivers. Or shipment from the factory if you wish.

I have a complete stock of all receivers, transmitters, kits, antennas, tubes, parts. Send to me for any equipment. I guarantee you can't buy for less or on better terms elsewhere. Your inquiries and orders invited.

Bob Henry
W9ARA

HENRY RADIO SHOP

BUTLER, MISSOURI

NEW AT TERMINAL FM RECEPTOR by MEISSNER

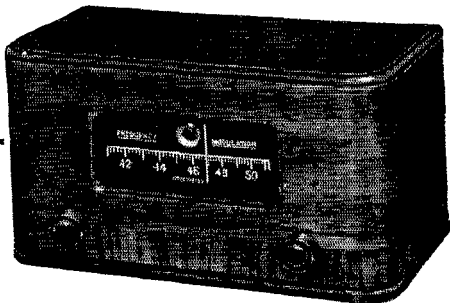

New developments of interest to radio amateurs get our immediate attention! If it's a radio product, **TERMINAL** has it! If it's new — head for **TERMINAL** . . . 2 stores, both easy to reach in New York City.

★ ★ ★ ★

The new **MEISSNER** F-M receptor is a complete, self-powered 8-tube converter, designed to add staticless F-M reception to any regular receiver. This perfectly engineered unit feeds directly into the input of the audio system.

Power output and tone quality are excellent, and are limited only by the capabilities of the audio equipment in the regular receiver! The RF stage provides maximum reception range and noise rejection. Comes complete in an attractive walnut cabinet, 13" wide, 7" high and 6 $\frac{3}{4}$ " deep. Also available without cabinet, if desired.

Features of This Unit Include:

- ★ Easy to install. Just connect to the Phono or Television terminal of the existing receiver.
- ★ Superhet circuit.
- ★ Only 2 knobs for control and tuning.
- ★ Tuning eye which guarantees perfect tuning.
- ★ 3-gang ceramic condenser.
- ★ Molded bakelite RF coil form.
- ★ Doublet or ordinary antenna connection.
- ★ AC-DC operation.

List price, complete with cabinet, \$39.95, Net \$23.49
List price, less cabinet, \$34.50, Net \$20.49

TERMINAL Radio Corp.

68 West 45th St. • 80 Cortlandt St.
2 stores in NEW YORK CITY
Yanderbilt 6-5050 • Cable: TERMRADIO

(Continued from page 58)

R.F.D. 1, North Vernon, Ind.

Editor, *QST*:

On page 58 of the January 1941 number of *QST* there appeared a letter written by W8DK titled "Sweepstakes." W8DK says in part: "This useless QRM (O.P.S. and S.S. parties) defeats our very purpose, and the justification of the bands we occupy." "They (these parties) serve absolutely no useful purpose, and clutter up those bands which are the avenues of communication."

My line of reasoning forces me to concur with these statements in several ways. The QRM caused by these parties does make the successful handling of important messages next to impossible. Moreover, it is extremely difficult for the free-lance message handler to contact any stations other than those working O.P.S. or S.S. . . .

Unfortunately, this "useless QRM" is not confined to any one place in each band, as it should be. I say concentrate the QRM from these parties so there will be more of it, and so there will be room left for amateur services and "rag-chewing" for those who are not interested "in the exchange of a few meaningless numbers and scores."

And why should there be more QRM? Communication receivers have come a long way in the past ten years or so in effectively reducing QRM, but the designing of super-selective receivers should not now remain at a standstill. We need much more selective receivers than the most selective ones now available. The S.S. and O.P.S. parties, as they are now conducted, do not necessitate this further development to any noticeable extent. It is paradoxically true that too much room is allowed in the parties for the boys to roam, especially since the "e.c.o." has made the dodging of QRM much easier than it was before the "grasshopper" came into its own. *Cui bono* — for whose good are these parties? The fun of competition is of relatively small importance. Why should we not now make our goal a receiver that will, for example, make an S3 signal perfectly readable when it is sandwiched in on one side by an S8 signal twenty cycles away, and on the other side by an S9 signal ten cycles removed? Then we will be getting somewhere with these parties, or, I should say, on account of them.

Let the parties be confined, for example, to narrow slices on each extremity of the various bands. Besides increasing the QRM with the resultant increase of interest in designing much more selective receivers, and leaving some space on the bands for non-contestants, this proposed new way of conducting the parties will make more of the contestants frequency-minded, and more of them will go in for frequency meters and measuring devices, which is conspicuously lacking in too many amateur stations. Have the band limits continuously monitored during the parties, and continue to disqualify all those who get out of the band. Perhaps this might encourage some of the receiver manufacturers to factory-install some kind of frequency standard in their receivers, so that the limits of the amateur bands may be definitely established.

— Jos. A. Terstegege, W9LQE

28-MC. W.A.S. PARTY — MARCH 7TH, 8TH, 9TH

Don't Miss It! All Amateurs Invited!

Five points a contact. Add .50 points fixed credit for code proficiency evidence. Multiply total points by the number of states worked. Operate any 20 hours between 5 p.m. CST, Friday, March 7th, and 2.01 a.m. CST, March 10th.

Follow the detailed announcement, page 19, February 1941 *QST*. We hope 10-meter conditions will stay favorable. In any event it will show which 28-Mc. stations can do the best work under prevailing conditions which will be the same for everybody. It ought to be a lot of fun. Get the 10-meter rig ready. Don't miss it! Report results to A.R.R.L. for *QST* mention.

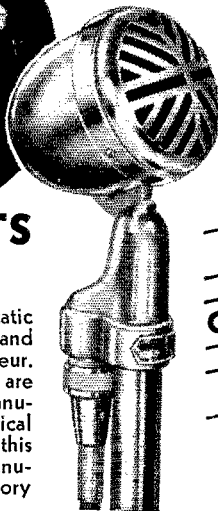

AMATEURS

PUBLIC ADDRESS

BROADCAST

RECORDING

COMMUNICATION

EDUCATION

COMPLETE
ASTATIC CATALOGS
ARE AVAILABLE
ON REQUEST

ASTATIC CRYSTAL PRODUCTS

Go Into Every Field of Service

● The efficiency, practicability and economy of Astatic Crystal Microphones, Pickups, Recording Heads and Cartridges, is known to practically every veteran amateur. And for the same reasons, Astatic Crystal Products are used exclusively by many of America's foremost manufacturers of radio, recording, public address and electrical phonograph equipment. Astatic Products have earned this right to leadership by careful engineering, efficient manufacture, rigid laboratory control and highly satisfactory performance.



ASTATIC CRYSTAL PRODUCTS LICENSED UNDER
BRUSH DEVELOPMENT CO. PATENTS

ASTATIC MICROPHONE

IN CANADA: CANADIAN
ASTATIC Ltd., TORONTO, ONT.

YOUNGSTOWN
OHIO

Laboratory Inc.

SICKLES COILS

ALL TYPES OF RF AND IF WINDINGS

Manufactured by

F. W. SICKLES COMPANY

300 Main Street

Springfield, Mass.

RADIO OPERATING QUESTIONS AND ANSWERS

Hilson & Hornung's new edition covers all FCC commercial license exam elements. Standard handbook 20 years. \$2.50, postpaid. Money back if not satisfied and book returned in 10 days. Send check or money order . . . not cash. Free circular on request.

HILSON RADIO SCHOOL, 51 East 42nd St., New York

JACOBS ADJUSTABLE SEPARATOR
U. S. patent No. 1,950,170 - March 5, 1934 - others pending



Made of translucent plastic, this Improved Separator provides efficient and split-second adjustment of open 2-wire R. F. feedlines of any spacing from 2" up to 36". Used in conjunction with Hertz, Zepp and Beam antennas; also vertical radiators. Weigh less; no tie wires; unbreakable. Price: \$1.50 for a set of 2.

270 Lafayette St.

New York, N. Y.

EASY TO LEARN CODE

It is easy and pleasant to learn the modern way — with an Instructograph Code Teacher. Ideal for the beginner or advanced student. ■ Many tapes available ranging from alphabet for beginners to typical messages on all subjects. Speed range 5 to 40 WPM. ■ Always ready, no QRM, beats having someone send to you.

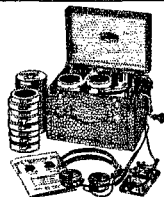

FOR SALE OR RENT
STANDARD with 10 tapes and book of instructions, A.C. motor \$24.50
With spring-wound motor \$18.50
JUNIOR with 5 tapes and book of instructions (not rented) \$12.00
RENTAL Standard with 10 tapes and book of instructions \$3.00 first month, \$2.25 each additional month. References or \$10 deposit required. All rental payments may be applied on the purchase price should you decide to buy the equipment.

Write for details today

INSTRUCTOGRAPH COMPANY

Dept. Q, 4701 Sheridan Road, Chicago, Illinois

Representative for Canada:

Radio College of Canada, 54 Bloor St. West, Toronto

RADIO COURSES

Mid-Term Classes Now Starting

RADIO OPERATING ● BROADCASTING ● CODE
RADIO SERVICING ● TELEVISION

● ELECTRONICS — 1 year day course; 2 years eve.
Day and Evening Classes — Booklet upon request

NEW YORK YMCA SCHOOLS

4 West 63rd Street, New York City

GENERAL COMMUNICATIONS CRYSTALS HOLDERS AND OVENS

Precision Made by *Bliley*

WRITE FOR CATALOG G-11

BLILEY ELECTRIC CO., ERIE, PA.

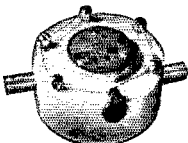
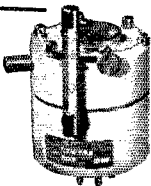

WHY NOT START NOW!

Waiting and wishing will never prepare you for a promising career in the Army, Navy or Commercial communications field. Find out today how you can easily learn RADIO CODE with the Candler System without leaving your own home. Expert radio operators are in demand. The Communications Reserve of the U. S. Navy is enlisting 5400 radio operators. The Candler System is a SPECIALIZED TRAINING backed by over a quarter century of success. Candler was the system selected by the U. S. Naval Reserve in the ninth district for training radio operators.

GET ALL THE FACTS!



Write today for the New Candler Book of Facts. It's FREE! It tells you the whole interesting story on how you can build a career. Send for it today. A postal will do, and there's no obligation.

CANDLER SYSTEM CO.

Dept. Q-3

ASHEVILLE, N. C., U.S.A.

Piezo-Electric Crystals Exclusively

● Quality crystals of all practical frequencies supplied SINCE 1925. Prices quoted upon receipt of your specifications.

Our Pledge: **QUALITY FIRST**
SCIENTIFIC RADIO SERVICE

"The Crystal Specialists Since 1925" University Park, Hyattsville, Md.

FULFILL YOUR AMBITION IN RADIO



Train yourself at home for that technical radio job or promotion you want. Study under personal direction of A. R. Nilson — for twenty years expert author-instructor. Three up-to-the-minute, low-cost, home-study technical radio courses:

1. *Essentials of Radio Communication*
2. *Advanced Radiotelegraphy*
3. *Broadcast Operating*

will help you succeed in your job or on license examinations. FREE BOOKLET "What the Modern Radioman Must Know" describes these courses in detail. Send for your copy now!

NILSON RADIO SCHOOL
51 East 42nd St., New York, N. Y.



A.A.R.S.

(Continued from page 53)

ARMY TO CANVASS AMATEUR RADIO STATIONS

THE War Department is arranging to send a questionnaire to every licensed amateur radio operator in the United States in the near future in order to obtain certain information for national defense purposes. The accomplishing of this questionnaire by the individual radio amateur does not obligate him in any manner nor does it constitute a form of registration. The data to be obtained are purely for statistical purposes in connection with the national defense activities of the Army. Further information about this questionnaire will appear in the press and in an early issue of *QST*. It is expected that Army Amateurs will assist in the distribution of these questionnaires by aiding in the addressing of the envelopes for mailing them to all amateur stations in their respective corps area. Further details will be announced by corps area signal officers.

I.A.R.U. News

(Continued from page 54)

"Review Militar" of Argentina calls for greater cooperation between the radio amateur body and the military people. He urges that special courses of military training, as well as amateur communications activities, be sponsored by the authorities. Speaking from a standpoint of national defense, he lauds the recent action of the government in restricting the issuance of amateur licenses to citizens only.

Texas Ice Storm

(Continued from page 49)

ports that the plate supply at W5ECL was a flock of "B" batteries, "and Tommie sure burned up the mills from them!" The grand total of traffic at W5ECL was 600 messages.

W5IAN and W5FTI also operated on 160. W5FTI, aided by W5HLG, set up in the telephone company building and strung an antenna from the top of the Santa Fe building — Amarillo's highest! W5IAN was operated at h.c. station KFDA by staff members, including W5IQD and W5HZZ. Considerable press was handled for International News Service. In addition to the ham work, they worked duplex over KFDA with KPDN after midnight with special F.C.C. permission.

W5DXA carried a portable outfit from Childress to Amarillo on Monday afternoon but power was on downtown then and four stations were operating. Instead he helped W5QE, W5ITQ and others.

W5DVQ took portable W5BAY:5 — two transmitters, two receivers and a 750-watt gas generator — in a panel delivery truck north of Amarillo to Dumas. This sparsely settled region was in desolate isolation, and he did a magnificent job, resulting in speeding up restoration of power.

It was W5HWA who put out the first QRR from this region on Saturday -- with 2 watts on 160 c.w.! After W5DVQ's arrival his 150-watt

Where to buy it

A directory of suppliers who carry in stock the products of these dependable manufacturers.

**THE NEW 1941
SUPER
Skyriders**

**TRIPLET
INSTRUMENTS**

ALBANY, N. Y. Uncle Dave's Radio Shack 356 Broadway
ATLANTA, GEORGIA 265 Peachtree Street
 Radio Wire Television Inc.
BOSTON, MASS. Radio Shack 167 Washington Street
BOSTON, MASS. 110 Federal Street
 Radio Wire Television Inc.
BRIDGEPORT, CONN. 177 Cannon Street
 Hatry & Young, Inc.
BRONX, N. Y. 542 East Fordham Rd.
 Radio Wire Television Inc.
BUTLER, MISSOURI 211-215 N. Main Street
 Henry Radio Shop
CHICAGO, ILL. 833 W. Jackson Blvd.
 Allied Radio Corp.
CHICAGO, ILL. 901-911 W. Jackson Blvd.
 Radio Wire Television Inc.
CINCINNATI, OHIO 1103 Vine Street
 United Radio, Inc.
DETROIT, MICH. 325 E. Jefferson Ave.
 Radio Specialties Co.
DETROIT, MICHIGAN 11800 Woodward Ave.
 Radio Specialties Co.
HARTFORD, CONNECTICUT 227 Asylum Street
 Radio Inspection Service Company
HOUSTON, TEXAS 1021 Caroline Street
 R. C. & L. F. Hall
INDIANAPOLIS, INDIANA 34 West Ohio Street
 Van Sickle Radio Supply Co.
JAMAICA, L. I. 90-08 166th Street
 Radio Wire Television Inc.
KANSAS CITY, MO. 1012 McGee Street
 Burstein-Applebee Company
NEW HAVEN, CONN. 1172 Chapel Street
 Hatry & Young, Inc.
NEW YORK, N. Y. Harrison Radio Co. 12 West Broadway
NEW YORK, N. Y. 100 Sixth Ave.
 Radio Wire Television Inc.
NEWARK, N. J. 24 Central Ave.
 Radio Wire Television Inc.
READING, PENN. 404 Walnut Street
 George D. Barbey Company
SCRANTON, PENN. 519-21 Mulberry Street
 Scranton Radio & Television Supply Co.
WASHINGTON, D. C. 938 F Street, N. W.
 Sun Radio & Service Supply Co.

ALBANY, N. Y. Uncle Dave's Radio Shack 356 Broadway
ATLANTA, GEORGIA 265 Peachtree Street
 Radio Wire Television Inc.
BOSTON, MASS. Radio Shack 167 Washington Street
BOSTON, MASS. 110 Federal Street
 Radio Wire Television Inc.
BRIDGEPORT, CONN. 177 Cannon Street
 Hatry & Young, Inc.
BRONX, N. Y. 542 East Fordham Rd.
 Radio Wire Television Inc.
BUTLER, MISSOURI 211-215 N. Main Street
 Henry Radio Shop
CHICAGO, ILLINOIS 833 W. Jackson Blvd.
 Allied Radio Corp.
CHICAGO, ILL. 901-911 W. Jackson Blvd.
 Radio Wire Television Inc.
CINCINNATI, OHIO 1103 Vine Street
 United Radio, Inc.
HARTFORD, CONN. 203 Ann Street
 Hatry & Young, Inc.
JAMAICA, L. I. 90-08 166th Street
 Radio Wire Television Inc.
LITTLE ROCK, ARKANSAS 409 W. 3rd St.
 Beem Radio Company
MINNEAPOLIS, MINNESOTA 1124-26 Harmon Place
 Lew Bonn Company
NEW HAVEN, CONN. 1172 Chapel Street
 Hatry & Young, Inc.
NEW YORK, N. Y. 100 Sixth Avenue
 Radio Wire Television Inc.
NEWARK, N. J. 24 Central Ave.
 Radio Wire Television Inc.
READING, PENN. 404 Walnut Street
 George D. Barbey Company
SCRANTON, PENN. 519-21 Mulberry Street
 Scranton Radio & Television Supply Co.
WASHINGTON, D. C. 938 F Street, N. W.
 Sun Radio & Service Supply Co.

Listings on this page do not necessarily imply endorsement by QST of the dealers or of other equipment sold by them.

**NEW 1941 PATENTED
JEWEL MOVEMENT**

DE LUXE GENUINE

VIBROPLEX

World's Finest Semi-Automatic Key

Send for
FREE
Catalog



The smartest looking, smoothest action, easiest to operate "Bug" Vibroplex has ever produced. Has Patented Jewel Movement found only in De Luxe Vibroplex Keys. Precision construction including DIE CUT contact and main spring. Highly polished chromium base and machine parts, colorful red switch knob, finger and thumb pieces and green silk cord and wedge. Large contacts. An outstanding key in smartness, signal quality, speed and ease of operation, users say. Vibroplex keys give quality performance — insist on Vibroplex. Three De Luxe Vibroplexes — Lightning Bug, Original and Blue Racer. The finest semi-automatic keys money can buy. Each is equipped with Patented Jewel Movement. Place your order NOW! Money order or registered mail. Write for catalog of Vibroplex keys priced from \$9.95 to \$19.50.

THE VIBROPLEX CO., Inc.
832 Broadway New York, N. Y.

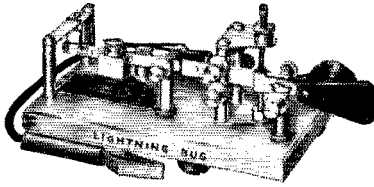

MATHEMATICS FOR RADIO AND COMMUNICATION

by **GEORGE F. MAEDEL, A.B., E.E.**
Chief Instructor, N. Y. School, RCA Institutes

To master the technicalities of radio — to read engineering literature intelligently — you must have the mathematical groundwork covered by these absorbing books prepared for home study. Book I (314 pp.) covers the algebra, arithmetic, and geometry; Book II (329 pp.) covers the advanced algebra, trigonometry, and complex numbers; necessary to read technical books and articles on radio.

MAEDEL PUBLISHING HOUSE Room 101
593 East 38 Street, Brooklyn, New York

Send me Mathematics for Radio and Communication as checked below. I enclose payment therefor with the understanding that I may return the book(s) within 5 days in good condition and my money will be refunded.

Name.....

Address.....

- Book I at \$3.75 plus 3c postage
 Book II at \$4.00 plus 3c postage
 Books I and II at \$7.75 postage prepaid

amplifier was hooked onto the W5BAY/1 portable.

Within the emergency zone practically all work was on 'phone, although much of the traffic was transferred to c.w. on the second relay. W5IMG worked cross-band with W5CXE from 40 to 75 and handled useful traffic. W5BKH took 80-meter traffic from a net including W5NW, W5DXA, W5GPV and W9AWP and fed it to W5DVQ for relay in and out of Amarillo. Some traffic from W5ECL was cleared through A.A.R.S. channels. Some of the 'phone stations resorted to c.w. when signals were too weak for voice.

These Amarillo amateurs also have been credited with activity during the emergency, although details of their performance are not known: W5BGT, W5BTW, W5ENK, W5EYX, W5GEE, W5GIB, W5GJG, W5GZZ, W5HZA, W5ICR, W5IEP and W5IWK.

Dozens of other stations aided splendidly in the relief work. Each of them merits detailed recognition, but space does not permit. Among them were: W5APW, W5AUJ, W5BAT (assisted by W5EGC), W5BKH (assisted by W5AUL and W5BNS), W5CDU, W5CKG, W5DAS, W5DFP, W5ECU, W5FAB, W5FDQ, W5FWZ, W5HDG, W5HQV, W5HXI, W5HXK and W5QA.

The following outside stations are credited with an "assist" for aiding in the emergency work: W1BPZ, W1FH, W2TP, W3FOJ, W4AZT, W4ERX, W4FT, W4PU, W5AFX, W5CEW, W5DUF, W5EGC, W5HXU, W5ZM, W8CDR, W8LRJ, W8MDU, W8PUF, W9BQO, W9EFC and W9PYS.

Local Boy Makes Noise

(Continued from page 47)

inserted caused such an increase in the interference level that it was almost fantastic.

Shielding the bottom of a chassis doesn't always work. In Case No. 2 I tried it to eliminate the last vestige of my signal, but it brought me back to S9 all over the dial. This may have been due to the fact that this particular b.c.l. used no antenna or ground, but connected the antenna post of the receiver to a stove which stood on a wooden floor. With a good ground the shield might have been effective. It is necessary to take into consideration the type of antenna and ground system in use by the b.c.l. Maybe he thinks he has a good ground but hasn't.

If you have the b.c.l. disconnect his antenna to determine whether your interfering signal is riding in through the antenna or not, be sure the antenna is disconnected right at the set and not at a window lead-in, which might leave five feet of wire still on the receiver for pickup.

When a beam antenna is in use at the transmitter, turn it right on the b.c.l. set when making tests. This makes a big difference in the field strength at the receiver, and you aren't kidding anybody by turning your beam around just to make the b.c.l. say his set is fixed.

(Continued on page 106)

BUY ON EASY TERMS · MAIL ORDERS PROMPTLY FILLED · WRITE FOR FREE CATALOG

2½ Meters

MRT-3



DK-2

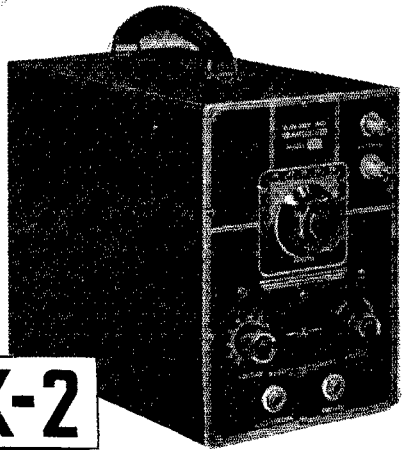

This Abbott 2½ meter Radio Telephone is a complete, self-contained transmitter and receiver. It is either transmitter or receiver simply by turning the "send-receive" switch. Compact carrying case, large enough to hold all batteries. Range — 2 to 30 miles. Frequency — 112 to 118 mc. Net price DK-2 transceiver **\$16.17**: tube kit **\$1.87**: Burgess battery kit **\$4.88**: Universal hand set **\$5.88**.

A fitting big brother to the DK-2 is the MRT-3 high power 2½ meter transceiver. This unit is purposely designed for mobile operation, having 6 to 7 times the power of ordinary transceivers, and as a consequence a better range is obtained. Easily installed in your car, self-contained permanent magnet dynamic speaker, makes phones unnecessary. Jacks are provided for microphone and they also can be used to measure oscillator and modulator current. Band coverage 112 to 116 mc. Size of case 9" x 8" x 4". MRT-3 transceiver **\$27.64**: kit of tubes; one HY75, one 6C5, and one 6C6 — **\$4.60**: AC power supply for home use **\$12.50**.

CONFIDENCE IN YOUR SUPPLIER

We refer you to the index page of *QST* for the message of your magazine about the companies asking for your patronage. We can think of no better expression of confidence.

*Immediate Delivery
on Communications Receivers*

**NATIONAL · HALLICRAFTERS
HAMMARLUND · RME**

	Down Payment	Monthly Payments	
Hallicrafter SX-28	\$15.95	\$12.68	12 months
Hallicrafter SX-25	9.95	7.91	12 months
Hallicrafter SX-24 with speaker	8.15	6.48	12 months
Hallicrafter SX-24 less speaker	6.95	8.29	8 months
Hallicrafter S-20R	4.95	5.90	8 months
Hallicrafter S-19R	4.43	4.43	6 months
Hammarlund HO-120-X	13.80	10.97	12 months
National NC-44, with speaker	4.95	5.90	8 months
National NC-200	14.75	11.72	12 months
RME-99, complete	13.74	10.92	12 months

The **RADIO SHACK**
167 WASHINGTON ST., BOSTON, MASS., U.S.A.

BE PREPARED— LEARN THE WIRELESS CODE

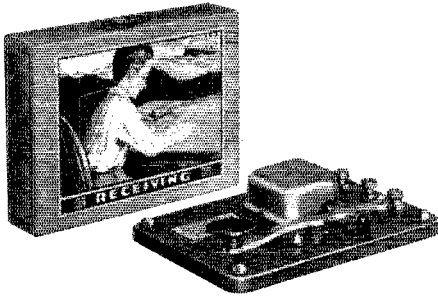

Make your spare moments count now! Learn the code with a SIGNAL Wireless Practice Set. Set consists of key lever, non-adjustable buzzer and code plate mounted on a metal base equipped with binding posts and rubber feet. List price \$1.75. If your jobber can not supply you, order direct.

SIGNAL ELECTRIC MFG. CO.
MENOMINEE, MICHIGAN

Established
1892

SIGNAL

RUBIES by HIPOWER

Hipower Rubies are super active, precision cut, low drift crystals, cut from the finest Brazilian quartz. They are without doubt one of the finest amateur crystal units available. With a guaranteed drift of less than 4 CY. per °C per MC. They are available with holder to all amateurs at "X" cut prices. 160-80-40 meter crystals...\$4.50 Special 20 meter crystal...\$7.25



The Hipower Crystal Company, one of America's oldest and largest manufacturers of precision crystal units, is able to offer the amateur and manufacturer attractive prices because of their large production and the exclusive Hipower grinding process. Numbered among Hipower's customers are:

U. S. Army and U. S. Navy
National Broadcasting Co.
Columbia Broadcasting System
Mutual Broadcasting System
United States Airlines

Such satisfied customers provide assurance that whatever the need may be, Hipower can supply it.

AVAILABLE AT YOUR PARTS DISTRIBUTOR
Manufacturers Write for Prices

HIPOWER CRYSTAL COMPANY

Sales Division—205 W. Wacker Drive, Chicago, Ill.
Factory—2035 Charleston Street, Chicago, Ill.

You'll probably run into cases where the b.c.l. claims you're \$9 all over the place, but on testing the receiver at your station, you find no sign of interference. This situation is good for a fight anytime, but it's best not to take advantage of it. Try to find a pickup point in the set even though you have to tap it onto the plate of your 204-A to make it pick up. Then apply the remedy according to whatever point it is. If you can't find a pickup point, even at the detector grid, apply the cure that is usual in a receiver of whatever type it happens to be.

Now a word about the b.c. performance of the sets you doctor. It might be well to listen carefully to the set before sneaking it under your coat and truckin' on out with it. And when you take it home, before you do any testing, hook it up and listen to it work on the b.c. band. This way you'll know whether your ministrations have affected its operation one way or the other, when you're through. If you're at home on the inside of a b.c. receiver, it won't hurt you any to ding it up a little bit, gratis. Maybe the r.f. could stand a little lining up. Take the tubes down to the service shop and have them tested. Older sets that have their r.f. ground connections made to soldering lugs riveted to the chassis sometimes show a surprising improvement in performance when these lugs are connected to a ground soldered to the chassis. As the metal ages, a film of oxide forms between the lug and the chassis which offers an extremely high resistance to a signal. Test the antenna primary coil for continuity. Maybe a shot of lightning opened it and the b.c.l. thinks your transmitter is causing all his signals to be weak. Go easy on the adjusting screws in superhets if you haven't got the proper equipment to line them up.

I don't mean that you should give a free service job to every case of b.c.l. interference. But you'll find that a lot of the sets you're interfering with are just barely performing in the b.c. band, and it will boost your stock no end if the receiver works better when you bring it back. Especially since most folks think letting you work on their precious squawkbox is equivalent to kissing it good-bye.

In conclusion let me admonish you again not to be frightened into inactivity by the apparently tremendous number of sets your transmitter is interfering with. Publicly announced tests will prove the actual number to be far less. The F.C.C. takes a swell attitude, and their reply to Mr. Soandso was a godsend to me. But it's an awful lot of work making out the report they require of you.

Better clean it up before it gets that far.

AMATEUR RADIO LICENSES

Day and Evening Classes in Code and Theory
HOME STUDY COURSES

Reasonable, Efficient and Thorough, Hundreds of
Licensed Students Now on the Air

American Radio Institute, 1123 Broadway, New York, N. Y.

HAM-ADS

(1) Advertising shall pertain to radio and shall be of nature of interest to radio amateurs or experimenters in their pursuit of the art.

(2) No display of any character will be accepted, nor can any special typographical arrangement, such as all or part capital letters be used which would tend to make one advertisement stand out from the others.

(3) The Ham-Ad rate is 15¢ per word, except as noted in paragraph (6) below.

(4) Remittance in full must accompany copy. No cash or contract discount or agency commission will be allowed.

(5) Closing date for Ham-ads is the 25th of the second month preceding publication date.

(6) A special rate of 7¢ per word will apply to advertising which, in our judgment, is obviously non-commercial in nature and is placed and signed by a member of the American Radio Relay League. Thus, advertising of bona fide surplus equipment owned, used and for sale by an individual or apparatus offered for exchange or advertising inquiring for special equipment, if by a member of the American Radio Relay League takes the 7¢ rate. An attempt to deal in apparatus in quantity for profit, even if by an individual, is commercial and all advertising by him takes the 15¢ rate. Provisions of paragraphs (1), (2), (4) and (5) apply to all advertising in this column regardless of which rate may apply.

Having made no investigation of the advertisers in the classified columns, the publishers of *QST* are unable to vouch for their integrity or for the grade or character of the products advertised

QUARTZ — direct importers from Brazil of best quality pure quartz suitable for making piezo-electric crystals. Diamond Drill Carbon Co., 719 World Bldg., New York City.

QSL'S, Maps, Cartoons, Free samples. Theodore Porcher, 7708 Navajo, Philadelphia, Pa.

USED receivers, Bargains, Cash only. No trades. Price list 3¢. W3DQ, Wilmington, Del.

CALLBOOKS — Winter edition now on sale containing complete up-to-date list of radio hams throughout entire world. Also world prefix map, and new time conversion chart. Single copies \$1.25. Canada and foreign \$1.35. Radio Amateur Call Book, 610 S. Dearborn, Chicago.

CRYSTALS, mounted, 80-160 medium drift \$1.25, 40-150; low drift 40-80-160, \$2.25. No Y's. R9 Crystals, 338 Murray Ave., Arnold, Pa.

MAC Auto code machines, low monthly rental, 50,000 words practice tapes. For those who own MacAutos, tapes for Maes, recording ink and blank tapes for sale. Write C. M. Ayers, 711 Boylston St., Boston, Mass. Tel. GRAnite 7189-W.

COMMERCIAL radio operators examination questions and answers. One dollar per element. G. C. Waller, W5ATV, 6540 Washington Blvd., Tulsa, Okla.

CRYSTALS: police, marine, aircraft. C-W Mfg. Co., 1170 Esperanza, Los Angeles.

QSL'S, all colors, cartoons, snappy service. Write for free samples today. W1BEF, 78 Warrenton, Springfield, Mass.

CRYSTALS: famous P.R., mounted in latest Alsimag 35 holders — 40, 80 meter PR-X, 160 meter PR-Z, \$3; 40, 80 meter PR-Z (low drift), \$3.50; 20-meter PR-20, \$4.50; unconditionally guaranteed. Immediate shipment. Quality blanks, 65¢. Wholesale Radio Labs., Council Bluffs, Iowa, W9GFQ.

TELEFLEXES, Instructographs bought, sold. Ryan's, Hannibal, Mo.

QSL'S — Brownie, W3CJL, 1725 Frankenhof Ave., Allentown, Pa.

TRANSMITTER, power supply — 61.6, 803, pair 852s, 700 watts CW. Coils for 40-20. Sacrifice at \$80. Detailed data and photos upon request. K. P. MacDowell, 2221 Lotus, Ft. Worth, Texas.

CRYSTALS in plug-in heat dissipating holders. Guaranteed good oscillators. 160-M 80M AT \$1.25; 40X \$1.65. 80M vari-frequency (5 kilocycle variance) complete \$2.95. State frequency desired, C.O.D.'s accepted. Pacific Crystals, 1042 S. Hicks, Los Angeles.

LEO, W9GFQ, offers the hams more and a better deal always. Lowest terms, no red tape (as finance own paper) on all new and used equipment. Free trial, personalized service. Write for 124-page bargain catalog and get acquainted. Wholesale Radio Laboratories, Council Bluffs, Iowa.

TRANSMITTING headquarters on latest Stancor Thordarson & other kits — commercially wired at low cost. New 70 watt transmitter kits complete only \$35 — speech amplifier modulator up to 80 watts \$25 — up to 150 watts \$49.50. Easy terms. Write Leo, W9GFQ, today.

QSL'S? — SWL's? — Modernistic? — Cartoon? — Photographic? QSL's unbeatable. Samples? W8DED, Holland, Mich.

WANTED: QST's before August 1919; 1920, Aug. through Dec., indexes before 1926. Sell or trade: 1919, Oct.; 1920, March, July; all 1921 except Jan., Feb., April, Sept.; 1927, July. Write W2FUU, 45-10 Kissena Blvd., Flushing, N. Y.

500 watt phone, 750 CW Triangle Radio Lab. transmitter, rack-panel, TW150 final, 203Z's modulators, three 3/4 kw. Kenyon Thordarson power supplies, seven meters, bias power supplies, automatic overload protection. Browning, 10-160 meter band switching exciter unit, E. C. or crystal, \$400 or will trade on new or used car. Send for pictures, W9PPB, YMCA, Kokomo, Ind.

SELL, National TMA-40DC xmtg condenser, like new, \$6.50. W5HZT.

SELL: QST all copies; 1930, \$2.50; 1931, \$2.25; 1932, \$2.50; 1933, \$2.50; or all for \$9.50. Remington monarch typewriter, \$19.50. Listening monitor 20, 40, 80, \$2. All above, COD only. W3HIG, Thomas Lightfoot, 214 Runnymede Ave., Jenkintown, Pa.

SELL: Utah Jr. complete xtal, \$10. W6RVH.

QUARTZ crystals — importers of highest quality tested for twinning suitable for cutting piezo-electric crystals. Donald, M. Murray Co., 38 Pearl St., N. Y.

WANTED — complete medium power 40 meter final. W6RPO **SELLING** out — W8RFE.

EXPERIMENTERS: three crystal blanks \$1; W8OUE, Crystal Manufacturer, Indiana, Pa.

COLLINS 30FXC 250 watts fone CW coils 160, 80, 20, new tubes, perfect photo, \$400. Mims 2 element 20 direction indicator, \$40. Will swap both for power boat or cruiser and will pay cash extra if necessary. W2LVZ.

QSL'S, Finest styles. Samples. Maleco, 1805 St. Johns Place, Brooklyn, N. Y.

WANTED: 32 to 110 volt converter. W9VQC.

NATIONAL 600 watt transmitter — perfect condition, real bargain — price \$375. W2IEU, Westfield, N. J.

SELL — Johnson Bassett three element 10 meter beam complete. W9JML.

60 QSL's 35¢. Vachovetz, Glenville, Tarrytown, N. Y.

SACRIFICE transmitter units, parts and accessories. Send stamp for list. W9IAO, Calumet, Mich.

DOUGLAS Universal modulation transformers. Output only, 100 watts audio \$5.50 postpaid. One year guarantee. Write W9IXR, Box 349, Rice Lake, Wis.

QSL'S — W2AEY, 338 Elmora, Elizabeth, N. J.

BATTERY model RME-69, noise silencer, crystal, \$70. Changeable to a.c. W9VQC, Virgil, S. Dak.

THORDARSON 100 watt phone transmitter complete \$85. SX-25 \$65. W8HZC.

QSL'S — SWL's. Colorful. Economical. W9KXL, 319 Wyandotte, Kansas City, Mo.

FOR sale — RME HF10 receiver, \$49.50; 2 kw. W.E. 110 a.c. generator, exciter, control, \$65; no trades. W9ARN.

SELL — QST's, 1920-1936. W9AWM.

RECEIVERS — new in original cartons — Breting 6's \$26.50. Howard 460's with crystals \$59.95, factory reconconditioned SX-23's, \$79.50; reconconditioned types, all makes, lowest terms. Free list. Write Leo, W9GFQ, today.

WHEATSTONE tape automatic transmitters. Also new parts for Creed automatic transmitters. Probor Instruments, 99 Rogers Ave., Brooklyn, N. Y.

CRYSTALS: commercial or amateur; police, aircraft, marine and all types of low drift units for commercial purposes at attractive prices. Send for catalog. Amateurs, remember there is only one T9 crystal, better than ever. Fully guaranteed. 40, 80 and 160 meter bands \$1.60, spot frequencies \$2, postpaid. T9 ceramic holder \$1. COD's accepted. Sold by: Valley Radio Distributors, Appleton, Wis.; Henry Radio Shop, Butler, Mo.; Distribuidora Fronteriza, Laredo, Texas; Frank Anzalone, 375 W. 46th St., N. Y. C.; Pemberton Labs., Ft. Wayne, Ind.; Kerr's Radio Shop, El Paso, Texas; Casa Edison, Havana, Cuba; and Edison's, Temple, Texas.

WRITE Bob Henry, W9ARA, for the best deal on all amateur receivers, transmitters, kits, parts. You get best terms (financed by Bob); largest trade-in; personal cooperation; lowest prices. NC-200 and all other National, Hallicrafter, RME, RCA, Howard receivers positively in stock for immediate delivery. Write, W9ARA, Butler, Mo.

RECONDITIONED guaranteed receivers and transmitters. All makes and models. Lowest prices. Free trial. Terms. New Howard 460's with crystals \$59.95, SX-23's \$79.50. List free. W9ARA.

MUST sacrifice Collins 30FX transmitter, 100 watts phone, 250 watts CW. \$150 cash only. W3HWO.

CRYSTALS, complete with plug-in holders. 160M 80M AT \$1; 40M X \$1.35. 80M 5 kilocycle vari-frequency complete \$2.75. 48 hour service. COD's O. K. Money-back guarantee by expert commercial finisher. State desired frequency. Copple Piezo Service, 344 So. Fetterly, Los Angeles.

QSL'S, SWL'S. 100 — 3 color — 75¢. Lapeo, 344 W. 39th, Indianapolis, Ind.

HUNDREDS of dollars worth of surplus standard parts, both new and used. Tubes, power transformers, chokes, I.F. transformers, relays, cabinets, chassis, generators, crystals, condensers, coils, meters, and many other items. Your chance to obtain just what you need at far below cost. Write for free list. Rex Bassett, W9ZDO, 402 E. Angela Blvd., South Bend, Ind.

OFF the air — See new HT9 Hallicrafters xmt, phone CW complete. Utah 80 wait CW. Oscar Bonter, State Road Hill, Meadville, Pa.

WANTED — Howard 430, 2361 Tasso St., Palo Alto, Calif.

WANTED: Licensed operator, age 20-30, unmarried; comprehensive knowledge Amateur Radio as counsellor summer camp, beginning about March 1st. \$50 monthly plus complete maintenance. Write fully enclosing photograph or clear snapshot (not returnable). Box 447, Falmouth, Mass.

FOR sale — Hallicrafters S-21 five-ten receiver. Good condition plus frequency calibration. Thirty dollars. Rehm, W2HNY, Westfield, N. J.

RADIO TECHNOLOGY



RCA Institutes offer an intensive course of high standard embracing all phases of Radio and Television. Practical training with modern equipment at New York and Chicago Schools. Also specialized courses in Aviation Communications, Radio Servicing and Commercial Operating.

Illustrated Catalog on request

RCA INSTITUTES, INC. Dept. ST-41

A Radio Corporation of America Service

75 Varick St., New York 1154 Merchandise Mart, Chicago

LEARN RADIO • TELEVISION

60-page catalog on request. Oldest, largest and best equipped in New England. New classes now forming. Write for new catalog.

MASS. RADIO SCHOOL

18 Boylston Street Boston, Massachusetts

PAR-METAL

PICTURE YOUR RIG

IN A

CABINET LIKE THIS!

Par-Metal Cabinet Racks are handsomely finished, modern in design and streamlined for eye appeal — but their beauty goes deeper than that. You'll find that all Par-Metal Parts are easy to assemble because they are so accurately machined — and they can be interchanged almost at will. It's things like that that really make Par-Metal Products worthy of your investigation.

CATALOG 40

describes and illustrates our De Luxe and Standard Lines. Everything you'll need to build from a simple chassis to a KW job or a complete Sound System. Get a copy from your jobber or from us direct.

PAR-METAL PRODUCTS CORP.

3262 49th Street

Long Island City, N. Y.

Export Address:

100 Varick Street, New York, N. Y.

PAR-METAL

108

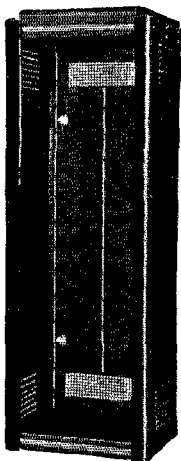

As Chief Condense Blower Outer Otto Oomph was a Flopperoc



EVER since Otto Oomph was a boy, I suffered from a strange disease. Smashophobia — the horror of breaking things — but there was nothing to be done about it. When he broke a Christmas tree ornament one year, poor Otto cried for two days. When he grew up, even the thought of denting fender would make him sick.

Eventually, however, Otto became an electrical expert. That got him a job in the Sprague Laboratories and Otto was really happy for the first time — that is, until someone made him Chief Condenser Blower Outer in the Test Division.

Now, voltage in the electric chair at Sing Sing is 1,200 volts. In contrast, controllable AC voltages in the Sprague lab run as high as 7,200 (and much higher in the special high voltage lab), for here is where Sprague condensers are torn apart, blown apart, tortured and blasted, not only to see how good they are, but how to make 'em even better.

WHAM! Poor Otto jumped six feet when a can condenser, deliberately loaded with supercharge to determine its breakdown point, exploded in a cage. Bam! SNAPPETY-CRACK, Otto shivered as another condenser gave its life under 4,000 volts of DC. CLICKETY-CLICK in monotonous regularity as AC motor starting condensers were switched tortuously on and off 150 times an hour.

SIZZ-SIZZLE and SISS as vapor streams played on condensers to prove their moisture-proof ability. In a massive oven, dozens of units were undergoing life tests at 200° F. Elsewhere, Television condensers were telling their story under 3,000 to 10,000 volts of DC and tiny electric razor condensers were getting the equivalent of 14 years of the hardest kind of use. Almost every minute some condenser gave up the ghost and another fact was added to the science of modern condenser manufacture.

"I can't stand it," wailed Otto at last, weeping over the remains of an 8 mid. 450 V. Atom. "Gosh, Otto," consoled an engineer. "What you worrying about? That condenser is only rated at 450 V. We had to smack it with almost 700 V. before it went." "Sure," sobbed Otto. "But it ain't fair to treat such swell condensers so downright mean. It makes me sick — I — I wanna quit." And quit Otto did.

"Twas a year before we heard from him again and then he wrote: Dear Boss: Maybe you think I was silly to quit my job, but it just isn't my nature to bust things up. I'd go home nights and dream about condensers on those torture racks — the finest condensers in the world just waiting to be blown up even if it took all the power in Massachusetts to do it. But all's well that ends well. I'm in the radio service business and doing fine. I use Sprague Condensers — and boy, are they real. Not a blow-out in a carload. No failures from moisture — or any thing else in fact. I realize it's largely because of the work you guys are doing back there in the lab, but I still say blowing up condensers is a helluva job for a sensitive man like me. Love and Kisses, OTTO OOMPH

P.S. Those Sprague High Voltage Micacs are really tops — and I'm tickled pink to see you're still selling 'em at the same old prices. I use them on every kind of by-pass job and have yet to see another make that can beat them for low leakage, safety and dependability. No wonder you fellows consider your high voltage lab so important — but I still say it's a helluva place to work!

SPRAGUE PRODUCTS CO. NORTH ADAMS, MASSACHUSETTS

Your Nearby Dealer Is Your Best Friend

Your nearby dealer is entitled to your patronage. He is equipped with a knowledge and understanding of amateur radio. He is your logical source of advice and counsel on what equipment you should buy. His stock is complete. He can supply your needs without delay. His prices are fair and consistent with the high quality of the goods he carries. He is responsible to you and interested in you.

One of these dealers is probably in your city—Patronize him!

ATLANTA, GEORGIA

Radio Wire Television Inc.
265 Peachtree Street
"The World's Largest Radio Supply House"

JAMAICA, L. I., NEW YORK

Radio Wire Television Inc.
90-08 166th Street (Merrick Road)
"The World's Largest Radio Supply House"

BALTIMORE, MARYLAND

Radio Electric Service Co.
3 N. Howard St.
Everything for the Amateur

MONTREAL, CANADA

Canadian Electrical Supply Co., Ltd.
285 Craig Street West
Largest Distributors of Radio Parts & Testers in British Empire

BOSTON, MASS.

Radio Wire Television Inc.
110 Federal Street
"The World's Largest Radio Supply House"

NEWARK, N. J.

Radio Wire Television Inc.
24 Central Avenue
"The World's Largest Radio Supply House"

BRONX, NEW YORK

Radio Wire Television Inc.
542 East Fordham Road
"The World's Largest Radio Supply House"

NEW YORK, N. Y.

Radio Wire Television Inc.
100 Sixth Avenue
"The World's Largest Radio Supply House"

BUFFALO, NEW YORK

Radio Equipment Corp.
326 Elm Street
W8PMC and W8NEL — Ham, service and sound equipment

NEW YORK, N. Y.

Harrison Radio Company
12 West Broadway
Harrison Has It! Phone WOrth 2-6276 for information or rush service

BUFFALO, NEW YORK

Dymac Radio
1531 Main Street — Cor. Ferry
Owned and operated by Hams for Hams GA. 0252

PHILADELPHIA, PENNSYLVANIA

Eugene G. Wile
10 S. Tenth Street
Complete Stock of Quality Merchandise

HARTFORD, CONNECTICUT

Radio Inspection Service Company
227 Asylum Street
What do you want? We have it. Radio exclusively

PROVIDENCE, RHODE ISLAND

W. H. Edwards Company
85 Broadway
National, Hammarlund, Hallicrafter, Thordarson, Taylor, RCA

HARTFORD, CONNECTICUT

Hatry & Young, Inc.
203 Ann Street
Stores also in Bridgeport and New Haven

RICHMOND, VIRGINIA

The Arnold Company
Broad at Harrison St.
W3EQQ — "The Virginia Ham Headquarters" — W3FBL

HOUSTON, TEXAS

R. C. & L. F. Hall
1021 Caroline Street (C 0721)
"Specialists in Amateur Supplies"

SCRANTON, PENNSYLVANIA

Scranton Radio & Television Supply Co.
519-521 Mulberry Street
Complete Stock of Quality Amateur Supplies

YOU CAN BE SURE
WHEN YOU BUY FROM

QST

ADVERTISERS

“Advertising for *QST* is accepted only from firms who, in the publisher’s opinion, are of established integrity and whose products secure the approval of the technical staff of the American Radio Relay League.”

Quoted from QST’s advertising rate card.

Every conceivable need of a radio amateur can be supplied by the advertisers in QST. And you will know the product has the approval of the League’s technical staff

Index to Advertisers

	PAGE
Aerovox Corporation	80
American Radio Institute	106
Astatic Microphone Laboratory, Inc.	101
Barker & Williamson	94
Billey Electric Company	87, 101
Candler System Company	102
Capitol Radio Engineering Institute	80
Cardwell Mfr. Corp., Allen D.	82
Centralab	5
ClaroSTAT Mfg. Company, Inc.	86
Collins Radio Company	Cov. 2
Cornell-Dublier Electric Corp.	70
Daven Company, The	82
Dodge’s Institute	98
Echophone Radio Corp.	71
Eitel-McCullough, Inc.	69
Gardiner-Levering Company	78
General Electric Company	77
Hallcrafters, Inc., The	1, 2
Hammarlund Mfg. Company, Inc.	65, 67
Harrison Radio Company	81
Harvey Radio Company	96
Henry Radio Shop	89
Hipower Crystal Company	106
Howard Radio Company	93
Instructograph Company, The	101
International Resistance Company	91
Jacobs, Charles F.	101
Janette Mfg. Company	90
Kenyon Transformer Company, Inc.	68
Maedel Publishing House	104
Mallory & Company, Inc., P. R.	64
Massachusetts Radio School	108
Melssner Mfg. Company, Inc.	72
Milten Mfg. Company, Inc., James	79
National Company, Inc.	Cov. 3, 63, 75
New York YMCA Schools	101
Newark Electric Company	95
Nilson Radio School	101, 102
Olmite Mfg. Company, Inc.	66
Parmetal Products Corp.	108
Pioneer Gen-E-Motor Corp.	86
Port Arthur College	78
Precision Apparatus Corp.	90
RCA Institutes, Inc.	108
RCA Mfg. Company, Inc.	Cov. 4
Radio Mfg. Engineers, Inc.	111
Radio Shack, The	105
Scientific Radio Service	102
Siekles Company, F. W.	101
Signal Electric Mfg. Company	106
Solar Mfg. Corporation	104
Sprague Products Company	108
Sun Radio Company	92
Taylor Tubes, Inc.	73
Teleplex Company	98
Terminal Radio Corp.	100
Thordarson Electric Mfg. Company	83
Triplet Elec. Instrument Company, Inc.	94
United Electronics Company	97
United Transformer Corp.	112
Vibroplex Company, Inc., The	104
Ward Leonard Electric Company	98
Wholesale Radio Laboratories	92
Yaxley	64

The Deluxe RME-99

FOR THE FIRST TIME . . . an *inclined* front panel is incorporated in a fine communications receiver by RME.

Radically new in appearance, providing 100% legibility of all controls, and more than practical in performance, here is a real console type cabinet that RME is introducing.

FOR THE FIRST TIME . . . *complete* transmitter control is possible from the panel of a communications receiver.

Space has been provided on the panel of this receiver for the mounting of all necessary controls for operating a transmitter. The black plate on the lower panel is removable for this purpose (punch-outs are located in the cabinet directly behind this plate).

AND IN ADDITION . . . here is a communications receiver with a truly deluxe appearance.

Two-tone crystalline finish, symmetrically placed bar-type knobs, plainly marked dials and controls . . . in short every feature you desire in a communications receiver.

Cabinet size $12\frac{1}{2} \times 11\frac{1}{4} \times 19$ Price with 8" PM speaker and tubes, but less speaker baffle, Net **\$139.65**.

AND — improved performance is now built into every "99" whether the standard or deluxe model.

RADIO MANUFACTURING ENGINEERS, INC.

One-Eleven Harrison Street

Peoria, Illinois

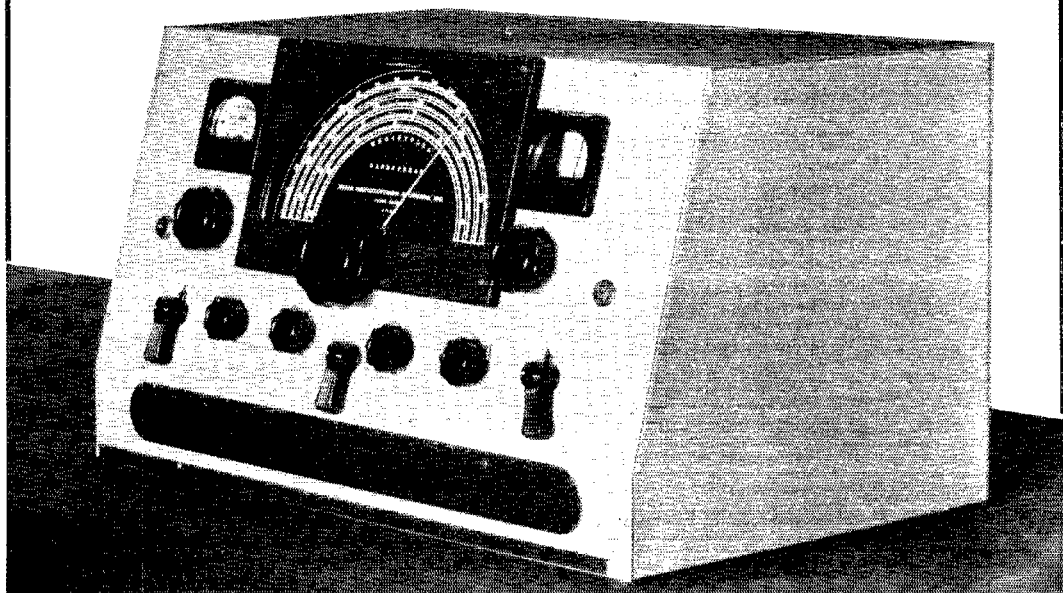

Variable Voltage

FOR YOUR LABORATORY, YOUR PRODUCT, OR YOUR PRODUCTION LINE

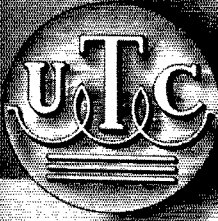

VARITRAN

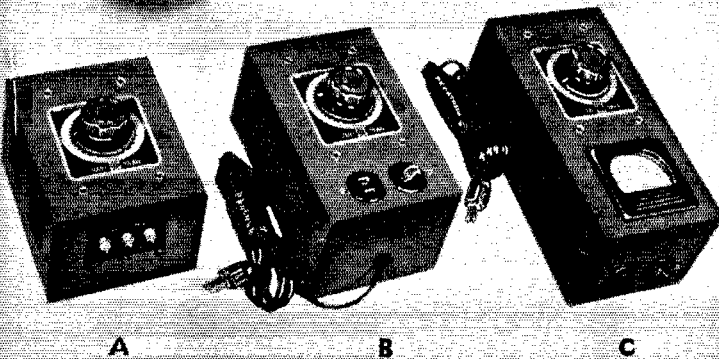

- ★ SMOOTH CONTROL
- ★ EXCELLENT REGULATION
- ★ HIGH EFFICIENCY
- ★ RUGGED CONSTRUCTION
- ★ WIDE RANGE (0-130 V.)
- ★ LOW TEMPERATURE RISE
- ★ ROLLER CONTACT
- ★ NO DISTORTION

VARITRAN CONTROL UNITS

For Controlling: Rectifier output, Motors, Heaters, Lights, Line voltage

METHOD OF OPERATION The UTC Varitran is a simple autotransformer with turns arranged on one layer so that every exposed turn may be used as a tap. A special non-fusing contact can be moved to any position on the winding, permitting the exact voltage desired to be obtained. The regulation and efficiency are excellent and no distortion of wave form occurs. The output voltage is independent of load.

Type	Input Voltage	Output Voltage	Watts	Max. Ampt.	Figure	Net Price
V-0	115 volts	0-130	250	2	A	\$7.50
V-0-B	230 volts	0-260	250	1	A	9.50
V-1	115 volts	0-130	570	5	B	10.00
V-1-M	115 volts	0-130	570	5	C	15.00
V-2	115 volts	0-130	570	5	A	9.00
V-2-B	230 volts	0-260	570	2.5	A	11.50
V-3	115 volts	0-130	850	7.5	A	14.00
V-3-B	230 volts	0-260	850	3.75	A	18.00
V-4	115 volts	0-130	1250	11	A	20.00
V-4-B	230 volts	0-260	1250	5.5	A	25.00
V-5	115 volts	0-130	1950	17	A	32.00
V-5-B	230 volts	0-260	1950	8.5	A	37.00
V-6	115 volts	0-130	3500	30	A	60.00
V-6-B	230 volts	0-260	3500	15	A	70.00
V-7	115 volts	0-130	5000	44	A	87.00
V-7-B	230 volts	0-260	5000	22	A	95.00

VARITRAN RATINGS

Standard Varitrans are designed for 115 or 230 volt service. The respective output voltages are 0-130 and 0-260 volts. The Varitran autotransformer current and wattage rating is based at 115 volts. The maximum current can be taken at any point from 0 to 20 volts and from 95 to 130 volts, tapering off to 50% of maximum at the 65 volt point.

UNITED TRANSFORMER CORP.

150 VARICK STREET



NEW YORK, N. Y.

EXPORT DIVISION: 100 VARICK STREET NEW YORK, N. Y. CABLES: VARILAN

QST for March, 1941, EASTERN Edition

PRINTED IN U. S. A.
RUMFORD PRESS
CONCORD, N. H.

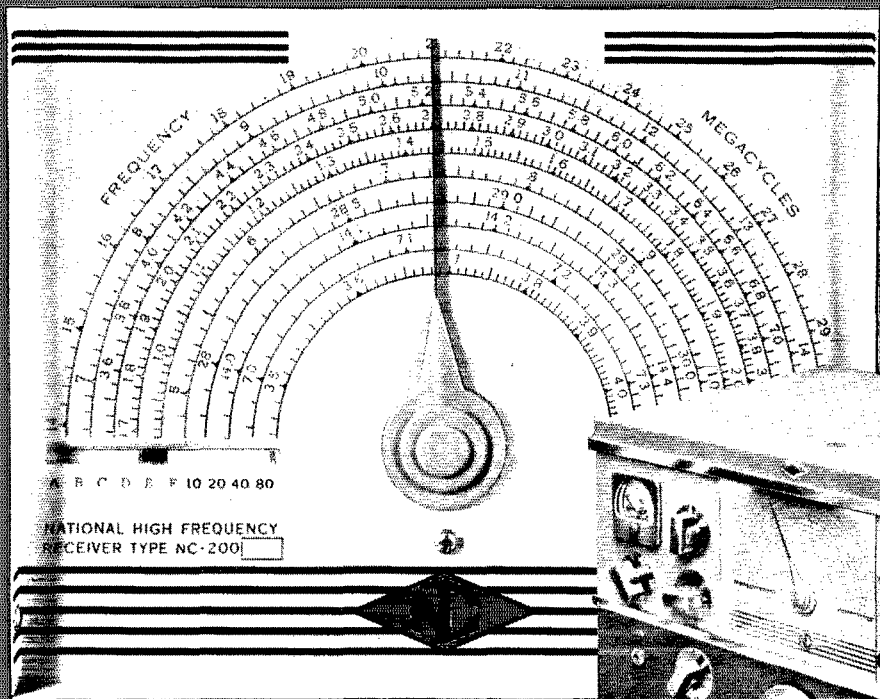

NC-200
DIAL
(2 1/2 Size)

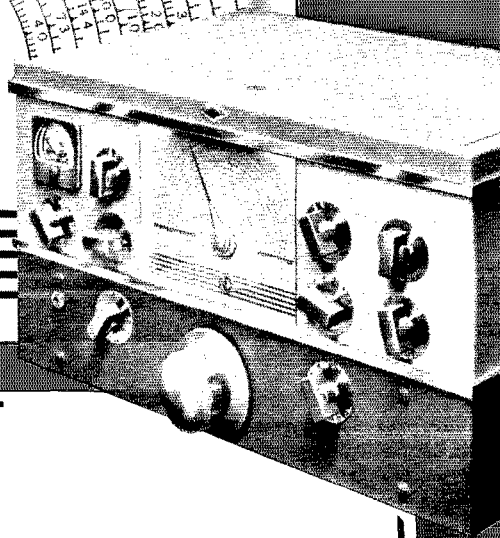

TEN RANGES

The NC-200 has ten calibrated coil ranges, as shown on the dial above. Six of these ranges provide continuous coverage from 490 KC to 30 MC. The remaining four ranges cover the 10, 20, 40 and 80 meter amateur bands, each band being spread out over the major portion of the dial scale. Each bandspread range is independent of the other ranges. Its calibration is fixed, it is tuned by the main tuning control, and its frequency is read by the big sweep pointer on the dial. And as a final assurance of logging free from errors, automatic indicators are always in view opposite each end of the scale in use.

OTHER FEATURES OF THE NC-200

- Sensitivity better than 1 micro-volt
- Series valve noise limiter
- Improved crystal filter with rejection ratios as high as 10,000 to 1
- Stability — 3 parts in 100,000 for 20-volt line fluctuation
- Temperature compensation
- AC line or portable operation
- Speaker in matching cabinet

Amateur Net Price \$147.50
with speaker, ready to run

NATIONAL COMPANY, INC.

MALDEN, MASS.

RCA-813

BEAM POWER AMPLIFIER

360 Watts Input with
Less Than 1 Watt
Driving Power!

Amateur Net **\$22.00**
(Reduced from \$28.50,
April 1, 1940)

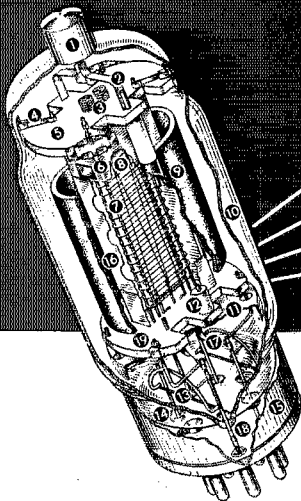

BIG-TIME MAGICIAN OF THE BEAM TUBE LINE!

Note These Features

1. Medium Metal Cap
2. Short Ribbon Plate Connector
3. Filament Support Springs
4. Mount Support
5. Top Ceramic Mount Support
6. Top Shield
7. Aligned-Turn Control and Screen Grids
8. Heavy-Duty Thoriated-Tungsten Filament
9. Large Sturdy Graphite Plate
10. Hard Glass Bulb with Mount-Aligning Dome
11. Bottom Shield Disc
12. Ceramic Plate-Support Spacer
13. Directive-Type Getter Container
14. Dish Type of Stem
15. Ceramic-Insert Giant Base
16. Beam-Forming Plate
17. Filament Connector
18. Tungsten-to-Glass Seal
19. Bottom Ceramic Mount Support



For high-power transmitters requiring exceptional overall efficiency—for ultra-modern rigs that need no neutralizing adjustments, rigs that can switch bands in a flash—for high-power gear with few tuning controls, requiring a minimum of driver equipment—use the RCA-813. It's the largest of the amateur "beams", big-brother magician of the famous RCA-807. It can handle a greater variety of big-time jobs than any other tube of its size or class.

As a final in c-w service RCA-813 takes 360 watts (CCS) with less than a watt of drive. As a final in plate-modulated service, it takes 240 watts with only 1.2 watts of drive. Moreover, it doubles, triples and quadruples with unusually high efficiency

and high harmonic output. It can be operated at full ratings up to 30 Mc— at reduced ratings up to 60 Mc. Power sensitivity of the RCA-813 is extremely high. Screen current requirements are very low.

In brief, the RCA-813 gives you *real power—real circuit simplification—real economy*. And it makes possible a flexible, high-power rig at a cost comparable with that of equipment using ordinary tube combinations.

Typical (Class "C" Telegraphy) CCS (Continuous Commercial Service) Ratings

Filament voltage, 10 volts (a.c. or d.c.); filament current, 5 a.; D-C plate volts, 2,000; D-C screen volts, 400; D-C grid volts, -90; D-C plate current, 180 ma.; D-C screen current, 15 ma.; driving power, 0.5 watt; power output, 260 watts.

COMPLETE DOPE ON THE NEW RCA-866-A/866 RECTIFIER . . .

. . . is contained in the January, 1941 issue of RCA H.A.M.T.I.P.S. Full technical details, typical circuit applications, etc. Ask your RCA Amateur Equipment Distributor for a copy.



Transmitting Tubes

RCA MANUFACTURING CO., INC., CAMDEN, N. J. • A Service of The Radio Corporation of America
In Canada: RCA Victor Company Limited, Montreal

