

# QST

february, 1941

25 cents

35c in Canada

devoted entirely to

# amateur radio



In This Issue—A Beginner's Two-Tube Superhet

# 16FA

... a new Collins Autotune Transmitter providing automatic multi-frequency operation on both intermediate and high frequencies.

**NOMINAL POWER OUTPUT AND FREQUENCY RANGE:** 150 watts, 2.5 to 20 mc. 90 watts, 300 to 500 kc.

**NUMBER OF FREQUENCIES:** 10 with Autotune throughout range.

**AUDIO FREQUENCY RESPONSE:** Uniform within 3 db from 100 to 5000 c.p.s.

**AMPLITUDE DISTORTION:** Less than 10% r.m.s. total harmonics at any modulation level measured at 400 c.p.s.

**ANTENNA IMPEDANCE:** High Frequency — unbalanced antennas of 70-600 ohms up to 60° phase angle. Low Frequency — 1-10 ohms, 500-1500 mmf.

**POWER SOURCE:** 220 volt single phase 50/60 or 25 cycle.

**AMBIENT TEMPERATURE RANGE:** 0° C to +50° C.

**REMOTE CONTROL:** Any of the five standard Collins arrangements can be used.

**SIZE:** 24"x24"x78". **WEIGHT:** 825 lbs.

**NOTE:** An output of 300 watts (h-f) and 180 watts (i-f) is available in the 16FA Transmitter which is of similar design.

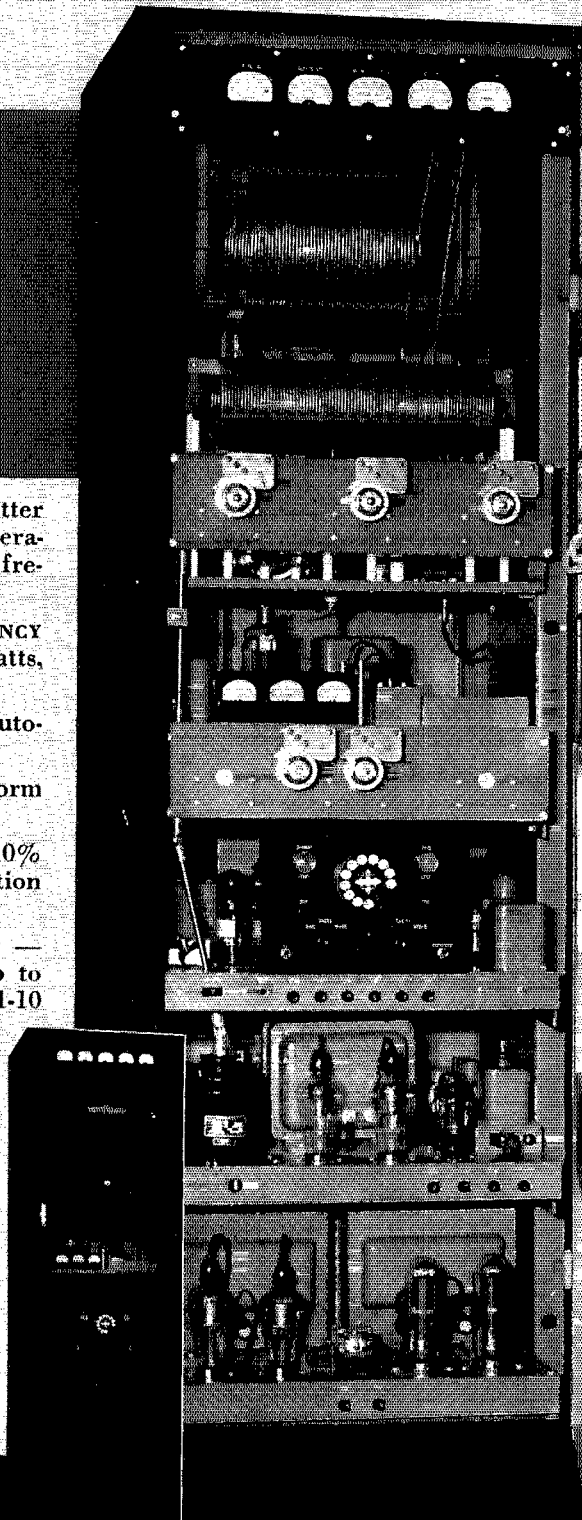

# COLLINS RADIO COMPANY

CEDAR RAPIDS, IOWA U.S.A. NEW YORK, N.Y. CHICAGO, ILL. ST. LOUIS, MO. PHOENIX, ARIZ.



# C Communications at its Best!

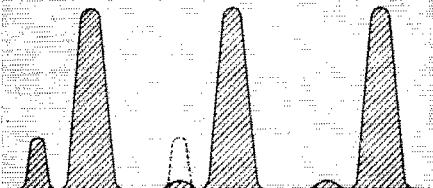
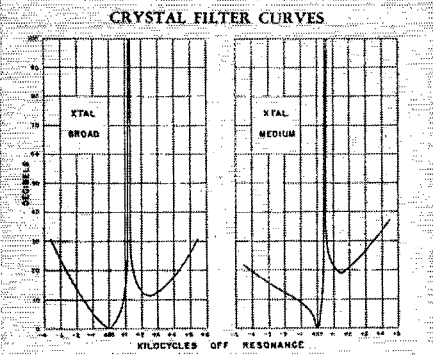
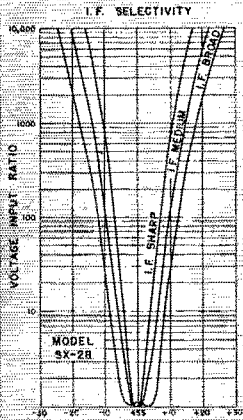
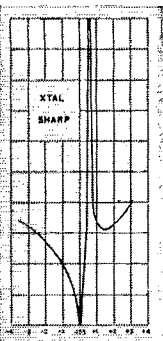

**T**HE NEW 1941 Hallicrafters Model SX-28 offers communications at its best. The outstanding reception capabilities of this new model are already winning high praise for top quality performance.

Model SX-28 is a 6 band, 15 tube receiver giving you complete front part control over every phase of the circuit. 2 stages of preselection . . . high fidelity push-pull audio . . . calibrated electrical bandsread . . . micrometer scale on main tuning knob . . . 6 position selectivity control . . . band pass audio filter . . . automatic noise limiter . . . new crystal filter circuit . . . ball bearing tuning mechanism . . . semi-floating main tuning and bandsread condensers. Covers 550kc. to 43mc. Panel is exact rack size. Chassis has rigid girder construction. Hallicrafters-Jensen Bass Reflex speakers available. With crystal and tubes, less only speaker.....\$159.50

New 1941 Hallicrafter Catalog just off the press. 20 color pages illustrating the complete new 1941 Hallicrafter line—ask for your copy today! Or write the factory.

the hallicrafters inc.  
CHICAGO, U. S. A.

USED BY 33 GOVERNMENTS • SOLD IN 89 COUNTRIES

# Dependable communications reception



## MODEL SX-25

Hallicrafter engineers have included every worthwhile advancement in the Model SX-25 to assure all the good reception requirements with a tuning range of from 540kc. to 42mc. in 4 bands.  
12 tubes—2 stages of preselection—Separate cali-

brated bandsread dial for 10, 20, 40 and 80 meter amateur bands—Six step variable selectivity—S meter calibrated in "S" and "DB" units—Push-pull output stage furnishes 8 watts of audio—Ten-inch heavy duty PM dynamic speaker—110 volt 50-60 cycle AC—provision for DC operation. Complete with speaker, crystal and tubes. \$99.50

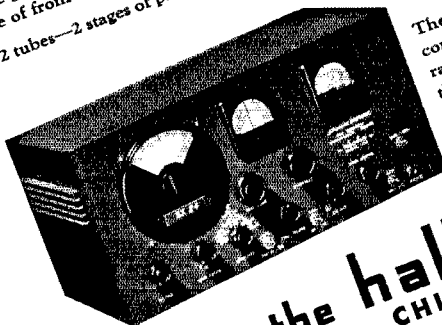

## MODEL SX-24

The Model SX-24 represents the best value in the communications field, 9 tubes—4 bands—Frequency range from 540kc. to 43mc.—Frequency stability throughout a wide range of line-voltage, temperature and humidity variations—DC operation socket—battery or vibrapack. Complete with tubes and crystal. \$69.50

**the hallicrafters inc.**  
CHICAGO, U. S. A.

USED BY 33 GOVERNMENTS • SOLD IN 89 COUNTRIES

FEBRUARY 1941

VOLUME XXV

NUMBER 2



STAFF

Editorial

KENNETH B. WARNER, W1RH.  
Editor and Business Manager

CLARK C. RODIMON, W1ZS  
Managing Editor

GEORGE GRAMMER, W1DF  
Technical Editor

DONALD H. MIX, W1TS  
BYRON GOODMAN, W1JPE  
Assistant Technical Editors

EDW. P. TILTON, W1HDQ  
Contributing Editor, U.H.F.

VERNON CHAMBERS, W1JEQ  
Technical Information Service

JAMES J. LAMB, W1AL  
Research Engineer, A.R.R.L.

Advertising

F. CHEYNEY BERKLEY, W1GS  
Advertising Manager

CHARLES BRUNELLE  
Asst. Advertising Manager

Circulation

DAVID H. HOUGHTON  
Circulation Manager

RALPH T. BEAUDIN, W1BAW  
Asst. Circulation Manager



OFFICES

38 La Salle Road  
West Hartford, Connecticut

Subscription rate in United States and Possessions, \$2.50 per year, postpaid; all other countries, \$3.00 per year, postpaid. Single copies, 25 cents. Foreign remittances should be by international postal or express money order or bank draft negotiable in the U. S. and for an equivalent amount in U. S. funds.

Entered as second-class matter May 29, 1919, at the post office at Hartford, Connecticut, under the Act of March 3, 1879. Acceptance for mailing at special rate of postage provided for in section 1103, Act of October 3, 1917, authorized September 9, 1922. Additional entry at Concord, N. H., authorized February 21, 1929, under the Act of February 23, 1925. Additional second-class entries to cover sectional editions authorized March 20, 1935.

Copyright 1941 by the American Radio Relay League, Inc. Title registered at United States Patent Office.

# QST

devoted entirely to

# AMATEUR RADIO

PUBLISHED, MONTHLY, AS ITS OFFICIAL ORGAN, BY THE AMERICAN RADIO RELAY LEAGUE, INC., AT WEST HARTFORD, CONN., U. S. A.; OFFICIAL ORGAN OF THE INTERNATIONAL AMATEUR RADIO UNION



## CONTENTS

Editorial . . . . .	7
A Compact 56-Mc. Converter . . . . . <i>Byron Goodman, W1JPE</i>	8
25 Years Ago This Month in QST . . . . .	11
A Two-Tube Superhet . . . . .	12
An Inexpensive Two-Stage Three-Band Transmitter <i>Vernon Chambers, W1JEQ</i>	16
Announcing — 1.8- and 28-Mc. W.A.S. Parties . . . . .	19
WWV Schedules . . . . .	19
A Simple 5- and 10-Meter Transmitter . . . . . <i>Wilbert L. Thompson</i>	20
What the League Is Doing . . . . .	22
Opportunity — Through Registration . . . . .	25
U.H.F. Superhet Design for Improved Performance in Audio and Video Reception. <i>Part I</i> . . . . . <i>Dana A. Griffin, W2AOE</i>	27
Self-Training Hints for Voice Operators . . . . . <i>F. E. Handy, W1BDI</i>	30
New Transmitting Tubes: 826, 1625, 1626, 866-A/866 . . . . .	31
A Wide-Range V. T. Voltmeter . . . . . <i>Thomas J. Kelley, W4CNY</i>	32
Navy Day — 1940 . . . . .	36
Practical Design of Mixer or Converter Circuits <i>Curtis R. Hammond, W9PKW</i>	38
On the Ultra Highs . . . . . <i>E. P. Tilton, W1HDQ</i>	44
Army-Amateur Radio System Activities . . . . .	47
This Business of Code . . . . . <i>John Huntoon, W1LVQ</i>	48
Hints and Kinks for the Experimenter <i>A Simple Break-In Keying System with Keying Monitor — Your Receiver or Audio Amplifier as an Intercommunicating System — Crystal Switch — Increasing Resistor Power Rating</i>	50
New Apparatus . . . . .	52
A.R.R.L. QSL Bureau . . . . .	52
Correspondence from Members . . . . .	53
Operating News . . . . .	54
How's DX? . . . . .	58
New Receiving Tube 3S4 . . . . .	82
Station Activities . . . . .	84
Book Reviews . . . . .	86
Hamads . . . . .	107
QST's Index of Advertisers . . . . .	110

## Section Communications Managers of the A.R.R.L. Communications Department

All appointments in the League's field organization are made by the proper S.C.M., elected by members in each Section listed. Mail your S.C.M. (on the 10th of each month) a postal covering your radio activities for the previous 30 days. Tell him your DX, plans for experimenting, results in phone and traffic. He is interested, whether you are an A.R.R.L. member or get your QST at the newsstands; he wants a report from every active ham. If interested and qualified for O.R.S., O.P.S. or other appointments he can tell you about them, too.

ATLANTIC DIVISION			
Eastern Pennsylvania	W3BES	Jerry Mathis	6042 Master St. 9701 Monroe St.
Maryland-Delaware-District of Columbia	W3CIZ	Hermann E. Hobbs	Silver Spring P.O.
Southern New Jersey	W3CCO	Lester H. Allen	704 Quinton Ave.
Western New York	W8PLA	Fred Chichester	
Western Pennsylvania	W8CKO	E. A. Krall	703 Broadway
CENTRAL DIVISION			
Illinois	W9UJH	Mrs. Carrie Jones	2407 Central Ave.
Indiana	W9AB	Harry B. Miller	729 E. Lowell Ave.
Kentucky	W9ARU	Darrell A. Downard	116 N. Longworth Ave.
Michigan	W8DPE	Harold C. Bird	R.F.D. 2
Ohio	W8AQ	E. H. Gibbs	405 Broad St.
Wisconsin	W9UIT	Aldrich C. Krones	2702 So. 46th St.
DAKOTA DIVISION			
North Dakota	W9WWL	Anton C. Theodos	Box 444
South Dakota	W9ADJ	E. C. Mohler	Box 149
Northern Minnesota	W9IGZ	Edwin L. Wicklund	R.F.D. 3
Southern Minnesota	W9YNQ	Millard L. Bender	608 N. Huron Ave.
DELTA DIVISION			
Arkansas	WSABI	H. E. Velte	4415 West 12th St.
Louisiana	W5DWW	W. J. Wilkinson, Jr.	Room 313, Jefferson Hotel
Mississippi	W5EWD	Jewell W. Cole	% City of McComb Water Dept.
Tennessee	W4DDJ	M. G. Hooper	4908 Georgia Ave.
HUDSON DIVISION			
Eastern New York	W2LU	Robert E. Haight	311 South Holmes St.
N. Y. C. & Long Island	W2AZV	E. L. Banchel	102 Central Ave.
Northern New Jersey	W2LMN	Edward Gursky, Jr.	367 Van Winkle Ave.
MIDWEST DIVISION			
Iowa	W9PTR	L. B. Vennard	1113 So. 9th St.
Kansas	W9AWP	A. B. Unruh	1617 S. Seneca St.
Missouri	W9OUD	Miss Letha Allendorf	1015 W. 3rd St.
Nebraska*	W9WKP	Garold Bennett	704 12th St.
NEW ENGLAND DIVISION			
Connecticut	W1CTI	Frederick Ellis, Jr.	19 Merrill Rd.
Maine	W1LIE	H. W. Casner	147 Church
Eastern Massachusetts	W1ALP	Frank L. Baker, Jr.	21 Colby Road
Western Massachusetts	W1JAH	William J. Barrett	239 Columbia St.
New Hampshire	W1FTJ	Mrs. Dorothy W. Evans	163 South Main St.
Rhode Island	W1HRC	Clayton C. Gordon	70 Columbia Ave., Gaspee
Vermont	W1KJG	Clifton G. Parker	Box 537
NORTHWESTERN DIVISION			
Alaska	K7GNN	James G. Sherry	
Idaho	W7CRL	Clifford A. Jessup	803 E. Seventh St.
Montana	W7CPY	Ker Roberts	Box 1088
Oregon	W7GNJ	Carl Austin	1137 Federal
Washington	W7FCG	W. Beale	R. 4, School Ave.
PACIFIC DIVISION			
Hawaii	K6ETF	Francis T. Blatt	837 16th Ave.
Nevada	W6BIC	Edward W. Heim	509 Claremont St.
Santa Clara Valley	W6IUZ	Earl F. Sanderson	101 Claremont Ave.
East Bay	W6TI	Horace R. Greer	414 Fairmount Ave.
San Francisco	W6CIS	Kenneth E. Hughes	622-36th Ave.
Sacramento Valley	W6MDI	Vincent N. Feldhausen	113 South Quincy St.
Philippines	KA1GR	George L. Rickard	Box 849
San Joaquin Valley	W6KUT	Edwin A. Andrews	2921 North Van Ness Blvd.
ROANOKE DIVISION			
North Carolina	W4CYB	W. J. Wortman	P. O. Box 566
South Carolina	W4BOE/ANG	Ted Ferguson	1213 College St.
Virginia	W3GWQ	Frank S. Anderson, Jr.	4703 New Kent Ave.
West Virginia	W8OXO	W. D. Tabler	1004 So. Davis Ave.
ROCKY MOUNTAIN DIVISION			
Colorado	W9EHC	Carl C. Drumeller	819 East Dale St.
Utah-Wyoming	W7ZGG	Henry L. Schroeder	P. O. Box 731
SOUTHEASTERN DIVISION			
Alabama	W4DGS	James F. Thompson	12 Clanton Ave. Waucombs Apts.
Eastern Florida	W4PEI	Carl G. Schaaf	Lakeview Hotel
Western Florida	W4AXP	Oscar Cederstrom	Second St. & Bruce Ave.
Georgia	W4AOB	William U. Hanks	4 Hunter St., S.E.
West Indies (Cuba-Puerto Rico-Virgin Islands)	CM2OP	Mario de la Torre	Escobar 110 (Altos)
SOUTHWESTERN DIVISION			
Los Angeles	W6MQM	Ralph S. Click	1038 Milwaukee Ave.
Arizona	W6KOL	John K. Oliver	Box 642
San Diego	W6BKZ	Louis A. Cartwright	370 Nautilus
WEST GULF DIVISION			
Northern Texas	W5DXA	Lee Hughes	125 N. Main St.
Oklahoma	W5GFT	Russell W. Battern	Box 50
Southern Texas	W5MN	Horace E. Biddy	1746 Schley Ave.
New Mexico	W5ENI	Dr. Hilton W. Gillett	
MARITIME DIVISION			
Maritime	VE1DQ	A. M. Crowell	69 Dublin St.
ONTARIO DIVISION			
Ontario	VE3EF	Flying Officer Donald R. Gunn	% Canadian Bank of Commerce
QUEBEC DIVISION			
Quebec	VE2CO	Lindsey G. Morris	Apt. 6, 4510 Girouard Ave., N.D.G.
VANALTA DIVISION			
Alberta	VE4GE	C. S. Jamieson	581 W. Riverside Drive
British Columbia	VE5DD	C. O. I. Sawyer	2634 West 31st Ave.
PRAIRIE DIVISION			
Manitoba	VE4AAW	A. W. Morley	747 McMillan Ave.
Saskatchewan	VE4SY	Arthur Chesworth	1071 4th Ave., N. W.

\* Officials appointed to act until the membership of the Section choose permanent S.C.M.s by nomination and election.



Complete  
NET  
only  
**\$10.56**



PORTABLE →

Always THE RIGHT  
REPLACEMENT CONTROL  
WITH THIS Centralab  
PORTABLE

## Adashaft Kit

You name the set and it's a hundred to one that you can do a replacement job right out of our PORTABLE Adashaft Kit . . . mighty good business sense . . . owning one of these kits . . . The strong steel case is 12" x 5" x 1 1/2" . . . you can even carry it in your coat pocket (note Old Man Centralab above) and you pay for the controls only . . . we give you the case "FREE".

Any shaft and control can be combined in a moment without special tools. Yet the RESULT is just as STRONG and RELIABLE as a ONE PIECE SHAFT.

Then replace the controls from your jobbers stock as they are used. Buy that ADASHAFT KIT today . . . you need it.

**CENTRALAB** Div. of Globe-Union Inc., Milwaukee  
Cable Address — Centralab

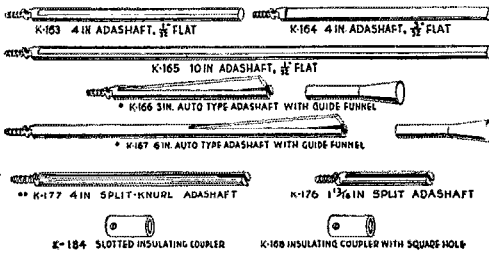
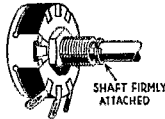
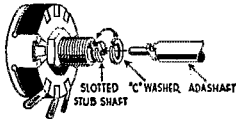

INCLUDED IN THIS ADASHAFT KIT  
ARE THE FOLLOWING CONTROLS:

1 EACH OF		CURVE
10,000	ohms	3
25,000	ohms	3
50,000	ohms	6
250,000	ohms	6
500,000	ohms	6
1 MEG	ohms	6
2 MEG	ohms	6
3 MEG	ohms	6
250,000	ohms	tapped
500,000	ohms	tapped
1 MEG	ohms	tapped
2 MEG	ohms	tapped

### SHAFTS

3	K163
2	K164
1	K165
1	K166
1	K167
1	K176
3	K177

### COUPLERS

1	K184
1	K168

### SWITCH COVERS

5	K155 SPST
1	K157 DPST

# Centralab

# THE AMERICAN RADIO RELAY LEAGUE

## Directors

<i>President</i>		
GEORGE W. BAILEY	WIKH	74 Webster Road, Weston, Mass.
<i>Vice-President</i>		
CHARLES E. BLALACK	W6GG	1700 Foothill Blvd., Altadena, Calif.
<i>Canadian General Manager</i>		
ALEX. REID	VE2BE	169 Logan Ave., St. Lambert, P. Q.
<i>Atlantic Division</i>		
WALTER BRADLEY MARTIN	W3QV	Box 512, Roslyn, Pa.
<i>Central Division</i>		
GOODWIN L. FOSLAND	W9TSN	40 No. Clark St., Chicago
<i>Dakota Division</i>		
FRED W. YOUNG	W9MZN	1333 North 12th Street, Fargo, North Dakota
<i>Delta Division</i>		
E. RAY ARLEDGE	W5S1	P.O. Box 286, Pine Bluff, Ark.
<i>Hudson Division</i>		
ROBERT AKERIDGE KIRKMAN	W2DSY	920 Eighth Ave., Brooklyn
<i>Midwest Division</i>		
FLOYD E. NORWINE, JR.	W9EEC	7405 Hiawatha Ave., Richmond Heights, Mo.
<i>New England Division</i>		
PERCY C. NOBLE	W1BVR	37 Broad St., Westfield, Mass.
<i>Northeastern Division</i>		
KARL W. WEINGARTEN	W7BG	3219 N. 24th St., Tacoma, Wash.
<i>Pacific Division</i>		
J. L. McCARGAR	W6EY	66 Hamilton Pl., Oakland, Calif.
<i>Roanoke Division</i>		
H. L. CAVENESS	W4DW	2607 Vanderbilt Ave., Raleigh, N. C.
<i>Rocky Mountain Division</i>		
C. RAYMOND STEDMAN	W9CAA	926 So. Gaylord St., Denver
<i>Southeastern Division</i>		
WILLIAM C. SHELTON	W4ASR	Box 652, Daytona Beach, Fla.
<i>Southwestern Division</i>		
JOHN E. BICKEL	W6BKY	801 E. California St., Whittier, Calif.
<i>West Gulf Division</i>		
WILLIAM A. GREEN	W5BKH	801 Ross St., Abilene, Texas

THE AMERICAN RADIO RELAY LEAGUE, INC., is a non-commercial association of radio amateurs, bonded for the promotion of interest in amateur radio communication and experimentation, for the relaying of messages by radio, for the advancement of the radio art and of the public welfare, for the representation of the radio amateur in legislative matters, and for the maintenance of fraternalism and a high standard of conduct.

It is an incorporated association without capital stock, chartered under the laws of Connecticut. Its affairs are governed by a Board of Directors, elected every two years by the general membership. The officers are elected or appointed by the Directors. The League is non-commercial and no one commercially engaged in the manufacture, sale or rental of radio apparatus is eligible to membership on its board.

"Of, by and for the amateur," it numbers within its ranks practically every worth-while amateur in the nation and has a history of glorious achievement as the standard-bearer in amateur affairs.

Inquiries regarding membership are solicited. A bona fide interest in amateur radio is the only essential qualification; ownership of a transmitting station and knowledge of the code are not prerequisite. Correspondence should be addressed to the Secretary.



## Past Presidents

HIRAM PERCY MAXIM, 1914-1936  
EUGENE C. WOODRUFF, 1936-1940

## Officers

President	GEORGE W. BAILEY, WIKH	Weston, Mass.
Vice-President	CHARLES E. BLALACK, W6GG	Altadena, Calif.
Secretary	KENNETH B. WARNER, W1EH	West Hartford, Connecticut
Treasurer	ARTHUR A. HEBERT, W1ES	West Hartford, Connecticut
Communications Mgr.	F. EDWARD HANDY, W1BDI	West Hartford, Connecticut
General Counsel	PAUL M. SEGAL	1026 Woodward Building, Washington, D. C.

Address all general correspondence to the administrative headquarters at West Hartford, Connecticut.



# "IT SEEMS TO US—"

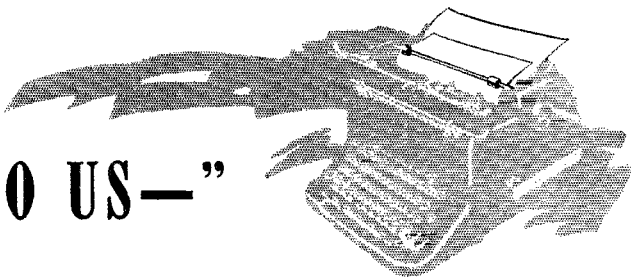

## THE DEFENSE COMMUNICATIONS BOARD

AS PART of the vast gearing up of national effort now under way, the Defense Communications Board begins its monumental task of planning a coordinated system of communications capable of serving the country in whatever may lie before it. With national defense the primary consideration, and with the communication needs of the military forces in mind, it is to set up a correlated plan that will take care of the nation's communication requirements through every phase of a major emergency. Participating in its work are experts from every segment of the communications art.

As long as the country remains at peace, the administration of communications may continue as it is at present. But against the possibility that darker days lie ahead, there ought to be a cohesive scheme to deal with any and every emergency aspect — something on tap, to be used in case of necessity. To prepare such plans is the function of the D.C.B. In simpler days we used to say that in case of need the Army took over certain functions, the Navy assumed others, this activity ceased, that operation doubled. It's no longer that simple; there are too many interlocking factors, and the art is so complex and the needs so prodigious that committees of experts are needed to allocate tasks and responsibilities and to lay plans that will assure communication while maintaining security. Hence the D.C.B. and its committees, as we have outlined them in *QST*.

The work of this board now takes on a large measure of importance to each branch of the art represented in its work. The activities of the Amateur Radio Committee, for instance, and the action taken upon its recommendations by the Board itself, will be of considerable moment to us radio amateurs; moreover, they will actually be of considerable importance to the nation.

To us these decisions will be important because this board will write the rules to govern amateur radio during an emergency. That, of course, is a subject of immense interest to us. But we believe that, in a larger sense, the decisions here to be taken are of much greater importance to the welfare of the nation as a whole. A proper realization of the capabilities of the radio amateur will make possible many

contributions of very great value. A short-sighted point of view will cost the country many vital services that the amateur alone can render.

The development of amateur radio in this country has done more than create a reservoir of skilled young fellows capable of serving in the Army and Navy. It has resulted in an even greater number who, by reason of age, dependents, sex or disability, are not capable of service with fighting forces but who do have skill in their art. But it has done more than the mere creation of numbers: it has resulted in building an *institution* devoted to communication, complete with its methods, morale and traditions. There are tasks the amateur institution alone is geared to handle. For instance, disaster emergencies. Even in placid years there are communication emergencies with which we alone can cope, because of our numbers, placement and organization. Natural disasters will not respect military emergency; they'll continue to happen and we'll be the only ones who can deal with them. Again, there are numerous fields of a military nature in which security or information-needs require a communications network so vast that it could never be constructed especially for the purpose. Nor should it be; we already have the facilities. By these two examples we illustrate a whole class of activity in which organized amateur radio constitutes an irreplaceable asset, one that must never be lost.

The League has completed its organization to represent amateurs in the work of the Board. Six widely-known amateurs, geographically spaced and representative of diverse amateur interests, have been appointed as special regional advisers, as reported elsewhere in this issue. Added to the already-existing League organization, this is formidable mechanism to speak for the amateur, to generate plans for service, to sift and study ideas. The work commences in January.

Meantime it is much to be hoped that the Board will be as aware of these potentialities of amateur service as we are eager to give them. The country has long encouraged amateur radio as a national policy. That action has been applauded as wise policy by those who saw how much it could mean in time of need. If the time be now approaching, we are ready. Let the D.C.B. agree on what it wants — we'll deliver.

K. B. W.

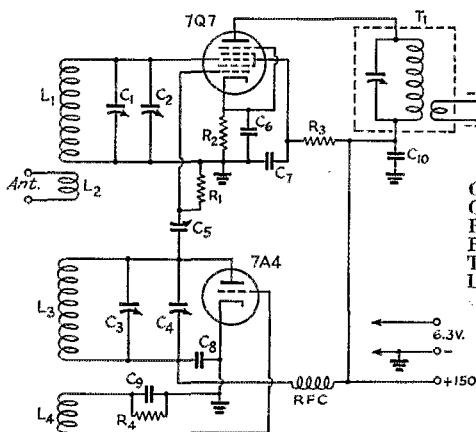

Fig. 1 — Wiring diagram of the 56-Mc. converter.  
 C<sub>1</sub> — 3-plate midget variable (National UM-15 with 3 plates removed).  
 C<sub>2</sub>, C<sub>4</sub>, C<sub>5</sub> — 3-30 compression-type variable (National M30).  
 C<sub>3</sub> — 5-plate midget variable, ganged to C<sub>1</sub> (National UM-15 with 1 plate removed).  
 C<sub>6</sub>, C<sub>7</sub>, C<sub>8</sub> — 0.005- $\mu$ fd. midget mica.  
 C<sub>9</sub> — 50- $\mu$ fd. midget mica.  
 C<sub>10</sub> — 0.01- $\mu$ fd., 400-volt paper. R<sub>2</sub> — 150 ohms,  $\frac{1}{2}$ -watt.  
 R<sub>1</sub>, R<sub>4</sub> — 20,000 ohms,  $\frac{1}{2}$ -watt. R<sub>3</sub> — 6000 ohms,  $\frac{1}{2}$ -watt.  
 RFC — U.h.f. r.f. choke (Ohmite Z-1).  
 T<sub>1</sub> — 3-Mc. converter output transformer (Miller 512 XT).  
 L<sub>1</sub> — 7 turns,  $\frac{3}{8}$  inch long.  
 L<sub>2</sub> — 4 turns, close-wound, mounted at ground end of L<sub>1</sub>.  
 L<sub>3</sub> — 4 turns,  $\frac{1}{2}$  inch long.  
 L<sub>4</sub> — 3 turns, close-wound. Wound in same direction as L<sub>3</sub>, mounted next to ground end of L<sub>3</sub>.  
 All coils wound of No. 14 enamelled wire on  $\frac{3}{8}$ -inch diameter tubing. When the wire is removed from the tubing, the coil springs out to  $\frac{1}{2}$ -inch diam.

# A Compact 56-Mc. Converter

**A Two-Tube Single Control Unit With 3-Mc. Output**

BY BYRON GOODMAN,\* WIJPE

THE average amateur who spends only a portion of his operating time in the 56-Mc. band usually uses a converter in conjunction with his communications receiver. Depending upon the pocketbook situation at the time of construction of the converter, the u.h.f. unit will be an elaborate affair with acorn tubes and possibly short-line tuning elements or a more simple affair with conventional receiving tubes and coil-and-condenser circuit elements. The converter to be described is intended for anyone who can use a simple converter that can be built without a great deal of effort and yet will perform satisfactorily for anyone but the most exacting.

Possibly that last sentence can stand a bit of explanation. All other things being equal, a converter without an r.f. stage will have a slightly lower signal-to-noise ratio than one with an r.f. amplifier ahead of the mixer stage. However, the signal-to-noise ratio of a receiver is only important when working with very weak signals and, since most signals worked in casual contacts on the 5-meter band are not this weak, extreme sensitivity of a 56-Mc. receiver becomes important only to those who spend most of their time on the band and are interested in weak-signal DX. Even then the difference between a receiver with an r.f. stage and one without is that a weak signal may be easier

to understand with the stage of r.f. amplification — it would be a very poor mixer stage compared with a very good r.f. stage that would make the difference between “readable” and “nothing doing” on the same signal.

### The Circuit

The converter uses a 7A4 tuned-plate grid-tickler oscillator and a 7Q7 mixer. Because the converter is a one-band affair, ganging is a simple matter and, for stability, a lower *L-C* ratio is used in the oscillator circuit than in the mixer circuit. The limited tuning range of the converter and the fact that the tuning condenser capacities are small compared to the total circuit capacities results in very nearly straight-line-frequency tuning. A 3-Mc. i.f. is used.

The 7A4 triode is a popular tube for u.h.f. oscillator work, and is similar to the 6J5 in electrical characteristics, while the 7Q7 is similar to the 6SA7. Loktal tubes were used because of a personal preference for their type of construction for use in u.h.f. gear. Although the use of a 7G7/1232 (similar to the 1852) as a mixer would result in slightly more gain and an improved signal-to-noise ratio, grid mixing would be required. Grid mixing has the disadvantages that, since the oscillator tuned circuit is coupled directly to the mixer tuned circuit, radiation from the oscillator through the an-

\* Asst. Technical Editor, QST

The 56-Mc. converter shown on these pages hides behind a lot of dial but not at all because it's ashamed of its performance. Instead, it got that way because it makes the gadget easy to construct and results in a novel arrangement that could be used for other units as well.

tenna circuit can be obtained and also serious pulling can result. A mixer like the 7Q7 or 6SA7 is free from these disadvantages.

The converter is designed to work from a 150-volt supply, since a regulated power supply is recommended and 150 volts is a convenient value that can be obtained through the use of a VR-150 regulator tube. Regulating the power supply adds to the stability of the oscillator and allows c.w. signals to be copied easily in spite of possible changes in line voltage or other factors affecting the stability of the receiving system.

#### Construction

Although the circuit of the converter is quite conventional, the construction manages to depart a bit from the usual run of such things. As can be seen from the photographs, a National ACN dial is used for the panel of the converter and a 3- by 4- by 5-inch Parmet box is used as the chassis and cabinet. The 4- by 5-inch faces of the box are removable, and all of the parts except the dial and antenna terminals are mounted on one of the removable faces. This makes the construction of the unit very simple, and the wiring would be almost impossible otherwise.

The first step in the construction of the converter is to mount the dial on one end of the box. The dial is backed up by a piece of 1/16-inch thick aluminum for extra strength. The plate of the dial can be used as a template and makes marking the aluminum and box a simple matter. The socket holes and screw holes for mounting the condensers are next made, and small brass pillars are used to support the condensers at the proper distance so that they will fit the dial properly. A flexible coupling is used between the two condensers, and the oscillator condenser fits directly into the coupling on the ACN dial. No extra insulation is necessary, since the dial coupling is insulated on the mechanism. The tube sockets are made of polystyrene by Amphenol, although the low-loss bakelite ones would doubtless be satisfactory. The sockets should be mounted at least  $\frac{3}{4}$  inch in from the sides so that they will clear the box when the unit is put together. The 3-Mc. output transformer is mounted at the rear of the unit, in a position that allows the shield to cover the heads of the two screws

mounting the mixer tuning condenser. A double tie-point is held underneath the output transformer by the two spade bolts and is used to connect the output terminals of the transformer to the shielded output line of twisted hookup wire.

When the tuning condensers, sockets and output transformer have been mounted in place, the unit can be wired. The power supply cable is brought in through the side of the can to a triple tie-point mounted on one end of the oscillator socket, so the tie-point should be mounted there before wiring is started. No special care is required in wiring, because the small size of the unit makes long leads rather difficult to occur. Reference to the photographs will give a good idea of the placement of parts.

When the wiring is finished, the coils and padding condensers can be put in place. The oscillator plate coil should be put in place first, along with the oscillator padding condenser,  $C_4$ , and then the grid coil,  $L_4$ , can be placed in position. The grid coil is supported by the grid terminal on the tube socket and by the grid condenser and leak, and it should be fastened to the plate coil with Duco or polystyrene cement after all coil adjustments have been made, to prevent any tendency toward microphonics. The antenna coil,  $L_2$ , is mounted on the National FWG assembly that is mounted on the side of the can, and need not be put in place until one is ready to make final adjustments. The mixer padding condenser,  $C_2$ , is mounted so that it can be adjusted through a hole in the side of the can, to make possible slight adjustments to compensate for different antennas.

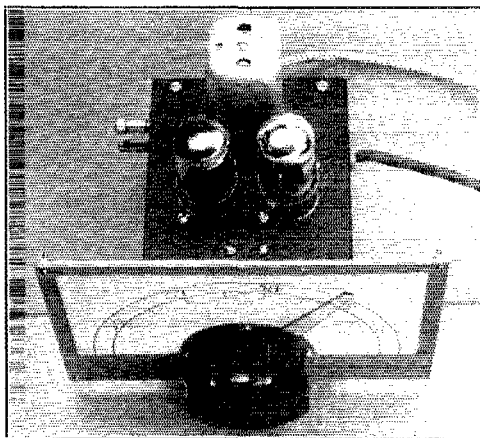

The two-tube 56-Mc. converter uses a 3- by 4- by 5-inch box for the chassis and one of the new National ACN dials for the panel. The input terminals are at the rear left, the power supply cable runs out the rear right, and the shielded output lead is brought out at the rear. The shield can at the rear houses the output transformer.

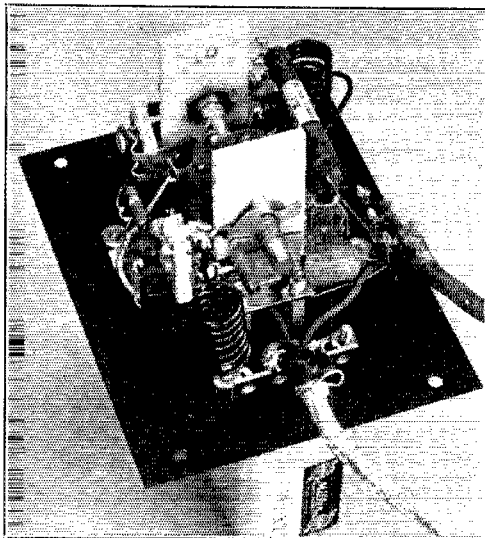

This view shows the mixer tuning condenser in the foreground. The paper by-pass condenser,  $C_{10}$ , can be seen under the right-hand side of the tuning condenser, and the screen dropping resistor,  $R_8$ , runs under it.

#### Coil Adjustment

When the wiring has been completed and checked, a 150-volt supply should be connected to the unit and the output connected to a receiver tuned to 3 Mc. or thereabouts. The output transformer is adjusted by turning the screw at the top until the noise in the receiver is at maximum, indicating that the output transformer is tuned to the receiver frequency. A source of signal should be turned on, and this signal can be either a harmonic from a crystal or other calibrated oscillator or a 5-meter signal of known frequency. By adjusting the oscillator padding condenser it will be possible to bring in the signal at the desired setting of the tuning condenser. It is most convenient if one has signals at each end of the band to work with, since it then becomes a simple matter to adjust the spread to the desired amount. If it is found that the oscillator doesn't give enough band spread, the turns of  $L_3$  should be pulled farther apart, and if the tuning range of the unit is less than the whole band, the turns should be squeezed closer together. It is necessary, of course, to make some slight adjustment of  $C_4$  after each coil adjustment.  $L_4$  should be left the same during these adjustments.

When the proper range is covered with the oscillator (so that the 5-meter band will take up about 75% of the dial space), the coupling condenser,  $C_5$ , can be adjusted. The connection between  $R_1$  and ground is broken and a low-range milliammeter is connected in. The

coupling condenser is then adjusted until the rectified current through the resistor to ground is approximately 0.5 ma. In the converter shown in these pages, it was found necessary to trim the top plate of  $C_5$  in order to get the current down to the proper value. If a low-range meter is not available, the condenser should be left in its minimum-capacity position (with the screw still in, however), and the current can be checked at some later date when a meter can be borrowed.

The last step in the adjustment of the converter is to make the mixer circuit track with the oscillator circuit. The tuning condensers are set to the high-capacity position and the mixer padding condenser,  $C_2$ , is set for maximum noise. The tuning condensers are then turned to the low-capacity end of their range and the mixer padder again peaked for the maximum noise. If the resultant position is the same as for the high-capacity end, it indicates that the two circuits are tracking and no further adjustment is necessary. If the pad has to be set at a lower capacity at the low-capacity end of the tuning range, the turns of  $L_1$  should be spread apart to reduce further the inductance. If the padding condenser has to be set to a higher capacity, it indicates that not enough inductance is present, and the turns should be squeezed together. The adjustment is a simple matter, and two or three trial runs should result in very close tracking of the two circuits.

The last step in the construction of the con-

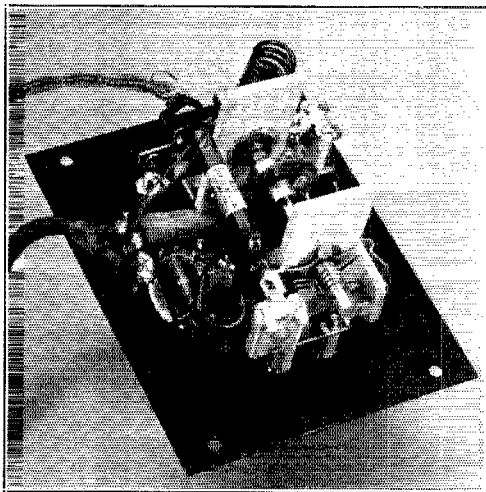

A view under the chassis showing the oscillator section in the foreground. The oscillator coil and padding condenser,  $C_4$ , are at the left of the tuning condenser, and the coupling condenser  $C_5$  is at the right. The 7A4 oscillator tube socket is at the left. Note the pillars used to support the tuning condenser.

verter is calibration of the dial. The unit is placed in the box and the dial is connected to the condenser gang. The power supply cable is brought out at the side of the box through a rubber grommet, and the shielded output cable is brought out at the rear of the box through a hole. A wire soldered to the shield braid is grounded to the box. After the antenna coil has been soldered in place on the antenna posts, the necessary markings can be made on the dial for the calibration and, after the celluloid covering has been put back in place, the converter is finished and ready for use.

Although it is not absolutely necessary, a slight increase in performance can be obtained by adding a small capacity between the signal and injection grids of the 7Q7. This capacity is not shown in the wiring diagram or photographs, but it is easily made by soldering a heavy piece of wire to the wire from the mixer tuning condenser to the signal grid and running this heavy wire near the coupling condenser  $C_5$ . The small amount of capacity obtained in this way neutralizes some of the space-charge effect of the mixer tube and results in slightly improved sensitivity and lessened pulling on the oscillator. It is, however, a refinement that need only be added after everything else is working properly.

A signal generator for the 56-Mc. region was not available, but comparisons with another mixer-oscillator converter using a 1232-7A4 combination showed the one described on these pages to be practically equal in sensitivity and superior in lack of pulling. Operating tests, of course, depend largely on antenna and location, but no trouble was had in receiving an amateur station near Boston, some 90 miles away.

This indicates the favorable attitude of the amateurs of the country toward an operating organization for relay work and for the mutual distribution of information. If this interest continues to grow, we can count upon being able to number ourselves among the strong organizations of the country.

"The amateurs of the country by this time are probably confident that the officers in charge of the American Radio Relay League are sincere in their efforts to make the transmitting of long distance amateur messages by relay a success, and that there is no money-making scheme connected with the matter in any way. Hundreds of letters received since *QST* has been published indicate this very clearly. Unfortunately, however, it requires money in addition to hard work in order to answer the large correspondence from a membership of nearly one thousand and as many more amateurs who are not in the League, but want to enter. This money can only be obtained through voluntary subscriptions, of which there have been several, and the sale of Station Appointment Certificates, List of Stations Book, and *QST* Magazine. We have no other source of income, and the success of our organization depends upon all of us coming forward and buying these three things. Every amateur should understand this, and do his share, both by ordering himself and also exerting his influence to see that his friends who are interested in wireless do the same."

The principal technical article, editorially pointed at as food for serious thought, dealt with apparatus arrangement in spark transmitters and dramatically showed the need for short heavy leads. Another article, on some remarkable "Long Distance Amateur Wireless Work," reported the reception of several stations at distances of 400 to 600 miles. The author, R. S. Miner, gave pointers from his experience in the critical adjustment of audions to secure these results, and also suggested that "when you receive a distant station, drop the owner a postal and tell him so."

In the Correspondence Department two writers divulged that even then in 1916 they had been amateurs for eight years: C. Stuart Ballantine, founder of R.F.L., Boonton, and C. R. Runyon, Jr., later to be League treasurer, now W2AG, associated with Armstrong in the development of f.m.

For the first time, *QST* carried advertising on the famous Crystaloi detector, on the Radio Apparatus Company Navy-type loose-coupler with silver-plated contacts, and on the Klitzen rotary, the first manufactured one with "spark-through" electrodes.

## Strays

In pruning an antenna to the proper length, instead of cutting off a few inches each time and then checking to see if the length is correct, feed the end of the antenna through the hole in the insulator and double the wire back on itself, holding it in place with a clip. In this way, the length may be increased again, if the resonance point is passed. — *W1LVQ*.

— . . . —  
W9HBF lives on South Carolina Street, Louisiana, Missouri. Does he count for three states for WAS? — *W3FVZ*.



*QST* for February, 1916, bore the rubber-stamp notice: "Last free copy — Subscribe to-day."

The leading article in this issue was "Practical Relaying," by Hiram Percy Maxim. A comprehensive outline for a solution of the practical problems of relaying, it outlined six major national trunk lines, each to have its headquarters for running "proof tests" and handling traffic. It was the beginning of the trunk-line system.

The new League had a bad case of growing pains. In big type a general notice from headquarters read in part:

"On the first of December, the League membership numbered 635. On the tenth of January, it numbered 961.

## A Two-Tube Superhet

A Simple Receiver that Can Be Constructed for \$11

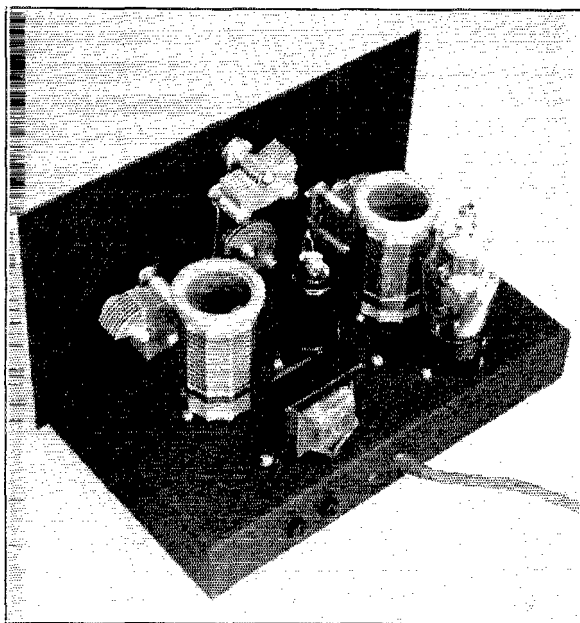

A back-of-panel view, showing the arrangement of parts on top of the 5½-by 9½-by 1½-inch chassis.

LONG-ESTABLISHED custom dictates that a beginner's first receiver, if he builds it himself, should be a two-tube regenerative affair. The reason, of course, is that a two-tuber is inexpensive to construct, and represents perhaps the simplest practical receiver that can be made. But it does have some very definite disadvantages.

Going to a superhet usually represents too great an increase in circuit and constructional complications, despite the promise of improved performance. However, it is *possible* to use the superhet principle in a two-tube set. By discarding a formal i.f. amplifier (a practically necessary omission in a two-tube super anyway) part of the cost and a difficult adjustment job are eliminated, but we are left with no choice but to use a regenerative detector as the complete i.f. system. At first glance this might seem to accomplish little more than to combine all the worst features of the regenerative receiver and superhet — and it is readily possible to do just that.

Fortunately, though, a properly designed two-tube super can be made to be markedly better than the ordinary two-tube regenerative

outfit; it is possible to overcome many of the defects of the latter which are most annoying in actual use. It is more logical to look at such a receiver as a stepped-up regenerative set rather than as a stepped-down super, and from this standpoint we find these advantages attainable: The regenerative detector works at a fixed frequency, and therefore can be designed primarily for stability rather than — of necessity in a conventional regenerative receiver — to cover a wide tuning range. Stability is helped by the fact that the detector also works at a relatively low frequency. In turn, the low i.f. means a fixed order of selectivity, and greater selectivity than is possible when the detector circuit itself must be tuned directly to the signal on the higher-frequency bands. Also, since the detector is not coupled to the antenna but to the rather constant load presented by the plate circuit of the tube preceding it, there is complete freedom from antenna dead spots, or points where antenna resonance pulls the detector out of oscillation. Thus the regeneration control is quite independent of tuning, and may be set at the

most sensitive point and left alone, regardless of frequency. By the same token, a swinging antenna will have no effect on the beat note. Furthermore, the detector circuit can be designed so that the regeneration control has practically no effect on the detector's oscillation frequency, a thing almost impossible to achieve in a detector working over a wide frequency range. Finally, body capacity, caused by working a regenerative detector directly into an antenna, is absent. Summing up, we find that we can make ourselves something approximating the ideal regenerative set simply because utilization of the superhet principle permits thorough isolation of the detector from the antenna (more thorough than in the case of a t.r.f. set) and permits working the detector on a fixed low frequency.

It would be too much to expect that all this could be achieved without some compensating disadvantages! These are pulling of the superhet oscillator frequency by tuning of the r.f. grid circuit, and the usual spurious responses experienced in superhets without preselection.

Although bound to be present, they can be minimized by using a high-enough intermediate frequency, at least at the signal frequencies most interesting to beginners. In practice, it turns out that they represent by far the lesser of two evils.

The receiver shown in the photographs represents a decidedly worth-while improvement over the usual beginner's two-tube regenerative set. It was designed with cost in mind, and therefore uses a minimum number of components; in part, this is accomplished by making the set work from a "B" supply consisting of a single 45-volt "B" battery so that comparatively few by-pass condensers and no dropping resistors are needed. Incidentally, this also reduces the power supply cost. Including tubes, the parts cost is below \$11; the most expensive single item is the dial, a \$1.50 item which was used because it works unfailingly while the cheap friction-drive dials we tried persistently slipped. A 6.3-volt filament transformer (an old adjustable toy train transformer will do just as well) and "B" battery can be purchased for a total of less than two dollars.

#### Circuit Data

The circuit diagram is given in Fig. 1. A 6K8 is used to convert the frequency of the incoming signal to the fixed or intermediate frequency, and the two triode sections of a 6C8G serve as the regenerative detector and audio amplifier respectively.  $L_1C_1$  is the r.f. circuit, tuned to the signal, and  $L_2$  is the antenna coupling coil.  $C_7$  is a by-pass condenser across the 1.5-volt battery used to bias the

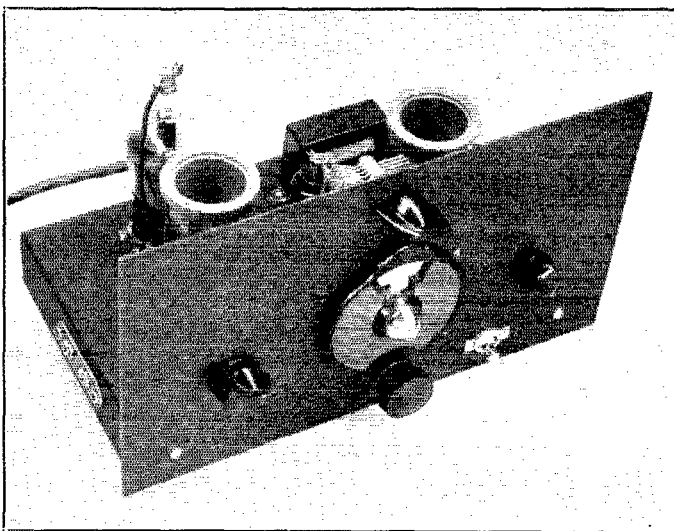

This two-tube superhet has one more control than the ordinary two-tube regenerative receiver, but is more stable and easier to tune.

signal grid of the 6K8. The high-frequency oscillator tank circuit is  $L_3C_3C_4$ , with  $C_3$  for band-setting and  $C_4$  for band-spread. For the sake of simplicity in coil construction the ordinary parallel-condenser method of band-spread is used.  $L_4$  is the oscillator tickler coil, and  $C_6$  is a by-pass condenser across the plate supply.

The performance of the receiver depends largely on the i.f. system. The i.f. tuned circuit (or regenerative detector circuit, whichever way it may be considered) is  $L_5C_5$ . This must be a high- $Q$  circuit if stability better than that of an ordinary regenerative detector is to be secured. The frequency to which it is tuned should be in the vicinity of 1600 kc.; the exact frequency does not matter so long as it falls on the low-frequency side of the 1750-kc. band. In the receiver shown, the coil  $L_5$  and its tickler coil  $L_6$  are wound on a small form, and  $L_5$  is tuned by a fixed mica condenser of the low-

Fig. 1 — Circuit Diagram of the Two-Tube Superhet.

- $C_1, C_2, C_3$  — 100- $\mu$ fd. variable (Hammarlund SM-100).
- $C_4$  — 15- $\mu$ fd. variable (Hammarlund SM-15).
- $C_5$  — 250- $\mu$ fd. silvered mica (Dubilier Type 5-R).
- $C_6$  — 0.01- $\mu$ fd. paper.
- $C_7$  — 0.005- $\mu$ fd. mica.
- $C_8, C_9$  — 100- $\mu$ fd. mica.
- $R_1$  — 50,000 ohms,  $\frac{1}{2}$ -watt.
- $R_2$  — 1 megohm,  $\frac{1}{2}$ -watt.
- RFC — 2.5-mh. r.f. choke.
- $T_1$  — Audio transformer, interstage type, 3:1 ratio (Thordarson T13A34).
- $L_1-L_4$ , inc. — See coil table.
- $L_5$  — 55 turns No. 30 d.s.c., close-wound on  $\frac{3}{4}$ -inch diameter form (National PRF-2); inductance 40 microhenrys.
- $L_6$  — 18 turns No. 30 d.s.c., close-wound, on same form as  $L_5$ ; see Fig. 2.
- S — S.p.s.t. toggle switch.

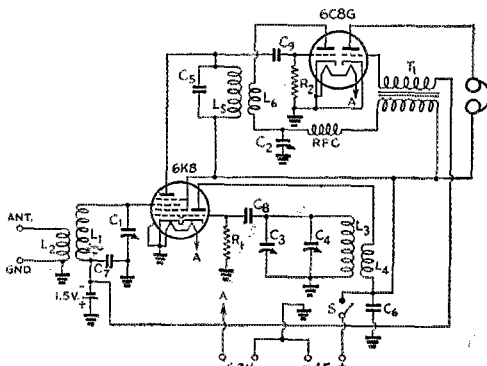

drift type. Since these condensers are furnished within a capacity tolerance of 5%, it is sufficient to wind  $L_5$  as specified under Fig. 1 and the resulting resonant frequency will be in the correct region. No manual tuning is necessary and therefore the frequency of this circuit need not be adjusted.  $C_2$  is the regeneration control condenser, isolated from the d.c. supply by means of the choke *RFC*. Only enough turns need be used on  $L_6$  to make the detector oscillate readily when  $C_2$  is at half capacity or more.

The second section of the 6C8G is transformer-coupled to the detector. The grid is biased by the same battery which furnishes bias for the 6K8. Although neither of the tubes will draw excessive plate current without this bias, the unbiased grids load the circuits to which they are connected and reduce the gain. A five-cent flashlight cell saves the cost of cathode resistors and by-pass condensers.

### Construction

The location of the various parts is shown in the photographs. Looking at the top of the chassis, from in front, the r.f. or input circuit is at the left, with  $C_1$  on the panel and  $L_1-L_2$  just behind it. The 6C8G is directly to the rear of the coil. The 6K8 converter tube is centered on the chassis, with  $C_3$  and  $C_4$  on the panel directly in front of it.  $C_4$  is driven by the vernier dial and  $C_3$  is toward the top of the panel. The coil at the right is  $L_3-L_4$ , in the oscillator tuned circuit. The regeneration-control condenser,  $C_2$ , is at the right on the panel. The audio transformer,  $T_1$ , is behind the oscillator coil.

Looking at the bottom of the chassis, the

antenna-ground terminals are at the left, with a lead going directly to  $L_2$  on the coil socket. The bias battery is fastened to a two-lug insulating strip by means of wires soldered to the battery. The zinc can is the negative end and the small cap the positive terminal. By-pass condenser  $C_7$  is mounted on the coil socket.

The i.f. coil is mounted on the chassis midway between the socket for the 6C8G and that for the 6K8. In winding the coil the ends of the wires are left long enough to reach to the various tie-in points. The grid condenser,  $C_5$ , is supported by the grid terminal on the tube socket and the end of the grid winding,  $L_5$ .  $R_2$  is mounted over the 6C8G socket. The i.f. tank condenser,  $C_6$ , is mounted by its terminals between the plate and screen prongs on the 6K8 socket, the ends of  $L_6$  being brought to the same two points.

The oscillator grid condenser,  $C_8$ , is connected between the coil socket prong and the oscillator grid prong on the 6K8 socket. By-pass condenser  $C_9$  is mounted alongside the oscillator coil socket as shown. The connections to the rotors of the tuning condensers for both coils go through holes in the chassis near the front edge. Grounds are made directly to the chassis in all cases. Make sure that there is an actual connection to the metal and not simply to the paint.

The "B" switch is a single-pole single-throw toggle. 'Phone tip jacks on the rear chassis edge provide means for connection to the headset.

Reasonable care in following the diagram should ensure the receiver's working immediately when it is finished. The method of winding coils is indicated in Fig. 2; if the connections to the circuit are made as shown there will be no trouble in obtaining the necessary oscillation. Both coils on each form should be wound in the same direction.

### Testing and Operation

To test the receiver, first try out the i.f. circuit. Connect the filament and "B" supply and place both tubes in their sockets. Put a high-frequency coil in the r.f. socket, but do not insert a coil in the oscillator socket. The only test which need be made is to see if the detector oscillates properly. Advance  $C_2$  from minimum capacity until the detector goes into oscillation, which will be indicated by a soft hiss. This should occur at around half

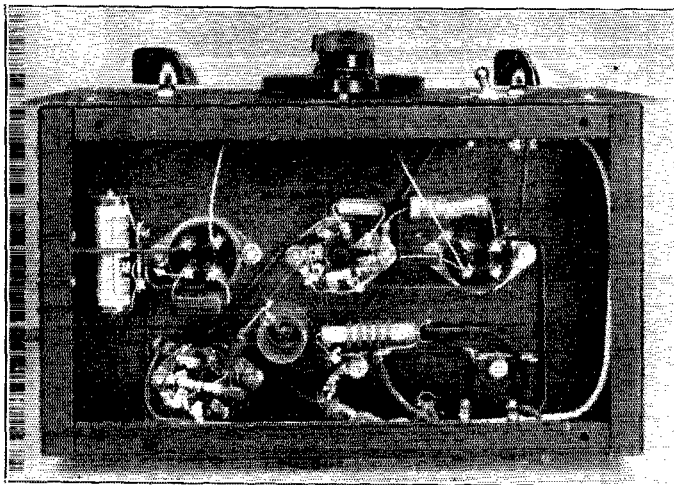

The i.f. circuit is underneath the chassis; no adjustment of its frequency is necessary. Since few parts are used, the remaining wiring is quite simple.



## TWO-TUBE SUPERHET COIL DATA

Coil	Grid Winding ( $L_1$ and $L_2$ )	Antenna ( $L_3$ ) or Tickler ( $L_4$ )
A	56 turns No. 22 enamelled	10 turns No. 24 enamelled
B	32 " " " "	8 " " " "
C	18 " " " "	7 " " " "
D	12 " " " "	7 " " " "
E	10 " " " "	8 " " " "

All coils wound on  $1\frac{1}{2}$ -inch diameter forms (Hammarlund SWF-4). Grid windings on coils B-E, inc., spaced to occupy a length of  $1\frac{1}{4}$  inches; grid winding on coil A close-wound. Antenna-tickler coils all close-wound, spaced  $\frac{1}{4}$  inch from bottom of grid winding. See Fig. 2.

Frequency Range	Coil at $L_1$ - $L_2$	Coil at $L_3$ - $L_4$
1700 to 3200 kc.	A	B
3000 to 5700 kc.	B	C
5400 to 10,000 kc.	C	D
9500 to 14,500 kc.	E	D

scale on the condenser. If it does not occur, check the coil ( $L_5$ - $L_6$ ) connections and winding direction, and if these seem right, add a few turns to the tickler,  $L_6$ . If the detector oscillates with very low capacity at  $C_2$ , it will be advisable to take a few turns off  $L_6$  until oscillation starts at about midscale.

After the i.f. has been checked, plug in an oscillator coil for a range on which signals are likely to be heard at the time. The 5400-10,000-kc. range is usually a good one. The coils are arranged so that a minimum number is needed, even though two are used at a time. For the frequency range indicated in the coil table, only one more coil is required than would be the case with an ordinary two-tube regenerative receiver. With coil C in the r.f. socket and D in the oscillator circuit, set  $C_1$  at about half scale and turn  $C_2$  slowly around midscale until a signal is heard. Then tune  $C_1$  for maximum volume. That is all there is to tuning. Should no signals be heard, the probability is that the oscillator section of the 6K8 is not working, in which case the same method of testing is used as described above for the i.f. detector — checking wiring, direction of windings of coils, and finally, adding turns to the tickler,  $L_4$ , if necessary.

It will be noted that the same oscillator coil, D, is used for two frequency ranges. This is possible because the oscillator frequency is placed on the low-frequency side of the signal on the higher range. This not only avoids winding a second coil, but also gives somewhat greater stability at the highest-frequency range. Some pulling — a change in beat-note as the r.f. tuning is varied by means of  $C_1$  — will be observed on the highest-frequency range, but it is not serious in the region of resonance with the incoming signal frequency.

A word about images. The receiver will, of course, respond to signals either 1600 kc. lower or 1600 kc. higher than the oscillator fre-

quency. The unwanted response, or image, is discriminated against by the tuning of the r.f. circuit. On the three lower-frequency ranges, when it is possible to find two tuning spots on  $C_1$  at which incoming random noise peaks up, the lower-frequency peak (the one requiring the highest tuning capacity at  $C_1$ ) is the right one. The oscillator frequency is 1600 kc. higher than that of the incoming signal on these three ranges. On the fourth range the reverse is true, since here the oscillator is tuned 1600 kc. lower. Actually, it does not matter a great deal which side is used except for calibration purposes. There is plenty of room to experiment with different-sized coils for these and other frequency ranges, and also to use other band-spread methods in the oscillator circuit. Band-spread is not needed in the r.f. circuit, since the tuning is not very critical and its main function is to peak up the desired-signal strength.

The heater requirements of the set are 0.6 amp. at 6.3 volts, approximately. Either a.c. or d.c. may be used. The "B" battery current is between 4 and 5 milliamperes, so that a standard 45-volt block will last many hundreds of hours. Although the "B" voltage is low, the converter circuit provides some gain so that more amplification is available than in a conventional two-tube regenerative receiver. The set does not give loud-speaker volume — the plate input to the audio amplifier is only a little more than a hundredth of a watt, so it would be hard to find the power to drive a speaker! The headset volume is quite satisfactory, however.

The user of a regenerative receiver will

(Continued on page 98)

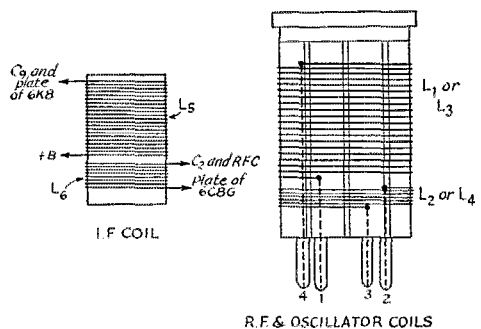

Fig. 2 — How the coils for the two-tube super are wound. The bottom end of the i.f. coil in this drawing is the end mounted to the chassis.  $L_5$  and  $L_6$  are wound in the same direction.

Both windings are in the same direction on each r.f. and oscillator coil. On the r.f. socket, pin 4 connects to the No. 3 grid (top cap) of the 6K8 and stator of  $C_1$ , pin 1 to  $C_7$ , pin 2 to ground and pin 3 to the antenna post. On the oscillator socket, pin 4 goes to  $C_3$  and the stators of  $C_3$  and  $C_4$ , pin 1 to ground, pin 2 to "B" plus, and pin 3 to the 6K8 oscillator section plate.

# An Inexpensive Two-Stage Three-Band Transmitter

**50-Watts C.W. Output with the 815**

**BY VERNON CHAMBERS,\* WIJEQ**

**I**N PLANNING a c.w. low-power transmitter to combine simple and compact construction, ease of operation, and inexpensiveness, it was only natural that full consideration should be given to the recently developed Type 815 double beam tube. Although this tube has been talked about mostly for ultra-high-frequency work, its obvious advantages—high-power sensitivity, push-pull operation, no neutralization, and low-voltage operation—certainly are attractive on the lower frequencies too. In particular, it seemed that it should be possible to construct a transmitter having only two stages, yet capable of working in three bands from one crystal, since the 815's excitation requirements are so low. The outcome is the transmitter illustrated here.

Fig. 1 shows the circuit diagram of the transmitter. A Tri-tet oscillator is used so that driving power can be obtained for the amplifier on three bands from one crystal. Since the efficiency of a crystal oscillator delivering fourth-harmonic output is comparatively low, a 6L6 is used as the oscillator tube so that the necessary driving power can be obtained without excessive dissipation. Because only 3.5-Mc. crystals are used, a fixed-tune cathode circuit may be used in the oscillator, which not only eliminates the cost of one variable condenser but also reduces the number of controls.

\*A.R.R.L. Technical Information Service.

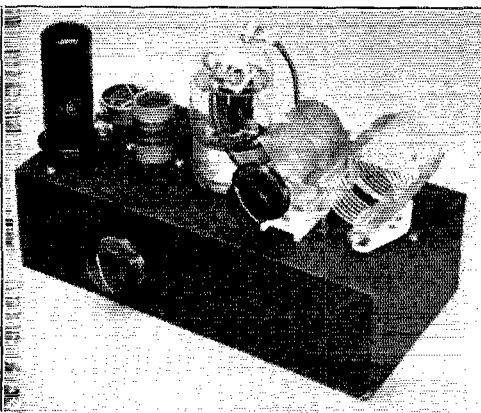

Front view of the transmitter. Construction is compact without undue crowding of the components.

The problem of coupling between the single-ended oscillator and the push-pull 815 grids was solved by the arrangement shown in the diagram. At least two other methods might have been used—capacity coupling with a tapped tank, or ordinary link coupling. However, the former is not altogether satisfactory because the driving tube is connected across only half of the circuit and therefore introduces some unbalance, while the latter requires two tuned circuits, which is neither economical nor convenient. The circuit shown consists of a balanced grid tank closely coupled to an untuned plate winding and resembles the r.f. transformers used in receiver circuits. Besides requiring only one tuning control, this method has the additional advantage that the amount of power fed to the 815 is readily controlled by the number of turns on the plate or primary winding,  $L_2$ . This is important in a set-up of this type, since at the crystal fundamental and second harmonic the driving power available is far more than the optimum for the tube, and some means must be provided for reducing it if over-excitation (with consequent heating of the screen and loss of power output) is to be avoided. In practice, the size of  $L_2$  is adjusted so that somewhat more than the rated grid current (approximately 4 ma. under the chosen operating conditions) is available, and fine adjustment is secured by detuning  $C_1$  slightly from exact resonance.

With oscillator keying, some method must be used to hold down the plate current of the amplifier when the key is up and there is no excitation. Fixed bias is the simplest method, and works out nicely in the present case since the operating bias required by the 815 in c.w. work is only 45 volts. A single 45-volt "B" block is convenient and costs comparatively little.

Here's a compact, simple-to-operate outfit for the ham whose primary interest is in c.w. operation in the 80-, 40- and 20-meter bands. Its cost is under twenty-five dollars— including tubes and crystal. Power supply requirements, too, can be met with a minimum of strain on the pocketbook.

Fig. 1 — Circuit diagram of the 75-watt transmitter.

- C<sub>1</sub> — 140- $\mu$ fd. per section dual midjet variable (Hammarlund HFD-140).
- C<sub>2</sub> — 140- $\mu$ fd. per section dual midjet variable (Hammarlund MCD-140-M).
- C<sub>3</sub> — 200- $\mu$ fd. mica.
- C<sub>4</sub> — 0.005- $\mu$ fd. paper, 1600-volt rating.
- C<sub>5</sub>, C<sub>6</sub>, C<sub>7</sub>, C<sub>8</sub> — 0.01- $\mu$ fd. paper, 600-volt rating.
- R<sub>1</sub> — 200 ohms,  $\frac{1}{2}$ -watt.
- R<sub>2</sub> — 20,000 ohms, 1-watt.
- R<sub>3</sub> — 20,000 ohms, 10-watt.
- R<sub>4</sub> — 6000 ohms, 25-watt.
- R<sub>5</sub>, R<sub>6</sub> — 5000 ohms, 25-watt.
- RFC<sub>1</sub> — 2.5-mh. r.f. choke (National R-100).
- RFC<sub>2</sub> — 1-mh. r.f. choke (National R-300).
- B — 60-ma. lamp.

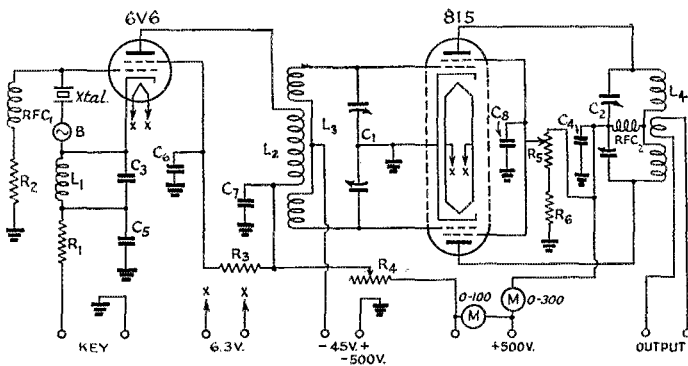

L<sub>1</sub> — 21 turns No. 24 d.s.c., close-wound,  $\frac{1}{2}$ -inch diam. (See Fig. 2 for specifications of L<sub>2</sub> and L<sub>3</sub>.)

### Construction

The front-view photograph shows how the main parts are mounted on a chassis which measures 3 by 5 by 10 inches. The 815 is centered between the front and rear edges,  $5\frac{1}{4}$  inches in from the right-hand end. The tube socket should be mounted with pins numbers 1 and 8 pointing toward the left-hand edge of the chassis; this allows the grid connections to be short and direct. Sockets for the 6L6, the 60-ma. bulb and the crystal are mounted in a line parallel with the left edge of the base. A socket for L<sub>2</sub>-L<sub>3</sub> is centered  $2\frac{5}{8}$  inches in from the left edge. C<sub>2</sub> and L<sub>4</sub> occupy the space between the 815 and the right end of the chassis. C<sub>2</sub> can be easily mounted by removing the small shield between the two sections so that a 6-32 machine screw may be slipped through the hole through which the lug passed, and the condenser bolted to the chassis. This method provides the insulated mounting which is essential to the type of circuit connection used.

The bottom view of the transmitter shows the arrangement of the components mounted below the chassis. All leads running to and from the unit terminate at the 10-terminal strip centered on the rear wall of the base. Although the circuit diagram shows the screen and plate returns of the 815 connected to a common terminal, it would probably be better to use a separate terminal for the screen circuit so that a milliammeter may be connected in the plate circuit alone. This will avoid the necessity for deducting the current flowing to the screen and its voltage divider from the reading of a meter in the "B" supply lead in order to obtain the plate current.

The cathode coil is held firmly in place by the cathode condenser with which it is in parallel. C<sub>1</sub> is mounted on the front wall of the chassis and has its shaft centered  $3\frac{3}{8}$  inches from the oscillator end. The rest of the parts may be laid

out in a convenient arrangement, keeping the r.f. leads as short as possible.

A word or two concerning the construction of the cathode coil: A sheet of paper should first be wrapped around a  $\frac{1}{2}$ -inch diameter form. The 21 turns of wire are then wound over the paper and are given a coat of Duco cement or coil-dope. Don't attempt to wind the coil without using the layer of paper, because the winding will stick to the form and the two will be difficult to separate.

### Operation

It is advisable to test the oscillator circuit first, and the plate and screen voltages should be removed from the 815 during this period. With voltage applied to the oscillator, the 815 grid circuit, C<sub>1</sub>L<sub>3</sub>, should be brought to resonance as indicated by maximum reading on a milliammeter connected in the amplifier grid-bias lead. The dropping resistor, R<sub>4</sub>, should be set at its full value of 6000 ohms during the preliminary testing; to secure proper plate voltage a final setting may be made when the power supply is completely loaded by the entire transmitter. The grid current should be in the neighborhood of 10 milliamperes on all three bands. The oscillator plate current will remain almost constant during this tuning, because relatively little power is taken from the oscillator circuit.

After the oscillator has been checked the amplifier may be put into operation. The screen voltage lead should be tapped in between the two 5000-ohm resistors, R<sub>5</sub> and R<sub>6</sub>; this reduces the voltage applied to the screen grid and thus provides a safety factor during the preliminary tests. With plate voltage and grid excitation applied, the off-resonance plate current should be 250 milliamperes or so, dropping to approximately 25 milliamperes with the plate circuit tuned to resonance. A load such as a lamp dummy should now be connected to the final tank circuit and the coupling adjusted (it may be necessary to wind a loop of several turns around the tank

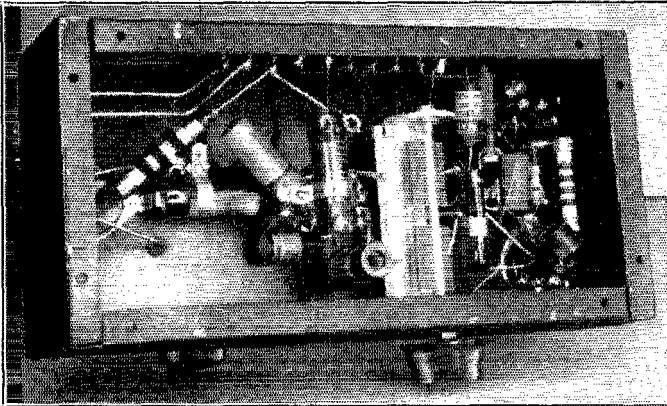

A bottom view of the transmitter. The fixed cathode coil may be seen at the lower right-hand corner. The variable condenser, C<sub>1</sub>, is tipped slightly so its frame will clear the tube socket mounted above.

coil to obtain proper coupling) to bring the on-resonance plate current to 150 milliamperes. Oscillator plate and amplifier screen-grid voltages may then be adjusted to 300 and 200 volts, respectively, by adjusting the taps on the two dropping resistors. It is probable that the amplifier plate current will either rise or fall at this point, depending upon whether the oscillator circuit and the 815 screen grid take more or less power than they did before. If the plate-current change is considerable it will be wise to reset the final load and then make another check of the various voltages.

With all voltages at the proper values it is to be expected that the various currents will be about as follows: oscillator plate, 40 milliamperes; 815 grid, 4 or 5 milliamperes; 815 plate, 150 milliamperes. It will be found that a grid current of 4 to 6 milliamperes gives the best output and that more grid current fails to increase either the output or efficiency. A meter inserted in the amplifier screen-grid circuit should show a current of 60 milliamperes; about four-fifths of this is taken by the voltage divider.

When the transmitter is in actual operation it may be observed that the amplifier plate current does not fall to complete cut-off when the excitation is removed. This is to be expected unless the power supply has such excellent regulation as to prevent any considerable increase in screen voltage when the load is greatly reduced. However, the plate current should drop to only a few milliamperes so long as the screen voltage does not reach a value which exceeds the normal voltage by more than 50 or 75 volts.

There is another reason why it is important to have good screen-voltage regulation. Should the amplifier be operated without a plate load, there is a possibility that self-oscillation will take place on the higher-frequency bands when the screen voltage goes above normal, because under

these conditions the tube's power sensitivity increases and stray feedback is maximum. Of course the transmitter is not normally worked without a load, and with normal loading there is practically no danger of self-oscillation, but it is just as well to make the outfit as stable as possible under conditions likely to be encountered only accidentally.

The amplifier plate coils are complete with links which permit working directly into a low-impedance line. This means that the amplifier may be fed into low-impedance (73 ohm) antenna feeders or that it may be link-coupled to an

amplifier operating at higher input. One of the antenna tuners described in the *Radio Amateur's Handbook* or the *A.R.R.L. Antenna Book* is recommended for those who intend using an antenna system which employs a high-impedance feed line.

### Power Supply Equipment

The circuit is arranged so that a single plate supply can be used to power the transmitter. A power supply of the type described on page 179 of the 1941 *Radio Amateur's Handbook* will handle the load called for by the complete unit. In any

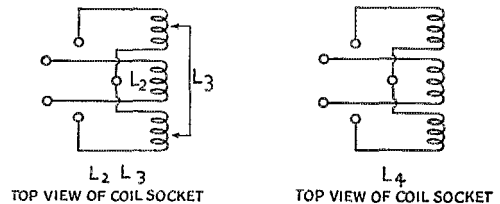

Fig. 2 — Coil connections and data.

- |  |  |
|--|--|
| <p><b>L<sub>2</sub></b><br/>3.5-Mc. — 17 turns No. 24 d.s.c.<br/>7-Mc. — 12 turns No. 22 d.s.c.<br/>14-Mc. — 9 turns No. 22 d.s.c.</p> | <p><b>L<sub>3</sub></b><br/>54 turns No. 28 d.s.c.<br/>27 turns each side of primary.<br/>22 turns No. 22 d.s.c.<br/>11 turns each side of primary.<br/>12 turns No. 22 d.s.c.<br/>6 turns each side of primary.</p> |
|--|--|

Coils wound on 1-inch diam. forms (Millen 45005). Approx. 1/8-inch spacing between windings.

- |   |
|---|
| <p><b>L<sub>4</sub></b><br/>3.5-Mc. — 40 turns No. 18, 1 3/4-inch diam., 2 3/8 inches long (B &amp; W 80-JVL).<br/>7-Mc. — 24 turns No. 16, 1 3/4-inch diam., 2 3/8 inches long (B &amp; W 40-JVL).<br/>14-Mc. — 14 turns No. 16, 1 3/4-inch diam., 2 3/8 inches long (B &amp; W 20-JVL).</p> |
|---|

Coils are wound in two sections with half the total number of turns each side of center. A 3/8-inch space is left at the center to permit the use of a swinging link. The Barker and Williamson coils are mounted on five-prong bases of the type which plug in tube sockets.

event, it is necessary that the supply be capable of delivering 500 volts at 250 milliamperes.

If it is more convenient or cheaper to use two lower-current supplies, the necessary modifica-

tion of the wiring can easily be made. A 300-volt, 100-ma. supply will suffice for the oscillator and the 815 screen, and a 500-volt, 150-ma. supply for the 815 plate.

# Announcing—1.8- and 28-Mc. W.A.S. Parties

**160-Meter Annual Event, February 14th-15th-16th—Ten-Meter Party, March 7th-8th-9th**

ONE of the most popular of operating events in recent years has been the annual 1.8-Mc. W.A.S. Party. We have another coming up this February, and in March a similar event for 28 Mc. 160-meter users have made this band high among the bands in individual interest. So we again announce this fraternal activity for testing what you can do with this frequency! Give 1.8-Mc. a twirl, selecting any 20 hours of the 57-hour contest period, February 14th-16th, to operate. See how many states you can work using the 160-meter band only! To compare merits of a high-frequency band in an equivalent period, we're trying the same operations plan, starting March 7th, for a 28-Mc. W.A.S. Party.

**Rules:** In the February period you contact only other 1.8-Mc. stations, in March only other 28-Mc. stations. Exchange signal reports and the name of the state you are located in. A given station can be worked but once for contest credit . . . and *each contact will net five points*. Add fifty points fixed credit if you include code proficiency evidence, either giving the date you got a Code Proficiency Award based on W1AW copy, or submitting copy made at any speed on the qualifying transmissions of February 21st<sup>1</sup> attached to the W.A.S. Party report.

**Multiplier:** Add the sum of all points as explained under the rules, and multiply by the *number of different states* in which any stations at all have been worked. (The District of Columbia also counts, for Maryland.) A last rule: All contest or party operations must take place in *any twenty hours*, or one or both of the following periods using the band mentioned.

*The February 14th-15th-16th—W.A.S. Party on 160 Meters*  
Starts — Friday, February 14th, 3 P.M. PST, 4 P.M. MST, 5 P.M. CST, or 6 P.M. EST.  
Ends — Monday, February 17th, 12:01 A.M. PST, 1:01 A.M. MST, or 2:01 A.M. CST, or 3:01 A.M. EST

<sup>1</sup> The fixed credit points for the February activity must be obtained by a claim based on February 21st copy (or a previous Award). In the March activity this 50-point credit to the score will have to depend on March 21st copy (or mention of a previous Award). Most hams should have one to refer back to by now.

*The March 7th-8th-9th W.A.S. Party on 10 meters*  
Starts — Friday, March 7th, 3 P.M. PST, 4 P.M. MST, 5 P.M. CST, or 6 P.M. EST.  
Ends — Monday, March 10th, 12:01 A.M. PST, 1:01 A.M. MST, 2:01 A.M. CST, or 3:01 A.M. EST.

Here are two operating opportunities, including a chance to test the relative merits of high and low frequency for contacting different states, with a comparable effort. It will not be safe to under-rate the capabilities of either band. All who are interested are urged to try *both* activities. Last year in the 160-meter doings, W1BFT worked 219 stations and W9JYW most states (41), five more than the best of the year before. Three other hams worked 40 states just in the short period of the Party. You will be surprised to see how many you can bag. Get in the 1.8-Mc. doings starting February 14th — and have the 28-Mc. gear tuned up for the early March comparative operating test. Let us know your results.

— F. E. H.

## Strays

A handy kink for quickly adjusting speed on a bug is to file the rod holding the weights slightly flat along the length of its top. Then adjust the set screw so that the weight will slide when the screw is in a vertical position, but will bind when turned slightly to one side or the other. — W9FB.

## WWV Schedules

DURING construction work on the new standard frequency station of the Bureau of Standards, the old schedule of transmissions has been discontinued. At present a 1-kw. transmitter is broadcasting continuously on 5000 kc. from 10 A.M. to midnight, E.S.T., every day except Sunday, using c.w. only. Telegraphic announcement of the call letters WWV is given every 20 minutes. Accuracy of the transmissions is better than one part in ten million.

A considerably enlarged service is contemplated when the new station is completed. Details will be given in *QST* as soon as available.

# A Simple 5- and 10-Meter Transmitter

*For Portable/Mobile and Home Station Use*

BY WILBERT L. THOMPSON\*

**W**ITH the lid clamped down on foreign DX, the high-power rig seems to be a waste of energy nowadays. Why not reduce power to the point where distances allowed can be spanned with some pride of accomplishment and at frequencies that are not jammed with QRM? For those who wish to "down" their power and "up" their frequency, this article describes a 5- and 10-meter 40-watt rig that can be operated as a mobile unit on 5 meters and in a fixed location on 10 meters, in compliance with F.C.C. ruling.

In spite of its orthodox appearance, as shown in the photographs, this little transmitter brought up some interesting points that I believe to be of interest. The front panel contains the meter which can be plugged into the crystal oscillator, r.f. amplifier and the modulator circuits. The left-

Here is a rig to satisfy anyone's yen for a small transmitter for the 5- and 10-meter bands. Small enough to make a good 56-Mc. mobile rig, it is large enough to provide plenty of 23-Mc. contacts from home.

hand dial tunes the 6J5G oscillator, the right-hand dial tunes the 807 amplifier, and the antenna is connected to the right-hand feed-through insulators. The jacks under the meter are, left to right, oscillator, amplifier, and modulator cathodes. The two red lamps indicate crystal current on the left and filament "on" on the right. The microphone jack and stand-by switch are immediately below. The bottom row left to right are the 6-volt receptacle, the audio gain control and the 400-volt d.c. receptacle. The entire unit is housed in a 7- by 9- by 15-inch metal case with a handle added.

\* 1107 Plum Street, Cincinnati, Ohio.

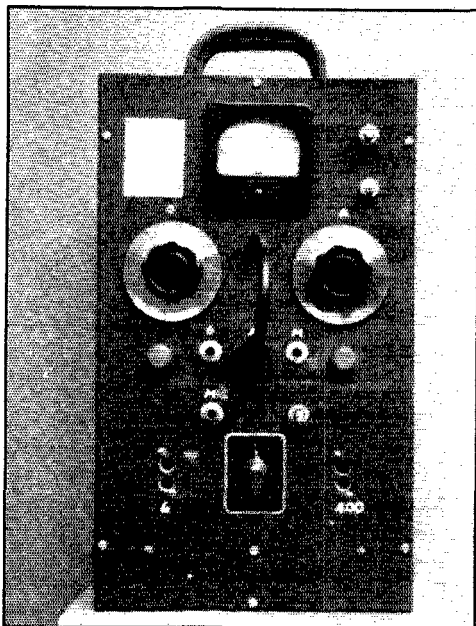

A 5 & 10 transmitter in a 7- by 9- by 15-inch cabinet, good for a 15- to 20-watt carrier. The two main dials control the oscillator and amplifier tuning, and below the dials can be seen jacks for metering the various cathode circuits. The two buttons directly below the dials are dial lamps used to indicate crystal current and filament "on".

There is nothing new or novel about the circuit. The original layout used a 40-meter crystal and a 6L6 quadrupling to 10 meters, with an 807 as a straight amplifier, but the new ruling of the F.C.C. caused the re-design so that 5 meters could be used for mobile work, leaving the 10-meter operation for fixed use only. As most fellows know, even the old stand-by circuits are often critical. With this in mind, care was taken in using fairly good parts and in making short leads. For reference, *QST* of January, 1938, the 1940 *Handbook*, and the Bliley Bulletin E-6 were read and re-read, but still the unit had several unsuspected "bugs."

In the 6J5G oscillator circuit, the only deviation from recommended practice was the grounding of the tank condenser. This offered no apparent difficulties. Much trouble was had, however, in making the oscillator function. This trouble was finally traced to a dirty crystal. I hope that anyone trying this circuit has a good crystal to start with, because much "trouble shooting" will be eliminated. Carbon resistors are recommended for the cathode. Wirewound resistors were tried, but found to be less satisfactory. In all cases, low-loss condensers should be used, not only for greater efficiency, but also because it may mean the difference between success and failure of the oscillator circuit.

The final amplifier circuit can be found in any radio book, hence no trouble should be expected

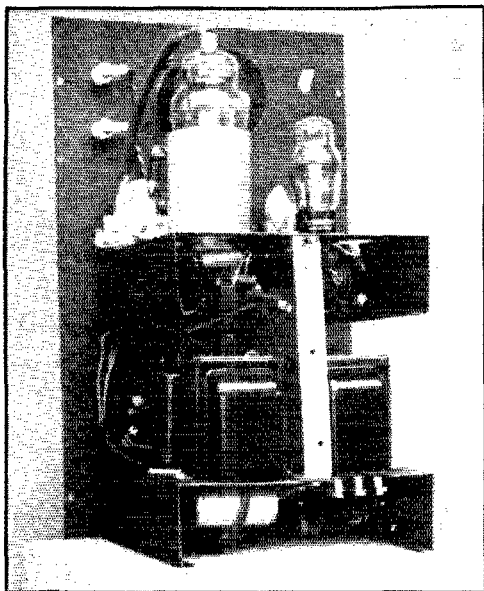

A rear view of the transmitter shows the r.f. portion on the upper chassis and the modulator below. The construction is conventional throughout.

here. Again Lady Luck frowned on this circuit, because a defective 807 resulted in considerable "trouble shooting." But RCA gives new "lamps" for old (with reservations).

For simplicity, no bias batteries were used on the 807 final, sufficient bias being developed by the grid leak. Screen-plate modulation was found entirely satisfactory, thus allowing for a simple modulation transformer. The output circuit can be any standard style to meet existing antennas. With mobile use in mind, link coupling with a short twisted feeder was used. Antennas of the half-wave or quarter-wave variety are very easy to use; in fact, odd lengths were tried with surprising results. The audio section is just as straightforward as the high-frequency section. A good single button carbon "mike" gave good intelligibility to the signal with plenty of drive. A 6N7 dual triode operated Class B gives good volume with good economy. The total current from a power pack of the vibrator or generator type doesn't exceed 150 ma. This keeps the mobile power-supply costs fairly low. Attention should be called to the lack of batteries. Microphone current is obtained from a resistor in the "B" minus lead, by-passed for audio frequencies. Any voltage from 2 to 10 seems to operate the

(Continued on page 26)

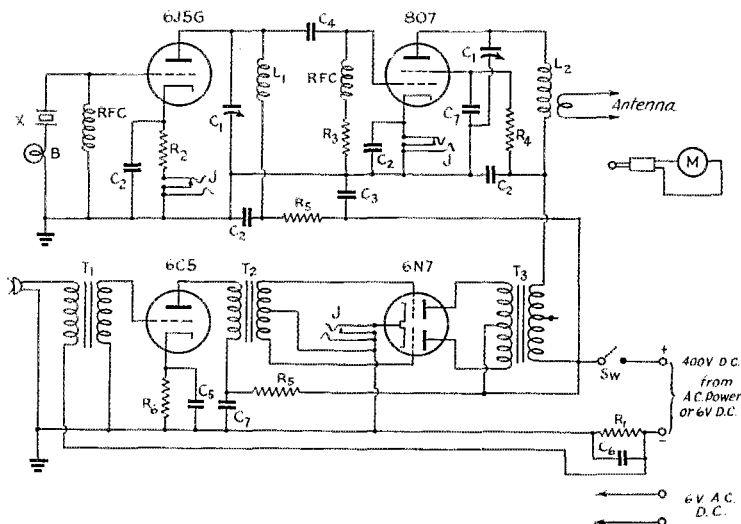

Fig. 1 — Circuit of the 5- and 10-meter transmitter.

- C<sub>1</sub> — 50  $\mu$ fd. variable.
- C<sub>2</sub> — 0.005  $\mu$ fd. mica.
- C<sub>3</sub>, C<sub>7</sub> — 0.1  $\mu$ fd. 600-volt.
- C<sub>4</sub> — 100  $\mu$ fd. mica.
- C<sub>5</sub> — 10  $\mu$ fd. 50-volt electrolytic.
- C<sub>6</sub> — 100- $\mu$ fd. 25-volt electrolytic.
- R<sub>1</sub> — 20 ohms, 10-watt.
- R<sub>2</sub> — 200 ohms, 2-watt.
- R<sub>3</sub> — 50,000 ohms, 1-watt.
- R<sub>4</sub> — 25,000 ohms, 10-watt.
- R<sub>5</sub> — 15,000 ohms, 10-watt.
- R<sub>6</sub> — 1000 ohms, 1-watt.
- T<sub>1</sub> — Microphone-to-grid transformer.

- T<sub>2</sub> — Single-plate to p. p. grids.
- T<sub>3</sub> — P.P. plates to r.f. load (6000 ohms).
- B — 2-volt 60-ma. bulb (or larger—up to 200 ma.).
- X — 10-meter crystal (Bliley).
- M — 0-100 milliammeter.
- Sw — S.p.s.t. toggle switch.
- RFC — 2.1-mh. chokes 125 ma.
- J — Closed circuit jack.
- L<sub>1</sub> — 6 t. No. 12 wire  $\frac{3}{4}$ " diameter spaced diameter of wire.
- L<sub>2</sub> — Commercial 10-meter plug-in coil. Same for 5 meters.

# ★ WHAT THE LEAGUE IS DOING ★

## ARMY QUESTIONNAIRE

AROUND the first of February the Army is sending a questionnaire to every amateur listed in the callbook, the work being done in each corps area signal office with the assistance of local A.A.R.S. members. The purpose is to acquire data for statistical studies by the War Department in connection with national defense. The Army stresses that the return of the questionnaire does not obligate the amateur in any manner nor constitute "registration," but they do need to have a better statistical knowledge of the physical and economic status of the amateur body as a whole. It is, therefore, hoped that every amateur will promptly fill out and file the forms.

The usual questions on personal data are asked, including code proficiency, military status, education, occupation, dependents. If not physically fit for military service, the amateur is asked to state if he would be interested in participating with his station in an aircraft warning net, and to give particulars on his availability for civilian hire as a fixed-station operator or as a radio instructor or technician. In connection with station participation, a brief description of the transmitter is asked.

It is expected that this survey will incidentally help publicize the A.A.R.S. and encourage amateurs to affiliate with it.

This seems a needed study and we are confident that amateurs will cooperate and fill out the forms promptly.

## NEW DIRECTORS ELECTED

SEVERAL changes in the A.R.R.L. Board of Directors resulted from the 1940 elections, in addition to Karl W. Weingarten's succession to the Northwestern Division as previously reported. By divisions, the story is as follows:

### CENTRAL

In the Central Division, seven candidates were active in the race to succeed R. H. G. Mathews, W9ZN, who was not a candidate. Goodwin L. Dosland, W9TSN, was the successful candidate by a goodly plurality:

Mr. Dosland . . . . .	568
James A. Eberhart, W8KKW . . . . .	74
Jesse O. Ellison, W8COW . . . . .	210
Mayer A. Griswold, W8JXM . . . . .	72
Willard E. Henderson, W8ORM . . . . .	33
Erwin W. Kreis, W9HRM . . . . .	305
Adam F. Moranty, W8CZT . . . . .	168

The competition for alternate director in this division was between Stuart H. Gates, W9CNE,

and John A. Kiener, W8AVH. Mr. Gates won handily, 831 to 591.

Mr. Dosland, having been an assistant director of the Central Division since 1937, is no stranger to League affairs. He is by profession an attorney. He has had an active career in the organized amateur activities of the Chicago area and was chairman of the committee for the last national convention held in Chicago. He is a lieutenant (j.g.) in the U.S.N.R. and commander of the local unit of the N.C.R.

Mr. Gates, who resides in Louisville, is a division transmission engineer for the Southern Bell Telephone & Telegraph Company and has likewise been actively associated with amateur clubs in his vicinity for many years.

### HUDSON

The Hudson Division provided an upset in selecting Robert A. Kirkman, W2DSY, to succeed Kenneth T. Hill, W2AHC, its director for many years. Mr. Kirkman received 776 votes, Mr. Hill 265.

Mr. Kirkman, 26 years old, is connected with the engineering department of New York's municipal broadcasting station, and has been an amateur for eight years. Robert M. Morris, W2LV, was reelected alternate director without competition.

### NEW ENGLAND

Percy C. Noble, W1BVR, the incumbent New England director, was returned by a good majority over his only competitor, Floyd L. Vanderpoel, W1WR. For Mr. Noble, 545 votes; for Mr. Vanderpoel, 286.

In the election for alternate, Clayton C. Gordon, W1HRC, won by a somewhat smaller majority over Winfield A. Ramsdell, W1FBJ, 490 votes to 334.

Mr. Gordon is in the plant department of the American Telephone & Telegraph Company in Providence. He has been our S.C.M. for Rhode Island since 1935 and an assistant director of his division since 1938. He is active in the A.A.R.S. and is, of course, an O.R.S. and a member of the A-1 Operator Club.

### ROCKY MOUNTAIN

Two years ago, Glen R. Glasscock, W9FA, won the Rocky Mountain election over C. Raymond Stedman, W9CAA, by a margin of but one vote. This year it was Mr. Stedman's time, and he has become the new director by a vote of 121 to 62. Charles W. Duree, W9EII, remains the alternate.



Mr. Stedman is associated with the Mountain States Telephone & Telegraph Company. He has been active in Denver amateur affairs for fifteen years and is our Emergency Coördinator for the Denver area, as well as O.R.S., A.E.C., A-1 Operator, etc. He was S.C.M. for Colorado from 1926 to '30.

Thus, there are four new faces on the A.R.R.L. Board this year. In welcoming the new directors, *QST* wishes to express to the outgoing directors the gratitude and appreciation that the League feels for their contributions of heart and mind to the advancement of amateur affairs.

Voting in our elections is now almost entirely by licensed amateurs. A few votes are still cast by persons entitled to the ballot only by virtue of uninterrupted membership in the League since 1934, but in this Central Division election there were but 28 such votes cast, or 1.96% of the total; in the Hudson Division, 38 or 3.65%; in the New England, 22 or 2.65%; in the Rocky Mountain, 4 or 2.19%.

#### DEFENSE COMMUNICATIONS BOARD

THE Defense Communications Board promises to be the most important agency in the control of radio in the months immediately to come. During December, the formation of committees was completed. It will be remembered that one of the eleven committees is an Amateur Radio Committee. Membership throughout this work is by organizations. In the case of our committee, the membership consists of F.C.C., the War and Navy Departments, the N.Y.A., the American Legion Net and the A.R.R.L. In the particular case of the League, the organization provides that A.R.R.L. is to be represented by one member and six advisers, to be selected on a "regional basis to represent radiotelegraph and radiotelephone amateurs and amateur emergency nets."

Pursuant to this directive, the League chose President George W. Bailey as its representative and Secretary K. B. Warner as his alternate and expert adviser. For the six regional advisers, and having in mind an appropriate distribution between 'phone and c.w. networks, the following: H. L. Caveness, W4DW; William A. Green, W5BKH; Kenneth T. Hill, W2AHC; J. L. McCargar, W6EY; Fred H. Schnell, W9UZ; Burton T. Simpson, W8CPC.

The D.C.B. committees commence active work in early January and there should be some more news shortly.

#### PROOF-OF-USE WAIVED

WE HAVE made several mentions that the League was promoting with F.C.C. an order that would permit the renewal of amateur licenses by conscripts and others in the military service upon a showing that they were so serving, waiving the customarily-required proof of use of licenses as a

condition to renewal. F.C.C. has now gone even further and, as an aid to those in the military services, has *suspended* until January 1, 1942, its rules requiring proof of satisfactory service in connection with commercial operator licenses and its rules requiring proof of use for renewal of amateur station and operator tickets. Order No. 77 of the Commission, effective December 4th, suspended Secs. 12.26 and 12.66 of the amateur rules until further order, but not beyond next January 1st.

This means that amateur licenses may now be renewed without showing three stations worked within ninety days of filing renewal application, etc. Until further notice, amateur applicants may simply *leave blank* those portions of the application showing use of licenses.

#### I.C.W. ON 160

OUR correspondence shows that there is some confusion about the use of the telegraph code in the 1750-2050-ke. band. While every amateur seems to know that the regulations do not authorize the use of A-2 tone-modulated telegraphy, some amateurs seem to think that it is all right to send code in the 1800-2050-ke. 'phone portion of this band by means of a buzzer or audio oscillator placed before the microphone of a 'phone transmitter, holding that this is A-3 emission.

Beyond failing to authorize A-2, the regulations themselves are silent on this subject. However, as previously reported in *QST*, it has been dealt with by a minute of the F.C.C. In the bands where A-2 is not authorized, such as the 160 band, Morse from an audio source before the microphone may be used only in the following circumstances: (1) In the transmission of lessons in the international Morse code where alternate transmissions of voice and code characters must be received on the same frequency with the same receiver; (2) to aid in identifying the call letters of the transmitting station. Other than that, 'phone stations are licensed only for A-3 emission, and general communication by means of the code is forbidden 'phone transmitters.

#### DIATHERMY-QRM CONFERENCE

PROGRESS in reducing diathermy QRM by establishing minimum standards of good engineering practice in operating electro-medical equipment should result from an informal conference held by F.C.C. on November 29th. In attendance, under the chairmanship of Chief Engineer Jett, were representatives of medical organizations, diathermy equipment manufacturers, broadcasting, manufacturing and communication companies, as well as people from the government agencies. A.R.R.L., of course, represented the radio amateur — through its research engineer, J. J. Lamb. The program followed the outline proposed in the Inter-American Agreement of Santiago. These recommended adoption of a

few specified frequencies exclusively for diathermy, close adherence to these assignments with good stability, and minimum radiation.

In the discussions there was general agreement on a lowest frequency somewhere around 13 Mc., with a second harmonically-related assignment around 26 Mc., a third around 39 Mc., and a possible fourth frequency above 100 Mc. — all provided, of course, the F.C.C. could find channels available. There was divergence, however, on frequency stability, ordinary good engineering practice calling for 0.05% and diathermy manufacturers insisting they couldn't do better than 0.5% (10 times as bad) without making the equipment too expensive. A technical committee was appointed to iron out this wide divergence but has not yet reported. Present equipment has a stability no better than plus or minus 30%, by the way.

Everybody agreed that A-0 (pure d.c.) should be the type of emission — which would at least get rid of those awful splatter notes — and that harmonic radiation could be held under 1%. Maximum output of 400 watts met no objection. There was no agreement on the efficiency of shielding and r.f. line filters, however, although the latter are already specified by the Council on Physical Therapy. "How-to-build-it" articles on diathermy equipment in radio magazines were condemned — and *QST*'s policy against this practice was pointed out.

If the technical committee can arrive at an acceptable figure for frequency instability tolerance, and F.C.C. can find available channels into which the emissions can be fitted, the situation should improve so far as new apparatus is concerned. But with no agreement on the matter of shielding or remodeling existing apparatus to comply with good engineering standards there will still be a lot of diathermy QRM. Really effective technical measures should be taken at once — or the diathermy field may be faced with the total shut-down for all equipment in private hands which has been found absolutely necessary in England because the interference to essential radio communications was not earlier alleviated by adoption of good engineering practice.

#### CLIP IT OUT!

**WHENEVER** you see a reference to amateur radio in a newspaper, magazine or other nonradio publication, please clip it out and send it in to the League. Some members have made a habit of doing that through the years, and it has been a big help to us. One of the League's jobs is to maintain a public opinion generally favorable toward amateur radio, and press mentions are a pretty good barometer of public opinion. Moreover, misinformation and unfavorable mentions can often be counteracted by prompt action (action which the on-the-scene amateur himself is often in the best position to take, by the way).

Vigilance in such matters is important in times like these. So clip anything you see having a bearing on ham activities, and send it along. The same thing applies to remarks heard over the broadcast band, too, of course; write down anything you hear and mail it in.

#### WORKING AMERICAN SHIPS

**WE** AGAIN call attention to the fact that, since the advent of Order No. 72, only those amateurs who are specially authorized are permitted to communicate with the ships of expeditions, etc.

By its Order 72-G, F.C.C. has authorized the following amateurs to communicate with KGMX aboard the *Lascaz II*: W4FCF, W6PGB, W9WGL, W1MWK, W3BWT and W3AEA.

#### AMATEUR EXAMINATIONS IN 1941

**THE** Federal Communications Commission will give amateur examinations during 1941 on the following schedule. Remember this list when you need to know when and where examinations will occur. Where exact dates or places are not shown below, information may be obtained, as the date approaches, from the Inspector in Charge of the district. No examinations are given on national or state holidays. All examinations begin promptly at 9 A.M., local time, except New Orleans and Honolulu at 8:30 A.M., and as may be noted below.

Boston, 7th floor Customhouse: Daily except Thursday.  
New York City, 748 Federal Bldg., 641 Washington St.:  
Class A, daily; Class B, Tuesdays, Thursdays, Saturdays.  
Schenectady, N. Y.: Two sessions at 1 P.M. and 7 P.M.:  
March 5th, 6th; June 11th, 12th; Sept. 10th, 11th;  
Dec. 10th, 11th.  
Philadelphia, 1200 Customhouse: Class A, daily; Class B,  
Wednesdays and Saturdays.  
Baltimore, Fort McHenry: Wednesdays and Saturdays.  
Norfolk, Va., 402 New P.O. Bldg.: Class A, daily; Class B,  
Fridays and Saturdays.  
Winston-Salem, N. C.: Feb. 1st, May 3rd, Aug. 2nd,  
Nov. 1st.  
Atlanta, 411 Federal Annex: Tuesdays, Fridays and  
Saturdays.  
Nashville: Feb. 21st, May 16th, Aug. 15th, Nov. 21st.  
Miami, 314 Federal Bldg. (P.O. Box 150): Tuesdays and  
Saturdays.  
Jacksonville, Fla.: May 17th, Nov. 22nd.  
New Orleans, 308 Customhouse: Mondays; other days by  
appointment.  
Little Rock: April 22nd, Sept. 16th.  
Galveston, 404 Federal Bldg.: Wednesdays, Fridays and  
Saturdays.  
Dallas, 500 U. S. Terminal Annex Bldg.: Tuesdays and  
Saturdays.  
Oklahoma City: Jan. 25th, April 26th, July 26th, Oct. 25th.  
San Antonio: Feb. 15th, May 24th, Aug. 23rd, Nov. 22nd.  
Albuquerque: March 29, Sept. 27th.  
Los Angeles, 1749 U. S. P.O. & Courthouse Bldg.: Wednes-  
days and Saturdays.  
Phoenix, Arizona: Two days in April, two days in October.  
San Francisco, 323 Customhouse: Class A, daily; Class B,  
Mondays and Saturdays.  
Portland, Oregon, 207 New U. S. Courthouse: Fridays and  
Saturdays.  
Boise, Idaho: Some time in April and in October.  
Seattle, 808 Federal Office Bldg.: Fridays.

(Continued on page 90)



aiding the nation in any emergency period through examination of the practical prospect for establishment of a Communication Reserve for the Home Guard and perhaps more important home purposes. Without passing on the scope or limitations of its functioning in any manner, we are first interested in the basis for such an organization, which can only be known through your expressions. Many League members who are over draft age, or who have a special physical disability, or perhaps have registered but find themselves in a deferred classification with a remote possibility of call, have written us to ask what they could do. Which amateurs (and how many) would be in a position to volunteer their stations or their services or both for some future time of need? Without promising immediate radio activity in such a group, but in order to create a basis for organization of practical groups of this nature, we are asking every amateur who feels that he would be in a position to participate in such plans for home guard communications to register completely his availability, and his station frequency and power, and similarly those interested in radio jobs.

**Register** if you have a reasonably good radio education or some special radio skill, and if you are available for a better radio job in any line.

**Register** if not eligible for military service due to age, disability, dependents, or other reason, or if eligible but on a deferred basis—and if you would be willing to volunteer your operating services and amateur station equipment, if authorized to do so.

**Do not register** if you have neither technical abilities nor available operating time, nor if you are designated for military training within six months, belong to N.C.R. or National Guard, etc., so as not to have either technical or radio operating availability. Registration may help A.R.R.L. to help you.

— F. E. H.

## A Simple 5- and 10-Meter Transmitter

(Continued from page 21)

average microphone well. The entire audio is mounted on the lower deck of the unit.

The oscillator plate current runs 20 to 25 ma. when tuned to resonance. Unlike common grid-leak-biased tubes, resonance is indicated by maximum plate current. The final amplifier plate dips to 20 or 25 milliamperes. Since the meter is in the cathode circuit, it reads combined grid, screen grid, and plate current. The grid current of only a few milliamperes is disregarded in the meter reading. With 8-10 milliamperes screen current I find that the drive to the 807 final is sufficient. This results in fairly good efficiency on 10 meters. With antenna or dummy load, it is possible to load up the final to about 55 ma. This results in a power input of approximately 22 watts and an output of about 12 watts.

A jack was included in the modulator plate circuit more for convenience than necessity, so that the meter can be used as a volume indicator if desired. The no-signal current runs about 40 ma., while average speech sends the current up to 60 ma. Steady sine wave input for maximum output (100 per cent modulation) runs about 70 ma.

While this transmitter was originally designed for portable and portable-mobile use on 5 and 10 meters, it seems not undesirable to have one of these units around the shack for emergency or local rag chews. With the commercial plug-in coils and several crystals, band change can be quickly accomplished. In spite of the difficulties encountered, this little outfit gave much satisfaction in its operation and appearance.

I wish to express my appreciation to W8QOG, Queen City Radio Club, for the tests on the signal, Mr. W. Cheshire, W8UPC, and Mr. W. A. Phillips and his associates in the laboratory for their assistance.



### Got Your Code Certificate Yet?

Have you got your code attainment award certificate from A.R.R.L.? This League award is available to every United States amateur licensed. The program aims to recognize your code ability. WIAW practice transmissions take place on 1761, 3825, 7280, 14,253 and 28,510 kcs. daily except Friday starting at 9:15 p.m. C.S.T. These will help you add to your ability to read code the knack of copying code. It is time now to prepare for the next official qualifying run from WIAW which will take place Friday, February 21st at 9:30 p.m. C.S.T. Aim to get your certificate or endorsement sticker for higher speed on that date.

# U.H.F. Superhet Design for Improved Performance in Audio and Video Reception

In Two Parts — Part I, The R.F. Circuit and Constructional Details \*

BY DANA A. GRIFFIN,\*\* W2AOE

Experience with amateur television communication is teaching us some new things about receiver design which are fully as useful for improving voice work as for getting better pictures. Here W2AOE introduces us to the details of the receiver with which he set up the amateur television records reported in December *QST*.

ALTHOUGH the receiver to be described is in many respects similar to the original model described in *QST*,<sup>1</sup> the mechanical layout has been changed for rack mounting, higher i.f. gain has been included and an r.f. stage has been added. The electrical changes are all directed to securing higher sensitivity. It is significant that no major changes have been found necessary in the video circuits; they proved very satisfactory.

To the constructor who may be discouraged by the strangeness of these video circuits, be of good cheer. While they are strange and look complex, they are extremely simple electrically and completely fool-proof in operation. As long as the right values of resistance and capacity are used in the right places, the video circuits will work. No alignment or trimming is necessary, as is the case with the more familiar r.f. circuits. The i.f. amplifier is also very simple, being much easier to build than the typical communications type. Alignment, too, is easier. The r.f. end is a bit more difficult but, again, those who have had experience with u.h.f. receivers will find no new problems here. With the advantage of some experience on a previous model, this receiver took but seven working days to construct. Parts cost was approximately forty dollars for tubes and forty-five dollars for the remainder of the material. Test equipment should include an all-wave test oscillator, volt-ohmmeter and an oscilloscope if possible. While the latter is not essential, it enables instantaneous checks on the oscillator circuits that must be otherwise checked by point-to-point voltmeter tests.

\* The second part of this article will appear in a following issue of *QST*.

\*\* 742 Central St., Plainfield, N. J.

<sup>1</sup> J. B. Sherman, "A Receiver for the New Amateur Television System," *QST*, June, 1940.

To summarize the television requirements, we need a receiver to build up the signal level, a video amplifier to supply the "picture details" and the blanking impulses to the Kinescope, two saw-tooth sweep oscillators, a sync separator to lock them into step, a scanning amplifier, and lastly two power supplies. The one supplies 1500 volts to the Kinescope anode, the bleeder string and 750 volts to the scanning amplifier plate. The other, a 300-volt supply, takes care of all other tube requirements. For purposes of simplicity, the diagram has been broken up into two sections, the r.f. section being detailed in Fig. 1 and the other equipment, including power supplies, in a second diagram to be given in Part II.

The circuit of the superhet should be of interest to all u.h.f. experimenters because it offers excellent utility for audio as well as video reception. While the band-width is far greater than required for 'phone reception generally, the i.f. channel is sufficiently flexible so that it can be sharpened up materially making it possible to secure extremely high gain and the proper amount of selectivity for 112-Mc. 'phone work. The tuned-grid tuned-plate r.f. amplifier was first employed by the writer several years ago in a regenerative preselector for 28- and 56-Mc. operation. Naturally we cannot stand for any regeneration in television circuits, but with proper by-passing and close coupling of the antenna this effect is completely eliminated. The circuit still affords the maximum amount of gain that can be obtained at these frequencies and still pass the required band width. The first detector is the sensitive

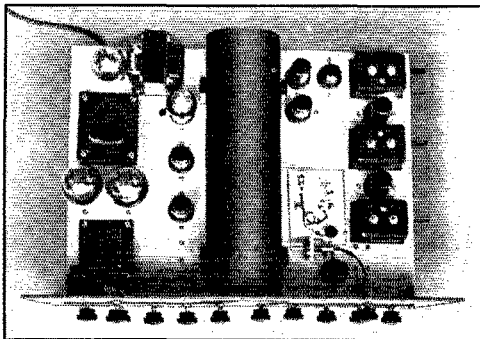

Top view of the complete receiver ready for standard relay-rack mounting.

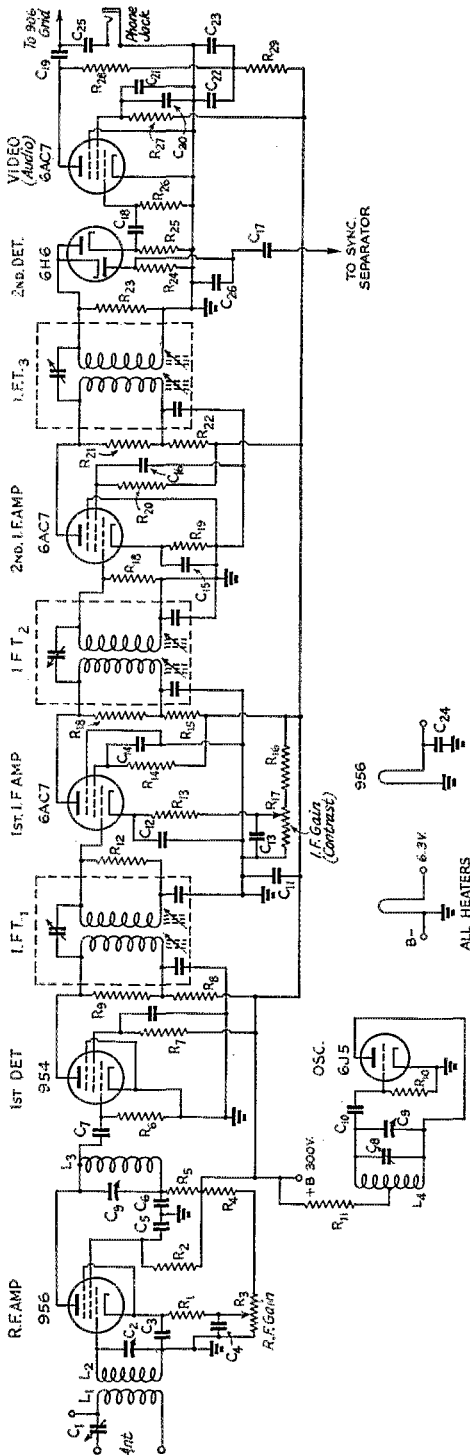

Fig. 1 -- Circuit of the receivers' r.f. section.

- R1 — 1000 ohms, ½ w.
- R2 — 250,000 ohms, ½ w.
- R3 — 10,000-ohm pot.
- R4 — 250,000 ohms, ½ w.
- R5 — 5,000 ohms, ½ w.
- R6 — 2 meg., ½ w.
- R7 — 500,000 ohms, ½ w.
- R8 — 5,000 ohms, ½ w.
- R9 — 20,000 ohms, ½ w.
- R10 — 30,000 ohms, ½ w.
- R11 — 20,000 ohms, 2 w.
- R12 — 20,000 ohms, ½ w.
- R13 — 200 ohms, ½ w.
- R14 — 60,000 ohms, ½ w.
- R15 — 5,000 ohms, ½ w.
- R16 — 250,000 ohms, ½ w.
- R17 — 10,000-ohm pot.
- R18 — 20,000 ohms, ½ w.
- R19 — 200 ohms, ½ w.
- R20 — 60,000 ohms, ½ w.
- R21 — 20,000 ohms, ½ w.
- R22 — 5,000 ohms, ½ w.
- R23, R24 — 20,000 ohms, ½ w.
- R25 — 10,000 ohms, ½ w.
- R26 — 500,000 ohms, ½ w.
- R27 — 75,000 ohms, ½ w.
- R28, R29 — 10,000 ohms, 1 w.
- (All resistors are I.R.C.)
- C1 — 3-30-μfd. mica trimmer.
- C2 — National UM 15, all plate off but one rotor, two stators each section.
- C3 — 0.002-μfd. mica.
- C4 — 5-μfd., 25-v. electrolytic.
- C5, C6 — 0.002-μfd. mica.
- C7 — 25-μfd. mica.
- C8 — 3-30-μfd. trimmer.
- C9 — National UM 15, 2 rotor 2 stators each section.
- C10 — 25-μfd. mica.
- C11 — 0.002-μfd. mica.
- C12 — 0.01-μfd. mica.
- C13 — 5-μfd., 25-v. electrolytic.
- C14 — 0.002-μfd. mica.
- C15 — 0.01-μfd. mica.
- C16 — 0.002-μfd. mica.
- C17 — 0.1-μfd. paper, 400 v.
- C18 — 0.25-μfd. paper, 200 v.
- C19 — 0.05-μfd. paper, 600 v.
- C20, C22 — 0.002-μfd. mica.
- C21, C23 — 4-μfd., 450-v. electrolytic.
- C24 — 0.002-μfd. mica.
- C25 — 0.01-μfd., 400-v. paper.
- C26 — 0.001-μfd. mica.

(All fixed capacitors are Cornell-Dubilier.)

- L1 — One turn, ½" diam.
- L2 — 4 turns, ½" diam., No. 20 wire.
- L3 — 4 turns, ⅜" diam., No. 22 wire.
- L4 — 3 turns, ¼" diam., No. 22 wire.

All coils mounted directly on condensers.

IFT-Standard Meissner 12.5-Mc. Television I.F. Transformers. Parts in dotted lines are included with i.f. transformers.

Chassis, 13" x 17" x 3" (Heavy-duty Parmetal).  
Panel, 8¼" x 19".

grid leak type. The oscillator is of the grounded cathode type to insure freedom from hum and a fairly high-*C* circuit is used to cut down drift. Coupling to the first mixer is secured by virtue of the location of the oscillator close to the first detector, no extra coupling coils or condensers being necessary. The i.f. amplifier uses two 6AC7/1852 tubes with standard Meissner television transformers. These stock units are very flexible in that the mutual coupling between the windings is varied by means of a 3-30 mica trimmer. Choice of padding resistors and the amount of coupling condenser make possible a range in band-width all the way from the 2-Mc. requirements of commercial television down to about 100 kc. for voice work. The values indicated give a band-width identical with that specified by Sherman,<sup>1</sup> that is, down 50% at 500 kc. either side of resonance. As no a.v.c. or b.f.o. is needed, the actual wiring is much simpler than in the conventional superhet receiver.

Gain controls are provided in both the r.f. and i.f. amplifiers for complete flexibility. The r.f. stage is separately tuned, since it is next to impossible at these frequencies to do an accurate tracking job; and if we are going to trim we might as well make the trimmer the tuning condenser as

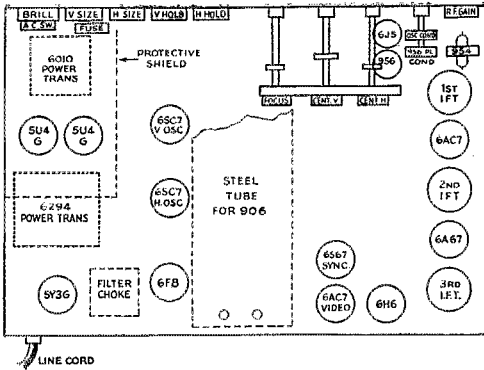

Fig. 2 — Location plan of principal components and controls as viewed from the bottom of the chassis.

well. Acorn tubes are used for the r.f. amplifier and first detector because they are the only tubes that give appreciable gain at these frequencies with a respectable signal-to-noise ratio.

The controls used on the receiver are twelve in number. Before anyone starts comparing it with the original one-tube blooper on this score, it might be well to point out that the adjustment of the majority of them is semi-permanent. In actual practice only four of these controls require operating adjustment. Across the bottom row from left to right we have the a.c. switch-brilliance control, which adjusts the intensity of the electron beam and consequently the brilliance of the picture. Following this are the vertical and horizontal "size" controls. These control the amplitude of sweep voltage fed to the deflection plates of the 906 and thereby control the size of the picture. Then come the vertical and horizontal "hold" controls. These controls are important because they are used to adjust the frequencies of the saw-tooth oscillators closely enough to the frequencies of the sync pulses of the transmitter so they will lock into step. Then we have the focusing control which accurately narrows the beam reaching the screen to give us a picture without fuzziness. The vertical and horizontal centering controls follow. These controls put a d.c. bias on the deflection plates so that the beam, and hence the picture, is centered on the screen. The next control is the tuning control of the u.h.f. oscillator and first detector, followed by the r.f. gain control. Immediately above the detector tuning is the r.f. grid tuning control. Balancing the appearance of the panel, on the other side of the 906, is the i.f. gain (contrast) control.

### Mechanical Construction and Wiring

The mechanical considerations in the design of the receiver are of course a bit unorthodox, but no serious departure from standard practice is necessary. The apparatus is mounted on a heavy duty chassis 13 × 17 × 3 inches and an 8 3/4" × 19" standard rack panel is used. The photographs and the layout sketch indicate the position of the principal components quite clearly. The complete unit fits in a standard cabinet designed for this size of panel, and the mounted receiver is a job that no one need be ashamed of insofar as appearance is concerned.

Careful attention to the layout of the apparatus used in the r.f. and i.f. circuits has made possible an assembly in which one can secure extremely short leads. The importance of this cannot be too strongly emphasized. In fact, it is a good idea to use one of the small soldering "pencils" to cope effectively with the problem of getting into some of the tighter spots. An ordinary large iron simply will not do.

The mounting of the r.f. and i.f. components is very important if stability is to be insured. Close adherence to the layout given is recommended to insure freedom from regeneration or oscillation. The antenna tuning components are mounted on a piece of polystyrene directly in back of the grid circuit of the r.f. amplifier. This grid circuit is tuned by means of a flexible coupling to get the circuit in the best position for short leads. The grid of the tube projects up through the chassis (which acts as a shield) to make a very compact input circuit. The plate end of the r.f. amplifier projects downward very close to its tuned plate circuit which sits right behind the oscillator circuit with which it is ganged. The detector tube is mounted on the side of the chassis by means of

(Continued on page 90)

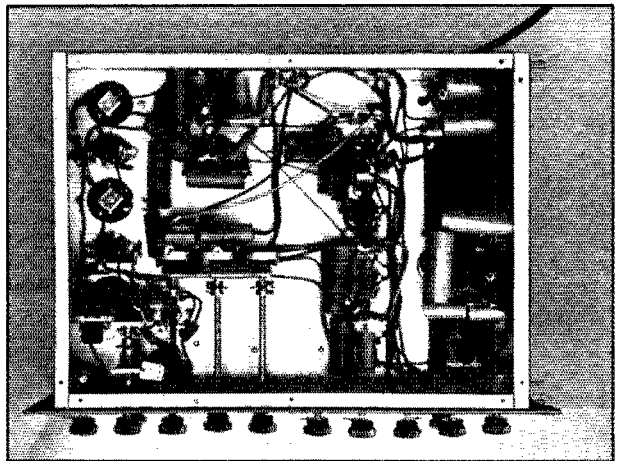

Under-chassis view, illustrating the accessibility of the i.f. coupling adjustments at the right.

# Self-Training Hints for Voice Operators

BY F. E. HANDY,\* WIBDI

This article calls upon voice operators to help train transmitting operators to use correct talking speeds so words can be written down. The Communications Department aim is to achieve top accuracy if possible . . . ham-to-ham courtesy and efficiency likewise can be improved at the same time.

ONE of the reasons why radiotelephone operating is not as accurate as radiotelegraph is the lack of proper self-training by the 'phone operator, to judge by an article in the Associated Police Communication Officers Bulletin. Les Wiechers, oldest two-way police radio telephone operator in Wisconsin, concludes with the appeal, "Train yourselves. . . ." directed at police station personnel, not amateurs. The lesson is one that we amateurs ought not to miss in these times, however. In gaining code proficiency *some* knowledge of procedure and of message handling customs and forms usually is included. The best voice operators are those who have had some such systematic training before becoming voice operators. Our trouble is that in too many cases the telephone operator has taken the most rudimentary interest and training in the *operation* of his equipment. His first love has been to get the shiny tubes and coils and condensers in the most superlative state of adjustment. His real experience in handling messages or recorded communicating work has been almost nil, except for occasional emergency opportunity. This amateur, as perhaps many, has gained all his experience building and rebuilding. His pleasure has been in lackadaisical and entertaining contacts with fellow amateurs — often finding it a struggle even to keep a commendable log, as per the F.C.C. requirements. He has felt that there was "nothing to know" about operating technique. It is this sort of a background that in cases of emergency communication has brought complaints from certain agencies served that voice operators were delivering duplicate messages, and garbled messages and undecipherable messages, and that something ought to be done about it.

Training, operator and operating training, is what is indicated as the need. Many c.w. telegraph operators in the amateur ranks have a distance to go to be *really* good, to perfect mill technique and spelling, and their ability to put ten groups on a line to facilitate check! But

\*Communications Manager, A.R.R.L.

voice operators, most of all those who have given themselves little operator training, should take an interest in the productive and fascinating business of "how to operate" most effectively. Many useful and sensible operating hints are contained in the article, "Say It with Words" (June 1940 *QST*), and we don't propose to repeat all that so soon in *QST*. Here are just a couple of hints — assuming that in the interest of national defense some of you telephoning hams are starting some message-handling nets and practice with your P.A.M. We have some plans underway for registration for "home guard" communicating possibilities. There will be practice and fun possible (and useful service to the country too!) in handling messages home from the boys in the camps and training schools. But to be able to get in on this fun, and at the same time to more or less justify Uncle Sam's confidence in giving you a radio call, it is necessary whether your work is code or 'phone **TO HAVE TRAINING**. There is no time to start making some schedules for the purpose of operator studies and self-training like right now! There's no kick like that of knowing you *can* do a communicating stunt and do it well, whenever the need comes up. Only advance self-training can make us ready.

Now for those hints: The first step in assuring accuracy, the first step in preventing distortions of information, that in a series of relays make it so garbled its own originator cannot recognize it, is for each operator to **COPY JUST WHAT IS SENT**. Many voice operators do not even take notes, resulting in many repeated questions, and quite a few trips over the same ground to get a given idea over, even when the transmissions go no further than one station and there is no attempt at exactitude! The best casual voice operators always take notes, so they haven't forgotten all of a general conversation and so they do not have to stumble and stutter and delay the game when it comes time to reply. This is nothing but a courtesy due fellow ham operators! But now we want to go beyond casual operating. It has been found that even note taking with repetitions of information results in the loss of particular and concise meanings. In the Ohio flood some years ago this sort of business caused the conveyance of some information as never intended by the originator! Inaccuracy may be prevented by making a habit of always copying *just what is sent!*

The point is that the message must be written down, not as a note, not as a memo, not in abbreviated form, but *exactly as the transmitting operator sends it*. It must be retransmitted word for



word just as received, also! But you may say that the other fellow talks too fast for you? You cannot get it down if you spell out all the words?

Tell him to slow down, if this is the case. He is even more anxious than you that his message get through accurately. If not, he should be! Part of the technique of being a good operator is to ask repeats when necessary. If you are not sure, then ask for a repeat. Don't let guess work enter into the calculations, or some day you will regret it. Get all you can of the message. Don't, however, receipt for any message until you have it all. You will be rendering a training service that helps the other fellow when you train him to know how fast to talk so that what he says can be accurately written down.

When you ask for a fill, ask for it in such a way that you show that the copy on both sides of the missed words is just what he sent! Ask for the "word after" a certain word if there is only one such word apparent in the text, or for "all after" a certain correctly copied message portion. It will inspire confidence in the other man that you are a good operator and can be depended on for reliable work.

Which reminds us to say that you can find many interesting and clever people in the world. But there's nothing like being a reliable person. Strive to be an accurate and reliable operator. Get some practice in actually doing things. Handle communications for your fellow ham. Use prescribed operating forms. Follow recommended procedure to save time and promote accuracy. Make proficiency and self-training the watch-word.

---

## ★ NEW ★ TRANSMITTING TUBES

---

### Type 826

THE 826 is a transmitting triode designed especially for operation at maximum ratings at frequencies up to 250 Mc. and to 300 Mc. at reduced input. Special precautions have been taken to reduce inductance of element leads to a minimum. The envelope and terminal arrangement are similar to those of the 829. Forced-air cooling is recommended. Important characteristics and typical operating ratings are as follows:

Filament voltage	7.5
Filament current	4 amp.
Plate dissipation, max.	60 watts
Amplification factor	31
Grid-plate capacity	2.9 $\mu\text{fd}$ .
Grid-filament capacity	3.7 $\mu\text{fd}$ .
Plate-filament capacity	1.4 $\mu\text{fd}$ .

<i>Class-C Telephony</i>	
Plate voltage	1000
Grid voltage, fixed supply	- 70
or grid resistor	2000 ohms
or cathode resistor	440 ohms
Peak r.f. grid voltage	183
Plate current	125 ma.
Grid current, approx.	35 ma.
Driving power, approx.	5.8 watts
Power output, approx.	86 watts

<i>Class-C Plate-Modulated Telephony</i>	
Plate voltage	800
Grid voltage	- 98
From a grid resistor of	2800 ohms
Peak r.f. grid voltage	198
Plate current	94 ma.
Grid current, approx.	35 ma.
Driving power, approx.	6.2 watts
Power output, approx.	53 watts

<i>Grid-Modulated Amplifier</i>	
Plate voltage	1000
Grid voltage	- 125
From a cathode resistor of	1700 ohms
Peak r.f. grid voltage	165
Peak a.f. grid voltage	95
Plate current	65 ma.
Grid current, approx.	9.5 ma.
Driving power, approx.	8.2 watts
Power output, approx.	25 watts

At frequencies between 250 and 300 Mc., plate-voltage and plate-current ratings should be limited to 90% of the above for grid-modulated telephony and to 80% for Class-C telephony and telephony.

### Type 1625

THE type 1625 is similar to the type 807 except that it is provided with a 12.6-volt heater and a 7-pin base.

### Type 1626

TYPE 1626 is a transmitting triode with a cathode heated indirectly by a 12.6-volt heater. It may be operated at maximum ratings at frequencies as high as 30 Mc. and, at reduced input, to 90 Mc. It is designed especially for r.f.-oscillator service in applications requiring unusual stability of characteristics. Characteristics and ratings for typical oscillator operation are as follows:

Heater voltage	12.6
Heater current	0.25 amp.
Amplification factor	5
Max. plate dissipation	5 watts
Plate voltage	250
Grid voltage	- 70
From a grid resistor of	14,000 ohms
Plate current	25 ma.
Grid current	5 ma.
Power output	4 watts

### Type 866-A/866

THE type 866-A/866 is a half-wave mercury-vapor rectifier which combines the ability of the type 866 to conduct at low applied voltages and that of the type 866A to withstand high peak inverse voltages. Two of these tubes as a full-wave rectifier are capable of delivering to the input of a choke-input filter a rectified voltage of 3180 volts at 0.5 amp. Ratings are the same as the 866A.

# A Wide-Range V.T. Voltmeter

**A Compact, A.C.-Powered Instrument for D.C., A.C., and R.F. Measurements**

BY THOMAS J. KELLEY, W4CNY\*

**T**HE vacuum-tube voltmeter is undoubtedly one of the most valuable instruments in radio testing, but for some obscure reason it has not been widely applied by amateurs. This is unfortunate because the v.t.v.m. is neither an expensive nor a complicated instrument.

The desirable attributes of a good v.t. voltmeter are; high sensitivity, low probe capacity, negligible loading effects, and simplicity of operation. After much work, an instrument fulfilling these requirements was evolved — and it did not cost a fortune, since most of the parts were from the junk box. The most expensive components required are a good 0-1 milliammeter or equivalent high-sensitivity voltmeter, a 0-1 (approximately) milliammeter that need not be accurate, and a 300- or 350-volt, 50-ma. power supply.

The instrument measures from 0.05 to 300 volts directly, and the range may be extended indefinitely with a small sacrifice in input impedance. The input capacity, approximately 2  $\mu\text{fd.}$ , will not introduce appreciable error on frequencies up to 60 Mc. provided the impedance of the circuit measured is not too high. The input

\* 1600 4th Terrace, West, Birmingham, Ala.

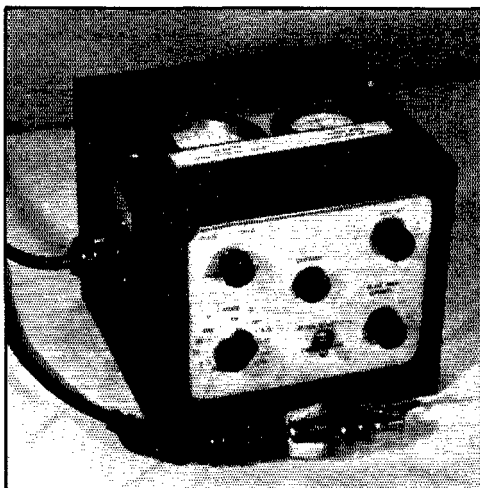

The vacuum-tube voltmeter. Controls are on the front panel, meters viewed through a cut-out in the lid. Probe-type construction is used, with the tube at the end of a plug-in cable.

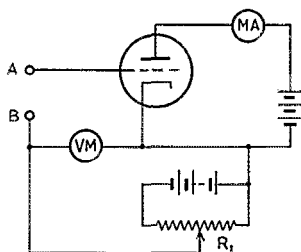

Fig. 1 — Fundamental v.t. voltmeter circuit, slide-back type.

impedance at the probe is infinite, for all practical purposes, with a.d.c. voltage across the probes and the v.t.v.m. balanced, but on a.c. varies from infinity at zero cycles to a somewhat lower value at higher frequencies because of high-frequency losses and the internal capacity of the v.t.v.m. tube. However, if the v.t.v.m. is used to measure the voltage across a tuned circuit, the tube capacity may be compensated by returning the circuit. The accuracy of the instrument is almost entirely dependent on the accuracy of the voltmeter multipliers except at extreme low-voltage values where the bridge meter reading is difficult.

To understand the operation of the instrument let us go briefly through the theory and design of this particular v.t.v.m. Fig. 1 shows the schematic of the elementary v.t. voltmeter, which is nothing more than an amplifier tube with variable grid bias and a meter in its plate circuit. To operate, the probes A and B are connected together and the potentiometer,  $R_1$ , adjusted to cause a small deflection on the plate meter (near plate current cut-off). With this done the v.t.v.m. is calibrated. Now if an a.c. voltage is connected between probes A and B, the tube begins to amplify and the plate current increases, but if  $R_1$  is readjusted to increase the bias and bring the plate current back to the calibrated value, the amount of grid bias increase is equal to the peak value of the voltage across the probes.

Batteries are bulky, expensive, and eventually wear out, so the greatest single improvement on the elementary v.t.v.m. would be to convert it to a.c. operation.

## A.C. Operation and Extended Range

Suppose we want the v.t.v.m. to measure from about 0.05 to 300 volts, which is approximately

the insulation limit of receiving tubes and other inexpensive components. It is obvious that reading low voltages would be difficult with only one range so the total range will be broken up into five sub-ranges, namely: 0-1, 1-5, 5-50, 50-100, 100-200, and 200-300; thus our v.t.v.m. takes on the aspects of Fig. 2. The range switch is an ordinary rotary unit containing two poles with 6 positions. Potentiometer  $R_1$  is connected across the moving contacts and the voltage divider,  $R_2$ , stagger cross-connected to the fixed contacts as shown in Fig. 3.

With the range switch in the lowest position,  $R_1$  turned to the zero end, and the probes shorted, the tube will pass a plate current depending on the magnitude of the "C" bias, which should be almost cut-off. If a voltage is impressed across the probes the tube will amplify, but when the range switch and potentiometer  $R_1$  are adjusted to bring the plate current back to the original value, the voltmeter will read *directly* the peak value of the impressed voltage, or 1.414 times the effective voltage for sine-wave a.c.

So far we have eliminated most of the costly and bulky batteries but we still have a few problems left. There are still two batteries which we would like to eliminate. The voltmeter must be changed for each range. The voltmeter and  $R_1$  load the voltage divider sections so much that the ranges have a gap between them. The plate current change at low voltage is too small to be read easily.

By increasing the power supply voltage to about 350 volts and adding to the voltage divider  $R_2$  two variable resistors (Fig. 4) one for the initial grid-bias drop,  $R_3$ , and one for the plate-voltage drop,  $R_4$ , the two batteries can be eliminated. The added variable grid-bias rheostat facilitates calibration or zero set, and the plate rheostat allows the range to be extended as shown later. It can be seen easily that the slide-back or bucking potential is the same as in Fig. 2, although it may seem at first glance that the polarity is reversed.

If another deck is added to the range switch, voltmeter multipliers can be switched simultaneously with the range switch to give a continuously direct reading. The voltmeter multipliers to the greatest extent determine the accuracy of the instrument, so too much stress cannot be laid on the use of the precision resistors.

The v.t. voltmeter is such a versatile instrument that it deserves wider application in amateur work than it has had. Here's how to build one suitable for a large range of voltages, using probe construction to increase accuracy on r.f. measurements. It's not costly.

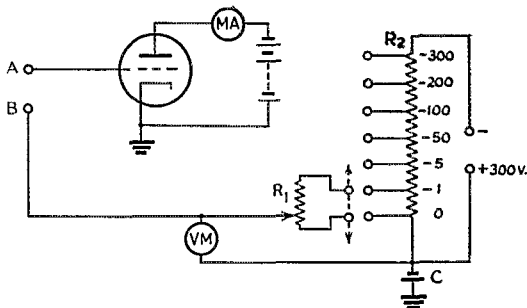

Fig. 2 — Voltage divider for extending the range of the v.t. voltmeter. A.c. supply may be used.

In choosing multipliers, use the value that gives full-scale deflection for the maximum voltage on that range in order to make reading as easy as possible; for instance, it is easier and more accurate to read 5 volts on a 0-5 scale than it is to read it on a 0-50 scale. A 1000 ohms-per-volt meter was used, but a more sensitive instrument may be substituted and is more desirable. If the scale is not calibrated for multiples of 1, 2, 3 and 5 full scale, the intermediate points may be inked in to provide quick reading of the instrument. By adding a closed circuit jack the meter may be used as an external voltmeter.

Any load across the voltage divider sections will cause a smaller drop across that section, since the load is in parallel with that section and reduces its effective resistance, thus causing a gap between ranges. By designing the divider for heavy current, using a large value of  $R_1$ , and using a high-resistance voltmeter, this drop may be reduced. On those rare but annoying occasions when the measured voltage falls at the end of the range but can't quite be measured, the range may be extended sufficiently by increasing the voltage-divider current slightly by reducing  $R_4$  in Fig. 4. This reduces the plate voltage on the v.t.v.m. tube slightly, but by recalibrating the instrument the input voltage can be read. The reostat  $R_4$  should be adjusted normally to cause 40 ma. to pass through  $R_2$ , thereby absorbing all the power-supply voltage above 300. Under no condition should the v.t.v.m. be operated with less than 50 volts across  $R_4$ , because the plate current will be too far down on the bend of the characteristic curve. If the power supply is not capable of delivering 350 volts, then the 200-300-volt range should be eliminated.

### Small Voltages

It was found in reading fractional voltages that the plate-current change was so small that difficulty was experienced in reading the plate-current meter, so a Wheatstone bridge arrangement with the v.t.v.m. tube as one of the arms was used in conjunction with a galvanometer. The galvanometer was an old castoff 0-1 mil-

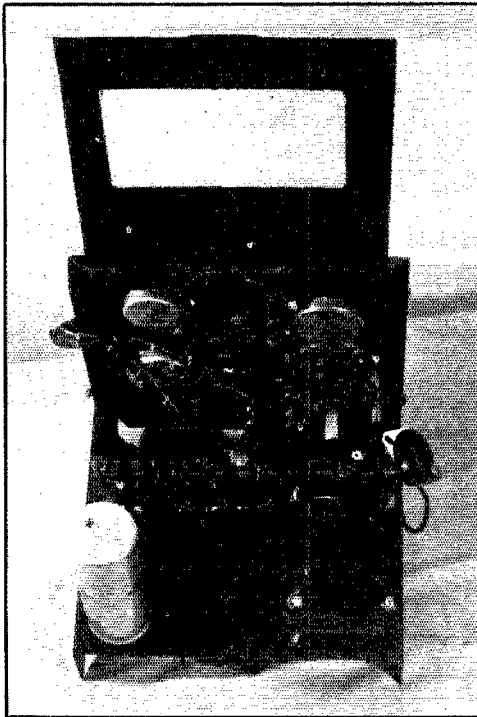

An inside view, with the meters and part of the cabinet removed. The socket at the right is for the probe cable, and fits into the side of the cabinet when assembled. The filter choke and voltage divider are below the chassis.

liammeter with the springs so adjusted as to cause the needle to stand at midscale with no current through it, thus giving a zero-center 500 microammeter. To make it more sensitive, the internal resistor was removed. To protect the meter from off-balance overloads a 10-times shunt was added with a switch to give coarse and fine adjustments. With the bridge, a fractional change in plate current is easily read, thus adding to the overall accuracy and ease of operation. The galvanometer determines the lowest voltage that can be read so the more sensitive it is the higher the accuracy on low voltages. The only other requirement for the meter is that it move freely on its bearings. Linearity and calibration are of no consequence.

#### Voltmeter Tube and Probe

In looking about for a suitable tube for the v.t.v.m., the most desirable seemed to be the acorn type, but is not physically adaptable because of its peculiar shape and connections, although it has excellent electrical characteristics — low electrode capacity and high voltage sensitivity — and is widely used in commercial v.t. voltmeters. Not far behind is the type 75 triode,

which is better suited because of its shape, and has low input capacity (about  $2 \mu\text{mfd.}$ ) along with excellent voltage sensitivity ( $\mu = 100$ ).

As stated earlier, one of the most important requirements is that the input capacity be low to minimize detuning and reactive loading effects. Fortunately the type 75 has its grid connection at the top of the tube and the grid cap may be used as one probe connection, thus requiring no connecting leads which would increase the input capacity. By applying the so-called "goose-neck" construction of placing the v.t.v.m. tube on the end of a cable, the tube grid can be connected directly to the source without disturbing that circuit's basic function.

The probe itself is made up of a standard six-prong female plug, the 75 tube, a short piece of flexible wire with a battery clip on the end, and two by-pass condensers, the whole connected to the chassis by a five-wire rubber-covered shielded cable ending in a plug. The plate, filament, cathode and ground currents are conducted to the probe through the cable, with ground connected to the by-pass condensers and the short flexible lead which clips to the low side of the voltage to be measured. The condensers are used to by-pass any r.f. or a.f. that might get into the bridge and divider circuits, causing incorrect readings. They are connected directly to the plate and cathode socket prongs and are covered over with a thick layer of tape, forming a sort of handle. In Fig. 4 the probe circuit is drawn within the dotted line portion and all connections entering it, plus ground, are brought in through the cable.

#### Construction

It was found that by placing the meters on the lid, the controls on the front panel, and the probe cable socket on one side, the entire v.t.v.m. could be built in a  $6'' \times 6'' \times 6''$  metal cabinet; in fact, so much room was left that in one experimental version a diode type v.t.v.m. was used in conjunction with the slide-back type. (The diode v.t.v.m. range and bridge changeover etchings are still on the panel.)

A durable escutcheon can be made by typing the calibrations on a piece of smooth cardboard and cementing it to the panel with duco cement. When the cement has hardened a generous coat of clear varnish is applied and allowed to soak in

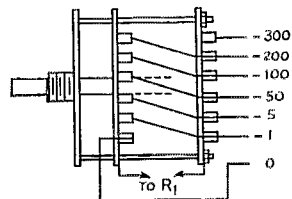

Fig. 3 — Method of making switch connections for various ranges.

for a few minutes, then the excess varnish is removed with a soft cloth. When the varnish dries hard the cardboard will have a glossy finish and the printing will not rub off.

In the finished v.t.v.m. the voltage divider is made up of several 10-watt wire-wound slider-type resistors, each resistor being used as several resistors. The normal divider current is 40 ma.,

but may be increased to about 44 ma. by adjusting the range extender control. Fig. 4 is the complete circuit.

Remember much of the equipment is operating several hundred volts above ground, and parts designed for low voltages should be well insulated. Note that the 75 cathode is connected directly to one side of the filament. On the highest range the cathode is 300 volts above ground and the filament-cathode insulation would probably be punctured if the filament were grounded.

By soldering a small copper-wire hook to the 75 grid cap, the probe may be hung on a connection so that the operator will not be accidentally shocked by careless holding of the probe. In using the capacity-coupled arrangement as explained later, never risk your life on a coupling condenser as a condenser failure would not only probably ruin the tube but would also put the previously blocked-off high voltage all over the instrument. In measuring high voltages it is always safest and cheapest to shut off the high voltage, connect the calibrated v.t.v.m. to the dead source, place the v.t.v.m. on the highest range, turn on the high voltage, and proceed with the measuring operation, otherwise damage to the tube and bridge meter is likely to result.

Since the meter reads the actual added bias and the bridge has similar value arms, line voltage fluctuations have practically no effect on the instrument.

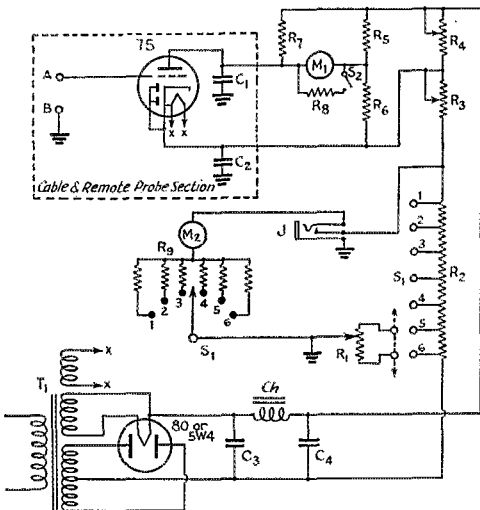

Fig. 4 — The practical v.t.v.m. circuit.

- R<sub>1</sub> — 25,000-ohm wire-wound, linear taper.
- R<sub>2</sub> — 1st section, 25 ohms.  
2nd section, 100 ohms.  
3rd section, 1125 ohms.  
4th section, 1250 ohms.  
5th section, 2500 ohms.  
6th section, 2500 ohms.
- Actual resistors are one 150-ohm with one slider, one 2500-ohm with two sliders, and one 5000-ohm with one slider; all ten-watt wire-wound.
- R<sub>3</sub> — 50-ohm wire-wound rheostat.
- R<sub>4</sub> — 5000-ohm wire-wound variable.
- R<sub>5</sub> — 10,000 ohms, 1-watt.
- R<sub>6</sub> — 350,000 ohms, 1-watt.
- R<sub>7</sub> — 10,000 ohms, 1-watt.
- R<sub>8</sub> — 10X shunt for M<sub>1</sub>. Average resistance 2 ohms if internal resistor is removed.
- R<sub>9</sub> — For 0-1 milliammeter: (M<sub>2</sub>).  
No. 1 — 1000 ohms (1 volt).  
No. 2 — 5000 ohms (5 volts).  
No. 3 — 50,000 ohms (50 volts).  
No. 4 — 100,000 ohms (100 volts).  
No. 5 — 200,000 ohms (200 volts).  
No. 6 — 300,000 ohms (300 volts).
- For greatest accuracy, subtract internal resistance of M<sub>2</sub> from these values, particularly if meter resistance is more than 1% of the multiplier resistance.
- C<sub>1</sub>, C<sub>2</sub> — 0.1- $\mu$ fd. paper, 600-volt.
- C<sub>3</sub>, C<sub>4</sub> — 8- $\mu$ fd. electrolytic, 450-volt.
- J — Closed-circuit jack.
- M<sub>1</sub> — Zero center 500- $\mu$ amp. meter (see text).
- M<sub>2</sub> — 0-1 milliammeter (a more sensitive meter may be substituted with appropriate multipliers).
- T<sub>1</sub> — Power transformer: 750 v.c.t. at 50 ma.; 6.3 v. at 0.3 amp.; 5 v. at 3 amp. (Thordarson T7OR61).
- Ch — 15-henry choke, 50 ma.
- S<sub>1</sub> — 3-gang 6-position rotary switch.
- S<sub>2</sub> — S.p.s.t. toggle.

### Operating the V.T. Voltmeter

To use, allow the instrument to warm up a few minutes, first short-circuiting the probes and throwing the bridge shunt switch, S<sub>2</sub>, to "coarse." Turn the range switch S<sub>1</sub> to the 0-1 position and turn the slide-back control R<sub>1</sub> to the zero or "calibrate" position (the voltmeter M<sub>2</sub> should read zero). Next adjust the initial grid-bias rheostat R<sub>3</sub> until the bridge meter reads zero (midscale). The v.t.v.m. is then calibrated and will remain calibrated for about an hour. If the voltage to be measured is altogether unknown and is likely to be high, always place the range switch in the highest position (200-300), then connect the probes to the voltage to be measured and rotate the slide-back control. If the bridge meter M<sub>1</sub> (in the "coarse" position) does not move, place the range switch in the next lowest position and repeat until the bridge meter passes zero, then adjust for zero on the fine scale and read the voltmeter for the peak voltage. By starting at the highest position, the tube plate current is cut off and the tube will not be damaged by high positive grid voltages. The plate current is saturated by a small positive grid voltage but high grid current might damage the grid and the grid lead. If the measured voltage falls in the gap between ranges, adjust the range extender R<sub>4</sub> enough to read the voltage, recalibrate the

(Continued on page 88)

# Navy Day—1940

**E**ACH year A.R.R.L., in coöperation with the Navy Department, conducts a Receiving Competition celebrating Navy Day. A message addressed to all radio operators of the United States and its possessions is transmitted at approximately 25 words per minute via Radio Washington (NAA) and Radio San Francisco (NPG) from the Secretary of the Navy, and letters of appreciation are awarded to those amateurs making perfect copy. The sixteenth consecutive activity of this type was conducted last October 27th.

Six hundred and forty-three operators copied the message during the 1940 competition. This was the greatest number of individuals ever to take part. Of these, 184 will receive acknowledgment from the Navy Department of their success in making an accurate transcription of a full transmission from either NAA or NPG. Reception of the Secretary's message was reported from forty-five states, the District of Columbia, Alaska, Canal Zone, Hawaii, Porto Rico, Canada, and by members of Uncle Sam's forces at the U. S. Naval Station at Guantanamo Bay, Cuba. As usual, several operators aboard ships at various points on the globe participated; one chap made his copy while afloat on the Mississippi River.

Thirty-one and one-tenth per cent of all participants were Naval Communication Reserve members. The tabulation presented below shows participation by Naval Districts, number of Reserve members who copied the message, number of copies of NAA, NPG, etc. The relative standing of the various Districts is also indicated.

All contestants are listed in the Honor Roll which is divided into two sections, those who made accurate copy, and all others who submitted entries. We extend our hearty congratu-

lations to the letter winners! Concentration on WIAW practice transmissions and participation in the A.R.R.L. Code Proficiency Runs should assist those who fell short of the mark to reach the goal next October. — J. A. M.

## 1940 Navy Day Honor Roll

### Letter Winners

*First Naval District:* W1AOT, W1BDU, W1BDV, W1BFA, W1BIV, W1BJB, W1FSV, W1HY, W1ILO, W1JAH, W1JET, W1KCT, W1LDL, W1MWU, W1WG, W. W. Chamberlain. *Third Naval District:* W1JTD, W1KFN, W1MGC, W2AUW, W2BDR, W2BZJ, W2CJX, W2CNU, W2CRK, W2CWT, W2DBQ, W2DQT, W2HQC, W2HYD, W2HZJ, W2ICJ, W2ISJ, W2JAI, W2JDC, W2JTC, W2JVJ, W2JVX, W2KC, W2KKU, W2KPU, W2LA, W2LDR, W2LFR, W2LR, W2MGT, W2MRJ, W2MRV, W2MSP, W2NDZ, W3FAK, W3IVO, W3MA, W8NVK, W8PSM, W8TKY, Raymond J. Huber, Jr. *Fourth Naval District:* W3ADE, W3AOC, W3ARK, W3BAK, W3BCZ, W3BIP, W3BXE, W3BZX, W3CNZ, W3DRO, W3EEW, W3EFH, W3FQS, W3FZO, W3HTG, W3HNY, W3OA, W3WT, W8AVK, W8BKS, W8DDC, W8EU, W8FUW, W8KD, W8MDB, W8QBK, W8RNH, W8RQ, W8TVC, M. L. Bergin, I. H. Hershey, P. F. Long. *Fifth Naval District:* W3AKN, W3BWT, W3CMV, W3ENQ, W3FFN, W3FSP, W3GJY, W3IQE, W3ORB, W9RGE. *Sixth Naval District:* W4AAR, W4BLN, W4DFC, W4DW, W4EBA, W4ECW. *Seventh Naval District:* K4KD, W4DVO, W4EFM, W4EHZ, W5DLZ, Forrest W. Dana, Edmund L. Roberts. *Eighth Naval District:* W3FPA, W4CRP, W4FLS, W4FRT, W5BRR, W5CEZ, W5CGJ, W5HHP, W5ITE, W5KC, Charles Knight, C. B. Trevey, Chester H. Young. *Ninth Naval District:* W8BKE, W8BKM, W8CLL, W8FTW, W8HZR, W8IQS, W8LXJ, W8MQC, W8REC, W8RRZ, W8SQE, W8SSJ, W8SSL, W9ANB, W9DH/BN, W9EMN, W9FQ, W9FWS, W9FUX, W9GVD, W9HDP, W9IYA, W9JKN, W9MDJ, W9MUW, W9RBI, W9RQR, W9TIT, W9UKV, W9VDY, W9VZH, W9WZG, W9YYA, W9ZQW, W9ZUO, W9ZYK, L. L. Monett. *Eleventh Naval District:* W5ENI, W5HPV, W5ZM, W6AM, W6FGT, W6SLU. *Twelfth Naval District:* W6CDA. *Thirteenth Naval District:* W6LVE, W7ANN, W7CKG, W7EBQ, W7FZB, W7GRE. *Fifteenth Naval District:* W5IAL, Arnold Pincus. *Miscellaneous:* W9JFS, W. H. Fishback, John Joiner, Joseph Kazokas, Howard T. Phillips, Lyall H. Winter.

Naval District	Number of Participants			Number Making Perfect Copy			% Perfect Copies	Number of Copies Submitted		
	N.C.R.	Non-N.C.R.	Total	N.C.R.	Non-N.C.R.	Total		Of NAA	Of NPG	Total
First.....	14	51	65	1	15	16	24.6	52	16	68
Third.....	43	73	116	18	23	41	35.4	104	16	120
Fourth.....	25	50	75	15	18	33	44.0	62	18	80
Fifth.....	2	22	24	—	10	10	41.6	23	5	28
Sixth.....	6	9	15	4	2	6	40.0	14	5	19
Seventh.....	1	10	11	1	6	7	63.6	10	2	12
Eighth.....	26	21	47	9	5	14	29.8	28	27	55
Ninth.....	23	87	115	11	25	36	31.3	93	30	123
Eleventh.....	12	37	49	1	5	6	12.2	5	46	51
Twelfth.....	18	37	55	—	1	1	1.8	3	54	57
Thirteenth.....	16	25	41	3	3	6	14.6	4	40	44
Fourteenth.....	6	6	12	—	—	—	—	—	12	12
Fifteenth.....	1	2	3	—	2	2	66.7	3	—	3
Miscellaneous.....	2	13	15	—	6	6	40.0	5	10	15
Totals.....	200	445	643	63	121	184	28.6	406	231	637

The number of N.C.R. and non-N.C.R. member participants was determined as accurately as possible by examination of copies received.

Alphabetical and numerical listing by Naval Districts of the remaining 459 participants follows:

*First Naval District:* W1ABG, W1AJ, W1ATU, W1BAD, W1BEH, W1BFT, W1BKG, W1BNO, W1BPI, W1BPN, W1BWR, W1CBU, W1DFQ, W1DGN, W1DIA, W1DLC, W1DUK, W1EHT, W1EUL, W1FJP, W1FTJ, W1HPC, W1HX, W1IAW, W1IHE, W1IJK, W1IWK, W1IXB, W1JOZ, W1KH, W1KWD, W1KXA, W1LEM, W1LHA, W1LRO, W1LUA, W1LVA, W1MEK, W1MPZ, W1MQR, W1MNV, W1PQ, W1PV, W1QX, W1RH, W1VF, W1WV, W1ZR, Fred C. Hall. *Third Naval District:* W1ADW, W1BDI, W1BYW, W1CCF, W1EAO, W1KRB, W1LQK, W1LZE, W1UE, W2AA, W2AIO, W2AMB, W2ANM, W2AYJ, W2AZV, W2BAI, W2CIZ, W2COG, W2DB, W2DKF, W2EC, W2EWM, W2GP, W2GQR, W2HUG, W2HXI, W2IJU, W2ISW, W2IUO, W2IYQ, W2JYI, W2JJC, W2KUM, W2KW, W2KZJ, W2LBI, W2LRO, W2LXI, W2LYC, W2LYG, W2LZT, W2MBC, W2MOZ, W2MQ, W2MSL, W2MXF, W2MZB, W2NED, W2PF, W2CFB, W2CWG, W2FRE, W2GUS, W2GJJ, W2CZM, W2DZC, W2ETH, W2GWY, W2LYW, W2NNJ, W2NVG, W2PCM, W2QXA, W2RKM, W2SBY, W2SSZ, W2UXG, Louis R. Clements, J. E. Doane, Herminio Feliciano, Ralph W. Held, Martin Hellman, Frank J. Henry, Paul H. Lee, William Precht. *Fourth Naval District:* W3ASW, W3AVJ, W3CAP, W3COY, W3DJ, W3DRQ, W3DXK, W3EPJ, W3FBF, W3FDH, W3FEG, W3FJK, W3FJU, W3FKT, W3FPC, W3FPG, W3FXZ, W3GKO, W3HTF, W2HZK, W3IAY, W3QP, W3AXH, W3BWP, W3HIS, W3JZN, W3KPU, W3LGD, W3MOT, W3MTO, W3NCJ, W3NOJ, W3NUG, W3OKK, W3PTE, W3RIT, W3RPP, W3RKB, W3SCE, W3UK, W3UVD, Louis E. Kearney, Edward Wagner. *Fifth Naval District:* W3BHE, W3FEP, W3HHT, W3HLQ, W3HQX, W3IFE, W3IFI, W3BWK, W3JMJ, W3ORD, W3PTJ, W3QDK, Jesse O. Starr, Clement Wolf. *Sixth Naval District:* W4DAW, W4FUS, W4FXG, W4GJM, W4GNQ, W4QD, W4GXF, W5INQ, Charles D. Harris. *Seventh Naval District:* W1EAS, W4CNZ, W4DAH, W4DYZ, W4IP. *Eighth Naval District:* W4BDB, W4FDT, W4GNR, W4GOX, W5ASQ, W5BEZ, W5BKH, W5BMI, W5BRV, W5BYC, W5BYV, W5BZT, W5CWW, W5DEO, W5DOM, W5ESL, W5FDR, W5GFL, W5HBD, W5HWG, W5HZN, W5GO, W5RH, W5NR, Charles P. Calhoun, Clifford C. Cross, J. J. Fischer, Jr., Paul Fraser, A. W. Freeman, Avery L. Howell, Charles H. Lewis, J. M. McCoy, T. J. Wilson. *Ninth Naval District:* W8AVH, W8BAH, W8BFB, W8DAE, W8DAQ, W8EIU, W8GXQ, W8HMH, W8HSW, W8IHX, W8IUI, W8JKG, W8KBE, W8QCU, W8QJJ, W8QLO, W8QRY, W8RN, W8SIS, W8SSV, W8STB, W8TYX, W8UHF, W8UGC, W8VG, W9ABB, W9ACC, W9AIR, W9BBL, W9BRY, W9C8J, W9CZB, W9DGS, W9DHQ, W9DTL, W9ENQ, W9EUL, W9EXW, W9FFD, W9FYX, W9GTA, W9GWF, W9GY, W9HPQ, W9HSK, W9HUJ, W9IMB, W9JMB, W9JSH, W9KHZ, W9KIK, W9NLA, W9NYW, W9OHQ, W9ORF, W9PGB, W9QMA, W9QVA, W9RLU, W9RSR, W9SGL, W9SWG, W9TGN, W9UAZ, W9ULQ, W9UUM, W9VAF, W9VEE, W9VFM, W9VRA, W9VSH, W9WMY, W9WUU, W9YTV, Neil Day, R. S. Pitkin, Jr., Charles V. Snyder, August E. Strom, J. Russell Thorburn. *Eleventh Naval District:* W2KNR, W5GXL, W6ALO, W6AWY, W6BBQ, W6BIH, W6CGY, W6CHV, W6DEP, W6DTY, W6EAG, W6FZQ, W6GTM, W6GVO, W6HWZ, W6IK, W6IOX, W6IPQ, W6IQ, W6ISG, W6JTN, W6KTQ, W6MKW, W6MPX, W6MQA, W6MWS, W6MXC, W6MYT, W6NYN, W6RKP, W6RUH, W6SJT, W6SLI, W6SRK, W6STX, W6SUD, W6SXY, W6TDM, W6WV, John Delaney, E. C. Heimerl, Charles J. Loyer, Robert D. Rietzke. *Twelfth Naval District:* W6ATT, W6BLZ, W6BZU, W6CBD, W6CHL, W6CIT, W6CWR, W6DHE, W6DHS, W6EBS, W6EJA, W6EY, W6GUR, W6GYX, W6IWU, W6JOH, W6LQG, W6LMZ, W6LNN, W6MDB, W6NZI, W6OBK, W6PDV, W6PFF, W6PGB, W6PTF, W6QJB, W6QLU, W6QQU, W6QVB, W6RDA, W6RFF, W6RGQ, W6RZO, W6WC, W6WF, W6WX, W6YCV, W6BY, W6DOY, W6GLI, W6HFC, W6HLH, W6KSE, W6SBB, W6SJT, W6VQZ, W6VTX, W. R. Bowles, Claudio Casari, H. M. Lewis, E. J. McDonald, Leslie A. Powell, Arnold M. Richard. *Thirteenth Naval District:* K7AAF, K7AIF, K7GBF,

## 1940 NAVY DAY MESSAGE

It is my pleasure to transmit a message of greeting to the radio operators of the United States and insular possessions in celebration of Navy Day. I am particularly gratified to learn that many of the Navy's reserve communication personnel are commercial or amateur radio operators. The Navy is proud of its Naval Communication Reserve. Created in 1925, it has grown steadily and today we have in the neighborhood of 6000 officers and men on its rolls and available in case of a national emergency. However in view of the present international situation our immediate aim is to increase the numbers on the rolls of the Naval Communication Reserve. The importance of our Naval communication service and the increasing demands thereon created by the growing size of our fleet is of particular interest to those skilled in the art of communication by radio. I sincerely believe that from among them will continue to step forward the additional reserve radiomen the Navy will require to satisfy the ever increasing need for communication personnel in the expanding Naval communication service.

*The Secretary of the Navy*

(This is the text of the message transmitted from NAA.)

W7AND, W7ANL, W7BFZ, W7BG, W7BYK, W7CBT, W7CWN, W7DET, W7DLN, W7ELC, W7EOR, W7ETO, W7FHW, W7FOZ, W7GNJ, W7GPD, W7GYO, W7GZG, W7HDF, W7HNP, W7HUG, W7HUK, W7HXX, W7HZG, W7IEL, W7ILD, W7ITE, George W. Fitzpatrick, H. V. Cox, Douglas J. Harrington, Lloyd F. Jordan, W. M. Harris, Douglas H. Reid, Geoffrey A. Woodhouse, *Fourteenth Naval District:* K8AYD, K8IQN, K8LKN, K8NDF, K8OLU, K8PAH, K8PHD, K8RVI, W9WTT, W9ZHD, L. D. Paulson, Edward W. Smith. *Fifteenth Naval District:* Earl W. Lockwood. *Miscellaneous:* VE3AJN, W1BGZ, W1BZO, W2GRJ, W3CBY, Carl Marcuson, Patrick A. Sisson.

## Strays

A good mechanism for rotating a beam antenna is the belt-driven unit from an old washing machine. This has a complete gear case and, by using a larger pulley on the unit and a smaller pulley on the motor, the speed of the wringer shaft is very slow. A rope may also be used to turn the mechanism. — W9ZOB.

— . . . —

Those of you who took the 25-w.p.m. run in the September 21st code-proficiency program may recall part of the text which ran this way:

“ . . . produces writers cramps and a very small hand. . . . ”

Here's the way that came out with some of the brethren:

“ . . . writers' cramps and a very sore hand. . . . ”

“ . . . writers' cramps and a very stiff hand. . . . ”

“ . . . writers' cramps and a swelled hand. . . . ”

“ . . . writers' cramps and a very swollen wrist. . . . ”

# Practical Design of Mixer or Converter Circuits

## Comparison of Tube Types and Checking Performance

BY CURTIS R. HAMMOND,\* W9PKW

THE design of an efficient mixer or converter circuit is often the one thing that prevents the amateur from building his own communications receiver. In application the amateur usually is unable to tell whether or not the stage is giving normal performance and, lacking equipment for checking gain, no attempt is made to find out if it is doing the job efficiently. However, there are simple ways of determining whether or not a mixer or converter is operating efficiently, and it is the purpose of this discussion to explain these methods and to give some theory on the operation of converters. The general characteristics of the several mixers and converters now available are also given, with a general discussion of the performance characteristics of each.

An elaborate mathematical theory of the operation of a converter or mixer<sup>1</sup> is of no great importance for our particular problems. Roughly, a converter operates as follows: Within the tube there is developed a current at oscillator frequency which is modulated by the incoming signal to produce an intermediate frequency. The ability of the tube to develop a current at an intermediate frequency is given by the "conversion conductance," which by definition is the ratio of an incremental change in intermediate frequency current to the incremental change in r.f. signal voltage that produces the current. This conductance in micromhos is published for all converters, and its use to calculate stage gain is analogous to the use of mutual conductance with r.f. amplifiers. The gain equation for a single tuned load is

$$\text{Gain} = \frac{G_c R_p R_L}{R_p + R_L}$$

where  $G_c$  is the conversion conductance,  $R_p$  is the plate resistance, and  $R_L$  is the tuned load resistance. Published values of plate resistance and conversion conductance can therefore be used to calculate conversion gain. The tabulation following gives a comparison of gain for a group of tubes now generally available. The gain figures were cal-

\* Ken-Rad Tube & Lamp Corporation, Owensboro, Kentucky.

<sup>1</sup> In common terminology, a "converter" is a tube performing the dual functions of mixer and oscillator; a "mixer" does not incorporate an oscillator section. Any converter tube can be used as a plain mixer by providing excitation from a separate oscillator tube. — Ed.

culated for a tuned load impedance of 200,000 ohms, which is equivalent to the better transformers now available.

Type	Conversion Conductance	Plate resistance in Ohms	Calculated Gain
6A8	550	360,000	60
6J8G	290	4,000,000	54
6K8	350	600,000	47
6SA7	450	300,000	65
6L7	375	1,000,000	58
1A7G	250	600,000	33
1R5	250	750,000	35

If gain was the only consideration the above would suffice for the selection of a converter tube. Tube noise is generally not a consideration when comparing converters simply because the converter is inherently a noisy device and most converters develop noise voltages of approximately the same magnitude. The noise output of converters of the 6A8 and 6SA7 type is approximately 4 times greater than that of an r.f. amplifier like the 6SK7 or 6K7. Where the ultimate in signal-to-noise ratio is desired it is necessary to precede converters of this type with an r.f. stage. Usually the selection of a converter is based on the characteristics of oscillator stability with regard to a.v.c. and terminal voltage fluctuation, pull-in characteristics, oscillator transconductance that determines the ease of oscillation especially at high frequencies, and other deleterious characteristics that cause loss in performance at certain frequencies. The chart on page 41 indicates some of the characteristics of the various converters. The gain figures and notes on stability and oscillator transconductance are of particular importance.

In general the converters perform equally well as mixers or as converters with the exception of the one characteristic of oscillator stability. Any of the converter tubes gives good stability if used with a separate oscillator and the circuits are isolated properly. Of the group the 6SA7 makes the best mixer because it gives high gain and has improved internal shielding of the signal and oscillator grids. The improved shielding is accomplished by using shielding plates similar to the beam-forming plates used in beam power tubes. These plates are attached to the side rods of the screen grid and confine the electron currents to beams which get into the outer regions



**What's the best mixer tube? How can a mixer circuit be tested to find out if it's doing the best job it can? Here are the answers — plus design information of highly practical value.**

of the tube where they are modulated by the signal grid. The sketch of Fig. 1 shows the construction of the 6SA7. The side rods of the No. 3 or signal grid are mounted so that they split the beam and make the electrons travel in radial paths. Electrons turned back by the signal grid because of a strong r.f. voltage do not return to the oscillator or No. 1 grid because they are caught by the collector plates. This reduces coupling between the signal and oscillator grids and improves stability. Simple structures of cylindrical grids such as used in the 6L7 and 6A8 do not have this additional isolation and are therefore not quite as good as the 6SA7. The improvement in stability evidences itself in the form of greater freedom from "pull-in" — that is, shifting of the oscillator frequency with signal-grid tuning or with a strong signal on the signal grid. This effect is usually not as serious as frequency shift due to terminal voltage fluctuation. The remarks relative to stability, given in the tabulation on page 41, refer to the stability with regard to terminal-voltage fluctuation.

### Converter Circuits

Typical circuits for the six converters listed in the tabulation are shown in Figs. 2 to 7 inclusive. The 1A7G, 1R5, 6K8, 6A8, and 6SA7 can be used with separate oscillators simply by connecting the oscillator grid of the converter to the oscillator grid of the oscillator tube. The screen and other positive electrodes should be maintained at their normal rated d.c. voltages but should be by-passed to ground.

Fig. 2 shows connections for a converter circuit using the 1A7G and Fig. 3 shows connections for the 1R5. The 1R5 is one of the new miniature tubes for hearing aids and small portable receivers. The 1A7G has the conventional 6A8 construction, using an anode for feedback. The chart above indicates that the gain obtainable with either tube is approximately 34. The oscillator transconductance of the 1R5 is slightly higher and the oscillator stability is somewhat better. These two features are of advantage for high frequencies.

Figs. 4, 5, 6 and 7 show connections for converter circuits with types 6A8, 6K8, 6J8G and 6SA7 respectively. The high oscillator transconductances of the 6K8 and 6SA7 make them particularly suited for all-around usage. They oscillate strongly at high frequencies where  $L/C$  ratios are unfavorable. The 6A8 construction is not sat-

isfactory for amateur usage because of instability in the oscillator. The oscillator electrode is a pair of rods located in the tube between the No. 1 grid and the screen. These side rods collect electrons from the cathode stream and the electrode current is controlled by the No. 1 grid. Unfortunately, changes in signal-grid or screen voltage also change the anode current. This conductance between signal grid and oscillator causes instability with variation in a.v.c. voltage. Fluctuations in screen voltage due to supply regulation also change the frequency. As a result, the 6A8 is subject to motorboating or "put-put" at high frequencies. Dial calibrations also drift with line voltage fluctuations. "Pull-in" is particularly bad with the 6A8.

The 6J8G construction incorporates a triode oscillator and a mixer section with a common cathode. This construction results in good stability insofar as screen and a.v.c. voltages are concerned. The 6J8G has two serious disadvantages, however, that have limited its application. The triode section shares a portion of the cathode area. The area used by the triode is quite small and as a result the oscillator transconductance cannot be made high. Also, at high frequencies a peculiar effect is experienced that causes a flow of current to the signal grid. This current causes a high negative potential across the resistance in the grid return, and this bias reduces the gain of the mixer. The effect can be reduced somewhat by using a high value of screen voltage, but it is then necessary to increase the bias to hold the cathode current to a safe value.

The 6K8 has been used extensively by the amateur and also the commercial manufacturer principally because it gives fair stability, and design problems are usually simple. The tuned-grid oscillator shown in Fig. 5 gives very little trouble and is easy to build. The oscillator frequency is not independent of screen and a.v.c. voltages, but in most designs the frequency shift caused by one is offset by the other so that good stability is obtained. The 6K8 has an effect known as space-charge coupling which is experienced at high frequencies. This effect is as follows: The oscillator voltage on the No. 1 grid causes a fluctuation in

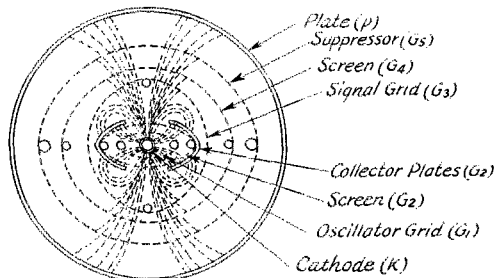

Fig. 1 — Diagram of the 6SA7 structure, showing electron beams.

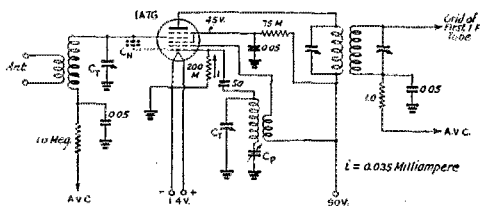

Fig. 2 — Converter circuit for the 1A7G or 1A7GT

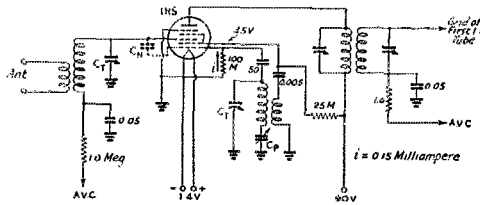

Fig. 3 — The 1R5 converter circuit.

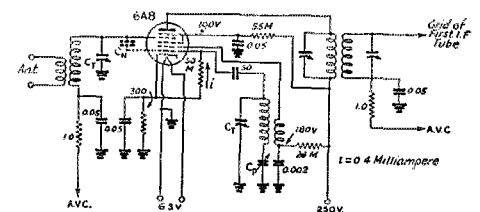

Fig. 4 — Converter circuit for use with the 6A8, 6A8G, or 6A8GT.

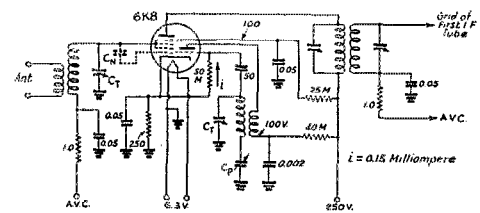

Fig. 5 — The 6K8, 6K8G or 6K8GT converter.

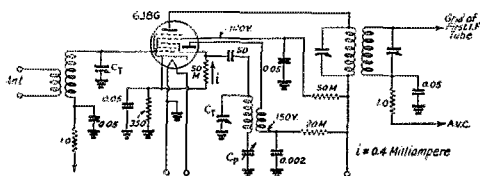

Fig. 6 — Converter circuit for the 6J8G.

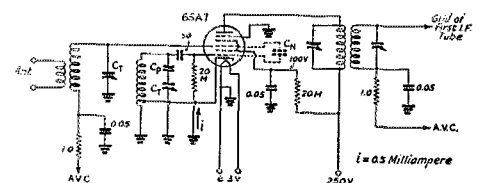

Fig. 7 — The 6SA7 converter circuit.

the number of electrons in the region of the signal grid. The electron density changes at the oscillator frequency and as a result a displacement current flows into the signal grid. At high frequencies where the signal grid and oscillator frequencies are quite close, the impedance of the signal grid circuit at the oscillator frequency is quite high and as a result the displacement current produces an a.c. voltage across the signal grid. This voltage, when smaller than the bias, reduces the gain of the tube slightly. Under extreme conditions it overrides the bias and causes rectification in the signal-grid circuit, causing a serious loss in gain. The coupling can be neutralized by a small capacitance — approximately 2 or 3  $\mu\text{fd}$ . — between oscillator and signal grids. Commercial practice is to use a condenser (known as a "gimmick") made by wrapping two pieces of wire together to give the desired capacitance. Neutralizing the space charge increases the gain and image ratio.

The 6SA7 construction has already been described. Using cathode feedback in the Hartley circuit shown in Fig. 7, excellent stability is obtained. The gain is quite high and the high oscillator transconductance makes a good oscillator.

The 6SA7 converter is tricky to use because the cathode returns through the oscillator coil. This connection, however, is the secret of the stability resulting with the 6SA7. The feedback is obtained from the total cathode current. A.v.c. voltage variations on the signal grid do not change the cathode current appreciably so that the oscillator frequency is almost independent of a.v.c. Screen-voltage variation produces a shift in frequency in the opposite direction and the two effects practically cancel. The frequency change with either variable is reduced by using the optimum tap on the oscillator coil. With average oscillator coils the tap should be adjusted to give a total oscillator voltage of approximately 10 volts grid-to-ground. Under these conditions the oscillator grid current measured in the grid leak will be approximately 0.5 milliamperes. This current can be measured with a 0 to 1 millimeter by connecting it at the bottom of the grid leak.

At high frequencies it is necessary to keep the leads connecting the cathode to the coil, and the bottom of the coil to ground, as short as possible. The cathode lead in particular should be short. The inductance of this lead is not a part of the oscillator tank and oscillator voltage developed across it does not contribute to feedback. The voltage does bias the signal grid, however, and will reduce the gain of the converter. Under extreme conditions the voltage may be high enough to cause a flow of current in the signal-grid circuit. This current results because of high voltage between cathode and ground and because of phase shift of this voltage with respect to the voltage between grid and cathode on the coil. The cathode connection to the coil should also be made so that

the lead pulls away from the coil at right angles. By pulling the wire away parallel to the winding the cathode-lead inductance may cancel a portion of the tap-to-ground inductance.

In band switching arrangements the circuit of Fig. 8 is recommended. It will be noted that the tap switch on the oscillator coil is located at the tap end of the coil. This puts the inductance of the switch and its connecting leads within the closed tank circuit. Since the tank currents flow through this inductance it contributes to feedback and gives oscillation with a minimum of cathode-to-ground voltage. If the switch was between the cathode and the coil, in the position of lead 1 the drop across the switch inductance would not contribute to oscillation, but would produce a high cathode-to-ground voltage. As mentioned above, this voltage is shifted in phase from the voltage in the tapped portion of the coil and may cause the signal grid to be driven positive and cause rectification.

The circuit of Fig. 9 shows the 6SA7 as a mixer. It will be noted that the neutralizing condenser  $C_n$  is used to neutralize the space charge. The 6SA7 as a mixer gives an increase in gain over that realized as a converter.

Space-charge coupling is also experienced with the 6SA7, and a "gimmick" is required for neutralization. This coupling is characteristic of converter or mixer systems wherein the oscillator voltage is injected next to the cathode or filament. The 6J8G, although not having this coupling, has the transit-time effect which is just as bad and cannot be neutralized. The transit time effect is experienced with converters or mixers in which the oscillator voltage is mixed in the cathode stream outside of the signal-grid injection.

It might be of interest at this point to give the accepted theory on what causes the transit time effect. Electrons accelerated through the No. 2 screen grid approach the No. 3 injector grid. At high frequencies, where the time of transit between cathode and No. 3 grid is an appreciable portion of the period of oscillation, electrons accelerated by the No. 3 grid on its positive swings

reach the grid at a time when it is going negative and are repelled and turned back toward the screen. On the way back they are accelerated by the positive potential on the screen and by the increasing negative potential of the No. 3 grid. Many of these returning electrons reach the screen and are drawn off as additional screen current. Some of the electrons, however, pass very close to the screen and are accelerated toward the No. 1 grid at high velocity; many of them obtain sufficient energy to overcome the negative potential of the No. 1 grid and flow in the external No. 1 grid circuit. This flow of current is d.c., and in a direction such that the drop in the external resistance increases the bias. If the tube is operated from the a.v.c. string as in the conventional case, the total return to ground is of the order of two megohms. A current of several microamperes increases the bias sufficiently to cause an appreciable loss in gain. The current can be eliminated for frequencies up to approximately eighteen megacycles by increasing the bias and the screen voltage.

### Checking Performance

The above information should be useful in determining the converter to be used for a particular job. Once the converter is built it is comparatively easy to ascertain whether performance is satisfactory. Of course in the laboratory the most satisfactory method is to check stage gain with a signal generator, but few of us have signal generators with which to make precision measurements. We usually rely on the sound of the set and whether it pulls in the signals.

The first check on any converter is to measure the electrode voltages with a high-resistance meter. The correct voltages are indicated for the various circuits. Next in order of importance is to check to see if the oscillator amplitude is high enough. The easiest method of checking this is to measure the d.c. grid current in the grid leak. This grid current increases directly with oscillator voltage and is so closely related to oscillator voltage that manufacturers, instead of rating the

### CHARACTERISTICS OF VARIOUS TUBES AS CONVERTERS OR MIXERS

<i>Tube</i>	<i>Relative Gain as Mixer</i>	<i>Relative Gain as Converter</i>	<i>Oscillator Stability as Converter</i>	<i>**Approx. Osc. Transconductance</i>	<i>Space Charge Coupling</i>	<i>Signal Grid Current Due to Transit Time</i>
1A7G	33	33	poor	600 micromhos	yes	no
1R5	35	35	fair	*800 "	yes	no
6A8	60	60	poor	1000 "	yes	no
6K8	47	47	fair	3000 "	yes	no
6J8G	54	54	good	1600 "	no	yes
6SA7	80	65	good	4500 "	yes	no
6L7	62				no	yes

\* Circuits using both plate and screen current for feedback can be employed and the effective transconductance is then 1200 micromhos.

\*\* Transconductance in micromhos at rated conditions.

NOTE. — Gain figures are relative for a tuned load resistance of 200,000 ohms.

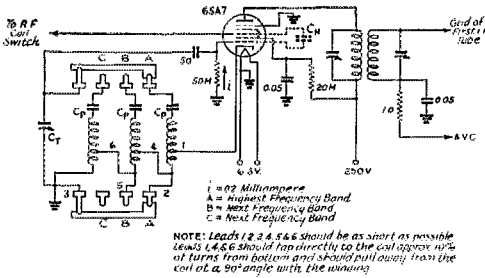

Fig. 8 — Recommended oscillator switching for the 6SA7.

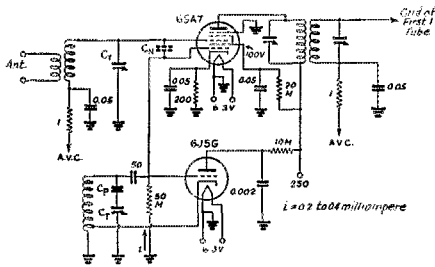

Fig. 9 — The 6SA7 mixer, separately excited by a 6J5 or 6J5G oscillator.

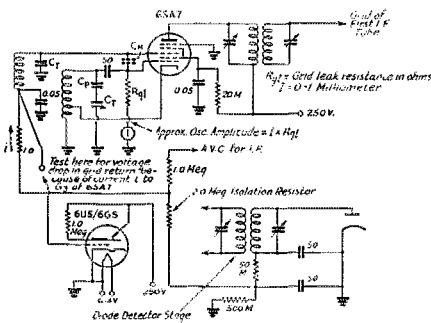

Fig. 10 — Circuit for making performance tests on the 6SA7 converter.

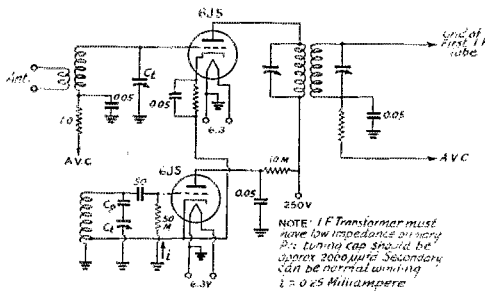

Fig. 11 — Triode mixer with separate oscillator.

oscillator voltage to be used with a converter, rate the grid current as measured in a recommended grid leak. On each of the preceding circuits the rated oscillator grid current is given. In practice the grid current cannot be held to this value over the band, especially if a wide tuning range is desired as in commercial broadcast sets. In communications receivers where the tuning range is small the variation is not large. A 2-to-1 variation in a set having a wide tuning range is not bad. If rated grid current is obtained in the middle of the band the variation over the band is usually not excessive. The grid current is important because it determines the point of optimum gain, and other than rated value results in a sacrifice in performance.

Converters using the 6A8, 6K8, 6SA7, 1A7G, or 1R5 should next be neutralized for space charge coupling. This is accomplished by connecting a "gimmick" between the oscillator and signal grids. If a gang condenser is used and the oscillator and signal grid sections are adjacent, neutralization can be accomplished by connecting the "gimmick" between the stators of the two sections. Commercial practice is to solder two small pieces of wire to the stator lugs and then to twist the ends together. About two turns is satisfactory. Note: Neutralization is done on the high-frequency edge of the highest-frequency band. Low-loss wire should be used. The capacitance should be adjusted to give maximum sensitivity.

There are several phenomena that can take place that will upset performance after the above considerations have been observed. Parasitic oscillations take place in the oscillator section if too much feedback is used or if the values of grid coupling condenser and grid leak are too high. A 50- $\mu$ fd. grid condenser is usually satisfactory for most circuits. Most grid-leak specifications call for 50,000 ohms. Battery tubes having low oscillator mutual are specified with as high as 200,000 ohms, and the 6SA7 with its high oscillator mutual or transconductance is rated with 20,000 ohms. If the oscillator and signal-grid circuits are not adequately shielded and isolated, severe coupling between circuits is obtained at some frequencies. The signal-grid circuit in extreme cases may load the oscillator enough to cause it to stop oscillating. This effect can be detected by observing the oscillator grid current as the set is tuned through the coupling point. A rapid dip in the oscillator grid current is experienced as the coupling point is passed. Shielding of coils and isolation of parts and leads eliminates this trouble. Motorboating on strong signals is the result of oscillator shift with a.v.c. and other element voltage variation. It was pointed out that the 6A8 was particularly bad in this respect, that the 6K8 was much better, and that the 6J8G and 6SA7 are very good. Motorboating can be experienced with the 6J8G and 6SA7 if power-supply regulation is bad and if the oscillator

amplitude is not adequate. Stability is improved by operating at or somewhat over rated amplitude.

The major troubles experienced with converters produce a flow of grid current in the signal-grid return. This is true of the transit time effect with the 6J8G, the space charge effect with 6K8, 6SA7, 6K8, 1A7G and 1R5, and the phase shift of the high cathode to ground voltage in the 6SA7. The circuit of Fig. 10 shows how a check for signal-grid current can be made without the use of a sensitive microammeter. An electron-ray indicator tube such as the 6U5/6G5 will indicate any current flow in the a.v.c. return. Most returns have about three megohms total and a d.c. current of 1 microampere will produce 3 volts, which will make a noticeable deflection on the target. The voltage drop between the bottom end of the coil and ground should never exceed approximately 1.5 volts. This voltage can exist because of contact potential in the diode and other grids connected to the a.v.c. system, and does not indicate trouble.

Signal grid current with the 6A8, 6K8, and 1A7G usually results from space-charge coupling, as already described. A convenient test for its presence is to short the signal-grid tuned circuit with a condenser. This shorts out the voltage and eliminates the current. The "gimmick" when adjusted properly neutralizes space charge coupling.

Signal-grid current because of space-charge coupling is also obtained with the 6SA7 but in addition current can flow because of high cathode-to-ground voltage and phase shift of this voltage with respect to the oscillator grid-to-cathode voltage. If by-passing the signal grid does not eliminate the current, the trouble will be found in the oscillator coil and connecting leads. The cathode lead should be kept short and the circuit of Fig. 8 adhered to. The ratio of length to diameter of the oscillator coil should not exceed more than about 1.5 to 1. With long coils and small diameters there is appreciable phase shift with attendant troubles. As mentioned previously the

cathode lead should pull away from the coil at right angles so that it does not couple to the coil.

Recently, certain manufacturers have used triodes for mixers. A typical circuit for this type of mixer is shown in Fig. 11. It will be recognized as similar to many of the circuits used in the older days. In commenting on this circuit it might be said that the chief advantage of the triode is that it develops very little noise. It is thus possible to add extra gain behind the converter in the i.f. and get high sensitivity with a good signal-to-noise ratio. The triode in this connection has serious disadvantages, however. It is necessary to use a special low-impedance primary i.f. transformer so that the grid-to-plate capacitance of the triode will not cause loading of the signal-grid circuit. In the practical case the tuning condenser required to tune the i.f. primary is approximately 2000  $\mu\text{mf}$ . The high cathode-to-grid capacitance causes severe coupling of the oscillator and signal-grid circuits. This evidences itself in the form of instability with a.v.c. variation, "pull-in" on strong signals, and oscillator shift with tuning of the signal grid circuit. In applications where stability is not of prime importance a pentode such as the 6SJ7 or 6AB7/1853 could be used to give good signal-to-noise ratio. The low signal-grid-to-plate capacitance in these types would allow the use of conventional i.f. transformers.

## Strays

In the din of horn-blowing at Times Square on election night, several CQ's were picked out. The result was an eventual gathering of 18 hams which included W1, W2, W4 and W9. — *W2JCS*.

—♦♦♦—

Finding it impossible to slow down to a speed of 15 w.p.m. with the electronic key described in April *QST*, I replaced R11 with two 15,000-ohm resistors, connecting the shorting lead from the relay contact to the center of these resistors. The key now operates as well at slow speeds as at high speeds. — *W8SMI*.

Here's one way to make sure that your 160-meter 'phone signals get out! All you need is an 82-foot lattice mast like this one shown going up at W5FTL. With the help of W5CYX, W5WX (who took the

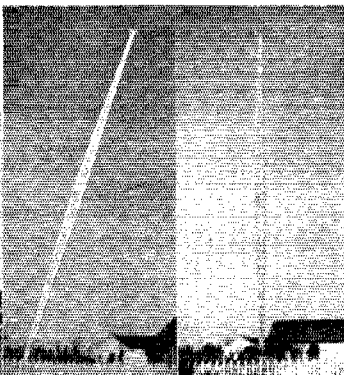

pictures) and a half-dozen interested non-ham neighbors, the raising job was done in an hour and a half, a car being used for the heavy pulling. The antenna is a top-loaded vertical.

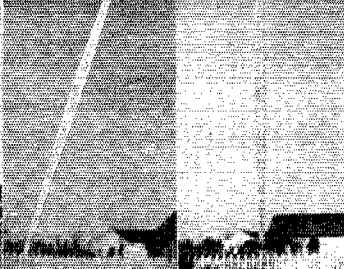
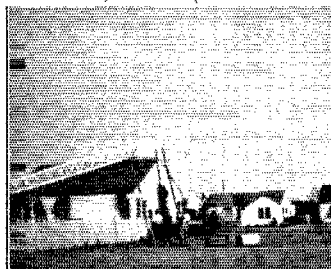



# ON THE ULTRA HIGHS



CAN YOU "take it"? No, we're not referring to physical ruggedness, but to the ability of u.h.f. operators in handling the code. The U.H.F. Relay of December 14th and 15th showed many of us that some concentrated effort aimed at improvement of our code proficiency is certainly in order. There were a few who could not copy code at any speed, and most of us found that our knowledge of the code, long considered adequate for an occasional low-frequency rag-chew, fell down rather badly when it came to accurate copy in the handling of relay traffic on c.w. and m.c.w.

While activity in some areas did not run high as in the May and September contests, scoring hit a new high (many of the gang making full use of the multiplier for use of c.w. and m.c.w. transmission), and a new relay record was established. In a whirlwind finish, messages from W9HAQ, Davenport, Iowa; W9's WIV, Mendota, ARN, Bartonville, and VHG, Glenview, all Illinois, reached destinations in the East. The message from W9HAQ, addressed to any East Coast Station, passed through the hands of several "east coast stations," ending up on your conductor's hook at exactly 8 P.M., having

established a new record for long-distance relaying without the aid of skip.

Contest reports from the West have been slow coming through, due no doubt to the Christmas rush, making it impossible to present much of a picture of contest doings at this time. We'll try to have some dope on the higher scores next month, with a complete report to follow in due time.

December gave us a surprising number of really good openings for skip DX, particularly in the southern half of the country. Short skip of almost summer proportions was noted on Ten frequently, with DX in evidence on Five on the 2nd, 3rd, 9th, 13th, and 24th, that we know of. Because the occurrence of skip DX in the so-called "dead" period for Five is of more than ordinary interest, we list a complete summary of all DX work which has come to our attention thus far.

December 2nd: W4EQM, Langdale, Ala.: worked W5AJG, W4EDD, W4FVW. W4FKN, Atlanta, Ga.: worked W4EDD and W4FVW. W4FBH, Decatur, Ga.: Same. W6SLO and W6OVK, Tucson, Ariz.: worked W5EHM and W5AJG, heard W4EDD! W6QLZ, Phoenix, Ariz.: heard W9ZHB, W5AJG, W5EHM, and W4EDD. W4EDD in for about an hour, reaching S-8 peaks between 7:28 and 7:45 P.M.! Heard W4GHW, probably a harmonic on 28.5 Mc. W9BDL, Marshall, Ill.: worked W4FVW. W8RUE, Pittsburgh: heard W4EDD. W5AJG, Dallas, Texas: Worked W4FBH, W4EQM, W4FVW, W6SLO, W6OVK. Heard W4FLH, W4EDD, W6QLZ.

December 3rd: W5AJG, Dallas, Tex.: heard by W9KQA and W9AZJ, S-9, while demonstrating rig to a visitor! W6QLZ: heard W5VV.

December 9th: W5AJG: heard W4EDD and W4FVW.

December 13th (Friday!): W5VV, Austin, Tex.: worked W6's QLZ, OVK, SLO. W5FSC, Huntsville, Tex.: heard W6OVK. W6GBN, Estrella, Ariz.: heard W5VV.

December 24th: W4EQM: worked W8SUL, W8QQP, W8RUE, W1LLL, W1HDQ, W1IJ, W3AWM, W2FMF, and W9ZHB — possibly more, faded out during this contact at W1HDQ.

Did somebody say, "No DX in Winter"?

Prospects for '41 are shaping up very well. At this time last year there was practically no daily activity on Five in any section of the country other than the Atlantic seaboard and the Great Lakes area. This winter we find operators in Arizona, Florida, Georgia, Texas, Indiana and Missouri conducting regular schedules with stations within a radius of 200 miles. In several other states where "local" contacts are not yet

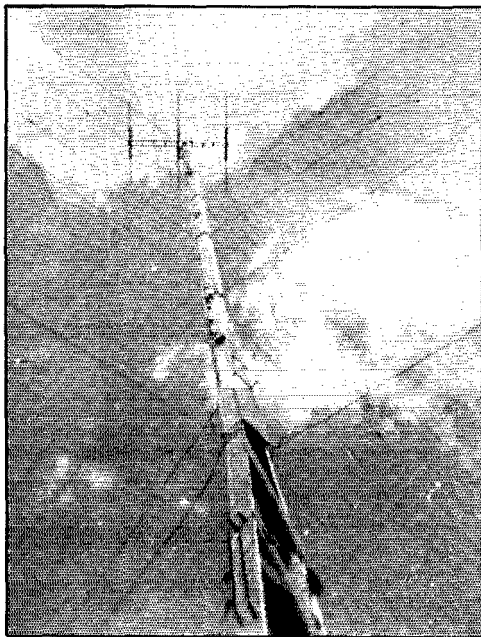

82 feet up! This 3-element "Q" array has netted W9ZHL, Terre Haute, Ind., contacts up to 250 miles on Five.

## U.H.F. DX RECORDS

### Two-Way Work

56 Mc.: W1EYM — W6DNS, July 22, 1938.  
2500 miles.  
112 Mc.: W6BJI/6 — W6KIN/6, July 4, 1940.  
255 miles.  
224 Mc.: W6IOJ/6 — W6LFN/6 August 18,  
1940 — 135 miles.  
400 Mc.: W6IOJ/6 — W6MYJ, September 23,  
1940 — 11 miles.

possible, fellows are tuning up 56-Mc. gear to be all set for the spring DX season. This is as it should be, for experience has repeatedly shown that the fellows who really get results on Five are the ones who plan ahead of time and have everything in tip-top shape. If you have any idea of "working Five" during the summer months, we urge you to get going on the project without delay. There's going to be plenty of fun on Five in '41!

### HERE AND THERE:

**T**HE Boston-Washington Relay is now an accomplished fact. After more than a month of unsuccessful attempts, a fast-working circuit has now been established, a two-way relay having been completed for the first time on December 2nd. Stumbling block in the path of the relay had been the gap between W3CGV of Wilmington, Del., and Washington, D. C. Because of the inability of W3WA, Catonsville, Md., to be active on Friday nights, a Monday attempt was made. A message from W1QB, Natick, Mass., originated at 7:57 P.M., was delivered to W1DEI/3 at 9:25. The reply, containing this information and Mel's expression of appreciation to the operators involved, was delivered to W1QB at 11:10. Since this first success, the round-trip relay time has been reduced to less than two hours. Stations cooperating include W1's KLJ, HDQ, KTF, W2's AMJ, MO, W3's HOH, HFY, GSX, GUF, CGV, GGR, WA, and AWM.

Recent developments indicate that we have a very good chance of completing a Maine-to-Florida network. W1LSN writes that W1AP, who is employed on the summit of Mt. Washington, will shortly be active on Five. As Mt. Washington to Portland, Maine, used to be easy in the old W1BPI-W1XR days on the mountain, we should soon have a reliable circuit to W1MFK, who is looking for business on Five in Portland. And from W4MR we hear that the Greensboro (N. C.) Radio Club, W4GNF, is setting up a 56-Mc. station at a high elevation near Greensboro, with the avowed intention of tying in with the Atlantic Seaboard Five-Meter Net. It remains now for W3CYW and W3FJ of Richmond to connect up with W3RL, Herndon, Va., on the north, and W3BZ at Danville (only 40 miles from Greensboro) on the south, and we'll be well on our way.

W1LSN, Exeter, N. H., wonders if many of the fellows realize the tremendous advances that have been made in 56-Mc. technique in the past two years. Jerry believes that some of the old gang would be mighty surprised to see what goes on as a regular thing on Five in 1941. For example, in a poor location at the northern end of the active area, with only 28 watts input to an RK-34, he worked 91 different stations in 1940. W1KLJ, over 100 miles away, is heard consistently; and several W2's at distances in excess of 200 miles come through when conditions are good.

W2MO, Livingston, N. J., has a series of twice-weekly skeds on Mondays and Fridays with W1QB, 8:30 P.M.; W1LL, 8:45; and a group of W3's at 9. During the period spent with the W3's, Earl stands by to listen for any of the gang who may wish to try to get through to him. With 700 watts to the final and an 8-element beam atop a 90-foot tower, the range of W2MO is probably the widest of any W2

on Five. W1DEI/3 reports that he has been hearing Earl, during the 9 P.M. workout, in Washington, a distance of about 200 miles.

"'Twas the Night Before Christmas" — and not many creatures were stirring on the Five-Meter Band, but those on deck enjoyed a swell opening during the early part of Christmas Eve. W4EQM, Alabama's lone representative on 56 Mc., had a field-day session lasting at least three hours, starting at 3:30 P.M. W4EQM was 8-9 or better during practically every minute of the two-hour period in which we were checking up on him, and the reports he dished out to nine stations in seven states and four call areas indicated that the band was just about as open as it can be — but the early hour on the busiest day in all the year (for things other than radio) found the band almost deserted.

The fellows in Texas are really in the middle of things when it comes to skip DX, and it now appears that they may have some real "local" activity as well, what with more fellows coming on the band right along. From Huntsville, W5FSC writes that he is waiting for a chance to use 225 watts to a pair of 35T's and a converter (1851-6K8GT) into an Ultra-Skyrider. An 8-element horizontal Sterba is under construction for north-south work. A long wire takes care of east-west coverage. Bud should be a likely prospect for extended-local workouts with W5VV at Austin, 130 miles; W5EEX, W5ATW, and W5BHO, of Houston, 75 miles; and W5AJG at Dallas, some 170 miles to the north.

## U.H.F. MARATHON

### NOVEMBER WINNER

W3HOH, 59 points, becomes first two-time winner

Call	Contacts Through November			Cumulative Score	States in 1940
	56	112	224		
W1AIY	23		3	68	2
W1CGY	52			136	5
W1DJ	102			163	4
W1EHT	66			98	3
W1EKT	119			317	12
W1ELP <sup>1</sup>	95	53		324	12
W1HDF	81	12	4	374	13
W1HDQ <sup>2</sup>	211	63	1	1477	24
W1HXP					20
W1JJR	110	4	3	588	17
W1JLK	90	23		203	6
W1JP	1	34		81	3
W1KLJ	150	7	5	1291	24
W1LLL	239			850	20
W1LPF	65			70	7
W1LSN	59			141	14
W1MBS		169		370	3
W1MEP	28			90	6
W2ADW	16	27		170	4
W2AMJ	194			886	24
W2BYM	47	7		255	15
W2BZR	32	115		314	5
W2COT	127	27		315	7
W2DZA				304	5
W2GHV	122			590	21
W2LAL	104	2		235	11
W2LXO		131		300	4
W3BZJ	217	58		1345	25
W3CGV	80			237	11
W3EIS	22	15	1	101	5
W3FSM		53		108	2
W3HOH	224	77		906	16
W3RL	70	1		563	21
W5AJG	163	6	5	1751	25
W6IOJ	8	95	4	393	3
W6ROVK	20			204	7
W6QG	24	4	2	136	4
W6QLZ	60			1065	18
W6RVL	1	191		523	1
W8MHM	32	16	1	113	7
W8NKJ	53	23		397	11
W8ODU	116	55		822	20
W8QCS	63			540	15
W8RUE	79	16		329	15
W9ARN	83			708	20
W9DQH	44			297	17
W9ZJB	138	1		1354	26

<sup>1</sup> Frequency modulation used exclusively at W1ELP.  
<sup>2</sup> Not eligible for award.

And across the Lone-Star State we find W5BYV, formerly of McCamey, now just getting settled in Lubbock. Jim has high hopes of getting things started on both 56 and 112 Mc. W5V now has an NC-200 (W5BB got back from his honeymoon, so Wilmer had to return the NC-101-X) working with a DM-36 converter. The rig now runs close to a kilowatt to 250TH's. Wilmer had a nice DX workout on Friday the 13th, with the Arizona boys.

Fine names these five-meter networks have! You've been hearing about the Horsetraders, the Gravediggers, and others — now meet the Arizona Desert Rats! Rat Number One is W6QLZ. Rat Number Two is W6OVK. Other Rats, numbers unknown, are W6SLO, Tucson, W6GBN at Estrella, and W6KTJ, Phoenix. To become a full-fledged Desert Rat, one must be able to work at least two other Rats. With the completion of a few more of those multi-element horizontal beams in the area within a hundred miles of Phoenix and Tucson, the roster of the Desert Rats is expected to grow by leaps and bounds. W6SLO recently put up a duplicate of QLZ's 4-element beam and now puts a good signal across that 110 miles of high mountains which separate Tucson and Phoenix, and a similar array has enabled W6KTJ to negotiate the path in the opposite direction!

Would anyone like to add New Mexico to their list of states worked on Five? Watch for W3EJQ/5 (probably with a new W5 call soon) of Las Vegas, N. M. Frank brought out complete rigs for 56 and 112 Mc. from Washington, D. C., and is going to be banging away all summer. Now will someone please get going in Utah (W6DTB?), Wyoming, Nevada, Colorado, Idaho, North Dakota, Mississippi, and South Carolina, so W5AJG can make W.A.S. on Five in 1947!

W7GBI, Great Falls, Mont., expects to be more active on Five this coming summer. With no signals on Five to listen to most of the time, Bud has been amusing himself by listening to signals from the weather balloons sent up from a near-by airport. Bud finds that these tiny outfits can be heard for amazing distances because of the great height reached by them. This stirs up the idea of aircraft work on Five and 2½ — Bud is a flier in his odd moments. New 112-Mc. records coming up?

Quite a few new prospects are in sight for central New York. W8RNE and several others in Syracuse and vicinity are trying to find the band, and W8QJT of Ithaca has promised to be on soon. W8TXB writes from Elmira that W8's RTW, OCY and TOE are working out regularly. All these boys would like test schedules with out-of-town stations. They hear the 200-watt fire-station transmitters at Binghamton, N. Y., and Wellsboro and Towanda, Pa., operating just outside the high end of Ten. Syracuse, Rochester, Ithaca, and even Buffalo and Erie should not be too difficult for regular contacts. How about some dope on frequencies, operating schedules, etc., so we can get some tests started?

W9ZJB, in his new location at Gashland, Mo., is getting his first taste of real long-range "local" work. On December 12th, Vince hooked W9YKX of Woodbine, Iowa, a nice 200-mile hop, for State Number 27 in 1940. It appears that this settles any doubt as to the winner of the states-worked award for 1940, putting Vince out in front of W5AJG and W3BZJ by two states. Another convert for horizontal polarization — Vince just got up a 3-element, ¼-wave spaced array, and hadn't had time to tune it up when this contact was made.

We have a little more dope on the daily coverage of Middle-West stations, comparing winter and summer conditions. W9ARN writes that, in general, fading seems to be about the same the year around, but that the average signal level is somewhat lower in winter, and the "good" nights are less frequent. Jack still has contact with W9BDL, Marshall, Ill., and W9NFM, Solon, Iowa, 135 and 105 miles, respectively. These two can be worked winter or summer, but complete fadeouts show up occasionally during the winter season. W9BDL has frequent contacts with W9ZHB, Zearing, Ill., a distance of 180 miles. Checks are made at noon, 6:30 P.M., and midnight, with the noon contact showing the best signal strength ordinarily, but with the late contact showing the most consistent signal. Elmer's log shows 747 QSO's to December 1st, at least 95% being of

the 100% variety. How many other bands can show an equal record of successful contacts?

## 112 MC. AND UP:

Not the least of the pleasures of operation on 2½ is the thrill of "working portable." The simplicity of the equipment required and the ease with which a beam array of considerable gain can be assembled on the spot make 112 Mc. the ideal band for mountain-top ventures with portable gear. The obvious approach to the portable problem is the construction of some sort of gear which can be operated in an automobile. While mobile operation is great stuff — it's one way in which you can satisfy the family's urge for a Sunday picnic trip and still keep in touch with the boys on the air — those who like to do things the hard way will favor the type of gear which can be operated entirely from portable power supply (usually dry batteries) in those choice spots which are inaccessible by car.

Such an expedition is described by W6NJJ. On a trip up Mt. Lassen, Ray and two assistants took along plenty of snow equipment. Two miles beyond the end of the auto road were negotiated on skis, lugging a storage battery and an HY-75 oscillator. Some nice DX, W6NJV/8 at Mt. Diablo (175 miles) and W6ADM/6 on Mt. St. Helena (100 miles), was worked. More expeditions are in prospect and the boys hope to arrange to have more stations in operation at highly elevated points, for a try at that 255-mile record.

Add W2DZA to the list of crystal-controlled stations on 112 Mc. Alex has an 89-807 exciter driving an 811 as a doubler to 112,728 kc. A 224-Mc. rig is under construction, to get in on the growing activity on that band in the Greater New York Area.

How many of the gang are using concentric lines in receiver circuits? W1JP, Providence, reports W1BIL of Pawtucket as being the first in that area to go in for plumbing in the receiver. We have Bill Conklin's word for it that this step should be more than worth the trouble, especially at 112 Mc. and higher.

George Bailey, W1KH (A.R.R.L. President), reports new activity on 224 Mc. in the Boston Area. The boys work out each Monday night between 9 and 11 P.M., with W1's BJB, COO, HUV, IHA and KH in action to date. Those having receivers only can call in on 56 Mc., as watch is kept on Five during the 224-Mc. tests.

And up comes another 400-Mc. report. W2KDB and W2TY, separated by 2¾ miles, made contact first on November 21st. W2TY uses a WE-31 -A at 4 watts input and a 3-element wide-spaced beam. W2' DB gets down (or up) to 400 Mc. with an HY-615 at 1.3 watts. Antennas include 3 half-waves in phase, a ¾-wave vertical, and a square-corner beam. Both fellows use 955 super-regen detectors. Signals are S-9 each way. Going up?

Requests for Marathon report forms are piling in. Have you sent for yours yet? From our standpoint the Marathon represents a systematic means of checking up on what is going on, the country over, in the entire u.h.f. spectrum. From your standpoint it represents a simple way of reporting your activity and receiving recognition in QST. It is our fond hope that every operator who is active regularly on any u.h.f. band will enter this year's Marathon. You will get more fun out of your u.h.f. operation if you join in now. You will know how you stack up alongside other operators. And from your monthly reports we shall be able to present a more complete picture of the doings "On The Ultra-Highs" each month. How about it?

## Strays

The draft registration-certificate holders found in dime stores will also fit ham radio-License cards. — W1KKS.

-----

If you watch the newspapers for raids on illegal pin-ball machines, a call on the sheriff may net several relays, pilot lamps, transformers, a dry rectifier, a motor, lots of hook-up wire and a swell piece of plate glass for the operating table.

— W6FKL.





## ARMY-AMATEUR RADIO SYSTEM ACTIVITIES

THE call "CQ v WAR," when heard on 4025 kc. every Tuesday, Wednesday, Thursday and Friday nights at 7 p.m., is the signal for a unique contest in which literally thousands of amateur stations are participating. All are eager to have the distinction of contacting WAR, the War Department radio station located at Fort Myer, Va., just across the Potomac from Washington, but controlled from the War Department Message Center in the Munitions Building.

This intercommunication between WAR and amateur stations is an extension of the Army Amateur Radio System activities and was inaugurated on December 3d at 7 p.m. when W1AW answered WAR's call and messages were exchanged between Major General Joseph O. Mauborgne, the Chief Signal Officer of the Army, and Mr. George W. Bailey, A.R.R.L. President.

The purpose of permitting amateurs to work WAR during certain schedule periods may best be indicated by quoting the message from General Mauborgne:

THIS MESSAGE INITIATES THE EXCHANGE OF CONTACTS BETWEEN WAR DEPARTMENT NET CONTROL STATION WAR AND AMATEUR STATIONS AS REPRESENTED BY W1AW THE ARRL HEADQUARTERS STATION STOP IT IS MY SINCERE HOPE THAT THESE CONTACTS WILL HELP TO FOSTER CLOSER RELATIONS BETWEEN THE SIGNAL CORPS AND THE RADIO AMATEUR FOR OUR MUTUAL BENEFITS STOP VERY 73 TO ALL.

George Bailey, W1KH, was at W1AW and acknowledged receipt of the above message — which was sent by Major David Talley, W2PF, at the key of WAR. As soon as WAR cleared

W1AW, the entire 80-meter band seemed to open up with stations calling WAR. W8SMH, Binghamton, N. Y., was the first station contacted, and in swift order the following were worked the first night during the 7 to 8 p.m. period: W3QV, W3AOC, W3EON, W3TL/3, W8DVC, W3ECP, W3EWK, W4PB, W3INH, W8PGI, W8MJK, W8AQ, W1LVQ, W1INU, W1EPE, W5HGL, W1IKE/1, W1LHA, W2MHJ, W3JIW, and W8PAF. At 10 p.m. WAR called "CQ ZCAA" on 13,320 kc. and the 20-meter band was monitored. Because of poor conditions, few stations were heard calling WAR or anyone else. W3ZZA was the first contact on this band, followed by W3ILD, W3IRO and W3DZR. The first 75-meter 'phone station worked was W3FJU and, as a result of his suggestion, arrangements were made to listen for 75-meter 'phones the last fifteen minutes of each hour period.

It is hoped that every active amateur in the United States will avail himself of this opportunity to contact WAR during one of the many schedule periods established for this purpose. During the first month more than 400 amateur stations worked WAR and, because of this great interest in the activities of the Signal Corps, the schedules have been increased to include the use of 6990 kc. to contact amateurs on the 40-meter band. The 20-meter schedule has been dropped. The following is the revised schedule:

### Every Tuesday, Wednesday, Thursday, and Friday Nights

E.S.T.	Amateur Band Monitored	WAR Frequency
7:00-7:45 P.M.	3500-3900 kc. (c.w.)	4025 kc.
7:45-8:00 P.M.	3900-4000 kc. ('Phone)	4025 kc.
9:00-10:00 P.M.	7000-7300 kc. (c.w.)	6990 kc.

A distinctive QSL card illustrating the WAR transmitting station at Fort Myer, Va., and carrying a message from the Chief Signal Officer, is in the process of preparation. It will be sent to those stations working WAR who send in their own cards. With no more new countries to work, it is hoped that all active amateurs will endeavor to attain the "WAR" (Worked Army Radio) distinction, to be evidenced by possession of a WAR QSL card.

To insure that as many amateurs as possible hear WAR signals, one of the 10-kw. transmitters is used on 4025 kc., while a 1-kw. set is employed for 6990 kc. operation.

(Continued on page 80)



The operating position at WAR-WLM-W3CXL as amateur contacts began. L. to r.: Pvt. Norton C. Richardson, W3GUV (NC); Pvt. Dorator, W2NDV; Major David Talley, W2PF.

# This Business of Code

## Suggestions on Improving Your Code Proficiency

BY JOHN HUNTOON,\* WILVO

ACCORDING to the last survey made by the League's Communications Department, 60 per cent of amateur activity consists of c.w. telegraph operation. At the risk of boring the other 40 per cent of you — though that chance is slim if one judges by the interest manifested by all of amateur radio in the Code Proficiency Program — I would like to talk about the business of sending and receiving code.

Too little attention is paid by the average amateur to acquiring skill in this basic form of radio communication. We amateurs spend money on equipment, time in building it, care in designing antenna systems — all excellent policies, to be sure — but why stop there? Too few of us realize that in communication, the basic function for which we have worked to gain our licenses, we are known to the world by the way we handle our signals . . . what listeners hear as well as what they see on the S-meter. Paderewski did not become a great pianist by altering his piano's sounding board to see if he could get more volume!

It is true that technical considerations enter into the production of a good note and clean keying, but I prefer to think that the fist itself, a direct product of the operator himself, is the main criterion by which the individual is judged. We can spend \$10 or \$10,000 on station equipment, but we can't buy a good fist. Good operating goes along with a good fist. It is important, then, that we amateurs give attention to how we send as well as to what equipment we use to send it. So, let's delve into it a bit.

It is well to point out here one fundamental thing which is true of every art and particularly so of code operating: real progress requires con-

stant and applied practice. There are no shortcuts; we have to be willing to do it the hard way.

First, let's "take the code apart." It is, really, another language. It is a conversion of intelligence, by letters of the alphabet, into signals which may be transmitted by wire or radio or visually, and then intercepted and deciphered back into intelligence. Specifically, it is a substitution of various combinations of signals and interim spaces for the 26 letters of the alphabet, ten numerals, various punctuation marks and special symbols.

When this system was devised, two of the elements comprising the code equivalents of letters were called the dot and the dash (the third element is the oft-forgotten space). This dot-and-dash conception may have been satisfactory back in wire telegraph days, but it causes a great handicap to those who wish to acquire skill in radio code work. As far as radio communication is concerned, the code should be thought of in terms of *sound* — dits and dahs, rather than as they are pictured on paper as dots and dashes. One wishing to improve his ability to handle code, be he just beginning or well along in his study, will have made much progress the day he begins to think of code solely in terms of sound. The principle is by no means new, but it cannot be stressed too strongly.

Let me digress from code a moment to show why. Repeat slowly to yourself the letter "i." It is not a single pure sound, but rather is enunciated by saying rapidly in succession the sounds "ah" (as in father) and "ee." You use the sound "i" so often you probably never noticed that; and what is more important, you learned it *right*, as one sound instead of a combination of others. Why then do we learn code letters as combinations of sounds instead of as sound units in themselves? If you have been taught to say "i" by the combination of "ah" and "ee," you probably would have had one devil of a time getting the "i" sound down pat. Another example in phonetics is the letter "u," which is formed by saying "ee" and "oo" in rapid succession. When you hear it, you don't think of the letters "ee" and "oo," do you? That's because you learned it as a unit. And that is why code should be learned in units of letters rather than dits and dahs.

When we learn the code in that way, we make the path of progress much easier; we shortly learn whole words by their code sounds rather than by their individual letters. A 25-word-per-

\* Assistant Secretary, A.R.R.L.

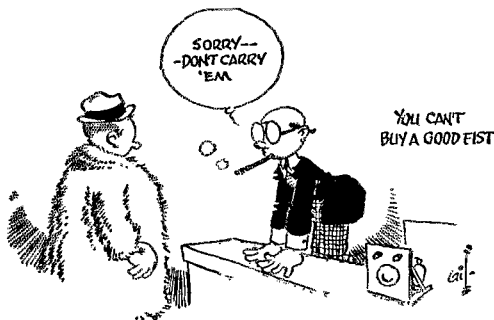

**Don't get the idea that an author with a WIL . . . call is being presumptuous when he writes a story on code, because you'd be very wrong in this case. WILVQ is just another disguise for ex-W9KJY, a fellow who really knows his dits. Besides being one of the fastest amateur operators in the country, John Huntoon has given the subject considerable thought, and we think you'll find his ideas both interesting and helpful.**

minute man when listening to 35- or 40-w.p.m. transmission can easily pick out the short words such as "and," "the," "stop" and others. Why? Because he has heard them so often that they have become indelibly fixed in his mind as word-sounds. At that speed he doesn't hear dits and dahs, or even letter units; it is as if someone had actually spoken the word to him.

The word "the" in Spanish is "el"; in French, "le." In code, it is the sound "dah didididit dit." It's merely another means of expression, another language — but *not* a combination of "dots and dashes."

Perhaps you are one of those who are "stuck" at some speed and can't seem to increase from that point. If so, the trouble doubtless is that you, whether you realize it or not, must take each code character and put it through a mental routine to get the letter for which it stands. You hear the sound "didah," must mentally convert it into "dot-dash" (ugh!) and from there, into the letter "a." You have to use this process because that is the way you learned it and you have not given conscious effort to overcome that fault. Your mind should work like a telegraph printer: producing the letter simultaneously with reception of the code signal — just as if it were spoken.

Why do students of music attend concerts, keep a close watch on the schedule of radio broadcast programs for good music, and buy recordings of the great artists? Because, of course, they want to get the *feel* of the music. They know the *maestro* probably can render the piece more perfectly than any other person. They want to know how the pieces they are studying sound when played correctly. And there is our cue.

We, too, must get the *feel* of the code, and know how it sounds when sent correctly. We have to get fixed in our minds, indelibly, the correct formation of each and every letter and mark in dit-dah sound language and, later, of as many complete words as possible. And, of course, there's one excellent way to do it: listening to commercial tape sending.

This suggested procedure is for already-licensed amateurs, persons who know the code at a speed of 15 words per minute or more. By reference to press and weather schedules in old Call Books,

the list of press transmissions recommended in *QST*'s "Operating News" section for code-practice, or by actually searching them out on the air, find a station or two with automatic keying sending just a bit below your maximum speed — *i.e.*, so you can just read it (not necessarily copy it down) solid. Then stick to him by the hour; hang onto every letter, word and phrase. Listen as you would at a musical concert; notice the formation of each letter and the spaces left between letters and words. Probably you will notice his businesslike "dahdidahdit" for "c," while you blush in remembering your own "dawwwdidawwdit." Notice the proportion in length of dits to dahs; what seem like exaggerated spaces between words (because you've probably been running yours together), and a score of other details where his sending is different than yours would show up in the same text. Take heed — and profit. Half an hour a night of *just listening* will work wonders with your code ability after a couple of weeks.

Even better, however, would be your locating a commercial tape station sending double. Man, here is where you can really get some unequalled practice! Rig up an audio oscillator for your bug or key, separate from the receiver, and as each word comes through initially, fix it in your mind. Then, as the tape repeats it, send the same word simultaneously with the tape, as closely to perfect synchronism as possible. Perhaps you will find yourself leaving too much or too little space between characters, or making certain dahs too long — these are the most common errors. Remember that all inaccuracies are yours, and profit accordingly. By such constant practice you will learn the proper rhythm and precision of perfect code. It's bound to work itself, subconsciously, into your sending.

A code instruction machine, particularly one where long spaces are left between each letter on the tape so the student may repeat it back, can be used if suitable commercial transmissions are not found. If you can't find a commercial station sending double, one sending straight press can substitute in a minor way. When a long word comes along, as soon as you get the first few letters you can often guess the remainder, and

(Continued on page 78)

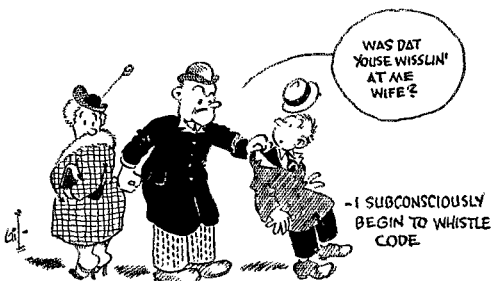



# HINTS AND KINKS FOR THE EXPERIMENTER



## A SIMPLE BREAK-IN KEYING SYSTEM WITH KEYING MONITOR

WHILE the particular system of keying a transmitter shown in Fig. 1 is not new, it is not in general use among amateurs. The arrangement eliminates the necessity for bias batteries or packs and will work nicely regardless of whether the transmitter operates from a single supply or from individual supplies for each stage.

The keying system used is of the blocked-grid class in which all stages of the transmitter are keyed simultaneously and for which the blocking voltage is obtained from the drop across a common cathode resistance. This resistance is of sufficiently high value to limit the plate current of the stage requiring the highest cut-off bias to a low value. Other stages will be completely cut off. The key merely short-circuits this resistance. The

simultaneously with the transmitter, since its grid return is tied into the common return lead. The output level may be adjusted by  $R_7$ , making it unnecessary to disturb the setting of the receiver audio gain control.

The circuit diagram also shows a relay connected in the cathode circuit of the oscillator. A relay which will operate at the plate current of the oscillator may be used to disable or partially disable the receiver should this be found desirable. The leads between the relay and the receiver should be well shielded.

The resistances  $R_1$ ,  $R_2$ ,  $R_3$  and  $R_4$  are grid leaks of usual values appropriate for the tubes in use.  $C_1$ ,  $C_2$ ,  $C_3$  and  $C_4$  should have a capacity of 0.01  $\mu$ fd.  $C_7$  should be at least 1  $\mu$ fd.

The common cathode resistance,  $R_6$ , should have a value high enough to reduce the plate-current of the stage requiring the highest cut-off bias to a low value. The other stages will then be cut off completely. The value will probably be somewhere between 25,000 and 40,000 ohms,  $C_5$  and  $R_6$  form the key-click filter which may or may not be found necessary.

To further increase the smoothness of break-in operation and to reduce b.c. interference, it is advisable to use a line filter and a Faraday screen on the transmitter. With the break-in relay mentioned above and the Faraday screen, the 90-watt transmitter cannot be heard 10 or 15 kc. away from its frequency.—Don B. Crouse, W5DGP and Harold Griffith, W5GEY.

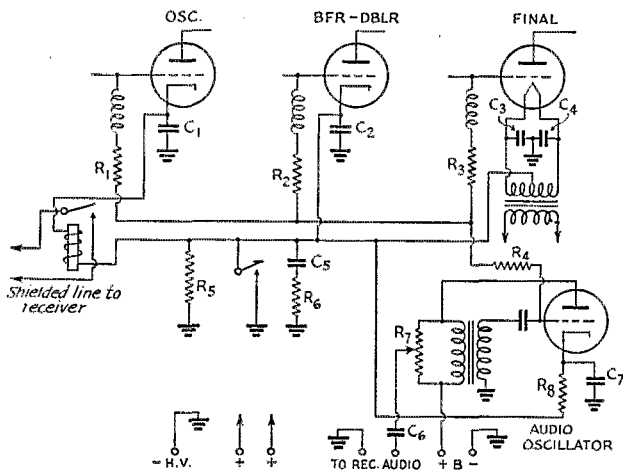

Fig. 1—Circuit of break-in system described by W5DGP. See text for suggested values.

only disadvantage of the system is that the amplifiers will draw high plate current should the oscillator fail to function but only so long as the key is closed so that there is little danger of damage to the tubes.

The circuit includes an ordinary audio oscillator employing a receiving triode which feeds into the audio amplifier of the receiver so that the keying may be monitored. This oscillator is keyed

## YOUR RECEIVER OR AUDIO AMPLIFIER AS AN INTER-COMMUNICATING SYSTEM

OWNERS of communication receivers, or any receiver or audio amplifier for that matter, can convert the receiver or amplifier into a useful inter-room communication system by the simple addition of a d.p.d.t. anti-capacity switch as shown in Fig. 2. The switch need not be installed

in the receiver proper nor need the receiver be changed in any way. In my case, the switch is installed on a panel close to the receiver. The input and output wires are run to the switch together with the wires from the local and remote speakers. The input is nothing more than one wire with a condenser in series, plus a switch to the control grid of the 6SQ7, first audio of the SX25, or the first audio of any receiver or amplifier. The input to grid connection is easily made by removing the first audio tube and wrapping one turn of fine wire around grid pin, keeping this wire as short as possible. Shielding is practicable but was not necessary in my case.

My receiver which is the SX25 has a 5000-ohm output with one side of the coil grounded. This ground connection makes it possible to use but one wire between the remote speakers and the

Fig. 3 — Simple crystal-selector arrangement used by W8JDV. The switch is Meissner type 27-1014, while the crystal sockets are Millen.

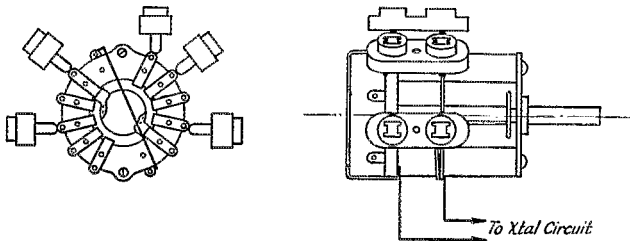

amplifier, the ground being the return. However, somewhat better quality is possible if two wires are run directly to all remote speakers and the one wire grounded at the receiver proper; otherwise the tone is affected. If any trouble is encountered with feedback due to input and output wires being in close proximity to each other at the switch, it can be eliminated simply by addition of a 0.01- $\mu$ fd. by-pass condenser from one side of the output transformer to ground of the receiver.

In the case of other types of amplifiers or re-

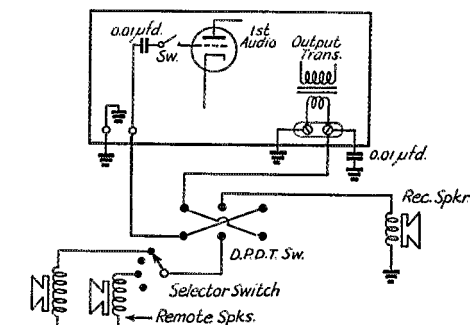

Fig. 2 — W8PCQ uses the audio amplifier and loud-speaker of his receiver in an intercommunicating system. Only simple connections to the receiver are required. For transmission from the receiver speaker, the d.p.d.t. switch is thrown to the right, while for reception, it is thrown to the left.

ceivers which do not have permanent-magnet type dynamic speakers and output transformers for such speakers, it is a simple matter to use a 0.1- $\mu$ fd. condenser off the plate of any amplifier — or receiver — output tube to magnetic speakers which work quite well although the PM type is better.

An anti-capacity switch is not absolutely necessary. A knife or rotary switch is practical so long as feedback from input and output circuits is not excessive due to close spacing of contacts.

As for volume and pickup this system is quite adequate for the purpose. Sounds 50 to 100 feet and more from the remote speakers can be heard plainly.

One remote speaker located at the door and one in another part of the house connected to this switching system saves quite a few steps, as well

as time, in the course of a day. — Ben J. Hummel, W8PCQ.

### CRYSTAL SWITCH

Fig. 3 shows a sketch of a simple crystal switch suggested by G. J. Gray, W8JDV. The crystals plug into Millen type 33002 crystal sockets, one terminal of each of which is soldered directly to the switch contacts. The terminals at the other ends of the crystal sockets are soldered to a ring of wire fastened to one of the switch supports to form a common connection. The two sections of the switch, which in this case happens to be a 5-point, 2-section switch, are wired together so that the two sections alternate in switching in crystals. Almost any single-gang tap switch with good insulation and spacing should be satisfactory. One of these assemblies can be made up in a few minutes.

### INCREASING RESISTOR POWER RATING

THE handy kink shown in Fig. 4 is very simple in principle, but for this very reason might not have occurred to some. The power rating given a vitreous-enameled resistor of the slider type applies to the entire resistance. Thus, when only a portion of the resistor is in use, its power rating is reduced. In other words, the current-handling ability of the wire with which the resistor is wound is the principal limiting factor.

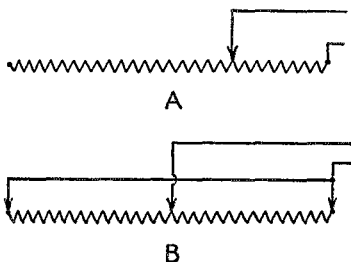

Fig. 4 — Simple method of increasing power rating of adjustable resistance at low-resistance values.

By putting the slider at the center and connecting the ends of the resistor together, as shown at B, Fig. 4, the two halves of the resistor are connected in parallel, the total resistance is reduced to one quarter of the original value and the current-carrying capacity has been doubled. If less than one quarter of the resistance is required, additional sliders may be placed at an equal distance from each end. This idea should be particularly useful in experimental adjustment of a series voltage-dropping resistor where the current through the resistance increases with a decrease in resistance. — *Elmer F. Blanchard, W1CHB.*

## ★ NEW APPARATUS ★

### Constant-Voltage Transformers

THE Sola Electric Co., 2525 Clybourn Ave., Chicago, Ill., produces a line of regulating transformers for applications requiring essentially constant voltages. Stock transformers range in power rating from 25 v.a. to 3 k.v.a. and are designed to hold a secondary voltage of 6 or 115 volts constant within less than one per cent with a primary voltage variation of 90 to 130 or 180 to 260. The smaller sizes are particularly applicable to service in amateur transmitters for holding filament voltages at the required levels.

### New Safety Device

A SAFETY device for making the tests in which neon bulbs and flashlight lamps are frequently used has been brought out by Radio Safety Devices Co., 4239 30th St., San Diego, Calif. It consists chiefly of an insulated tubular

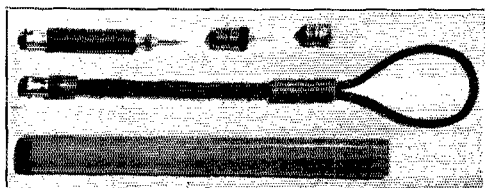

handle with a receptacle at one end for either a plug-in loop of insulated wire or a prod. The other end is fitted with another receptacle for either a flashlight lamp or a neon bulb.

## ★ A.R.R.L. QSL BUREAU ★

FOR the convenience of its members, the League maintains a QSL-card forwarding system which operates through volunteer "District QSL Managers" in each of the nine United States and five Canadian districts. In order to secure such foreign cards as may be received for you, send your district manager a standard No. 10 stamped envelope (standard business size,  $9\frac{1}{2}'' \times 4\frac{1}{8}''$ ). If you have reason to expect a considerable number of cards, put on an extra stamp so that it has a total of six cents postage. Your own name and address go in the customary place on the face, and *your station call should be printed prominently in the upper left-hand corner.*

- W1 — J. T. Steiger, W1BGY, 35 Call Street, Willimansett, Mass.
- W2 — H. W. Yahnel, W2SN, Lake Ave., Helmetta, N. J.
- W3 — Maurice Downs, W3WU, 1311 Sheridan St., N. W., Washington, D. C.
- W4 — Eddie J. Collins, W4MS, 1517 East Brainard St., Pensacola, Fla.
- W5 — James F. Manship, W5ALE, 910 So. Boston, Tulsa, Okla.
- W6 — Horace Greer, W6TI, 414 Fairmount Ave., Oakland, Calif.
- W7 — Frank E. Pratt, W7DXZ, 5023 So. Ferry St., Tacoma, Wash.
- W8 — F. W. Allen, W8GER, 450 Fountain Ave., Dayton, Ohio.
- W9 — Alva A. Smith, W9DMA, 238 East Main St., Caledonia, Minn.
- VE1 — L. J. Fader, VE1FQ, 125 Henry St., Halifax, N. S.
- VE2 — C. W. Skarstedt, VE2DR, 236 Elm Ave., Westmount, P. Q.
- VE3 — Bert Knowles, VE3QB, Lanark, Ont.
- VE4 — George Behrends, VE4RO, 186 Oakdean Blvd., St. James, Winnipeg, Manitoba.
- VE5 — H. R. Hough, VE5HR, 1785 First St., Victoria, B. C.
- K4 — F. McCown, K4RJ, Family Court 7, Santurce, Puerto Rico.
- K5 — Fourth Coast Artillery, K5AA, Radio Section, Fort Amador, Balboa, C. Z.
- K6 — James F. Pa, K6LBH, 1416D Lunalilo St., Honolulu, T. H.
- K7 — Jerry McKinley, K7GSC, Box 1533, Juneau, Alaska.
- KA — George L. Rickard, KA1GR, P. O. Box 849, Manila, P. I.



## CORRESPONDENCE FROM MEMBERS

The Publishers of *QST* assume no responsibility for statements made herein by correspondents.

### "HAMS AND JOBS"

1647 Golden Gate Ave., Los Angeles, Calif.

Editor, *QST*:

"Strictly Ham's" letter published in the December *QST* reads like a story of unrequited love in Dorothy Dix's column. It is to be regretted that so many amateurs who are seriously desirous of obtaining employment in the radio field will read — and be swayed — by a story of personal failure such as this. I trust that most of them will appreciate that "Strictly Ham," by his own admission having no experience in any branch of commercial radio, is hardly competent to outline the requirements desired in job seekers in these various fields. Yet he takes it upon his shoulders to inform all and sundry that amateurs are not welcome in radio industry.

Well, square your shoulders and get that grin back on your face, Brother Ham. The experience you have gained in design, construction, and operation of an amateur station has provided you with a nice wedge to widen the crack through which you can pass into commercial radio industry.

You will note I say "the experience you have gained" and "widen the crack." I doubt if any but the most naive could interpret the September and October *QST* articles as stating that a *ham ticket* was the "open sesame" that would fling wide the door to the rich fields waiting in commercial radio. It is the knowledge you have gained as a ham, not your ticket, that will give you the opportunity to prove your aptitude in this field.

Yet, woefully, there are still many of us who walk briskly into the employment office of a radio manufacturer and say blandly, "I am an amateur, and I'd like to go to work for you." Or, worse yet, "Can you use an amateur in your business?" Horrible, isn't it? Yet, "Strictly Ham" must have used an approach akin to this. That is evident from the answers he received from the employment interviewers.

What business, radio or otherwise, is looking for amateurs? What does the word "amateur" imply? Unskilled? That is about it. At the very sound of the word the interviewer goes cold. How much better it would be to trade on the knowledge and experience we have gained in the pursuit of our hobby — how much better to speak of the fact that we are familiar with vacuum tube characteristics, superheterodyne receivers, image frequency response, signal generators, audio oscillators, frequency modulation, oscillograph alignment, etc. . . .

"Strictly Ham" writes that the job seeker in radio (manufacturing) must be armed with an E.E. degree, plus radio training. Otherwise, to quote, "he stands only a slightly better chance of employment than does any person entirely ignorant of the subject." That statement is almost too ridiculous for comment. Who would have a better chance at a bus driving job; an applicant who had driven an automobile for pleasure, or a man who didn't know the clutch from the brake?

Personally, when I walked into the employment office of one of the largest radio plants in Chicago and told them I could line up a superheterodyne, I was immediately given a chance to prove it. Luck, "Strictly Ham"? Two months later I was in charge of the test department. Luck again? That advancement was due simply to the fact that I knew what image frequency was, and why it was separated from the true signal by twice the frequency of the i.f. stage of the receiver under test. Did I learn that in college? Wrong again, "Strictly Ham." My education was equal to yours. Experience? Only that gained during four years as an active ham.

In the five years I spent with this company I handled at one time or another almost every supervisory position in

the plant. I rose finally to the position of assistant superintendent. For "Strictly Ham's" information, I was never asked to work as a wireman, assembler, or checker (a term I never heard used in a radio factory). This plant, like 90% of the radio factories, used girls on the production lines for chassis assembly and wiring. In interviewing applicants for employment I have talked with many amateurs. Many of these received positions with the firm. But, sad to relate, it was necessary in most cases to dig out of the applicant his actual experience.

Too many, like "Strictly Ham," marked their application blanks: "Amateur — no experience. . . ."

— Jerry Crowley, *W6HBT*

12 Willow Ave., Corte Madera, Calif.

Editor, *QST*:

. . . "Strictly Ham" waves several licenses at us and says, in effect, "I have what it takes" — but does he? A person may hold a chauffeur's license, but that does not qualify him as an auto mechanic. Ham licenses and commercial licenses are a dime a dozen. The usual practice is to memorize the answers like a parrot. No wonder the Western Electric interviewer states amateurs are lacking in technical background. Licenses merely allow one legally to hold an operating position. You cannot expect communications companies to hire you simply because you state, "I hold a Radiotelegraph First" or "a Radiotelephone First." You must bring something else along. If you are applying for an operating position, you need "operating background." As an example, take aviation radio. Before you apply are you certain you can stand up under the strain of a circuit test making good copy of five-letter code groups, coming at you from a strange "fat" between 25 and 35 w.p.m., with the characteristic "aeronautical swing"? If you can, go to it. You will not have any trouble finding a position. Aviation needs good men — and I mean good. In connection with the above, the current A.R.R.L. code program of proficiency is excellent. . . .

You may ask, "How can I get experience on my license so needed for an 'operating background'?" Well, I got mine the hard way — in the Army. . . . You don't like the idea of spending three lean years in the Army? Well, some are going to spend one year anyway, so the next two won't matter. I didn't like the idea, either, but I had commercial licenses and could not get a job because I lacked "operating experience." So I played a long shot and won. I got plenty of experience in marine operating, point-to-point operating (punching a Klein and reading slip), and manual operating. You think I sound like a recruiting sergeant? That's not the idea at all. Look ahead. You can't get something for nothing. . . .

What amateurs who intend to make radio their livelihood need is a good stiff course in *basic electricity and radio fundamentals*, learning them backwards and forwards so they can visualize all that happens when they hook up a few parts. Many hours of bug chasing would be eliminated. And you do not need to go to a radio school to learn. Instead of working "Joe" around the block on 160 'phone, spend about three or four nights a week studying theory. It's tough going and dry as the dickens, but it pays dividends in your hobby or your job. . . .

— John M. Sharpe, *W2EEL/B*

e/o Airport, Butte, Mont.

Editor, *QST*:

. . . There are undoubtedly many underpaid men in radio, but by far the great majority are paid just about  
(Continued on page 52)



F. E. HANDY, WIBDI, Communications Mgr.

J. A. MOSKEY, WJMY, Asst. to the Coms. Mgr

**Use CQ Ahead of Calls Not Strictly F.C.C. Designations.** The F.C.C. monitoring stations are reporting many things to Washington, including some things not strictly illegal but having defense angles, or capable of misinterpretation by the uninformed, or having nuisance value or positive danger in time of national emergency. An F.C.C. representative recently focussed his attention with some excitement on a group of hams apparently calling a Latvian station whose call was YLRL. Hi! A thorough investigation disclosed that the call referred to the Young Ladies' Radio League! But it becomes apparent that Uncle Sam wishes to devote his entire monitoring facility to things that need to be monitored, with a minimum of trouble looking into our many abstruse, if harmless, designations. We are restricted from engaging in foreign communications. To avoid F.C.C. letters and admonitions and to facilitate all monitoring A.R.R.L. now recommends that all netters, trunk liners, and special officials or groups refrain from use of any independent special designations or abbreviations *by themselves* as calls. Instead, use CQ and *any such designation*. Any of our particular designations may still be used *if amateurs will put the general inquiry call (CQ) ahead of them*. This will make it apparent that *any station* in a named group may answer, and make it clear no one is calling foreign stations contrary to Order No. 72.

**Coming Activities.** The 1.8-Mc. W.A.S. Party receives full announcement elsewhere in this issue. It offers five points per station worked, and a fixed credit for all amateurs that are doing their stuff on the Code Proficiency Defense Program. March will bring a similar chance to try out the merits of 28 Mc. — new operating fun and similar new incentives for all who want them.

Feb. 14th-15th-16th — 1.8-Mc. A.R.R.L. W.A.S. Party.  
 Feb. 19th — Frequency Measuring Test <sup>1</sup> (for Observers).  
 Feb. 21st (Friday) — W1AW Code Proficiency Qualifying Run starts 9:30 P.M. CST.  
 March 7th-8th-9th — 28-Mc. A.R.R.L. W.A.S. Party.  
 March 21st (Friday) — W1AW Code Proficiency Qualifying Run starts 9:30 P.M. CST.  
 March-April — Nationwide Red Cross Test of Emergency Communications Facilities (dates tentative as yet, depending on progress of Emergency Corps and Coördinator appointees).

<sup>1</sup> Any League member who wishes to participate or test his frequency measuring ability and equipment, may write the Communications Department for the W1AW schedule of transmissions for February 19th, and on reporting will later receive a confidential report of his measurement accuracy.

**On the Rate of Copy.** There are several standard concepts of expressing a man's Code Speed. It can be expressed as the number of words per minute that a man can receive or put down on paper, *exactly as a station sends them*. Also the rate that an operator can send is another criterion. The speed is *never gaged* by the rate at which code characters "go in one ear and out the other."

The W1AW transmissions constitute a national amateur standard for sending qualifying tape transmissions. Copying ability is the number of words at the rate of five characters and a space per each that can be put down on paper with 100% accuracy for at least one full minute when plain language Continental code is used. The W1AW transmissions, both practice and qualifying runs, go progressively 15-, 20-, 25-, 30-through 35-word-per-minute rates of speed.

It is one thing to hear some information coming in and get the general drift of the text sent — and quite another to be able to *write down accurately* all that is sent. Some amateurs are just finding this out. One's curiosity about his speed can be gratified almost daily by listening to the scheduled practice. Every amateur not yet equipped with the CODE PROFICIENCY CERTIFICATE AWARD is urged to mark dates of the next qualifying runs on his calendar. Every U. S. licensee by participation in the League proficiency program has opportunity to win recognition, by qualifying for an award at a speed higher than required by the government for amateur licensees.

**W1AW Code Proficiency Runs.** The code *practice* continues daily, except Friday, starting 9:15 P.M. CST. 1762-3825-7280-14,253-28,510 kcs. are used simultaneously. You can pick the best frequency to copy. The next *qualifying* runs follow transmissions at the usual practice time, qualification copy starting at 9:30 P.M. CST:

February 21st, Friday	May 14th, Wednesday
March 21st, Friday	June 17th, Tuesday
April 17th, Thursday	July 20th, Sunday

State on copy if you are working for a first certificate or for endorsement. Underline the full minute of perfect copy that you believe qualifies you at any speed. Attach a statement that you copied by ear, without aid (except typewriter or pencil which please mention). Mail your original copy, for best chance of qualifying. We want to give *every* U.S.A. licensee a certificate. Got yours? If not, there's no time to start like now. — F. E. H.



## ARTICLE CONTEST

The article by H. W. Castner, W1IIE, wins the C.D. article contest prize this month. We invite entries for this monthly contest. Regarding subject matter, we suggest that you tell about what activity you find most interesting in amateur radio. Here you will find an almost limitless variety of subjects. Perhaps you would like to write on working for code proficiency, Emergency Corps planning, traffic work, working in Section Nets, 'Phone and Telegraph operating procedures, holding a League appointment, working on radio club committees, organizing or running a radio club, the most interesting band or type of ham activity, or some other subject near to your heart.

Each month we will print the most interesting and valuable article received. Please mark your contribution "for the C.D. contest." Prize winners may select a bound *Handbook*, *QST* Binder and League Emblem, six logs, eight pads radiogram blanks, DX Map and three pads, or any other combination of A.R.R.L. supplies of equivalent value. Try your luck!

## QTC 1

BY HAROLD CASTNER,\* W1IIE

**L**ISTEN on the common traffic bands at almost any time and you will be convinced that a great volume of traffic is being handled. We hear many nets operating and find ourselves eavesdropping on much actual traffic procedure. There is a significant contrast in operators. To the untrained observer little difference would be noted. To men trained in the fine points of sending a message there is a vast difference.

Those who ask "fills" fail often to regard the immediate receiving conditions and position of the receiving operator. Only minor changes have taken place in a message form for many years. In 1908 I learned that a message consisted of four parts: The preamble, the address, the body and the signature. These should be definitely set off by those handling pencil or typewriter. I also learned the definition of a double dash. In a message it is used to separate the address from the body and the body from the signature. Common practice that produces accurate reception is to use "R" for a period in a filing time; two A's at the end of each line in the address to tell the receiver to start another line; and proper reception of message numbers, difficult station calls, checks that may be mistaken and especially places of origin with difficult spelling.

In consideration of the preamble let us suppose that we have the following example: Nr 45 W1IIE Ck 55 DAMARISCOTTA, MAINE 540 PM Dec 2. If you rip this right off to a receiving operator he will be mentally confused with the 45's, the 55's, etc. He will certainly ask for a repeat on that horrible QTH. Whatever happens, like many other preambles it will be difficult to copy solid when run right off with straight sending. We don't propose to be an expert but here's how we would tear that preamble apart in sending.

Hr Nr 145—145 W1IIE (Slow), Ck 55 IMI 55 (Slow now) D a m a r i s c o t t a IMI Damariscotta Maine 5 R 4 0 PM Dec 2. Repeating the number at the start gives the receiving operator time to adjust his blank in the mill, to adjust his mind to the job in hand, and to confirm the figures in case the first characters caught him off guard. Between the Ck 55 and place of origin we would hesitate just a fraction to allow the receiver to have just a moment's reflection on the accurate number. We would make a

definite space between the place of origin and the time group and between the time group and the date, and put a definite double dash after the date. Here would be one of those double spaces wherein mentally we would see the receiver shifting his typewriter carriage or his pencil to be ready with the first of the address which all too often is an initial letter and generally followed by another. If these sections require repeats for commercial men and machines, how can an amateur expect to run off proper names in a message at the same speed he has been running the text, without expecting later "fills" or confirmation?

We hear repeated use of abbreviations in the body of messages which is absolutely wrong! We hear tricky and difficult words run right along at the same speed and then we note the receiver asking for fills. Certain parts of a text are easy, plain language and parts are more complicated. The wise operator makes a mental division of the text that assists the receiving operator tremendously.

A double dash goes at the end of the text as at the beginning. This avoids any confusion in the mind of the receiver as to what is coming next, which is the signature. If it is tricky or has extra words, it should be sent cautiously. Directly after this should be a well defined "end of message" signal (AR).

Two actual cases: W2 sends with a slightly jerky style. He is not too easy to copy without watching. Yet he observes the finest judgment in all the fine points which so greatly assist the receiving operator. I seldom hear them ask *him* for repeats. W1 has a smooth fist and is very steady with a bug. Landline experience may have influenced him. This chap does not hesitate at the right places in message forms. I note how infrequently he gets a message over the first time. He probably thinks all the operators are "bum" copiers. (Actually this is what every reliable receiving operator should and must be — *sure* of his copy!)

We have seen an operator sitting at a position facing upwards of 10,000 messages. Yes, I said Ten Thousand! Time is the essence when one must clear the hook. This does not indicate the use of speed especially since exertions in that direction lead to heavy requests for fills and frazzled nerves without much profitable result. This dissertation is wholly from the standpoint that proper message sending technique must always consider the receiving operator, to really get the message over in the shortest time with least transmitting. Let's buck up and cut out this erratic transmitting. Let's inject real thoughtfulness in our operating and let's do better. A capable Naval officer boss once gave us as his motto the thought, "To do as well you must do better."

-----

## BRIEFS

About fifty amateur stations participated in a Presidential Election Returns Network last November. Information on the progress of the election from various points in the country was relayed into New York City and then delivered to Municipal Broadcast Station WNYC. Mrs. Kay Kibling, W2HQX, was instrumental in lining up the net and in furnishing the b.c. station with the returns as they came in. Dr. Seymour N. Seigel, Director of Programs at WNYC, was pleased with the manner in which the amateurs handled the undertaking, and is having printed certificate awards which will be signed by Mayor LaGuardia and forwarded to those who took part.

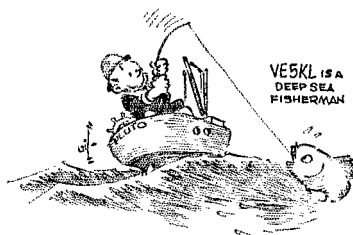

\*Damariscotta, Maine.

## BRIEFS

The Baltimore Amateur Radio Association assisted the Boy Scouts in their practice emergency mobilization, October 19, 1940. The club transmitter was set up in Druid Hill Park and operated by W3EHT. W3EEI had his rig at Paterson Park working from a 700-watt A.C. generator. W3HAL operated his battery-powered station at the grounds of School No. 234. W3EQK, W3IBP, W3OZ, W3LXE, W3GWS, W3HRI, and W3EKZ operated their home stations, using Boy Scouts as messengers, to and from mobilization points. All contacts were made on 1888 kc., using 'phone. W3EKZ acted as net control and took all traffic for Scout Headquarters. Forty-two messages were received, eighteen originated and five relayed by EKZ. W3IER and W3ESM assisted Robert McCleary, who had his HQ120 at the Scout Offices in order to hear how the tests were progressing.

— • • • —

"Dot" Wilkins, W1FTJ, won top honors in the First Anniversary QSO Party of the Y.L.R.L. She has been awarded a silver loving cup, to be held for one year. The first member winning the cup three times gains permanent possession of it. FTJ worked 26 YL stations in 17 states.

— • • • —

### Mother's Life Saved by Amateur Radio

W7EVT had a schedule with K7HTI on Kanatak Island, Alaska, late one afternoon last fall. Upon hooking up, he was informed by the K7 that an Eskimo mother, close by, was dying from childbirth complications. There was no doctor within a 500-mile radius. W7EVT was asked to get in touch with a doctor. He called a local physician on the telephone and relayed a description of the case. Instructions were received and radioed to K7HTI. Mrs. K7HTI carried out the instructions, and the Eskimo mother finally recovered.

And so, another worthy accomplishment is added to the fine record of amateur radio's service in emergency!

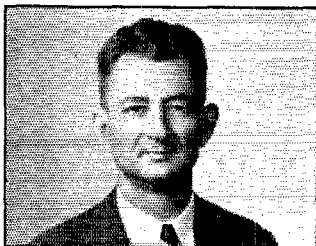

## Meet the S.C.M.'s

### HORACE E. BIDY, W5MN

S.C.M. Southern Texas is active on 1.75, 3.5, and 7 Mc. His pet frequency, however, is 3626 kc., and that's where he can most often be found. All operation is confined strictly to c.w. V.F.O. and crystal control are used with the Collins 30FX transmitter which is normally run at 150 watts. Reception is provided by a Comet Pro. In the event that commercial facilities fail, a battery/generator supply and a 900-watt, 110-volt A.C. generator are kept ready to take over the job of furnishing power. The station is located in a rather novel type of shack; its a "dog house" built on an old automobile chassis and is located in the back yard. W5MN was first licensed in 1921. He's O.R.S., R.M., active on TL K, ex-Emergency Coördinator, holds an A-1 Operator certificate, and is a member of the San Antonio Radio Club. In the newspaper game since 1909, S.C.M. Bidy is at present employed by the Express Publishing Co. In addition to amateur radio his hobbies include cryptanalysis and swimming and his favorite sport is baseball.

# W1AW Operating Schedule

## OPERATING-VISITING HOURS:

3:00 P.M.—3:00 A.M. E.S.T. daily, except Saturday-Sunday  
Saturday — 8:30 P.M.—2:30 A.M. E.S.T.  
Sunday — 7:00 P.M.—1:00 A.M. E.S.T.

OFFICIAL BROADCAST SCHEDULE (for sending addressed information to all radio amateurs).

## Frequencies

C.W.: 1761-3825-7280-14,254-28,510 kcs. (simultaneously)

Starting Times (P.M.)		Speeds (W.P.M.)										
E.S.T.	C.S.T.	M.S.T.	P.S.T.	M	T	W	Th	F	SatSun			
8:30	7:30	6:30	5:30	20	15	25	15	20	—	20	—	
Midnight	11:00	10:00	9:00	15	25	15	20	15	15	—	—	

PHONE: 1806, 3950.5, 14,237, 28,510 kcs.

Each code transmission will be followed in turn by voice transmission on each of the above frequencies.

## CODE PRACTICE:

Besides the O.B.S. times and word speeds given above, W1AW will adhere to a schedule for sending code practice transmissions at progressively increasing speeds (15 to 35 w.p.m. in 5 w.p.m. steps) daily except Friday, starting at 10:15 P.M. E.S.T. Proficiency Certificate Award qualifying runs start 15 minutes later than practice schedules on a date announced for each month. (Feb. 21st, Mar. 21st, Apr. 17th.)

## GENERAL OPERATION:

Besides specific schedules in different bands, W1AW devotes the following periods, except Saturday and Sundays, to GENERAL work in the following bands:

Time E.S.T.	Frequency
4:00 P.M.—4:30 P.M.	28,510-kc. 'phone/c.w.
4:30 P.M.—5:00 P.M.	14,237-kc. 'phone
6:00 P.M.—6:30 P.M.	14,237-kc. 'phone
6:30 P.M.—7:00 P.M.	14,253-kc. c.w.
8:00 P.M.—8:30 P.M.	14,253-kc. c.w.
9:15 P.M.—9:45 P.M.	3950-kc. 'phone
12:45 A.M.—1:15 A.M.	1806/1760-kc. 'phone/c.w.
1:15 A.M.—2:00 A.M.	3825-kc. c.w.
2:00 A.M.—3:00 A.M.	7280-kc. c.w.

7:00 P.M.—8:00 P.M.: Schedules on 3500-kc. band  
10:15 P.M.—11:00 P.M.: Code Practice, all c.w. freqs.  
11:00 P.M.—Midnight: National Trunk Line Net N.C.S.

At other times, and on Saturdays and Sundays, operation is devoted to the most profitable use of bands for general contacts and to participation in special week-end operating activities. The station is not operated on legal national holidays.

— • • • —

## Chicago Luncheon Club

After dunking doughnuts together at an informal luncheon nearly every week for several years, W9BNX, W9QDA, W9QHZ and W9OMP decided to become less exclusive and invite other hams to the get-togethers. An arrangement has been made with Harding's Dining Room on the seventh floor (west) at the Fair Store, in Chicago's "loop," to set aside a private room each Monday noon, for all amateurs who may care to come. The cost of the luncheon depends on what is selected from the menu. The minimum charge is only 10 cents. There is no guarantee on attendance required, and there is no intention of organizing a formal club, collecting dues, or having any sponsorship. It provides a chance for many hams able to drop in to "chew the fat" while chewing the starch — literally. We recommend this idea to amateurs in general as an excellent way of furnishing the opportunity for local amateurs to get together informally to discuss doings in their vicinity.

# Code Practice

THE amateur stations listed below conduct automatically-sent code practice transmissions for the benefit of those who are trying to improve their code copying ability. There follows the schedules of several commercial stations whose press and weather transmissions make excellent code practice. We remind you that addressed information *may not be divulged* except to the addressee. Do not use such transmissions for anything but practice.

## Amateur-Band Code Practice

- W1AW — 10:15 P.M. EST, except Fri. (15-35 wpm); 1761-3825-7280-14254-28510 kcs.  
 W2KYF — 9:00-10:00 P.M. EST, Wed. & Fri. (25 wpm); 3545 kcs.  
 W6AM\* — 5:45-6:10 P.M. PST, Mondays (15-35 wpm); 14306 kcs.  
 W7YG — 7:30-8:30 P.M. PST, Mon. (15 wpm), Tues. (20 wpm), Wed. (25 wpm), Thurs. (30 wpm), Fri. (35 wpm); 7022 kcs.  
 W9IBC — 7:00-7:30 P.M. CST, Mon., Tues. & Wed. (15-25 wpm); 7004 kcs.  
 \*Subject to cancellation on occasional dates when opr. is away.

## Press and Weather Transmissions

(All Times Given are E.S.T.)

- |           |            |                |          |
|-----------|------------|----------------|----------|
| 22 W.P.M. | 1:50 P.M.  | Mon. thru Sat. | WBE/WCB  |
|           | 6:30 P.M.  | Mon. thru Sat. | WBE/WJP  |
|           | 9:00 P.M.  | Sun. thru Fri. | WCB/WBG2 |
|           | Midnight   | Mon. thru Fri. | WJP/WBG2 |
| 30 W.P.M. | 5:00 A.M.  | Mon. thru Sat. | WDH/WHL  |
|           | 8:00 A.M.  | Sun. only      | WDH/WRK  |
|           | 9:00 A.M.  | Mon. thru Sat. | WDH/WRK  |
|           | 2:00 P.M.  | Daily          | WDH/WRK  |
|           | 6:15 P.M.  | Daily          | WRK      |
|           | 7:00 P.M.  | Daily          | WRK/WHL  |
| 37 W.P.M. | 7:00 A.M.  | Mon. thru Sat. | WCX/WJS  |
|           | 8:00 A.M.  | Mon. thru Sat. | WCX/WJS  |
|           | 10:00 A.M. | Sun. only      | WJS      |
|           | 11:00 A.M. | Mon. thru Sat. | WCX/WJS  |
|           | Noon       | Mon. thru Sat. | WCX/WJS  |
|           | Noon       | Sun. only      | WCX/WJS  |
|           | 1:15 P.M.  | Mon. thru Sat. | WJS      |
|           | 2:15 P.M.  | Mon. thru Sat. | WJS      |
|           | 4:30 P.M.  | Daily          | WCX/WJS  |
|           | 5:15 P.M.  | Daily          | WCX/WJS  |
|           | 8:00 P.M.  | Mon. thru Sat. | WCX/WJS  |
|           | 8:05 P.M.  | Daily          | WCX/WJS  |
|           | 8:50 P.M.  | Daily          | WCX/WJS  |
|           | 10:05 P.M. | Daily          | WCX      |
| 50 W.P.M. | 6:00 A.M.  | Mon. thru Sat. | WPU      |
|           | 6:30 A.M.  | Mon. thru Sat. | WRM      |
|           | 8:00 A.M.  | Mon. thru Sat. | WRM      |
|           | 10:00 A.M. | Mon. thru Sat. | WRM      |
|           | Noon       | Mon. thru Sat. | WRM      |
|           | 1:50 P.M.  | Mon. thru Sat. | WRM      |
|           | 2:50 P.M.  | Mon. thru Sat. | WRM      |
|           | 6:30 P.M.  | Mon. thru Sat. | WPU      |
|           | 8:40 P.M.  | Mon. thru Sat. | WPJ      |
|           | 9:15 P.M.  | Mon. thru Sat. | WPK2     |

Frequencies: WBE 19850; WBG2 7615; WCB 15580; WCX 7850; WDH 19470; WHL 10750; WJP 8810; WJS 15700; WPJ 11640; WPK2 13185; WPU 14635; WRK 15910; WRM 18580.

### Miscellaneous:

- 3:30-4:30 P.M. IAC 12865 (Appx. 40 W.P.M.)  
 5:00-8:00 P.M. GIC 8640; GID 13555; GIH 10650 (20 W.P.M.)  
 6:00-8:00 P.M. DLE 10130 (Appx. 20 W.P.M.)  
 6:30-8:00 P.M. DON 10128 (Appx. 35 W.P.M.)  
 7:00 P.M. LOL 8690; PPR 8310; WFC 6785  
 8:00 P.M. WAC 10470; WFD 4985  
 8:30 P.M. WPN6410  
 9:00 P.M. NSS 5965 (50 W.P.M.)

# Brass Pounders' League

(November 16th-December 15th)

Call	Orig.	Del.	Ref.	Extra Del. Credit	Total
W3GKO	19	42	2061	31	2153
W3AOC	41	61	1267	45	1414
W9INU	223	79	968	62	1332
W9ILH	30	141	1008	62	1241
W6LIJ	144	322	344	315	1125
W1KKS	54	29	870		953
W6DH*	69	292	425	161	947
W2LZR	66	136	614	113	929
W3BWT	95	98	623	87	903
W6IOX	26	42	792	42	902
W5FDR	120	184	392	161	857
W2HXI	30	66	834	61	791
W7EBQ	29	52	648	40	769
W6PGB	67	77	552	65	761
W9OZN	58	11	574	18	761
W6DH	79	21	638	21	759
W5MNN	33	107	530	36	756
W3QP	197	262	3	259	721
W3EEW	90	91	398	64	643
W6ROZ	35	35	520	21	611
W3EML	28	94	380	94	596
W6MDI	12	42	462	27	543
W9CRK	10	59	412	55	536
W1MEC	45	90	312	87	534
W8SAY	14	20	475	16	525
W5CEZ	12	110	368	20	510
W1JSM	40	58	368	36	502

## MORE-THAN-ONE-OPERATOR STATIONS

Call	Orig.	Del.	Ref.	Extra Del. Credit	Total
KA1HR	1085	640	60	604	2389
W5OW	140	93	1014	51	1298
W1AW	70	100	346	93	609
W5ECL	0	0	600	0	600
W9BNT	13	146	335	8	502

These stations "make" the B.P.L. with total of 500 or over. One hundred deliveries+Ex. Del. Credits also rate B.P.L. standing. The following one-operator stations make the B.P.L. on deliveries. Deliveries count.

W2KI.....	225	W3HBH.....	159	W2MNT..	120
W5GFT.....	190	W3BZE.....	140	W8OKK...	107
W6RBQ.....	184	W8JIW.....	136	W6ZX.....	108
W1FFL.....	181	W7APS.....	134	W9QG.....	107
W9VBQ.....	175	W8KWA.....	133	W2DW.....	100
W5CYX.....	170	W9TTJ.....	123	W9TGK..	100
W6SN.....	160	W9YTV.....	121		

More-than-one-opr.  
 W5CEB/5..149

## MORE-THAN-ONE-OPERATOR STATIONS

Call	Orig.	Del.	Ref.	Extra Del. Credit	Total
WLM (W3CXL)	214	159	2780	91	3244

A total of 500 or more or 100 deliveries+Ex. D. Cr. will put you in line for a place in the B.P.L.

\*Oct.-Nov.

- 10:00 P.M. KUP 6440; NAA 9250; NPG 12885; NSS 4525; XDP 4800; XDD 13043  
 11:15 P.M. WSC 8430; WSL 5555  
 Midnight KPH 8440, 12735; KTK 6400, 8680; NSS 4525

(All Times P.S.T.)

- 7:00 A.M. NPG 9090 kc.  
 8:30 A.M. JUP 13060 kc.  
 2:30 P.M. KTK 16740 and 12495 kcs.  
 4:00 P.M. NAA/NSS 9250 kc.  
 5:15 P.M. WPN 11295 kc.  
 7:00 P.M. NPG 9090 kc.  
 8:00 P.M. KJH 7815 kc.  
 8:20 P.M. WGG/WSC 6340 kc.  
 9:00 P.M. KTK 3680 and 12495 kcs.  
 10:00 P.M. KFS 8380, 12550 and 97.5 kcs.  
 10:00 P.M. KWJ 15000 kc.  
 12:10 A.M. KPH 8440 and 12380 kcs.

# How's DX?

## HOW:

WHEN the holiday season descends full blast on a guy, it isn't too unlikely that he will make a mistake now and then. That is exactly what happened when W9QJR's story was accepted without question and run in the December issue. The story had to do with a very persistent station that called W9QJR on several occasions, and W9QJR, an ardent amateur not giving to overlooking opportunities for a contact, would have been pleased to QSO this persistent station if it had not been signing "D5GZR." We used the incident as an excuse to sermonize about virtue triumphant and some other stuff we read about in a book once. We got away with it but not for long, because W9ERN, W9BRD and W2MMT wasted very little time in pointing out the fact that if a certain DX columnist were a little more wide-awake he might have known that the afore-mentioned D5GZR was none other than K4GZR, a new gentleman of the air-waves who has what might be known as a "peculiar keying characteristic," or in medical terms, "short-last-dash-itis," a very serious malady once confined to the Lake Erie region but liable to crop up anywhere now that spark is on its way out and most of the fellows are using valve detectors, resulting in DX of several hundred miles on a good night.

Anyway, our ears are sufficiently pinned back, but a word of warning to the K4 (and any other fellows who might have the same trouble with the code): A poor fist is the mark of a careless operator at any time, but when world conditions are as they are these days it can be downright dangerous. A fellow might go along for weeks without making a single contact with anyone but the F.C.C.!

## WHERE:

THERE doesn't seem to be any new or exciting ones to report this month, but a few of the old reliables are still at it. . . . W5KC reports **KF6JEG/KG6** at 14,310, while W9AEJ heard him on 7170 . . . . We don't know how much longer **KD4GYM** (14,260) will be on — W9GNG worked him back in November and that's the last report we've had . . . . W8TOB tells about **KB4FTU** (14,340), W3IWS/3 worked **K6SZP** (7150) with 15 watts input, and W8TXB reports **K6AG** (7160), **K6SAJ** (7145), **NY1AE** (7190), **K6AY** (7155), and **K6AH** (7210), with **K6MNV**, **K6ROJ**, **K6QTW**, **K6BAZ** and **NY4AD** coming through on 28-Mc. 'phone.

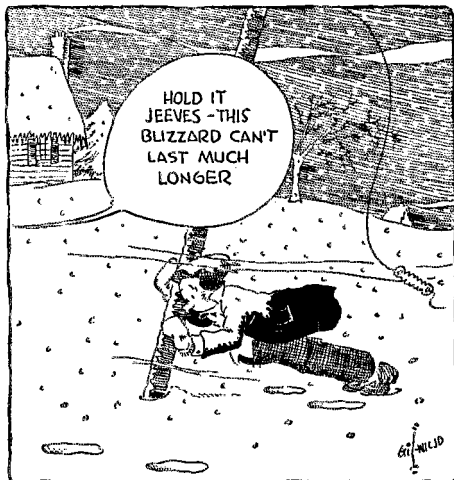

## DXCC ROUND UP:

THE results of the second DX Round Up were shown independently to three different judges, who must remain unnamed because of their importance in the world of letters and science, and their opinions were more or less unanimous. Dr. W . . . said, "After studying the results of this and the previous Round Up, I can say that the trend seems to be towards extinction. Remember the dodo bird?" We didn't remember the dodo bird, and asked Prof. K . . . what he found. "DX Round Up? Oh, yes, I remember now. Good idea, wasn't it?" We thanked Prof. K and hastened to the laboratory of Dr. Z, the well-known statistician. Looking up from a beaker full of yellow solution, Dr. Z observed, with his usual dry humor, "The public seems to like them better with less lemon juice and a bit more sugar. However, I've found that a dash of bitters is a nice touch." We noted this sage observation, and waited patiently for further developments. Nothing happened, and we left thirsty. We don't think much of Dr. Z as an experimenter.

However, the fact remains that only about 42 members of the DXCC were on over the weekend of the Round Up. The results were as follows, in number of contacts: W1JPE 22, W4MR 13, W9VDY 13, W1TS 12, W8OQF 8, W1WV 7, W1APA 6, W4IO 5 and W6AM 4. Others known to be active were W1BXC, W1DUK, W1LAS, W1ICA, W1KHE, W2AV, W2CMY, W2GT, W2GTZ, W2WC, W3AGV, W3KT, W4ZZ, K4FCV, W5KC, W6BAM, W6KIP, W6LDJ, W8CED, W8JMP, W8LFE, W9CWW, W9DIR, W9ERU, W9FS, W9GBJ, W9GKS, W9GMV, W9NNZ, W9PST, W9VDY, W9YFV.

The impression is that not enough of the gang is interested in the idea to make the thing worth trying again, so we won't unless a large flock of guys indicate otherwise. Too bad, we think, because everyone who gets in them seems to have a lot of fun.

## WHO:

W8PQQ sends along the QTH of XUOA, obtained via XU7CH, as C.A.R.L. Hq. Station, Box 172, Chungking, China. Homer mentions that XU7CH sent along cards for W8OSL, W8CRA, W8ADG and W8LEC, which can be obtained by sending a stamped envelope to W8PQQ. Of course there still is a W8 QSL Manager who could handle the thing, but we suppose the good old days of ham spirit are over . . . . W2CMY was very pleased to have Bert Lower, XU4XA, drop in for a surprise visit. Bert is now attached to the U.S.S. *Curtiss*, at the Philadelphia Navy Yard . . . . W2GT sends along a newsy letter which includes the dope that Jean Lips, HB9J, was married last August. Jean wishes to be remembered to the gang he met while he was here, as well as to the many more he has worked. Other items from Ed's letter include the dope that G3RO had a close one — he's a chief op on a ship and it was torpedoed. After hanging on to a piece of wreckage for five hours he passed out and came to on the destroyer that rescued him. G2ZQ was recently promoted to Flight Lieutenant, and VE5ZR just received his commission as Pilot Officer in the RAF . . . . G6RH would like his new address noted: Bob Holmes, 68 Carmarthen Avenue, Cosham, Portsmouth, England . . . . W6TI says that Bill Gardenheir, W6NKL, will be on Midway Island for the next year, on 10, 20 and 40 'phone and c.w. . . . Best wishes are in order for Marie Devaux, VP2LC, who is now Mrs. A. W. Forbes. Bill Forbes used to be a G ham in the early days . . . . KA1AC hastens to tell us that the Call Book address for him is wrong — he should be listed as Clark W. Cox, 36 A. Mabini, Manila. He is ex-W6DKM and uses 10, 20 and 40 'plane and c.w. from a 7044-ke crystal . . . . W6ITH says that XUSAM said "hello" on his way through to New York, where he will go to school. W2GNQ is anxious

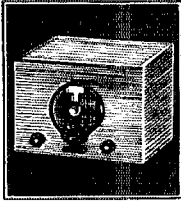

IN A FEW MONTHS, the little SW-3 receiver will be ten years old. For a communications receiver, this is usually hoary old age, but the SW-3 gives every indication of still being in its prime. There have been many minor changes in those ten years, often prompted by users. We owe many thanks to Pan American Airways, for instance, for their help in making the SW-3 resistant to tropical climates. But still and all, it has been the same old receiver until this year. The SW-3 has just had its first major change. It is now possible to use either low-drain 1.4 volt tubes or 6.3 volt heater tubes at will, so that any new SW-3 can be operated from an AC line with the 5886 power pack, from an automobile storage battery with the 686 vibrator power pack or from a single dry cell and a 90 volt B-battery. These two tube series are quite different, but with a little scheming they can be used interchangeably in the same tube sockets, as we shall show.

For AC (or battery) operation, 6J7-G's are used for the RF and Detector stages. Grid bias is supplied by a conventional cathode resistor, and suppressors are tied to the cathodes at the sockets. One side of the heater circuit is grounded. If 1N5-G tubes are used in these same sockets, the circuit will be changed automatically. The 1N5-G has no cathode, and the cathode connection (Pin No. 8) is not used. Consequently the cathode resistor will no longer be in the circuit. Similarly, the 1N5-G has the suppressor connected internally, so that connection (Pin No. 5) is missing too. The 1N5-G requires no bias, so one side of the filament must be grounded. This is taken care of by ground connection already provided for the heaters of the 6J7-G's.

The plate circuit connections are the same for both types. However, the power supplies for the 6.3 volt tubes provide about 180 volts, so that a series resistor is required to drop the screen voltage. On the other hand the 1N5-G's take the full battery voltage (90 volts) on both plate and screen. To make this change, a switch on the chassis must be thrown to short out the resistor.

The chassis switch mentioned above also reconnects the standby switch. For AC operation, the standby switch disconnects the B-supply, leaving the heaters on, as usual. For DC operation, the standby switch is changed to also disconnect the filament circuit, to save battery power. This is permissible, because the 1N5-G's heat almost instantly.

The audio stage uses either a 6C5-G for AC or a 1A5-G for battery. These tubes have identical socket connections, except that the 6C5-G has no screen, and the 1A5-G has no cathode. Both tubes require bias, which is obtained from the drop across a resistor in the B- lead. The 6C5-G requires more bias than the 1A5-G, but the total plate and screen current is greater with the 6.3 volt tubes, so the bias is automatically adjusted.

A potentiometer across this same resistor acts as an RF gain control, by applying an adjustable bias to the grids of the RF and Detector tubes. Here again more voltage is needed, and more is supplied, when operating with 6.3 volt tubes. It all works out very nicely.

The really nifty thing about the whole arrangement is that performance is not sacrificed, no compromises had to be made, and the same coils can be used with either tube series. And last but not least, it makes the old SW-3 about the newest thing in receivers.

CALVIN HADLOCK



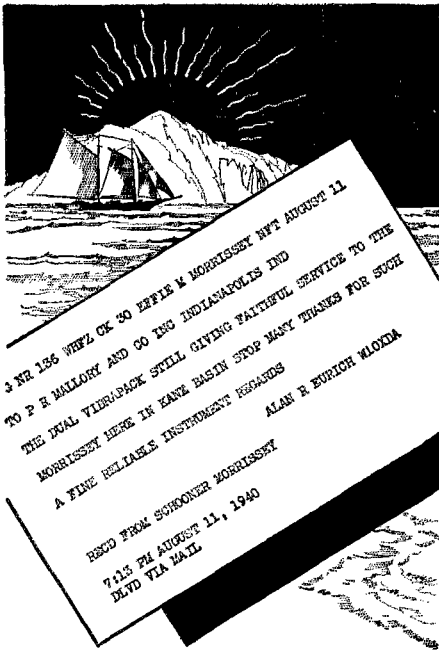

3 NR 136 WEPZ OK 30 EFFIE M MORRISSEY NPT AUGUST 11  
 TO P R MALLORY AND CO INC INDIANAPOLIS IND  
 THE DUAL VIBRAPACK STILL GIVING FAITHFUL SERVICE TO THE  
 MORRISSEY HERE IN EARLY EASTERN STOP MANY THANKS FOR SUCH  
 A FINE RELIABLE INSTRUMENT REGARDS  
 ALAN R BURICH ALABAMA  
 RECD FROM SCHOONER MORRISSEY  
 7:15 PM AUGUST 11, 1940  
 DLTD VIA MAIL

## Vibrapak

(TRADE MARK REG. U. S. PAT. OFFICE)

# Gives the Schooner MORRISSEY Perfect Service in the Arctic

The Schooner Morrissey, commanded by Captain Bartlett was almost in the shadow of the Pole when this tribute to Vibrapak was relayed.

Surely no power supply could be subjected to more rigid service. Yet in spite of ice and extreme cold, Vibrapak has unfailingly provided 100% daily service.

Even if winter in your area never brings the extreme low temperatures of the true Arctic, you'll want the long lived dependability of Vibrapak for your portable equipment . . . or any other battery operated installation requiring a source of high plate voltage. Vibrapacks are available for 6, 12 or 32 volts operation . . . with outputs up to 60 watts in the Dual Units. Write today for free booklet giving complete technical data.

**P. R. MALLORY & CO., Inc.**  
 INDIANAPOLIS INDIANA  
 Cable Address—PELMALLO

Use

**P. R. MALLORY & CO. Inc.**

# MALLORY

APPROVED  
PRECISION PRODUCTS

to have the present address of XUSAM, in case anyone who knows it reads this . . . . . PK2LZ would like to have a few of the W cards owed him so he can get his WAS. His address is C. Loze, Magelang, Java, N.E.I. . . . . W8JSU doesn't think that daylight 7-Mc. transcontinental stuff we mentioned last month is at all impossible — he has done it on several occasions, having worked W6 and W7 at 4:30 P.M. EST and a K6 at 5 P.M. In fact, he and W8LAT and W8HUL have done it often enough to consider the fact not worth mentioning. Well, all right, but they haven't done it from Connecticut, and that's what we were talking about. (That sounds pretty lame. — *Jeeves.*) . . . . . W8OSL, home from Langley Field for Xmas, packed up his XEC and receiver, so he'll probably be heard from down Virginny way . . . . . W8DWV has been called for active duty in the N.C.R. . . . . WIBUX thinks we don't know a thing about cooking loons, having failed to mention that the loon should first be hung by the neck long enough for the head to fall off, to insure its tenderness. Then, he says, we forgot to mention the important part, that after you can stick a fork in the rock, indicating that the loon is tender, one should throw away the loon and eat the rock. We have a lot of respect for the Cape Cod school of cooking, and we don't doubt but that there's a lot to be said for these flourishes that Doug suggests. However, they are fine points that would occur only to an old loon eater who was brought up on the dunes of Touisset and wouldn't know a loon from a hot rock . . . . . Rather than waste your time and QST's space, we're going to button up this pillar for the nonce. We'll be waiting patiently by the sidelines, keeping the fist well oiled, at least three legs of the rhombic intact and with an eagerness unexcelled even by a DX man with a new QTH, for the clouds to clear and our pet diversion to come back in full force. And because you've all been so kind, we leave this final gem, to you from us:

In the very near future, we hope, we hope,  
 When certain guys swing from the end of a rope,  
 And the ham bands ring with "VS" and "PX" —  
 There'll be something to write about in "How's DX?"  
 — *WIJPE*

## Use the General Traffic Period

### AID TO MOVING TRAFFIC

**T**RY IT! Everybody patronize the General Traffic Period. It will make for effective amateur results in the traffic line.

The daily period 6:30-8:00 P.M. (your local time) has been designated the "General Traffic Period." All Official Relay Station appointees are requested to keep this period, working general with all amateurs. Trunk Line Station appointees are likewise requested to work general during this period. In this manner operators who are unable to maintain regular schedules or whose operating time is limited may get on the air from 6:30-8:00 P.M. and clear their traffic through O.R.S. and T.L.S. who keep schedules on established traffic routes. Make use of this period so that delivery of traffic and dependability of service may be improved. Give your traffic to stations signing "ORS" or "T.L.S." "CQ TFC" is the general call for the "traffic hour." Directional CQs will also be found useful during this period.

For 7- and 3.5- and 1.8-Mc. band operators the local time designation 6:30-8:00 P.M. will enable traffic-training minded hams to swap messages over north-south strips of territory within their time zones and perhaps extending a zone each way.

14- and 28-Mc. band operations (and longer hops on 7 Mc.) can be taken care of by making a selective use of the designated period. That is, let us assume we are in San Francisco and have a message for New York. We know that 8:00 P.M. New York time is 5:00 P.M. locally, so we get on the air with our 14-Mc. transmitter and tune for New York stations, starting at 3:30 P.M. and continuing until 5:00 P.M. PST. When we identify a station logged in our call book as a New York fellow, we go after him.

*Performance!*  
tells the Story

AT  
WLMC -  
W4NG

HQ-120-X

WLMC-W4NG has held daily schedules with the Antarctic Expedition at Little America for over a year, and during that time, over 12,000 messages have been handled. Mr. Edward J. Day (ED), Chief Operator of the station reports that the "HQ-120-X" has been giving excellent results. He says, "The chief piece of equipment in the station is the 'HQ-120-X'. This receiver was responsible for continued success in receiving the many messages from Little America." Some operating periods were as long as four hours and at speeds of 40 to 45 words per minute, and to use Ed's words, "A receiver of lesser quality would have been too great a strain on the operators."

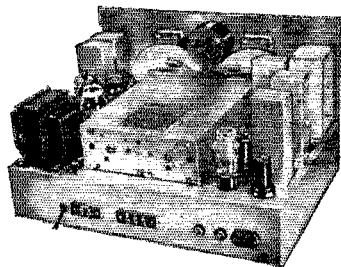

The "HQ-120-X" is the last word in receiver engineering and we think it is the greatest dollar value ever offered to the amateur. Just operate an "HQ-120-X" and you will immediately see the difference, or ask the ham who owns one and he'll tell you it's tops in every respect. Altho the average ham doesn't operate 40 to 45 words per minute, hours on end, he will appreciate the smooth, stable performance of the "HQ-120-X".

WRITE DEPT. Q2 FOR "HQ" BOOKLET



**HAMMARLUND MFG. CO., INC.**  
424-438 WEST 33rd ST., NEW YORK



EXPORT OFFICE: 100 VARICK STREET, NEW YORK CITY

CABLE—ARLAB

# for EXTRA QUALITY

## Specify

**CORNELL-DUBILIER  
MICA TRANSMITTING CAPACITORS**

**W**HEN capacitors operate under unfavorable conditions—as they are often called upon to do—it's the Hidden Extras in "Cornell-Dubilier's" that make them stand up when others fail. Thirty-one years of capacitor specialization have enabled Cornell-Dubilier to build these invaluable extras into every C-D Capacitor—for consistently efficient operation under all conditions of service. Use C-D Capacitors—get the hidden extras—be sure of exceptional performance.

**SOME OF THE  
HIDDEN EXTRAS  
IN  
C-D TYPE 86  
TRANSMITTING CAPACITORS**

- Patented C-D Series Mica Stack—Low corona losses.
- Ruby Mica Dielectric—Low Power factor, high Q.
- Dehydrated Porcelain Case—Low R.F. losses.
- Soldered Foils—Affords high current ratings.



**WHEN THE BEST IS A "MUST"**  
*Specify C-D's* **CAPACITORS  
YOU CAN TRUST**  
Capacitor Specialists for 31 years.

**CORNELL-DUBILIER  
ELECTRIC CORPORATION**  
1013 HAMILTON BLVD. • SO. PLAINFIELD, N. J.

### ELECTION NOTICES

To all A.R.R.L. Members residing in the Sections listed below: (The list gives the Sections, closing date for receipt of nominating petitions for Section Manager, the name of the present incumbent and the date of expiration of his term of office.) This notice supersedes previous notices.

In cases where no valid nominating petitions have been received from A.R.R.L. members residing in the different Sections in response to our previous notices, the closing dates for receipt of nominating petitions are set ahead to the dates given herewith. In the absence of nominating petitions from Members of a Section, the incumbent continues to hold his official position and carry on the work of the Section subject, of course, to the filing of proper nominating petitions and the holding of an election by ballot or as may be necessary. Petitions must be in West Hartford on or before noon of the dates specified.

Due to a resignation in the Nebraska Section, nominating petitions are hereby solicited for the office of Section Communications Manager in this Section, and the closing date for receipt of nominations at A.R.R.L. Headquarters is herewith specified as noon, Monday, February 17, 1941.

Section	Closing Date	Present SCM	Present Term of Office Ends
Philippines	Feb. 3, 1941	George L. Rickard	Oct. 15, 1938
Alberta*	Feb. 3, 1941	C. S. Jamieson	Feb. 18, 1940
Kentucky	Feb. 3, 1941	Darrell A. Downard	Apr. 15, 1940
Maritime*	Feb. 3, 1941	Arthur M. Crowell	June 15, 1940
Michigan	Feb. 3, 1941	Harold C. Bird	Oct. 15, 1940
Quebec*	Feb. 3, 1941	Lindsay G. Morris	Dec. 14, 1940
Arkansas	Feb. 3, 1941	Henry E. Vette	Feb. 15, 1941
San Joaquin Valley	Feb. 3, 1941	Edwin A. Andrew	Feb. 15, 1941
Vermont	Feb. 3, 1941	Clifton G. Parker	Feb. 15, 1941
Mississippi	Feb. 3, 1941	Jewell W. Cole	Feb. 15, 1941
Hawaii	Feb. 17, 1941	Francis T. Blatt	Feb. 23, 1941
Nebraska	Feb. 17, 1941	William J. Bamer (resigned)	.....
North Carolina	Mar. 3, 1941	W. J. Wortman	Mar. 18, 1941
Western Florida	Apr. 1, 1941	Oscar Cederstrom	Apr. 15, 1941
Rhode Island	Apr. 1, 1941	Clayton C. Gordon	Apr. 15, 1941
Mex Mexico	Apr. 1, 1941	Dr. Hilton W. Gillett	Apr. 15, 1941
N. Y. C. & L. I.	Apr. 15, 1941	Edward L. Baumach	Apr. 22, 1941
East Bay	May 15, 1941	Horace R. Greer	May 26, 1941

\* In Canadian sections nominating petitions for Section Managers must be addressed to Canadian General Manager, Alex Reid, 169 Logan Ave., St. Lambert, Quebec. To be valid such petitions must be filed with him on or before the closing dates named.

1. You are hereby notified that an election for an A.R.R.L. Section Communications Manager for the next two-year term of office is about to be held in each of these Sections in accordance with the provisions of the By-Laws.

2. The elections will take place in the different Sections immediately after the closing date for receipt of nominating petitions as given opposite the different Sections. The Ballots mailed from Headquarters will list in alphabetical sequence the names of all eligible candidates nominated for the position by A.R.R.L. members residing in the Sections concerned. Ballots will be mailed to members as of the closing dates specified above, for receipt of nominating petitions.

3. Nominating petitions from the Sections named are hereby solicited. Five or more A.R.R.L. members residing in any Section have the privilege of nominating any member of the League as candidate for Section Manager. The following form for nomination is suggested: (Place and date)

Communications Manager, A.R.R.L.,  
38 La Salle Road, West Hartford, Conn.  
We, the undersigned members of the A.R.R.L. residing in the..... Section of the..... Division hereby nominate..... as candidate for Section Communications Manager for this Section for the next two-year term of office.

(Five or more signatures of A.R.R.L. members are required.)  
The candidates are five or more signers must be League members in good standing or the petition will be thrown out as invalid. Each candidate must have been a licensed amateur operator for at least two years and similarly, a member of the League for at least one continuous year, immediately prior to his nomination or the petition will likewise be invalidated. The complete name, address and station call of each candidate should be included. All such petitions must be filed at the headquarters office of the League in West Hartford, Conn., by noon of the closing date given for receipt of nominating petitions. There is no limit to the number of petitions that may be filed, but no member shall sign more than one.

4. Members are urged to take initiative immediately, filing petitions for the officials for each Section listed above. This is your opportunity to put the man of your choice in office to carry on the work of the organization in your Section.  
— F. B. Handy, Communications Manager

### ELECTION RESULTS

Valid petitions nominating a single candidate as Section Manager were filed in a number of Sections, as provided in our Constitution and By-Laws, electing the following officials, the term of office starting on the date given.

Georgia	William U. Hanks, WAOB	Nov. 29, 1940
Colorado	Carl C. Drumeller, W9EHC	Dec. 17, 1940



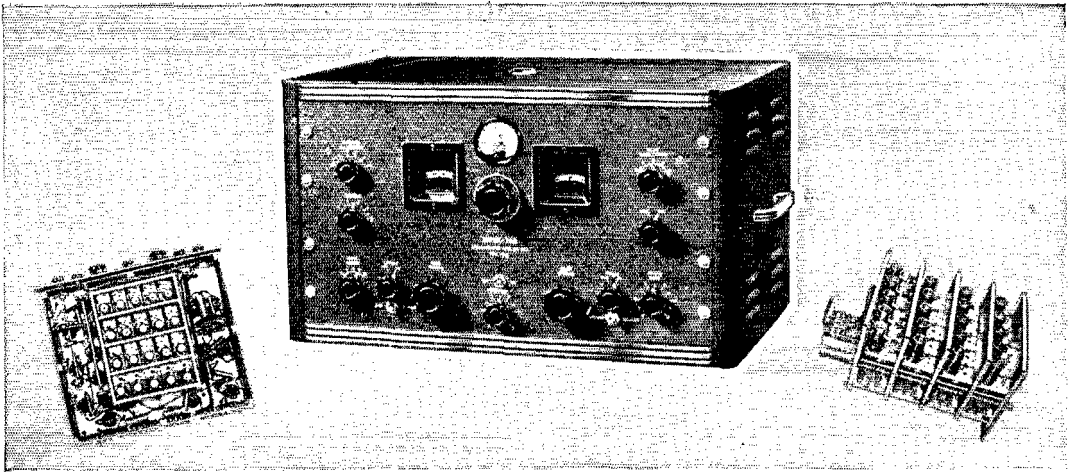

# Equal to any EMERGENCY!

IN Alaska, Antarctic, Far East, everywhere, you will find "Super-Pro" receivers. Many provide the sole means of communication with the outside world. The sound design of the "Super-Pro" and its record of dependable performance is your guarantee of satisfaction. Engineers who choose receivers for such service just can't be wrong. Their choice of a "Super-Pro" is acknowledgment of its superiority. Take a tip from the experts and make your next receiver a "Super-Pro". It is economical too. You don't have to trade every year when you own a "Super-Pro".

Send coupon or call at your nearest dealer's for 16-page booklet containing complete technical information on the "Super-Pro" Series 200. The "Super-Pro" is available in several ranges, taking in frequencies as low as 100 kc.

"Super Pro"

SERIES - 200

---

HAMMARLUND MFG. CO. Q-2  
 424-438 W. 33rd St., New York City  
 Please send "Super-Pro" Booklet.....  
 Name.....  
 Address.....  
 City.....State.....

*Export Office:*  
 100 Varick St., N. Y. C.

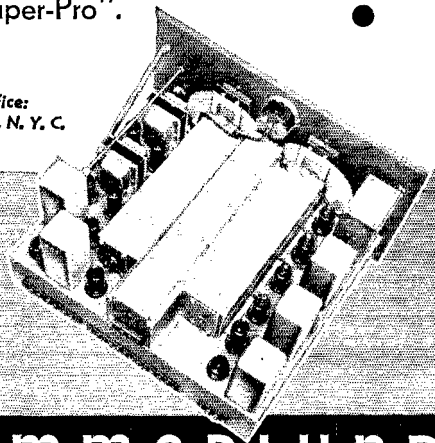

## HAMMARLUND

# More of everything but price!

**T**HAT is the reason Simpson instruments have become so popular. Here you have panel instruments that embody the same construction that is followed in expensive laboratory instruments—full bridge type movement with soft iron pole pieces.

Such a movement is more accurate to begin with. But more important than this is the fact that it stays accurate year after year. How can these extraordinary instruments be sold at ordinary prices? The answer is found in designing skill, modern manufacturing facilities, advanced production methods.

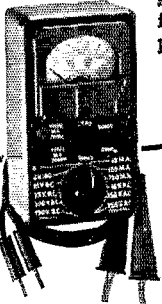

**SIMPSON ELECTRIC CO.**  
5210 Kinzie St., Chicago, Ill.

## The one and only "HAMMETER"

● Designed expressly for you. Holds the answer to testing, checking or trouble-shooting needs.

Utmost precision and lasting accuracy are assured by the finer Simpson movement. Ranges (with resistance of 1000 ohms per volt—both AC and DC): AC volts—0-15, 150, 750; DC volts—0-15, 150, 750, 3000; DC millivolts—0-15, 150, 750; ohms—0-3000 (center scale 30) and 0-300,000 (center scale 3,000). Light weight, 20 ounces—small, handy size. 5 1/4" x 2 7/8" x 1 3/4". Shockproof throughout. 3000 volts self-contained (no external multipliers necessary). Net price **\$14.75**

## You can afford the best in PANEL INSTRUMENTS

Simpson instruments offer maximum quality. These typical prices show why they are today's biggest values in electrical instruments. R.F. Ammeters—Internal, thermo-couple radio frequency ammeters (1, 1 1/2, 2, 2 1/2, 3 or 5 Amps). Your net price.....**\$4.67**

High Range Voltmeters—DC plate voltmeters, complete with external resistors (1,000, 1,500, 2,000, 2,500, 3,000 or 4,000 volts). Your net price.....**\$9.07**  
(5,000 volt range \$12.24 net)

Decibel Meters—Rectifier type volume level indicator (-10 to 6 db [500 ohm line; 6 M. W.]). Your net price..**\$8.00**

Other Outstanding Values Are: DC plate milliammeters (all popular ranges from 0-5 to 0-1,000 milliamperes). List \$6.35. Your net price.....**\$4.23**

AC filament voltmeters (0-10 or 0-15V.). List price \$6.35. Your net price.....**\$4.23**

Illuminated dials for all popular ranges, including 6 V lamp, 50c net additional.

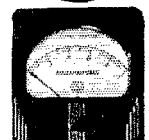

# SIMPSON

INSTRUMENTS THAT STAY ACCURATE

In the Tennessee Section of the Delta Division, Mr. M. G. Hooper, W4DDJ, and Mr. Harvey B. Conover, W4FDT, were nominated. Mr. Hooper received 42 votes and Mr. Conover received 30 votes. Mr. Hooper's term of office began November 15, 1940.

In the Oregon Section of the Northwestern Division, Mr. Carl Austin, W7GNJ, and Mr. A. Robert Cunningham, W7HAL, were nominated. Mr. Austin received 80 votes and Mr. Cunningham received 14 votes. Mr. Austin's term of office began November 22, 1940.

## WHEN TO TRY FOR NAA<sup>1</sup> AND WAR<sup>2</sup>

Amateur Band (Mc.)	Call	Freq. (Kc.)	EST	CST	PST
3.5 <sup>3</sup>	WAR	4025	7-8 P.M.	6-7 P.M.	4-5 P.M.
3.5	NAA	5865	8-9 P.M.	7-8 P.M.	5-6 P.M.
7	NAA	5865	9-10 P.M.	8-9 P.M.	6-7 P.M.
7	WAR	6990	9-10 P.M.	8-9 P.M.	6-7 P.M.

<sup>1</sup> Mon., Tues., Wed., Fri.

<sup>2</sup> Tues., Wed., Thurs., Fri.

<sup>3</sup> Between 7:45 and 8:00 P.M. E.S.T. WAR covers 3900-4000 kc.

## BRIEFS

Last December 10th at 12:45 A.M. E.S.T., W2MBS called CQ on 3.9-Mc. 'phone. W8CHP in West Virginia answered the call, and it was suggested that an attempt be made to hook up with other stations for a round table. Both stations called CQ, which brought W7BZX in Washington and W1LOA in Maine into the party. By 4:30 A.M., a 24-way QSO, including 16 states and all districts, was in progress. An indication of the success enjoyed by this round table was the fact that each station could hear all others. The following participated: W1LOA, W2MBS, W2LMC, W3EQK, W3AQV, W4EQB, W4DAM, W4CPQ, W4AOK, W5EWD, W6ONQ, W6DYJ, W7BZX, W7EXB, W7GLM, W8AQT, W8CHP, W8SXX, W8CW, W8NUI, W8HSC, W8REI, W9OJD, W9KLC.

The Harlem Radio Club of New York City is conducting code and theory classes Monday through Thursday evenings from 7 to 10 P.M. Further details may be secured at the Activities Office, Harlem Branch Y.M.C.A., 180 West 135th Street, N. Y. C.

## A.R.R.L. HEADQUARTERS OPERATORS

W1AW, A.R.R.L. Headquarters:  
Hal Bubb, "Hal," Stn. Eng. and Chief Opr.  
George Hart, "Geo," 2nd Opr. See others, below.

The following calls and personal signs belong to members of the A.R.R.L. Headquarters gang:

W1BAW, R. T. Beaudin, "rb"  
W1BDI, F. E. Handy, "fh"  
W1CBD, C. B. de Soto, "de"  
W1DIF, George Grammer, "gg"  
W1EH, K. B. Warner, "ken"  
W1ES, A. A. Hebert, "ah"  
W1GS, F. C. Beekley, "beek"  
W1INF, A.R.R.L. Headquarters Operators Club  
W1JEQ, Vernon Chambers, "ve"  
W1JFN, A. L. Budlong, "bud"  
W1JMY, Joseph A. Moskey, "joe"  
W1JPE, Byron Goodman, "by"  
W1JTD, Hal Bubb, "hal"  
W1LVQ, L. John Huntoon, "jh"  
W1MEC, W. J. Fricke, Jr., "bill"  
W1MFA, Harold K. Isham, "hi"  
W1SZ, C. C. Rodimon, "rod"  
W1TS, Don Mix, "don"  
W1UE, E. L. Battery, "ev"  
W3AMR, George Hart, "geo"  
W9NFL, J. R. Buckler, "jeem"



**JULES WENGLARE**  
**W8OSL**  
 DX Century Club Winner  
 No. 23  
 135 countries confirmed

**A pair of Eimac 35T's with  
 999.9 Watts Input**

The stack of QSL cards shown here is an indication of the results obtained by Jules Wenglare with his pair of Eimac 35T's. He has worked all zones, 149 contacts, and has a DX Century Club "sheepskin." Today Jules is with the Air Corps at Langley field "pounding brass." The photo at left shows Eimac 35T's running with the 999.9 watts input. Ability to perform and continue to perform under such conditions has won Eimac a place in radio's hall of fame. This outstanding service can be yours too when you install Eimac Tubes in your rig.

**Eimac**  
**TUBES**

Eitel-McCullough, Inc.,  
 San Bruno, California

**EIMAC REPRESENTATIVES**

- |  |   |  |   |
|--|---|--|---|
| California, Nevada<br>HERB BECKER, 1530 W.<br>104th St., Los Angeles, Cal.   | Wash., Ore., Idaho, Mont.<br>GENERAL SALES CO.,<br>Verner O. Jensen, 2605-07<br>Second Ave., Seattle, Wash. | Chicago, Illinois, Wisconsin<br>G. G. RYAN, 549 W.<br>Washington Blvd., Chicago,<br>Ill.                             | Texas, La., Okla., Ark.<br>J. EARL SMITH, 2821 Live<br>Oak St., Dallas, Texas.  |
| N. Y., N. J., Penn., Md., Del.,<br>Dist. of Col., Maine, N. H.,<br>R. I., Conn., Mass.<br>ADOLPH SCHWARTZ,<br>14726 Elm Ave., Flushing,<br>New York. | Colo., Wyo., New Mexico,<br>Arizona, Utah<br>RICHARD A. HYDE, 4253<br>Quitman St., Denver, Colo.            | N. Caro., S. Caro., Georgia,<br>Tenn., Flor., Ala., Miss.<br>JAMES MILLAR, 316 Ninth<br>St. N. E., Atlanta, Georgia. | Ohio, Mich., Ky., Ind., Minn.,<br>Mo., Kan., Neb., Iowa<br>PEEL SALES ENGINEER-<br>ING CO., E. R. Peel, 154<br>E. Erie St., Chicago, Ill. |



# CONQUERORS OF TIME!

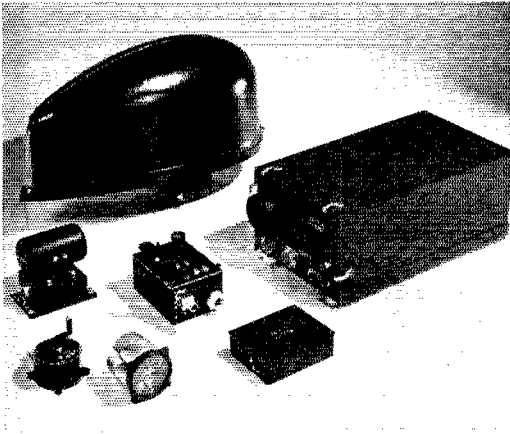

It took millions of years for Mother Nature to prepare the crude oils which make it possible to fly modern Giants of the Air in record-breaking time.

And it has taken years of experience, too, to contrive the thousand and one essential parts which go to make up these Conquerors of Time.

Wherever skillful engineering and experience, forged by time, are tied together — there, too, the name KENYON is likely to be found.

Typical of this is the splendid Radio Compass manufactured by Fairchild Aviation Corporation which is illustrated here. Engaged in important Defense Production they have recognized that dependability is the keynote of success.

We are proud of the fact that KENYON has been designated as a source of supply for their transformer requirements — just another bit of accumulating evidence of Kenyon Superiority.

*Bring your transformer problems to us and benefit by the wide experience that only time makes possible. Our engineering department is always at your service.*

**KENYON TRANSFORMER CO., Inc.**

840 BARRY STREET

NEW YORK, N. Y.

Cable Address: "KENTRAN"—New York

## Hamfest Schedule

**February 15, 1941, at Pittsburgh, Pa.:** The Second Annual Hamfest of the Pittsburgh Area Radio Council will be held February 15th at the Fort Pitt Hotel, Pittsburgh, Pa. Registration: \$1.00. The program will start at 8:30 P.M. and will include a buffet lunch, speakers, and opportunity for hamfesting. Further information available from R. M. Francis, 3577 Elmhurst St., Pittsburgh, Pa.

**February 22, 1941, at Rochester, N. Y.:** The Rochester Amateur Radio Association will hold its Annual Hamfest and Banquet, February 22nd, on the Starlight Roof of the Sagamore Hotel, Rochester, N. Y. Doc Smith, W8RGA, will be Master of Ceremonies. The registration fee is \$2.00. Additional details may be obtained from R.A.R.A. President, Elmer Grabb, W8DOD, 242 Herald St., Rochester, N. Y.

### BRIEFS

Coöperation: W8OOL has a radio-equipped plane at Wayne Co. Airport, Detroit, which he has placed at the disposal of the E. C. if needed.

Amateurs who work for the Western Union Telegraph Company have organized a net to operate on 3592, 7184, or 14,368 kc. The main schedule is Sunday, 8:30 A.M. P.S.T., although those who can't get on at this time are invited to call or answer a CQ WU on the above frequencies at any time. A list of amateurs employed by the company has been mailed to each W.U. ham; anyone who has not received his copy should communicate with W6KMQ, W6REP, or W6SUT.

The Bell Radio Amateurs of Denver, Colo., are the sponsors of a series of code practice lessons which are being transmitted over the air by several of the members. Anyone located in the region where the signals may be copied, and interested in using the lessons, should tune in the 3.5-Mc. band at 7 P.M. M.S.T., according to the following schedule: Mon., W9BQO, 2572 kc.; Tues., W9TFP, 3640 kc.; Wed., W9CAA, 3640 kc.; Thurs., W9SPO, 3580 kc.; Fri., W9IDB, 3640 kc.

### ON THE USE OF "SK"

Why can't we amateurs be correct in the use of SK? It is true that there are practically no specifications of procedure in the amateur regulations, but amateur procedure has always followed quite closely that laid down in the international regulations for the commercial mobile service. We used to follow that practice quite closely in the employment of SK. It is only in recent years that we have deviated from it and it seems to me that it is just one of those improper practices that inadvertently take root in amateur radio and flourish. Should we not get back to doing it properly?

Our present practice differs sharply from that of our mobile model in two respects:

- (1) We put the SK as the very last thing instead of just before our call.
- (2) We introduce the call of our correspondent as well as our own. While there may be justification for this at the beginning of a transmission, there is none at its end and particularly in the final transmission of a QSO.

The way we do it now it looks like this:

AR W3BWT de W1AW SK

The way it should be is:

AR SK W1AW

After the call would come the sine, if any, and any further indication such as that of closing down. For example, at the end of the final transmission in the night's work:

AR SK W1AW HAL CL

Let's do it right.

— W1EH



And you *can* get it! We are sorry we have to ask you for patience, because it is hard to be patient when you are waiting for a receiver like the NC-200. But so many other amateurs feel the same desire for an NC-200 that we are a month behind on deliveries to dealers. We are building them as fast as we can, but the NC-200 is a precision instrument, and precision work takes time.

*It's a nice job, and you can get it. All it takes is a little waiting, and surprisingly little money.*

*Ask Your Dealer!*

NATIONAL  COMPANY



**NOW**  
**this high-powered radio engineering library**

sent to you for 10 days' trial —  
 at a special price and terms

These books cover circuit phenomena, tube theory, networks, measurements, and other subjects — give specialized treatment of all fields of practical design and application. They are books of recognized position in the literature — books you will refer to and be referred to often. If you are a practical designer, researcher or experimenter — if your interest in radio is deep-set and based on a real desire to go further in this field — you want these books for the help they give in hundreds of problems throughout the whole field of radio engineering.

**RADIO ENGINEERING LIBRARY**

— especially selected by radio specialists of McGraw-Hill publications

— to give most complete, dependable coverage of facts needed by all whose fields are grounded on radio fundamentals

For home-study and reference. Contains a revised selection of books culled from latest McGraw-Hill publications in the radio field.

5 volumes, 3319 pages, 2298 illustrations

1. Eastman's FUNDAMENTALS OF VACUUM TUBES
2. Terman's RADIO ENGINEERING
3. Everitt's COMMUNICATION ENGINEERING
4. Hund's HIGH-FREQUENCY MEASUREMENTS
5. Henney's RADIO ENGINEERING HANDBOOK

**Special Low Price and Easy Terms**

Bought singly, the five volumes comprising this library would cost you more. Under this offer you save money and, in addition, have the privilege of paying in easy installments beginning with \$2.50, 10 days after receipt of the books, and \$3.00 monthly thereafter. Already these books are recognized as standard works that you are bound to require sooner or later. Take advantage of these convenient terms to add them to your library now.

SEND THIS ON APPROVAL COUPON

McGraw-Hill Book Co., Inc.  
 330 W. 42nd St., New York, N. Y.

Send me Radio Engineering Library, 5 vols., for 10 days' examination on approval. In 10 days I will send \$2.50, plus few cents postage, and \$3.00 monthly till \$23.50 is paid, or return books postpaid. (We pay postage on orders accompanied by remittance of first installment.)

Name.....

Address.....

City and State.....

Position.....

Company..... QST-2-41  
 (Books sent on approval in U. S. and Canada only)

**Advance Planning Pays Dividends**

**A.E.C. Work in South Dakota Fire**

ON JUNE 30TH, members of the Black Hills Amateur Radio Club and A.R.R.L. Emergency Corps personnel at Rapid City, South Dakota, conducted a "forest fire drill," demonstrating what radio can do in combating such disasters. It was purely a "test" drill in line with the preparedness program of the club and the A.E.C. On August 1st these same amateurs were called upon for service during a real fire, and they did a splendid job, thanks to their advance planning! Wally Koppmann, W9YOB, Emergency Coördinator, tells the story:

"The Black Hills Amateur Radio Club had seven operators in the forest operating government equipment during a fire that started about 10 A.M., August 1st. I received a call from the U. S. Forest office at Deadwood, at 4 P.M., asking for operators. Members of the A.E.C. had reported in during the afternoon and advised they would be available. Inside of ten minutes two men were on their way. Inside of an hour and a half all seven operators had left town to report to the Forest Ranger station at Hill City. They were assigned for duty immediately, and all saw active duty throughout the night and the following day. Those participating were W9APT, W9KNV, W9ADJ (S.C.M.), W9YKY, W9GCW, W9IWT and W9SWV. We held a forest fire emergency drill on June 30th. On August 1st we found the same forest on fire, the same transmitters in use, the same forest personnel, and we furnished the same men to operate. All operators worked all night without sleep, operating from mountain peaks as lookouts, from base camps as control stations, etc. One report was that a call came in by radio of a fire breaking out in a canyon where there had been no fighters. Fifty men were transported at once with trucks, and the fire put under control before it had spread to greater proportions.

"We consider our planning and practice ahead of time very important. The forest officials knew where to find me, and the members of the club had reported for duty when the call for service came. It takes advance planning to make things click when you really need to show results. I think that much could be done by radio clubs in other forest areas. The government has equipment but does not have sufficient operators. Equipment is of no use when operated by personnel without experience, especially in isolated places. The members of the Emergency Corps really have the spirit to jump right in and make things work. W9GCW (high school age) sat on a mountain top alone all night, reporting the progress and location of the main fire. W9IWT (same age) did the same from another point. We are proud of our Emergency Corps personnel and our advance plans for service when needed."

**BRIEFS**

While W2KYH and YF were on vacation in Florida, his wife's uncle in Ridgewood, N. J., passed away. They were not expected to arrive in time for the funeral, and the family knew of no way to reach them by telephone or telegram. However, knowing that W2KYH was an active amateur, they got in contact with W2LTC. He drove thirty miles to pass the information along to W3IIZ, who in turn passed the message south. Traveling through W4GAV, W4FCD and W4FDJ, the message finally reached W2KYH via W4FPF in Brunswick, Ga., where he stayed over night. The return message was relayed back through W4FPF, W4FDJ, W4FCD, W4GJS, W4GAV, W3IIZ and W2LTC. W2KYH says, "This is a fine example of ham radio coöperation, and the gang on 1.75-Mc. 'phone did a wonderful job and one that was very deeply appreciated by the family."

The United Radio Amateur's Club of Wilmington, Calif., on Sunday, August 13th, held an experimental field day at Seal Beach, Calif. Six club members participated: W6KCCX, president, W6HCF, W6MED, W6DIS, W6NGK and Kenneth Tuttle. The purpose of the outing was to test vertical kite-suspended antennas for use on emergency equipment. The group operated portable under the call W6DIS on 1.75-Mc. 'phone. Power was obtained from a motor-driven Dodge generator. Antenna used were: (1) a

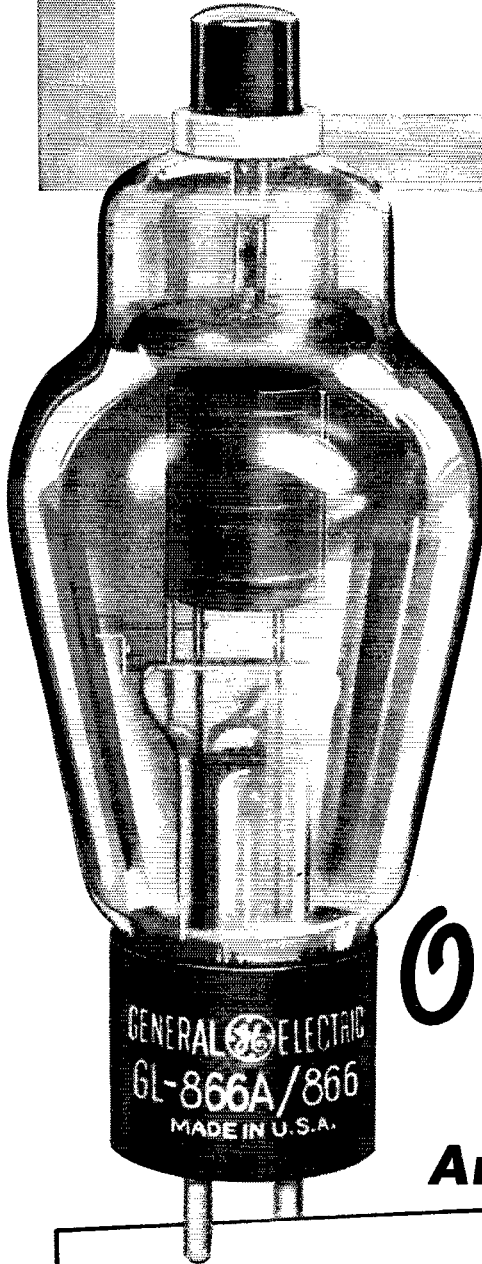

# NEW!

## GL-866A/866

**All the Wallop  
of an 866A**

**at the Price of an 866**

**Completely Interchangeable  
with Both Types...**

*Only* **\$1.50**

**An amazing new tube  
and it's a bargain!**

See or write your G-E dealer without delay.  
General Electric, Schenectady, N. Y.

RATING	
Fil. volts.....	2.5
Fil. Amp.....	5
Max. inverse peak plate volts....	10,000
Average plate amp.....	0.25
Peak plate amp.....	1.0

**BANDSWITCHING?**  
See "Magnetic Bandswitching" by Lew Bellem in QST for October, 1940. See your G-E dealer for those GL-807's and GL-814's.

**GENERAL ELECTRIC**

# Announcing INCA'S

## New MIDGET TRANSFORMER SERIES

Special — Small Size — Ultra Light-weight  
For Voice Frequencies Only — 300 to 3,000 Cycles  
Designed especially for Portable Radio and Sound Equipment  
Aircraft, Police, Mobile and Portable-Mobile

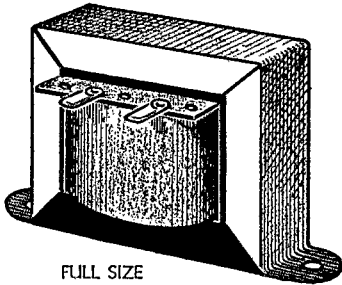

FULL SIZE

Dimensions: Height  $1\frac{1}{8}$ " length  $1\frac{1}{16}$ ", width 1". Weighs ONLY two and one quarter ounces. CLIMATITE TREATED, assuring protection against the most rigorous weather conditions. Only INCA transformers have CLIMATITE treatment.

TYPE NO.	LIST PRICE
I-42. Single button mike to single or P.P. grids.	\$1.65
I-43. Double button mike or line to single or P.P. grids.	1.75
G-52. 10,000 plate to one or two grids.	1.65
I-45. Single button mike and plate (2 primaries) to grid.	1.80
L-48. Class B input, 1G4G to 1G6Gs or similar.	1.60
L-47. Class B input, 1E4G or similar to P.P. grids.	1.60
F-64. Output tube to voice coil.	1.50
F-65. Output tube to line or phones.	1.50
N-37. Modulation-Class B, 10,000 ohms to 5,000, 8,000 or 10,000 ohms.	1.50

AT YOUR NEAREST JOBBER'S or  
**PHELPS DODGE COPPER PRODUCTS CORP.**  
Inca Manufacturing Division  
2375 East 27th Street  
Los Angeles, California, U. S. A.

quarter-wave horizontal, about 30 feet high, running against counterpoise; (2) a half-wave vertical suspended by six box kites; and (3) a quarter-wave vertical suspended by one five-foot box kite. It was found that the quarter-wave horizontal antenna gave much more consistent local coverage than either of the verticals. The club group plans another outing at which time they expect to try horizontal kite suspended antennas on 1.75 Mc., one-half-wave above ground.

In order to test emergency equipment under the new Saturday-Sunday portable regulations, W6AM portable was set up 7000 feet up the side of Mt. San Geronio. The 6AM portable gear, transmitter and receiver, is in a small case. The weight as used, with call book, log book, paper, pencils, headphone, cords, antenna, balls of string, and key, is 70 pounds. When the lid is dropped forward, everything is ready for operation. Mt. San Geronio is the highest mountain in Southern California, 11,485 feet. The portable received its power from a gas driven generator. The usual 48-hour notice was given the F.C.C. office, and when the sun rose over the mountain tops, the QSO's began. The whole 6AM family climbed to the top of the mountain and return, a reasonably stiff 18-mile hike. They were surprised to find a 56-Mc. rig in operation at the top. W6SAO, leader in a Y.M.C.A. camp on the other side of the mountain, had led a group of boys to the top. His portable was strapped to a boy scout pack frame and had worked W6NTO, some 85 miles away. The W6AM base contacts were made partly on July 19th and partly on July 20th. Interest in testing portable equipment is still running high.

Learning that a severe storm might strike his area (September 1, 1940), C. Leo Riley, W1JY, A.R.R.L. Emergency Coördinator, Bristol County, Massachusetts, notified operators to be in readiness to set up an emergency network should it be required. Plans called for stations to be set up at Hyannis, Tremont or Wareham, and Marion, to make contact with one of two stations at New Bedford. From New Bedford, stations in Fall River and Vineyard Haven were also contacted, as well as another net which could relay messages to Providence and Boston. A station was sent from New Bedford to Hyannis, from where it contacted stations at Wareham, New Bedford and Vineyard Haven. Then all stations stood by, ready to be used if needed. The storm, however, blew out to sea without causing any interference to regular communication. The experience gained by planning and setting up this net will make it a very simple matter to do so again, should this be required. The following operators deserve great credit for the time and effort they put in, and for the planning they have been doing in the past to be ready for just such service: W1JY, W1MQT, W1LDV (operated W1JY/1), W1KHE (portable), W1ICA (portable), W1MMI and W1LIE.

W6PCB has been declared the Arizona 'phone winner in the 12th A.R.R.L. DX Contest, following the technical disqualification of the entry from W6OJK (see scores October QST).

### TRIBUTE TO A PIONEER

4125 W. Montrose Ave., Chicago, Ill.

#### Editor, QST:

Recently a short biographical sketch of a forgotten man appeared in the *Journal* of the Canadian Dental Association. This man, an American who devoted his life to experimenting in the field of wireless telegraphy, was known to his friends and colleagues as Dr. Mahlon Loomis, a modest and unassuming Virginia dentist. Electricity greatly intrigued this devotee of the healing art, and the fascination in the study of conducting currents led him to spend hours in "fooling around" when he could be furthering his own financial status or relaxing from a hard day's work. In the year 1868 Dr. Loomis had conducted his experiments in electrical research to the stage where he was able to send electrical signals, without the use of wires, between two Virginia mountain peaks situated eighteen miles apart. To carry on his experiments, he obtained private financial support which lasted until the end of the year, when the panic of Black Friday in 1869 wiped out all financial aid. Undaunted, he again obtained financial help but lost it in the Chicago fire of 1871. Finally Congress passed a bill to help him, but did not make sufficient appropriations in that bill of 1873 for him to continue his experiments for but a short



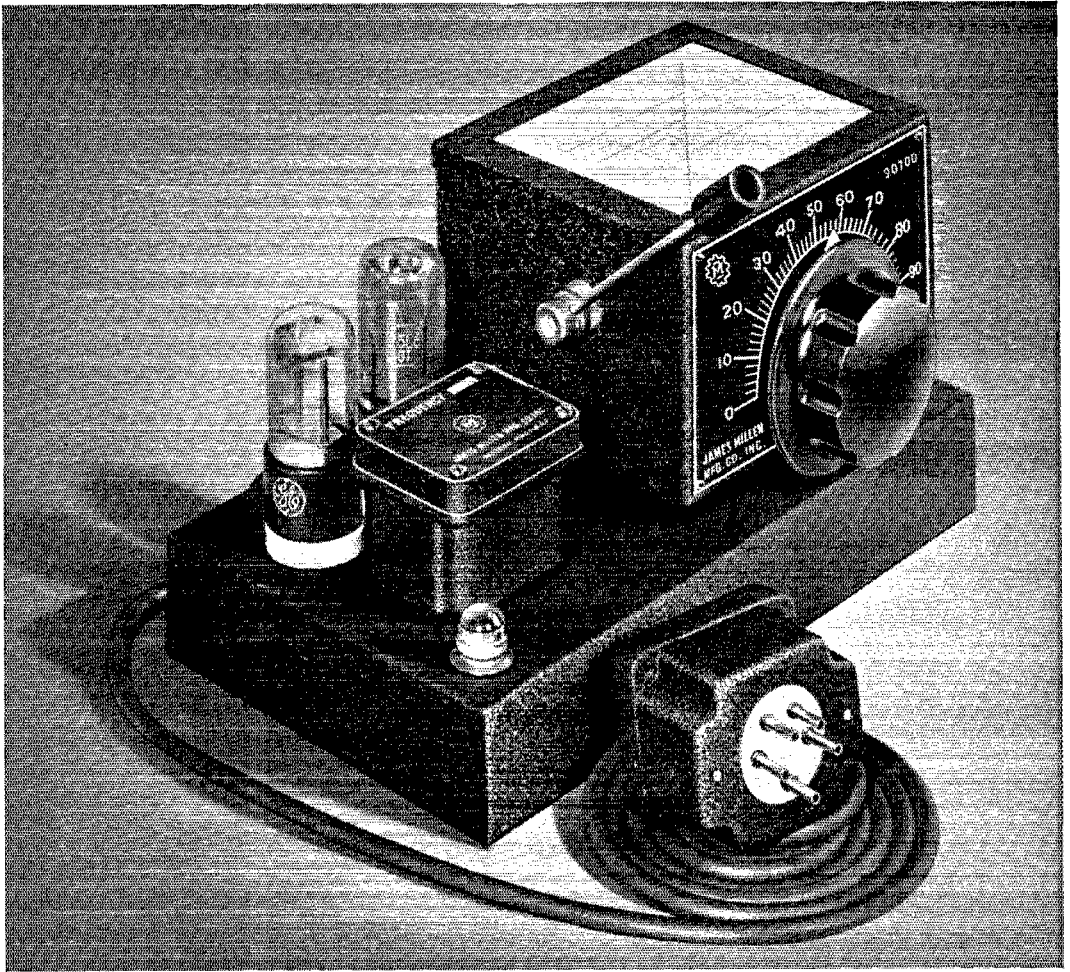

*Something Radically New in ECOs*  
**The RICE-VARIARM**

There are many approaches to the ECO design, most of them having been described in the past; such as expensive, ruggedly-built h.f. oscillators with their external regulated power supplies, low-frequency dual heterodyne oscillators, etc. All have their merits, but are necessarily expensive to manufacture and must ultimately end up by selling in the 50 to 60 dollar price bracket.

A new approach to this problem has been evolved by Henry Rice, Jr., and was described in detail in January *QST*. Probably the outstanding feature of the Rice development is its high-performance-per-dollar which makes possible a factory built commercial ECO with modern performance, complete with tubes, ready to use, for less than 30 dollars!

MILLEN Model No. 90700 is now available at your dealer's at \$29.50 net, complete with General Electric tubes

**Modern Parts**

**for Modern Circuits**

**JAMES MILLEN**  
**150 EXCHANGE ST**



**MFG. CO. INC.**  
**MALDEN, MASS.**

# RADIO TRAINING



**P**ORT ARTHUR COLLEGE—not privately owned, not operated for profit, a college built and endowed by the late capitalist-philanthropist, John W. Gates—offers the most thorough practical Radio training in America. P. A. C. owns Radio Station KPAC, which is equipped with the very latest type 1000-Watt high fidelity RCA transmitter, operating on 1220 kc. with directional antenna system. The college is authorized to teach RCA texts. Additional equipment consists of the latest type Marine and Airways Transmitter installation complete; SOS Automatic Alarm; Marine Direction Finder, two-way Television Transmitter and Receiver; Trans-radio Press Receiving Equipment; laboratory facilities where every phase of practical radio assembly technique is taught. Students assemble composite transmitters, audio amplifiers, RF amplifiers, etc. The Radio training covers thoroughly Airways, Press, Announcing, Teletype, Typewriting, Laboratory and practical experience at KPAC transmitter, control room and studios. Announcing is an optional part of this training; nevertheless a number of students annually make successful announcers.

Port Arthur College pioneered the teaching of radio with its first classes in 1909, and for thirty-one years has maintained an active Employment Bureau that is successful in placing graduates in airways, broadcast and marine radio industries.

*If interested in details about the Radio Course, write for Bulletin R*

**PORT ARTHUR COLLEGE**  
**PORT ARTHUR (World-Known Port)**  
**TEXAS**

## LEARN CODE THE WAY YOU'LL USE IT—BY HEARING IT

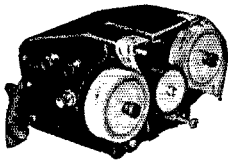

### Type S - \$17.50

Sends from 4 to 60 words per minute. Higher speeds if desired. Complete with 10 rolls of double-perforated lesson tape of carefully selected and arranged matter for speediest results in learning code. Most compact and practical code teacher on market.

### Type J - \$12.50

Sends from 6 to 70 words per minute. Built-in tape perforator. Cut your own code-practice tapes and message tapes. Complete with already cut practise tape and 5 rolls of blank tape. Length of messages practically unlimited.

*If your dealer can't supply you, write us*

**GARDINER-LEVERING CO.** Haddon Heights, New Jersey, U. S. A.

time. Struggling along as best he could without financial aid, Dr. Loomis valiantly carried on his valuable work. But it was a hopeless task. Money was needed and none was forthcoming for him to experiment further and to perfect his work. Like Marconi, he was a tireless worker; but, unlike Marconi, he failed to secure that much-needed financial help to achieve perfection. Finally in 1886, broken-hearted and despondent over his inability to progress further, because of lack of money, in the work he loved so dearly, Dr. Loomis died. Nine years later, Marconi, in Italy, took up where Loomis left off.

Like Dr. Horace Wells, famous contemporary of Dr. Loomis and the "father of anesthesia," Loomis suffered ridicule and never achieved the distinction accorded to him until years after he had passed away. Lack of complete success in demonstrating the benefits of "laughing gas" made Wells the brunt of national and even international ridicule. Later, a colleague, Dr. Morton, took all the glory when he demonstrated successfully with sulphuric ether. Loomis became despondent and died grief-stricken. Wells, also despondent and later very bitter for want of faith and support from his fellow Americans, took his own life and never knew that men soon would herald him throughout the entire world as the first to discover and apply anesthesia for the prevention of pain during surgical operations, even though the success he achieved with the crude material was very limited. Like anesthesia, the brainchild of Experimenter Wells, wireless telegraphy must and shall be remembered as the dominant thought of Experimenter Loomis.

It is not the writer's purpose in any way to add to or detract from the glory of men who have pioneered in wireless telegraphy or who are well known to many of us. But history plays curious tricks and time itself arouses our curiosity eventually in the very end. Outstanding individuals, like deeds, may far overshadow others in prominence. But for the sake of fairness, of justice, of the determination to make history in the field of wireless telegraphy an open book for us all to understand and cherish, let us not forget for one moment a man who lived not long since among us and helped us to attain perfection today—faithful to the last and true American experimenter in the field of wireless telegraphy, Dr. Mahlon Loomis.

— Dr. G. S. Jacks, W9UFU

## PREPAREDNESS

425 Ingleside, Lake Charles, La.

Editor, *QST*:

As this is written, the situation abroad grows darker hourly. The President and other American leaders are making insistent demands that our national defense system be perfected.

This country's amateurs yield to no other group in their patriotism and their loyalty to their country. In peace times, they have rendered valuable, often heroic, service; if the safety of this nation should become imperilled, those in command may take it for granted that the legion of trained, technically skilled amateurs are ready to do what is expected of them.

If that time does come, there will be an immediate demand for the better grade of equipment. It will probably be of the highest importance to have the nation literally covered with modern, stable, selective receivers, engineered jobs that can be depended on for work in a crisis; doubtless there also will be need for high-grade parts of all kinds, even including complete band-switching transmitters. Patrolling the air, regulating of short-wave communication is as great a factor in our national defense as are batteries of guns along our coasts. But to do any emergency job will require an immediate supply of the best grade apparatus. There cannot be too much of it.

When war clouds gather, it is of course the natural inclination of the amateur to delay buying that expensive new receiver, that calibrated frequency meter, that precision monitor. For we may be taken off the air.

Yet might it not be the part of wisdom (since the government will pay for such equipment as it uses and it will want only the best) as well as the part of patriotism not to delay getting that equipment, testing it, becoming familiar with its use?

Amateur radio is a vital (more so than is generally realized) part of our national defense. Since the need now is for perfection of that defense, we can and should do our part.

If an emergency should arise suddenly, we as amateurs should be able to provide not only a great reservoir of radio

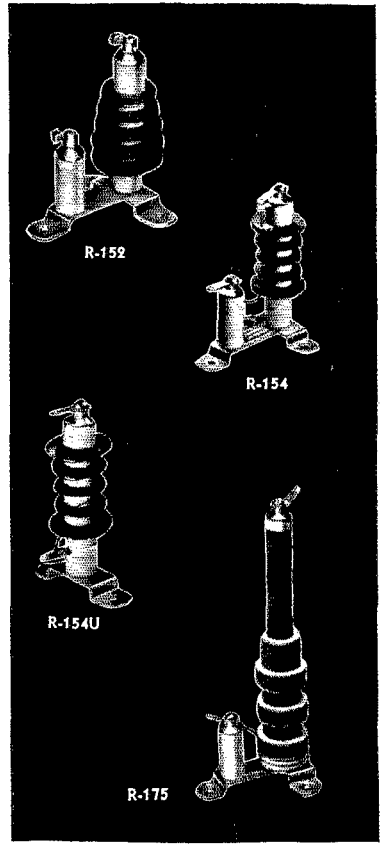
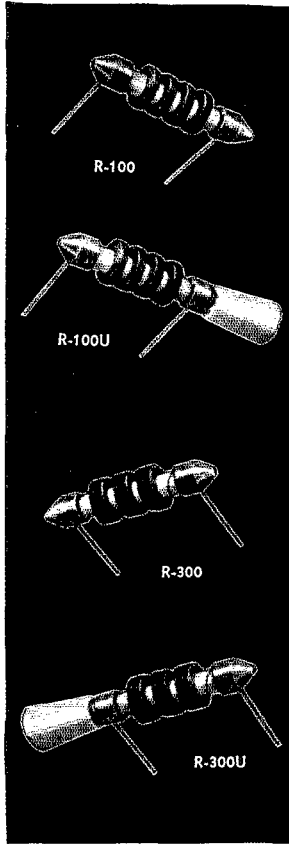
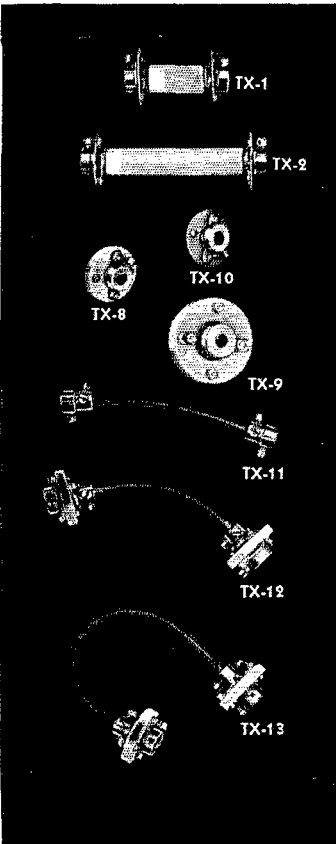

## FLEXIBLE COUPLINGS AND RF CHOKES

**TX-1** Leakage path 1". **Net \$0.60**

**TX-2** Leakage path 2 1/2". **Net \$0.66**

Flexible couplings, Isolantite insulated.

**TX-8** **Net \$0.45**  
Non-flexible coupling. Isolantite.

**TX-9** **Net \$0.66**  
Flexible, Steatite insulation 1 5/8" Dia.

**TX-10** **Net \$0.33**  
Flexible coupling with canvas Bakelite insulation. 1 1/16" Dia.

**TX-11** **Net \$0.36**  
The flexible shaft of this coupling connects shafts at angles up to 90°. Not insulated. Length 4 1/4".

**TX-12** Length 4 5/8" **Net \$0.75**

**TX-13** Length 7 1/8" **Net \$0.90**  
Flexible shaft couplings like the TX-11, but with Isolantite insulators at each end.

All couplings above fit 1/4" shafts.

**R-100** **Net \$0.30**  
Without standoff insulator.

**R-100U** **Net \$0.36**  
With standoff insulator.

RF Chokes R-100 and R-100U are identical electrically, but the latter is provided with a removable standoff insulator screwed on one end. Both have Isolantite insulation. Inductance 2 1/2 mh., distributed capacity 1 mmf., DC resistance 50 ohms, current rating 125 ma.

**R-300** **Net \$0.30**  
Without standoff insulator.

**R-300U** **Net \$0.36**  
With standoff insulator.

Similar to the R-100 series above in size and construction, but current rating is 300 ma. Inductance 1 mh., distributed capacity 1 mmf., DC resistance 10 ohms.

**R-152** **Net \$1.35**  
For the 80 and 160 meter bands. Inductance 4 mh., DC current 600 ma., DC resistance 10 ohms. Isolantite core.

**R-154** **Net \$1.35**  
**R-154U** **Net 1.05**  
For the 20, 40 and 80 meter bands. R-154 and R154U are the same except for mounting (See illustration). Inductance 1 mh., DC current 600 ma., DC resistance 6 ohms. Isolantite core.

**R-175** **Net \$1.65**  
For parallel feed as well as series feed in transmitters with plate supply up to 3000 volts modulated or 4000 volts unmodulated. Reactance is high throughout the 10 and 20 meter bands as well as the 40, 80 and 160 meter bands. Inductance 225 μh, distributed capacity 0.6 mmf., DC resistance 6 ohms, DC current 800 ma., voltage breakdown to base 12,500 volts.

**National Company**  **Malden, Mass., U.S.A.**

# Janette

## ROTARY CONVERTERS

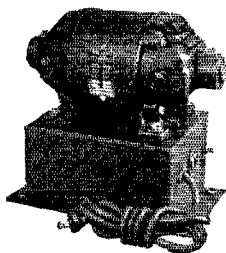

Janette Converters were the ORIGINAL machines designed and built especially for radio apparatus.

These machines progressed with the industry and have made record for economical operation that today Janette and quality products are synonymous.

such an outstanding reliable, trouble-free Janette and quality products are synonymous. **WARNING:** Janette converters are being imitated—be sure Janette is stamped on the name plate. Dynamotors, generators and motor-generators are also available.

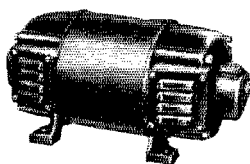

MAY WE SEND LITERATURE?

Janette Manufacturing Company  
556-558 West Monroe Street Chicago, Ill. U. S. A.

## Oil-filled MIDGETS



Oil-impregnated oil-filled paper condenser. Brass cadmium-plated can with varnished-paper jacket. Hermetically sealed.

Center mounting strap for added connection.

400, 600, 1000 and 2000 v. D.C.W.

.006 to .5 mfd. Only 21c to 60c net!

● Ideal for vibrator applications, coupling, low-power transmitters, high-power amplifiers, and for severe-service test equipment. ● Ask your jobber for these Type — 89 oil-filled tubular condensers. ● Ask for new 1941 catalog — or write us direct.



operators and technicians but an overabundance of the best possible grade apparatus to make our part of the national defense immediately and completely effective.

— J. H. Leegeu, W5HHV

## F-M COMMENTARY

28 Friendship St., Newport, R. I.

Editor, *QST*:

Since early last fall I have been experimenting with reception of experimental frequency modulation. During this time I have found several flaws that can easily be overcome in the reception of signals.

First off, I have a good argument (I hope), to shut up the diathermy equipment. I have severe interference at times from two machines operating on about 22 Mc., second harmonics of which completely block out the f-m stations. From the commercial view point this will be quite detrimental to the selling of equipment, to the amateur it might afford a means of clearing up this unnecessary QRM.

Second, through the unwise choice of I.f. in some of the commercial f.m. receivers, trouble from 160-meter amateur 'phones is quite bad. I have had trouble from this complaint. The i.f. in question was 2.1 Mc. and any frequency I used above 1.9 Mc. introduced my signal to block out the f.m. transmissions from W1XOJ. The f-m set didn't have a pre-selector stage, and I believe that a wave trap tuned to 2.1 Mc. and in the antenna circuit would overcome this trouble.

Third, harmonics from lower frequency transmissions are also quite a bit of trouble. I have had trouble from this by local amateur's operating on 40-meter c.w. breaking up the W1XOJ transmissions, which in themselves operate the limiter of the f-m set satisfactorily. The commercials have a rightful kick coming from this score, but it isn't the amateur alone who has harmonics, I know of some very bad ones from government and commercial transmitters.

With the marked improved reception from f-m transmissions I feel that all the things I mentioned can and should be corrected. Everybody will benefit and another step forward will have been made.

A sidelight of interest. I have heard claims from various commercial interests that the f-m signals don't fade. Boy, I wish they could hear them at Newport! For some unknown reason W1XOJ is considerably stronger during the day than at night.

— George W. Brooks, W1JNO

## Beware! High Voltage

**An Example of Carelessness  
Resulting in Bad Burns**

BY LARRY ROCK, W9QAX

**B**EWARE! High voltage! How often have you encountered a sign like this and passed by with little thought as to the consequences which would result from contact with that voltage. As time goes on and experience with high-power transmitters becomes more and more common, amateurs are inclined to become careless when handling voltages that run as high as the thousands. Unless one has had a bad shock from a high-voltage power supply, he is likely to disregard the warnings of his friends and give little heed to the lethal powers in a transmitter using high-voltage power supplies.

A short while back, after rebuilding my transmitter and adding high-power stages to it, I was so careless as to be making adjustments with the large power supplies turned on. The rig is contained in a metal relay-rack cabinet and, as is usual with such arrangements, all of the parts

\* 2950 Jackson Blvd., Chicago, Ill.

# Flexible!

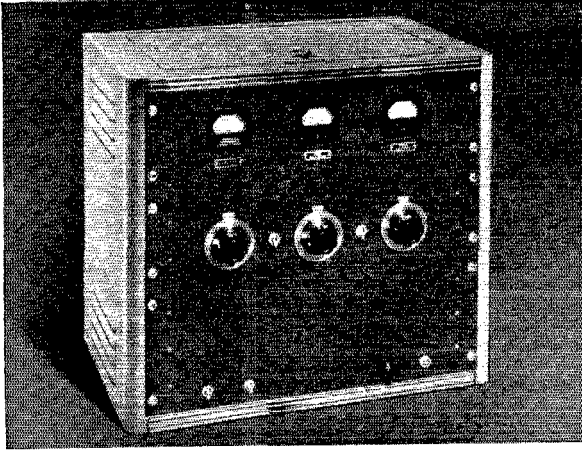

(Cabinet View)

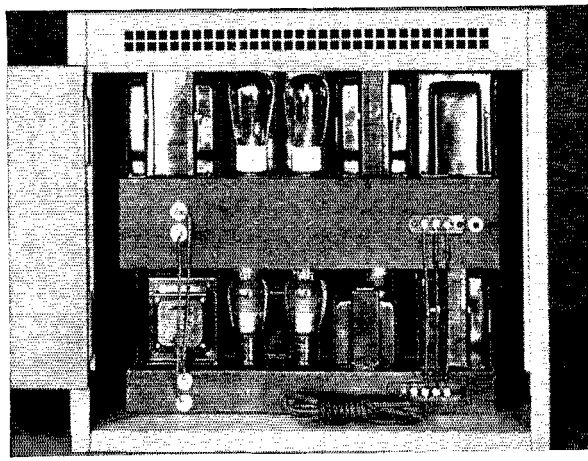

(Rear View)

## 55 WATT PHONE 80 WATT CW

Compactness, reliability and ease of operation are the three outstanding features of this Thordarson 55 watt phone and 80 watt CW transmitter. Designed with entirely separate audio and RF sections and each having its own power supply, either of these two matched units may be used separately. For the CW operator there is the compact and neat appearing RF section. Operating with 80 watts input, the high plate efficiency of the final stage not only makes it an outstanding transmitter but also a highly desirable exciter unit for transmitters having inputs as high as 500 watts. Circuits are strictly conventional, and components are conservatively chosen. Complete kit of the above parts with large size circuit diagram available from your local Thordarson distributor.



Get a Copy Today of the New Thordarson Transmitter Guide No. 344-E

Forty-four pages of invaluable information compiled and laboratory tested by Thordarson Engineers. From your Distributor, or write the factory . . . Price 15c postpaid anywhere in U. S. A.

*Transformer Specialists* **THORDARSON** *Since 1895*  
500 W. HURON ST., CHICAGO

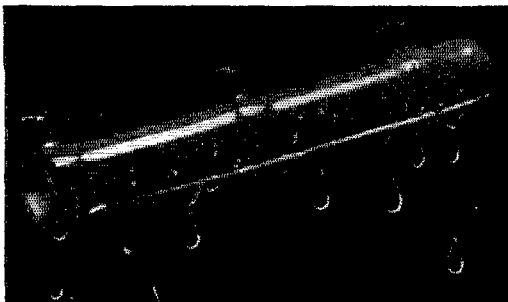

## WHEN A RESISTOR SWEATS!



Moisture, visible or invisible, will cause trouble if it can penetrate the protective surface of a resistor. A microscopic examination of the surface of a Vitrohm Resistor will show freedom from even minute enamel crazes or cracks. The resistance wire is sealed in Vitrohm, a glass-like enclosure, excluding moisture and assuring complete protection.

## WARD LEONARD ELECTRIC COMPANY

41 South Street, Mount Vernon, N. Y.

### A FAIR QUESTION—

**"What will CREI  
training do for Me?"**

CREI training will do nothing for you, if you are content to wait for someone to hand you a better radio job on a silver platter.

But if you are ambitious and desire to improve your position then CREI advanced technical training backed by your own radio experience cannot help but equip you for a higher-salaried technical position. A survey of our graduates disclosed that as a group they are among the *highest paid* in radio — 69% enjoy *salary increases* during or immediately after their training! 5,000 other radiomen can't be wrong. Why don't you follow them to a better job by enrolling now?

Write for facts today —

Let us send you our interesting booklet, together with personal recommendations for your success in radio. To help us intelligently answer your inquiry, please state briefly your education, radio experience and present position; also whether interested in home study or residence training.



### Capitol Radio Engineering Institute

Dept. Q-2

3224 16th St. N. W., Washington, D. C.

are accessible at the back of the cabinet. Consequently, when my right hand came into contact with the final amplifier tank coil (the coil is used in a series-fed circuit) while my left hand rested against the metal cabinet, I was connected across 1400 volts of a power supply capable of this voltage at a  $\frac{1}{2}$ -ampere load! It seems that in the moment of losing consciousness I was attempting to back away from the transmitter, but due to the paralyzing effect of the shock, I was being drawn up into the rear of the rack. I felt as though my head was going to burst. A buzzing took place inside my head which sounded as though it were filled with bees swarming about and trying to outdo each other.

When I regained consciousness, I was free from the transmitter and was leaning against the wall behind it. The transmitter was moved out from the wall at least a foot farther than the normal position. I was gazing stupidly at my hands and arms which were so drawn up that my hands were only a few inches from my chin. They were completely numb from the shock, and, except for the fact that they were plainly visible, seemed not to exist. A long time passed before I was capable of moving any part of my body.

Finally my arms hung limply at my side, and then I became able to move my fingers. As soon as I was able to speak, I called in a friend from an adjacent room. Several bad burns on each hand had to be treated and bandaged, and these burns have required six weeks to completely heal, with much pain and discomfort meanwhile.

I wonder how many amateurs reading this account of my shock recall similar experiences. Undoubtedly, those fortunate survivors have made certain their equipment is safer to-day than it was before the time of their shock, and it is a safe bet that those amateurs are careful in the construction, maintenance, and operation of their transmitters.

One should never forget that it is much easier to come into contact with a high-voltage supply than to release it, and too often the unfortunate ham fails to break the contact, with a "Silent Key" as the result.

Keep in mind the fact that what has happened before to other amateurs may happen to you, and remember that a good meaning for ABC is "Always be careful." Read all articles on safety devices and precautions to be used with amateur transmitters, and be certain that your station is safe for you and your friends.

### This Business of Code

(Continued from page 49)

then send with key and oscillator the rest of the letters in the word in synchronism (we hope!) with the tape. Ideal practice can be obtained by using the W1AW official broadcasts. After you have copied the text once, you can use it to send on an oscillator simultaneously with W1AW on subsequent transmissions during the week when it is repeated. If you don't have and can't get an audio oscillator, whistling the characters aloud will accomplish nearly the same purpose.

# 2 Reasons Why-

TAYLOR 866/866A's\* HAVE  
LONGER LIFE AND  
HIGHER RATINGS

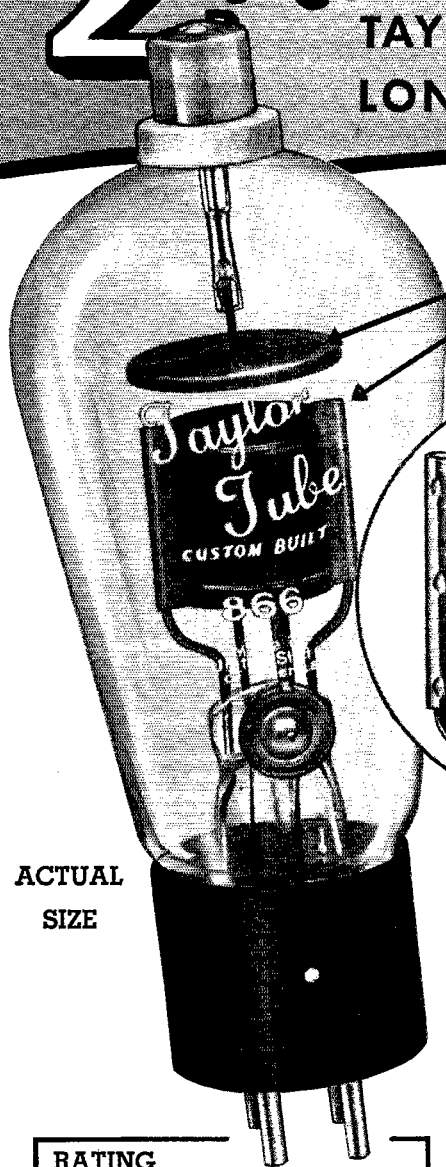

ACTUAL  
SIZE

1

The shield and anode of Taylor's 866/866A are made of pure Svea metal which eliminates any possibility of filament poisoning due to loose carbon.

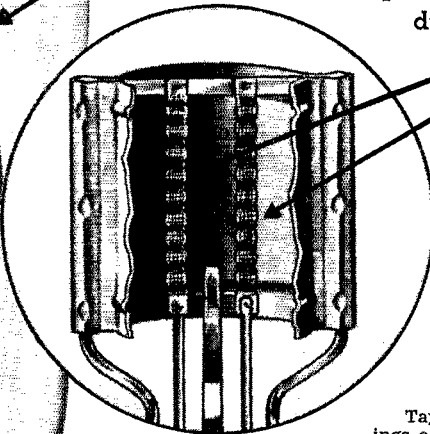

2

The cathode of the Taylor 866/866A is a multi-strand (mesh) filament which has approximately twice the emitting area of the ribbon type.

\* For the past 2 years, Taylor's 866 has had the ratings of an 866A. See QST advertisement—April 1939.

Only \$1.50  
OVER 100,000 SOLD!

SEE YOUR PARTS DISTRIBUTOR  
TODAY FOR TAYLOR TUBES

*"More Watts Per Dollar"*

**RATING**

Fil. Volts .....	2.5
Fil. Amps. ....	5.0
Max. Inverse Peak Plate Volts..	10,000
Average Plate Amp.....	0.25
Peak Plate Amp. ....	1.0

Taylor **HEAVY CUSTOM BUILT DUTY** Tubes

TAYLOR TUBES, INC., 2341 WABANSIA AVE., CHICAGO, ILL.

# RACKS \* PANELS CHASSIS \* CABINETS by PAR-METAL

"The Line of Beauty"

Ask the man who builds his own and he'll tell you that you can depend upon Par-Metal Parts to be of easy assembly, accurately machined and interchangeable almost at will. You'll learn, too, that they are streamlined, modern in every respect and handsomely finished for lasting beauty.

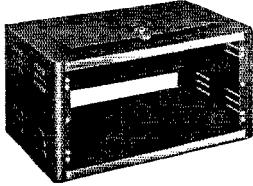

There are Par-Metal Parts for every job — from simple chassis to complete Sound Systems or Kilowatt Transmitters.

*Our Catalog No. 40 describes and illustrates both our DeLuxe and Standard Lines. Get a Free copy at your Jobber's or from us direct*

**PARMETAL PRODUCTS CORP.**  
3262 49th St., Long Island City, N. Y.  
Export Dept.: 100 Varick Street, New York, N. Y.

NEW 1941 PATENTED  
JEWEL MOVEMENT

DE LUXE GENUINE

# VIBROPLEX

World's Finest Semi-Automatic Key

Send  
for  
**FREE**  
Catalog



The  
GENUINE  
Vibroplex

The smartest looking, smoothest action, easiest to operate "Bug" Vibroplex has ever produced. Has Patented Jewel Movement found only in De Luxe Vibroplex Keys. Precision construction including DIE CUT contact and main spring. Highly polished chromium base and machine parts, colorful red switch knob, finger and thumb pieces and green silk cord and wedge. Large contacts.

An outstanding key in smartness, signal quality, speed and ease of operation, users say. Vibroplex keys give quality performance — insist on Vibroplex. Place your order NOW! Money order or registered mail. Write for catalog of Vibroplex keys priced from \$9.95 to \$19.50.

THE VIBROPLEX CO., Inc.  
832 Broadway New York, N. Y.

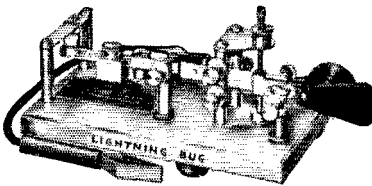

When sending with key or bug, whether with an audio oscillator for practice or when actually on the air, let your mind be thinking of the sound of each character as it is sent. This can be accomplished by softly whistling each character in synchronism with the key.

Practice of this sort will not only let you send better code, but shortly will increase your receiving and sending speeds. But don't rush it — let it come naturally. Keep your sending speed well below your receiving ability; never under any circumstances send as fast as you can receive. Those who do so have a conception of the code that is mechanical rather than aural.

Direct copy on the typewriter at high speeds should be the eventual objective of every licensed amateur. Complete success will not come unless the amateur is an accomplished touch typist; two-fingered typing will not allow you to receive at speed much greater than you can put down with pencil. For any speed in code reception, you have to be able to type automatically and without conscious effort. A touch-typing course for you lads still in school, an evening school class for those past that stage, or perhaps a home-study course will do the trick for non-typists.

Practice copying at a steady speed. Don't listen and then type ferociously for a second . . . and listen . . . and type hurriedly again. Your typing must be dissociated, consciously, from code reception.

Often we hear the question, "How can I learn to copy behind?" Too many such amateurs attempt to copy behind before their code ability reaches the necessary stage. I do not mean in rate of speed, but rather in *manner* of copying. That is, to successfully copy behind, an operator must have reached the point where he is reading *word-sounds*, and not letters. A person cannot carry a series of letters in his mind any more than he can numbers (that's why we fellows carry those little red 'phone-number books), but if he associates them as complete words it is not difficult. Furthermore, when an operator copies individual letters, he must set the text down in letter units, and that forces him to write (pencil or mill) with conscious effort — which completely blocks any attempt to copy behind.

Then what is the way to copy behind? Merely the same listening practice suggested above. You've got to make this language of code a word-language to your mind. You will know when you have reached this stage because suddenly you will automatically begin to copy behind, so don't force the issue.

It all gets back to the same thing — practice and habit. As far as the code goes, even today when driving alone in a car or walking alone, I subconsciously begin to whistle code. I sometimes drive the household to near insanity by attempting to sing arias when shaving before the bathroom mirror; but just as often I pretend to be a big bad commercial sending V-wheels, or WIAW sending its nightly *QST* broadcast. Try it. You'll find yourself getting quite chummy with code.



# GET YOUR 1941 STANCOR HAMANUAL!

FULLY ILLUSTRATING  
AND DESCRIBING  
THE NEW  
**1941 KITS**

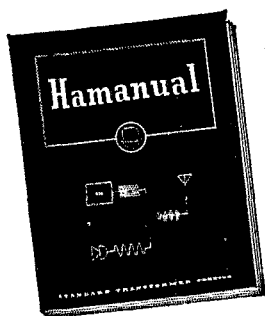

**H**ERE are but three representative kits shown in the 1941 Stancor Hamanual . . . the finest ever printed.

It is more complete than ever before. Nineteen modern transmitter and amplifier kits . . . all with complete descriptions, diagrams, and detailed parts lists. Also twenty-three power supply kits listed . . . antenna data . . . helpful formula, and many other features . . . for the first time a **GUARANTEE POLICY** for each complete Stancor kit.

See the 1941 Stancor kits in the Fifth Edition Hamanual. Hamanuals are available at your Stancor dealer or mail 15c to the Standard Transformer Corporation.

## STANCOR 112-T TRANSCEIVER

A compact 2.5 meter transceiver employing the new HY75, a 6J5 and 6V6 to give comparatively high power "transmit" and excellent sensitivity on "receive". Has self-contained loud speaker and requires single button carbon microphone for radio-telephony transmission. May be powered by a 110 volt AC or 6 volt DC vibrator supply.

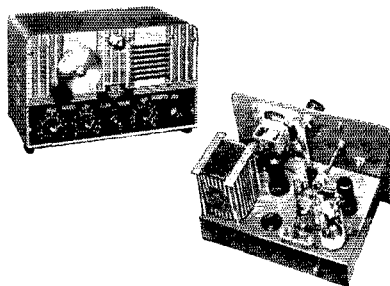

## STANCOR 10-P TRANSMITTER

Fulfills the need for an extremely compact, crystal controlled 12 watt phone — 20 watt CW transmitter having a frequency range of 1.7 to 14.4 mcs. and needing only one coil per band. Uses two 6L6's, one 6J5 and one 80. Dimensions of attractive cabinet 10 $\frac{3}{4}$ " by 6 $\frac{1}{4}$ " by 6 $\frac{1}{2}$ ".

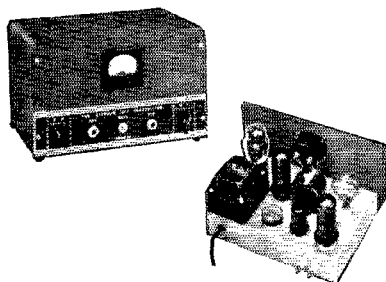

## STANCOR 110-C TRANSMITTER

Offers a complete self-contained 100 watt phone-CW transmitter featuring cathode modulation, having a frequency range of 1.7 to 14.4 mcs. and needing only two coils per band with crystal control. Uses one 812, one 6L6G, two 6V6's, one 6C5, one 6SJ7, one 5Z3 and one RK60. Incorporates complete metering and oscillator keying. Here is a transmitter designed on a high wattage per dollar basis.

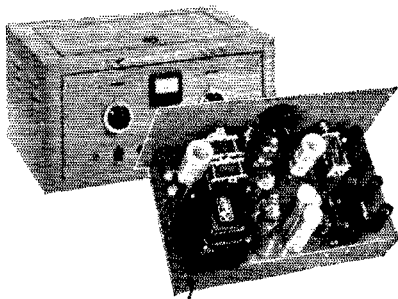

**STANDARD TRANSFORMER**  
• CORPORATION •  
1500 NORTH HALSTED STREET . . . CHICAGO



**Satisfied** SAY  
**THOUSANDS OF PINCOR  
CONVERTER USERS**

Where uninterrupted operation of such A.C. electrical equipment as gasuous signs, power amplifiers, motors, radios, musical instruments, etc., depend upon your converters, they save by using Pincor Rotary Converters. They give thousands of hours of trouble-free service, even under the most adverse conditions.

Available with or without filter for converting 6, 12, 42, 115, 230 or special voltages D.C. to 110 or 220 volts A.C. up to 2500 KVA. Quiet, smooth, light weight and compact. Send for NEW complete catalog today.

**PIONEER GEN-E-MOTOR CORPORATION**  
Dept. No. R-6, 5841-9 West Dickens Avenue, Chicago, Illinois  
Cable: SIMONTRICE New York

**DYNAMOTORS**  
**SMALL MOTORS**  
**HIGH FREQUENCY CONVERTERS**  
**POWER PLANTS**

**PINCOR Products**  
FOR AIRCRAFT • SOUND • POWER SUPPLY USES

## Army-Amateur Radio System Activities

(Continued from page 47)

### New Liaison Officer

Effective November 28, 1940, Major David Talley, Signal Corps, on extended active duty in the Office of the Chief Signal Officer, Washington, was designated as the A.A.R.S. Liaison Officer, in addition to his other duties, to replace Captain A. D. Stephenson who had been transferred to the Middletown Air Base. Major Talley, W2PF, has been an active amateur radio operator since 1915 and previous to being ordered to active duty resided in Brooklyn and served as the Second Corps Area Radio Aide.

The new chief operator at W3CXL-WLM-WAR is Staff Sgt. Charles W. Clemens, W3DZR ("CW"), and the assistant chief operator is Pvt. Norton C. Richardson, W3GUV ("NC"). Both are from Philadelphia.

### Armistice Day Message Contest

The twelfth annual Armistice Day Message Contest, which was held on November 11, 1940, was won by the Ninth Corps Area (states of Washington, Oregon, California, Wyoming, Nevada, Utah, Montana, and Idaho) with 329 members successfully copying the message from the Chief Signal Officer. A total of 1206 members copied the message this year, compared to 1035 reports received in 1939. A summary of the contest is given below, in order of Corps Area standing:

Corps Area	Total Active Members	Number Copying Armistice Day Message	Per Cent
Ninth.....	397	329	82.7
Sixth.....	300	222	74.2
Fourth.....	223	160	71.8
Fifth.....	229	141	61.6
Third.....	152	79	52.0
Eighth.....	243	89	36.6
Second.....	162	46	28.4
Seventh.....	326	80	24.6
First.....	275	60	21.8
Total.....	2307	1206	52.3%

## ★ Performance ★ Accuracy ★ Value

### All in the NEW PRECISION No. 872

Automatic Push Button AC-DC Multi-Range Tester  
29 RANGES including 3000 Volts AC & DC

- ★ LARGEST METER (3 1/4 inches wide) ever provided in a compact instrument, 7" x 4 1/4" x 3" overall.
- ★ Simplified push-button selection: ALL measurements made from ONLY TWO tip jacks (except 3000 volts).
- ★ RANGES ● 6 DC voltage ranges at 1000 ohms/volt: 0-6/30/300/600/1200/3000 volts ● 5 AC voltage ranges at 500 ohms/volt: 0-12/60/600/1200/3000 volts ● 5 DC current ranges to 1200 MA. ● 3 OHMMETER ranges to 5 MEGS; up to 500M ohms on internal battery ● 5 DECIBEL ranges (-10 to +64 DB) ● 5 OUTPUT ranges to 3000 volts.
- ★ IT'S "PRECISION" BUILT!—1% wire wound bobbins—1% matched metallized multipliers—individually sealed calibrating controls—telephone cabled wiring, etc.

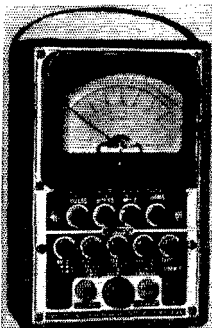

COMPARE THIS "PRECISION" VALUE at only \$17.95 net  
This is only one of the more than 40 models comprising the complete "Precision" line of dynamic mutual conductance tube testers, combination set testers, multi-range testers, signal generators, etc. Prices start as low as \$14.95.

Ask for the PRECISION TEST EQUIPMENT 1941 CATALOG

**PRECISION TEST EQUIPMENT**  
Standard of Accuracy SEE THEM AT YOUR JOBBER

**PRECISION APPARATUS COMPANY**

647 Kent Avenue Brooklyn, New York  
Export Div.: 458 Broadway, New York, U. S. A. — Cables: Morhanex

## Strays

Tubes no larger than an ordinary dial lamp have recently been brought out by the Microtube Laboratories of Chicago. Designed primarily for hearing-aid and similar applications, the filaments operate at 1/2 volt, 20 to 40 ma. Plate current is less than 1 ma. at 45 volts.

In an emergency, c.w. may be received on a super-het not equipped with a b.f.o. by coupling the grids of the first and second i.f. tubes with a small piece of insulated wire wrapped around the grid leads. — VESPA, VESA UW.

A smoothly-working reamer for holes up to one-half inch in diameter is a large rattail file clamped in a carpenter's brace. Rotation must be counter-clockwise. — W4PFD.



# New FM/AM TUNER

**HIGH FIDELITY TUNER FOR FREQUENCY MODULATION AND AMPLITUDE MODULATED RECEPTION**

**MODEL S-31** New 1941 Hallicrafter designed FM/AM Tuner. The No. 1 band covers all frequencies used by amplitude modulated broadcast stations. The No. 2 band covers frequencies used by high fidelity frequency modulated broadcast stations. The circuits involved in the reception of the two types are much different, usually requiring two separate receivers. The Model S-31 tuner combines both circuits and changes from FM to AM with the bandswitch.

**Specifications:** 8 tubes — Frequency range, band one: 540 to 1650 kc., band two: 40 to 51 mc. — Power output 130 milliwatts undistorted — Power consumption 120 watts — Controls, Bandswitch, Phone switch, Main tuning, audio gain, Tone control, "S" meter adjustment — Operates on 115-125 volts, 60 cycle AC. Model S-31 Tuner complete with 19" x 8¾" rack panel, metal cabinet and tubes.....\$69.50

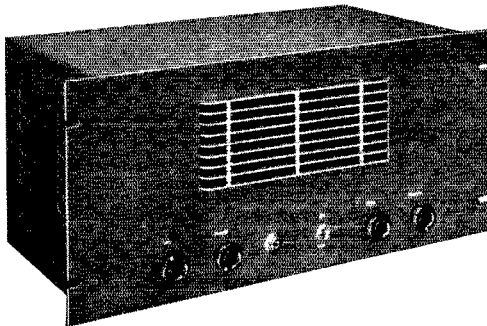

## AMPLIFIER FOR MODEL S-31 TUNER

Hallicrafter engineered amplifier designed for rack mounting and for use as a companion unit to the FM/AM Model S-31 Tuner. Delivers 25 watts of high fidelity audio power to either speaker or 500 ohm load.

**Specifications:** 6 tubes — Fidelity 2 DB from 50 to 15,000 cycles — Gain: Channel No. 1, microphone (high impedance) 96 DB — Channel No. 2, phone (low impedance) 60 DB — Power output 25 watts — Power consumption 100 watts — Output impedance No. 1, 500 ohms; No. 2, 8 ohms; No. 3, 4 ohms. Dimensions: panel 19" x 8¾". Dust cover 18" x 8¾" x 10". Complete with cabinet and tubes.....\$49.50

# TERMINAL RADIO CORPORATION

68 West 45th Street • 80 CORTLANDT STREET  
NEW YORK, N. Y.

Cable Address: TERMRADIO

*New York's Leading Distributor of  
Quality Radio Equipment*

# New EFFICIENCY

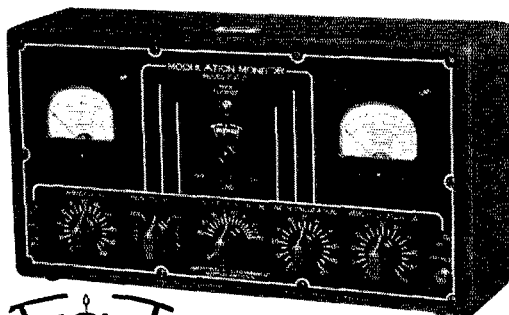

## TRIPLET MODEL 1696-A

You've solved your problem of getting maximum efficiency from your transmitter when you invest in a Model 1696-A Modulation Monitor. . . . A new monitor with improved shielding. . . . Just the unit for 10-meter bands. Plug it into your AC line — make simple coupling to the transmitter output and the monitor shows:

● Carrier Reference Level ● Per cent of Modulation ● Instantaneous Neon Flasher (no inertia) indicates when per cent of modulation has exceeded your predetermined setting. Setting can be from 40 to 120 per cent.

Helps comply with FCC regulations. Has two RED DOT Lifetime Guaranteed Triplett instruments. Modernistic metal case. Model 1696-A — Amateur Net Price. . . . \$34.84

Also available as a push panel mounting unit

For More Information — Write Section 252, Harmon Avenue

THE TRIPLET ELECTRICAL INSTRUMENT CO.

Bluffton, Ohio

# ★ ★ ★ ★ ★ ★ TRAIN NOW! ★

FOR THE

# ★ ARMY, NAVY or ★ ★ COMMERCIAL FIELD ★

★ YOU, too, can qualify in half the usual time for your amateur or commercial license and a good rating by training in your own home with the Candler System. Candler teaches you code by a simple, practical method — the same easy-to-learn Candler System that has taught thousands including world famous speed champions. ★

★ The Candler System has, for over a quarter of a century, shown how easy it is to learn code in your own home and secure a steady, good paying job. Remember the Candler System is the time-tried and proven method. ★

★ Over 5000 expert radio operators will be enlisted by the Communications Reserves of the U. S. Navy. You can qualify for this now — the Candler way. ★

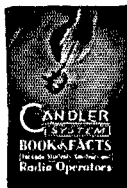

**FREE** Candler's New Book of FACTS  
— Tells you all the inside tips — Get your free copy Now — Drop a postcard today!

**CANDLER SYSTEM CO.**

DEPT Q-2

ASHEVILLE, N. C., U. S. A.

## A Wide-Range V.T. Voltmeter

(Continued from page 35)

v.t.v.m. and then read the voltage. Care must be exercised in setting  $R_4$  because too much extension will reduce the tube plate voltage so much that the plate current is likely to be completely cut off. About a 30-degree rotation should be sufficient.

When measuring a.c. across tuned circuits and networks be sure you are not measuring in addition to the desired voltage other common voltages such as bias and plate potentials. If these voltages are inescapable, place a 5-megohm resistor between the two probes and connect B to the source through a 0.1- $\mu$ fd. condenser, blocking off the unwanted d.c. potentials.

The meter reads d.c. direct, but the positive side must always be connected to the grid probe. Occasions arise when the range of the instrument is not high enough, but by connecting a voltage divider made up of non-inductive resistors to the source and measuring with the v.t.v.m. across a portion of the divider the voltage can be calculated. The divider will draw a small amount of power, and its value may be as high as 100,000 ohms per volt.

In application the v.t.v.m. is almost unlimited in scope. A few examples are: measuring the Q of coils<sup>1</sup>, percentage of modulation; excitation of amplifiers; audio amplifier gain, and neutralization. By measuring the drop across a known reactance, usually a fixed condenser, the instrument may be used as an r.f. ammeter.

In using this v.t.v.m. both in broadcast and amateur stations, it was found adequate and compared favorably with the available commercial types in characteristics and ease of operation. Add one to your instruments and enjoy your radio work more.

<sup>1</sup> C. B. Stafford, "Q Measurements," *QST*, January, 1940.

## ★ New Receiving Tube ★

Type 3S4

**R. C. A. ANNOUNCES** the type 3S4, similar in characteristics to the 1S4 but having a center-tapped filament to permit series operation at 2.8 volts or parallel operation at 1.4 volts. Filament current with the series connection is 50 ma.



Imagine the chagrin of W9WOA who wrote to his home county of Hancock, Illinois, for a birth certificate only to have the report come back that he was a girl! — W9RAU.

Ordinary black shoe dye makes a good quick-drying finish for wood or unfinished Presdwood panels. It gives a nice dull-black finish. — W9YGR.

# *The Radio Amateur's* **HANDBOOK**

---

**T**HE HANDBOOK tells the things which are needed for a comprehensive understanding of Amateur Radio. From the story of how Amateur Radio started through an outline of its wide scope of the present — from suggestions on how to learn the code through explanations of traffic-handling procedure and good operating practices — from electrical and radio fundamentals through the design, construction, and operation of amateur equipment — this book covers the subject thoroughly. It includes the latest and the best information on everything in Amateur Radio.

**\$1** **POSTPAID**

*\$1.50 Outside Continental U. S. A.*

*Buckram Bound \$2.50 Postpaid*

*Spanish Edition \$1.50 Postpaid*

**AMERICAN RADIO RELAY LEAGUE, WEST HARTFORD, CONN.**

# Station Activities



## HUDSON DIVISION

**EASTERN NEW YORK**—SCM, Robert E. Haight, W2LU—JSD reports all traffic originating at the Larchmont Army Barracks. Nils is to be congratulated on the noteworthy work he is doing with the F.T.S. boys and the publishing of *Etherettes*. MHW is on the air with a new 6L6-809 rig running 60 watts. LU is QRL with N.C.R. activities. LLU schedules W1MBN and DHU with some traffic. Congrats are in order to NIY, ex-8DHU, upon the arrival of a jr. op. 2ACB, E.C., in his new home and promises that his signals will be pushing out during 1941. We welcome MEC as a new O.P.S. The boys of E.N.Y. must have been busy Xmas shopping from reports received. We hope 1941 will bring our total up, 73, S.C.M.

Traffic: W2LSD 295 MHW 49 LU 24 LLU 8 NIY 3. (Oct.-Nov.: W2LSD 96.)

**NORTHERN NEW JERSEY**—SCM, Edward Gursky, Jr., W2LMN—RM's: BZJ, CGG, HXI, IYQ. PAM-HNP. Section Net frequencies 3630 and 7070 kc. New appointment: O.R.S., MHJ; O.P.S., JKH. Well, gang, with this report, another year comes to a close. On behalf of Pat Jessup, Fred Read and myself, thanks for your splendid cooperation throughout the year, and we are happy to have served you. Best wishes for a happy and prosperous New Year. The Forty-Meter Net is under way and operates on 7070 kc. at 8 p.m. every evening except Sunday. At present there is a lot of traffic but not enough stations. Anyone interested should get in touch with 2IYQ for more information. MAX and MNT are operating the Irving High School rig, under the call MTZ. JKH is building a new exciter. JRU received his certificate for 25 w.p.m. MRJ and KSR are rebuilding. MRX has a new antenna mast; his old one came down in a wind storm. HXI, who makes B.P.L. with 791, says that traffic seems a little slow. What a man! MNO reports that a lot of traffic for Ft. Monmouth and nearby points.

Traffic: W2HXI 791 MNT 246 CGG 241 MAP 100 IYQ 92 BZJ 88 (WLNF 19) LMN 61 (WLNX 22) MAX 58 MNO 54 MKW 39 JUJ 27 CHQ 23 JUC 8 MRX 5 JIY 1. (Oct.-Nov.: W2MNT 212 IYQ 47 HCO 33 JIY-CIZ 1.)

**NEW YORK CITY AND LONG ISLAND**—SCM, Ed. L. Baunach, W2AZV—BO and MRL are new O.R.S. HCS is O.P.S. and works on 29018 kc. FLD's new QTH is 481 Chauncey St., Brooklyn. DKF is interested in becoming O.O. on 14 Mc. LXQ is located at 313 E. 40th St., N. Y. C. IYC received his Class A ticket and a 30 w.p.m. endorsement for code proficiency. IHT soon expects to be a W1. PF's new A.A.R.S. call is WLMT. BWC is WLNS in the A.A.R.S. DXO is new State Radio Aide for S.N.Y. A.A.R.S. ITX is touring the country with General Motors. LZR works WLXA in Hawaii on 6990 kc. with 70 watts input. LZR makes the B.P.L. for the 12th time. BOTH SC and 3MA/2 report a lull in traffic. JGC is operating 2JCA/4 from Fort McClellan with the N. Y. National Guard, and will be there for one year. HYJ built a new 20-watt, 112-Mc. job using a 6E6 with long lines on a 5-by-7 chassis. URY is giving it the life test. IYX works all the K's with his new three-element beam on 28 Mc. JGB revamped his Comet Pro. FNJ spent the past month building his 600-watt rig. BYK, JSV and LJP are active nightly on 28 Mc. LGK is working on a plan to get more replies to the traffic that is mailed out. NAZ just got on the Section Net when the rig went west. EC reports that most of the members of the A.P. Net are old timers, dating back to spark days. IXZ is looking for a schedule with a W1 or W3 to keep traffic moving on 7236 kc. The Section Net is carrying on in great shape, and anyone desiring to move traffic in N.Y.C. should call in any night on 3710 kc. at 8:30 p.m. At the Tubor Radio Club annual meeting the following were elected for the coming year: HHW, President; BYK, Vice-President; M/J, Secretary-Treasurer. It is very easy to qualify for membership in the Nit Wit Net on 1804 kc. All you need to do is call AA and he will give you the dope.

Traffic: W2LZR 929 SC 460 FAQ 335 KI 294 3MA/2 178 DBQ 140 MT 138 BWC 127 DW 125 MRL 102 LR 80 EC 69 AZV 51 NAZ 49 AV-LGK 43 IYX 36 AA 19 ADW 14 HJY 13 CTF 12 LBI 11 CHK 10 CET 9 EXR-

NHD 8 PF-FLD 7 BGO-DLR 6 AEU-LYC 5 FF 5 VG 4 LYH-IXQ 3 DOG-IXZ 2 JAU-KTA-HGO 1.

## ATLANTIC DIVISION

**EASTERN PENNSYLVANIA**—SCM, Jerry Mathis, W3BES—EEW is starting to experiment on the ultra-highs. Asst. S.C.M., BXE, has been improving his station of late and has a new skywire. 8ASW is QRL with the National Guard. 3AKB has replaced her antenna which had fallen down. 3EFH has a new mill. AQN sez, "If any of ye guys want to get rid of your traffic, just break into the Eastern Penna. Traffic Net at 6 or 10 p.m., 3635 kc., after roll call." 3ATF sends his report via radio. 8EU says his low total is due to the K6 traffic hitting the skids. 3BES lost his antenna pole in the high wind. 3GET is going after some traffic. DRO paid the S.C.M. a visit. JAH is a new ham in Oak Lane. JBW is a new call in Central City. GYK worked WAR, as did BES and BXE. GUV is operating WAR and WLM. EEW, INH and EON are new A.A.R.S. members. 80ML is busy with N.C.R. and Eastern Penna. Traffic Net. 8UQM is A.A.R.S. in Plymouth. 3DGM visited Texas, but could not locate any of the O.R.S. boys. FLH is reorganizing his shack. 8SNZ worked KDAGYM and received his 35 w.p.m. code proficiency certificate. 3HFD continues his schedules with Antarctica. 3GOW claims his revamped station will show the gang in general, and the F.R.C. in particular, where to head in at incoming contests. All traffic from HFE was on u.h.f. AGV got a QSL from UX1CP and worked a new state on 56 Mc. in one month! Dick suggests that this Section put 28-Mc. c.w. back on the map by going on from 2 to 4 p.m. BIL hasn't put up the rig at the new QTH yet. BRZ wants more stations on 56 Mc. DRQ was in the SS on phone. HXA's 812 met a gruesome death. New officers of the Frankford Radio Club are: Pres., 3AGV; Vice-Pres., 3GHH; Secy.-Treas., 3ILK. Best wishes in 1941.

Traffic: W3GKO 2153 3AOC 1414 3QP 721 3EEW 643 3EML 596 3BXE 227 8ASW 213 3AKB 206 3EFH 193 3AQN 185 8ATF-8EU 77 3FXZ 39 3BES 34 3ADE 30 3GET 24 3DRO-3GYK 21 80ML 20 8UQM 17 3IAY 16 3DGM 13 3INH 8 3HCT-3FLH 5 8SNZ-3HFD-3GOW-3GV 2 3GHH-3HFE 1.

**MARYLAND-DELAWARE-DISTRICT OF COLUMBIA**—SCM, Hermann E. Hobbs, W3CIZ—Eppa W. Darne, Chief RM 3BWT. Roy Corderman Regional Co-ordinator. BHE is giving c.w. a whirl being on 'phone for several years. BKZ is troubled with local QRM, but thinks it can be eliminated by a few code lessons. BWT has been initiated into the H & B Trunk Line. CDQ has a 25 w.p.m. certificate and a W A S, and took a trip to Florida to bring home a little more sunshine for the Y.L.R.L. Net. WLM/CXL has been very busy the past two weeks working amateurs using the WAR transmitters. FPK is back with a pair of 812's. He has also been appointed alternate S.N.C.S. for the Md. A.A.R.S. Net. GMK is not satisfied with his e.c.o. and is rebuilding. HUM is QRL with traffic on TL-AP; twenty-one stations are in the line-up. IVT has joined the AP trunk and is a regular with the Central California Net; he visited Chicago during the holidays. EZ is trying to set up a local distributing system for Baltimore traffic. He made 50 contacts in five hours' operating time in the S.S. IXP is a new emergency station for Cumberland.

Traffic: W3BKZ 98 BWT 903 CDQ 14 CIZ 462 CXL (WLM 3244) DRD 101 EQK 4 EUT 15 HUM 211 IVT 125 OZ 55.

**SOUTHERN NEW JERSEY**—SCM, Lester H. Allen, W3CCO—Ass't SCM and A.A.R.S. Liaison R.M., Ed. G. Raser, W3ZI—NCR Liaison R.M., Ed. B. Kerr, W3CCC—Regional Co-ordinator in charge of Emergency Co-ordination, Ted Toretti, W3BAQ—R.M.'s: 3BEI, 3BYR, 3ITU—P.A.M., Bill Hannah, W3EUI. Section net frequencies, ORS 3700 kcs. OPS 1980 kc. 3PLA, S.C.M. for Western New York, wishes to advise the S. J. gang that he is organizing an American Legion Net, and any member of the Legion is welcome to join, provided, however, that he is in good standing at his local post. For further information contact Fred at his home in Sonyea, N. Y. The first Southern New Jersey Field Day was won by the Sectional Co-ordinator W3BAQ with 325 points, and W3DCQ took second place with 300 points. Other participants were: 3AQ, HTJ, IOW, FBC, GCU, AVJ, DAJ, ZI, BM, IOK-3, KW-3, GMY, EED, ITU, EUH and CCO. This was a fine showing for the first attempt, and a 2nd such Field Day will be tried in a few months. HPX, besides being active in the traffic work (O.R.S. and A.A.R.S.), finds time to do a little secretarial work for the Somerset Hills Radio Club. AEJ has a

new half-wave antenna for 1.75 Mc. IMY has a new 28-Mc. rig and an FB 3-element rotary, and is starting to put up a half-wave vertical for 1.75 Mc. GMY completed a new e.c.o., and expects to be on 1.75-Mc. 'phone shortly. The new line-up is 6SK7-6V6-HY25-35T final. BZX intends to make H.P.L. again this year. HSL has condensed his rig and is attempting to get on 1.75-Mc. 'phone. HYT is interested in becoming O.R.S. He keeps daily schedules with 3 stations and has outlets for K4, K5, K6, K7 and KA stations; he scored 60,000 points in the S.S. W2DGM/3 of Haddonfield have a W3 call before very long. HAZ sends in his first traffic report since joining the A.A.R.S. Net, and mentions that he is open for schedule with anybody anywhere. GHR tells of a newly developed silent inexpensive keying relay that works FB, ACC and ABS are doing right well on 56 Mc., according to latest reports. IOK in his first traffic report sends along a sizeable total. FB, Charlie. INF has an 8-watter on 1.75-Mc. 'phone using a 56 oscillator and 2A5 final. ZI is reporting into A.A.R.S. Net from the N.Y.A. center at Verona, N. J., under the call 3GNU/2. Ed is on 3700 kc. and will work the S.J. gang directly after O.R.S. Net. FFE recently renewed his license, and expects to do a has applied for an O.R.S. appointment. BYR sends along his very FB traffic report, and is still swinging along with the A.A.R.S. and O.R.S. Nets. CWG is doing a little c.w. work when not busy with O.R.S. duties. The S.N.J. 'Phone Net took a vote on night and time for operation, and it was decided to keep Thursday as the night and the time the same at 8 p.m. IFT worked K6OQE on 3.9-Mc. 'phone and received verification. HRO is working all bands with a new e.c.o. unit. HOJ received a call from the N.C.R., and leaves shortly for one year of active duty. CCC reports he expects to have more power on soon. OQ has been experimenting on 14 Mc. The South Jersey Radio Association has formed a Club Net. BEI is tied up 6 nights a week on 3700 kc. with the O.R.S. and S.J.R.A. gangs. ABS made 6 points in the last u.h.f. contest; about the time Stan got started the rig went haywire! HKO arrived back in Trenton and immediately went to work on the A.A.R.S. Net. Bud lined up a little over a 100 points in 4 days. BZX renewed his ORS appointment for another year. HWT reports the following are operating 112 Mc. in Trenton: HPE IIN, HW, IDY and IOK. More are expected to be on the air shortly. The boys are using modulated 6A6 oscillators.

## WESTERN N. Y. QSO PARTY

"A Western New York QSO Party will be held on Saturday and Sunday, Feb. 8th and 9th. The contest will open at 6 p.m. on Saturday and close at midnight on Sunday. The call will be CQ WNY, and any New York station in the eighth call area is eligible to participate. Each complete QSO will consist of an exchange of reports and will count two points. Stations heard but not worked may be counted as one point. Logs must be submitted to your S.C.M. not later than Feb. 15th, and the winner will be announced at the Rochester hamfest on Feb. 22nd. As a prize the winner may choose an RCA 811, 812 or a pair of RCA 866's to be donated by Beaucaire of Rochester. Let's all turn out and make this occasion a grand get-together."

Thank you,

F. CHICHESTER,  
S.C.M., W.N.Y.

W8VO, Chief Engineer of WHEC and consulting engineer for all Gannett stations, was instantly killed on Dec. 15th, under conditions very similar to those under which "Johnny" Long, W8ABX, was killed. His car struck the abutment of the N.Y.C. Railroad. TEP is a new E.C. in the Section. THC has his new half-wave 1.75-Mc. antenna up, and is giving it a tryout. UNX has a Stancor 60P on 1.75-Mc. 'phone. CKC visited GPS at Jamestown. The N.Y.A. at Jamestown is sponsoring a code and theory course in conjunction with national defense. Classes meet two nights a week, with 20 members. VFG, Vernon, and VFI, Rochester, are two new hams in the Section. RQX is in O.B.S. SWC now has Class "A" ticket, and is doing fine on 3.9-Mc. 'phone with 30 watts. NAX, who has been on 14 Mc. for a long time, is now on 7 Mc. The Telephone Employees Amateur Radio Association had a nice write-up in the New York Telephone Company's employees' magazine. Pictures of DSU, IOT, SMI and CSE were included. KYR is doing nicely as Emergency Coördinator. SZB is experimenting with an 851 as a linear stage. RTX is getting out fine on 2037 kc. with 12 watts. BCU expects to do some traffic work very soon. SOW had a power supply go up in smoke, but is back with us again. GZX is selling out completely and beginning all over again. JAD is working swell DX on 1.75-Mc. 'phone with 3 watts input. The Rochester Amateur Radio Association will hold its annual hamfest on Washington's Birthday, Feb. 22nd, on the Starlight Roof of the Sagamore Hotel. "Doc" Smith will be master of ceremonies. A special table will be reserved for the W.N.Y. O.R.S. and A.A.R.S. gangs. JIW, with his low-powered rig, needs two cards for W.A.S. on 3.5 Mc., six for W.A.S. on 7 Mc., and only Vermont for W.A.S. on 14 Mc. Activity is increasing on 112 Mc. in the Buffalo area again. NEL is now in Washington, D. C. He expects to be on 3.5-Mc. c.w. soon, to work the local boys. UEP is taking up radio service work. Seneca Vocational High School, Buffalo, anticipates a kw. rig on 56 Mc. FQS was awarded the trophy in the 5-Meter Club 112-Mc. contest, at a banquet at Hotel Stuyvesant, Dec. 12th. VE3AYE and VE3FT, still showing interest in amateur radio, visited K.B.T. Club at their Dec. 13th meeting. K.B.T. offers its appreciation for being awarded affiliation with the A.R.R.L. NNP will be on 7 Mc. soon. MQX is building u.h.f. equipment in his new QTH. ROZ is now an employee of the N. Y. Telephone Co. Speaker at the K.B.T. Club, Dec. 13th meeting, was WSCDM, an employee of WBEN. He gave an interesting talk on "Antennas for All Amateur Bands." Preparation has been started for K.B.T. Club participation in 1941 Field Day. Design of transmitters best suited to our conditions is to be the subject of discussion at future meetings. OMD now has a non-microphonic e.c.o. using a 6F6. He is now Acting A.A.R.S. UXT has been appointed an A.A.R.S. member. NWH is teaching in the national defense program. UY now has Class "A" ticket. W1CDX is a new ham in the Section. His QTH is Hamilton St., Plattsburgh. SFD expects to get his 60-watter back on soon.

Traffic: W8AOR 22 BJO 50 FCG 262 NTK 36 JIW 307 PCN 208 PLA 150 SBV 62 SMI 57 UPJ 98 RKM 250.

WESTERN PENNSYLVANIA — SCM, E. A. Krall, W8CKO — Ass't SCM in charge of O.R.S. activities,

(Continued on page 88)

## SOUTHERN NEW JERSEY QSO PARTY

The aim of the Section QSO Party will be to work as many amateurs in as many S.N.J. counties as possible. The Contest will start Sunday, March 2, 1941, at 7:01 A.M., and continue for eighteen hours until 1:01 A.M., Monday, March 3, 1941.

1. Message exchanged will consist of:

Number of QSO	Town
Your Name	Section
Your Call	County
Signal Report	

EXAMPLE: Nr 1 Walt W3HOJ RST 599X Glassboro S.N.J. Gloucester County.

2. Each station may be worked only once to count for score. Any combination of bands may be used.

3. 'Phone and c.w. scores will be listed separately.

4. Scoring will consist of 2 points for each fixed station worked, and 4 points for each portable station worked. For each message originated reaching W3HOJ, 10 points will be added before multiplier. Total points will be multiplied by the number of different counties worked. Portable stations multiply their scores by 4.

5. All scores must reach W3HOJ by March 10, 1941.

Traffic: W3BZX 273 BYR 175 (WLVN 20) INF 147 CCC 120 HAZ 103 ZI 69 IFT-IOK 85 GMY 87 HPX 63 AQ 46 HYT 41 AEJ 38 EWK 34 BEI 26 ITU 20 CCO 18 HKO 9 GHR 5 HSL-ACC 4 ABS 2.

WESTERN NEW YORK — SCM, Fred Chichester, W8PLA. R.M.'s: BJO, CSE, DSS, FCG, PCN. P.A.M.'s: CGU, RVM, UNY. E.C.'s: FNT, GWY, KRY, SBV, SMH, THC, TEP. Net frequency 3720 kcs. Maurice Clark, ex-

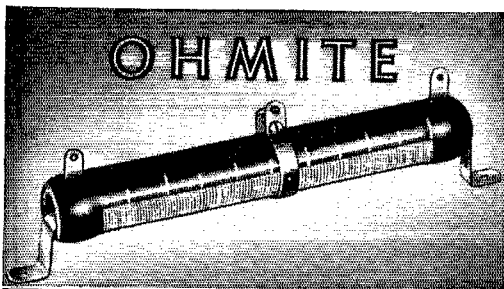

## Adjustable Dividohms

It's the quick, easy way to adjust the resistance in your rig, or make a needed replacement in a hurry — and be sure of dependable performance! One or more taps can be added whenever desired. Sizes from 10 to 200 watts. Resistances up to 100,000 ohms. At Your Jobber.

Send 10¢ in coin for New  
Ohmite Ohm's Law Calculator

**OHMITE MANUFACTURING CO.**  
4863 Flournoy Street, Chicago, U.S.A.

*Be Right with* **OHMITE**  
RHEOSTATS • RESISTORS • TAP SWITCHES

## RADIO TECHNOLOGY



RCA Institutes offer an intensive course of high standard embracing all phases of Radio and Television. Practical training with modern equipment at New York and Chicago Schools. Also specialized courses in Aviation Communications, Radio Servicing and Commercial Operating.

Illustrated Catalog on request

**RCA INSTITUTES, INC.** Dept. ST-41

A Radio Corporation of America Service

75 Varick St., New York 1154 Merchandise Mart, Chicago

## READ AND SEND CODE

Learn Easily at Home  
This Quicker Way

No experience needed. Beginners read code quickly, copy accurately. If already an op, speed up your wpm with this approved, amazing, all Electric Master Teleplex Code Teacher. Only instrument ever produced which records your sending in visible dots and dashes on specially prepared paper tape — then sends back your own key work at any speed you wish. Fascinating, fool-proof — get results because you learn by HEARING as well as SEEING. That is why thousands agree this method is surest and quickest. While not designated standard equipment, Teleplex is used at many U. S. Army Posts, Naval Training Stations. We furnish Complete Course, lend you the New All Electric Master Teleplex, and personal instruction with a MONEY-BACK GUARANTEE. Low cost, easy terms. Write today for folder Q-2, no obligation.



'HAM'  
SPECIAL

TELEPLEX CO., 67-69 Park Place, New York

In Canada, Write

Canadian Electronic Institute, Toronto, Ontario

## ★ BOOK REVIEWS ★

**Getting Acquainted with Radio**, by Alfred Morgan. Published by D. Appleton-Century Co., New York. 285 pages (including index), numerous illustrations. Price, \$2.50.

**Understanding Radio**, by Herbert M. Watson, Herbert E. Welch and George S. Eby. Published by McGraw-Hill Book Co., New York City. 603 pages (including index), 26 photographs and 379 diagrams. Price, \$2.80.

"Getting Acquainted with Radio" is a broad, generalized and reasonably entertaining picture of the entire radio field, intended for "those of us with inquiring minds who wish to pierce the mystery that surrounds our radio set." The publishers remark that "those of us who contemplate adopting radio as a hobby will find here valuable advice of the most practical sort."

We do, in fact, find these things, and we find further a rather comprehensive and well-digested review of the whole radio field. The principal value of the book lies in the complete simplicity of style and analogy. It is the sort of thing you can recommend to your grandmother, or your girl friend, or the neighbor next door who wants "a book on radio" for a sixth-grade son, with confidence that anyone can read and comprehend it. Of course, it is of little value to the practising amateur or to the serious seeker after technical radio knowledge — but for the lay reader it is a superb job.

"Understanding Radio" is apparently a collection of lectures used by the authors in teaching radio at Stockton (Calif.) Junior College. It is arranged in text-book style, with questions for self-examination following each section. The purpose of the book is to explain the functioning of the various elements of radio circuits in a fashion readily comprehensible by the layman. Actual constructional examples for demonstrating each circuit are suggested. The foreword states: "The subject matter of the book is arranged in the order in which you will need it as you work with each set. As far as possible, each circuit is studied as a single lesson, which is divided into the following parts: 1. The Purpose of the Lesson. 2. How to Build and Wire any Needed Apparatus. 3. How to Operate the Set or Apparatus. 4. Why the Set Works as It Does."

— C. B. D.

**Television Broadcasting**, by Lenox R. Lohr. Published by McGraw-Hill Book Company, New York City. 274 pages (including index), 88 illustrations. Price, \$3.00.

Mr. Lohr is president of the National Broadcasting Company. Mr. Sarnoff, who writes the Foreword, is president of the Radio Corporation of America. In this book they write about RCA-NBC's adventures in television.

Mr. Lohr has an enviable quality of simplification, and he makes RCA-NBC a human and sympathetic entity without any very obvious effort at doing so.

The book covers the entire gamut of questions relating to television — production, economics, technique. The whole picture — from the social and economic aspects (the problem of raising capital for further exploitation is discussed quite frankly) to the legal and technical aspects (including a very good layman's explanation of television theory), winding up with a complete television script with annotations—is reviewed in a manner quite intensive but thoroughly understandable and readable.

— C. B. D.

**SWITCH  
TO SAFETY!**





# A real COMMUNICATIONS RECEIVER *only*

**19.95**

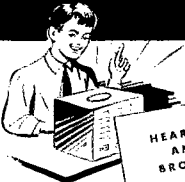

HEAR ALL THE  
AMATEUR  
BROADCASTS



GET FOREIGN NEWS  
AND ENTERTAINMENT  
FROM THE WORLD'S  
CAPITALS... LONDON,  
ROME, BERLIN, ETC.



LISTEN TO AVIATION  
BROADCASTS...  
WEATHER REPORTS, ETC.



YOU CAN HEAR ALL  
THE STANDARD  
BROADCASTS... SAME AS  
YOUR PRESENT RADIO



HELPS YOU LEARN  
THE CODE... HEAR  
YOUR OWN SENDING

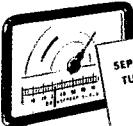

SEPARATE BANDSPREAD  
TUNING... TUNES ALL  
THE STATIONS ON  
ALL THE BANDS



HERE IS THE GREATEST VALUE EVER OFFERED  
IN A COMMUNICATIONS RECEIVER

Now at this sensationally low price you can have ALL these important 1941 features. Three bands covering from 545 kc. to 30.5 mc. — (550 to 9.85 meters). Electrical bandspread on all bands. Beat frequency oscillator. Self-contained PM Dynamic Speaker. 6 tubes. AC/DC operation — 115-125 volts. Good selectivity and exceptional sensitivity. Bandspread logging scale. Complete isolation for headphones through phone circuit transformer. Dial calibrated in megacycles with all important service bands indicated.

Every necessary feature is incorporated in the EC-1 to give up to the minute communications receiver performance at a price everyone can afford to pay.

**Echophone**  
COMMERCIAL

ECHOPHONE RADIO CO.  
201 East 26th Street, Chicago, U. S. A.

(Continued from page 85)

SKWA. New RM, W8NCJ, W8MOT rings the bell this month for traffic handled, FB, and keep it up. We need an alternate on Trunk "L" to give MOT assistance. NCJ now uses e.c.c., and gets over the band to clean traffic. OKK beams the fact that O.R.S. members do not take enough interest in their work. O.R.S. should remember that they are the cream of the amateur crop and report for net work to uphold their hard-earned reputation. We can always rely upon CMP to have his report in on time. RBO received a SX24 for a premature Christmas present. RWF has finally succumbed, and is trying 1.75-Mc. 'phone. NED boasts of a new Sky Champion, and states he is on 1.75 Mc. ere long. IOH says that he spends 90% of his time on experimental work. TOJ worked NAA and will report in the W. Pa. Net as soon as he gets a crystal. JSQ and KYW both have new QTH's right across the street from each other. CKO has been issued the call W1QL and is Senior Net Control Station in the W. Pa. 3.9-Mc. A.A.R.S. Net. ZAE is on active duty with the N.C.R. HKU does good work on the Weather Net. BWP is a new O.B.S. station. O.P.S. have been rather negligent in sending in their monthly reports. AJV is secretary of the Mon-Yough Radio Club, and would like to contact hams in that territory regarding club membership. PFV joined the N.C.R. UK is too busy on plans for a new home to be very active on the air. OEM/9 will be on the air at Bismark, N. D., and asks the old gang to listen for him. SFV had 346 QSO's in the SS contest, and worked all 48 states. AXE is building a new shack, and will be on the air again late in January. RIS still bats high on 10 meters. AJA has increased power, and craves reports on his signals.

Traffic: W8MOT 420 NCJ 304 KWA 214 OKK 141 CKO 139 (WLQL 123) CMP 67 PX 48 KRY 45 MJK 15 RAT 10 PER 8 NDE 7 RAU 6 BWP 5 IOH 4 NDE 3 TOJ-RIS 2 BOZ 1. (Oct.-Nov.: W8MOT 204.)

#### NEW ENGLAND DIVISION

CONNECTICUT—SCM, Frederick Ellis, Jr., W1CTI. WIKKS is back on top of the traffic pushers, and no fooling! AW and MEC are right behind. All three crack the B.P.L. MGC has a nice healthy total and rates O.R.S. TD is still pushing 'em out from West Haven. CTI contacted WAR. ES continues to improve, but says it is slow going. LQK is working on an e.c.o. 2MQB has a new HQ:20 and a 60-P. MJY has an HQ, and will rebuild a flock of 6L6's. HYF is now W2NLQ, and will be on from Brightwaters, N. Y. B.A.R.A. has moved into their new rooms in the Bridgeport Police Headquarters. They will cooperate with the Police for National Defense Work. Emergency A.C. is on hand, and JHT is being rebuilt for e.c.o. by CCF. BCG has a new e.c.o. and has been testing the exciter on the air. A pair of 812's will be used as the final. GB, the N.H.A.R.A., plans a pair of 812's for a final. Their new chief operator is GRF. KFN got a job pounding brass for American Airlines. IOV pounds brass for Pan American eight hours a day, and then pounds some more at CBA, Thursday nights. It looks like several of the gang were busy Christmas shopping or something; anyhow, we didn't hear from them. Shoot in the dirt, so we can make a big splash in this column. Flash! Gil, CJD, is a proud papa. Yep, it's a Junior op. If you don't hear CJD on the net, you will know it's because he is teaching William the dots and dashes.

Traffic: WIKKS 953 AW 609 (WLKMK 9) MEC 534 MGC 333 TD 97 CTI 82 BDI 41 KQY 36 ES 33 KAT 33 KSJ 7 LQK 5 KYQ 162 LVQ 30 TS 56 UE 137 LMK 9.

MAINE—SCM, E. W. Caster, W1EIE—A most efficient net is running at 6 to 7 A.M. 5MN collects from K7HZM, K6PDQ, W6, W7, and gives it to 3CIZ, 2CGG, 1BDU and 1E, who all copy at once. A message was delivered to a woman in South Thomaston recently, in the morning, that left Alaska the previous evening. F.B. The Maine Sea Gull Net of about 22 stations on 3.9-Mc. 'phone is surely an active bunch. FBJ, who is in Florida, has worked some of the boys on 28 Mc. from a W4 station, and reports hearing most of the local boys down there. We had a surprise visit from JCT. Johnny is now at the headquarters of the C.G. in Boston. The U. of M. Radio Society will sponsor the All-Maine QSO Party again this year. No date has been set, but it will be either in February or March. Definite notice later. A committee is working out the details of scoring and prizes now. YA has a new NC 200 receiver and a new transmitter built by the boys, under the supervision of Mr. Bliss, for 3.9-Mc. 'phone primarily. There is a lot of activity at Bates College also with IKE, LNM, MZQ and 2LUQ;

IKE works in the Pine Tree Net. They are going to invite Bates students to send messages after Xmas, and it will most likely speed up the P.T.N. traffic. It is planned to have station IKE on display at the annual science exhibit in February. MZL, Bob Michaud, is a new ham in Portland. LMM has moved to new QTH, and his filters contracted "Burnouts," so he says. He also has a Morse line from his house to LWO. KVK is building a new rig with T20 final. MXC is on 7 Mc. with low power. Warden "Jo," LJG, is now a game warden instead of a fire warden, and is located in Norway. GXF is a new ham in Auburn. Several are learning code and theory in Lewiston. Harold Purington, who was a W4 in Georgia, is after his old call, 1KYR, again, as he is back at West Bowdoin. Ed Hudon, LYK, lectured on ham radio before the Odd Fellows, and pleased them so much that he has been requested to repeat. HSE says his new QTH in Fairfield is F.B. for ham radio. The P.A.W.A. in Portland put on one of the finest times I ever heard of for an annual Christmas party. We hear VF and LRQ on the early morning schedule. I'm delighted to hear that QH will be foreman of the radio unit of the N.Y.A. which will open in Bangor soon. It is a branch of the Quoddy unit, and they certainly have picked a swell man in Benn. He will have another assistant who will also be a ham, and there is much interest in Bangor in this activity. LLP has been on 1.7-Mc. 'phone, and LYI is at home in Milltown and on 1.7-Mc. 'phone also. LIP and MNI have been experimenting with modulating the rig, and had a lot of fun. FJP is on 28-Mc. 'phone with e.c.o. KSL is most interested in code practice. EOP is on 3.9-Mc. 'phone occasionally. LEH and MTN and others at "Quoddy" have left for home. To many of you boys, who work along by yourself, I suggest you listen in at 5 p.m. to the Sea Gull Net of 3.9-Mc. 'phone boys and see what a fine time they have, and to the Pine Tree Net at 7:30 p.m., on 3597 kc. Notice the other activities where we work in groups and see if they don't attract you. The latching string is way out in all official activity, and those are the places where you really learn to operate. New OPS: LWX and KYT. New PAM: LIP.

Traffic: W1IIE 87 MFK 2 LYK 14 IKE/1 47 GXY 16 BAV 188 LKP 12 LIP 2 MNI 3 HSE 22 GMD 18 KYT 4 AMR 110 CFO 42 EFR 26 FAP 91 GE 35 GHT 8 GVS 134 IJF 84 IST 26 KOU 170 KTN 72 LAF 57 LML 108.

EASTERN MASSACHUSETTS—SCM, Frank L. Baker, Jr., W1ALP. IID reports Greater Boston 234-Mc. Net active on Monday nights, 9 to 11 p.m. Give them a report, or get in on the net gang. LMO and HUP have Class A now. Four new OPS: MDN, LWH, LBH, KON. Let's have some more of them. Four new E.C.'s: EAU for Weymouth, IZL for South Orleans, MDU for Cambridge, HMA for Quincy. If you are willing to help them out in this fine work, get in touch with them. The South Shore Radio Club bought a code machine, and will have weekly code classes at the Quincy Y.M.C.A. The Eastern Mass. and South Shore Clubs held a joint Xmas party for members and y'l's. MDN has new antennae on 28 Mc. BMO is working on a 250TH final, and had QSO with K4KD on 3.5 Mc.; he will be O.R.S. soon. IN has new 300 watts on 7 Mc. Welcome to new ham NBI on 28 Mc. in Arlington. DMS is back on 28 Mc. AHD has a new rig on 28 Mc.; he is going to Hawaii in February. Luck, OM, Local OPS in skeds with LDR/5 in Palacios, Texas, whose mother is in Newton. LTC is working on a radio-controlled plane. Welcome to 81QB, now living in Cambridge; he will be on 14-Mc. 'phone. JSM made B.P.L. this month. F.B., Don. QD is net control, and MON is alternate for the 112-Mc. A.A.R.S. Net. They have 7 p.m. schedules each night besides Sunday A.M. and Wed. night drills. BDU says traffic is slow with 4PL away on vacation. LBY has a 1000-watt gas generator for emergency power. HOB will give code lessons on 3900 kc. on Friday nights. JRN is putting a pair of 810's on 3.5 Mc. FLZ is now 6TEV. WV had 4480 points in the SS, and worked K6BZD on 14-Mc. c.w. LZW is on 1.75 Mc. DA is a new member of the 56-Mc. Minutemen. JXU has gone to Fort Leavenworth, Kansas, for 2 months, at an Army Training School. EAU is on 1.75-Mc. 'phone now. The Brockton Amateur Radio Club had a nice get-together, with a bean and hot dog supper, prizes, etc. KH was the speaker. MTP in Mansfield is on 7 Mc. and handling traffic. FSL will be O.R.S. soon. HPC is on Newton's Defense Committee for Radio. KMQ reports for the North Shore A.A.R.S. Net which includes: AKS, HWE, JFS, LBS, LOG, LWH, AGX. HUP is now on 14-Mc. 'phone. AION reports a total of 42 points in the U.H.F. Contest. JSV was the means of arranging a QSO with LDR/5 for a YL whose fiancé was at Army Camp in

Texas. This month 18 out of 27 O.R.S. and 14 out of 26 O.P.S. reported. What say you, fellows? Let's make it 100%.

Traffic: W1JSM 502 LWH 254 JCK 245 (WLGW 85) AAR 237 EPE 215 (WLGGS 24) BDU 135 LBY 86 FWQ 71 HWE 70 FSL 56 EMG 54 AGX 47 AAL 45 BMO 39 KXU 36 LNN 21 KH 13 KTE 9 GAG 6 LBE 4 WV 2 MQO 2 LZW 2 EHT 1 HUV 1 KZT 57 MTP 15 KCT 85 KMQ 77 2 1/2-meter A.A.R.S. Net: MONT 102 EYR 39 QD 39 MQH 15 ISR 11 LKT 7 KAL 6 MBS 6 AAR 3 MIF 2 (Sept.—Oct.: W1JSM 391 FWQ 60) (Oct.—Nov.: W1KZT 61 LSA 29 LGH 22).

WESTERN MASSACHUSETTS — SCM, William J. Barrett, W1JAH. BIV leads the parade again this month. IOR wants to know when there will be some activity on the West. Mass. O.R.S. Net frequency of 3732.5 kc. How about it, fellows? How many are willing to get behind an A.R.R.L. Net to keep our W.M.S. A.A.R.S. Net company? FOI handled plenty of traffic as liaison between the 'Phone and C.W. Nets in A.A.R.S. BKG presided at the Christmas party of the Pittsfield Radio Club. JAH, KZS, MKR, LNH and BVR attended a meeting of A.A.R.S. in Boston. KZS is in the process of becoming an O.R.S. BVR conducted the A.A.R.S. meeting at Boston, Dec. 14th. KZU reports KUW back on 1.75 Mc. after a long absence. LRE has a new SX24 receiver. IIP and MJP joined the A.A.R.S. KVN is now at the Signal Corps School at Fort Monmouth. NAB in Adams and NAQ in Shelburne Falls are among the recent licensees. Guess that's the story for this time, gang. Keep the reports coming and, if interested in a Section Net, please get in touch with either the S.C.M. or our R.M.'s, IOR and AZW. 73.

Traffic: W1BIV 293 (WLGW 136) IOR 148 FOI 124 BKG 123 (WLGW 60) JAH 110 (WLGH 21) KZS 74 AZW 71 AJ 47 HNE 37 CZL 14 DCH 13 BVR 4 (WLG 103).

NEW HAMPSHIRE — SCM, Mrs. Dorothy W. Evans, W1FTJ. Here it is — the long talked of N. H. QSO party.

Your SCM has decided to give the N. H. gang something a little new (to them) in activity this year, and sincerely hopes that you will participate and enjoy it. Due to the small number of N. H. stations that are active, and due to the number of outside stations who are continually looking for N. H. for W.A.S., it was decided to invite everyone to join in this party. Time: Saturday, 6 p.m., E.S.T., to Sunday, 6 p.m., E.S.T. Prizes will be given to leading N. H. stations as well as the leading station outside of N. H. An engraved certificate will be issued to all stations reporting. Scoring: Outside of N. H., 3 points per N. H. contact, total points to be multiplied by the number of different N. H. counties worked (10 maximum). Here is your chance to get NEW HAMPSHIRE for W.A.S.! Stations in N. H.: 5 points per contact with each N. H. station, 1 point per contact with stations outside N. H., total points to be multiplied by the number of N. H. counties worked. Contact information required on reports: from stations outside N. H., RST (or BS on 'phone) report, plus city or town and state. For stations in New Hampshire, RST report plus their county. The same station may be worked for additional credit on another band (not 'phone and c.w. on same band). Cross-band contacts will be allowed. General call on c.w. will be "CQ NHQP"; on 'phone "CQ New Hampshire QSO Party." Scores must be received not later than February 25th. The decisions of the committee will be final. Reports and scores should be mailed to Dorothy W. Evans, S.C.M. of N. H., W1FTJ, Post Office Box 312, Concord, N. H. Committee members include the S.C.M. and BFT, R.M.; IP, R.M.; and APK, P.A.M. They are ineligible for prizes. Prizes will be given as follows: For the highest scoring station in N. H., for the highest scoring station in N. H. on c.w. only, for the highest scoring station in N. H. on 'phone only, and for the highest scoring station outside of N. H. 'phone or c.w., or both. Two prizes will not be issued to one station; in cases of ties, duplicate prizes will be awarded. Well, here's the dope: Through the cooperation of ex-S.C.M., BFT, each prize winner will receive a merchandise credit for \$5. An engraved certificate will be issued to all stations in or out of N. H. who participate and send in their logs and scores. P.S.: Here's a tip! New Hampshire Net frequencies include 1840, 3735, 3840, 3925 and 7200.

MZV is a new ham in Concord. IIF is down on 3.5-Mc. c.w. for a workout on his fist. MLO and CMR attended Boston A.A.R.S. meeting of the 1st CA. HFO got F.B. radio parts for Xmas which he needed to rebuild with. LVK is

on the air again. MZS is a new ham in Manchester. JKH is proud possessor of a 25 w.p.m. endorsement on his Code Proficiency Certificate. NAZ is a new ham in Nashua. IP has his new final working OK. MLO has been down on 7 Mc. trying to add a few new states. MUW is sporting a new signal shifter. LIN is on 28-Mc. 'phone. The Nashua Mike and Key Club is holding their third annual banquet on January 18th. AOQ is going places with his new shifter.

Traffic: W1FFL 293 KIN 254 JDP 128 GEY 78 BFT 62 IP 45 MMG 29 GMM 35 BFA/1 26 HFO 21 JKH 18 MLO 18.

RHODE ISLAND — SCM, Clayton C. Gordon, W1HRC. Special! All Rhode Island hams, please note. Rhode Island QSO Party will be held Lincoln's birthday, February 12th, from 8 p.m. to 11 p.m. E.S.T., on all bands. Under the Leadership of LWA, the Combined Radio Clubs of Rhode Island (N.A.A.R.O., P.R.A., AQ and the Westerly Radio Club) are sponsoring an All-Rhode Island QSO Party to be held at the above time and date, in which all licensed amateurs of Rhode Island are invited and urged to participate. The following information should be exchanged in QSO: A message with Number, RST Report, City or Town, County, your "handle" and the time. Scoring 1.75 and 3.5 Mc., one point; 7, 14 and 28 Mc., two points; 56 and 112 Mc., one and one-half points. Multiply total by number of different counties worked. Scores to be sent to LWA, 8 Duke St., Providence, R. I., to reach him not later than March first. Prizes: Each club is donating a prize to go to its highest member-scorer. Although not compulsory, each participant is requested to send ten cents to LWA to go toward a grand prize to the contestant with the highest score for the state. ALL CONTESTANTS WILL USE THE STRAIGHT HAND KEY IN THIS PARTY. Use of other than hand key will disqualify contestant. This is to make it easier for the slower fellows. LWA is now a Route Manager and the above is one of his efforts to merit his new appointment. He has combined the wishes of a great many representative hams in the state in lining up this party, and we hope as many will be in on the fun as possibly can make it. How about some of the old-timers dusting off the rigs and joining in the fun? The N.A.A.R.O. is now affiliated with A.R.R.L. MJL has a new Sky Champion receiver and is a member of the A.A.R.S. KYK has new job in a radio lab working on F.M., etc., and has a new e.c.o. unit. LWA scored 44,200 in the SS. KOG scored 39,000 in the SS with his new e.c.o. The following went up to the Brockton Radio Club and enjoyed a bean supper: MO, MJL, KOG, KYK, LWA. LWA won a prize. INU is now Acting S.R.A. in A.A.R.S., and is trying to build up the weak spots in Westerly, Newport, Woonsocket, etc. With the prospects of some good third-party traffic coming into and going out of the state to the boys in the Selective Service Draft Camps, this net activity should hold more appeal to you fellows than it has in the past. Monitor 3752.5 kc. any week-day night, at 7 p.m., and see how it's done.

Traffic: W1KOG 171 KYK 161 INT 116 INU 80 (WLGW 261) LDL 62 LWA 81 LDM 29 KWA-MCN 13 KKE 10 IMY 9 KZN-HRC 6.

VERMONT — SCM, Clifton G. Parker, W1KJG — W1MFL gave a very interesting lecture on ultra-high frequency antennas before the Burlington Amateur Radio Club; the club has KXY scheduled for next meeting on "Army Radio." JVS reports fine success on 28 Mc. with his new rig using cathode modulation. LVP and brother have been trying out f.m. converters. KTS has changed QTH from Lyndonville to Church St., Essex Junction, and is stationed at Fort Ethan Allen. JRU is back on the air after long absence, with most work on 80 c.w. AEA is busy rebuilding the small 'phone rig and working out a new e.c.o. BIC reports success on removing bugs from his new rig, and is getting good coverage. KUY is now located at Barre, and is busy on a new rig using 6L6G-6L6G-pp 812's. MMV has moved his shop to his home on upper Camp Street, Barre. KOO is remodeling his rig for his anticipated trip to Florida. EKU and CGV are engaged in radio work for the N.Y.A. project at Waterbury. MVX is the call of Mrs. Paul Estey, Brattleboro, who is on the air with a new Hallcrafters rig. CGX is heard from occasionally on 3.5-Mc. c.w. JRU and KTB are covering the N. H. Traffic Net for a tie-in with the Vt. Section. Traffic for N. H. can be cleared via the A.A.R.S. Net, 3715 kc., 7 p.m., daily except Sunday, or via the A.R.R.L. Traffic Net, 3860 kc., 8 p.m. daily, except Sunday.

Traffic: W1AD 44 FSV 123 JRU 14 JVT 20 KJG 117 KTB 91 KXY 179 MMU 6 KJR 94.

# FLEXIBLE DESIGNS For The Service

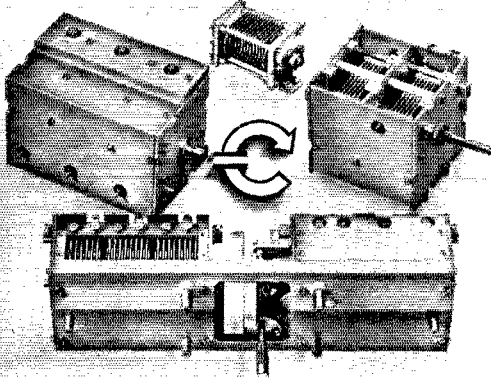

CARDWELL components are built-to-fit, yet are capable of quick modification, because they use so many standard CARDWELL stock parts.

This is one of the reasons why many CARDWELLS like these shown, and others, are now being widely used in military field equipment.

**THE ALLEN D. CARDWELL  
MANUFACTURING CORPORATION**  
83 PROSPECT STREET • BROOKLYN, NEW YORK

## Piezo-Electric Crystals Exclusively

• Quality crystals of all practical frequencies supplied SINCE 1925. Prices quoted upon receipt of your specifications.

Our Pledge: **QUALITY FIRST**

**SCIENTIFIC RADIO SERVICE**

"The Crystal Specialists Since 1925" University Park, Hyattsville, Md.

## CLEARANCE SALE!! WELL KNOWN GROSS TRANSMITTERS

Completely Wired and Tested

95 WATTS C.W.....	\$ 64
95 WATTS PHONE & C.W...	110
150 WATTS PHONE & C.W...	200
250 WATTS PHONE & C.W...	295

Descriptive Bulletin on Request

### 2½ METER TRANSCEIVERS ABBOTT DK-2... \$16.50

Portable Battery operated. Price is less Tubes and Batteries

### ABBOTT MRT-3... \$28.20 HI-POWER—20 WATTS

For Mobile or Fixed Station. Price is less Tubes and Power Supply

## GROSS RADIO INC.

51 Vesey Street

New York City

## U.H.F. Superhet

(Continued from page 29)

brackets in such a position that the grid lead to this tuned circuit consists of little more than the coupling condenser. The plate lead to the first i.f. transformer is about one inch long. By-pass condensers on the i.f. stages are mounted directly under the sockets wherever possible so that they will act as shields between the grid and plate connections.

Wire used in the "hot" circuits is of the lacquered insulation type. *Ordinary push back wire should not be used in these circuits.* Panel bushings are used for the extended shafts of the three insulated pots which must also be isolated by insulated flexible couplings. Bakelite extension shafts are recommended here. Bushings are also necessary on the two tuning control shafts. The r.f. stage grid condenser is tuned "round-a-corner" by means of a flexible shaft coupling. The oscillator and detector tuning condenser must be ganged, and aligned quite accurately with the bushing, in order to secure smooth operation. The only other important consideration partly mechanical, and partly electrical, is the wiring. Beauty of wiring should be sacrificed wherever it is possible to get shorter leads except in the case of circuits carrying d.c. only. This is particularly true in the r.f. and i.f. stages, which are both operating at high frequencies.

## What the League Is Doing

(Continued from page 24)

Butte, Montana: Some time in May and in November.  
Spokane: Some time in May and in November.  
Denver, 504 Customhouse: First and second Saturdays of each month.  
Salt Lake City: Some time in March and in September.  
Billings, Montana: Some time in April and in October.  
St. Paul, 208 Uptown P.O. and Federal Courts Bldg.: First and third Saturdays of each month; other days by appointment.  
Bismarck, N. D.: No announced dates; consult Inspector in Charge at St. Paul.  
Kansas City, 927 U. S. Courthouse: Saturdays; other days by appointment.  
Des Moines: Jan. 11th, April 12th, July 12th, Oct. 11th.  
St. Louis: Feb. 15th, May 10th, Aug. 9th, Nov. 15th.  
Chicago, 246 U. S. Courthouse: Saturdays.  
Detroit, 1025 New Federal Bldg.: Saturdays; other days by appointment.  
Cleveland, 541 Old P.O. Bldg.: Saturdays; other days by appointment.  
Cincinnati: Some time in Feb., May, Aug. and Nov.  
Columbus, Ohio: Some time in Mar., June, Sept. and Dec.  
Buffalo, 518 Federal Bldg.: First and third Saturdays of each month.  
Pittsburgh: Some time in March, June, September and December.  
Honolulu, Aloha Tower: Mondays and Saturdays.  
Other Hawaiian points: Hilo, Jan. 25th, Aug. 20th; Lihue, Feb. 21st, Aug. 23rd; Kaunakakai, Aug. 4th; Lanai City, Aug. 5th; Wailuku, Aug. 6th.  
San Juan, Puerto Rico, 322 Federal Bldg. (P.O. Box 2987): By appointment.  
Washington, F.C.C. Headquarters: Thursdays; other days by appointment.  
Savannah, 208 Post Office Bldg. (P.O. Box 77): By appointment.  
Tampa, 203 Post Office Bldg.: By appointment.  
San Diego, 301 Customhouse and Courthouse Bldg.: By appointment.  
Juneau, Alaska, 7 Shattuck Bldg. (P.O. Box 1421): By appointment.

# A WORD OF THANKS

## to the Amateur Fraternity

The Western Union Telegraph Company avails itself of this medium to express its admiration for and appreciation of the timely, effective and efficient co-operation of Radio Amateurs during and after the devastating sleet storms which recently disrupted wire facilities in Western Michigan, Minnesota and in the Texas Panhandle.

Many urgent telegrams, which, without the assistance of Amateur

Radio, might have suffered serious delay, were promptly and efficiently relayed to Western Union offices not affected by interruption. Thus a public service was maintained.

In acknowledgment of the service performed by amateurs during these emergencies, and in appreciation of their public-spirited co-operation, Western Union has been pleased to award its **CERTIFICATE OF PUBLIC SERVICE** to the following:

**W4FT** Donald M. Parsley,  
*Wilmington, N. C.*

**W5AFX** A. R. La Marche, Jr.,  
*Oklahoma City, Okla.*

**W5ARS** Robert D. Clark,  
*Wichita Falls, Tex.*

**W5AVM** J. B. Redfearn,  
*Amarillo, Tex.*

**W5AZQ** Wm. K. Barton,  
*Austin, Tex.*

**W5BAT** Leroy C. Tyaack,  
*Oklahoma City, Okla.*

**W5CVJ** Cecil K. Farris,  
*Oklahoma City, Okla.*

**W5CXE** K. W. Cochran,  
*Oklahoma City, Okla.*

**W5CYX** Pryer C. Smith,  
*Amarillo, Tex.*

**W5DAS** N. C. Settle,  
*Dallas, Tex.*

**W5DXA** Lee Hughes,  
*Childress, Tex.*

**W5ECL** Dr. Wm. B. Thomas, Jr.,  
*Amarillo, Tex.*

**W5EGA** Harold W. Frank,  
*Oklahoma City, Okla.*

**W5EGC** Robert E. Brown,  
*Oklahoma City, Okla.*

**W5FAB** W. E. Varley,  
*Fort Worth, Tex.*

**W5FNA** Bill Case,  
*San Antonio, Tex.*

**W5FRL** R. J. B. Beistel,  
*Oklahoma City, Okla.*

**W5FWZ** Marvin "Bob" Morrow,  
*Tulsa, Okla.*

**W5GFT** Russell W. Battern,  
*Enid, Okla.*

**W5GNP** Searcy J. Woodworth,  
*Oklahoma City, Okla.*

**W5HDK** L. L. Stephenson,  
*San Antonio, Tex.*

**W5HGB** Culver Breckenridge,  
*Oklahoma City, Okla.*

**W5HKE** Dewey W. Miles,  
*Oklahoma City, Okla.*

**W5HXD** C. L. Buell,  
*Dallas, Tex.*

**W5IMG** James H. Blossom,  
*Amarillo, Tex.*

**W5IQN** George D. Thomas,  
*El Paso, Tex.*

**W5IRU** Fred J. Trotter,  
*Amarillo, Tex.*

**W5IWW** Dale W. Watt,  
*Tulsa, Okla.*

**W5QA** Vol Hargrove,  
*Abilene, Tex.*  
Herman Kreger,  
*Pampa, Tex.*

**W8BQA** Everett O. Troup,  
*Hudson, Mich.*

**W8CBI** D. C. McCoy,  
*Dayton, Ohio*

**W8DPE** Harold C. Bird,  
*Pontiac, Mich.*

**W8DTJ** Fred E. Norton,  
*Cheboygan, Mich.*

**W8JTK** Carl Anderson,  
*Ludington, Mich.*

**W8KE** F. K. McKesson,  
*Frankfort, Mich.*

**W8LA** Ralph E. Jackson,  
*Frankfort, Mich.*

**W8NNF** Wilburn A. Schattler,  
*Center Line, Mich.*

**W8NQI** W. Clair Edwards,  
*Grand Rapids, Mich.*

**W8SSQ** James B. Sackrider,  
*Owosso, Mich.*

**W8SVQ** Anael T. Kirkby,  
*Traverse City, Mich.*

**W8UPA** Cheboygan High School  
Amateur Radio Club,  
*Cheboygan, Mich.*

**W9BMJ** T. L. Graffunder,  
*Marshall, Minn.*

**W9CAA** C. Raymond Stedman,  
*Denver, Colo.*

**W9EVT** Mrs. Caroline A. Schisler,  
*Colorado Springs, Colo.*

**W9JWC** John D. Boatright,  
*Colorado Springs, Colo.*

**W9ORE** Frank E. Huffman,  
*Gary, S. Dak.*

**W9QIQ** Bon H. Hill,  
*Marshall, Minn.*

**W9UCD** Elbert C. Monkman,  
*Sault Ste. Marie, Mich.*

**W9UIT** A. C. Krones,  
*Milwaukee, Wis.*

**W9WHR** Donald M. Snortum,  
*Marshall, Minn.*

**W9WWB** Elliott S. Buchanan,  
*Pueblo, Colo.*

**W9YJS** James N. Blair,  
*Kansas City, Mo.*

**W9YWH** Raymond H. Williams,  
*Kansas City, Mo.*

THE WESTERN UNION TELEGRAPH COMPANY

 PRESIDENT

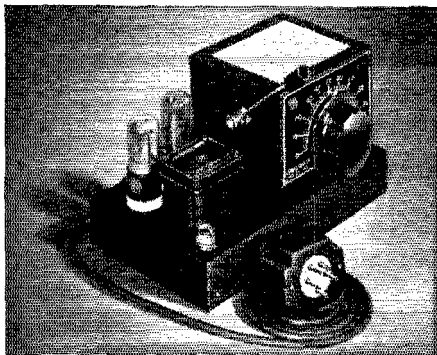

## THE MILLEN ECO VARIARM

- A GOOD ECO AT A LOW PRICE
- LOW DRIFT  
Less than 0.06% from cold start.  
Most drift in first 10 minutes.
- VIBRATION IMMUNE  
Shock mounted oscillator section; rugged construction.
- NO HAND CAPACITY
- CHIRPLESS KEYING  
Constant load on power supply.
- GOOD BAND SPREAD  
100 dial divisions from 3500 to 3650 kc. "Variarm" vernier tuning.
- COMPLETE  
Vibrationless power supply, three tubes, output coupling units.

**\$29.50**

W2JL W2LJA W2KWY

OUR *Best* VALUE IS OUR RECORD OF LOYAL SERVICE

**HARVEY**  
*Radio Company of New York*

103 WEST 43rd STREET • NEW YORK, N. Y.

CABLE ADDRESS: "HARADIO"

## A Two-Tube Superhet

(Continued from page 15)

appreciate the stability and ease of tuning of this outfit. The regeneration control may be set to give desired sensitivity and left alone while tuning; only when an exceptionally strong signal is encountered is it necessary to advance it more to keep the detector in oscillation. Once tuned in a signal "stays put" in the same fashion that one expects it to on a regular superhet; even drastic fading hardly changes the beat note. The detector can be set just on the edge of oscillation for 'phone reception and forgotten when combing the ham 'phone or s.w. broadcast bands, and the somewhat better selectivity of the low-frequency circuit is a help in separating stations.

— G. G.

## Correspondence Department

(Continued from page 53)

what they have made themselves worth to their respective employers. . . .

. . . . The Burbank office of the airline for which I work . . . hired within the past year four capable operators, who . . . were hams who had never had a commercial job in their life and who had never been to any kind of a radio school. Does that sound like discrimination against the poor ham? One of the admittedly-best operators in the entire company, now a well-paid dispatcher for the line, came to the company four years ago with a lot of ham experience and about six months on a "tuna boat" to his credit. Anyone who knows will tell you the tuna boats make fine fishermen out of a man but are not noted for their development of outstanding radio operators. . . .

When an airline hires an operator they aren't interested in his pretty license, just so long as it is of the legal class for the work they want him to do. They aren't interested in how good he says he is or what ships he was on or what school he graduated from, radio or otherwise. They only want to know if he can "hold down the circuit." In other words, is he an operator?

About two out of three old time ship ops, who usually apply to the airline with a condescending sense of superiority, sneak out a half hour or so later with their tails figuratively between their legs. To be brutally frank they usually prove utterly helpless when presented with the "circuit" and told to "take over." . . .

Lots of pure hams qualify for this work where old time commercials from other fields fall down. They are fast thinkers, hard to rattle, and you can't keep 'em under the table. . . .

Too many hams regard radio as their hobby for years and suddenly want to capitalize on that hobby. They know a little theory and very little real operating. They don't seem to realize that they have been playing at radio. They have never learned to "work" at it. Naturally they find themselves unfitted for a living in radio. . . .

Best regards to the only magazine in the radio field that I ever considered worth subscribing to.

— Stuart Walcott, W6PQU/B

San Luis Obispo, Calif.

Editor, QST:

In regard to the two letters in December QST by "Strictly Ham" and by Frederic L. Stafford, I would like to say a few words in defense of broadcasting and radio in general. First, "wages." The only figures I have are in *Electronics*, January 1937. Wages are without doubt higher now than they were then. Here are *Electronics* figures for the salary-per-week averages for the nation: Under 100 watts, \$23.70; 101-1000 watts, \$31.50; 1000-49,000 watts, \$49.30; 50,000 watts, \$43.10. I know that a great many stations may not pay this much, but look at it from the other side. All the operator has to do is keep a log on the transmitter every half hour, keep the quarters clean and do routine mainte-

# Modernize YOUR Station

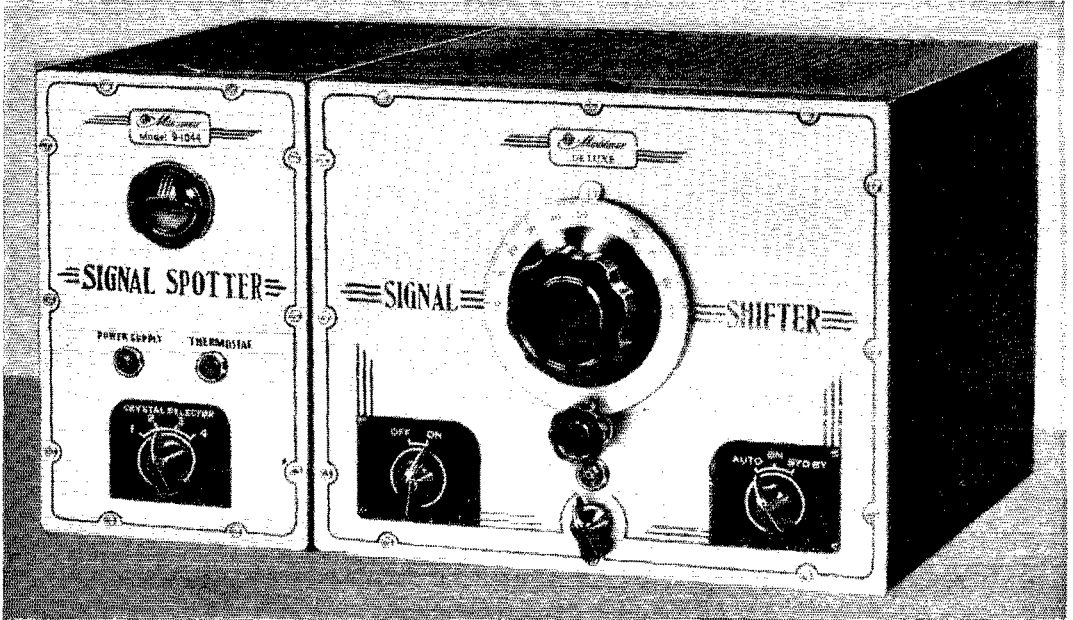

## With this Outstanding Combination!

It's really surprising, the number of stations that are equipped with Meissner SIGNAL SHIFTERS! Of course we realize the instrument is "tops" but it's almost uncanny to get on the air and have station after station come back with, "I'm using a Meissner DeLuxe SIGNAL SHIFTER."

We are proud of this unsolicited praise of our product by ACTUAL USERS! When we stop to realize that the SIGNAL SHIFTER is accepted as one of the highly important necessities in a well equipped station — we just wouldn't be human if we failed to mention the fact!

A few weeks ago, we announced a companion unit to the popular SIGNAL SHIFTER — known as the SIGNAL SPOTTER. This unit is basically a crystal oscillator assembly in which four crystals can be used and instantly selected by the turn of a switch. FOUR CRYSTALS for spot-frequency operation — on band edges, Army and Navy networks and on "traffic" channels. The required operating power is supplied by the SIGNAL SHIFTER. A two-position control-switch enables the operator to instantly select the type of excitation desired: "ECO," for full-band flexibility, or "XTAL," for spot-frequency operation.

\*NOTE — This control switch is factory-mounted in the new 1941 model Signal Shifter, No. 9-1058. For addition of the Signal Spotter to previous model Signal Shifters, the switch is supplied separately, at no extra cost, with simple instructions for installation.

The SIGNAL SHIFTER-SIGNAL SPOTTER Combination provides the LAST WORD in a precision type frequency control system for the Amateur Station! Appearance? The Boys tell us that the "combination," shown in the photo above, is the "best looking equipment on the operating table!"

It has never been our policy to introduce so-called "new models" that would make previous models obsolete or "out of date." The SIGNAL SPOTTER is designed for use with the FIRST SIGNAL SHIFTER, placed on the market three years ago, as well as with the LATEST SIGNAL SHIFTER to come out of our lab! Regardless of WHEN your SIGNAL SHIFTER was purchased, it may be effectively used with the SIGNAL SPOTTER.

Don't fail to see this modern "combination" at your local Parts Jobber's — TODAY! You will experience a new thrill when you see the attractive, clean-cut appearance of this equipment — and a greater thrill when you give it an actual "on-the-air" test! Join the fast-stepping gang who are proud to say, "Frequency is controlled with Meissner Precision-Built Equipment."

SIGNAL SPOTTER, complete with tubes and coils  
**No. 9-1044 Amateur Net . . . . . \$22.45**

SIGNAL SHIFTER, New 1941 Model, complete with ECO-XTAL selector switch, tubes and coils for one band  
**No. 9-1058 Amateur Net . . . . . \$47.50**

Write Today for New Amateur Catalog!

ADDRESS DEPT. Q-2

**Meissner** MT. CARMEL ILLINOIS  
 "PRECISION-BUILT PRODUCTS"

## FIRST THOUGHT WHEN YOU BUILD

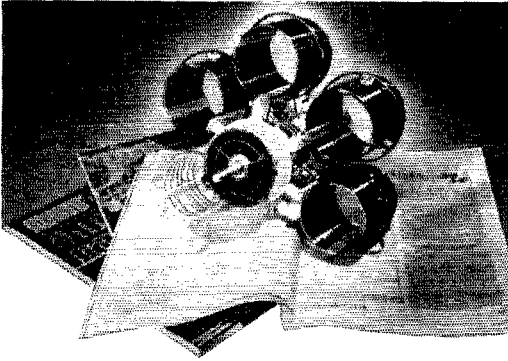

WHEN you start thinking about that new "super-de luxe" 100-watter . . . think of the greater efficiency and versatility you can obtain by incorporating a B&W Type BCL 5-Band Turret in your design.

With the BCL you get faultless individual-coil performance in a single compact unit . . . You can cover the 10- to 160-meter bands quicker than you can say "B&W" . . . You can use the BCL with tubes operating at 1,000 to 1,250 volts and a maximum input power of 165 watts. The cost? . . . actually *less* than any comparative method now available! It's worth investigating before you build or re-build — see your jobber, or write for details.

### BARKER & WILLIAMSON

Radio Manufacturing Engineers • ARDMORE, PENNSYLVANIA

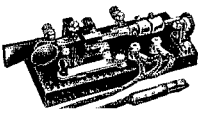

### TELEGRAPH SPEED KEYS

Radio Type in Kits — \$2.89

Send Card for Complete Information

ELECTRIC SPECIALTY MFG. COMPANY

Box 645, Cedar Rapids, Iowa

## FULLFILL YOUR AMBITION IN RADIO

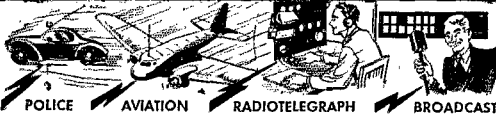

POLICE AVIATION RADIOTELEGRAPH BROADCAST

Train yourself at home for that technical radio job or promotion you want. Study under personal direction of A. R. Nilson — for twenty years expert author-instructor. Three up-to-the-minute, low-cost, home-study technical radio courses:

1. Essentials of Radio Communication
2. Advanced Radiotelegraphy
3. Broadcast Operating

will help you succeed in your job or on license examinations.

FREE BOOKLET "What the Modern Radio-man Must Know" describes these courses in detail. Send for your copy now!

### NILSON RADIO SCHOOL

51 East 42nd St., New York, N. Y.



(Continued from page 98)

nance on his equipment. The rest of the time he can read, write, study, loaf or anything else that he cares to as long as he stays close to his equipment. Is it any wonder that a station manager can't see paying a high salary for a man to do this? . . .

I worked at servicing for some time, and I never made much money at it, either, I must admit. But I would have been glad to hang around the shop for long hours for "12 dollars per," as "Ham" puts it. Hang around for a while and then you won't be an amateur! You will be a service man and will be able to go out and get better pay. . . .

— Earle Travis

Bristol, Va.

Editor, *QST*:

. . . I notice that both letters in last month's *QST* were of a pessimistic character. I would like to add an optimistic view.

For those hams who are considering radio as a vocation because they consider it a field with chances of high salaries I would say, "Don't try it." There are some well-paid radio jobs, but if you enter the radio field with *only* that goal I'm afraid you will never get one of these highly paying positions.

For those hams who want to work in radio because they like radio and wouldn't be happy in another job, I would say, "More power to you, and you have a good chance not only of getting the job you want but of advancing to a fairly well-paid job if you stick with it and study meanwhile."

You can do it even without a college education if you have the courage and will-power to stick with it long enough. Don't go into radio with the idea that you are going to shoot straight to the top of the pile. There is *no* kind of work in which this is possible. If you are self-educated you will have to be content with low pay at first until you can prove you are worth more.

One reason pay is low in many branches of radio is that it requires no mental wizard to secure radio licenses, either amateur or commercial. I secured both my tickets before I ever went to college, and in securing my first operating job I didn't even mention my college education. I had to work for a year as a soda-jerker after going to college before I was able to find work in radio, but now I have been in radio as a vocation for two years and I am happy with my work, although you may be sure I am not getting rich from it yet. If I never do, I'll still be happy in radio. . . .

*QST* was correct in saying there are openings for hams, but should have added, "for hams who *really* want to work in radio."

— R. V. Robinson, W4GCR/3

Box 271, Chesterton, Ind.

Dear "Strictly Ham":

. . . You seem to think that just because you are a ham with five years of experience and hold the necessary licenses some good firm should hire you as the vice-president or ranking engineer in the firm. Well, those jobs just don't grow on bushes, my friend. They are obtained only after years of hard work, waiting, and loyalty to the firm. . . .

— J. Spade, W9PIL

Old Forge, N. Y.

Editor, *QST*:

. . . I wish to commend you on your fairness in printing the letter from "Strictly Ham." This young squirt, with a boy's training and experience started looking for a man's job. . . .

I doubt very much if the average ham with the same amount of "equipment," would have the nerve to send in a Civil Service application for an operator's job. The fact we can "use a soldering iron" does not qualify us for service as a radio monitoring officer, marine operating or as an operator on a transport, and we know better. . . .

If we should see a fellow in a row boat crossing the ocean, it might be him!

— Riley Parsons, W8BXV

(Continued on page 98)



For top performance on all bands, buy me—Hallicrafters' latest and finest—the SX-28. Terms \$12 a month. Write to W9ARA for information on me or any receiver.

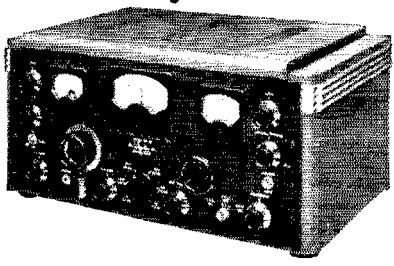

For top performance at medium cost, buy me, the SX-25. Terms only \$7 a month. W9ARA gives you the best trade for your old set on any new one. Write him!

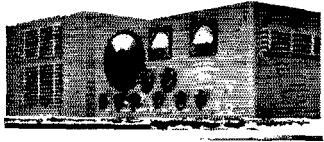

I'm S19R and a lot of radio for \$29.50. Terms, \$2.08 a month. Bob finances all terms himself, so you buy with less cost—no red tape—quicker delivery. Write Bob for details.

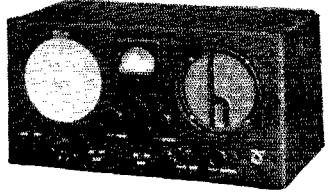

S-29 9-tube portable—that's me!—operating from 110V AC-DC or self-contained batteries. I tune 9-500 meters. Send \$5.00 deposit & I'm shipped on free trial plan.

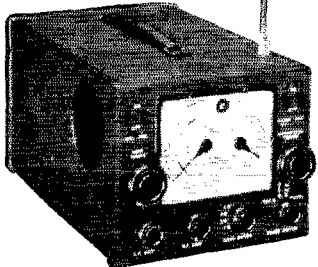

I'm SX-24, the 9-tuber with electrical bandspread and frequency tuning from 43.5 to .54 MC., costing only \$69.50. Try me or any other set on Bob's free trial plan.

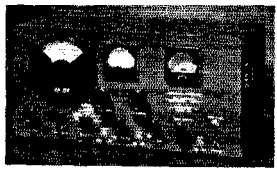

I'm the 9-tube S20R, giving top performance at \$49.50. When ordering me or any other set state whether you prefer shipment from W9ARA's world's largest stock or from factory.

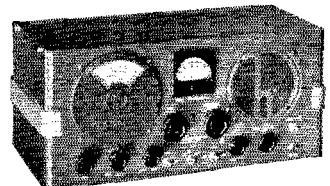

I sell all makes and models of receivers, xmtrs, parts. I want to help you get the best apparatus for your use and to see that you are 100% satisfied. I guarantee you can't buy for less or on better terms elsewhere. Write and tell me what you want and how you want everything handled. Bob Henry W9ARA

HENRY RADIO SHOP  
BUTLER, MISSOURI

# TO BETTER SERVE YOU...

Not content with our already "near-perfect" service, which countless "hams" have come to enjoy since 1922, SUN leaves no stone unturned in striving to achieve "penultimate" customer satisfaction. To this extent, we are proud to announce the addition to our staff of W2IOP (Larry Le Kashman) and W2JZH (Art Stangel), long well-known in amateur radio circles — aimed to provide BIGGER and BETTER SERVICE. SUN RADIO's highly competent technical staff now includes SIX licensed amateurs — a greater number than is to be found elsewhere in the East, insuring prompt and wise attention to your every requirement. Thus, whether 16 or 60, WE HERE AT SUN SPEAK YOUR LINGO! Drop us a line when next puzzled by some problem. There's no obligation.

## THIS MONTH'S SPECIAL! STANCOR FULLY CASED FILAMENT X'FORMER

Tapped Primary — 105/115 Volt A.C.  
2.5 V. at 10 Amps., 5 V. at 3 Amps.

SPECIAL  
SALE PRICE — **\$1.47**

Quantity Limited — Mail Orders Filled

## NEW EQUIPMENT IN STOCK JUST OUT!

### HALLICRAFTERS FM/AM S-31

A real high fidelity frequency modulation and amplitude modulation tuner, designed by skilled engineers. Combines both circuits and changes from FM to AM by means of bandswitch. 540 to 1650 Kc. and 40 to 51 Mc. coverage. Complete with 8 tubes, "S" meter adjustment, 19" x 8 3/4" rack panel and metal cabinet. **\$69.50**

### MEISSNER SIGNAL SPOTTER

A companion to the popular Meissner Signal Shifter. Provides instant selection of any "spot frequency" covered by 4 crystals. Pre-tuned tank circuits. **\$22.45**

## GREAT CLEARANCE VALUES!

Write for your copy of our newly issued SPECIAL CLEARANCE BULLETIN. Hundreds of bargains and values at tremendous savings. We must make room for 1941 goods. Parts, tubes, test instruments, speakers, new and used "ham" receivers — trade-ins, discontinued models, demonstrators, much hard-to-set equipment — all at drastically reduced prices. Quantity is limited — SO HURRY!

New York's Oldest "Ham" House

W2JEH — W2DXC — W2LFV  
W2CLH — W2IOP — W2JZH



# RADIO CO.

212 Fullon Street, Dept. QT New York

Cable Address: SUNRADIO NEW YORK

(Continued from page 84)

433 East Maumee St., Adrian, Mich.

Editor, *QST*:

... Seemingly impossible things are happening to-day — and happening fast! We hang over the b.c. receiver and wonder, with just a little apprehension, what to-morrow will bring forth. To many of us it would appear as if Destiny itself had grabbed the world by the slack of the pants, so to speak, and was whirling it madly around, undecided as yet just where to pitch us all.

We can't do much about Destiny, but we can hope for better things to come in spite of the dizzy events of the times. Could not this acceleration in world affairs presage a tremendous upswing of the communication arts, especially radio? I, for one, would prefer to think so. "Strictly Ham" may be right about employment conditions in radio right now, but what about two years hence? Five years? Before condemning employment prospects in any industry I'd want to peek just a little ways into the not-too-immediate future of that industry.

Remember how the "unpleasantness" of 1914-18 stimulated the development of radio in pioneer days? The art was swept forward at a terrific pace under the pressure of immediate necessity. Have we any reason to believe that a similar condition will not arise from the present emergency? And who can foretell what opportunities may arise in radio as a result of forces way beyond and above the industry?

In my opinion, we younger amateurs who hope someday to find a place for ourselves in radio need, above all else today, faith in the future of radio.

— Donald L. Desendorf, W8EGI

Room 302, Maritime Bldg., 10 Bridge St., N. Y. City

Editor, *QST*:

Have been a constant reader of *QST* for many years but some of the misleading statements in *QST* must be corrected. I am unaware whether these statements are intentional or unintentional but they certainly are incorrect.

The statement was made that a shortage of radio operators exists in the United States. This same cry is made by practically all employing interests, the Federal Communications Commission on occasion, the Maritime Commission, the Navy Department and the Army.

No statement that there is an actual shortage of trained radio operators is correct. Not only are there considerably more radio operators available than there are jobs but the reason that employing interests and the government are having difficulty in obtaining skilled radiomen is the simple fact that they are unwilling to pay salaries or wages commensurate with the job offered.

For example, no marine radio operator now employed at the prevailing scale, which is approximately \$160 per month, is going to give up such a job for a civil service job in the Civil Aeronautics Authority unless he is willing to work for about \$130 per month, purchase a car, pay his own rent and work plenty of overtime without extra compensation.

Commercial radiomen turned down the Federal Communications Commission jobs by the hundreds because this job offered them exactly \$1800 per year and demanded that they commit themselves to go to Puerto Rico, Hawaii or the Philippines or Alaska without extra compensation. For your information, the living costs in all of those places is about 60% over and above that prevailing in New York City for comparable housing and much less cultural and climatic conditions.

The jobs that the "hams" took in the Federal Communications Commission I am informed by a source usually considered reliable was for the salary of \$1620 per year. That is less than the amount offered to commercial men. No wonder the government appointed hams.

The Naval Reserve is complaining that they are unable to obtain many commercial men as recruits. Is it any wonder when they offer a third class radioman rating and at the same time give to men who have just graduated from college but without an iota of radio experience ratings of Chief Petty Officer and in some cases commissions. The statement is that a radioman is not an officer in the Navy. Quite true, but the standards for selection of officers are certainly open to question. From a large number of commercial men I have obtained quite negative answers when the question of joining the Naval Reserve has been raised and the answer is always

(Continued on page 98)

# Here's News! HOWARD

Adds **TUNED R.F. Stage**  
to **\$29<sup>95</sup>** and **\$39<sup>95</sup>** **RECEIVERS!**

## You Get—

- INCREASED SENSITIVITY
- IMPROVED SELECTIVITY
- HIGHER IMAGE RATIO
- BETTER SIGNAL TO NOISE RATIO

## Plus—



**ALL THE ADVANTAGES OF THE FAMOUS HOWARD PROGRESSIVE SERIES DIRECT FACTORY CONVERSION PLAN**

Now, for the first time—at record low prices—HOWARD Models "435-A" and "436-A" bring you Tuned Radio Frequency on all Bands, using 3-gang tuning condensers! No effort or expense has been spared in the development of these great new receivers—they are definitely outstanding in design, performance and value.

Lowered production costs, because HOWARD manufactures such an exceptionally large number of component receiver parts in its own modern factory, make these spectacular values possible.

You owe it to yourself to get all of the important facts about the brilliant new 1941 HOWARD Communication Receivers. See them now at your local distributor or write the factory for complete information.

### PROGRESSIVE MODEL "435-A"

**7 Tubes** Incorporates a highly efficient Tuned R.F. Stage, 3-gang condensers for both main and electrical band spread tuning, ceramic coil forms, silver plated switch contacts, iron core I.F.'s, BFO, AVC, illuminated slide rule dial, 6½" Howard-Jensen electrodynamic speaker, plus dozens of other exclusive HOWARD features. Power output 2¾ watts. Tube complement: 6SD7GT, T.R.F.; 6SA7, Mixer-Osc.; 6SK7, I.F. Amp.; 6SQ7, AVC, Det. and 1st A.F.; 6K6G, Output; 6J5, BFO; 5Y3G, Rectifier. Welded steel cabinet is finished in gray wrinkle. Tunes continuously without skip from 540 KC to 43 MC (556 to 7 meters) in four bands.

AMATEUR PRICE—Complete with **\$29<sup>95</sup>** tubes and built-in speaker.....

### PROGRESSIVE MODEL "436-A"

**8 Tubes** Contains all of the features of basic Model "435-A" plus an efficient automatic noise limiter and the famous HOWARD Inertia "Fly-wheel" action tuning controls for both main dial and band spread. Noise limiter adds 6H6 tube.

AMATEUR PRICE—Complete with **\$39<sup>95</sup>** tubes and built-in speaker.....

Pacific Coast and Export Prices Slightly Higher

*America's Oldest Radio Manufacturer*

# HOWARD RADIO COMPANY

1731-35 Belmont Ave., Chicago, Illinois  
Cable Address: HOWARDCO., U. S. A.

# RUBIES

by

# HIPOWER

Hipower Rubies are super active, precision cut, low drift crystals, cut from the finest Brazilian quartz. They are without doubt one of the finest amateur crystal units available. With a guaranteed drift of less than 4 CY. per °C per MC. They are available with holder to all amateurs at "X" cut prices.

150-80-40 meter crystals...\$4.50  
Special 20 meter crystal...\$7.25



The Hipower Crystal Company, one of America's oldest and largest manufacturers of precision crystal units, is able to offer the amateur and manufacturer attractive prices because of their large production and the exclusive Hipower grinding process. Numbered among Hipower's customers are:

U. S. Army and U. S. Navy  
National Broadcasting Co.  
Columbia Broadcasting System  
Mutual Broadcasting System  
United States Airlines

Such satisfied customers provide assurance that whatever the need may be, Hipower can supply it.

**AVAILABLE AT YOUR PARTS DISTRIBUTOR**  
Manufacturers Write for Prices

## HIPOWER CRYSTAL COMPANY

Sales Division—205 W. Wacker Drive, Chicago, Ill.  
Factory—2035 Charleston Street, Chicago, Ill.

# RADIO

**ENGINEERING**, broadcasting, aviation and police radio, servicing, marine radio telegraphy and telephony, Morse telegraphy and railway accounting taught thoroughly. 48 weeks' engineering course, equivalent to three years of college radio work. School established 1874. All expenses low. Catalog free.

DODGE'S INSTITUTE, Day Street, Valparaiso, Indiana

## EASY TO LEARN CODE

It is easy and pleasant to learn the modern way—with an Instructograph Code Teacher. Ideal for the beginner or advanced student. ■ Many tapes available ranging from alphabet for beginners to typical messages on all subjects. Speed range 5 to 40 WPM. ■ Always ready, no QRM, beats having someone send to you.

### FOR SALE OR RENT

**STANDARD** with 10 tapes and book of instructions, A.C. motor.....\$24.50  
With spring-wound motor.....\$18.50  
**JUNIOR** with 5 tapes and book of instructions (not rented).....\$12.00

**RENTAL** Standard with 10 tapes and book of instructions \$3.00 first month, \$2.25 each additional month. References or \$10 deposit required. All rental payments may be applied on the purchase price should you decide to buy the equipment.

Write for details today

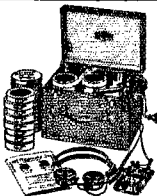

## INSTRUCTOGRAPH COMPANY

Dept. Q, 4701 Sheridan Road, Chicago, Illinois  
By arrangement for Canada:  
Radio College of Canada, 54 Bloor St. West, Toronto

## RADIO OPERATING QUESTIONS AND ANSWERS

Nilson & Hornung's new edition covers all FCC commercial license exam elements. Standard handbook 20 years. \$2.50, postpaid. Money back if not satisfied and book returned in 10 days. Send check or money order . . . not cash. Free circular on request.

**NILSON RADIO SCHOOL, 51 East 42nd St., New York**



(Continued from page 96)

the same, "A deck or engineer officer on a Merchant Marine vessel receives an officers' rating—the radioman does not. Why, I know deck and engineer officers that can't write a literate letter." I think that answers the question quite fully. . . .

Broadcasting offers generally about \$15 to \$25 per week for a man with a first-class radiophone ticket to work anywhere from 8 to 12 hours per day, six to seven days per week, and in some cases they want him to solicit advertising on the side. In a few of the larger stations operators are offered \$35 to \$60 per week, but these are rare exceptions, and usually only after many years of experience and long service with an engineering degree or a course from Capitol finished and proven. The average is \$25 per week and no more. Some future!

Aviation wants commercial men with 1st class radiotelegraph and 2nd class radiophone licenses with ability to handle everything, including a teletype and 35 w.p.m. mixed code, for \$100 per month and hope of promotion to \$150 if they are good and can pass an engineering degree in radiophone work and dispatcher's examination in aviation traffic handling at the end of six months. That is, of course, if you make no protests about working hours and overtime when required and provided further that you are willing to join their company unions. You are required to travel anywhere at any time and live anywhere under any conditions, or else you don't stay, and certainly don't reach the \$150 level. The great Pan American Airways hires for \$100 per month "apprentice operators" for their clippers. When does a man become a full operator? Well, that is problematical. You might and you might not—dependent entirely upon whether or not you are liked by your immediate superior, not on your ability.

All other industries are identical. M.I.T. men can be had for \$80 per month in New York City almost any day. Is it any wonder that men who have years of experience in radio won't go to work at these wages? Will they leave their jobs now paying \$160 or more per month to take these "defense" jobs? Would you?

—Wayne P. Paschal, Acting Secretary,  
American Communications Association, C.I.O.,  
Marine Division Local Two

P. O. Box 446, Lancaster, S. C.

Editor, QST:

. . . For many years radio training and technical schools have painted a very pretty picture of the radio profession. They have imbued it with romance and adventure; have pictured it as a "gravy train" of the first order, a veritable "bed of roses." Any job or position—and there is a fine distinction—in radio is very similar to the ordinary, garden variety of "bread and butter" jobs in that it requires a certain amount of proficiency and skill. It also requires a considerable quantity of application, or "elbow-grease" if you prefer. The pay is usually in proportion to the grade of services or knowledge required, and it does not mean that the two must go hand-in-hand.

From the foregoing it is very easy to see why so many amateurs are disappointed when they try to crash the field of radio. No doubt the services are in need of trained men, but an amateur ticket is not the only requirement. The top-notch job of to-day carries a very stringent set of requirements: College degree, operating experience, and, not the least, considerable "pull."

The reason why set manufacturers do not give amateurs preference is principally due to mass production. An operative who can make two perfect soldered joints is preferable to one whose mind may be delving into such things as plate input to the second detector. The large manufacturer concentrates on single-track minds and patience. The ham should beware. . . .

A job in the radio field is not everything. To those who will not be denied, I cannot recommend Mr. Zeh Bouck's little book, "Making a Living in Radio," too highly. This should do much to guide those who must enter the radio field.

It is a difficult game, and I am glad that I am not a participant. The same amount of effort in another profession is bringing much greater returns. I hope that the last thing I do will be to make the "Silent Keys" column, but never to engage in radio professionally again.

—Ralph L. King, W4GMO

(Continued on page 100)



# LOOK! A HAMMARLUND HQ-120-X for only \$13.<sup>80</sup> down!

Pay balance on easy Terms  
only \$10.<sup>95</sup> per month for 12 months

## HAMS! Snap this up! FILTER CONDENSERS

OF SUCH QUALITY WILL  
NEVER COST YOU LESS  
Oil Filled—Impregnated

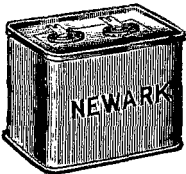

As low as **59c**

Thousands now in use by "hams" who are still wondering how we can sell such dependable quality condensers at such low prices. No compromise with quality. Made by a leading manufacturer and **GUARANTEED** at rated voltages.

Mfd.	Volts DC.	Size	Price
1	1000	5 x 3 3/4 x 1 1/2	\$ .59
2	1500	Misc.	.99
4.4	1500	5 x 3 3/4 x 1 1/2	1.50
2	2000	4 7/8 x 3 3/4 x 1 1/2	1.50
8	2000	5 x 3 3/4 x 3 3/4	2.75
4	3000	5 x 3 3/4 x 3 3/4	3.75

**This is it!** The famous HQ-120-X... *dual stabilized* with voltage regulation and drift correction! Strictly up to the minute with the kind of performance demanded by the exacting professional, amateur, or short wave listener. Special high gain RF stage with antenna compensator; 3 IF stages with silvered mica condensers and permeability tuned transformers. Covers 9.7 to 555 meters in 6 bands. Cash price, including tubes, 10" PM Dynamic speaker and . . . . . **\$138.00**

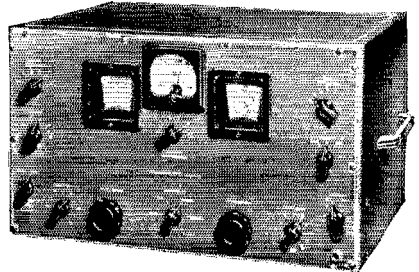

or... the **SUPER-PRO FOR ONLY \$27.<sup>90</sup> DOWN**  
and \$22.<sup>18</sup> per month  
for 12 months

18-tube "super" with improved noise limiter, two stages tuned RF, variable selectivity crystal filter, S meter, and continuous bandspread tuning through entire frequency range. Tuning unit has 20 laboratory adjusted coils on Isolantite bases, four gang main tuning condenser, and 12 to 1 ratio direct reading dials. A host of other exclusive features make the Super Pro one of the most desirable sets on the market.



Available in two tuning ranges . . . SP-210-X, 15 to 560 meters, and SP-210-SX 7 1/2 to 240 meters. Cash price, complete with crystal tubes, 10" speaker, and separate power supply . . . . . **\$279.00**

### ★ YOUR CALL LETTERS IN GOLD — 10¢

Put these big shadowed decalcomania letters on your Ham Shack door, auto window, etc. *Nearly 2" high.* Send dime for yours today. Be sure to give call letters.

### ★ GET THIS BIG NEW CATALOG — FREE

Just out . . . with many more items than we've ever put between the covers of any catalog. Thousands of bargains, sets, parts, accessories, supplies, of best known makes. Hundreds of illustrations. This book belongs in every "ham" shack, ready for instant reference. **WRITE FOR IT!**

### ★ ORDER DIRECT FROM THIS AD—TODAY

Send down payment with your order. We ship immediately upon credit approval. You pay balance plus 6% carrying charge in equal monthly payments of \$5 or more.

# NEWARK

*Electric Company*

323 W. MADISON ST.  
Dept. Q CHICAGO, ILL.

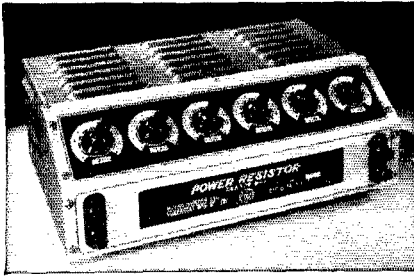

## THE POWER DECADE BOX

- ★ It's the answer to the radio designer's prayer! Handles real power. Tells what resistance value to use, instantly, accurately, simply. ★ Provides any resistance value from 1 ohm to 999,000 ohms. Handles voltages up to 1000. Each decade dissipates 225 watts. ★ Insert in circuit, turn knobs, and presto! Here's the resistance required, read off the knob dials. ★ Handsome. Sturdy. Indispensable. ★ Write for descriptive literature.

**CLAROSTAT MFG. CO., Inc.**  
285-7 N. 6th St., Brooklyn, N. Y.



### RADIO COURSES

Mid-Term Classes Now Starting  
**RADIO OPERATING • BROADCASTING • CODE**  
**RADIO SERVICING • TELEVISION**  
 • **ELECTRONICS** — 1 year day course; 2 years eve.  
 Day and Evening Classes — *Booklet upon request*  
**NEW YORK YMCA SCHOOLS**  
 4 West 63rd Street, New York City

### SICKLES COILS

ALL TYPES OF RF AND IF WINDINGS

Manufactured by  
**F. W. SICKLES COMPANY**  
 300 Main Street Springfield, Mass.

### LEARN RADIO • TELEVISION

60-page catalog on request. Oldest, largest and best equipped in New England. New classes now forming. Write for new catalog.

**MASS. RADIO SCHOOL**  
 18 Boylston Street Boston, Massachusetts

(Continued from page 98)

Morrison, III.

Editor, *QST*:

. . . I say work at the kind of thing that offers the best living, whether you like it or not. Which is better — enjoy your work and starve (if such be the case) or do something you don't like and be paid for it? I don't know of one case in ten where one works at his hobby and gets rich. . . .

My advice to young America is to look around and see what field of endeavor has the biggest demand. Generally speaking, demand being equal, the longer it takes to prepare, the fewer will be the ones preparing and better will be the chances.

Don't be misled by high-pressure advertising; not in the radio field alone, but in every field. . . . This is what it all boils down to. There is always room at the top. Those at the top started at the bottom in most cases. . . .

— Leander J. Smith, *W9EEZ*

5311 Melrose Ave., Hollywood, Calif.

Editor, *QST*:

Congratulations on being big enough to publish both sides of the "ham employment" situation. The anonymous letter and the one from Mr. Stafford are timely and certainly true. The editorial notes are also true but on the extremely weak side. . . .

Most of the manufacturers, who do not make amateur equipment a large part of their business, do not want amateurs.

The same is true for the radio service business. The C.C.C. and N.Y.A. jobs are not showing anything much for amateurs either. I have applied at fifteen service places and ten manufacturers, including tube factories, and numerous broadcast stations within a radius of five hundred miles of Los Angeles and Central Ohio during 1940. There were many offers of work, for ten to twelve dollars a week. . . .

I am 31 years old and married, and do you think I am going to be foolish enough to try to support a wife by any part of the radio business? If or when it becomes necessary to use my services for radio needs of the government I will be more than willing to do whatever is necessary, but at present there seems to be a demand for fewer amateurs. . . .

Please don't go too far and raise several thousands of false hopes. There are jobs available, sure — lots of them — but not nearly "a job for all who are so inclined."

(Continued on page 108)

## AMATEUR RADIO LICENSES

Day and Evening Classes in Code and Theory  
**HOME STUDY COURSES**

*Reasonable, Efficient and Thorough, Hundreds of Licensed Students Now on the Air*

American Radio Institute, 1123 Broadway, New York, N. Y.



## GENERAL COMMUNICATIONS CRYSTALS HOLDERS AND OVENS

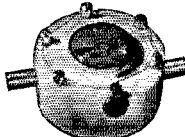
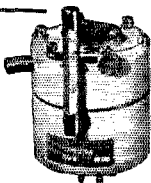

Precision Made by *Bliley*

WRITE FOR CATALOG G-11

**BLILEY ELECTRIC CO., ERIE, PA.**

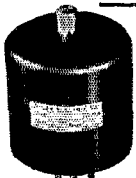

# HARRISON • RADIO • COMPANY

• 12 WEST BROADWAY • NEW YORK CITY

Dear Friend:

If you are thinking of buying some radio equipment, every word of this letter is of importance to you. I am an Authorized Distributor of all Amateur apparatus, and can supply you with everything you need. I deal direct with every manufacturer and can give you the latest and best at lowest prices. I have one of the most complete stocks in the country. My prompt delivery service, very liberal trade-in allowances, easiest and simplest time payment terms, and my personal attention to your every wish is sure to please you!

I have all latest model Hallicrafters, Hammarlund, National, RME, RCA, Howard, Echophone, etc, receivers in my stock for immediate shipment. (From the factory if you prefer) You need send only a \$5.00 deposit with your order. Try it for ten days and if you don't like the receiver your money will be returned.

Also all National, Hallicrafters, Thordarson, Abbott, RTL, UTC, Stancor, etc, Transmitters and Kits are offered. We wire and test kits in our Shop at reasonable rates.

You can buy everything from me on my easier credit terms for your convenience. Receivers, Transmitters, Kits, etc. Down payment can be as little as 10% of the cash price. The balance in easy monthly payments. Your entire cost for credit is only 6% on the balance. The larger your down payment, the smaller your interest.

I take your old receiver or transmitter in trade. Tell me make, model, age, and condition. Also mention what allowance you feel would be fair to us both.

I also buy modern transmitters, receivers, and complete stations for cash. I always have some good values in reconditioned equipment. It will pay you to communicate with me.

Send to me for prompt delivery of any item you see in any catalog or advertisement at the lowest price shown. I know you'll like doing business with me because I really want every one of my customers to be completely satisfied. Send me your orders; you, too, can depend upon my fullest cooperation and help. I want you to be my customer and friend, and I promise to always give you the very fairest and squarest deal.

•  
SHORT WAVE  
SPECIALISTS  
SINCE 1926

•  
EVERYTHING  
IN RADIO  
ELECTRICAL AND  
ELECTRONIC  
EQUIPMENT

•  
TELEPHONE  
WORTH 2-  
6 2 7 6

Sincerely yours,

73



W2AVA

HARRISON HAS IT!



## New, Efficient LINE FILTER

This sensational new Miller Line Filter positively prevents line noises from reaching radio receiver through power lines. Use it to prevent crackling and sizzling in your radio caused by household appliances and powerline disturbances which "noiseless" antenna systems cannot eliminate. Merely plug it in — no adjustments or attention. Exclusively combines both inductive and capacitive filtering, with the famous Miller duo-lateral wound choke, and oil impregnated paper dielectrics.

More efficient than any filter on the market. Complete in handsome chromium and black Kam-Art metal case, rubber cord and unbreakable plug. Shipping weight 16 ozs. Beat the demand. Order now.

No. 7818

**\$4.00**

Underwriters Laboratories Approved

### J. W. MILLER COMPANY

5917 So. Main Street, LOS ANGELES, CAL.

## WE OFFER IMMEDIATE DELIVERY The Millen Eco Variarm

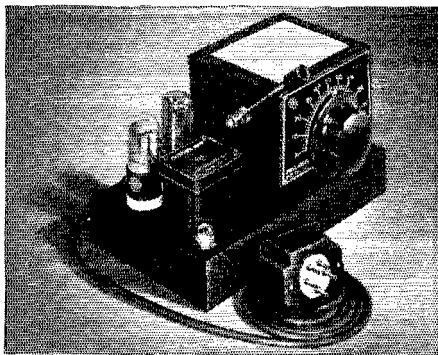

Amateur Price. . . . . Only \$29.50

For only twenty-nine dollars and fifty cents you get a complete self-powered ECO unit with all coils and tubes — nothing else to buy.

For full information read article by W9YZH in January QST, page 81. Mail orders promptly filled.

**THE RADIO SHACK CORP.** 167 Washington St.  
Boston, Mass.

(Continued from page 100)

The December QST is one of the finest yet. May the A.R.R.L. be able to continue as the finest thing radio has produced.

— C. N. (Bud) Loewenstein, W6TEG

U. S. Army Air Corps, Bolling Field, Washington, D. C.  
Editor, QST:

. . . I know how that fellow feels. I tried to "crash" commercial radio but met with little success. Every word that fellow tells is true; they don't want "inexperienced" men. An amateur feels as though he knows radio, and thinks that he can qualify for almost any job in radio. This we know to be not so; there is more to radio than just the practical end of it. I am not a "theory man"; I don't profess to be. I am just a radio op — nothing wonderful, just fair. I like operating and wanted to get into operating on the outside, but didn't have the experience, so I just joined the Army Air Corps (this is not a publicity stunt, to entice anyone into the Army, hi). I found out that it was one of the smartest things I ever did. I am doing the type of work I like, exactly like the regular scheduled airline traffic, working planes, etc. Upon fulfillment of my enlistment, I am quite sure I will be with the airlines. . . .

— J. H. Carroll, Jr., W8IIL

### EXPERIENCE

U. S. Marine Barracks, San Diego, Calif.

Editor, QST:

I have been a member of the A.R.R.L. for the past two years; but now, as a member of the Marine Corps Reserve, I have been called into active duty with the Marine Corps. . . . I was placed in a machine-gun company and I find it hard to transfer into communications because I have no amateur license. I wish now that I had studied my code and qualified. I have a commercial 'phone license, but it doesn't seem to make much difference here to the office. . . .

— Corp. W—— K——, U.S.M.C.

### F.C.C. AND NEW REGS

431 LaPorte Road, Waterloo, Iowa

Editor, QST:

In regard to W9CVU's article in the December issue of QST, the fact that anyone can gripe over the slowness in getting larger 'phone bands on 80 and 20 meters is the last straw.

It is apparent that the F.C.C. is up to its neck in work, checking every licensee's citizenship, renewing licenses, etc., without being bothered with trying to work out more frequencies for the ham.

The League has represented the amateur very well in its business with the F.C.C. and has played no small part in the continuation of ham radio during the current situation. We are one of the few countries in the world that still has the privilege of ham radio. In these trying times we should be thankful that the F.C.C. has let the ham continue his activities.

Wouldn't it have been much simpler for the F.C.C. to have shut the ham off completely than to require proof of citizenship and addition of new regulations, as Order No. 72, etc.?

. . . Let's cooperate with the F.C.C. in an effort that will enable us to continue our activities in the future as we have in the past.

— Dale Barrows, W9MYA

### QST OVERSEAS

111 Lake St., Englewood, N. J.

Editor, QST:

I thought you would be interested in the following letter dated November 1st, just received from PÄGGE, Mr. G. H. Pieterson, 115 Terborgse weg, Doetinchem, Holland:

"Dear OM:

"When you spend just a minute looking over your wall-paper you will find the card I send you in August 1939, confirming the nice chat we had on August 19 of that year.

"I am remembering you of this fact cause I am going to ask a favour from you. Due to the circumstances I am not able to pay the subscription for the next year for QST. Now I'd be very sorry, if I would not any longer receive this up-to-date amateur magazine which at the present

(Continued on page 104)



# Where to buy it

A directory of suppliers who carry in stock the products of these dependable manufacturers.

THE NEW 1941  
**SUPER**  
*Skyrider*

**ALBANY, N. Y.** Uncle Dave's Radio Shack 356 Broadway  
**ATLANTA, GEORGIA** 265 Peachtree Street  
Radio Wire Television Inc.  
**BOSTON, MASS.** Radio Shack 167 Washington Street  
**BOSTON, MASS.** 110 Federal Street  
Radio Wire Television Inc.  
**BRIDGEPORT, CONN.** 177 Cannon Street  
Hatry & Young, Inc.  
**BRONX, N. Y.** 542 East Fordham Rd.  
Radio Wire Television Inc.  
**BUTLER, MISSOURI** 211-215 N. Main Street  
Henry Radio Shop  
**CHICAGO, ILL.** 833 W. Jackson Blvd.  
Allied Radio Corp.  
**CHICAGO, ILL.** 901-911 W. Jackson Blvd.  
Radio Wire Television Inc.  
**CINCINNATI, OHIO** 1103 Vine Street  
United Radio, Inc.  
**DETROIT, MICH.** 325 E. Jefferson Ave.  
Radio Specialties Co.  
**DETROIT, MICHIGAN** 11800 Woodward Ave.  
Radio Specialties Co.  
**HARTFORD, CONNECTICUT** 227 Asylum Street  
Radio Inspection Service Company  
**HOUSTON, TEXAS** 1021 Caroline Street  
R. C. & L. F. Hall  
**INDIANAPOLIS, INDIANA** 34 West Ohio Street  
Van Sickle Radio Supply Co.  
**JAMAICA, L. I.** 90-08 166th Street  
Radio Wire Television Inc.  
**KANSAS CITY, MO.** 1012 McGee Street  
Burststein-Applebee Company  
**NEW HAVEN, CONN.** 1172 Chapel Street  
Hatry & Young, Inc.  
**NEW YORK, N. Y.** Harrison Radio Co. 12 West Broadway  
**NEW YORK, N. Y.** 100 Sixth Ave.  
Radio Wire Television Inc.  
**NEWARK, N. J.** 24 Central Ave.  
Radio Wire Television Inc.  
**READING, PENN.** 404 Walnut Street  
George D. Barbey Company  
**SCRANTON, PENN.** 519-21 Mulberry Street  
Scranton Radio & Television Supply Co.  
**WASHINGTON, D. C.** 938 F Street, N. W.  
Sun Radio & Service Supply Co.

**TRIPLET**  
**INSTRUMENTS**

**ALBANY, N. Y.** Uncle Dave's Radio Shack 356 Broadway  
**ATLANTA, GEORGIA** 265 Peachtree Street  
Radio Wire Television Inc.  
**BOSTON, MASS.** Radio Shack 167 Washington Street  
**BOSTON, MASS.** 110 Federal Street  
Radio Wire Television Inc.  
**BRIDGEPORT, CONN.** 177 Cannon Street  
Hatry & Young, Inc.  
**BRONX, N. Y.** 542 East Fordham Rd.  
Radio Wire Television Inc.  
**BUTLER, MISSOURI** 211-215 N. Main Street  
Henry Radio Shop  
**CHICAGO, ILLINOIS** 833 W. Jackson Blvd.  
Allied Radio Corp.  
**CHICAGO, ILL.** 901-911 W. Jackson Blvd.  
Radio Wire Television Inc.  
**CINCINNATI, OHIO** 1103 Vine Street  
United Radio, Inc.  
**HARTFORD, CONN.** 203 Ann Street  
Hatry & Young, Inc.  
**JAMAICA, L. I.** 90-08 166th Street  
Radio Wire Television Inc.  
**LITTLE ROCK, ARKANSAS** 409 W. 3rd St.  
Beem Radio Company  
**MINNEAPOLIS, MINNESOTA** 1124-26 Harmon Place  
Lew Bonn Company  
**NEW HAVEN, CONN.** 1172 Chapel Street  
Hatry & Young, Inc.  
**NEW YORK, N. Y.** 100 Sixth Avenue  
Radio Wire Television Inc.  
**NEWARK, N. J.** 24 Central Ave.  
Radio Wire Television Inc.  
**READING, PENN.** 404 Walnut Street  
George D. Barbey Company  
**SCRANTON, PENN.** 519-21 Mulberry Street  
Scranton Radio & Television Supply Co.  
**WASHINGTON, D. C.** 938 F Street, N. W.  
Sun Radio & Service Supply Co.

Listings on this page do not necessarily imply endorsement by QST of the dealers or of other equipment sold by them.

# TO HELP *You* GET STARTED IN AMATEUR RADIO

## How to Become a Radio Amateur

Universally recognized as the standard elementary guide for the prospective amateur, *How to Become a Radio Amateur* features equipment which, although simple in construction, conforms in every detail to present practices. The apparatus is of a thoroughly practical type capable of giving long and satisfactory service — while at the same time it can be built at a minimum of expense. The design is such that a high degree of flexibility is secured, making the various units fit into the more elaborate station layouts which inevitably result as the amateur progresses. Complete operating instructions and references to sources of detailed information on licensing procedure are given, as well as a highly absorbing narrative account of just what amateur radio is and does.

**25¢**

POSTPAID ANYWHERE

## The Radio Amateur's License Manual

Before you can operate an amateur transmitter, you must have a government license and an officially assigned call. These cost nothing — but you must be able to pass the examination. The examinations are based on the multiple-choice type of questions. The "License Manual" has been written to make it as easy as possible for the individual to acquire the necessary knowledge to pass the examination with flying colors. Whether you are going up for your Class C, B or your Class A ticket, "The License Manual" will provide the most direct path to getting that ticket. If you are one of the thousands who always wants a "License Manual" around the shack for ready reference for amateur regulations, it will please you to know that the regulations are very thoroughly indexed.

**25¢**

POSTPAID ANYWHERE

AMERICAN RADIO  
RELAY LEAGUE  
WEST HARTFORD, CONNECTICUT

(Continued from page 108)

moment is the only means of remaining in touch with the latest developments in radio. Would you be so kind and pay next year's subscription for me? If so I'd be mighty thankful to you and you can be sure I'll return you this favour as soon as circumstances allow. I am sure they will allow one day.

"So far I got all copies of the magazine with the exception of the May number which I fear is resting on the bottom of the Atlantic. Maybe you know a means to complete my 1940 volume with another May number.

"As I saw in the last number of *QST* you American amateurs are still in the lucky position of being allowed to live out your hobby. I hope that will remain in the case and I hope we will be allowed to bring our hobby in practice as soon as possible.

"Thank you in advance and be greeted from Another Rabid Radio Loon.

(Signed) *G. H. Pierson, PA0GE*"

After reading the above, think for a moment what it means not only to that ham but thousands like him, deprived of his hobby and even forbidden to send money out of his country to pay for the subscription to his favorite magazine. When he says we are lucky, he does not adequately express himself. We should all be proud to be Americans and living in a country that appreciates our efforts by continuing to grant us amateur privileges. Let us insure a continuation of those privileges by keeping the ham game clean. . . .

— *J. A. Herlein, W2CSS*

## 2050-KC. HARMONICS

1744 Commercial St., East Weymouth, Mass.

Editor, *QST*:

This evening while tuning over the 4.0- to 7.0-Mc. frequencies looking for some code practice, I came upon a W8 testing and calling CQ 160 meters on about 4080 kc.

This is in the vicinity of a great many active government and commercial services, and I think *QST* would do a great favor in reminding the 2.00- to 2.05-Mc. 'phone boys that their second harmonics are most serious due to the fact that they do not fall within the 80-meter band.

Perhaps this point has been brought up in *QST* and I have missed it. This is, however, the second time I have logged a 'phone operating on the new section of the 160 meter 'phone band with a strong second harmonic outside 80 meters. . . .

— *James A. Wood, W1AYG*

## SS CODE SPEED

1324 College Ave., Palo Alto, Calif.

Editor, *QST*:

. . . I'm in quite a fog to-night as a result of the SS of the past two weekends, but I'll try to make this letter somewhat intelligent in spite of my condition. All day long I have had funny noises in my head. . . . when the car in which I'm driving squeaks as it passes over a bump the sound is CQ SS . . . when the electric ice box in the kitchen starts up it goes W6HJT W6HJT BK BK . . . when I doze off to sleep in class I hear . . . HR NR . . . but enough of that.

Let me get into a more serious mood. My primary impression of the 1940 SS is that the amateur radio operator is a better, more efficient man at the key than he was a year ago . . . and a lot better at that. As an example of this: I made an automatic CQ machine before the contest with a CQ SS at about 28 w.p.m., figuring that this speed would be about right for the average ham and thus would get me the greatest number of contacts. However, after a few hours I came to the conclusion that the speed should be 38 w.p.m. and not 28! In fact, all the way through the contest I found that the higher speed was by far the most satisfactory in practically all cases. Even if some of the gang sent rather slowly, they all could receive the SS messages at 35 w.p.m. or so. I know that this decided improvement in operating ability on the part of the gang is largely due to the fine work the League has done toward increasing code proficiency

— *Cam Pierce, W6HJT*

BUY ON EASY TERMS · MAIL ORDERS PROMPTLY FILLED · WRITE FOR FREE CATALOG

*Service + Fair Dealings = Confidence*

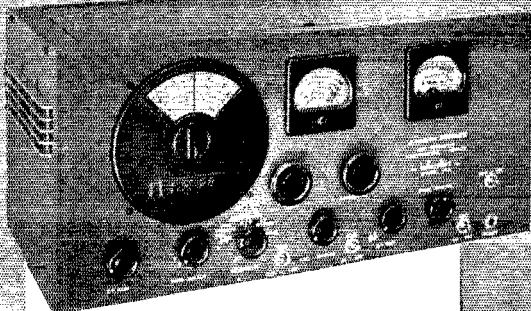

### HALLICRAFTER MODEL SX-24

A winner in any race — This nine tube receiver has everything: — Crystal filter — Calibrated band spread — Noise limiter — S-meter — Terminals for break-in operation. Best of All YOU can buy it for only..... **\$6.95 Down**

Cash price \$69.50

*and*

THAT IS THE MAJOR REASON WHY THOUSANDS OF CUSTOMERS HERE AND ABROAD DEPEND 100% ON THE

## RADIO SHACK

FOR THEIR WANTS

### SKY TRAVELER — MODEL S-39

Already this remarkable nine tube portable has made a real spot for itself in Ham radio. All the features of the job that you would use in the operating room. Coverage 542-1490 KC. Runs on batteries or 110 Volts AC or DC.

Only  
**\$5.95**  
Down

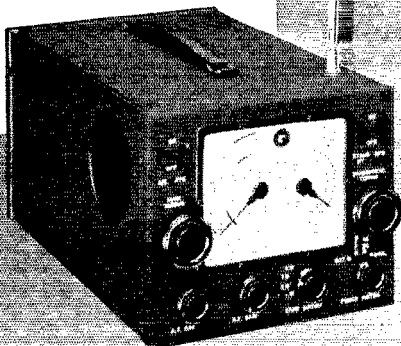

### MODEL SX-28

This most famous member of the Hallicrafter family is a superlative receiver — Built to Government Specifications this 15 tube Communications is electrically perfect and mechanically the most rigid receiver of the entire line. Catalogue on request.

Down Payment **\$15.95**

*The* **RADIO SHACK**  
167 WASHINGTON ST., BOSTON, MASS., U.S.A.

# Now! REVISED AND ENLARGED

RADIO'S ONLY COMPLETE HANDBOOK ON

## Quartz Crystals

Engineering Bulletin E-6, FREQUENCY CONTROL WITH QUARTZ CRYSTALS, has been revised, rewritten and expanded. This authoritative booklet, prepared by the same engineers who design and develop Bliley Crystal Units, is now larger and more comprehensive in scope. The new edition, like the original (over 20,000 copies distributed), covers the theory and application of quartz crystals in a thorough, yet practical manner. It includes, also, sections devoted to frequency standards and frequency measurement procedure.

Engineering Bulletin E-6 has the distinction of being the only manual of its type—no other single publication contains equally complete information. Whether you are an engineer, amateur, serviceman, experimenter or radio engineering student, you will want a copy of this outstanding handbook on crystal control.

Bliley Electric Company, Erie, Pa.

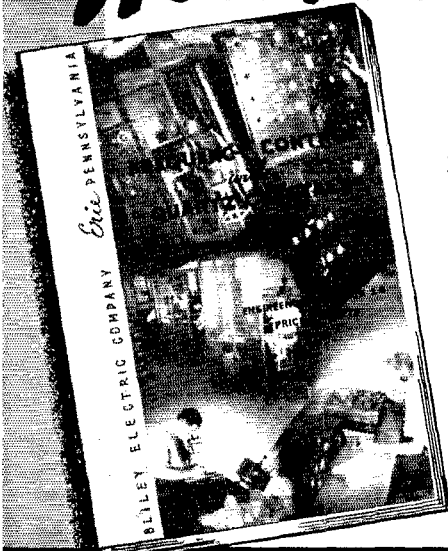

18  
*Chapters*

35 PAGES PACKED WITH REAL  
'DOPE' ON CRYSTAL CONTROL

10¢ at your  
*Bliley dealer*  
(CANADA & FOREIGN 15¢)

## ASTATIC "Speech Range" MICROPHONES

That Have What It Takes  
To Satisfy Veteran Amateurs

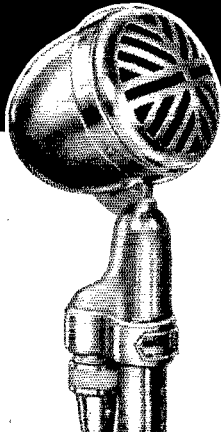

MODEL UT-48  
List Price \$16.50

AMONG the many dependable quality crystal microphones in Astatic's complete line are these two moderately priced units that appeal particularly to amateurs because of their exceptional "speech range" characteristics. The high output level of these microphones, -48 db, allows minimum gain in the associated speech amplifier and assures a minimum of r-f feedback. To stress voice-range response, both models are designed with rising characteristics above 500 cycles.

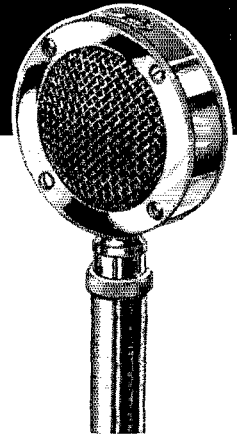

MODEL D-104  
List Price \$22.50

See your Radio Parts Jobber or write for  
Astatic's new catalog

**ASTATIC**  
ASTATIC CRYSTAL PRODUCTS LICENSED UNDER  
BRUSH DEVELOPMENT CO. PATENTS

IN CANADA: CANADIAN  
ASTATIC Ltd., TORONTO, ONT.



*Laboratory Inc.*

# HAM-ADS

(1) Advertising shall pertain to radio and shall be of nature of interest to radio amateurs or experimenters in their pursuit of the art.

(2) No display of any character will be accepted, nor can any special typographical arrangement, such as all or part capital letters be used which would tend to make one advertisement stand out from the others.

(3) The Ham-Ad rate is 15¢ per word, except as noted in paragraph (5) below.

(4) Remittance in full must accompany copy. No cash or contract discount or agency commission will be allowed.

(5) Closing date for Ham-Ads is the 25th of the second month preceding publication date.

(6) A special rate of 7¢ per word will apply to advertising which, in our judgment, is obviously non-commercial in nature and is placed and signed by a member of the American Radio Relay League. Thus, advertising of bona fide surplus equipment owned, used and for sale by an individual or apparatus offered for exchange or advertising inquiring for special equipment, if by a member of the American Radio Relay League takes the 7¢ rate. An attempt to deal in apparatus in quantity for profit, even if by an individual, is commercial and all advertising by him takes the 15¢ rate. Provisions of paragraphs (1), (2), (4) and (5) apply to all advertising in this column regardless of which rate may apply.

Having made no investigation of the advertisers in the classified columns, the publishers of QST are unable to vouch for their integrity or for the grade or character of the products advertised

**QUARTZ**—direct importers from Brazil of best quality pure quartz suitable for making piezo-electric crystals.  
Diamond Drill Carbon Co., 719 World Bldg., New York City.

**QSL'S**, Maps, Cartoons, Free samples, Theodore Porcher, 7708 Navajo, Philadelphia, Pa.

**USED** receivers. Bargains. Cash only. No trades. Price list 3¢. W3DQ, Wilmington, Del.

**QSL'S**, W8JOT, Box 101, Rochester, N. Y.

**TELEPLEXES**, Instructographs bought, sold. Ryan's, Hannibal, Mo.

**CRYSTALS**: famous P.R., mounted in latest Alsimag 35 holders—40, 80 meter PR-X, 160 meter PR-Z, \$3; 40, 80 meter PR-Z (low drift), \$3.50; 20-meter PR-20, \$4.50; unconditionally guaranteed. Immediate shipment. Quality blanks, 65¢. Wholesale Radio Labs., Council Bluffs, Iowa, W9GFQ.

**CALLBOOKS**—Winter edition now on sale containing complete up-to-date list of radio hams throughout entire world. Also world prefix map, and new time conversion chart. Single copies \$1.25. Canada and foreign \$1.35. Radio Amateur Call Book, 610 S. Dearborn, Chicago.

**QSL'S**—Brownie, W3CJI, 1725 Frankenfield Ave., Allentown, Pa.

**CRYSTALS**: police, marine, aircraft. C-W Mfg. Co., 1170 Esperanza, Los Angeles.

**COMMERCIAL** radio operators examination questions and answers. One dollar per element. G. C. Waller, W5ATV, 6540 Washington Blvd., Tulsa, Okla.

1000 watt G.E. transformers 1100-2200-4400 volts each side c.t. Guaranteed \$13.50. Dawson, 5740 Woodrow, Detroit, Mich.

**CRYSTALS** in plug-in heat dissipating holders. Guaranteed good oscillators, 160-M 80M AT \$1.25; 40X \$1.65. 80M varifrequency (5 kilocycle variance) complete \$2.95. State frequency desired. C.O.D.'s accepted. Pacific Crystals, 1042 S. Hicks, Los Angeles.

**QSL** samples, prices, on request. W2AEX, 338 Elmora, Elizabeth, N. J.

**FOR** sale—two fine fone transmitters complete. W9ZAL, Delmont, S. Dakota.

**NATIONAL 101X**—perfect condition. Best offer takes it. Write F. J. Raufer, 530 S. W. 27th Rd., Miami, Fla.

**QSL'S?**—SWL's?—QSL's? America's finest. Quickest service. Samples? W8DED, Holland, Mich.

**WANTED**: Meissner DeLuxe, RF section capable of running up to 500 watts on 160 with possibility of changing bands—also 16 MM movie equipment. Cash or trade Remington 37 new, Winchester 52 very good, S&W Police Special 38, new etc. W9BZT.

**QSL'S**, all colors, cartoons, snappy service. Write for free samples today. W1BEF, 78 Warrenton, Springfield, Mass.

**TRANSMITTER**, power supply—6L6, 803, pair 852a. 700 watts CW. Coils for 40-20. Sacrifice at \$80. Detailed data and photos upon request. K. P. MacDowell, 2221 Lotus, Ft. Worth, Texas.

**WANTED**: QST 1923 and earlier. W9ZNN, Box 212, Estes Park, Col.

**BARGAIN** Howard receiver, powerpack, Pioneer dynamotor. 107 Augusta, Akron, Ohio.

**CRYSTALS**, mounted, 80-160 medium drift \$1.25, 40—\$1.50; low drift 40-80-160, \$2.25. No Y's. R9 Crystals, 338 Murray Ave., Arnold, Pa.

**NATIONAL 101X** latest model gray with noise limiter. Used 2 months. \$100. W9CVU, P. O. Box 224, Cedar Rapids, Iowa.

**QSL'S**, Beautiful styles. Samples. Maleco, 1805 St. Johns Place, Brooklyn, N. Y.

**WANTED**: transmitter—W2EYG.

**FOR** sale—new RCA tubes in original cartons at a bargain price. Send for list. Lowell Ecker, Sedan, Kansas.

**LEO**, W9GFQ, offers the hams more and a better deal always. Lowest terms, no red tape (as finance own paper) on all new and used equipment. Free trial, personalized service. Write for 124-page bargain catalog and get acquainted. Wholesale Radio Laboratories, Council Bluffs, Iowa.

**TRANSMITTING** headquarters on latest Stancor, Thordarson & other kits—commercially wired at low cost. New 70 watt transmitter kits complete only \$35—speech amplifier modulator up to 80 watts \$25—up to 150 watts \$49.50. Easy terms. Write Leo, W9GFQ, today.

**RECEIVERS**—New in original cartons—436 Howard \$29.95—Howard 460's with crystal \$59.95—SX-23's \$79.50—Reconditioned types all makes lowest terms. Write to Leo, W9GFQ, for free list.

**FOR** sale—500 watt phone transmitter, 100TH's final, complete with coils, tubes, speech amplifier, enclosed relay rack, 6 triplet meters. A real buy. Write—photos and description. W. L. Brown, W9PFL, 415 S. Broadway, Pittsburgh, Kansas.

**CRYSTALS**: Edison commercial crystals meet all F.C.C. requirements. Police, aircraft, geophysical, marine and all types of low drift units for commercial services. Send for catalog—get our prices. Amateurs: Those T9 crystals, twice as good—half the cost. Fully guaranteed: 40, 80 and 160 meter bands \$1.60, spot frequencies \$2, postpaid. T9 ceramic holders \$1. COD's accepted. Sold by: Henry Radio Shop, Butler, Mo.; Frank Anzalone, 375 W. 46th, N. Y. C.; Pemberton Labs., Ft. Wayne, Ind.; Kerr's Radio Shop, El Paso, Texas; Valley Radio Distributors, Appleton, Wis.; Casa Edison, Havana, Cuba; and Edison's, Temple, Texas.

**SACRIFICE** Collins 32G transmitter, 7K speech. General Radio 586B power level meter. RCA-803 unopened. W6ITH, Moraga, Calif.

**WRITE** Bob Henry, W9ARA, for best deal on all amateur receivers, transmitters, kits, parts. You get best terms (financed by myself); largest trade-in; personal cooperation; lowest prices. Prompt delivery of all the newest apparatus like the NC-200. Write W9ARA, Butler, Mo.

**RECONDITIONED** guaranteed receivers and transmitters. All makes. Lowest prices. Free trial. Terms. New Howard 460s with crystals \$59.95; SX-23s \$79.50. List free. W9ARA.

**SACRIFICE** 150 watt phone CW rig—35 watt rig—parts—photo sent. W2GNZ, 956 East 172 St., N. Y. C.

**SELLING** all equipment and parts from station. Many fine bargains. W3FAI, Bozman, Md.

**BUD 42"** cabinet \$10. New Biiley H.F.2 14657 kc. for 10 meters \$3. QST Nov. 1934 to Dec. 1939. Make offer. W8NNJ.

**SACRIFICE**—170 watt fone xmt—parts worth \$300 rack & panel—\$150 cash. Consider outawl, Brischograph or movie camera in trade. Stamp for photo, etc. W9DRO, 1823 No. DuPont, Minneapolis, Minn.

**MAC** Auto code machines, low monthly rental, 50,000 words practice tapes. For those who own MacAutos, tapes for Macs, recording ink and blank tapes for sale. Write C. M. Ayers, 711 Boylston St., Boston, Mass. Tel. GRANite 7189-W.

**QSL'S**—SWL's. 100—3 color—75¢. Lapco, 344 W. 39th, Indianapolis, Ind.

**CRYSTALS**: unmounted oscillating \$1; three blanks \$1. QSO Crystals, Indiana, Pa.

**WANTED**. A good microscope and 16 millimeter movie camera. Will swap transmitter parts. W2LVZ.

**SELL**—Meissner Deluxe Shifter. Used 2 months, perfect condition. 80-40 coils. \$33. W2NCY, Dumont, N. J.

**X-RAY** Tube, good condition. Want Vibropack or ? Write K7GNN, Chichagof, Alaska.

**CODE** practice oscillators, \$2.85 to \$7.95. Keys, \$1.00 to \$2.85. Bugs, \$5.95 to \$9.50. Everything in transmitting and receiving equipment. Seel's Radio, Hartford, Conn.

# AMATEURS - YOUR THOUGHT MAY BE WORTH MONEY

## ZENITH RADIO CORPORATION

— 6001 DICKENS AVENUE —

CHICAGO

OFFICE OF  
E. F. McDONALD, JR.  
PRESIDENT

January 15, 1941

TO RADIO AMATEURS:

Frequency modulation is here - but where are the amateurs?

For 25 years this company, founded by amateurs, has encouraged the "hams" of the United States to bring their ideas.

As recently as the summer of 1939 we invited the entire fraternity to give us ideas on loops and we have sent reprints of the best published information on receiving loops available in the world today to hundreds of amateurs who wrote in for further information. We did not receive back very many useful ideas but after all the loop, which revolutionized radio last year, was old in the art and its sudden importance was due to rediscovery by the radio industry.

Now we have frequency modulation which is a really more important and more difficult field to furrow. This new art was introduced to the world in 1936 after 13 years of development in Major Armstrong's Laboratories. It has been introduced to the receiver buying public during the past year and many of its features have been publicized by the amateur magazines for many months. But, where are the amateurs?

Only a handful of frequency modulation receivers are known to us to be operating in Chicago and we have kept a very worthwhile program on the air for more than 17 hours a day and will continue to broadcast this program from now on. Other programs are being broadcast in other parts of the country and it is all high frequency experimental broadcasting.

In the last 3 months we have made 3 startling new discoveries about frequency modulation and the features of these inventions have been incorporated into our radio sets. But every one of these inventions originated in our own laboratories because we haven't heard a peep out of any "ham" on the subject.

This field is new and is wide open. Where are the amateurs?

Sincerely yours,



EFMCD-wh

# Your Nearby Dealer Is Your Best Friend

Your nearby dealer is entitled to your patronage. He is equipped with a knowledge and understanding of amateur radio. He is your logical source of advice and counsel on what equipment you should buy. His stock is complete. He can supply your needs without delay. His prices are fair and consistent with the high quality of the goods he carries. He is responsible to you and interested in you.

One of these dealers is probably in your city — Patronize him!

## ATLANTA, GEORGIA

Radio Wire Television Inc.  
265 Peachtree Street  
"The World's Largest Radio Supply House"

## JAMAICA, L. I., NEW YORK

Radio Wire Television Inc.  
90-08 166th Street (Merrick Road)  
"The World's Largest Radio Supply House"

## BALTIMORE, MARYLAND

Radio Electric Service Co.  
3 N. Howard St.  
Everything for the Amateur

## MONTREAL, CANADA

Canadian Electrical Supply Co., Ltd.  
285 Craig Street West  
Largest Distributors of Radio Parts & Testers in British Empire

## BOSTON, MASS.

Radio Wire Television Inc.  
110 Federal Street  
"The World's Largest Radio Supply House"

## NEWARK, N. J.

Radio Wire Television Inc.  
24 Central Avenue  
"The World's Largest Radio Supply House"

## BRONX, NEW YORK

Radio Wire Television Inc.  
542 East Fordham Road  
"The World's Largest Radio Supply House"

## NEW YORK, N. Y.

Radio Wire Television Inc.  
100 Sixth Avenue  
"The World's Largest Radio Supply House"

## BUFFALO, NEW YORK

Radio Equipment Corp.  
326 Elm Street  
WBPMC and WBNEL — Ham, service and sound equipment

## NEW YORK, N. Y.

Harrison Radio Company  
12 West Broadway  
Harrison Has It! Phone WOrth 2-6276 for information or rush service

## BUFFALO, NEW YORK

Dymac Radio  
1531 Main Street — Cor. Ferry  
Owned and operated by Hams for Hams GA. 0252

## PHILADELPHIA, PENNSYLVANIA

Eugene G. Wile  
10 S. Tenth Street  
Complete Stock of Quality Merchandise

## HARTFORD, CONNECTICUT

Radio Inspection Service Company  
227 Asylum Street  
What do you want? We have it. Radio exclusively

## PROVIDENCE, RHODE ISLAND

W. H. Edwards Company  
85 Broadway  
National, Hammarlund, Hallicrafter, Thordarson, Taylor, RCA

## HARTFORD, CONNECTICUT

Hatry & Young, Inc.  
203 Ann Street  
Stores also in Bridgeport and New Haven

## RICHMOND, VIRGINIA

The Arnold Company  
Broad at Harrison St.  
W3EQQ — "The Virginia Ham Headquarters" — W3FBL

## HOUSTON, TEXAS

R. C. & L. F. Hall  
1021 Caroline Street (C 0721)  
"Specialists in Amateur Supplies"

## SCRANTON, PENNSYLVANIA

Scranton Radio & Television Supply Co.  
519-521 Mulberry Street  
Complete Stock of Quality Amateur Supplies

YOU CAN BE SURE  
WHEN YOU BUY FROM

**QST**

ADVERTISERS

“Advertising for QST is accepted only from firms who, in the publisher’s opinion, are of established integrity and whose products secure the approval of the technical staff of the American Radio Relay League.”

*Quoted from QST’s advertising rate card.*

*Every conceivable need of a radio amateur can be supplied by the advertisers in QST. And you will know the product has the approval of the League’s technical staff*

*Index to Advertisers*

	PAGE
Aerovox Corporation	74
American Radio Institute	100
Astatic Microphone Laboratory, Inc.	106
Barker & Williamson	94
Billey Electric Company	100, 106
Candler System Company	82
Capitol Radio Engineering Institute	76
Cardwell Mfg. Corp., Allen D.	90
Centralab	5
Clarostat Mfg. Company, Inc.	100
Collins Radio Company	Cov. 2
Cornell-Dubilier Electric Company	62
Dodge’s Institute	98
Echophone Radio Corp.	87
Eitel-McCullough, Inc.	65
Electric Specialty Mfg. Company	94
Gardiner-Levering Company	72
General Electric Company	69
Gross Radio, Inc.	90
Halicrafters, Inc., The	1, 2
Hammarlund Mfg. Company, Inc.	61, 63
Harrison Radio Company	101
Harvey Radio Company	92
Henry Radio Shop	95
Hipower Crystal Company	98
Howard Radio Company	97
Instructograph Company, The	98
Janette Mfg. Company	74
Kenyon Transformer Company, Inc.	66
Mallory & Company, Inc., P. R.	60
Massachusetts Radio School	100
McGraw-Hill Book Company, Inc.	68
Meissner Mfg. Company, Inc.	93
Millen Mfg. Company, Inc., James	81
Miller Company, J. W.	102
National Company, Inc.	Cov. 3, 59, 67, 73
New York V.M.C.A. School	100
Newark Electric Company	99
Nilson Radio School	94, 98
Ohmrite Mfg. Company, Inc.	86
Par-Metal Products Corp.	78
Phelps Dodge Copper Products Corp.	70
Pioneer Gen-E-Motor Corp.	80
Port Arthur College	72
Precision Apparatus Corp.	80
RCA Institutes, Inc.	86
RCA Mfg. Company, Inc.	Cov. 4
Radio Mfg. Engineers, Inc.	111
Radio Parts Distributing Company	81
Radio Shack, The	102, 105
Scientific Radio Service	90
Sickles Company, F. W.	100
Simpson Electric Company	64
Solar Mfg. Corp.	100
Standard Transformer Corp.	79
Sun Radio Company	96
Taylor Tubes, Inc.	77
Teleplex Company	86
Terminal Radio Corp.	81
Thordarson Electric Mfg. Company	75
Triplett Elec’l Instrument Company, Inc.	82
United Transformer Corp.	112
Vibroplex Company, Inc., The	78
Ward Leonard Electric Company	76
Western Union Telegraph Company	91
Wholesale Radio Laboratories	96
Yaxley	60
Zenith Radio Corp.	108





# Why

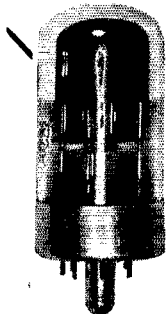

## RME Uses Lock-in Type Tubes in the "99"

*Recalling the not so good "good old days" when radio tubes had long floppy grid leads and inefficient bases, we can thank our lucky stars that we now have SINGLE-ENDED tubes with low-loss glass envelopes.*

**M**ORE than any one single thing the incorporation of Lock-in type tubes in the circuit of the RME-99 has been instrumental in making it the outstanding example of a quiet, sensitive, and selective tuner that it is. These diminutive tubes have been almost magical in the manner which they perform, especially at the higher frequencies. A close examination of one of these tubes will reveal that:

First, they are extremely small in size. This has the good effect of shortening all internal leads, thus making for a much more compact and efficient circuit.

Second, the socket leads *terminate in the tube elements themselves*. This eliminates soldered connections between tube elements and socket, which consequently cuts down extraneous noises due to the possibility of poorly made joints.

Third, each lead comes out the base of the tube through a tiny bead of hard glass. No more inefficient tube bases!

Fourth, each tube is perfectly shielded by an *internal shield*. This shield is placed quite close to the tube elements where it is most effective in its function of shielding.

Fifth, extensive laboratory measurements show with *all* electrodes terminating at the base, perform damping at the higher frequencies.

definitely that these tubes, with much reduced grid

With such ideal characteristics Radio Mfg. Engineers could *not* leave these tubes out of a truly precision high frequency receiver. **THAT'S WHY WE HAVEN'T LEFT THEM OUT OF THE RME-99!** Stop in your radio supplier's and take a look at the *only* communications receiver using the modern LOCK-IN type tubes.

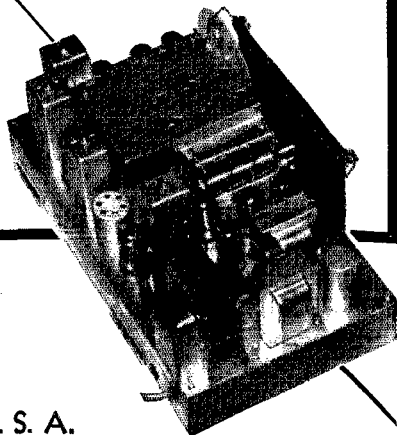

# RME

TIME WILL TELL

RADIO MFG. ENGINEERS, INC.

111 HARRISON STREET

PEORIA, ILLINOIS, U. S. A.

# Constant Voltage

FOR YOUR LABORATORY, YOUR PRODUCT, OR YOUR PRODUCTION LINE

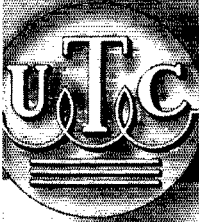

# STEADY-VOLT

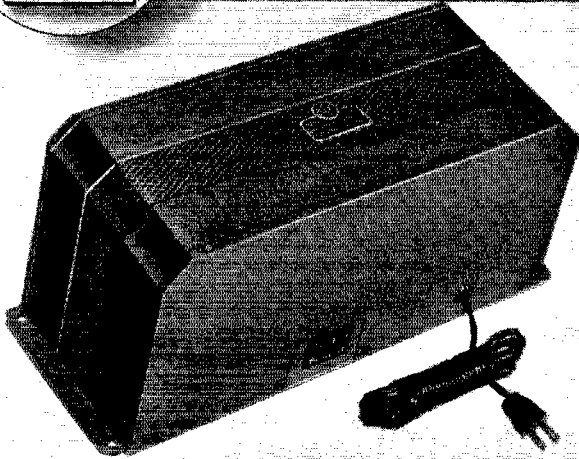

- ★ ACCURACY 1%
- ★ INDEPENDENT OF LOAD
- ★ NO MOVING PARTS
- ★ HIGH POWER FACTOR
- ★ HIGH EFFICIENCY
- ★ NEGLIGIBLE TIME CONSTANT
- ★ LOW DISTORTION
- ★ LOW TEMPERATURE RISE

## AUTOMATIC VOLTAGE REGULATORS 95-130 VOLT INPUTS . . . 110, 115, 120 VOLTS OUTPUT $\pm 1\%$

The UTC automatic voltage regulator is NEW. It involves no moving parts and effects instantaneous correction for either transient or chronic line voltage fluctuations.

### STANDARD TYPES

Type No.	Capacity VA — 60 Cyc.	Net Price
AR-1	15	\$12.00
AR-2	30	15.00
AR-3	60	21.00
AR-4	120	28.00
AR-5	250	46.00
AR-6	500	67.00
AR-7	1000	110.00
AR-8	2000	200.00

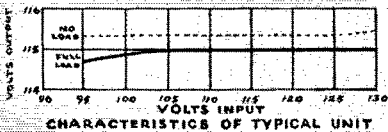

CHARACTERISTICS OF TYPICAL UNIT

Designs for 220 volt service available at 25% increase in price, for 50 cycle units increase price 25%; for 42 cycles, 35% increase; for 25 cycles, increase price 100%. Special secondary voltages available to customers' specifications at small increase in price.

### SPECIAL UNITS

The unique design of these regulators makes possible the construction of special units with relative ease. The output can be arranged to provide filament and plate voltage, or any other special voltages that may be required. Write for details.



# UNITED TRANSFORMER CORP.

150 VARICK STREET ★ NEW YORK, N. Y.  
EXPORT DIVISION: 100 VARICK STREET NEW YORK, N. Y. CABLES: "ARLAB"

# W2MGE

## FEATURES

- Frequency range 1.7 to 30-MC
- Coils available to 30-KC
- Separate, fixed-calibrated amateur bands spread ranges
- Two preselector stages
- Air-dielectric tuning capacitors
- Crystal filter
- Signal strength meter
- Automatic and manual volume control
- Beat oscillator

## HRO for SUPERB PERFORMANCE

Wherever the choice of a communication receiver is based on proved performance, the HRO is unfailingly selected. For the HRO is cleanly designed for master operators — free from superfluous tubes or details, yet including everything that can aid the users skill. The HRO combines ease of operation with brilliant performance and superb reliability.

**NATIONAL COMPANY, INC., MALDEN, MASS.**

# RCA 866-A/866

HALF-WAVE  
MERCURY-VAPOR  
RECTIFIER

\$150

Amateur Net



RCA engineering scores again! Not only does the new RCA-866-A/866 half-wave, mercury-vapor rectifier handle higher voltage at lower initial cost, but its truly great life means even greater value for your money. Once installed in your rig you can forget rectifier tube problems for a long, long time to come.

This new tube supersedes the 866 and 866-A and may be used in equipment designed for these types. An exclusive RCA development, it combines the ability of the 866 to conduct at relatively low plate voltage with that of the 866-A to withstand a high peak inverse voltage—and, in addition, gives you a *plus* performance that makes it far and away the greatest rectifier value RCA has ever offered.

Secret of the 866-A/866 is another top notch RCA engineering achievement—an edgewise-wound coated ribbon filament, illustrated at right, of great mechanical strength and providing more cathode area for the same filament power rating. This filament utilizes a new alloy material that not only has tremendous electron-emitting capabilities, but also holds the key to greater life.

Important among other features of the tube is the special filament shield which makes practical the use of a very low starting voltage. A ceramic cap insulator and new dome-top bulb minimize danger from bulb cracks caused by corona discharge and resultant electrolysis.

Get more for your money! Make sure your new rectifiers are RCA-866-A/866's.



*Unique New  
Filament  
Design Used in  
the 866-A/866*

#### RATINGS

Filament Voltage (A-C) .....	2.5 volts
Filament Current .....	5.0 amperes
Peak Inverse Voltage .....	5,000 max. volts
Up to 150 cycles per second ..	10,000 max. volts
Up to 1,000 cycles per second ..	5,000 max. volts
Peak Plate Current .....	1.0 max. ampere
Average Plate Current .....	0.25 max. ampere
Tube Voltage Drop (approx.) .....	15 volts

## SENSATIONAL PERFORMANCE

...at a New Low Price!

- **LONGER LIFE**—Assured by radically improved new filament, dome bulb and insulated plate cap.
- **HIGH RATING**—10,000 volts, peak inverse voltage. 1000 ma., peak plate current.
- **ENORMOUS EMISSION RESERVE**—Provides ability to withstand high peak loads.



# Transmitting Tubes

PROVED IN COMMUNICATION'S MOST EXACTING SERVICES

RCA MANUFACTURING CO., INC., CAMDEN, N. J. - A Service of The Radio Corporation of America

In Canada: RCA VICTOR COMPANY LIMITED, MONTREAL

