

QST

november, 1940

25 cents

35c in Canada

devoted entirely to

amateur radio



In This Issue—A Complete Two-Tube Multi-Band Receiver

COLLINS 161

RATED POWER OUTPUT: 500 watts
A₁, 300 watts A₂ and A₃.

FREQUENCY RANGE: 2000-16000 kc.

NUMBER OF FREQUENCIES: 10 with
Autotune throughout the range.

AUDIO RESPONSE: 100-5000 c.p.s.
Less than 3 db from 1000 cycle refer-
ence.

AMPLITUDE DISTORTION: Less than
10% r.m.s. total harmonics at any modu-
lation level. Measured at 400 c.p.s.

ANTENNA IMPEDANCE: Unbalanc-
ed antennas of 70-600 ohms up to 60°
phase angle.

POWER SOURCE: 220 volt, single
phase, 50/60 cycle.

AMBIENT TEMPERATURE RANGE:
0° C. to +50° C.

REMOTE CONTROL: Any of the five
standard Collins arrangements.

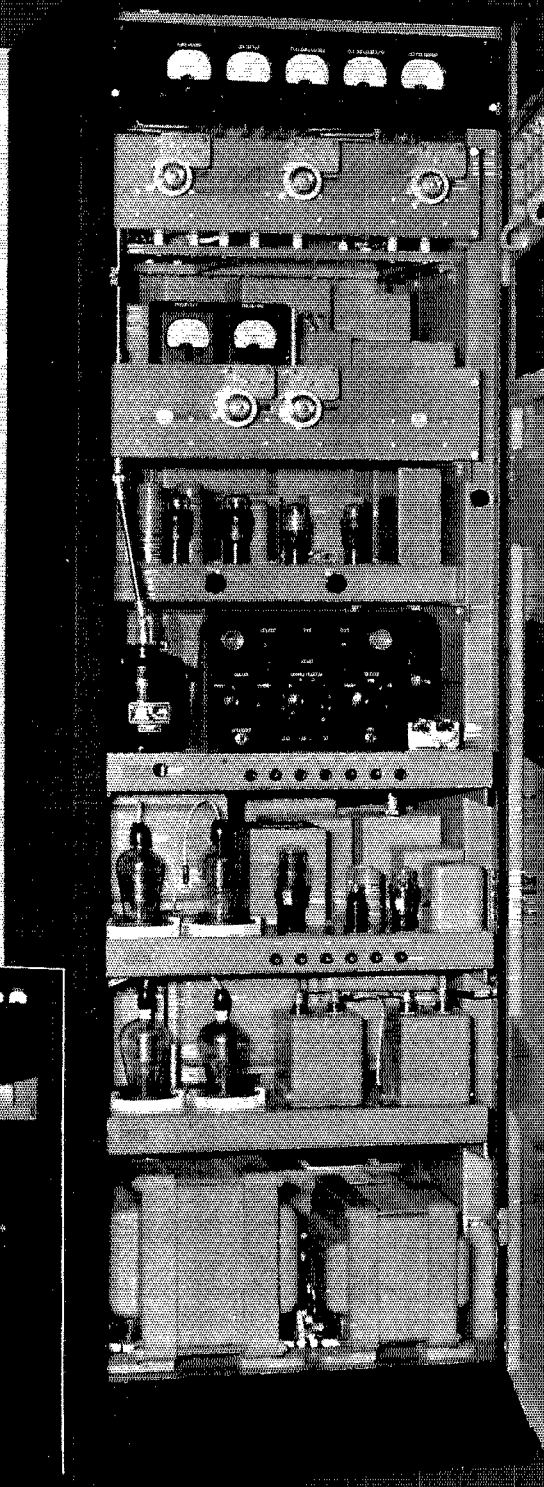

COLLINS
RADIO COMPANY

CEDAR RAPIDS, IOWA

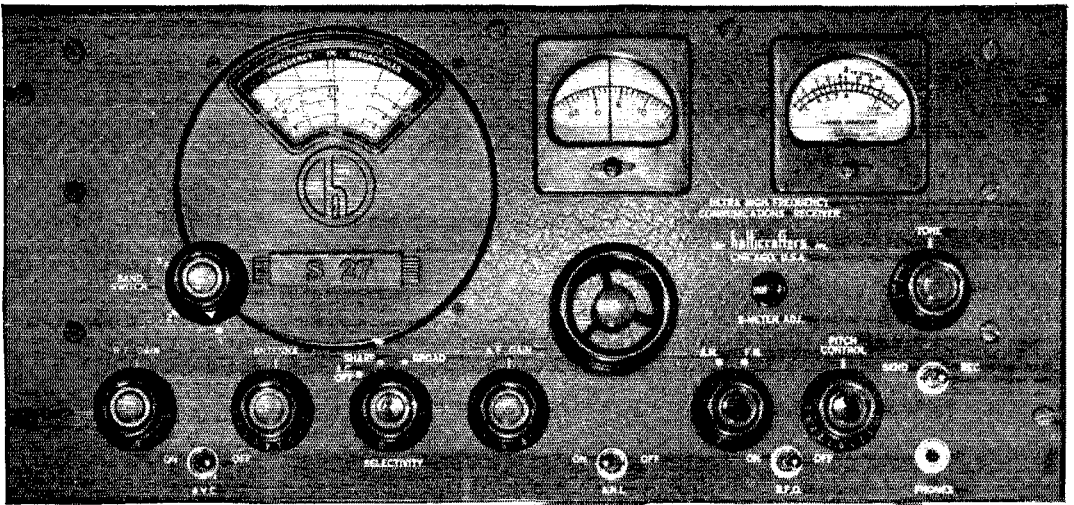

Super Efficiency!

IN TWO NEW HALLICRAFTER RECEIVERS

BOTH designed to government specifications. Model S-27 (above) is the first general coverage UHF receiver providing reception of both Amplitude and Frequency modulated signals. (27 to 145 Megacycle coverage). **Q** The new Model SX-28 (below) is a 15 Tube general purpose communication receiver incorporating the latest technical advances. Each sells for less than two hundred dollars.

the **hallicrafters inc.**
CHICAGO, U. S. A.

*Used by 33 Governments
Sold in 89 Countries*

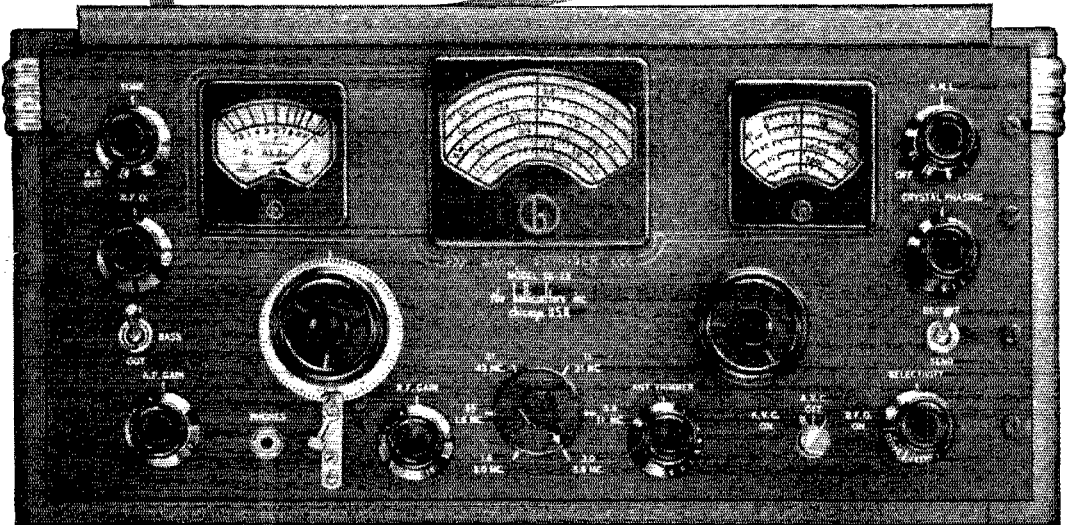



a new hallicrafters
 WITH 1941 IMPROVED FEATURES
The SKYRIDER MARINE
 (MODEL S-22R)

THIS communications model is truly an all purpose receiver: Covers Weather and Time Signals (NAA), Beacons and Aircraft Weather, Commercial wave lengths—Ship-to-Shore, Ship-to-Ship, (calling and working on the same band.) The Broadcast band, The Amateur Bands (160 to 20 meters inclusive.) Police, High Frequency Ship-to-Shore, Aircraft, Press and Government channels. Plus the International Short Wave channels, 4 Bands, Frequency range from 16.5 to 2730 meters

IMPROVED FEATURES—Two stages of IF—Greater sensitivity and selectivity. Permeability tuned IF transformers assure permanency of tuning.

Specially treated variable mica condensers will maintain adjustment under all atmospheric changes.

Directly calibrated main tuning dial.

Permeability-tuned beat oscillator with control to change BFO setting.

All steel parts and chassis heavily copper plated and nickelled.

(18 mc. to 110 kc.), 110 volt AC/DC operation.

Easy logging is provided by mechanical bandspread with separate dial. The directly calibrated main tuning dial eliminates the use of confusing charts and tables. The improved image rejection at the higher frequencies is achieved through the use of a 1600 kc. IF amplifier. Tuning permanency is assured through permeability tuned IF transformers. The 1941 Sky Rider Marine (Model S-22R) will give the maximum in utility and dependability.

Highly efficient mechanical bandspread with separate dial provides easy logging.

Frequency range 16.5 to 2730 meters (18 mc. to 110 kc.). Band 1—110-410 kc. Band 2—400-1500 kc. Band 3—1.7-5.9 mc. Band 4—5.3-18 mc. 8 Tubes, cabinet dimensions 18 1/4" x 9 1/2" x 8 1/2"

The Sky Rider Marine (Model S-22R) complete with tubes and speaker, \$64.50 net.

the hallicrafters inc.
 CHICAGO, U. S. A.

USED BY 33 GOVERNMENTS • SOLD IN 89 COUNTRIES

NOVEMBER 1940

VOLUME XXIV

NUMBER 11



STAFF

Editorial

KENNETH B. WARNER, W1EH
Editor and Business Manager

CLARK C. RODIMON, W1SZ
Managing Editor

GEORGE GRAMMER, W1DF
Technical Editor

DONALD H. MIX, W1TS
BYRON GOODMAN, W1JPE
Assistant Technical Editors

EDW. P. TILTON, W1HDQ
Contributing Editor, U.H.F.

VERNON CHAMBERS, W1JEQ
Technical Information Service

JAMES J. LAMB, W1AL
Research Engineer, A.R.R.L.

Advertising

F. CHEYNEY BEEKLEY, W1GS
Advertising Manager

CHARLES BRUNELLE
Asst. Advertising Manager

Circulation

DAVID H. HOUGHTON
Circulation Manager

RALPH T. BEAUDIN, W1BAW
Asst. Circulation Manager



OFFICES

38 La Salle Road
West Hartford, Connecticut

Subscription rate in United States and Possessions, \$2.50 per year, postpaid; all other countries, \$3.00 per year, postpaid. Single copies, 25 cents. Foreign remittances should be by international postal or express money order or bank draft negotiable in the U. S. and for an equivalent amount in U. S. funds.

Entered as second-class matter May 29, 1919, at the post office at Hartford, Connecticut, under the Act of March 3, 1879. Acceptance for mailing at special rate of postage provided for in section 1103, Act of October 3, 1917, authorized September 9, 1922. Additional entry at Concord, N. H., authorized February 21, 1929, under the Act of February 28, 1925. Additional second-class entries to cover sectional editions authorized March 20, 1935.

Copyright 1940 by the American Radio Relay League, Inc. Title registered at United States Patent Office.

QST

devoted entirely to

AMATEUR RADIO

PUBLISHED, MONTHLY, AS ITS OFFICIAL ORGAN, BY THE AMERICAN RADIO RELAY LEAGUE, INC., AT WEST HARTFORD, CONN., U. S. A.; OFFICIAL ORGAN OF THE INTERNATIONAL AMATEUR RADIO UNION



CONTENTS

Editorials	7
A Simple Two-Tube Exciter Don H. Mix, W1TS	9
Modernizing the Regenerative Superhet George Grammer, W1DF	14
The Square-Corner Reflector Beam Antenna for Ultra-High Frequencies John D. Kraus, W8JK	18
1940 Field Day Scores	23
What the League Is Doing	24
An Electron-Coupled Oscillator, 1941 Model F. G. Southworth, W5JJ	26
Don't Miss the Eleventh A.R.R.L. Sweepstakes F. E. Handy, W1BDI	30
A Stabilized 2½-Meter Oscillator Byron Goodman, W1JPE	33
Two-Way Television Inaugurated	36
More on Balloon-Supported Antennas R. Carleton Greene, W8PWFU	38
Naval Communication Reserve Notes	40
Link Coupling Between Transmitter Stages W. Van B. Roberts, W3CHO	41
On the Ultra Highs E. P. Tilton, W1HDQ	42
Silent Keys	45
I.A.R.U. News	46
Hints and Kinks for the Experimenter	
Composite Oscillator — Simple Transformerless Duplex Bias Supply — Modulator as Keying Monitor in Portable Transmitter — Converting the B.C. Receiver for 160-Meter Work — Shunt-Fed Mobile Antennas — Roll Paper Attachment for Underwood Typewriter	47
New Transmitting Tube 815	50
Correspondence from Members	51
Operating News	52
How's DX?	56
A.R.R.L. Affiliated Club Honor Roll	80
WWV Schedules	98
Hamads	107
QST's Index of Advertisers	110

Section Communications Managers of the A.R.R.L. Communications Department

All appointments in the League's field organization are made by the proper S.C.M., elected by members in each Section listed. Mail your S.C.M. (on the 16th of each month) a postal covering your radio activities for the previous 30 days. Tell him your DX, plans for experimenting, results in phone and traffic. He is interested, whether you are an A.R.R.L. member or get your QST at the newsstands; he wants a report from every active ham. If interested and qualified for O.R.S., O.P.S. or other appointments he can tell you about them, too.

ATLANTIC DIVISION				
Eastern Pennsylvania Maryland-Delaware-District of Columbia Southern New Jersey Western New York Western Pennsylvania	W3BES W3CIZ W3CCO W8PLA W8CKO	Jerry Mathis Hermann E. Hobbs Lester H. Allen Fred Chichester E. A. Krall	6042 Master St. 9701 Monroe St. Silver Spring P.O. 704 Quinton Ave. 703 Broadway	Philadelphia Linden, Maryland Trenton Sonyea East McKeesport
CENTRAL DIVISION				
Illinois * Indiana Kentucky Michigan Ohio Wisconsin	W9ILH W9AB W9ARU W8DFE W8AQ W9UIT	Mrs. Carrie Jones Harry B. Miller Darrell A. Downard Harold C. Bird E. H. Gibbs Aldrich C. Kronos	2407 Central Ave. 729 E. Lowell Ave. 116 N. Longworth Ave. R.F.D. 2 405 Broad St. 2702 So. 46th St.	Alton Mishawaka Louisville Pontiac Warsaw Milwaukee
DAKOTA DIVISION				
North Dakota South Dakota Northern Minnesota Southern Minnesota	W9WWL W9ADJ W9IGZ W9YNQ	Anton C. Theodos E. C. Mohler Edwin L. Wicklund Millard L. Bender	Box 444 Box 149 R.F.D. 3 608 N. Huron Ave.	Williston Rapid City Kensington Spring Valley
DELTA DIVISION				
Arkansas Louisiana Mississippi Tennessee	W5ABI W5DWW W5EWD W4DWS	H. E. Vette W. J. Wilkinson, Jr. Jewell W. Cole William Harold Walker	4415 West 12th St. 1523 Laurel St. c/o City of McComb Water Dept. 1901 Cedar Lane	Little Rock Shreveport McComb City Nashville
HUDSON DIVISION				
Eastern New York N. Y. C. & Long Island Northern New Jersey	W2LU W2AZV W2GMN	Robert E. Haight E. L. Baunach Fred C. Read	511 South Holmes St. 102 Central Ave. 1014 North Ave.	Scotia Massapequa, L. I. Elizabeth
MIDWEST DIVISION				
Iowa Kansas Missouri Nebraska	W9PTR W9IEG W9OUD W9DI	L. B. Vennard Melvin D. Kirby Miss Letha Allendorf William J. Bamer	1113 So. 9th St. 1015 W. 3rd St.	Burlington Arlington Jonh Tobias
NEW ENGLAND DIVISION				
Connecticut Maine Eastern Massachusetts Western Massachusetts New Hampshire Rhode Island Vermont	W1CTI W1IE W1ALP W1JAH W1CPT W1HRC W1KJG	Frederick Ellis, Jr. H. W. Castner Frank L. Baker, Jr. William J. Barrett Mrs. Dorothy W. Evans Clayton C. Gordon Clifton G. Parker	19 Merrill Rd. 147 Church 21 Colby Road 239 Columbia St. 163 Sbr W. Main St. 70 Columbia Ave., Gaspee Box 537	Norwalk Damariscotta North Quincy Adams Glenford Plateau, Warwick Morrissville
NORTHWESTERN DIVISION				
Alaska Idaho Montana Oregon Washington	K7GNN W7CRI W7CPY W7GNT W7FCG	James G. Sherry Clifford A. Jessup Rex Roberts Carl Austin W. Beale	803 E. Seventh St. Box 1088 1137 Federal R. 4, School Ave.	Chichagof Moscow GlenDive Bend Walla Walla
PACIFIC DIVISION				
Hawaii Nevada Santa Clara Valley East Bay San Francisco Sacramento Valley Philippines San Joaquin Valley	K6ETF W6BIC W6IUZ W6TI W6CIS W6MID KA1GR W6KUT	Francis J. Blatt Edward W. Heim Earl F. Sanderson Horace R. Greer Kenneth E. Hughes Vincent N. Feldhausen George L. Rickard Edwin A. Address	837 16th Ave. 509 Claremont St. 101 Claremont Ave. 414 Fairmount Ave. 627-36th Ave. 113 South Quincy St. Box 849 2921 North Van Ness Blvd.	Honolulu Reno San Jose Oakland San Francisco McCloud Manila Fresno
ROANOKE DIVISION				
North Carolina South Carolina Virginia West Virginia	W4CYB W4BOE/ANG W3GWQ W8OXO	W. J. Wortman Ted Ferguson Frank S. Anderson, Jr. W. D. Tabler	P. O. Box 566 1213 College St. 4703 New Kent Ave. 1004 So. Davis Ave.	Morganton Columbia Richmond Hikins
ROKY MOUNTAIN DIVISION				
Colorado Utah-Wyoming	W9EHC W7CLG	Carl C. Drumeller Ernest E. Parshall	819 East Dale St. Salt Creek Electric Plant	Colorado Springs Midwest, Wyoming
SOUTHEASTERN DIVISION				
Alabama Eastern Florida Western Florida Georgia West Indies (Cuba-Puerto Rico- Virgin Islands)	W4DGS W4PEI W4AXP W4AGI CM2OP	James F. Thompson Carl G. Schaal Oscar Cederstrom Leland W. Smith Mario de la Torre	12 Clanton Ave. Waucoma Apts. Lakeview Hotel Second St. & Bruce Ave. 2010 Pennsylvania Ave. Escobar 110 (Altos)	Montgomery Clermont De Funiak Springs Augusta Habana, Cuba
SOUTHWESTERN DIVISION				
Los Angeles Arizona San Diego	W6MQM W6KMM W6BEZ	Ralph S. Clark Marion B. Hull Louis A. Cartwright	1038 Milwaukee Ave. 617 North Fourth Ave. 370 Nautilus	Los Angeles Phoenix La Jolla
WEST GULF DIVISION				
Northern Texas Oklahoma Southern Texas New Mexico	W5DXA W5GFT W5MN W5ENI	Lee Hughes Russell W. Battern Horace E. Biddy Dr. Hilton W. Gillett	125 N. Main St. Box 290 1746 Schley Ave.	Childress Enid San Antonio Lovington
MARITIME DIVISION				
Maritime	VE1DQ	A. M. Crowell	69 Dublin St.	Halifax, N. S.
ONTARIO DIVISION				
Ontario	VE3EF	Flying Officer Donald R. Gunn	% Canadian Bank of Commerce	New Toronto, Ont.
QUEBEC DIVISION				
Quebec	VE2CO	Lindsey G. Morris	Apt. 6, 4510 Girouard Ave., N.D.G.	Montreal, P. Q.
VANALTA DIVISION				
Alberta British Columbia	VE4GE VE5DD	C. S. Jamieson C. O. L. Sawyer	581 W. Riverside Drive 2634 West 31st Ave.	Drumheller, Alta. Vancouver
PRAIRIE DIVISION				
Manitoba Saskatchewan	VE4AAW VE4SY	A. W. Morley Arthur Chesworth	747 McMillan Ave. 1071 4th Ave., N. W.	Winnipeg Massage Jaw

* Officials appointed to act until the membership of the Section choose permanent S.C.M.s by nomination and election.

HOW MANY OF THESE Do YOUR Tubes Give You?

- 1—Low Driving Power—Fewer Stages
- 2—Easy Frequency-multiplication
- 3—More Compact Construction
- 4—High Output—High Efficiency
- 5—High-frequency Operation
- 6—Quick Band Change
- 7—No Neutralizing

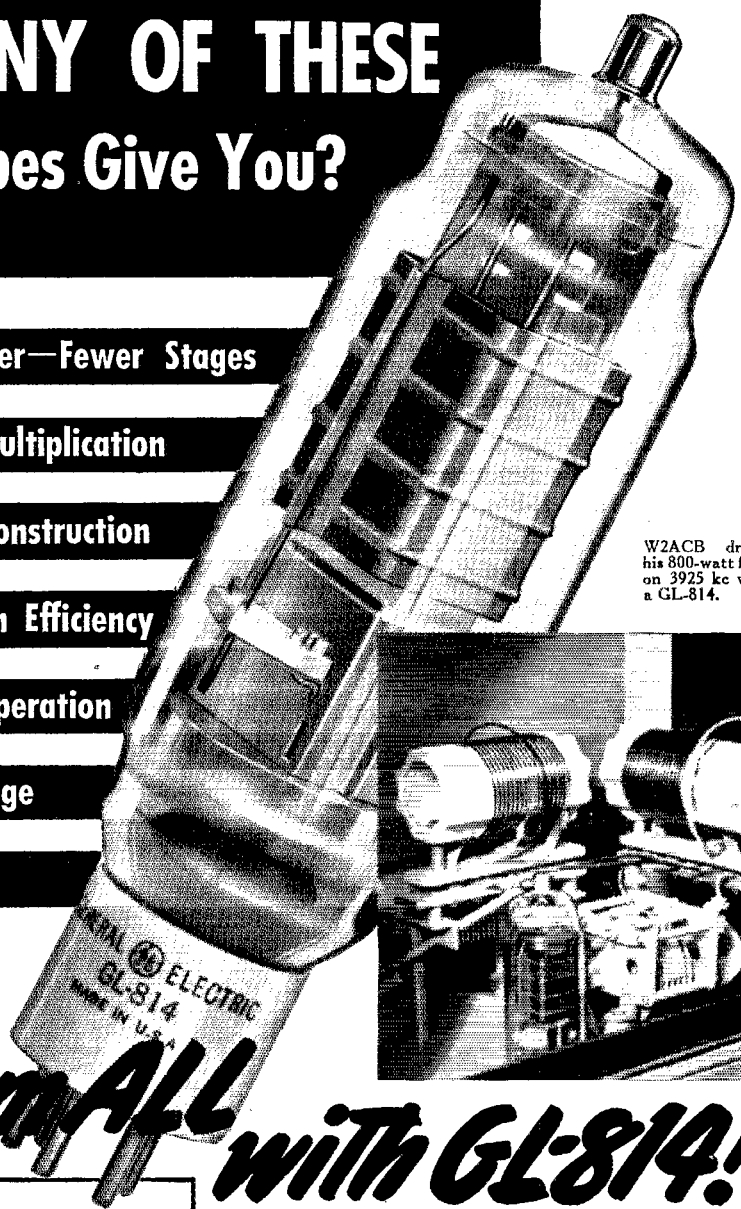

W2ACB drives his 800-watt transmitter on 3925 kc with a GL-814.

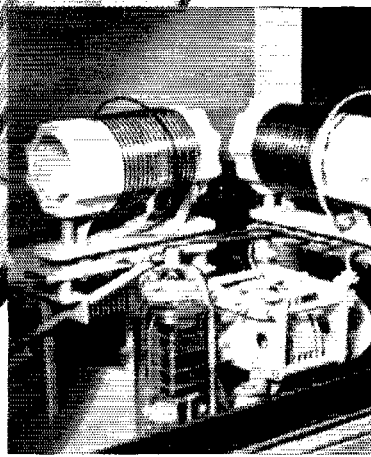

Get Them ALL with GL-814!

GL-814—BEAM-POWER TETRODE ICAS* RATINGS

Fil. Volts . . . 10 Fil. Amp. . . . 3.25

	Class C Telegraph	Class C Telephone	
		Plate Mod.	Grid Mod.
Plate Volts	1500	1250	1500
Plate Milliamp	150	144	60
Driving Power, Watts . .	1.5	3.2	4.2
Output Power, Watts . .	160	130	35

**Intermittent Commercial and Amateur Service*

For the low-power man who wants to step up a notch or the high-power man who wants greater flexibility in his rig, the GL-814 deserves plenty of consideration. GL-814's high power-sensitivity puts you up to 160 watts (cw) with only 1.5 watts driving power. As a frequency multiplier it's great. Band switching becomes a snap. By cutting out intermediate stages you cut down on equipment required, and on transmitter size. And there's no neutralizing to worry about. Figure how GL-814's can do a job for you . . . then see or write your G-E dealer. *Try G.E. and measure the difference!* General Electric, Schenectady, N. Y.

GL-814 - - \$17.50

THE AMERICAN RADIO RELAY LEAGUE

Directors

<i>President</i>	
GEORGE W. BAILEY.....	WIKH 74 Webster Road, Weston, Mass.
<i>Vice-President</i>	
CHARLES E. BLALACK.....	W6GG 1700 Foothill Blvd., Altadena, Calif.
<i>Canadian General Manager</i>	
ALEX REID.....	VE2BE 169 Logan Ave., St. Lambert, P. Q.
<i>Atlantic Division</i>	
WALTER BRADLEY MARTIN.....	W3QV Box 612, Roslyn, Pa.
<i>Central Division</i>	
R. H. G. MATHEWS.....	ex-W9ZN 4534 Dover St., Chicago
<i>Dakota Division</i>	
FRED W. YOUNG.....	W9MZM 107 Hanover St., Mankato, Minn.
<i>Delta Division</i>	
E. RAY ARLEDGE.....	W6SI P.O. Box 286, Pine Bluff, Ark.
<i>Hudson Division</i>	
KENNETH T. HILL.....	W2AHC 115 Willow St., Douglaston, L. I., N. Y.
<i>Midwest Division</i>	
FLOYD E. NORWINE, JR.....	W9EFC 7405 Elawatha Ave., Richmond Heights, Mo.
<i>New England Division</i>	
PERCY C. NOBLE.....	W1BVR 37 Broad St., Westfield, Mass.
<i>Northwestern Division</i>	
RALPH J. GIBBONS.....	W7KY c/o United Air Lines, Portland, Ore.
<i>Pacific Division</i>	
J. L. McCARGAR.....	WBEY 66 Hamilton Pl., Oakland, Calif.
<i>Ronoko Division</i>	
H. L. CAVENESS.....	W4DW State College Station, Raleigh, N. C.
<i>Rocky Mountain Division</i>	
GLEN R. GLASSCOCK.....	W9FA 2164 So. Corona St., Denver
<i>Southeastern Division</i>	
WILLIAM C. SHELTON.....	W4ASR Box 652, Daytona Beach, Fla.
<i>Southern Division</i>	
JOHN E. RICKS.....	W6BKY 801 E. California St., Whittier, Calif.
<i>West Gulf Division</i>	
WILLIAM A. GREEN.....	W5BKH 801 Ross St., Abilene, Texas

THE AMERICAN RADIO RELAY LEAGUE, INC., is a non-commercial association of radio amateurs, banded for the promotion of interest in amateur radio communication and experimentation, for the relaying of messages by radio, for the advancement of the radio art and of the public welfare, for the representation of the radio amateur in legislative matters, and for the maintenance of fraternalism and a high standard of conduct.

It is an incorporated association without capital stock, chartered under the laws of Connecticut. Its affairs are governed by a Board of Directors, elected every two years by the general membership. The officers are elected or appointed by the Directors. The League is non-commercial and no one commercially engaged in the manufacture, sale or rental of radio apparatus is eligible to membership on its board.

"Of, by and for the amateur," it numbers within its ranks practically every worth-while amateur in the nation and has a history of glorious achievement as the standard-bearer in amateur affairs.

Inquiries regarding membership are solicited. A bona fide interest in amateur radio is the only essential qualification; ownership of a transmitting station and knowledge of the code are not prerequisite. Correspondence should be addressed to the Secretary.



Past Presidents

HIRAM PERCY MAXIM, 1914-1936
EUGENE C. WOODRUFF, 1936-1940

Officers

<i>President</i>	GEORGE W. BAILEY, WIKH Weston, Mass.
<i>Vice-President</i>	CHARLES E. BLALACK, W6GG Altadena, Calif.
<i>Secretary</i>	KENNETH B. WARNER, W1EH West Hartford, Connecticut
<i>Treasurer</i>	ARTHUR A. HEBERT, W1ES West Hartford, Connecticut
<i>Communications Mgr.</i>	F. EDWARD HANDY, W1BD1 West Hartford, Connecticut

General Counsel..... PAUL M. SEGAL
1026 Woodward Building, Washington, D. C.

Address all general correspondence to the administrative headquarters at West Hartford, Connecticut.

"IT SEEMS TO US—"

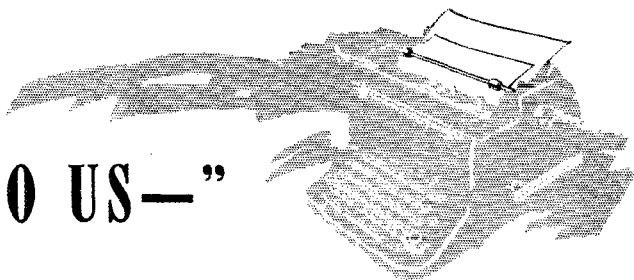

CONFIDENCE

ARE you one of those amateurs who are holding off from buying some needed or much-desired piece of gear because of fear that amateur radio in this country is going to be closed up soon? There seem to be several of you, and we have a few words we'd like to get off on the subject:

Manufacturers and dealers are currently offering us the most interesting line of apparatus and parts that has existed in the history of radio. If we and they are not to lose contact, if we are not to lose the benefit of their business interest in us and their new developments especially designed for our field, it is perfectly manifest that we must continue to patronize them — if we can feel safe in doing so. Otherwise they'll go broke and fold, or — what is of almost the same result to us — concentrate on government orders and abandon us. The thing seems to hinge entirely, then, on whether we can feel safe.

For twenty-odd years we've been keeping the rails hot between Hq. and Washington. We frequently visit many government officials there, both military and civil. They were somewhat concerned about amateur operation early this past summer. That's why they got up the orders that were imposed on us last June — to correct the things that they thought needed correcting. All of them now profess to us to be satisfied with our present situation. They realize that amateur radio is that most remarkable kind of a training school, one in which ardent devotees train themselves in the intricacies of a very complex art at their own expense! They want to see this self-training intensified, not discouraged; national defense considerations require it. Do you think that F.C.C. would be engaged in the present terrific expense and effort of getting our fingerprints and citizenship histories if there were intention of shutting us down shortly? No, the indexes all point the other way and they tell us that no new regulations are even under contemplation. We do not have the slightest knowledge whether this country will eventually get into the war but there is certainly no suggestion that it will in the near future; and we feel that, short of that, we are going to continue our present serene course without further material restriction.

So if you're planning a new antenna system or eyeing a new receiver or lying awake nights visualizing a new sender-outer, we consider that you are safe in investing in it; hop to it.

CONSCRIPTION

NOVEMBER will be a momentous month in the American chronicle, marking the first peace-time induction for compulsory military training in our country's history. Inevitably, amongst those thus drafted will be a goodly number of radio amateurs, members of A.R.R.L. A word to you young fellows:

The military folks will be keeping a sharp lookout for numerous kinds of technical specialists amongst the men called up. You, because you're a radio amateur, will prefer radio work — because it will be more interesting to you than other work, because you'll learn something new, and because you know you can serve best by giving of your radio talents. You will find that arrangements have been provided to give radio assignments to conscripts who are hams. This is the way we understand it will work:

When conscription begins in November, the men called up for duty will first be ordered to a local "induction station" or "reception center," where their qualifications will be determined and the proper arm or service for them decided. Have your license with you, because *right there is the place for you to announce your radio qualifications and press hard for an assignment to radio work.* It shouldn't be difficult since, we are told, they will have instructions to locate as many radio men as possible. From the reception center the men will be sent to the "replacement center" of the service to which they have been assigned, to receive training for a period of up to three months. The Signal Corps and the Air Corps and probably other arms will maintain such centers for the training of their communications personnel. After the schooling the men will go to duty with tactical units of their arm, filling out the remainder of their training year with field service. If you are quite a skilled amateur you will not have to take the entire school course but will slip through with a small amount of "processing" and be assigned to a unit, or perhaps retained at the school in an instructorship. Your cue is to advertise the

fact that you're a communications man right from your first reporting, until you have a radio assignment.

You men are giving up a year to receive training and experience at the hands of your government. That year can be pretty much what you make it. It will be no bed of heliotrope but if you apply yourselves you'll come out of it a whole lot smarter and healthier than when you went in. Remember that you will be the representatives of the institution of amateur radio. For years we have said that the amateur body provided a great reservoir of trained personnel for national needs. In you the government is now sampling that reservoir. Show them what a radio amateur can do! Don't be too cocky but show them that he's good! Play the game and do your part to maintain the tradition that a good ham can lick any other kind of a radio man at whatever needs to be done.

Incidentally, the League has proposed to the F.C.C. that it would be swell if the expiring licenses of men on active service were renewed upon application without the usually-required proof of activity. Sort of keeping the home fires burning. The Commission says it will be glad to cooperate and we believe something can be worked out. Watch *QST* for the news.

Which reminds us: Have your folks remain *QST* to you, so you'll keep up with what's going on. (Requires additional postage.) When you're "permanently" located you can have us change your address, if you wish, but in such a request give us the *QTH* of the old homestead as well as the one where Uncle Sam is putting you up. Matter of fact, we'd like a postcard occasionally anyway, both to have the news and because we'd like to keep a score-sheet on the ham's contributions to the defense training program. The best of luck, OM!

DEFENSE MATTERS

THERE has been an American Radio Relay League in this country since 1914—nearly twenty-seven years. It belongs to you fellows and it looks after your interests through the directors whom you elect. Whatever the new problems or whatever the changing aspects of American life, the League can be counted upon to be on the job in your interests. It has the record of having done so unflinchingly for a full generation.

It isn't necessary to assert to you that it is busy to-day, both in looking after your interests and in consulting with government officials on the best employment for amateur talents as the country gears up to face a mad world. You already know it, because you have seen these relations growing over the past generation. Your League is already here and it's all set; it is *the* amateur organization. There is no need for A.R.R.L. suddenly to wrap itself

in the star-spangled banner and start screaming like eagles as to how, with the help of the heavenly host and divers names of big-shots, it will overnight raise a hundred million radio militiamen and save the country from the powers of darkness, including taking over the monitoring functions of the federal government. If our organization seems a bit too conservative and dignified for that sort of thing, perhaps it is because our contacts are better and our knowledge of the situation and the needs sounder.

In recent months, officials of the League have had many conversations with government authorities, both civil and military. We have explored the possibilities for amateurs to help in the defense picture. Some interesting ideas are in the works, ideas that can't be talked about yet but which will be announced as they take definite form. The important thing we want you to see now is that your association is, as usual, on the job, and that what needs to be done is being done, even if we aren't waving flags.

In the meanwhile, the greatest contribution to national preparedness that the individual amateur can make is to look after his personal preparedness by raising his code proficiency, including copying on the mill. Phone amateurs have not only that code duty but also the opportunity to develop proficiency in handling traffic by voice. For those with a yen for active-service training, both Army (Signal Corps and Air Corps) and Navy are seeking enlistments, offering schooling, contact with new gear and methods, and field experience.

As we go about our work on the air, we are requested to keep our ears open and report any monkey business we hear to the nearest office of F.C.C. It is their work; we just help. If we're approached with improper operating proposals, ditto nearest office of F.B.I.

As the National Guard moves out for active duty, a Home Guard will be formed in each state, mostly of men out of draft age or with dependents or flat feet. They have to start from scratch, with little or no equipment, no radio personnel. In some states they are already calling for amateur help. Here is a chance—see if they don't need you in your state.

With over a million men away from home in camps and bases and schools, there is going to be an amateur message-traffic problem of big proportions. Our Communications Department is planning now what ought to be done about it. It's down our groove, the kind of public service we've always given, and it will be important in the coming year. It will take our best skill as relayers and will provide traffic proficiency as well as code proficiency itself. There will be a place in it for everybody.

K. B. W.

A Simple Two-Tube Exciter

Compact Multi-Band Plug-in-Coil Unit Delivering up to 50 Watts or More

BY DON H. MIX,* W1TS

Here is a simple exciter or low-power transmitter which ought to be just the ticket for the more advanced beginner — the ham who is looking for something more pretentious with which to replace his simple 6L6 oscillator transmitter. Making use of a pair of the less-expensive tubes and a system of plug-in coils, it will deliver power up to 50 watts or more and cover five bands — four bands with one crystal.

THE first transmitter for most beginners is the crystal-controlled oscillator. Although limited in performance, it is a logical choice because of its extreme simplicity and low cost. While such a transmitter will furnish much in the way of fun and operating experience, most amateurs, sooner or later, wish to expand. Just as a good communications-type receiver is considered a good long-term investment, a well-built exciter is something which, once built, may be used as the nucleus for almost limitless expansion in the transmitting end of the station.

An exciter need not be complicated nor an item of great expense. A pair of the less-expensive tubes and a system of plug-in coils are about all that are needed for a multi-band exciter which

*Asst. Technical Editor, *QST*.

will serve as a transmitter of quite respectable power in itself, or may be used to drive any sort of amplifier up to one of a half-kw. rating or so.

In the unit shown in the accompanying photographs, a 6L6G oscillator is used to drive an 807 as an amplifier-doubler. As shown in the diagram of Fig. 1, a Tri-tet circuit, which is used to obtain output from the oscillator at harmonics of the crystal frequency, is reduced to the simple tetrode circuit for oscillator output at the crystal fundamental by short-circuiting the cathode tank circuit. Sufficient oscillator output at the fourth harmonic of the crystal fundamental frequency, as well as at the second-harmonic and fundamental frequencies, is obtainable to drive the 807 which may be operated as either a straight amplifier at the frequency of the oscillator output or as a frequency doubler. This makes it possible to obtain an output of 25 to 50 watts or more in four bands from a single crystal of properly-chosen frequency with the unit operating from a 750-volt, 250-ma. power supply.

If, for example, we start out with a crystal ground to a frequency of 1760 kc., Sw_1 will be closed and, with the oscillator operating in the tetrode circuit, its plate circuit, as well as the plate circuit of the 807, will be tuned to this frequency. The 807, operating as a straight amplifier, will then deliver power output at 1760 kc. If the 1.7-Mc. coil is plugged in at L_1 and 3.5-Mc. coils at L_2 and L_3 and Sw_1 opened, the oscil-

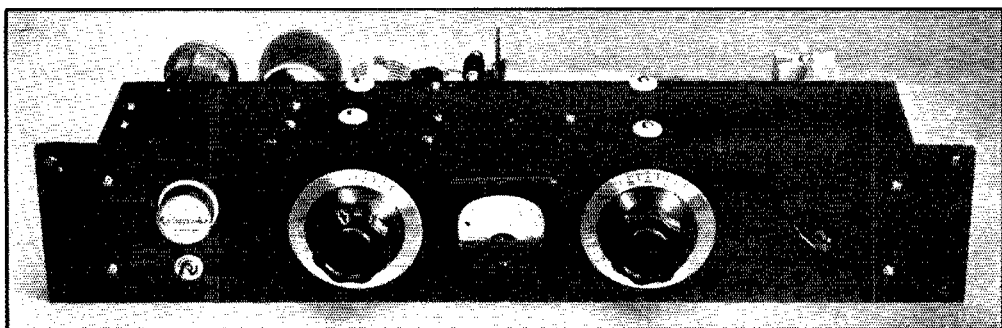

The two-tube plug-in coil exciter is built to conserve space in the relay rack. The panel is $3\frac{1}{2}$ in. by 19 in. A clearance hole is cut in the left end of the panel for the crystal socket which is mounted in the chassis directly above the cathode-circuit switch. The left-hand dial controls the tuning of the oscillator plate tank circuit, while the one to the left is the control for the output tank circuit. The switch at the right-hand end is for the 200-ma. meter. The outer ceramic buttons used in providing insulating mountings for the tank condensers are the only things appearing on top of the chassis.

lator will double the frequency when its plate circuit is tuned to 3520 kc. and the plate circuit of the 807 when tuned to the same frequency, will deliver power at 3520 kc. The same output frequency could be obtained by operating the oscillator in the pentode circuit with SW_1 closed and its plate circuit tuned to 1760 kc., while the 807 is allowed to double frequency by tuning its plate circuit to 3520 kc. This, however, results in a less-efficient form of operation, so it is always advisable to operate the 807 as a straight amplifier whenever possible.

If 7-Mc. coils are plugged in at L_2 and L_3 , frequency will be quadrupled to 7040 kc. in the plate circuit of the oscillator and the amplifier tuned to this frequency will deliver power in this band. Output on still another band may be obtained with the 1760 kc. crystal by plugging a 14-Mc. coil, instead of the 7-Mc. coil at L_3 .

Then, with the 807 plate circuit tuned to 14 Mc. and the output circuit this time doubling frequency, power output will be on 14080 kc.

By starting out with a 3.5-Mc. crystal, output may be obtained in the 28-Mc. band as well as the 3.5-, 7- and 14-Mc. bands; or, by the use of a 7-Mc. crystal, somewhat higher output at 28 Mc. may be obtained by operating the 807 as a straight amplifier at this frequency while quadrupling frequency in the plate circuit of the oscillator tuned to 28 Mc.

The entire unit is designed to operate from a single 250-ma. supply delivering up to 750 volts, the maximum voltage at which the 807 is designed to operate. A fixed bias of 45 volts is required for the 807 and the two heaters together consume 1.8 amperes at 6.3 volts. In the keying system shown, both the oscillator and amplifier are keyed simultaneously in the common cathode

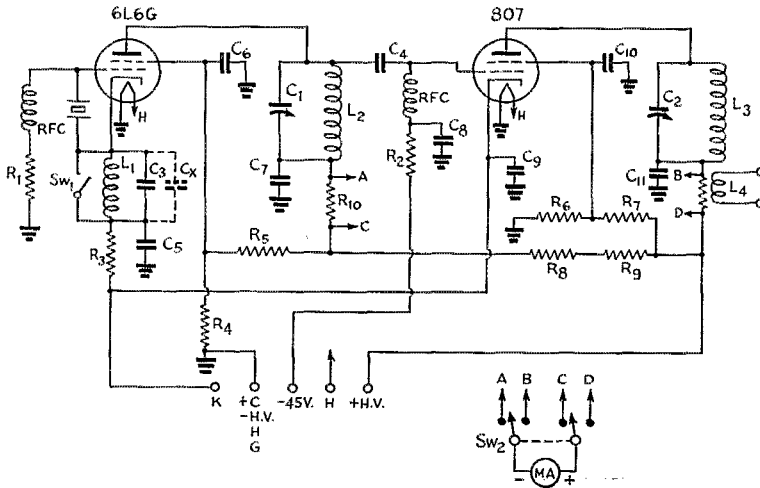

Fig. 1—Circuit diagram of the two-tube plug-in coil exciter.

C_1 —140- μ fd. midget variable (Hammarlund MCI40M).

C_2 —150- μ fd. variable (Cardwell MR150BS).

C_3 —100- μ fd. mica.

C_4 —20- μ fd. mica.

$C_5, C_6, C_7, C_8, C_9, C_{10}$ —0.01- μ fd., 600-volt paper.

C_{11} —0.01- μ fd., 1000-volt paper.

C_x —100- μ fd. mica (see text).

MA—Milliammeter, 0-200-ma. scale (Triplett Mod. 227A).

R_1 —20,000 ohms, 1-watt.

R_2 —25,000 ohms, 2-watt.

R_3 —200 ohms, 2-watt.

R_4 —10,000 ohms, 25-watt.

R_5 —3500 ohms, 25-watt.

R_6, R_7 —15,000 ohms, 25-watt.

R_8, R_9 —1250 ohms, 50-watt.

R_{10}, R_{11} —10 ohms, 1-watt.

R.f.c.—2.5-mh. r.f. choke.

SW_1 —S.p.s.t. toggle switch.

SW_2 —D.p.d.t. rotary switch (Mallory 3222J).

L_1 —17-Mc. crystals—32 turns No. 22 d.s.c., close-wound.

3.5-Mc. crystals—10 turns No. 22 d.s.c., 1-in. long.

Note: C_x connected in parallel with this coil; mounted in form.

7-Mc. crystals—6½ turns No. 22 d.s.c., ¾-in. long.

Above coils wound on Hammarlund 1½-in. diam.,

4-pin forms.

L_2 —1.7 Mc.—56 turns, 1¼-in. diam., 1¾-in. long, 54

μ hs. (National AR80—no link).

3.5 Mc.—28 turns, 1¼-in. diam., 1½-in. long, 15

μ hs. (National AR10—no link).

7 Mc.—14 turns, 1¼-in. diam., 1¼-in. long, 4.2

μ hs. (National AR20—no link).

14 Mc.—8 turns, 1¼-in. diam., 1½-in. long, 1.25

μ hs. (National AR10—no link).

28 Mc.—4 turns, 1¼-in. diam., ¾-in. long, 0.5 μ h.

(National AR10, 4 turns removed—no link).

L_3 —1.7 Mc.—50 turns, 1½-in. diam., 2½-in. long, 52

μ hs. (Coto Coil CS6160E).

3.5 Mc.—25 turns, 1½-in. diam., 1½-in. long, 16

μ hs. (Coto Coil CS680E).

7 Mc.—16 turns, 1½-in. diam., 1½-in. long, 5.7

μ hs. (Coto Coil CS640E).

14 Mc.—8 turns, 1½-in. diam., 1½-in. long, 1.5

μ hs. (Coto Coil CS620E).

28 Mc.—4 turns, 1½-in. diam., 1½-in. long, 0.7

μ hs. (Coto Coil CS610E).

lead. If preferred, the fixed bias on the 807 may be increased to 90 volts and the oscillator circuit keyed alone.

The exciter is built in the form of a unit to fit a standard transmitter rack and is so constructed that the vertical panel space required is reduced to a minimum — only $3\frac{1}{2}$ inches. This style of construction, in which the tubes and coils are mounted on the rear edge of the chassis, also makes hand-changing especially convenient, since another rack unit immediately above will not interfere with the removal of coils or tubes. The crystal socket is at the front so that frequencies within a band may be changed without the necessity for going to the rear. A single milliammeter with a scale of 200 ma. is provided for checking the plate current of either oscillator or amplifier tubes. The switch, *Sw*₂, throws the meter across a 10-ohm resistance in either plate-feed circuit. These resistors are sufficiently high in value in comparison with the resistance of the meter as to have no practical effect upon the calibration of the meter.

Construction

The chassis is a standard item measuring 17 inches long by 3 inches deep by 4 inches wide. As many of the holes as possible should be drilled or cut before assembly is started. The two tank condensers are placed with their shafts $5\frac{1}{2}$ inches from either end of the chassis. Half-inch holes should be drilled at the point of each mounting hole for the National button-type insulators on which the condensers are mounted. The rear buttons should come as close to the rear edge of the chassis as possible to allow sufficient room for the Millen flexible shaft couplings and the panel-bearing units. To make the buttons clamp the chassis tightly, bend tight-fitting rings of No. 18 enameled wire around the shoulders of each

button before inserting in the hole. Small $\frac{1}{8}$ -inch spacers should be placed between the under side of the button and the bottom of the midget condenser to bring its shaft up level with that of *C*₃. All of the isolantite sockets are sub-mounted in the chassis and their relative positions, as well as those of the plug-in mounting for *L*₂ and the two switches, may be determined from the photographs. A 4-prong socket is used for the cathode-circuit coil; a 6-prong socket with each group of three terminals wired together serves as the crystal socket so that the crystal may be plugged in in any position; while the output coil requires a 5-prong socket.

The 5-prong socket for the 807 is sub-mounted in a partition cut and bent from any handy sheet metal $\frac{1}{16}$ -inch or so thick. It is 3 inches square. A Hammarlund type PTS shield is fastened with the socket-mounting screws. Amphenol insulated pin jacks for link output are set in the end of the chassis next to the output tank coil and a Millen 5-terminal connector strip at the left-hand end under the 6L6 and cathode coil is used for making connections to the key and power supply. Half-inch holes should be drilled in the rear edge of the chassis immediately under each end terminal of *L*₂, under the center of the 807 socket and under the plate terminal of the 807. These are for passing connections through the chassis to parts inside and should be lined with rubber grommets to prevent accidental contact with the chassis.

The large resistors should be mounted as shown in the bottom-view photograph. *R*₈ and *R*₉ are the two large resistors at the right, *R*₅ and *R*₇ the two mounted vertically against the rear wall of the chassis and *R*₄ and *R*₆ the two behind the meter.

The panel is $3\frac{1}{2}$ inches high and 19 inches long and is cut from $\frac{1}{4}$ -inch presdwood with crackle finish. Clearance holes must be cut for the

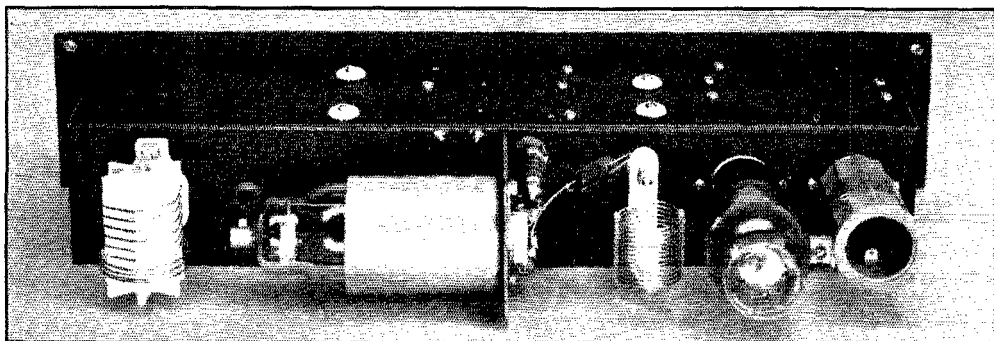

The 4-prong socket for the cathode coil, the octal for the 6L6G oscillator and the 5-prong socket for the Coto coils used in the output tank circuit are sub-mounted in the rear edge of the chassis. The mounting for the National AR coils used in the oscillator plate circuit is fastened on short cone insulators, while the socket for the 807 is sub-mounted in the small steel partition. The grid r.f. choke and screen and cathode by-pass condensers are fastened directly to the socket. Large clearance holes lined with grommets are provided for passing the connections through the chassis from the oscillator plate coil to the tank condenser and for the 807 plate lead. A pair of pin jacks serves as the link output terminals and power-supply connections are made to the Millen strip at the right end.

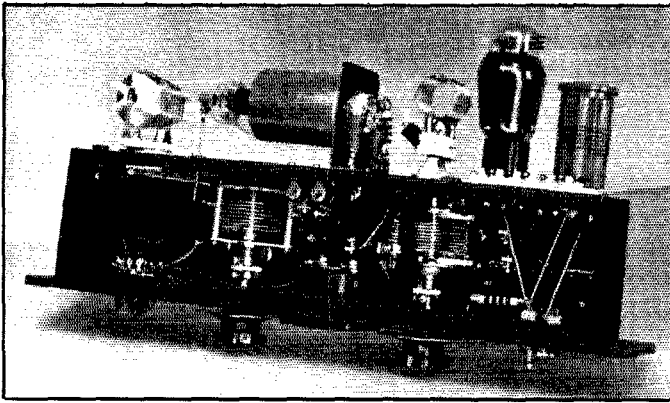

Space inside the 4-in. by 17-in. by 3-in. chassis has been utilized to the greatest extent possible. R_8 and R_9 are to the right of the oscillator tank condenser, while R_4 , R_5 , R_6 and R_7 are mounted to the rear of the meter. The oscillator r.f. choke and grid leak are fastened to the crystal socket. Connections between the crystal socket and cathode switch are made directly and kept well spaced. Meter-shunting resistances are fastened to the meter switch. Both tank-condenser shafts must be fitted with insulated couplings and panel bearings.

milliammeter and the crystal, the latter large enough so that the crystal will fit close against the socket when plugged in. Standard mounting holes will come $\frac{1}{4}$ -inch from both top and bottom and $\frac{3}{8}$ -inch in from the edges.

Wiring

The power wiring should be done first of all after the assembly is complete. Push-back wire may be used for the heater wiring, but wire with heavier insulation should be used for high-voltage circuits. Length of power leads is unimportant, but the wiring should be kept bunched together and down against the chassis and as well-spaced from the stators of the variable condensers and the crystal and tube sockets as possible. By-pass condensers should be connected directly to the points to be by-passed, with the other side connected to the nearest convenient mounting screw grounded to the chassis. One end of the oscillator grid-circuit r.f. choke is fastened directly to one side of the crystal socket, while its opposite end is fastened to a small fibre lug strip which insulates it from the chassis. R_1 is fastened between this lug strip and a grounded mounting screw.

On the 4-prong cathode-coil socket, each of the two large prongs is connected to one of the small prongs. C_3 is then connected between the two large prongs. When the cathode coils are wound, the ends of the winding connect to the two large pins. The cathode coil for use with 3.5-Mc. crystals requires an extra 100- μ fd. capacity — C_x . This is placed inside the coil form with its ends connecting to the two small pins.

One end of R_3 is connected to the pair of socket prongs connecting to the bottom end of L_1 , while the other end connects to the ungrounded key terminal. Soldered to the 807 socket are the cathode and screen by-pass condensers and the grid r.f. choke whose other end is anchored to a small insulating lug strip fastened to one of the screws at the base of the partition. The 807 grid leak is on the inside of the chassis with one of its terminal wires running through the grommetted

hole at the base of the partition to the lower end of the r.f. choke, and its opposite end fastened to another short insulating lug strip which is connected to the negative bias terminal of the power-supply strip with a short length of wire. The coupling capacity, C_4 , is soldered directly between the plate end of the socket for L_2 and the grid terminal of the 807 socket. The meter-shunting resistances, R_{10} and R_{11} , are soldered directly to the meter switch.

Connections between the cathode coil, the 6L6 socket, crystal socket and Sw_1 are made with rigid No. 14 bare wire well-spaced from other wiring. This wire is also used to make connections between the sockets of L_2 and L_3 and their respective tuning condensers and also for the connections between the plate of the 807 and the stator of C_2 .

Tuning

Since the 807 requires no neutralizing, tuning the exciter consists chiefly of selecting the proper coils and tuning the two plate circuits to resonance. Because it is possible to double or quadruple frequency in the plate circuit of the oscillator and to double frequency in the plate circuit of the 807 as well, there are several possible combinations of coils and crystals which will produce the same output frequency. However, much better efficiencies are obtainable when operating the 807 as a straight amplifier, rather than doubling, so that it is always advisable, as mentioned previously, to operate the output stage in this manner whenever possible. This possibility occurs in all cases except where it is necessary to obtain output at the eighth harmonic of the crystal frequency — 14-Mc. output from a 1.7-Mc. crystal or 28-Mc. output from a 3.5-Mc. crystal. The accompanying chart will enable the operator to choose at a glance the combination required for the desired output from a given crystal. It also indicates the position in which Sw_1 should be thrown. Always be sure that the crystal frequency chosen is one whose

harmonics will fall in the band in which operation is to take place.

With the proper coils and crystals in place, Sw_1 thrown to the correct position and both condensers set at minimum capacity (100 division on dial), the high-voltage should be applied with the meter switch in the second position where it will read plate current to the 807. If all resistances are correct and the plate voltage 750, the plate current should run approximately 25 ma. Now close the key and turn the oscillator tank condenser to the approximate setting given in the accompanying table and watch for a rise in amplifier plate current. Do not hold the key closed for long periods under this condition. As soon as the peak has been obtained, tune the amplifier plate tank condenser for resonance as indicated by a pronounced dip in plate current. Should the points of response on either condenser be found at points on the scale differing appreciably from those given in the table, each circuit should be checked with an absorption wavemeter to make sure that it is tuned to the correct frequency, since the ranges covered by some of the coils include odd or unusable even harmonics which would result in responses outside the amateur bands. Once checked, the dial setting can be logged for quick resetting to the desired frequency.

With the amplifier tuned, the meter switch may now be thrown to the first position, where the meter reads oscillator plate current, and the oscillator tank circuit tuned for minimum plate current consistent with satisfactory keying. Active crystals will usually oscillate continuously in the Tri-tet circuit, regardless of the setting of the tank condenser. When the tetrode circuit is in use, however, the circuit will oscillate only so long as the plate circuit is tuned within relatively narrow limits. Sw_1 should never be left open when the oscillator plate circuit is tuned to the crystal frequency. The plate current to the oscillator will be found to vary widely in

value, depending upon whether output is taken at the fundamental, second harmonic or fourth harmonic. At the specified plate voltage, it should run between 40 and 50 ma. At resonance with the plate circuit tuned to the crystal fundamental or second harmonic. When tuned to the fourth harmonic, the plate current will normally run between 85 and 95 ma.

Because the plate and screen of the 6L6 are operated from a voltage divider, their voltages will vary considerably with conditions of tuning. Plate voltage will vary between 400 and 450 except when operating at the fourth harmonic when it will normally fall to 340 volts or so. The screen voltage varies simultaneously from 280 to 210 volts or so.

The tank coils for the output circuit are fitted with link windings for coupling to a following stage with link input, to a low-impedance transmission line feeding an antenna or to an antenna coupler. In most cases, the maximum rated dissipation of 30 watts will not be exceeded in loading the output circuit until the 807 draws the maximum rated plate current of 100 ma. However, when doubling frequency in the output stage, the plate current should be limited to 70 ma. At 28 Mc. and 80 ma. at 14 Mc., and to 90 ma. when operating the 807 as a straight amplifier at 28 Mc. Power output under these conditions should average 40 to 55 watts on all bands so long as the 807 is operated as a straight amplifier. When doubling frequency in the output circuit to 14 and 28 Mc., the output will normally be reduced to about 27 and 18 watts respectively.

Amplifier screen voltage will normally vary between 240 and 300 volts, the higher values obtaining when quadrupling in the oscillator.

If the exciter is operated from a power supply of lower voltage, the power output will, of course, be reduced in proportion. In such a case, it may be of advantage to alter somewhat the values of resistance specified for the voltage dividers in order to increase the voltages on the oscillator plate and screen and also that of the screen of the 807. With a 600-volt supply, R_3 and R_9 should be changed to 1000 ohms each and R_4 to 20,000 ohms and R_5 to 10,000 ohms. Power output will average 30 to 35 watts with the 807 operating as a straight amplifier.

COIL AND TUNING TABLE

Xtal Band Mc.	Output Band Mc.	SW_1	L_1 Band Mc.	C_1L_2 Band Mc.	C_2L_3 Band Mc.	C_1^*	C_2^*
1.7	1.7	Closed	1.7	1.7	1.7	10	10
1.7	3.5	Open	1.7	3.5	3.5	10	30
3.5	3.5	Closed	3.5	3.5	3.5	10	30
1.7	7	Open	1.7	7	7	20	50
3.5	7	Open	3.5	7	7	20	50
7	7	Closed	7	7	7	20	50
1.7	14	Open	1.7	7	14	20	70
3.5	14	Open	3.5	14	14	35	70
7	14	Open	7	14	14	35	70
3.5	28	Open	3.5	14	28	35	80
7	28	Open	7	28	28	75	80

* Approx. dial settings for low-frequency ends of bands with dial reading zero at full capacity of condenser.

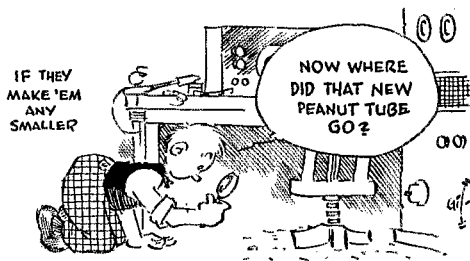

Modernizing the Regenerative Superhet

A 1941 Version with Stepped-Up Performance

BY GEORGE GRAMMER,* W1DF

Here's a revamped version of a popular *QST* receiver. Bringing the old set up to date won't be hard work for those who have the original model. And fellows who are looking for an economical receiver to build will find this one gives a lot more in the way of results than the cost of its parts would lead them to suspect.

THE regenerative superhet described in *QST* about two years ago¹ seemed to catch the fancy of a good many of the gang — especially the ones to whom economy is important. Those who have stuck with it probably will be interested in knowing about some relatively simple changes in the circuit which not only modernize the outfit but — considerably more important than just the satisfaction of installing some of the newer tubes — markedly improve its performance. The fellows who came in late can, if they want, be introduced to a ham-band receiver which will easily repay in operating satisfaction its relatively small cost — less than thirty dollars with tubes.

The basic design of the receiver is unchanged — regenerative mixer to give gain and improve signal-to-image ratio, regenerative i.f. stage for single-signal selectivity, separate high-frequency and beat oscillators for stability. Most of the parts are the same as in the original set. Some circuit details differ; these will be discussed in order. Chief results of the rebuilding are an increase in gain (about five times overall compared to the original circuit), lessened interaction between h.f. oscillator and mixer, and a higher order of stability. These are the result of circuit changes. Mechanically, the installation of a new dial which

* Technical Editor, *QST*.

¹ Grammer, "A Low-Cost Single-Signal Receiver," *QST*, October, 1938.

can be directly calibrated is a highly-desirable operating convenience. In response to requests for it, we have added an audio volume control, and for the same reason an a.v.c. circuit is included.

The new circuit diagram is given in Fig. 1. The mixer, originally a 6L7, is now a 6SA7, which has been found to give greater freedom from pulling of the oscillator frequency, is easier to "drive" properly by the oscillator, and gives a better signal-to-noise ratio. The 6J5 oscillator circuit is, with minor changes in circuit values, the same as before. A 6SK7 replaces the 6K7 in the i.f. amplifier; this change is not important, but in rebuilding the set we thought we might as well stick to single-ended tubes. Instead of the 6C5 second detector we now have a 6SQ7, installed mostly for the purpose of getting a a.v.c. voltage conveniently; it also offers an opportunity to put an audio volume control in a good spot. The 6C5 beat oscillator and 6F6 audio stage are essentially the same as in the original model. A highly-recommended addition to the receiver is the VR-105 regulator tube; one of these tubes ought to be put in the old set even if none of the other changes are made, since it practically washes out the effects of varying supply voltage.

The Voltage Regulator

The original chassis layout did not offer a good place for the regulator tube so we made a new one, rearranging the i.f. section to make room for it. This is not strictly necessary, since there is space enough underneath the chassis to install the tube if one wants. As shown in the diagram, the regulator is connected across the "B" supply voltage in series with a resistor; the plate voltage for the two oscillators, screen voltage for the 6SA7 mixer and screen voltage for the 6SK7 i.f. amplifier are taken from the junction of tube and resistor. This keeps these voltages constant at 105 volts regardless of changes in current drawn from the "B" supply or reasonable changes in line voltage. The most obvious result of the use of the regulator tube is the fact that the r.f. gain control can be varied over its whole range without the slightest effect on the oscillator frequency. However, there are other factors which affect the voltage applied to the oscillator plate as well, and in compensating

The modernized regenerative s.s. super includes a new National Type ACN dial which can be directly calibrated in frequency, a voltage regulator, and a new tube line-up which increases gain and stability.

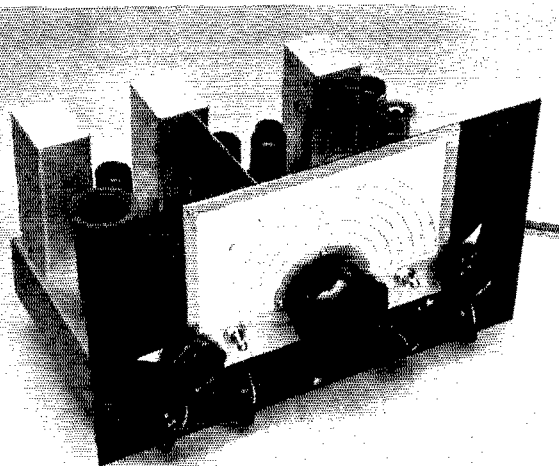

QST for

In this top view, the mixer tuning condenser is at bottom left, band-spread condenser in the center, and the band-set condenser at the right. The left-hand switch is for a.v.c., that at the right is B-plus on-off. The mixer section is to the left of the vertical shield, oscillator to the right. Along the rear, the first i.f. transformer is at the left, followed by the i.f. tube, second i.f. transformer, second detector, beat oscillator tube, h.o. transformer, and the 6F6 audio output.

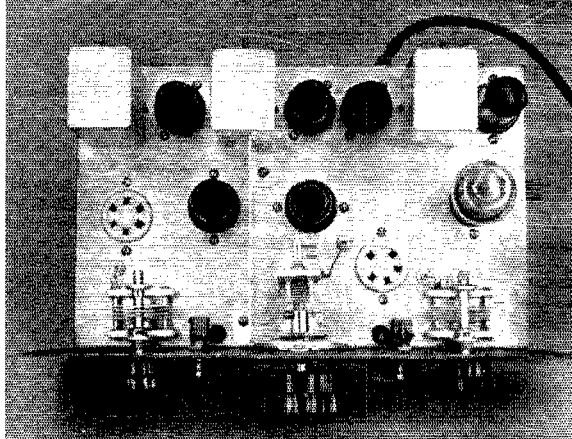

for all of them, the regulator gives that "B battery" steadiness to the signals which is all the more appreciated because so few receivers seem to sound that way these days.

Regulating the mixer and i.f. tube screen voltages maintains constant tube operating conditions despite changes in supply voltages, a particularly helpful feature when the regeneration is pushed up near maximum. There is therefore less tendency for a regenerative stage to spill over when the line voltage gives a momentary jump. The screen dropping resistors normally used with these tubes are of course no longer needed. Fixed screen voltage on the i.f. amplifier also makes the gain control more effective, since the screen voltage cannot rise as the bias is increased. The screen-cathode voltage, in fact, drops with larger grid bias, since the voltage to ground is maintained constant.

The dropping resistor, R_{14} , will need to be adjusted for the individual "B" supply voltage. The full 5000 ohms is about right for a supply voltage of 250 to 300 volts. Lower voltages will require less resistance. Use the maximum resistance which will permit the tube to remain ignited under normal operating conditions; if R_{14} is too large and the plate voltage too low, the VR-105 will ignite when the set is first turned on, but will go out as soon as the tubes get warmed up. On the other hand, the series resistance should not be too small, because the tube will be overloaded during the warming-up period.

The regulator tube is provided with a jumper between one pair of base pins which can be used as an automatic switch when the tube is plugged into or removed from the socket. In this case we used the jumper as shown at "X" on the diagram. It is in series with the 105-volt lead from the tube to the rest of the receiver and breaks this lead when the tube is taken from the socket. This is done to prevent running the oscillator plate and the screens of the mixer and i.f. amplifier at excessive voltage (it will be close to the full plate voltage) if the regulator is taken out.

The Mixer Circuit

The 6SA7 has some special characteristics of its own which account for the changes in this part of the circuit. The grid arrangement is different from that of the 6L7; the oscillator grid (used as an injection grid in this case) is nearest the cathode, while the signal grid is No. 3. The construction of

the tube is such that changes in signal-grid voltage have no effect on the space charge in the vicinity of the cathode, so that the cathode current remains constant regardless of the voltage on the No. 3 grid. The changes in plate current are compensated for by opposite changes in screen current. This feature is partly responsible for the greater freedom from pulling with this tube as compared to other mixers. To get the full benefit of it, however, the voltage-regulation on the screen is desirable, and it is also desirable to avoid changes in cathode current such as would be brought about by cathode-resistor control of regeneration. Hence in the present circuit the regeneration control, R_{15} , is placed across the tickler winding.

This type of regeneration control is quite smooth in operation, besides minimizing oscillator pulling. It has one defect, however; the detuning effect on the mixer grid circuit is greater than that of the cathode control which it replaces. The greater oscillator stability seemed to us more desirable than smaller detuning in the mixer circuit, since the latter is simply an amplitude effect.

The No. 1 grid of the 6SA7 requires a leak of 20,000 ohms for best conversion, and the oscillator voltage must be adjusted to cause a rectified grid current of 0.3 to 0.5 ma. to flow through it. Since the resistance is fairly low, an impedance step-down from the oscillator tank is indicated. This is most simply obtained by using the coupling arrangement shown in the diagram, with the mixer injection grid connected to the plate of the oscillator through a small coupling condenser. The oscillator tickler, L_5 , should be adjusted to give the proper grid current through R_2 ; the oscillator coil specifications give suitable values. If a 0-1 d.c. milliammeter is available, it may be connected temporarily between the lower end of R_2 and ground (a by-pass condenser with short leads should be used across the same points) and the oscillator ticklers adjusted individually for best results in the various bands. Since fairly strong feedback is required, it is necessary to reduce the oscillator grid leak, R_3 , from its original value of 150,000 ohms to 50,000 ohms.

The mixer grid coils are much the same as in the

original receiver, except that a turn or so is taken off the higher-frequency coils to compensate for the difference in tubes. The antenna coils, L_2 , have been rewound to present an impedance of 500 ohms to a balanced line; smaller or larger coils probably will be better for lines of different impedance. As a matter of convenience, the ticklers, L_3 , are scramble-wound and of a diameter to fit conveniently inside the coil form. They should be mounted on stiff leads long enough to bring them just inside the grid coils at the bottom. The amount of feedback can be adjusted by bending the coil on its mounting leads so that its axis is shifted with respect to the axis of the grid coil. The ticklers may be coated with Duco cement to keep the turns in place. Needless to say, the assembly should be made as firm as possible so that the feedback will be unaffected by vibration or the ordinary jars to the table on which the receiver sits.

The I.F. Amplifier

The use of the single-ended 6SK7 in the i.f. stage makes some small circuit changes necessary. Chiefly, care should be taken to keep the plate

and grid leads to the i.f. transformers well separated and fairly close to the chassis. Since there is no top cap on the tube, the regeneration is introduced by means of a small condenser connected between grid and plate instead of the wire in the i.f. transformer can used previously. Somewhat more feedback is needed because the diode detector loads the plate circuit more than did the plate detector in the original circuit. The condenser, C_{15} , is a 30- μ fd. trimmer with the adjusting screw removed and the movable plate bent out to reduce the capacity below the rated minimum of 3 μ fd. The capacity should be adjusted so that the i.f. stage goes into oscillation well below the maximum gain position on the gain control, R_{16} . This increases the effective single-signal selectivity of the stage by preventing "spreading out" of strong signals.

We need to mention one point in connection with the i.f. amplifier. Don't use cheap mica-trimmed i.f. transformers! Several sets we had correspondence about, and one we had personal experience with, turned out to be away below par simply because of the transformers. The permeability-tuned units specified are satisfactory and

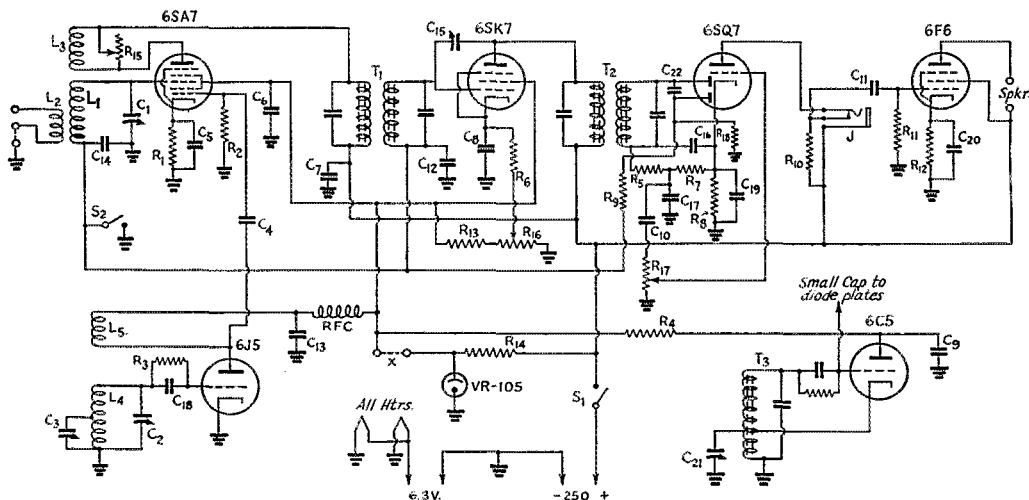

Fig. 1 - Circuit diagram of the regenerative superhet.

- | | | |
|--|---|--|
| C_1, C_2 - 50- μ fd. variable (Hammarlund MC-50-S). | C_{21} - 25- μ fd. variable (Hammarlund SM-25). | R_{17} - 2-megohm volume control. |
| C_3 - 35- μ fd. variable (National UM-35). | R_1 - 200 ohms, $\frac{1}{2}$ -watt. | R_{18} - 2 megohms, $\frac{1}{2}$ -watt. |
| C_4 - 50- μ fd. mica. | R_2 - 20,000 ohms, $\frac{1}{2}$ -watt. | T_1 - 460-kc. permeability-tuned i.f. transformer, interstage type (Millen 64456). |
| C_5, C_6, C_7, C_8 - 0.1- μ fd. paper, 600-volt. | R_3, R_4, R_5 - 50,000 ohms, $\frac{1}{2}$ -watt. | T_2 - 460-kc. permeability-tuned i.f. transformer, diode type (Millen 64454). |
| $C_9, C_{10}, C_{11}, C_{12}$ - 0.01- μ fd. paper, 600-volt. | R_6 - 300 ohms, $\frac{1}{2}$ -watt. | T_3 - 460-kc. beat-oscillator transformer (Millen 65456). |
| C_{13}, C_{14} - 0.005- μ fd. mica. | R_7 - 0.2 megohm, $\frac{1}{2}$ -watt. | RFC - 2.5-mh. r.f. choke. |
| C_{15} - 3-30- μ fd. trimmer (National M-30); see text. | R_8 - 2000 ohms, $\frac{1}{2}$ -watt. | J - Closed-circuit jack. |
| C_{16} - 250- μ fd. mica. | R_9 - 1 megohm, $\frac{1}{2}$ -watt. | S_1, S_2 - S.p.s.t. toggle. |
| C_{17}, C_{18}, C_{22} - 100- μ fd. mica. | R_{10} - 0.1 megohm, $\frac{1}{2}$ -watt. | L_1-L_5 , inc. - See coil table. |
| C_{19}, C_{20} - 25- μ fd. electrolytic, 50-volt. | R_{11} - 0.5 megohm, $\frac{1}{2}$ -watt. | X indicates jumper inside VR-105 base. |
| | R_{12} - 450 ohms, 1-watt. | |
| | R_{13} - 75,000 ohms, 1-watt. | |
| | R_{14} - 5000 ohms, 10-watt adjustable. | |
| | R_{15} - 10,000-ohm volume control. | |
| | R_{16} - 25,000-ohm volume control. | |

Practically all the wiring is below the base. The most crowded part is around the second detector (third socket from the right) where a number of small resistors and condensers have to be fitted in. Condenser C_{15} , which normally mounts directly between the grid and plate prongs on the 6SK7 socket, has been removed to permit the wiring to show more clearly. The r.f. layout is practically identical with that of the original model.

inexpensive; if anything else is to be substituted, use good air-tuned transformers.

Second Detector

The diode second detector represents a considerable change in the circuit. The chief benefits to be derived from its use are increased audio gain, especially when using the loud speaker, the use of an audio gain control without loss of volume, as would be the case if resistance coupling were used from a plate detector to the headset, and the possibility of automatic gain control. The latter is effective chiefly in holding down the strength of quite strong signals, since with only one i.f. stage the control is somewhat limited. For c.w. work it is of little value, and a dollar or so can be saved by leaving it out.

In Fig. 1, the upper diode is the one used for detection of the i.f. signal. Either of the two diode plates can be used for the purpose. The load resistor consists of R_5 and R_7 in series, R_5 being used

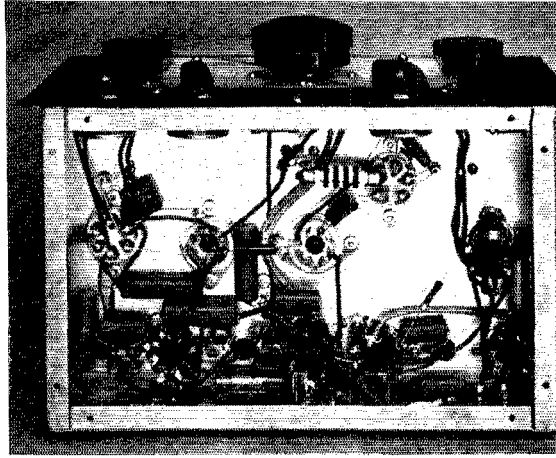

for the purpose of r.f. filtering along with C_{17} . The audio output is taken through C_{10} to R_{17} , the audio gain control, which is in the grid circuit of the triode section of the 6SQ7. It is important to prevent r.f. from getting to the triode grid, and it was found necessary to use shielded wire for the leads from C_{10} (which is mounted near the tube socket) to R_{17} , and from R_{17} to the grid of the triode. R_8 and C_{19} are the cathode resistor and by-pass condenser for the triode section.

The second diode plate is coupled to the first through C_{22} , a small mica condenser. R_{18} is the a.v.c. load resistor and R_9 the filter resistor. C_{12} and C_{14} are the by-pass condensers (and part of the time-constant circuit) for the grid circuits of the i.f. and mixer tubes, respectively, the a.v.c. voltage being fed in series with the tank coils in these circuits. S_2 grounds the a.v.c. line to make the a.v.c. inoperative.

If the a.v.c. is not wanted, the bottom of L_1 should go directly to ground, likewise the bottom connection of the grid winding of T_1 . The two diode plates of the 6SQ7 should be connected directly together. C_{22} , C_{12} , C_{14} , R_9 , R_{18} and S_2 can then be omitted from the circuit.

The beat oscillator is coupled to the second detector by means of a spaghetti-covered piece of stiff wire, connected at one end to the grid of the 6C5 beat oscillator, and with the other simply placed near the diode plate connections on the 6SQ7 socket. This gives sufficient coupling for average work. Those who prefer a weak b.o. signal can connect the wire to the cathode terminal of the 6C5. As in the original model, the beat oscillator is switched off by shorting C_{21} . This is done by bending over a corner of one rotary plate so that it touches the stator when the condenser is turned to maximum capacity.

Adjustment and Tuning

Because of the different method of regenerative coupling in the i.f. stage, it is preferable to line up the i.f. with C_{15} set at about the right capacity rather than to line up first without regeneration. Using a steady modulated signal on about 460 kc., adjust the i.f. trimmers for greatest response,

(Continued on page 76)

COIL TABLE

Band	Coil	Wire Size	Turns	Length	Tap
1.75 Mc.	L_1	24	70	Close-wound	—
	L_2	24	15	" "	—
	L_3	22	15	—	—
	L_4	22	42	Close-wound	Top
	L_5	24	15	" "	—
3.5 Mc.	L_1	22	35	" "	—
	L_2	22	9	" "	—
	L_3	22	12	—	—
	L_4	22	25	1 inch	18
	L_5	22	10	Close-wound	—
7 Mc.	L_1	18	20	1 inch	—
	L_2	22	5	Close-wound	—
	L_3	22	9	—	—
	L_4	18	14	1 inch	6
	L_5	22	6	Close-wound	—
14 Mc.	L_1	18	10	1 inch	—
	L_2	22	5	Close-wound	—
	L_3	22	7	—	—
	L_4	18	7	1 inch	2.4
	L_5	22	4	Close-wound	—
28 Mc.	L_1	22	4	1 inch	—
	L_2	22	4	Close-wound	—
	L_3	22	1.5	—	—
	L_4	18	3.6	1 inch	1.4
	L_5	22	2.4	Close-wound	—

All coils except L_3 are $1\frac{1}{2}$ inches in diameter, wound with enamelled wire on Hammarlund SWF Forms. Spacing between L_1 and L_2 , and between L_4 and L_5 , approximately $\frac{1}{8}$ inch. Band-spread taps are measured from bottom (ground) end of L_4 .

L_3 for 28 Mc. is interwound with L_1 at the bottom end. L_3 for all other coils is self-supporting, scramble-wound to a diameter of $\frac{3}{4}$ inch, mounted inside the coil form near the bottom of L_1 .

The Square-Corner Reflector Beam Antenna for Ultra High Frequencies

BY JOHN D. KRAUS,* W8JK

Here is an antenna system particularly suited to u.h.f. work that combines considerable gain with no necessity for critical adjustment and tuning. It has a gain approaching 10 db over a single half-wave antenna, can be either horizontally or vertically polarized, and can be folded for transportation when used for portable work.

THE small physical size of ultra-high-frequency antennas makes many designs practical which are not feasible to build on lower frequencies. The sheet reflector is an antenna of this type. Sheets in the shape of a section of a parabolic cylinder have often been used. Fig. 1-A shows such a reflector with a driven radiator situated at the focus, one of the first directive types of antennas ever tried.

The parabolic reflector antennas are analogous to the parabolic reflectors or mirrors used in optical systems. If the parabolic reflector is sufficiently large, so that the distance from the focus to the reflector is many wavelengths, optical conditions are approached. However, if the reflector is of the same order of dimensions as the operating wavelength, or less, the analogy to optics is not complete, since the driven radiator is appreciably coupled to the reflecting sheet.

Another type of reflector, which forms a very

practical and effective system, consists of two flat conducting sheets which intersect at an angle so as to form a corner. This system has been termed a "corner" reflector antenna.^{1,2}

Fig. 1-B is a perspective view of a typical corner reflector antenna. The same antenna is shown in cross-section in Fig. 1-C. If the driven radiator is situated on the line bisecting the corner angle, as shown, the maximum radiation is also in the direction of this line. There is no focus point for the driven radiator as with a parabolic reflector, and the radiator can be placed at a variety of positions along the bisecting line. Because of the shape of the reflector, it might also be appropriately referred to as a "V" reflector or a "sphenoidal" (wedge-shaped) reflector.

An advantage of the sheet reflector is that, if the sheet is sufficiently large, its dimensions are not critical as to frequency. Hence, the reflector can be put into operation without the need for any tuning adjustments.

The corner reflector antenna is particularly suitable for use on the higher frequencies where structures one or two wavelengths in maximum dimensions are practical to build. Tests indicate that parabolic reflectors of this size have no particular advantage in performance over the corner type. On the other hand, the corner type has the advantage of being simpler to construct.

¹J. D. Kraus, "The Square-Corner Reflector," *Radio*, March, 1939.

²J. D. Kraus, "The Corner Reflector," *Proc. I.R.E.*, Sept., 1939, p. 613 (abstract of paper given at N. Y. C. Convention of I. R. E., Sept., 1939).

* Arlington Blvd., Ann Arbor, Michigan.

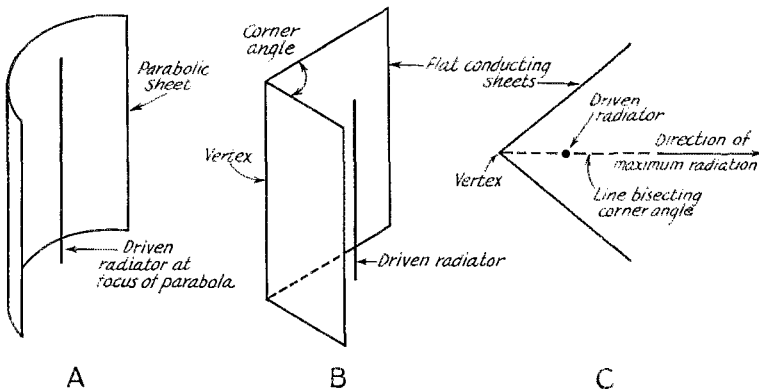

Fig. 1 — A radiator with a parabolic reflector is shown at A. A radiator with a "corner" reflector is shown in perspective at B and in cross-section at C.

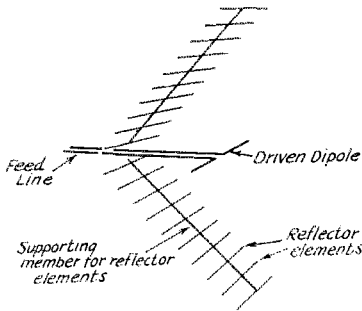

Fig. 2 — Horizontal square-corner reflector antenna with grid-type reflector.

The reflecting sides are flat and are readily adapted to a folding structure for portable work. The corner reflector antenna constitutes a distinct type of antenna system having unique properties and characteristics which make it especially suitable for use as a beam antenna on the ultra-high-frequencies.

The two sheet reflectors of the corner antenna may be arranged to intersect at a variety of angles. When the sheets intersect at right-angles, the system is referred to as a "square-corner" reflector.¹

Corner angles larger than 90° can be used, with some decrease in gain. A 180° "corner" is equivalent to a single flat sheet reflector, and this may be regarded as a limiting case of the corner type of reflector. The application of a single flat sheet reflector to a directional system has been discussed by George H. Brown.³

Corner reflectors with angles smaller than 90° are also practical. Theoretically, the gain increases as the corner angle is decreased. However, to fully realize this gain it is necessary that the size of the reflecting sheets also be increased. For a structure of the smallest size consistent with a substantial power gain and high directivity, the 90° corner offers a practical compromise. Accordingly a square-corner reflector will be described which is especially suitable for amateur use on the ultra-high-frequencies.

Instead of employing solid sheets, a very practical arrangement is to use a number of parallel wires or conductors to simulate the reflecting sheet. Fig. 2 is a perspective drawing of a square-corner antenna with a grid-type reflector. The parallel conductor arrangement is cheaper, more effective, and presents relatively little wind resistance as compared to solid sheet or many screen-type reflectors. For these reasons, the grid-type reflector is recommended.

Construction and Dimensions

Fig. 3 shows the construction for a square-corner reflector with dimensions for the 224- to

³G. H. Brown, "Directional Antennas," *Proc. I.R.E.*, Jan., 1937, p. 122.

230-Mc. band (1¼-meter band). The dimensions for this band are also listed in Table I, which, in addition, gives dimensions for the 112- and 56-Mc. bands. The dimensions for the 112-Mc. antenna are twice, and the 56-Mc. antenna four times those for the 224-Mc. antenna.

Furthermore, alternative dimensions are given for 112-Mc. and 56-Mc. square-corner reflectors of somewhat smaller overall dimensions. These are suitable where the bigger reflectors would be inconveniently large. The decrease in size causes only a slight reduction in performance.

As shown in Fig. 3, the main supporting structure for the reflector is an A-shaped frame. The two sides of this "A" frame are about one wavelength long and are joined at right angles at the vertex. These side members carry the reflector elements. A cross-member joins the two side members and carries the driven element or radiator. The distance between the driven radiator and the vertex, or corner, is not critical and can be varied over rather wide limits with little change in the directivity of the antenna. Especially suitable values are between 0.35 and 0.5 wavelength. A value of 0.5 wavelength is recommended for the antenna described. This amounts to 26 inches for the 224-Mc. antenna.

At a spacing of 0.5 wavelength from the driven dipole to the vertex, the radiation resistance of the driven dipole is a maximum. It is, in fact, almost twice the radiation resistance of the same driven dipole when alone in free space. Under these conditions the effect of losses in both the driven dipole and the reflector is minimized, mak-

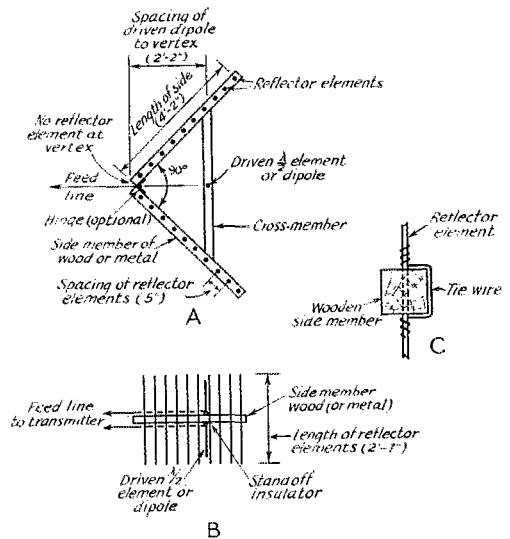

Fig. 3 — Construction of a square-corner reflector antenna with grid-type reflector. With the antenna vertical, A is the top view and B the side view. With the antenna horizontal, A is the side view and B the top.

ing for maximum radiation efficiency. In order to realize the full benefit of this high radiation resistance, the use of a closely-spaced director with a corner reflector system is not recommended. However, a few directors spaced at intervals of $\frac{3}{8}$ wavelength can be used to advantage. This high radiation resistance is an important advantage of the corner reflector over the close-spaced 3- or 4-element beam in which the low feed point resistance is a limiting factor to the efficiency.

Smaller spacings of driven dipole and vertex are entirely practical, but at a slight sacrifice in efficiency. The alternative design for the 112- and 56-Mc. square-corner reflector in Table I has a dipole-to-vertex spacing of 0.4 wavelength. At this spacing the driven dipole radiation resistance is still somewhat higher than its free space value, but is considerably less than when the spacing is 0.5 wavelength.

The driven dipole is situated at the mid-point of the cross-member so that it is equidistant from the two planes of reflector elements. The side member, which supports the reflector elements may be of either wood or metal, there being no appreciable difference in operation whether the mid-points of the reflector elements are electrically connected or not. The reflector wires should be No. 12, No. 10, or larger diameter. For the 224-Mc. reflector, No. 12 or 10 wire is sufficiently stiff to be self-supporting. For the 112- or 56-Mc. bands, heavier wire or tubing may be required. A satisfactory method of securing the reflector conductors to the supporting structure is shown

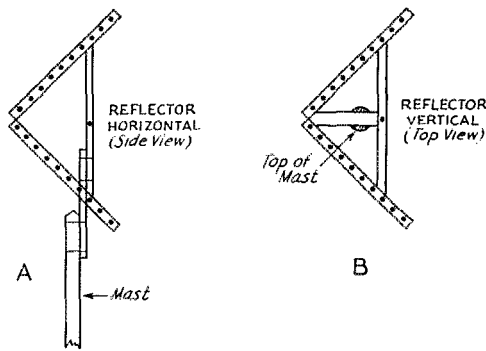

Fig. 4 — Method of mounting a square-corner reflector for horizontal operation (A), and for vertical operation (B).

in Fig. 3-C. Holes are drilled for the reflector elements along the wooden supporting member. After the conductors are in place they are fastened by a tie wire.

If portable operation is contemplated, a hinge may be installed at the corner to join the side members as in Fig. 3-A. The cross-member carrying the driven dipole is held in place by clamps so that this member can then be removed and the reflector folded flat. Additional hinges can be located mid-way along the side members so that the reflector can be folded into a still more compact form. Instead of fastening the reflector elements in place as indicated in Fig. 3-C, they can be held by fuse clips mounted on the "A" frame. With this construction, all of the reflector elements are easily removed and can be tied in a bundle for transport.

The reflector elements are about 0.6 wavelength long. Their length is not at all critical, slight increases or decreases in length producing no noticeable difference in performance. This means that the performance of the reflector is substantially uniform over a wide frequency band.

Multi-Band Operation

Not only is the reflector effective on the band for which it is designed but also on all higher frequencies as well. The reflector is, thus, suitable for multi-band operation. A square-corner reflector designed for the 56-Mc. band can be used effectively on both the 112- and 224-Mc. bands with no change required in the reflector. Some improvement may, however, be obtained on the higher frequency bands by adding more reflector elements between those already in use so that the spacing does not exceed about 0.1 wavelength between elements on the highest frequency used. On the lower frequencies, the closer spacing of the reflector elements produce very little difference in performance. If anything it results in a slight improvement. In multi-band operation with the same reflector, different driven dipoles are

TABLE I

Frequency Band	Length of Side	Length of Reflector Elements	Number of Reflector Elements	Spacing of Reflector Elements	Spacing of Driven Dipole to Vertex
224-230 Mc. (1 $\frac{1}{4}$ meter)	4' 2"	2' 7"	20	5"	2' 2"
112-116 Mc. (2 $\frac{1}{4}$ meter)	8' 4"	5' 2"	20	10"	4' 4"
112-116 Mc.* (2 $\frac{1}{4}$ meter)	6' 8"	5' 2"	16	10"	3' 6"
56-60 Mc. (5 meter)	16' 8"	10' 4"	20	1' 8"	8' 8"
56-60 Mc.* (5 meter)	13' 4"	10' 4"	16	1' 8"	6' 11"

Table I. — Dimensions of square-corner reflector for the 224-, 112-, and 56-Mc. bands. Alternative designs are listed for the 112- and 56-Mc. bands. These designs, marked (*), have fewer reflector elements and shorter sides, but the effectiveness is only slightly reduced. There is no reflector element at the vertex in any of the designs. The construction is shown in Fig. 3.

employed for each band, with the spacing to the vertex adjusted to approximately 0.5 wavelength on the band being used.

Frame Construction

A style of construction different than the one described for the corner reflector is to support the ends rather than the mid-points of the re-

zation Fig. 3-A represents the top view of the antenna, and Fig. 3-B, the side view. For horizontal polarization, the driven dipole and reflector are turned horizontal, and Fig. 3-A then represents the side view and Fig. 3-B the top view of the antenna.

Whether horizontal or vertical polarization is used is largely a matter of individual preference.

Fig. 6-- Possible ways of leading the feed line from the driven dipole to the transmitter with antenna horizontal (A) or vertical (B).

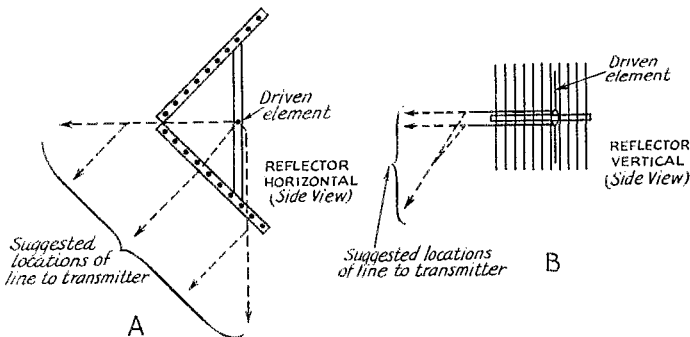

lector elements. This type of construction requires two rectangular wooden frames, one for each reflecting plane. These frames can be similar in construction to the frames for ordinary window screens. The length of the frame is made equal to the side length given in Table I, and the width equal to the reflector element length. Although somewhat heavier and bulkier, this construction is an entirely practical one. The first tests on a corner reflector at W8JK were made with a reflector supported on a wooden frame of this type.¹ No. 12 or No. 10 wire can be used for the reflector elements. The wires are secured to the frame by means of nails or screws. Painting or varnishing of the frame is desirable. The wires of the reflector curtain are not electrically connected at any point.

Polarization

The corner reflector antenna is suited for the transmission or reception of either vertically or horizontally polarized waves. For vertical polar-

ization, it is generally desirable to use the same type of polarization for both transmitting and receiving unless, due to reflections over some particular path, tests indicate that different polarization at the transmitter and receiver is preferable.

For horizontal operation a practical method for supporting the entire antenna is shown in Fig. 4-A. An extension of the cross-member of the antenna frame is fastened to a mast. In the case of vertical polarization, the mast can be fastened to an additional member placed between the cross-member of the frame and the corner, as shown in Fig. 4-B.

Another method of support, suitable for either vertical or horizontal operation, is by means of rope bridles tied to the reflector structure, so that the entire system can be pulled up alongside a tower or supported between two towers.

As regards the height of the antenna, it is in general true that to transmit the maximum distance on the ultra-high-frequencies, the antenna should be placed as far above the ground as possible.

Driven Dipole

Once constructed, no adjustments are necessary on the corner reflector. This is an important advantage over antennas which require tune-up adjustments before maximum performance can be realized. With the corner reflector, it is only necessary that adjustments be made on the driven dipole to obtain maximum input to this radiator.

The type of driven radiator used with a corner reflector is largely a matter of individual preference. A wide variety of driven dipoles having coaxial or open-wire feed can be used successfully.

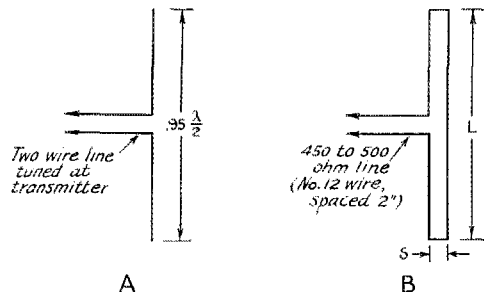

Fig. 5— Driven dipoles for use with a square-corner reflector.

Two systems using open-wire feed are shown in Fig. 5. If the distance between the antenna and transmitter is relatively short, such as 1 or 2 wavelengths, a tuned line is satisfactory for feeding the center of a single conductor half-wave dipole as shown in Fig. 5-A. The dipole length is computed in the usual manner, being 5 or 6 per cent less than a free-space half-wave.

If the distance from the antenna to the transmitter is somewhat greater, such as two or more wavelengths, a matched impedance feed is more satisfactory. An arrangement of this type is shown in Fig. 5-B, the driven radiator being a 2-wire half-wave dipole.^{4, 5, 6} Carter⁵ refers to a radiator of this type as a "folded dipole." Dimensions for a 224-Mc. 2-wire dipole are:

length (L) = 25 inches
spacing (S) = 1 inch.

For the 112-Mc. band, these dimensions (both length and spacing) are doubled and for the 56-Mc. band, the dimensions are multiplied by four. Both wires are the same diameter. No. 12 or 10 wire is satisfactory for a 224-Mc. dipole. Larger wire or tubing can be used on 112 and 56 Mc. A transmission line of 450 to 500 ohms characteristic impedance (No. 12 wire spaced 2 inches) is used to feed the dipole. This line can be coupled to the transmitter tank circuit by a coil of one or more turns. The coil should be arranged symmetrically with respect to the transmitter tank.

Several possible locations for the transmission line are shown in Fig. 6. The locations in Fig. 6-A are suitable when the antenna is horizontal and the paths in Fig. 6-B when the antenna is vertical. Inside of the reflector, the transmission line should be kept substantially in the plane of

⁴ (A) J. D. Kraus, "Multi-wire Doublet Antennas," *Radio*, May, 1939, p. 24; (B) "Multi-wire Type Antennas," *Radio*, June, 1939, p. 21; and (C) "Multi-wire Dipole Antennas," *Electronics*, Jan., 1940, p. 26.

⁵ P. S. Carter, "Simple Television Antennas," *RCA Review*, Oct., 1939, p. 177.

⁶ J. D. Kraus and S. S. Sturgeon, "The T-Matched Antenna," *QST*, Sept., 1940, p. 25.

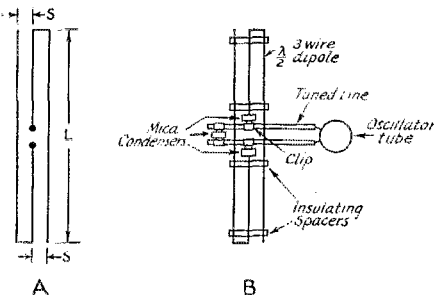

Fig. 7—3-wire half-wave dipole (A) and method of mounting to tuned-line transmitter (B).

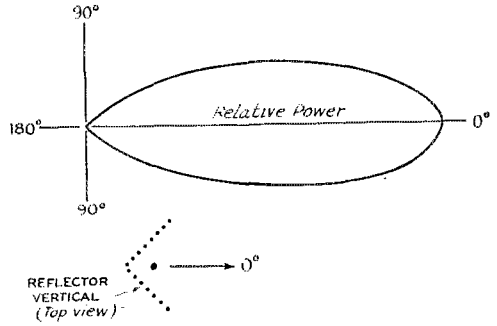

Fig. 8—Measure horizontal directional pattern for a vertical 224-Mc. square-corner reflector antenna of the type described.

the supporting members, or "A" frame. The line should be supported as symmetrically as possible and sharp bends should be avoided.

If the distance between the antenna and the transmitting equipment is many wavelengths, it may be advantageous to locate the transmitter at the antenna with filament and modulated plate voltages supplied by a 3- or 4-wire cable. This arrangement is well suited for use with low-power equipment on 112 and 224 Mc. where simple oscillator transmitters are permitted. The oscillator tube and associated circuits are placed in a weatherproof box with the antenna protruding. An antenna especially suited for use with this kind of an installation is the 3-wire half-wave dipole.^{4(B, C)} The terminal resistance is relatively high and the antenna can be directly connected to the oscillator circuit, no transmission line being used. A 3-wire dipole is illustrated in Fig. 7-A, while Fig. 7-B shows a tuned-line oscillator with the terminals of a 3-wire dipole connected by clips to the line. The point of attachment may be adjusted for maximum power transfer to the antenna. A pair of condensers (mica 0.002 μ fd.) between the antenna terminals and the clips keeps d.c. voltages from reaching the antenna. The same size wire is used for each of the 3 wires of the dipole. A 224-Mc. 3-wire dipole has a length, L , of 24 inches and a spacing, S , between adjacent wires of 0.5 inch. For the 112-Mc. band these dimensions are doubled. The power cable supplying the transmitter should be arranged to follow a path similar to one of those suggested for the transmission line in Fig. 6.

There is no appreciable difference in the directivity of a 2- or 3-wire half-wave dipole. When used with a square-corner reflector, the 2-wire is better suited for use with a transmission line and the 3-wire with the transmitter at the antenna.

In addition to the systems described, in which the antenna is fed at the center, end-fed antennas can also be used. End feed is best adapted to vertical antennas, the feed point being the lower

end. Any of the common types of end feed, such as the "J" stub type, can be used.

Performance

Tests have been made on many types of corner reflector antennas at W8JK. The measured directional pattern of a 221-Mc. square-corner reflector is shown in Fig. 8. The antenna is vertical and the pattern is in the horizontal plane. The construction is as shown in Fig. 3. The dimensions are approximately the same as given in Table I. A 3-wire half-wave driven dipole is used with the transmitter located at the dipole as in Fig. 7-B.

The measured front-to-side and front-to-back

ratios are high, 25 db for the front-to-side and 35 db for the front-to-back ratio. At an angle of 10° from the center line of the beam, the signal is 1 db down; at 20° 3 db, 30° 6 db, 40° 10 db, 50° 16 db, 90° 25 db and 180° 35 db down. The directional pattern is very smooth, being free from minor lobes of any appreciable size. The power gain of the antenna approaches 10 db over a comparison half-wave dipole in free space with the same power input.

In conclusion, it may be said that the square-corner reflector gives a large power gain, high directivity, and is capable of excellent performance as a beam antenna on the ultra-high-frequencies.

1940 Field Day Scores

THE Eighth A.R.R.L. Field Day, June 1940, not only was the most successful F.D. of all time, but it also enjoyed a participation greater than any previous operating contest of any kind! At least 2041 individuals participated in the mass-testing of portable-emergency gear; 141 amateur radio clubs entered stations in the activity and reports also were received from 88 non-club stations.

We have completed the checking of logs and tabulation of scores just in time to make the deadline for this issue of *QST*. However, the complete analysis of results, the photos and write-ups of the various F.D. stations, which customarily accompany the scores, must be held over until the December issue. We will then give you more complete data on many of the set-ups as we have done in the case of past F.D.'s. Rather than withhold the scores another month, we present them now.

Scores are listed under three major headings: (1) Club Stations, (2) Individuals and Non-Club Groups, and (3) Home Stations. Under the first two headings participating stations are grouped according to the number of simultaneously operated transmitters used at any time during the activity. F. D. leaders this year are considered to be the leaders in each such grouping. Watch for the additional details in December *QST*.

CLUB STATIONS

One Transmitter	QST's-Power-Score *
W1DMD/1 Merrimack Valley Amateur Radio Assn. ¹	221-A - 3366
W1AQ/1 Associated Radio Amateurs of So. N. E. ²	132-A - 2322

* The "power classification" used in computing the score is indicated by A, B, or C after the number of QSO's shown. A indicates power up to and including 30 watts (multiplier of 3); B indicates power over 30, up to and including 100 watts (multiplier of 2); C indicates over 100 watts (multiplier of 1). More than one letter means that at different times power inputs fell within different classifications. An R or T after the score indicates that receiver or transmitter was supplied from the public mains; no indication after scores where work was entirely independent of mains, r or t is used where only part of operations used mains supply.

W8CHU/8 Elmira Amateur Radio Assn. ³	118-A - 2007
W8SBV/8 Elmira Amateur Radio Assn. ⁴	101-A - 1853
W9RFT/9 Waterloo Field Day Assn. ⁵	96-A - 1773
W1LWA/1 Narragansett Assn. of Ama. Radio Opra. ⁶	133-B - 1632
W8MGQ/8 Key Klub of Detroit ⁷	89-A - 1602
W1TA/1 Nashua Mike and Key Club ⁸	91-AB-1272
W1LVK/1 Manchester (N. H.) Radio Club ⁹	77-A - 1215
W5FBL/5 Ponca City Key Klikers Club and Unit 5, Sec. 8, N.C.R., 8th Naval Dist. ¹⁰	88-A - 1196
W1INM/1 Providence Radio Assn. ¹¹	62-A - 1143
W5DPA/5 Houston Amateur Radio Club ¹²	63-A - 1089
W5MH/5 Baton Rouge Amateur Radio Club ¹³	76-A - 1035
W8DEC/3 Susquehanna Valley Amateur Radio Club ¹⁴	97-B - 1014
W8QLU/8 Mike & Key Club of Ithaca ¹⁵	75-A - 981
W5RU/5 Muskegon Amateur Radio Club ¹⁶	77-B - 882
W4KZ/4 Groenville Amateur Radio Club ¹⁷	76-B - 858
W1IGO/1 Merrimack Valley Amateur Radio Club ¹⁸ (Mass.).....	38-A - 819
W1LXT/1 Rerotation Radio Club ¹⁹	88-B - 801
W2MUB/2 Delaware Valley Brass Pounders Assn. ²⁰	40-A - 783
W8RNG/8 Finger Lakes Transmitting Soc. ²¹	77-AB- 780
W9JMG/9 Freeport Amateur Radio Club.....	37-A - 778.5
W1JRK/1 Tri-State Amateur Radio Club ²²	44-A - 774
W1CBA/1 Conn. Brass Pounders Assn. ²⁴	32-A - 765
W9OKY/9 Pikes Peak Amateur Radio Assn. ²⁶	43-A - 747
W3GIW/3 The Ether Agitators ²⁵	64-A - 684 T
W6YU/6 San Mateo Junior College Radio Club ²⁷	44-A - 612
W8SWS/8 Piqua Radio Club ²⁸	26-A - 612
W6KMM/6 Radio Club of Arizona ²⁹	43-A - 576
W7HWZ/7 Butte Amateur Radio Club ³⁰	28-A - 549
W5HTE/5 Enid Amateur Radio Club ³¹	54-AB- 547.5
W1MRP/1 Norwalk Amateur Radio Assn. ³²	39-A - 540
W4GTG/4 Chattahoochee Amateur Radio Assn. ³³	36-A - 513
W7DK/7 Radio Club of Tacoma ³⁴	42-A - 513
W8HXT/8 Ludington Amateur Radio Club ³⁵	18-A - 513
W8UMJ/8 Rubber City Radio Club ³⁶	35-A - 501
W8NLG/8 Detroit Amateur Radio Assn. ³⁷	34-A - 491
W7CAM/7 Yakima Amateur Radio Club ³⁸	27-A - 441
W2BMW/2 Tuboro Radio Club ³⁹	23-A - 333
W9MCS/9 L.M.A.R.R. (New Munster, Wis.) ⁴⁰	14-A - 324
W1HOB/1 Parkway Radio Assn. ⁴¹	103-C - 306 T
W8RVM/8 Ogdenburg Amateur Radio Club ⁴²	4-A - 297
W8TEW/8 Sidney Amateur Radio Club ⁴³	55-A - 240 RT
W8APJ/8 Bluffton Radio Club ⁴⁴	11-A - 180
W9KXE/9 Chicago Amateur Radio Club ⁴⁵	7-A - 84 T

(Continued on page 92)

★ WHAT THE LEAGUE IS DOING ★

CODE PROFICIENCY

It is impossible to have in *QST* a department entitled "What the League Is Doing" and not start it off this month with at least a brief mention of the vast interest which members are showing in the recent program for increasing code proficiency. As never before, the American amateur realizes the importance of being able to put down legible and exact copy at a usefully high speed. Nothing the League has done in recent years seems to have attracted such enthusiastic interest, and we dare say that no recent amateur activity has greater national value.

We need more participation by the fellows in the lower speed brackets. There is no reason why you 15-w.p.m. men should be ashamed to claim your A.R.R.L. certificate just because Willie Wagonwheel can copy at 35. As a matter of fact, probably the most interesting such certificate would be that of a chap who, on the first official transmission, could make perfect copy only at 15 and had that figure written into the body of his certificate but who, on each successive test, won a sticker for a five-word increment until he had the complete set of endorsements up to 35! So come on, you Fifteeners — we have a certificate waiting for you.

This activity holds something for everyone. At the opposite end of the picture are you fellows who can copy 30 or better and who are, therefore, likely to think that this campaign holds nothing to interest you. But can you do it on a *typewriter*? Many old-timers have never mastered copying on a mill, an accomplishment which is to-day required of all good operators. It is almost amusing what messy copy an old-timer can make of an easy 30 when first tackling the mill. The nightly (except Friday) transmissions of W1AW offer excellent practice. You are not really finished with this job until you have an A.R.R.L. certificate for a perfect 35 copied on the typewriter.

1.7-MC. BAND SHIFTED

At long last the F.C.C. has made the shift in our lowest frequency band contemplated by the Habana arrangement. On November 1st the old 1715-2000 band becomes 1750-2050 kc. Thus the harmonic relation of our bands becomes a straight line on the low-frequency edges and the "overhang" goes to the high end; we give up 35 kc. of exclusive c.w. territory and receive 50 kc. open to A-1, A-3 and A-4.

At the same time, the emergency calling band of 1975-2000 kc., specified in Sec. 12.155(b), is similarly moved up 50 kc. so as to remain on the edge of the band, and hereafter is to be 2025 to

2050 kc. During emergencies these frequencies are reserved for initial calls from isolated stations or for "first calls" concerning very important emergency relief matters or arrangements, all stations shifting as quickly as possible to other frequencies for carrying on communication.

LICENSE ISSUING

The proof-of-citizenship business threw a terrible load of extra work on the F.C.C. licensing section and put them far behind in issuing amateur tickets, so that even renewals and modifications were not coming through in time and some fellows were temporarily off the air. Some were even wondering whether this was a policy of deliberate discouragement to amateurs. We can tell you that it is absolutely nothing of the kind and that the Commission regrets that it has not been able to keep up with the work. At this writing, strenuous special steps are being taken to break the log-jam, with some special announcements due soon. We believe that by the time this issue of *QST* is out, great progress in overcoming the accumulated work will have been made and that soon tickets will be coming through in the usual time. There is no intentional delay; quite the contrary, everything possible is being done to get your pasteboards to you on time.

SOME WARNING NOTES

WE HAVE several items on which a word of caution needs to be said. Take care in talking over the air about your job. It's a common topic of conversation, but some jobs can't be talked about without telling things that alien interceptors would like to hear. This applies not only to jobs in aircraft and munition plants but in such places as railroad dispatching yards, long-distance telephone centers, etc.; and ditto about conversations that divulge government frequencies for various kinds of work.

Remember that we can't work all KA stations, but only those licensed to U. S. citizens. As information on this is hard to get, F.C.C. is likely to cite amateurs working stations other than those on the A.R.R.L. list. Such a list was first published on page 50 of August *QST* and is brought up to date in the Operating News this month. Better stick to that list!

When you have changed your permanent address and have applied for modification and are operating under portable procedure while awaiting the new license, don't forget that it is still necessary to send a separate notice to the inspector of your district every 30 days of such operation in portable status. Inasmuch as port-

able work is restricted these days, take pains to explain that it is not portable apparatus but simply the invoking of portable procedure under Sec. 12.93(a) while awaiting modification. Such procedure is not permitted for longer than 60 days and in no event beyond the expiration date of the license. And don't forget to sign the diagonal and numeral while so working.

EMERGENCY RIGS UNDER 73-A

SOME amateurs have apparently been trying to stretch Order 73-A, the special relaxation on portable work which the League secured, resulting in a sharp warning by F.C.C. through a publicity release which almost sounds as though no ordinary QSO's are permitted in the testing of emergency apparatus. We have discussed this with the Commission and find that their purpose is to put a quick stop to the abuses. Let us briefly summarize the present situation: No change above 56 Mc. Below 56 Mc., no more portable operation of sets that depend upon city power. Only self-powered apparatus useful in communication emergencies may be used. And even that may not be used Mondays to Fridays, inclusive, but only on Saturdays and Sundays, and then only during the daylight hours, and then only provided notice of at least 48 hours has been given the district inspector. However, for weekend daylight operation of self-powered apparatus, pursuant to notice, ordinary amateur QSO's may be engaged in for portable experience and for bringing apparatus to a high state of reliability. Don't be scared out of testing your emergency apparatus on weekends. Those who unduly stretch the regulations will catch the devil but you are perfectly entitled to work within the scope of the relaxation that the League secured for you.

GROWTH STATISTICS

THE number of U. S. amateur stations on June 30, 1940, was 56,295, compared with 53,568 a year before. We continue a satisfactory rate of growth. The number of licensed amateur operators on June 30th was almost exactly 55,000. Of these, half held Class-B licenses, over a third had Class A, and less than one-sixth were Class C.

BROADCASTING SHIFT

ALL the broadcasting stations operating above 720 kc. will be moved upward in frequency on March 29th next by 10, 20 or 30 kc. This will make a lot of push-button readjusting for servicemen, but it also means to amateurs that many broadcasting stations used for the calibration of frequency meters (or having a "helpful" third harmonic in the 80-meter band!) will then be on a different frequency. Watch this and don't be misled.

FINANCIAL STATEMENT

THE second quarter of the year was a rather slim one from the business standpoint, as

it always is in League operations, but a little better than last year — and the League entered the second half of the year with a slightly better margin than usual. By order of the Board of Directors, the operating statement is here reproduced for your information.

STATEMENT OF REVENUE AND EXPENSES, EXCLUSIVE OF EXPENDITURES CHARGED TO APPROPRIATIONS, FOR THE THREE MONTHS ENDED JUNE 30, 1940

REVENUES	
Membership dues	\$ 9,536.60
Advertising sales, <i>QST</i>	22,053.12
Advertising sales, Handbook	6,844.00
Advertising sales, booklets	1,800.00
Newsdealer sales, <i>QST</i>	10,359.81
Handbook sales	5,226.80
Spanish edition Handbook revenues	3,654.85
Booklet sales	3,912.58
Calculator sales	321.23
Membership supplies sales	1,568.53
Interest earned	530.94
Cash discounts received	363.50
Bad debts recovered	21.45
Profit on sale of capital assets	10.00
	\$66,203.41
<i>Deduct:</i>	
Returns and allowances	\$ 3,988.95
Cash discounts allowed	500.62
Exchange and collection charges	166.67
	\$ 4,656.24
Less: decrease in reserve for newsdealer returns of <i>QST</i>	499.62
	4,156.62
Net Revenues	\$62,046.79
EXPENSES	
Publication expenses, <i>QST</i>	\$15,492.58
Publication expenses, Handbook	3,455.16
Publication expenses, booklets	1,178.39
Publication expenses, calculators	165.75
Spanish edition Handbook expenses	1,797.30
Salaries	24,631.75
President's defense expenses	123.31
Membership supplies expenses	946.25
Postage	1,144.51
Office supplies and printing	1,794.43
Travel expenses, business	1,604.14
Travel expenses, contact	1,230.47
<i>QST</i> forwarding expenses	1,308.83
Telephone and telegraph	671.24
General expenses	1,559.71
Insurance	75.15
Rent, light and heat	1,132.95
General Counsel expenses	258.68
Communications Dept. field expenses	179.59
Headquarters Station expenses	543.63
Alterations and repairs expenses	201.72
Bad debts charged off	43.63
Provisions for depreciation of:	
Furniture and equipment	312.33
Headquarters Station	448.89
	60,350.39
Total Expenses	60,350.39
Net Gain before expenditures against appropriations	\$ 1,696.40

REGISTRATION

F.C.C. is proposing to Congress that the Communications Act be amended to provide for

(Continued on page 72)

An Electron-Coupled Oscillator, 1941 Model

Automatic In-Band Operation and 'Phone-C.W. Switching

BY F. G. SOUTHWORTH,* W5JJ

ELECTRON-COUPLED oscillators are probably the most cursed and discussed subject in amateur radio today. Much of the ease against them resolves itself into poor use of them coupled with the dangers of out-of-band operation and the use of 'phone in the c.w. bands. Numerous articles have appeared in the literature showing that e.c. oscillators can be built to have stability approaching that of a good crystal oscillator and exceeding that of a poor one, and it has often been pointed out in *QST* that *intelligent* use of the e.c.o. can result in reduced QRM. However, many have stayed away from any type of variable-frequency oscillator because of the possibility of out-of-band operation, and it is the purpose of this article to show how an e.c.o. can be constructed that will cover any and all bands yet cannot be tuned outside of one. A further advantage is that the oscillator makes it impossible to use 'phone in the c.w. bands and c.w. in the 'phone bands.

Very little space has been devoted in this arti-

used must first be reduced to a one-band equivalent, which should be one-half the frequency of the lowest frequency band desired. In our case this was the 80-meter band, since we work in the 40-, 20- and 10-meter bands. Inspection shows that the 40-meter band is equal to an 80-meter equivalent of 3500 to 3650 kc. The 20-meter band is equal to 3500 to 3600 kc., and the 10-meter band is 3500 to 3750 kc. Therefore the oscillator must cover 150 kc., 100 kc., and 250 kc., respectively, for full coverage of these bands. Probably the easiest method of obtaining such variable band widths is to use a variable capacity in series with the tuning condenser. By doing so the effective capacity of the tuning condenser can be varied from one-half its minimum to about one-half its maximum capacity. For example, a condenser which changes 250 $\mu\text{fd.}$ with 180° rotation connected in series with another 250- $\mu\text{fd.}$ condenser would give approximately 125 $\mu\text{fd.}$ change, while the same condenser could give an effective capacity change of 100

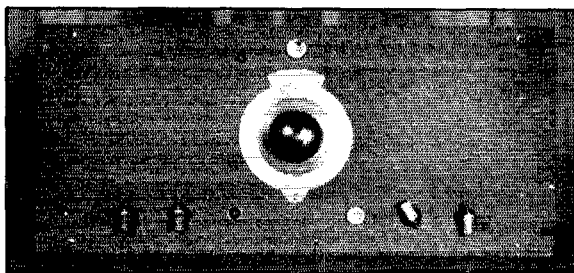

A front view of the e.c.o. shows the arrangement of the controls. The band indicator can be seen just above the main tuning dial in the center and, from left to right, the controls along the bottom are output tuning, band-change switch, audio volume control and a B-switch for r.f. only, a.f. only, or both sections together.

cle to general e.c. theory or operation, because to do so would be to duplicate the very fine article by W6CUH which appeared in *QST*.¹ The exciter described here follows the Perrine one closely except for a few details which will be brought out. For convenient operation and accessibility, a speech amplifier-driver was incorporated in the unit. Incidentally, this a.f. circuit is the smallest simple amplifier for its cost we have ever seen. Its output is 13 watts, enough to drive any size of Class-B modulator or to cathode-modulate 150 watts of carrier.

In attacking the problem of completely covering several amateur bands, all of the bands to be

$\mu\text{fd.}$ by changing the series condenser to about 167 $\mu\text{fd.}$ It would be possible, therefore, to set the series condenser to cover exactly the band each time we changed band. However, this would defeat the original requirement of permanently setting each band once and for all, so a rotary switch is used to cut in pre-tuned series condensers, one for each band. The main tuning condenser will then have an effective capacity change from minimum to maximum necessary to cover fully each band. Two switches, one on each side of the series condenser group, must be used, since both sides of the series condenser are above ground for r.f. voltages. Changes in the setting of any one series condenser would affect the setting of all others if they were connected together on one side. These switches are labeled

* Miller Street, Vickery, Texas.

¹ Perrine, "An Answer to the E.C.O. Problem," *QST*, Sept. 1939.

Sw_1 and Sw_2 in Fig. 1. Positions *a*, *b*, and *c* represent the 40-, 20- and 10-meter bands respectively.

If the series condenser is set to the correct capacity to give a frequency change of 150 kc. with a 180° rotation of the tuning condenser, and the circuit constants are adjusted to give that 150-ke. variation in the range from 3500 to 3650 kc., or the equivalent of the 40-meter band when doubled, all of the other bands will then end at approximately 3650 kc. instead of properly at 3600 kc. for 20 meters and 3750 kc. for the 10-meter band. This is because the effective capacity

change of the tuning condenser in series with the band-width control condenser is raised or lowered by increasing or decreasing the band-width control value, but the minimum-capacity value will not be varied to any degree, and only the high-capacity end of the range will reflect the variation. Since the low-capacity value sets the high-frequency limit of each band, and since these high-frequency limits are not harmonically related, we must also add or subtract a small value of trimming capacity for each change of series capacity. This is done in this particular case by adding another gang to the band switch

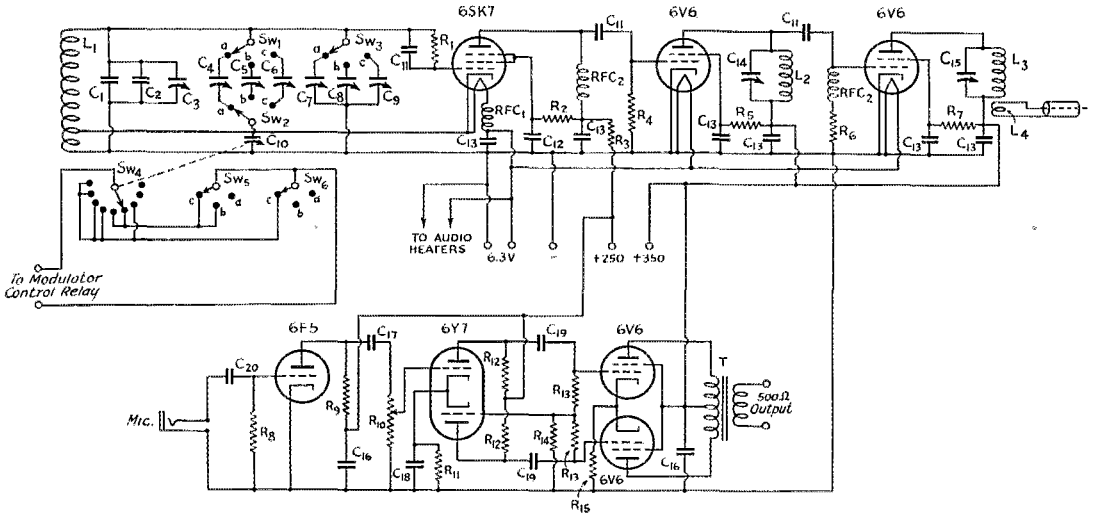
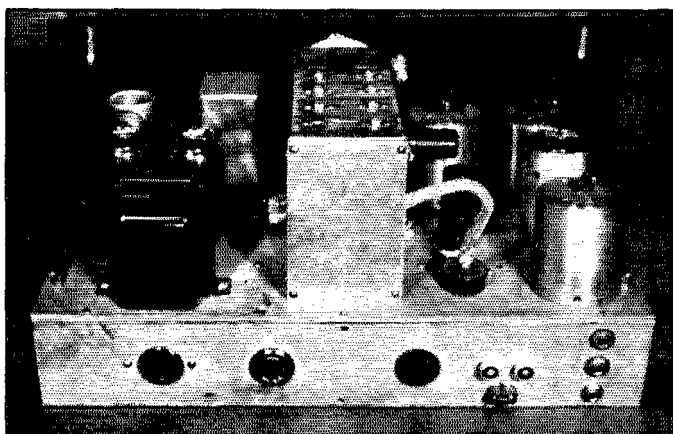

Fig. 1 — Circuit diagram of the e.e.o. and audio channel.

- C₁ — 400- μ fd. zero temperature-coefficient condenser (Centralab No. 816).
- C₂ — 15- μ fd. temperature coefficient condenser (Centralab No. 913).
- C₃ — 100- μ fd. variable condenser (National ST 100).
- C₄ — 50- μ fd. midget variable condenser. 7-Mc. band-width control (Hammarlund APC 50).
- C₅ — 50- μ fd. midget variable condenser. 14-Mc. band-width control (Hammarlund APC 50).
- C₆ — 100- μ fd. midget variable condenser. 28-Mc. band-width control (Hammarlund APC 100).
- C₇ — 50- μ fd. midget variable condenser. 7-Mc. band-setter control (Hammarlund APC 50).
- C₈ — 50- μ fd. midget condenser. 14-Mc. band-setter control (Hammarlund APC 50).
- C₉ — 15- μ fd. midget variable condenser. 28-Mc. band-setter control (Hammarlund APC 15).
- C₁₀ — 250- μ fd. midget variable condenser. Main tuning condenser (National SF 250).
- C₁₁ — 100- μ fd. midget mica.
- C₁₂ — 0.001- μ fd. midget mica.
- C₁₃ — 0.005- μ fd. midget mica.
- C₁₄ — 50- μ fd. midget variable condenser. 7-Mc. tank capacity (Hammarlund APC 50).
- C₁₅ — 50- μ fd. midget variable condenser. 7- or 14-Mc. tank capacity.
- C₁₆ — 0.25- μ fd., 450-volt paper.
- C₁₇ — 0.1- μ fd., 450-volt paper.
- C₁₈ — 25- μ fd., 50-volt electrolytic.
- C₁₉ — 0.1- μ fd. midget mica.
- C₂₀ — 0.1- μ fd. 400-volt paper (enclosed in shield with first a.f. tube).

- R₁ — 1.5 megohms.
- R₂ — 15,000 ohms, 5-watt.
- R₃ — 6000 ohms, 5-watt.
- R₄ — 100,000 ohms.
- R₅ — 20,000 ohms.
- R₆ — 15,000 ohms.
- R₇ — 2500 ohms, 2-watt.
- R₈ — 0.1 megohm, 1-watt (enclosed in shield with first a.f. tube).
- R₉ — 0.25 megohm, 1-watt.
- R₁₀ — 0.5-megohm volume control.
- R₁₁ — 250 ohms, 10-watt.
- R₁₂ — 0.2 megohm, 1-watt.
- R₁₃ — 0.5 megohm, 1-watt.
- R₁₄ — 10,000 ohms, 1-watt.
- R₁₅ — 250 ohms, 10-watt.
- L₁ — 18 turns No. 20 spaced to 1½ inches on 1-inch form, tapped at 4th turn from ground.
- L₂ — 25 turns No. 20 enam. on 1½-inch diam. form spaced to 1½ inches.
- L₃ — 7 Mc.; same as L₂.
- L₄ — 14 Mc.; 13 turns No. 22 enam. on 1¼-inch diam. form spaced to 1¼ inches.
- L₅ — 3 turns close-wound at cold end of L₄.
- RFC₁ — ¼-inch dowel, 4 inches long, close-wound full length with No. 22 s.c.c.
- RFC₂ — 2.5 mh. (National R 100.)
- T — Push-pull 6V6 Class A to 500-ohm line (Thordarson 17S11).
- Sw₁, Sw₂, Sw₃, Sw₅, Sw₆ — 3-gang, 3-position, 6-circuit (one unused Ehy 2605-3).
- Sw₄ — See text for detailed description.



A rear view shows the audi channel on the left, the e.c.o. in the center, and the buffer and output stages on the right. Note the trimmer and band-set adjustment screws showing through the top of the e.c.o. compartment. The sockets at the rear of the chassis, from left to right, are for 500-ohm audio output, heater and plate power leads, and relay circuits in the modulator (controlled by Sw_4 , Sw_5 , and Sw_6). Although not all shown in Fig. 1, the two connectors serve as output terminals from the plate circuits of the 6V6's, and the jacks are used for metering the grid and plate currents of the 6V6's.

which cuts in and out pre-tuned midget variable condensers. This section is labeled Sw_3 in Fig. 1.

'Phone and c.w. switching is made possible by ganging a very special switch to the tuning control. This switch, labeled Sw_4 in Fig. 1, is shown in detail in Fig. 2. It is made with a one-inch switch arm acting on $\frac{1}{4}$ -inch switch-contact points set in a 2-inch half circle, and so positioned that a closed-circuit condition exists. In other words, the switch arm can engage the next contact slightly before breaking contact with the contact it is being moved from. These contact points are so connected as to represent segments of the amateur bands. These segments are then cut in and out of the circuit by Sw_5 and Sw_6 , which are ganged to the other band-change switches, so that only the 'phone portion of each band is in the circuit. For instance, at position *b* (the 20-meter band) only the center segment of two contacts (or 45°) is in the circuit. This 45° -segment is reached when the main tuning dial is between 37.5 and 62.5 (100 divisions representing 180°), and when the main tuning control is properly set to cover the 20-meter band this segment will exactly cover the 20-meter 'phone band of 100 kc. On 10 meters all of the segments are connected with the exception of the first 45° of rotation. The connected segments therefore represent the 'phone band of 28,500 to 30,000 kc. When turned to any spot in any 'phone band, this switch connects the modulator plate supply, removes a short from the Class-B output transformer and turns on a red "Phone" pilot light, all by means of a 3-pole double-throw $2\frac{1}{2}$ -volt a.c. relay.

The complete unit is mounted on a standard 10- by 17- by 3-inch chassis. An aluminum box 5 inches high, 4 inches wide and 7 inches long is mounted in the center of the chassis. This box contains the complete oscillator: grid coil, main tuning condenser, etc. Notice C_3 at the right side of this box with its lock which is made by National. The 6SK7 oscillator tube is mounted

at the left side of the box in a horizontal position, providing short leads yet keeping most of the tube heat out of the box where it might affect the stability of the circuit. All of the series band-width-setting midget variables and the trimming condensers are mounted in the top of this box where they may be easily reached. The Eby switch has been worked over and separated into two units; two gangs are in the box and the third gang is mounted underneath the chassis. Thus Sw_1 , Sw_2 , and Sw_3 are in the box and Sw_3 and Sw_5 are under the chassis. These latter two portions of the switch are ganged by bronze cables and flat-faced pulleys taken from an old 1924 or 1925 Atwater-Kent receiver. The same means is used to gang Sw_4 to the tuning condenser.

All audio components are mounted on the right-hand side of the chassis, leaving the left side for the two 6V6's and their associated tank circuits. These tank circuits use midget Hammarlund APC condensers and Hammarlund plug-in coil forms wound with No. 20 wire. The shield over each has a half-inch hole drilled in the center of the top for ready access to the condenser. A rubber grommet is fitted in this hole to prevent accidental shorting of the plate voltage. It was found advisable to wind the oscillator grid coil with No. 20 wire instead of the usual smaller wire, to prevent undue heating by the 300-ma. heater current. Another variation from the original circuit is the r.f. choke in the ungrounded

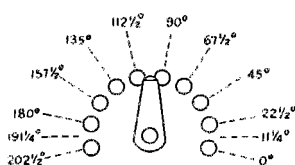
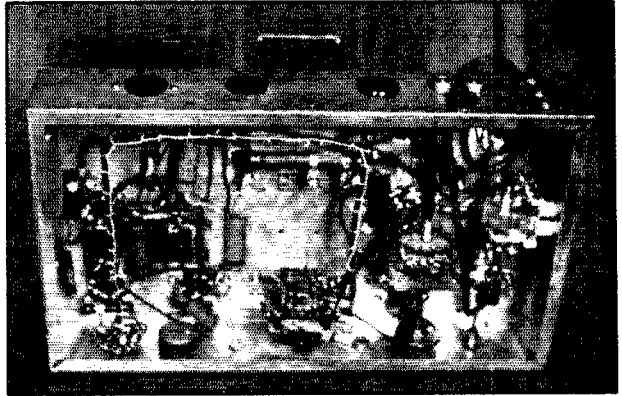

Fig. 2—A sketch of switch Sw_4 , illustrating the positioning of the contacts for automatic 'phone-c.w. switching. The switch is ganged with the main tuning condenser.

◆

The ganging of the switches can be seen in this under-chassis view. The switch in the center of the chassis is ganged to the tuning condenser, and the switch on the right-hand side is ganged to the band-change switch. Ganging is done with cables and pulleys from an old h.c. receiver.

◆



side of the heater. This method of floating the heater for r.f. has proved most satisfactory and is much easier than using an interwound coil on the tank coil. The power supply in use is capable of 200-ma. drain. The output voltage with a choke input and two-section filter-choke combination is 250 volts. The 350 volts is taken off between the input choke and the first smoothing choke.

In tuning and lining up this e.c. oscillator, it will be found that condensers C_3 through C_8 will all be set very near maximum capacity for proper operation. With these condensers set at about 80 per cent of maximum, tune the receiver to 30,000 kc. with the oscillator band switch set on 10 meters and set C_{10} at minimum capacity. Tune C_3 until a beat is heard and then rotate C_{10} to maximum capacity and check the frequency on the receiver. It should be about 28,000 kc. If it is less than 28,000 kc., decrease the capacity of C_6 slightly and if it is more than 28,000 kc. increase C_6 . When C_6 is set to 28,000 kc., tune C_{10} for minimum capacity and set the receiver on 30,000 kc. and retune the oscillator with C_9 . This operation should be repeated until C_{10} at

maximum gives a 28,000 kc. signal and at minimum a 30,000 kc. one. The band switch should be turned to 40 meters and the procedure repeated until this band is completely covered. Last, the 20-meter band should be lined up.

While the use of temperature compensation condensers and voltage regulated power supplies greatly minimizes drift and unintentional frequency change, *always monitor signals frequently during operating times*. This is, of course, particularly important when working near a band edge, but it should be done at all times.

◆ Strays ◆

OUR COVER

A "natural" seemed to present itself in the form of an angle shot of By Goodman's version of a "pot" oscillator. Usually the really effective pieces of equipment arrive in a most complicated manner. This $2\frac{1}{2}$ -meter oscillator is certainly the opposite in all respects as it represents a really stable oscillator that any ham can rig up with a couple of shield cans and just a mite of care.

How Is Your Code Proficiency?

Have you got your code attainment award certificate from A.R.R.L.? This League award is available to every United States amateur licensed. The program aims to recognize your code ability and WIAW practice transmissions take place on 1761, 3825, 7280, 14,253 and 28,510 kcs. daily except Friday starting at 9:15 p.m. C.S.T. to help you add to your ability to read code the knack of copying code. It is time now to prepare for the next official qualifying run from WIAW which will take place Wednesday, November 20th at 9:30 p.m. C.S.T. Aim to get your certificate or endorsement sticker for higher speed on that date.



Don't Miss the Eleventh A.R.R.L. Sweepstakes

**Nor. 9th-11th, 16th-18th—Awards to Section¹ Leaders—C.W. and
'Phone Certificate in Each Club—Gavel to Winning Club—Use
'Phone or C.W. Any Ham Band(s)**

F. E. HANDY,* WIBDI

MANY hams complete QSL-card records and achieve "WAS" through each year's "SS." This is the best chance of the year to progress toward that objective. Former DX men have had their eye on this leading A.R.R.L. activity for months. The "SS" seems to suit everybody — has a universal appeal.

The contest is to work as many stations as possible. The points from such work will be multiplied by the number of *different* A.R.R.L. Sections² worked with at least a complete one-way exchange in the contest. All essential contest information is sent in the form of a standard preamble. Exchanges are for the record sent to Hq. New hams may also add to their knowledge of the way preambles to A.R.R.L. messages are sent and acknowledged, and fills requested, accuracy of 'phone communication assured, etc., if they take part and follow the standard practices set forth for these things in *The Radio Amateur's Handbook*. Good operating practices, avoid delay, prevent garbles, and overcome inability to write or take standard message forms. The "SS" builds operating keenness and order of work follows order of message preambles. New station records are invariably made in each SS. It's operating fun.

In the annual "SS" telegraphing operators will contact and compete with other telegraphing operators. 'Phone hams will compete with other 'phone hams. Paper work is completed as you go along with nothing to do but total and summarize points and send it in. *Mimeographed contest forms will be sent gratis to anyone who sends a radiogram or drops a card for the same.* Use of our sheets is not required nor is advance entry necessary. The purpose is to help participants keep a uniform log. Follow the arrangement or form shown with this announcement. Draw your own columns on your own paper if you like . . . or ask us for a form.

You cannot work more than *40 hours' total operating* in the two contest periods, but you can operate "solid" for one 33-hr. week-end (with 7 to go) if you wish. Use any amateur frequency bands you choose. Timing can be planned to permit the average ham time for meals, for 8 hours' daily sleep, etc. Cross-examination of logs makes it possible to check operating time. Every

* Communications Manager, A.R.R.L.

¹ Including Porto Rico, Hawaii, Alaska, P. I.

amateur active in any A.R.R.L. field organization² section is cordially invited to take part. A single, snappy CQ SS will often bring results! CQ SS CQ SS CQ SS de W . . . W . . . W . . . is used by stations looking for contacts in the Sweepstakes.

Award Certificates

A.R.R.L. will provide certificates for winners this year. The c.w. winner, and the radiotelephone winner for each A.R.R.L. Section will receive this special recognition of his score and achievement. There will be an additional certificate to recognize competitive effort in clubs, where three or more club members submit properly identified logs connecting their work with a particular club. At least three must compete for it, and report, to rate either a club 'phone, or a club c.w. "SS" certificate. The sum of all club member scores ('phone and c.w.) for which logs are submitted will count toward a club gavel award to the nations' leading club in the "SS."

Proof of QSO

At least *one* way complete six part exchange must be completed and acknowledged between two stations as "proof of QSO"³ before points or Sections can be claimed.

It is not essential that each station worked be taking part in the contest to make your points count. Any operator who needs information can be referred to this announcement. First, ask the operator to take your preamble and come through with like information in preamble form.

² See list of Sections in the A.R.R.L. field organization, page 4, of this issue of *QST*. . . Note that in view of F.C.C. Order No. 72 that no contacts with Cuba will be counted, and only the P. I. stations operated by U. S. citizens whose calls are given elsewhere in this issue.

³ There is no point in working the same station more than once in the contest period if two points have been earned by an exchange. If but one point is made the first time, you can add a point by working this station again for exchange in the opposite direction. Underline all such exchange entries in your "list," identify them by showing parenthetically the call of the correspondence station. Leave right or left report columns blank so that other pairs of exchanges completed in *one* contact are side by side.

THE CONTEST PERIOD

Time	Starts	Ends
E.S.T.	Nov. 9 & 16, 6:00 P.M.	Nov. 11 & 18, 3:01 A.M.
C.S.T.	Nov. 9 & 16, 5:00 P.M.	Nov. 11 & 18, 2:01 A.M.
M.S.T.	Nov. 9 & 16, 4:00 P.M.	Nov. 11 & 18, 1:01 A.M.
P.S.T.	Nov. 9 & 16, 3:00 P.M.	Nov. 11 & 18, 12:01 A.M.

Scoring and the Power Factor

If the power input to the final stage (plate current times plate voltage — $E \times I$) is:

(a) Up to and including 100 watts — multiply score by 1.25.

(b) Over 100 watts — multiply score by 1.

Operating in both low- and high-power classes at different times is still permitted, but note that rule 2 places all QSO's in the high-power class if one does not stick to inputs below 100 watts.

Scoring system in brief:

All contacts:

One point for each QSO when "receipt" is completed for an exchange one way.

Two points for each QSO when the required information is exchanged both ways.

For final score:

Multiply totaled points by the number of different A.R.R.L. Sections² worked, that is, the number in which at least one *bona fide* SS point or exchange has been made.

Multiply this by 1.25 if you used 100 watts or less transmitter input at all times.

Additional Rules

1. Information in contest exchanges (six parts) must be sent in the order indicated, that of the A.R.R.L. message preamble. Incomplete exchanges or wrong order of sending justifies disqualification.

2. Entries should be (a) in the low-power class, or (b) high-power class. Any work on high-power places all of one's score in the high-power class. Logs must show the power used for each QSO or for groups of QSOs.

3. Reports must show operating time for each period spent on the air in the "SS," and the total of such operating time.

4. Logs must be marked for "phone" or "C.W." entry, grouping all work by either method together as one score.

5. All work must fall in the contest period.

6. Decisions of the award committee shall be accepted as final.

7. Reports must be received at A.R.R.L. Hdq. from all stations except those in Alaska, Hawaii, and P. I. on or before noon, Dec. 20, 1940, to be considered for certificate awards. From outlying points, reports must similarly be received on or before Jan. 24, 1941.

Club Participation

Certificate awards (besides the 'phone and telegraph Section awards) will be made through each club where *three or more* individual club members, or new hams invited and reported by such a club, in addition to sending a contest report *have their club secretary* write Hq. listing their individual calls and scores, and the total of such scores. Only the aggregate of scores confirmed by receipt here of Contest Logs shall count for the club. If there are both club 'phones and c.w. entries, A.R.R.L. will provide two certificate awards for the club to give its leading members. The sum of the scores of all club participants ('phone and c.w.) confirmed by logs will be added by the secretary, *to count for the club!*

A genuine gavel, with engraved sterling silver band, is offered as an award to that club whose officers or activities' manager submits the greatest collective score from "SS" logs. Club members must send in full reports either direct or through the secretary to substantiate the club's claim on the gavel award! A chance to win honors for your club and a valuable trophy for the club's presiding officer to use at meetings!

Competition comes only from operators in one's immediate Section. Awards are for the operator running up the best communication record for each Section (as indicated by the score). Operators thus have equal DX conditions and operating opportunity. Fullest operating enjoyment is assured. See May QST for full details on the last SS or ask any amateur who took part last year!

Reporting Results

Report⁵ to A.R.R.L., West Hartford, Conn., as soon as the contest is over. Use the log form shown in the example. List all operators⁶ whose work at your station is responsible for any part of the score.

All active ham operators are invited to take part and report. You will work a new bunch of stations, make new records for your station, get QSL cards (be sure to send one

⁵ All hams are requested to submit lists, even if they only show a small score, on a postal. By doing this they help support claims made in logs from other stations and receive credit in QST.

⁶ The highest individually-attained score of any one of the operators of amateur stations having more than one operator is the official score for such a station. The summary of score must show *all* stations worked by *all* operators however, circling the entries of stations and/or Sections that cannot

EXPLAINING CONTEST EXCHANGES

<i>Send Like Std. Msg. Preamble</i>	<i>NR</i>	<i>Call</i>	<i>CK</i>	<i>Place</i>	<i>Time</i>	<i>Date</i>
In the "SS" Exchanges.....	Number contest info. sent consecutively, 1, 2, 3, etc., a new nr. for each station worked	Send your own call	CK (RST report ⁴ of station worked)	Your city and section ^{2, 4}	Send time of transmitting this "NR"	Send date of QSO
Purpose.....	The QSO-nr tells how you are doing; aids Hq. checking	Identification	All stations exchange complete reports	The A.R.R.L. Section is vital contest data	Time and date must check in both logs and fall within the contest period to prove each point claimed	

⁴ Send the letters CK and just the three number RST report. In 'phone exchanges only two numerals need be used. Make a habit in all 'phone reports of saying, READABILITY . . . STRENGTH. . . This avoids confusing abbreviations. It is best radiotelephone practice *always* to avoid use of abbreviations. Instead of just the state (which is the same as the Section in many cases), identify your A.R.R.L. Section as, for example, Salem, Eastern Mass.; Providence, R. I.; Buffalo, W. N. Y.; Omaha, Neb.; Oakland, E. Bay, Hewlett, N. Y. C.-L. I.

STATION W . . . SUMMARY OF EXCHANGES 10TH A.R.R.L. ALL-SECTION SWEEPSTAKES

Freq. Band (Mc.)	Time On or Off Air	NR	SENT (1 point)			Time	Date (Nov.)	RECEIVED (1 point)				Time	Date (Nov.)	Number of each Different New Section as W'd	Points
			Stn.	CK-RST	Place			NR	Stn.	CK-RST	Place				
3.5	On 6:10 P.M.	1	W1AW	579	W. Hartford, Conn.	6:15 P.M.	10	3	W1KQY	589	West Haven, Conn.	6:18 P.M.	10	1	2
"	"	2	"	439	W. Hartford, Conn.	6:25 P.M.	10	7	W1KFN	479	New Haven, Conn.	6:30 P.M.	10	..	2
"	"	3	"	589	W. Hartford, Conn.	6:40 P.M.	10	2	W3BKZ	389	Chevy Chase, M.D., D.C.	6:45 P.M.	10	2	2
7	"	4	"	499	W. Hartford, Conn.	10:18 P.M.	10	3	W8BEN	569	Rochester, W. N. Y.	10:24 P.M.	10	3	2
"	"	5	"	579	W. Hartford, Conn.	1:25 A.M.	10	7	W9BES	589	Chicago, Ill.	1:15 A.M.	10	4	2
"	Off 3:00 A.M. 8 hours 50 min. On 1:00 P.M.	6	"	549	W. Hartford, Conn.	2:50 A.M.	10	15	W9VKF	479	Minneapolis, So. Minn.	2:55 A.M.	11	5	2
14	"	7	W1AW	479	W. Hartford, Conn.	2:15 P.M.	18	14	W5KC	339	Plaquemine, La.	1:05 P.M.	18	6	1
"	"	8	"	589	W. Hartford, Conn.	3:00 P.M.	18	17	W5CWW	459	El Paso, So. Texas	2:20 P.M.	18	7	2
"	"	9	"	579	W. Hartford, Conn.	4:06 P.M.	18	11	W1EWD	589	New Britain, Conn.	2:55 P.M.	18	..	2
"	"	10	(W5KC) W1AW	349	W. Hartford, Conn.	4:30 P.M.	18	16	W6MEK	439	Bakersfield, S.J.V.	4:31 P.M.	18	8	2
"	Off 5:20 P.M.	11	"	479	W. Hartford, Conn.	5:10 P.M.	18	9	W9IPT	579	Wheaton, Ill.	5:15 P.M.	18	..	2

4 h. 20 m.
13 h. 10 m.

8 sec. 22 pts.

3.5,
7 and
14 Mc.
used.

85 watts Input Power

Number and name of operators having a share in above work
 Claimed score: 22 points X 8 Sections = 176 X 1.25 (85 watts input) = 220.
 I hereby state that in this contest I have not operated my transmitter outside any of the frequency bands specified on my station license, and also that the score and points set forth in the above summary are correct and true.

Signature

My tube line-up

Address

Number different stations worked

for each QSO), have a lot of fun, meet new friends, and perhaps rate an A.R.R.L. award at the conclusion. Do your best operating. Send A.R.R.L. the results for QST mention. MAIL YOUR REPORT IMMEDIATELY AT THE END OF THE CONTEST TO AVOID DELAY AND INSURE THAT YOUR RESULTS ARE CREDITED AND KNOWN THROUGH QST.

count in the official total. Awards will be based on the official total and will be made to the individual operator accredited with this total. To show the possible scores that can be built up by several operators at one station, such scores (all Sections listed by all points listed) may be shown parenthetically after the "official" score that counts toward a possible award.

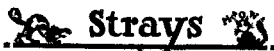

FORMER A.R.R.L. PUBLICITY MAN WRITES HIT BOOK

OLD-TIME hams, particularly those who once graced the rolls of the historic "Inkslingers,"

will be glad to learn that the Joshua K. Bolles who authored "Father Was An Editor," currently listed by the W. W. Norton Co., is none other than J. Kenneth Bolles, newspaperman and head of A.R.R.L. Publicity from 1922 to 1924. Climaxing a couple of decades of newspaper and publicity work, "Jake" has in recent years been struggling for authorship recognition. This time it seems he has rung the bell. "Father Was An Editor" is being lauded by reviewers for all sorts of things, including social and sociological implications; but above all it is grand entertainment and a pungent, readable account of the era of American life from which we have quite recently emerged. A trip to your bookseller will not only bring current news of a man who did much for ham radio in its early perilous days, but will also mean a pleasant winter's evening.

A Stabilized 2½-Meter Oscillator

Simplified Construction of "Pot" Tank Circuits

BY BYRON GOODMAN,* WJJE

If you're looking for a more stable oscillator on 2½ meters, but have avoided the Peterson "pots" because they looked like too much machine work, you'll find that shield cans can be used to build a high-*Q* tank circuit without a great deal of difficulty. The results surpass those with any other u.h.f. self-excited oscillator.

There is no particular need to go into the reasons for using stable signals on the 112-Mc. band, since they should be self-evident. There have been several approaches to the problem. The obvious one, that of using crystal control from a lower frequency, normally requires the use of a multiplicity of frequency-multiplying stages and a search for tubes that will work well and still not drag down the purse too much. The use of parallel rods to furnish a high-*Q* tank for a self-excited oscillator doesn't seem to have met with too wide an acceptance, although it does give a higher degree of stability than a coil-and-condenser circuit. A very promising avenue of approach was described some time ago in *QST*,¹ where so-called "pots" were used to give a high-*C* low-loss circuit for controlling the frequency of the oscillator. However, many readers were frightened away at the thought of intricate machine work in the construction of the gadget. There is no need for such fear, as we hope to point out in this story. And the results far surpass any other form of self-excited u.h.f. oscillator that we have seen.

The "pot" circuit gives, in effect, a high-*C* low-*L* circuit with quite low losses, which results in a very high-*Q* tank. Unfortunately, the tube has to be connected across the circuit and thus lowers the *Q*, and coupling the load into the circuit further reduces the *Q*, but the net result is still a much better circuit than can be obtained by more conventional means. The condenser is similar to the neutralizing condensers used for lower-frequency rigs that are made of two concentric cylinders of slightly different diameters. The inductance is a short length of coaxial line with one end shorted. By using the outer conductor of the coaxial line as the inner cylinder of the condenser, and supporting the outer plate of the condenser by the open end of the inner con-

ductor of the coaxial line, a parallel-tuned circuit is obtained that has no losses except the resistance along the surfaces of the metal, since the only insulator in the circuit is air and there are practically no radiation losses because of the complete shielding. The metallic surfaces have considerable area and so the resistance there is much less than in conventional circuits.

The "pot" tanks have looked good to a number of experimenters, but they seemed to involve too much machine work for the average amateur and so have not been used. However, Frank Lewis, ex-W9AOG, happened to let slip to us one day that they were using pots at M.I.T. and had tried some made from ordinary shield cans, with fair success. It was another of those "why-didn't-I-

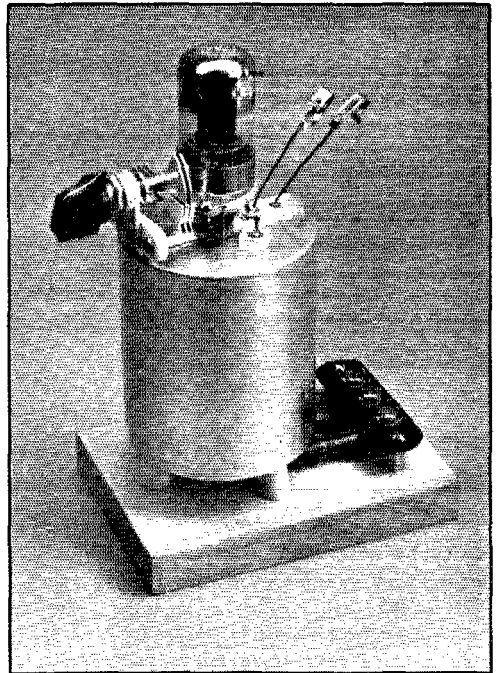

A Peterson "pot" oscillator for 112 Mc. using two shield cans and a copper rod for the tank circuit. The stability is superior to any other form of u.h.f. self-excited oscillator.

The grid lead and the output coupling kink are brought out through the small polystyrene blocks cemented to the top of the can. The tuning condenser is an ordinary midget that has been modified by removing the rear rotor and stator supports.

* Assistant Technical Editor.

¹Peterson, "High-*Q* Tank Circuits for the Ultra-High Frequencies," *QST*, Sept., 1939.

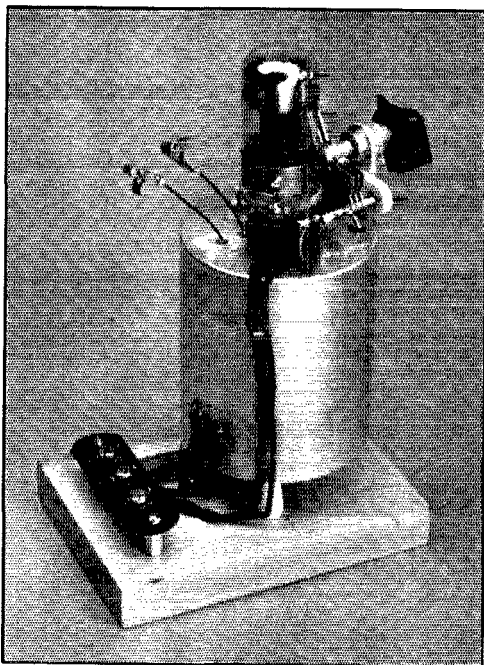

Another view of the "pot" shows the plate lead brought out through the can and fastened to the stator of the tuning condenser, and the heater and cathode bypass condensers grouped closely around the socket. The heater and cathode wires are secured to the side of the can by cellophane Scotch tape.

think-of-that?" affairs, and immediately one desk at HQ was covered with all of the catalogs listing aluminum shield cans. A pair was found that looked promising (because the dimensions were right to hit near 112-Mc. with the proper-sized inner conductor), and the first "pot" was built. No provision was made for tuning the circuit and, with a 7A4 tube in the circuit, it hit around 130 Mc. The pot was cut down until the tube showed signs of refusing to oscillate, at something above 160 Mc. The pots described in the original article used "flippers" to tune them, but this looked to be a difficult mechanical job, and it was decided to try an ordinary midget variable condenser across the circuit. The thought of the losses in the Isolantite insulation worried us a bit, and a strip of polystyrene was substituted for the Isolantite. However, it was found that there was practically no difference in the results with polystyrene or Isolantite insulation, and the final model uses no trick tuning condenser, although it is a nice refinement.

The Circuit

Although it may not look like one at first glance, the circuit shown in Fig. 1 is a tuned-plate oscillator using a pot tank and inductive coupling to the grid. The plate of the tube is connected to the

open end of the inner cylinder, which corresponds to one end of a conventional coil-condenser parallel circuit, and the grid coupling is obtained by running a wire up through the inner cylinder parallel to the rod. Changing the position of this wire in its relation to the rod changes the coupling and hence the excitation. Power is coupled out of the circuit by a hairpin loop of wire running parallel to the rod and in the plane of a radius. Pushing the loop farther down in the pot increases the coupling. The tuning condenser is connected between the plate of the tube and the outer shield can, or, in effect, across the tuned circuit. Since the pot is connected directly to the plate, the whole pot is at the d.c. plate voltage above ground. However, as a safety measure it is easy to give the whole outer surface of the pot several coats of clear lacquer. The rest of the circuit consists simply of by-pass condensers, the grid leak and an r.f. choke, all in conventional locations. The condenser C_3 was found necessary to help remove r.f. from the power-supply leads.

Construction

There is no trick at all to building the pot, and no special tools are required except a 6-32 tap and the No. 35 drill to go with it. The outer shield can is a 3-inch diameter I.C.A. and the inner one is a 2½-inch diameter I.C.A., both measuring 3½ inches long. Points are located in the exact centers of the ends of each can and holes drilled

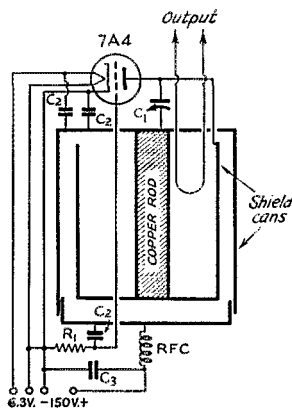

Fig. 1 — Circuit diagram of the "pot" oscillator using shield cans for the concentric cylinders. The copper rod is ¾ inches in diameter and 3½ inches long. The outer shield is a 3-inch diameter I.C.A., the inner shield is a 2½-inch diameter I.C.A. with a ¼-inch strip removed.

- C_1 — 20- μ fd. midget variable, modified. (Hammarlund MC-20-S.) See text.
- C_2 — 100- μ fd. midget mica.
- C_3 — 500- μ fd. midget mica.
- R_1 — 10,000 ohms, 2-watt carbon.
- RFC — 20 turns No. 22 enam. wound on ¼-inch diam. form and stretched to space turns a wire diameter. Self-supporting.

The grid coupling wire running up through the can is No. 14, and the output loop is No. 18 enam.

to clear 6-32 screws. A strip $\frac{3}{16}$ inches wide is removed from the open end of the smaller shield by first marking it with a pencil and then cutting half-way through with a sharp knife. The strip is then started by cutting down to the cut with diagonal cutters and then peeling the strip off with long-nosed pliers, in much the same fashion that a can of sardines is opened. It results in an even cut that needs but little cleaning with a file. A piece of $\frac{3}{4}$ -inch diameter copper rod is cut to exactly $3\frac{1}{2}$ inches in length, and holes drilled in the center of each end are tapped to receive 6-32 screws for fastening the shields.

The socket, one of Amphenol's polystyrene loktals, is supported by a bracket of half-inch-wide strap brass bent in the form of a shallow U with lips bending outward at the ends. Tapped holes on these lips take the screws that fasten the socket. Another piece of the strap brass is used to support the tuning condenser. It is sweated to the under side of the socket bracket at an angle of 45° to the bracket in a position that places the center mounting hole in the bracket through the center-line of this strip. Its length is just sufficient to reach the edge of the can when the socket bracket is fastened to the can by a screw passing through the bracket and center of the can into the copper rod. The tuning condenser is made a single-support affair by sawing the rotor shaft just past the last plate and sawing the right-hand stator support just past the last plate. The left-hand stator support is left full length and is easily loosened by applying a hot soldering iron. The tuning condenser is mounted on the end of the brass strap with a flat-headed screw and, if everything has been aligned properly, the end of the left-hand stator support should come right at the plate connection of the socket.

This condenser and socket assembly can now be fastened to the large shield can for marking the various holes. A $\frac{1}{4}$ -inch diameter hole is drilled

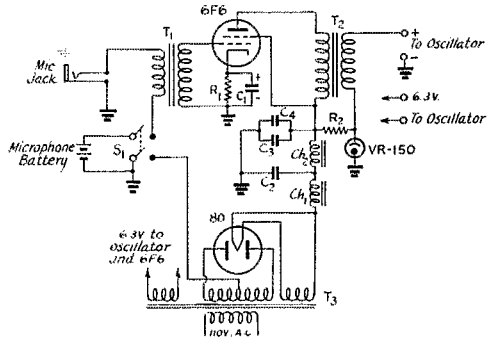

Fig. 2 — A modulator and power supply that can be used with the "pot" oscillator.

- C₁ — 25- μ fd. 25-volt electrolytic. (Not necessary if adequate gain can be obtained without it.)
 - C₂, C₃, C₄ — 8- μ fd. 450-volt tubular electrolytic.
 - R₁ — 350 ohms, $\frac{1}{2}$ -watt.
 - R₂ — 3000 ohms, 10-watt wire-wound.
 - S₁ — D.p.s.t. toggle switch.
 - T₁ — S.b. or d.b. microphone to single grid (T-23A57).
 - T₂ — Universal modulation transformer, 12 watts (UTC S-18).
 - T₃ — 700-volt 90-ma. c.t., with 6.3- and 5-volt windings (T-13R13).
 - Ch₁ — 9-henry 85-ma. choke (T-13C29).
 - Ch₂ — 15-henry 85-ma. choke (T-68C07).
- All transformers and chokes Thordarson except T₂.

$\frac{5}{16}$ inch in from the edge of the can to allow the lead from the inner can to come through and fasten to the tuning condenser stator. A small lug riveted to the top of the inner can furnishes this connection. Opposite the grid terminal of the socket and $\frac{3}{4}$ inch in from the edge, a $\frac{1}{4}$ -inch diameter hole is drilled to take the grid lead. Directly opposite the strap supporting the tuning condenser and $\frac{7}{16}$ and $\frac{1}{8}$ inch respectively in from the edge, two more $\frac{1}{4}$ -inch diameter holes are drilled to take the coupling loop. Quarter-inch holes are also drilled in the end of the small shield and the bottom of the large one for passing the grid lead, placed so that the grid lead will run parallel to the copper rod.

The grid lead and the coupling loop are insulated from the cans by cementing small strips of $\frac{1}{8}$ -inch thick polystyrene (Millen Quartz-Q or Amphenol 912-B) to the can with Duco cement, after drilling holes to pass the No. 14 wire grid lead and the No. 18 wire coupling loop. If only a little cement is used, there will be less danger of its running out on to the surface of the polystyrene and reducing the effectiveness of the insulator.

The bottom cap of the outer shield can is used to support the assembly and, in turn, is mounted on three pillars to raise it above the base-board and provide room for the grid condenser and leak. It is advisable to fasten the by-pass condensers and the heater and cathode leads at the socket before fastening the socket to the bracket.

If all of the holes have been accurately drilled,

(Continued on page 102)

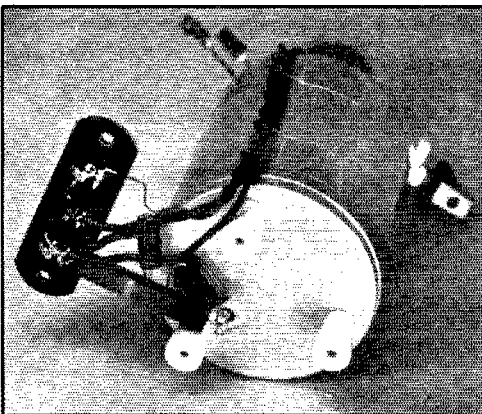

A view under the oscillator shows the grid condenser and leak, the r.f. choke and supporting pillars.

Two-Way Television Communication Inaugurated — Another Important “First” for Amateur Radio

WHAT is believed to be the first successful two-way television communication radio circuit ever established between licensed stations in regular operation was formally inaugurated at the New York World's Fair on September 27th, with W2USA in the Communications Building as one terminus and W2DKJ/2 in the New York Daily News Building, eight miles away, as the other. Sight and sound are simultaneous each way, the television channels being on the 112-Mc. band and the voice on 56 Mc. With W2USA's Managing Director, Arthur H. Lynch, W2DKJ, as master of ceremonies, a number of well-known figures in amateur radio participated in the event. These included A.R.R.L. President George W. Bailey, W1KH; Hudson Division Director Kenneth T. Hill, W2AHC; former Hudson Division Directors Dr. L. J. Dunn, W2CLA and Dr. A. L. Walsh, W2BW; A.R.R.L. Research Engineer J. J. Lamb, W1AL; Dr. James M. B. Hard, XE1GE, and the operating staff of W2USA. Also cooperating were W. A. Ready, president of the National Company, and R. S. Burnap, D. Y. Smith, ex-2AYD, and D. A. Richards of RCA Manufacturing Company. In addition to taking part in the television QSO's from the television booth, the gang also joined in the regular Friday night QST over W2USA's five 'phone transmitters operating simultaneously on different bands. Needless to say, the successful demonstration of two-way television communication was the principle topic of the various speakers.

Following the description of the new amateur television system by J. B. Sherman and L. C. Waller, W2BRO in the articles which appeared in the May, June and July issues of *QST*, and after viewing the successful demonstration of this equipment put on by W2BRO during the radio show in Chicago last June, Art Lynch was convinced that television communication should be added to the otherwise completely representative amateur activities at W2USA, "the most visited amateur station in the world." Although time was short, with the Fair closing at the end of October, he was not to be discouraged. An immediate conference with Ed Braddock, W3BAY, manager of the Amateur Division and Doug Smith, ex-2AYD, manager of the Special Tubes Division of RCA Manufacturing Company, and representatives of A.R.R.L. Headquarters, re-

sulted in tentative adoption of a plan. Before its final execution, however, there were a number of trying setbacks. Suitable space for the television shack had to be obtained at the Fair and a suitable site in New York City had to be found where the owner would permit erection of antennas for the other station. Dr. John S. Young, Director of Radio and Television for the New York World's Fair, who has fought many a battle for the W2USA gang, was instrumental in persuading the Fair administration to donate the \$8,750 worth of space which had been selected as most suitable. Clifford B. Denton, an old time friend of amateur radio and Director of Radio for the New York Daily News, arranged for antenna space on the roof and "shack" room on the upper floors of the Daily News Building which is 40 stories high and in the heart of New York City, eight miles from the site of W2USA. A group of manufacturers, including RCA, National, Thordarson, Hallicrafters, Kenyon and Hammarlund, generously aided in provision of the booth and equipment.

The television equipment at each end of the circuit consists of a camera-modulator unit, a receiver and a transmitter for operation on the 112-Mc. band. These units are duplicates of the camera-modulator, receiver and transmitter described in the May, June and July 1940, issues of *QST*. The 56-Mc. voice transmitter is a National Type NTEA unit to which a Kenyon Type 261 transformer has been added for coupling the audio output circuit to the plate circuit of the final 6L6. The voice receiver at W2USA is a National NHU. The other station uses a National 1-10 receiver. Since continuous "duplex" operation is not permitted on the 56-Mc. band, an operating "on-off" switch is provided which controls a multi-pole relay for antenna change-over as well as for switching the B-supply between the transmitter and receiver. Both stations use "pitchfork" antennas of the type shown in Fig. 5C, page 16, January 1939 *QST*, for the 56-Mc. circuit. The frequencies of the two transmitters on this band are 57.2 and 58.6 Mc. Each of the television transmitters, which operate on 112.5 and 115.5 Mc., uses a 3-element close-spaced array. Similar antennas are used for the television receivers.

Lee Waller, W2BRO, who has had plenty of



Upper Left — Operating position in the television booth at W2USA with W2DKJ at the mike and W2HYJ, custodian, behind the camera. Upper Right — Viewed over the television camera focused on a visiting Legionnaire are A.R.R.L. President Bailey (center) with Jim Lamb (left) and Art Lynch (right). Lower Left — High interest is shown by hams and other fair visitors crowding around the television booth. Lower right — Inside the shack at the other end of the circuit with W2HID, custodian of the New York station, focusing the camera. Television receiver in the foreground, transmitter left-rear. (Photos courtesy of W2WD and N. Y. Daily News)

television experience, assisted ably in getting the video portion of the system in operation. The New York end of the television circuit is rather unique, being somewhat in the nature of an upside-down station because the 56-Mc. voice transmitter and its associated apparatus is located two full stories above the video equipment with its transmitting and receiving antennas.

An essential for television transmission is proper lighting. A single thousand-watt bulb in a reflector mounting is used at W2USA and a group of smaller bulbs with built-in reflectors is used at the New York station. In the interest of comfort for the televised, to say nothing of economy, it is desirable to avoid unnecessary operation of the lights. You don't get illumination without heat as well as glare — and a little heat goes a long way. Accordingly, switching is arranged to cut off the light during reception. This lighting control arrangement also gives the folks outside the booth a better view of the received pictures, since the apparent brilliance and contrast of the image are improved with the glare removed.

In the operation of the combined voice and television circuit a number of interesting new features of operating technique have been revealed. For instance, cross-band operation with television one way and voice the other proves to be surprisingly effective, answers to oral questions being given by a shake of the head or other appropriate gesture. A two-way "conversation" by sign language is, of course, entirely feasible using the television channels alone. Mutual interference between the voice and television circuits, and even between the two picture channels, is surprisingly slight. It is also noticeable that the television in particular seems to be much less susceptible to electrical noise interference than would be expected. One peculiarity that has been observed is that radio signal interference which sounds especially bothersome with a voice receiver tuned to the television channel does not affect the received picture on the television receiver in the slightest.

Reactions of the amateurs who have witnessed this television demonstration, as evidenced by

(Continued on page 102)

More on Balloon-Supported Antennas

Practical Dope on a Practical Sky Hook

BY R. CARLETON GREENE,* WBPWU

RECENTLY, there has been a great deal of interest by most amateurs in balloon-supported antennas. Many recognize the advantages of having a vertical antenna, and a balloon seems about the most inexpensive means of obtaining one. Such an antenna is particularly advantageous on the low-frequency bands, where most amateurs are unable to obtain proper antenna heights. One might say that, in the balloon-supported antenna, we have the proverbial "sky hook" which many have dreamed of to stick up in the air and attach an antenna to. A limited number of amateurs are using balloon-supported antennas at the present time, while many have expressed their desire to try one providing they knew where to get the balloons and the gas to inflate them.

At the present time, there are two types of balloons suitable for supporting antennas, although the balloons are designed primarily for meteorological purposes. One type is the sounding balloon which was developed primarily for carrying *radiosonde* (radio meteorograph). The other type is known as a pilot balloon and is used to measure the direction and velocity of the wind. The Darex No. 350 Sounding Balloon and the Darex No. 100 Pilot Balloon are the two balloons most suitable for amateur purposes. These balloons are a product of The Dewey and Almy Chemical Company of Cambridge B, Massachusetts. The balloons are made of pure latex rubber, assuring maximum strength, elasticity and aging qualities. The great strength of such rubber makes it possible to build the balloons with very thin walls, thus assuring balloons of the greatest possible lightness, in which hydrogen or helium can be used for net lifting power rather than for carrying the dead weight of the balloons themselves. However, care should be exercised in handling these balloons because of their thin wall structure. The inflation diameters, lifting powers and other data on these balloons is to be found in the table. Greater lifting powers can be obtained by using a cluster of balloons. The Darex No. 100 Balloon sells for less than a dollar, while the cost of the larger Darex No. 350 Balloon is slightly under three dollars. For more purposes, the Darex No. 100 Balloon is the more desirable, since it has sufficient lifting power, requires less gas for inflation, and its cost is much less than the larger one.

Hydrogen or helium for the balloons can be purchased in various sizes of refillable cylinders

* 24 High Street, Avon, New York.

ranging in capacity from twenty to one hundred eighty cubic feet. Hydrogen costs between two and fifteen cents per cubic foot, depending upon the quantity of gas purchased. Helium costs between seventeen and thirty cents per cubic foot, so its cost is prohibitive for most amateurs. When a cylinder of gas is purchased, some companies loan the cylinder free for a period of thirty days, after which time there is a rental fee of around two cents per day. Possibly some amateurs have the facilities so that they can manufacture their own gas. If so, it might be said here that the balloons will inflate fully under a pressure of 13 mm. ($\frac{1}{2}$ in.) of water. The local welding company can tell you where hydrogen can be obtained.

If hydrogen is used, great care should be exercised in the inflation of these balloons, as the gas is highly explosive. *The balloon should be inflated out of doors, and all lighted cigarettes, flames, or sparks of any kind should be kept at a good distance from the balloon.* Sparks from static electricity can be guarded against by grounding the tank during inflation of the balloon. After inflation, the neck of the balloon can be closed by folding it lengthwise and then taking a pipe cleaner, folded double, and twisting it around the neck of the balloon with a pair of pliers. If pipe cleaners are not available, No. 18 solid hook-up wire will serve the purpose. It is advisable to use several seals in order to prevent escape of the gas from the balloon. The ends of the wire seals should be trimmed to prevent puncturing of the balloon.

The most desirable antenna wire for attachment to such a balloon is phosphor-bronze fish line which is very light, strong, a good conductor and will not stretch. No. 18 or No. 20 hard-drawn copper wire also makes an excellent antenna. The writer has also used 1/16 inch galvanized steel cable with excellent results. If the antenna is to be very long, either the fish line or the hard-drawn copper wire is recommended, since the steel cable is much heavier. A 135-foot length of 1/16 inch steel cable weighs a little less than $\frac{3}{4}$ of

Balloon-supported antennas are far from impractical for the amateur, as this story points out. It also gives the complete dope on lifting powers of various balloons and tells how to keep them from swaying too much in the breeze.

a pound, yet is easily carried aloft by a Darex No. 100 balloon inflated to a diameter of a little over three and a half feet. The antenna is attached to the balloon by tying the antenna around the neck of the balloon, which is made of much heavier rubber than the body of the balloon. The manufacturer claims the safe load on the neck of any single balloon to be about 2500 gm. (5 lb. 8 oz.)

The functioning of the balloon-supported antenna will depend largely upon the length of antenna used. A half wave will probably be found most satisfactory when there is no wind. In breezes the antenna will not be perfectly vertical, in which case a longer antenna may be desirable in order to obtain the proper angle of radiation. A small reel could be connected on the station end of the antenna so that the length of the antenna could be changed, and this would provide for use of the antenna on several bands. Although most amateurs use a single piece of wire for an antenna, there is the possibility of using various arrays. Several half waves could be stacked one above the other and a coil and condenser in parallel used between each half wave section for phasing. This would give us a Franklin antenna. Broadside arrays could also be used and information on these various types of antennas may be found in the A.R.R.L. Antenna Book.

The balloon should remain aloft for a week or so, providing the balloon has been handled carefully and the neck of the balloon properly sealed. Weather conditions will also affect the length of time one will remain aloft. If the balloon has been handled with greasy hands, the grease should be wiped off and talcum powder shaken on these



A balloon "sky hook" inflated and ready to take the antenna upstairs for a week or so. The hydrogen tank is in the left foreground.

spots. If this is not done, the grease will hold heat and cause the balloon to blister in these spots and this in turn will weaken the balloon. Broken balloons may be traced to this or over-inflation, failing to allow for expansion in the sun.

The balloon-supported antenna offers a wonderful field of experimentation and should also be of interest to emergency corps. The balloons can be obtained in sealed cylindrical cardboard containers which are waterproof and semi-airtight. The manufacturer claims that balloons packed in these containers have consistently been inflated to their full specified bursting diameters, even after storage in the tropics for a year or more. The balloons can also be obtained in vacuum-sealed containers. An emergency corps could always have an emergency antenna by keeping a tank of hydrogen, an antenna and several of these balloons on hand at all times. This type of antenna should also be of interest to those desiring portable operation, and they will increase the range of low-powered equipment.

Should a balloon-supported antenna be used in strong winds, it would be advisable to guy it. Three guys would serve the purpose, the guys making angles of 120° with each other and their bases spread out as far as possible. Kite string can be used for the guys. In a very high wind, a balloon is inclined to blow down close to the ground and also is subject to breakage due to the

(Continued on page 82)

DAREX NO. 100 PILOT BALLOONS

Weight: 100 gm. (3.5 oz.) Neck Diameter: 16 mm. ($\frac{5}{8}$ in.)
 Deflated Diameter: 36 cm. (14 in.) Neck Length: 48 mm. ($1\frac{3}{4}$ in.)
 Bursting Diameter: 2.0 m. (6.5 ft.) Colors: White, red, black.

Inflation Diameters and Lifting Powers

Diameter	Lifting Power	Hydrogen Required
.60 m. (23 in.)	30 gm. (0 lb. 1 oz.)	113 l. (4.0 cu. ft.)
.80 m. (31 in.)	208 gm. (0 lb. 7 oz.)	269 l. (9.5 cu. ft.)
1.00 m. (39 in.)	300 gm. (1 lb. 5 oz.)	323 l. (18.5 cu. ft.)
1.20 m. (47 in.)	940 gm. (2 lb. 1 oz.)	904 l. (31.9 cu. ft.)

DAREX NO. 350 SOUNDING BALLOONS

Weight: 350 gm. ($\frac{3}{4}$ lb.) Neck Diameter: 25 mm. (1.0 in.)
 Deflated Diameter: 0.90 m. (36 in.) Neck Length: 12.5 cm. (5.0 in.)
 Bursting Diameter: 4.00 m. (13 ft.) Color: White

Inflation Diameters and Lifting Powers

Diameter	Lifting Power	Hydrogen Required
1.20 m. (47 in.)	690 gm. (1 lb. 8 oz.)	904 l. (31.9 cu. ft.)
1.40 m. (55 in.)	1300 gm. (2 lb. 14 oz.)	1437 l. (50.8 cu. ft.)
1.60 m. (63 in.)	2120 gm. (4 lb. 11 oz.)	2144 l. (75.9 cu. ft.)
1.80 m. (71 in.)	3160 gm. (6 lb. 15 oz.)	3053 l. (107.9 cu. ft.)

For supporting an antenna, no Darex balloon should ever be inflated to more than 60% of its specified bursting diameter.



NAVAL COMMUNICATION RESERVE NOTES

N.C.R. Activity in Sixth Naval District

BY LT. (JG) W. R. FOLEY,
U.S.N.R.

CALIFORNIA to the contrary notwithstanding, the climate of the Sixth Naval District is so superior that we have no earthquakes, hurricanes, or floods. As a result, we have had no opportunity to make the headlines by disaster work, and we have contented ourselves by quietly training some of the finest radiomen and signalmen the Navy will ever see.

After this modest opening, may we introduce ourselves? Our organization rests on a firm foundation of "old salts." The three top-ranking officers, Lt. Comdr. E. J. Gluck, U.S.N.R.; Lt. T. B. Smiley, U.S.N.R.; and Lt. S. C. Sweeney, U.S.N.R., have a total of 30 years' naval service among them. The first mentioned is our Commander, and we might mention that he is no tyro in radio. He started out with a broadcast station and nursed it from the chemical rectifier stage right up to 50 kilowatts. Now he owns a station of his own, WSOC, and a good half-dozen portables and mobiles. Hams know him as W4CQ.

Section 1 is under the command of Ensign T. H. Wood. He has made a name for himself by the excellent section drills and his comments thereon, and by the fact that his units are the largest and always receive highest mention for their excellent military conduct. Their specialty is to send ten or fifteen men down to the Navy Yard for a week-end cruise. In civil life he is connected with the U. S. Department of Agriculture. You might have met him as W4ANK.



Section 2 is famous for leading the district in this year's competition. Lt. (jg) W. R. Foley admits that having only two units makes it easy to pile up a score, but on the other hand each failure counts more heavily, so all told Section 2 think they are pretty good. The commander is F.C.C. Inspector in civil life. Some of you may have worked him as W3MQ or W4FEC.

Lt. S. C. Sweeney is in command of Section 3, and he is famous for (1) the careful scoring of each unit in his own section competition, (2) his excellent articles on navigation that appear monthly in our bulletin, and (3) his good Irish nature. In civil life he is a forestry expert, a far cry from the Navy! A ham? Sure, W4BRK.

It may sound a bit old-fashioned, but NEF (our Master Control Station) is using a 1-tube transmitter. No, Oscar, it isn't a Hartley. It's an up-to-the-minute pentode giving out 200 watts of the cleanest sort of crystal controlled signal. It is so compact there was room for two of them in the same frame, so NEF changes frequency by changing transmitters—a matter of a second.

On the last National Drill of the 1939-1940 season, NEF had a power failure, and for a few minutes it looked as though the N.C.R. perfect attendance record would be ruined. A plan set in operation last summer saved it. The emergency station at Savannah, Ga., more than 200 miles away, noticed that NEF didn't answer up during roll call. Signing NEF-1, they came in and took over the guard.

Charlotte, N. C., seems to be an exceptionally good receiving location, and NEF can copy solid when NAA isn't getting a thing. Experiments are now in progress for automatic relaying. Signals from weaker stations, such as Canal Zone, will be used to key the NEF transmitter. The experiment is being watched with tremendous interest as it may pave the way for a wholly new conception of drill operations.

NDJ, the Alternate Control Station, under Ensign W. V. Gearhart, U.S.N.R., claims the record for something-or-other by having three transmitters but only one receiver. One of those "it is more blessed to send than to receive" stations. By the time this appears the situation will be improved as a new receiver is on the way. This station is located in Naval Quarters—the Georgia Tech Naval R.O.T.C. Armory. Swell quarters and a nice big unit, under Ensign V. J. Cheek, U.S.N.R., doing a swell job.

A side of a Reserve Officer's education that is

(Continued on page 82)

Link Coupling Between Transmitter Stages

Circuit Factors Influencing Driver Loading

BY W. VAN B. ROBERTS,* W3CHO

Most of us have used link couplings with the general idea that they are equivalent to mutual inductance. In many cases, such as when they are used to couple the plate tank of one stage to the grid tank of the following stage, the load is placed across the terminals of the second tuned circuit. It may be of interest, therefore, to give the results of a rather tedious mathematical analysis of this case which was undertaken to find out what is the maximum load that can be transferred back to the plate tank by means of link coupling to a succeeding grid tank. The accompanying diagram shows the circuit considered, R being a resistance equivalent to the grid loading across the second tuned circuit. It is fairly obvious that if C_2 is given a value considerably too small or too large, very little loading will be reflected back into the plate tank. As C_2 is varied from too small a value to too large a value, it somewhere passes through a value which causes the maximum possible loading of the plate tank. This critical value of C_2 may be expressed in terms of the various circuit constants, but the expression will not be given since in practice such an adjustment of C_2 is most easily found by trial. However, assuming that this critical value has been found, it is of interest to study the expression for the resulting plate tank loading, which is as follows:

$$\frac{w^2 L_1 L_2}{R} \left[\frac{1 - (\alpha^2 + \beta^2)}{\alpha\beta} \right]^2$$

where α is the coefficient of coupling between coil L_1 and the entire link circuit, and β is the coefficient of coupling between L_2 and the entire link circuit.

The above expression represents the lowest value of the effective resistance appearing across the plate tank that can be obtained by any adjustment of C_2 . It should be remembered that since we are imagining the resistance to be reflected across the plate tank rather than in series with the plate tank coil, a low value of resistance represents heavy loading of the tube and vice versa. It is assumed of course that C_1 is always adjusted to produce the usual minimum of plate current, which adjustment tunes out any reactance effects reflected across L_1 by the coupling.

In practice it is not likely that either α^2 or β^2 can be made to exceed about 0.1 so that the

* Patent Department, Radio Corp. of America, New York City.

part of the expression depending on these couplings is not likely to be smaller than 64. This is, of course, only an estimate indicating the order of magnitude of the bracketed part of the formula. The chief use of the formula is merely to indicate the effects to be expected from variations of the circuit constants. That is, the formula shows that the maximum tube loading that can be obtained becomes greater as the resistance across the second circuit is increased, is less as the inductances are increased, and of course is greater as the couplings between the link and the tuned circuits are made closer. It is of particular interest to note that the number of turns of the link has nothing to do with the effective coupling introduced by the link circuit except indirectly in that if there is much inductance in the wires of the link which connect the end turns together, the effect of this inductance on reducing the coefficients of coupling α and β is less when the link terminates in several turns at each end than when it is terminated in fewer turns.

To find out whether the link acts like a simple mutual inductance between the coils L_1 and L_2 the formula was generalized to include a coefficient of coupling γ directly between L_1 and L_2 . The formula already given is for link coupling alone. If mutual inductance between L_1 and L_2 is used alone the expression becomes

$$\frac{w^2 L_1 L_2}{R} \left[\frac{1 - \gamma^2}{\gamma} \right]^2$$

while if both link and direct mutual inductance are used at the same time the expression is

$$\frac{w^2 L_1 L_2}{R} \left[\frac{1 - (\alpha^2 + \beta^2 + \gamma^2) + 2\alpha\beta\gamma}{\alpha\beta - \gamma} \right]^2$$

It will be seen that these three formulas differ only in their bracketed terms, and since each of these terms is a constant determined by the overall effectiveness of the coupling used, it is evident that so far as the behavior of the circuits is concerned, there is no difference

(Continued on page 74)

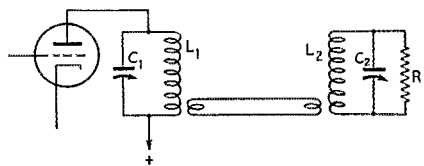

Fig. 1—The circuit discussed in the text



ON THE ULTRA HIGHS



CONDUCTED BY E. P. TILTON,* W1HDQ

AFTER all, the only thing that Five is really good for is 'ground-wave' work. Skip is just something to worry about, most of my worry being that when I am not around the receiver the band will open up and somebody else will hear something that I don't!" When a well-known W9, for many seasons one of the most successful workers of skip DX, comes out with a remark like that, it's news. It suggests that we might all do well to take time out to consider the ways in which we can improve our local coverage and increase our local activity on Five.

General use of high-gain beam arrays has certainly added many miles to our effective working range, but this gain has not been achieved without some disadvantages, too. High "front-to-back" may well be striven for in a beam for Ten or Twenty, but with the limited amount of activity on Five it can hardly be classed as a desirable characteristic. A field pattern shaped like a toothpick is swell for working skip; and an array, either horizontal or vertical, having all possible forward gain should be an important

* 329 Central St., Springfield Mass.

part of every u.h.f. station wherever possible; but we insist that there is still a definite place for a highly-elevated non-directional (or nearly so) antenna.

Herein lies one fundamental advantage of vertical polarization. With the possible exception of the Turnstile, there is no such thing as a non-directional horizontal. Even a bi-directional array of high performance is difficult with horizontal polarization. The uni-directional array has earned a well-deserved place in the u.h.f. picture; but from many quarters, particularly from the Middle West where such arrays are practically standard equipment, is coming the complaint that too often beams are pointed in the wrong direction; and that random QSO's, resulting from a spontaneous desire to talk to someone, are becoming increasingly difficult.

With vertical polarization there are other ways of increasing coverage than by concentrating radiation in one direction. Stacking of elements vertically lowers the radiation angle, thus concentrating at useful angles the energy wasted, with the simple dipole, in high-angle radiation. The extended double Zepp, two half-waves in phase, and various stacked arrays having three or more collinear elements, all will give a definite improvement over a single half-wave, without sacrificing that desirable characteristic, general coverage.

Consider the mobile enthusiast. With vertical polarization demanded by mobile operation, he is apt to find the going rather tough in an area where only horizontal arrays are in use. Before the storm of protest from the advocates of horizontal polarization breaks, let us say that this is not intended as "taking sides" in the case of horizontal vs. vertical. We concede that horizontal polarization has been definitely superior to vertical during the summer skip season at W1HDQ. We grant that horizontals may have the edge in extended-local work, particularly in regard to noise pickup. But we'd hate to be without our verticals during most of the year, when friendly contacts over a wide area in all directions make Five the thoroughly enjoyable band it is.

There are other ways in which our operating range can be extended which have nothing to do with beams, high power, or choice locations. How many times have you struggled with a signal which registers perhaps S-2 or S-3 where the audio was completely unintelligible? The obvious answer is wider use of c.w. (no, *not* i.c.w. or m.c.w.) for calling and signing. There is another answer, too, and that is to be certain that the final stage is operating as a class-C stage should;

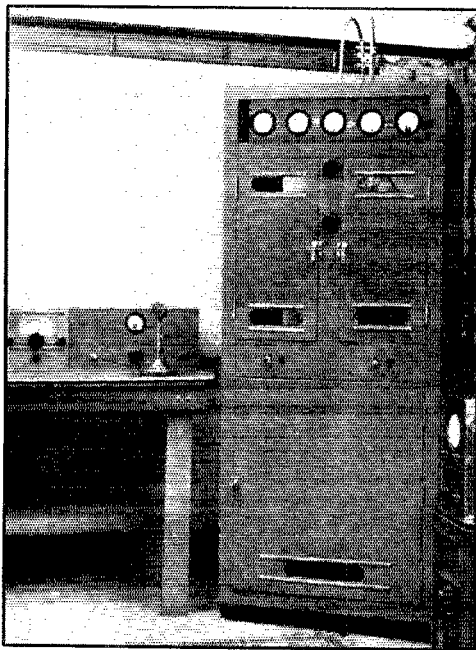

A pair of 250TH's run a full kilowatt, with either amplitude or frequency modulation, at W9WOO, Peoria, Ill. The linear output circuit shows above the top of the cabinet.

that is, with sufficient excitation to permit full 100 per cent modulation. Plenty of audio of good quality, and proper adjustment of the final to make full use of it, can make an S-1 signal readable on voice. Development of good microphone technique, with clear pronunciation of all words and care in signing one's call, are oft-neglected factors which may make the difference between success and failure in many contacts on any 'phone band.

We have frequently stressed the value of organized operation in stimulation and maintenance of local activity on the Ultra-Highs. The U.H.F. Relay is the League's part in providing operating incentive. In these affairs, teamwork and the willingness to work anyone, near or far, are stressed; and it is gratifying to note that in the September Relay, though no skip DX was worked (to our knowledge) in any part of country, several messages traveled over distances in excess of 1000 miles. As in past contests, this one seemed to bring out large numbers of stations which are not normally heard on the u.h.f. bands. Invariably many new contacts are made by the gang who operate regularly on Five and $2\frac{1}{2}$, but it is difficult to tell how much of this is actual contest work and whether the Relay idea is generally popular. We would like to feel that every operator who has u.h.f. gear in the shack would get it going for these affairs; and, what is more important, that he would send in a report of his activities. If you enjoy these relays and want them continued, won't you drop a line to your conductor or to the Communications Department and say so. If you are on the other side of the fence, your criticism will be equally welcome.

It is too early to present a comprehensive picture of the doings in the Relay of September 14th and 15th, but from early reports it appears that first place was captured by W1AUN/1. Operating during the whole period from Mt. Wachusett, 2250-foot elevation in Princeton, Mass., Gordon Wiley made 45 contacts on 112 Mc. and 20 on 56 Mc. Add 34 points for message handling and apply the field multiplier and you have a score of 476 points. A mere 20 miles north of Wachusett, on Pack Monadnock Mountain, near Peterboro, N. H., W1BSG/1 got off to a late start but ran up 46 contacts on 112 Mc. in rapid succession posting a score of 392 points. The rig was a pair of '45's in a tuned-filament oscillator, with power supplied by a small gas-engine AC generator. The antenna was a 4-element "J" beam.

In every Relay there has been some point along the line from the East Coast to the Middle West which has been a stumbling block in the path of traffic started at each end. The long stretch from Detroit to Philadelphia was bridged successfully this time and the tough spot was, of all places, the New York area. With mainstays in past Relays, W2AMJ and W1KTF,

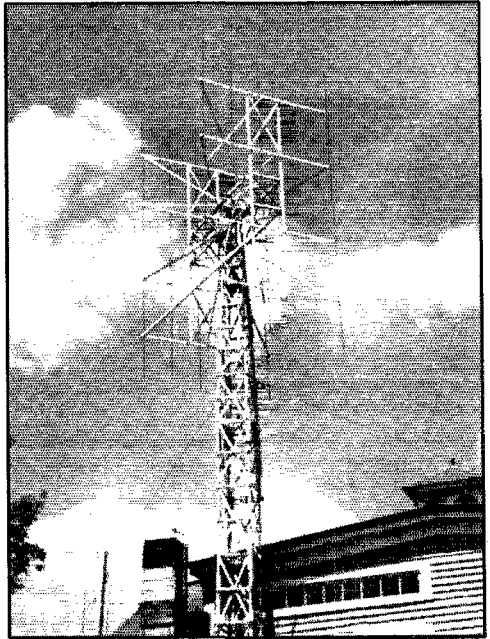

One of the most successful beams ever erected for 56-Mc. work — the 16-element array of W1DEI, Natick, Mass. Four halfwaves in phase, with quarter-wave spaced reflectors and two sets of close-spaced directors atop a 50-foot lattice mast replace a 12-element structure lost in last winter's ice storm. Photo by W9CBJ.

both off the air temporarily, many messages were delayed for several hours in the vicinity of New York. Beyond the big city, W3ABS, South Branch, N. J., and W3AXU, Trenton, both in the Relay for the first time, provided reliable service to Philadelphia. Here, W3BZJ got traffic off to W3HWN and W3BKB. The next stop was W8CIR at Aliquippa, Pa., where Ed maintained contact with W8QUO/8 and W8QDU. W8QUO/8 helped out mightily in maintaining this circuit, having installed a 75-watt rig at the top of the 350-foot Perry's Victory Monument on South Bass Island, Lake Erie. The W8QDU-W8CVQ-W9VHG circuit functioned smoothly all day Sunday, providing delivery for numerous Chicago messages. In the Boston area, W1EKT and W1HXP were on deck for delivery of traffic for that area, while W1's CEA, JDV, COO, and IUI/1 kept New Hampshire in the picture. Others performing yeoman service included W2's ILK/2, GHV, CUZ, W3HOH, W8's MDA, RFW, and scores of others yet to be heard from. The complete story will appear in *QST* in due time.

HERE AND THERE:

Known far and wide for his work in connection with analysis of sporadic-E skip, Mel Wilson, W1DEI, is also one of the most consistent workers of extended-local DX. The

U.H.F. DX RECORDS

Two-Way Work

- 56 Mc.: W1EYM — W6DNS, July 22, 1938.
2500 miles.
112 Mc.: W6BJI/6 — W6KIN/6, July 4, 1940.
255 miles.
224 Mc.: W6IOJ/6 — W6LFN/6, August 18,
1940. 135 miles.
400 Mc.: W6IOJ/6 — W6MYJ, September 23,
1940. 11 miles.

16-element beam shown in the accompanying photo is largely responsible for this. Mel has kept consistently successful schedules with W1KTF, Darien, Conn., and W2AMJ, Bergenfield, N. J., 150 and 180 miles. Elevations at each end are close to sea level, with rough country ranging up to 1200 feet and more intervening. This is not phenomenal as an occasional occurrence under exceptional conditions, but as a daily event over a period of months it represents a standout accomplishment. When the band gets hot, Mel gets down to W3BZJ, 270 miles, and W3GGR, 315 miles, with ease. The first-in last-out signal that you fellows in the Middle West hear from Natick comes, not from this vertical array, but from what we believe to be something unique in u.h.f. antennae, a pair of man-sized rhombics, stacked one above the other! As this is being written, Mel is expecting a call to take a position in other parts. As one of the country's leading exponents of five-meter operation, W1DE1 will be sorely missed.

W1ELP, Cambridge, Mass., has at last found someone with whom he can work two-way f.m. W1CCZ, Wianno, (that ham's paradise described some time back in *QST*¹) is now on with up to 500 watts f.m. and one of the new S-27 receivers. Daily schedules have been successful a major portion of the time. Comparisons of W1CCZ using a.m. and f.m. have been made by W1ELP and W1KH. Though somewhat higher power is used on the f.m. rig, it is significant that the f.m. signal has been readable on several occasions when the a.m. was lost in the noise level.

Skip DX was conspicuous by its absence during September. The only sign of skip reported was a partial contact between W7FFE and W6OVK on Sept. 3rd. Jim and W6QLZ are still campaigning for more activity on Five. They bear down on everyone they contact on Ten, and have converted W6PBD at Douglas, and expect to get W6SAV going soon. They are after all the boys in the high elevations; PBD, SAV, and another convert, GBN, all being up over 4000 feet. These boys are going to concentrate on c.w. transmissions between 10 a.m. and noon, M.S.T., daily, from Oct. 15th to Nov. 10th, in a "college try" for a contact via F-8 reflection. W6QLZ heard signals up to 52 Mc. from the East Coast last November, and reports a top of 46 Mc. on Sept. 26th of this year.

If you must have "DX" to keep your interest in Five alive, don't give up the ship just because the summer season is over. Comes now the aurora season! Already, on several of these crisp fall evenings, aurora displays have been lighting the northern sky, and a few instances of "aurora flutter" have been reported. Around midnight of Sept. 14th, W3BZJ heard W8CVQ and W9VHG coming through with the characteristic raspy quality on c.w. This business of working abnormal distances (up to 600 miles) by way of reflection from a vertical layer in the region of the aurora borealis is essentially an amateur discovery. Practically nothing is known about it and it represents a fine opportunity for the amateur to contribute something new in the field of wave propagation.

A word of warning about recognizing signs of aurora reflection may be in order. It often appears when all normal indications point to the poorest possible conditions for extended-local work and this points to the possibility that we may have missed many opportunities for this sort of work because we took it for granted that the band was dead. If

¹Phone-C.W., DeLuxe, W1CCZ" *QST*, November, 1936.

you hear a fellow's modulation go fuzzy and his carrier broaden out, don't hasten to assume that his final has gone into oscillation. If you have a beam, swing it in all directions and note from which direction the signal appears to come in strongest. If the aurora is responsible, the signal will usually appear to peak with the beam pointed north, regardless of the direction to the station heard.

In cases of strong aurora reflection, voice or tone modulation may be completely unintelligible. The only means of communication will be c.w., with the slow, ponderous type of fist getting the best of it every time. The fact that this sort of work is usually over distances which are difficult to cover by any other means, coupled with the eerie quality of the aurora itself and the signals it produces, makes this business of aurora DX a fascinating field. We need to know more about it — so be on the lookout, and report your observations promptly and completely.

And in conclusion, we would like to offer the reminder that inversions, while not as frequent as in summer, do occur regularly in the fall and winter months. Weather conditions are much more stable during this period and a study of the daily weather map and careful observation of local weather conditions make it possible to predict the peaks of inversion bending several days in advance. We commend a study of the behavior on the Ultra-Highs in Winter to those lost souls who feel that there is nothing left in Amateur Radio, now that the snagging of rare prefixes is denied to them.

112 MC.:

THE September Relay provided many new contacts on 2½ in the East. Extended-local work reached a new high on Saturday night, with a network providing a route from New York to Boston entirely on 112 Mc. Messages from the New York Area were relayed by W1MRF, Bridgeport, Conn., to W1IJ at Madison. Owen then passed them to W1HDQ where they were dispatched to the Boston area via W1AUN/1 on Mt. Wachusset. Around midnight things really started to happen, with the Boston stations coming through at Wilbraham for the first time. W1's SS, PI, MBS, FIK, and JDF were contacted, along with W2's ADW, LBK, and DZA. Though it is only 70 miles to Boston compared with 125 miles to the W2's, the former path is over high hills and is usually tough going even on Five. W1LZB/1, Hyde Park (Boston) heard W2ADW and W1IJ, both over 120 miles distant, and several unidentified W2's at greater distances. High scorers on 2½ include W1's IJ, AUN/1, BSG/1, MRF; W2's BZB, DZA, MWA, FZA, and others not yet heard from. In Michigan, W8's QDU, SNN, SLU, MDA, and others were active on 2½. Reports from the W6's, leaders in activity on 112 Mc. in past Relays, have not been received as this is being written.

With a concentration of 112-Mc. population in many cities, 2½ presents a good opportunity for emergency net organization. W1PI reports upwards of twenty-five stations drilling every Thursday night from 6:45 to 8 P.M. in the region around Boston.

From Providence, R. I., W1JP reports that 2½ has quieted down considerably with the elimination of the swarm of illicit stations from the band. Their loss is little mourned, however, and was accomplished by the simple expedient of the legitimate stations refusing to work any station known to be operating illegally. Jack says that W1's HEN, MNC, MBU, DBA, MSD, JXQ, and LNK are active locally. Several of these have been able to work up to New Hampshire, about 70 miles, where W1JSL in Derry and W1MUB in Windham have been providing good signals whenever the band opens up for extended-local work.

W8CVQ, Kalamazoo, Mich., has worked W8QDU in Detroit, crossband, 2½-5, with CVQ running 85 watts to p.p. HK-24's. This is a 130 mile hop over flat country. Two way work is contemplated shortly.

From Denver, Colo., W9WYX reports a 2½-meter field day on Sept. 8th, with W9VTK/9 on Mt. Evans, W9OKY/9 on Pike's Peak, W9QCX/9 at New Raymer, Colo., and W9WYX/7 at Cheyenne, Wyoming. Distances covered included: VTK-OKY, 65 miles; VTK-WYX, 110 miles; VTK-QCX, 100 miles. VTK also heard WYX when Bob was at Kimball, Nebraska, and Peetz, Colo., 175 and 180 miles, respectively.

We wouldn't want anyone to take this as subtle propaganda for the elimination of simple equipment from the 112-Mc. field, but we like W4FKN's approach. Having added an HK-24 amplifier to his Utah 5-10-20 rig to improve the performance on Five, he found that this same stage would do a very nice job as a doubler to 2½. It occurs to us that many of the gang who have gear for Five go to 2½ by building an oscillator for this band, when a doubler would be fully as simple a solution, to say nothing of the better quality which results from the stable signal. W4FKN and W4GXU are working out on 2½ and expect to have more converts in the Atlanta Area shortly.

224 MC. AND UP:

NOTE that this department has a new heading. This is occasioned by two reports of activity on 400 Mc. W1COO,

Brentwood, N. H., is working with W1JK, Exeter; a distance of four miles, with Five one way and ¾ the other. And here is W6IOJ, with hardly sufficient time for his 135-mile record on 224 Mc. to appear in print, coming along with work on 400 Mc. with W6MYJ. Both use WE-316-A oscillators and 955 receivers. W6MYJ, working from his home in North Hollywood, runs 30 watts. IOJ has his "doorknob" installed in his car, running at 5 watts input. Work up to 11 miles has been done, with more coverage expected shortly.

With Five quieting down, a number of fellows are taking up 224-Mc. work. For the experimentally minded, this represents a more interesting field than 2½; the latter being principally the old days on Five right over again. W1AJJ reports a contact with W1COO, 1¼-5, with AJJ using mobile equipment at the summit of Mt. Washington, N. H. This 90-mile hop duplicates the work of others in working cross-band from New England's highest peak, but this is the first instance where truly portable gear was in use on the mountain. Schedules were maintained with WIBVL/1 on Mt. Greylock, Mass., but no contact was made. This is an indirect path of about 145 miles and used to be tough going on Five in your conductor's early mountain-climbing days.

Via 28 Mc., W7EUI tells us of experimental work getting started on 224 Mc. Several of the gang in Seattle and vicinity went to 2½ from Five.

W1AIY and W1HDF have made progress in their diard attempt to get over the hills between Elmwood and Wolcot, Conn. AIY has heard the sig from Carl's HK-54's and 12-element beam, but the 22-watts to an HK-24 feeding a 7-element Yagi in Al's attic have not negotiated the return trip, to date.

They still try for crystal control on 1¼. W1AKD reports about a half a watt output on 224 Mc. in his mobile rig. W1LH (and your conductor, too) have doublers (?) from crystal-controlled 112-Mc. stages which put out, strangely enough, on 2½.

U.H.F. MARATHON

AUGUST WINNER: W1KLJ, 115 POINTS

Call	Contacts Through			Cumulative Score	States in 1940
	56	112	224		
W1AIY	23		3	68	2
W1BCY		10		22	2
W1CGY	41			110	3
W1CJH	72			264	13
W1CUC	25	6		53	4
W1EHT	56			85	3
W1EKT	102			286	11
W1ELP ¹	71	51		271	11
W1GJZ	115			485	12
W1HDF	59	12	4	278	13
W1HDD	192	39		1263	24
W1HXP					19
W1JTS	23			65	4
W1JJR	110	4	3	588	17
W1JLK	90			28	6
W1JP	27			63	3
W1KLJ	239	7	5	1291	24
W1LLL	136			303	20
W1LPP	59			123	6
W1LSB	43			106	13
W1MBS		120		248	3
W1MEP	20			62	5
W2ADW	14	21		133	3
W2AMJ	185			858	24
W2BYM	40	7		241	15
W2ZB	32	115	4	314	5
W2COT	122	12		275	7
W2DZA		79		184	4
W2GHV	122			590	21
W2LAL	81			203	11
W2LXO	122			282	4
W3BYF	58			314	18
W3BZJ	213	48		1307	25
W3CGV	75			213	10
W3EIS	22	8	1	87	5
W3FX	37	28		307	3
W3KOH	205	17		678	16
W3RL	69	1		562	21
W4ELZ	31			280	12
W4FBH	82			738	18
W5AJG	163	6	5	1751	25
W5EYF	11			101	6
W5VY	59			662	18
W6IOJ	8	95	3	383	3
W6OVK	19			194	7
W6PGO	7			61	6
W6QG	20		2	118	4
W6QLZ	58	2		1051	18
W6RVL	1	180		493	1
W8MHM	32	18	1	113	7
W8NKJ	53	23		397	11
W8QDU	106	41		777	20
W8QSS	61			530	15
W8RKE	72			591	19
W8RUE	71	16		315	15
W8SNN		21		42	1
W8TIU	25			181	8
W9ARN	78			690	19
W9DQH	44			297	17
W9ZJB	137			1351	26

To conserve space, stations not reporting for two consecutive months have been deleted. These will be listed upon receipt of further reports.

¹ Frequency modulation used exclusively at W1ELP.
² Not eligible for award.

Silent Keys

It is with deep regret that we record the passing of these amateurs:

Dr. K. Bientema, PA0AF, Groningen, Netherlands

Lt. W. G. P. Brigstocke, G5ZQ, Rams-gate, Eng.

James A. Carroll, W9NA, Kansas City, Kansas

Lester W. Cornford, W7AKE, Portland, Oregon

George S. Dozier, W9GLH, Stanford, Kentucky

John L. Green, W9ETT, Pineville, Kentucky

Robert Marcum Haswell, W9RMH, Mansfield, Mo.

Charles W. Holdiman, W6AGJ, San Jose, Calif.

Jack Hollenback, W6CUC, San Diego, Calif.

William J. North, VE3OH, Windsor, Ontario

Raymond Hugh Putnam, W8PGF, Homer, Michigan

Edward Seppia, W9CEX, Dollar Bay, Michigan

F/Lt. George Zech, R.A.F.V.R., GM8TT, Shirlingshire, Scotland

★ I. A. R. U. NEWS ★

Devoted to the interests and activities of the

INTERNATIONAL AMATEUR RADIO UNION

Headquarters Society: THE AMERICAN RADIO RELAY LEAGUE, West Hartford, Conn.

MEMBER SOCIETIES

American Radio Relay League
Asociația Amatorilor Romani de Unde
Scurte
Associazione Radiotecnica Italiana
Burma Amateur Radio Society
Canadian Section A.R.R.L.
Československá Amatérská Vysílací
Deutscher Amateur Sende-und-Empfangs-
Dienst
Estif Radio Amatoride Uhing
Experimental Radio Society of Egypt
Experimenterende Danske Radioamatorer
Federation des Emetteurs Belges
Irish Radio Transmitters Society
日本アマチュア無線聯盟 Japan

Lietuvos Trumpuju Bangu Radio Megeju
Draugija
Liga Colombiana de Radio Aficionados
Liga Mexicana de Radio Experimentadores
Magyar Rövidhullámú Amatőrök Országos
Egyesülete
Manchoukuo Amateur Radio League
Nederlandsche Vereeniging voor Interna-
tionaal Radioamateurisme
Nederlandsch-Indische Vereeniging Voor
Internationaal Radioamateurisme
Newfoundland Amateur Radio Association
New Zealand Association of Radio Trans-
mitters
Norsk Radio Relæ Liga

Polski Związek Krotkofalowcow
Radio Club Argentino
Radio Club de Cuba
Radio Club Venezolano
Radio Society of Great Britain
Rede dos Emissores Portugueses
Reseau des Emetteurs Français
Reseau Luxembourgeois des Ama-
teurs d'Ondes Courtes
South African Radio Relay League
Suomen Radioamatöörijilitto r.y.
Sveriges Sändareamatörar
Unión de Radioemissores Españoles
Union Schweiz Kurzwellen Amateure
Wireless Institute of Australia

LITHUANIA

ON JULY 1st, amateurs in Lithuania were closed down. All transmitters were sealed by government authorities, but were left in the owners' possession. A second blow came on the 8th, when all radio organizations and societies were ordered closed, including the L.R.M. Secretary Satas despairs that no indication was given as to the future destiny of amateur radio, nor can anything be learned.

The small but rapidly-growing society was nipped in the midst of its most successful year. New QSL stamps as well as logbooks had been printed, a Handbook issued for beginners, membership buttons acquired, and a monthly bulletin produced. There were 71 licensed amateurs in the country, most of whom were affiliated with L.R.M. An additional 50 members consisted of short-wave listeners, interested in becoming licensed.

To our LY friends we send 73 and the hope we shall meet them on the air again soon.

SOUTH AMERICA

REPORTS reach us that both Uruguayan amateurs, who some months ago were closed down, and Brazilian amateurs, who were prohibited from contacting stations outside their own country, have been allowed to return to normal operation.

HUNGARY

A TOTAL of 75 HA stations participated in the amateur "Hungarian Test" on April 28, 1940. HA4H with 85 contacts won first honors, with HA9Q (83 contacts) a close second in the one-day contest. Eighty and forty meters were used, and the input power of all stations averaged about 100 watts.

HASS, who sends us the information, points out that the numerals in Hungarian amateur calls are not indices of districts. HA9- stations, for example, are military stations of the government using such calls in amateur operation. HAØ- calls are assigned to Boy Scout radio stations.

QSL BUREAUS CHANGES

Canal Zone: Fourth Coast Artillery, K5AA, Radio Section, Fort Amador.

India: John G. McIntosh, VU2LJ, Bukhial T. E., Letekujan P. O., Assam.

Eire: R. D. Mooney, EI2P, "Aughnacloy" Killiney, Dublin.

Nicaragua: E. H. Andreas, YN1OP, P. O. Box 118, Nanagua.

NEWS AND NOTES

L. H. GARLAND has been appointed headquarters secretary of S.A.R.R.L. for the duration of war. . . . On June 10th the Philippine Department of National Defense prohibited its amateurs from communicating with any external country excepting the United States and possessions. Considered in the light of existing U. S. regulations, this means that Filipinos may now intercommunicate only among themselves. . . . Amateurs in the Dominican Republic were recently prohibited from communicating with stations outside the country. . . . According to the Australasian "Radio World," a new regulation of the Australian P. & T. Department prohibits trafficking in communications equipment. Amateurs, who have been permitted to retain their station equipment, may not now dispose of it or acquire more in any quantity, without a special permit. . . . "Amateur Radio," official organ of the W.I.A., makes its August appearance with a

(Continued on page 74)



HINTS AND KINKS FOR THE EXPERIMENTER

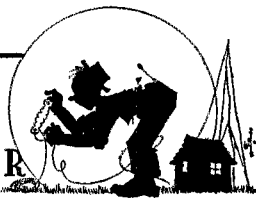

COMPOSITE OSCILLATOR

This composite oscillator should prove attractive to the amateur to whom the smell of soldering reacts as a perpetuating tonic — the circuit-changer eternal and the experimenter.

Primarily the chief advantage in the arrangement shown in Fig. 1 is its extreme flexibility in adapting itself to purposes for which modern oscillators are generally designed. Each of the various circuits is well known, but the combination of these oscillators into a composite circuit is probably new and justifies its presentation.

By merely selecting the proper coil or plug-in unit for the grid or cathode circuit, it is possible to secure any one of six types of oscillator circuits as follows: straight tetrode or pentode crystal oscillator, Tri-tet, regenerative crystal with choke in cathode (the grid-plate oscillator), regenerative crystal with screen-grid feedback, electron coupled oscillator and variable-crystal oscillator.

Tuning of the various oscillator circuits has been covered in *QST* and *The Radio Amateur's Handbook* and, therefore, needs no repetition. It might be mentioned, however, that tuning of regenerative types of crystal oscillators requires careful adjustment of the regeneration condenser to a setting that will promote good output with safe crystal current and stable keying.

The electron-coupled oscillator is used chiefly for emergencies, but may be used for regular fixed-station work, provided oscillator voltage is regulated and mechanical, thermal and electrical constants are stabilized. Much has been written of late on the e.c.o. and its ills and cures, but for the most part, the proper construction of this type of oscillator calls for isolation, stabilization and complete shielding of the oscillator itself from the following stages of the transmitter. Unless these precautions are taken, the e.c.o. circuit is recommended for experimental work only.

The condenser C_1 tunes the e.c.o. and Tri-tet coils and is used for regeneration control in the screen-grid feedback oscillator, therefore it should be of sufficient size to cover its various uses. A condenser of smaller capacity than that recommended would probably cause erratic operation in regenerative crystal oscillators. It may be as high as 500 $\mu\text{fd.}$, although some difficulty might be encountered in setting frequency with the e.c.o. while doubling or quadrupling frequency.

A fixed high capacity is connected across the e.c.o. coil for stability and is mounted inside the coil form. The crystal need not be removed when using the e.c.o.

If a 6L6 is used, sufficient output should be obtained to drive a buffer-doubler or amplifier

Fig. 1 — Experimental oscillator circuit suggested by W6SM and W7HXM. By inserting different plug-in units in the socket, six different circuit combinations are obtained. A — E.c.o. B — Variable-frequency crystal. C — Screen feedback crystal. D — Grid-plate crystal circuit. E — Tri-tet circuit. F — Tetrode circuit.

- C_1 — 300 $\mu\text{fd.}$
- C_2 — 250 $\mu\text{fd.}$
- C_3 — 0.01 $\mu\text{fd.}$
- C_4 — 0.002 $\mu\text{fd.}$
- C_5 — 100 $\mu\text{fd.}$
- C_6 — 0.01 $\mu\text{fd.}$
- C_7 — 0.001 $\mu\text{fd.}$
- C_8 — 250 $\mu\text{fd.}$
- R_1 — 20,000 to 50,000 ohms.
- R_2 — 50,000 ohms.
- R_3 — 15,000 ohms.
- P — 60-ma. pilot lamp.

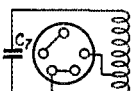
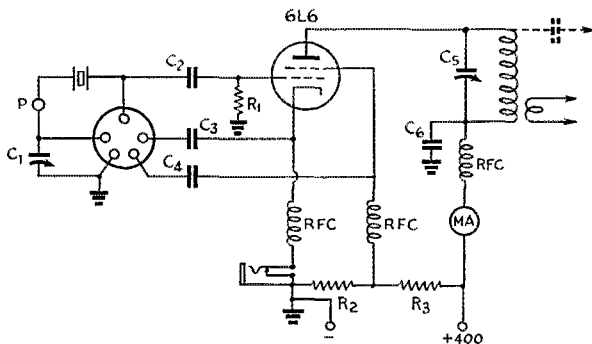

COIL AND PLUG CONNECTIONS

requiring a driving power of approximately 10 to 20 watts, which should be ample for most applications. — *L. H. Dunning, W7HXM and R. H. Lindquist, W6SM.*

SIMPLE TRANSFORMERLESS DUPLEX BIAS SUPPLY

IN FIG. 2 is the circuit diagram of a simple transformerless duplex bias supply built by Dr. Eugene C. Woodruff, W8CMP. It consists of only a pair of 117Z6 full-wave rectifiers, a filter condenser and a few resistances.

The plates of the first 117Z6 rectifier are connected in parallel to form a half-wave circuit. The two sections of the second 117Z6 are used as isolating rectifiers so that two transmitter stages may be biased from the single supply without having the grid current of one stage affect the biasing voltage of the second stage. The condenser *C* is the only filter required. *R*₁ is the usual bleeder resistance.

*R*₄ and *R*₅ are the recommended grid-leak resistances for the transmitter tubes in use, while the variable resistances *R*₂ and *R*₃ are used to adjust the output voltage of each branch to the cut-off value required for each stage. Normal bleeder current can flow through the rectifier in each branch and the rectified grid current of each stage flows through its own grid-leak branch, but cannot flow through the other branch, since the other rectifier is so polarized that it prevents any such action.

The resistances to be used at *R*₂ and *R*₃ may be determined from the following formula:

$$R = 2 \frac{E_o}{E_{co}} \times R_b - R_b,$$

where *E*_o is the output voltage of the pack, *E*_{co} the biasing voltage required for plate-current cutoff of the r.f. tube in question with no excitation and *R*_b is the recommended grid-leak resistance. *E*_{co} is determined approximately by dividing the plate voltage at which the stage is to be operated by the amplification factor of the tube. The voltage output of the pack will run slightly above the voltage of the supply line.

One unique feature of the circuit is the single connection to the line plug. The chassis of the

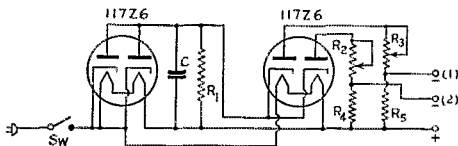

Fig. 2 — Simple transformerless duplex bias supply used by W8CMP.

C — 4 to 8 μfd.
*R*₁ — 15,000 to 25,000 ohms.
*R*₂, *R*₃, *R*₄, *R*₅ — See text.
SW — S.p.s.t. toggle switch.

supply is grounded. With the single connection, if the plug is inserted in the wrong direction, nothing happens, while if it is inserted correctly, the heaters light up and the supply is in operation. This prevents possible short-circuit of the line should the plug be polarized incorrectly.

MODULATOR AS KEYING MONITOR IN PORTABLE TRANSMITTER

MANY portable transmitters built for emergency work are designed for both voice and code operation. Since emergency work is often done under unfavorable conditions, a keying monitor is especially desirable in code work. Carl Drumeller, W9EHC, suggests the arrangement shown in Fig. 3 in which the modulator is converted to an audio oscillator by which keying may be monitored.

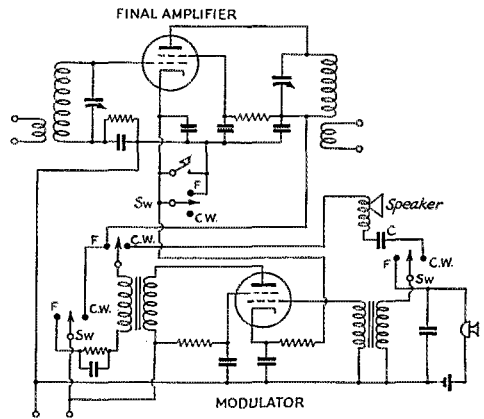

Fig. 3 — W9EHC's scheme for converting modulator in portable to keying-monitor oscillator for code work. The four switches are sections of a four-gang switch. The size of the capacity *C* determines the pitch of the audio tone generated.

A four-gang double-throw switch makes all the necessary connections in changing from voice to telegraph. The size of the capacity *C* determines the pitch of the audio tone generated and should be determined by experiment. It will vary somewhat with the type of transformer used.

CONVERTING THE B.C. RECEIVER FOR 160-METER 'PHONE WORK

THIS method of converting a broadcast set for short-wave use has the advantage of being extremely simple and requires no mutilation of the broadcast receiver.

According to the formula:

$$L = \frac{1}{\frac{1}{L_1} + \frac{1}{L_2}}$$

the total inductance of coils connected in parallel is reduced.

It is easy to obtain from your junk box or someone else's junk box, the r.f. coils taken from the r.f. stages or first-detector stage of a broadcast receiver. It will take one coil for the first detector and one for each stage of the r.f. between the first detector and the antenna. For almost all receivers tuning the broadcast band these coils will have approximately the same inductance.

If the spacing is left unchanged, the inductance of a coil is roughly proportional to the number of turns, and for purposes of computation it will be assigned a value of one.

From the law that the frequency of a resonant circuit varies inversely as the square root of the product of the inductance and capacity, it may be determined that to double the frequency when the capacity is constant, it is necessary to reduce the inductance to one-quarter of its original value. Substituting in the formula we have:

$$\frac{1}{4} = \frac{X}{1+x} \text{ or, } X \text{ equals } \frac{1}{3},$$

where L_1 equals 1, L_2 equals x , required inductance equals $\frac{1}{4}$.

Since the value of inductance was taken as one, it is only necessary to count the turns on the coils taken from the junk box and then take off $\frac{2}{3}$ of the total number.

Connect one of these altered coils between the control grid and the r.f. ground of the first detector. In each stage ahead of the detector connect a coil in the same manner.

Since the capacity was constant in determining the inductance, the second harmonic of the high frequency oscillator will beat with the incoming signal and it will not be necessary to make any changes in this stage.

The antenna input circuit, if inductively coupled, will now be out of resonance. A few turns of the antenna wrapped around the coil which has been shunted across the first stage of r.f. will take the place of the former coupling.

Because of the low cost of old broadcast-band superhets, a serviceable 160-meter 'phone receiver can be had for almost nothing. — Donald Lauderdale, W8RJP.

SHUNT-FED MOBILE ANTENNAS

THE shunt-fed arrangement shown in Fig. 4 was first tried after I had had some difficulty with my first antenna for mobile use, which was a bumper-rod on the back bumper. This was fed in the conventional manner with a concentric line, using crystal-mike cable for the purpose, and it apparently worked quite well on transmitting. I later installed a relay operating from the transmitter plate voltage to throw the antenna over to the receiver. This worked well while the car was stationary, but when in motion so much static was picked up by the antenna that it was impossible to receive. It was while attempting to eliminate this that the shunt feed was first tried.

It was the solution so far as static was concerned and I have since found it superior in other respects. Perhaps this is because of a better impedance match, since there is undoubtedly some mismatch between a crystal-mike cable and the bottom of a quarter-wave antenna.

The antenna proper is an adjustable bumper-rod of the usual type which has an extended length of 8 feet. This can be used as either a quarter- or half-wave antenna on five meters and as a quarter-wave antenna on ten meters. Ten-meter mobile operation is, of course, illegal at present. The feeder is crystal-mike cable

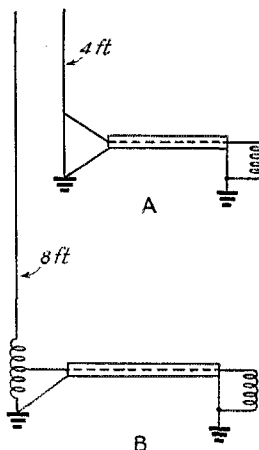

Fig. 4 — Shunt-fed mobile antennas used by W2DYR to reduce noise. A — Quarter-wave; B — Half-wave.

which is very reasonable in price compared to the 34-ohm concentric line which is necessary to match correctly the bottom of a one-quarter-wave antenna. Crystal-mike cable has a higher impedance, but it can be well matched by shunt-feeding the antenna. For quarter-wave operation, the bottom of the antenna is grounded to the car frame and the outside conductor of the feeder is grounded at both ends. At the antenna end, a copper clip is fastened to the center conductor. This clip is moved about on the antenna until the best transfer of power is accomplished. A field-strength meter will be advantageous in making this adjustment, although it will not be found too critical.

Superior results may be obtained on five meters if the antenna is run out to its full length, making it one-half-wave long. In this case, it will be necessary to insert a quarter-wave loading coil (6 turns of heavy wire 2 inches in diameter) between the bottom end of the antenna and the car frame. The center conductor is now connected somewhere about the center portion of the loading coil. Here again, the field strength meter will be helpful.

In my own installation, to facilitate antenna changes, I am using copper clips on the outside end of the feeder (both inner and outer conductors) on a short flexible lead from the bottom of the antenna, and on both ends of the loading coil. — *Eric W. Cruser, W2DYR.*

ROLL-PAPER ATTACHMENT FOR UNDERWOOD TYPEWRITER

For a long time, I've spent a little spare time, now and then, copying press transmissions on a mill for code practice. But, it always seems that whenever I just get going in good shape, I reach the end of the sheet of paper and have to stop to insert another one. The old stunt of feeding in another sheet by dropping it in between the rubber roller and the end of the sheet in use isn't always satisfactory, for it still requires reaching around for another sheet of paper, which amounts to an interruption no matter how you look at it.

Having seen the standard continuous rolls of 8½-inch-wide teletypewriter paper, I decided to rig up a fitting on the typewriter carriage of my Underwood No. 5 which would carry one of these rolls. Since it is an extremely simple arrangement, I think the traffic boys and those following the code practice transmissions from WIAW will be interested.

Referring to the sketch of Fig. 5, I folded up a couple scraps of 14-gauge aluminum to make a pair of angle strips ½ inch on a side 6 to 8 inches long (or ready-made angle stock may be used). Near the end of each a ¼-inch hole is drilled to form bearings for a section of ¼-inch diameter brass rod. A reel for the roll is formed by drilling ¼-inch holes all the way through a pair of old bakelite dials and sliding them on the rod. Compression-type dials are just the thing for the purpose, but set-screw dials will also work. The protruding ends of the shaft are fitted with collars with set screws. This reel, when correctly adjusted, keeps the paper roll in line with the margin marker at all times.

The brackets are fastened to the top of the carriage by removing the two nicked trim strips on either side and substituting the angle brackets in their place. The mounting holes in

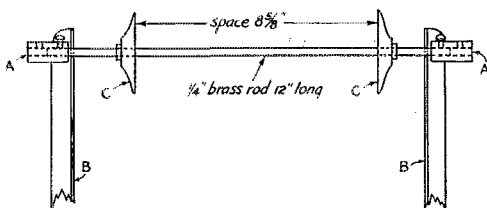

Fig. 5 — Reel for holding paper roll on typewriter carriage for continuous code copy as used by W9IBC. A — Shaft couplings for ¼-in. brass rod. B — Half-inch aluminum or brass angle. C — Old bakelite dials.

the angle pieces should be drilled to match the screw holes in the carriage.

The new roll of paper, which may be purchased from most office-supply houses for about 40 cents, weighs 3½ lbs. This weight may be sufficient to stall the carriage of an older-model machine. If this difficulty is encountered, unwind about 30 ft. of paper, make a loose roll and slip it on the reel. This, together with the reel, weighs but 8 oz. and will not affect the carriage action. Thirty feet will keep you going for several evenings.

The reel may be installed on the carriage of a Royal machine, but this requires the drilling and tapping of holes in the carriage for the mounting screws. — *D. L. Warner, W9IBC.*

★ NEW ★ TRANSMITTING TUBE

RCA-815

A NEW dual beam-power tube that will interest all u.h.f. men has just been announced by RCA. It appears to be a low-priced version of the 829 and should fill a long-felt need. The fact that it is rated at full ratings to 150 Mc. and at 85% to 200 Mc. opens up many possibilities in transmitter construction. It is a cathode-type tube with the heaters for each tube section connected in series, so that the heaters can be operated on either 12.6 volts (heaters in series) or 6.3 volts (heaters in parallel). Its ratings follow:

Interelectrode capacities	
Grid to plate (with external shielding)	0.2 μ fd.
Input	13.3 μ fd.
Output	8.5 μ fd.
Maximum overall length	4 ½ inches
Maximum diameter	2 ¼ inches
Base	Metal shell, micanol, octal

Typical Operating Conditions

As A.F. Amplifier and Modulator, Class AB₂

	CCS	IC & AS
Plate voltage	400	500 volts
Screen voltage	125	125 volts
D.c. grid voltage	— 27	— 27 volts
Peak a.f. grid-to-grid voltage	84	84 volts
Zero sig. d.c. plate current	25	25 ma.
Max. sig. d.c. plate current	150	150 ma.
Max. sig. d.c. screen current	20	20 ma.
Load resistance, plate to plate	6100	8000 ohms
Max. sig. driving power	0.75	0.75 watts
Max. sig. power output	42	54 watts
Plate-Modulated R.F. Power Amplifier — Class C Telephony Carrier conditions per tube for use with a max. mod. factor of 1.0		
D.c. plate voltage	325	400 volts
D.c. screen voltage of	165	175 volts
From a series resistor of	10,000	15,000 ohms
D.c. grid voltage of	— 45	— 45 volts
From a grid resistor of	11,250	15,000 ohms

(Continued on page 106)



CORRESPONDENCE FROM MEMBERS

The Publishers of *QST* assume no responsibility for statements made herein by correspondents.

USE THE MILL

U. S. S. *Rathburne* (113), San Diego, Calif.
Editor, *QST*:

I read with interest your editorial on encouraging the amateur radio operator to increase his code speed. I was especially glad to hear that you are encouraging hams to copy code on the "mill."

In the class of naval reservists that volunteered for active duty, the majority being amateurs, we found that our main fault in copying the code was that we were unable to copy on the mill. Most of us could copy FB with the "stick," but when it came to the mill our speed was nil.

Requirements in the service require the copying of code on the mill. Regardless of whether you get into the service or not, your copying ability will increase much faster when copying on the mill, and I believe that your c.w. QSO's will become much more interesting.

In closing I wish to congratulate *QST* and the A.R.R.L. on helping us amateurs enjoy our great hobby in this troubled world, while our fraternal brothers overseas are waiting . . . hoping. . . .

— *Carl F. Gombor RMSC/USN, W9UYF/6*

LET'S COÖPERATE

17 Crestview Hill Road, Livingston, N. J.
Editor, *QST*:

It was very gratifying to me to hear that the League was taking into consideration the code and realizing the necessity for building up real operators in the c.w. ranks.

My first thought was that the gang would cooperate 100% with the idea, which would be the natural reaction of any ham really interested in the betterment of his operating and the possibility of his usefulness to our country if the necessity arises.

The frequencies were announced in *QST*, yet we have continuous QRM on the frequency which is being used by the League for our help.

Is it too much to ask any real ham to vacate this one frequency for a period of 15 minutes each evening? Listening to the QRM on forty meters, the fellows who are causing the nuisance certainly can use the code practice if their fists are any indication of their operating ability. . . .

Fellows, let's coöperate and give WIAW a

break, and give yourself some good necessary code practice.

Clear the frequency for that few minutes each evening.

— *G. S. MacMillan, W2JQE*

LICENSE RENEWALS FOR CONSCRIPTS

603 Spring St., Aurora, Ill.

Editor, *QST*:

With conscription imminent . . . I believe it fitting that any amateur who has assigned to him an operator's license and call letters, and who serves our country in military service, should have his licenses renewed without having been active three months prior to the renewal of said licenses.

There are movements to restore employment and defer debts so conscripts can continue without interruption their civilian life when their military services are completed. I believe that a gesture from our government in respect to the amateurs would be proper and fitting. . . .

— *Harold H. Nelson, W9EDW*

EDITOR'S NOTE. — Arrangements for waiving the activity requirement in the case of amateurs who cannot comply because of expirations occurring during service under the selective draft are being made, and there is every likelihood that some provision along these lines will be adopted.

THE CHOCTAWS' SECRET CODE

706 West Duke St., Hugo, Okla.

Editor, *QST*:

I have read the article on Operator Training by Clyde M. Bartlow, W8TPQ, in which he stated that there was a Cherokee Indian used by the Signal Corps during the last World War to baffle the German wire tappers. I wish to state here that it was not a Cherokee but several Choctaw Indians that did this fine piece of work. . . .

Seven full-blooded Choctaws, Solomon Lewis, Ben Cartaby, Robert Taylor, Pete Maytubby, James Edwards and Jeff Wilson, were assigned to Company E, a part of the 36th Division under General Roy Hoffman. They sailed from New York on July 1, 1918, and disembarked at Lazzarre, France. The morning of October 7th they arrived at the front lines, and on the morning of the 8th they went over the top for the first time at St. Mihiel.

(Continued on page 100)



OPERATING NEWS

F. E. HANDY, WIBDI, Communications Mgr.

E. L. BATTEY, W1UE, Asst. Communications Mgr.

Current Activities. Operating features arranged by A.R.R.L. are open to every F.C.C.-licensed amateur.

... a chance for everybody to make new contacts, which in turn gives everybody a score. THE 9TH A.R.R.L. SWEEPSTAKES (November 11th and 16th-18th) also announced in this issue, needs no introduction!

... THE NAVY DAY RECEIVING COMPETITION will be well worth the attention of every real amateur. Announcement was on page 37 of last QST. Be at your receiver on the early evening of October 27th. We'll look for your reports.

... coming up, another U.H.F. CONTEST (December 14th-15th). These dates are set to give all u.h.f. workers time to correspond and line up 2½- and 5-meter routes, testing each Saturday and Sunday to extend these as far as possible east-west and north-south, looking to new records of all kinds in the quarterly test opportunity.

Code Proficiency Award News. 1447 applications for the new League award were received as a result of the second qualifying run. We thought we were snowed under, on the first one, with such a volume of "copy" to check. Indications are that the interest in the program is increasing in keenness, and the precautions to limit the program to certain speed ranges, were well taken. Failures came up to 7%. We are proud to indicate all certificate winners elsewhere in this department. This time also we present (and congratulate) those who receive Silver Endorsement Stickers, indicating their additional qualification for such recognition by proving themselves in a higher speed range, after initial qualification. Only about 20% of the total of applicants is represented by these endorsements... the majority being those of the fraternity who have not yet got their Attainment Certificates.

To assist in the program we present more press schedules this month, and a selection of suitable practice transmissions from page 84, last issue, should cover almost any requirement. The daily-except-Friday W1AW practice transmissions, sent simultaneously on 1806, 3825, 7280, 14,253, and 28,510 kcs., starting about 10.15 P.M. EST daily, are available to most amateurs, but those who want more should turn to the other transmissions enumerated.

Next Monthly Runs. The W1AW qualifying runs, following explanatory transmissions at the usual practice time, start at 10:30 P.M. EST on

October 17th, Thursday
November 20th, Wednesday
December 17th, Tuesday

Don't miss these opportunities if you haven't yet received your attainment certificate and a sticker on same. The W1AW certification is our national standard, and every F.C.C. licensee is invited to participate, submitting his best copy, *marking the particular minute of perfect copy*, for the A.R.R.L. Certificate of Proficiency for such attainment. Tune in fifteen minutes early to get all set!

Mill Copy. Many letters from amateurs who have been doing summer duty in various government services emphasize the importance of being able to copy on the typewriter, at speeds of at least 25 or 30 words per minute. We originally anticipated that about all the "proficiency copies" at the higher speeds would automatically be made, using a mill, because of the convenience of copying that way. The indication of those papers copied direct on the mill by asterisk identification in the award list is continued, and the predominance of such copies in the top-speed lists may be noted both this and last month. Due to the volume of program work which makes it necessary to avoid extras we follow a rigid policy of giving no special or extra endorsements for the *kind* of copy, for the fellow who can do it on the mill knows it, and better... can be proud of his ability to demonstrate that qualification when necessary!

There is no special secret to cultivating ability to copy on a typewriter. It is a matter of making good by *regular practice* just as we mentioned under "how to progress" last month. The *ability to coördinate* one's aural, mental, and writing processes is the essential ability. We run a comment from an Old Timer, W9VKF, who had held the theory for 25 years that copying with a pencil was limited to the lower speeds, to show that with either the "stick" or the "mill" it is a matter of practice in one's ability to coördinate.

"I had always believed that the limit of copying was caused by physical inability to push the pencil faster. I knew I could listen intelligently at 45 w.p.m., but there was no way to prove it... However, I found the inability to copy fast with a pencil not caused by inability to write faster at all. It is caused by lack of coördination between reading and copying. This coördination can be increased by practicing, simply by trying to copy at top speeds.

"While at first I could understand at, say 45 w.p.m., I could not write it down. After covering a lot of scrap paper with scribbles, I began to get more and more of it down. While chagrined to find about 30 w.p.m. a limit on the first Proficiency Run, practice in copying now makes it possible

to coordinate the reading and the writing-down. This is offered with the thought of encouraging others in the ability to make actual copy. . . ."

Returning to our subject of copying on a typewriter, while this cannot be done overnight, it is something that comes just as surely as speed with plain pencil copy, with practice. In practically every message center of groups ashore or afloat, typewriters are used, though naturally enough they are not used to the same extent in mobile field applications. We want to emphasize the thought, then, that if you beg or borrow a machine to practice on, you will want to make your proficiency copy on a typewriter. First, we invite every ham to qualify *the best way he can*. Then we invite every amateur to start in the process of polishing up his technique.

That means not only the cultivation of the ability to "do it on a mill," but the ability to *send* correctly, to use message forms intelligently, to break or ask fills without wasting time, to mark down time of receipt or transmission and responsibility for recording messages accurately without wasting circuit time, to handle a circuit!

Opportunity to Broaden Ability. Amateur message handling is a fast and pleasant road to top proficiency in all the things that pertain to code reception and transmission. We want to invite and urge every amateur to join with like minded fellows in aiming at field organization appointments, and getting in the swim in every activity this fall. A private schedule with somebody of like ability, some traffic schedules, an aim at Official Relay Station appointment (Official 'Phone if you work voice), participation in Section c.w. and 'phone nets, in actual exchange of record communications, these things will put your ability to the front and class you with the top notchers in our hobby. It's going to be a big season. We amateurs may shortly have opportunity to render a public and patriotic service by increasing our message handling to assist in keeping boys at the various camps and schools in touch with their homes. Let every one of us make ourselves capable, and plan to have our ability at the top, and to get amateur enjoyment from assisting in any such venture. A.R.R.L. will be giving you more on this opportunity as plans are formulated.

15 w.p.m. To all you fellows who haven't got your certificates at 15 w.p.m., we should like to extend a special invitation to send in copy on the very next W1AW qualifying run! We want to be able to tell Uncle Sam that there isn't a single amateur licensee who remains satisfied with keeping his attainment at the 13 w.p.m. level of the government examination. To invite you to send copy for checking is probably just sticking our neck out (more work!), but we point out it will: (1) add to the strength and showing for the whole amateur body in connection with this program; (2) will give you a proof-of-attainment

that you will value; (3) give you a start on a beautiful certificate that can eventually possess a whole row of Endorsement Stickers. Try it and see what fun it is. Do it as soon as you can. Here's luck. . . .
— F. E. H.

ARTICLE CONTEST

The article by Don F. Holaday, W9DOY, wins the C.D. article contest prize this month. We invite entries for this monthly contest. Regarding subject matter, we suggest that you tell about what activity you find most interesting in amateur radio. Here you will find an almost limitless variety of subjects. Perhaps you would like to write on working for code proficiency, participating in League contests, keeping schedules for traffic work, working in Section Nets, holding a League appointment, working on radio club committees, organizing or running a radio club, or some other subject nearer to your heart.

Each month we will print the most interesting and valuable article received. Please mark your contribution "for the C.D. contest." Prize winners may select a bound *Handbook*, *QST* Binder and League Emblem, six logs, eight pads radiogram blanks, DX Map and three pads, or any other combination of A.R.R.L. supplies of equivalent value. Try your luck!

The Regional Radio Club

One Way To Keep the Radio Club Alive

BY DON F. HOLADAY, W9DOY*

ONE sort of demise in the ham ranks never appearing in "Silent Keys" yet one which would surely rate three or four lines a month, is the death of various and sundry radio clubs of the country. Between the Main Modulators and the Kalifornia Key-Klickers lie hundreds of amateur radio clubs: associations born of the naturally gregarious instincts of amateur operators. Probably not one of these but was instituted with the idea of making it a community fixture, and enduring group serving hamdom in that section of the nation . . . yet the mortality rate is so high that it is doubtful if Lloyd's of London would care to quote an insurance rate for such an enterprise. The writer would not attempt to analyze or criticize the liquidation of so many optimistically spawned radio clubs, the whys and wherefores having been recounted many times before. This bit has only to do with one rather successful system, which may serve as a model for other interested groups.

I have belonged to three clubs in my twelve years as an amateur (having helped to found or reorganize two): one at a sizeable midwestern college, one in a city of 40,000, and one in a northwestern metropolis of about a half million population. Personal experience, plus the accounts of visiting hams, has convinced me that there is a definite relationship between the number of men within the boundaries of the club territory and the probability of long life for the association. The college club mentioned has died and been revitalized four or five times in the past decade, since its founding by "our gang." Likewise, in my home town of forty thousand souls, the club founded by the actives of 1931 has seen three complete renovations in nine years. When the big city club comes under our microscope we find a different picture. This particular club has been in existence since post-war days and has never passed completely from the scene. This is not to say that the incorporators of the club are now the mainstays; no indeed, most of the fellows now in the unit would probably not even recognize the names and calls of 80 per cent of the members of the turbulent Twenties.

* Radio Station KVOX, 14th St. and 12th Avenue So., Moorhead, Minn.

Code Proficiency Endorsements

(August 30, 1940)

The first endorsement stickers to be issued in the A.R.R.L. Code Proficiency Program go to the following. These operators on August 30th bettered the speeds for which they earlier (Aug. 5th) received certificates. Endorsements have been made at the indicated speeds.

35 w.p.m.

The history of the last mentioned club proves one big point, the writer believes; namely, that present members of any club will positively fade out in a period of a few years. Like a family, the men of the club come and go, oldsters are replaced by youngsters, individuals fade out but the club, if backed by sufficient population in its designated boundaries, will go on. Sheer numbers of potential hams seem to cement the structure of the club; without this asset the club is most likely to disintegrate. Of course, there are dozens of exceptions to prove this rule, but they are the exceptions, certainly. If this contention is true, as we believe, then the best guarantee for permanence is a metropolitan background, or its equivalent.

A means of embracing a large number of amateurs without establishing the club in a super-city has been devised by a group of Dakota Division hams, and the *Min-Dak Radio Club* is a living testimonial to organized hamming in rural areas. As the name implies, the club draws its membership from the common territory of Minnesota, North and South Dakota, its axis being the western Minnesota boundary. The club depends for its membership, not upon the three or four sizeable cities within the accepted territory, but enlists the men of isolated towns or farms, with probably no more than three men from any particular point. Hams of the cities mentioned are not excluded, far from it! Their membership is solicited; and many men belong both to their local city club and to the *Min-Dak Radio Club*. With over a hundred men in this geographical segment belonging to the club, each monthly meeting takes on the aspect of a picnic. "Gil," the dean of *QST* cartoonists, would obtain a lot of pen-fodder following just one car of enthusiastic men trekking to the designated meeting spot for a particular month. A car, starting from one of the outposts, gathers up the various members of the clan, and transports them to the gathering, often a hundred miles or more away. Starting in the middle of Sunday morning, they arrive in plenty of time for the afternoon sessions: except for a couple of notable times when cars bogged down in bad weather on side roads. Even so, as when one contingent made a side trip to visit one of the boys on a farm (and got mired for the better part of two days) the whole expedition comes definitely under the head of pure fun. Pro rating the expenses, it is possible for a long trip to be made with a total cost per man scarcely exceeding a dollar.

Each month, one Sunday is set aside for the regular meeting, a different town designated as meeting place each month. The turnout has several times transformed a quiet country spot into a motion picture version of a boom town; several times the largest hall available or the movie house, has been necessary to hold the crowd. Food is never demanded of the hosts; but they invariably arrange for an economical lunch to be served the visitors. In all cases the total cost of the day has been small, and large turnouts have been the rule. It is often impossible for men living in the extreme north or south end of the long territory to travel to the other end, but the meeting spot is so carefully rotated that all members may attend to the majority of the meetings. Nothing pretentious (often nothing definite) is arranged for a program, the entire available time designated for ham shack inspection and gabfesting, with the host station's rig steamed up all the time. There seems to be no necessity for a technical or political discussion in any panel form. Anything that requires talking over is promptly run through the mill and a set of conclusions formed without the slightest formality. Several amateur friends insist that clubs are made for the purpose of instructing the membership; to them, the advice to form a restricted group of like-thinking men would perhaps best be given. It seems to me that such a club could only survive as an adjunct to a school, Y. M. C. A., or other such center. But, for a durable, general interest organization, dedicated to the strictly human interest of hamdom, hats are off to the *Min-Dak* founders. Time will certainly tell, but it looks like the *Min-Dak* boys (and those other far-seeing organizers who form regional radio clubs) will be rolling right along, like Ol' Man River, for many, many years to come. From father to son, the parchment of membership in this genial gang will travel down, along with the old homestead, the family Bible; and, yes, the bookcase full of *QST*'s.

W1BJB, W1CPV, W1KFN, W1KQY, W1CCF, W1EFM, W1AJK, W1AKS, W1JCF, W1IKE, W1ZR, W1MJG, W1JCK, W1MJD, W2CHO, W2GE, W2BMX, W2HUG, W2MT, W2BOT, W2CIZ, W2AER, W2CLC, W2ALK, W2BWC, W2LFR, W2NDQ, W3INV, W3FIG, W3BXE, W3ITW, W3FSP, W3AOC, W3ARN, W3BES, W3BAK, W3LJJ, W3HTF, W3GRF, W3IGK, W3IQE, W3DJ, W3FO, W3EEW, W3NF, W3AGV, ex-W4AKV, W4DVO, W4FEC, W4BRB, W4ZU, W4KD, W4EV, W4FZO, W4TZ, W5GRN, W5BB, W5ITK, W5BUK, W5EGA, W6MUO, W6DEF, W6ONG, W6GTM, W6SEI, W7EBQ, W7EQC, W7AJ, W8OE, W8BHK, W8REC, W8EIU, W8BJ, W8ORD, W8KPL, W8UEY, W8TFS, W8LEC, W8NCJ, W8JSU, W8KXS, W8UHL, W8EU, W9AYH, W9QYI, W9GBJ, W9MBG, W9OGZ, W9YZN, W9AOB, W9ZYK, W9NSU, W9KAQ, W9YEX, W9KBL, W9HQZ, W9RYZ, W9RQZ, W9DOU, W9VKF, W. R. Faries.

30 w.p.m.

W1HWE, W1IKT, W1ZAC, W1CA, W1WS, W1JLT, W1HYE, W2MDW, W2DQP, W2MDI, W2IR, W2IYZ, W3EXQ, W3FQB, W3DAJ, W3ADZ, W4ERG, W4CNZ, W4FVN, W4FSA, W5GDE, W6BDZ, W6LPX, W6RNO, W6RUE, W6PHZ, W6KRI, W6QXK, W7HXX, W8ENH, W8OML, W8UVL, W8TQE, W8JIW, W8SS, W8TZW, W9BIN, W9QNP, W9MI, W9CVU, W9FWW, W9QIP, W9MGN, W9CSJ, W9DBO, W9HKA, W9DB, W9CJS, W9NBX.

25 w.p.m.

W1EFR, W1GZL, W1MLO, W1LXE, W1PV, W1IDX, W1MJP, W1RH, W1EHT, W1KWU, W1GXV, W1KTT, W1KVP, W2BYO, W2GTA, W2DOG, W2MXF, W2JEB, W2LCD, W2KEG, W2IBK, W2LYC, W2MRJ, W2LRO, W2ETC, W2LTK, W2ISQ, W2NED, W2CBL, W3ATR, W3IDQ, W3IGS, W3EEI, W3FUM, W3INT, W3HBT, W3BYF, W3HRD, W3IWM, W3FRE, W3AIZ, W4FXG, W4MA, W4GKO, W4EFE, W4PCJ, W4FDJ, W4JO, W4DIZ, W4GBV, W4DDJ, W5TN, W5CPC, W5AUT, W5IVE, W5FL, W5DNN, W6SUD, W6YH, W6BKY, W7ZN, W7FHW, W8BT, W8IFQ, W8HKS, W8LCO, W8UHV, W8AXH, W8SJD, W8TJB, W8UQM, W8SVD, W8RVM, W8BSS, W8NFM, W8SWB, W8RSD, W8NWW, W8GWT, W8MTO, W8JHP, W8THN, W8QCU, W9FAQ, W9NN, W9ETZ, W9QVA, W9OWQ, W9PRK, W9DTE, W9CVL, W9PGP, W9NYH, W9ERN, W9LHD, W9KYZ, W9ODX, W9LAF, W9NDA, W9GBS, W9ACC, W9OQP, W9UWE, W9KIK, W9CEY.

20 w.p.m.

W1MIM, W1MPP, W1MHS, W2LXI, W2KJP, W3GWM, W3HWO, W3GGT, W3IOK, W4EPE, W4DPQ, W4CJM, W5HHC, W5HQR, W5DYS, W5HA, W5HEE, W5IMN, W6MYG, W6NGC, W8SWA, W8LCY, W8TKM, W8UUA, W8NVC, W9LKW, W9AHG, W9MXT, W9PRM, W9DFW, W9GLG, W9ONS, W9FZM, W9SPO, L. F. Hellman.

Amateur License Suspended

The F.C.C. on September 6, 1940, announced adoption of its Proposed Findings of Fact and Conclusions, and entered its Final Order (No. T-13) suspending the amateur radio operator license of Louis Raymond Choiniere, Holyoke, Mass., for a period of three months, for "deceptive tactics" in broadcasting music and singing in "deliberate violation" of certain rules governing amateur stations. This action affirms the Commission's Order of Suspension dated August 8, 1939, which had been held in abeyance pending hearing.

U. S. CITIZEN-STATIONS IN P. I.

Under F.C.C. Order No. 72, contacts by U. S. amateurs with the Philippines may be only with KA stations licensed to U. S. citizens. This of course covers stations at military and naval posts. We have compiled a list of KA stations that are OK to work. It is suggested that U. S. amateurs use this list in determining whether or not a given KA should be worked:

KA1AA 1AB 1AK 1AR 1AS 1BB 1BN 1BS 1CG 1CM 1CO 1CS 1CW 1DM 1FA 1GC 1GX 1HQ 1HR 1JH 1JJ 1JM 1JP 1KX 1LB 1ME 1MN 1OZ 1PO 1PM 1RK 1RV 1TW 1VL 1WW 1XR 1XS 1YL 1ZL 3BW 3KK 3RA 4LH 7FS 7HB 8AA 8ED.

BRIEFS

In the 1.75-Mc. W.A.S. Party held last February, W3BES made a score of 6016, which places him right up with the leaders. His report failed to reach us in time for inclusion in the September QST write-up.

W7FHB and W6RJH made contact on September 17, 1940. Just as W6RJH was about to mention that 7FHB's call letters were his (RJH's) initials (F. H. Brock), W7FHB advised that 6RJH's call letters were his (FHB's) initials (R. J. Hougum)! Tie that one, gang!

Meet the S. C. M.'s

STARTING this month we plan to present in each QST photos of A.R.R.L.'s Section Communications Managers. In this way it is hoped that the gang generally will become better acquainted with the various Section administrators.



WALTER D. TABLER, W8OXO

S.C.M. West Virginia, is most active on 3770-kc., the W. Va. Section frequency, but he may also be found from time to time on the 3.9-Mc. 'phone and 7- and 14-Mc. c.w. bands. His rig runs 1 kw. to a pair of 250TH's. An RME69 and DB20 preselector take care of reception. "Tabe" received his ticket in November, 1935, and has been outstanding in operating activities ever since; he was W. Va. SS winner in '37 and '39. In addition to S.C.M., W8OXO also signs "ORS" and "RM," and is a member of the Mountaineer Amateur Radio Ass'n. In the sports field S.C.M. Tabler participates actively in baseball, golf and fishing. He is an ex-Navy man and also served in the W. Va. N. G. When not hamming or looking after his other hobbies, "Tabe" is Rural Electric Extension Supervisor for the Monongahela West. Penn. Public Service Co.

Code Proficiency Certificates Issued

(August 30, 1940)

The following amateurs received A.R.R.L. Code Proficiency Certificates at the speeds indicated, for copy of the W1AW official qualifying run of August 30th. These are in addition to those receiving certificates following the August 5th run (list in October QST). An asterisk on an operator's call or name indicates that original copy was made on a typewriter.

15 w.p.m.

W1LZI, W1FVR, W1EHF, W1MHT, W1PN, W1LVM, W1MSN, W1KSB, W1MTQ, W1MVC, W1GCG, W1MQT, W1GOL, W1MRN, W2MPJ, W2HMF, W2NEN, W2BLD, W2EWM, W2CLF, W2MWE, W2MLV, W2NFR, W2NBJ, W2FID, W2CHZ, W2HGO, W2LIB, W2MIO, W2MLM, W3HXY, W3GNU, W3FPL, W3INS, W3ZU, W3HND, W3HOQ, W3EWW, W4FYS, W4FCQ, W4EUM, W4BE, W4FHM, W4GEF, W4EHF, W4VX, W4XXM, W4FUM, W5HNJ, W5IRM, W5HEK, W5FFH, W5HAX, W5HLM, W5FGF, W5IUF, W6NBJ, W6MWW, W6PAX, W6SNE, W61WU, W6KUI, W6SJM, W6SHO, W6PFH, W7JC, W7HHH, W8PQY, W8TRK, W8APK, W8TWA, W8RZG, W8CJR, W8SJS, W8UUS, W8JAH, W8BRT*, W8TFQ, W8PJM, W8BZU, W9HYQ, W9HDA, W9LFC, W9HGQ, W9WUM, W9YZQ, W9OFL, W9TVO, W9TZG, W9IZE, W9CFC, W9URO, W9QLL, W9HFB, W9YQR, W9MTO, W9LJO, W9FKH, W9JKF, W9CPL, W9JWS, W9LNI, W9JSV, W9ZIE, W9HZI, W9HIG, W9LED, W9IHF, W9ICZ, W9ALU, W9HRD, W9MZS. Gerald J. Brown, Thomas J. Crehan, Herman Simard, Jr., Stanton L. Hart*, Clifton Moore, Herman Joseph Daily, Edward M. Coan, A. Harry Sharbaugh, Jr., L. F. Princell, Carl Menely, E. D. Muhleman, Walter F. Bergmann, Lawrence Cobb, F. A. Kline, Robert C. Bellisle, Charles Kern, C. F. W. Anderson.

(Continued on page 68)

HORACE R. GREER, W6TI

S.C.M. East Bay and W6 QSL Manager, received his first license and call 6TI in 1920. An active member of the Oakland Radio Club, he has a keen interest in organization work. He holds W.A.S., W.B.E. and W.A.C. awards and has worked 36 countries on c.w. W6TI, located in a 10 by 10 shack in the backyard, has a pair of 211D's in the transmitter final (800 watts input) on 7 and 14 Mcs. Receiver is a Super Pro. S.C.M. Greer is interested in all kinds of sports activities, particularly fishing, baseball, football and golf. He is an ardent traveler, having been to Europe twice, across the Atlantic three times, around the world once, through both Canals, the Panama twice, and across the continent several times. He is Assistant Manager of Sales Promotion for the National Distillers Prod. Corp.



How's DX?

HOW:

We're a lot happier about the whole thing this month. In the first place, we're glad to know that we were hasty in our judgment of the DX men who haven't yet qualified for their Code Proficiency awards. A number of fellows called us on this, saying that for one reason or another they hadn't yet been able to be on during one of the nights when the test is given. That's what we like to see, because we hate to have that old faith in the DX gang shaken, even a little bit.

To further strengthen our faith, however, and to bear out our private opinion that the very large majority of DX men are more honest than their ex-DXCC-aspirant acquaintances, we had a couple of fellows take us up on that offer last month and send in some bullet-box tops. WIDUK didn't have a cancelled stamp, but he sent in a sample target and, for our money, he's really eligible. He promised a nice clean job, nothing messy, and we think he could do it. The target had had two bullets fired through it, right through the X ring, and the hole is so small it looks like the bullets went through and pulled the hole in after them. It was nice shooting, but apparently with a .22, which is a different idea than W8BTI had. Carl sent in tops from a .38 box and a .38-55 soft-nose job. If our memory serves us correctly, that .38-55 soft-nose can really discourage almost anyone, including a card-firer. Which, of course, is what we had in mind. Fortunately for the potential victim, we promised to disclose the name upon receipt of two box tops from a box of bullets, and all the applicants sent in tops from different boxes. Those old-fashioned boxes with two tops must be getting a little hard to find these days.

DXCC ROUND UP:

It looks like the time should be ripe around November 30th for another over-the-air DXCC Round Up and so, weather and women permitting, get the rig warmed up and the wrist oiled for that date. The majority seem to be in favor of a no-contest angle, with just some good rag chewing and a chance to meet the gang. Since we've had no contrary suggestions, we'll run it at the same hours, from 5 P.M. EST (2 P.M. PST), Nov. 30th, to midnight EST (9 P.M. PST), Dec. 1st. Most of the gang will be in the high end of 20, but if 20 goes dead on Saturday night we suggest a look at the low end of 7 Mc. All members of the DXCC and those listed

in the 75-or-better are welcome to the Round Up, and the general call will again be "CQ CC." And even if your favorite football game falls on that weekend, you'll still have a chance to get on and say "Hello." Try it this time — we think you'll enjoy it.

WHERE:

This month we have the full list of cards submitted by W6GRL for his DXCC score, so if you want to gloat, just look over his list and think of all the nice ones you have that he hasn't. (Then look at his score and think of all the nice ones he has that you haven't. That is, all of you but W2GT.) We'll list them in the alphabetical order of the countries but by calls: K7CHP, FA8JO, ST6KR, CR6AF, LU6AX, VK6SA, OE1ER, CT2BK, VP7NA, VU7BR, K(F)6XJI, VU2AN, VP6TR, ON4CSL (Belgian Congo), ON4AU, VP9R, CP1AA, PK5VO, PY1CJ, VP1JR, XZ2LZ, VE5OA, NY2AE, EA8AO, CR4HT, PK6AG, VS7RF, VQ8AS, G8MF (Channel Is.), CE7AA, XU6LN, J8CB, HJ3AJH, TI2DB, CM7LR, OK1BC, YM4AA, OZ7SS, HI5X, HC2MO, SU1WM, G6VP, ES5C, I7AA (Ethiopia), VP8AD, VS2AG, VR2FF, OH5NR, F8FC, FN1C, F18AC, D3DSR, ZB2B, VP3AM (Gilbert & Ellice and Ocean Is., now VR1), ZD4AB, SV1KE, OX2QY, OM2BC, TG9AA, VP3THE, PZ1AL, FY8E, HH4AS, K6AUQ, HR1UQ, VS6AX, HA3D, TF3C, VU2LG, GI5QX, EI7L, G6IA (Isle of Man), I1KN, VP5PZ, J8FZ, KG6NVJ, PK2NM, KE6NYD, VQ4KTC, J8PG (Kwantung), YL2CG, VP2BX, EL2A, HB1CE, LY1J, KC4USA, CR9AC, FB8AG, CT3AB, ZB1H, MX2B, FM8AD, VQ8AF, XE2AI, KD6QH, CN8AV, CR7MB, PA0QZ, PJ1BV, FK8AA, VO3R, PK6XX, VK9BA, ZL2FX, YN1AA, ZD2H, LA5N, ZC6EC, HP1A, VK4HN (Papua), ZP6AC, OA4J, KA1PT, VR2FR (Phoenix Is.), VR6AY, SP1HJ, CT1ZZ, K4DDH, FR8VX, VQ2JC, ZE1JN, YR5VV, YS1FM, KH6SHS, GM6IZ, HS1RJ, VR4BA, ZS3F, U1AP, U2NE, U5AH, U9ME, EA4AO, VS1AJ, PK4RK, SM6WL, HB9BY, VQ3HJP, EK1AF, VK7CL, VP4TF, FT4AG, ZS6Y, W9FO, CX1BG, YV1AP, KB4AAAN, KC6TE, GW5KJ, VP2LD and YU7DX. (Gosh, boss, the only one you've got that he hasn't is that VQ9AA card you made yourself. — *Jeeves.*) (Oh, yeah? Well, I never tried to get it by. — *W1JPE.*) (What, no bullet-proof vest? — *Ed.*) The reason we mentioned W2GT back there is because Ed is tied with Doc for top honors this month. Next month we'll show you what ones Ed has that Doc hasn't.

WHEN:

News of the month is **KD4GYM** (14-Mc. 'phone) at Swan Island in the Caribbean. He is Paul Stephen, U. S. Weather Bureau, Swan Island, West Indies, and is supposed to be sending along a QSO list to help those fellows who have worked him and want credit for another country. They'll get it when the list comes through, because the place is far enough away from any other U. S. possession to count separately Still no word on the missing KH6SHS, whom a lot of the fellows are still snooping for. W2GT says he heard some rumor about a KH6ODD (14,400 T9) some time ago, but with no follow-up. Gosh, if Jerry only knew how we missed him! ("Missed" is right! — *Jeeves.*) We hope no one is answering a 4QET when he calls, because he is quite probably D4QET, and the F.C.C. still says "No." Some of the still-active foreign stations have even been signing KB6 calls for the boys to bite at, so we girls can't be too careful these days. The F.C.C. knows about it, so the excuse that "you didn't know they were phoney" won't be much of a help to you. You wouldn't want to admit that the F.C.C. knows more about DX than you do, would you? But, seriously, be careful about working stations with calls that are at all questionable — we want those skirts to be kept clean G2MI passes along the dope from

(Continued on page 58)

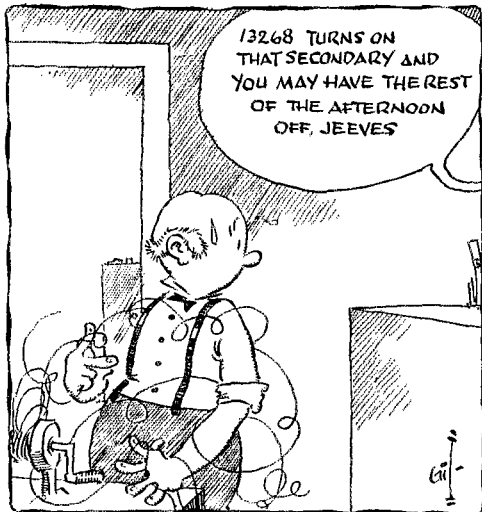

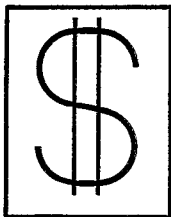

IN THE February issue of *QST* we announced that we would give cash prizes for the best pictures and descriptions of amateur stations sent to us. The judging is now finished, so we are free to talk about the entries. This contest brought home to us in a dramatic way the trend toward high power. Most of the stations entered had inputs of over 250 watts, and nearly all of the well designed home-built transmitters ran to high power.

Perhaps we should be overjoyed that everybody builds high power rigs (because the parts run to more money, hi!). Nevertheless, we wonder whether the men who blink all the lights in the neighborhood when they pound the key ever gave low power a real try. Often a low power rig is made from junk box parts, using inexpensive tubes that can take a lot of punishment. There is not much at stake, so there may not be much care in design, either. Practically anything goes, except the signal, which often does not go very far.

So low power is no good, and a kilowatt job is planned. This runs to a lot of money, so there is much careful planning before the cash is laid down on the counter. The plate dissipation of the final is "only 200 watts," so the tubes have to run better than 80% efficiency to keep from blowing up. This means more planning, and lots of nice adjustment. Finally it gets the power, and with 800 watts into the feeders, the signal does go places.

But suppose the same care and the same skill had been used in building the low power rig? W2WD has an NTX-30 Transmitter (30 watts output on 10, 20, 40 and 80 meters). He says, "Low power does exactly as much for me as five times as much power ever did — on any band. In ten days I worked 26 states on 3688 KC. The rig does all I ask it to and has given me more real fun than anything else I have ever had." He also mentions the "joy" of being able to shift frequency easily and quickly. All of which agrees with what a lot of other amateurs have told us. And there is plenty of confirmation of what low power can do in the pages of *QST*.

To change the subject, most of the stations in the contest showed that their owners were safety conscious. Inclosed racks with door-operated safety switches, meters near ground potential, dials insulated and grounded, safety plate caps and other safety details all showed a desire to keep the "OP from making a ghost of himself" as W2BKX put it. However, most of the transmitter racks were pushed back close to the wall. This may be necessary because of space limitations, but do not make the mistake of thinking it is a safety feature, even though it does make high voltage terminals hard to get at. Give yourself lots of room when you work on the rig. If you do get across high voltage, the muscular reaction is likely to throw you clear. If you are jammed between the wall and the rack, you stay there. The difference may mean life or death.

Judging the contest was slow, because there were so many fine entries to be studied carefully. The winners — W1KIB, W1LEA, W1MKK, W2BKX, W2KWB, W2MGE, W4PL — have probably received their checks by now. To them we offer our congratulations. To the many others who submitted fine entries — better luck next time.

W. A. READY



Avoid a run-down battery with a **MALLORY** BATTERY CHARGER

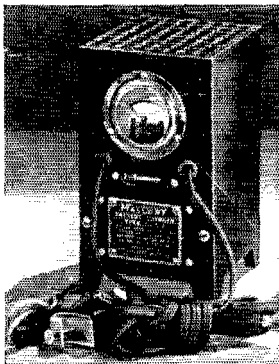

TYPE 5535B

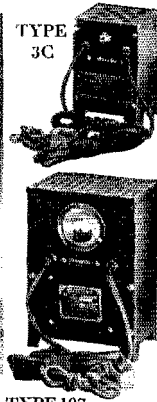

TYPE 107

In your rig, automobile, plane, boat or laboratory apparatus, a fully charged storage battery is your best insurance against shutdowns, delays and loss of service. Battery charging is easy and inexpensive with a Mallory Battery Charger. There is no need to disconnect or remove the battery—just plug the Mallory Battery Charger into the easily installed special receptacle.

Mallory Battery Chargers are available in three standard types:

Type	Maximum Charging Rate	Tapered Charging Rate
3C	4 amperes	2 amperes
5535B	6 amperes	4 amperes
107	10 amperes	7 amperes

Mallory Battery Chargers are protected by built-in thermal circuit breakers—there are no fuses to blow. The Chargers are designed for use with a 3-cell lead-acid battery, but can be used with lower voltage batteries by simply inserting resistance in the DC circuit. Airplane and similar 12-volt storage batteries can be serviced by using two chargers with DC outputs connected in series.

The heart of a Mallory Battery Charger is the rugged Mallory Magnesium Copper Sulphide Dry Disc Rectifier, operated with a transformer having a separate, insulated secondary. There is no danger of shock, as might occur if an auto transformer were used. Trouble-free service is yours by using a Mallory Battery Charger. See these units at your dealer or write for a descriptive folder.

P. R. MALLORY & CO., Inc.
INDIANAPOLIS INDIANA
Cable Address — Pelmallo

Use
P.R.MALLORY & CO. Inc.
MALLORY
APPROVED
PRECISION PRODUCTS

VU2LJ that the VU2LK who was listed as the VU QSL Bureau has not been doing such a hot job and cards have been going astray. Which might be the reason you never received a reply to cards sent via 2LK. VU2LJ says he is willing to take over again The KC4 gang has been hitting 10 meters lately; W6PMB raised **KC4USB** (28,540), and W9QVY and W9JVR worked **KC4USA** (28,680) W7GPY on 20 'phone snagged **KC4USA** and **W7DBR/KF6** (14,200) The KA's are coming through well at W9DIB, who also grabbed **KF6SJJ** (14,300) W4LZR bats around on 40 and mentions **K6RQO** (7070) and **K7ANK** (7080), while W7HIF's activity on the same band yielded **KAIHQ** (7060), **KB6OCL** (7040), **K7FOS** (7050), **K7EHMY** (7025), **KA7TT** (7105), and **K6SAJ** (7060) W6PMA says he had HR1JR call him on a CQ on 40—apparently the HR hadn't heard of the ban. But PMA did work **K6SOT** (7030), **K6QNX** (7050), **K7GCE** (7010), **K7BAQ** (7015), **KC4USB** (7020) and **K6SQE** (7010).

WHO:

We had a visitor last week from Panama, none other than ex-HP1X. He had been up to Rochester helping W8DOD get married Speaking of getting married, W2GVZ is engaged, according to the local papers. Which makes it ducky— we lose our pet competition in the DXCC after there isn't anything to work W9TJ passes along the dope that a letter from VP8AD informs him that Reuben is now at South Georgia Island. A juicy one when we get a chance to work him again Nice letter from PK1TM, who wonders if his 2000 W QSO's in 8 months is some kind of a record. It probably is for PK, but we venture to say that CX2AJ has him licked among all the DX countries. Anyhow, 1TM sends his 73 to the gang and is looking forward to another crack at them. He had worked 91 countries before the closedown Somebody sneaked a microphone into K4KD's coffee, and now the hard-boiled old brass pounder can be found on 14,170 and 28,760, elbowing his way through the splatter. But not until after he had his 35 w.p.m. certificate W3IGK got it from KB6GJX that KB6ILT is now in Chicago and wonders if anyone knows ILT's address There's a full-length sermon in VK2PV's story of how he worked KB6PMP for his only Guam contact, only to have the card come to "VK2PST"! Which is reminiscent of all that mix-up over VP3BEST/VP3NV W9EXW says to QSL to KF6SJJ to his old call W1KFV, where he will be returning soon KA1DM needs Miss., Ala. and S. C. for WAS, and W6SUD needs Vt. and Del. Incidentally, W6SUD used to be second operator at J2MI ZL1TF says some of the lads are still listening down there and haven't lost the old itch, although sealed transmitters don't give them much of a chance to scratch ZL2CW is in the same boat, but a card and photo from LZ1ID for the first LZ-ZL helped to ease the pain VK2ACX had the pain eased in the same way when he got a card from HB1CE for the first HB1-VK W8OSL writes to say that the weather job required some math that wasn't in his book, so weather or not he could do it he QSY's to radio. (Don't you think you've worked that pun to death?—Ed.) (Yes, I dew. —W1JPE.) W6IOA still knocks off the QRP DX—this time his 8 watts accounted for KAIHQ W6QAP is back at the Univ. of Arizona, after a stay in L.A. with the Bendix outfit W2GT writes to say that he's moving to a new QTH which he "hopes" will be good for wireless. Unless we're badly mistaken, Ed will know before he moves. He also mentions that Tommy Wimbush, ex-G2TW, ex-SU2TW, ex-ZC6XX, is up in Canada these days, and that a letter from AC4YN explains that, although a lot of W's were heard over there, he had to restrict much of his operating time to working W9HLF and KB6RWZ because they were helping to arrange for some things for him. So, if you called AC4YN but didn't raise him, you can console yourself with the thought that he heard you—maybe!

—W1JPE

BRIEFS

W6QXV, Santa Barbara Amateur Radio Club "memorial" station in the Santa Barbara Armory, has the telephone number 73-88!

On August 14th W1FH made his 71st successful 14-Mc. 'phone contact with KC4USA. W1FH schedules KC4USA on 14 Mc. and also has made several c.w. contacts with the expedition.

AXIAL LEAD

RESISTORS

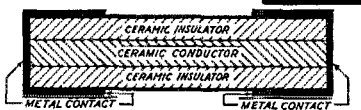

Magnified cross section showing the important and exclusive Centralab features:

Note center core of resistance material surrounded by a dense shock-proof ceramic providing strength and protection against humidity.

Both core and jacket are fired together at 2500 degrees F. into a solid unit hard and durable as stone.

Pure copper covers the resistor ends for contact.



AXIAL LEAD RESISTORS

Completely insulated

Designed to fit into limited space without danger of shorting to the chassis or other parts. Same resistor bodies are used as in Radial Lead units, millions of which are now in use . . . only difference is in method of making end contact. End leads brought through bakelite insulation. Will withstand five times rated load without permanent change.

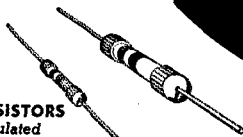

Old Man Centralab continues to score a bulls eye with the millions of Fixed Resistors that are doing duty in new and replacement jobs the country over. Manufacturers, experimenters, hams and service men continue to believe (and justly so) that Centralab's unique method of uniting the resistance material with the ceramic body makes for a resistor of unusual strength and efficiency under any and all conditions. Available in either Radial or Axial Lead . . . color coded (R.M.A.) in convenient sizes and ratings.

Always insist on CENTRALAB.

CENTRALAB: Division of Globe Union Inc., Milwaukee, Wis.

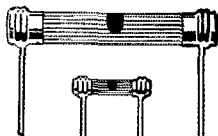

RADIAL LEAD RESISTORS
90% Insulated

The ceramic body of all Centralab resistors is in itself an insulator of the highest quality. Only the radial leads where attached to the body are un-insulated. Electrical characteristics of the Axial and Radial lead types are identical.

By

Centralab

TEN CALIBRATED COIL RANGES

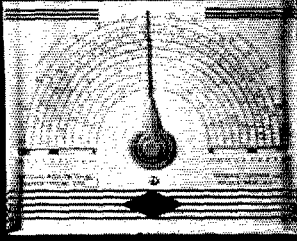

The NC-200 has ten calibrated coil ranges. Six of these ranges provide continuous coverage from 490 KC to 30 MC. The remaining four ranges cover the 10, 20, 40 and 80 meter bands, each band being spread out over the major portion of the dial scale. Each bandspread range is independent of the other ranges. Its calibration is fixed, it is tuned by the main tuning control and its frequency is read from the big sweep pointer on the dial.

WIDE RANGE CRYSTAL FILTER

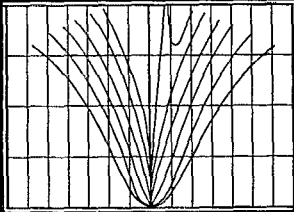

An improved wide range crystal filter is used in the NC-200. Selectivity is adjustable in six steps, corresponding to total band widths of approximately 200, 1000, 2200, 4000, 5800, and 7600 cycles respectively for 10 to 1 attenuation. The phasing circuit has been given particular attention with the result that rejection ratios as high as 10,000 to 1 are available when the interfering signal is only a few hundred cycles from the desired signal.

MOVABLE COIL TUNING SYSTEM

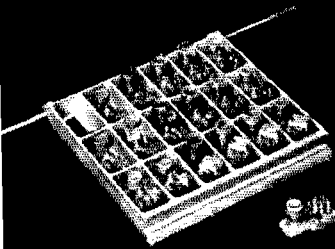

The NC-200 employs the movable coil tuning system which has thoroughly proved its soundness on the NC-100. RF and Oscillator coils, together with their associated padding condensers, are mounted in separate pockets in a heavy cast aluminum shield. This shield moves bodily on a track, bringing the desired coils into operating position directly below the tubes and condenser, and taking unused coils out of the way. The shield is shown at the left without its heavy cast cover. Ranges are selected by the same knob on the front of the receiver that is used for tuning.

PORTABLE OR AC OPERATION

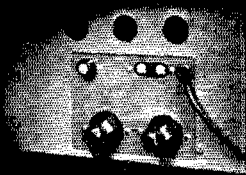

Typical of the refinement of detail in the NC-200 is the provision for operating standard AC models on batteries for emergency or portable use. All that is necessary is to plug in a battery cable in place of the dummy plug supplied with the receiver. This makes all necessary connections, and leaves the speaker and standby switch in operation. The B-supply filter is left in circuit to assist in filtering vibrator and dynamotor B-power units.



THE NEW NC-200

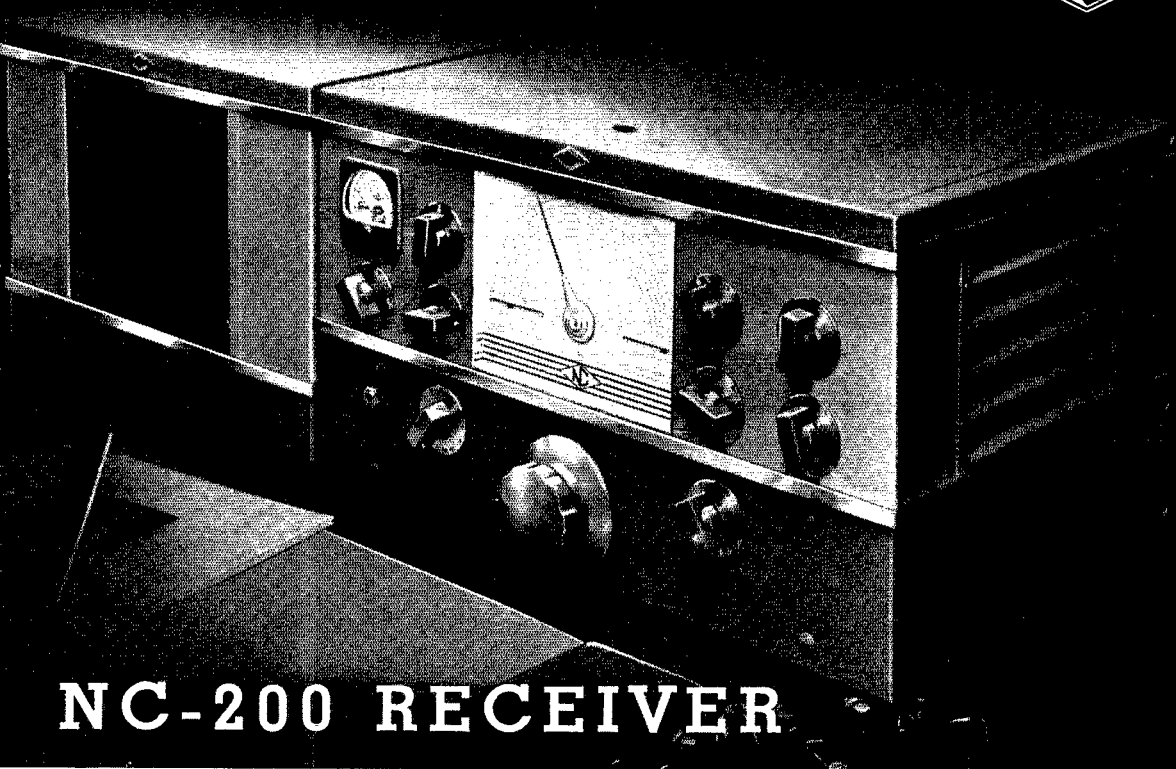

NC-200 RECEIVER

**A RECEIVER DEDICATED TO THE AMATEUR
ON OUR TWENTY-FIFTH ANNIVERSARY**

HOW IT LOOKS

The NC-200 is an outstandingly handsome receiver, finished in two-tone grey with chrome trim. The speaker cabinet is finished to match. Look it over at your dealer's; its appearance is as outstanding as its performance.

HOW IT OPERATES

In every respect, the NC-200 is a remarkable performer. For instance — at the most unfavorable frequency — at ten meters, the signal-to-noise ratio is better than 30 db, the sensitivity is better than 1 microvolt, the frequency stability better than .003% for line voltage variations from 100 to 120 volts! *How good is your present receiver at ten meters?* The NC-200's performance is just as spectacular on the lower frequencies, which is more to the point.

WHAT IT COSTS

The NC-200 is priced amazingly low. Complete with speaker to match, ready to run, it sells for only \$147.50, net to amateurs.

NATIONAL COMPANY INC.

HIDDEN EXTRAS!

That's the difference

That's the reason for the extra performance in C-D Capacitors

Most capacitors look alike. But amateurs and engineers know there's a big difference in C-D's. Built into these capacitors are extra quality... long-life... economy and extra VALUE.

GET THE EXTRAS WITH CORNELL-DUBILIER CAPACITORS

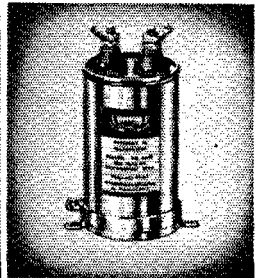
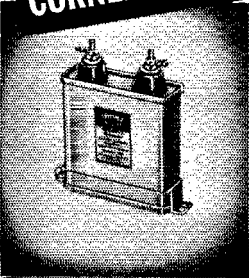

TYPE **TJU** DYKANOL TRANSMITTING CAPACITORS

TYPE **TQ** DYKANOL TRANSMITTING CAPACITORS

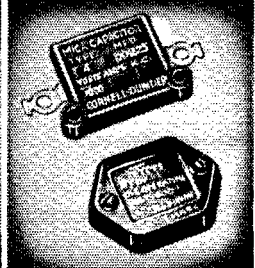
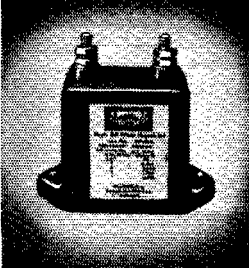

TYPE **86** MICA TRANSMITTING CAPACITORS

TYPE **4&9** MICA TRANSMITTING CAPACITORS

For complete listing of the C-D line of Mica, Dykanol, Paper, Wet and Dry Electrolytics send for Catalog. No. 185A

CORNELL-DUBILIER ELECTRIC CORPORATION
1013 HAMILTON BLVD. • SO. PLAINFIELD, N. J.

(Continued from page 55)
G. Frank Shuck, Glenn Jean, Jr., William E. Myers, F. T. Alderson, Don Leahy, John B. Lomas.

20 w.p.m.

- W1ADB, W1IHH, W1LMQ, W1LIR, W1GUP, W1IIS, W1MFB, W1MTC, W1MOR, W1KZQ, W1MIV, W1BEH, W2GMM, W2NDN, W2LZW, W2BGV, W2LNL, W2APM, W2JZK, W2JSE, W2ALF, W2BBU, W2MBY, W2MUH, W2KSO, W2LTY, W2GDK, W2HOL, W2JK, W2VK, W2MUQ, W2KTG, W2AAZ, W2MMT, W2MTG, W2MJC, W3BHE, W3ELE, W3DL, W3INU, W3ETC, W3GCU, W3GMC, W3ABL, W3HHC, W3FVS, W3ADM*, W3OP, W3IKG, W3FYP, W3BGL, W3ELC, W4FKV, W4FRE, W4FLN, W4EGT, W4AXP, W4FLI, W4CYC*, W4ELA, W4EPA, W4GKK, W4FZG, W4FLF, W5IBN, W5CXD, W5AVE, W5HKE, W5GOC, W5HEH, W5CVO*, W5IGD, W5HXP, W5IYU, W5ITU, W5GFY, W5ISM, W5DY, W5CIQ, W5HWE, W5IJH, W5FRB, W5SID, W6NMA, W6DZK, W6CHV, W6SKW, W6QDV, W6LVQ, W6KTQ*, W6LYF*, W6RKA, W6CDO, W6SSF*, W6RPI, W7FIS, W7ETH, W7GVH, W7HWL, W7GUU, W7HVS, W8TXL, W8SIQ, W8SOW, W8V8Q, W8LPL, W8THK, W8RTK, W8JFC, W8OKP, W8OD, W8NPI, W8RIH, W8NSS, W8UWJ, W8AHV, W8DEI, W8OKC, W8UGC, W8BFB, W8DHU, W8RFP, W9THB, W9GHV, W9XNH, W9ZWW, W9ULL, W9CMA, W9JNC, W9ZNO, W9HLS, W9ZWL, W9IIV, W9N9V, W9PCN, W9LEF, W9UAZ, W9SAI*, W9DXX*, W9GFP, W9QIQ, W9IPD, W9JWJ, W9CGZ, W9KRW, W9KJ, W9WKP, W9NLA, W9YNQ, W9SGL, W9GQJ, W9UTO, W9JUQ, W9EZZ, W9EZF, W9GSW, W9DYY, W9QI, W9IWT, W9RFQ, W9EPV, W9EHC, W9UIA, W9JBF, W9UTL, W9EFA, W9ASF, W9KJP, W9CGK, W9GOM, W9EWO, W9BCB, W9ZJJ, A. W. Miles, Charles L. Corderman, M. B. Millett, Paul Crowell, Kenneth W. Young, Cornelius Van Zoest, Donald B. Rolph, Alfred Baechlin, Jr., Leora E. Howe, Clarence J. Hartneck, K4DSE, W2IFM, W5FEX, W5HOY, W8HMJ.

25 w.p.m.

- W1EWD, W1KUY, W1MFT, W1MDC, W1PG*, W1EHJ*, W1LWC, W1MQR*, W1KCF, W1EGL, W1MGZ*, W1MKC, W1ATP, W1LRO, W1KH, W1GZ, W1ILO, W1LEA, W1MDV, W1LVG, W1KMY, W1LIN, W1HYH, W1KRQ, W1FXO, W1HWY, W1IVU, W1BPN, W1ZV, W1MFH, W1MWU, W1EZZ, W1BIV, W1MLT, W1DIC, W1HQ, W1KIO, W1BYW*, W1MBG, W1BMG*, W1ESG*, W1BOY, W1LDV, W1ASG*, W1JFX*, W1MY, W1GC, W1KXA, W1AVB, W1MVE, W1KNV, W1LIV, W1LVZ, W1BHW, W1BPN*, W2JRH*, W2JQE, W2JRU, W2ANX, W2LUT, W2KZJ, W2KWK, W2AXP, W2MDV, W2MOC, W2MWY, W2LRI, W2LPR, W2CFD, W2MIY*, W2FYL, W2ITA, W2MNO, W2MSL, W2BEW, W2LHD, W2IAS, W2MYT, W2MKW, W2EW, W2KVS, W2TP, W2JIN, W2LVH, W2HPB, W2MPI, W2IRP*, W2AAV, W2JGP, W2AMB*, W2KVV, W2MEC, W2NCY, W2GNQ, W2KME, W2NEC, W2KVH, W2LVF, W2HNQ, W3IMI, W3IKU, W3FDF, W3HRG, W3AKN, W3BAQ, W3ITD, W3IOR, W3IQN, W3BSB, W3IKP, W3GXU, W3IJI, W3FTQ, W3AKR, W3GLQ, W3HYT, W3LN, W3FNR, W3IJL, W3FPP, W3ISF, W3ANZ, W3IIP, W3HKK, W3FQZ, W3HYU, W3EJM, W3HHS, W3AG, W3GZX, W3HFK, W3HFC, W4FOM*, W4GJW, W4EPA, W4MR, W4ECF, W4EYK*, W4EHH, W4GAG, W4UP, W4GXL, W4CNV, W4OS, W4CVX, W4BGO*, W4FWJ, W4FKV, W4DLX*, W4GHL, W4FTK*, W4GQD, W4DGF*, W4FIJ, W4CJH, W4EVZ, W4BCL, W4FNR, W5GKB, W5HEJ, W5IDJ*, W5HGO, W5IUS, W5FZG, W5FZU, W5LJK, W5EGE, W5YIC, W5BGZ, W5FSK, W5ASA, W5HZA, W5BMU*, W5AWT*, W5FMZ, W5AUL*, W5IYW, W5FNA, W5HLK, W5CY, W5DPI, W5BDX, W5CFQ, W5FTM, W6EZJ*, W6QOZ, W6EQW, W6QHF, W6LJG, W6NGK, W6SRK, W6NVC, W6RZO, W6SJ, W6NKR*, W6NQV, W6LLH, W6RMM, W7FUQ, W7ANB, W7DLN, W7HCV, W7GTD, W7HZG*, W7HUK, W7GDB, W7BCT, W7CQE, W8EDD, W8UXS, W8TTD, W8POX, W8TGH, W8SFV, W8UES, W8MUR, W8CUY, W8OVB, W8LCN, W8MRS, W8OKK, W8RIT, W8TRN, W8UWZ, W8TIF, W8AYK, W8TJW, W8CBT*, W8UGR, W8OIP, W8MCF, W8RMC, W8HZR, W8TYE, W8SMI, W8UCV, W8TJU, W8QHA*, W8IHR*, W8STE, W8QYR*, W8FAK, W8ABZ, W8RYO, W9FCV, W9HA, W9KSV, W9HHQ, W9LJ, W9KLY, W9KLE, W9TBB, W9VIN, W9DUC, W9DNY, W9GCW, W9CDS, W9GSO,

(Continued on next left-hand page)



**NEW HIGH FIDELITY
EXTENDED RANGE
REPRODUCERS
WITH**

Bass Reflex

2 Models are with New Type J Dual Loud Speaker and Frequency Dividing Network. 2 Models with PM12-CT, 12" Loud Speaker. 1 Model with PM8-CT, 8" Loud Speaker.

All with **BASS REFLEX**. Dealer price range, complete Reproducers, \$17.70 to \$56.55*... All Loud Speakers are Permanent Magnet... All Loud Speakers are available separately... All Cabinets are available separately.

With the advent of Frequency Modulation in addition to the amazing interest everywhere in the reproduction of sound at High Fidelity there is a demand for these new products. Foresight together with Jensen engineering skill and facilities made these products possible. Write at once for Catalog No. 119; note the scope and wide price range of this new line and observe that each product is characteristically Jensen in every detail of performance ability, appearance and value. Jensen Radio Mfg. Co., 6601 South Laramie Ave., Chicago. (cable address JERAD, Chicago)

*Dealer price, Loud Speakers only, from \$5.40 to \$27.90.

Jensen
High Fidelity
REPRODUCERS



Kilovolt Tester

FOR
TELEVISION AND HIGH VOLTAGE

Here is just the unit every Amateur Television Experimenter will want. Model 1280 is truly the tester for use in your experimental work, and also is invaluable for regular testing requirements. Ranges begin at 2500 and go to 10,000 volts. Also measures Direct Current. This High Voltage Tester gives you a new testing procedure. Metal contacts and instrument parts are removed a minimum of one inch from sides of the case. The prods attached to the test leads are inserted through holes in the top panel to the contacts in the sub-panel beneath. Tests AC-DC Volts in steps of 2500 and 10,000 (25,000 ohms per volt DC). DC Microamperes 0-50-500-5000. RED • DOT Lifetime Guaranteed 4-inch Measuring Instrument. Dealer Net Price: **\$31.50**. Sturdy metal case with red sanded enamel finish.

TRIPLET
MODEL
1 2 8 0
\$31.50

DEALER NET PRICE
RED • DOT LIFETIME
GUARANTEED
INSTRUMENT

MODEL 666-H

This Volt-Ohm-Milliammeter is a complete pocket-size tester for amateurs, engineers, experimenters and radio service engineers. Has AC-DC voltage ranges: 0-10-50-250-1000-5000 at 1000 ohms per volt; DC Milliamperes 0-10-100-500; High and Low Ohms Scales. With RED • DOT Lifetime Guaranteed Measuring Instrument. Dealer Net Price **\$14.50**.



Write for Catalog on complete line of test equipment. Triplet also manufactures electrical measuring instruments in more than 25 case styles. Section 2611, Harmon Drive, Bluffton, Ohio.

THE TRIPLET ELECTRICAL INSTRUMENT CO.
Bluffton, Ohio

W9KFB, W9WPA*, W9FEM*, W9ZOI, W9DBV, W9BCV, W9JUJ, W9KYV, W9MZN, W9ANM, W9QAK, W9IDU, W9OHH, W9SW*, W9DHO, W9KJI, W9OBP*, W9DBS, W9HFV, W9QDC, W9SGB, W9RPW, W9EKH, W9IVD, W9ONW, W9MJN, W9WFS, W9VBQ, W9QEC, W9ZWR, W9UQT, W9YPT*, W9DTX, W9EUO, W9ZAD, W9YOX, W9QWE, W9OCO, W9ILU, W9BVJ, W9ZGB, W9QCA, W9RLU, W9MIN, W9PK, W9VIP, W9ORU, W9YPM*, W9KWU, W9FEO, W9FCL*, W9SCW, W9QDG, W9JO*, W9DOB, W9BRB, W9LZB, W9ZWG, W9FDL, W9UXI, W9ZRP, W9CHY*, W9MZJ, W9LYX, W9DOY, W9WOD, W9DDH, W9FBU, W9MYN, David S. Kaufmann, W. Maurer, Edward Rosenberger, Charles W. Duree, Joe C. Garner, Charles D. Harris, Carl F. Hamilton, Robert E. Olson, Stanton E. Martin, Carlton R. Smith, Edward W. Taylor, Arthur Chan, A. C. Bellavit, Warren Entwistle, Stewart W. Hopkins, Gordon Bachand, W1MDF, W5HZN, W9ONH*.

80 w. p. m.

W1DIZ, W1LBY*, W1KYK, W1LWK, W1JOW*, W1QF, W1AFF, W1JZZ, W1LAB, W1KYQ, W1JNV, W1TO, W1RR*, W1FNY, W1BZZ, W1QQ*, W1AXW, W1GEJ, W2JAI*, W2LU, W2BNJ*, W2KYH*, W2LVN, W2EJK, W2MRL, W2HNJ, W2FDA, W2JAU, W2MPM, W2KSC*, W2KTF, W2KJZ, W2LID, W2LWX, W2FAB*, W2EC*, W2DCM, W2BMG, W2BWE, W2GTZ*, W2MBS, W2NAZ, W2HVD, W3HGY*, W3DUR, W3DGC, W3KT, W3ON, W3FJU, W3AKT, W3EPJ, W3IEZ*, W3AVJ*, W3FGS, W3AGH*, W3IHZ, W3FPG*, W3ASW*, W3HAT*, W4CXY*, W4AHK, W4DIN, W4AEG*, W4KK, W4BAF*, W4AEL*, W5ALE*, W5HAY*, W5BNO*, W5GQW, W5ASQ*, W6EUH, W6SMQ, W6LAI, W6AFH*, W6EPM, W6CGJ, W6SDT*, W6LNN, W6OBK*, W7LD*, W7HLY, W7ANV, W7GNJ, W7HAT*, W7GRE, W8TKW*, W8ONK, W8TYW, W8SJP, W8MME, W8ATF, W8MUQ, W8UPJ, W8KXP, W8CUG, W8UQL, W8TDW*, W8MTZ, W8VD*, W8DDC*, W8IZW, W8JGX*, W8JKK, W9ZTU, W9WHF, W9ZJC, W9MPH, W9MDJ*, W9ZFC, W9BXM, W9MYA, W9BBI, W9AMM, W9VNN, W9END*, W9ENH*, W9TDH, W9YMN*, W9BMJ*, W9DWC, W9OKB, W9JIT, W9VGT*, W9HGA*, W9ZMP*, W9TKN, W9BKI, W9IRN, W9MLG*, Robert S. Palmer, Frank Mosher.

85 w. p. m.

W1CRU, W1KHA*, W1TD, W1LZ, W1CME*, W1FDS, W1MBP, W1ABG*, W1JSM, W1KKS, W1LUA, W1FMV*, W1MCG, W1JRP*, W1KHE, W1BDV, W1HQV*, W1BXC, W1IOE, W1HFO, W1AYG, W1BVR, W1WG*, W1LDL*, W1ZL, W1ZP, W2LPA, W2HOA, W2BUP, W2JN*, W2AYJ, W2AJ*, W2LBI, W2ICX*, W2LG, W2FL, W2MIQ, W2IOP, W2MTC*, W2ISJ*, W2JGC, W2KAP*, W2PIH, W2MWQ*, W2BRE*, W2OA*, W2KTR, W2GZA*, W2DYO*, W2LR*, W2LZR*, W2GTP, W2LME, W3ZF, W3EON*, W3ZH, W3HXP, W3CQQ, W3HTX*, W3BNM*, W3EFH*, W3HJH*, W3EEX, W3GLN*, W3EFM, W4AAO*, W4FX*, W4FCU*, W4EFM*, W4GNQ, W4GBW, W4FHR*, W4AKH, W4GLL*, W4AAQ, W4GWZ*, W4TI*, W4DMQ, W4GYL*, W4GPG*, W4EKF*, W4DQA*, W4GOC, W4ZL, W5BKC*, W5BJT*, W5FDR*, W5GJU*, W5ABE*, W5DEL, W5HT*, W5HBD*, W5FVD*, W5BMP*, W5FFX*, W6QAC, W6CJ*, W6JJI*, W6SAQ*, W6CUY*, W6LKL*, W6AXN*, W6MUM*, W6ETJ*, W6BOY*, W6MXC*, W6PXX*, W6AGF*, W6RUI*, W6SLU*, W6PBV*, W6OVG*, W6HJT, W6AOA, W6DTY, W6PZC*, W7LM*, W7KL*, W7GMC, W7PQC, W7GXD, W7BUB, W7ECL, W8FFL*, W8RMH*, W8DFN, W8CJJ, W8KEV, W8KKW*, W8SEI*, W8BMA, W8BBH*, W8SZK, W8SQE, W8HUX*, W8OWC, W8YI*, W8FLA*, W8PP, W8UGO*, W8KVI*, W8AHC*, W8NOE*, W8SCW, W8PTE*, W8JZ, W8JO, W8ATN*, W8OKS*, W8JTT, W8RWF*, W8PCL, W8PCN, W8IQS, W8OG*, W8JLF*, W8TOG*, W8RIM, W8DUA, W8BKE*, W8NCJ, W8OUD*, W9CYU*, W9MIO, W9DIR*, W9HPJ*, W9QRV*, W9DNC*, W9YYA*, W9IPJ*, W9NAT*, W9VEF*, W9VDY, W9TKX*, W9QXG, W9CWR*, W9FS, W9KZV, W9EYI*, W9BRD*, W9UI, W9SDK, W9RVW*, W9BKK, W9TGN*, W9POB*, W9GFS*, W9JDP*, W9BWN, W9CWW*, W9LJX, W9EW*, W9EKQ*, W9IIL, W9HSM, W9GNS*, W9LVD*, W9NNZ*, W9AHJ, W9ZUD*, W9IYT*, W9DGS*, W9QUA*, W9LOH*, W9GFU*, W9YJS*, W9QKJ*, W9UKV, W9HLX*, W9QLH*, W9QCP*, W9CQ*

(Continued on next left-hand page)

HQ-120-X

From the "ARCTIC" to "LITTLE AMERICA"

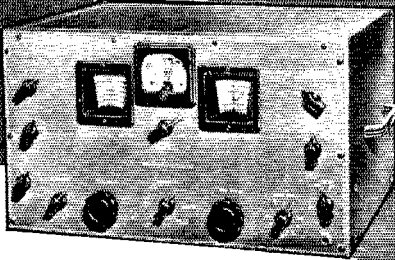

THE AMERICAN RADIO RELAY LEAGUE
RADIOGRAM
A SERVICE TO AMATEURS

159 WIOXDA NONE SCHOONER MORRISSEY 8:30 P AUG. 11, 1940

To: MR. GEORGE SHUART
HAMMARLUND MFG. CO.
NEW YORK CITY, N.Y.

THIS MESSAGE WAS RECEIVED AT
VELOCITY RADIO STATION: W2APT RAR-
ADDRESS: GERS TURNEY PHONE: 6125
CITY AND STATE: 2815 - 34TH STREET
ASTORIA 1, N.Y.

YOUR HAMMARLUND HQ-120-X IS MAKING POSSIBLE CONSTANT COMMUNICATION ON THIS RECORD TRIP OF THE MORRISSEY ALSO MADE A HAMMARLUND TO HAMMARLUND CONTACT BETWEEN WIOXDA NORTHERNMOST STATION IN THE WORLD AND KXIK AT LITTLE AMERICA PHONE BOTH ENDS. 75

ALAN BURICH

RECD WIOXDA SCHOONER MORRISSEY AUG. 11 8:40 PM GT
SENT

THE great popularity of the "HQ-120-X" among leading amateurs and engineers is the direct result of its superb performance. When Alan Eurich selected the "HQ" for the Morrissey's main receiver, he was playing safe. The enviable reputation of Hammarlund receivers accounts for their use by many expeditions and in many important government services. The Byrd Expedition, for example, with which the Morrissey communicated on a more or less schedule basis, uses Hammarlund receivers entirely. There is little we can say about the "HQ" that would be as convincing

as an actual demonstration. Visit your local jobber — there you can see and operate the "HQ-120-X." Take particular notice how effectively each control functions. Its accurately calibrated band spread dial, antenna compensator, and variable crystal filter are just a few of the features which make the "HQ" an outstanding amateur receiver.

MAIL COUPON TODAY!

HAMMARLUND MFG. CO., INC. Q-11
424 W. 33 Street, New York City
Please send "HQ-120-X" booklet
Name.....
Address.....
City.....State.....



Canadian Office:
41 West Ave. No., Hamilton

HAMMARLUND

EXPORT DEPARTMENT, 100 VARICK ST., NEW YORK CITY

OHMITE

Ohm's Law Calculator

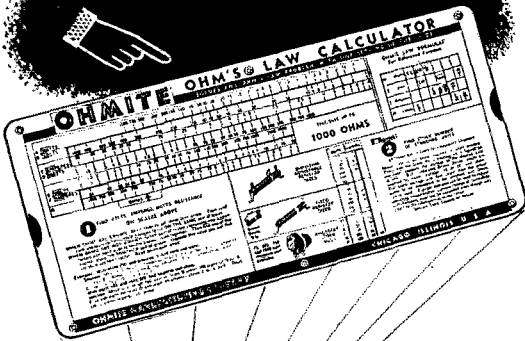

solves any Ohm's law problem
with one setting of the slide

IT'S
NEW

Here's the handiest Ohm's Law calculator you've ever seen! Specially designed for you by Ohmite Engineers. Gives the answer to any Ohm's Law problem in a jiffy, with one setting of the slide. No decimal points to worry about because all values are direct reading. Simple as can be. Does not require any knowledge of a slide rule to operate. Nothing else like it. Smaller than any such calculator ever available. Size $4\frac{1}{8}'' \times 9''$. Covers the range from .1 ohm to 10 megohms, also the range of currents, wattages and voltages commonly used in radio and commercial work. A setting of the slide also tells the stock number of resistor or rheostat you may need. Available to you for only 10¢ to cover handling cost. At your Jobber, or send 10¢ in coin now.

SIMPLE
EASY

and
Complete

OHMITE MANUFACTURING CO.
4864 Flournoy Street, Chicago, Illinois

10¢ in coin enclosed. Send
Ohm's Law Calculator.

Name.....
Address.....
City..... State.....
OST-Nov.

OHMITE

RHEOSTATS RESISTORS TAP SWITCHES

W9GAD*, W9GMT*, W9EYW*, W9VVQ, W9VW*,
W9EJV*, Casey Lafrate*, Martin M. Hellman, Paul Mer-
rill, Elliott S. Buchanan*, Edmund L. Roberts*, W. Alonza
Ogletree*, Melvin S. Newell*, Fred L. Totten, Albert P.
Payne*, Sgt. T. A. Maret, L. J. Wolf*, S. P. Jones*, Jacob
P. Sinnes*, F. W. Baum*.

Brass Pounders' League

(August 16th-September 15th)

Call	Orig.	Del.	Rel.	Extra Del. Credit	Total
W4PL	8	51	1330	42	1431
W5FDR*	97	222	610	207	1136
W3GKO	16	58	884	55	1013
W9QIL	48	114	723	109	994
W7EBQ	0	0	899	0	899
W5OW	91	61	524	53	729
W6PGB	43	38	446	77	654
W3BWT	53	95	405	88	641
W6CFN	307	211	56	14	588
W4DWB	17	52	472	45	586
W4AOB	30	77	361	71	539
W6IOX	29	55	382	52	518
W9GFF	47	34	400	31	512
W8GZ	14	23	444	21	502

MORE-THAN-ONE-OPERATOR STATIONS

Call	Orig.	Del.	Rel.	Extra Del. Credit	Total
KAIHR	664	668	14	457	1803
KAIHQ	212	105	560	98	975
W2USA	697	52	40	68	857

These stations "make" the B.P.L. with total of 500 or over. One hundred deliveries + Ex. Del. Credits also rate B.P.L. standing. The following one-operator stations make the B.P.L. on deliveries. Deliveries count.

W6LUJ, 300	W2LZR, 163	W9BHY, 102
W9CR0, 287	W2AV, 138	More-than-one-opr.
W7GVH, 261	W2ISQ, 136	W2SC, 197
W9NCS, 192	W2MIY, 118	W1AW, 142
W7APS, 183		

A.A.R.S.

Call	Orig.	Del.	Rel.	Extra Del. Credit	Total
WLTW (W9QIL)	46	82	428	77	633

MORE-THAN-ONE-OPERATOR STATION

Call	Orig.	Del.	Rel.	Extra Del. Credit	Total
WLM (W3CXL)	162	92	1870	63	2187

A total of 500 or more or 100 deliveries + Ex. D. Cr. will put you in line for a place in the B.P.L.

* July-Sept.

BRIEFS

Attention, Seattle amateurs: The Eleventh Battalion, U. S. Marine Corps Reserve, is forming a Communication Platoon, to be a component part of the M.C. Reserve organization in Seattle, Wash. It is desired that personnel of the new platoon be composed of men having a basic knowledge of short wave radio work, and, if possible, licensed amateur operators. The Communication Platoon will need 25 men. Requirements: (1) Age: 17 to 35 years. (2) Pass physical exams. (3) Minimum height, 65½ inches. (4) Must attend weekly meetings and summer camp. Interested amateurs in the vicinity of Seattle are requested to get in touch with Captain Ewart S. Laue, Headquarters, Eleventh Battalion, U.S.M.C.R., 213 Canadian National Dock, Seattle, Wash.

W2IYH is interested in the organization of a State Guard Radio Net in New York State among the older hams who are not eligible for service or conscription. He would like to hear from other amateurs through N. Y. State who would be interested in such a net. Address Robert K. Wingood, W2IYH, 24 Prospect St., Poughkeepsie, N. Y.

Add to special W.A.S. endorsements: W5ASG, all states worked on 'phone.

80 HOURS ON THE AIR...323 DX CONTACTS



KALZ

**Second place in
world wide DX
phone contest
using Eimac tubes**

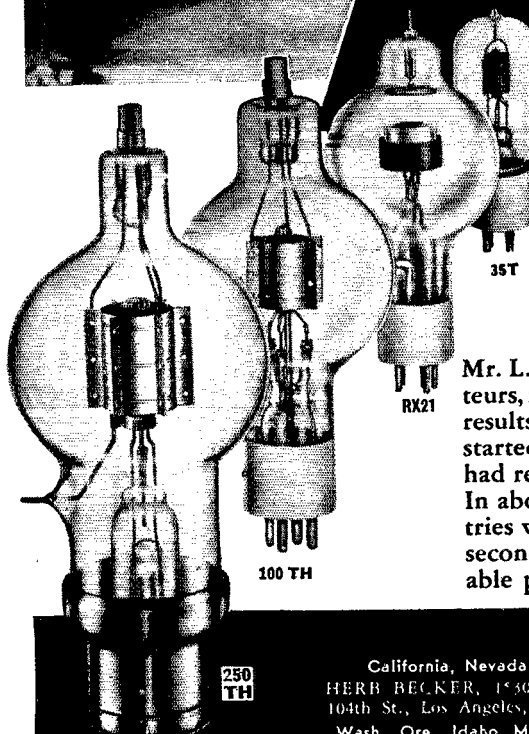

Mr. L. Zavattero, like most of the world's leading amateurs, finds that Eimac tubes reward him with outstanding results when it comes to gruelling DX work. KALZ started operation only 15 days before the war and has had remarkable results for so short an operating period. In about 80 hours operating time 19 zones and 28 countries were contacted... a total of 323 contacts to place second in the world wide competition. Certainly a creditable performance for both Zavattero and Eimac tubes.

EIMAC REPRESENTATIVES

California, Nevada
HERB BECKER, 1530 W.
104th St., Los Angeles, Cal.
Wash., Ore., Idaho, Mont.
GENERAL SALES CO.,
Verner O. Jensen, 2605-07
Second Ave., Seattle, Wash.
Colo., Wyo., New Mexico,
Arizona, Utah
RICHARD A. HYDE, 4253
Quitman St., Denver, Colo.

Ohio, Mich., Ky., Ind., Minn.,
Mo., Kan., Neb., Iowa
PEEL SALES ENGINEER-
ING CO., E. R. Peel, 154
E. Erie St., Chicago, Ill.
N. Y., N. J., Penn., Md., Del.,
Dist. of Col., Maine, N. H.
R. I., Conn., Mass.
ADOLPH SCHWARTZ,
14726 Elm Ave., Flushing,
New York.

N. Caro., S. Caro., Georgia,
Tenn., Flor., Ala., Miss.
JAMES MILLAR, 316 Ninth
St. N. E., Atlanta, Georgia.
Texas, La., Okla., Ark.
J. EARL SMITH, 2821 Live
Oak St., Dallas, Texas.
Chicago, Illinois, Wisconsin
G. G. RYAN, 549 W.
Washington Blvd., Chicago,
Ill.

**Eimac
TUBES**

EITEL-McCULLOUGH, INC. • SAN BRUNO, CALIFORNIA

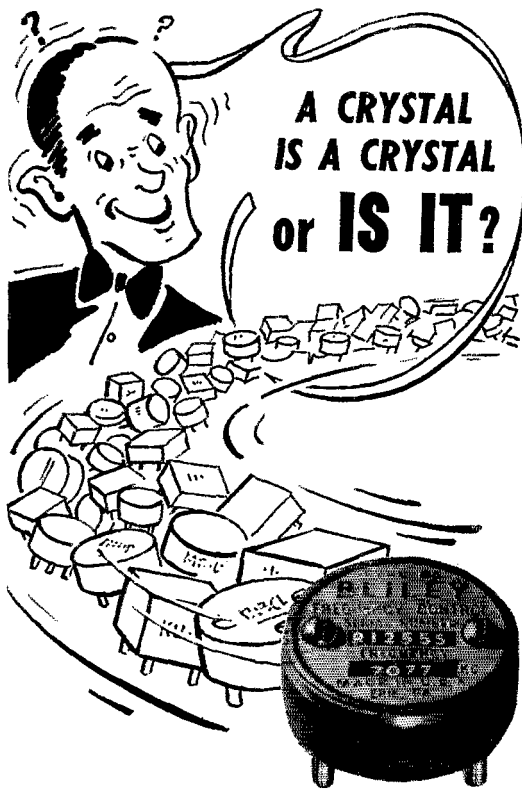

Quartz crystals are manufactured from quartz. Yes, and all finished quartz crystals look just about alike. Does that mean one crystal is necessarily as good as another? No Sir! It takes more than raw material or appearances to bring out true performance — and performance is what counts!

Under visual examination, it would be difficult, if not impossible, to detect the difference between a good and a questionable crystal. Yet, behind the properly made crystal lie many precision operations, thorough checking at every processing step, immediate rejection of questionable material, and the skill of trained craftsmen guided in their work by effective engineering. How else could any precision-made product be produced?

In the manufacture of each Bliley Crystal, nothing is taken for granted. Engineering, individual skill and the application of adequate equipment are all combined to produce not a better, but the best possible, final product. Sure, there is a difference in crystals — install a Bliley Crystal Unit in your transmitter and find out for yourself.

BLILEY ELECTRIC CO.
 UNION STATION BUILDING ERIE, PA.

MORE PRESS/WEATHER SCHEDULES

The following schedules, for use as good code practice material, should be added to the list on pages 84 and 86, October QST. Data specifically addressed *may not be divulged* except to the addressee. These transmissions should be used for practice only.

(All Times P.S.T.)

7:00 A.M. NPG	9090 kc.
8:30 A.M. JUP	13060 kc.
2:30 P.M. KTK	16740 and 12495 kcs.
4:00 P.M. NAA/NSS	9250 kc.
5:15 P.M. WPN	11295 kc.
7:00 P.M. NPG	9090 kc.
8:00 P.M. KJH	7815 kc.
8:20 P.M. WGG/WSC	6340 kc.
9:00 P.M. KTK	8680 and 12495 kcs.
10:00 P.M. KFS	8380, 12550 and 97.5 kcs.
10:00 P.M. KWJ	15000 kc.
12:10 A.M. KPH	8440 and 12380 kcs.

BEGINNERS' CODE PRACTICE

The following operators, working in the 1750-kc. band, have volunteered code practice schedules for the benefit of beginning amateurs. It is expected that more volunteers will send in their schedules soon and a complete mimeographed list of all code practice stations will be available about November 1st. Beginning amateurs should send a postal for a copy.

- K6PAH, Hawaii, 1976 kc., Mon. through Fri., 8:15-9:15 P.M. H.S.T.
- W8NQS, Michigan, 1984 kc., Mon. through Fri., 8:00-8:25 A.M. E.S.T.
- W8FFK, Ohio, 1805 kc., Tuesdays, 7:00 P.M. E.S.T.
- W8QBU, New York, 1878 kc., Wednesdays, 7:30-8:00 P.M. E.S.T.
- W8SES, West Virginia, 1878 kc., Wed., Thurs., Fri., Sun., 8-9 P.M. E.S.T.
- W9BQL, Illinois, 1920 kc., Mon. through Sat., 6:30-7:30 P.M. C.S.T.
- W9BB, Nebraska, 1960 kc., Tues., Thurs., Fri., Sat., 7:15-8:15 P.M. C.S.T.

BRIEFS

Employees of telephone companies who are also radio amateurs will be interested in the formation of the Telephone Employee Amateur Radio Association. Qualifications for membership are: (1) Employee of any telephone company, (2) Holder of amateur station and/or amateur operators license. Aims and objectives include (1) Promotion of fraternal contacts between members through the medium of amateur radio. (2) Development and coordination of such communications and individual amateur station operation to the end that the best use of the amateur service may be realized during communication emergencies. (3) Operation of our association and its member amateur radio stations shall be in full recognition of our individual status as amateurs.

The T.E.A.R.A. has been organized for about one year, and membership as of this writing includes the following: W8SED, RL, SMI, ISN, IGT, SEF, KXN, NY, DSU, CSE, IOT, MUQ, PSX, ALP, ARY, TOD, SUQ, MBH and W2HKZ. It is the ambition of the organizers that this association be operated for the most part by amateur radio contact. Meeting times have been designated as follows: 3850 kc., Tuesday and Friday nights, 7:00 to 10:00 E.S.T.; 3978 and 1925 kcs. (cross-band), Sunday mornings, 9:00 to 11:00 E.S.T. As organization progresses and more operators report in it is planned to run these schedules on an emergency drill basis. Interested operators, who are employed by telephone companies, are invited to call in during the designated periods, or write for more information to Fred J. Merry, W8DSU, 16 Perry Street, Auburn, N. Y.

W9GQR's first W7-QSO on 7 Mc. and his first Wyoming contact was W7GQR!

When the daughter of Mr. and Mrs. W6SGL (ex-9DEA) arrived in this world last April, her first "cries of greeting" were transmitted over daddy's 1.75-Mc. 'phone. A waiting network of stations, with W6BVA as m.c., gave the little gal a real welcome. Incidentally, she was named "Ariel"!!

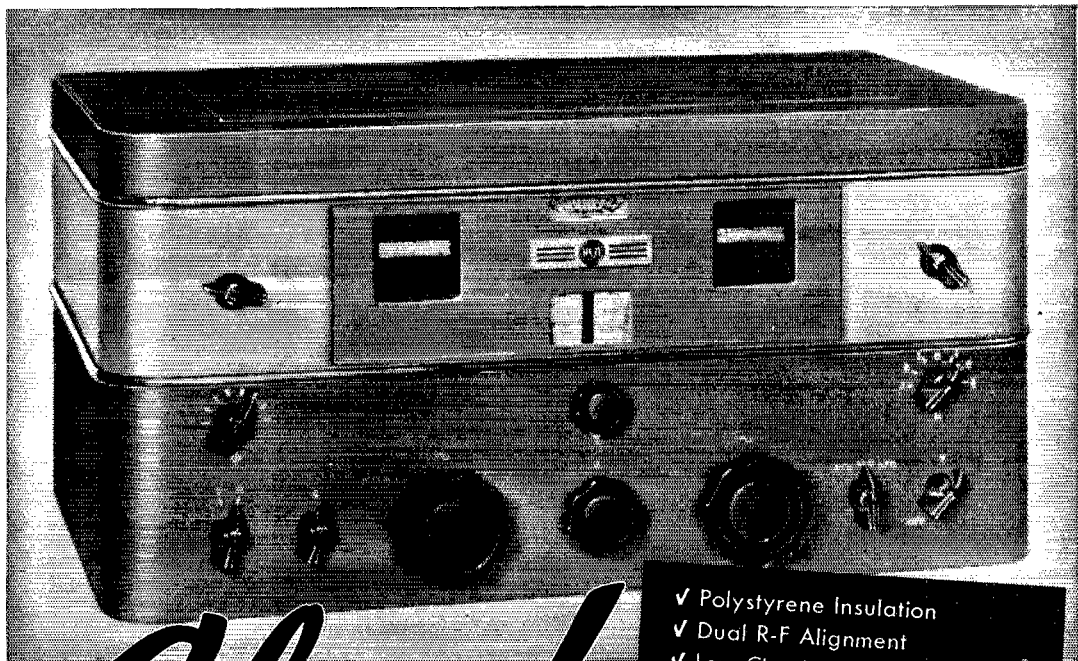

Check

The AR-77 is one of the most stable, most sensitive receivers of its type ever built. It has more features for the money. It has finer performance as gauged by any test you care to name. Before getting that new receiver for your shack, we suggest that you check the AR-77, feature for feature, point for point, against any other outfit on the market at anywhere near the price. You be the judge!

Amateur's Net Price **\$139.50** f.o.b. factory
 MI-8303 Table Speaker in matched cabinet, \$8.00 extra

**Circuit arranged so that two AR-77 receivers, operating on separate antennas, may be connected together to provide efficient diversity reception.*

- ✓ Polystyrene Insulation
- ✓ Dual R-F Alignment
- ✓ Low Circuit Noise
- ✓ Negative Feedback
- ✓ Stay-Put Tuning
- ✓ Uni-view Dials
- ✓ Accurate Signal Re-set
- ✓ Calibrated Bandspread
- ✓ Variable Selectivity
- ✓ Crystal Filter
- ✓ Diversity Reception *
- ✓ 60 to 5000 cycles \pm 4 d. b. A-F range
- ✓ Voltage Regulation
- ✓ Break-in Operation
- ✓ Exceptionally High Image Rejection
- ✓ Improved Noise Limiter
- ✓ 540 to 31,000 KC Range
- ✓ Magnetite Core I-F Transformer
- ✓ High-Gain Pre-Selector Stage
- ✓ Temperature Compensation for Frequency Drift
- ✓ Single-ended Tubes
- ✓ Carrier Level Meter
- ✓ Antenna Trimmer



AR-77 COMMUNICATION RECEIVER



RCA MANUFACTURING COMPANY, INC., Amateur Division, CAMDEN, N. J. • A Service of the Radio Corporation of America

"MARVELOUS, ME EYE!"

SAID PROFESSOR OSWALD SQUEEGEE



PROFESSOR OSWALD Z. SQUEEGEE, Ph.D., ABC, PDQ., etc., turned an austere eye on the eager, upturned faces of his class in industrial engineering. Then, in the simple dignity becoming to a great man (which everyone, including himself, admitted he was) the Professor spoke:

"Listen, you dimwits," he thundered. "If there's one thing I want to pound through your thick skulls, it's simply this: The easiest way of doing any job

is generally the complicated way. The hardest way is to keep plugging along until you've developed the simple way. That takes time. It takes patience and — ahem! — it takes brains."

Here the Professor paused, reached for the glass of water on his desk, got the ink by mistake, and sipped it calmly. Then he cleared his throat and continued:

"Some of the world's greatest inventions have been so simple that everyone wondered why Noah hadn't thought of them while he was sitting in the Ark."

"What, for instance, was more logical than putting an eraser on the end of a pencil? What was more logical than the safety razor? What was more logical than, instead of making nuts to fit the wrench, to make the monkey fit the nuts. I mean — ahem — the monkey wrench."

Fishing through the pile of notebooks, overshoes and chewing gum wrappers on his desk, Professor Squeegie found a Sprague Koolohm Resistor and held it up.

"Now here is a practical example of simplified improvement," he bellowed. "One of you clucks brought this resistor in and told me how marvelous it was."

"Marvelous, me eye! The only thing marvelous is that some resistor manufacturer didn't do it sooner — that it took a condenser manufacturer to figure out how much simpler it would be to insulate the wire itself, instead of trying to insulate the resistor after it is wound without shorting a lot of turns, or without having a coating that will crack, chip or maybe even peel like a banana. Now hand me that crowbar and cold chisel and I'll show you something real."

After 15 minutes' hard work and 3 skinned knuckles, the Professor pried the outer ceramic shell off the Koolohm.

"There it is," he beamed, "a practical example of a little simple simplification that meant a whale of a big improvement. Larger wire. No danger of shorted turns. More resistance in less space. So moisture-proof a duck's back would turn green with envy. So well designed it runs cooler than any other resistor of equal size and rating. The only resistor with an automatic overload indicator and the first . . ."

Just then the 'phone rang. It was the Professor's wife telling him he was already three hours late for lunch. Without even waiting to bid his class goodbye, he laid a handkerchief carefully on his head, crammed his hat into a pocket, shut the door and walked calmly out through the open window.

SPRAGUE PRODUCTS COMPANY
North Adams, Mass.

P.S.—See Koolohms at your Sprague jobbers. Free catalog on request.

70

Colorado Sleet Storm

ON THE morning of March 6th, Denver and most of Colorado awoke to find that during the night they had been visited by a heavy sleet storm, the second such storm in less than a week. Wires ordinarily about $\frac{1}{8}$ inch in diameter had been coated with ice until they were 2 and 3 inches in diameter, with disastrous effect on telephone lines. W9WYX and W9QXJ, realizing the severity of the storm, called me on the telephone to offer their services. Upon arrival at the office, I found the situation around Denver was serious, most circuits being down. Shortly after that, Mr. Paul H. Broman of the Colorado Traffic Department (Telephone Co.) called me to ask if I could get a message through to Boulder, Colorado, for him, the telephone lines to that point all having come down in the storm. While two operators had already volunteered their services, I knew both were at work, and as I had many others registered in the Emergency Corps, I preferred to call on someone who would not be called away from a job, if possible. Accordingly, I called W9BQO, who my records showed was working evenings. BQO turned his set on but discovered his antenna draped over the shrubbery in the back yard. However, a "counterpoise wire" was still intact. Hurriedly utilizing this wire as an antenna, he sent out a call for Boulder. He was agreeably surprised in a big way when a Boulder station answered his second call.

From this time until Boulder telephone circuits were recovered late in the day, numerous messages were handled for the Traffic Department by amateur radio. The Boulder Wire Chief utilized the amateur radio channel to order twisted pair wire and other material required for service restoration work, and other messages relating to the material supplies and condition of toll lines were also exchanged between the Boulder Wire Chief and the Colorado Plant Superintendent. Shortly after the radio channel was established, one wire circuit was recovered into Boulder from the North. This circuit was badly congested, there normally being over 15 additional circuits to handle the business. However, use of amateur radio for company business made it possible to give maximum service to the public over the one available wire circuit. W9BQO was scheduled to go to work at 4:00 P.M. The radio work was, therefore, taken over at the Denver end by W9WYX, who handled it from about 3:00 P.M., until normal service was restored. Credit at the Boulder end belongs to W9TMA, who first answered the Denver call, and W9IVT, who took over a short time later when a filament transformer in TMA's transmitter burned out. An incident of interest occurred during the morning when Mr. Harry Jones, Mountain States Company Maintenance Engineer, desired to get a message through to one of the Telephone Company's emergency portable radio stations which were receiving their first field tryouts between Keensburg and Fort Morgan, Colorado, two isolated communities northeast of Denver. W9BQO, taking time out from the Boulder circuit, succeeded in contacting W9HBU, in Keensburg, who obtained the desired information for Mr. Jones. Another incident was a call for a doctor (specialist), which the Boulder parties couldn't get through by telephone due to the congested conditions, and which was, therefore, put through ham radio. In addition to the telephone company, I also contacted Postal, W.U. and A.P., but they said they were OK.

— C. Raymond Stedman, W9CAA,
A.R.R.L. Emergency Coördinator

George Bird, W5HGC, advises of the organization of a club of amateur radio operators who devote their entire time to the Fire Service, that is, members of fire departments, fire alarm operators, mechanics and electricians attached to any fire department, etc. The only requirements for membership are that applicant hold an amateur license and be a full time member of any fire department. Volunteer firemen are excluded at present. It is planned to form networks on the various bands and hold roundtables for the members. Amateurs qualified for the club are requested to forward the following information: Call, frequency and band most used (e.c.o. or c.c.?), phone or c.w., or both, and fire department title (Private, Lieutenant, Captain, Asst. Chief or Chief, etc.). Retired members of fire departments, for either disability or time, are eligible for club membership. Address all communications to Thomas W. Baldwin, W2HYV, 108 North 17th St., East Orange, N. J., or to George L. Bird, W5HGC, 722 East 10th St., Pawhuska, Okla.

Sealed bids, in _____
 to be received until _____ o'clock _____
 for the following supplies, and/or services, for delivery _____

NATIONAL BUREAU OF PURCHASES
 U. S. DEPARTMENT OF COMMERCE
 WASHINGTON, D. C. (Address)

INVITATION
 subject to the conditions on _____ and then _____
 May 1, 1940 National Bureau of Purchases

When Specifications Read

You are Demanding the Best!

A transformer "equal" to a Thordarson means one made under the highest quality standards by an organization with forty-five years of precision engineering and production back of it. It is little wonder that the word "Thordarson" so often appears in Government specifications.

Thordarson is constantly in production on complete lines of the highest quality Power, Plate, Filament, Driver and Modulation transformers and Chokes. Thordarson production facilities can immediately be turned to meeting the exact specifications of any transformer requirement.

The exclusive Thordarson "TROPEX" process makes transformers impervious to atmospheric conditions in *any part of the world*. It has withstood the most rigid laboratory tests for three years and has performed to expectations in the field since March 1939. Write for complete, technically detailed catalogs.

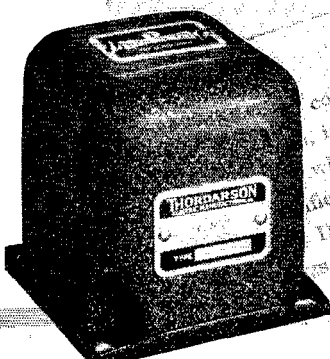

Transformer Specialists **THORDARSON** *Since 1895*
 CHICAGO, U. S. A.

We've never worn
the "high-hat" and
WE NEVER WILL

True, CARDWELL CONDENSERS have been specified and used generously in the finest radio equipment . . . and, equally true, they have never failed to justify their selection. We, rightfully, are proud of such recognition.

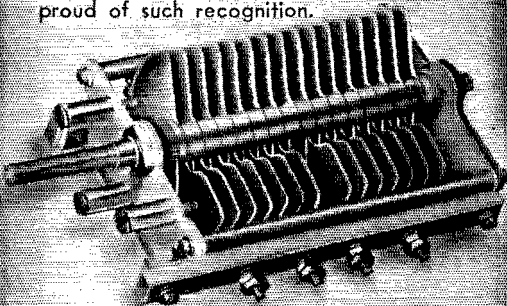

Today, however, with demands on CARDWELL facilities greater than they have ever been, we must ask your indulgence.

The United States Army and contractors for governmental agencies are looking to CARDWELL for speedy fulfillment of orders that are linked with our national defense program. It is essential that these demands be given primary consideration.

Frankly, this leaves our jobbers subject to occasional delays in shipment of merchandise. We, and not they, are to blame if the CARDWELL product you want is "on order — but out of stock".

We ask your consideration when deliveries are slow. We thank you for your friendly cooperation.

**THE ALLEN D. CARDWELL
MANUFACTURING CORPORATION**

83 PROSPECT STREET
BROOKLYN, NEW YORK

What the League Is Doing

(Continued from page #6)

the registration of transmitting apparatus whenever it is not actually installed in a licensed station. The purpose would be to protect against the unauthorized use or possession of radio equipment. Transmitters not in service would bear a registration number and every person transferring the apparatus to another would be obliged to report the sale, the same as one reports the transfer of an automobile to a motor vehicles department. We do not understand that the amendment would present any hardship or particular inconvenience to amateurs.

MORE JOBS

TO SUPPLY radiomen and signalmen in the Naval Reserve, the Navy is opening seven additional radio schools scattered across the country, having the combined capacity to graduate 3200 radiomen and 800 signalmen per year. Acceptable candidates will be enlisted in the Naval Reserve, ordered to active duty and sent to training school for four months' instruction, with uniform allowance and pay. Class A and B amateurs would be initially rated as seamen first class, pay \$54 per month (Class C, seamen second class, \$36). Those who make satisfactory marks will be advanced to radioman or signalman third class, \$60, and serve eight months on active duty at sea, or in some cases at shore stations. Applicants must be between 17 and 35 years of age. They should apply to the nearest Naval Reserve activity or to the headquarters of their naval district. . . . Members of the Naval Reserve are exempt from the provisions of the conscription bill. There is still time for amateurs who prefer duty in the Navy to enlist.

When the League sent out the call that the F.C.C. wanted 200 amateur operators for the expanded monitoring establishment, the amateur response was immediate and the F.C.C. got the operators. They have been too busy to count up just how many were hams and how many were commercials, but we know that a good many hams applied and we gather that ex-W's (or still-W's!) are holding down most of the jobs. They are all filled up now for operators but still have positions open for monitoring officers. See page 30 of October *QST* for the general outline and consult your director or S.C.M. for further particulars.

We understand N.Y.A. is still looking for instructors. At this writing, the League is engaged in making a preliminary survey, at the request of C.C.C., on the probable availability of a thousand or so radio instructors and supervisors, against the probability of a vast radio program in C.C.C. Candidates must have five years' experience maintaining and operating equipment, or four years' technical schooling plus one year of practical experience, a comprehensive knowledge of theory and practice; they must possess or obtain second-class commercial licenses; in particular, they must be competent class-room lecturers and code-room instructors. Residence must be at

TW-75 WINS PRAISE!

Easy to Drive to 650 Watts Phone Input Writes W7GGG

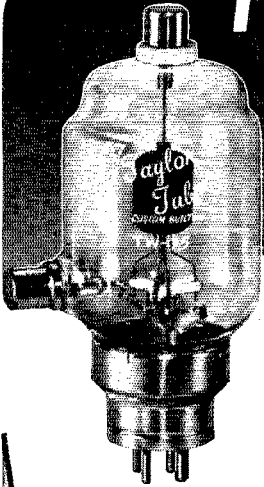

SAM S. ZUCKERMAN, M.D., F.A.S.C.P.
CLINICAL PATHOLOGIST
HYNDY BUILDING, CHEYENNE, WYO.

April 22, 1940

Mr. Frank Hajek
Taylor Tubes, Inc.
Chicago, Illinois

My dear Frank:

The TW-75's are in the rig and working fine. I've had several of the fellows on the air ask me just how difficult it is to excite these new tubes. So here's the dope -- I am putting from 500 to 650 watts of ten or twenty meter phone RF on the air with a pair of TW-75's driven by one 807 acting as either a straight driver or as a doubler-driver. We use one of Herb Becker's X-EC's to drive the 807. A three stage 600 watt phone rig. You know how we sound on 75 and I think it's probably a lot better on 20.

I hope to see you on the air soon. Until then, best 75's to you and the gang.

Cordially yours,
Sam

W7GGG

To say we are greatly pleased with the information given in W7GGG's letter is putting it mildly. Of course we are pretty well sold on the TW-75's ourselves, but we are just amateurs enough to always get a kick out of it when the hams tell us they like our tubes.

VIEW OF CHASSIS WITH TW-75'S
As Described in Taylor Manual—Page 47.

TW-75 RATINGS

The TW-75 is a Thin Wall Carbon Anode tube with a 75 watt plate dissipation. It can be operated at full ratings up to frequencies as high as 60 MC. Reports have been received of very satisfactory operation at 112 MC. It has a Safety Factor of 525-watts and will stand temporary overloads up to 800%.

Filament Volts 7.5
Filament Amps. 4.15
D.C. Plate Volts. 2,000
D.C. Plate Current MA. 175

\$8⁰⁰

"More Watts Per Dollar"

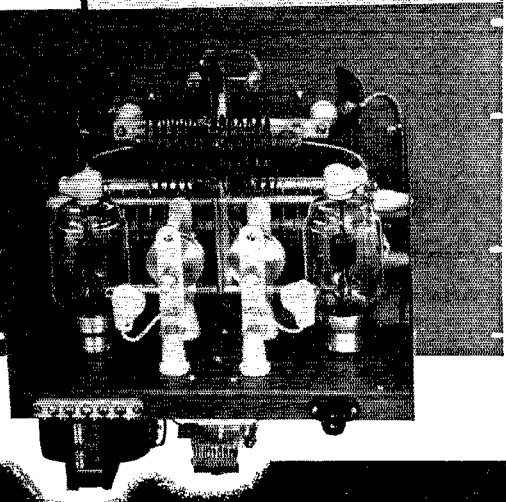

Taylor HEAVY CUSTOM BUILT DUTY **Tubes**

TAYLOR TUBES, INC., 2341 WABANSIA AVE., CHICAGO, ILL.

THRIFTY HAMS BUY

RCP
dependable
TEST
instruments

AC-DC COMBINATION TUBE AND SET TESTER

MODEL 802

Tests all new and old tubes, ballast tubes, hot inter-element short and leakage tests on each individual element. Smooth line voltage regulation 103 to 135 volts with direct meter indication. As multi-tester, 802 provides four range DC voltmeter 0/10/50/500/1000. AC, 0/10/50/500/1000. DC milliammeter 0/1/10/100/1000. DC amps 0/10. Also, D.B. meter and output meter. Fused D'Arsenal Meter Alnico Magnet. Where could you buy these two essential instruments individually and get RCP quality at this low price? Complete with tube, battery and test leads. Net..... **\$27.95**

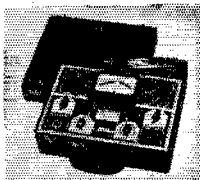

AC-DC MULTI- RANGE RCP SUPER- TESTER MODEL 411

Provides accurate measurements in ranges never before available in small instruments. 5 AC and 5 DC voltage ranges 0/10/100/250/1000/5000 volts. Six AC and DC ampere ranges to 25 amps. 4 ohmmeter ranges reading from 0.1 ohm to 4 megohms. DC milliamps 0/10/100. DC microamps 0-200. The most comprehensive compact tester ever devised. In hardwood case. Net..... **\$16.25**

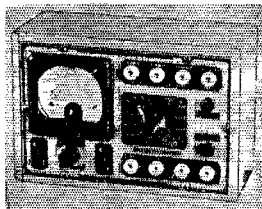

Send for the new RCP Dependable Test Equipment Catalog No. 124 describing this complete line of test instrument values

Prices as low as \$9.95

RADIO CITY PRODUCTS CO., INC.
88 PARK PLACE • NEW YORK CITY

RCP

C.C.C. camp. The contemplated salary is \$2000. If you are qualified and wish to be considered if such a program is instituted, register your name immediately with A.R.R.L.

The Civil Service is looking for radiosonde technicians. Also \$2000. Formal announcement and application forms from the Civil Service secretary at any major post office or from the Civil Service Commission at Washington.

NEW SOUTHWESTERN DIRECTOR

The Southwestern Division has chosen John E. Bickel, W6BKY, of Whittier, as its new director to succeed Charles E. Blalack who was elevated to the vice-presidency this past spring. Mr. Bickel was the alternate and has been acting director since the Board meeting. The results of the special election:

Mr. Bickel.....	332 votes
Ralph S. Click, W6MQM.....	155 "

Mr. Bickel, in a long amateur career dating back to 1912, is a past-president of the Whittier Amateur Radio Association and past-treasurer of Federation of Radio Clubs of the Southwest, and has been alternate director of his division since 1936. In business he is the owner of a citrus orchard.

Link Coupling Between Stages

(Continued from page 41)

whether they are link-coupled or mutual-inductance coupled, or both, except that it may be easier in actual practice to get larger amounts of coupling by mutual inductance than by link coupling alone. Of course, both may well be used at once and by proper choice of relative polarity may be made to add or to buck, the latter being a useful trick when coils are undesirably coupled and shielding is for any reason not possible.

Sometimes if R is unusually low it is difficult to obtain enough coupling by means of the link circuit unless R is tapped across a portion only of L_2 , but in case the coupling turns out to be more than sufficient, the loading is easily decreased to the desired amount by simply throwing C_2 sufficiently off tune. In this case the coupled circuits are being used as an impedance-matching network, and the method of adjustment is much the same as for the well-known "pi" network which is often used to couple an antenna to the final plate tank.

I. A. R. U. News

(Continued from page 46)

new, attractive cover. . . . Although Cuban stations until recently had been licensed with the privilege of optionally using the prefix "CM" for c.w. and "CO" for 'phone work, it apparently is now the practice to issue only one license — for either 'phone or c.w. — to each operator. This gives rise to the possibility that stations CM2AA and CO2AA, for example, being licensed to different persons, might be on the air simultaneously, one on c.w. and the other 'phone.

NEW!

**SEE IT!
TRY IT!
COMPARE IT!**

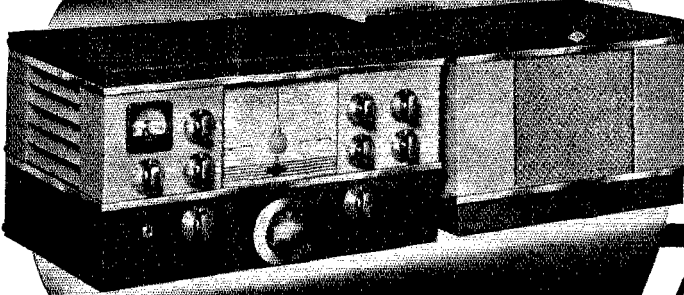

NATIONAL NC-200

I SINCERELY BELIEVE YOU WILL LIKE THE NEW NC-200 VERY MUCH. MECHANICALLY IT IS "TOPS" LIKE ALL NATIONAL RECEIVERS AND THIS SET HAS BRAND NEW FEATURES THAT MAKE IT REALLY OUTSTANDING. WRITE TO ME FOR COMPLETE INFORMATION ABOUT IT OR ANY OTHER SET. LET ME SEND THE NC-200 OR NC-55 OR ANY OTHER SET TO YOU ON TEN DAY FREE TRIAL SO YOU CAN SEE IT - TRY IT - COMPARE IT. WE HAVE AN EXTRA LARGE STOCK OF NC-200s SO WE CAN SUPPLY THEM PROMPTLY.

SEND TO US FOR A FREE COPY OF THE 1941 NATIONAL CATALOG. WE HAVE A COMPLETE STOCK OF NATIONAL AND ALL OTHER AMATEUR EQUIPMENT.

WE HAVE A COMPLETE STOCK OF ALL MAKES AND MODELS OF COMMUNICATIONS RECEIVERS. I WANT TO HELP YOU GET THE BEST SET FOR YOUR USE. SO WRITE AND TELL ME ABOUT YOUR NEEDS AND WISHES.

**IT PAYS TO
DEAL WITH
BOB HENRY, W9ARA**

1. YOU GET TERMS ARRANGED TO SUIT YOU. I FINANCE ALL TERMS MYSELF SO I CAN GIVE YOU BETTER TERMS WITH LESS COST TO YOU - NO RED TAPE - QUICKER DELIVERY. WRITE TO ME FOR TERMS.

2. YOU GET BEST TRADE-IN FOR YOUR RECEIVER. SEND ME A DESCRIPTION OF IT AND GET MY OFFER. TERMS ON THE BALANCE IF YOU WISH.

3. YOU GET PERSONAL ATTENTION YOU CAN'T GET ELSEWHERE. I WILL COOPERATE WITH YOU TO SEE THAT YOU ARE 100% SATISFIED.

SO WRITE TO ME FOR ANY AMATEUR EQUIPMENT IN ANY CATALOG OR ADVERTISEMENT. OR SEND ME YOUR ORDER AND I GUARANTEE THAT YOU CAN'T BUY FOR LESS OR ON BETTER TERMS ELSEWHERE. WRITE AND TELL ME WHAT YOU WANT AND HOW YOU WANT EVERYTHING HANDLED. YOUR INQUIRIES INVITED.

Bob Henry
W9ARA



**HENRY RADIO SHOP
BUTLER, MISSOURI**

QUALITY ABOVE ALL!
SOLAR
 CAPACITORS

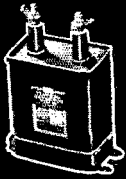

**XL
 TRANSOIL**
 For
 Permanent
 Filters

**XD, XC
 TRANSOIL**
 for Filters
 and Bypass

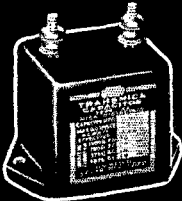
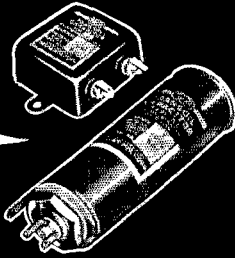

**XA, XH
 MICA**
 Oscillator
 Tank Circuits

**XR, XS
 MICA**
 Tank Circuits,
 R. F. Bypass

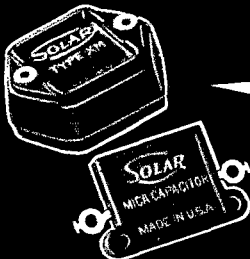
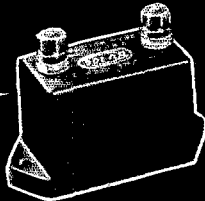

**XM, XQ
 MICA**
 Coupling, Blocking
 R. F. Bypass

**MH, MW
 MT, MO
 MICA**
 Low-voltage

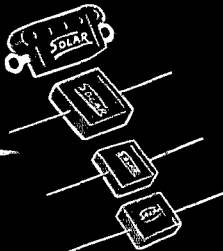

**XT
 OIL TUBULAR
 S**
 Wax-Molded
 Paper Tubular

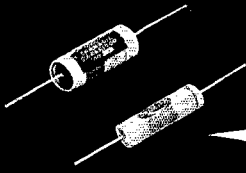

Catalog Free Upon Request

SOLAR MFG. CORP., Bayonne, N. J.

Modernizing the Superhet

(Continued from page 17)

backing off on the i.f. gain control, R_{16} , each time the circuit goes into oscillation. Eventually a set of adjustments will be reached where the tube oscillates at a minimum setting of the gain control. If the signal strength is too small at this adjustment, open C_{15} a bit more and go through the process again. With the right amount of feedback, signals will have the same strength with regeneration that they have with none when the gain is set full on. If no test oscillator is available, any incoming signal may be used for the purpose providing it stays on long enough for the adjustments to be made.

The mixer stage is adjusted for oscillation with the regeneration control, R_{15} , in the region of half to three-quarters of the maximum resistance. This is done by bending the tickler with respect to the grid coil, as previously described. If the mixer will not oscillate at the first trial, reverse the coil entirely by bending it a complete half turn. Try it first with the antenna disconnected to make sure that there is no additional loading to prevent oscillation. The coils can be changed easily if the first one turns out to be too large or too small. The circuit should oscillate readily on all bands except 28 Mc.; on this band the presence of oscillator voltage on the injection grid may prevent the 6SA7 from going into oscillation close to the oscillator frequency. In this particular layout the mixer would not quite oscillate at 460 kc. off the oscillator frequency, although with a somewhat greater frequency difference it would perform in the same way as on the lower-frequency bands. There is sufficient regeneration to give a noticeable boost in signal strength, however.

In operation, it is advisable to set the mixer regeneration control, R_{15} , so that there is a definite regenerative gain or else to turn it completely to the short-circuit or "off" position. As the control is turned down from maximum regeneration, the signal strength will continue to decrease until it becomes noticeably below its value in the completely non-regenerative condition. This is because of the increased loading on the tuned circuit as the resistance is made smaller. With a complete short circuit the losses are smaller and the gain increases; as a matter of fact there is no apparent difference between using a coil with the tickler removed and one with the tickler present and short-circuited. It is in the intermediate-resistance range that the effect is most pronounced. The mixer tuning condenser, C_{15} , will have to be re-peaked as the regeneration is changed, because the amount of resistance in the tickler circuit controls the tuning to some extent. The effect is much the same as that of varying the number of shorted turns in a coil.

The general procedure of tuning is the same as for the original model, and need not be repeated. The new version is, however, better adapted to working completely without regeneration, since the gain is higher. Those who prefer less selectivity in the i.f. can omit C_{15} and simply line up the

New **WAVEMETER** for ULTRA-HIGH FREQUENCIES

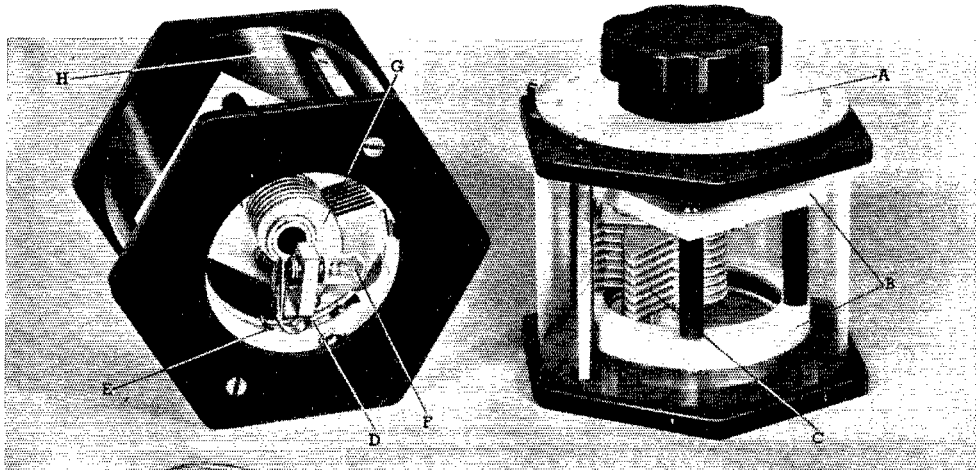

FROM 55 TO 400 MEGACYCLES

FOR SOME TIME there has been an increasing demand for a simple, small, accurate and portable wavemeter of the tuned-circuit absorption type for use at the very high frequencies. General Radio now announces the new Type 758-A Wavemeter to meet these needs.

Design and construction features include:

- A **EXTREMELY WIDE RANGE** — direct reading from 55 Mc to 500 Mc on a single coil.
- B **GOOD INSULATION** — Isolantite.
- C **NEW CONDENSER** — extra heavy, silver-plated brass plates.
- D **SINGLE TURN INDUCTOR** — flat silver strip securely fixed in Isolantite ring.
- E **VARIABLE INDUCTANCE** — 2-finger silver spring making low resistance contact with single turn.
- F **LAMP RESONANCE INDICATOR** — small lamp coupled to wavemeter circuit through fixed loop.
- G **STRAIGHT-FREQUENCY-LINE PLATES** — heavy construction.
- H **TRANSPARENT PROTECTIVE CASE** — resonant illumination of lamp can be seen in any position of wavemeter.

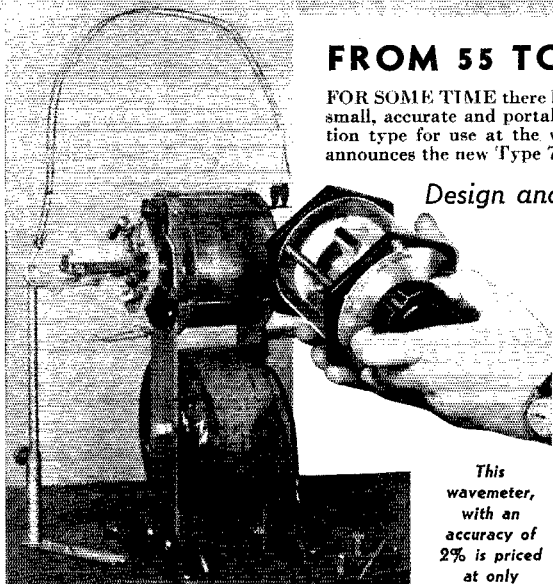

*This
wavemeter,
with an
accuracy of
2% is priced
at only*
\$28.00

Unique design involves the use of a variable single-turn inductance the value of which is changed continuously as the capacitance is changed. The condenser shaft is equipped with a positive sliding contact which bears on a single turn of flat strip, thus changing capacitance and inductance simultaneously and providing an enormous frequency range from a single coil.

When used with circuits generating some power a lamp indicator, coupled to the wavemeter circuit through a fixed loop, is used for resonance indication. For measuring very low power oscillators or receiving circuits, resonance is indicated by the usual absorption-type wavemeter means such as plate or grid milliammeter dip.

● WRITE FOR BULLETIN 635 FOR INFORMATION

GENERAL RADIO COMPANY CAMBRIDGE MASSACHUSETTS

Actual Size
4½" by 9½"
— 272 fact-
filled pages

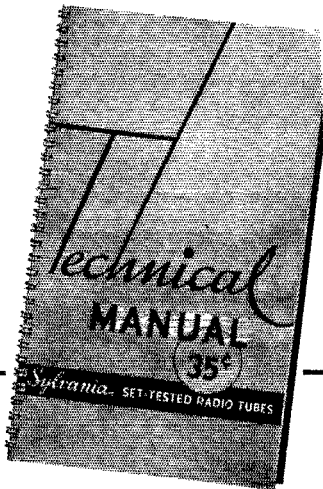

GET YOUR COPY OF THE BIG SYLVANIA *Tube Fact Book*

272 Pages of Vital
Tube Information
Including
Operating Conditions
Tube Characteristics and
Circuit Applications on
374 Tube Types

USE THIS COUPON TODAY

SYLVANIA
Set-Tested Radio Tubes

HYGRADE SYLVANIA CORPORATION
Emporium, Pa. Q110
Enclosed is 35c. Please send me a copy of the latest
edition of the Sylvania Technical Manual.

Name

Address

City State

Serviceman Experimenter Dealer Amateur

i.f. "straight." Operated in this way the selectivity is good enough for average work, and the tuning is of course less critical. This method also permits greater freedom in the use of the r.f. gain control; personally, we like to run the audio gain full on and control the signal strength with the i.f. control for c.w. reception, since this gives a better effective signal-to-noise ratio (especially with a weak beat oscillator) and keeps the stronger signals from spreading out.

Operating the mixer non-regenerative also makes tuning simpler, since the setting of C_1 becomes considerably less critical and one adjustment, that of R_{15} , is eliminated entirely. The signal strength will be great enough under ordinary conditions so that the mixer regeneration is not needed. Its big advantage is that on the higher-frequency bands it can be used to build up the strength of the desired signal without correspondingly increasing response to an interfering image, thus improving the image ratio. Since the actual cases of image interference are not as numerous on 7 Mc. and lower as on the higher-frequency bands, probably most operation can be carried on without the necessity for mixer regeneration on these bands at least. However, it is just as well to have the regeneration there for use when needed, even though normally it is not employed.

A final word on calibration. Only those who have used receivers with full-scale, direct frequency calibration in the amateur bands can fully appreciate this feature. The calibration can be made just as accurate as the means at hand permit, and subsequent accuracy depends only on how closely the band-set condenser is returned to the calibrating position. A reference signal, such as a commercial near the edge of the band, is helpful for band-setting, or the ever-useful 100-kc. oscillator may be used. One of these should be on hand in any event for the original calibration.² We used a 10-kc. multivibrator to get the intermediate points in calibrating this receiver; this is the best way to do it, but the accuracy will not suffer much if each 100-kc. segment is simply marked off in ten equal divisions. Putting in the dial made it necessary to use a new and smaller band-spread tuning condenser at C_3 , but it was certainly worth the extra effort!

² Such an oscillator can be built at very small cost — most of the parts can be found in the average junk box. See *QST* for May, 1937, D. H. Mix, "A 100-kc. E.C. Oscillator for Frequency Checking."

Strays

Fluorescent lamps in the 15-, 20-, 30- and 40-watt sizes, which have served their regular useful lives, make excellent r.f. indicators. The 15-watt size has a useful life of 2000 to 3000 hours, but a burn-out does not affect its sensitivity as an r.f. indicator. They may usually be obtained for nothing from stores or other establishments which use them. — *W8TCL*.

"SIGNAL-SPLICER"

**Provides High Signal Gain
Without Tubes!**

A simple, highly efficient pi network, designed to accurately match the input impedance of any type of receiver to any antenna system. Provides noticeable increase in signal strength, substantial reduction in noise pick-up and decided improvement in image rejection. Especially useful when transmission antenna is also used for reception.

No. 9-1022 Amateur Net \$3.95

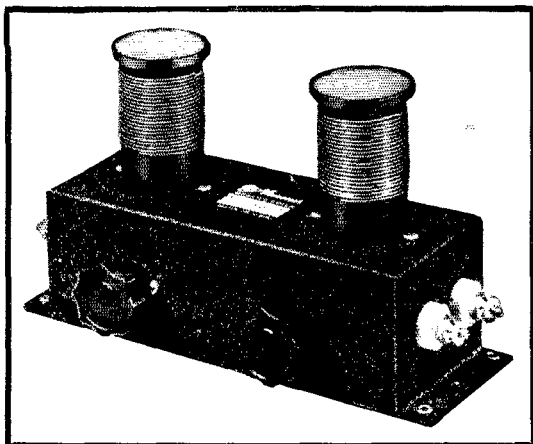

YOUR RECEIVER BELONGS IN HERE

With the use of these two inexpensive instruments — the Signal Splicer in front and the Uni-Signal Selector on the output end — your present receiver will take on entirely new life! When conditions are difficult — when more than ordinary importance is attached to some particular contact — their use may easily spell the difference between success and failure! See them at your Jobbers TODAY!

"UNI-SIGNAL SELECTOR"

For Noiseless CW Reception

A complete speaker unit for CW reception only — incorporates a radically new three-way filter which effectively eliminates everything except the desired signal! Gives super-selectivity to any receiver — takes up where the crystal leaves off. QRM and QRN are practically abolished! Special Stethoscopic Headphones may be plugged into this unit for ideal individual reception.

No. 9-1026 Amateur Net \$13.75

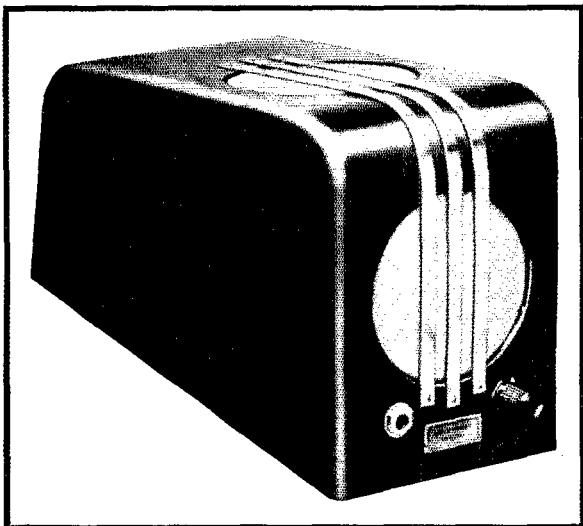

Special Stethoscopic Headphones, No. 26-1001, Net \$4.85

Send for your Free Copy of the New Meissner Ham Catalog!

ADDRESS DEPT. Q-11

 **Meissner** MT. CARMEL
ILLINOIS

"A FAMOUS NAME FOR TWO DECADES"

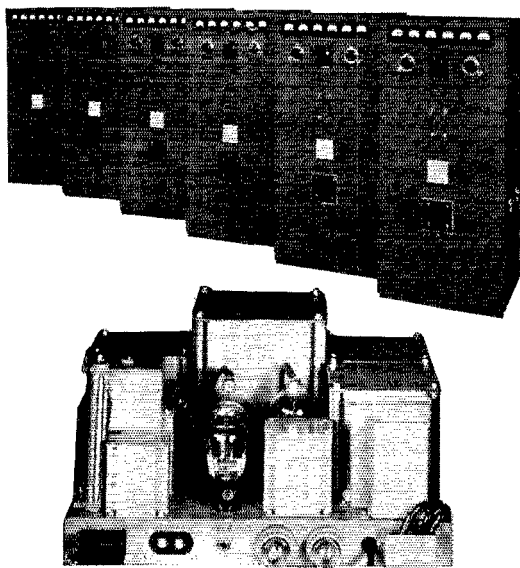

FOR THE NATIONAL GUARD!

Just recently, Transmitter Equipment Manufacturing Co., of New York, completed this group of Temco 150 watt, 4-band, radio telephone and telegraph transmitters for the Illinois National Guard.

They are typical of the outstanding engineering and careful craftsmanship that identifies all Temco transmitters — equipment which must render dependable service — sometimes under the most adverse circumstances imaginable.

Because the first consideration in the building of these units was dependability, it was only logical that KENYON TRANSFORMERS were specified just as they have been by so many other manufacturers who must deliver *plus* value in their equipment.

If it's a prestige product, more than likely it's a Kenyonized Product. There must be a reason for such preference!

Our engineering Department will be glad to give you the facts which will convince you of the desirability of Kenyonizing your equipment!

KENYON TRANSFORMER CO., Inc.

840 BARRY STREET

NEW YORK, N. Y.

Cable Address: "KENTRAN"—New York

A.R.R.L. AFFILIATED CLUB HONOR ROLL

All members of these are A.R.R.L. members

- Asheville Amateur Radio Club, Asheville, N. C.
- Associated Amateur Radio Operators of Denver, Colo.
- Bridgeport Amateur Radio Association, Bridgeport, Conn.
- Chester Radio Club, Chester, Pa.
- Connecticut Brass Pounders Association, Noroton Heights, Conn.
- Delaware Valley Radio Association, Trenton, N. J.
- Dells Region Radio Club, Portage, Wis.
- Detroit Amateur Radio Association, Detroit, Mich.
- Frankford Radio Club, Philadelphia, Pa.
- Glendale Amateur Radio Society, Glendale, Calif.
- Helix Amateur Radio Club, San Diego County, Calif.
- Hi-Q Radio Club, Lynn, Mass.
- Intercity Radio Club, Galion, Ohio
- Iowa-Illinois Amateur Radio Club, Burlington, Iowa
- Baton Rouge Amateur Radio Club, Baton Rouge, La.
- M.A.K. Amateur Radio Association, Mass.
- Mike & Key Club of Ithaca, New York
- Northwest Amateur Radio Club, Des Plaines, Ill.
- O.B.P., Chapter No. 1, St. Louis, Mo.
- Parkway Radio Association, Jamaica Plain, Mass.
- Radio Club of Tacoma, Inc., Tacoma, Wash.
- Raleigh Amateur Radio Club, Raleigh, N. C.
- Short Wave Amateur Club of America, New Orleans, La.
- The L/C Club of New Jersey, Jersey City, N. J.
- The T9 Club, Beverly, Mass.
- Trenton Radio Society, Trenton, N. J.
- Valley Radio Club, Eugene, Oregon
- Winston-Salem Amateur Radio Club, Inc., Winston-Salem, N. C.
- Yakima Amateur Radio Club, Yakima, Wash.
- York Radio Club, Elmhurst, Ill.
- York Road Radio Club, Glenside, Pa.
- The 56-Mc. Minutemen, Winchester, Mass.



In 1933 W8GMI noticed the listing of W4AGI in the call book and wrote him a note, opening a brief exchange of correspondence. A few weeks ago the two happened to contact on 75-meter 'phone. Leland Smith is the name of each op.

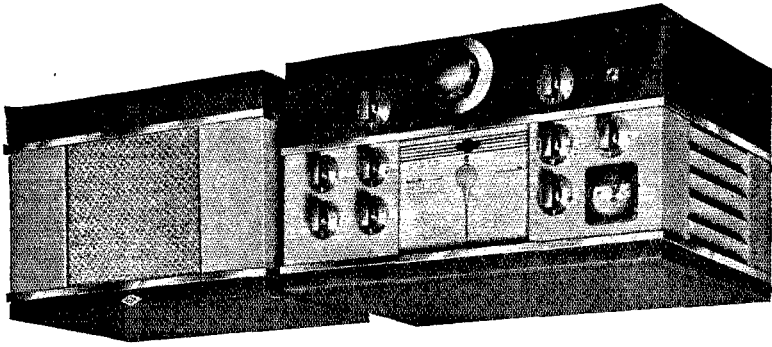

Here's the receiver that will have the boys standing on their heads! It's that good

You've been hearing and reading about this newest National receiver — the NC-200 — for the past few months. Now, here it is!

Twelve tubes — *ten* frequency ranges (six general coverage 490 Kc to 30 Mc, four complete spread of 80, 40, 20 and 10 meter bands) — direct calibration — six step crystal filter — improved noise limiter — S meter — temperature compensated oscillator — etc., etc. This receiver combines the desirable features of the NC-101-X, the NC-100XA, the HRO, and the NHU — and then some!

NET
\$147.50
Price

Priced at only \$147.50, complete with crystal, tubes, speaker, and speaker cabinet, they will sell like hot cakes (good ones)! So rush in your order to *Harrison* for early delivery.

HARRISON
for
TIME PAYMENTS!

Easier terms — lowest cost — no red tape. You can buy *ANY* Receiver, Transmitter, Kit, Parts, etc. on Harrison's Easier Credit Plan. Send in your order, or write.

A \$5.00 deposit will bring you this new NC-200. The balance can be paid upon delivery or you can buy it on Harrison's Easier Time Pay Plan. \$18.42 upon delivery and 12 monthly payments of \$11.00; or \$14.46 and six payments of \$22.00 per month. Or how about — well, you name the terms most convenient to you! We'll do the rest.

YOUR OLD SET?—Harrison's trade in allowances are the most considerate in the country! You can't get a better deal anywhere!

HARRISON RADIO CO.

12 WEST BROADWAY • NEW YORK CITY

WOrth 2-6276

RADIO TRAINING



PORT ARTHUR COLLEGE — not privately owned, not operated for profit, a college built and endowed by the late capitalist-philanthropist, John W. Gates — offers the most thorough practical Radio training in America. P. A. C. owns Radio Station KPAC, which is equipped with the very latest type 1000-Watt high fidelity RCA transmitter, operating on 1220 kc. with directional antenna system. The college is authorized to teach RCA texts. Additional equipment consists of the latest type Marine and Airways Transmitter installation complete; SOS Automatic Alarm; Marine Direction Finder, two-way Television Transmitter and Receiver; Trans-radio Press Receiving Equipment; laboratory facilities where every phase of practical radio assembly technique is taught. Students assemble composite transmitters, audio amplifiers, RF amplifiers, etc. The Radio training covers thoroughly Airways, Press, Announcing, Teletype, Typewriting, Laboratory and practical experience at KPAC transmitter, control room and studios. Announcing is an optional part of this training; nevertheless a number of students annually make successful announcers.

Port Arthur College pioneered the teaching of radio with its first classes in 1909, and for thirty-one years has maintained an active Employment Bureau that is successful in placing graduates in airways, broadcast and marine radio industries.

If interested in details about the Radio Course, write for Bulletin R

PORT ARTHUR COLLEGE
PORT ARTHUR (World-Known Port)
TEXAS

★ TR-112 ★

Transmitter - Receiver

The six tube no compromise 2½ meter Transmitter-Receiver with many exclusive features.

Write for literature on this and other properly engineered equipment.

TR-112..... \$39.75
 Amateur Net

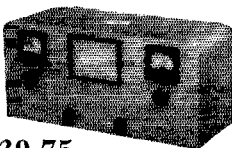

RADIO TRANSCEIVER LABORATORIES

8627 115 STREET RICHMOND HILL, NEW YORK CITY
 CABLE ADDRESS: "RATRALAB", NEW YORK

Balloon-Supported Antennas

(Continued from page 39)

whipping of the antenna, but guys will remove much of the danger.

It might be advisable to add a few words of caution at this point. The antenna should be kept away from all power lines. It will also be found that a great deal of static electricity builds up on one of these vertical antennas. An ideal static drain is an r.f. choke connected between the station end of the antenna and ground. This will not in any way interfere with the functioning of the antenna, provided a good grade of r.f. choke is used. A transmitter type of r.f. choke is recommended due to its greater current carrying capacity.

Naval Communication Reserve Notes

(Continued from page 40)

frequently neglected is the ability to tell his story in words. The Sixth Naval District is not falling down in this, and we have a bulletin which rates high among such organs. Our officers begin with simply reporting personnel notes, and gradually develop until now we are getting some first-rate technical and historical items. The necessity of keeping within space limits develops conciseness, and the qualifications of our readers demand accuracy.

The Sixth Naval District has initiated an officers' conference plan. Periodically all the N.C.R. officers get together and discuss District problems. Such mysteries as the secrets of advancement, and the mystic lore of procurement are unfolded before our eyes. A good feed tops off the program to make a decidedly worth-while day. The attendance is so good that we note the absentees instead of bothering to record who is present.

Every time our District Communication Officer tells us he has been ordered to other duty, we are convinced that the new D.C.O. can't be half as good. Then after the new one has been there a while, we realize we were wrong, and begin to wonder what we'll do when he goes! The whole-hearted cooperation we get from the regulars in the Sixth Naval District cannot be excelled, and we are glad for this chance to thank them publicly.

🐞 Strays 🐞

The crystal-checked frequency meter of "Frequency Measurement and Regular Check" in March *QST* can be made into a dandy record player by the simple expedient of inserting a closed-circuit jack in the 6J7 suppressor lead to ground. One can either listen to records on the b.c. set or by headphones from the meter itself. The phono pick-up is plugged into the jack and the oscillator is tuned to some point in the b.c. band.

— W8JKN

NATIONAL NC-200

- Six general coverage ranges
- Four uniform amateur band-spread ranges
- All ranges have definite, accurate calibration
- Actual single control tuning
- New crystal filter
- Series valve noise limiter
- Stabilized circuit
- Temperature compensation

**Complete with 10" Speaker
in Cabinet to Match**

\$147.50

Amateur Net Cash Price

\$14.75 Down

\$11.73 per month for 12 months



BUY ON NEWARK'S LIBERALIZED CREDIT PLAN

★ **Free** **BIG NEW CATALOG**

Just out . . . with many more items than we've ever put between the covers of any catalog. Thousands of bargains, sets, parts, accessories, supplies, of best known makes. Hundreds of illustrations. This book belongs in every "ham" shack, ready for instant reference.

★ **YOUR CALL LETTERS IN GOLD 10c**

★ Put these big shadowed decalcomania letters on your Ham Shack door, auto window, etc. Nearly 2" high. Send dime for yours today. Be sure to give call letters.

★ **HOW TO ORDER**

★ Send down payment with your order. We ship immediately upon credit approval. You pay balance plus 6% carrying charge in equal monthly payments of \$5 or more.

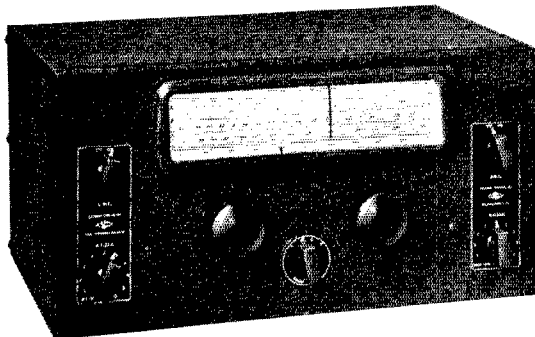

NATIONAL NC 44 A

Cash Price \$49.50 Complete
Only \$4.95 Down
\$7.87 per month for 6 months

**ORDER DIRECT FROM
THIS AD — NOW**

★ ★ ★

NEWARK *Electric Company*
 323 W. MADISON ST.
 Dept. Q CHICAGO, ILL.

Station Activities



HUDSON DIVISION

EASTERN NEW YORK — SCM, Robert E. Haight. W2LU — ISQ is attending school at Dartmouth; his QTH: 403 Lord Hall, Hanover, N. H. He would like to hear from the gang. MIY, new R.M., is doing swell job organizing E.N.Y. O.R.S. Net. MHW visited MIY and MXR at Albany. KWG is heard regularly on 3510 kc. LU is on 3530 kc. and busy with recruiting drive for N.C.R. members. JRG contacted his 100TH Girl Ham! (How he pulls in the YL's.) LSD changed rig to safety cabinet; reports FTS/Y3RL contest big success. LLU schedules W1MBM and W1RDF from Feura Bush. 8DHU, ex-W.N.Y., moved to Albany, and joins O.R.S. boys. E.N.Y. welcomes Andy. MZR is running 160 watts to a T7-40 on 3652, 3563, 7240 and 7126 kes. MHW reports GTW back home and new ham NFZ with handle "ham." EGI is back on with 50 watts on 7152 kc. VJ is working on 7160 kc.

Traffic: W2ISQ 369 MIY 340 MHW 126 KWG 110 LU 75 JRG 17 LSD 10.

NEW YORK CITY & LONG ISLAND — SCM, Ed. L. Baunach. W2AZV — KTA is now O.P.S. AV is out for O.R.S. again after 14 years. FAQ is spending one hundred per cent of his time to get W.A.S. CIT is busy with the N.C.R. frequency. HNJ is adding another stage for multi-band operation. HGO is joining the N.C.R. With EC's e.c.o. he can break into any traffic net and dispose of his traffic. PF has moved to a new apartment at 130 Martense St., Brooklyn, built by IID who installed a special antenna for him. LZR made the B.P.L. for the ninth time this year. LYC went to California on his three weeks' vacation. IXQ has more room since he moved the shack down in the cellar, and visitors are always welcome. JGC is all ready for winter traffic. IYR is back on 14 Mc. after a long layoff. A junior op. arrived at IYX, Sept. 1st. Congratulations. VG is experimenting with V.F. single wire for 3.5 Mc., using PI-Section filter. LGK is using self-power on the 3710-kc. Section Net every night; the power supply is a vibrapak. IYX and QF want to know if any of the DX gang know what has happened to XUSAM, as a number of the boys are looking for QSL's to complete their W.A.C. DBQ, the Section E.C., is looking for any of the Brooklyn gang who would be interested in becoming Assistant E.C. to get in touch with him. The N.N.W.A. is conducting code classes for beginners, etc. All those interested are invited to attend on Tuesdays, at 8:30 p.m., at the club house in Albertson Estates. The A.-P. trunk line started fall operations on Sept. 30th at 9:30 p.m. on 3630 kc. More stations are wanted for the Section Net on 3710 kc. that operates every night at 8:30 p.m. LR is the control station, and will listen for all newcomers who are interested.

Traffic: W2USA 857 SC 416 LZR 391 KI 54 AV 145 MT 39 DBQ 35 AZV-NAZ-ITX 34 LR 29 LYH 15 IYX 14 JAU 13 CIT 12 AA-BGO 11 PF-LGK 10 ADW 9 CHK-CET 8 AZM-LBI 7 ELK-HNJ 6 JGC-AEU 5 EC-AVS 4 BWC 3 FAQ-VG-DWW 2 HGO-DRI-DW-AYI-CEN-FF 1.

NORTHERN NEW JERSEY — SCM, Fred C. Read, W2GMN — Pat Jessup has resigned his R.M. and O.R.S. appointments for the present. He has done a fine job, and we are going to miss him. Pat is engaged to be married, and, as he puts it, "that explains a lot." Congratulations and good luck! BJZ spent two weeks on N.C.R. cruise in August. MBO qualified for F.C.C. job and is attending F.C.C. school in Baltimore. GYY is back on 1.75-Mc. 'phone after lapse of years. HXP has used same rig for more than three years and still is satisfied with its performance. BOE now has a T20 working. MLV, KWK, KHK, NFG and NDN are new A.E.C. members. KHK has been appointed coordinator for Metuchen. KWK is new O.R.S. at Cliffside Park. HXI expects to be active in the N.N.J. Net this season; Bob is in business, building e.c.o.'s in his spare time. ISZ has new rig on 1.75 Mc. FB is 112-Mc. 'phone addict. IZZ is trying out television. IYQ has improved rig. The N.N.J. Net resumed activities Sept. 9th. Stations reporting were BZJ, CGG, HXI, IYQ, JUU, LMN, LXI, MKW, MNT, HCO, CTT has scholarship at Ohio State and is working for his Ph.D. CPU, who has just been married, is on 7 Mc. DKA is building new ham shack and improving rig. ACT put in new

filter condenser and is saving heavy cost of blown fuses. ACT, LV, DKA, IDZ and BZR are active on Sunday morning "Ear Benders Net." LV has pole lowering and raising bee to help install new pulley and halyard. JME is working on new beam. LXI now has 48 states. HMJ moved from Staten Island to Newark and is active on 7 Mc. JMX resigned as Assistant S.C.M. due to pressure of business. ELJ and LJR have been building 112-Mc. battery-powered rigs. NGV is new Newark station.

Traffic: W2CGG 258 HXI 243 LMN 71 MNT 52 MKW 46 IYQ 32 BZJ 24 JYI 8 KWK 7 MEO 6 IZV 3 LXI-CIZ 2 HMJ (WLNX 104). (July-Aug.: W2CGG 102.)

NEW ENGLAND DIVISION

CONNECTICUT — SCM, Frederick Ells, Jr., W1CTI — The Nutmeg Net resumed operations Sept. 3rd with most all of the old members reporting in at 6:45 p.m. The fall get-together of Nutmeg Net members was held at WIGB with 12 of the gang attending. CCF heard his own signal at GB and decided may be he would make a few changes in his rig! AW tops all in traffic with KKS right behind. AIEC is pushing plenty of traffic and has a real outlet in W2MRL schedule. CTT had to QRT and free a baby squirrel from his antenna during a QSO with LUN and GMR. FMV is now O.R.S. LAU says he has had so many visitors he can't remember all their calls! All Conn. amateurs that can operate on 3640 kc. are invited to report into the Nutmeg Net, daily except Sunday 6:45-7 p.m. HYF is now with the F.C.C. LHE is nearly ready to get on the air after a long absence. CBA has the new rig on the air with a 35T final. Club members will operate on 3640 kc. Thursday evenings. MHH has been called to the colors with the 242nd C.A. and is leaving civilian life for a year.

Traffic: W1AW 393 (WLMK 31) KKS 258 MEC 172 CCF 74 KQY 70 IPI 51 CTT 39 KYQ 38 TD 30 UE 18 LQK-CJD 11 FMV 8 MHF 6 GC 4. (July-Aug.: W1KKS 122).

MAINE — SCM, H. W. Castner, W1IIE — Things are certainly looking up in the Section. There is a great amount of interest and as our activities are mostly confined to local work, many of the boys are making plans to assist in the organized work of the nets and emergency preparedness. The Pine Tree Net opened Sept. 24th with Carl, W1LHA acting as Chief Route Manager. GOJ will be on the net until they leave for the South. LIP had a pleasant visit with KNJ, who does some fine work on 28 Mc. Several of the boys around "the Bay" are on 28 Mc., including MGP, MCW and GQ. EOP is on 3.9-Mc. 'phone. MTN is at Quoddy. LIP has 20 watts on 1.75-Mc. 'phone. APX is at home in Rangeley and had his antenna blow down recently. BOR is also at home in Rangeley. LKP is a new O.B.S. LER is at his new QTH, Norway, Maine. MGP is new O.P.S. VF, PCI and LRQ attended the N. H. Hamfest in Manchester. LHA has a half kw. on the P.T.N. frequency. Anyone interested in joining the net should write him. ISH has been working in Bucksport. 21JW has been in Wayne, Maine, using 7-Mc. and 3.9 'phone; he's a Counselor at Camp Androscoggin. LMM visited LJJ on Mount Bigelow. Johnson has to carry everything for his rig up 2½ miles to an elevation of 4100 feet. When you load a wind charger and storage battery with all the other junk on your back and start up that trail you want some meat and "pertaters" to lug with. The Waterville Amateur Radio Club applied for a club call and the club is growing all the time. LMM also visited IBE up in the northern part of the state. MGP writes that he received his O.P.S. supplies and QST on the same day and that he has reading enough to last about all winter. During July and August LYK visited hams in nine cities and towns and six counties. Ed sure gets around. INW has been called to duty with the F.C.C. Monitoring stations and reported Sept. 3rd. We wish him lots of luck. It seems necessary to explain again the method and dates of reporting activities. You who may be interested in service in our hobby, ask yourself how you can be of service, and you'll find the many organized activities the answer. Possibly it is the Pine Tree Net or the A.A.R.S. or the Emergency Corps or affiliation with the Naval Communication Reserve. In all cases it applies to building up a good name for us and is of service to the community, state and nation. If any one of you is the least in doubt about what you could do, just drop your S.C.M. a line and I would be pleased to advise you of how I think you can help these things materially and get some real fun out of it besides.

Traffic: W1MGP-LKP 5 LYK 14 HSE 2. W21JW 37.

EASTERN MASSACHUSETTS — SCM. Frank L. Baker, Jr., W1ALP — On Sept. 14th an Emergency Meeting was held in Boston at the Western Union Building, with the following present ALP, KBQ, JSM, LBY, JIX, JCK, IXO, QW, MEH, ASB, LJO, KCT, TY, IPS, JGQ, JJJ, HMA, FWS, KZT, EMG, DI, JXU, LUG, MTG, GCU, EPE, INC, FSK, JEZ, KPO, SS, LOB, AFW, 3EDA/1 and Mr. Broadhead of Boston Red Cross. Thanks, gang, for your interest. MBE is new E.C. for Barnstable County. KCT is now R.E.C. for the New Eng. Power Assoc. Amateur Emergency Net. He had his net lined up for any possible trouble in recent storm headed this way. LRO and KPW were also ready, and JJJ, MQT, LDV at JJJ/1, KHE, ICA, MMI, LIE and MEU were all set for the worst. This whole gang deserve a lot of credit for being ready in case something happened, and this is just an example of what your S.C.M., HXE and all E.C.'s are driving at; to be ready and prepared before, and not after a disaster strikes. Let us have your name listed in the Emergency Corps, or as an E.C. for your town. LQQ and MQO sponsored the First Annual Outing of the 28 Mc. gang from Boston & North Shore, with 25 hams and their families present. 112 Mc. portable rigs were available and a good time was had by all. BDT is building new 'phone rig. IYU is changing QTH. KH gave a talk at opening meeting of Eastern Mass. Club, on U.H.F. South Shore Club held its first meeting. BJB's XYL is now MWU. Congrats. IID has worked 100 stations on 112 Mc. and is interested in 224 Mc. IKW will be on 112 Mc. with T50's. JGQ is still on 1.75 Mc. 6NHK visited LMB and LEU. LEU has a new yacht and will have a rig on board. KSU and KJT have Class A. SI is back on 28 Mc. EKT has a new beam. HWC is back on 1.8 Mc. EHT, EKT and MJ have e.w. bug. FWQ went on N.C.R. cruise. MDN hopes to have new 56-Mc. beam, and is forming local Emergency net. DYC and MEJ are on 1.75-Mc. 'phone. IN is quite active on 7-Mc. c.w., also on 28 Mc.; has 200 watts now. KAO, Mystic Valley Radio Club of Malden, has renovated its club rooms, and has new receiver and transmitter; they will have a gala Halloween Party as a dedication; write Sec'y for details. LBH has new rig with HK54. DSE, DRO, DJ, MQB and LMO furnished 56 Mc. communication for Cottage Park Yacht Club 3-day Regatta over Labor Day. FCE from Portland now lives at Arlington Heights. Welcome to our Section. OM. Let's hear from you. JXU has pair of T-40's and E.C.O. for 3.9-Mc. 'phone. ALP, FWS and JXU went to Manchester, N. H., Hamfest.

Traffic: W1EPE 152 (WLGS 1) BDU 123 AKS 78 AAR 62 LWH 50 EMG 36 LGH 35 KXU 32 HWE 19 WI 16 AGX 17 KH 13 LNN 12 IXL-EHT 3 LBH 1 LBY 43 KCT 64 AAL 38. (May-June: W1KCT 108.) (June-July: W1KCT 14) (July-Aug.: W1KCT 18 LGH 17 LMO 6). (July-Sept.: W1JSM 96 KZT 51).

WESTERN MASSACHUSETTS — SCM. William J. Barrett, W1JAH — AZW leads our traffic parade this month. Prent did a swell job arranging the West. Mass. A.A.R.S. picnic. JAH and BVR took in the New Hampshire State A.R.R.L. convention. Also seen there were ARE, JXE, KIK, AUN and BNO. BIV says he has checked rig and soldered up a few joints so they will stand up through the ensuing traffic season. BKG added bandswitching and regulated power supply, together with temperature compensating condensers to the super, and now he hopes it works! KK, LEQ and GZL visited DQK and KEP on Canadian border over Labor Day weekend. Quoting GZL, our West. Mass. P.A.M. "I operate 99.9% 'phone, but wouldn't want to get rusty on code reception. Why not polish up your c.w.? Get in the A.R.R.L. Code Proficiency Program tonight." How about it, boys? IOR is back for some old fashioned B.P.L. traffic totals after a summer of ragchewing — Hope you make it monthly, Chet. FOI has new antenna system all set for active traffic season. Hank brought his pee-wee portable-emergency rig to the A.A.R.S. picnic, and it certainly is a nice piece of work. Sounds as good as it looks, too. KJK is back for short spell from Maryland. George has new XYL and reports she is a ham-to-be. That's the spirit. BNL spent week at N.Y.W.F. KEL reports that W1XTG has applied for 50 kw. F.M. KZU is keeping schedules on 3.5 and 112 Mc. DUZ is getting set for the coming season. Everything points to a banner year, so let's all get started right, and don't forget to report each month. AJ says that MJP is getting out well on 3.5 Mc. Those who really want to build up their code handling ability are strongly urged to become members of active nets. If interested, drop me a line for further dope.

Traffic: W1AZW 57 (WLGC 49) JAH 55 (WLGH 16)

BIV 50 (WLGN 37) BKG 39 GZL 13 IOR 12 FOI 5 BVR 2 (WLG 77).

NEW HAMPSHIRE — SCM. Mrs. Dorothy W. Evans, W1FTJ — This is my first report as S.C.M. for my state, and I want to thank all who have made my election possible. I will do my utmost in this capacity and hope that the hams will all cooperate with me in making my term a successful one. Please send me your monthly reports and help keep New Hampshire on the map. On Sept. 21st New Hampshire held its Seventh Annual A.R.R.L. Convention at Manchester with nearly 300 in attendance. Registration started at noon, and during the afternoon hours traffic and 'phone meetings were held while a code contest with ICME in charge, was held in the banquet hall. Movies on Radio Tube Manufacturing and a 224-Mc. demonstration were put on by the Hytron Tube Corporation. The A.A.R.S. and N.C.R. boys had meetings also with FFL and BFT in charge. The Phone Meeting was under the direction of 1APK, P.A.M. for N. H., and the N. H. Net meeting was headed by 1BFT/DMC, R.M. At the banquet Committee Chairman 1IVU welcomed 1KH, President of the A.R.R.L. as Toastmaster. The Yankee Network gave a special Frequency Modulation broadcast which was thoroughly enjoyed. Guests included 1KH, Lt. Commander R. B. Meader, N.C.R. Commander of the 1st Naval District, Joseph Moskey, 1JMY, Communications Department A.R.R.L., Lt. Col. Henry J. Schroeder, Liaison Officer, 1st Corps Area, Percy C. Noble, 1BVR, N. E. Director A.R.R.L., Glenn T. Browning and Dr. Greenleaf W. Picard. After the drawing of prizes all those who wanted to try for their code proficiency certificates on the run from W1AW, went to an upstairs room where receivers were set up and typewriters, pencils and paper provided. A grand good time was had by all, and thanks are to be extended to the Committee which included 1HPM, Honorary Chairman, 1IVU, General Chairman, together with BFT, CMR, FFL, HFO and LKK. AXL has new Defiant receiver. The Wolfeboro Radio Club is increasing power to 800 watts. ATE moved from N. H. to Michigan. MXL is new ham in Manchester. CMR took unto himself a YF, and on the day of the N. H. Convention at that! Good luck and congratulations, Lou. The boys at LVK are rebuilding Club transmitter. HFO is new Secretary of Manchester Radio Club, while CMR has been chosen second vice-president. EDN is giving 112 Mc. a try from Concord. In all eight different licensed YL operators were counted at the Manchester hamfest! The gals sure turned out! MWI is new ham in Pierce Bridge; she is YF of JDP. Good going, Eleanor. ICS is now with the F.C.C. APK is back on 3.9-Mc. 'phone with 200 watts. You'll find him around 3930 kc. MXP is new ham in Concord. LBD is on active duty at Boston Navy Yard. GDE is getting back on 3.5 Mc. this fall. So is his brother, JBM. KKQ is new Secretary of the Nashua Mike & Key Club. FB, Leora! ARM is getting on the air soon. All N. H. hams extend their deepest sympathy to HOV on the loss of his YF. A grand time was had recently at the QTH of ITF in Northwood. About 25 of the Farmers' Net were present with their XYL's. George and Blanche surely showed everyone a good time. Hot dogs, corn, marshmallows, etc., were enjoyed over an outdoor fireplace. The N. H. State Traffic Net starts up again right away. It will operate at the same time, 6:30 p.m., on the same frequency, 3840 kc. Net members will be glad to have any interested hams check in with them. The Farmers' Net extends many thanks to Grace Hadley, "The Spook Lady," of Peterborough, N. H., who entertained about 75 hams recently at her home. She is a most ardent S.W.L. and took this means of showing her interest. Don't forget that the Annual SS Contest is coming on weekends of Nov. 9th-10th and 16th-17th. We want N. H. well represented. Let's get in on the fun! FCI won the prize for the best QSL card at N. H. Convention. Nice card, Lloyd. Your S.C.M. urges all N. H. hams to copy W1AW. Get your Code Proficiency Certificate for your shack wall. It is something of which to be proud. Copy W1AW nightly and see how quickly your code speed comes up. KIN has now received his Class A Amateur, 1st Class radiotelephone and 2nd Class telegraph licenses. JKH will now be found on 3.5 Mc. MMG was active in ZCB contest. MLW is also active ham in Milford.

Traffic: W1KIN 90 MMG 32 HXJ 22 GEY 21 BFT 11 FTJ 10 JKH 8 LIN 4 APK 3.

RHODE ISLAND — SCM. Clayton C. Gordon, W1HRC — Anticipating a Hurricane Sept. 1st the Westerly Radio Ass'n went into action and started to get the emergency rigs

(Continued on page 88)

**THE
NEW
1941
RADIO
AMATEUR'S
HANDBOOK**

**REVISED
EXPANDED
IMPROVED**

**NOW
AVAILABLE**

\$1 Postpaid
in Continental U.S.A.
\$1.50 (U.S. Funds) Elsewhere

American Radio Relay League
West Hartford
Connecticut
U.S.A.

(Continued from page 85)

set up in various locations around the town. LZD and MAE with MVL set up their rigs in Bradford ready to go over to emergency power if necessary. In Westerly the gang went to work and rigged up an a.c. generator wound by IEJ with a gasoline motor and put an a.c. line of 110 volts into the club rooms where the radio equipment was assembled. Two members were detailed to keep in touch with the Police Dept. and the Coast Guard, who were following the progress of the storm. The rest of the gang worked on the rigs and stood by for about eight hours until the danger was over. The gang included Clayton Dixon, AGJ, Pres. of the club, INN, MOK, IGJ, KCG and KRQ with some of the non-licensed members ready also. BDS was ready in Ashaway with an emergency rig ready to go. AGJ is putting up a 3.9-Mc. 'phone antenna for this winter's operation. INN is getting out fine on 3.9-Mc. 'phone. KRF has returned from Maine and goes back to R. I. State College. KCG joined the Westerly Radio Club. MVL is working them right and left with QSL-60. LZD and MAE of Bradford are on 7 and 3.5 Mc. KRQ has a new speech amplifier and is adjusting for Cathode Modulation 3.9-Mc. 'phone this fall and winter. MOK is working with 112 Mc. INN, KRQ & Cy. Ashworth put up a new antenna for the W.R.A.'s new transmitter. Before listing the activities of the Providence Gang it is necessary to report to you the passing away of one of the best liked Radio Amateurs in Rhode Island, Dr. A. W. Taft, W1AVH. "Doc," as he was known to everybody, was one of the old-timers whose association with W1AQ will be missed by many of us of other club affiliations. He was most active in the high-frequency bands, notably 56 Mc. Besides being the friend of many of us, he also served many of us as the family dentist. JEZ is still working on emergency equipment and says that at least 50 Boy Scouts and Sea Scouts were ready to help us in and around Providence during the recent hurricane scare. LDM has new e.c.o. 6F6 (with provision for crystal also) and 6L6 buffer, 40 watts. FUB is on 112 Mc. with 2-toned i.c.w. and 'phone. KZN is being mobilized and plans to take the N.C. 44 and a portable transmitter. MWY (twin brother of MBM) received ticket this week after 13 weeks wait. MBM completed band switching rig, 6L6 tri-tet osc., with push-pull HY-61 on 7-14 Mc. and push-push on 28 Mc. LYE is back on 3.5 and 112 Mc. MEK bought a new Vibroplex and went to Boston for Class A. LDL incorporated crystal in e.c. rig a la Perrine — line-up is now 6SK7 e.c.o., 6F6 doubler-crystal osc., 6L6 buffer-doubler, TZ-40 final, 75 watts. DDY is renewing Navy activities; has one auxiliary transmitter, 6L6-T20, for Navy and emergency operation. JP built new 6A6 Class "B" modulator for emergency rig, finished converting 101X for battery operation, and is holding up Providence's name in 112 Mc. activities.

VERMONT — SCM, Clifton G. Parker, W1KJG — GAE visited KVV, GAZ, GAN, AVP and FSV on his vacation. KVV is reported making good recovery from a broken ankle. DHX visited at AHN, ERJ and GNF. GNF reports some activity on the air. MLJ has completed a new rig using 6L6 crystal-807-pair RK51's with 300 watts input and has FB results. Visitors at JKG during month were JRU and XYL, MMU and XYL, MLJ and XYL, KUY, LJZ, KXL, KXY and XYL. KXL is now control engineer at WDEV and hopes to have rig on air soon at new location. KXY is now at Ft. Ethan Allen and renews activity on traffic nets. BJP plans a vacation visiting amateur stations and overhauling that FB antenna system. BLC has completed a new all-band transmitter and secures excellent results. DQK/KEP have been busy moving their station across road to the new filling station. CUN has been visiting at Richford and assisting BLC to complete the new rig. LJZ is located at Johnson for the school year where she has position teaching. JRU is back on the air on 3.5 Mc. and visited QQ. QQ changed location to Island Pond Oct. 1st and is trying to complete W.A.S. FPS is now at Boston on new F.C.C. job and resigned as Emergency Coördinator for Southern Vermont area. We need some amateur in this area to take over his duties. Will someone volunteer? KTB has changed location to Lyndonville. KXY has a new Vibroplex. MJU reports he will be on nets for the season as he is foregoing college this year. N.E.P.A. emergency net is anxious to secure net members in Burlington and Montpelier areas. The net frequency is 3575 kc. If interested, write W. C. Phillips, W1KCT, 441 Stuart St., Boston. LRL leaves the Section and is being transferred to Ft. Preble, Maine. AD has installed duplex antenna circuit for quick band shifts.

Traffic: W1AD 28 FSV 55 KJG 23 KXY 26 MJU 8 MLJ 12. (July-Aug.: W1FSV 19.)

ATLANTIC DIVISION

EASTERN PENNSYLVANIA — SCM, Jerry Mathis, W3BES — 3ADZ, ARK, NF and 8FLA are working for the F.C.C. 3AGV received his final card for proof of a three-band W.A.S. 3AKB is back with T.L. "C." 3AOC and GYK note that the Phila. Wireless boys can get their beauty sleep and still top the York Road gang. 3BRZ is working out on 56 Mc. 3BXE moans that he missed the B.P.L. by three points. Six members of the Lancaster Radio Transmitting Society have been called to active duty with the Penna. National Guard, according to 3DRO. 3EEW is still infested with the building mania, but finds time for traffic. 3DFU made second best rating for accuracy in the last frequency measuring tests. 3EEW and FJU also came through. 3FXZ keeps daily weekday schedules with the A.A.R.S. 3GDI increased from one-watt 'phone to 500-watt c.w. 3GHM has an NC101X and is hoping for better showing in the various contests. 3GKO shows a fine total as per usual. 3JOU is a new O.P.S. on 1.75-Mc. 'phone. 3HCT is getting geared for traffic season. 3HFD schedules KC4USB. 3HXA is still trying for those 25 K4's. 3HZK wants amateurs of the Harrisburg area who are interested in the A.E.C. to contact him. 3ILK is proud possessor of an FBXA. 8ASW is back from National Guard camp. 8EU has a fine set of schedules and promises to show plenty of traffic. 8SNZ worked KC4USA. 8NNY is N.C.S. for 3.9 E. Pa. Net, 3994 kc., 5:30 to 6:30 p.m., and is looking for new members. 3BXE visited W1AW and Hal. On his return he saw 21LE and 2HX1.

Traffic: W3ADZ 14 3AKB 37 3AOC 58 3BES 20 3BXE 200 3BRZ 1 3CHH 4 3DRO 5 3EEW 95 3FJU 4 3FXZ 4 3GDI 8 3GHM 3 3GKO 1013 3GKR 2 3GYK 11 3HFD 7 3HXA 33 3HZK 71 3ILK 3 8ASW 4 8EU 16.

MARYLAND-DELAWARE-DISTRICT OF COLUMBIA — SCM, Hermann E. Hobbs, W3CIZ — AXP in the Army Air Corps has been transferred to Maxwell Field, Montgomery, Ala. DRD schedules MA/2 twice a week. EIZ moved to separate quarters with 100-ft. masts. EQK is D.N.C.S. of the A.A.R.S. 'Phone Net and is active each Sunday at 11 p.m. EST. The following members expect to be active: EIZ, FTD, GME, GTN, GUT, HAL, HLX, IIS and FPK. HAL spent his vacation on a mountain side in Beaverkill Valley, N. Y., and kept weekly schedules with SN by battery-operated receiver and 10-watt transmitter. He has been appointed Radio Aide, 3rd Corps Area Phone Net. FPK is building a signal shifter and will be on 3.9-Mc. 'phone. FTD took upon himself an XYL on Sept. 15th. Congratulations. EBI has been appointed E.C. for Baltimore and vicinity. GJY joined the 16th Sig. Service Co. and operates at FIO at Ft. Geo. G. Meade, Md. GYQ expects to join the 198th C.A. and operate from Camp Upton, L. I., with the call MA/2. HUM moved to 6 Williamsburg Dr., Silver Spring, Md., and opened T.L.-A.P. on 3630 kc., Sept. 30th. IMN is rebuilding. IVT, Ex-6FMZ, 7FTL, Radioman 1st Class in Navy, is O.R.S. and clears traffic through Virginia and Conn. State Nets. WU attended the Convention of Roanoke gang and distributed a bunch of QST's.

Traffic: W3BWT 641 CIZ 249 DRD 14 ECP 60 EIZ 10 HUM 36 CXL 36 (WLM 2187) IVT 8 July-Aug. EIZ 1 EQK 6 HUM 12.

SOUTHERN NEW JERSEY — SCM, Lester H. Allen, W3CCO — Ass't SCM and A.A.R.S. Liaison R.M., Ed. G. Raser, W3ZI — N.C.R. Liaison R.M., Ed. B. Kerr, W3CCC — Regional Coördinator in charge of Emergency Coördination. Ted Toretti, W3BAQ — R.M.I.s: 3BEI, 3BYR, 3EUH — P.A.M.: 3GNU: Section Net frequencies: O.R.S. — 3700 kc.; O.P.S. — 1980 kc. With the opening of winter activities the O.R.S. and O.P.S. Nets are off to an early start under their respective leaders but, with National Guards in training and Conscripts leaving for camps, we need more attendance. GWZ, HEO, HRJ and IFT helped to move GLZ to new QTH. HOJ returned to 7 Mc. AEJ still has time to get the Official Broadcasts out. AXU is working out FB with his new extended doublet on 56 Mc. ABS has been quite busy on 56 and 28 Mc., first rebuilding the rig for better efficiency, then taking time out for the u.h.f. contest; Stan collected 114 points. IDZ visited the World's Fair, and did a neat traffic job for ZUSA relaying 76 messages. OQ, our O.O. in the Camden area, is complaining of lack of off-frequency and bad notes. This looks like a good sign, fellows. Keep up the good work. BZX will again take over Eastern Terminal for Trunk Line "B." FFE is returning to the Univ. of Penna. EDP is greatly interested in traffic work. EFM moved to

Linwood, DNU reported into both O.R.S. and A.A.R.S. Net first drill night of the season. FBM joined the N.C.R. over in N.Y.C. and is already standing watch at NDB. HAZ joined N.C.R. and A.A.R.S. IOK has been on 1.75-Mc. 'phone with 25 watts. CCC has started to build a new 100-watt rig. VE will be at Fort Dix operating portable this winter, as he is in the Army for a year's training. FXN will also be at Fort Dix and provide a traffic outlet for the soldier boys. GHR is interested in traffic and expects to join the O.R.S. Net. HPX was on for the first meeting of the O.R.S. Net. IFT schedules GMY and 2LXN Wednesdays at 5 p.m. FVZ, EBC, IMA and HAZ are new members of the A.E.C. The Somerset Hills Radio Club is now a full-fledged A.R.R.L. affiliated club. FB, fellows. GNM is on active duty with the Army at Fort Dix. GSR also is on active duty with the Army at Fort Dix. CCO had a very enjoyable 2-weeks' trip through Canada, and ended the return trip with a very swell visit to Headquarters, also going through WIAW. ITU is new O.P.S. CGU recently signed up as Emergency Coordinator for North Plainfield. The Delaware Valley Radio Assn. is planning an Open House night for the month of Oct. 9QPK of Russell, Kansas, spent 3 days of his vacation with CCO. EUH is proud papa of a 9-lb. boy. Congratulations, Bill. HOJ has a new rig, 6C5-6L6-HY25, and a new Sky Champion receiver. HUZ is building an e.c.o. and putting up new antenna. HHY has returned to the air with a 6L6-T20 rig. FXV is looking for W.A.S. LH returned to Trenton after being in Philadelphia all summer. AQ is being heard on the various bands testing the new 1-kw. rig. GRW reports his new home-made receiver working FB. EED is making new 3-element beam for 28 and 14 Mc. ITS is working out FB on 7 Mc. ZI installed a new half-wave antenna for 1.75 Mc. AFH changed crystal circuit in 28-Mc. transmitter and reports his crystals start to oscillate without any hesitation. ISZ is working out FB on 7 Mc. using a 6L6 at 30 watts input. ENZ is back on with a 250-watt after being idle for a couple of years. IOW has new antenna for 1.75 Mc. IUQ is new call in West Trenton. CFB is quite active on 3.5 Mc. GRW is experimenting with loop antennas on automobiles. ASQ is back on 1.75 Mc. after spending the last year on 28 Mc. IBF is new signal on 1.75 Mc. HKO is getting portable rig ready for trip through the South.

FIRST SOUTHERN NEW JERSEY A.E.C. MEETING

All amateurs and A.E.C. members in the S.N.J. Section are invited to attend the first S.N.J. Amateur Emergency Corps meeting to be held Saturday, November 2nd, at 8 p.m. EST, at the Trenton Yacht Club, Trenton. N. J. Plans will be discussed to further organize the A.E.C. in our Section, to appoint Emergency Coordinator, and enlist more amateurs in the A.E.C. Short talks will be made by W3CCO, S.C.M., and W3BAQ, Regional Coordinator. A feature motion picture produced by the Delaware Valley Radio Assn., titled "Radio Amateurs," will be shown.

SOUTHERN NEW JERSEY FIELD DAY

The first S.N.J. Section Field Day will be held on Sunday, November 10th, starting at 7 a.m. EST and ending at 4 p.m. EST. This Field Day is dedicated to testing, in actual operation, independently powered station equipment; and to stimulate interest in emergency operations so we may be prepared in time of need. The aim for each field portable is to work as many other amateur stations in the S.N.J. Section as possible in the time allotted, reporting location and circumstances by radio message to A.E.C. headquarters, 11 Livingston Street, Trenton. Advance entry is not required. All participating will use the call (c.w.) CQ SNJ, (Phone) Southern New Jersey Field Day. Mobile word does not count as it is test portables actually engaged in the field. Manufacturer contacts do not count. A.E.C. members of S.N.J. Section who cannot participate in the field will be eligible to operate at their fixed locations during the contest. To comply with F.C.C. regulations, do not fail to notify your inspector in charge 48 hours in advance of your portable intentions. To have points count, station control points at an F.D. station must be within 100 feet of some given spot. The entire 1.75- and 3.5-Mc. bands, both 'phone and c.w., shall be used. All operations including rigging of antennas and gear shall not start before sunrise, Sunday, November 10th.

Scoring and Multipliers: These will remain the same as those of the 8th A.R.R.L. Field Day Contest. (See June 1940 issue of QST, page 29.) **Reporting.** Scores claimed must be shown as the sum of points for each set-up. A station-worked list for each band must show contact times for each contact. Complete logs of activities and stations worked

shall be submitted. All the above information must be sent to S.N.J. A.E.C. Hqtrs., 11 Livingston St., Trenton, not later than Thursday, November 14, 1940. — W3BAQ.

Traffic: W3IFT 246 IDZ 76 EUH 50 ABS 40 GCU 38 CFB 22 OQ 40 GNU 12 ITU-IOK-AEJ 10 LH 5.

WESTERN NEW YORK — SCM, Fred Chichester, W8PLA — K.M.'s: BJO, CSE, DSS, FCG, PCN, P.A.M.'s: CGU, RVM, UNY, E.C.'s: FNT, GWY, KYR, RVM, SBV, SMH, THC. Section Net frequency: 3720 kc. Oneida amateurs mourn the death of Clayton Page, W8BWW. He was president of Oneida's largest bank. Besides amateur radio he also pursued botany as a hobby and had one of the finest collections of native mosses to be found in the state. He gave much of his time and money in forwarding any program sponsored by local amateurs. Another death in the Section since our last report was that of Leo Hower, W8PFM of Rome, who drowned on August 17th. We all unite in extending our deepest sympathy to both the bereaved families. NWH visited A.R.R.L. HQ's on his New England vacation trip. MQX is working plenty of DX on 7 Mc., including the Antarctic Expedition. PMI and NEL are on 7 Mc. NVJ and LQC visited 2USA. NTN of Tonawanda is attending Tri-State College. OWT visited A.R.R.L. HQ's. AOM is re-vamping his new rig for c.w. and 'phone. RV is reporting ham activities for the Buffalo papers. NOR is building an F.M. rig for 56 Mc. JTH is rebuilding his rig for all bands. DXE acquired an XYL. REM is attending Union College and is operating the television station at WGY several times a week. ILD is using a 30-foot vertical antenna on 14 Mc. with great success. LQC is building an e.c.o. for 14, 7 and 3.5 Mc. with 807 final. UHI is going great guns on 112 Mc. with a pair of 76's, and XA reports reception of his signals clearest heard. Others reported on 112 Mc. are UCO, UQV, UQB, IHG and UHT. QBU, Buffalo Boy Scout station, sends code practice on 1815 kc., Wednesday evenings from 7:30 to 8:00. RRL will be on 112 Mc. with television transmitter and receiver. SOK claims the longest contact on 28 Mc.; can anyone beat three-and-a-half hours? PAN, RRL, CUU, PCD, RCO, DXE, BSM and PLU are all on 28 Mc. PCN has built a combination monitor, a.c.-d.c., which operates as an audio oscillator or signal monitor and contains two keyer tubes. FKJ has the new antenna up and is now building speech equipment to modulate his T40. NBJ is back on working 1.75-Mc. 'phone after a 2-year lay-off. TKM has a Class "A" ticket. TRR is building a 112-Mc. rig. LMO is on 3.9-Mc. 'phone. RKO was married last month. PPR bought some new equipment and is going to QRO. RVM expects to change his QTH to Lowville, but will stay in the St. Lawrence Valley Net. EDD/8 and XYL leave shortly to spend the winter in Florida. RMR has been working plenty of DX on 7 Mc. with his Signal Shifter. KYR, of Buffalo, is the new Emergency Coordinator for Erie County. PLA is working some 1.75-Mc. 'phone. JIW is the father of a new junior op. Congrats, Howy. JTT applied for station license for Buffalo, and will soon have a special rig on there. NEL is handling some traffic on 3.5 Mc. TBD visited 2USA. UXT is new A.A.R.S. SHO is reporting into A.A.R.S. Net in place of ON. PWU is now "Class I" O.O. BJO is back on the air after spending the summer playing with a cabin cruiser. If you get tangled up with the State Police up around Malone, try flashing your A.R.R.L. button; UNY may have you. FNT is doing a fine job of clearing Rochester traffic. AQE passed the exam for one of the F.C.C. monitoring jobs. THC reports tough going in trying to organize emergency stations in Syracuse. CSE begins to show signs of "coming-out" for the fall season. DHU changed QTH, and will now operate in the second call area. Sorry to lose you, Andy. NNJ and TEP enjoyed a week's trailer trip through Pennsylvania. They visited several hams en route. JQE is working hard toward a commercial ticket, but hopes to get back in net soon. FFF has up a new 65-foot mast. The Tri-County Radiophone Club are going in for code practice. FCG visited QMR. CSE is keeping cross-band schedule with NCJ. Twenty-five hams attended a birthday party for DFN, Sept. 16th: Elmer Grabb, DOD, president of Rochester Amateur Radio Assn. and operator in the control room of WHAM, and Miss Irene Gedney, TUQ, at one time staff pianist for WHAM and now heard over WSAY; they will honeymoon on the west coast. We join with their many friends in wishing them happiness and prosperity. DHB is back in town after operating portable at camp since May 1st; he operates 1.75-Mc. 'phone.

Traffic: W8CSE 22 DSS 16 AQE 87 FCG 34 FNT 6 GWY 40 JIW 248 JTT 42 LJD 43 PCN 255, PLA 100 RKM 25 RVM 8 SBV 42 SOW 14 SMI 12 UPJ 7 DHB 2.

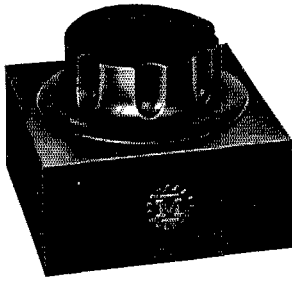

HETROFIL*

Gives advantages of the phasing control of the Crystal circuit and is easier and quicker to operate. Simply rotate the knob until the objectionable audio signal is removed. Can be used to fullest advantage on both CW and Phone signals and can be attached to any type of Receiver. Operates directly in the audio output stages without the use of tubes. The price is \$3.50.

* Reg. U. S. Pat. Office

JAMES MILLEN
150 EXCHANGE ST.



MFG. CO. INC.
MALDEN, MASS.

CRYSTAL TALK

By HIPOWER

The Hipower Crystal Company, one of America's oldest and largest manufacturers of precision crystal units, is able to offer the amateur and manufacturer attractive prices because of their large production and the exclusive Hipower grinding process. Numbered among Hipower's customers are:

U. S. Army and U. S. Navy
National Broadcasting Co.
Columbia Broadcasting System
Mutual Broadcasting System
United States Airlines

Such satisfied customers provide assurance that whatever the need may be, Hipower can supply it. For the amateur, we offer the following world famous crystals.



"EMERALDS"
Guaranteed to have a drift with temperature change of less than 10 CV. per °C. per MC. With holder.
160-80-40 meters . . . \$3.35
Special 20 meter unit. . . \$5.50

"RUBIES"
One of the finest amateur crystal units available. Guaranteed drift of less than 4 CV. per °C. per MC. With holder.
160-80-40 meters . . . \$4.50
Special 20 meter unit. . . \$7.25

AVAILABLE AT YOUR PARTS DISTRIBUTOR
Manufacturers Write for Prices

HIPOWER CRYSTAL COMPANY

2035 CHARLESTON ST.

CHICAGO, ILL.

★ BOOK REVIEW ★

Radio as a Career, by J. L. Hornung. Published by Funk & Wagnalls Co., New York. 212 pages, including appendix. Price \$1.50.

Radio Workers, by The Picture Fact Associates, Alice V. Keliher, Editor. Published by Harper & Brothers, New York. 56 pages, numerous illustrations. Price \$1.00.

A year or so ago various publishers seemed to feel that a need existed for vocational guidance, and various books and series of books were commissioned. Some of these have now reached print. Among these is a pair dealing with the radio field.

Mr. Hornung, already well known for his various operating texts, has contributed a volume in the "Kitson Careers Series" that discusses soberly and comprehensively the various phases of radio work, the requirements of the different fields, educational factors, and future prospects. It is recommended reading for anyone interested in radio as a career, whether as operator, serviceman, engineer, or even publicity or program writer.

The Picture Fact Associates are an industrious crew who have combined words, pictures and pictorial charts into a pleasant series of small volumes on the job possibilities in various professions and fields. Sandwiched in between "Office Workers" and "Railroad Workers" is this one on radio. It is strictly juvenile stuff; entertaining and even informative enough, but not particularly instructive.

— C. B. D.

★ NEW APPARATUS ★

NEW VARIABLE NEGATIVE TEMPERATURE COEFFICIENT TRIMMER CONDENSERS

OF PARTICULAR interest to builders of receivers, measuring apparatus and other equipment in which negative-coefficient condensers for temperature compensation will be found useful is the new line of variable-capacity units announced by Centralab, Milwaukee, Wis.

The fixed plate is bonded to the ceramic base, eliminating the usual variable air film, while the variable plate rotates on a ground ceramic surface. The characteristics are equally stable at all capacity adjustments. The available capacity ranges are: 2-6 $\mu\text{fd.}$, 3-12 $\mu\text{fd.}$, 7-30 $\mu\text{fd.}$ and 60-75 $\mu\text{fd.}$ These condensers provide a negative temperature compensation of 0.0006 $\mu\text{fd.}$ per $\mu\text{fd.}$ per degree C. Power factor is given as less than 0.1 per cent. Capacity change with humidity or temperature cycling is less than 0.5 per cent.

— D. H. M.

**SWITCH
TO SAFETY!**



NEVER BEFORE A BARGAIN

Oil-Impregnated FILTER CAPACITORS!

- 2 mfd.—1000 Volts D.C.W.
- Unconditionally Guaranteed for ninety days (3 months)
- Made by a well-known condenser manufacturer
- Sold and Guaranteed by New York's leading amateur supply house, famous for quality and service

ONLY
79¢
EACH
3 for
\$2.10

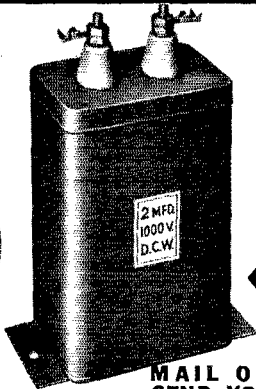

capacity:
2 mfd.-1000V

size:
2"x3 1/4"x5"

weight:
1 1/2 lbs.

LIKE THIS



**MAIL ORDERS FILLED!
SEND YOUR ORDER TODAY!**

Quantity Limited — Buy Now!

TERMINAL Radio Corp.

2 STORES IN NEW YORK CITY
68 WEST 45th ST. · 80 CORTLANDT ST.

TERMINAL RADIO CORP.
68 West 45th Street
New York City

Enclosed find \$..... Send me.....
2 mfd., 1000 volts D.C. working, oil-impregnated
transmitting condensers.

NAME.....
ADDRESS.....
CITY..... STATE.....

LEARN RADIO • TELEVISION

60-page catalog on request. Oldest, largest and best equipped in New England. New classes now forming. Write for new catalog.

MASS. RADIO SCHOOL

18 Boylston Street Boston, Massachusetts

RADIO

ENGINEERING, broadcasting, aviation and police radio, servicing, marine radio telegraphy and telephony, Morse telegraphy and railway accounting taught thoroughly. 48 weeks' engineering course, equivalent to three years of college radio work. School established 1874. All expenses low. Catalog free.

DODGE'S INSTITUTE, Day Street, Valparaiso, Indiana

EASY TO LEARN CODE

It is easy and pleasant to learn the modern way — with an **Instructograph Code Teacher**. Ideal for the beginner or advanced student. ■ Many tapes available ranging from alphabet for beginners to typical messages on all subjects. Speed range 5 to 40 WPM. ■ Always ready, no QRM, beats having someone send to you.

FOR SALE OR RENT
STANDARD with 10 tapes and book of instructions, A.C. motor, \$24.50
With spring-wound motor, \$18.50
JUNIOR with 5 tapes and book of instructions (not rented), \$12.00
RENTAL Standard with 10 tapes and book of instructions \$5.00 first month, \$2.25 each additional month. Referees or \$10 deposit required. All rental payments may be applied on the purchase price should you decide to buy the equipment.
Write for details today



INSTRUCTOGRAPH COMPANY

Dept. Q, 4701 Sheridan Road, Chicago, Illinois
Representative for Canada:
Radio College of Canada, 54 Bloor St. West, Toronto

F. C. C. PRECISION — PLUS! BROWNING FREQUENCY MONITOR

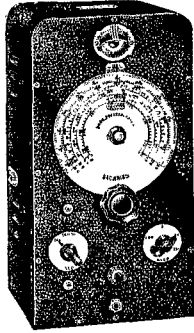

The Browning Visual Frequency Monitor answers the problem of precise frequency measurements in the amateur bands. With an accuracy better than 2 parts in 10,000 it enables you to work close to the edge of the bands with confidence. The basic circuit consists of a heterodyne frequency meter with a built-in mixing circuit and a visual zero beat indicator. Built-in 100 and 1000 Kc. oscillator allows accurate checks to be made against WWV.

See it at your dealer's or write for Bulletin 103C.
Amateur Net Price ONLY \$39.90 with TUBES

SPECIAL CUSTOM BUILT MODELS IDEAL FOR POLICE, FIRE, MARINE

The Browning Visual Frequency Monitor is also available in a custom built model, Type S1, covering any three specified frequencies between 1.5 and 60 MC. These hand calibrated models are intended for the fixed frequency services — police and fire depts., marine, etc.

(Write for complete information and prices)



WINCHESTER, MASS.

NEW!

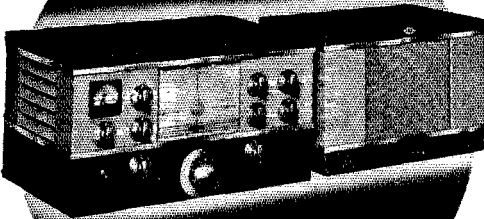

**NATIONAL
NC-200**

NEW National NC-200

The sensational new NC-200 is now in stock at Harvey's. Has ten calibrated coil ranges, with fixed-calibration bandspread on four ham bands. Includes six-step crystal filter, series-valve noise limiter, and separate speaker in cabinet to match. Range 490 KC to 30 MC.

Complete, **READY TO GO**.....Net **\$147.50**

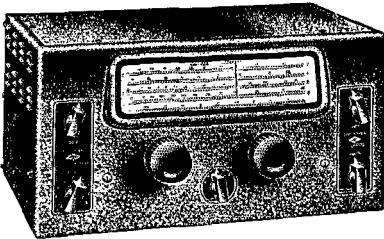

National NC-44

Complete with tubes, power supply and external speaker, and ready to run, the NC-44 is an outstanding buy at

Net **\$49.50**

NTE Exciter

The NTE Exciter and Speech Amplifier saves most of the headaches in building a flexible rig. Exciter has push button band changing, crystal controlled. Speech Amplifier has high gain and ten watts output.

Net Price, less crystals.....**\$129.00**

WRITE FOR FURTHER DETAILS
PHONE NO. — BRyant 9-1916

W2IJJ W2LJA W2KWY

OUR *Best* VALUE IS OUR RECORD OF LOYAL SERVICE

HARVEY
Radio Company of New York

103 WEST 43rd STREET • NEW YORK, N. Y.

CABLE ADDRESS: "HARADIO"

Field Day Scores

(Continued from page 23)

Two Transmitters Operated Simultaneously

W3AIR/3	Trenton Radio Society ⁴⁶	202-A	-3033
W2CWE/2	Queens Radio Amateur Club ⁴⁷	184-A	-2835
W8OAJ/8	Valley Key and Mike Club ⁴⁸	185-A	-2745
W3IGU/3	Harrisburg Amateur Radio Club ⁴⁹	178-AB	-2460
W3CGV/3	Delaware Amateur Radio Club ⁵⁰	131-A	-2250
W4DW/4	Raleigh Amateur Radio Club ⁵¹	127-A	-2043
W1KIK/1	Chair City Radio Assn. ⁵²	119-A	-1953
W9MKS/9	Starved Rock Radio Club ⁵³	119-A	-1890
W9GRU/9	Topeka Amateur Radio Operators ⁵⁴	110-A	-1692
W4GB/4	Palmetto Amateur Radio Club ⁵⁵	90-AB	-1680
W9BP/9	Minneapolis Radio Club ⁵⁶	104-A	-1548
W3CDY/3	Lebanon Valley Radio Assn. ⁵⁷	83-A	-1296
W6BRV/5	Sabine District Amateur Radio Club ⁵⁸	74-AB	-1191
W1LRN/1	Hi-Q Radio Club ⁵⁹	71-AB	-1155
W6AM/6	Associated Radio Amateurs of Long Beach ⁶⁰	167-AC	-1098
W9EWY/9	LaCrosse Radio Amateur Club ⁶¹	62-B	-792
W1HE/1	Eastern Mass. Amateur Radio Assn. ⁶²	49-A	-756
W1MCO/1	Lowell Radio Operators Club ⁶³	32-A	-621
W8CHE/8	Steubenville Amateur Transmitters Assn. ⁶⁴	38-A	-567
W8QZF/8	Horseshoe Radio Club ⁶⁵	45-AB	390
W4DUG/4	Champa Amateur Radio Club ⁶⁶	103-B	354 RT
W9ZWL/9	Aberdeen Amateur Radio Assn. ⁶⁷	8-A	342
W8GJS/8	Toledo Amateur Radio Assn. ⁶⁸	23-A	216 t
W6OKF/6	Ogden Amateur Radio Club ⁶⁹	11-AB	156

Three Transmitters Operated Simultaneously

W1UJ/1	Radio Oprs. Assn. of New Bedford ⁷⁰	327-A	-4914
W3DRQ/3	Chester Radio Club ⁷¹	234-A	-3798
W9TCK/9	Cahokia Amateur Radio Club ⁷²	233-A	-3402
W8MRM/8	Motor City Radio Club ⁷³	198-A	-3339
W8CUG/8	Amateur Transmitters Assn. of W. Penna. ⁷⁴	203-A	-3087
W8SVT/8	Warren County Radio Club ⁷⁵	187-A	-2907
W1DJC/1	Manchester (Conn.) Radio Club ⁷⁶	175-A	-2826
W5AXD/5	Louisiana Tech Radio Club and Red River Radio Club ⁷⁷	206-AB	-2808

Club Participants: 1 W1BFT, JBA, JCA, LBD, LIN, LVG, 2 W1AOP, BOY, CPV, LAB, W3DZC, DSY, TOG, SWB, CEU, Geans Trask, Ralph Trask, 4 W8WBV, TNP, JJ, Lew Roy, 5 W8FT, IPO, DDC, MYA, IQF, NUH, TWB, 6 W1KKS, KOG, KYE, LWA, MJL, 7 W8KXX, LSF, MCG, OOR, RMH, SCW, MPR, 8 W1FGC, MKD, MMG, HTO, GEY, MLW, KTN, DUB, TA, 9 W1VIV, HFO, MLO, PFL, KBU, HQS, MOI, CME, LKX, FYH, 10 W6ASQ, HZG, HFW, JLR, LXS, MCL, SMC, HES, 11 Twelve ops, 12 W8GJ, HAN, GHA, 13 W8BRB, MH, GEB, HBJ, BJZ, IYD, HEZ, W4BGO, Austin Mary, Hollander, 14 W8DCE, UOH, GGE, RJL, 15 Ten participants, 16 Twelve ops, 17 W4FNS, EJH, GPX, DAM, EZF, GCW, EDQ, EMT, KZ, plus 15 other club members, 18 W1WIG, HXK, 19 W1JNK, 20 W1KXE, 21 W1KJ, 22 W1KJ, 23 LDV, LXE, LTY, MBI, 24 W2KKF, LOB, MEW, 25 W8BQV, ROI, BDV, BEB, RNG, BCN, 26 W9JMG, YDJ, JCT, EEP, Ellsworth, Krol, 27 Participants not indicated, 28 W1BCG, CTT, IOV, IWT, Bertram, 29 W9FXQ, KKY, HHD, BGE, FBF, 30 W3GKE, CTT, GIW, Levy, Cremera, Breneman, 31 W9PBY, QLO, SEA, Jordan, 32 W1WJ, Fink, 33 W8GJ, 34 Eight ops, 35 W6KMM, RJJ, JRK, KVL, 36 W7GDB, HWZ, HBD, 37 Participants not indicated, 38 W1MRP, KWF, MGX, 39 Ten ops, 40 Participants not indicated, 41 Six ops, 42 W8NXL, LGM, SLF, TOL, Cain, Russell, Lacey, Lyman, 43 W8CLL, NXT, BIU, FET, 44 W7GRJ, AUC, HW, HYL, CMX, ECS, CAM, 45 Participants not indicated, 46 W9VQD, MCG, SSU, 47 W1KJH, GUF, KTE, IIM, LXL, IFF, 48 W8RWL, SUV, 49 W8TEW, UPT, URG, FOB, FSX, LUR, KKP, Moore, Wackford, Miles, Cook, W2CVT, 50 W8OEY, OEZ, PUY, OLE, RV, 51 W9KXG, KXE, RED, 52 Oprs: Snedeker, Slagle, Toth, Latham, West, Best, Powers, Knowles, South, 53 W1CJG, JVN, 54 W8GJ, RFA, 55 W8KCH, 56 W8GJ, 57 Ten ops, 58 W8BUM, EYM, BOS, EUC, IAY, GPH, 59 W3BTQ, CGV, DNI, DRD, FNI, GYQ, HBE, 60 Oprs: Derby, Smiley, Patterson, Wade (Ben), Wade (Roger), Browning, Caveness, Given, 61 W1JXE, DKX, RIV, DCH, AUN, LLN, KIK, LDI, LQS, 62 W9LNT, YBY, NIA, NGY, JNA, IGO, AXE, JY, WJZ, ZEN, NQG, 63 IELJ visitors: W9ACJ, WOO, ZOF, OLM, KTA, NQL, 64 W8GRA, JXD, CGZ, ZOI, KCR, GUZ, VQA, 65 Eight ops, 66 W9BP, AVH, ZXV, OTE, TKX, GAL, ITQ, NNO, RTE, 67 W3CDY, HFZ, IGP, HZK, LEG, IGO, GUM, DPK, 68 Twelve ops, 69 Seven ops, 70 W6LFR, EZL, MND, NRY, LXC, 71 W1L, NRY, LJA, CYS, RTG, AM, Loyner, 72 W9EYV, QDL, AKY, HSK, 73 W1HE, CTW, IIQ, 74 W1ABG, QF, KMY, OQ, ops, 75 Participants not indicated, 76 W8TXQ, NUI, 77 Fifteen ops, 78 W9ZWL, YEZ, YQR, ISF, SMK, PRX, KOS, RSE, PHP, RYZ, EOJ, ORB, 79 Participants not indicated, 80 W1L, MDP, NFM, 81 W1L, GPT, HTP, RWR, W8KF, visitors: SST, RLM, 70 W1AGW, CEZ, ICA, KHE, JJY, GLF, EJJ, IZF, 71 W3ATK, BIL, BNS, CSN, CWQ, DDX, DGM, DRJ, HFO, EQF, HNC, Piper, Obenhein (George and Everett), Mowry, Messmer, 72 W7CK, EBX, VLT, ERA, WPC, NMY, QAW, FOL, NVW, GFF, GWW, SMY, END, EGD, FIN, JWG, ZVN, 73 W8GJ, 74 W8GJ, ONK, PUF, REJ, GGV, FVW, SKA, UAS, NBF, RLT, RCM, BRU, RJL, Milton, 75 W8CFR, KWA, AIE, HGG, AVY, ZU, OQ, AVY, JAV, OLW, QEL, SGH, SWX, BSO, CUG,

(Continued on next left-hand page)

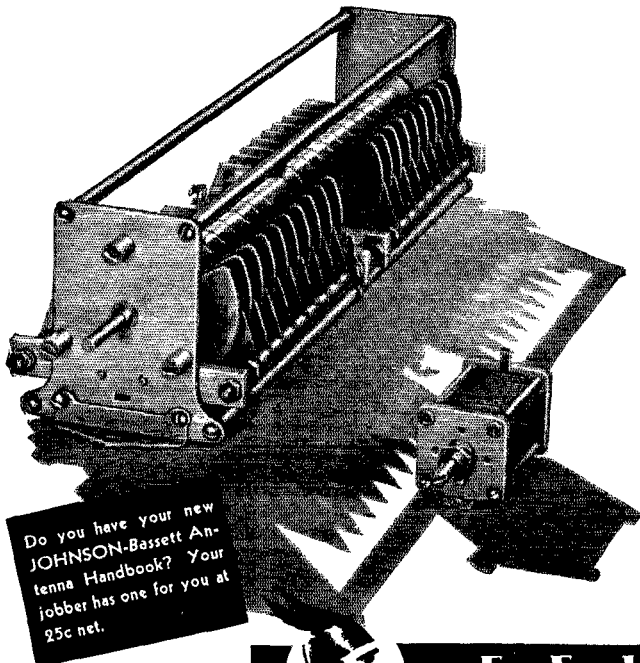

Do you have your new JOHNSON-Bassett Antenna Handbook? Your jobber has one for you at 25c net.

JOHNSON

has the answers

Whether it is a 10KW broadcast transmitter or a crystal oscillator, there is a JOHNSON condenser for any job.

JOHNSON parts are to be found in 90% of all broadcast transmitters; and these same parts are available to you through your parts jobber.

Your jobber has a new catalog for you featuring the JOHNSON-Bassett Antenna line. Ask for Catalog 966J.



E. F. JOHNSON CO

WASECA, MINNESOTA

EXPORT: 25 WARREN ST., NEW YORK, N. Y.

"MANUFACTURERS OF RADIO TRANSMITTING EQUIPMENT"

RADIO COURSES

Classes Now Starting

RADIO OPERATING • BROADCASTING • CODE
RADIO SERVICING • TELEVISION

• ELECTRONICS — 1 year day course; 2 years eve.
Day and Evening Classes — Booklet upon request

NEW YORK YMCA SCHOOLS
4 West 63rd Street, New York City

LEARN TO SEND AND RECEIVE CODE

Learn to send and receive code signals, like operators on ships at sea and at commercial and amateur land stations. Intercept distress signals, news flashes, bulletins, and dozens of other kinds of interesting radio communications.

MASTER TELEPLEX teaches you to receive code exactly the way the world's best operators do — by sound. A heavy waxed paper tape, running through a machine, operates an automatic key which sends messages to you, at any speed you desire. As you improve in speed, the machine sends faster, gradually preparing you for top-speed amateur and commercial signals. With the new All Electric MASTER TELEPLEX you learn to send by sending and the signals you send are repeated back to you, exactly as you sent them, thus enabling you to correct your own errors. We furnish a complete course, lend you the improved All Electric MASTER TELEPLEX and give you personal instruction with a MONEY BACK GUARANTEE. Send for our new TELEPLEX FOLDER Q-11 today. IT'S FREE.



"HAM" SPECIAL TELEPLEX CO., 67-69 Park Place, N. Y.
In Canada, Write
Canadian Electronic Institute, Toronto, Ontario



Stack-mounting mica capacitors offered in five sizes.

.00001 to .01 mfd.
1000 to 35,000 v. Eff.

For grid, plate blocking, coupling, tank, and by-passing functions.

Minimized losses even at u.h.f. Low power factor. Handle large KVA loads without overheating. Ideal for extra-heavy-duty work.

They're
AEROVOX!

• Yes, you can now have the same commercial-grade transmitting capacitors which Aerovox has been supplying to the Army, Navy, communication companies, broadcasters, etc. • Ask your jobber about this new line.



B & W "BAND-HOPPERS"

Completely Redesigned! Vastly Improved!

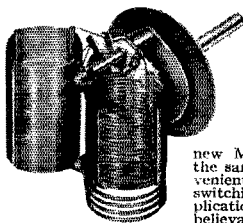

Two Models Now Available!

We've redesigned the 2A BAND-HOPPER to give you a sturdier, better 25-watt unit. We've developed the new Model 2AB to provide the same accurate, fast, convenient panel-control band switching in your 50-watt applications. Both units are unbelievably compact, yet cover all five bands. Both do a swell job! Try 'em!

The Mighty Midgets of Band Switches!

MODEL 2A (25 W. Rating) — For interstage coupling with beam power tubes. Amateur net, \$3.25.

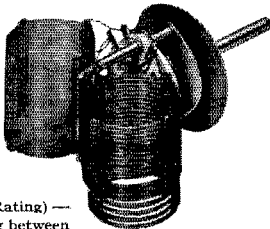

MODEL 2AB (50 W. Rating) — For interstage coupling between beam power tubes and triodes or high-powered beam tubes. Amateur net, \$3.50.

See Them at Your Jobber's!

BARKER & WILLIAMSON

Radio Manufacturing Engineers • ARDMORE, PENNSYLVANIA

W4NC/4	Winston-Salem Amateur Radio Club ⁷⁸	222-AB-2466
W8CP/8	Central New York Radio Club ⁷⁹	161-AB-2241
W4EDR/4	Birmingham Amateur Radio Club ⁸⁰	144-A -2205
W9TGL/9	Des Moines Radio Amateurs Assn. ⁸¹	124-A -2070
W8RJS/8	Akron University Radio Club ⁸²	116-A -1854
W3HOJ/3	Cumberland Radio Club ⁸³	119-A -1845
W9MWJ/9	Tri-Town Radio Amateur Club ⁸⁴	145-AB-1836
W8QBT/8	North-East Amateur Radio Club ⁸⁵	118-A -1827
W3LJP/3	Lancaster Radio Transmitting Soc. ⁸⁶	107-A -1710
W5CNG/5	Quachita Valley Amateur Radio Club ⁸⁷	104-A -1674
W9ADJ/9	Black Hills Amateur Radio Club ⁸⁸	88-AB-1161
W9KQX/9	Western Nebraska Radio Club ⁸⁹	114-AB-1089

Four Transmitters Operated Simultaneously

W3ATR/3	Beacon Radio Amateurs ⁹⁰	391-A -5670
W1JHT/1	Bridgeport Amateur Radio Assn. ⁹¹	382-A -5562
W8BOK/8	Mountaineer Amateur Radio Assn. ⁹²	322-A -4806
W2PY/2	North Newark Amateur Radio Club ⁹³	210-A -3411
W8GYR/8	Westlake Amateur Radio Assn. ⁹⁴	216-A -3195
W8NC/8	Greater Cincinnati Amateur Radio Assn. ⁹⁵	220-A -3141
W8NWH/8	Kenmore, Buffalo and Tonawanda Radio Club ⁹⁶	214-A -3132
W3BEK/3	Norfolk Radio Club ⁹⁷	188-A -2607
W3EEL/3	Baltimore Amateur Radio Assn. ⁹⁸	182-AB-2589
W9NI/9	Kaw Valley Radio Club ⁹⁹	160-A -2547
W6MKI/6	Glendale Amateur Radio Society ¹⁰⁰	185-A -2304
W2LEI/2	Albany Radio Club ¹⁰¹	125-A -1998
W5IAS/5	Tulsa Amateur Radio Club ¹⁰²	126-AB-1749
W9OUB/9	Milwaukee Radio Amateurs' Club ¹⁰³	119-A -1647
W9CAA/9	Associated Ama. Radio Oprs. of Denver ¹⁰⁴	131-A -1597.5
W1BKQ/1	Worcester Radio Assn. ¹⁰⁵	67-A -1134
W8ESN/8	Toledo Radio Club and Civilian Air Reserve Communication Co. ¹⁰⁶	107-AB-1116
W3CBL/3	Reading Radio Club ¹⁰⁷	61-A -1044
W9BDX/9	Wichita Amateur Radio Club ¹⁰⁸	55-A -846
W5FRL/5	Oklahoma City Amateur Radio Club ¹⁰⁹	62-A -756
W8AQ/8	Medina County Radio Club ¹¹⁰	77-A -438 T

Five Transmitters Operated Simultaneously

W2AER/2	Jersey Shore Amateur Radio Assn. ¹¹¹	596-A -8253
W9ATU/9	Egyptian Radio Club ¹¹²	509-AB-6904
W3AQ/3	Delaware Valley Radio Assn. ¹¹³	385-A -5400
W8UK/8	South Hills Brass Pounders & Modulators ¹¹⁴	267-A -3807
W9LIP/9	Northwest Amateur Radio Club ¹¹⁵	247-AB-3345 t
W9UQT/9	Central Illinois Amateur Radio Club ¹¹⁶	237-AB-3312
W3KW/3	South Jersey Radio Assn. ¹¹⁷	124-A -1737
W2FSN/2	Raritan Valley Radio Club ¹¹⁸	178-A -1602R
W3CNZ/3	Allentown Mike and Key Club ¹¹⁹	91-A -1503
W7EPN/7	Olympia Radio Club ¹²⁰	95-A -1314

⁷⁸ W8SVT, BOZ, HKU, ESR, NTJ, KYW, NBD, JSQ, PHC, LTQ, TOJ, TWI, Lindberg, MacCainland, Kolpelt. ⁷⁹ W1DJC, HJW, BAK, BEQ, KOY, KKS, LMR, CSC, FSH. ⁸⁰ W5AND, DNY, ECH, PUS, FVD, FXF, GKS, GUX, HBY, HJ, HNW, IJ, INL, ITS, WG. ⁸¹ W8KYH/4 W4CTE, DWB, WK, ABT, RA, DCW. ⁸² W8CP, NXQ, JPO, QGS, SHC, JUG, LJJ, DRW, GYL, EJJ, QDS. ⁸³ Fifteen oprs. ⁸⁴ W9RAI, LDM, TGL, NTA, EMB, FGG, BBB, QGF. ⁸⁵ W8OJN, TLY, OYL, KOJ, UKT, FJG, TLX, RIM, UKU, PZW, EJS. ⁸⁶ W3HOJ, HHY, HBJ, HCA, HUZ, HT, INS. ⁸⁷ Eighteen participants. ⁸⁸ W8NGW, OZA, NIC, NID, OPC, RPT, RJB, EJJ, MMQ, POR, SIV, ORM, DeWulf, McNally, Tuckerman; visitors: W8TNE, JGE, TAG, RPE, FYL, RCW. ⁸⁹ W3ADM, ADX, APO, AXI, CHV, DFI, DQP, DRO, DXL, EUL, EWB, FFJ, FHV, FWB, GGT, HW, ISB. ⁹⁰ W5AKA, KKT, CNG, CHV, DRF, DXL, EFL, FV, HEE, HES, HDK, HIE, JIE, JVE. ⁹¹ W9ADJ, AKO, GLA, YKY, YOB, ANW, GCW, IWT, JKD, HYH, APT, SWV, BLK, KNV; visitors: IQX, VOD, LNF, AGL, IYN. ⁹² Ten oprs. ⁹³ W3ATE, CMW, GNP, DYL, PHD, GRF, HTF, HTM, LDQ, W6QYH. ⁹⁴ W1ACV, AMQ, APA, APW, BBA, CIG, DQV, FSV, GRU, HJS, TCB, JEB, JWN, KAB, LCN, LIG, MDO, MHE, MHT, MGO, MQM, MRE, MRF. ⁹⁵ W8BOK, NTV, MIP, BCN, GBF, MKE, MZD, JRL, OXO, OJI, KWI, KWL, JM, RFP, SPY, ESQ, UNH. ⁹⁶ W2IWI, JSF, HRN, LGY, LIJ, KRA, LY, PY, LXI, DBY, WIGC, WFAH. ⁹⁷ Fifteen oprs. ⁹⁸ W80DH, MGD, TYL, ALV, AEL, BOS, BER, OD, RJC, TPC, JIN, KZT, LFD, NDN, NDV, NMB, QAS, QUM, RIV, SHD, SMC, STS, STY, TDW, UFA, TFE, TYM, UEV, UVA, UYN, UOD, W9LX, TLZ, ZWR, Corcoran, Jacobs, Mink. ⁹⁹ W8MQX, NEL, PQC, PMI, NVJ, UHI, UBR, UJW, NWH, NJR, CL. ¹⁰⁰ Eleven oprs. ¹⁰¹ W3OVA, EKN, EKK, ESM, FAM, GWS, HAL, HFT, HWH. ¹⁰² W3VY, EBY, EQW, FAP, FRC, KZY, KXB, MUY, ICR, YCG, VWU, JDK. ¹⁰³ W8SCP, NLZ, LCV, QIU, MMH, DSP, EHL, MQA, QXS, MKP, NLI, RIP. ¹⁰⁴ W2MIY, AWF, MTF, GSM, TQ, MCM, CMF, LQL, LEI, Paly, Swider. ¹⁰⁵ W8BOR, FFW, LW, LKJ, FDQ, GGJ, LW, IKY, BEE, GIN, AYE. ¹⁰⁶ W8OUB, NRX, VWG, CRE, VDY, KQM.

(Continued on next left-hand page)

ARMY, NAVY OR COMMERCIAL RADIO COMMUNICATIONS OFFER INTERESTING CAREER!

Begin now to prepare yourself through Candler System Training, even if you know nothing of code or radio fundamentals. Or if you know code but copy "letter-for-letter" and send jerkily, Candler High-Speed training will soon have you reading code as easily as you read print and copying behind at high speeds.

You may be practicing wrong — following old fashioned methods that are slow and hard. Why not send today for

Candler's New 1940 BOOK OF FACTS?

It gives you many helpful tips and points the way to success as an amateur or commercial operator. In the light of 28 years' experience in training operators in the Army, Navy, Commercial and Amateur Communications, The Candler System will be glad to give you expert advice which does not obligate you. Write today. You will receive a personal reply and the Book of Facts, free.

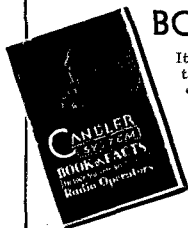

CANDLER SYSTEM CO.
Dept. Q-11, ASHEVILLE, N. C., U. S. A.

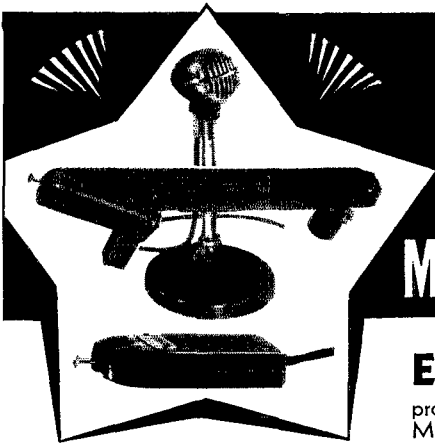

ENJOY FINEST RECORDER PERFORMANCE WITH ASTATIC'S MATCHED *CRYSTAL* PARTS

See Astatic's complete catalog of Crystal Products. If this is not available at your Radio Jobbers, Astatic will be pleased to mail you one upon request.

EVERY veteran amateur knows the efficiency of Crystal Microphones, Pickups and Recording (Cutter) Heads. These three products, so necessary to modern recorder performance, have been **MATCHED** in Astatic engineering and manufacture to work in unison for the most satisfying results. A majority of leading manufacturers have incorporated them in the new recording sets. These facts are well to keep in mind in the purchase of a complete recorder or in the assembling of such a set. Only with the introduction of Astatic's Crystal Cutting Head has high class home recording been brought within the purchasing possibilities of the ordinary individual.

ASTATIC

ASTATIC MICROPHONE

ASTATIC CRYSTAL PRODUCTS LICENSED UNDER
BRUSH DEVELOPMENT CO. PATENTS

IN CANADA: CANADIAN
ASTATIC Ltd., TORONTO, ONT.

YOUNGSTOWN
OHIO

Laboratory Inc.

AMATEUR RADIO LICENSES

Day and Evening Classes in Code and Theory
HOME STUDY COURSES

*Reasonable, Efficient and Thorough, Hundreds of
Licensed Students Now on the Air*

American Radio Institute, 1123 Broadway, New York, N. Y.

Piezo-Electric Crystals Exclusively

- Quality crystals of all practical frequencies supplied **SINCE 1925**. Prices quoted upon receipt of your specifications.

Our Pledge: **QUALITY FIRST**
SCIENTIFIC RADIO SERVICE

"The Crystal Specialists Since 1925" University Park, Hyattsville, Md.

Now Ready!!

SEVENTH (1940) EDITION
Nilson & Hornung's
**RADIO OPERATING
QUESTIONS AND ANSWERS**

Covers all elements, 1 to 6, of the sample questions published by the F.C.C. in their Study Guide for Commercial Operators. Ideal handbook. Pocket size, flexible. Price \$2.50, postpaid. Money back if not satisfied and book is returned in 10 days. Send check or money order . . . not cash. C.O.D. charges extra. Free circular on request.

NILSON RADIO SCHOOL
51 East 42nd St., New York, N. Y.

PRECISION Series 844-34 RANGE AC-DC VOLT-OHM-DECIBEL-MILLIAMMETER

A Precision engineered instrument providing all measurement facilities to meet the exacting requirements of Amateur Radio, Service, Laboratory, Television and Industrial. 6 AC and DC voltage ranges to 6000 volts. 6 current ranges to 12 AMPS. 4 resistance ranges to 10 MEGS. SIX DB ranges from -12 to 70 DB. SIX output ranges to 6000 volts. 4 1/2" 400 microampere easy reading meter. 2% accuracy.

Series 844L (illustrated) in hardwood walnut finished carrying case (7 1/2 x 8 1/2 x 4) less batteries and test leads. **\$22.95**
Net Price

6000 VOLTS AC-DC

10
Megohms
12
Amperes

PRECISION TEST EQUIPMENT

Standard of Accuracy **SEE THEM AT YOUR JOBBER**

PRECISION APPARATUS COMPANY
647 Kent Avenue Brooklyn, New York
Export Div.: 458 Broadway, N. Y. C., U. S. A. Cables: Morhanex

A SENSATIONAL RECEIVER AT A SENSATIONAL PRICE

NEW NC-200

NET
\$147⁵⁰
Price

Complete with 10" speaker
in separate cabinet to match.
READY TO RUN.

THE NC-200 HAS EVERYTHING

Four uniform amateur bandspread ranges with fixed calibration, plus 10 general coverage ranges • Stabilized circuit • New crystal filter • Series valve noise limiter • Temperature compensation.



SUN HAS EVERYTHING, TOO!

ONE OF THE LARGEST, MOST COMPLETE STOCKS OF AMATEUR RADIO EQUIPMENT in the EAST

THE FASTEST SERVICE

THE HIGHEST TRADE-IN ALLOWANCES

THE EASIEST PAYMENT PLAN OF ALL

TRY US YOURSELF and be CONVINCED!

New York's Oldest "Ham" House
W2JEH — W2DXC — W2LFV — W2CLH



RADIO CO.

212 Fulton Street, Dept. NY New York

Cable Address: SUNRADIO NEW YORK

Six Transmitters Operated Simultaneously

W9KYC/9	St. Paul Radio Club ¹²¹	505-A	-8853.5
W9RBI/9	Della Region Radio Club ¹²²	362-A	-4941
W3GAG/3	Philadelphia Wireless Assn. ¹²³	314-A	-4869
W1GB/1	New Haven Amateur Radio Assn. ¹²⁴	305-A	-4725
W2WQ/2	Northern Nassau Wireless Assn. ¹²⁵	342-A	-4599
W8ODJ/8	Buckeye Radio Club ¹²⁶	319-A	-4527
W9KA/9	York Radio Club ¹²⁷	281-A	-4275
W2ACB/2	Schenectady Amateur Radio Assn. ¹²⁸	370-AC	-4023
W9MD/9	Illinois Ham Club ¹²⁹	261-A	-3807
W2AVS/2	Suffolk Amateur Radio Club ¹³⁰	244-A	-3771
W9UJM/9	Sheboygan Radio Amateur's Club ¹³¹	241-A	-3492
W8CMB/8	South Cleveland Radio Club ¹³²	232-A	-3042
W9PEQ/9	Chicago Suburban Radio Assn. ¹³³	163-A	-2268
W6CL/6	Amateur Radio Researchers ¹³⁴	139-A	-1638

Seven Transmitters Operated Simultaneously

W3BKX/3	Frankford Radio Club ¹³⁵	601-A	-8106
W8URA/8	Cuyahoga Radio Assn. ¹³⁶	338-A	-4869
W3QV/3	York Road Radio Club ¹³⁷	321-A	-4707
W6VX/6	City of Amateur Radio Oprs. ¹³⁸	363-AB	-4023

Ten Transmitters Operated Simultaneously

W2GW/3	Tri-County Radio Assn. ¹³⁹	618-A	-8154
W6BKZ/6	Palomar Radio Club ¹⁴⁰	326-A	-4176

Eleven Transmitters Operated Simultaneously

W3GKI/2	Tri-States Radio Club ¹⁴¹	423-A	-5449.5
---------	--------------------------------------	-------	---------

HOME STATION SCORES

W1TS	120	W8ROX	113	W9YWQ**	110
W9BRD	115	W8YX*	111	W3IMH	97

*W9SDN, and W9VNN, oprs.

**W9UUM, opr.

SYT, DDB, EFX, ESO, HRM, ANA, JPS, EEL, GSP, HMO, MZZ, IZT, DII, CVL, MPV, UIR, SZH, UNJ, 104 W9RCJ, OLL, GVL, CAJ, TTY, NCD, BQR, YTH, WYX, AYY, FVV, JLD, QYU, NBB, CBE, VGC, TFF, BIN, 106 W1JNA, LBU, MTD, LOD, JOP, IZV, LTA, IOR, DDK, JDI, 107 W8ERN, KPH, SKB, TIV, TPX, RZO, UFN, UQE, UUC, 108 W3FJL, FQS, GIT, GQU, GWY, HXK, HXQ, HPD, HPG, HVL, ICI, ICK, ILX, IUI, IUT, Essely, Kendall, Martyr, 109 W9AIB, WIN, BDX, YVL, QKV, DJL, IBN, JGU, QEF, 100 Participants not indicated. 110 W8KNE, OGR, LCV, JYY, EEL, RPS, TAF, HPD, AQ, 111 W2FQR, HWX, IKL, LMB, LYY, GUM, FZY, ABR, CJU, CZP, GME, FC, BZJ, CYS, AIV, AFU, GAK, MYW, BUX, FRC, GSA, DIL, HZI, JPT, WIKVY, JNE, WYBS, EFM, Victor and Albert Colacourt, Tallman, Woolley, Cornman, 112 W9KEH, RCQ, EKD, AFE, EFC, DZG, BPN, FXN, RVY, RXT, YZH, OWY, UAK, WCM, DJG, THB, YRX, NKS, RVN, GHW, Watson, 113 W3QNU, HZO, CCC, CCO, ZI, EUB, CFS, IOK, ITO, GRW, BAQ, ISZ, EEP, FIAZ, HTY, LEM, 114 W8FGA, OX, OKO, BK, LVI, AIG, MFO, OKP, SFV, TGE, TVG, GJM, ESD, AMY, QXT, OVT, UK, Snelksy, Stoner, Kelly, 115 Twenty participants. 116 Twenty-five oprs. 117 W3KW, CES, VX, GHJ, GBT, DAJ, 118 W2KAV, RTX, FRD, FSN, MNE, CAH, CVD, KAB, MET, LPL, W3FPE, W3HHG, RST, AIX, OE, EYN, BFC, CML, DOV, 119 W9PC, YCE, OXQ, QDF, QJL, ORL, JIE, MPW, OYC, IFV, ZWV, 120 W8HHR, DIR, YYZ, ORL, NKT, BOK, EMO, FGU, 121 W3BYB, EHF, FXG, FYC, GUV, GYK, GZB, HRD, HRG, IIN, DVG, DIV, DJJ, Mayall, Barsky, Peterman, Shaw, 122 W1KQV, BYW, WCD, GLE, TUD, GLE, TUD, GLE, TUD, GLE, TUD, GLE, HSK, CSY, JHN, WR, GDC, W2AMD, Naughton, Libertino, Brown, Hallock, Starzyk Bros., 123 W2BWC, LZP, DXO, ICO, AHC, AYJ, WQ, DUA, AZS, MIL, HYJ, DDU, INF, MJY, HIX, MET, GZS, HQJ, IRY, LFA, HUP, GJ, DKJ, Ankerson, Stevenson, Kuzhka, Schweitzer, 124 W8CFL, AKQ, BDG, GCL, SBA, FUP, ESR, JYM, EYP, LWB, KFW, OJJ, BZL, NZW, SAE, UJB, POZ, KLB, LBU, DZI, QYR, 125 W9BGI, CIU, CQI, CJP, CWP, GY, JO, KA, MDM, NST, PAE, PNB, QDG, QHE, RTA, RQZ, SKR, SMB, TGB, VBI, WC, XPV, UXO, 126 Twenty-eight oprs. 127 W9TO, MVU, WZE, NBL, ATG, GUL, AHH, UNJ, 128 W9CJ, GSP, SFW, FVT, ULV, ROP, FVJ, BGA, ABU, 129 W2AVS, ADV, BEA, BUK, DOG, LVB, LUD, KLC, LLL, LKK, CMJ, BIU, CGD, JER, 130 W9BLB, DLA, FHA, ITH, JDP, JTZ, KYY, MYG, NEM, NVJ, NZP, OJI, POS, QYH, QZO, UJM, WSE, YNP, Grant, Beware, 131 W8CRB, TCS, OQV, OBG, OKU, PSS, QJL, LEM, BKB, OOC, EFC, MXX, IRL, OXK, LXR, 132 W9PBQ, PNY, ISO, KKK, MNW, FJY, TQL, WGD, USJ, IOQ, UIE, WWQ, ZPR, GPV, DGR, PGW, IEN, IV, Gable, Brown, 133 W6CL, RMK, RCH, RJV, QOR, BPP, SOY, QEF, QOK, CNJ, RUY, RDI, PFG, GHU, NAT, SAE, REG, Williams, 134 W3GV, BES, GOW, GYH, BNE, BNL, RQG, FET, GED, GDM, FEG, GYH, EHT, HED, HQE, HXA, HYT, IGE, IKW, ILE, KT, 135 W8GKG, NV, QV, EBJ, WV, AVH, IOL, PKF, BMX, MMO, DS, TMI, FFK, TMA, EFW, AOK, AUH, QIN, SSV, UCY, CFI, PLQ, NEH, TAY, UNA, PWY, 136 W3DGO, GYY, EHZ, ALB, BRP, ADZ, HIO, EYS, GQU, IOI, EYR, QV, HFE, KTB, GRY, DPU, GOR, GUB, EFC, EFM, 137 W9AIB, GYU, WIIGN, 138 Oprs: Woerner, Cady, Seese, Atkins, Matthews, Blanchard, Mitchell, Bailey, Tynes, Westler, McCargar, Dufour, Frey, Gompertz, Murdoch, Smith, Robertson, Brown, McCullough, 139 Forty oprs. 140 W6NWG, CLT, FAX, BOS, EGL, IWI, RPI, GIV, PCG, EMB, FCB, HZ, 141 W8HIZ, HMA, G, FRQ, NAR, SBF, MEB, Perry, Hickman, 142 W8HIZ, HMA, G, GKT, W2KMI, CGG, HOZ, BOC, IQO, KHY, LCP, LEX, HVM, LCW, LAX, GFX, JOG, NE, LXX, LVD, GXM, LXO, 143 W2MEO, KZG, AUI, FBB, IVP, MOR, AGX, IMX, HDA,

W4FIJ	75	W6IOJ	21	W3ABS	5
W8SLH	70	W2HTH	20	W8UUZ	5
W4ERG	64	W8SCW	20	W1ALP	4
W2HUG	54	W9OLD	18	W6DHS	4
W8NCJ	53	W6SN	17	W8DTV	4
W8DAE	50	W1BIH	15	W1DWK	3
W1MEC	47	W8JTT	15	W1KIN	2
W8QQB	38	W2MFR	13	W1LQK	2
W8TKM	35	W2JPV	12	W7HHH	2
W4PL	32	W8EU	7	W1LUA	1
W2MLV	30	W1ZR	6	W2MHE	1
W3QP	24	W2MZB	6	W2MIV	1
		W2MEW	5		

INDIVIDUALS AND NON-CLUB GROUPS

One Transmitter

W3FVJ/3	W3FEW-FFC-FVJ-HQU-GOA- Shenton.....	195-A -3267
W8QOK/8	W80FN-NAB-QOK-Reiter.....	110-A -2831
W6PKW/9	W9PKW-GVZ-NZM.....	154-A -2601
W3CBK/3	W3EHV-GBO-FQF-CBK.....	156-A -2574
W1EH/1	W1JFN-EH-JPE-LVQ-JEQ.....	129-A -2183
W3BSY/3	W3BSY-AVR.....	111-AB-1947
W9FWS/8	W9FWS-SVH-DEE-BYI.....	94-A -1503
W6BAM/6	W6IBN-LQX-NRM-STM-SIX- RLQ-NGO-BAM-RKD.....	84-A -1422
W8JNJ/8	W8JNJ-LEV-FBC.....	89-A -1332
W8OPX/8	W8APC-OYY-OPX.....	119-B -1332
W7GEE/7	W7CJR-GEE.....	67-A -1323
W2FBA/8	W2JBC-FBA.....	71-A -1251
W8IBU/8	W8IBU-QKM-RRQ-PUZ-AFE- RQT-QBE-QXS-TIO-AAR.....	78-A -1116
W3FPQ/3	W3ZD-FPQ.....	50-A -1071
W9LJL/9	W9LJL-Donald Taylor.....	63-A -1071
W2ILE/2	W2ILE-FHU.....	80-A - 999
W3NF/3	W3IKG-FIS-NF-IMK.....	56-A - 980
W1LN/1	W1LN-EKT.....	45-A - 900
W8MHM/8	W8MHM-ALG-CBN-IYH-MQC.....	75-A - 846 R
W2EQS/3	W2EQS.....	70-A - 828 R
W5HQN/5	W5HQN.....	71-B - 828
W8KO/8	W8KO.....	44-A - 801
W5BEH/5	Two optrs.....	61-B - 780
W8CTC/8	W8QFC-CTC.....	35-A - 765
W5BTK/5	W5BTK-HWZ-HNB.....	52-B - 684
W4FDT/4	W4FDT-AGW-FWP.....	38-A - 666
W2LWD/2	W2LWD-LDH-IOC-MJC.....	66-A - 648
W4DGS/4	W4DGS.....	37-A - 594
W1JLT/1	W1JLT.....	36-A - 567
W7RT/7	W7RT.....	23-A - 549
W1BK/1	W1BK.....	34-A - 540
W9NQP/9	W4DL-W9HLS-IYA-MUX-NQP- VFO.....	41-A - 540
W3BHE/3	W3BHE-GUT-FRV-ACQ-GME.....	50-B - 510
W3FRB/6	W3FRB-GAC.....	34-A - 492 T
W2LOP/2	W2LOP-JMX.....	24-A - 486
W9JZK/9	W9JBL-JZK-OKB.....	17-A - 468
W6HY/6	W6HY-EOP.....	34-A - 450
W4FLW/4	W4FLW.....	20-A - 441
W8OML/8	W8OML-TJU.....	30-B - 414
W3FKJ/3	W3FKJ-FKX-ITZ.....	16-A - 396
W8PVK/8	W8PTW-QGD-QQK-QZF-UUO-IXJ.....	23-A - 396
W9QAQ/9	W9QAQ-SEE-PGG-NPB-YYF.....	14-A - 361
W4ECF/4	W4ECF.....	12-A - 351
W4GIQ/4	W4GIQ-GIV.....	45-A - 344 RT
W9AB/9	W9ZYK-AB.....	21-A - 333
W9KRQ/9	W9EJZ-MLG-KRQ.....	20-A - 315
W8RKM/8	W8CEC-CYD-RKM-W9FBL.....	27-B - 312
W9WVP/9	W9KLM-QUE-WVP.....	16-A - 284
W9WXD/9	W9WXD.....	11-B - 252
W9QNH/9	W9QNH.....	26-B - 216
W8BAL/8	W8JXW-BAL-DBL.....	12-A - 207
W3EYX/3	W3EYX.....	18-B - 192
W9JAU/9	W9JAU-WJS.....	19-A - 192 R
W8OMA/8	W8FMX-OMA.....	11-A - 180
W8SVC/8	W8SVC-UJM.....	13-A - 150 T
W2MLX/2	W2MQF-MLX-Trimmell.....	12-A - 126
W4GSI/8	W4GSI.....	23-A - 123 RT
W9ZXA/9	W9ZXA.....	9-A - 108
W8JIW/8	W8JIW.....	9-A - 96 T
W6QPN/6	W6QPN.....	1-A - 18

Two Transmitters Operated Simultaneously

W3GGC/3	W3ISE-FVC-FWH-LN-GGC-Sheck- ler-Almond.....	217-A -3438
W2IYQ/3	W2IYQ-IGT-JFB-JSE-KMK-MNT.....	170-A -2727

THANKS FELLAS!

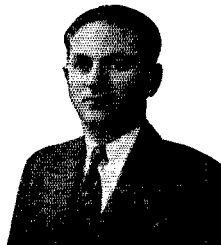

I thought this would be the easiest means of thanking all my many friends for the kind sentiments and best wishes extended me since joining SUN RADIO. No kidding, fellas, it's great to learn there are so many whom one can call "friend." If I were to sit down and write each and every one of you a personal note of appreciation it would take me weeks on end. Believe me, then, with an endeavor to express my heartfelt thanks with as much warmth as this method of message can convey.

Sincerely,

Hyman Hakes

P.S. Should you be around this way, don't hesitate to drop in. I'd be only too glad to see you — even if only to discuss the good old days. And, boy, should you want anything, why, just yell out. You'll find I'm still at your service. In a bigger and better way, too, for there's a great bunch here at SUN and we really can do things up brown.

The Whole Town's Talking
about SUN'S EASY PAYMENT PLAN and
GENEROUS TRADE-IN ALLOWANCES

We don't actually give anything away, but where else can you find such liberal, friendly treatment? There's no fuss, no bother, no trouble in arranging terms for we finance your purchase *ourselves* — and at the lowest carrying charge of any radio concern. Fed up with your old rig? Bring it in or write us about it and we'll give you the fairest, squarest trade-in offer ever! Customers find SUN extremely generous in the valuation of used equipment . . . especially when it's applied towards the purchase of new "ham" gear, hi!

JUST OUT!

THORDARSON X'MITTER GUIDE

Schematic diagrams, parts lists and complete instructions on "How to Build" 14 different transmitters — from a 20 Watt C.W. to a 1000 watt model. Send for Bulletin 344-E. Price 15c.

TRY SUN for SERVICE

New York's Oldest "Ham" House

W2JEH — W2DXC — W2LFV — W2CLH

SUN RADIO CO.
212 Fulton Street, Dept. NT New York
Cable Address SUNRADIO NEW YORK

PINCOA



DYNAMOTORS

Pinco Dynamotors are as much "at home" on tough jobs as on ordinary ones. No wonder they are specified by governmental and commercial users universally for aircraft, marine and broadcast service, police units, sound systems, auto radios, etc. Available in a wide variety of types and frames for any requirement. Highest efficiency and regulation. Capacities: 5 to 850 watts. Input, 6 to 110 volts; output, up to 1750 volts. Specify "Pinco" and be sure of thousands of hours of dependable, quiet service. Mail coupon for complete information.

PIONEER GEN-E-MOTOR CORP.
CHICAGO, ILLINOIS

Export Department: 25 Warren St., New York, New York
Cable Address: SIMONTRICE, New York

Pioneer Gen-E-Motor Corp.

Dept. R-6K, 466 W. Superior St., Chicago, Ill.

Please send information on Pinco Dynamotors, Motor Generators and special power supply unit.

Name

Address

City State

BE PREPARED — Learn the Telegraph Code

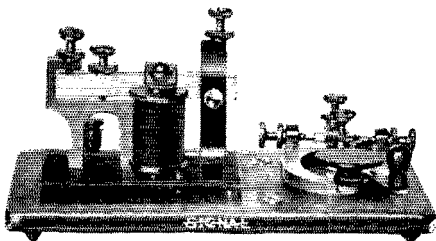

Make your spare moments count now! Learn the telegraph code with a Signal Telegraph Learner Set. Set consists of high grade key and sounder. It is easy to handle and has a clear, distinct tone. Bar frame and key base are black enamel. Bridge is brass, sounding bar aluminum with black lacquered steel sounder plate. Key lever is nickel plated. Sounder and key are mounted on a mahogany finished wood base. Price of instrument illustrated is \$5.75 list. If your jobber cannot supply you, order direct.

SIGNAL ELECTRIC MFG. CO.
MENOMINEE, MICHIGAN

Established
1892

SIGNAL

W1BDI/1	W1BDI-UE-JTD-JMY-AFB-JWG-BQL	101-AB-2676
W4FRU/4	W4FRU-GRD-GJB	120-A -2214
W9ARN/9	Five oprs.	106-A -1818
W9QJG/9		101-A -1656
W2LA/2	W2CUD-GNB-IDY-ISJ-JAI-LA-LDS	70-A -1242
W3AWS/3	W3AWS-EIS-FQB	67-A -1227
W4FDA/4	W4EOS-EID-EOE-DIQ-CRZ-EUD-GFI-FDA	83-A -1170
W1CRP/1	W1CRP-LNL-JRS-GKJ	56-A -1080
W5GRL/5	W5GRL-HML-IDU-W3HEM-Gor-linsky	48-A - 909
W6REC/9	W6AUT-KAQ-NNA-ZXE	45-A - 747
W8SDH/8	W8RAE-JZD-PYP-SDH-HKT-SCS-SWG	50-AB- 501
W2BPV/2	W2BPV-HLS	44-A - 432

Three Transmitters Operated Simultaneously

W9ERU/9	W9AGV-AIC-ASB-BNO-OCO-CZB-ERU-FFQ-JK-MAP-PGQ-TET-Miller	184-A -2502
W2FUV/2	Woodbridge Amateur Radio Emergency Corps ¹⁴	164-A -2439
W5FOP/5	W5FOP-HBH-CVW-IA-PRD-FVH	171-A -2430
W6CFI/6	W6CFI-NSC-KSX-VB-AQJ	170-A -3301
W9TEW/9	W9TEW-WNG-FI-YZN-GFU-LBN	150-A -2184
W1JYX/1	W1JYX-LOF-HHY-KUN-LEI-KUO-LVX-JBV-MEM	150-A -2178
W5EB/5	W5EB-GMR-BQD-BTH-JRO-HSH-HUZ-A DJ - HNW - Holden - Michand-Bell-Ayotte-Arsenault	100-A -1638
W9FVY/9	W9CXI-AUL-SQV-FVY	86-AB- 873

Four Transmitters Operated Simultaneously

W9JU/9	Prairie Dog Emergency Crew ¹⁴	224-A -3474
W3HBD/3	W3RIP-GUR-GUX-HAC-HOG-ITW	168-A -2664
W6MSM/6	W6KEV-MRB-RXU-RXK-MSM	128-AB-1549

Five Transmitters Operated Simultaneously

W6CIS/6	San Francisco Radio Amateur Emergency Corps ¹⁴	275-A -3519
---------	---	-------------

Six Transmitters Operated Simultaneously

W9VSX/9	W9FIB-FWU-GFG-GPS-HWN-HXW-HTZ-IMB-IMN-IMV-KBO-KKH-MRQ-MUZ-RRC-SXZ-TJD-TUV-VSX-YZV-Wood-Kimball-Huston	211-A -3114
W9ARU/9	Twelve oprs.	82-A - 798 T

IGN, ISW, ICG, ELV, COF, CNP, MDP, FUV, GKX, DPV, KJR, WCGNM, EZF, GUW, HLB, JU, EKY, LNG, OQT, TAL, TDF, UYB, VVY, NXX, YWA, ZKO, ZPV, ZYL, Wol-tenhaupt, W6RBBQ, PGB, MCQ, WNY, SCR, SBT, ATY, CSX, AHH, BIP, CIS, QBD, RH, MZ, BUJ, KJ, EKQ, McGurk.

WWV Schedules

EXCEPT for the special broadcasts of WWV using 20 kw. as described below, WWV is now running a continuous schedule (day and night) on 5000 kc. with a power output of 1 kw. This continuous transmission is modulated with the standard pitch in music, 440 cycles per second.

Each Tuesday, Wednesday and Friday (except legal holidays), the National Bureau of Standards station, WWV, transmits with a power of 20 kw. on three carrier frequencies as follows: 10:00 to 11:30 A.M., E.S.T., on 5000 kc.; noon to 1:30 P.M., E.S.T., on 10,000 kc.; 2:00 to 3:30 P.M., E.S.T., on 15,000 kc. The Tuesday and Friday transmissions are unmodulated c.w. except for 1-second standard-time intervals consisting of short pulses with 1000-cycle modulation. On the Wednesday transmissions, the carrier is modulated 30% with a standard audio frequency of 1000 c.p.s. The accuracy of the frequencies of the WWV transmissions is better than 1 part in 10,000,000.

Have You Seen the NEW INCA TRANSFORMER CATALOG?



New type format of Bulletin L-45 permits much more space for descriptive material, charts, tables and diagrams. Lists the sensational new "Ti-get" series of midget high fidelity transformers as well as standard transformers for Amateurs, Radio Broadcast, Sound Equipment, Television, and Replacement.

All Inca transformers are treated by the exclusive "Climatite" system* which has proven its worth in the most humid regions of the globe. *ONLY Inca transformers have Climatite* treatment.*

Get Bulletin L-45 from your jobber or from . . .

*Reg. U. S. Pat. Off.

THE PHELPS DODGE COPPER PRODUCTS CORPORATION

Inca Manufacturing Division—Dept. D 2375 East 27th Street, Los Angeles, California

TURNER
Microphones
Write for free new literature to
The TURNER CO. Cedar Rapids, Iowa
Crystals licensed under patents Bush Development Co.

SICKLES COILS

ALL TYPES OF RF AND IF WINDINGS

Manufactured by

F. W. SICKLES COMPANY

300 Main Street

Springfield, Mass.

RADIO TECHNOLOGY



RCA Institutes offer an intensive course of high standard embracing all phases of Radio and Television. Practical training with modern equipment at New York and Chicago Schools. Also specialized courses in Aviation Communications, Radio Servicing and Commercial Operating. Illustrated Catalog on request

RCA INSTITUTES, INC. Dept. ST-40

A Radio Corporation of America Service

75 Varick St., New York

1154 Merchandise Mart, Chicago

LEARN CODE THE WAY YOU'LL USE IT—BY HEARING IT

Type S - \$17.50

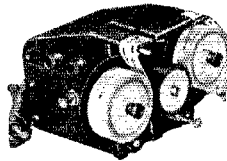

Sends from 4 to 60 words per minute. Higher speeds if desired. Complete with 10 rolls of double-perforated lesson tape of carefully selected and arranged matter for speediest results in learning code. Most compact and practical code teacher on market.

Type J - \$12.50

Double-purpose instrument—code teacher and automatic sender. Sends from 6 to 70 words per minute. Built-in tape perforator. Cut your own code-practise tapes and message tapes. Complete with already-cut practise tape and 5 rolls of blank tape. Repeats calls and messages indefinitely. Length of messages practically unlimited.

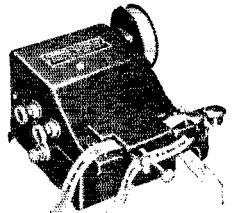

If your dealer can't supply you, write us

FULLY GUARANTEED

GARDINER-LEVERING CO. Haddon Heights
New Jersey, U. S. A.

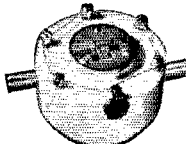
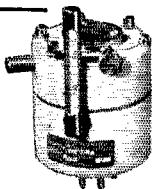

GENERAL COMMUNICATIONS CRYSTALS HOLDERS AND OVENS

Precision Made by *Bliley*

WRITE FOR CATALOG G-11

BLILEY ELECTRIC CO., ERIE, PA.



CAMERADIO

has the NC-200

The New NC-200 is the real buy of the year. Never before has a receiver had so many desirable features at such an amazingly low net price. The NC-200 is backed by National's famous standards for quality.



- Six general coverage ranges
- Four uniform amateur bandspread ranges
- All ranges have definite accurate calibration
- Actual single control tuning
- New crystal filter
- Series valve noise limiter
- Stabilized circuit
- Temperature compensation
- Speaker in matching cabinet
- Amateur net price, \$147.50

Available on our time-payment plan

Drop in and try the New NC-200 for yourself,
or order now by mail

You can depend on our usual prompt service

CAMERADIO COMPANY

963 Liberty Ave.
Pittsburgh, Pa.



1002 Main Street
Wheeling, W. Va.

Correspondence Department

(Continued from page 51)

The officers of the Allied forces learned that their telephone lines were being tapped by the Germans, and all their orders were known by the enemy even before an order could be carried out. Captain E. W. Horner conceived the idea of having Indians talk over the lines in an attempt to fool the Germans, this being done of course in their native language.

Solomon Lewis was asked to choose seven Choctaws who were well versed in the Choctaw language. He selected Cartaby, Nelson, Wilson, Edwards, Maytubby and Taylor. Joseph Oklahombi was also in the group chosen. The seven Indians were placed in the front lines some distance apart.

Edwards was with the Field Artillery Lewis was at division headquarters. Edwards told Lewis that the Germans were preparing to go over the top. The other Indian boys all along the line disclosed the same information, but Ben Cartaby stressed his message a little more specifically: "Go tell Colonel Brewer it is hell down here where I am," he said. "The German crack troops are getting ready to go over the top tomorrow. They are the Prussian Guards."

Colonel Brewer gave orders for the division to go over the top at 6 o'clock the next morning. A message was dispatched to the field artillery in Choctaw for a barrage to be laid down at 5:55 A.M. When the division went over the top that day more than 500 prisoners were taken in 30 minutes. German dead littered the battlefield. Joseph Oklahombi, the Choctaw who made such a wonderful record for the Indians of Oklahoma and the American troops, also distinguished himself in this encounter.

All the Choctaws lived to return to Oklahoma, and are now living in and around Hugo. Most of them to-day are farmers.

Although I am not a Choctaw nor an Indian, I have lived and worked with these people now for over 30 years.

— Ed. Harris, W5TW

SUPPORT

401-2-3 Arcade Bldg., Kankakee, Ill.
Editor, *QST*:

Enclosed herewith find money order . . . for which I wish membership in the League, as per application also herewith enclosed. . . .

I am not new to amateur radio, having received my first license in 1926, as a youngster of 16 with the dotty call of 9ELH. Scarce pennies forbade the gross outlay of the membership fee of A.R.R.L. then, but about five years' newsstand issues of *QST* are among my most treasured possessions, dated 1924 to 1929.

To-day, with eight years' experience as an attorney, I realize to the fullest the value of organized group effort in all fields, and particularly can I appreciate the inestimable service A.R.R.L. has rendered the amateurs of the whole world.

With the realization that A.R.R.L. is a clear expression of the true American way, striving to maintain free speech in the most modern medium, I assure A.R.R.L. of my whole-hearted support in its every effort.

— Edward P. Drolet, W9IBU

HAM SPIRIT

44 Holloway Head, Birmingham 1, England Editor, QST:

I would like to take this opportunity of putting on record the true ham spirit shown by Mr. Percy Spencer, W1GBE, to me with regard to the evacuation of my boy.

Some time ago, I decided to send my son to M.I.T., Boston, to continue his education, and my good friend, Percy Spencer, W1GBE, to whom I appealed for help, spent considerable time and trouble in getting him entered and accepted by the Institute.

Owing to the urgency of the situation, he cabled me many times at his own expense, and in reply to my request to find the boy suitable accommodation, his cable read:

“MY HOME TED’S HOME ALWAYS”

At a later date it was found that Currency Regulations prohibited my paying for the boy’s education at M.I.T., despite the fact that I had funds here it was not possible, in the national interests, to convert them for this purpose. In addition to this, I was not allowed even the dollars to pay for my boy’s maintenance over there.

I immediately informed Percy of this state of affairs, but the offer still held; in other words, he cabled back to say he would be glad to have Ted and keep him, although we could not pay for him.

How much we appreciated the kindness shown can hardly be expressed in words, and although we cannot educate the boy we feel that he will do, for his part, as much as possible by working to repay, at least a part of the kindness shown him.

Some months ago we had word from a Britisher, resident in Holland at the time of the German invasion there, who had come across to this country with his wife and baby, and we, at this address, have been able to find him employment and accommodation.

If there are any skeptical people wondering whether it is worthwhile being a ham, we trust this letter, if published, will give the answer.

73.

— W. H. D. Nightingale, G5NI

Strays

Those who like to trim up their panels might use the scheme used in certain types of RCA equipment. An ornamental trim is made by drilling holes at appropriate points and stretching chromium wires between them. The wires are held in place by bending over on the back of the panel. At a short distance, the wires create the illusion of being machined or cast on the surface.

— W9DOY.



The answer to a Ham’s prayer is now in stock on our shelves. Six coil ranges covering from 490 KC to 30 MC, plus four separate band-spread ranges for ham bands. Six step crystal filter, temperature compensation, noise limiter, separate speaker and a dozen other features make it *the* buy for amateur work. It’s the new National NC-200, and it sells for only \$147.50 net, ready to run.

TIME PAY. FOR CONN. HAMS

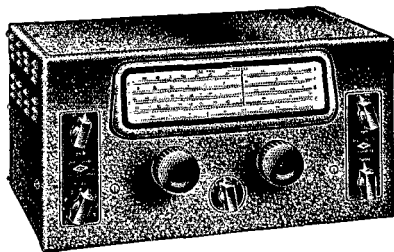

NATIONAL NC-44

The NC-44 is another receiver bargain that is too well known to need a description here. We’ll merely remind you that the price is only \$49.50 net, ready to run.

SAVE EXPRESS CHARGES

Hatry & Young is organized to give you quick, dependable service from three Connecticut stores. Save delay and express charges.

HATRY & YOUNG

203 Ann St., Hartford, Connecticut
1172 Chapel St., New Haven, Connecticut
177 Cannon St., Bridgeport, Connecticut

3 CONVENIENT STORES

Operating Pleasure

**FREQUENCY FLEXIBILITY
with CRYSTAL STABILITY**

The Bliley Vari-X, with VF2 wide range variable crystal units, provides V.F.O. flexibility with full crystal stability. Circular D2, obtainable from your Bliley Distributor, gives complete information.

**BLILEY Vari-X
VARIABLE CRYSTAL OSCILLATOR**

TINKERER? . . . OR BUSINESSMAN?

Less Time to Repair Radios . . .
Means MORE Time to Build Business!

RCA

RIDER CHANALYST

Progressive servicemen today spend less time bending over receivers—more time going out after business . . . developing business-getting ideas . . . building their business. They use the Rider Chanalyst!

Greatest advance in radio servicing instruments since servicing began, the RCA Rider Chanalyst uses the newest method of attack: the

signal itself, common to every radio. It's an investment worth investigating! Ask your RCA Distributor for on-the-circuit proof of the Chanalyst's effectiveness by means of the Dynamic Demonstrator.

Over 380 million RCA Radio Tubes have been purchased by radio users. In tubes, as in test equipment and accessories, it pays to go RCA All the Way.

RCA Test Equipment

RCA Manufacturing Co., Inc., Camden, N. J.
A Service of Radio Corporation of America

Two-Way Television Communication

(Continued from page 37)

their unanimously enthusiastic comments, indicate that ham television has a thoroughly practical appeal. Blasé old-timer and veriest beginner both get the same kick out of it.

The W2USA gang have done another fine thing for amateur radio in establishing this television demonstration for the final month of the Fair. Art Lynch and the boys rate high credit for giving the game another historical "first."

— J. J. L.

A Stabilized 2½-Meter Oscillator

(Continued from page 35)

the entire assembly will fit together nicely and no trouble will be had in threading the grid wire up through the three polystyrene blocks.

Although all of the above may sound confusing and a bit complicated, the actual work involved is slight and, since the materials are all easy to work with, should take no more time than the building of any other one-tube oscillator.

Tuning

The nice thing about these little oscillators is that there are almost no adjustments to be made other than connecting the power supply and tuning the thing to the proper frequency. Of the several built in the laboratory, every one worked right off and required practically no adjustment. Some time was spent in noting the effect of various excitation adjustments (made by pushing down on the grid wire to bend it over towards one side of the can) and with grid leaks, and the only trouble we found was a tendency to "squeg" when the grid-leak resistance was made too high. A flash-light bulb dummy load was used to measure the output, and a 35- μ fd. midget tuning condenser was placed in series with the loop and the bulb to tune for maximum output. It was possible to overcouple the oscillator (as evidenced by double-peak tuning) without throwing it out of oscillation. With the dimensions given above, 112 Mc. hit with the tuning condenser about $\frac{3}{4}$ meshed.

Output and Stability

We didn't expect to get terrific outputs with the small receiving tube that was used, and so we weren't disappointed when the power, as measured by the dummy load, proved to be only 0.3 watts, with an input of 2 watts (150 volts, 13 ma.). The 15% efficiency can be considered good for an ordinary receiving tube at 112 Mc. The input can be run higher, and the tube was operated for considerable periods at 4 watts (200 volts, 20 ma.) without any apparent damage. However, the power supply had a VR-150 stabilizing the voltage on the oscillator, and the normal operating voltage was consequently limited to 150. If one is not so meticulous about the stability of the plate voltage, the regulator tube can be dispensed

Where to buy it

A directory of suppliers who carry in stock the products of these dependable manufacturers.



ALBANY, N. Y. Uncle Dave's Radio Shack 356 Broadway
ATLANTA, GEORGIA 265 Peachtree Street
 Radio Wire Television Inc.
BOSTON, MASS. Radio Shack 167 Washington Street
BOSTON, MASS. 110 Federal Street
 Radio Wire Television Inc.
BRIDGEPORT, CONN. 177 Cannon Street
 Hatry & Young, Inc.
BRONX, N. Y. 542 East Fordham Rd.
 Radio Wire Television Inc.
BUTLER, MISSOURI 211-215 N. Main Street
 Henry Radio Shop
CHICAGO, ILL. 833 W. Jackson Blvd.
 Allied Radio Corp.
CHICAGO, ILL. 901-911 W. Jackson Blvd.
 Radio Wire Television Inc.
CINCINNATI, OHIO 1103 Vine Street
 United Radio, Inc.
DETROIT, MICH. 325 E. Jefferson Ave.
 Radio Specialties Co.
DETROIT, MICHIGAN 11800 Woodward Ave.
 Radio Specialties Co.
HARTFORD, CONNECTICUT 227 Asylum Street
 Radio Inspection Service Company
HOUSTON, TEXAS 1021 Caroline Street
 R. C. & L. F. Hall
INDIANAPOLIS, INDIANA 34 West Ohio Street
 Van Sickle Radio Supply Co.
JAMAICA, L. I. 90-08 166th Street
 Radio Wire Television Inc.
KANSAS CITY, MO. 1012 McGee Street
 Burstein-Applebee Company
NEW HAVEN, CONN. 1172 Chapel Street
 Hatry & Young, Inc.
NEW YORK, N. Y. Harrison Radio Co. 12 West Broadway
NEW YORK, N. Y. 100 Sixth Ave.
 Radio Wire Television Inc.
NEWARK, N. J. 24 Central Ave.
 Radio Wire Television Inc.
READING, PENN. 404 Walnut Street
 George D. Barbey Company
SCRANTON, PENN. 519-21 Mulberry Street
 Scranton Radio & Television Supply Co.
WASHINGTON, D. C. 938 F Street, N. W.
 Sun Radio & Service Supply Co.

ALBANY, N. Y. Uncle Dave's Radio Shack 356 Broadway
ATLANTA, GEORGIA 265 Peachtree Street
 Radio Wire Television Inc.
BOSTON, MASS. Radio Shack 167 Washington Street
BOSTON, MASS. 110 Federal Street
 Radio Wire Television Inc.
BRIDGEPORT, CONN. 177 Cannon Street
 Hatry & Young, Inc.
BRONX, N. Y. 542 East Fordham Rd.
 Radio Wire Television Inc.
BUTLER, MISSOURI 211-215 N. Main Street
 Henry Radio Shop
CHICAGO, ILLINOIS 833 W. Jackson Blvd.
 Allied Radio Corp.
CHICAGO, ILL. 901-911 W. Jackson Blvd.
 Radio Wire Television Inc.
CINCINNATI, OHIO 1103 Vine Street
 United Radio, Inc.
HARTFORD, CONN. 203 Ann Street
 Hatry & Young, Inc.
JAMAICA, L. I. 90-08 166th Street
 Radio Wire Television Inc.
LITTLE ROCK, ARKANSAS 409 W. 3rd St.
 Beem Radio Company
MINNEAPOLIS, MINNESOTA 1124-26 Harmon Place
 Lew Bonn Company
NEW HAVEN, CONN. 1172 Chapel Street
 Hatry & Young, Inc.
NEW YORK, N. Y. 100 Sixth Avenue
 Radio Wire Television Inc.
NEWARK, N. J. 24 Central Ave.
 Radio Wire Television Inc.
READING, PENN. 404 Walnut Street
 George D. Barbey Company
SCRANTON, PENN. 519-21 Mulberry Street
 Scranton Radio & Television Supply Co.
WASHINGTON, D. C. 938 F Street, N. W.
 Sun Radio & Service Supply Co.

Listings on this page do not necessarily imply endorsement by QST of the dealers or of other equipment sold by them.

SEE IT AT TERMINAL

NEW!

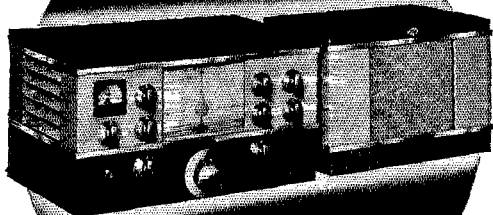

**NATIONAL
NC-200**

- Six general coverage ranges • Four uniform amateur bandspread ranges
- All ranges have definite accurate calibration • New crystal filter • Stabilized circuit • Series valve noise limiter.

Ready to operate and complete with speaker in matching cabinet

NET
\$147⁵⁰
Price

See the NC-200 at
TERMINAL — on display at both stores

**TERMINAL IS RADIO AMATEUR
SUPPLY HEADQUARTERS IN
NEW YORK CITY!**

Friendly Service — Capable Assistance

Complete line of National Products in stock at
both Terminal stores

TERMINAL Radio Corp.

68 West 45th St. • 80 Cortlandt St.
2 stores in NEW YORK CITY
Vanderbilt 6-5050 • Cable: TERMRADIO

with, although it does remove completely those little burbles that always appear with a self-excited oscillator running from an unregulated supply.

The stability of the signal was checked by listening to the signal on one of the new S-27 u.h.f. receivers, which has provision for c.w. reception in the 112-Mc. range. Except for a slight ripple which was apparently introduced by running the oscillator from an a.c. power supply and couldn't seem to be ironed out, the oscillator was remarkably stable. The drift practically disappeared in the first five or ten seconds and was probably caused by a heating of the tube elements. After that it kept a steady beat note with the well-warmed receiver for as long as any normal transmission would last. Load changes and voltage changes would alter the frequency but only a matter of a kilocycle or so instead of the usual many kilocycles. Under plate modulation, intelligible speech could be received with the receiver set in the "sharp" position, while a typical transceiver oscillator could not be held even in the "broad" position. Heavy modulation of the oscillator resulted in considerable frequency modulation, but that is the case with any self-excited oscillator we know. However, the stability of the oscillator greatly surpasses that of any we have seen on the 112-Mc. band. There are, of course, body-capacity effects when the operator's hand approaches "hot" points of the circuit, but the can itself can be touched without throwing the beat note off more than a few kilocycles, and the same is true of the power-supply cable running from the terminal strip to the power supply. Ohmite Z1 r.f. chokes inserted in each power lead right at the terminal strip will remove all traces of r.f. in the cable, but it isn't too bad without them and they aren't shown in the diagram. Possibly further refinements would further remove traces of r.f. from the can, but it is a lot "colder" than we expected it would be.

Modulator

The modulator can be almost anything that will deliver a watt of audio power. The unit shown in Fig. 2 uses a 6F6 and delivers much more audio than is required. As a matter of fact, with only a single 1½-volt microphone battery it is necessary to speak softly to avoid overmodulating the oscillator. Running the input up on the oscillator by removing the VR-150 will more readily accommodate the audio but there is still more than enough. Something like a 6G6 running at 200 volts on the plate would be more nearly right. This unit is shown simply to give an idea of what can be used.

Future Developments

A neutralized amplifier could be built to follow the oscillator and would result in an effective if small rig, although for flea-power work the oscillator working into an antenna directly is enough. In a slightly different form and with more rugged construction, it should make a good portable rig. A 1LE3 1½-volt loktal tube was

BUY ON EASY TERMS · MAIL ORDERS PROMPTLY FILLED · WRITE FOR FREE CATALOG

Here's an Outstanding Value

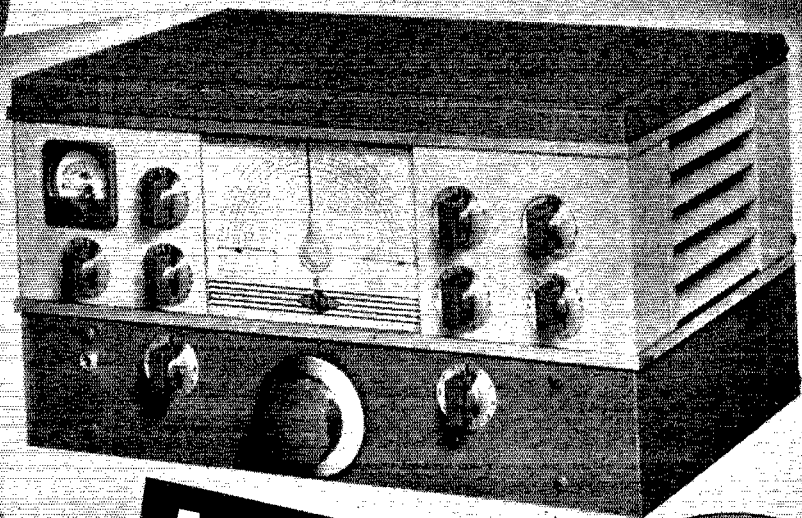

NC-200

for only

\$ 147⁵⁰
Cash

These are some of the Features of the
NATIONAL RECEIVER

- 12 tubes employed.
- Each tube with individual function.
- 10 accurately calibrated ranges.
- Four accurately calibrated band spread ranges.
- Band spread similar to method used in HRO.
- Single control tuning.
- Full vision dial-ratio 30-1 selection.
- Sensitivity — one micro-volt input produces 1-watt audio output.
- Signal to noise ratio better than 30DB on 10 meters.
- Adjustable selectivity crystal filter in six steps.
- Calibrated signal strength meter.
- Coverage 30,000 KC to 490 KC.
- 500 KC marine band.
- 8 watts P. P. audio output.
- New high frequency oscillator design — permitting manual RF adjustment without change of frequency.
- Equipped with plug for battery operation.

EASY PAYMENT PLAN

Down Payment \$14.00
and \$11.79 per month for twelve months

Send for our New and Bigger Catalog with Exceptional Values

The RADIO SHACK
167 WASHINGTON ST., BOSTON, MASS., U.S.A.



E. H. Rietzke
Pres. CREI

● Here's How YOU CAN Qualify for a BETTER RADIO JOB!

**CREI Technical Training is Preparing
Others for Good-Paying Radio Jobs—
WHY NOT YOU?**

Are you "pinned down" into a routine radio job? Are you plodding along while others are advancing to important engineering jobs? The lack of technical training is the stumbling block that keeps the average radioman from getting a better job or even holding his present job. You CAN do something about it—if you will!

Your radio experience backed by technical training will equip you to share in the good-paying jobs that await trained men. CREI home study courses in Practical Radio and Television Engineering are prepared for experienced radiomen who realize not only the value—but the necessity of CREI training if they are to rise above the routine jobs to make good in the important jobs where trained men are always in demand.

Write for Facts Today!

Our free booklet and personal recommendations may hold the answer to your future success. In your inquiry, please state briefly your background, education, present position—and whether you are interested in Home Study or Residence training.



Capitol Radio Engineering Institute
Dept. Q-11, 3224 16th St. N.W., Washington, D. C.

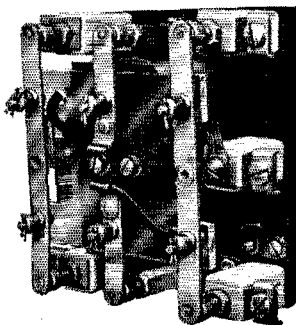

A New BREAK-IN RELAY in the HEAVY DUTY CLASS

This relay is recommended for radio phone transmitters where push-to-talk operation is desired.

WHEN THE RELAY COIL IS ENERGIZED:

- (1) Antenna will be switched from receiver to transmitter.
- (2) Oscillator is turned "On."
- (3) Receiver plate circuit is "Open."

Write for Circular 507B

WARD LEONARD

ELECTRIC COMPANY

41 South Street

Mt. Vernon, N. Y.

106

tried with 90 volts of battery on the plate, and it worked just as well except, of course, that the input and output were much lower. The note, however, was clean and quite steady. With both the a.c. tube and the battery tube it was possible to key the signal and copy it, although it must be confessed that the keying characteristic was more reminiscent of some of those Central American c.w. signals than it was of XDA. But the fact that it stayed within audibility during the entire character is indeed a point in its favor.

The loktal tube adapts itself well to a low-powered version of the oscillator, as would any single-ended triode with close spacing of the elements. A de-based 45 was made to oscillate but its efficiency was about one-quarter that of the 7A4. A 7C5 (loktal 6V6) with the plate and screen tied together worked but the output was no greater than with the 7A4 and the efficiency was about half that of the triode. It is hoped in the near future that we will be able to try a slightly different version with a larger tube like the HK24 or 35T, using instead of a single straight wire for grid pick-up a hairpin loop at the bottom of the pot. In the meantime, we recommend this version to anyone who has steered clear of 2½ meters because he couldn't make a stable oscillator simply. He can now.

New Transmitting Tube

(Continued from page 50)

Peak r.f. grid voltage	56	58 volts
D.c. plate current	123	150 ma.
D.c. screen current	16	15 ma.
D.c. grid current	4	3 approx. ma.
Driving power	0.2	0.16 approx. ma.
Plate dissipation	13.5	20 max. watts
Power output	30	45 approx. watts

The base connections are:

		Pin No.									
		1	2	3	4	5	6	7	8	Cap	Cap
		Element									
H	G ₁	K	K & Sh.	G ₂	HCT	K & Sh.	G ₁	H	P	P	



ALWAYS BE CAREFUL

★ ★ ★



(A) Kill all transmitter circuits completely before touching anything behind the panel.

(B) Never wear 'phones while working on the transmitter.

(C) Never pull test arcs from transmitter tank circuits.

(D) Don't shoot trouble in a transmitter when tired or sleepy.

(E) When working on the transmitter, avoid bodily contact with metal racks or frames, radiators, damp floors or other grounded objects.

(F) Keep one hand in your pocket.

(G) Develop your own safety technique. Take time to be careful.

★ ★ ★

Death Is Permanent!

HAM-ADS

(1) Advertising shall pertain to radio and shall be of nature of interest to radio amateurs or experimenters in their pursuit of the art.

(2) No display of any character will be accepted, nor can any special typographical arrangement, such as all or part capital letters be used which would tend to make one advertisement stand out from the others.

(3) The Ham-Ad rate is 15¢ per word, except as noted in paragraph (6) below.

(4) Remittance in full must accompany copy. No cash or contract discount or agency commission will be allowed.

(5) Closing date for Ham-Ads is the 25th of the second month preceding publication date.

(6) A special rate of 7¢ per word will apply to advertising which, in our judgment, is obviously non-commercial in nature and is placed and signed by a member of the American Radio Relay League. Thus, advertising of home made surplus equipment owned, used and for sale by an individual or apparatus offered for exchange or advertising inquiring for special equipment, if by a member of the American Radio Relay League takes the 7¢ rate. An attempt to deal in apparatus in quantity for profit, even if by an individual, is commercial and all advertising by him takes the 15¢ rate. Provisions of paragraphs (1), (2), (4) and (5) apply to all advertising in this column regardless of which rate may apply.

Having made no investigation of the advertisers in the classified columns, the publishers of QST are unable to vouch for their integrity or for the grade or character of the products advertised

QUARTZ — direct importers from Brazil of best quality pure quartz suitable for making piezo-electric crystals. Diamond Drill Carbon Co., 719 World Bldg., New York City.

QSL'S. Maps. Cartoons. Free samples. Theodore Porcher, 7708 Navajo, Philadelphia, Pa.

CRYSTALS, mounted, 80-160, \$1.25, V-cut 40, \$2.25. R9 Crystals, 338 Murray Ave., Arnold, Pa.

USED receivers. Bargains. Cash only. No trades. Price list 3¢. W3DQ, Wilmington, Del.

QSL'S, SWL's. 100 — 3 color — 75¢. Lapeco, 344 W. 39th, Indianapolis, Ind.

CRYSTALS: famous P.R., mounted in latest Alsimag 35 holders — 40, 80 meter PR-X, 160 meter PR-Z, \$3; 40, 80 meter PR-Z (low drift), \$3.50; 20-meter PR-20, \$4.50; unconditionally guaranteed. Immediate shipment. Wholesale Radio Labs., Council Bluffs, Iowa, W9GFQ.

CALLBOOKS — Fall edition now on sale containing complete up-to-date list of radio hams throughout entire world. Also world prefix map, and new time conversion chart. Single copies \$1.25. Canada and foreign \$1.35. Radio Amateur Call Book, 610 S. Dearborn, Chicago.

QSL'S — Fritz, 455 Mason, Joliet, Ill.

CRYSTALS in plug-in heat dissipating holders. Guaranteed good oscillators. 160M-80M AT \$1.25; 40X \$1.65. 80M variable frequency (5 kilocycle variance) complete \$2.95. State frequency desired. C.O.D.'s accepted. Pacific Crystals, 1042 S. Hicks, Los Angeles.

COMMERCIAL radio operators examination questions and answers. Two dollars per element. G. C. Waller, W5ATV, 6540 Washington Blvd., Tulsa, Okla.

QSL'S, W8JOT, Box 101, Rochester, N. Y.

TELEPLEXES, Instructographs bought, sold. Ryan's, Hannibal, Mo.

CRYSTALS: amateur, marine, police, aircraft, experimental. Request quotations or catalog. Ham Crystals, 1104 Lincoln Place, Brooklyn, New York.

MACAUTO code machines: low monthly rental 50,000 words practice tapes. Write N. C. Ayers, 711 Boylston St., Boston, Mass. GRANITE 7189-W.

QSL'S — Brownie, W3CJL, 1725 Frankenfield Ave., Allentown, Pa.

CRYSTALS: police, marine, aircraft. C-W Mfg. Co., 1170 Esperanza, Los Angeles.

SELLING out — 500 watt CW transmitter, complete, commercially built, 4 stages, 8 Weston meters, 5 Velvet Vernier dials, \$50. Photo on request. Thurston, Maumee, Ohio.

PHONE — CW rack transmitter complete, 100 watts, \$175. W1H8K, 119 Woodstock Rd., Southbridge, Mass.

FOR sale — old KFBI 5 kilowatt composite transmitter including 50 kilowatt rectifier. Will sell component parts. Write for list. KFBI, Wichita, Kansas.

QSL'S, all colors, cartoons, snappy service. Write for free samples today. W1BEF, 78 Warrenton, Springfield, Mass.

450 watt phone Taylor-Thordarson transmitter, beautiful rack & panel job, \$300. ACR-111, \$75; RME-99, \$100; Guthman U-10A frequency meter monitor, \$25; NC-44, \$30. Also station meters, microphones & speech amplifiers; cheap. W8SBH.

SELL — Howard 436, All Star Senior, QST's 1924 — date. W9CDG, 112 6th St., Sreator, Ill.

QSL'S? — SWL's? — Ham Christmas cards? Samples? W8DED, Holland, Mich. (Bliley crystal sales.)

SELLING out — WIAKC.

DOUGLAS Universal modulation transformers, 50 watts audio \$4.95 pair; 100 watts audio \$7.75 pair postpaid. Guaranteed. Crystals 80-40 meter AT cut = 5 kc. \$1.35 postpaid. Guaranteed. Write W9LXR, Box 349, Rice Lake, Wis.

100 watt break-in transmitter, rack and panel with ECO. Best offer. W9OMC, Lakefield, Minn.

QST'S — Nov. 1922 — Mar. 1935 inclusive. Best offer for lot takes them. H. W. Chapin, 17 N. Adams St., Ypsilanti, Mich.

SIGNS cast aluminum with your call letters. Send \$1 cash with order. Mark Specialty Co., 89 Westminster Rd., Rochester, N. Y.

QSL'S. Finest designs. Samples. Maleco, 1805 St. Johns Place, Brooklyn, N. Y.

WANTED: late model commercially built 160 or 10 fone xmitter complete 75 watts up. W51BN, Wickes, Ark.

HAMMARLUND 120X, and speaker, \$97.50 cash. Clyde Thompson, Wilson Dam, Ala.

WANTED: 500 to 1200, 16 to 2000 meter receiver. Write William, 1444 Riverside Ave., Baltimore, Md.

SELL QST'S 1924 — 1940. Original covers. Don McKinley, Hubbard, Iowa.

COLLINS — 30-FX for sale. Cash only. Coils 5 bands — 250 watts CW 100 watts G.M. phone with Collins 7M amplifier. Perfect condition. Now on 160 phone. Write W3HWO.

PUSH-PULL HK-54 final amplifier, power supply, coils ten to forty, TZ-40 modulator, power supply — all rack mounting. Best offer takes. Also 1250 — 2200 v. 300 ma. plate transformer. W1JUL.

WANT QST issue September 1916 good condition to complete Volume I. Cash or swap for December 1916 or February 1917. W1HPC.

RME-70 \$80. 100 watt CW transmitter with coils 20 — 40 m. Husky power supply, fully metered plus antenna tuner \$110. J. B. Maher, 549 Savin Ave., West Haven, Conn.

MODERN kilowatt transmitter. All latest features, \$500. Write for details, W8FXC, Harrisburg, Pa.

QSL'S. Free samples. Printer, Corwith, Iowa.

WANTED: all type Sky Buddies, SX-24, Champions, 430 Howard. Will give the highest prices cash or trade. Write for bargain catalog — get acquainted with Leo W9GFQ.

RECEIVERS reconditioned — all models at lowest prices. Free trial and name your terms. Few left new Howard 460 \$59.95, SX-23 \$79.50. Write Leo for the best buys. Wholesale Radio Labs., Council Bluffs, Iowa.

TRANSMITTER headquarters. 70 watt xmit complete \$35 — speech amp modulator up to 80 watts \$25 complete — same up to 150 watts \$49.50 complete. Plenty more bargains. Write Leo, W9GFQ, today.

FOR sale — complete amateur station. Write W1LPO.

CRYSTALS, commercial or amateur: aircraft, police, marine and all types of low drift units for commercial services at attractive prices, send for catalog. For the amateur: Those FB, fully guaranteed T9 crystals — the choice of thousands of hams everywhere. T9 crystals are suitable for keying such as break-in work. 40, 80, and 160 meter bands \$1.60 postpaid, close frequency choice, immediate shipment. T9 ceramic holders \$1. C.O.D.'s accepted. Sold by: Pembleton Labs., Ft. Wayne, Ind.; Kerr's Radio Shop, El Paso, Texas; Frank Anzalone, 375 W. 46th, N. Y. C.; Valley Radio Distributors, Appleton, Wis.; Henry Radio Shop, Butler, Mo.; Glucksmann & Noceti, Buenos Aires, Argentina; and Eidson's, Temple, Texas.

TRADE for HRO — RME-69 etc., nearly new \$150 Bacon tenor banjo and three channel speech — parts cost over \$50. never used. W9MAQ, Beloit, Wis.

WANT 25 to 50 Mfd. 2000 v. d. c. capacitor. Geo. E. Shipman, N. Muskegon, Mich.

CRYSTALS: active oscillators \$1, three blanks \$1. Byers Crystals, Indiana, Pa.

WRITE Bob, W9ARA, for best deal on all amateur receivers, transmitters, kits, parts. You get best terms (financed by myself); largest trade-in; personal cooperation; lowest prices. Prompt delivery of the new NC-200, NC-55 and all other newest 1941 receivers. New Howard 460's with crystals \$59.95, SX-23's \$79.50. Write, W9ARA, Butler, Mo.

RECONDITIONED guaranteed amateur receivers and transmitters at lowest prices. All makes and models cheap. Ten day free trial. Terms. Write for free list. W9ARA, Butler, Mo.

NEED cash — best offer gets NC-44, Used little, in original packing case. Lloyd Walker, Lincoln, Kansas.

COLLINS 30-FXC 300 watts fone CW. Beautiful commercial appearance, \$400; lefty Vibroplex with case, \$8; power supply and r.f. parts hi-power final. Swap for movie equipment. Mims 2-element 20 beam inductostub standard rotary direction indicator, \$50. W2LVZ.

NEW SX-25 Hallicrafters receiver \$70. 500 watt CW xmtr \$50. Harrison, c/o KORN, Fremont, Nebr.

SELL: late Harvey 80T transmitter complete, coils, tubes, four crystals, key, microphone, FB, \$90. W. Robinson, Boyce, La.

WANTED: compact, complete, 50 to 250 watt fone — CW rig. Send full details. All replies answered. R. L. Scott, W8SFK/8, Phi Delta Theta, State College, Pa.

RIDER'S Manuals. Fine lot meters, laboratory instruments — frequency meters — microphones — W. E. pickup — big B.C. transmitter tube — tube tester. Big lot ham and service materials. Bargains. Chas. Snyder, Richmond, Ind.

OCTOBER QST one-tube shortwave converter kit, complete with one set coils, drilled cabinet, chassis, dials, etc., \$15 net. Seeli's Radio, Hartford, Conn.

SELL: Lafayette 15 watt amplifier with D-104 crystal microphone and 12 inch speaker, sell all or parts separately. Richard Carey, 1102 State, La Crosse, Wis.

BEST offer takes NC-101X, good condition. WIJMY.



HANDI-MIKES

for the AMATEUR

Universal's new handi-mike for small transmitters, sound equipment, etc. Clear, crisp voice reproduction. Bal. grip, pol. chrome plate, snap switch, 6 ft. flex. cord, choice of circuits and switches, single and double button carbon, crystals, dynamics in all impedances. At your dealer or jobber.

Universal also manufactures over 100 models and types of microphones, stands and accessories: recording machines, blank discs, lead screws, cutting heads, needles, styli and the new UNIVERSAL RECORDER KIT.

UNIVERSAL MICROPHONE CO., Ltd.
Inglewood, California, U. S. A.

Getting your
RADIO OPERATOR'S
LICENSE made easier—

If you prepare for exams
this direct, tested way



Check your training and knowledge and focus on the key points of theory and practice as covered in new Government license requirements, in the quickest, easiest way with this new book.

JUST OUT — New 7th Edition — NILSON AND HORNUNG'S
RADIO OPERATING QUESTIONS and ANSWERS

415 PAGES, 5 X 7 1/2, 87 ILLUSTRATIONS, \$2.50

This book gives an answer to every question in the FCC Study Guide and Reference Material for Commercial Radio Operator License Examinations. Here is a wealth of concise information on radio communication — theory, apparatus, circuits, laws and regulations, etc. — classified exactly as in the six elements on which all professional radio operator license examinations now are based. You spend no time on superfluous material, but get right at the important facts that will help you pass examinations.

SEE IT 10 DAYS — SEND THIS COUPON

MCGRAW-HILL BOOK CO., INC., 330 W. 42 ST., N. Y.
Send me Nilson and Hornung — Radio Operating Questions and Answers for 10 days' examination. In 10 days I will send \$2.50 plus few cents postage or return it postpaid. (We pay postage if remittance accompanies order.)

Name.....
Address.....
City and State.....
Position.....
Company..... QST 11-40
(Books sent on approval in U. S. and Canada only)

FULFILL YOUR AMBITION IN RADIO

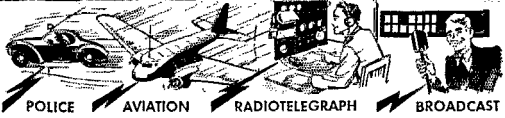

Train yourself at home for that radio job or promotion you want. Study under the personal direction of Arthur R. Nilson, co-author of Nilson and Hornung radio textbooks. Up-to-the-minute, low-cost, home-study courses will help you increase your technical knowledge or fit you for license examinations. As the next step toward your success, send for descriptive literature on these courses.

1. **Essentials of Radio Communication:** includes all technical essentials for 2nd class radiotelephone license and radiotelegraph permit. A complete foundation course.
2. **Advanced Radiotelegraphy:** covers the scope o Element 6 when combined with course *Essentials of Radio Communication*. Twelve supplementary lessons, mainly on marine radio and mathematics. Cover requirements of 1st and 2nd class licenses.
3. **Broadcast Operating:** covers the scope of Element 4. Mathematics, circuits and equipment, and rules and regulations. Ideal course for the experienced man who wishes to increase his knowledge or prepare for broadcast license or job.

SEND FOR FREE 16-PAGE BOOKLET "What the Modern Radioman Must Know." Make this step toward your successful radio career . . . now!

NILSON RADIO SCHOOL
51 East 42nd St., New York, N. Y.

25¢
PER COPY

\$3.00
PER YEAR
U. S. OR FOREIGN



NOW!

**A MONTHLY MAGAZINE
DEVOTED ENTIRELY TO F-M**

Already, FM Magazine has become MUST reading for everyone connected with radio activities • Because it covers ALL phases of f-m developments and progress • Edited by M. B. Sleeper • Address subscriptions to:

FM COMPANY
42 WASHINGTON STREET, NEWTON, MASS.

Your Nearby Dealer Is Your Best Friend

Your nearby dealer is entitled to your patronage. He is equipped with a knowledge and understanding of amateur radio. He is your logical source of advice and counsel on what equipment you should buy. His stock is complete. He can supply your needs without delay. His prices are fair and consistent with the high quality of the goods he carries. He is responsible to you and interested in you.

One of these dealers is probably in your city — Patronize him!

ATLANTA, GEORGIA

Radio Wire Television Inc.
265 Peachtree Street
"The World's Largest Radio Supply House"

JAMAICA, L. I., NEW YORK

Radio Wire Television Inc.
90-08 166th Street (Merrick Road)
"The World's Largest Radio Supply House"

BALTIMORE, MARYLAND

Radio Electric Service Co.
3 N. Howard St.
Everything for the Amateur

NEWARK, N. J.

Radio Wire Television Inc.
24 Central Avenue
"The World's Largest Radio Supply House"

BOSTON, MASS.

Radio Wire Television Inc.
110 Federal Street
"The World's Largest Radio Supply House"

NEW YORK, N. Y.

Radio Wire Television Inc.
100 Sixth Avenue
"The World's Largest Radio Supply House"

BRONX, NEW YORK

Radio Wire Television Inc.
542 East Fordham Road
"The World's Largest Radio Supply House"

NEW YORK, N. Y.

Harrison Radio Company
12 West Broadway
Harrison Has It! Phone WOrth 2-6276 for information or rush service

BUFFALO, NEW YORK

Radio Equipment Corp.
326 Elm Street
W8PMC and W8NEL — Ham, service and sound equipment

PHILADELPHIA, PENNSYLVANIA

Eugene G. Wile
10 S. Tenth Street
Complete Stock of Quality Merchandise

BUFFALO, NEW YORK

Dymac Radio
1531 Main Street — Cor. Ferry
Open Evenings GA. 0252

PROVIDENCE, RHODE ISLAND

W. H. Edwards Company
85 Broadway
National, Hammarlund, Hallicrafter, Thordarson, Taylor, RCA

HARTFORD, CONNECTICUT

Radio Inspection Service Company
227 Asylum Street
What do you want? We have it. Radio exclusively

RICHMOND, VIRGINIA

The Arnold Company
Broad at Harrison St.
W3EQQ — "The Virginia Ham Headquarters" — W3FBL

HARTFORD, CONNECTICUT

Hatry & Young, Inc.
203 Ann Street
Stores also in Bridgeport and New Haven

HOUSTON, TEXAS

R. C. & L. F. Hall
1021 Caroline Street (C 0721)
"Specialists in Amateur Supplies"

SCRANTON, PENNSYLVANIA

Scranton Radio & Television Supply Co.
519-521 Mulberry Street
Complete Stock of Quality Amateur Supplies

YOU CAN BE SURE
WHEN YOU BUY FROM

QST

ADVERTISERS

“Advertising for *QST* is accepted only from firms who, in the publisher’s opinion, are of established integrity and whose products secure the approval of the technical staff of the American Radio Relay League.”

Quoted from QST’s advertising rate card.

Every conceivable need of a radio amateur can be supplied by the advertisers in QST. And you will know the product has the approval of the League’s technical staff

Index to Advertisers

Aerovox Corporation.....	93
American Radio Institute.....	95
Astatic Microphone Laboratory, Inc.....	95
Barker & Williamson.....	94
Bliley Electric Company.....	68, 99, 102
Browning Laboratories, Inc.....	81
Cameradio Company.....	100
Candler System Company.....	94
Capitol Radio Engineering Institute.....	106
Cardwell Mfg. Corp., Allen D.....	72
Centralab.....	59
Collins Radio Company.....	Cov. 2
Cornell-Dubilier Electric Corp.....	62
Dodge’s Institute.....	91
Eitel-McCullough, Inc.....	67
FM.....	108
Gardiner-Levering Company.....	99
General Electric Company.....	5
General Radio Company.....	77
Halicrafters, Inc. The.....	1, 2
Hammarlund Mfg. Company, Inc.....	65
Harrison Radio Company.....	81
Harvey Radio Company.....	92
Hatry & Young.....	101
Henry Radio Shop.....	75
Hipower Crystal Company.....	90
Hygrade Sylvania Corp.....	78
Instructograph Company.....	91
Jensen Radio Mfg. Company.....	63
Johnson Company, E. F.....	93
Kenyon Transformer Company, Inc.....	80
Mallory & Company, Inc., P. R.....	58
Massachusetts Radio School.....	91
McGraw-Hill Book Company, Inc.....	108
Meissner Mfg. Company.....	79
Millen Mfg. Company, Inc., James.....	90
National Company, Inc.....	Cov. 3, 57, 60, 61
New York YMCA Schools.....	93
Newark Electric Company.....	83
Nilson Radio School.....	95, 108
Ohmite Mfg. Company.....	66
Phelps Dodge Copper Products Corp.....	99
Pioneer Gen-E-Motor Corp.....	98
Port Arthur College.....	82
Precision Apparatus Corp.....	95
RCA Institutes, Inc.....	99
RCA Mfg. Company, Inc.....	Cov. 4, 69, 102
Radio City Products.....	74
Radio Electric Mfg. Company.....	111
Radio Shack, The.....	105
Radio Transceiver Laboratories.....	82
Scientific Radio Service.....	95
Shuler Supply Company.....	104
Sickles Company, F. W.....	99
Signal Electric Mfg. Company.....	98
Solar Mfg. Corp.....	76
Southwest Radio Supply.....	105
Sprague Products Company.....	70
Sun Radio Company.....	96, 97
Taylor Tubes, Inc.....	73
Teleplex Company.....	93
Terminal Radio Corp.....	91, 104
Thordarson Electric Mfg. Company.....	71
Triplett Elec. Instrument Company, Inc.....	64
Turner Company, The.....	99
United Transformer Corp.....	112
Universal Microphone Company, Ltd.....	108
Ward Leonard Electric Company.....	106
Wholesale Radio Laboratories.....	96
Yaxley.....	58

2 in ONE

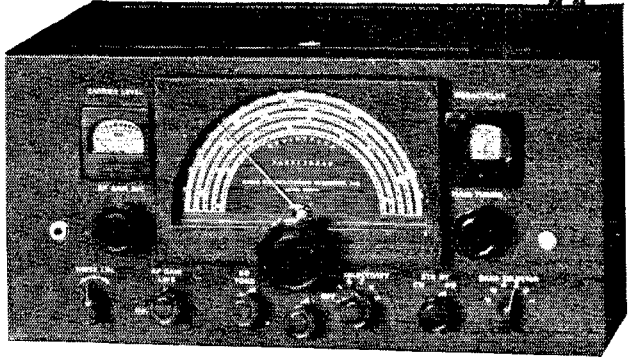

THE RME-99

professional and amateur **COMMUNICATIONS RECEIVER**

WHEN you buy your new RME-99, precision-built communications receiver, you really are getting **TWO** receivers for the price of **ONE**! For the "99" may be used with equally high efficiency as a commercial instrument or as a fine amateur band receiver.

Its **LABORATORY TYPE** construction classifies it as a **DOUBLE-DUTY** unit of positive characteristics. For example the RME method of assembly and test is of the **INDIVIDUAL** type. That is, each receiver is built as an **INDIVIDUAL UNIT** to conform to a strict set of **LABORATORY** standards. This system of construction assures **UNIFORMNESS** in all RME receivers.

In addition, RME communications instruments are designed so that they may be **ALTERED** slightly to specifications with a minimum of **EXPENSE** or **TIME LOST** to the purchaser. Certain variations of this fine receiver are available for specific industrial applications.

Finally, each "99" is equipped with all **STANDARD FEATURES** of the modern communications receiver such as **FULL-RANGE TUNING** of 550 to 33,000 kilocycles, **CALIBRATED BANDSPREAD** dial for amateur use, **NOISE LIMITER**, **VOLTAGE REGULATOR**, **5 POSITION** crystal filter, and **CALIBRATED R-DB METER**, **PLUS**, such outstanding **NECESSARY EXTRAS** as, a **CAST ALUMINUM** chassis frame, **GROUNDING CATHODE** type oscillator, **LOKAL** tubes, and velvet smooth **PLANETARY DIAL MECHANISM**.

Whether you are an amateur station owner, or whether you are chief engineer of a powerful commercial transmitter, investigate the **DUAL POSSIBILITIES** of the New RME-99. We have a copy of technical specifications waiting your request . . . why not write today?

Net price of the RME-99 complete with speaker and tubes ready for operation is \$139.20

RADIO MFG. ENGINEERS, INC.

111 Harrison Street

Peoria, Illinois



From the **LARGEST** To the **SMALLEST**

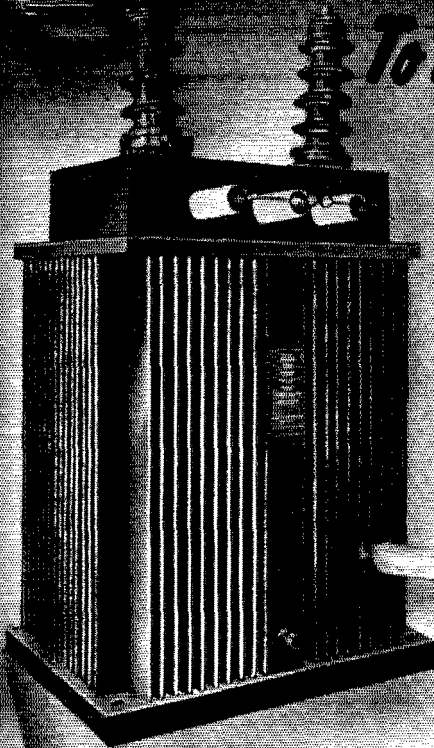

Typical of the large broadcast equipment manufactured by UTC is the filter choke illustrated on the left, designed for a 100 KW broadcast station and weighing about 3½ tons. This unit is 100,000 times the size of the UTC OUNCER.



OUNCER HIGH FIDELITY AUDIO UNITS

The new UTC OUNCER series represents the acme in compact quality transformer practice. These units are ideal for hearing aid, aircraft, glider, portable, concealed service, and similar applications. The overall dimensions are 7/8" diameter by 1-3/16" height, including lugs. Mounting is effected by two screws, opposite the terminal board side, spaced 13/16". Weight approximately one ounce. Units not carrying D.C. have high fidelity characteristics being uniform from 40 to 15,000 cycles. Items with D.C. in pri. and O-14 and O-15 are for voice frequencies from 150 to 4,000 cycles.

(MAX. LEVEL 0 DB)
200 ohm balanced winding may be used for 250 ohms.

Type No.	Application	Pri. Imp.	Sec. Imp.	List Price
0-1	Mike, pickup or line to 1 grid	50, 200, 500	50,000	\$10.00
0-2	Mike, pickup or line to 2 grids	50, 200, 500	50,000	10.00
0-3	Dynamic mike to 1 grid	7.5/30	50,000	9.00
0-4	Single plate to 1 grid	8,000 to 15,000	60,000	8.00
0-5	Single plate to 1 grid, D.C. in Pri.	8,000 to 15,000	60,000	8.00
0-6	Single plate to 2 grids	8,000 to 15,000	95,000	9.00
0-7	Single plate to 2 grids, D.C. in Pri.	8,000 to 15,000	95,000	9.00
0-8	Single plate to line	8,000 to 15,000	50, 200, 500	10.00
0-9	Single plate to line, D.C. in Pri.	8,000 to 15,000	50, 200, 500	10.00
0-10	Push pull plates to line	8,000 to 15,000 each side	50, 200, 500	10.00
0-11	Crystal mike or pickup to line	50,000	50, 200, 500	10.00
0-12	Mixing and matching	50,200	50, 200, 500	9.00
0-13	Reactor, 200 Hys.—no D.C., 50 Hys.—2 MA, D.C., 6,000 ohms			7.00
0-14	50:1 mike or line to 1 grid	200	½ megohm	10.00
0-15	10:1 single plate to 1 grid	8,000 to 15,000	1 megohm	10.00

UNITED TRANSFORMER CORP.

Write: COMMUNICATIONS DIV. ★ 150 VARICK ST. ★ NEW YORK, N. Y.
EXPORT DIVISION: 100 VARICK STREET NEW YORK, N. Y. CABLES: "ARLAB"

QST for November, 1940, EASTERN Edition

PRINTED IN U.S.A.
RUMFORD PRESS
CONCORD, N. H.

THE NEW NC-200

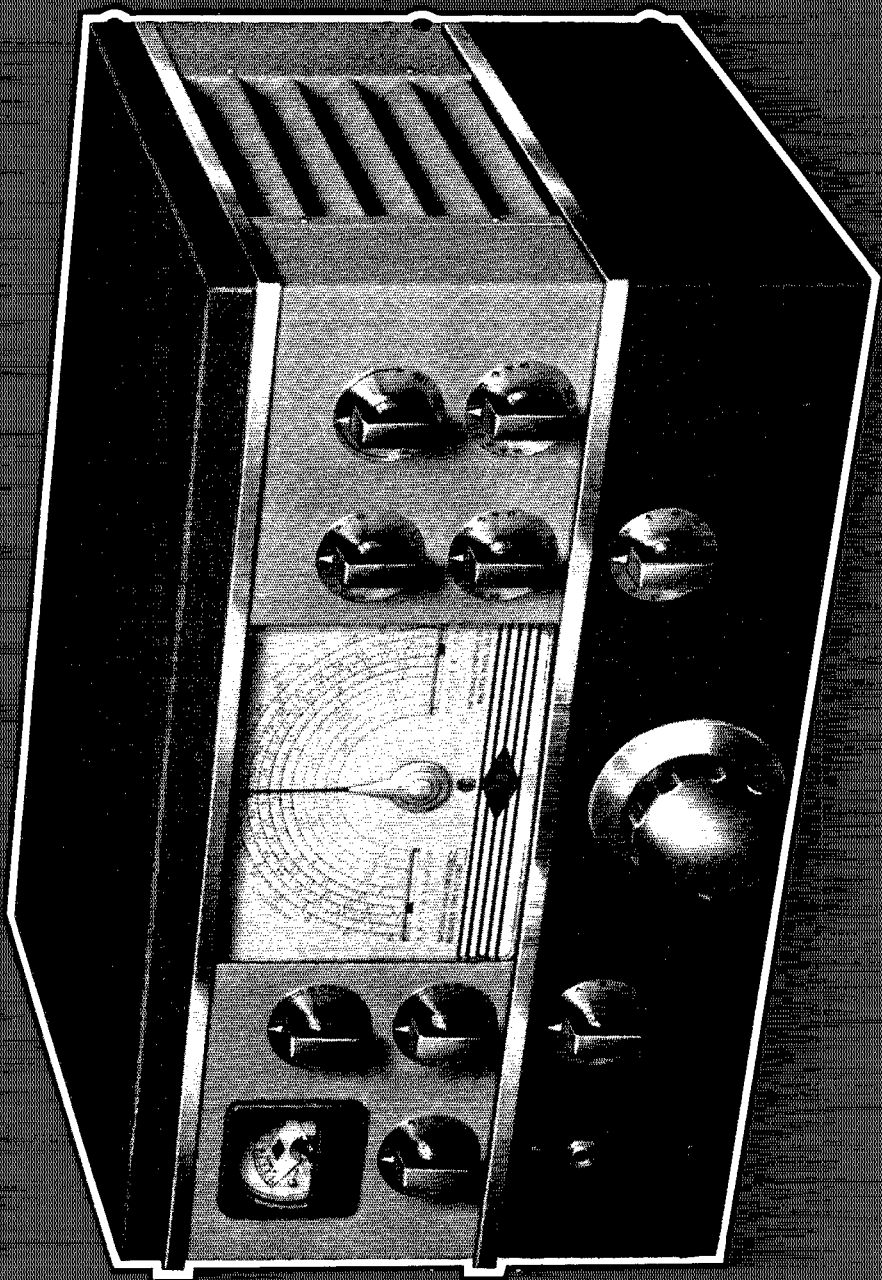

SERIES VALVE NOISE LIMITER

TEN CALIBRATED RANGES

NATIONAL COMPANY

This ONE TUBE covers them all!

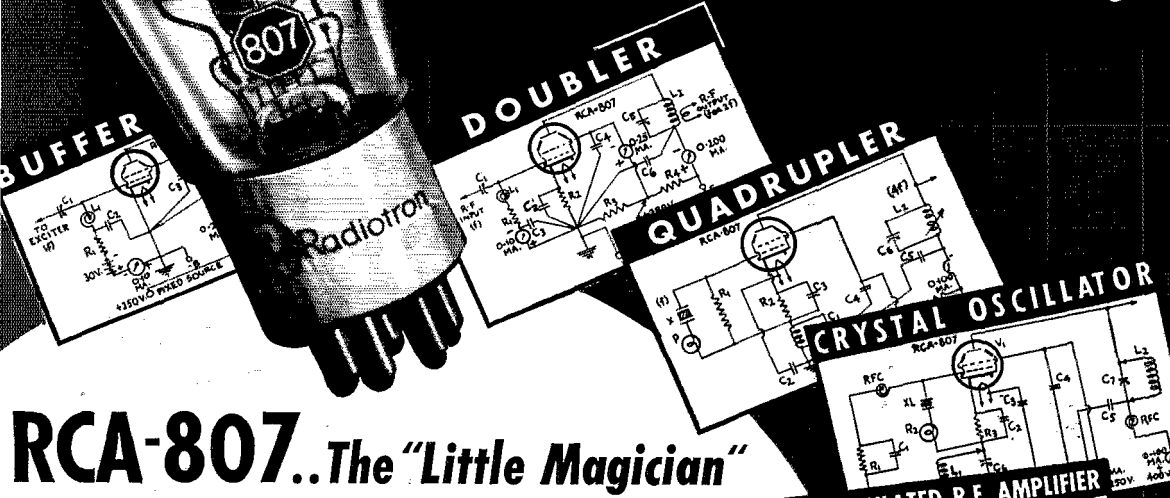
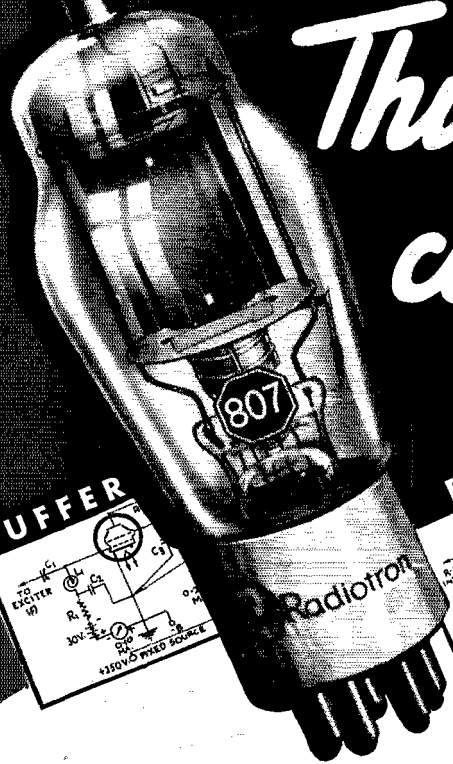

RCA-807..The "Little Magician" of Beam Power Amplifier Tubes

Most hams have used the RCA-807 Beam Power Amplifier, but not all are familiar with its ability to turn in a record-breaking performance on literally dozens of jobs. No matter how often you change your rig, there's nearly always a place for this versatile little tube. From crystal oscillator to doubler, quadrupler, buffer, Class C r-f amplifier, grid-modulated r-f amplifier, or modulator you can shift this little magician of beam power tubes and, each time, be assured of performance and durability not to be beaten at any price. It is especially useful for a low-power, portable, storage-battery-operated transmitter; a 6J5-G crystal oscillator will drive it very nicely. The RCA-807 is, without doubt, the handiest tube in any amateur shack. It will pay you to get acquainted with all of its countless possibilities.

RCA-807—HALF A DOZEN TUBES IN ONE

- Plate voltage, 750 V.
- Plate Dissipation, 30 W.
- Plate input, 75 W.
- Amateur Net, \$3.50

Above ratings are maximum RCA ICAS Ratings for Class C Telegraphy.

HAM TIPS FREE!—A helpful little publication brimful of information for amateurs—free—from all RCA Power Tube Distributors.



Radio Tubes

RCA MANUFACTURING CO., INC.,
CAMDEN, N. J.
A Service of The Radio Corporation of America

FIRST IN METAL—FOREMOST IN GLASS—FINEST IN PERFORMANCE