

# QST

September, 1938  
25 cents

devoted entirely to

# amateur radio



*In this issue—*  
**Why This  
is 48 Mc. DX?**  
**New  
Emergency  
Equipment**

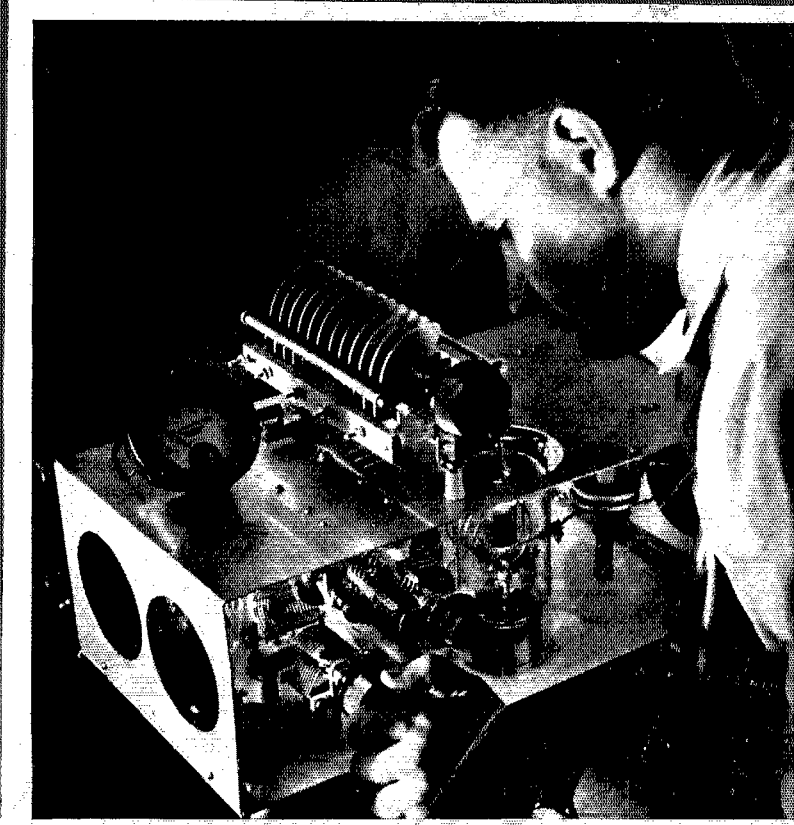

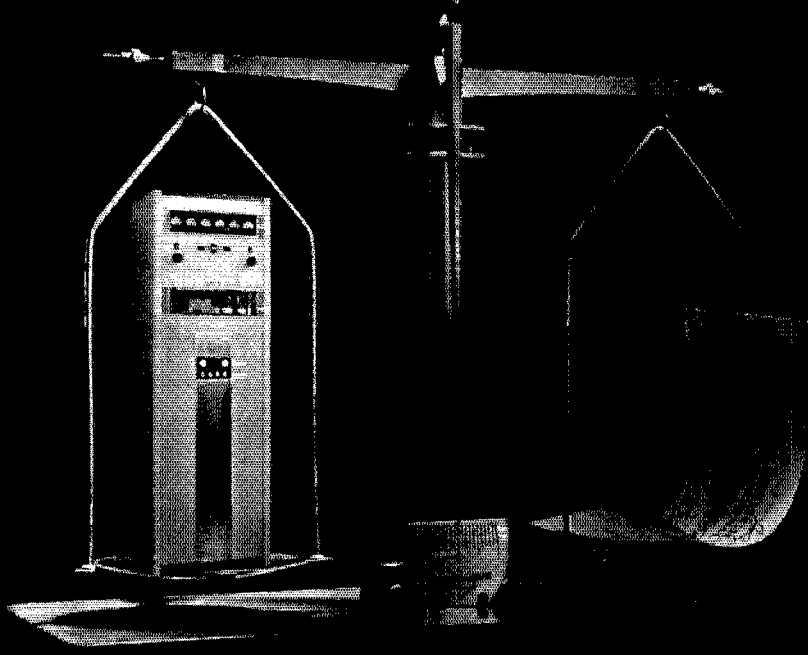

## “How do you measure the cost of owning a Collins Transmitter?”

This question is frequently asked us by our customers. Any true answer must take into account the fact that most amateurs indulge in their hobby in cycles of three or four years duration, and, also, that the perennial amateur is in the habit of re-equipping his station at least every three years, either to increase power or to modernize his gear. Therefore, we think that an accurate picture of the cost of an amateur transmitter is its established resale value after three or four years of use, subtracted from the original purchase price.

We have obtained some interesting figures on the resale value of Collins transmitters by studying the QST “ham-ads” during the last six months. We found twelve “ham-ads” offering Collins transmitters for sale and four “ham-ads” advertising to buy Collins transmitters. The twelve Collins sets offered were valued at an average of 50% of the original purchase price after being in service an average of three and one-half years. The want-ads indicate a very definite preference for Collins transmitters. A ready market for used Collins equipment is shown by the fact that no set was offered for sale more than once.

The experience of many of our own customers who have been in and out of amateur radio and of those who have sold their original sets and purchased higher powered Collins sets confirms the conclusions we may draw from the “ham-ads.” These conclusions are:

- A Collins transmitter is a tangible asset which, considering its unusually high resale value, costs surprisingly little to own.
- It is far cheaper in the long run to buy Collins than it is to buy a make which does not have an established resale value.
- It is sound business judgment to buy a Collins transmitter.

# COLLINS RADIO COMPANY

CEDAR RAPIDS, IOWA

NEW YORK, N. Y.: 11 WEST 42 STREET



## AN INVITATION TO ALL AMATEURS

**T**HE MEMBERS of the Hallicrafters organization, and I am sure that we speak for all citizens of Chicago as well, are proud that we can welcome the American Radio Relay League to this city. Chicago is signally honored that it should be chosen as host for the first national convention of the ARRL in fourteen years, and it is our hope that it will be a memorable one.

**T**HE HALLICRAFTERS wish to extend an especially cordial invitation, not only to visit our booth in the exhibit hall, but also to visit the Hallicrafters Laboratories as well, during your stay at the convention. The latch string is out, and there is a big "Welcome" sign being painted on the Door Mat.

73.

*W. J. Halligan*

PRESIDENT

**the hallicrafters, inc.**

2611 S. INDIANA AVE.

CHICAGO

# Announcing The NEW hallicrafters MARINE TRANSMITTER-RECEIVER

50 WATTS PHONE OUTPUT

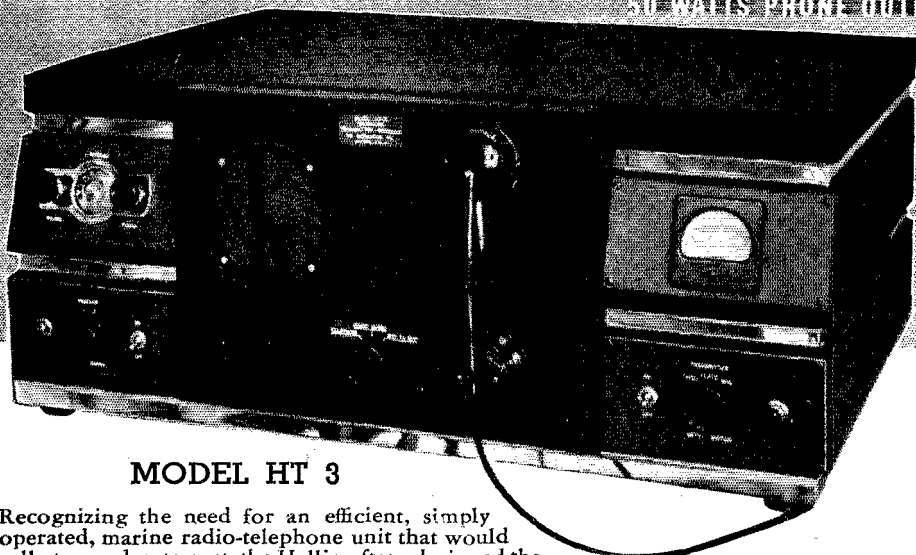

MODEL HT 3

Recognizing the need for an efficient, simply operated, marine radio-telephone unit that would sell at a moderate cost, the Hallicrafters designed the Model HT-3. Built only after a thorough study of the requirements for this service, the Model HT-3 answers every need for a unit of this type, — compact, — entirely self-contained, requiring only a 12 volt or 32 volt battery and an antenna, — simple to operate and highly efficient in operation. It consists of a 50-Watt-Output Phone Transmitter for operation on any 3 frequencies in the Marine Band (2100–2900 KC) and a 6-Tube, 2-Band receiver covering 2100 to 2900 KC on one band and the standard broadcast band on the others.

The receiver output is normally connected to the speaker but is switched to the earpiece when the handset is lifted from the hook. A button in the handset starts the transmitter (push-to-talk) so that conversation can be carried on with the same ease as on an ordinary telephone.

In this efficient Marine Communications Unit, the same painstaking, careful engineering is evidenced, — it is just another example of Hallicrafters Policy to build communications equipment to fill a definite need.

SEE YOUR HALLICRAFTERS DEALER OR WRITE  
TODAY FOR COMPLETE SPECIFICATIONS

## SPECIFICATIONS IN BRIEF

### Transmitter

- ★ 50 Watts Carrier Output
- ★ Any three frequencies in Marine Band (2100–2900 KC)
- ★ Three-position Band Switch
- ★ Low-Drift Crystal-Controlled Oscillator
- ★ Tubes: 1-6F6 Crystal-Oscillator, 2-RK39 Class C Amplifier, 4-6L6G Modulator
- ★ Power Supply — 12- or 32-Volt Battery, Transmitter Plate power furnished by built-in 450-Volt Dynamotor.

### Receiver

- ★ 6 Tubes
- ★ 2 Bands: 2100–2900 KC, Standard Broadcast
- ★ 3 Watts Output
- ★ Built-in Speaker ★ Telephone Handset
- ★ Volume Control ★ Band Switch

ALL HALLICRAFTERS  
RECEIVERS SOLD ON  
LIBERAL TIME  
PAYMENTS

# the hallicrafters inc.

2611 Indiana Ave., Chicago, U. S. A.  
Cable Address "Hallicraft" Chicago

"WORLD'S LARGEST BUILDERS OF AMATEUR COMMUNICATIONS RECEIVERS"



# QST

devoted entirely to

# AMATEUR RADIO

PUBLISHED, MONTHLY, AS ITS OFFICIAL ORGAN, BY THE AMERICAN RADIO RELAY LEAGUE, INC., AT WEST HARTFORD, CONN., U. S. A.; OFFICIAL ORGAN OF THE INTERNATIONAL AMATEUR RADIO UNION

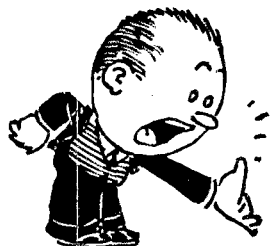

## SEPTEMBER

## 1938

### Volume XXII

### Number 9



Kenneth B. Warner, General Manager of A.R.R.L. Publications; Ross A. Hull, Editor; James J. Lamb, Technical Editor; George Grammer, Assistant Technical Editor; Clark C. Rodimon, Managing Editor; David H. Houghton, Circulation Manager; Ralph T. Beaudin, Assistant Circulation Manager; F. Cheyney Beekley, Advertising Manager; Charles Brunelle, Assistant Advertising Manager.

Editorial and Advertising Offices

38 La Salle Road  
West Hartford, Connecticut

Subscription rate in United States and Possessions and Canada, \$2.50 per year, postpaid; all other countries, \$3.00 per year, postpaid. Single copies, 25 cents. Foreign remittances should be by international postal or express money order or bank draft negotiable in the U. S. and for an equivalent amount in U. S. funds.

Entered as second-class matter May 29, 1919, at the post office at Hartford, Connecticut, under the Act of March 3, 1879. Acceptance for mailing at special rate of postage provided for in section 1103, Act of October 3, 1917, authorized September 9, 1922. Additional entry at Concord, N. H., authorized February 21, 1929, under the Act of February 28, 1925.

Additional second-class entries to cover sectional editions authorized March 20, 1935. Copyright 1938 by the American Radio Relay League, Inc. Title registered at United States Patent Office.

## The Contents

Editorials . . . . .	7
Norfolk Amateurs Prepare for Emergencies <i>Fenton Priest, W3EMM and Laurie Turner, W3BEK</i>	8
Preselection Simplified . . . <i>T. M. Ferrill, Jr., W1LJI</i>	11
A Five-Band Switching Exciter With 807 Output <i>T. P. Kinn, W1CC</i>	14
What the League Is Doing . . . . .	19
Further Reports on 56-Mc. DX . . . . .	21
Interpreting 1938's 56-Megacycle DX <i>J. A. Pierce, W1JFO</i>	23
The Canada-U.S.A. Contact Contest, 1938 <i>Fred H. B. Saxon, VE3SG</i>	25
A DeLuxe Rotary Antenna Structure <i>Bryon Trowbridge, W9TMP</i>	26
Grid-Bias Power Packs . . . <i>N. M. Patterson, W4EG</i>	30
Army-Amateur Radio System Activities . . . . .	33
An Auxiliary Transmitter for 1.7- and 3.5-Mc. Work <i>Don H. Mix, W1TS</i>	34
Ham Radio and Models . . . <i>Clinton B. DeSoto, W1CBD</i>	38
Freshman Marlow . . . . . <i>J. C. Flippin, W4VT</i>	41
The Permatron — A New Type of Rectifier With Magnetic Control . . . . .	42
McNinch Praises Amateur Radio . . . . .	43
The A.R.R.L. National Convention . . . . .	44
The Maxim Memorial Relay . . . . .	45
Hints and Kinks for the Experimenter . . . . .	46
How Would You Do It? . . . . .	49
I.A.R.U. News . . . . .	51
Operating News . . . . .	53
Correspondence Department . . . . .	61
A.R.R.L. QSL Bureau. . . . .	68
New Apparatus . . . . .	80
Original Cast to Present R.O.W.H. at National Convention	80
Silent Keys . . . . .	98
Midwest Division Convention . . . . .	110
Rocky Mountain Division Convention . . . . .	110
Massachusetts State Convention . . . . .	110
WWV Transmissions . . . . .	110
Hamads . . . . .	123
QST's Index to Advertisers . . . . .	126

## Section Communications Managers of the A.R.R.L. Communications Department

All appointments in the League's field organization are made by the proper S.C.M., elected by members in each Section listed. Mail your S.C.M. (on the 16th of each month) a postal covering your radio activities for the previous 30 days. Tell him your DX, plans for experimenting, results in phone and traffic. He is interested, whether you are an A.R.R.L. member or get your QST at the newsstands; he wants a report from every active ham. If interested and qualified for O.R.S., O.P.S. or other appointments he can tell you about them, too.

Eastern Pennsylvania Maryland-Delaware-District of Columbia Southern New Jersey Western New York Western Pennsylvania	W3QP  W3BAK W3BEI W8CSE W8OFO	<b>ATLANTIC DIVISION</b> John Buck Morgan  Edgar L. Hudson W. W. Filson Ed Preston Kendall Speer, Jr.	Blue Bell  Laurel, Delaware Audubon Tully Lowermer
Illinois Indiana Kentucky Michigan Ohio Wisconsin	W9RMM W9QG W9ARU W8DPE W8AQ W9UTT	<b>CENTRAL DIVISION</b> Leslie M. Dickson Noble Burkhart Darrell A. Downard Harold C. Bird E. H. Gibbs Aldrich C. Krones	Edellyn Farms R. 4, Box 1 116 N. Longworth Ave. R.F.D. 2 405 Broad St. 3127-A West Madison St.
North Dakota South Dakota Northern Minnesota Southern Minnesota*	W9RZA W9VOD W9IGZ W9VNO	<b>DAKOTA DIVISION</b> Ernest Bloch Dr. A. L. Russell Edwin L. Wicklund M. L. Bender	Box 202  R.F.D. 3 608 N. Huron Ave.
Arkansas Louisiana Mississippi* Tennessee	W5ABI W5DKR W5GHF W4DEP	<b>DELTA DIVISION</b> H. E. Vette Eugene H. Treadaway Robert E. Barr B. G. Lowrey Smith	4415 West 12th St. 2749 Myrtle St. 673 Hillcrest St.
Eastern New York N. Y. C. & Long Island Northern New Jersey	W2LU W2AZV W2GMN	<b>HUDSON DIVISION</b> Robert E. Haight E. L. Baunach Fred C. Read	511 South Holmes St. 102 Central Ave. 1014 North Ave.
Iowa Kansas Missouri Nebraska	W9ARE W9PB W9ODU W9FAM	<b>MIDWEST DIVISION</b> Clyde C. Richelieu Harry E. Legler Miss Letha Allendorf Samuel C. Wallace	815 Dunham St. 304 Miami St. 1015 W. 3rd St. Green St.
Connecticut Maine Eastern Massachusetts Western Massachusetts New Hampshire Rhode Island Vermont	W1CTI W1FBJ W1IWC W1IAH W1BFT W1HRC W1GNF	<b>NEW ENGLAND DIVISION</b> Frederick Ellis, Jr. Winfield A. Ramsdell Sam Gross William J. Barrett Carl B. Evans Clayton C. Gordon Alvin H. Battison	19 Merrill Rd. 1188 Washington Ave. Pleasant St. 239 Columbia St. 83 No. State St. 191 Washington Ave. 1 Central St.
Alaska Idaho Montana Oregon* Washington	K7ENA W7EMT W7FL W7FNO W7FCG	<b>NORTHWESTERN DIVISION</b> Leo E. Osterman Carl Eichelberger G. A. Woodhouse J. R. MacManiman W. Beale	Customhouse Route 2 Holter Dam 1545 N. E. 48th Ave. R. 4, School Ave.
Hawaii* Nevada Santa Clara Valley East Bay San Francisco Sacramento Valley Philippines San Joaquin Valley	K6OOE W6BTC W6TPW W6JTV W6SG W6GZY K4IGR W6LPE	<b>PACIFIC DIVISION</b> Harold C. Smith Edward W. Heim Elbert Amarantes Harold J. Burchfield Alan D. Whittaker, Jr. J. L. C. Buckenham George L. Rickard Angelo V. Astone	P. O. Box 150 509 Claremont St. 454 Washington St. 2340 106th Ave. 79 Elinor Ave. 2720 22nd St. Box 849 729 Safford
North Carolina South Carolina Virginia West Virginia	W4OG W4ROE W3OVA W8HD	<b>ROANOKE DIVISION</b> H. S. Carter Ted Ferguson Charles M. Waff, Jr. C. S. Hoffmann, Jr.	P. O. Box 111 1113 College St. 2607 Stuart Ave. 47 Lynwood Ave.
Colorado Utah-Wyoming*	W9FA W7CLG	<b>ROCKY MOUNTAIN DIVISION</b> Glen Glasscock Ernest Parshall	2164 So. Corona St. 540 Peake St.
Alabama Eastern Florida Western Florida Georgia-Cuba-Isole-of-Pines- Porto Rico-Virgin Islands	W4DGS W4DVO W4BSJ *W4PM	<b>SOUTHEASTERN DIVISION</b> James F. Thompson L. A. Connolly Ellis R. Curry Charles W. Davis	102 Narrow Lane Rd. 719 So. Willow Ave. Box 425 2136 N. E. Boulevard Dr.
Los Angeles Arizona San Diego	W6MQM W6KFC W6JRM	<b>SOUTHWESTERN DIVISION</b> Ralph S. Cline Victor C. Clark Howard K. Breedlove	979 Farnam St. 747 E. Polk St. R. 2, Box 630
Northern Texas Oklahoma Southern Texas New Mexico	W5DXA W5CEZ W5BHO W5CGJ	<b>WEST GULF DIVISION</b> Lee Hughes Carter L. Simpson Dave H. Calk Joseph M. Eldott	125 N. Main St. 2010 So. 4th St. 6726 Ave. Q
Maritime	VE1DQ	<b>MARITIME DIVISION</b> A. M. Crowell	69 Dublin St.
Ontario	VE3SG	<b>ONTARIO DIVISION</b> Fred H. B. Saxon	302 Lee Ave.
Quebec	VE2EE	<b>QUEBEC DIVISION</b> Stan Comach	780 Brault Ave.
Alberta British Columbia	VE4GE VE5HP	<b>VANALTA DIVISION</b> C. S. Jamieson J. Hepburn, Jr.	581 W. Riverside Drive 335 Foul Bay Road
Manitoba Saskatchewan	VE4BG VE4SY	<b>PRAIRIE DIVISION</b> A. J. R. Simpson Arthur Chesworth	635 Garfield St. 1071 4th Ave., N. W.

\* Officials appointed to act until the membership of the Section choose permanent S.C.M.'s by nomination and election.

## PLATE TRANSFORMER SPECS.

### 1. PRIMARY VOLTAGE AND FREQUENCY —

- (A) Does voltage fluctuate widely (more than  $\pm 10\%$ )?  
(B) Is the wiring in your building heavy enough to carry the load? (If not, the voltage will drop when the load comes on and poor regulation will result).

### 2. SECONDARY VOLTAGE (R.M.S.) —

- (A) For a full wave choke input rectifier system this is —  
 $1.1 X$  (D.C. output + choke drop + tube drop each side center tap.).

### 3. D.C. OUTPUT VOLTAGE —

- (A) Type of rectifier system used: I. Full wave choke input;  
II. Full wave condenser input; III. Type of rectifier tubes.  
(B) Type and resistance of chokes used.  
(C) Capacity of condensers used.

### 4. D.C. LOAD (in amperes or milliamperes) —

- (A) Type of load: I. Constant; II. Variable — give maximum and minimum values; III. Continuous (4 hours or more may be considered continuous); IV. Intermittent — give length of time load is on and length of time load will be off.

## Kandid Ken-O-Talk, No. 10

### • PLATE TRANSFORMER SPECIFICATIONS •

PROBABLY the most common cause of unsatisfactory operation in all types of electrical equipment may be traced to faulty or misunderstood specifications. If any trace of doubt exists, the manufacturer should always be consulted to determine the exact meaning of his specifications.

In the above "Page from an Engineer's Notebook" are listed the detailed specifications which are required by an engineer before he can design a plate transformer. If any one of these specifications is missing it means a delay while the information is obtained. If it is impractical to wait for complete specifications, the unit must be built so it will operate satisfactorily under the worst conditions which would normally be expected. This of course means a larger and more expensive transformer than necessary.

The plate supply for class B stages sometimes has poor regulation due to the fact that the primary is supplied by a line which is incapable of supplying the power. As the load comes on, the line voltage drops and the resulting poor regulation introduces distortion in the class B stage. It is usually possible to find out the maximum safe load for a line from the power company.

If plate transformers are ordered by the D. C. voltage output required, it must be remembered that the type of rectifier tubes, the resistance of chokes, and whether condenser or choke input must be known in order to determine the secondary voltage. Even if secondary voltage is specified, it is important to know whether choke or condenser input will be used, for as much as 40% difference in secondary current may be caused, even with the same D. C. output, by a change from condenser to choke input.

In specifying the load current, account should always be taken of the bleeder resistor. This seemingly unimportant factor may mean the difference between correct operating conditions and a 15% overload.

If the load is of the swinging or variable type the maximum signal and zero signal drain should be specified. This information is necessary to determine the average value of load, as well as to get an indication of what the regulation should be.

Transformers to supply intermittent load, may be made smaller and less expensive than those for continuous duty. If the duty cycle (say 15 minutes on — 10 minutes off) is known, the unit may be designed to take advantage of this fact. A transformer to take care of this type of load is by no means an inferior type. It is one in which a complete set of facts have been made available so that an economical design is possible.

*F. P. Fenyon*

# The American Radio Relay League



• T

HE AMERICAN RADIO RELAY LEAGUE, INC., is a non-commercial association of radio amateurs, bonded for the promotion of interest in amateur radio communication and experimentation, for the relaying of messages by radio, for the advancement of the radio art and of the public welfare, for the representation of the radio amateur in legislative matters, and for the maintenance of fraternalism and a high standard of conduct.

It is an incorporated association without capital stock, chartered under the laws of Connecticut. Its affairs are governed by a Board of Directors, elected every two years by the general membership. The officers are elected or appointed by the Directors. The League is non-commercial and no one commercially engaged in the manufacture, sale or rental of radio apparatus is eligible to membership on its board.

"Of, by and for the amateur," it numbers within its ranks practically every worth-while amateur in the nation and has a history of glorious achievement as the standard-bearer in amateur affairs.

Inquiries regarding membership are solicited. A bona fide interest in amateur radio is the only essential qualification; ownership of a transmitting station and knowledge of the code are not prerequisite. Correspondence should be addressed to the Secretary.

HIRAM PERCY MAXIM, FIRST PRESIDENT

## OFFICERS

- President*.....EUGENE C. WOODRUFF, W8CMP  
State College, Pa.
- Vice-President*.....GEORGE W. BAILEY, W1KH  
Weston, Mass.
- Secretary*.....KENNETH B. WARNER, W1EH  
West Hartford, Connecticut
- Treasurer*.....ARTHUR A. HEBERT, W1ES  
West Hartford, Connecticut
- Communications Mgr.*...F. EDWARD HANDY, W1BDI  
West Hartford, Connecticut
- ◆
- General Counsel*.....PAUL M. SEGAL  
1026 Woodward Building, Washington, D. C.
- ◆

Address all general correspondence to the administrative headquarters at West Hartford, Connecticut

## DIRECTORS

- President*  
EUGENE C. WOODRUFF.....W8CMP  
234 W. Fairmount Ave., State College, Pa.
- Vice-President*  
GEORGE W. BAILEY.....W1KH  
74 Webster Road, Weston, Mass.
- Canadian General Manager*  
ALEX REID.....VE2BE  
169 Logan Ave., St. Lambert, P. Q.
- Atlantic Division*  
WALTER BRADLEY MARTIN.....W3QV  
Box 612, Roslyn, Pa.
- Central Division*  
R. H. G. MATHEWS.....W9ZN  
100 East Ohio St., Chicago
- Dakota Division*  
FRED W. YOUNG.....W9MZN  
Apartment 16, 500 Harvard St., Minneapolis, Minn.
- Delta Division*  
E. RAY ARLEDGE.....W5SI  
P. O. Box 286, Pine Bluff, Ark.
- Hudson Division*  
KENNETH T. HILL.....W2AHC  
115 Willow St., Douglaston, L. I., N. Y.
- Midwest Division*  
FLOYD E. NORWINE, JR.....W9EFC  
120 South Fourth St., St. Louis, Mo.
- New England Division*  
PERCY C. NOBLE.....W1BVR  
37 Broad St., Westfield, Mass.
- Northwestern Division*  
RALPH J. GIBBONS.....W7KV  
c/o United Air Lines, Pendleton, Ore.
- Pacific Division*  
J. L. McCARGAR.....W6EY  
66 Hamilton Pl., Oakland, Calif.
- Roanoke Division*  
H. L. CAVENESS.....W4DW  
State College Station, Raleigh, N. C.
- Rocky Mountain Division*  
EDWARD C. STOCKMAN.....W9ESA  
618 So. Williams St., Denver
- Southeastern Division*  
BENNETT R. ADAMS, JR.....W4APU  
1512 Grove Place, Homewood, Ala.
- Southwestern Division*  
CHARLES E. BLALOCK.....W6GG  
443 Main St., El Centro, Calif.
- West Gulf Division*  
WAYLAND M. GROVES.....W5NW  
c/o Humble Pipe Line, Mt. Pleasant, Texas



# "It Seems to Us — —"

WELL, folksies, we're going to have another national convention, as every ham in Christendom now knows and as has been extensively mentioned in our pages in recent months. It will be the first one in many a long year and the Chicago gang has been working industriously for months to make it a long-remembered one. Some of the details are to be found in this issue. The Chicago fellows have the habit of throwing pretty grand conventions, and we think everybody can look forward to a swell time at this one. As can be expected from the word "national," the scope of this convention should be greater than any we have had in over a decade and every effort is being made to arrange a program that will have nation-wide appeal, whatever the individual amateur's pet interest in radio may be.

Perhaps the grandest feature of a national convention is the renewing of old friendships and the making of new ones with fellows we meet for the first time face to face, despite years of radio contacts. We still encounter many hams whom we have met only once before—at one of the national conventions. Chicago on September 3d, 4th and 5th will be the center of American amateur radio, a never-to-be-forgotten period in our ham lives. Any ham who misses it when he doesn't have to is simply begging for future heartaches. So pack up the O.W. and all the little harmonics, O.M., and shove along to Chi. BCNU tr!

K.B.W.

ONCE, way back when, there was a fellow who said that amateur radio had lost all its fascination—that everything had been done and that all hams could do now was sit and coast. Of course, the bird was dead wrong, but in spite of that he was able to get quite a few followers. These are the guys who mumble about having worked the world and as how nobody has anything to do any more. What the ham game needs, of course, and what it seems invariably to get, is some "miracle" to ram home the fact that ham radio is *still* a limitless paradise for the worker blessed with some imagination. The most recent and most stunning of these "miracles" is this latest five-meter business. Here we sat for years pretty thoroughly convinced that five-meter waves were not privileged to arch their way through the ionosphere and bound down to delight the ears of the DX man. To be sure, we have witnessed the anticipated freak conditions, when some wandering five-meter signal managed to escape for a run of a thousand miles or so. But we were only too prepared to scoff faintly and say, "Another of those freaks—don't mean nuthin'." And now look at us—a group of amateurs (with engineers and scientists on the side) utterly flabbergasted at the way in which 56-Mc. signals have been smearing most of the country most of the days for the last three months. Thrills—why, there were never any like 'em. Excitement—you should just crank up that five-meter receiver on one of these "hot" mornings or evenings! But more than all that, this five-meter orgy is destined to result in a major contribution to the field of science. One only needs to glance at Jack Pierce's preliminary survey, published elsewhere in this issue, to realize that, while much of the picture is still shrouded in mystery, a really comprehensive explanation and a new understanding of certain irregularities of the ionosphere are on the way. They will be contributions of first importance and they will be the direct outcome of that pioneering spirit and dauntless enthusiasm which most amateurs seem to have. We can chalk up one more of those all-important phenomena which almost certainly would have gone unobserved had it not been for the hams.

R.A.H.

# Norfolk Amateurs Prepare for Emergencies

## Standardized Transmitters with Interchangeable Power Supplies for Flexibility in Portable-Emergency Work

By Fenton Priest, W3EMM,\* and Laurie Turner, W3BEK\*\*

*Evidence that amateurs are preparing, not only individually, but in groups for communications service during emergencies is supplemented by this story about the equipment which has been built by Norfolk, Va., amateurs. Five transmitters, all using the same circuit and parts, have been built; several more are under construction. The sets work on four bands, both 'phone and c.w., with inputs between 15 and 30 watts. Some good receiver suggestions are included, too.—EDITOR.*

**I**T WAS decided at a meeting of the amateurs of Norfolk, Virginia, that what the city and vicinity needed most in the line of emergency communication was a local net made up of portable battery-operated transmitters and receivers which could be relied upon to maintain communication with Red Cross Headquarters in the city, other sections of the town, and the outlying beaches. The most distant point to be covered would be Virginia Beach, approximately 20 miles from downtown Norfolk. The city covers quite an area for its population and is peculiarly situated in that it is almost completely surrounded by water.

With this idea in mind, we decided upon a transmitter that would work on a 6-volt storage

results are obtained with this voltage, both as to modulation and efficiency.

The five units already completed have two power supplies each. One, for a.c. operation, delivers 350 volts to the transmitter and the other, for 6-volt operation, uses generators that deliver 300 volts. On a.c. the maximum power input to the final is 25 to 30 watts on 'phone and 30 to 40 watts on c.w. On the 6-volt supply the input is between 15 and 20 watts on 'phone and about 25 watts on c.w. Three of the transmitters already built are exactly alike in every detail; the other two differ only in the size and shape of the cabinet. Some of the transmitters to be built (and being built) are identical units and the others will vary only in physical design and layout. The coils, tubes and parts are all interchangeable. The power plug connections likewise are all identical so any transmitter can be used on any power unit, whether a.c. or 6-volt. The power units vary somewhat as to the voltage delivered and the type of transformers, generators and general construction, but all have the same socket connections so any transmitter can be worked on them. These units are not "pack transmitters" in any sense of the word, but are designed to be portable, in that they can be very easily put into a car, or carried anywhere and put into operation with a minimum amount of work, and can operate independently of outside power. All the units are as compact and as light as possible and still are good dependable outfits.

Each portable station consists of a transmitter unit, a power unit, a receiver with "B" batteries, a storage battery and an antenna. When it becomes necessary to use the equipment in the field at least two operators, and three if possible, will go with each station. With two or three hams along, handling of equipment is easy and 24-hour operation, with shifts, can be carried on. If it is

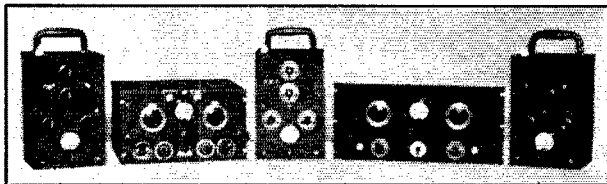

**THE FIVE TRANSMITTERS SO FAR COMPLETED**

*Three are identical in construction; the other two use the same circuit but with different mechanical arrangement. Power supplies and components are interchangeable. They belong respectively to W3BEK, W3NT, W3EMM, W9INC/3 and W3FQP.*

battery or on the 110-volt power line. The transmitter works on 160, 80, 40 or 20 meters, 'phone or c.w., uses a 6F6 oscillator and an 807 final in the r.f.; with 6J7, 6C5, and 6L6 tubes in the audio working from a crystal mike. The audio and r.f. units work very nicely with a plate voltage of 150 to 400 volts, the power input to the final being 5 to 30 watts on 'phone and about 40 watts maximum on c.w., depending upon the plate voltage used. The sets are designed to work on a plate supply delivering 300 to 350 volts and optimum

\* 903 Hanover Ave., Norfolk, Va.

\*\* 115 W. 33rd St., Norfolk, Va.

necessary to keep one of these units going outside of the city on its own power for any great length of time, it will be easy enough to commandeer batteries from automobiles in the vicinity.

#### TRANSMITTER DETAILS

Panel and inside views of one of the three identical transmitters are shown in the photographs. The complete transmitter, including r.f. and audio units, is built in a Par-Metal cabinet (No. PC-1276) 12 by 7¾ by 6½ inches. The two chassis are also Par-Metal (No. 15760), 6½ by 6¼ by 1½ inches.

The circuit diagram is given in Fig. 1. A grid-plate type crystal oscillator circuit is used, this circuit having the advantage that no tank circuit is necessary. Its output drives the 807, which operates either as straight amplifier or doubler. To cover the four bands from 14 to 1.75 Mc., it is



IN THE FIELD WITH THE NORFOLK PORTABLES W3NT (with microphone), W3II, W3FQP, and W3EMM's brother.

necessary to have only two crystals and two coils. One coil is cut to cover 1.75 and 3.5, the other 7 and 14 Mc. With a 1.75-Mc. crystal, 3.5 Mc. can be used by doubling in the final. With a 7-Mc. crystal, 14 Mc. can be covered by doubling. Of

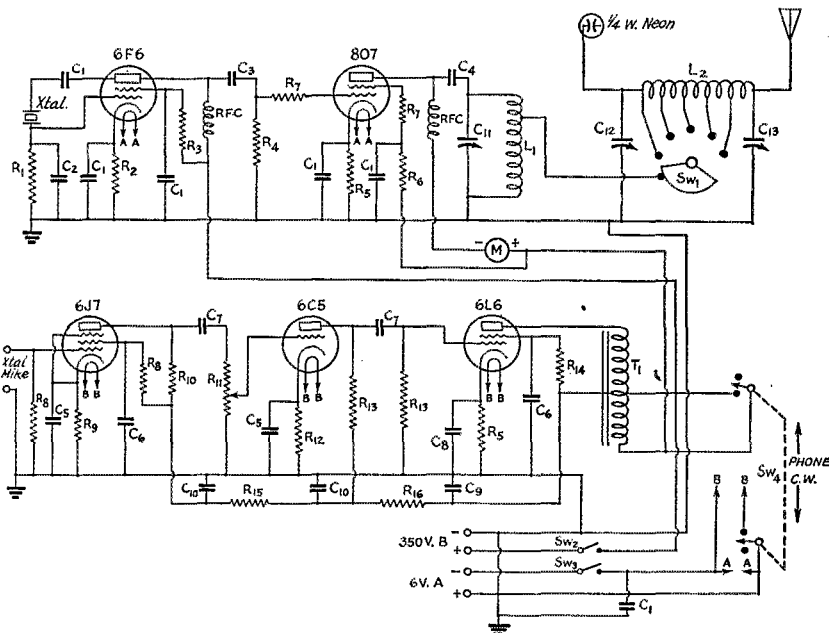

FIG. 1—CIRCUIT DIAGRAM OF THE NORFOLK EMERGENCY TRANSMITTER

- |  |   |   |   |
|--|---|---|---|
| C <sub>1</sub> —0.005- $\mu$ fd. mica, 500-volt.     | C <sub>10</sub> —4- $\mu$ fd. electrolytic, 450-volt.           | R <sub>7</sub> —100 ohms, 1-watt.                       | T <sub>1</sub> —Output transformer (see text) (Thor-darson T-13S41).  |
| C <sub>2</sub> —150- $\mu$ fd. mica, 500-volt.       | C <sub>11</sub> —200- $\mu$ fd. variable (Hammarlund MC-200-M). | R <sub>8</sub> —1 megohm, ½-watt.                       | L <sub>1</sub> —1.75 and 3.5 Mc.: 42 turns No. 18 d.c.c., tapped 7th turn from plate end, close-wound on 1¾-inch diameter plug-in form. |
| C <sub>3</sub> —100- $\mu$ fd. mica, 500-volt.       | C <sub>12</sub> —320- $\mu$ fd. variable (Hammarlund MC-325-M). | R <sub>9</sub> —1000 ohms, 1-watt.                      | L <sub>2</sub> —46 turns No. 18 d.c.c. wire, close-wound on 1¾-inch form, tapped every 9 turns for four taps, 10 turns last tap.        |
| C <sub>4</sub> —0.002- $\mu$ fd. mica, 1000-volt.    | C <sub>13</sub> —260- $\mu$ fd. variable (Hammarlund MC-250-M). | R <sub>10</sub> —250,000 ohms, ½-watt.                  |   |
| C <sub>5</sub> —10- $\mu$ fd. electrolytic, 25-volt. | R <sub>1</sub> —50,000 ohms, ½-watt.                            | R <sub>11</sub> —5-megohm potentiometer.                |   |
| C <sub>6</sub> —0.1- $\mu$ fd. paper.                | R <sub>2</sub> —1000 ohms, 1-watt.                              | R <sub>12</sub> —3000 ohms, ½-watt.                     |   |
| C <sub>7</sub> —0.02- $\mu$ fd. paper.               | R <sub>3</sub> —75,000 ohms, 1-watt.                            | R <sub>13</sub> —100,000 ohms, ½-watt.                  |   |
| C <sub>8</sub> —25- $\mu$ fd. electrolytic, 25-volt. | R <sub>4</sub> —15,000 ohms, 2-watt.                            | R <sub>14</sub> —10,000 ohms, 10-watt.                  |   |
| C <sub>9</sub> —8- $\mu$ fd. electrolytic, 450-volt. | R <sub>5</sub> —250 ohms, 10-watt.                              | R <sub>15</sub> —50,000 ohms, 1-watt.                   |   |
|  | R <sub>6</sub> —6000 ohms, 10-watt.                             | R <sub>16</sub> —10,000 ohms, 1-watt.                   |   |
|  |   | Sw <sub>1</sub> —6-point tap switch (Centralab F-K121). |   |
|  |   | Sw <sub>2</sub> , Sw <sub>3</sub> —S.p.s.t. switch.     |   |
|  |   | Sw <sub>4</sub> —D.p.d.t. switch.                       |   |



course, fundamental operation is best, and for emergency work one of the three lower-frequency bands—7, 3.5 or 1.75 Mc.—would be used.

The two 100-ohm resistors in the 807 control grid and screen grid were necessary to kill a tendency toward self-oscillation when the crystal

MC. Several values of resistors and condensers were tried in the audio and r.f. circuits and those that gave the proper bias, excitation, voltages and gain for the different stages are shown in the diagram. They are correct for optimum performance of the audio end, the crystal oscillator and the 807 final. Although the cabinets are not very large, there is plenty of room when small parts are used, and the assembling and wiring is easy where it would be difficult and crowded with big parts.

The modulation transformer is a standard receiver-type universal output transformer rated at 20 watts audio, and will carry 60 ma. d.c. each side. It is designed to work from a push-pull output stage to any voice coil. The plate load impedance of the 6L6 modulator tube working Class-A is approximately the same as the r.f. load impedance at 25 watts input. With a 1:1 ratio transformer the mismatch is only a few percent. The primary of the transformer, connected as an auto-transformer, fills the bill and is large enough to handle the power very nicely. The voice coil windings are not used and are left floating. The electrolytic condensers in the audio end are the new midget type.

The final is properly loaded with 350 volts on the plate when the current is about 70 to 75 ma., for 'phone operation. With 300 volts the plate current should be from 50 to 60 ma. These little sets when finished were checked with an oscillograph and found to have almost perfect wave-form, and looked surprisingly good at 100 per cent modulation with 25 watts input to the 807 from the a.c. supply and 18 watts from the 6-volt supply. The  $\frac{1}{4}$ -watt neon bulb is used for a visual modulation indicator, giving a rough check on the peaks. After using the set for a while and watching the bulb "bounce," it is possible to get a fair idea of just how much audio to use. The brilliance of the glow will vary under different antenna load conditions and plate voltages, and has nothing at all to do with the tuning adjustments. The set there-

*(Continued on page 122)*

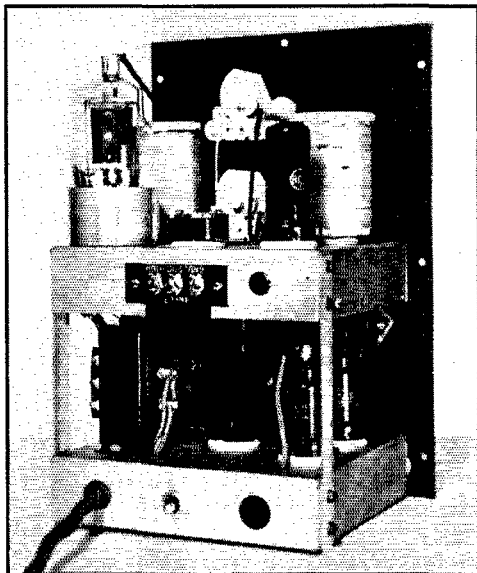

#### INSIDE THE TRANSMITTER CASE

*R.f. section on the upper chassis, audio on the lower. Circuits and construction are simple but highly practical for the job.*

was removed. With these resistors the final shows no trace of self-oscillation even when the tube draws 80 ma. plate current with no excitation. The resistors have no apparent effect on the efficiency of the amplifier. The grid current to the 807 is 3 to 5 ma., depending upon the activity of the crystal in use.

The antenna is coupled to the plate tank of the 807 through a pi-section coupler. The tap switch has a 6-point stator and half ground-riding rotor. As the diagram shows, when the switch arm is on the first tap, the antenna and coupler are completely disconnected from the final. This makes it possible to bring the final tank circuit to resonance, then cut in the network and antenna with the switch, adjusting for proper load and resonance with the taps and the network condensers as with any other Collins coupler.

All of the by-pass and coupling condensers in the r.f. unit, with the exception of the 807 plate blocking condenser which has a 1000-volt rating, are postage stamp mica type. The tuning condensers are Hammarlund midget condensers, Type

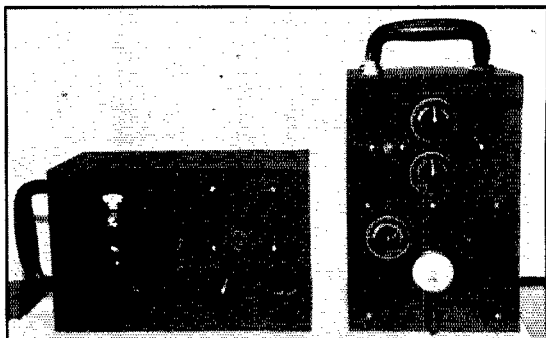

ONE OF THE TRANSMITTERS AND A RECEIVER

*The receiver is a revamped all-wave broadcast set.*

# Preselection Simplified

## An Effective One-Tube R.F. Amplifier with Switching for Five Bands

By T. M. Ferrill, Jr.,\* W1LJI

**H**OW many will disagree with the statement that "our modern receivers are still far from perfect?" Despite the many large advances made in the design and construction of expensive sets, some additional features, or some improvements in performance, however slight, often remain to be desired.

One of the improvements needed by some commercially manufactured and homebuilt receivers is an r.f. stage which will increase signal-to-noise ratio and reduce at the receiver the blocking effect of strong local stations. In addition, there are times when even a superheterodyne receiver with as many as two conventional r.f. amplifier stages lacks sufficient r.f. gain for very weak signals. Furthermore, sets with only one tuned r.f. amplifier with 465-ke. intermediate-frequency stages and sets incorporating higher-frequency i.f. stages with no tuned r.f. stage can well use the increased signal-to-image ratio which an additional r.f. amplifier stage will provide.

The simple one-tube regenerative r.f. amplifier shown in the accompanying illustrations is a step in the right direction for many amateur receivers. Built at an amazingly low cost and at the expense of very little time and effort, it undoubtedly provides the maximum of operating enjoyment for the cost involved. Although only few words and little space are required to describe completely this gadget, its value to many readers would justify the use of several pages, for it accomplishes, simply and thoroughly, the several desired results suggested in the paragraph above.

\* Technical Department, QST.

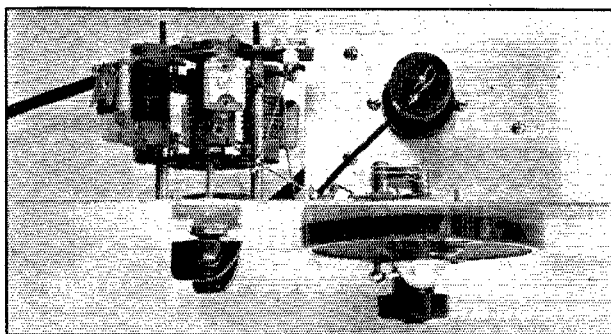

A TOP VIEW OF THE AMPLIFIER, SHOWING TUBE AND TUNING UNIT

The tube in use is an 1851.

### CIRCUIT

In the interest of simplicity and economy, a single stage with untuned output circuit is used. By incorporating the circuit most commonly used for regenerative detectors, substituting cathode-resistor bias for grid-leak bias, a commercially-made tuning unit designed for a coil-switched regenerative receiver is made into a very effective

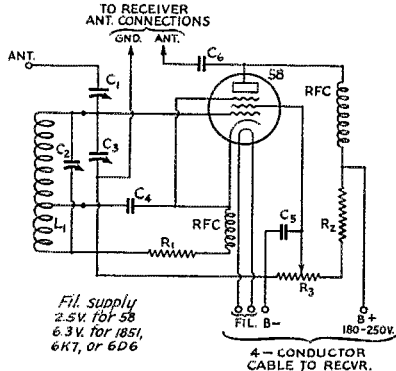
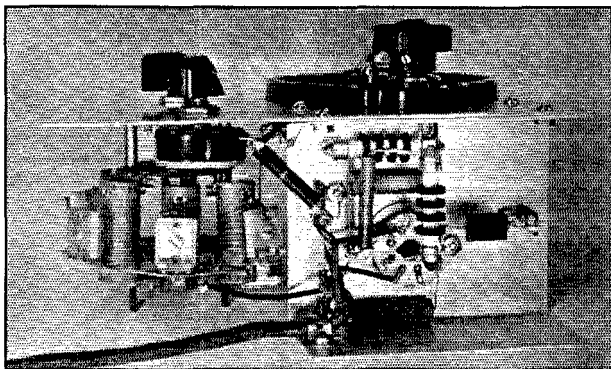

FIG. 1—CIRCUIT DIAGRAM OF THE PRESELECTOR WITH 58 TUBE IN USE

(When metal types are used ground the shell.)

- C<sub>1</sub>—5-25- $\mu$ fd. variable mica trimmer.
- C<sub>2</sub>—5-25- $\mu$ fd. variable mica trimmer (one for each coil).
- C<sub>3</sub>—15- $\mu$ fd. variable air-tuning condenser.
- C<sub>4</sub>, C<sub>5</sub>—0.01- $\mu$ fd. fixed, tubular paper or mica.
- C<sub>6</sub>—250- $\mu$ fd. fixed mica.
- R<sub>1</sub>—300-ohm, 1-watt carbon.
- R<sub>2</sub>—50,000-ohm, 1-watt carbon.
- R<sub>3</sub>—25,000-ohm receiving-type carbon-element potentiometer.
- L<sub>1</sub>—See Coil Table.
- RFC—2.5-millihenry receiving-type r.f. chokes.

preselector. Ganging worries often associated with two or more tuned circuits in such a device, and the expense represented by use of such features, are eliminated. Since many of the modern receivers require only rotation of a knob or an equivalent simple operation for moving the receiver from one band to another, it is very desirable that the preselector stage added be one which will not greatly increase the time required for band-change, and hence, switched coils are used in this set. In order to adjust the circuit so that the desired amateur band is properly located on the tuning dial when the



BOTTOM VIEW, SHOWING THE SIMPLICITY OF WIRING

switch is set at the correct position, mica-dielectric trimming condensers,  $C_2$ , are connected in parallel with the tuning coils. In addition to the above function, these trimmers load the circuits with enough fixed capacity to give good band-spread on the narrow bands.

In the circuit diagram, Fig. 1, it will be noted that the antenna used with the preselector is coupled through a variable condenser,  $C_1$ . This also is a mica-dielectric unit of the trimmer type, and is supplied as part of the commercial assembly.

Blocking condenser  $C_4$ , resistor  $R_1$ , and the r.f. choke in series with  $R_1$  form the cathode bias circuit of the amplifier. No control is specifically provided for the purpose of r.f. gain control, although a 2000-ohm variable resistor could be added in series with the 300-ohm bias resistor for this purpose if desired. Actually, such a wide range of amplification is available with the regeneration control resistor,  $R_3$ , in addition to the range provided by the r.f. gain control usually included in the superheterodyne receiver, that an additional control on this stage is considered unnecessary.

Although more gain would result from the added efficiency of a tuned plate circuit link coupled to the input terminals of the receiver, the gain provided by this unit on several receivers with which it was operated indicates that the disadvantages of the extra equipment outweigh the value of gain produced by the latter, since the amplification of the single stage with untuned output is tremendous. To give some definite idea of the amplification and selectivity of the stage, the results of experience with one commercially-made receiver should be given. The receiver, a modern superheterodyne with one preselector stage, 456-kc. intermediate frequency, and provision for an antenna input impedance of approximately 600 ohms, was tuned to a strong station in the 20-meter amateur band. The preselector was then tuned to a frequency 912 kilocycles higher than the frequency to which the receiver

was tuned, and the regeneration was run up to the maximum usable value without oscillation. At this point, it was found that the amateur station could barely be heard with all the gain available in the receiver, and that most 20-meter amateur stations which could easily be heard before the connection of the preselector had become inaudible. On the other hand, with the gain controls of the receiver set to the original reference settings (the points at which they were adjusted before the preselector was connected), it was noted that stations in the vicinity of the frequency to which the preselector was tuned could be received with more than comfortable volume. Upon disconnecting the preselector and tuning the receiver to the higher frequency (the former image frequency) it was found that additional gain was necessary to bring the volume level to that which the combination of preselector and image-tuned receiver had produced.

By setting the receiver for reception on a frequency 912 kc. lower than that of a station in the 20-meter amateur band, and tuning the preselector to the frequency of the 20-meter amateur station, again using the reference setting of the gain controls, it was found that the amateur stations were received with more volume than when properly tuned in with the antenna connected directly to the receiver.

This simply means that the single regenerative preselector stage with untuned output circuit gave a better image ratio than the properly tuned and coupled r.f. amplifier and detector in the receiver.

#### CONSTRUCTION

The panel and chassis for the preselector are made of 1/16-inch aluminum sheet. Dimensions, and details for bending and drilling, are given in Fig. 2. One hexagon nut is removed from the variable condenser, and one from the band switch, before mounting the tuning assembly. This unit is then fastened to the panel exactly in the manner used to mount a switch and a condenser separately. The grid leak and grid condenser are then removed from the coil-condenser assembly, and are replaced by a grid lead approximately  $2\frac{1}{2}$  inches long. The single wire connection to the tuning condenser is left intact, and the other connection is of course completed through the metal frame, as supplied. Two lug terminals are provided at the rear of the band switch: The one nearer the tuning condenser is the cathode-tap switch terminal, and must be connected to the cathode blocking condenser,  $C_4$ , while the terminal farther from the tuning condenser is wired through the antenna condenser,

$C_1$ , to the grid connection of the coil switch. This terminal is used for the antenna connection post on the preselector. Thus, aside from the use of one of the two terminal lugs at the rear for an antenna connection, only two wires are connected to the tuning unit, and only one change—removal of grid leak and grid condenser—is made in the tuner.

Two lug strips are screwed to the aluminum chassis; one strip with a single lug is used to support the end of  $C_6$  opposite the plate terminal of the tube, and at the same time to provide a terminal for connection of the wire to antenna post on the receiver; and a strip with four insulated lugs is used to receive the connection of  $R_2$  and RFC (supporting the ends of these two parts) and the B+ lead in the cable, connections between two of the cable wires and the heater terminals of the tube socket, and the connection between the cathode-tap switch terminal and blocking condenser  $C_4$ . The last-mentioned lug serves to keep the r.f. circuit rigid.

The regeneration control resistor,  $R_3$ , is mounted directly below the coil switch, and the terminals serve to complete the rigid wiring used throughout the preselector.

The diagram of Fig. 1 shows the connections of a 58 tube in the amplifier. The connections for the 6D6 are identical to those shown, while for an 1851 (or a 6K7, which type has also been used in the set) the shell pin of the tube socket should be grounded.

#### POWER SUPPLY

The power connections for the preselector are most conveniently taken from the receiver through a four-conductor cable. Of course, if the receiver uses 6.3-volt tubes, either the 1851 or the 6D6 tube should be used in the preselector;

whereas a 58 should be used if the receiver is equipped with 2.5-volt tubes.

#### OPERATION

The preselector should be placed as near the receiver as possible, not only for operating convenience, but also to provide for short connections between preselector output and receiver antenna

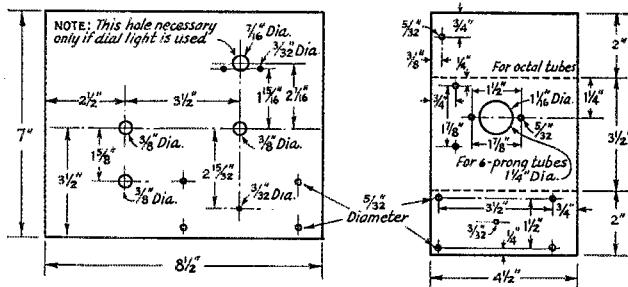

FIG. 2—DETAILS OF PANEL AND CHASSIS

The material is 1/16-inch aluminum sheet. Chassis should be bent along the dotted lines. Note that two sets of dimensions are given for the tube socket; one set applies to the 6-prong sockets, and the other to octal types.

input terminals; and the power cable should be connected internally to the set. With the antenna connected to the receiver, some amateur station in the 20- or 40-meter band should be tuned in. The antenna connection should then be moved from the receiver input to the antenna condenser on the preselector, and the output of the preselector should be connected to the receiver. Then, with the switch of the preselector set for the band on which the receiver is tuned and the tuning condenser dial set for approximately half-capacity of the condenser, the trimmer on the coil in use should be adjusted for maximum signal strength by means of a screwdriver. If the regeneration-control resistor is moved from minimum to maximum screen-voltage position during this adjustment process, it should be found that the preselector can be made to oscillate strongly, producing a loud howl in the receiver. The correct adjustment for this control is that which is reached just before the point of oscillation when turning the control from minimum toward maximum. At this adjustment, the tuning of the preselector is quite sharp, and with frequent movements of the regeneration control while the trimmer condenser is being adjusted, the trimmer may be set right "on the nose." Then, upon tuning across the band to which the receiver and preselector are set, it can be determined whether this setting of the trimmer allows complete coverage of the band—if it does not, a slight readjustment of the trimmer condenser will remedy the trouble.

This procedure is repeated on the other amateur bands, and need be made only once for a

(Continued on page 70)

#### COIL DATA

All coils are wound on fiber forms, 5/8-inch diameter by 1 3/4-inch length.

Frequency	Turns	Total Turns	Turns from Ground to Tap	Spacing, or Winding Length
1.7 Mc....	135	9.5	34*	Close-wound
3.5 Mc....	55	3.5	27*	Close-wound
7 Mc.....	20	1.5	22	7/8" length
14 Mc.....	9	1.5	18	13/16" length
28 Mc.....	6	1.5	18	1/2" length

\* Enamelled

The commercial assembly, including switch, coils ready-wound, trimming condensers ( $C_2$ ), antenna coupling condenser ( $C_1$ ), and tuning condenser, all assembled mechanically and wired together, is obtainable from Browning Laboratories, Winchester, Mass. If preferred, a two-section, five-position selector switch may be obtained, and trimming condensers and hand-made coils may be mounted on the switch.

# A Five-Band Switching Exciter With 807 Output

Single Frequency Control With Crystal; Alternative E. C. Oscillator

By T. P. Kinn,\* WICC

*The theme of operating convenience continues popular. Here is an exciter capable of covering five bands at the turn of a switch, and any frequency inside a band at the turn of a knob. A new "untuned" coil system in the low-power stages does the trick. And again the combination of crystal and electron-coupled oscillator.—EDITOR.*

**M**OST of us are forever engaged in planning or actually building a new transmitter. Possibly we are just making changes in line with a new article we have read. But why this continual planning and rebuilding? It takes away many hours of happy operating and makes a continuous drain on the pocketbook. The answer, I believe, lies in the fact that up to now none of us has come even close to the ideal for which we all are apparently striving. Some of us are rebuilding to get more power, but the majority are rebuilding, I feel sure, in the hope of realizing that ultra-ultra rig with which, by means of one control, we could put our signal anywhere in any one of the ham bands.

Recently, we have seen some very fine designs featuring simplicity of frequency change, proving

\* 6502 Liberty Road, Woodlawn P. O., Baltimore, Md.

that we are progressing towards this ideal. Here at WICC the same problem was being considered very seriously last fall, and the outcome is the exciter unit to be described. Before we start, however, let's lead up to the design by attacking the problem from the beginning. When first thinking of the new rig, the following general requirements were set down:

1. It should operate in as many bands as possible.
2. It should select the band desired with a minimum of effort.
3. It should be possible to select any desired frequency within any band with a minimum of effort.
4. The control of band and frequency selection should be from the operating point.
5. The signal should at all times be of a character which would produce maximum operating efficiency.
6. The power should be the maximum allowed by law.

The reasons for all of these requirements are quite obvious, and they probably represent in general the basic desires of any amateur contemplating a new modern amateur transmitter. Considering the 4th and 6th requirements first, it was necessary from a practical standpoint to make somewhat of a compromise right at the start. Although not impossible it was felt it would introduce too many complications to attempt to put a 1-kw. outfit on the operating table within easy reach of the operating position. Two units therefore decided on; one an exciter which would sit on the operating table within easy reach of the

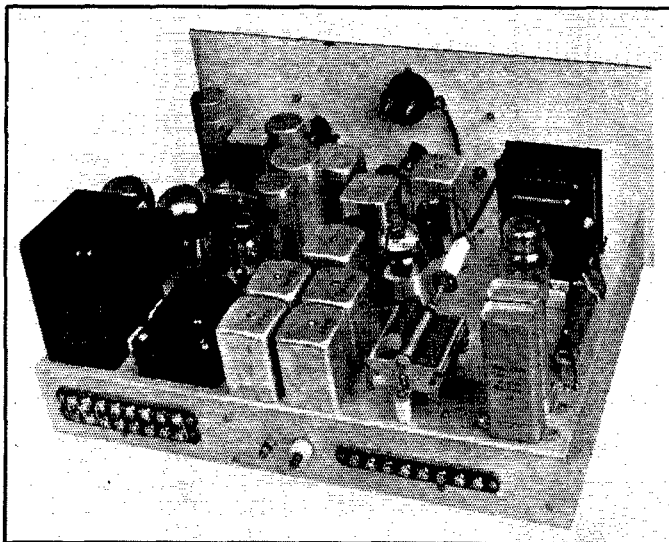

THE TOP OF THE CHASSIS SOMEWHAT RESEMBLES A SUPERHET RECEIVER

Terminal strips along the back are for metering when making adjustments. Voltage-regulator tubes are used on the oscillator power supply.

operator. It is the exciter unit that will be described herein, so let's go on with the details.

From the start it was decided that the exciter must cover the five main bands, namely; 160, 80, 40, 20 and 10 meters. If 5-meter operation was desired, a separate amplifier including an additional doubler stage would be the most practical solution. An attempt to include 5 meters in the exciter would, it was felt, introduce complications and possible sacrifice of flexibility on the lower frequency bands.

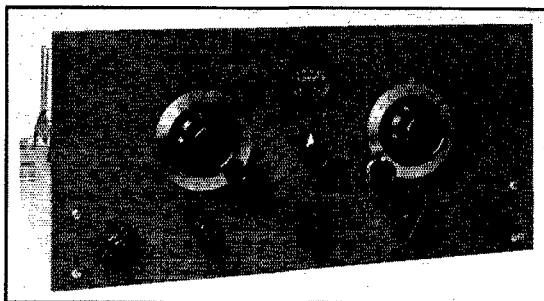

SEPARATE VERNIER TUNING CONTROLS ARE PROVIDED FOR THE SELF-CONTROLLED OSCILLATOR AND THE 807 OUTPUT STAGE

*Crystal oscillator and intermediate stages are fixed tune, so that the unit is essentially single-control within a band. An unusual feature is a built-in keying monitor.*

#### CIRCUITS

Referring to Fig. 1, the diagram of the exciter, it can be seen that the unit includes two separate oscillators—one crystal-controlled and the other self-controlled—two frequency multiplying stages and an output stage. Two power supplies are used, one for the two oscillators and the other for the frequency multipliers and the output stage. The crystal oscillator uses a Type 76 tube in a straight-forward semi-tuned<sup>1</sup> oscillator circuit. The plate circuit of this oscillator is designed for operation with either 1.75- or 3.5-megacycle crystals. The crystal selector switch  $S_1$  has two sections, one to select the crystals and the other to select the corresponding plate-circuit inductance. The self-controlled oscillator is a conventional electron-coupled oscillator except for the fact that the plate circuit is again of the semi-tuned type. The grid-cathode circuit of this oscillator operates on either 0.875 or 1.75 megacycles. Two separate oscillating tank circuits, each consisting of coil and fixed condenser, are used to obtain the two fundamental frequency bands. The fixed condensers are of such a value that reasonable bandspread is obtained by means of the variable condenser controlled from the front panel. The untuned plate circuit is designed to provide maximum efficiency at the fourth harmonics of these two bands, namely, 3.5 and 7 megacycles. A four-section ganged three-position switch  $S_2$  is used to select either of the two self-controlled fundamental frequencies or crystal. Section A of this switch is used to transfer the coupling to the first doubler from one oscillator plate circuit to the other. Section B selects the proper plate inductance for the self-controlled oscillator. Sections C and D select the proper oscillator tank circuit. It will be noted that when  $S_2$  is in the

<sup>1</sup> I. e., tuned by tube and miscellaneous circuit capacities.  
—Editor.

crystal position the 1.75-Mc. oscillator tank circuit is left connected so that during the time crystal is being used the self-excited oscillator is also running. Drift is therefore reduced to a minimum when transfer is made to this oscillator.

Coupling to the first doubler is adjusted by means of the small variable condenser  $C_{14}$ . Type 6F6 tubes are used in

the two multiplier stages, as it was found that these tubes provided more than enough excitation on the grid of the final and were far superior from the standpoint of self oscillation because of their good internal shielding. Type 6L6 tubes will function, but provide no more excitation to the final and have much greater tendency toward self-oscillation. Small 25-ohm resistors,  $R_8$  and  $R_9$ , were found necessary in the plate lead to each 6F6 to eliminate high frequency parasitics. These resistors do not affect operation at the normal frequencies, but eliminate all tendency to oscillation at high frequencies. The plate tank circuits of the two frequency multiplying stages also are of the semi-tuned variety. The diagram, Fig. 1, shows two variable condensers,  $C_{13}$  and  $C_{22}$ , connected across these two plate circuits and may appear misleading.  $C_{13}$  is a very small trimmer of  $\frac{1}{2}$  to  $1\frac{1}{2}$   $\mu\text{fd.}$  and  $C_{22}$  is a similar condenser of 2 to 5  $\mu\text{fd.}$  These two condensers are used to bring the plate circuits more nearly in resonance at 14 Mc. For the sake of possible reproduction by others the coils were designed to require this slight amount of trimming by means of  $C_{13}$  and  $C_{22}$ . They are adjusted once, when the unit is first made, for best operation on 14 Mc. and then left alone. The use of semi-tuned plate circuits in the oscillator and frequency multiplying stages gives extremely broad tuning and allows wide frequency coverage without adjustment of any kind. It is through the use of this type of plate circuit that the third requirement listed above is practically fulfilled.

The final tube in the exciter is a Type 807 tube operating into a conventional tuned plate tank circuit. To provide output on the five bands, five separate tank coils are used in the output stage. Selection of any one of the five bands is accomplished by the band-switch  $S_3$ . This switch is composed of four individual sections so located with respect to the plate circuits of the frequency multipliers and output stage as to provide the minimum length of leads. Section A and Section B select the proper plate inductance for the first and second multiplying stages respectively.

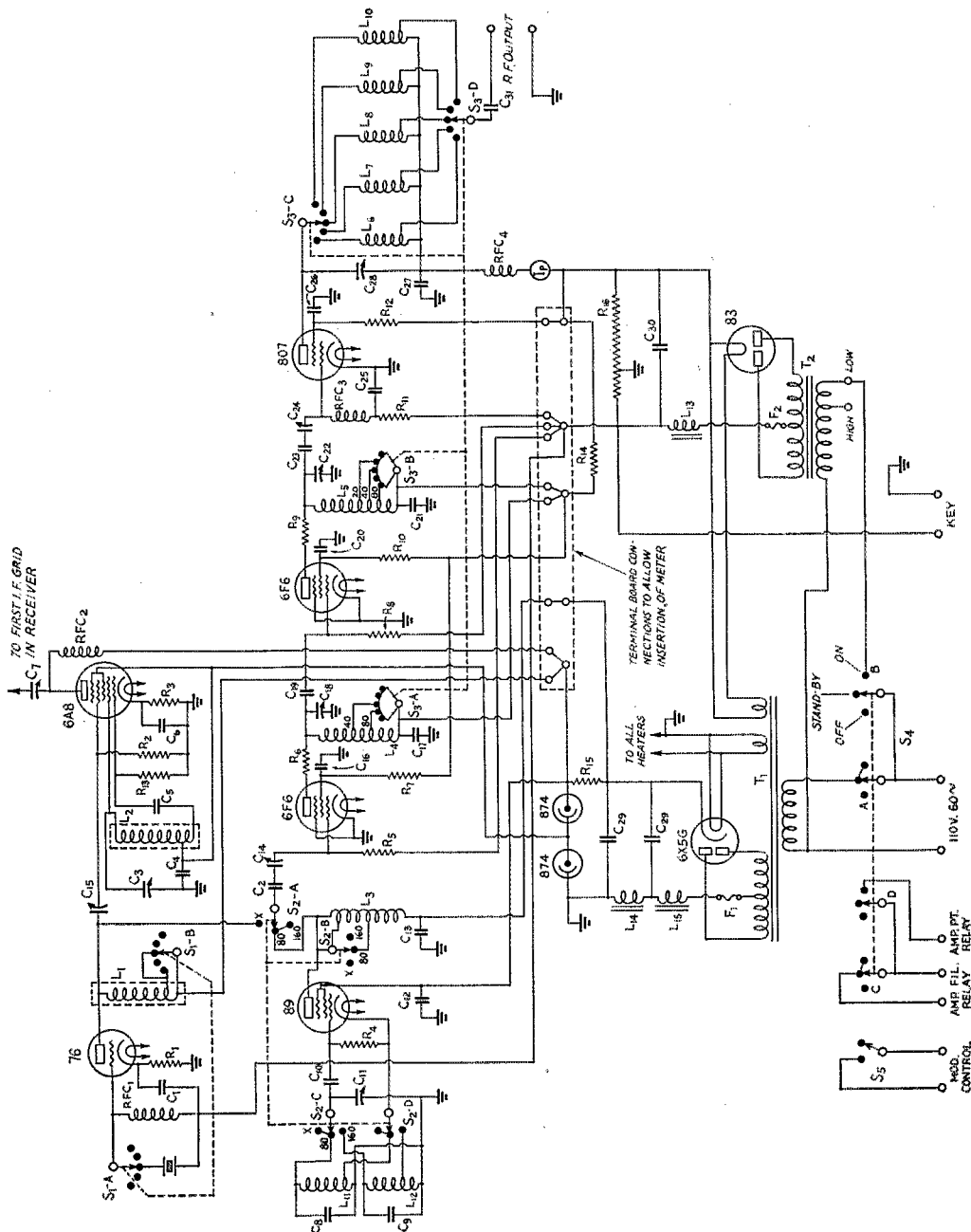

These two sections are of the continuous shorting type, as it was found necessary to short all unused sections of the doubler plate coils to prevent the unused portions from becoming resonant at the higher frequencies. Section C selects the proper plate coil for the final. Section D transfers the output circuit to the proper coupling tap on the

corresponding tank coil. Basically, the output circuit is designed for link coupling to whatever type of amplifier is to follow the exciter. However, the tank coils each have four taps which allow rough adjustment of coupling for loads up to 500 ohms and make possible operation of the exciter directly into an antenna system.



FIG. 1—COMPLETE CIRCUIT DIAGRAM OF THE EXCITER

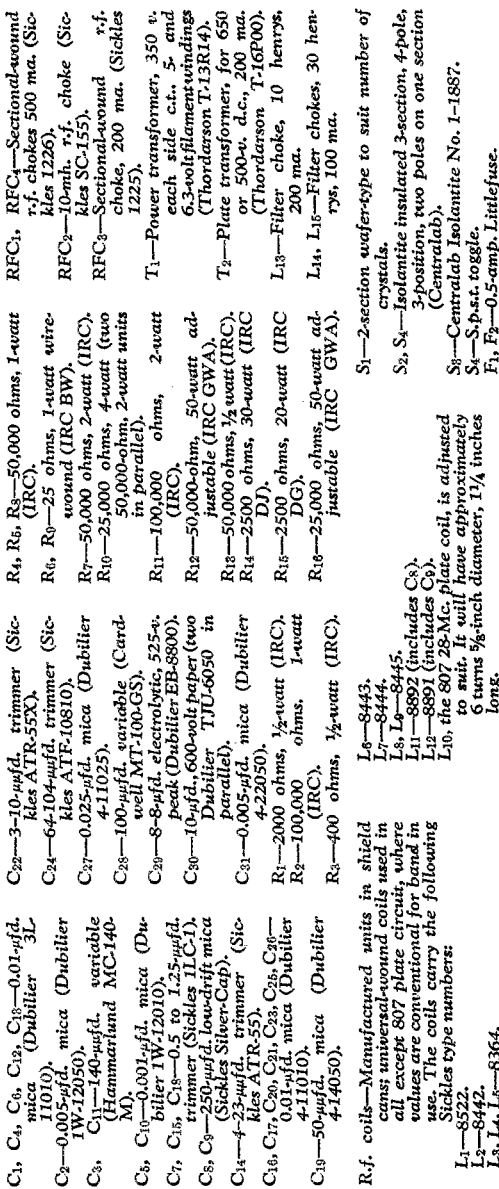

POWER SUPPLY

The oscillator power supply is conventional except for the fact that the output is regulated by two Type 874 tubes. These two tubes provide a regulated source of d.c. at 180 volts which is used for plate supply to the crystal oscillator and the screen of the self-controlled oscillator. The full output of this rectifier, approximately 250 volts, is applied to the plate of the self-controlled oscillator. A Type 6X5G rectifier tube is used for economy's sake only. Since the r.f. tubes are all of the

heater type it was necessary to have a standby position in which power was left on the heaters all the time. It was decided that it would be desirable to leave the self-controlled oscillator also running all the time to reduce drift during periods of no transmission. After much thumbing of catalogs it was found that no standard transformer was available with separate windings for the heater circuits of the r.f. tubes, the oscillator rectifier tube and the main rectifier tube. The transformer finally selected had two heater windings, one for 6.3-volt tubes and the other for a 5-volt rectifier tube, which made it necessary to find a rectifier tube, for the low-power rectifier, which had a separate cathode. The Type 6X5G fills this bill perfectly and allows operation of all heaters, including the oscillator rectifier tube, from one winding, the result being that in the standby position the oscillator power supply and heater power for the r.f. and rectifier tubes is left on.

The main power supply uses a Type 83 rectifier in the usual full-wave circuit. The fact that the filament of this tube is on at all times allows quick application of plate potential. The output of the rectifier is 500 volts under normal load. The plate transformer used has a tapped primary permitting an output voltage of around 700 volts if desired, but to insure operation of both the rectifier and output tubes within the manufacturers' ratings the lower-voltage tap is used.

The switch *S*<sub>4</sub>, which is used to control power, is a 4-section, 3-position switch with the extra two sections wired to terminals to allow control of the amplifier filament and plate power by means of relays, thereby keeping full control at the operating table.

KEYING

The problem of keying was solved by utilizing the voltage drop across part of the main-rectifier bleeder resistor for blocking bias when the key is open. All stages except the self-controlled oscillator are keyed by this blocking bias. No keying relay is necessary with this type of keying, but combinations of inductance, capacity and resistance

are necessary to eliminate sparking at the key. The circuit or exact values are not shown on the diagram, as each individual installation will require a different solution due to length of keying leads and local pickup conditions. The *Handbook* covers all satisfactory types of spark elimination circuits so no difficulty should be had from that source by any one using this type of keying circuit. Any network or filter will also be more effective if located right at the key where the spark originates. One very easy adjustment, however,

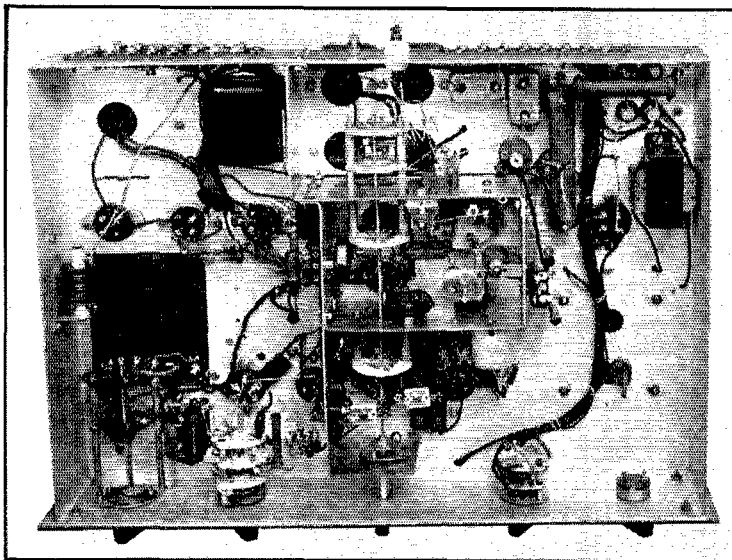

UNDERNEATH THE CHASSIS, THE STAGES ARE SHIELDED TO PREVENT FEEDBACK

The crystal section, blank when the photograph was taken, is at the left.

was found to cut sparking at the key to a minimum and that was to use a blocking bias across the key which allows between 2 and 5 ma. of plate current to flow in the 807 final with the key up.

Complete break-in operation is provided when operating crystal control by the fact that the oscillator is keyed along with the other stages. After much work it was found that good keying of the self-controlled oscillator could be had, provided a selection of oscillator tubes was available, and

be secured on 7 Mc. or higher when using the self-controlled oscillator due to the fact that the harmonic output of the oscillator itself is low and any signal of reasonable strength will override it. The shielding used in the oscillator circuit also reduces the interference to a low value.

#### MONITOR CIRCUIT

Although not appearing in the original requirements, it was felt that monitoring of c.w. trans-

(Continued on page 114)

TABLE I  
TYPICAL OPERATING DATA

	Oscillator			1st Doubler			2nd Doubler			Final	
	Freq.	Plate Freq.	$I_p$	Freq.	$I_g$	$I_p$	Freq.	$I_g$	$I_p$	Freq.	$I_g$
Crystal Control	1.75	1.75	6	1.75	1.25	30	1.75	3.0	25	1.75	2.6
	1.75	1.75	6	3.5	1.3	30	3.5	1.9	24	3.5	1.2
	1.75	1.75	6	7	1.3	30	7	0.6	20	7	2.8
	1.75	1.75	6	7	1.3	30	14	0.5	20	14	0.5
	3.5	3.5	10	3.5	1.2	30	3.5	1.8	22	3.5	0.8
	3.5	3.5	10	7	1.2	30	7	2.6	20	7	2.9
	3.5	3.5	10	7	1.2	30	14	2.2	21	14	1.8
	0.875	3.5	32	1.75	1.2	30	1.75	3.0	25	1.75	2.5
	0.875	3.5	32	3.5	1.2	30	3.5	3.0	25	3.5	2.0
Self-Controlled	0.875	3.5	32	7	1.4	30	7	1.2	22	7	2.5
	0.875	3.5	32	7	1.5	30	14	1.0	20	14	1.1
	1.75	7.0	35	1.75	0.6	28	1.75	1.0	25	1.75	1.9
	1.75	7.0	35	3.5	0.6	28	3.5	0.6	22	3.5	0.6
	1.75	7.0	35	7	0.6	28	7	3.2	18	7	3.1
	1.75	7.0	35	7	0.6	28	14	3.2	22	14	2.6

Plate voltage of crystal stage	180
Screen voltage of s.c. oscillator	180
Plate voltage of s.c. oscillator	275
Plate voltage of coublers	350
Screen voltage of 1st doubler	150 av.
Screen voltage of 2nd doubler	200 av.
Plate voltage of final	500
Screen voltage of final	200-250

# What the League Is Doing

League Activities, Washington Notes, Board Actions—For Your Information

**Election Notice** To all members of the American Radio Relay League residing in the Central, Hudson, New England, Northwestern, Roanoke, Rocky Mountain, Southwestern and West Gulf Divisions.

You are hereby notified that, in accordance with the constitution, an election is about to be held in each of the above-mentioned divisions to elect both a member of the A.R.R.L. Board of Directors and an alternate thereto, for the 1939-1940 term. Your attention is invited to Sec. 1 of Article IV of the constitution, providing for the government of the A.R.R.L. by a Board of Directors; Sec. 2 of Article IV, and By-Law 12, defining their eligibility; By-Laws 13 to 23, providing for the nomination and election of division directors, and By-Law 14 providing for the simultaneous election of alternate division directors. Copy of the Constitution & By-Laws will be mailed any member upon request.

Voting will take place between November 1 and December 20, 1938, on ballots that will be mailed from the headquarters office in the first week of November. The ballots for each election will list, in one column, the names of all eligible candidates nominated for the office of director by A.R.R.L. members residing in that region; and, in another column, all those similarly named for the office of alternate. Each member will indicate his choice for each office.

Nomination is by petition. Nominating petitions are hereby solicited. Ten or more A.R.R.L. members residing in any one of the above-named divisions may join in nominating any eligible member of the League residing in that division as a candidate for director therefrom, or as a candidate for alternate director therefrom. No person may simultaneously be a candidate for the offices of both director and alternate. A separate petition must be filed for the nomination of each candidate, whether for director or for alternate director. The following form for nomination is suggested:

(Place and date)

*Executive Committee*

*The American Radio Relay League  
West Hartford, Conn.*

*We, the undersigned members of the A.R.R.L. residing in the..... Division, hereby nominate....., of....., as a candidate for director (or for alternate director, as the case may be) from this division for the 1939-1940 term.*

*(Signatures and addresses)*

The signers must be League members in good standing. The nominee must have been both a member of the League and a licensed radio amateur operator for a continuous term of at least four years immediately preceding the receipt by the Secretary of his petition of nomination. He must be without commercial radio connections: he may not be commercially engaged in the manufacture, selling or renting of radio apparatus normally capable of being used in radio communication or experimentation, nor commercially engaged in the publication of radio literature intended, in whole or in part, for consumption by licensed radio amateurs. Further details concerning eligibility are given in By-Law 12. His complete name and address should be stated. All such petitions must be filed at the headquarters office of the League in West Hartford, Conn., by noon E.S.T. of the 20th day of October, 1938. There is no limit to the number of petitions that may be filed, but no member shall append his signature to more than one petition for the office of director and one petition for the office of alternate director. To be valid, a petition must have the signatures of at least ten members in good standing; that is to say, ten or more members must join in executing a single document; a candidate is not nominated by one petition bearing six signatures and another bearing four signatures. Petitioners are urged to have an ample number of signatures, since nominators are frequently found not to be members in good standing.

Present directors and alternates for these regions are as follows: Central Division: director, R. H. G. Mathews, W9ZN, Chicago; alternate, Adam F. Moranty, W8CZT, Cleveland. Hudson Division: director, Kenneth T. Hill, W2AHC, Douglaston, L. I.; alternate, Robt. M. Morris, W2LV, Millburn, N. J. New England Division: director, Percy C. Noble, W1BVR, Westfield, Mass.; alternate, Frederick A. Ells, Jr., W1CTI, Norwalk, Conn. Northwestern Division: director, Ralph J. Gibbons, W7KV, Pendleton, Ore.; alternate, A. L. Smith, W7CCR, Missoula, Mont. Roanoke Division: director, Hugh L. Caveness, W4DW, Raleigh, N. C.; alternate, J. Frank Key, W3ZA, Buena Vista, Va. Rocky Mountain Division: director, Edward C. Stockman, W9ESA, Denver; alternate, Eddie L. Heyer, W9GBQ, Sedalia, Colo. Southwestern Division: director, Charles E. Blalack, W6GG, El Centro, Calif.; alternate, John E. Bickel, W6BKY, Whittier, Calif. West Gulf Division: director, Wayland M. Groves, W5NW, Mt. Pleasant, Texas; alter-

nate, Wm. B. Hollis, W5FDR, Houston, Texas.

These elections constitute an important part of the machinery of self-government in A.R.R.L. They provide the constitutional opportunity for members to put the direction of their association in the hands of representatives of their own choice. Members are urged to take the initiative and file nominating petitions immediately.

For the Board of Directors:

K. B. WARNER,  
Secretary

August 1, 1938.

### Revised Regulations

-----  
Last month we reported that the F.C.C. was beginning work on revising the amateur regulations as part of a general revision of all regulations. This work has suddenly accelerated, and at this writing a complete redraft of our regulations is progressing step by step through the higher chambers of the F.C.C., with a view to being announced soon and to become effective in the early autumn, probably in middle October. The League was accorded an opportunity to participate in all of the preliminary discussions. The regs were given a pretty thorough overhaul and many changes are contemplated, some of them important, most of them trivial. Just as soon as the new text is released, *QST* of course will carry it, with detailed explanations. It is expected that the new regs will assign our new u.h.f. bands and will incorporate rules for participation in communication emergencies. There is almost certain to be a general tightening up of technical requirements, some simplification of licensing procedure, and an elimination of some outworn practices. The dope will be of vital interest to every amateur—watch for it in *QST*.

-----

### Cairo and Rome

It is probably not news that we have been misquoted, but we think we ought to say so. In another radio journal we read the flat statement, in three different places, that an A.R.R.L. official has stated that we shall lose our 40-meter and 20-meter bands at Rome. Just like that; no qualification.

The reports are inaccurate. We do believe that we must expect that, at the Rome Conference, a strong attempt will be made by European administrations to liquidate amateur radio in these two bands. Considering the extent to which Europe tends to go its own way in international radio matters regardless of technical facts, and considering its heavy plurality of votes, we think it rather more likely than not that the European amateur will suffer heavily with respect to these two bands, at Rome. The European amateur, not the American amateur. We do not expect that

the United States amateur will lose the right to these frequencies. We have no reason to doubt that, if it comes to cases, the United States administration—and, for that matter, all the American administrations—would sign such a treaty only with a reservation retaining these bands for amateurs. But stop and think what it would mean to us if we retained the bands but the European nations filled them up with non-amateur stations of high power! The usefulness of the bands would be seriously impaired, perhaps almost totally destroyed, and DX would be a scarce article. So it is our opinion that the Rome Conference constitutes a pretty serious threat against the future usefulness of these bands. But not because we would lose them in the United States; our worry is Europe, where the influence of American amateur radio and of the United States government does not extend.

Articles in the other radio magazine referred to suggested that, because of this situation, amateurs ought to appeal direct to the U. S. Senate and ask the lawmakers to protect us before the Rome Conference convenes. While it is conceivable that the Senate might, in some undisclosed fashion, indicate in advance to what it would or would not give its consent for ratification, this would be extremely unlikely; and the suggestion was based on the mistaken assumption that the Congress can instruct a delegation. Not so; these international agreements are negotiated by the executive end of the government, not the legislative. The Senate enters such a picture only after the treaty has been concluded by the executive branch of the government, whose creature the delegation is, and the Senate's function is to consent to ratification or to deny consent. Because the American amateur is a very valuable institution, we believe that we can count on the continued sympathetic support of our government. We don't have to worry about that part of it now, and least of all with Congress, which has no authority in the *negotiation* of such matters. The A.R.R.L. may be counted upon to continue, as always, its best efforts on behalf of its members.

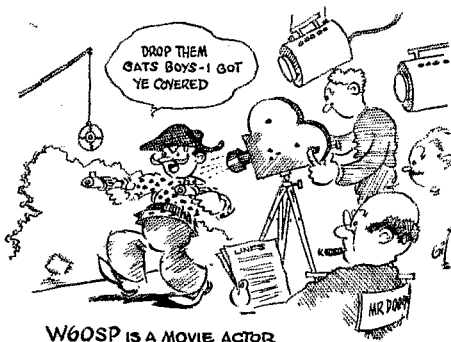

# Further Reports on 56-Mc. DX

## W1EYM and W6DNS Click Off History-Making Transcon

**W**E had the idea when we rounded out last month's tale of the crazy way five meters had been acting, that the end of it was surely near. That was on June 29th. Since then things have been slowing up somewhat but the July period was still chock full of achievement. Choicest morsel by far, of course, was the first 56-Mc. transcon between Nathaniel Bishop, W1EYM, and H. W. Hasenbeck, W6DNS. W1EYM heard W6DNS at S7 working a W7. As soon as he had signed, EYM called and grabbed him—the QSO lasting from 9:10 to 9:16 P.M. E.D.S.T. on July 22nd. Signals got up to S9 at the eastern terminal and lasted until 9:40. As suggested in Jack Pierce's story elsewhere in this issue, the contact undoubtedly resulted from a very unusual E-layer setup which allowed the necessary double hop. But it must be said that the contact is the direct result of skillful work on the part of two widely-experienced and super-enthusiastic u.h.f. workers. Bishop used a pair of crystal-controlled 6L6's feeding a vertical Johnson Q arrangement together with an acorn converter and a Super-Pro as the i.f. part. Hasenbeck used a pair of HK54's driven from a concentric-line-controlled HK54 and feeding three co-linear half-wave elements with tenth-wave directors. His receiver is a National 1-10.

It is too bad that space prohibits a full tale of all the work that went on during July, but we will list all contacts reported—arranging them by days to clarify the general picture. All reports of stations worked and heard are now being given the closest possible study at Headquarters and at Harvard's Cruft Laboratory in the attempt to get to the bottom of the whole business. More of that anon. Here, then, is the listing of contacts:



HERE, LADIES AND GENTLEMEN, IS THE WESTERN END OF THE FIRST FIVE-METER TRANSCON

Harold W. Hasenbeck, W6DNS, is at the downstairs receiving and control position. The transmitter (shown in another photograph) is in a dog-box on the roof.

July 1st—W8CIR worked W3CMZ.  
 July 2nd—G5MQ worked I1IRA; W8CIR worked W5ML.  
 July 3rd—W8CIR worked W5CSU W8QDU.  
 July 6th—W5EHM worked W8KAY RYK NED W3DBC.  
 July 7th—W1KJT worked W9ARN; W8CIR worked W5AJC EHM CSU.  
 July 8th—W2HYJ worked W9ZCN; W5AJG worked W8CIR CLS DAL NED KAY OPO



AND THIS, FOLKS, IS THE EASTERN END OF THE TRANSCON

Nathaniel Bishop, W1EYM, relaxes in front of his unusually clean-cut layout. The transmitter is a 6L6 Tritet oscillator on 14 Mc., a 6L6 doubler and a pair of the same tubes in the final. An acorn converter feeds the Super-Pro for reception.

W9NY ZHB SQE; W5EHM worked W3HJO SCLS CIR CJL OPO RZZ ESN NED PWE OIA DAL QAK W9USI VFO CQV ARN NY OPW PFG WIO; W8QDU worked, W1SI; W8CIR worked W5EHM W9UIZ W9USI; W9UIZ worked W3BZJ; W9ARN worked W1KNM KJT JLK LIJ HXT IXP SI W2FQM ETN MO JCY FGB W3HOH EZM W5EHM; W9NY worked W1IJ W3HKM GJU GQS GKW W5AJG EHM W9CLH.

July 9th—W1IJ worked W9ARN NY; W5EHM worked W8CIR; W9UIZ worked W8CIR VE9HG; W9USI worked W3HJO RL DBC GHY HPD HKM GLV W8CIR OPO KAY CLS NED NKJ RAZ RML QAK OBL OPW PEJ BSM AWB; W8PK worked W9URZ ARN.

July 10th—W1IJ worked W9UDO; W1JUE worked W9ANA VE9HG; W1ZR worked W9ANA; W8QDU worked W1JUJ ETS W8VO; W9SQE worked W1KXK HLW HXE AQM JNX IZY LFI KCY ISS KBQ IXP JXN JUJ.

July 11th—W1KJT worked W9CLH WDO;

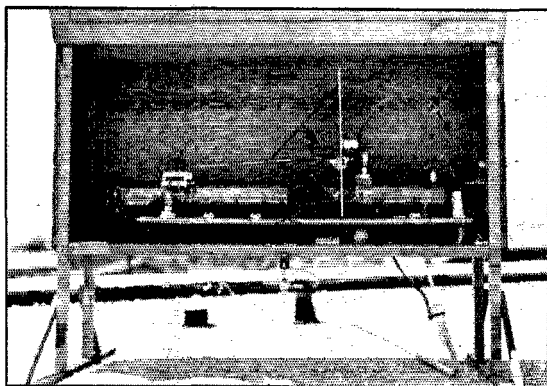

THE TRANSMITTER AT W6DNS IN ITS BOX ON THE ROOF

The concentric grid line is 6 inches in diameter and has the HK54 oscillator tube sitting near its left end. The two HK54 amplifiers are mounted on top of the grid line toward the right.

W1KEE worked W8HGG W9LNV VSB SQE ARN; W1JUE worked W8AOC QFV W9CLH; W4EDD worked W1KNN W2HWX GZC W8DLN NOR JLQ; W5EHM worked W8NED BDG; W8OKC worked W9ANA; W8JLQ worked W1KOE ELP W4EDD W9USI; W8QFV worked W1JNX DFY KCF KNX W5CSU; W9ARN worked W1KEE HXE APJ W2KLZ W8JWH W9CLH; W9USH worked W2MO W3HJO GMZ BR HG W8JLQ NED LHV AOC FZY NBV; W9SQE worked W1FKV KUE KJP KJL KTF JNX DRL HDF APJ KEE BWJ W2JCY GAH FQM MO KLZ IUM; W9CCY worked W9BNT; W9ARN worked W1HXE APJ KEE W2KLZ W8JWH W9CLH.

July 12th—W5EHM worked W8RQG LZN RKE CIR W9HPP FFG ZGD, W9USH worked W3HJO RL W8PGV NED AOC RAZ ODL; W9SQE worked W1DEI DPW OE KTV W2LAD; W8CIR worked W5EHM W9USI.

July 13th—W5EHM worked W6IDF OIN MLA MKS.

July 14th—W5EHM worked W9USI WVN.

July 15th—W4EDD worked W1ADD W2HGD MO FBA HWX W3AIR W8VO LJP W9CLH; W5EHM worked W3GMZ

GLV HKM W4EDD W8CIR NED EUK OPX BMU NZW FVY CLS OJN LKD BDG KC NAT QDU AOC LJP OBS IEF PTG FMI FTG CIR W9ZEO UJD NYY SQE BFW FP; W8JLQ worked W5ZS BEX FI; W8QDU worked W5ML ZS CSU-EEX EHM FI ML W8VO W4FLH; W8CIR worked W5EEX ML AKI CSU FI EHM W4EDD W8NOR.

July 16th—W4EDD worked W5EHM CSU; W8CIR worked W5ML EHM W8RV.

July 17th—W1KJT worked W9RBK; W5AJG worked W8KG; W5EHM worked W8MZW BDG LHU W9USI; W9USH worked W5EHM FI; W8CIR worked W5EHM CSU W9ZJB AHZ USI ZD.

July 18th—W5EDM worked W8NED QFV BDG LKD NPE GCI NSS CIR; VE3DC worked W4AUU; W9ARN worked W3FOP.

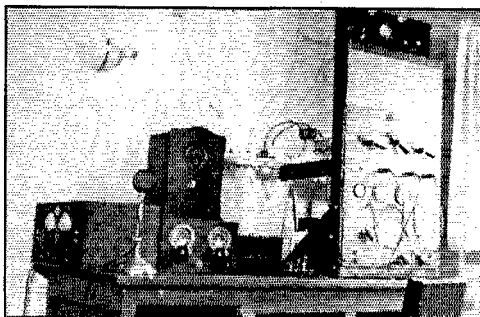

THE RIG AT W8CIR

Edward Doherr has worked eight districts and twenty-four states on five. He grabbed a couple of sixes on the night that W1EYM and W6DNS contacted. His transmitter had a pair of crystal-controlled 35T's in the final, while the receivers include an acorn converter and a resistance-coupled super. The antennas include a dipole, 80 feet high, and a seven-element Yagi, 20 feet high.

July 19th—W1JJ worked W8EUK NED SFV NPE W9AHZ ARN ANA OLY; W1EHT worked W8LJQ LJP W9NY; W1IXF worked W8RAZ IZJ NPE SAW; W5AJG worked W8CIR LJP LZN W9WAL YWQ ZSS VJO SQE ANA ZHB; W5EHM worked W1CSR W3BBC GMZ W8NIX JLQ MSK CMK LJP QDU NED QFV QAW CIR MST FPH W9SQE LVK ZHB ANA ZGD NY; W8JLQ worked W1EHG W2KOZ BCCBVY KPX W3AQE QSX; W8QFV worked

(Continued on page 115)



THIS OUTFIT AT W8QDU HAS BEEN IN ON ALL THE BIG STUFF

The 56-Mc. transmitter is crystal-controlled and ends up with a pair of 35T's. The receiver is an Ultra-Skyrider with a two-stage acorn preselector up front.

# Interpreting 1938's 56-Megacycle DX

## Ionosphere Conditions Deduced from Long-Distance Amateur Work on Five Meters

By J. A. Pierce,\* W1JFO

This is "must" reading for any progressive amateur. It is a brilliant example of the way in which a basic contribution can result from ham work accompanied by careful observation and fulsome reporting. Mr. Pierce's prime interest is the layer height measurement program being conducted at Harvard University, this study of u.h.f. behaviour being a logical offshoot from it. The study, of course, is to be continued and the League is collaborating in the preparation and reduction of ham reports. The only fly in the ointment is that while the hundreds of available reports paint a fairly complete picture, they are not sufficiently complete for a scientific study of this kind. Pierce joins us in a plea for reports of every single DX contact that occurred this year. Of particular consequence are details of contacts over distances greater than 1200 miles. Badly needed also is more dope on work between the West and Middle West. But all reports are important. We urge you to look up the log and send us an abstract.—EDITOR.

THE reports which are being submitted to A.R.R.L. on 56-Mc. DX this summer are furnishing valuable scientific data, because the conditions which make 56-Mc. contacts possible are unusual and cannot be predicted with the same success we have when dealing with the lower frequencies. The story goes roughly like this: Most of the ionization in the upper atmosphere is caused by the action of ultra-violet light from the sun, although there are other sources whose relative importance is uncertain. The only ionized layer of interest to us in this study is the *E*, or Kennelly-Heaviside layer, which is about 70 miles above the surface of the earth. Ordinarily the amount of ionization in this layer increases during the morning and decreases in the afternoon; that is, it follows the height of the sun

\* Research Laboratory of Physics, Harvard University, Cambridge, Mass.

above the horizon. This is true throughout the year as well, there being more ionization in summer than in winter.

This ionization exists because ultra-violet light knocks electrons out of the atoms in the upper air. The amount of it is well known, and ordinarily never exceeds 200,000 free electrons per cubic centimeter. At times, however, the *E*-layer ionization shoots up to tremendous levels, in some cases as much as 5,000,000 electrons per cubic centimeter. This differs from the normal ultra-violet ionization in several ways. It may last only a few minutes, or for several hours; it may be strong or weak; and it may occur in very small patches or extend over hundreds or even thousands of miles. This last characteristic makes it hard for the two or three ionosphere observatories in this country to study the phenomenon because it often occurs in places where measurements are not being made.

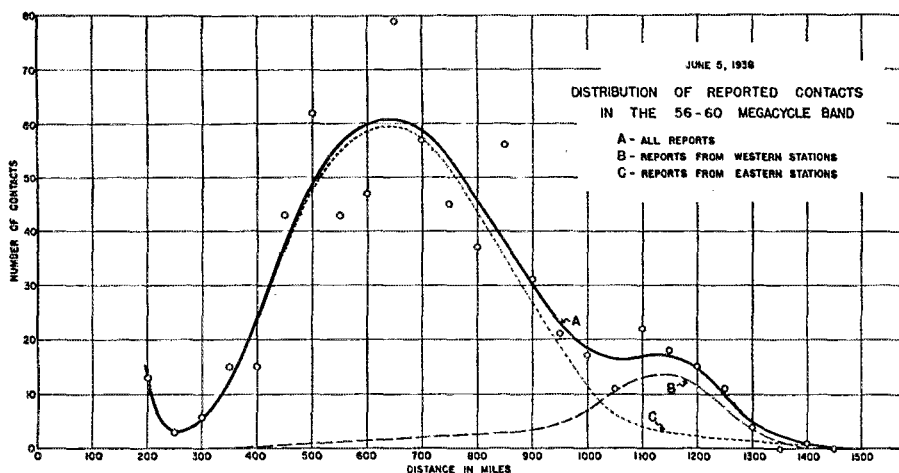

FIG. 1—GRAPH OF NUMBER OF STATIONS HEARD AGAINST DISTANCE



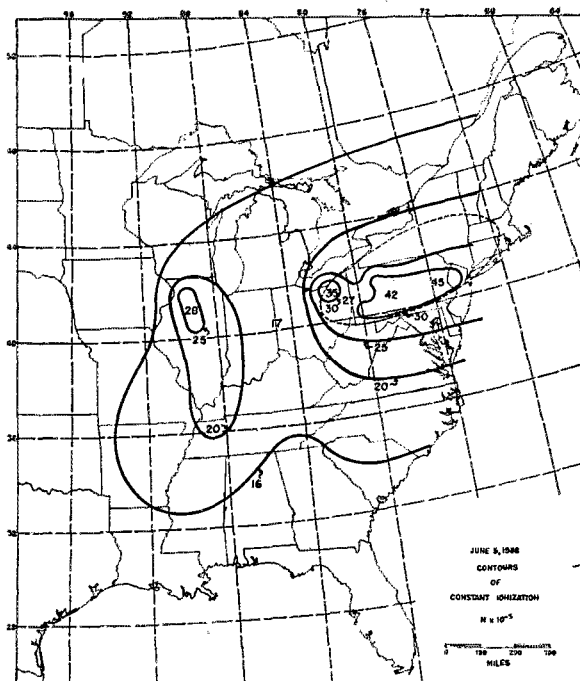

FIG. 2—CONTOURS OF CONSTANT IONIZATION DENSITY  
The dotted oval is the region where atmospheric refraction was high.

When the ionization gets up above 1,500,000 electrons per cubic centimeter, five-meter DX is possible. There are so many amateur stations that, if this happens anywhere over this country, some DX is quite sure to be heard. If we can gather enough reports we can study them carefully and find out a number of things we need to know, such as the answers to questions like these: Is there any particular latitude at which this effect is most likely to be observed? At what time of day is it most likely? How often does it extend across half the continent? Is it true that it is most frequent about the end of June, at the maximum of the sun-spot cycle? Answers to these questions can be found by amateurs, and will lead to our understanding the source of all this random energy. At the moment we can only guess that it may be due to corpuscles of some sort which are shot off by explosions in the sun. These particles might be electrons traveling at a thousand miles a second or so, or they may be heavier than electrons. If they are charged particles, they must deviate from a straight path when they come into the earth's magnetic field. By finding out the most favorable latitude and the time of day which is most likely we may be able to estimate the path that they have followed. This in turn will give us some ideas not only about the particles but also about the sun itself and the constitution of the upper atmosphere.

#### UTILIZING 56-MC. DX DATA

All this is getting a bit technical, so let's turn to a sample study and see what we can learn from it. The A.R.R.L. has let me mull over the early reports on the work of June 5th. There didn't seem to be much chance of getting anywhere by studying the times of the various QSO's (we need a lot more data before going into that) so I started in with a call book and a map. After listing all the contacts with the distance each one covered, I grouped them according to distances. That is, I found how many contacts covered more than 675 miles but less than 725, and so on. By plotting these groups I made up Fig. 1. This shows that on June 5 you were more likely to hear a station about 650 miles away than any other distant station. But it shows more than that. If you have enough data to get a smooth curve in a case like this, you expect to find just one maximum in it. That is, up to 300 miles or so you don't hear any stations because of skip. Then you hear them better and better, but after a while the distance gets so great that the number drops to zero again. There are two things in Fig. 1 that don't fit with this idea. One is the upturn at 200 miles and the other is the bulge at 1100. Since you

can't cover 200 miles at 56 Mc. without atmospheric bending,<sup>1</sup> we can conclude at once that there was a lot of refraction that day caused by atmospheric stratification. This probably helped in working DX because it bent the signals down into cities and made pretty poor locations into good ones.

The bulge at 1100 miles is a bit more tricky. It turned out that if I plotted only the reports from east of the Mississippi I got a smooth curve C, and the same thing happened for the small number of reports from the region west of the river. The western curve (B) stuck way out on the distance axis and accounted for the bulge in the main curve A. This shows that the western stations had a long skip, which means less ionization where the signals were reflected. There were plenty of stations on the air in Ohio, for instance, but the boys in Kansas couldn't work them and had to go clear to the east coast to be heard. At this point I was able to say that there was less ionization over Indiana that day than there was over Pennsylvania.

The next step was to carry things farther along the same line. By marking on the map all the locations worked from Massachusetts I could see

(Continued on page 72)

<sup>1</sup> Ross A. Hull, "Air-Mass Conditions and the Bending of U.H.F. Waves," *QST*, June, 1935 and "Air-Wave Bending of U.H.F. Waves," *QST*, May, July, 1937.

# The Canada-U. S. A. Contact Contest, 1938

By Fred H. B. Saxon,\* VE3SG

**B**ELIEVE IT OR NOT, 2396 VE and W stations took part in the contest by exchanging message preambles; 282 logs were received, a 30 per cent increase over last year's contest. As I sat here night after night and day after day putting down the information contained in each log, I tried to visualize the net that was woven by the contacts of all these stations. From Alaska to Cuba and Porto Rico, from Halifax to San Diego on the continent, out over the Pacific to Hawaii and on to the Philippines, each contact bearing its little message of friendship and goodwill. I was thrilled by it all. YL and XYL operators had no small part in the contest. VE2HI in Montreal, Quebec; VE3HE in Stratford, Ontario; and VE5NG in Vancouver, B. C., are three we know were active; there may have been more.

An explanation of the long contest period: In setting the date, the Easter week-end was the only one which was clear of some kind of contest or activity, and in having the contest spread over five days, the idea was to give as many as possible a chance to participate and avoid making it a contest of endurance.

W9FOQ leads South Dakota again this year, making it four times in a row. W6MVK has made it three times for San Joaquin Valley. The following stations lead their sections again this year: VE5QP, British Columbia; W3FQZ, Md.-Del.-D. C.; W3FAX, Southern New Jersey; W9MUX, Illinois; W5KC, Louisiana; W2IOP, N. Y. C. and L. I.; W9YAH, Kansas; W1TS, Connecticut; W1RY, Eastern Massachusetts; K6CGK, Hawaii; W6ITH, East Bay; W6NEN, San Francisco; W9YAD, Colorado; W4DIQ, Eastern Florida; W5DQD, Northern Texas; W5FZD, Southern Texas. Congratulations to you all.

The Canadian prize winners:

FIRST PRIZE—Cup—Won by VE2EE, Montreal, Quebec.

(Donated by The Canadian General Electric Co., Ltd., Toronto.)

SECOND PRIZE—RCA804—Won by VE5QP, Eburne, B. C.

(Donated by The Canadian Marconi Co., Ltd., Montreal.)

THIRD PRIZE—100- $\mu$ fd. Transmitting Condenser—Won by VE3IR, Agincourt, Ont.

(Donated by Hammond Mfg. Co., Guelph, Ont.)

FOURTH PRIZE—RCA809—Won by VE5VO, Vancouver, B. C.

(Donated by Canadian Westinghouse Co. Ltd., Toronto.)

FIFTH PRIZE—RCA809—Won by VE2EP, St. Lambert, Quebec.

(Donated by Canadian Westinghouse Co., Ltd., Toronto.)

SPECIAL PRIZE FOR VE PLACING 23RD—1KBX crystal—Won by VE2DJ, Montreal, Quebec.

(Donated by the VE Operators' Association, Toronto.)

The ten highest scoring Canadian and United States stations:

CANADA			
VE2EE	39,468	VE3SF	31,089
VE5QP	38,001	VE3GT	30,213
VE3IR	34,642	VE3ES	30,150
VE5VO	32,604	VE5QA	25,177
VE2EP	32,220	VE3NA and VE4SH	23,963
UNITED STATES			
W6MVK	30,145	W9IU	15,998
W9MUX	16,726	W2IOP	15,687
W3BES	16,070	W3GPG	14,931
W9RXL	16,065	W3FQZ	14,080
W1TS	16,065	W9YAD	14,013

VE2EE's splendid score was derived from 353 contacts in 52 sections. W6MVK again leads in the United States with 30,145 points made by contacting 161 VE's in all 7 sections. He used the low-power multiplier, for 95 watts. W9RSO called CQ VE and got VU2BT; another night he got K6BAZ-6 on Howland Island! VE3DA and VE3AD must have had some kind of working agreement, for it is astonishing how often they followed each other on "W" logs. W7GLH of Vancouver, Wash., made 11 QSO's with Vancouver, B. C. W7FIV pads the VE's on the back for friendliness and goes on to say that he almost wore out the set of key contacts calling and answering CQ's of VE5NG, but that she spurned him during the entire contest. VE5VO had a very interesting log, 28- and 14-Mc. 'phone, 14- and 7-Mc. c.w. with contacts made "all over the place." VE1MA did all his work on 1.75-Mc. 'phone. A complete fadeout of radio signals was noticed during the contest, with varying length of duration in different localities. VE5QA noted the shortest time of duration, from 11:30 p.m., P.S.T., April 15th to 12:30 a.m., P.S.T., April 16th. VE4NQ, station of the Calgary Radio Club, and the Lafayette College Radio Club Station, W3GPG, turned in very nice logs. The Michigan 9's were in there fighting this year, but sorry to say no logs received. While every section of the 70 had participants this year, there are eight sec-

(Continued on page 82)

\* A.R.R.L. Section Communications Manager, Ontario.

# A DeLuxe Rotary Antenna Structure

A Supporting Assembly for Stacked Multi-Element Directional Antennas

By Byron Trowbridge, W9TMP\*

Most stories about rotary antenna systems put the chief emphasis on electrical features, but here is one dealing with the—to the average ham—knottier problems of designing, building and erecting the rotating structure itself. Big enough to support a fairly elaborate 20-meter beam, it can also be used to hold a multi-element 10-meter array. No guy wires, negligible ground space, but ample strength to withstand strong winds without damage. —EDITOR.

**T**HE problem of obtaining more consistent results in amateur work can be solved in two ways: by increasing the power to the maximum limit or—the far better method—by putting all the power one can in the desired direction, and at the optimum radiation angle. To achieve the latter, one must use either a number of antennas or rotate one which gives the greatest gain obtainable in the space available. The so-called footing space required by many directive arrays also is frequently a damper to the ham living in town.

The antenna structure described here is self-supporting, requiring no external guys, and occupies a ground space only six feet square. The ten-meter antenna which it supports consists of a

influenced by the builder's preferences, so the description will be confined to the more important mechanical features of the rotating structure itself. The dimensions are such as to accommodate 20- as well as 10-meter directive arrays.

## THE TOWER

A general drawing of the tower and rotating structure is given in Fig. 1. The tower consists of the cross-braced part above ground plus four

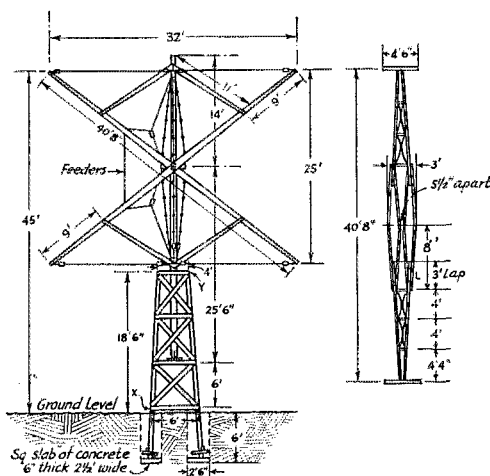

FIG. 1—GENERAL PLAN OF THE TOWER, MAST AND CROSSARMS

two-section flat-top 46 feet above ground with a second flat-top  $\frac{3}{4}$ -wavelength below fed in phase. The whole structure has a total height of 47 feet and a spread of 32 feet. It is rotated manually from the operating room. The choice of a particular type of antenna, however, usually is

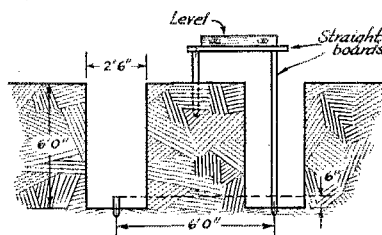

FIG. 2—METHOD OF LEVELLING THE FOUR SUNKEN FOUNDATIONS

anchor posts, one on each of the four legs, sunk into the ground. The anchor posts, of burr oak, can be obtained from a sawmill and will last indefinitely. Each is 5" by 5" by 8', with the bottoms slightly beveled to set squarely on the concrete foundations. A pair of 2" by 4" by 18" crossarms is put on each one, set about six inches from the bottom, mortised into the post one inch and spiked. These pieces are sawed from the top where the legs of the tower proper are mortised in. There is a two-foot lap between tower and post, with four  $\frac{1}{2}$ " by 6" bolts per leg.

The holes for the anchor posts are dug  $2\frac{1}{2}$  feet square, six feet deep, and centered at the corners of a six-foot square. A foundation is formed by pouring concrete to a depth of about six inches in each hole. To ensure that the tower is level, a ten-inch stake is first driven in each hole, then a center-post set up as shown in Fig. 2, and by using a level on a straight board from the center post to a board held on top of the stake in the hole, each stake is driven in until its top is level with the tops of the others. The concrete is then

\* 124 West Grove St., Kendallville, Ind.

poured in and levelled to the tops of the small stakes.

The legs of the tower each consist of two 2" by 4" by 18' pieces spiked edgewise to form an "L" section. Two legs are laid out as level as possible and then boards X and Y, Fig. 1, are tacked on. A bevel square is used to get equal angles on the two opposite sides. Then the cross braces are marked out, laid in position and after being sawed are planed to give a tight fit at the ends. The horizontal braces are 2" by 6" and the diagonal braces 1" by 6". Eight-penny coated nails are used on the 1 by 6's and 16-penny spikes on the 2 by 4's. The cross-pieces should be securely nailed at the center. When spiking near the ends of the 2 by 4's it is wise to drill holes for the spikes if the wood shows any tendency to split. A  $\frac{3}{8}$ " drill is about right for 16-penny spikes.

The anchor posts are then bolted fast with the sections laid ready to go into the holes, and one side is walked up with the base sliding down planks. Then the other side is walked up and the two opposite sides are squared by temporarily tacking a couple of boards across between them and using a square or measuring diagonally between corners. Next the lower bracing can be put on, but leave the handiest side open in the two top sections so the mast can be swung in through the opening. The 2" x 6" sections are bolted to the legs with  $\frac{3}{8}$ " x  $4\frac{1}{2}$ " bolts. The holes are filled by packing the dirt back in, using a hose to keep it damp and tamping it down with a piece of 2" x 4". A tower similar to the one described, used to support a windmill, stood thirty-five years and was in good condition when torn down.

#### THE MAST

The type of mast to be described can be used to hold about any kind of rotary beam simply by strengthening the lower half, if necessary. The main consideration is to get as much strength as possible with the least wind resistance. A quick solution is to get a light cedar pole from a tele-

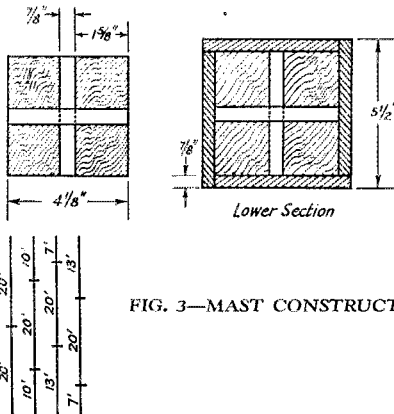
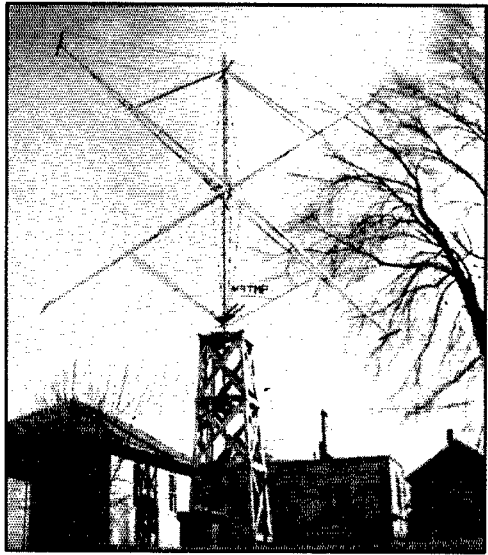

FIG. 3—MAST CONSTRUCTION



THE ROTARY BEAM AT WOTMP IS AN IMPOSING STRUCTURE

*Designed to support a fairly elaborate 28-Mc. antenna system—two horizontal double-section flat-top beams, stacked—it can readily be used for a 14-Mc. antenna.*

phone or light company; some of these poles are extremely light and strong and if one can be obtained thirty or forty feet in length it will save building one. We had to build our own mast.

Fundamentally the mast is constructed of 2 by 2's, as shown in Fig. 3, four being used spaced  $\frac{3}{8}$ " apart. A 40-foot mast will require eight sections of 2" x 2" x 20' long or their equivalent. The joints should be staggered as in Fig. 3. To make the mast, lay a 20-foot piece and a 10-foot piece level, place a  $\frac{1}{8}$ " board between the two near the end and tighten them together with a clamp, then spike (16-penny) a five-inch piece of 1" x 4" across the two. The 1 x 4's are really only  $\frac{7}{8}$ " thick and are used throughout the mast. Place another  $\frac{1}{8}$ " piece between them about two feet from the first and spike another five-inch piece of 1" x 4" there. The square section will be about  $4\frac{1}{8}$ " so the extra length can be sawed off after they are nailed. Where the butt ends of the 2 x 2's come together they should be mortised and lapped three inches and a  $1\frac{1}{8}$ " metal plate,  $1\frac{1}{8}$ " x 6", bolted across the joint with  $\frac{3}{16}$ " bolts, after nailing. The core of the mast will thus be four 2 x 2's spaced  $\frac{7}{8}$ " with so-called 1" x 4" nailed crosswise both ways every two feet, and will be about 39' 6" long. The justification for spacing the 2 x 2's is that the mast will be much stiffer than if they were laid solid against each other. For the top section the cross pieces on one side are made 10 inches long to provide steps to the top.

Ship-lap is used to put another  $\frac{7}{8}$ " layer

around the lower 25 feet, making this section about  $5\frac{1}{2}$ " square. The protruding ends are rip-sawed off. Twenty-foot sections of ship-lap were used and no joints were left above the tower. We then added a 15-foot section of  $\frac{3}{8}$ " ship-lap, starting  $1\frac{1}{2}$  feet from the bottom. The bottom section was left  $5\frac{1}{2}$ " square to fit a coupling for the lower bearing. The last section of ship-lap will extend about 3' above the tower, making this part of the mast  $7\frac{1}{8}$ " square.

#### THE LOWER BEARING

The lower bearing for the mast is a regular ball bearing ( $1\frac{1}{4}$ " balls) from a truck. It has an outside diameter of 8" and the inner hole is 3" in diameter. The coupling, Fig. 4, should be made after a bearing has been obtained because possibly a thrust bearing or a larger or smaller one will be available. The only dimensions that would need to be changed are those of the inner hole and connecting pipe if a different size of bearing is used. A piece of 3" diameter by  $3\frac{1}{2}$ " long pipe with  $\frac{1}{8}$ " walls, with a  $3\frac{1}{2}$ " piece of iron pipe with  $\frac{1}{4}$ " walls inside, is welded on to the flat bottom of the coupling for our particular bearing to make a good tight fit. The arc welding should be good and strong, since in a strong wind there is a calculated possible ton of side thrust on the antenna structure we have. To keep the outer end of the bearing from settling into the wood below and binding, a 12" square of  $\frac{3}{16}$ " iron plate with a 5" round hole was put directly under it, and the two-inch plank holds the bearing securely sidewise. Two planks  $2" \times 10" \times 5\frac{1}{2}$ " long rest on Section 2 of the tower with a  $2" \times 6"$  plank on edge across under them; two pieces of  $2" \times 10" \times 20"$  with an 8" diameter hole are bolted on the above, with eight  $\frac{3}{8}" \times 6"$  bolts, to hold the bearing.

#### THE TOP BEARING

The top bearing is made from two brake drums (Fig. 5) which have about  $\frac{1}{16}$ " clearance between them, the one fitting snugly into the other but rotating easily in it. All the weight is carried on the bottom bearing and the top bearing is only to hold the mast vertical. The rim diameter of the larger drum we have is 12". To get these drums go to a junk yard and pick out a pair so that one will rotate inside the other, the smaller having an inside diameter of at least 10 inches for the  $7\frac{1}{8}$ " mast described here. Cut with a cold

chisel a  $7\frac{1}{8}$ " square hole in the smaller one and then form four wooden blocks 6" long to fit snugly around the mast and down inside the smaller drum, to hold it fast to the mast. The larger drum, which fits outside the other, has a 10" diameter round hole chiseled in it and fits inside a collar of two-inch plank. Do not fasten these drums until after the mast has been placed in position in the tower; they can be held in approximate position by a couple of small boards nailed under them. About  $\frac{1}{4}$ " clearance should be left between the tops of the rims to allow for any settling, which will probably be about  $\frac{1}{8}$ ". The outer drum is fastened to the planking by sawing, with a hacksaw,  $\frac{1}{8}" \times \frac{3}{16}"$  slots on four sides of the rim and nailing. A hexagon band of  $\frac{1}{8}" \times \frac{3}{4}" \times 1\frac{1}{4}"$  iron strips is bolted around the bearing with  $\frac{3}{8}" \times 4\frac{1}{2}"$  bolts. Holes are drilled 1" from the ends of the strips for the bolts. Two by 10-inch planks are used for the top also; two pieces of  $2" \times 10" \times 4\frac{1}{2}"$  long and two pieces  $2" \times 10" \times 20"$  long.

#### OTHER DETAILS

The mast is trussed with No. 9 wire, and a pair of spreaders is used to secure a 3-foot spread at the middle. The top fastening is made by bending two pairs of brackets from  $\frac{1}{4}" \times 1\frac{1}{4}"$  strap iron with inside dimensions the size of the mast, in this case  $4\frac{1}{8}"$ . A  $\frac{3}{8}" \times 6"$  bolt is used to hold the hooks for the guys, and also to hold the brackets tightly around the mast. The mast should be filled in with wood where these brackets are put on. The hooks are made of  $\frac{3}{8}"$  rod (at a blacksmith shop); eight are required for both top and bottom connections. The top

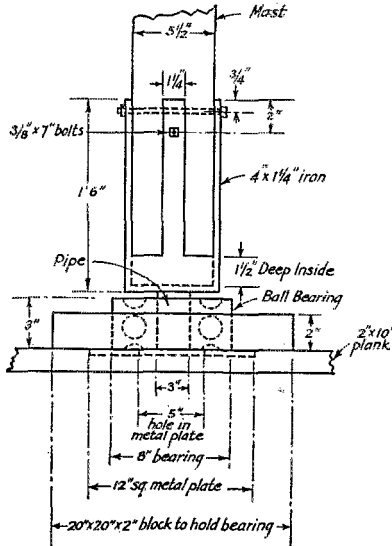

FIG. 4—LOWER MAST BEARING DETAILS

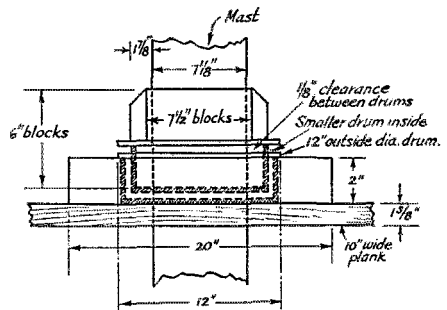

FIG. 5—THE UPPER MAST BEARING

brackets hold the mast very securely and no twist can spread the mast as it would break first. Since the bottom is already held securely by the brake drum, the bolts and hooks alone are used there— $\frac{3}{8}$ "  $\times$  9" bolts are used. The spreaders at the middle are made of 1"  $\times$  4" with a base spread of 8 inches. The 1  $\times$  4's are each 16" long and a piece of 2"  $\times$  2" oak, 4" long, is set in the outer end of each, and a  $\frac{1}{4}$ " groove sawed to pass the wire.

To make the center guys, about 300' of No. 9 galvanized wire is used; heavy duty compression-type strain insulators are inserted every two feet. The smaller varieties of insulators were tried but would crush and powder up, since these guys have to be quite tight to secure any bracing action. They are tightened with  $\frac{3}{8}$ " turnbuckles installed at the lower end. Larger spacing of the insulators can be used, but two-foot spacing will minimize any effects the guys might have on the antenna pattern. The turnbuckles have a take-up of four and one-half inches, so make the guys as short as possible and then snap them over the spreader in the middle.

#### THE BRAKE

The brake provides positive locking of the mast in any position and eliminates the whip which usually occurs when only pull ropes are used. It also allows complete calibration of the steering wheel in the house. It is put on after the mast is permanently in position. A round drum  $12\frac{1}{2}$ " in diameter is built out on the mast at section three of the tower by planing blocks of wood to form a good circle. Alternatively, a brake drum could be used as in the top bearing. A band of sheet iron  $\frac{1}{16}$ "  $\times$  4"  $\times$  42" is next nailed on the drum

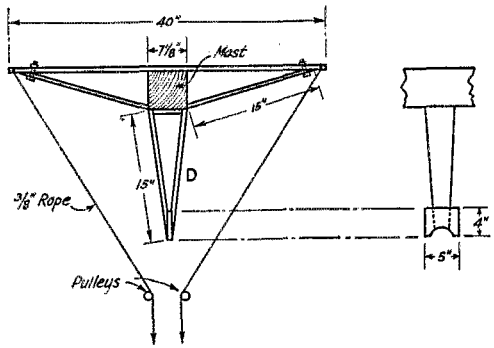

FIG. 7—ROTATING MECHANISM

with eight-penny coated nails, counter sunk with a dull center punch before nailing.

Four 2"  $\times$  4"  $\times$  5' pieces are used to hold the brake assembly. Two are made as follows; 10"  $\times$  4"  $\times$   $\frac{1}{16}$ " metal plates are bolted to the middle of the five-foot sections and a  $\frac{5}{8}$ " hole is drilled through, centered 1" from side C and 5" from each end. The other pair is similar except that the  $\frac{5}{8}$ " hole is centered exactly in the middle.

The outer brake band is made in two sections with a hinge joint, with the open ends terminating in short lever arms. Two sections  $\frac{1}{16}$ "  $\times$  4"  $\times$  25" are used, cut as shown in Fig. 6. Bend the ends around a  $4\frac{1}{8}$ " piece of  $\frac{3}{4}$ " pipe, which is left in, and bolt with  $\frac{3}{16}$ "  $\times$   $\frac{1}{2}$ " bolts. The holes are drilled after the bend has been made. Four 17" pieces of 2" wide brake lining were used to line the outer band, with rivets every 4 inches.

(Continued on page 100)

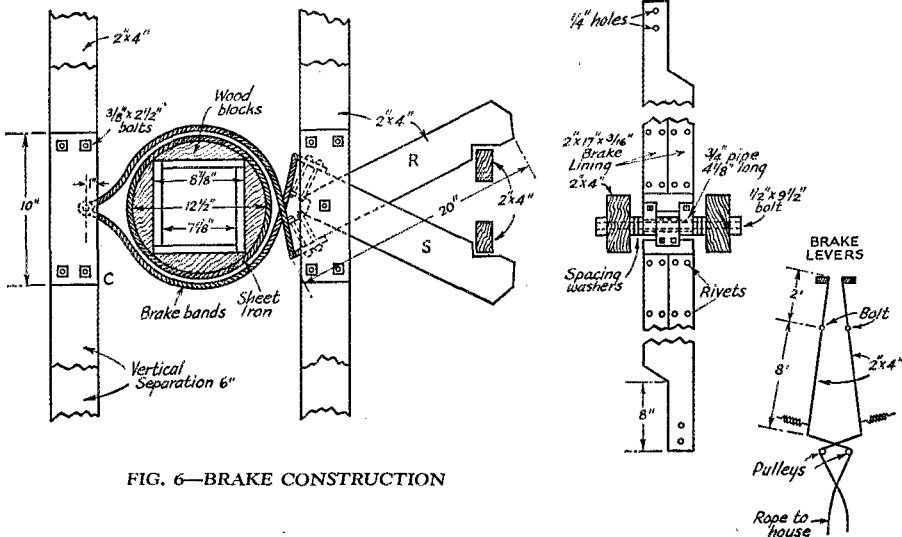

FIG. 6—BRAKE CONSTRUCTION

# Grid-Bias Power Packs

An Analysis of Their Operation and Some Practical Design Pointers

By N. M. Patterson,\* W4EG

The author takes a.c.-operated grid bias supplies apart to see what makes them tick, and uncovers some rules to follow to get the wanted results. Practically eliminates the guesswork in building that bias supply for the new transmitter.—EDITOR.

THE matter of grid-bias supply is not a serious or complicated one with low-powered transmitters, but it does present some real difficulties when one starts construction of a multi-stage high-powered rig. The writer was interested in building a separate power supply with the necessary voltage and voltage regulation to bias the several stages of a one-kilowatt trans-

mitter. Information as to the correct bias power supply voltage, bleeder load and resistance values to give the necessary cut-off and operating bias voltages for each stage, with the required voltage regulation and the explanation for these requirements, were not obtainable in a form which satisfied our interest in the subject. So a power supply was built up and several tests, under actual operating conditions, were made in an effort to understand fully its behavior. The results of these tests are described briefly in the hope that they will serve to aid others in a better understanding of this subject.

The first series of tests gave results that were puzzling, and efforts to calculate what the tests should show quickly proved that something was haywire. It became apparent that several things were to blame, including errors attributable to the unknown voltage regulation of the bias supply, to the possible 10% plus or minus variation in resistors, to the possible variation in meters, to

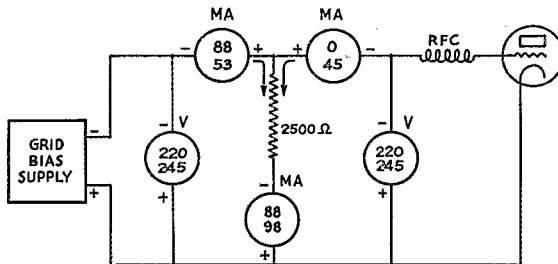

FIG. 1—TYPICAL CONDITIONS IN A BIAS SUPPLY USING A LOW-RESISTANCE BLEEDER, AND WHERE THE VOLTAGE DEVELOPED AS A RESULT OF GRID-CURRENT FLOW DOES NOT EXCEED THE SUPPLY VOLTAGE

grid current leakage through the bias supply, and to the additional current through the voltmeters shunted across the circuit. While preparing to make a curve of the voltage and current of the bias supply, it occurred to us that with measured resistances and currents, the voltage for any set of conditions easily could be calculated by Ohm's law, so no curve was made. The several resistors used in these tests were measured by using the series-connected battery, milliammeter and resistor method. None of the resistors showed departures of less than 5% from the value printed on the label, one being more than 20% off. The milliammeters were connected in series and found to vary as much as 3% at some current values. Obviously, to obtain consistent results, only one meter should be used, plugging it in to read the current in each part of the circuit.

Leakage of grid current through the supply was found to be negligible unless very high voltages were developed. In one test with a very high resistance and high grid current, nearly 1500 volts was developed and caused about 5 ma. leakage through the supply. Meters placed in the supply circuit indicated that all, or nearly all, of this was leaking through the 4- $\mu$ fd. filter condenser in the output of the supply. We believe that the

rectifier tube prevents any grid-current leakage through the supply transformer. To avoid upsetting circuit conditions, it was decided not to use the voltmeters except as a

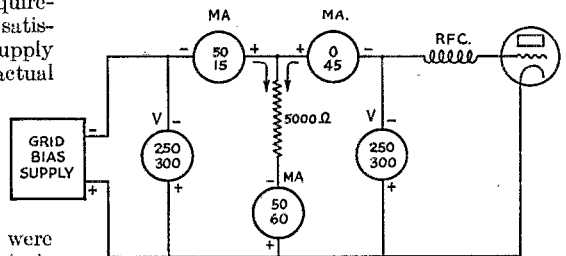

FIG. 2—THE SAME SUPPLY AND AMPLIFIER AS IN FIG. 1, BUT WITH A BLEEDER OF HIGHER RESISTANCE

rectifier tube prevents any grid-current leakage through the supply transformer. To avoid upsetting circuit conditions, it was decided not to use the voltmeters except as a

\* 2804 Hillsbro St., Raleigh, N. C.



check on the calculated voltages. In practice the meters usually read slightly different voltages than those found by calculation, but were always close enough to prove the point.

**SUPPLY BEHAVIOR**

With all these variables confronting us it was seen that it would require laboratory equipment to pin the results down exactly. However, for our purpose a small error is not important; what we really want is to understand the thing so that we can get the best possible results with the least effort.

Speaking broadly, the supply generates a substantially fixed voltage while its current may be anything from zero to full load. The grid is exactly the opposite, generating a substantially fixed current while developing a voltage across an external resistor anywhere from zero to a high value. When we connect the supply and the grid circuits across a common load resistance (bleeder-grid leak) any voltage developed by the flow of grid current is in parallel with the supply voltage.

Since parallel voltages do not add, then if the grid current develops less voltage than the supply, the voltage across the resistor will be the supply voltage only. If the grid current develops more voltage than the supply, the voltage across the resistor will be only that resulting from grid-current flow.

So long as the bias voltage is substantially fixed by the supply—i.e., up to where the grid current develops more voltage—the current that can flow also is substantially fixed because, since grid current must flow and supply current need not flow, a rise in grid current causes a drop in

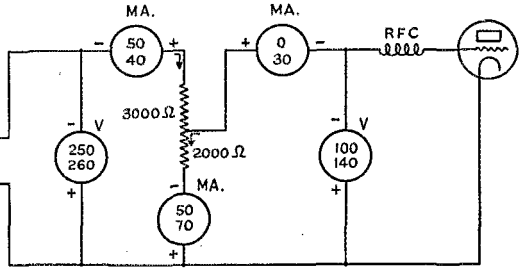

FIG. 5—A CASE WHERE THE SUPPLY VOLTAGE IS GREATER THAN THE DESIRED GRID BIAS

supply current or a drop in grid current causes a rise in supply current. The currents behave in see-saw fashion—as one goes up the other comes down.

If the supply voltage regulation is perfect, the rise in grid current will be equal to the fall in supply current, and vice versa, because with a fixed voltage, the total current must be fixed also. However, no supply will have perfect voltage regulation, and when the rise in grid current

causes a drop in supply current, the load on the supply is reduced, in turn causing the supply voltage to rise. This rise in voltage increases the voltage across the bleeder-grid leak, thereby increasing the total current flow, with the result that the drop in supply current will

not equal the rise in grid current.

From this we learn that any change in bias voltage for any condition where the grid current develops less voltage than the supply is due entirely to the voltage regulation of the supply. If the grid current develops more voltage than the supply, the supply current will drop to zero with its voltage as high as it can go at no load and the supply could be removed without changing the bias leakage or the current through the grid leak neglecting possible small leakage.

**EXAMPLES**

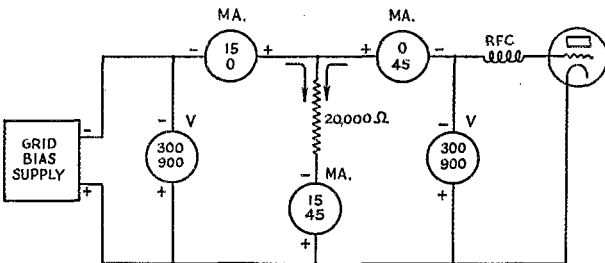

FIG. 3—CONDITIONS EXISTING WHEN THE VOLTAGE DEVELOPED FROM GRID CURRENT EXCEEDS THE SUPPLY VOLTAGE

flowing, and shows the change in current or voltage due to the flow of grid current.

With grid current at zero, Fig. 1, the supply delivers 220 volts and 88 ma. to a 2500-ohm load. When 45 ma. grid current flows the supply current drops to 53 ma. and the reduced load on the supply caused its voltage to rise to 245 volts. This

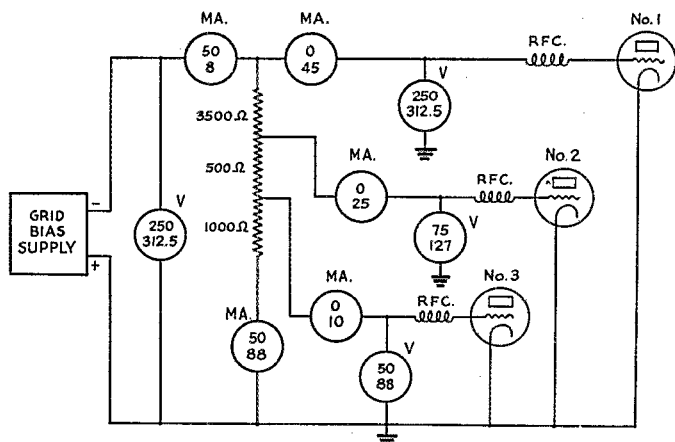

FIG. 6—AN EXAMPLE OF CONDITIONS EXISTING WHEN ONE BIAS SUPPLY HANDLES THE REQUIREMENTS OF SEVERAL AMPLIFIER STAGES

25-volt rise adds  $25/2500=0.01$  amp. or 10 ma., so that the total current is increased to 98 ma., of which 45 ma. is grid current and 53 ma. is supply current.<sup>1</sup> The grid voltage regulation is  $25 \times 100/220=11.4\%$ , which is not bad.<sup>2</sup>

In Fig. 2 the resistance is increased to 5000 ohms. With the higher load resistance the load on the supply will be lower and its voltage higher, so at zero grid current the supply delivers 250 volts and 50 ma. When 45 ma. grid current flows, the supply current drops to 15 ma. and the reduced load on the supply caused its voltage to rise to 300 volts. This 50-volt rise adds  $50/5000=0.010$  amp. or 10 ma., so that the total current is increased to 60 ma., of which 45 ma. is grid current and 15 ma. is supply current. The grid voltage regulation is  $50 \times 100/250=20\%$ , which is not as good as in Fig. 1.

In Fig. 3 the resistance has been increased to 20,000 ohms. At zero grid current the supply delivers 300 volts and 15 ma. When 45 ma. grid current flows, the supply load is reduced to zero and its voltage increases to a value approximately 1.41 times the r.m.s. voltage of the supply

<sup>1</sup> There is an instantaneous effect not considered here, in that the change in net bias voltage probably also would affect the amount of grid current flowing, so that an initial 45 ma. would drop slightly as the power-supply voltage rose. The final result, however, will not be affected so long as the grid current is maintained at a constant figure.—*Editor*.

<sup>2</sup> Regulation usually is expressed in terms of the load voltage, but use of the no-grid-current voltage as a base is more indicative in this case.—*Editor*.

transformer,<sup>3</sup> which is of no importance because the grid current develops 900 volts. However this 900 volts might easily blow the supply filter condensers. The current is all grid current and all the voltage is developed by grid current, so the supply could be removed for all the good it is doing other than furnishing 300 volts at zero grid current. The grid voltage regulation is  $600 \times 100/300=200\%$ , which is terrible.

If the required bias voltage is greater than the supply voltage, the method of Fig. 4 should be used. The additional voltage is developed across a series resistor and is not added across the supply to endanger the filter condensers. The behavior of this circuit will be seen to be like that of Fig. 2 except that the 112.5-volt drop across  $R_2$  adds to the grid voltage.

The circuit of Fig. 5 shows typical conditions where the required bias voltage is less than the supply voltage. The bias voltage regulation is 40%, which is probably satisfactory for many types of operation.

#### SEVERAL TUBES ON ONE SUPPLY

A case where more than one grid is biased from the same supply is shown in Fig. 6. Note the way in which the currents add: The supply and No. 1 grid current add through  $R_1$ , this current in turn adds to No. 2 grid current through  $R_2$ , and this current in turn adds to No. 3 grid current through  $R_3$ . The voltages developed across  $R_1$ ,  $R_2$  and  $R_3$  are in series and add up to a sum that is in parallel with the supply voltage. The voltage on No. 3 grid is the voltage developed across  $R_3$  only. The voltage on No. 2 grid is the voltage developed across  $R_2$  plus the voltage across  $R_3$ . The voltage on No. 1 grid is the voltage developed across  $R_1$  plus the voltages on  $R_2$  and  $R_3$ .

#### CONCLUSIONS

Now that we have an idea of bias-supply behavior, we need a simple rule to follow that will permit us to build a supply to fit our needs, whatever they may be. The final amplifier probably requires the best bias voltage regulation and usually takes the highest bias voltage. Therefore, the transformer selected for the supply should, when

(Continued on page 98)

<sup>3</sup> This rise in voltage occurs regardless of whether a choke—or condenser—input filter is used in the supply. The choke-input filter will give better regulation so long as the portion of the current furnished by the supply is greater than the critical value (see power supply chapter in the *Handbook*) but below that point the voltage will rise rapidly toward the peak output voltage of the rectifier.—*Editor*.

# ● ARMY-AMATEUR RADIO SYSTEM ACTIVITIES ●

THE following article prepared by the Fifth Corps Area is the fifth of a series appearing on this page. The Fifth Corps Area comprises most of the states of the Ohio River Valley: Ohio, Kentucky, Indiana, and West Virginia.

Writing about the Army-Amateur Radio System in the middle of July is not the easiest task in the world, for our season begins in September and ends the following May, which period embraces all of the emergencies in which the A.A.R.S. has been called upon to furnish communication facilities. We cannot, however, adopt the philosophy of the Arkansas Traveler whose roof never leaked when it didn't rain. It is the purpose of the A.A.R.S. to develop and maintain a network of active radio stations during the normal operating season and under ordinary circumstances in preparation for the time when an effective radio link is the only available means of communication.

Naturally, when no actual emergency exists, there are other ways of keeping our nets active. During the past season, Kentucky has made use of its stations along the Ohio River to furnish dam reports to several offices of the U. S. Engineers at vantage points, these reports originating from their office in Paducah. With seven dams concerned in these reports, it is easy to see the importance of such information in emergency flood work.

Ohio has been making a determined effort to become useful to the American Red Cross so that they may be well acquainted with the services of the A.A.R.S. before future emergencies crop up. On January 31st and again on February 28th of this year, a demonstration was staged for the purpose of contacting various chapters throughout the state for the exchange of Red Cross traffic. In both instances, almost the entire Ohio membership participated, and on the latter date the entire Corps area cooperated to make the demonstration a considerable success. Now that we have managed to "break the ice," it is hoped that the coming season will see further activity along this line.

Throughout the country, past experience has been mostly with floods, tornadoes, and hurricanes, although other emergencies can and often do arise. What has been done is history, and can be read in back issues of *QST*. The question now confronts us: How are we prepared for the future?

Each section of the country has its weak spots—places that are most likely to offer up emergency situations at more or less regular intervals. While it is the policy of the A.A.R.S. to be prepared for anything that might happen, regardless

of where it might be, these weak spots are the ones that call for the most attention and preparation. In the Fifth Corps Area it is the Ohio River Valley. During the floods of 1936 and 1937 many stations along the river were able to step in and render yeoman's service to the stricken areas.

Now there is no mystical formula by which an amateur is transformed into a member of the A.A.R.S. The only requirements are a *bona fide* interest, a willingness to cooperate with the other members and to be regular, reliable and prompt. It is not necessary that he be a speed merchant, for many of our most reliable members operate at moderate speeds. Nor is high power required, for the A.A.R.S. is a cooperative system, and if a weak signal cannot be picked up successfully at one point, it is sure to come through at another, giving an outlet for any traffic that there may be.

As in other Corps Areas, the Fifth Corps Area has been operating in spot frequency net fashion, with one channel for each state as follows:

	Kcs.
Indiana . . . . .	3656
Kentucky . . . . .	3810
Ohio . . . . .	3780
West Virginia . . . . .	3700

Not only does this method utilize a minimum of amateur channels at any one time, but affords an opportunity for easy and positive break-in, since all stations in one particular state net are listening on just one frequency, and can follow the entire procedure almost without touching their dials.

At present writing, we find ourselves greatly in need of more members along the Ohio River—in all four states of the Corps Area. It is extremely difficult to make any decent preparations for emergencies when no stations are available where they are most needed. We would like to recommend that any licensed amateur in the Ohio River Valley interested in contacting the A.A.R.S. and placing himself in a position to be of service to his community in time of need, write to the Corps Area Signal Office, Fifth Corps Area, Fort Hayes, Columbus, Ohio. We can use stations anywhere in the states of Ohio, Kentucky, Indiana, and West Virginia, and we shall be glad to furnish additional information to any who are interested.

— . . . . —

The following cryptogram is presented for those interested in these problems. Solutions received by the Liaison Officer, A.A.R.S., 3441 Munitions Building, Washington, D. C. will be acknowledged by mail.

AAFCN ORELC TIEIE LTCAY MITEI IUBIH NUTBA  
SETLI NSTCV QAFTE TSXII OPASS BNAAN NENSY  
ORSUO NIARN

# An Auxiliary Transmitter for 1.7- and 3.5-Mc. Work

A 50-Watt Self-Contained Unit With Ganged Tuning for Quick Frequency Change

By Don H. Mix,\* WITS

**T**HE transmitter described was designed primarily with the requirements for state or section traffic net operation in mind. While rapid band-changing is not a requirement, it should be possible to tune to any frequency within the band of operation with a minimum of effort and time. Provision should be made for break-in operation, of course, and it would be desirable to build it as a completely independent unit to eliminate any possibility of failure because of its dependence upon station units which may be used for other purposes. An input power of 50 watts should be sufficient for reliable work.

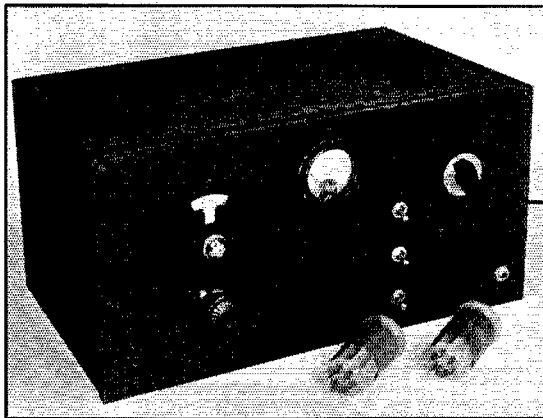

THE MAIN DIAL CONTROLS THE FREQUENCY AND THE SMALL CONTROL TO THE RIGHT ADJUSTS ANTENNA TUNING

No other tuning adjustments required.

The first requirement was fulfilled by the use of an electron-coupled oscillator and ganged tuning controls. Only two tuning adjustments are necessary for even wide changes in frequency. The main dial sets the frequency and the only other adjustment is the tuning of the antenna system. The 89 and 807 were selected as the most practical tubes for the purpose, considering cost and simplicity of circuit design for the power desired.

#### CIRCUIT DETAILS

Referring to the circuit diagram of Fig. 1 it will be noted that the oscillator circuit is quite

\* Technical Department, QST.

conventional except that a separate winding is provided for the cathode tickler. In addition to the many other variables which affect the stability and output of the electron-coupled oscillator, an investigation showed that the amount of feedback must also be taken into consideration. In fact, this adjustment now seems to be one of the most important in eliminating chirp with keying. It also has a very considerable effect upon the power output of the oscillator as indicated by grid current to the following stage. The separate tickler winding makes these adjustments much easier and also permits cathode keying of the oscillator for break-in operation even though the coil and condensers of the tuned circuit may be grounded.

The grid-screen circuit of the oscillator operates at a frequency of 875 to 1025 kc. This range was selected principally to permit direct checking of frequency against a broadcast receiver tuned to stations of known frequency, and secondarily because it is usually easier to obtain good frequency stability at the lower frequencies. This means, however, that the circuit must be well shielded to prevent interference with broadcast reception in the immediate vicinity of the transmitter. The plate circuit tunes over the range of 1750 to 2050 kc. (the band limits which are to be authorized in the near future). The output tank circuit covers either the same range or that of 3500 to 4000 kc. by means of a pair of plug-in coils. Very little efficiency is sacrificed in doubling frequency for the latter band. The tracking system is the same as that used in the transmitter described in QST for June.<sup>1</sup>  $C_4$ ,  $C_5$  and  $C_6$  are the circuit padding condensers while  $C_1$ ,  $C_2$  and  $C_3$  are the ganged tuning condensers. A switch is provided to open the cathode of the 807 while the frequency of the oscillator is being set. Parallel feed in the plate circuits of both oscillator and amplifier removes d.c. voltage from the tank circuits and eliminates the necessity for insulating the tuning condensers from ground; thus they may be mounted directly upon the chassis.

<sup>1</sup> Mix, "Ganged Tuning for the Multi-Stage Transmitter," QST, June 1938.

In order to make the unit complete, an antenna tuner and a power supply are built in. Successful tracking of the final amplifier tank circuit with the antenna coupler depends upon rather careful adjustment of antenna coupling. It was deemed advisable, therefore, to use separate plug-in coils in the antenna circuit so that permanent optimum coupling would be provided for each band.

Since the space available did not permit separate power supplies for oscillator and amplifier, the problem of well-regulated plate voltage for the oscillator was solved by the use of a pair of the new VR150 gaseous voltage regulator tubes in series. Regulation is held to within a few per cent of 300 volts.

#### ASSEMBLY

A National Type C-HRO cabinet with dimensions of  $16\frac{3}{4}$  by  $8\frac{3}{4}$  by 10 inches was selected as a convenient size. The depth of power transformers of sufficient rating exceeded the depth of the chassis (3 inches) furnished with this cabinet, but it was a simple matter to move the chassis up one inch in the cabinet and fasten the bottom plate in position with 1-inch spacers.

Referring to the photograph showing the top view, the line of shield-cans to the left contains the oscillator grid and plate coils and the 89 oscillator tube. The coils are wound on  $1\frac{1}{2}$ -inch diameter Hammarlund forms. Since these coils are not changed, the prongs were removed and the forms fastened permanently to the base with machine screws. Leads from the coils pass through clearance holes drilled in the chassis before mounting the forms. Coil adjustments could be made more conveniently, however, if the forms were mounted in sockets of the sub-mounting type. The coil shields are the National Type J30. The oscillator grid condenser and leak are mounted inside the oscillator grid-circuit coil form.

The National Type B dial controls the tuning gang. The oscillator tuning condensers are in front with the amplifier tuning condenser to the rear. The mounting insulators, which may be seen under the oscillator grid tuning condenser in the photographs, are unnecessary with the revised circuit shown. The tube in front of the 807 is the 83 rectifier. The amplifier coil is immediately behind the 807 and its socket is mounted on a short stand-off insulator. The two small knobs at the left-rear of the chassis are the controls for the oscillator and 807 plate-circuit padding condensers, which are mounted beneath the chassis. The two small tubes to the right of the 807 are the voltage regulators. The antenna coupling coil and tuning condenser are to the right.

Careful shielding and placement of circuit com-

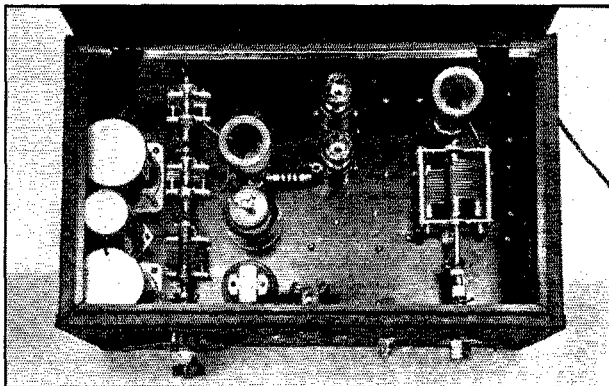

THE TOP VIEW SHOWING SHIELDING

*Antenna tuner is to the right. The antenna tuning condenser is mounted on small stand-off insulators.*

ponents are important to avoid instability in the amplifier circuit. All grid-circuit components, with the exception of the tuning condenser in the plate tank circuit of the oscillator, are mounted beneath the chassis, while the units comprising the plate circuit, aside from the padding condenser, are mounted on top. The tube is supplied with the usual low cylindrical shield coming up level with the lower edge of the plate. Because of the height of the tube, the socket for the 807 must be set about an inch below the surface of the chassis. This can be done easily with spacers.

A 2-inch milliammeter with a scale of 0 to 150 ma. is mounted on the panel. The top toggle switch controls the filaments, the central switch is in the primary circuit of the high-voltage transformer and the lower one opens the amplifier cathode circuit. The antenna tuning control is in the upper right-hand corner and the jack for the key is in the lower right-hand corner.

Turning to the bottom-view photograph, the power-supply equipment may be seen occupying the right-hand side. Some thought should be given to the arrangement of power-supply components so that space will be provided for mounting screws for the antenna tuning condenser and also for the toggle switches and key jack. The oscillator and amplifier plate-circuit padding condensers are near the lower left-hand edge. The fixed mica padding condenser for the oscillator grid circuit is near the upper left-hand corner. One of the new low-drift mica condensers is recommended if frequency drift due to heating is to be held to a minimum.

#### WIRING

It will be noted that very little wiring shows above the chassis. Components have been arranged so that most of the wiring may be hidden beneath the chassis. Power wiring may be bunched in cable form where it happens to be convenient, but the r.f. wiring should be spaced well out from

the chassis. The connection between the amplifier plate coil and the stator of the padding condenser underneath the chassis should be made through a small feed-through insulator. A small hole must be drilled in the top of the can shielding the oscillator grid coil for the grid lead to the 89. By-pass condensers are located as close as possible to the points to be by-passed. Wire with heavy insulation is recommended for the positive high-voltage line. Flexible leads from transformers, chokes, etc., are brought out to terminal strips fastened to the chassis before the wiring is continued to the proper points. These strips are used also to form insulating supports for small resistors and chokes when nothing else offers a convenient anchorage. The power supply cord is brought out through a bushing or grommet in the rear of the cabinet and a pair of small feed-through insulators mounted in the rear of the cabinet near the right-hand end for the antenna connections.

#### TUNING

Preliminary tuning and adjusting should not be a difficult job. The screen voltages for the 89 and 807 should be first set to appropriate values—100 for the 89 and 250 to 300 for the 807. Both tubes should be in place with filaments lighted but no plate voltage on the 807. The oscillator should then be tuned to the high-frequency end of the band. If frequency is checked against a broadcast receiver, the receiver should be tuned to some station in the vicinity of 1025 kc. for the 1.7-Mc. band or 1000 kc. for the 3.5-Mc. band. It may be necessary to open the cover of the transmitter cabinet or even run the receiver antenna lead-in near the transmitter to provide sufficient signal strength. With the frequency of the grid circuit set, the plate circuit may be tuned to resonance, indicated by a milliammeter connected temporarily in the circuit, by means of the padding condenser  $C_5$ . When resonance has been found, the

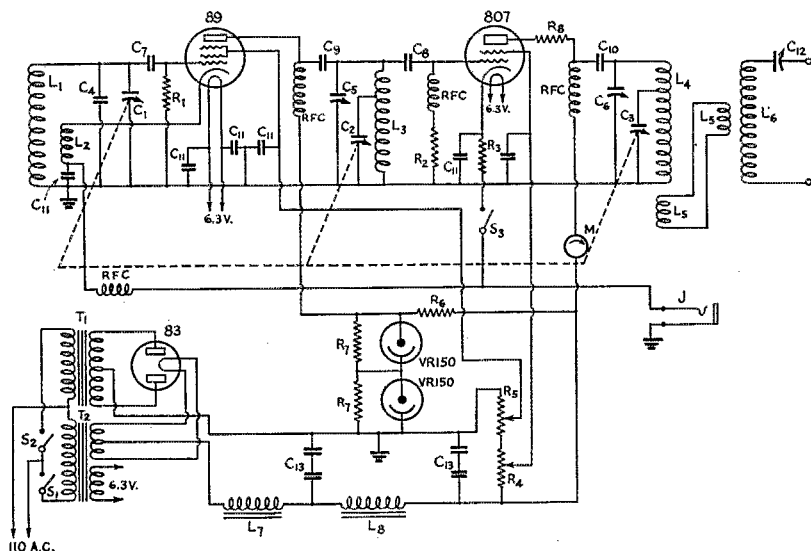

FIG. 1—CIRCUIT DIAGRAM OF THE AUXILIARY TRANSMITTER

- $C_1$ —140- $\mu$ fd. midjet variable (Hammarlund MC140S), oscillator grid tuner.
- $C_2$ —50- $\mu$ fd. midjet variable (Hammarlund MC50S), oscillator plate tuner.
- $C_3$ —Same as  $C_2$ , amplifier plate tuner.
- $C_4$ —350- $\mu$ fd. fixed mica (250 and 100 in parallel), oscillator grid paddler.
- $C_6$ —Same as  $C_3$ , amplifier plate paddler.
- $C_7$ —250- $\mu$ fd. mica midjet fixed, oscillator grid condenser.
- $C_8$ —Same as  $C_7$ , amplifier grid condenser.
- $C_9$ —5000- $\mu$ fd. mica (600 volts), oscillator plate-voltage blocking condenser.
- $C_{10}$ —5000- $\mu$ fd. mica (1000 volts), amplifier plate-voltage blocking condenser.
- $C_{11}$ —0.01- $\mu$ fd. tubular paper (600 volts) by-pass condenser.

- $C_{12}$ —260- $\mu$ fd. variable (Cardwell MR260BS) antenna tuner.
- $C_{13}$ —Double-8- $\mu$ fd. electrolytic, sections in series (450 volts working).
- $R_1$ —50,000 ohms, 1-watt, oscillator grid leak.
- $R_2$ —20,000 ohms, 1-watt, amplifier grid leak.
- $R_3$ —400 ohms, 5-watt, amplifier cathode biasing resistor.
- $R_4$ —25,000 ohms, 50-watt, voltage divider.
- $R_5$ —25,000 ohms, 25-watt, voltage divider with slider.
- $R_6$ —15,000 ohms, 50-watt, oscillator plate-voltage dropping resistor.
- $R_7$ — $\frac{1}{4}$ -megohm, 1-watt voltage equalizer.
- $R_8$ —25 ohms, 1-watt parasitic suppressor.
- $T_1$ —750 v. each side center, 200 ma. (Stancor P3699).

- $T_2$ —Filament transformer, 6.3 v., 3.6 a., and 5 v., 3 a. (Stancor P5009).
- $L_7$ —8-40 henrys, swinging filter choke, 175 ma. (Stancor C1400).
- $L_8$ —20 henrys smoothing choke, 175 ma. (Stancor C1410).
- $L_1$ —52 turns No. 28 d.c.c.,  $1\frac{1}{2}$  inches diameter, close-wound.
- $L_2$ —12 turns No. 24 d.c.c. wound over ground end of  $L_1$  in same direction as  $L_1$ .
- $L_3$ —60 turns No. 24 d.c.c.,  $1\frac{1}{2}$  inches diameter, tapped 6 turns from plate end.
- $L_4$ —1.7 Mc.—50 turns No. 22 d.s.c.,  $1\frac{1}{2}$  inches diameter, tapped 6 turns from plate end.
- 3.5 Mc.—28 turns No. 20 d.c.c.,  $1\frac{1}{2}$  inches diameter, tapped 8 turns from plate end.
- $L_5, L_6$ —See text.

setting of the padding condenser should be marked on the chassis. The oscillator should then be tuned to the low-frequency end of the band and the padding condenser again adjusted for resonance. If the resonance setting has changed, the tap on the coil is not correctly placed. If the padding capacity must be increased to regain resonance, the tap should be moved slightly towards the plate end of the coil, while if the padding capacity must be decreased, the tap should be moved away from the plate end of the coil. No difficulty should be experienced in locating a point for the tap where the tuning of the plate circuit will remain at resonance over the entire tuning range. When the proper adjustment has been found, the setting of the padding condenser should be marked in case it may be disturbed later by accident. Once tuned, this circuit should not have to be adjusted again in operation.

The same process should be followed in adjusting the plate circuit of the amplifier for either band. Proper padding-condenser settings for both bands should be marked on the chassis. The only difficulty encountered in tuning up the amplifier was the presence of an ultra-high parasitic oscillation. If similar oscillations are encountered they may be suppressed by the insertion of a small non-inductive resistance in series with the plate lead

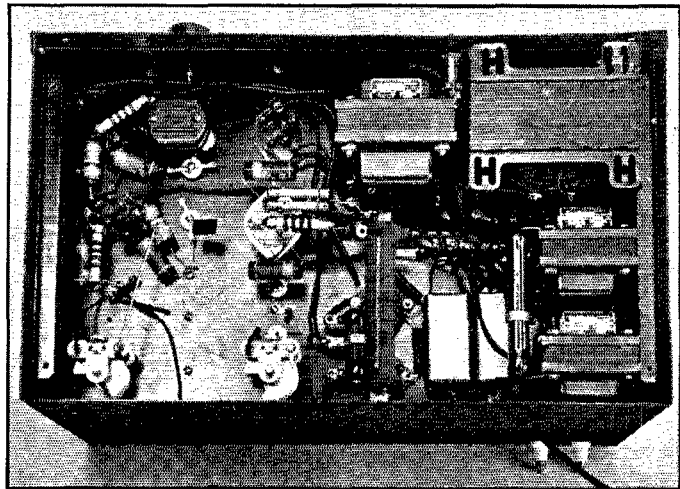

SHOWING ARRANGEMENT OF POWER-SUPPLY COMPONENTS AND SUB-BASE WIRING

of the 807 close to the tube. The resistance need not be more than 25 ohms, even 5 ohms being effective in this particular instance.

#### ANTENNA COUPLER

The dimensions of the antenna coil and the question of whether series or parallel tuning should be used will depend upon the antenna system with which the transmitter is to be used. It is advisable, therefore, to wind experimental coils until a satisfactory combination has been found. When the best dimensions have been found, the coil may be wound permanently and the terminals soldered to the pins of the coil form. In general, it may be said that a comparatively small number of turns in the antenna coil and series tuning will be required if the antenna system is being fed near a current loop and that a comparatively large number of turns and parallel tuning will be required if the antenna system is being fed near a voltage loop. Once the correct combination has been found which will tune the antenna to resonance, the link windings may be adjusted to provide proper amplifier loading. In adjusting the link windings, it will be found that the amplifier tuning will not track if the coupling is too tight. It should be possible, however, to run the plate current up close to the maximum rating without disturbing the tracking, providing the antenna circuit is kept tuned to resonance. With the antenna coupled it may be necessary to readjust the setting of  $C_6$  to maintain tracking, and in some instances it may be necessary to alter the position of the tap slightly. It will be noted in Fig. 2, which shows the connections for the antenna coil and socket, that either parallel or series tuning may be used simply by changing the connections

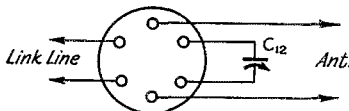

ANT. COIL SOCKET WIRING, BOTTOM-VIEW

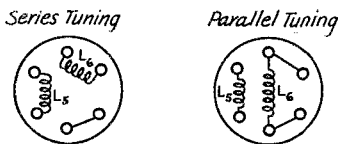

COIL FORM CONNECTIONS BOTTOM VIEW

FIG. 2—SHOWING MANNER IN WHICH CONNECTIONS ARE MADE TO ANTENNA COIL SOCKET AND FORM

Six-prong sockets and forms are required.

(Continued on page 74)

# Ham Radio and Models

Latest News in the Radio-Controlled Aircraft Field

Clinton B. DeSoto,\* W1CBD

**T**HIS is its second year. In other words, it's just learning to walk and talk. Radio-controlled model aircraft, that is—not the neighbor's youngest child. But any art has to pass through stages of infancy and growth, as does any youngster.

Of course, there was talk of radio-controlled aircraft before last summer. In fact there were those who claimed they had flown models under control—and even those who would sell detailed plans for a consideration. Without peering too closely into these phases, however, it is generally agreed by the various authorities in the field that practical radio control first arrived during the summer of 1937.

Practical, did we say? Well, yes. It usually worked on the ground, and sometimes it worked in the air. There were a variety of systems. At the 10th National Model Airplane Competition at Detroit in July of 1937, where the new radio-control event was a novelty that excited popular imagination, no two similar methods were used in any of the six ships entered. Chester Lanzo, the winner, used a single channel with a regenerative 80-meter receiver, a gear train and a toy train motor giving single-cycle rudder control. His ship, an elementary stick affair, was the only one that flew; two others cracked up on the take-off. The remainder did not attempt to fly. One system was based on the principle of tuned vibrating reeds

to select audio-frequency pulses for control maneuvers. Another entrant used miniature wind-driven dynamos to generate the current for control solenoids.

Solenoids—they were the standbys of these early radio-control experiments. Logical, and to some extent practical, they formed the basis of most systems. But actually to drive a control surface with a small electromagnet required an astonishing amount of power—power painfully bought with weight and bulk.

Then, in the late summer of 1937, *QST* introduced a new tool—the escapement, with the control surfaces powered by means of rubber bands.<sup>1</sup> A series of soaring planes fitted by Ross Hull with this type of control made over a hundred flights during the summer and fall of 1937, providing a wealth of data for experimental development. This information was reduced to practical applications during the early spring in anticipation of the annual soaring meet at Elmira.

There Ross and R. B. Bourne, W1ANA, his pilot and co-worker, planned to enter a high-performance r.-c. soarer in competition with the regularly-manned ships, but unfortunately technicalities in the rules prevented this! A number of experimental flights were made during the course of the meet, however, each under perfect radio control. The principal result of this experience was the discovery of various enlightening aeronautical characteristics of large, high-performance model soarers of the type used.

For the 1938 meet Ross Hull adapted an improved, if bulkier and heavier, method of control employing continuously-reversible small d.c. motors. This system of control had the obvious advantages of permitting the precise degree of control desired for a given maneuver, and also of permitting instantaneous reversal of the control without going through a complete cycle.

Such a control system necessarily introduced appreciably more weight than the rubber-band powered escapement arrangement, however, and the latter still ruled supreme in the field of ultralightweight devices. In fact, following its presentation in *QST* modellers generally came to recognize the worth of this idea and it formed the basis for much of the experimental building and testing carried on during the past winter.

Indeed, so fully did the principle register that it literally dominated the 1938 national radio-

\* Assistant Secretary, A.R.R.L.



WALTER GOOD AND HIS 8½-FT. SPAN, 7½-LB. RADIO-CONTROLLED GAS MODEL AT WAYNE COUNTY AIRPORT, DETROIT, DURING THE NATIONALS

At the left is Paul Kreilick, W8QQE, the radio operator. Although the picture doesn't show it, the self-assigned number of the plane is "7388."

<sup>1</sup> Hull and Bourne, "Radio Control of Model Aircraft," *QST*, October, 1937, p. 9.



control competition, the 11th National model meet, again held in Detroit in July.

The competition itself was not, unfortunately, a success. This was due basically to weather conditions, for a strong wind that grew stronger every hour made successful flying very nearly impossible. The winning ship was the only one to attempt to fly, and it suffered a severe crack-up on the take-off.

What the story might have been had the weather been favorable is conjectural. So far as is known Walter Good of Kalamazoo—who won the event—was the only one who had a tried and proven ship, one that had been put through a routine of test hops. Such experience is a tremendous asset. On the other hand there were some good-looking control systems in evidence.

The outstanding characteristic of the meet was that, in contrast to the previous year, it seemed more representative of radio talent turned to modelling than of modellers trying to vanquish radio. This is as it should be, for successful radio control is an astonishingly elusive goal even to those versed in radio technique. On the other

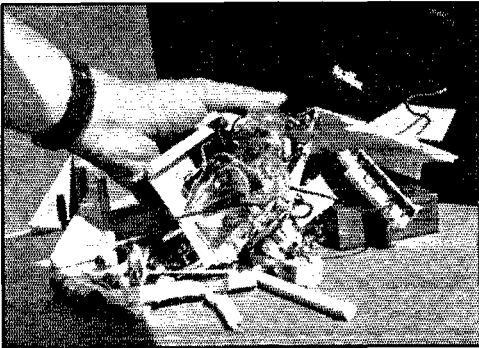

**IT DOESN'T SEEM POSSIBLE, BUT THIS TWISTED MASS OF RECEIVING EQUIPMENT—RESULT OF A STALL BY WALTER GOOD'S SHIP AT TAKE-OFF DURING THE 1938 DETROIT MEET—WORKED WITH THE RE-CONNECTION OF A SINGLE WIRE**

hand, weakness in the aeronautical department is equally unfortunate. A joining of forces, as was evidenced at the 1938 meet, is a healthy sign—one that leads to a prediction that next year will see some real progress in the field.

#### WINNING SHIP USES ESCAPEMENTS

Walter Good's winning ship used two-channel one-cycle control, with movable tabs on both rudder and elevator actuated by ingenious little escapements built into the fixed surfaces right at the tail. Although apparently an awkward place for extra weight, the mechanical reliability of so direct a linkage seemed advantageous. At least, Good made several test flights under control before the meet—even landing back on the run-way in one case. Since the unfortunate crack-up, the

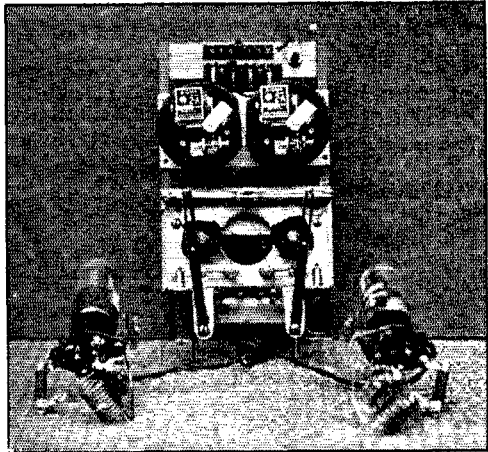

**RADIO CONTROL EQUIPMENT BUILT BY AL PO-CHELON, WSJYH, FOR HOWARD FLANNIGAN'S 8-FT. SCALE "CUB"**

*The receivers weigh 2¾ oz. each, complete with tube. Light-weight relays, escapements and plunger-type electromagnets bring the total weight down under 2 lbs.*

re-built ship has continued to perform reliably and a number of other flights have been made—including three at a public demonstration.

The flying technique is quite simple. The ship is adjusted on the ground for normal take-off and climb, and it then takes off as would any gas model. Once in the air it is maneuvered in slow turns and gradual dives and climbs by pulses which move the escapements through their positions. Landing is accomplished by the usual glide to earth after power cuts, the rudder being used for directional control.

Two radio channels are used. The receivers employ a trick circuit; Good says he himself does not fully understand its operation. The tube is a single Type 30, superregenerative on 56 Mc., in the familiar "Minute Man" circuit. By juggling plate voltage and circuit constants a critical condition is found which gives 2-ma. plate current change. Actually, the tube seems to act something like a QY-4.<sup>2</sup>

The sensitive relays are of the polarized type, using small permanent magnets. This type was chosen on the basis of Good's three years of experience with about a dozen different varieties as being the most stable mechanically, less subject to shocks and changes in flight altitude than other types.

The total weight of the radio equipment, using penlite cells for filament supply, etc., is under 2 pounds. The transmitter uses a pair of T-20's. The frequency changer is a small relay which ties in additional capacity, giving the two-channel control.

Another interesting entry at the 1938 meet was

<sup>2</sup> Hull, "New Gear for Radio-Control Systems," *QST*, July, 1938, p. 44.

that of Howard Flannigan of Detroit, in which Al Pochelon, W8JYH, was the capable radio collaborator. The control system utilized QY-4's and Sigma relays, with two channels—rudder and elevator. The most notable feature was the lightweight construction and the ingenious use of the escapement principle. Flannigan, a quiet, competent man past fifty, is a capable mechanical engineer, and his workmanship shows it.

Speaking of competence, it is a remarkable thing to note the variety of talent which is being attracted to this radio-control game. Mechanical engineers, aeronautic experts, radio folk—they all find ample room for fascination in its confines. As a hobby it offers not only the absorbing interest of complex technical problems and the appeal of an interesting constructional project, but to that it adds thrills in the form of spectacular results not to be found in most technical pursuits—and it most certainly is a thrill to see those models fly!

But enough digression. The pictures show the general plan of the Flannigan-Pochelon control. The receiver tubes are plugged into wafer sockets, but these are used in lieu of a chassis rather than for mounting. All other parts are wired to the socket terminals. The tubes are mounted in the ship by light metal sleeves which are tightened over the bases.

The relays are assembled integrally with the minute escapements and midget plunger-type electromagnets on a wooden frame which slides into the fuselage. Control wires run back to the movable surfaces.

The writer's ship, which was awarded second place at the Detroit meet on the basis of a demonstration on the ground, is an experimental high-wing monoplane of 14-foot span powered with a special  $\frac{3}{4}$ -hp. Forster opposed-type motor. It was originally designed to carry 10 or 12 pounds of radio gear in experimental set-ups, but the 25-lb. weight rule at the Nationals necessitated considerable paring. As a result, the control was limited to two channels—rudder and elevator—actuated by reversible d.c. motors. To accomplish this four receivers using Raytheon QY-4's, two for each channel in order to accomplish the reversing action, were used.

A detailed constructional description of this system and its application is scheduled for next month's *QST*.

If there is a moral to this yarn—and it seems there should be—it is that it takes radio folk to build radio gear and airplane people to build air-

planes. Speaking in generalities, the 1937 Detroit meet was apparently characterized by modellers with ample aeronautical but inadequate radio experience. At the 1938 meet, on the other hand, all the radio-control systems functioned at least reasonably well on the ground, but when it came to actual flying—well, there just hadn't been enough of it.

The best recommendation that we can make, therefore, is that hams and modellers work together on a coöperative basis. That way all the details of both aircraft and control will be coöordinated—and each will have an expert's attention. We have established that it takes hams to devise adequate control systems, but the reverse is usually true as well. So if you're interested in the thing, get in touch with your local modeller's club—aircraft or yachting; the latter is a lot simpler from the radio standpoint—and get going on a partnership basis. You'll be in for some of the biggest fun of your life.

## More on the 1851

SINCE publication of the squib on using the 1851 in amateur-band communications' receivers' some additional data on the characteristics of the tube have been furnished us through the courtesy of J. R. Nelson of the Raytheon Production Corp. It develops that the undesirable feature of low input resistance and consequent circuit loading is to a very considerable extent a function of the operating voltages applied to the tube elements. By increasing the grid bias beyond the normal rated value it is possible to

bring the input resistance up to a figure which is even better than that of the 6K7 at its maximum ratings. The mutual conductance naturally is lower, but still is high enough so that there is an increase in gain over the 6K7. More important than gain, however, is the fact that operating the 1851 at lower plate current does not affect the noise appreciably, so that with the increased bias the tube still gives an improvement in signal-to-noise ratio. The fact that the circuit loading can be reduced by increasing the grid bias on the 1851 makes it relatively easy to substitute the tube for a 6K7, because the tapping-down process previously suggested no longer is necessary.

In an experimental check it was found that, in substituting the 1851 for a 6K7 in one receiver

(Continued on page 78)

<sup>1</sup> "The 1851 in Communications Receivers," p. 41, *QST*, June, 1938.

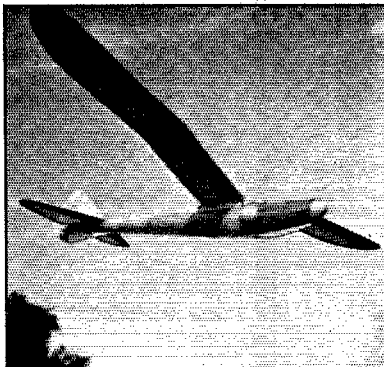

ROSS HULL'S HIGH-PERFORMANCE 16-FOOT SOARER SHOWING OFF ON A RADIO-CONTROLLED TOUR OF THE COUNTRYSIDE

# Freshman Marlow

## A Story

By J. C. Flippin,\* W4VT

THE clock in the tower of the Engineering Building sounded faintly in the distance. The wind was coming up fast now, howling and cold, blowing smoke down the chimney at each frigid gust. The windows of the shack rattled eerie accompaniment to the moan of the wind 'round the eaves. It was black outside, the cold blackness of early morning, made more dark and sinister by the occasional erratic flashing of lightning on the eastern horizon.

It was three thirty. Most of the fellows had departed over an hour ago, and now only Collier Parkes and Professor Wortham remained, toasting their shins in front of the flickering logs, talking in that way that friends talk—when the spirit moves them, answering in monosyllables, chuckling now and then, smoking peacefully as they stared at the fire.

Parkes had come off duty at two o'clock. When he signed on at midnight, the static had been imperceptible, but soon it had picked up to sharp, pistol-shot crashes occurring with increasing rapidity, and necessitating double sending at ten words, and breaks for fills every few seconds. So at the end of two hours, with conditions growing worse, he closed the station. Downstairs, Freshman Bradfield was cleaning up the bias motor-generator sets, a job that fell his lot once a month. It was an all-night job, usually, but to-night there were only two of the machines to work on, and to-morrow was Sunday and he could sleep late.

At the moment he was sanding in a pair of new brushes on Generator No. 4, and happy, being not only a small chap who could "take it," but a man of good disposition, and prideful of a good job. He snapped the tension springs all around, gauging the thrust with the air of a man inspecting the exciter-brush rigging on a 50,000-Kva. turbo, and went around again just to make sure all was right. Bias, Freshman Bradfield knew, was a very important thing. He held the lamp close, and inspected critically the polish of the commutator. The carbon dust in his taffy-colored hair and the smudge in his left ear gave him the appearance of a man who worked with zeal at the job.

Professor Wortham removed his horn-rimmed glasses, looked through them, and reached for his handkerchief. "Looks like a storm coming up."

"Won't be long, I guess. Enough QRN up there to take care of two of them."

Parkes glanced at the clock over the fireplace, stood up, looked at it closer. "Time for coffee, Prof. How about it?"

"Why, yes! Certainly."

Parkes went over to the stairway leading to the basement. "Rustle up a scuttle of java, frosh."

"Yes, sir," answered Freshman Bradfield, promptly. Coffee was something that went well about this time of the morning.

"How're they looking?"

"Pretty good. We're trying out a softer grade on No. 4. I had to change only two of them, this time."

A fierce gust of wind beat against the shack, hammering at the windows.

"On the job, frosh."

"Yes, sir."

Parkes walked over to the window and looked out, cupping his hands beside his face. Lightning in the east. A fierce glare overspread the landscape for an instant. A long period, followed by a distant rumble of thunder.

Freshman Bradfield came up the stairs, wiping his hands on a piece of waste.

"Hold the deal, frosh. I'll get the coffee started. Go get a flashlight and dash over yonder on the hill and take a look at that rotary beam. See that the tarpaulin is lashed fast over the motor mechanism. If it gets wet, we'll have a time with it."

Once before, the fastenings had come loose in a heavy rain, soaking the rotating mechanism, requiring pulling the motor and baking it out. Almost as bad, the water upset the readings on the Wheatstone bridge, one arm of which was a rheostat geared to the drive, which allowed the position of the beam to be ascertained in the operating room by galvanometer deflection.

"Don't let the rain catch you. Make it swift."

"Yes, sir," answered Freshman Bradfield, disappearing on a run through the door of the store room. Reappearing in a moment with a flashlight and his overcoat, he hurried out of the shack, pulling on his overcoat as he ran.

Outside, it was pitch black. The wind hit him in gusts. Damp feeling, in front of rain. He jogged along in the darkness, following the dimly outlined path to the beam. He knew every foot of the way, whether the path had been there or not, having helped erect the beam. Some job it had been, too!

The two great old wooden towers, which could be seen miles away in fair weather, were wholly invisible. The path to the beam followed the line of the towers, the beam being only a couple of hundred feet beyond the farther one.

(Continued on page 80)

\* 3071 Southern Ave., Memphis, Tenn.

# The Permatron—A New Type of Rectifier With Magnetic Control

**G**RID-CONTROLLED mercury-vapor rectifiers are more or less familiar to the amateur fraternity, but probably few of us are acquainted with the fact that a similar

oscillator in the transmitter—capable of supplying a few watts to a pair of electro-magnets readily will handle the keying.

A typical keying circuit is shown in Fig. 1.  $M_1$  and  $M_2$  represent the magnet coils, wound on U-shaped cores the ends of which are placed on either side of the tube. Externally the Permatron resembles any conventional mercury-vapor rectifier, but internally has two pole pieces running vertically downward from the elements. The ends of the magnet core should be placed as close as possible to these pole pieces, and as near their tops as is practicable. When current is sent through the magnets, the magnetic field exerts a control over current flow similar to that of the electrostatic field in the grid-controlled tubes. Depending upon the strength of the field, current flow will be prevented until the voltage on the rectifier rises to a critical value, when the vapor ionizes and conduction takes place. Once current is flowing, the control is lost until the plate voltage drops to zero during the course of the cycle. If the field is made strong enough, the tube will not

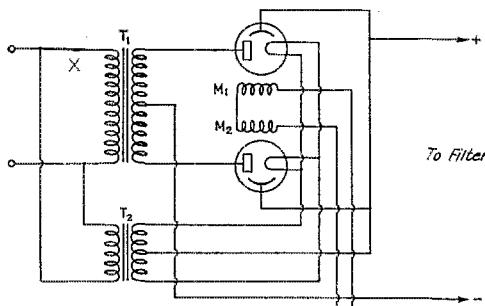

FIG. 1—MAGNETIC KEYING CIRCUIT FOR PERMATRONS

$R$ —4000 ohms, 75-watt.  
 $M_1$ ,  $M_2$ —See text.  
 $T_1$ —Plate transformer.  
 $T_2$ —Rectifier filament transformer.  
 $X$ —Switch to allow preheating filaments.

control by magnetic means is possible. Although magnetically-controlled gas-filled tubes have been in use for some time in various applications, chiefly at low voltages, it is only recently that types suitable for plate-supply requirements have been developed. We are now able to report, however, that magnetically-controlled tubes, to be known as Permatrons, are being made available by the Raytheon Production Corporation.

Permatrons have a number of interesting features which make them adaptable to a wide variety of applications. The one of chief importance to amateurs, however, is the obvious use as a keyed rectifier. Since the magnetic control circuit is external to the tube and needs no direct connection to the rectifier circuit, special insulation between the key and the power supply is not necessary, as it is in the case of grid-controlled rectifiers. A source of direct current—which conveniently may be the low-voltage plate-supply for the

(Continued on page 86)

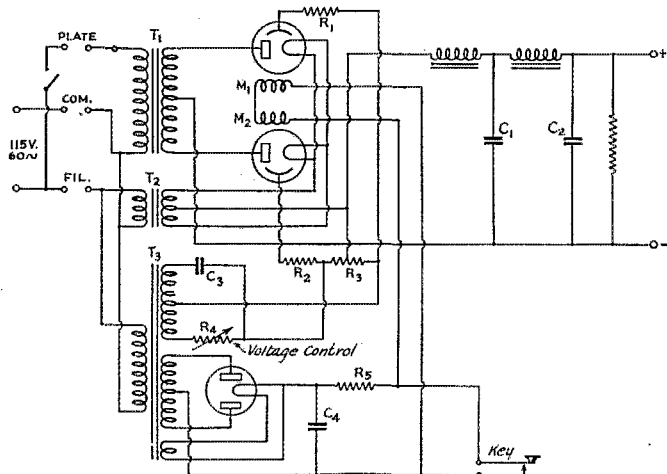

FIG. 2—PERMATRON POWER SUPPLY WITH VOLTAGE CONTROL

$T_1$ —Plate transformer, 2500 volts, center-tapped.  
 $T_2$ —Filament transformer, 2.5 volts, 10-amp. Secondary insulated for full plate voltage.  
 $T_3$ —Control transformer, three secondaries: 300 volts center-tapped for voltage control; 500 volts for plates of 83 rectifier; 5 volts for 83 rectifier filament.  
 $M_1$ ,  $M_2$ —Electro magnets. See text.  
 $R_1$ ,  $R_2$ —100,000 ohms, 1-watt (for limiting grid current).  
 $R_3$ —10,000 ohms, 25-watt wire-wound center-tapped.  
 $R_4$ —2500 ohms, 25-watt variable.  
 $R_5$ —4000 ohms, 75-watt.  
 $C_1$ ,  $C_2$ —4- $\mu$ fd., 1500-volt.  
 $C_3$ —4- $\mu$ fd., 1000-volt.  
 $C_4$ —8- $\mu$ fd., 600-volt electrolytic.  
 Filter chokes and bleeder according to output current. See Handbook.

# McNinch Praises Amateur Radio

F.C.C. Chairman, Principal Speaker at Atlantic Division Banquet, Lauds Our Accomplishments; President Woodruff Responds

**A**T the convention of the Atlantic Division of the A.R.R.L. in Washington on June 25th, the guest of honor and principal speaker was the Honorable Frank R. McNinch, chairman of the Federal Communications Commission. Mr. McNinch's address, illustrative of the esteem in which amateur radio is held by the Commission, was broadcast over a nationwide network. We quote the greater part of Mr. McNinch's remarks:

Mr. Toastmaster, distinguished guests, members of the Atlantic Division of the American Radio Relay League, and those of you who are listening to this program which is being broadcast from coast to coast: I am gratified that I have this opportunity to speak to you amateurs and to the public. Many who hear this program may know that there are radio amateurs but know little or nothing concerning the history and evolution of the radio amateur to his present estate. Indeed, until I became Chairman of the Federal Communications Commission, I myself did not know much about the work of the amateurs. But now that I have come into a very great appreciation of the amateur, I ask the indulgence of those present at this banquet to recount some facts that will be an old story to you as I describe what to me seem some of the most significant and outstanding achievements of radio amateurs and tell some of the things I have learned about them.

Before coming with the Commission, I had, of course, read of the fine public services rendered by amateurs at times of flood, earthquake, fire, and other local and national calamity. I had read that radio amateurs had furnished an important and sometimes the only link between civilization and exploring expeditions into the polar regions of the Arctic and Antarctic. Until recently, however, I had no conception of how vast is the number of people who can lay claim to the title of radio amateur. I did not realize that amateur radio was probably the only hobby, not even excepting stamp and coin collecting, which is officially recognized and actively fostered by the Government of the United States and by some of the more forward-looking governments in other countries of the world. Neither did I realize how universal in character is the group of women as well as men radio amateurs, who according to Clinton DeSoto's book "Two Hundred Meters and Down. The Story of Amateur Radio" range in age from "8 to 80; in education from those who halted in the grammar grades to the erudite holders of doctor's degrees; in social status from convicts in federal prisons to scions of wealthy families and the son of an ex-President of the United States; in occupation, from coal miners and bellhops to major executives in giant corporations."

I have learned something of the history of the American Radio Relay League and of the high place which it holds not only in the United States but in the world. For it, like radio itself, is not bounded by geographical lines in its activities or its importance. The name of its founder, Hiram Percy Maxim, is a household word throughout the world.

To me the outstanding achievement of radio amateurs does not lie in the scientific field though I have a high appreciation of the remarkable developments in the art which have been originated and in many cases perfected by radio amateurs. I know that radio as we know it to-day would not be an actuality and perhaps not even a dream for the future were it not for the many scientific contributions that have grown out of the experimentation, the creative imagination and the ingenuity of radio amateurs who have struck out

boldly along paths untrod by those who have engaged in orthodox scientific research. Nor do I think its greatest achievement is to be found in any or all of the many public services rendered by radio amateurs in times of public distress such as was caused by hurricanes in Florida, the Mississippi, New England, Texas, California, Kentucky and other floods; the California dam break; many devastating forest fires; and the New Zealand and Nigerian and California earthquakes. These were indeed great public services, saving many, many lives, and millions of dollars' worth of property. But to me the glory of amateur radio lies in the creation and development of this altruistic passion for the unselfish dedication of the time and talent of the more than 60,000 radio amateurs in the world to the public service. No other aspect of amateur radio has so captured my imagination. The many isolated public services rendered by radio amateurs, great as they were, should, I think, be regarded as a geologist does those outcroppings of surface ore which, valuable in themselves, are of greatest value in showing the mother lode of precious metal beneath the surface. I like to view these particular acts, not for their surface values but rather as proof of the underlying golden desire and ability of amateur radio to serve humanity.

At the outbreak of the World War, the Army and Navy Communication Systems were of utmost importance. They needed radio operators, and they needed them badly. The radio amateur's fraternity supplied this need. More than 3500 amateurs contributed their skill and experience to the American cause. They were already skilled and experienced and were available at a moment's notice. To train raw recruits would have required upward of a year to learn the telegraph code alone, and many more months to acquire the technical knowledge and skill based on experience that the amateurs possessed.

The amateur has lent assistance to these arms of the Government on many occasions. In 1924 amateurs maintained reliable communication with the United States dirigible "Shenandoah" as it made a tour of the country. In 1925, when the United States battle fleet made a cruise to Australia, the Navy wanted to test out short wave equipment. The American Radio Relay League furnished amateur operators for the job who proved the value of these short waves for Naval use.

So valuable were the amateurs considered, that in 1925 both the Army and the Navy came to the American Radio Relay League with proposals of definite cooperation. The result is that the Navy now has its Naval Communication Reserve and the Army its Army Amateur Radio System with several thousand members throughout the entire United States. These amateurs secure actual training and handle routine matters over the air, become skilled in military procedure, and thus add greatly to national security.

In providing a secondary reserve line of national and international communication the amateur fills a rôle scarcely less important from the standpoint of the national welfare of our country than his rôle as a supplement to our military and naval forces. There are some 47,000 amateur stations in the United States and an equal number of amateur operators, all licensed by the Federal Communications Commission. This, in effect, constitutes a complete nationwide communication network which is available for emergency purposes and with the other 13,000 amateur stations and operators in other parts of the world, a fairly effective international communications system. I may say in passing that it is a source of great satisfaction to me that more than seventy-eight per cent of all the amateurs in the world are to be found in the United States.

It is the very essence of amateurism that whatever is done is done without hope or desire for pecuniary gain. I have no doubt there are amateurs in other fields who devote them-

selves as whole-heartedly and as single-mindedly to their hobby as do radio amateurs. I know of no other field, however, where the public at large receives such great benefits as a direct consequence of the work of amateurs. I know of no other field of amateur activity which operates under a code so high minded in conception as the code of the radio amateur. I want to read two articles from that code not so much for the benefit of those of you who are present tonight, but for the information of those who are listening in:

Article 1. *The Amateur is Gentlemanly.* He never knowingly uses the air for his own amusement in such a way as to lessen the pleasure of others. He abides by the pledges given by the American Radio Relay League in his behalf to the public and the Government.

Article 6. *The Amateur is Patriotic.* His knowledge and his station are always ready for the service of his country and his community.

My time is too limited to discuss in more detail the history and achievements of radio amateurs. I want, however, before closing to appeal to the radio amateurs in this country to throw their organized and effective efforts into another important public service, and that is to support the Federal Communications Commission in the work that the Congress has delegated to it. I extend the same invitation to all of you who are listening in tonight. You amateurs know better than most the gravity and difficulty of many of the problems that face the Commission. . . .

Dr. Eugene C. Woodruff, president of A.R.R.L. and I.A.R.U., responded to Mr. McNinch as follows:

An amateur is one who struggles—not necessarily “struggles” followed by marked successes, but nevertheless struggles—against odds. Unfortunate indeed is he who knows of no odds against which to struggle. However, in such case, that is, in the case of the lack of the usual difficulties, financial and material, there arises the even greater and more satisfying struggle, first to create (or better, to recognize) the handicaps and then to overcome them. This is, of course, not a case of simply setting up a straw man and then using him as a boxing partner. Progress is inhibited more by the limitations of which we know not, than by the more obvious troubles. In fact, an “odd” to be conquered needs to be seen but clearly, and then real human nature finds no obstacle to an ultimate triumph. It takes insight and imagination to spot the real lions in the way. The way

in which the human creature approaches a resemblance to the gods is by the demonstration of a creative ability. Still, even this does not mean the production of something new and different. (Strictly speaking, there is nothing new under the sun.) The things that appeal more or less directly to our limited senses of seeing, hearing, and feeling constitute but a small proportion of the whole of creation. The bulk of items have no direct physical appeal. Their actual existence is recognized only by an exercise of what may well be called the creative imagination. Once recognized, the control of such items becomes a matter of a further special exercise of said imagination, and this control is the real function of the amateur, no matter along what particular line his activity lies.

Exercise of such abilities is accompanied by a development of those most desirable individual characteristics, initiative, ingenuity and independence. Only as these characteristics are developed does the ranking of the individual, in the scale of real values, go upward. In the field of radio activity lies the best chance for the development of these virtues for the average individual. Progress may be instituted by mere imitation. The subject is so fascinating that the ambition to make a start is readily aroused. Almost from the start, however, the exercise of initiative, ingenuity, and independence is called for, as the conditions under which any two individuals operate are certain to vary enormously. The initial problems, while super-physical, so to speak, are still of such a nature as not to be impossible even for the most limited tyro, and this makes this hobby of such inestimable value. The development of the individual through such self-training, and the acquirement of these most-desired characteristics, constitute the greatest service the individual may render to the social order. The group of individuals may constitute but a small percentage, numerically, of said social group, yet the leavening process is nonetheless indispensable and inevitable. Encouragement of such individual activities by the general group constitutes the best insurance this group may have of a final freedom from destructive outbursts, and a continuance of the development of a most desired teamwork that will result in the common good. This seems to be the major reason why amateur radio activity should be considered as in the public interest, convenience, and necessity.

We amateurs certainly appreciate our friends. In the names of the many one chances to represent, much gratitude is extended to you, Mr. McNinch, for your kind expressions of interest and friendship. We thank you.

## The A.R.R.L. National Convention

THE speakers' roster for the A.R.R.L. National Convention to be held in Chicago September 3rd, 4th and 5th is a veritable “Who's Who” of amateur radio. Each speaker is outstanding in his field, whether he has charge of a group meeting or a mass meeting, and has been selected because of his ability to present his subject interestingly and thoroughly. Accordingly, we find the League represented by our president, Dr. Woodruff, and our vice-president, Mr. Bailey, as well as by Warner, Handy, Hebert, Hull and Grammer. For the technical demonstrations the names of John Reinartz of RCA, Prof. Hartig of the University of Minnesota, Ted McElroy, world's champion radio telegrapher, Frank Lester, W2AMJ, John Kraus, W8JK, Fred Schnell, W9UZ, Marshall Wilder of National Union Tube Co., and Fritz Franke of the Bendix Corp. are all well known to you. These

men will discuss with you the various phases of radio and television.

The equipment display and registration will open at 9:00 A.M., Saturday, September 3rd, and that morning will be spent viewing the displays and meeting your friends.

The program proper will open at 1:00 P.M., Saturday afternoon, and will be taken up with demonstrations of television, new circuits, antenna design and exhibits of high-speed code copying. Saturday evening the big party will be held in the main Ball Room where you will be entertained by various contests and such features as “Amateur Hour,” “Professor Quiz” and “Awarding of the Chisel,” as well as free refreshments. This will be an informal party for both men and women, with fun for all. Prizes will be awarded to winners of various events. Stars of the

(Continued on page 82)

# Announcing—The Maxim Memorial (WIAW) Dedication Relay

September 2, 1938 (6 p.m. local time to sunrise)

Dedication Memento to Be Sent to All Participating in Relaying Messages from  
Officials of Each Division and Section



You are invited to get in the Relay. Operate and report results.

Hiram Percy Maxim, whose inspiration and guidance as our First President was so largely instrumental

in bringing amateur radio to its present eminence, would have been 69 years old on September 2nd. Your League's Board of Directors have honored his memory in the building of a station at your Headquarters to bear his call and carry on exemplary operations in his tradition. It is altogether appropriate that the new station be dedicated by your President and Vice-President and other officials on the anniversary of his birthday.

It is an occasion of significance in A.R.R.L. history. At the brief ceremony of dedication in the afternoon H. P. M.'s daughter and son will be present, with A.R.R.L. officials and the local members of the League who will be invited. Attendance will be by invitation and it is possible the simple exercises will be broadcast, as the broadcasting chains have inquired as to details. If so, information on the time and stations will be given in O.B.S. transmissions as soon as known, so all members who can may listen. Following the dedication exercise, messages will be received from every Division and every A.R.R.L. Section, we hope, and every member is invited to help in relaying the official messages. Nearly one hundred such messages will be started, addressed to WIAW, and to be received by WIAW or any other cooperating Connecticut station which will operate to assist in fast dispatch of traffic in the Relay.

Since only local members of A.R.R.L. can conveniently attend, the WIAW Dedication Relay will be an exercise to permit officials and members who wish to do so to send their good wishes on the occasion, and honor the memory of H. P. M., who himself established outstanding relaying records in the early days of the growth of our hobby.

#### RELAY PLANS

To take part. Just get on the air (any band) on telegraph or 'phone and look for Hartford-bound messages. "CQ CONN" will be used by stations

having actual messages in the Relay. Besides the messages which Sectional officials are sending, any Member may send his own message. Try to send your message and relay at least one other additional message towards its destination.

Relay. The idea is not to attempt to put your message direct all the way. This is a commemorative Relay with which the '38-'39 active season is being opened. To make it a true Relay, in the full spirit of those days before the vacuum tube, try to make every message a relay through at least one intermediate station! Note the calls of all handling stations consecutively in the preambles to messages; as they are passed along, add your call.

Report. The relay starts at six (6.00) P.M., your local time, continuing until sunrise September 3rd. Start traffic early. Stick with the relay as long as possible. Do as much relaying as possible. If you go off the air before morning, clear your hook first. If stuck with traffic at sunrise deliver it by mail, with your report on what you did. Calls of all stations participating will be listed in QST.

In addition, each participating station reporting will receive a memento of the occasion of the dedication of WIAW!!!!!!

#### CONNECTICUT STATIONS

WIAW will be operated continuously throughout the period of the Relay, sending a short announcement to amateurs of the nature of the occasion from time to time, changing at least hourly from band to band, or 'phone to c.w., to take traffic offered. The following frequencies will be used (c.w.): 1800.5, 3825, 7150, 14,254 kcs. ('Phone): 1808, 3950, 14,234 kcs.

To get continuous coverage on each band, Connecticut amateurs specializing in work on particular bands will assist in receiving messages in the Relay. The "best bets" are likely to be some of the following, who gave an excellent account of themselves in the Maxim Memorial Relay (3.5-, 7-, 14-Mc. c.w.): W1HSX, W1IKE, W1AFB, W1GME, W1KV, W1FE, W1IT1, W1JMY, W1GVV, W1IYB, W1TD, W1CSC, W1JXP, W1GKM, W1JUD, W1BIH, W1FAJ, W1UE, W1TS, W1JB, W1LJI, W1BHM, W1GS, W1HPI, W1KAY, etc. (3.9- and 14-Mc.

(Continued on page 114)

# HINTS and KINKS for the Experimenter



## A Simple Gear Drive for Rotary Antennas

IN designing the gear drive of the rotary beam of the accompanying photographs and drawings, two main thoughts were kept in mind: First, that the arrangement must be reasonably light in weight, and second, that it should be inexpensive of construction. The antenna is an 8JK beam arrangement, and a "Mims Signal Squirter" frame is used for the center structure. The base plate and upright was ideal for a basis upon which to plan the rotating structure, as use of this system saved a great deal of work and fitted perfectly with the original W8JK antenna.

The gear and drive mechanism, obtained from a nearby junk yard, is taken from the rear section of a discarded Model T Ford car. The parts required are the ring and pinion gear, and a small portion of the drive shaft, the exact length of the latter depending on the constructional details of the rotating arrangement. In addition to the above major parts, the large washer which is a stop for the shaft bearing may well be used for this purpose in the antenna system. After the gears are taken from the housing, all screws are removed from the ring gear. This gear is then mounted by means of wood-screws on an oak block which is turned out on a lathe to fit the outside dimensions of the gear. A pipe flange is centrally located on the opposite side and screwed to the block. The end of a section of iron pipe is then threaded to fit the flange, and

this pipe, inserted firmly into the flange, is used to rotate the antenna structure.

A hanger must be provided to hold the pinion gear shaft. For this purpose, a horizontal piece of 2-inch by 4-inch wood and bearing brackets made of 1-inch by 1/4-inch strap iron may be used as shown in Fig. 1. First, the pinion gear and sleeve

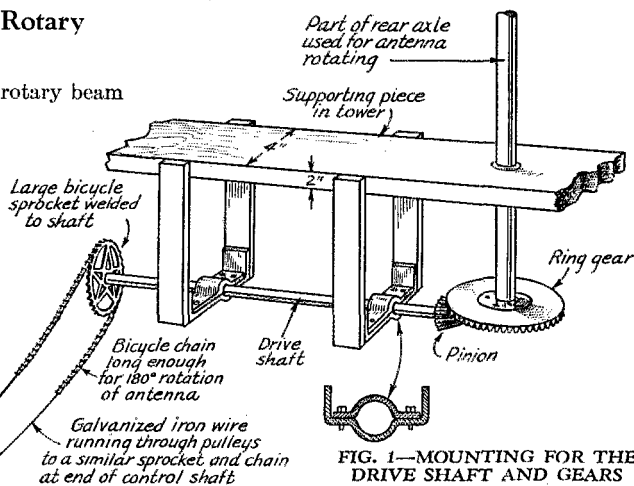
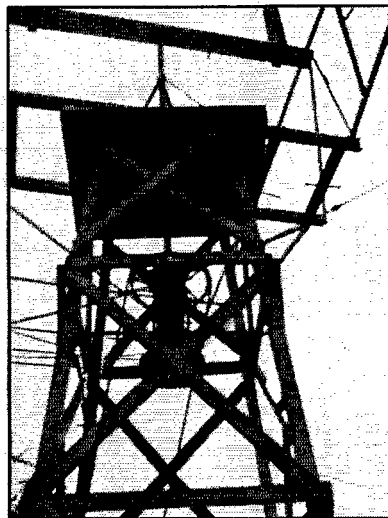
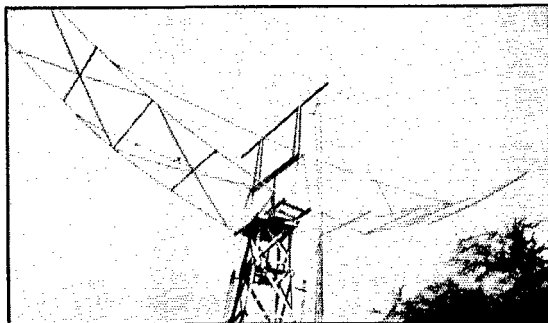

FIG. 1—MOUNTING FOR THE DRIVE SHAFT AND GEARS



TWO VIEWS OF THE ROTATING ANTENNA ARRANGEMENT



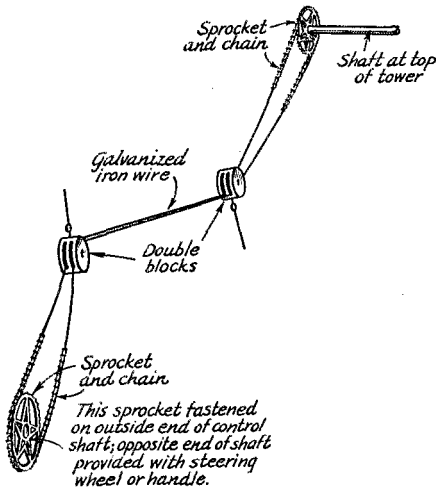

FIG. 2.—GALVANIZED WIRE AND BICYCLE CHAIN ARE USED IN THE STEERING SYSTEM

are removed from the drive shaft. The top part of the bearing is made by beating a short piece of strap around the shaft, forming a semicircular depression in the middle to receive the top of shaft. The straight ends are then cut off to length, leaving only a small flat area large enough to be drilled for the bolts. The corresponding depression in the hanger is formed in the same manner, and the latter is drilled to mate the top half of bearing. These strap iron parts are heavily coated with enamel, for rust would otherwise soon bring about difficulty in the use of the system.

In order to rotate the pinion drive shaft from the operating position, two bicycle sprockets and a quantity of bicycle chain are used, together with sufficient galvanvanized clothesline wire to connect the two lengths of chain, as shown in Fig 2. The length of the chain at each sprocket is slightly more than is required to rotate the antenna through 180 degrees. One sprocket is welded to the end of the gear drive shaft, and the other sprocket is welded to the steering shaft at the operating table. At W4CCH a steering wheel and shaft from a discarded automobile are used, with pipe flanges screwed on inside and outside of window sill used as bearings. These flanges, with threads reamed out, make a watertight fit with the Chevrolet steering shaft.

The galvanvanized wire used to connect the two sections of chain is flexible enough to make two right-angle turns between the steering mechanism and the drive shaft, and affords an economical

connection which will withstand long exposure to the weather. Two double-wheel idling blocks are used to align the drive wires at the turns.

Although this application of discarded auto parts is used on a tower, it may be readily adapted to a rotatable beam on a single large pole by means of a light supporting platform at the top of the pole.

Ball bearings are mounted upright on the tower platform, and are of the large type mentioned by Mims in *QST* for December, 1935.

—J. M. Carstarphen, Jr., W4CCH

### Handy Kink for Tuning 5-Meter Auto Antenna

A READILY constructed and very convenient device for adjusting portable and mobile 5-meter tubular antennas is shown in Fig. 3. One hole is drilled near each end of a thin bakelite strip of a few inches length and approximately one inch width. One clip for each end of the strip is formed from brass or phosphor bronze, and a hole is drilled in the base of each clip to receive a mounting screw. A round-head machine screw just long enough to receive a nut in the completed assembly is then run through a soldering lug, a hole in the bakelite strip, and the base of a clip, and a nut is firmly tightened on the end of the screw to complete the construction at each end. The point contact of a flashlight bulb is then soldered to the free end of one of the soldering lugs, and a short piece of copper wire is used to connect the base-thread terminal of the bulb to the other lug. The connections to the lamp serve to hold it firmly in place on the gadget. When clipped on the 5-meter antenna near the center, the brilliance of the indicator will increase when the antenna current is increased by proper adjustment.

—Goyrn Reinhardt, W3AC

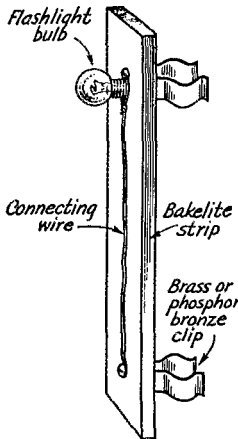

FIG. 3—KINK FOR 5-METER ANTENNA TUNING

### Remote Control of a Protective Relay

ALTHOUGH an overload relay in the load circuit of a large plate power transformer is a good investment in a transmitter, use of such a device ordinarily complicates the use of remote control of the transmitter. The usual type of overload relay operating with field coil in series with the center tap of the plate transformer and contacts in series with the primary of the transformer makes use of a mechanical latch which holds the contacts open after an overload occurs. This is necessary because there would otherwise be an intermittent opening and closing of the contacts as long as the overload

condition existed. The use of a mechanical latch on the overload relay makes it necessary to go to this relay and operate the mechanical reset device each time an overload opens the contacts.

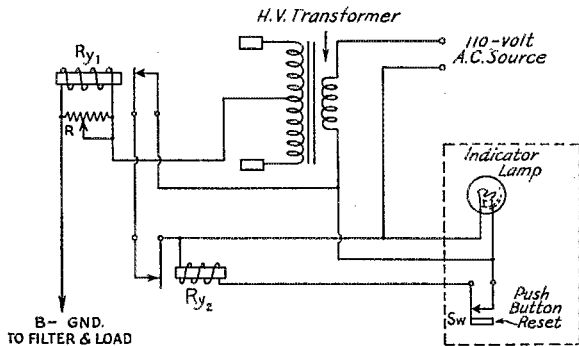

FIG. 4—CIRCUIT FOR REMOTE OVERLOAD PROTECTION

A solution for this difficulty is shown in Fig. 4. This circuit, making use of two home-made relays in the author's application, is quite suitable for use with commercially available relays of conventional types. The circuit incorporates a d.c. operated, single-contact-normally-closed relay. Except for the fact that no mechanical latch is used to hold the contact circuit open after an overload, this relay is similar in function and circuit connections to the usual overload relay. A second relay, also with contact normally closed, but with a.c.-operated field coil rather than d.c. coil, is used to serve electrically in the holding, or latch, function. The combination provides for a remote reset control and indicator for the protective circuit. If the d.c. relay is opened by an overload, the circuit is held open by the a.c. relay, and an indicator lamp at the remote operating position lights, informing the operator of the trouble. The operator may then press a reset button located immediately below the lamp, and if the overload was of a temporary nature such as that caused by a flashover in a tank condenser, the light ceases to burn, indicating that the circuit is restored to normal operating condition. If the cause of the overload still exists, on the other hand, the light flashes on and off intermittently until the button is released. This latter trouble, of course, necessitates a visit to the transmitter to determine the cause.

The circuit functions as follows: The contacts of both relays, closed, under normal operating conditions form a short circuit across the winding of the a.c. relay and also across the indicator lamp, and at the same time maintain the circuit

closed through the primary of the high-voltage plate transformer. When an overload occurs, excessive current flows through the winding of the d.c. relay, opening the contact. This removes the normal 110-volt source from the primary of the plate transformer and at the same time removes the short circuit from the winding of the a.c. relay. This operation places the a.c. relay in series with the primary winding of the plate transformer, causing current to flow in the a.c. relay, opening the contacts of this second relay and maintaining open the circuit to the plate transformer from the 110-volt a.c. source, except for a small current (a few milliamperes) through the transformer primary and the parallel combined load of the indicator lamp and the a.c. holding relay. The contact of the d.c. relay immediately returns to the normally closed condition, and the pilot lamp

indicates that the a.c. relay is holding the protective condition in the circuit. This condition is sustained, due to the current through the a.c. relay holding the 110-volt source from the transformer primary, until the reset button at the operating position is pressed. When this latter operation is performed, the field circuit of the a.c. relay is opened, allowing the contact to return to the normal position, applying 110 volts a.c. to the primary of the plate transformer. If the circuit is restored to operation, indicated by the pilot bulb going out and remaining dark, the button is released and the circuit is then in the condition which existed before the overload. If the overload condition continues to exist after the reset button is pressed, the d.c. relay will again operate closing the primary circuit just long enough to make the field current open the contact, and will thus alternate between open and closed condition, causing the pilot lamp to flicker off and on. The flickering pilot lamp immediately warns the operator of trouble in the transmitter, and the reset button is released until investigated.

For the indicator, a 5- or 10-watt 110-volt night-lamp or a neon bulb may be used.

Both relays must have contacts capable of breaking an overload current in the transformer primary. The d.c. field coil should be such as to operate on the smallest current for which it is designed to be used, and the parallel resistor may then be set for any value of overload current. The a.c. relay should have a field coil designed to operate on 90 to 100 volts, and should require only a small value of field current.

(Continued on page 88)

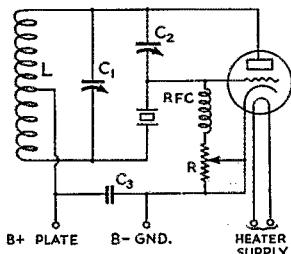

FIG. 5—BALANCED BRIDGE OSCILLATOR

# How Would You Do It?

## Methods of Varying Transmitter Tank Coil Inductance for Tuning in Conjunction with a Fixed Tank Capacity

WITHIN the past few months, new air condensers, sealed in vacuum, designed for r.f. tank circuit applications have been introduced. Their use makes possible the construction of high-voltage r.f. tank circuits of compact proportions. Since these condensers are necessarily of fixed values of capacity, some additional means must be provided for tuning the circuit to exact resonance. Most of the experimental transmitters which have been built thus far using the fixed condensers have been tuned by changing the inductance of the tank coil by means of a rotatable metal ring or disk mounted in haywire fashion in the field of the coil. While such an arrangement may be entirely adequate for experimental work, it is obvious that something more permanent and reliable is desirable if the idea is to be incorporated in the construction of a permanent transmitter for serious work, especially if it is to be operated on more than one frequency. It was with the hope that some

method of varying the inductance in a reliable and predictable manner would be forthcoming that we presented Problem No. 19 in *QST* for July.

Regrettably, it must be said at the outset that while the ideas submitted undoubtedly accomplish the primary object of a variable inductance,

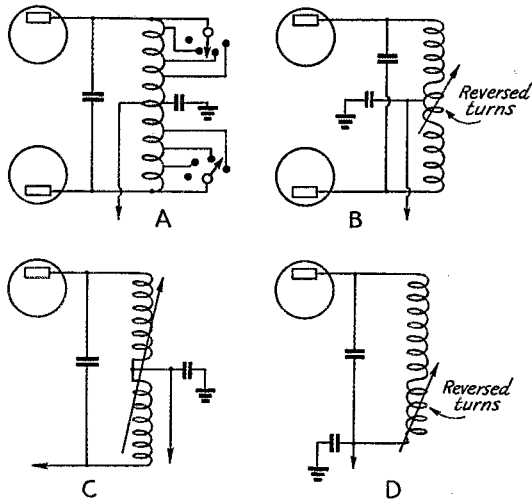

FIG. 2

all of them involve mechanical or electrical weaknesses. It is our opinion that the use of a small variable capacity is still the most satisfactory way of doing the job. The following ideas are presented with the idea that they may serve to spur the development of simpler and more satisfactory means of tuning by variable inductance for the purpose of economy in space requirements.

Four different methods are suggested. The first involves the variometer principle in which a portion of the coil is made rotatable so that its inductance will either buck or assist that of the fixed portion of the coil. The second method varies the inductance by changing the mutual inductance between sections of the coil into which

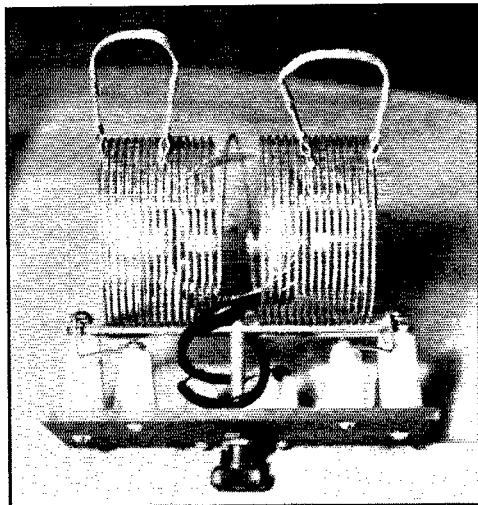

FIG. 1

### Problem No. 21

For some time Our Hero has been trying to devise a suitable method for connecting the different units of his transmitter. The time-honored system of bringing all connections to a single terminal strip, making the connections and then cabling the wires together is all right but it isn't versatile enough. Our Hero does too much experimenting and rebuilding to expect to have the same unit in one place a long time and, further more, he doesn't like the inconvenience of unscrewing eight or ten binding posts every time he removes or replaces a unit. What can you suggest as a simple and effective way to make connections between r.f. units and power supply that will be versatile, speedy and capable of standing the high voltage to the final amplifier?

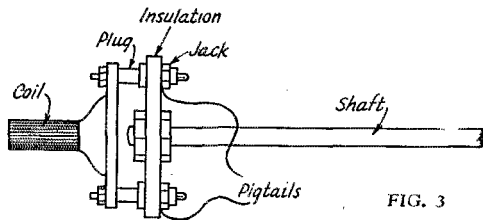

FIG. 3

it is divided. In the third scheme a body of metal is introduced in varying degree into the field of the coil resulting in a reduction of the inductance by eddy currents induced in the body of metal, while the fourth makes use of closely-spaced short-circuiting taps on the coil.

The photograph of Fig. 1 shows an example of the first method in which a variometer arrangement is used. A rotatable coil of a few turns is coupled to the main coil either at the center for a split tank circuit as shown at Fig. 2B or at one end for a single-ended circuit as shown at D. The unit shown in the photograph was constructed by J. J. Prekot, W3CHH. Two unmounted "air-wound" coils with a diameter of approximately  $2\frac{1}{2}$  inches and whose combined inductance is suitable to tune the tank circuit to the middle of a band with the fixed capacity selected are made or purchased. A second coil approximately 2 inches in diameter with about 4 turns is also required. The two larger coils are mounted on a  $\frac{1}{2}$ " by 6" strip of celluloid or other insulating strip with Duco cement, leaving a space of about one-half inch between the coils. A  $\frac{3}{32}$ " hole should be drilled at the center of the strip to clear the shaft of a Bud No. 531 shaft-and-bearing assembly. Holes to clear a No. 10 screw should be drilled also at each end of the strip. These holes are for mounting the coil on  $1\frac{1}{2}$ " cone insulators.

The smaller coil is then mounted on a small strip of celluloid  $\frac{1}{2}$ " by  $\frac{3}{4}$ " which has been drilled and tapped at the center for a  $\frac{3}{32}$ " flat-head machine screw. The head of the screw is soldered to the center point of the small coil

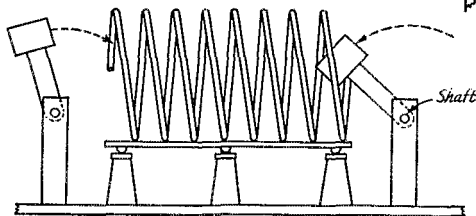

FIG. 6B

and the strip threaded onto the screw and cemented in place.

The panel is made of a piece of tempered Masonite and is  $6\frac{1}{2}$ " by 4". This is drilled at the center to take the shaft and bearing assembly. Holes are also drilled for the mounting insulators. When the unit has been assembled, a piece of  $\frac{1}{4}$ " copper braid covered with spaghetti is soldered to each end of the small coil and also to the adjacent inner end of each of the larger coils so that the three coils are in series with the small coil at the center of the series. The end of the shaft is drilled and tapped for the flat-head  $\frac{3}{32}$ " screw.

In series-fed circuits the shaft will be at plate potential so that it will be necessary to use an insulating shaft coupling between the shaft of the unit and the control dial on the panel. If the unit is built for the 3.5-Mc. band, turns may be short-circuited at each end for 7- and 14-Mc. operation. With this arrangement, the coil could be tapped each side of center

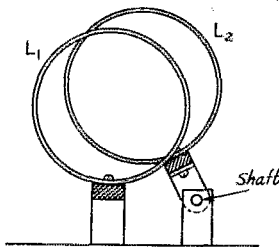

FIG. 4

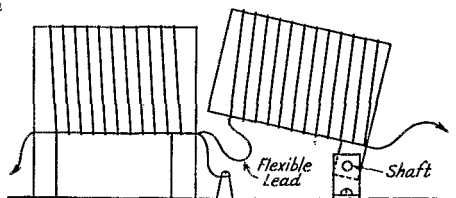

FIG. 5

for a link line to the antenna coupler or a link coil wound outside the tank coil with provision for clearing the control shaft.

If the scheme is to be used with a single-ended

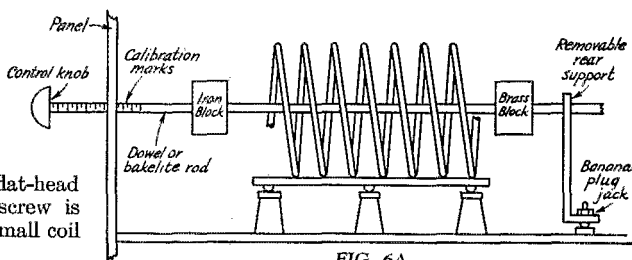

FIG. 6A

circuit, the rotatable coil may be mounted at the ground end and turns short-circuited at the plate end.

The same scheme is suggested by GM6RG and Robert Roberts, Louisville, Ohio. Mr. Roberts offers the suggestion shown in Fig. 3 for mounting the rotatable coil so that it may be changed conveniently along with a system of plug-in coils.

(Continued on page 76)

# • I. A. R. U. NEWS •

Devoted to the interests and activities of the

## INTERNATIONAL AMATEUR RADIO UNION

Headquarters Society: THE AMERICAN RADIO RELAY LEAGUE, West Hartford, Conn.

### MEMBER SOCIETIES

American Radio Relay League  
Asociația Amatorilor Romani de Unde  
Scurte  
Associazione Radiotecnica Italiana  
Canadian Section A.R.R.L.  
Československá Amatérská Vysílací  
Deutscher Amateur Sende-und-Empfangs  
Dienst  
Eesti Raadio Amatooride Ühing  
Experimental Radio Society of Egypt  
Experimenterende Danske Radioamatorer  
Federation des Emetteurs Belges  
Irish Radio Transmitters Society

日本アマチュア無線聯盟 Japan  
Liga Colombiana de Radio Aficionados  
Liga Mexicana de Radio Experimentadores  
Magyar Rővidhullámú Amatőrök Országos  
Egyesülete  
Nederlandsche Vereeniging voor Internationaal Radioamateurisme  
Niederländisch-Indische Vereeniging voor  
Internationaal Radioamateurisme  
Newfoundland Amateur Radio Association  
New Zealand Association of Radio Transmitters  
Norsk Radio Relæ Liga

Polski Związek Krotkofalowców  
Radio Club de Cuba  
Radio Club Venezolano  
Radio Society of Great Britain  
Rede dos Emissores Portugueses  
Reseau des Emetteurs Français  
Reseau Luxembourgeois des Amateurs d'Ondes Courtes  
South African Radio Relay League  
Suomen Radioamatööriilitto r.y.  
Sveriges Sändareamatorer  
Unión de Radioemisoras Españolas  
Union Schweiz Kurzwellen Amateure  
Wireless Institute of Australia

### Conducted by Byron Goodman

#### New Members:

We welcome with cordial best wishes the two new members of the Union, the *Eesti Raadio Amatooride Ühing* (E.R.A.U.), Estonia, and the *Radio Club de Cuba* (R.C.C.), Cuba. The membership of the Union now totals 33 member-societies, the highest in its history.

#### Switzerland:

With a total of 100 licensed amateurs now in Switzerland, 25 stations participated in National Field Day on June 11th-12th. Highest scores were made by HB1X, HB1AW and HB1CN. HB1 is the prefix for portable stations—HB9 is, of course, the prefix used with the same call at the fixed station.

A great deal of 56-Mc. work is being done, especially in the mountains. Permission was obtained from the Post Office to establish 5-meter 'phone links between the "High-Alpine Research Institute" at the Jungfrauoch (altitude 12,000 feet) and various refuges of the Swiss Alpine Club. Members of the USKA did all of the design, construction, and installation work, and already the system has shown itself to be invaluable, particularly for rescue work. Also, the USKA is making measurements of the radio shadow of the Jungfrauoch 5-meter station in the Jungfrau glacier region, in collaboration with the federal topographic department.

#### QSL:

The C.A.V. (Czechoslovakia) advises that the Post Office there refuses to transport QSL's stamped as "printed matter," and they, there-

fore, have to pay double postage on every parcel of QSL's. This has become quite a burden upon the union treasury, and they will, therefore, in the future refuse to accept QSL-parcels with insufficient postage. They advise that such consignments at least be stamped as "commercial papers" in the future.

#### VK-ZL Contest:

Last year's VK-ZL Contest saw considerable participation throughout the world, and we present some of the final high scores (by radio VK2ADE-W5VQ).

#### SENIOR SECTION

VK2ADE	83,430	VE5BI	2,232
VK4BB	51,455	VE4GD	564
VK2HF	41,312	PAOUN	5,030
VK3KX	34,020	OK2OP	4,620
VK2TF	33,675	G6WY	4,590
VK2DG	33,170	HA1P	4,030
VK2ZC	31,512	SU1MW	3,370
VK2RA	30,813	GM6RV	3,152
ZL1DV	71,335	YR5AA	3,051
ZL2CI	52,435	D48NP	3,040
ZL2GN	44,736	F8YZ	2,940
ZL1GX	25,984	NY1AE	2,925
W1GCW	3,800	J2ML	2,380
W2BHW	5,790	V57MB	2,656
W3EVT	7,150	G2IO	2,530
W4DCZ	5,150	LU9BV	2,376
W5QL	6,340	GM5YG	2,349
W6CXW	11,460	HB9J	2,344
W7DVF	505	OE1ER	2,183
W8ZY	5,930	XE1CM	2,160
W9ARL	6,680	K6JPD	2,043
VE3AU	3,530		

This year's contest is run as part of Australia's 150th Anniversary Celebrations, and should be

bigger and better than ever. VK2TI, the Contest Manager, sends the following rules for the event:

The Contest is divided into three sections, viz., Senior Transmitting, Junior Transmitting, and Receiving. The Senior Section embraces a power limit of 150 watts input to the final stage. The Junior Section is limited to 25 watts input to the final stage and this limitation is an endeavor to cater for the interests of the QRP enthusiast.

Three trophies have been provided for each Transmitting Section. In addition, certificates will be awarded to the highest scoring station in each country. In making these awards each W, G, VE, ZL and VK prefix will rank as separate countries. In order to obtain a certificate it is necessary for the contestant's score to exceed 100 points.

A plea is made to all participants to send in a log irrespective of the number of contacts made. As an inducement a special verification card will be sent to all amateurs who send in a log.

#### *Rules—Senior Transmitting Contest*

1. The Wireless Institute of Australia, New South Wales Division, Contest Committee shall be the sole adjudicators and their rulings will be binding in cases of dispute.
2. The nature of the contest requires the world to contact VK and ZL. Six-cypher serials are to be exchanged. The first three characters to be the RST of the station received and the last three the number of the QSO. For example, VK2RA may be in contact with W6TI and would send 579055. That would mean that VK2RA was receiving W6TI at RST 579 and that W6TI was VK2RA's 55th QSO in contest.
3. The contest is to be held from 1200 GT Saturday, 1st October, 1938, to 1200 GT, 2nd October, 1938, and repeated over same time period during next week-end, namely 1200 GT Saturday, 8th October, to 1200 GT, Sunday, 9th October, 1938.
4. The contest is open to all licensed transmitting amateurs throughout the world. Unlicensed ship and expedition stations are not permitted to enter the contest.
5. Power input to the final stage is limited to 150 watts. Where the national regulations of any country do not permit the use of this power, participants must not exceed the power allowed them by the said national regulations.
6. Only one contact with a specific station on each of the bands will be permitted during the contest.
7. All amateur frequency bands may be used.
8. Only one operator is allowed to work any station. Where more than one operator has worked a station, individual logs must be forwarded under the call sign of each operator, and each operator will be considered a separate competitor.
9. SCORING. Twelve points will be scored by the first contact with a station outside VK-ZL, 11 points for the second, 10 points for the third, and so on until the twelfth will score 1 point. Thus the first twelve contacts will score 78 points and each additional contact after the twelfth will count one point. In all cases contacts are irrespective of the band used. This will apply to all countries except England and the United States of America; in these countries twelve or more (as above) contacts will be permitted with stations having the following prefixes: G2, 3, 5, 6, 8, GW and GM and W1, 2, 3, 4, 5, 6, 7, 8, 9. The points by contacts in the above manner will be added together and multiplied by the total number of countries worked on all bands which will give the final score. Each W and G district will not constitute a separate multiplier

10. SCORING by competitors beyond VK-ZL. Twelve points will be scored for the first contact with a VK-ZL Prefix Zone, 11 for second, 10 for third, and so on to the twelfth contact which will count 1 point. Thus the first twelve contacts with a particular prefix zone will score 78 points. Each additional contact after the twelfth will count 1 point. This will apply to each prefix zone worked. The points scored in the above manner will be added and the total multiplied by the total number of VK-ZL prefix zones worked on all bands. Prefix zones are VK2, 3, 4, 5, 6, 7, 8, 9, and ZL1, 2, 3, 4.
11. No prior entry is required, but each contestant is to submit a log at the conclusion of the contest showing date, time (GT), band, station worked, ciphers exchanged, points claimed for the QSO, together with a declaration that the rules of the contest have been followed and that the power limit has not been exceeded.
12. A large percentage of reports under T8 will render the participant liable to disqualification.
13. Out-of-band operation will also be a ground for disqualification. In all cases the national regulations of each country must be observed by the various competitors.
14. Entries from ZL Stations must reach N.Z.A.R.T. not later than 26th November, 1938. All overseas logs must reach Contest Committee W.I.A. (N.S.W. Division) G.P.O. Box No. 1734 JJ Sydney, N.S.W., not later than 31st December. All VK logs must reach Contest Committee not later than 2nd December, 1938.

#### *Rules—Junior Transmitting Contest*

1. The contest will be held from 1200 GT Saturday, 22nd October, 1938, till 1200 GT Sunday, 23rd October, 1938, and repeated during the same time period during the following week-end.
2. Power input to the final stage will be limited to 25 watts.
3. All other rules as set out for the Senior Contest apply.

#### *Awards*

Three handsome trophies are available for competition in each of the Transmitting Sections and will be competed for as follows:

First. For that station outside VK-ZL that has the highest score in the world. This trophy will become the outright property of the winning station.

Second. For that station in Australia or New Zealand who obtains the highest score. The winner will retain this trophy for all time.

Third. For that district of Australia or New Zealand whose first six participants aggregate a greater score than any other district. This trophy will also be won outright and its property will be vested in that division of the Institute or branch of the N.Z.A.R.T. which has the highest aggregate.

In addition to these trophies, handsome certificates will be awarded to the highest scoring station in each country. All G, W, VE, ZL, and VK districts to be considered countries when these awards are being made. The only proviso to these awards is that a contestant must score at least 100 points.

Each participant who forwards a log will receive a verification card of Australia's 150th Anniversary Celebrations and Souvenir of the 1938 VK-ZL.

## The Cover

WITH 56-Mc. signals acting up the way they have been and with 28 Mc. headed for a big season, it is only natural that the DX man should hanker for a special rig that can be flopped from ten to five in no time at all. W1SZ has worked up just such a transmitter and in the picture is attending to a few final details. The rig is scheduled for description in an early issue. That four-o'clock shadow is, we would have you know, really a shadow.



# OPERATING NEWS



Conducted by the Communications Department

F. E. Handy, Communications Manager

E. L. Battey, Asst. Communications Manager

September marks the start of a new season in amateur operating! The coming year promises further progress in emergency organization, traffic efficiency and DX practices. S.C.M.s ought to see that every community of any importance has an able Emergency Coördinator for the amateur service. Every Coördinator should start plans in his community that will result in amateur meetings, discussions—and registration of every active licensed transmitting amateur, of whatever frequency band or interest, in the League's Emergency Corps. In so registering, preparedness for communications emergencies is definitely advanced, and A.R.R.L. is enabled to point to a large body of men as going far in justification of frequency assignments through readiness for public service.

**The Maxim Memorial W1AW-Dedication Relay** announced elsewhere in this issue starts at 6 p.m., September 2nd, the anniversary of H.P.M.'s birthday. Get your station on the air and take part in this. Look for the official messages. Send one yourself. Relay 'em. Report what you did. This activity lasts until sunrise next day, and marks the official opening of the '38-'39 radio season as well as the opening of the new W1AW. Don't miss the fun of getting in on a real old time message relay. You can help make every amateur band one carrying relay activity.

**The A.R.R.L. National Convention** at Chicago will be held September 3rd, 4th and 5th. A record-breaking crowd has made reservations, and you will want to be one of the gang. See you there.

**56 Mc.** The hottest operating news of the past month (July) is recounted in the report on 56-Mc. DX. The month marked one more milestone on the route to winning that M.R.A.C.-A.R.R.L. Cup Trophy. Think of it. The first and the sixth district linked by direct communication on five meters! The question propounded in this column in July *QST* (who would work over the Rockies) answered that same month! We're now looking for claimants—for the cup award to be given for the first United States amateur's work two-way, over great circle distances of over 2000 miles, between continents, using 56-60 Mc. Step right this way and receive the glad hand. To all and sundry: Remember to report every speck of DX over 500 miles that you log on "five" and all

two-way work, particularly. In doing this you will also win our warmest thanks, and you will not only be in line for mention in future *QST* reports, but will be making a real contribution to the scientific analysis of this phenomena.

—F. E. H.

## Briefs

Sunday, June 5th, was the occasion of the fifth annual pilgrimage of Georgia, Alabama and Tennessee hams to the barbecue and hamfest staged each year by the Northwest Georgia Radio Club at Rome, Ga. The affair this year was handled largely through the efforts of W4UC, W4VO, W4BAZ, W4ENQ, W4APK, W4DBW, W4BIO, W4DAY and others. Over 300 were present to enjoy the festivities, which, besides the old-fashioned Georgia barbecue and Brunswick stew, included the distribution of numerous and highly-sought prizes, most of which were purchased by the club from the proceeds of previous hamfests, and the usual short but interesting speeches, presided over by Doc Sanford, W4DHM, master of ceremonies. Three members of the F.C.C. field staff and practically every prominent ham within a reasonable distance were present. This affair has grown steadily in size each year since its inception and next year, on the first Sunday in June, the Rome fellows are planning on having an attendance of 500!

## How to Send Fractions

In transmitting combinations of number groups and fractions by radiotelegraphy the sign AU (-.-) should precede the numerator of the fraction. For example, in sending 45- $\frac{1}{2}$  this is transmitted "45 AU 1 DN 4." DN is, of course, the fraction bar-.- and is well known. In counting words the sign AU does not count since it is merely an operating signal and is not recorded; 45- $\frac{1}{2}$  counts as five words.

The Greater St. Louis Radio Amateur Club held its fourth annual picnic, July 10th, in Bellevue Park, Belleville, Ill. About 200 members, their YL's and YF's were present. One of the most interesting features was provided by the U. S. Army Aviation Service, which sent a truck equipped with a mobile transmitter. When the station was set up the operator notified the Army station at Lambert Field in St. Louis and an airplane was dispatched to Belleville. Radiotelegraph communication was maintained with the plane from the time it left the field until it was sighted nearing the picnic grounds. A switch was then made to radiotelephony and the plane was directed to the location of the mobile installation. They were soon flying overhead, talking to the amateurs on the ground through the receiver on the truck. The Belleville Police Department also sent over one of its radio cars and the hams were able to inspect the two-way equipment which had recently been installed. The usual games, eats and prizes were in evidence and the crowd left at a late hour after a very enjoyable day.

Members of the Pittsfield Radio Club set up and operated a system for reporting events held during the Stanley Club Field Day at Pittsfield, Mass., June 25th. All operation was on 56 Mc. W1BKG, located at the boat club, transmitted on 60 Mc.; all other installations transmitted on 56

Mc. W1CLI was at the tennis court, W2HKQ/1 aboard a motor boat, W1JLT at the boat dock and W1HAZ and W1FAU mobile at the golf course. Reports from all outlying points were put through a P.A. system at the boat club. A series of competitive events were successfully covered throughout the afternoon.

— . . . . —  
"East is east and west is west"—and to W9GBJ "west is east"; at least that's what he thought when his 14-Mc. CQ one July evening was answered simultaneously by W2JB and W6JB, both on the same frequency!

— . . . . —  
James Ferguson, GM6WD, Glasgow, Scotland, is a newspaper photographer. Last November he was assigned the job of taking news pictures in the overturned scuttled German Warship *Grosser Kurfurst*. The assignment was successfully completed, and as a souvenir of the occasion GM6WD recently was presented with a Morse key taken from the ship, which had lain on the ocean bed for over 20 years. He writes, "The key is in remarkably fine condition and the souvenir is much appreciated, but being a seasoned 'phone man it will only ornament the shack." A nifty ornament, say we!

— . . . . —  
The usefulness of amateur radio was again demonstrated when, on April 13th, a doctor was urgently needed to attend a maternity case in the isolated mining camp of Surf Inlet, B. C. The regular government station being unable to contact the coast station since it was after schedule time, VE5LA at the camp hooked up a small oscillator and made contact with W2IBT/6, Oakland, Calif. W2IBT took the message, which was addressed to the mission boat at Alert Bay, B. C., and forwarded it by Western Union. VE5ID, Vancouver, whom W2IBT later contacted, also put the message into the wireless station which maintains contact with Alert Bay. A doctor was finally sent from Prince Rupert and everything turned out satisfactorily. W6GAC also worked VE5LA and attempted to notify the government service of the emergency.

#### PRIZES FOR BEST ARTICLE

The article by Mr. P. C. Feng, XU6LN, wins the C.D. article contest prize this month. Each month we print the most interesting and valuable article received marked "for the C.D. contest." Contributions may be on any phase of amateur operating or communication activity (DX, 'phone, traffic, rag-chewing, clubs, fraternalism, etc.) which adds constructively to amateur organization work. Prize winners may select a 1938 bound *Handbook*, QST Binder and League Emblem, six logs, eight pads radiogram blanks, DX Map and three pads or any other combination of A.R.R.L. supplies of equivalent value. Try your luck. Send your contribution to-day!

## Short Calls Get DX!

By P. C. Feng, XU6LN\*

WITH the directional Vee recently constructed, signals from the east coast and central U. S. A. are decidedly much stronger than the W6's, which in the old times when a half-wave antenna was used completely controlled the whole atmosphere in the evenings here in Canton. On the first evening with this Vee antenna I contacted 16 stations including all W districts other than W6 and W7, all from the same frequency, 14,000 kc.—right on the edge of the band. This is easy to explain for when an XU calls CQ DX hundreds of W's will run after him, and when it is found that he finally picked up a station right at the low edge of

\* Lingnan University, Canton, China.

the band, you are sure that his way of listening after a CQ is QLM! That is how I tune.

The clever W's immediately QSY to the same frequency on the edge and wait for the "QRZ?" Some are not even patient enough to QRX and now and then interrupt the QSO with a few calls and say "Hr QRX." When one QSO is over at least three or four calls will be heard at exactly the same spot on the receiver. I pick up the one who makes the shortest call and tell the rest to QRX if they care to. Just think what a treasure an XU is to W1, 2, 3, 4. I cannot make each QSO long enough even for a short rag chew, for I can see how anxious the QRX'ers are while listening to us chewing about the WX and DX condition! I have to tell the one with whom I am talking that many others are waiting for a "break" (of course, he knows, for he was one of them) and that he could be sure that I will QSL for his first XU, etc., and then sign off. And then without touching the dial of the receiver, the crowd comes up and I repeat the whole thing. This is repeated again and again.

On my part, I deeply appreciate the patience of our W friends. Can I forget the time when I first contacted W6 with my first flea-power rig? Can I forget the hours that I had spent trying to raise a ZS for my W.A.C. certificate? With these thoughts in mind, every time I finish a QSO, I call a QRZ? and I have never failed to reply whenever I heard a call. But there are so many! If you want to satisfy everybody, you can never go to bed. Last night, while I was leaving the shack (it was already midnight) there were still several left calling me. I felt sorry that I couldn't answer them, but I really needed sleep. I certainly hope they will be the very first ones that I'll pick up tonight when I will be on the air again.

When I looked back at the log, I was deeply impressed by the fact that while the total operating time was two hours for 16 stations (average only 7 minutes each), nearly one third of the time was wasted in long calling. As I said before, I always pick up the shortest, but even the shortest took more than two minutes! They feared too much that I might QML or QHL! But if so, could they expect to make a contact at all? Don't they know that I could hear them without having to tune the receiver? If so, why not follow the conventional rule: "Call three times and sign three!" In fact, this is more than necessary in a case like this. If the rule had been followed, probably the QSO's could have been made much longer or for the same length of QSO, more contacts each hour could have been made.

I am writing this to my DX-hunting friends, hoping it will be of some help to the DX-hunting technique. I know that many are like myself—always pick up the one with the shortest call. The longer the call, the longer you will have to wait. So let's apply the principle of QLM or QMH, etc., even when not in the period of a contest.

## Briefs

W6DPT, Compton, Calif., transmits code practice on 1790 kc. each Monday and Thursday from 7:00 to 8:00 p.m. Pacific Time, running speeds from 5 to 13 w.p.m.

## XU3MA and XU8DI Perform Real Service

With the commercial cable from Chefoo to Shanghai cut, leaving Chefoo without communication with the outside world, amateur radio stepped in and bridged the gap during the whole month of January. Dr. Wm. Malcolm, a 77-year-old ham and port doctor at Chefoo, working with Mr. J. Macdonnell, XU8DI at Shanghai, handled all commercial code, as well as other traffic for eighty-two firms. Several hundreds of messages were handled. Without the amateur radio circuit, business at Chefoo would have been under a severe handicap, if not at a standstill. Letters of appreciation and gratitude were received from the British Chamber of Commerce, Chefoo; The Commercial Pacific Cable Company, Shanghai; The Great Northern Telegraph Company, Ltd., Shanghai; Chefoo Foreign Chamber of Commerce; and The Eastern Extension Australasia & China Telegraph Co., Ltd.



# The Navy's Strange People

By G. M. Millican, RM2C

**A**MONG the strange people in the Navy are radiomen. A radioman is a person either going on watch or coming off.

Contrary to popular belief, radiomen are not crazy. A radioman has two brains, one perfectly normal brain which is destroyed during the process of learning radio, another in a state of turmoil and used proficiently in his rating. This brain is filled with dots and dashes and procedure signs.

Radiomen are like ground hogs; they seldom see the sun, coming up on topside only on Saturday mornings at the special request of their Commanding Officer. If the sun is shining and a radioman sees his shadow, he goes below and everyone knows there will be six more days without inspection.

Sitting at his typewriter a radioman receives an endless story of the world flowing through his ears, unable to get out because both ears are stopped by headphones, so the stuff flows out through his fingers and is given to the ship as press news, msg's and orders to officers.

When conversing with a radioman do not try to point your story by asking him if he remembers "The Message to Garcia" because he will jump up and scream, "What's the 'R' number of it? Who sent it? If it's lost, it didn't come in on my watch."

Radiomen live on black coffee and canned dogs. All through the long mid-watches they sit and dit and dot, so tired and weary of it all, wondering why they ever chose radio as a rate. When they go ashore on watch-stander's liberty, they hurry home to their little "Ham" set and just dit and dot to their heart's content.

Girls who fall for radiomen will find that they are courted with considerable sparking and many love messages in Morse code; and after they are married, they will receive much broadcasting both loud and long.

Radiomen are found on all ships and stations in the Navy and are quite harmless if left alone, occasionally fed and aired, and given annually thirty days' leave so that they may rig up their new outfits at home.

—"The Nevada Cheer Up,"  
U.S.S. Nevada's ship paper.

## South Carolina Convention

The first statewide South Carolina Convention under the auspices of the Palmetto Amateur Radio Club was held at Columbia, April 3d. One hundred eighteen amateurs and their ladies, including some from Georgia, Virginia and North Carolina, registered for the affair. Among the speakers were Roanoke Division Director Caveness, W4DW; William R. Foley, W3MQ, radio inspector; Bannie Stewart, W4CE, Phone Activities Manager; Ted Ferguson, W4BQE, S.C.M.; and Vic Howell, W4CZA, Route Manager. A banquet was held following the business session. A meeting in Greenville is scheduled for later in the year.

## Crime Doesn't Pay!

According to a clipping from the *Pittsburgh Sun Telegraph* sent to us by W8KUN, fifty individuals face prosecution for transmitting without licenses on the 56-Mc. amateur band. Radio Inspector M. W. Grinnell spent several days in the Pittsburgh area tracking down the "bootleg" operators. The 56-Mc. band in that vicinity is once more "amateur" and will remain so unless some unwise chaps wish to invite more trouble.

The following is quoted from the bulletin of the Amateur Transmitters Assn. of Western Penna., which organization was responsible for the effort which cleaned up "5 meters": "The bootleggers have had their own way more or less and despite warnings from licensed amateurs and the F.C.C. the illegal stations continued to operate. The F.C.C. decided the PARTY was over so on August 10th, Mr. M. W. Grinnell, U. S. Radio Inspector, arrived in town with the Test Car, Mr. Grinnell . . . spent several evenings and days covering

the entire city and getting evidence. Many of the stations were located, addresses and names obtained and action started. . . . One station operating with a call borrowed from a licensed station was closed down, the operator's statement signed and sworn to and the apparatus dismantled. . . . There are many more stations to be visited and some of them may be taken care of by now. . . . Within the next 90 days plenty of action will take place to clean up this situation here and any one licensed or unlicensed who has helped these illegal stations will be apprehended and given the proper punishment. . . . The illegal stations have been warned many times by licensed stations to get off the air until they get a license, but they would not listen. . . . The Editor of this NEWS has also warned the illegal stations, but they thought it a joke—IT WAS—A JOKE ON THEM."

The above situation is not common to Pittsburgh alone! The same clean-ups can and will take place elsewhere. Licensed hams—if, after warnings, illegal operators continue their dirty work, turn over to the F.C.C. all the information you have. Keep our amateur bands for amateurs.

An interesting incident at the time of the Los Angeles flood is recounted by W5DNX, O.R.S. On March 5th he received a telephone call with the request that he get word to a cousin that his father was at the point of death and to come home at once. This cousin was on the U.S.S. Nevada, anchored off San Pedro, Calif. Attempts to reach him by W.U. and telephone had failed due to flood conditions. W5DNX sent the message to W7EQA, who relayed it to W6NQL, Glendale, Calif. NQL made delivery to the Naval station at San Pedro. They called the Nevada, got the chap ashore, where a plane was waiting to take him home to Arkansas. W5DNX thanks W7EQA, W6NQL, W6MNA and W5FPD for coöperating in handling the message.

## Illinois Tornado and Blizzard

On the night of March 30th, amateurs in the Peoria area got a chance to see what they could do in an emergency. As soon as it was learned that communications from South Pekin had been cut off by a tornado, we started getting equipment together. Since the bulk of the traffic was for Pekin, about three miles airline from South Pekin, it was decided to use 56 Mc. We assembled two carloads of equipment and five operators within an hour, and were at the scene of the disaster in another half hour. We found that the local police, state police and the portable ultra-high transmitter (W9XPS) of the local broadcasting station (WMBD) had things fairly well under control. However, due to poor conditions, W9XPS found it necessary to establish a receiving point at Pekin. This was accomplished through the coöperation of W9MDF, Pekin, who offered the use of his station. He picked up the signals from the small 31.1-Mc. W9XPS rig on his RME-69, fed it into the landline and on into WMBD, Peoria.

Directions to ambulance crews, doctors, nurses and relief agencies were handled very effectively, and requests for food, portable lights and other necessities brought gratifying results. W9MDF worked with the W9XPS crew all night.

When the various police units found need for extra receivers to cover the several different channels they were endeavoring to monitor simultaneously, the necessary equipment was supplied by the amateurs. The operators who participated in the emergency work during the South Pekin disaster are W9MDF, W9FEU, W9VKU, W9DQH, W9FST, W8ADJ/9 and W9LWB.

—Herbert L. Lipson, W9LWB

What's all this I'm hearing about "beam" tubes? First we had beam antennae to shoot the signals where we wanted them. Now we have beam tubes to shoot the signals up into the beam antennae. Next we should develop beam receivers to shoot the operators of poorly operated beam transmitter-beam antenna stations. Also, think the R.C.A. receiver slogan could be changed to advantage, viz.: Magic Brain, Magic Eye and Mental Tubes.

—W2AOY

## Briefs

The following hams were students at the California Institute of Technology during the '37-'38 school year: W6DEL EGS EZD FJJ (ex-W2ESG) GMD GSL GXZ HAC HBG HDT HVD IHT IZF JAB JPY JQW JUX JVJ KIY KVK LEZ LKX LNB LQY MIL MSC NBK NHK NWP OPS RZ PMW (ex-W3FYS) ex-W8KZP W9TCH VWZ ex-W6KYW ex-W6LIL ex-W6LLR CP4ANB ex-XU7JT ex-ZL3CR2-BL ex-W6CYA W5ENK. A studious bunch, radio amateurs!

Here's one that will make a lot of W.A.S. aspirants weep: W9WEN had cards from all states except Utah and Nevada . . . those were his bugaboos. One evening, June 21st to be exact, he was tuning through the 14 Mc. band when he was brought to attention by W6OZ calling "CQ hr NEV." He raised him (lucky guy), got a promise of a QSL and mentioned that it was "Utah only" now. W6OZ promptly explained that he was located in West Wendover, Nevada, just across the state line from Utah, that right across town on the Utah side was W6OEY and if W9WEN would QRX, he would take his crystal, dash over to W6OEY and give WEN a Utah contact! Sure enough, in about ten minutes there was W6OEY, Wendover, Utah, calling W9WEN. OZ had dragged OEY out of bed, tuned up his rig and made one ham very happy. A real exhibition of ham spirit!!

## W1AW Schedule

Effective September 5th, the new W1AW, Maxim Memorial A.R.R.L. Headquarters Station, will observe the following regular Official Broadcast schedules:

Frequencies	Starting Times (P.M.)				Speeds (w.p.m.)				
OW: 1800.5-3825-7150-14254-kcs.	EST	CST	MST	PST	M	T	W	Th	Fri
	8:30	7:30	6:30	5:30	20	15	25	15	20
	Midnight	11:00	10:00	9:00	15	25	15	20	15

'Phone:

Each code transmission will be followed, in turn, by voice transmission on 1808-3950 and 14.234 kcs.

General Operation: Following completion of the early evening (8:30 EST) transmissions on each frequency as above indicated, W1AW will operate each night of regular operation until the time for transmission of the midnight QST (Official Broadcast). This schedule will be expanded and announcements made in future issues of QST of additional periods of general operating.

## Here's Nevada!

For the benefit of operators needing a Nevada contact for W.A.S., Andrew J. Williamson, W6OTU, Boulder City, Nevada, announces the following operating schedule: 28,800 and 29,010 kc. 'phone . . . week days, 7:00-8:00 A.M., 12:30-1:00 P.M. and 5:00-6:00 P.M. PST . . . Sat. and Sun., 7:00 A.M.-6:00 P.M. PST. He also works 3.5 and 14-Mc. c.w. in the evenings, and will be pleased to arrange schedules to furnish Nevada contacts. Go git 'im!

A reliable Canal Zone traffic circuit is available through the daily schedule maintained by W1HSX, New Haven, Conn., and K5AF, Albrook Field, C. Z. Traffic may be routed to W1HSX via A.A.R.S. circuits or A.R.R.L. Trunk Lines.

SU1CH made a novel QSO on April 10th when several stations were linked up to enable the American Minister to Egypt to say hello to his brother in Orlando, Fla. Stations involved were SU1CH, W4BYY, W4DU and W4CLW. SU1CH transmitted on 28-Mc. 'phone to W4DU, who retransmitted on 3.9 Mc. to W4CLW, where the brother and party were sitting in. Reply transmissions from W4CLW went on 3.9 Mc. to W4BYY, who retransmitted on 28 Mc. to SU1CH. At the end of the contact W4WS, Deland, Fla.,

working 3.9 Mc., broke in on W4CLW's frequency with some more friends of the Minister. The entire work was completely successful.

## Commas vs. Periods

Regarding the possibility that a change in International Morse Code, whereby a period would be indicated by the present symbol for a comma, and a comma would be in-

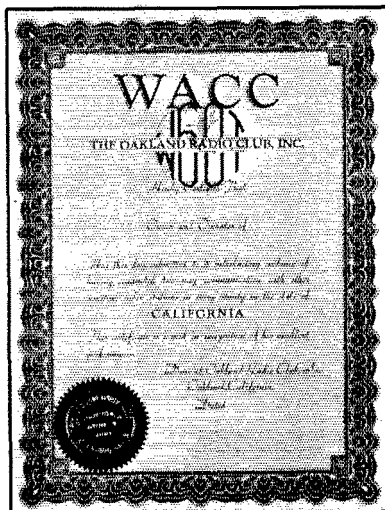

**THIS BEAUTIFUL CERTIFICATE IS OFFERED BY THE OAKLAND RADIO CLUB TO ANY OPERATOR WHO SUCCEEDS IN MAKING A TWO-WAY AMATEUR RADIO CONTACT WITH EVERY COUNTY IN THE STATE OF CALIFORNIA**

*There are fifty-eight counties in all! The rules: Work all fifty-eight counties. The station worked does not have to be a permanent one, but can be a mobile unit. The mobile unit cannot get a certificate. The person applying for the award must be present at a regular meeting of the Oakland Radio Club for the presentation, if he is within reasonable distance of Oakland. He does not have to be a member of the club. QSL cards confirming all contacts must be presented. Any further information desired can be obtained from S. C. Houston, W6ZM, secretary, Oakland Radio Club, 3164 Bona Street, Oakland, or from W6KZN, 1158 63d Street, Oakland. Who will be the first to W.A.C.C.?*

indicated by the present designation for the exclamation point, will be promulgated in our United States practice starting in 1939, some observations by Mr. Clare Newman, W7YG, are of interest:

"Practically all radio communication companies use 'automatic' transmitters. While the signals are transmitted in continental code, the received signals are copied by eye from an ink-recorded 'slip.' Dots, dashes and spaces are almost perfect so it is impossible for a receiving operator to tell whether a period or three-letter 'I's are intended. The present practice is to use the combination AU (sign for separation of a fraction from a number group) between the word and the period. Used several times in each message these 'AU III' groups naturally slow down circuits as well as provide openings for errors.

"Using AAA as a period would eliminate the necessity for the AU sign as it contains no spaces and therefore could not be copied as three letters. The exclamation mark in 'boxcar' code has been generally contracted to M (space) M and used with AU would give a combination that would suffice for the very few times that this punctuation is used in commercial communications."

# How's DX?

## How:

DX has been pretty fair the past month, in spite of the weather gods' attempts to make operating a mite uncomfortable, and we'll get on to more specific talk in a moment, but first we'd like to take time out for a few general remarks about this column. Any small measure of success that it may enjoy is due entirely to the fact that youse guys are so generous and helpful with your reports, and we're mighty proud of the splendid list of contributors. However, we would like to make one small request: when you send in dope, please make it as complete as possible. This simply means giving the pertinent dope as to frequency, tone (xal or not), and time. It isn't necessary of course on the less rare stuff, but anything that looks good should be reported that way so that the others will know where and when to look. And anything of general interest that you notice, such as the best times for different continents, is always quite welcome. "The more the merrier," if we may coin a phrase.

Another thing. This gosh-awful bootlegging of calls is getting to be a pain in the neck. There are too many mental midgets who think it's just too, too funny to sign a fat call and give the boys on the bands a thrill. It used to be funny, and still is, if you have that kind of a sense of humor, but we don't want any part of it. Therefore, we're almost of a mind to offer a substantial reward for every call-bootlegger delivered to our doorstep, dead or alive, preferably dead. We want to see, just once, that goofy look in their eyes when, because they can't work anything very hot, they borrow a juicy DX call and have such peachy fun. . . .

## Where:

After reading that last paragraph you might get the impression that we're a little bitter on the subject of "phonies." You are right, and just to present one side of the case, the following calls, recently active, have shown up as phoney: VQ8AA, PX1A, VQ1AJ, EL2R, LX1AO, LX1AG, LX1AS, a mess of FF's, CR6PG, VP7NI, XU8OL, VP7NH, ZC6PO, SU1EQ, PK6XX (on c.w.), and EL2F. These are practically certain—others will show up later. . . . One that looks pretty good from here is ZD4AB (14,350 T9x), who comes through around 4-6 P.M. EST. He said to QSL to T. Hall, Post Office Engineering Department, Accra, Gold Coast. ZD4AA (14,165) is supposed to be active but no W reports on him yet. . . . VP8AF (14,435 T8), worked by W2BHW, W6DOB, and others, gives his QRA as % Radio VPC, Port Stanley, Falkland Islands, and we hope he's legit. . . . On May 1st, W6KQK worked a station signing AC4YN on 14,120 kc. (the right frequency) with no confirmation yet, and W8KKG has been hearing him on 14,105, T8, on Thursdays from 1250-1315 GMT. But we still don't know who'll get credit for the first QSO with him. . . . FO8AC (14,410 T9) gives his QRA as Andre Valette, Papeete, Tahiti, according to W3FRY and W9ETP. . . . Then there's this TM8AA/TM1AA (14,300, 14,410 T7) who is supposed to be at Port Victoria, Seychelles, according to FB8AB. Dunno why he doesn't use VQ9, unless it's that old reason we were talking about a while back. . . . In the questionable class goes HZ1B, worked by W2JVU, and ST6AL (14,290 T9x) worked by W3FQO. . . . W2BHW has some new ones that look good: TA1AA (14,385 T7), ZA1B (14,320 T9), who gives his QRA as P. O. Box 21, Tirana; UK5KJ (14,415 T7), VQ3EJP (14,360 T7), and VQ2HC (14,310 T9). . . . W1ACV says that ZC6NX (14,010) is old G5KW. . . . These fellows UX1CN and UX1CP (14,405 T9) are on Rudolph Island, Franz Josef Land, which is on the list as Fridfjord Nansen Land. . . . W9EF says that G5CZ on 160 'phone and G6IA on 20 'phone are the only stations active on the Isle of Man. . . . According to our dope, ST2CM (14,300 T7) and ST6KR are the only legit stations in Sudan. . . . W2CYS has ZA1A (14,280 T8) and ZA1C (14,350 T8). The latter gives his QRA as Box 15, Valona, Albania. . . . W8GBF worked one that may

be on the OK side of the ledger: FF8AC (14,440 T3), who gave his location as near Tarangia, French West Africa, QSL via FF8AA. But there ain't no FF8AA! . . . W4DVO says FVAL (7100 T6) gives his QRA as La Legion Etanger, A Sidi del Abbes, Algeria. . . . That call AH2BU is awfully funny, and so is US2YLS. But at least they don't pretend to be what they aren't, even if AH2BU does tell the boys he's at Annabon Island and using a 5 KW ex-commercial job. . . . W9YVF gives the address of VQ8AI as L. G. Raoul Thomas, Thompson Road, Vacoas, Mauritius.

## When:

We're short on anything but 20-meter reports this month, although W3BGD tells us that OK1BC (7295), EA7XX (7320 T7) and K4AAN (7298) are cinch bets on 40 if you need those countries. K4AAN is in the Virgin Islands, and on around midnight, EST. . . . W6PCP really has the dope on 40, with the following worked: K4ERY (7265) in



## THE SUMMER STATION OF JAROSLAV CHMEL OK1BC, AT HRADISTHO, CZECHOSLOVAKIA

During the summer, OK1BC operates at his country lodging, and it has proved itself an excellent location. His signal pounds through on weekends on either 7 or 14 Mc., and gets a good start to this country via a Vee beam with director. A W8JK flat-top is used on 28 Mc. The rig uses a 35T final on all bands with separate exciters; the receiver is a rebuilt FBX with two-stage preselector. But the power seems unimportant—S8 and S9 reports have been given by W6's when the input was down to 5 watts, and an S8 has been received from there when the input was only 1 watt, at 50 volts.

Virgin Islands, UX3FI (7298), NY1AD (7150), MX2F (7000 T5), PZ1RL (7000), J8CD (7100), J8CH (7190), J8CB (7060), XU8DI (7025), XU8LS (7015), XU8GW (7080), KA1HR (7090), KA1MM (7020), KA9CG (7095), and KA1AS (7000).

W2HHF sends one of those swell lists of his, and moans because with 124 countries he still hasn't the necessary pasteboards for the CC. Oh, well, he can console himself with VS2AE (14,335 T9), HP1C (14,410 T9) (he looks phoney because HP1A is the only legit we know of in Panama), KA1HR (14,300 T8), K6NVJ (7185 T9) at Jarvis, VP9X (14,110 T9), PK1MF (14,380 T9), PK1RI (14,280 T9) and VK9BW (14,245 T7). . . . Lindy at W2BHW says J's have been worked between noon and 2 P.M. EST, including J2KN, J2KJ, J2KG, J2JJ, and J2MI. Some of the heard stuff includes J8CG (14,395 T8), KA1BC (14,145 T9), XU6TL (14,355 T7), PK1TM (14,205 T9), XU8NR (14,335 T8X), and VS6AO (14,355 T9). . . . W8OUK suggests OQ5AQ (14,370 T8x), EL2A (14,375 T9), and VK4KC (14,410 T8) in Papua. . . . W2CYS worked OY5R (14,420 or 14,230, T8) and K6OVN (14,300 or 14,140 T9) in Guam. . . . W8DFH knocked off XU8CM (14,315 or 14,270 T9), VP3AA (14,135, 'phone), and says that he thinks FG8AB (14,435 T8) and AH2BU are the same guy. . . . W8JDB drops in with some nice ones which in-

clude FT4AG (14,400), VSTRA (14,085), J2JJ (14,405), VQ8AE (14,005), HR7WC (14,440), and HK4LE (14,040) . . . . . W3FQO contributes YN1AA (28,080 T8), YK9VG (14,110 T9x), YU7LX (14,400 T7), and CT2BO (14,400 T7) . . . . . W1JLJ has HC1PZ (14,480), VQ8AI (14,350), ZB1H (14,370 T9), and YV1AE (14,487) . . . . . W9RSO, flattered because someone has been signing his call, reports VS7GJ (14,110), KA1DL (14,025), HS1BJ (14,070), PK3AA (14,360), and VU2LK (14,010) . . . . . W7GPY tells about J7CR (14,260 'phone), U1AD (14,420 T7), KA7EF (14,150 'phone), and KA2OV (14,150 'phone) . . . . . W9YFV has only been after DX a short while, but he's been cracking down on guys like HC2MR (14,020 T9x) (QSL via HC1FG), PJ3CO (14,330 and 14,410 T7), VQ8AS (14,300), KA1KR (14,285 T9x), and XU8GC (14,010 T8) . . . . . W2IOP hasn't been wasting any time, and his list includes VQ4KTF (14,075), VQ5KLB (14,420), XZ2DP (14,030), VQ2GW (14,360), CR7AU (14,260), VS7RS (14,320), and VQ4CRO (14,090). Larry lists the following on the Channel Islands: G8OK (14,270) and G8DO (14,300) . . . . . Old VE3AU up there in Unionville is doing OK, and he passes along FY8AA (14,430 T9), FB8AB (14,350 T9), YP1AA (14,420 T4), CR7AD (14,300 T8), and FB8AC (14,280 T9) . . . . . W6KWK reports hearing AR8MK (14,450 T9), OZ4H (14,400 T8), PAOZB, OK1PZ (14,400 T9), and PJ1BV (14,440 T7).

### What:

We have some antenna dope this month that looks good enough to pass along to the mob. First off, a splendid article by ST2CM in the July issue of the *T & R Bulletin* points out a likely-looking improvement in the ol' single-wire feed system. You probably know that the best place to feed an antenna of this type, for multi-band operation, is at a point  $\frac{1}{4}$  in on the wire, but you usually use No. 14 wire or so for the feeder, and get a mismatch. ST2CM found that with No. 14 in the flat-top and a feeder of No. 18 he got much better matching, as indicated by the absence of standing waves. An editorial note suggests that this still doesn't overcome the change in resonant frequency of the flat-top when operated on harmonics, and suggests a more aperiodic operation by using two wires in parallel for the flat-top, and normal sized feeder. We'd be glad to hear from anyone that tries either system.

The other item about antennas is that when W6CUH was through here the other day with W2UK he told us that the antenna to use is the so-called "lazy H." You know, two horizontal half waves in phase a half-wave above two more half waves in phase. A lot of the W6's use it, and they all swear by it. It should be good, because it's easy to feed (matching stub or tuned line) and it will bring the angle down a lot.

### Who:

Just to keep the records straight, we record here that W5KC made WAC in 45 minutes by working HK3AL, G3IQ, VE5UL, VK4JB, J5CC, and ZS1CX, between 1:55 and 2:40 A.M., CST, which should be the record in W5 if not in the whole east . . . . . A printer's error a couple months back had I1QR getting married—it should have been I1IR. Sorry . . . . . W9HIF says that the only active J8's are CB, CD, CG, CH, and CI . . . . . W3EMA skeds VQ4KTF, who uses a '10 final with 25 watts input. KTF says that VQ4CHS is leaving for G and won't be on for a spell, and that VQ4KGM uses only 2 watts . . . . . K6BAZ is no longer at Howland, but K6DSF (14,390) is using the rig and the antenna. Kenny has been transferred to American Samoa, but only d.c. mains down there, and it may be some time before he gets on. But Samoa . . . (Jeeves, stop licking your chops) . . . . . Some of the boys out at San Jose, Calif., have a 210 Club of their own, all using tubes like the '10 or equivalent, and powers around 100 watts. Pres right now is W6KQK with 75 countries, W6MZH secretary, and W6GOZ is most of the active membership because the others are QRL work. W6KQK has been working things like ZM1AA (14,450 T9x), QSL via K6QCB; K4ERY (7230 T9x) in Virgin Islands, VS1AL (14,300), VS2AS, HR7WC, K8TE, GI5YW, YL2CD, and

ES5C. W6MZH contents himself with IIMZ (14,420 T9), PAOQF (14,410 T6), ON4WX (14,410 T9), HC2MR, CR7AK, HI2T, and F8PXP (14,350 T7) . . . . . W9RCQF of the "Podunk Hollow" gang is busy burning out transformers, but the buffer accounts for YS1FM (7100), ZD2H, PZ1AB, F8ABG, VQ8AB (14,300), and enough stuff to bring him up to 106 countries . . . . . W1KKS says that OA4AB uses 40 watts and the old receiver of OA4U . . . . . W9IDW is quite popular with DX looking for South Dakota (as per the Call Book), but the sad story is that he's in North Dakota, which is better yet . . . . . W4BPD will give 'em South Carolina and W6NPU Utah . . . . . Speaking of WAS, G6QS suggests that W hams in some of the rarer states could work DX on CQ's if they'd sign their state during the CQ. An amazing number of DX stations are after WAS . . . . . ON4AU says that EQ4AC was never on from Persia, but there may be an EP4AC there presently. They're awfully tough on hams over there, though. ON4AU needs only Nevada for his WAS . . . . . Win Peebles, W8GQB, says to tell the foreign stations that they're very welcome to join the 210 DX Club if they can qualify (see July column) . . . . . If you see WIACV walking around with the buttons popped off his vest, it's only justifiable pride at working WAC after only 25 years of hamming . . . . . KA1ME, well-known on 20 'phone, is moving to a new QTH where he'll have rombsies and stuff, according to W6ITH . . . . . W5EWZ is doing all right with his 50 watts, working things like F8AF, J2JJ, J2KN, KA1ER, KA1BC, ON4PZ, PK1BX, and PY2AC . . . . . Latest at W4EPV include U6WB, K6OCL (Guam), J2JJ, CN8AN, VR6AY, CT2BC, YN3DG, and K6OVN (Guam) . . . . . W3EDP is up to 124 with VP9X, K6OVN, and VK9VG . . . . . W3EMM has a simple requirement: he wants a backyard antenna with controlled directivity in both planes and a gain of 10 db. But when he isn't smoking that pipe he works ZC6AQ, YV2CU, K6BAZ, VQ2HC, and ZD2H . . . . . HK3AL works a lot of DX, but he's really interested in Arkansas, Nevada, Utah, Montana, and North and South Dakota, for his WAS . . . . . A nice letter from VU2AN out there in Baluchistan tells how he's handicapped by d.c. mains but has finally QRO'd from a district with 110 volts to one with 220! Tom doesn't like these fellows who *think* they've worked him, and try to wangle a card . . . . . Speaking of card wangers, AC4YN wrote the other day to return the card of a W9 who tried that stunt. Advice to card wangers: pick a station that has a lot of W contacts, and then wait until he works a station with a call very much like yours. You'll have a better chance, Mr. Rat . . . . . W5ACA was pleasantly surprised the other morning when he missed the prefix of a station calling CQ, and called Z2IC, to have him come back and sign J2IC! . . . . . ZL1J (14,305) needs R. L. Vt., Mississippi and Nevada for his WAS . . . . . K4KD is up to 78 countries, with QSO's with TF3C, YV2CU, FT4AG, CT1CO, and the like. He needs Wyoming and Nevada for guess what . . . . . That serious student of the night clubs, W2BMX, has been clicking with W57RP, VS6AO, U9ML, EL2A, ZB1R, and VQ8AL, and says that TA1AA (14,350 T5) is no phoney . . . . . W6LFD, via W8QXT, says that VR6AY can't use those International Reply Coupons you've been sending him, and he'd prefer either a NZ or US stamp. Sorry, we gave you the dope as it was given to us . . . . . V2P2C (7057) is known as the "Duchess," and is the only YL op in VP. Her rig is 25 watts to a 6L6 oscillator. QTH: Marie L. Devaux, "Chesterfield," St. Lucia . . . . . W4COB put up a diamond with 225' legs, and was rewarded by two Asians the first two days, after four years of ND. He ran into several wasp nests, and on the way back just missed stepping on a rattlesnake, which he shot. After two days, someone cut the ropes, so now he can't lower the wires, and he had to shoot out the lamp resistors he had at the end. (There's no truth in the rumor that W4DZH said he didn't want ever to meet COB's daughter.) . . . . . W1AXW says that J2GX will be back on shortly, after a three-year lay-off. That's good news for WAC aspirants . . . . . G2YY has worked 81 countries with battery-powered 9 watts . . . . . W1BUX says things are a little slow, just OY4C, VP7NT, VR4AD, VQ3HJP, VK9BW, ZD4AB, UX1CN, VS2AE, V57RF,

ZC6AQ, and XU8NR. If that's slow, we know plenty of fellows in reverse! . . . W6DOB is up to 131, with VP4TP, VP8AF, PJ3CO, CT2BM, and OY5C . . . Definition of the best time for DX: the one night in the week that the XYL makes you take her to the movies.

—W1JPE

-----  
LDUC

Seid of W2MQ sailed August 15th with the *Wyatt Earp*. Norwegian sailing ship bound for the Antarctic. LDUC (The Ellsworth '38-'39 Expedition) is located on 14,000 an l 28,000 kcs. for work with amateurs. Uses a 1000-watt transmitter with a pair of HF300's and an NC100XA receiver. VE2IC, the chief aviation pilot, will also be behind the key at times, when working amateurs.

-----  
W9YHD, Maysville, Ky., suggests as an aid to hams trying to Work All States that we add the abbreviation for our particular state after our call, thus: W9YHD KY AR, or W9YHD in Ky. This should prove particularly helpful in states having a small ham population. It should also do away with the need of referring to the call book so much.

-----  
"With the VK/ZL contest coming up in October, I have a suggestion to offer (to give stations away from the band edges a chance). This suggestion could be used equally well in other contests. Briefly, let's assume VK5HG (14,350 kc.) calls CQ; tuning from the high-frequency edge to the middle of the band he gets an answer just a few kilocycles inside. After signing with this station, why not, instead of again going back to the edge, continue to tune through the band to middle, working stations in order of frequencies; for example, he may work W6CUH (14,385), then tuning towards the middle work others on 14,350, 14,275, 14,260, etc.: when he reaches the middle he can start tuning back towards the high-frequency edge. Stations operating near the low-frequency edge could use the same procedure, tuning towards the middle, then back to the low edge."

—Herbert S. Brice, W9EGQ.

-----  
F.C.C. Disciplinary Actions

The F.C.C. en banc on July 26th took the following action:

Ralph Manley, Anderson, Ind. Barred from examination for radio operator privileges for a period of 6 months from date, because he attempted to obtain an amateur radio station license and radio operator license by fraudulent means.

Robert Joseph Wells, Anderson, Ind. Suspended amateur radio operator license with Class B privileges, for a period of 6 months, because said licensee attempted to obtain an amateur radio station license and amateur radio operator license by fraudulent means for Ralph Manley, Anderson, Ind., in violation of Rule 440.

-----  
Hamfest Schedule

**September 11th, at Binghamton, N. Y.:** The Binghamton Amateur Radio Association will hold its Annual Hamfest, September 11th, in the American Legion Hall, Binghamton, N. Y. The feature speaker will be L. S. Bellem, WIBES, of the Pitcairn Island Expedition. Fee is \$1.25 in advance, \$1.50 at the gate.

**September 12th-17th, at Spencer, Iowa:** It will be hamfest time in Spencer, Iowa, during the Clay County Fair, September 12th-17th. Radio amateurs of Clay County, under the leadership of L. W. Andrews, W9OC, will have a booth at the fair grounds. Equipment for all bands will be in use. Everybody is invited.

**October 1st, at Schenectady, N. Y.:** The Annual Hamfest of the Schenectady Amateur Radio Association will be held in Schenectady on Saturday, October 1st. The usual list of well-known speakers and ham-fun is scheduled. All inquiries should be addressed to the General Chairman, Roy D. Jordan, W2KUD, R.F.D. No. 7, Schenectady, N. Y.

-----  
DX Century Club

THIS month we welcome nine new members, as follows: PA0XF, W9EF, G6KP, J5CC, W2CJM, W6FZL, VK5WR, W6GAL and W3EVT. With the addition of J5CC

and VK5WR, all continents except Africa and South America are represented. FB8AB with 87 countries has a good start towards being the first member in Africa. No South American has yet made a start. Who will be first?

There are now 51 actual members and 97 in the below-100 group. How the lads are bearing down on 'em! G6WY maintains the lead position, with W8CRA and W1SZ tied for second place, and W1TW a threatening third. The Century Club and "75-or-more" listings represent the only official confirmed countries worked list in existence! It really means something to be included in such a list. Send in your confirmations when you can qualify for at least 75 countries, including (please) sufficient postage to finance the return of your QSL's. A truly beautiful certificate awaits you when you reach the century mark!

MEMBERS, DX CENTURY CLUB

G6WY (No. 5) . . . 135	W8JMP (No. 22) . . . 107
W8CRA (No. 1) . . . 126	W8LEC (No. 25) . . . 107
W1SZ (No. 7) . . . 126	W8OQF (No. 30) . . . 107
W1TW (No. 3) . . . 125	W5BB (No. 37) . . . 106
ON4AU (No. 40) . . . 124	W9GDH (No. 41) . . . 106
G2ZQ (No. 6) . . . 123	ON4UO (No. 31) . . . 105
W1TS (No. 9) . . . 121	W6ADP (No. 34) . . . 105
W8DFH (No. 14) . . . 121	W9PST (No. 35) . . . 105
W6GRL (No. 15) . . . 121	G6RH (No. 36) . . . 105
W1BUX (No. 2) . . . 118	W6GAL (No. 50) . . . 105
W2GTZ (No. 12) . . . 118	G6KP (No. 45) . . . 103
W1LZ (No. 10) . . . 114	W4CBY (No. 20) . . . 102
W2GW (No. 11) . . . 114	VK5WR (No. 49) . . . 102
W6CXW (No. 4) . . . 113	F8RJ (No. 8) . . . 101
W6KJP (No. 28) . . . 113	W2BHW (No. 39) . . . 101
H9PJ (No. 13) . . . 111	J5CC (No. 46) . . . 101
W9KG (No. 16) . . . 111	E1SF (No. 19) . . . 100
W8OSL (No. 23) . . . 111	G6CL (No. 24) . . . 100
W7AMX (No. 26) . . . 111	W5VU (No. 38) . . . 100
W1DF (No. 29) . . . 111	W9KA (No. 42) . . . 100
W2GT (No. 32) . . . 111	PA0XF (No. 43) . . . 100
W9ARL (No. 18) . . . 110	W9EF (No. 44) . . . 100
W2UK (No. 33) . . . 110	W2CJM (No. 47) . . . 100
W8DWV (No. 17) . . . 108	W6FZL (No. 48) . . . 100
W8DHC (No. 27) . . . 108	W3EVT (No. 51) . . . 100
W6HX (No. 21) . . . 107	

The following have submitted proof of contacts with 75-or-more countries.

W3E VW . . . 99	W9AEH . . . 87	W1GCX . . . 80
W1ZB . . . 98	FB8AB . . . 87	W1GNE . . . 80
W3EDP . . . 98	G2DZ . . . 87	W3BVN . . . 80
W1DUK . . . 97	PA0QZ . . . 87	W3EPR . . . 80
W1JPE . . . 97	W1RY . . . 86	W8DGP . . . 80
W1WV . . . 97	W2HHF . . . 86	W8OXO . . . 79
W2OA . . . 97	W5KC . . . 85	VK6SA . . . 79
W1CC . . . 96	W8CJJ . . . 85	W1EWD . . . 78
F8RR . . . 96	G6GH . . . 85	W6GPB . . . 78
W2GVZ . . . 95	W3ZX . . . 84	W8AAT . . . 78
W3EMM . . . 95	W4PDD . . . 84	W8FJN . . . 78
PA0QF . . . 95	W4CCB . . . 84	W9UM . . . 78
W4AJX . . . 94	W4CFD . . . 84	G6RY . . . 78
G5RV . . . 94	W8AAJ . . . 84	W1LCA . . . 77
W8EUY . . . 93	W8AU . . . 84	W2GRG . . . 77
W9ADN . . . 93	G2TR . . . 84	W3EMA . . . 77
W2DC . . . 92	VE2EE . . . 84	W6PKZ . . . 77
W4CEN . . . 92	W1ADM . . . 83	W9OVU . . . 77
W8ADG . . . 92	W2BYP . . . 83	SU1WM . . . 77
W1ZI . . . 91	W2CYS . . . 83	W2DSB . . . 76
W2CBO . . . 91	W3AIU . . . 83	W8DOD . . . 76
W3BES . . . 91	W3FRY . . . 83	W8LZK . . . 76
W3EPV . . . 91	W3GAU . . . 83	W9CWW . . . 76
W4DRD . . . 90	W6ITH . . . 83	G2ML . . . 76
VE2AX . . . 90	G5QY . . . 83	G5BD . . . 76
W8KKG . . . 89	HB9X . . . 83	G6ZO . . . 76
W3JM . . . 88	SP1AR . . . 82	ZS2X . . . 76
W8BOX . . . 88	W1BGY . . . 82	W2IOP . . . 75
W1FTR . . . 87	W1BFT . . . 81	W3CKT . . . 75
W3DDM . . . 87	W5ASG . . . 81	W6LJD . . . 75
W6BAM . . . 87	W6GHU . . . 81	PA0JMW . . . 75
W8KTW . . . 87	W8BSF . . . 81	VE2GA . . . 75
	W9FLH . . . 81	

## Briefs

Many an operator of a few years ago will recall W9ZZAF, portable call of Bill Clarke, W9DLS. Bill's ham activities during the past four years have been confined almost exclusively to portable operation. Now, however, he has more or less settled down and has a permanent installation signing W4EPM at Miami, Fla. He's on watch for his many friends throughout the country.

### Expedition Note

By letter dated July 23th, W2CIF tells of some excellent expedition work: "The MacGregor Arctic Expedition (WAWG) has been ice bound in Baffin Bay with disabled motors and leaky ship. Frantically they have been trying to contact W1OXDA (the Bartlett Expedition). Last evening I heard W2OJ working W1OXDA, called him on long distance telephone and established contact with W1OXDA, asking the operator to stand by as I had a schedule with WAWG. I took a message from WAWG, gave it to W1OXDA and had an answer back within two minutes. The MacGregor Expedition left Etah, Greenland, July 14th, and has had a hard time due to ice and disabled motors. They are ready to abandon ship at any time if ice pressure continues. In this case they will use portable transmitter on experimental frequencies assigned to W1OXAB. I contact them nightly at 7:30 EST on 16,280 kc. To date we have handled over 500 messages, press and weather reports for them."

Attention, traffic hounds: W8LSF, RM-ORS, Detroit, advises that amateurs interested in message pushing should register their calls and addresses with local American Legion posts. LSF secured quite a quantity of traffic this way last season and he says it's a regular gold mine of messages.

On April 10th a plane crashed in Barranquilla, Columbia. YV5AD, Caguaga, Venezuela, on 14 Mc., assisted HK1DA in relaying the information to the parents of the flyer and to the government via HK1EF and HK1LA, skip preventing solid contact between the HK's.

### S.A.R.O.

The Society of Amateur Radio Operators, Inc. (California) has as its main objective "emergency preparedness." Construction of emergency equipment is fostered as well as regular drills to actually test facilities. An S.A.R.O. 'Phone Net operates every Monday evening at 7:30, on 1907 and 1990 kc., with an alternate frequency of 3980 kc. A C.W. Net on 3814 kc. meets on Thursday evenings at 7:30. Membership in the Society includes W6AEX BGY BUY CBX DKS DMY DSV DUB EHS FRD GPY HJN HOW IKQ IMA IPK JFA LCG LCH LCT LJJ LRD LRY NDM NQJ NWB NZJ NZG UW ZA SAE ZF-XG ZX LOS (Associate) and Mr. Chas. Turner, American Red Cross (honorary).

The S.A.R.O. is in its third year of successful work. Various committees are maintained and all function splendidly. "SARO News" is the official publication and the Society owns its own mimeograph machine. A Ford Radio Trailer and a large I-kw. gas-driven unit are also part of the S.A.R.O.'s equipment. Plans are under way for S.A.R.O. chapters in Sacramento and Fresno. The c.w. net ties in with the Central California Net, which provides excellent traffic outlets. Negotiations are under way for a connection with the Mission Trail Net on 1.75-Mc. 'phone.

### O.B.S.

The following is a supplement to the list of A.R.R.L. Official Broadcasting Stations in October QST (page 50): WIKIN, W5GDU, W6BF, W6ZM, VE1KS.

## BRASS POUNDERS' LEAGUE

(June 16th-July 15th)

Call	Orig.	Del.	Int.	Extra Del.	Total
W4PL	16	169	1101	165	1451
W7EBQ	38	102	666	166	972
W5DKR	284	173	123	123	703
W6LLW	16	58	538	25	637
W6ITH	112	188	144	179	623
W3CTZ	25	115	310	115	565
W7DUE	6	12	468	24	510
W6JTV	144	146	108	107	505

### MORE-THAN-ONE-OPERATOR STATIONS

Call	Orig.	Del.	Rel.	Extra Del.	Total
KA1HR	553	371	170	—	1094
W5OW	168	80	770	68	1086
K5AA	285	58	262	44	649

These stations "make" the B.P.L. with total of 500 or over. One hundred deliveries + Ex. Del. Credits also rate B.P.L. standing. The following one-operator stations make the B.P.L. on deliveries. Deliveries count!

W6PFL, 296	W6INI, 170	W8ASW, 112
W6IG, 258	W5BN, 152	W2ICM, 106
W3EML, 243	W9VDY, 150	W6KMF, 104
W6QP, 219	W6HH, 131	W8PFW, 101
W6KFC, 6, 172	W6MN, 119	

A.A.R.S.

### MORE-THAN-ONE-OPERATOR STATIONS

Call	Orig.	Del.	Rel.	Extra Del.	Total
WLM (W3CXL)	125	53	2040	41	2289

A total of 500 or more, or 100 deliveries Ex. D. Cr. will put you in line for a place in the B.P.L.

## Emergency Planning

THE Radio Emergency Coördinating Committee of Long Beach, Calif., has been meeting now for about ten months. The meeting of June 3rd is typical of all regular meetings which are held the first Friday of each month at the Richmond Café, Fourth and American Avenues, Long Beach. Two days before the meeting, a W.P.A. assignee to the Police Department is given the list of likely radio amateurs, broadcasters, airport operators, or anyone else who is an engineer at a transmitter. These people are phoned concerning the meeting. The process is repeated about two hours before the meeting time and in that way a fair turn-out exists. Larry Lynde, W6DEP is chairman of the committee.

At the June 3rd meeting Captain O. M. Murphy had a large wall map showing the emergency set-up of the city. The members decided that each point of importance should be numbered to make radio communication easier. The following plan was tentatively suggested: Nos. 0 to 100, radio transmitter locations; 200 series, traffic communication; 300, public utilities; 400, traffic blockades; 500, traffic divisions; 600, Red Cross; 700, Red Cross Communications, concentration camps; 800, housing; 900, food depots; 1000 mobile units. The numbering system could extend on indefinitely, and each number would indicate the type of depot, fire station, police station, concentration camp, or anything else pertaining to an emergency.

Lawrence McDowell, chief engineer of KFOX, explained the operation of his five portable transmitters and the fact that practically all of them are immediately available for an emergency inasmuch as only one or two would be used for station itself. At the present time, there are four available amateur 56-Mc. mobile units on a moment's notice, and one all-wave transmitter (the one owned by W6DEP, and which did such good work during the last flood). The city has offered to furnish each of ten amateurs with a six-volt heavy duty motor generator, and an emergency frequency crystal. Application has been made to the F.C.C. for a frequency somewhere in the vicinity of nine meters to tie in with the local three-way police broadcasting system, these systems to be used for emergency only and to be a part of the amateur's car. These will be in addition to the present mobile units.

—W6AM

(Station Activities on page 109)



# CORRESPONDENCE

The Publishers of QST assume no responsibility for statements made herein by correspondents

## The Archduke Explains

Schloss Sonnberg, Bei Hollabrunn, N. O.

Editor, QST:

I have just read the article published in June QST, page 25, under "Hamdom" about OE3AH. I thank you very much for all the interesting and correct information about my station and my work as a ham, but I feel grieved that much incorrect news which has, alas, been published in many newspapers for the purpose of anti-German propaganda, should also have been reproduced in your paper. I would therefore ask you to listen to OE3AH himself, who is writing this letter about the 1938 contest and the days afterwards.

A few days before the 1938 contest I had been at Merano in Italy with my wife, the Archduchess Ileana, Princess of Roumania, paying a visit to my mother-in-law, the Queen Marie. I returned alone to begin the contest and started to QSO U.S.A. and Canada. Day after day I only pressed the key and added scores to my log. On the night of Friday, the 11th, I was told by a telephone call of the great event, and therefore I immediately listened at the wireless to get the last news. I interrupted the contest, having worked already 79 hours, and I spent that night listening on the long waves. On Saturday, the 12th, I had to drive with my car to Vienna, about 40 miles from here, to fetch my wife who was arriving by train from Merano, where I had left her. The train arrived normally and after we returned home and after a night's rest from the many sleepless nights of the contest, I began again to operate my station on Sunday morning, the 13th, on until the end of the contest, making still 101 QSO's and so completing the 90 hours. I ask you, would this have been possible if there had been any intention of arresting me?

Soon afterwards foreign newspapers published untrue reports about my imprisonment and I was not able entirely to stop those invented stories. To convince even my relations that I was a free man was sometimes difficult, and therefore I drove with my car again to Italy with my wife, passing the frontier in less than three minutes, without having been stopped a single time during the journey. It was funny to hear during my drive on the motorcar's receiver from a station about my arrest and so on.

The incorporation of the Austrian amateurs into the D.A.S.D. was accomplished in the friend-

liest manner and with great consideration towards us. I myself, as ex-president of the Oe.V.S.V., have been intrusted with the reorganization of the ex-Oe hams and have been named "Landes Verbandsfuhrer der Donaulande," that is to say: "Leader of the association of the Danube district."

I trust you will find room in your columns for this letter, which will I think correct the bad impression made by false reports.

—Anton Habsburg, Archduke of Austria

## Class A Endorsement

### Not a Renewal

1042 No. Calvert St., Baltimore, Md.

Editor, QST:

It has been brought to my attention that most amateurs are of the opinion that when they take the Class A examination and their license is endorsed for Class A privileges this automatically extends the expiration date to three years from time of endorsement.

This misunderstanding has resulted in two of our members losing their tickets within the past month. Of course they have unwittingly been operating illegally for a period of time. They of course will be required to take the examination over to regain their license.

I believe this misunderstanding is caused by not fully reading Rule No. 410.

—R. W. White, W3GXO

## For Public Service Nets

Port Wing, Wis.

Editor, QST:

Have just read with interest the two letters approving amateur help in recording geological data. Frankly, this is a better response than I expected to Dr. Campbell's suggestion.

But I can't understand why they pick on geology! (Beg your pardon, Dr. Campbell.) While I know next to nothing about geology, I don't see where the quick communication amateur radio brags about could help gather seismographic information, except in a few isolated cases.

I suggest an investigation into other possible services that would be benefited by daily reports from all parts of the country. To name a few: U. S. Weather Bureau; small-town municipal police; Depts. of Conservation (particularly fire-fighting and insect pest reports); transportation facilities (investigate the L. & N.R.R. Net in

Kentucky and Tennessee). Note that small towns would be most served, but such public-service nets would also have inestimable value in emergencies.

Having read "The Battle of Cairo" in the same issue, I am convinced that a public-service net would furnish an infinitely greater reason for amateur radio than the necessarily somewhat vague references to emergency communication, in the eyes of foreign diplomats.

—Herbert Brooks, W9SDG

## Commercial Vs. Amateur Practice

131 River St., Chicago, Ill.

Editor, *QST*:

Often some modern young amateur drops into a ship station with cadmium-plated expectations. These crackle-finished young fellows begin to stare, and later to scoff, at the pile of antiquated junk. They wouldn't have it for the world! Marconi wireless receiver—what museum gave that away? These same young fellows get a big kick out of seeing a separately-housed two-stage 201A amplifier with separate filament rheostats on it.

The old 1921 self-rectifying push-pull 211 oscillator is a laugh also, and those spiral wound coils are the last straw. Yes, I myself thought so, till I had to work with such equipment. I then saw the difference between my super-doop regenerative, etc., amateur rig and the out-of-date commercial equipment—dependability! The battleship-like transmitter and receiver could take it, had been taking it from 15 to 20 years, and were still able to serve the same purpose that they were built for. They were built for covering a certain radio range and were still doing it.

The only point in this letter is to show that while commercial and experimental radio often travel the same road, commercial radio must usually stay far enough behind to build time-tried dependable equipment.

The amateur experimenter builds a five-in-one set and gets infinitely better results. Only—for how long? But more power to him. He is the one showing the commercial man the future dependable path to follow.

—Henry F. Sarnowicz, W9VPQ

## Re-Exams for Renewals

626 N. Poplar St., Allentown, Pa.

Editor, *QST*:

Being of sound mind (I hope) I hereby want to go on record as favoring the renewal of amateur licenses only upon the applicant reappearing for examination. I believe that some such idea is now occupying the F.C.C. minds in relation to commercial operators and it certainly would be the best thing for ham radio yet to happen.

Everything else these days seems to be the law of "survival of the fittest," and there certainly are too darn many misfits in ham radio.

Such a course of re-examination would accomplish the following:

1. Make the boys remember that there is such a thing as code.
2. Thin the ranks of the "dabblers" who are only slightly interested.
3. Eventually get rid of those guys who never took their exam (and although I can't prove it I've got a few choice ideas on some and so have you, I'll bet).
4. Get rid of the old timer who never got any further than a series-fed Hartley, in knowledge.
5. Make me darn unpopular.

But I certainly would like to see some such idea in force although it would mean a hardship on fellows who have to go far for exams (I have 50 miles). It would simply be a "greatest good for greatest number" policy.

Publish this and I'm a dead one. Hi!

—Preston R. Schuler, W3BYF

## Let Freedom Rule

Lima Center, Wis.

Editor, *QST*:

Re W6KBY's letter in August *QST*, we wonder if his "careful thought and consideration" included how the East and Middle West are going to work the West coast on 'phone if 20 meters is limited to DX only. It's a cinch that 20 is the band for it unless one is a nite owl to use either 160 or 75. Ten is not an all-year band. The less restrictions, the better. Rome will probably take care of that in 1942. Plenty of DX is being worked all the time under the present conditions, so what? After all, the number of American hams far exceeds that in foreign places, so what would the odd 75 per cent or so of the American hams do after the first 25 per cent are all engaged in QSO with all the foreign stations to be heard? Let freedom rule. We got it in 1776; let's keep it that way.

—Clinton E. Gates, W9KBT

## QSL Analysis

86 Highland Ave., Tuckahoe, N. Y.

Editor, *QST*:

Early in 1936, when I decided to go back on the air after a lapse of 19 years, I decided I would accurately determine just what this QSL business is all about. Several ham friends told me that they had virtually stopped sending QSL cards because of the grossly unfair treatment they had received at the hands of other "brothers."

They told sad tales of working certain states dozens of times in their quest for the elusive WAS; of sending not one, but two, three and even four cards with no results. Cards were followed by pleading letters that all but dripped with tears; of sending stamps and already filled in and self-addressed cards but with usually no responses. These friends told of the vain efforts to get cards from certain foreign countries and the result of all of it was they had stopped QSLing unless the other guy did so first. They told me their responses, before the adoption of the new policy, had been between 20 and 35 per cent.

So, I decided (as in the case of love, they tell me, you must learn by experience) I would go forth on the ether and become, as far as finances would permit, the QSLingist ham possible. I would keep an accurate record of all cards sent and received and whether or not the card was sent first from my station or came from the other fellow's, and whether or not he first raised the QSL question during the QSO or if I did.

I planned to keep my survey going until at least 1000 cards had become involved. With approximately 30,000 active amateurs in the world (so I'm told) and with little sense of QSLing with the same ham more than once this seemed to me to be a means of getting a fair cross section of the amateur world and its attitude toward QSLs.

In my own country I kept track of the responses by states and foreign contacts by individual countries. The number of cards involved has passed the 1000 mark after two years and two months. During that time I worked 47 states, all VE districts and 36 foreign countries. I used 5-meter 'phone and 20, 40 and 80 c.w. and 160-meter 'phone.

And here is what I found. Of 1006 cards sent out I received 788 or 78.3 per cent returns. This is broken down so that of 851 cards mailed to United States contacts there came back 710 or 83.4 per cent. Canadian contacts saw 64 cards sent with 56 coming back for a percentage of 87.5 with the foreign responses very bad by comparison. I mailed 91 cards to foreign hams in all continents and received only 22 for a percentage of 24.1 per cent.

In the United States I found 19 states where the returns were 100 per cent. These states were Arkansas, Colorado, Delaware, Florida, Georgia, Iowa, Massachusetts, Minnesota, Mississippi, Nebraska, New Hampshire, New Mexico, North Dakota, Oregon, South Carolina, South Dakota, Vermont, Wisconsin and Wyoming.

(Continued on page 84)



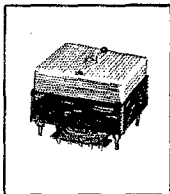

AS WE HAVE REMARKED BEFORE on this page, there are a number of good reasons why we do not like to put a power transformer inside of a communication receiver. To anyone who has made comparative tests, the increase in temperature drift due to the extra heating and the greater background noise from stray fields is self-evident. So a long line of National Communication Receivers have had their transformers outside, at the end of a cable. The only exceptions to this rule have been receivers of the NC-100 series. These are rather a special case, because their use for broadcast reception has thrown emphasis on the audio output stage, and tone quality dictated the use of a built-in power unit.

The NC-80 is also somewhat of a special case, because low voltage beam tubes first became available at about the time it was being designed. We had long realized that 110 volts was entirely satisfactory for the plates of RF and IF stages and that omission of the transformer would improve regulation. Also, it would obviously eliminate heat and background noise originating in the transformer. Consequently, when the 25L6G made it possible to provide a two watt output with 110 volts, we swung over to an AC-DC design.

There are two objections to the use of a good AC-DC power supply in a communication receiver. The first is that it costs more than the usual AC supply. To be sure, there is no transformer to buy, but transformers do not cost much anyway. On the other hand, various complications such as insulating both sides of the power line from the cabinet increase the cost of construction more than might be imagined. However, after careful tests we decided that the extra cost of a *good* AC-DC supply was entirely justified. For example, the stability resulting from the excellent regulation of the power supply is an important factor in the remarkable performance of the NC-80 in the 10-meter band, where it can hold its own with any receiver on the market regardless of price.

The other objection is more serious from our point of view, and is entirely a matter of prejudice. "Most gyp sets are AC-DC, therefore all AC-DC sets are gyps." Most of our customers judge sets on performance, fortunately, but we continually run into men who know that AC-DC sets are no good because they owned one once. Whenever we have had an opportunity to demonstrate the NC-80 in comparison with an AC set of similar price, we have been able to prove our point. We can prove it has no tunable hum. We can prove the tone is good. We can prove it will pull signals in. But we cannot reach all our customers that way, which is the reason we are writing this page.

We think that in most cases the AC-DC supply is the logical choice for a communication receiver, and we are going to stick to it. If our customers want a transformer inside, they can get one of the NC-100's. But we do wish you would be broadminded about it. At the next meeting of the Radio Club, borrow an 80 from your dealer and give it a comparative test alongside *any* receiver of similar price. And invite the dealer, too. Apparently some of our dealers also owned an AC-DC set once!

JAMES MILLEN



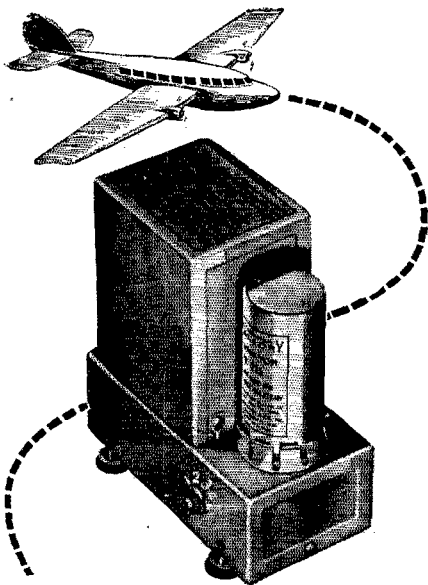

## P. R. MALLORY & CO. INC. MALLY Vibrapack Gives Flyers One Foot on the Ground

The widespread popularity of Mally Vibrapack for use in airplane radio transmitters is additional evidence of the truth of the Mally slogan, "Perfect Portable Power". Pilots know they can rely on Mally Vibrapack for a dependable signal and low battery drain.

Mally Vibrapack provides the ideal source of plate voltage wherever commercial electric power is not available, whether it's in the air or on the ground. Mally Vibrapacks are available for operation from both 6 volt and 12 volt batteries with outputs of up to 300 volts at 100 m.a. of easily filtered D.C. In addition, the low voltage models are ideal for converting 110 volt receivers for 6 volt battery operation.

Mally Vibrapack is made in the following models . . .

Type	Nominal Input Voltage	Nominal Output Voltage
VP-551-Self-Rectifying	6.3	125-150-175-200
VP-552-Self-Rectifying	6.3	225-250-275-300
VP-553-Tube Rectifier	6.3	125-150-175-200
VP-554-Tube Rectifier	6.3	225-250-275-300
VP-G556-Self-Rectifying*	12.6	225-250-275-300

\*Specially designed for aircraft, bus and boat service.

See your Mally-Yaxley distributor now. He has complete specifications and operating instructions. Ask for your copy.

**P. R. MALLORY & CO., Inc.**  
**INDIANAPOLIS INDIANA**  
 Cable Address—PELMALLO

Use **P. R. MALLORY & CO. INC.**  
**MALLY**  
 APPROVED RADIO  
 PRECISION PRODUCTS

Use **YAXLEY**  
 APPROVED RADIO  
 PRECISION PRODUCTS

## Correspondence Department

(Continued from page 68)

Massachusetts was by far the best with 41 cards sent and 41 returned. To the other states fewer cards were involved although more than 10 cards came from six of these 100 percenters.

The following states gave me returns of 80 per cent or better: New Jersey, Missouri, New York, Ohio, Illinois, Kansas, Montana, Pennsylvania, Washington, California, Indiana and Maine. Because of five-meter work New York, my own state, saw the most cards involved with 72 responses out of 78 sent out. I received, however, more than 60 cards from Pennsylvania and California and in excess of 40 from Ohio and Illinois.

The responses were 70 per cent or better from Idaho, Rhode Island, Maryland and Michigan. Tennessee and Utah had percentages between 60 and 70 and Texas, Louisiana, District of Columbia, Alabama and Connecticut were between 50 and 55 per cent.

The other states, West Virginia, North Carolina, Oklahoma, Arizona and Kentucky were all under 40 per cent with Kentucky and Arizona at the bottom with 33 per cent. The only state where there was no contact was Nevada, not yet having heard a station in that state.

With the exception of Mississippi, New Mexico, South Carolina, Vermont and Wyoming, there were at least six cards sent into all other states. In these five the number ranged between three and five.

In the Canadian districts out of 64 cards sent 56 of the recipients returned cards with the VE1 district 100 per cent with 10 out and 10 back.

With the exception of Mexico, where the response to six QSLs so far has been nil, North American amateurs are not so bad in QSLing taking the U. S. and Canada as a whole, although there are some states in our country where there seems to be considerable indifference, particularly in some of the Southern states, as you can see by the percentages.

But, it's another story with foreign amateurs. I have found them very poor despite avowed statements such as, "Sure QSL here OM," "Will and erd today direct," "Always QSL OM," "Sure QSL," and so forth. Most of them seem to have short memories.

I have only found one foreign country, England, where the responses were even 50 per cent. France, Germany, Denmark have sent no cards although I sent not less than 10 into each.

Australia and New Zealand have been very poor. Of 15 cards sent to the former only one, from Tasmania, came back. Just one out of 11 has returned from New Zealand.

With few contacts in South America because neither of my DX antennas hit into that continent, I can't say much about the reputation of excellent QSLing. Generally speaking I would say that Europe is very poor in sending cards. The higher percentages, however, have come from England, Sweden, Norway, Belgium, Poland, Czechoslovakia.

And lest I forget, Hawaii and Porto Rico have been 100 per cent with seven out of seven from Hawaii and five for five from Porto Rico.

Summing it all up, however, I'd say the response is pretty good, being just shy of 80 per cent.

—Guy A. Stewart, Jr., W2JRG

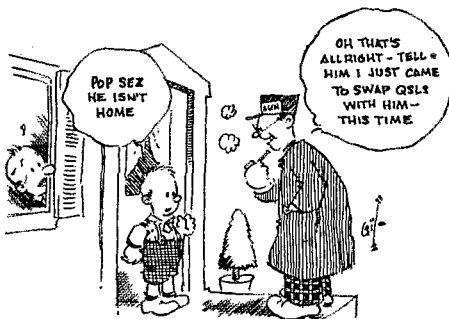

W5ABA IS AN INTERNAL REVENUE AGENT

# ONE OF THE FINEST ENGINEERING TREATISES ON TUBES EVER WRITTEN!

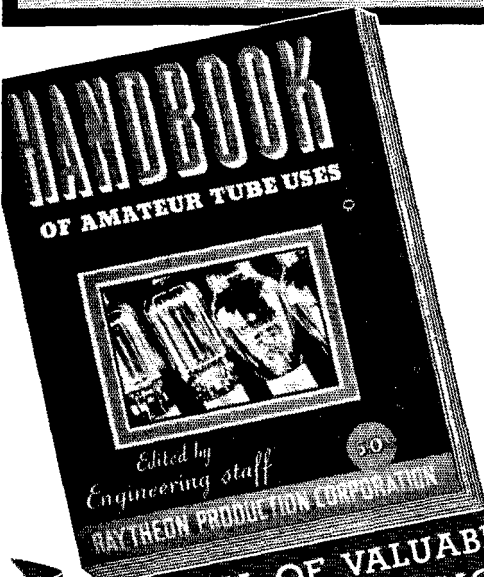

AN  
ENCYCLOPEDIA OF  
TECHNICAL INFORMATION  
INCLUDING THE ONLY  
*TEMPERATURE COLOR CHART*  
AVAILABLE FOR AMATEURS!

Are you planning to design a new transmitter? Would you like to have the latest information which will enable you to design it so that you may obtain maximum results—and be exceptionally proud of your rig! Then you need Raytheon's "HANDBOOK OF AMATEUR TUBE USES!"

**CHOCK FULL OF VALUABLE FACTS WHICH WILL PERMIT YOU TO EASILY DESIGN YOUR OWN EQUIPMENT!**

Incorporated in this book is the famous RAYTHEON TEMPERATURE COLOR CHART, which enables you to tell when a tube is properly operated, merely by comparing the color of the plates of the tubes with the chart—and reading the temperature. Complete tube theory and application with the latest circuits—full data on modulation systems, classification of tubes for different uses, tube characteristics are all treated in detail together with pages of the newest circuit developments on Ultra High Frequency operation. This is the first time the amateur has been able to get all this data together, so that his choice of tubes can be intelligently made.

The Raytheon "Handbook of Amateur Tube Uses" is now available at all Raytheon jobbers at a price of 50c each. If your jobber cannot supply you, write direct to Raytheon Production Corporation, New York City, enclosing 50c for your Handbook. You'll say it's the best 50c investment you've ever made!

# RAYTHEON RK

## AMATEUR TUBES

CHICAGO • ATLANTA • NEW YORK • NEWTON, MASS. • SAN FRANCISCO

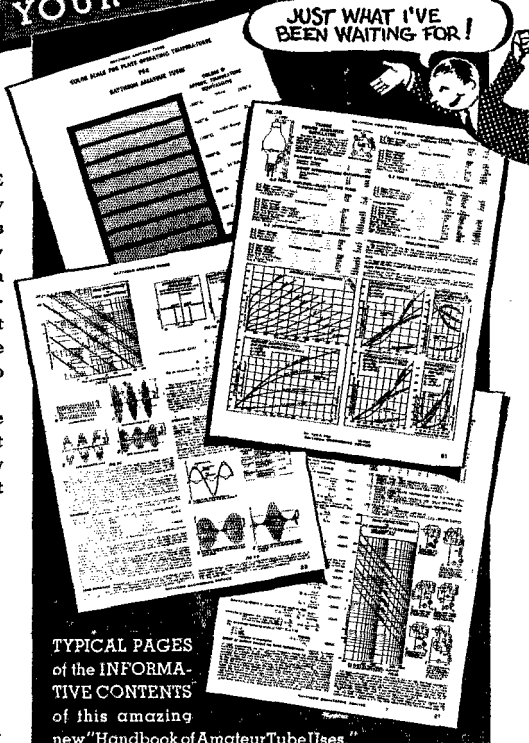

JUST WHAT I'VE BEEN WAITING FOR!

TYPICAL PAGES of the INFORMATIVE CONTENTS of this amazing new "Handbook of Amateur Tube Uses."

# EVERY "HAM" SHOULD HAVE ONE!

# "MULTI-BAND" TRANSMITTER

## THORDARSON 100 WATT TRANSMITTER

# NEW

QUALITY PARTS  
SUPPLIED by  
THESE  
MANUFACTURERS

Aerovox Corporation

American Phenolic Corp.

Barker & Williamson

Bud Radio, Inc.

Cornell-Dubilier Corp.

Coto-Coil Co., Inc.

Crowe-Name Plate & Mfg. Co.

National Company, Inc.

Ohmite Manufacturing Co.

Taylor Tubes, Inc.

Triplett Company

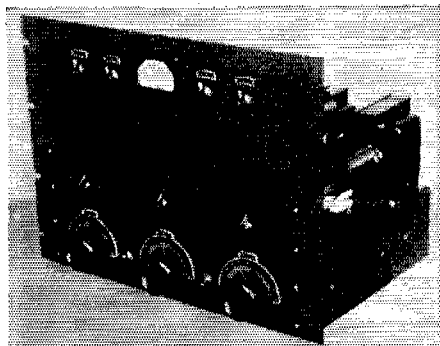

**RADIO FREQUENCY UNIT**  
Mounts in standard cabinets or racks.

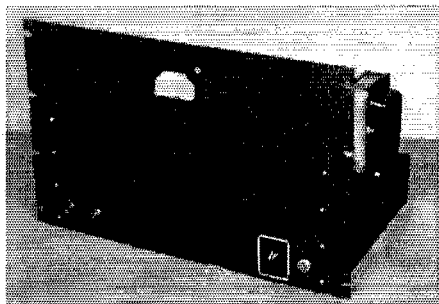

**MODULATOR UNIT**  
Mounts in standard cabinets or racks.



**AMATEUR SPEECH AMPLIFIER**  
Mounts in standard cabinets or racks.  
Metal screen cover for table use.

# "MULTI-BAND" TRANSMITTER

**BY THORDARSON**

# With Panel Band-switching

## FEATURES

- 100 watts input on all bands.
- Power supply and R. F. section on one chassis.
- Single meter reads all plate currents as well as grid current of the final stage.
- Modulator and power supply on one chassis.
- Bands switched from front of panel.
- R. F. lineup 6L6G—6L6G—TZ-40.
- Modulator lineup 6J7, 6F5, 6F6, 2—6L6's.
- Band-switching feature optional, plug-in coils may be used.

Here is the answer to the demand of amateurs for a high-quality transmitter which they can build with assurance of top performance. Only nationally-known, highest quality, standard parts are used throughout. Chassis, panels and chassis brackets are supplied completely punched for easy assembly. The complete transmitter requires only 26¼" of panel space and may be mounted in any standard rack or cabinet.

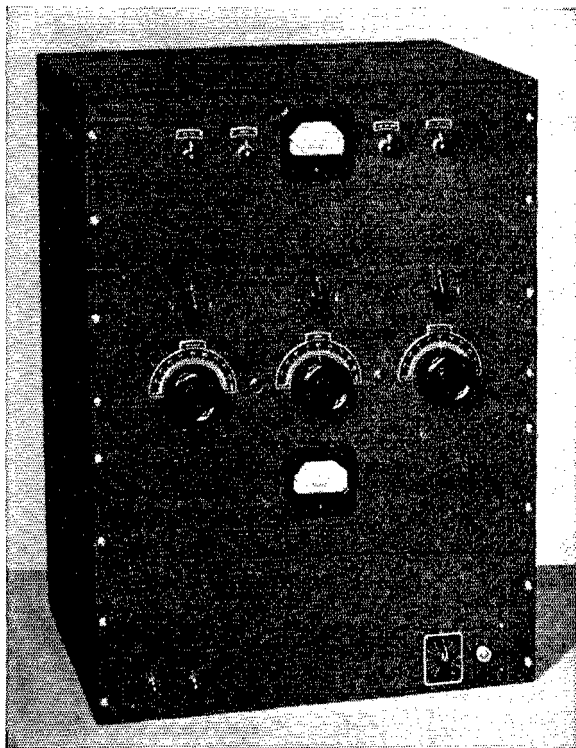

## AMATEUR SPEECH AMPLIFIER

Designed specifically for Ham requirements—Adapted to any phone transmitter—Optional over-modulation control—Sufficient driving power for any Class B Modulator—R. F. feedback and Hum eliminated—Standard rack and panel or with metal screen cover as table model.

See your distributor or write factory for descriptive bulletin SD-378A.  
Available in foundation unit or kit form.

**THORDARSON ELECTRIC MFG. CO.**  
500 W. HURON ST. CHICAGO, ILL.

**BY THORDARSON**

# Ideal... for TRANSMITTERS



MODERN • LONG-  
SCALE PRECISION  
INSTRUMENTS

18 STYLES

2" to 7"

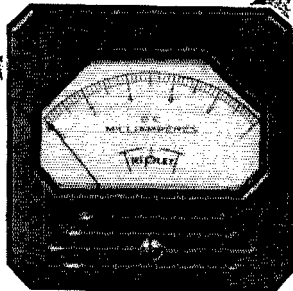

**Model 327**

3" Instrument designed for flush mounting; molded case.

## MOST MODELS AVAILABLE with FRONT or REAR ILLUMINATION

Today's most modern instruments . . . 18 styles to fit individual taste . . . at popular prices.

New methods and extremely accurate processes are embodied in Triplet instrument designs. An example is the long research in developing a super-magnet (the heart of the instrument) by means of which it has been possible to eliminate extra pole pieces. This achievement has brought from prominent laboratories, graphs that prove Triplet magnets give more uniform scale characteristics.

**Model 327 used in NEW THORDARSON 100 Watt Multi-Band TRANSMITTERS**

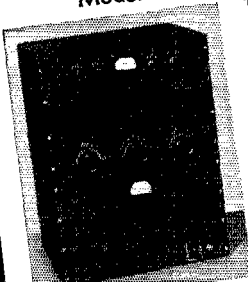

*(Full details are elsewhere in this issue).*

The Model 327 used in the R.F. unit has a range from 0 to 200 Milliamperes.

The Model 327 used in the Modulator unit has a range from 0 to 300 Milliamperes.

The Triplet Electrical Instrument Co.  
259 Harmon Dr., Bluffton, Ohio

Please send me more information on . . . . . Model 327.

Name . . . . .

Address . . . . .

City . . . . . State . . . . .

## A.R.R.L. QSL Bureau

FOR the convenience of its members, the League maintains a QSL-card forwarding system which operates through volunteer "District QSL Managers" in each of the nine United States and five Canadian districts. In order to secure such foreign cards as may be received for you, send your district manager a standard No. 10 stamped envelope. If you have reason to expect a considerable number of cards, put on an extra stamp so that it has a total of six-cents postage. Your own name and address go in the customary place on the face, and *your station call should be printed prominently in the upper left-hand corner.*

- W1—J. T. Steiger, W1BGY, 35 Call Street, Willimasset, Mass.
- W2—H. W. Yahnel, W2SN, Lake Ave., Helmetta, N. J.
- W3—R. E. Macomber, W3CZE, 418 10th St., N. W., Washington, D. C.
- W4—G. W. Hoke, W4DYB, 328 Mell Ave., N. E., Atlanta, Ga.
- W5—E. H. Treadaway, W5DKR, 2749 Myrtle St., New Orleans, La.
- W6—Horace Greer, W6TI, 414 Fairmount Ave., Oakland, Calif.
- W7—Frank E. Pratt, W7DXZ, 5023 So. Ferry St., Tacoma, Wash.
- W8—F. W. Allen, W8GER, 324 Richmond Ave., Dayton, Ohio.
- W9—Roy W. McCarty, W9KA, 11 South Michigan Ave., Villa Park, Ill.
- VE1—J. E. Roue, VE1FB, 84 Spring Garden Rd., Halifax, N. S.
- VE2—C. W. Skarstedt, VE2DR, 236 Elm Ave., Westmount, P. Q.
- VE3—Bert Knowles, VE3QB, Lanark, Ont.
- VE4—George Behrends, VE4RO, 186 Oakdean Blvd., St. James, Winnipeg, Manitoba.
- VE5—H. R. Hough, VE5HR, 1785 First St., Victoria, B. C.
- K4—F. McCown, K4RJ, Family Court 7, Santurce, Puerto Rico.
- K5—Norman F. Miller, K5AF, 15th Air Base Squadron, Albrook Field, Canal Zone.
- K6—James F. Pa, K6LBH, 1416D Lunalilo St., Honolulu, T. H.
- K7—Dean Williams, K7ELM, Box 2373, Juneau, Alaska.
- KA—George L. Rickard, KA1GR, P. O. Box 849, Manila, P. I.

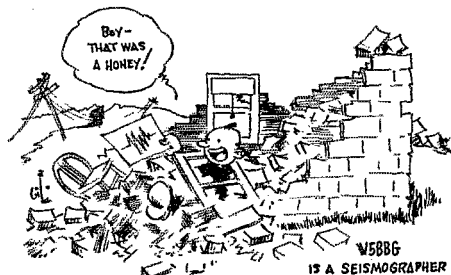

# Taylor Tubes Endorses THORDARSON

## 100 WATT TRANSMITTER

The SALES CHAMPION



# TZ-40

has been chosen by THORDARSON as the tube which offers more value and finer performance.

Taylor Tubes is honored and happy at this selection by America's Oldest Transformer specialists. We are certain that the TZ-40 will live up to all legitimate claims made for it. We *highly endorse* this fine 100 Watt Transmitter. For better results use Thordarson T-14M49 Class B. Audio output transformers with the TZ-40.

### COMPARE !!

#### TZ-40 RATINGS — CLASS B AUDIO

- Filament — 7.5 Volts..... 2.50 amps
- Amplification Factor..... 62
- \* Plate — 1,000 Volts..... 220 ma
- \* Driving Power..... 3 watts
- \* Plate to Plate Load..... 6800 ohms
- \* Audio Output..... 175 watts

Price — \$3.50

\* Indicates Two Tubes

# IT'S NEW! Panel Band-Switching

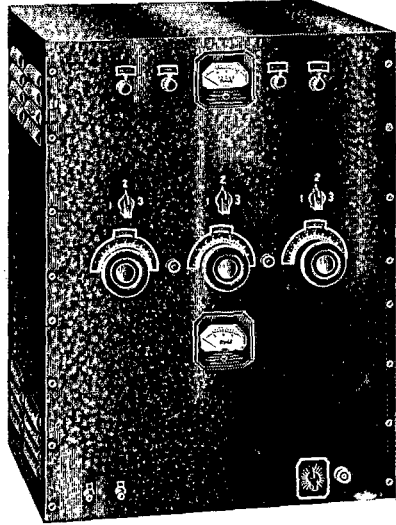

## THORDARSON "MULTI-BAND" TRANSMITTER

AVAILABLE ON THE M & H TIME PAYMENT PLAN  
Designed to give the amateur what he wants. You will like the flexibility which panel band-switching gives your operation. Mounts in standard cabinets or racks.

#### AMATEUR SPEECH AMPLIFIER

Optional over-modulation control—  
Adapted to any phone transmitter—  
R. F. feed-back and hum eliminated  
—Standard rack and panel or table model.

Headquarters for all Nationally-Advertised Parts

# M & H

**SPORTING GOODS CO.**  
512 Market St., Philadelphia, Penna.  
1709 Atlantic Ave., Atlantic City, N. J.

BY THORDARSON



**NOW**  
**this high-powered radio engineering library**

sent to you for 10 days' trial —  
 at a special price and terms

These books cover circuit phenomena, tube theory, networks, measurements, and other subjects — give specialized treatment of all fields of practical design and application. They are books of recognized position in the literature — books you will refer to and be referred to often. If you are a researcher or experimenter — if your interest in radio is deep-set and based on a real desire to go further in this field — you want these books for the help they give in hundreds of problems throughout the whole field of radio engineering.

**RADIO ENGINEERING LIBRARY**

— especially selected by radio specialists of McGraw-Hill publications — to give most complete, dependable coverage of facts needed by all whose fields are grounded on radio fundamentals  
 For home-study and reference. Contains a revised selection of books culled from latest McGraw-Hill publications in the radio field.

**5 volumes, 3064 pp., 2000 illustrations**

1. Glasgow's PRINCIPLES OF RADIO ENGINEERING
2. Terman's MEASUREMENTS IN RADIO ENGINEERING
3. Chaffee's THEORY OF THERMIONIC VACUUM TUBES
4. Hund's PHENOMENA IN HIGH-FREQUENCY SYSTEMS
5. Henney's RADIO ENGINEERING HANDBOOK

**Special Low Price and Easy Terms**

Bought singly, the five volumes comprising this library would cost you \$25.00. Under this offer you save \$1.50 and, in addition, have the privilege of paying in easy installments beginning with \$2.50, 10 days after receipt of the books, and \$3.00 monthly thereafter. Take advantage of these convenient terms to add them to your library now.

**SEND THIS ON-APPROVAL COUPON**

McGraw-Hill Book Co., Inc.  
 330 W. 42nd St., New York, N. Y.

Send me Radio Engineering library, 5 vols., for 10 days' examination on approval. In 10 days I will send \$2.50, plus few cents postage, and \$3.00 monthly till \$23.50 is paid, or return books postpaid. (We pay postage on orders accompanied by remittance of first installment.)

Name.....  
 Address.....  
 City and State.....  
 Position.....  
 Company..... QST 9-38  
 (Books sent on approval in U. S. and Canada only)

**Preselection Simplified**

(Continued from page 15)

single antenna. However, a change of receiving antennas will probably necessitate slight readjustment of at least the antenna coupling condenser, and possibly of the various trimming condensers as well. For a given antenna, the antenna coupling condenser is set to give a good balance between sensitivity and freedom from blocking. The sensitivity is increased slightly by an increase of capacity of the antenna coupling condenser, whereas the sharpness of tuning is decreased by an increase of capacity of this control. Because only one antenna condenser is used, the final setting is determined by the general operation of the preselector on all bands, or on the bands on which its operation is considered most important.

Just as there was little to be said on the construction of this unit, there is also little to be said on troubles to be expected with it. Of the former, little need be done; while of the latter, there is little likelihood that any will be encountered. The preselector requires only a short while for construction, only a few minutes for adjustment, and, very likely, no time at all for correcting trouble. Any of the three tube types works well with the set. The 1851 gives slightly improved operation with 6.3-volt sets, and is to be preferred even at a somewhat higher cost.

It is interesting to note that when this preselector was planned, it was expected to prove a valuable addition to the receivers in the medium- and low-price class, but it was certainly not expected that the operation of the device would warrant continuous use of it in conjunction with one of the most expensive amateur receivers. Operation of the preselector has proved otherwise, however, and it is found to be quite a decided improvement with a set of the latter class.

Furthermore, those amateurs possessing regenerative receivers and desiring to take the step to t.r.f.-regenerative receivers will find this a simple way to achieve the latter without a complete rebuilding operation. While this means that the r.f. stage and detector lack the gang tuning feature usually associated with such receivers, the superiority of a regenerative r.f. amplifier over the usual non-regenerative stage must not be forgotten.

Thus, while the major advantages of this simple gadget include increased signal-image ratio and added sensitivity for large superheterodynes, an important reduction of image and increase of r.f. amplification for medium-size supers, and a tremendous advantage on all counts for the smallest superheterodynes, it also finds a place beside one-, two-, three-, and four-tube regenerative receivers with or without built-in r.f. stages; and it aids more than anything else could, with any of the sets listed above, in reducing the effect of exceptionally strong signals in the same band, distant perhaps from the frequency of the desired station, but too strong to allow satisfactory reception with the receiver alone.



# BIG NEWS-GOOD NEWS for HAM'S

ORDER TODAY  
Direct from this ad!

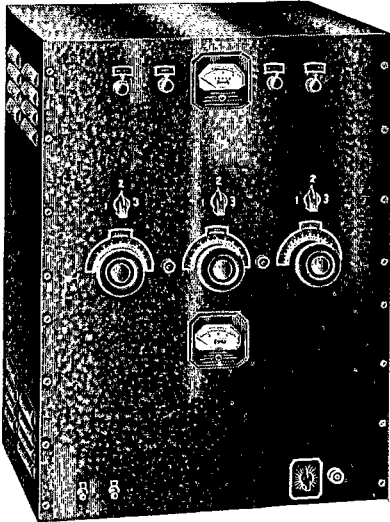

## PLATE and FILAMENT TRANSFORMERS

600 VOLTS—200 MILS  
Another Scoop by Newark.  
Famous plate and filament  
transformer made for us only.  
Thousands used in Ham rigs.  
600-0-600 at 200 M. A.; 2.5 v.  
at 10 amps; 5 v. at 3 amps;  
7.5 v. at 3 amps. Weight 10  
lbs. Use this transformer for  
your Buffer and Final amp.  
stages. Just the thing  
for 46's, T-20's, 807's, \$2.95  
etc. N.1000.....

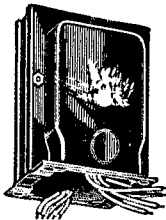

## NEW "FOREIGN ORDER" DEPARTMENT

Special Attention given to FOREIGN  
ORDERS in this new Export Department.  
Hams outside the U. S. be sure to WRITE  
TODAY for Big New Catalog and full  
details of Newark's New Foreign Order  
Dept.

# NEWARK Electric Company

323 W. MADISON ST.  
Dept. Q CHICAGO, ILL.

BY THORDARSON

## THORDARSON MULTI-BAND TRANSMITTER

SEND ONLY \$10 WITH ORDER

then a small payment on delivery  
and the balance in 6, 9, or 12 months.

on NEWARK'S  
EASY-PAY PLAN

## THORDARSON's latest design

with Panel Band Switching and Other Big Features!

- 100 watts input on all bands.
- Power supply and R.F. section on one chassis.
- Single meter reads all plate currents as well as grid current of the final stage.
- Modulator and power supply on one chassis.
- Bands switched from front of panel.
- R.F. lineup 6L6G-6L6G TZ-40.
- Modulator lineup—6J7, 6F5, 6F6, 2-6L6's.
- Crystal for each band.
- Band-switching feature optional, regular plug-in coils may be used.

All parts are ready for immediate delivery from complete stock on hand and will be shipped promptly in "Foundation Unit" form with complete instructions for assembly and operation. Chassis, panels and chassis brackets are supplied completely punched for easy assembly. Entire transmitter, requiring but 20% of panel space, may be mounted in any standard cabinet or rack on the market. Only standard parts of nationally known manufacture and highest quality are used. Both R.F. and modulator units supplied complete with their own power supplies. Complete band-switching from front of panel. Approximate Price Complete Including Cabinet but Less Tubes and Crystals..... **\$139.50**

Write for Complete Circular and Time Payment Details

## Thordarson Universal SPEECH AMPLIFIER

Total approximate price \$27.45

less tubes and metal cover with regular type transformers and 500 ohm output. Prices on C. H. T. Transformers on request.

Designed to eliminate transmitter building troubles for the Ham. The 2A3 Output stage provides ample driving power. Chassis adaptable to rack-and-panel mounting or to conventional chassis type with metal screen cover and bottom. Supplied less panel, but with panel, drawing and full instructions included. Easy terms when included in an order of \$60.00 or more.

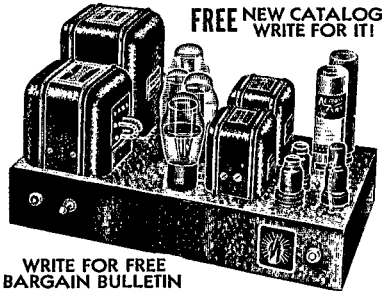

FREE NEW CATALOG  
WRITE FOR IT!

WRITE FOR FREE  
BARGAIN BULLETIN

See us at the AMATEUR SHOW—SEPT. 3-4-5, CHICAGO

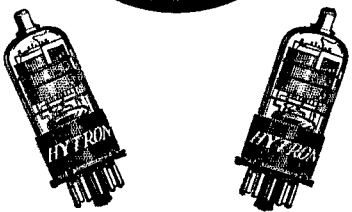

## BANTAM SERIES RADIO TUBES

1. Lower interelectrode capacities.
2. Longer life — more rugged construction.
3. Space economy, — Dia.  $1\frac{1}{4}$ " , overall dimensions ranging from  $2\frac{1}{4}$ " to  $3\frac{5}{16}$ ".

**Bantam Tubes Cost No More Than "Metal" or "G" Series**

### TYPES

6AC5GT	*6K5GT	*6R7GT
*6A8GT	6K6GT	6X5GT
*6C5GT	*6K7GT	25A6GT
*6F5GT	*6K8GT	25A7GT
6H6GT	*6P5GT	25L6GT
*6J5GT	6Q5GT	25Z6GT
*6J7GT	*6Q7GT	

**Bantam Types are Interchangeable with "Metal" and "G" Series**

*\*Shields furnished with necessary types as indicated.*

Packed in "sealed cartons" for your protection. Ask your distributor or write us for technical data.

## HYTRON CORPORATION

76 Lafayette Street  
Salem, Massachusetts

## Interpreting 1938's 56-Megacycle DX

(Continued from page 24)

what the skip distance was in different directions. Knowing the skip distance and the height of reflection (more about this in a minute) I could calculate the amount of ionization which had to be at the midpoint of the path to reflect a five-meter wave. After marking these points I went on to study the locations heard in Kansas City, and so on. When I had been through all the reports I had a map with nearly a hundred points marked on it, and alongside each point a note of the ionization there. Then I drew contours much like those on a topographic map, except that in this case they show how far the high ionization extended. Of course there is a serious flaw in it, because we don't know at what time of day the various levels were reached. We can say, though, that the map shows the highest levels reached at each point, which is a good step in the right direction.

Now a word about this question of height of reflection. We have known for some years what is called "abnormal E ionization" occurs mostly in May, June, and July. Since this is just the time when 56-Mc. DX occurs, it looks as though there were a connection. This year we have been noting that the abnormal E ionization, which we usually observe at low frequencies to be about 70 miles up, occurs on the same days and often at the same hours with 56-Mc. DX. This pretty well settles the matter, but there is still a nice point in connection with Fig. 1. If you figure out how far you can send a signal around the curve of the earth by reflecting it at a height of 70 miles, the answer turns out to be about 1400 miles, and this is just the place where our curve reaches zero. This means that the height of reflection really is about 70 miles, and that if we want to talk over 1400 miles the signal must make it in two or more jumps. Since this sort of ionization doesn't often extend over as big a region as 1500 miles we can't expect that transcontinental QSO's will happen very often. The only confirmed report of one yet is between Fairfield, Conn. and San Diego in the early evening of July 24. At this time there must have been high ionization over Indiana and over Northern New Mexico, and the signals probably were reflected from the earth somewhere near Kansas City. If this is right, stations in Missouri and Kansas should have been able to work both the East and West coasts. We hope the gang will report any work of this sort which took place.

All this should give a rough idea of the way this sort of data can be worked up. What we want is to find out as much as possible about when and where 56-Mc. DX has occurred. It is a lot of work to study all the data, and it may take years before we can be sure of all the answers, but sooner or later we shall be able to foretell radio conditions and that, to most of us, will be the useful outcome of this sort of study. There will be other results, too, but, like the results of much scientific work, we can't tell just how the answers will be useful until after we get them. It's all a fascinating conundrum, and another chance for the amateur to contribute to the knowledge of radio.

**QUICK**  
BAND SWITCHING!

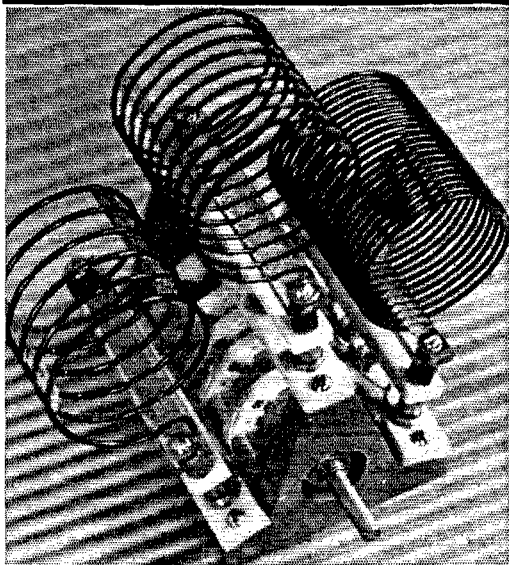

*. . . with the B & W*  
**MODEL B TURRET**  
*used in the NEW*  
**THORDARSON 100-WATT**  
**"MULTI-BAND" TRANSMITTER**

The B & W MODEL B TURRET makes possible one of the most important features of the THORDARSON "MULTI-BAND" — *fast, effortless, highly accurate band switching!*

It was selected by Thordarson engineers as the only band switching unit on the market today that offers the high standard of scientific design, proved efficiency, rugged construction and easy, positive operation they insisted upon in designing the "Multi-Band."

The MODEL B TURRET enables you to change bands and "tune on the nose" with a flick of a switch . . . *from the front of the panel!* You can select any 3-band combination — simply plug in the desired coils! You can pre-tune coils for spot frequency operation! In short, you get the quickest, easiest and most practical band changing you've ever known!

See the new Thordarson "Multi-Band" Transmitter at your dealer's — note particularly the many advantages in the use of the B & W TURRET. At the same time, get acquainted with other B & W AIR INDUCTORS — there's a type and size for every inductance application!

● **BARKER & WILLIAMSON**  
ARDMORE, PENNA.

See the  
NEW  
**THORDARSON**  
"MULTI-BAND"  
TRANSMITTER  
with  
**PANEL**  
**BAND-SWITCHING**

and the  
NEW UNIVERSAL  
SPEECH AMPLIFIER  
Designed for Hams  
at the

CALIFORNIA AMATEUR'S  
Favorite Supply House

**PACIFIC RADIO**  
EXCHANGE, INC.

729-31 SOUTH MAIN ST.

LOS ANGELES, CALIF.

**BY THORDARSON**

# REMEMBER

ONLY UNTIL  
AUGUST  
31

To take advantage of the special offer of membership-subscription and a copy of the 1938 edition of the "Handbook" for

\$3

## ? COMMERCIAL RADIO ?

In planning to prepare yourself for a job in Commercial Radio be sure and investigate the advantages offered by our resident day and evening courses.

**EASTERN RADIO INSTITUTE**  
899 BOYLSTON STREET BOSTON, MASS.



He's right, my lad! For real results on 5

USE A

**BLILEY HF2 10-Meter CRYSTAL**

## An Auxiliary Transmitter for 1.7- and 3.5-Mc. Work

(Continued from page 37)

to the coil form pins. Thus, if series tuning is required on one hand and parallel tuning on the other, the change may be made automatically when antenna coils are changed.

With the antenna coupled and the entire transmitter running, a last check should be made on the screen voltages to make certain that they are still appropriate. It would also be advisable to check grid current to the 807 to make sure that the tube is receiving sufficient excitation. A grid current reading of 3 to 5 ma. should be satisfactory.

### NOTES ON E.C.O. ADJUSTMENT

It has been mentioned previously that the position of the cathode tap (or the size of the cathode winding) has been found to have appreciable effect upon frequency stability when keying and upon the power output of the oscillator. If the details given have been followed carefully, no trouble should be experienced with chirpy keying. The following suggestions may be helpful, however, in case something goes amiss and checking becomes necessary.

Starting with a cathode winding with approximately one-third the number of turns in the grid winding, turns in the cathode coil should be reduced one at a time, each time noting the grid current to the 807 and monitoring the signal for stability. As the number of turns is reduced, the grid current will probably increase and a maximum of 7 or 8 ma. may be obtained. Usually at this point chirps with keying are quite evident, however, so that it is necessary to reduce turns still further until the chirp disappears. It should be possible to maintain a grid current of 3 to 5 ma. with good keying characteristics.

### OPERATION

Once everything is set, operation is of utmost simplicity. If the oscillator has not been calibrated, the frequency may be set to any desired point by monitoring with the station receiver. While setting frequency, the 807 cathode switch should be opened to prevent the signal from being radiated. As soon as the frequency has been set, the final amplifier may be turned on and the key closed momentarily while the antenna tuning is swung to resonance as indicated by maximum rise in plate current. To change bands only a change of plug-in coils in the amplifier plate and antenna circuits is necessary.

Since considerable heat is developed during the course of operation, it would be well to drill several large holes in the upper part of the cabinet. Otherwise, some initial drift in frequency may be experienced. Once the unit has become thoroughly warmed up, frequency should remain quite constant.

**"MULTI-BAND" TRANSMITTER**

*naturally . . . .*

# "MULTI-BAND" TRANSMITTER BY THORDARSON

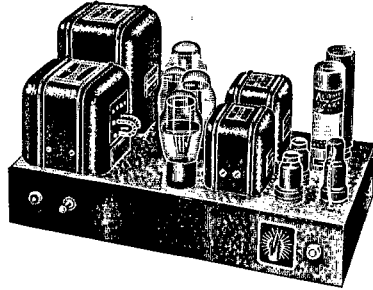
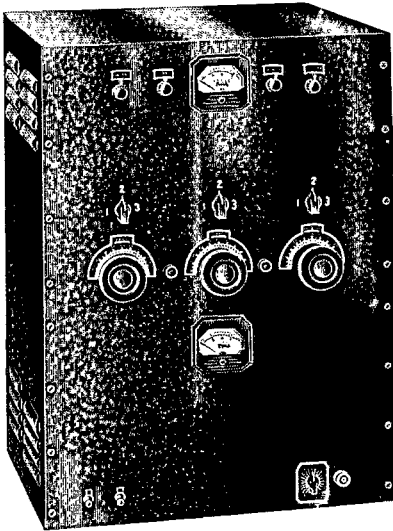

*. . . would be*

# HERE

FIRST WITH THE LATEST . . . as usual . . . we present for your investigation the completely assembled and wired transmitter . . . also the amplifying equipment . . . drop in and have a look-see

# TERMINAL *Radio Corporation*

80 CORTLANDT STREET, NEW YORK, N. Y.

**BY THORDARSON**

THE STANDARD OF COMPARISON

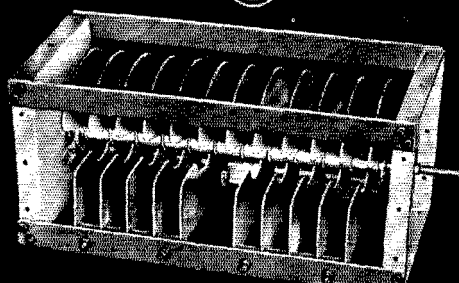

# New CARDWELL TYPE "P" LIGHT WEIGHT CONDENSER For COMMERCIAL And AMATEUR HIGH POWER TRANSMITTERS

Intended as it is for commercial application, the "P" type Cardwell is characteristic of all its larger and smaller companions in the Cardwell line, representing highest quality of material and workmanship. Four types are listed which may be of interest to high power amateur constructors as well as the commercial designers for whom they are intended.

### General specifications on "P" type CARDWELLS:

- End Plates**—Stamped and folded  $\frac{1}{4}$ " aluminum  $7\frac{1}{2}$ " square, satin finish.
- Mounting**—On any side—alsimag stand-off insulators provided for raising electrically and mechanically above chassis ground, if desired.
- Rotor Contacts**—Heavy disc type double finger wipers on each end of condenser.
- Insulation**—High frequency G.E. mycalex. No metal tie rods.
- Rotor Plates**— $.0625$ " thick,  $6\frac{3}{4}$ " diameter, buffed and polished aluminum. Extra large plates make possible dual condensers for high power amplifiers of sufficiently high "C" for optimum "Q", without abnormal frame length.

## NEW "P" TYPE CARDWELL High Power Dual Transmitting Capacitors

Type	Per Section		Air Gap	Depth Back	List Price	Amateur Price
	Max. Cap.	Min. Cap. Plates				
PKD-70-OD	70	7	.350"	8 $\frac{1}{2}$ "	\$58.00	\$34.80
PKD-100-OD	95	22	.350"	12"	66.00	39.60
PZ-70-OD	75	9	.500"	14"	69.50	41.70
PZ-100-OD	95	26	.500"	16"	77.50	46.50

Specials made to customer's requirements. Inquire.

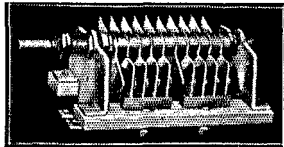

ANOTHER INDUSTRIAL APPLICATION permits us to offer you TYPE NP-35-DD, a modification of the very popular Ultra H.F. Dual Condenser, NP-35-ND. Identical with the familiar type except plate edges are specially processed to prevent corona and flashover, instead of being buffed and highly polished. Slightly

lower flashover rating is the only difference in electrical characteristics.

- NP-35-ND, with buffed and polished plates..... \$6.00 list
- NP-35-DD, not buffed or polished..... 5.35 list

SEND for reprint of the excellent article by Irv. Wolf, W2KTC, on "the QRM DODGER."

ALSO: New and up to date condensed listing of CARDWELL QUALITY PRODUCTS. JUST ASK FOR "UCP SHEET FOR 1939."

**THE ALLEN D. CARDWELL  
MANUFACTURING CORPORATION**  
83 PROSPECT STREET, BROOKLYN, NEW YORK

## How Would You Do It?

(Continued from page 50)

A very similar idea was submitted by W80MM. It is shown in Fig. 4. A coil of a few turns wound in a direction opposite to that of the tank coil is inserted in series with the coil at the center or at one end and provision made for varying the coupling. The circuit is shown in Figs. 2B and 2D. As the coupling is increased, the total inductance decreases because of the bucking action of the reversed coil. If the small coil is wound in the same direction as the main coil, the variation in frequency will be reduced somewhat, but the Q of the coil should be better than with the reversed-turn arrangement. In this case, inductance increases with an increase in coupling. With circuit A, the link winding preferably should be split and coupled to the outside ends of the tank coil. Electrostatic shielding between tank coil and links is recommended to eliminate electrostatic coupling.

W80KP suggests the arrangement shown in Fig. 5 in which half of the tank coil is mounted so that the coupling between it and the other half may be varied. The circuit is shown in Fig. 2C. W80KP states that a tuning range of about 300 kc. at 3.5 Mc. may be obtained in this fashion.

The third method of changing inductance by the introduction of a block, ring or disk of metal is suggested by W8KYN and W1KFN. W8KYN uses a mechanical arrangement similar to that shown in Fig. 4. A ring of wire or heavy brass or copper is substituted for the coil. Its resistance should be as low as possible and the ends should be brazed together rather than soldered.

Figs. 6A and 6B show the method used by W1KFN. The block of brass, when brought into the field of the coil, will reduce its inductance, while the iron will increase it. If the brass block is sufficiently large, the change in inductance should be sufficient to make the iron block unnecessary. The iron block was used to eliminate the necessity for pruning the tank coil within close limits, although it reduces the efficiency of the coil. W1KFN uses large  $1\frac{1}{2}$ " brass nuts, which he obtained at a hardware store, for the brass blocks. This system has the advantage that standard-type coils may be used and no complications are involved in antenna coupling.

In the first arrangement shown at A, the metal blocks are mounted on a sliding rod controlled from the panel. The rod is marked with a scale of points so that settings may be duplicated. If plug-in coils are used, it is necessary to use a plug-in scheme at the rear support to permit removal of the coil. This objection is eliminated in the second arrangement shown at B. A similar idea was submitted by W2KZK.

The last idea is shown in Fig. 2A. The tank coil is provided with short-circuiting taps. This simple scheme might work out satisfactorily if operation at only two or three fixed frequencies is desired, but would undoubtedly be unsatisfactory for a continuous frequency range.

# "MULTI-BAND" TRANSMITTER

## RADIOGRAM

ST. LOUIS, MO., 1100 PINE ST., SEPT. 1, 1938

TO ALL AMATEUR OPERATORS  
AND BROADCAST ENGINEERS:

WE WISH TO STATE THAT AS ALWAYS WE MAINTAIN A COMPLETE STOCK OF THE BEST MATERIALS OBTAINABLE FOR CONSTRUCTION OF BOTH AMATEUR AND BROADCAST STATIONS.

OUR AIM IS TO PLEASE THE MOST DISCRIMINATING BUYER AND TO GIVE PROMPT SERVICE. OUR TECHNICIANS W9FIS W9KEH ARE ALWAYS ON HAND TO ASSURE YOU OF THIS SERVICE PLUS HELPFUL ADVICE AND ULTIMATE SATISFACTION.

YOU ARE INTERESTED IN THE THORDARSON MULTI BAND TRANSMITTER AND YOU MAY REST ASSURED WE CARRY IN STOCK AT ALL TIMES EVERY SINGLE ITEM FOR THE COMPLETION OF THIS UNIT. NO SUBSTITUTIONS ARE NECESSARY.

WE ARE DISTRIBUTORS FOR THE FOLLOWING MANUFACTURERS WHOSE PRODUCTS ARE INCORPORATED IN THE THORDARSON MULTI BAND TRANSMITTER.

AMPHENOL  
BARKER & WILLIAMSON  
BLILEY  
BUD

CENTRALAB  
CORNELL DUBILIER  
COTO COIL  
CROWE

IRC  
JOHNSON  
MALLORY  
NATIONAL  
OHMITE

SIMPSON  
TAYLOR  
THORDARSON  
TRIPLETT

THIS COMPLETE STOCK PLUS OUR ASSISTANCE IN EVERY CONCEIVABLE MANNER ARE THE REASONS YOU SHOULD PURCHASE YOUR PARTS FOR THE MULTI BAND TRANSMITTER FROM US.

(SIGNED) WALTER ASHE RADIO CO.  
G. E. BIDWELL W9FIS  
J. KEESE W9KEH

## First Consideration... CORNELL-DUBILIER Capacitors WITH THORDARSON MULTI-BAND TRANSMITTER

RADIO amateurs know they can rely on C-D quality and dependability for best results in high voltage power supplies — it's no wonder most hams insist on Cornell-Dubilier!

We recommend DYKANOL capacitors for high powered transmitters. Cornell-Dubilier types TJ-U and TL-A Dykanol filter capacitors will operate even at voltages 10% higher than rating!

C-D Dykanol capacitors are FIREPROOF!

THERE ARE CORNELL-DUBILIER CAPACITORS FOR EVERY RADIO REQUIREMENT — PAPER, MICA, DYKANOL, WET & DRY ELECTROLYTICS

Write for catalog 161 for complete listing

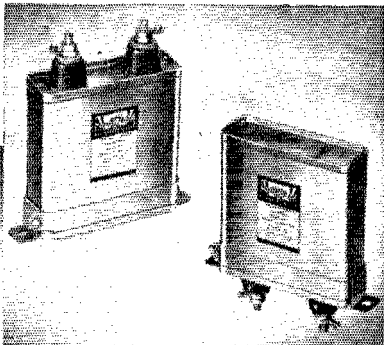

### TYPE TJ-U

Hermetically sealed.  
Universal mounting  
brackets.

### TYPE TL-A

Hermetically sealed  
in round aluminum  
containers.



## CORNELL-DUBILIER ELECTRIC CORPORATION

1022 Hamilton Boulevard, South Plainfield, New Jersey  
Cable Address: "CORDU"

### BY THORDARSON

Say You Saw It in QST — It Identifies You and Helps QST

# INTERESTED IN TELEVISION?

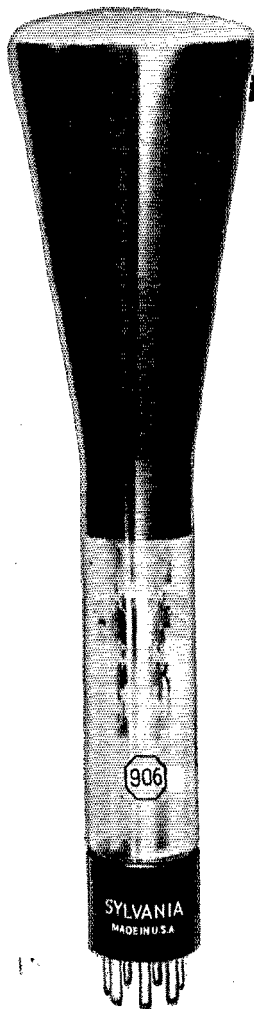

## — Sylvania announces cathode-ray picture tube type 906

If you are one of today's modern amateurs . . . this announcement will prove of value to you.

For Sylvania's new television tube, type 906, is especially intended for use in compact equipment sets. Due to its size (approximately 12" x 3") and the brilliance of its image . . . this cathode-ray tube is just what you want — particularly for that small-sized receiver you plan to build. And of course, type 906 is high in quality like every other Sylvania tube.

Send today for **FREE** technical information on this tube. Write Dept. Q-9, Hygrade Sylvania Corp., Emporium, Pa. Also makers of famous Hygrade Lamp Bulbs.

# SYLVANIA

SET-TESTED RADIO TUBES

No information as to the relative losses involved by the various methods was submitted. It is probable that the difference is not marked, but it is quite obvious that the losses introduced by any of the systems described, with the possible exception of the tapped coil method, would run appreciably higher than with the usual variable air condenser and low-loss coil combination. It would appear that the schemes of Figs. 5 and 6 would cause some unbalance in a push-pull or neutralized amplifier circuit unless the split-stator neutralizing circuit is used.

Prize-winners are as follows:

First Prize: Thomas Marshall, W1KFN  
Second Prize: Joseph J. Frekot, W3CHH

Rules under which the contest is conducted are as follows:

1. Solutions must be mailed to reach West Hartford before the 20th of the publication month of the issue in which the problem has appeared. (For instance, solutions of problem given in the April issue must arrive at *QST* before April 20th.) They must be addressed to the Problem Contest Editor, *QST*, West Hartford, Conn.

2. Manuscripts must not be longer than 1000 words, written in ink or typewritten, with double spacing, on one side of the sheet. Diagrams must be neat and legible.

3. All solutions submitted become the property of *QST*, available for publication in the magazine.

4. The editors of *QST* will serve as judges. Their decision will be final.

Prizes of \$5 worth of A.R.R.L. station supplies or publications will be given to the author of the solution considered best each month, \$2.50 worth of supplies to the author of the solution adjudged second best. The winners are requested to specify the supplies preferred.

## More on the 1851

(Continued from page 40)

having a single preselector stage, proper adjustment of grid bias resulted in a reduction in circuit loading to the point where the performance with respect to image response was about the same as with the 6K7. The gain of the stage, however, increased 40 per cent to 50 per cent, and the noise equivalent (signal input required to give the same audio power output as the noise alone) dropped about 20 per cent. These results were obtained with 250 volts on the plate, 150 on the screen, and 3.25 negative on the control grid, and represented optimum conditions obtained after trying a considerable number of combinations. To get these voltages, the screen was fed through a 40,000-ohm series resistor from the plate supply, and the cathode resistor was 1500 ohms. The gain and signal-noise ratio figures apply, of course, only in the particular instance taken.

The improvement in signal-to-noise ratio is likely to depend considerably on the particular receiver in which the comparison is made. On the basis of the tubes alone, the 1851 according to the



## "MULTI-BAND" TRANSMITTER

Butler, Missouri  
August, 1938

Now and then I get enthused about some new piece of equipment. The New Thordarson 100 Watt Multi-Band Transmitter and Universal Speech Amplifier are such items. If you are new in the game they are just the gear to start with and if you are an old timer you will realize the extra features that make them so well liked.

Think of the advantage of being able to use ALL amateur bands and of being able to use band switching on ANY THREE BANDS. I know from my experience that I pass up lots of QSOs and DX because it takes time and effort to change bands.

These new kits give you maximum performance and value and will not go out of date "next year." The RF unit and its power supply are complete in one unit and, if you should wish to increase power, will drive a 1 kw final stage. The speech amplifier and modulator unit will drive a 500 watt, class B audio stage. Both units can be used either in relay racks or in cabinets for table use.

Thordarson has done for you the hard work of designing the units and drilling all holes. The line-up is most sensible. All parts are arranged for greatest accessibility, ease of operation, and maximum efficiency. Excitation is more than sufficient, even on the highest frequencies.

Thordarson has made the kits available. Bob Henry makes it easy for you to own them. Consider these reasons why it is to your advantage to buy from Bob Henry, W9ARA:

You get personal attention. I will see that everything is handled as you wish and that you are 100% satisfied. From our experience in building the kits, we supply you with valuable information about using them. We have the kits as a packaged unit containing everything. Or we have the parts individually.

You can buy the kits assembled and wired ready for you to use.

You can buy them on Bob Henry's economical, 6% time plan, on terms arranged to suit you personally and financed by myself, so you can buy with less cost and more convenience. No finance company is concerned in the matter.

It is not possible to give complete details here, so write to Bob Henry, Butler, Missouri for prices, terms, and all other information. Your inquiries are invited. You can reach me by letter, telegram, 'phone, or visit nearly 24 hours a day, 365 days a year.

*Bob Henry*

**Henry Radio Shop**

**W9ARA 211-215 N. Main S, Butler, Missouri**

**BY THORDARSON**

Your Favorite Jobber has  
**The New**  
**PRECISION 842-L**

**A.C.—D.C.—VOLT—OHM—DECIBEL  
 MILLIAMMETER—AMMETER**

**WITH 2500 VOLT A.C.—D.C. RANGE  
 AND 1000 M.A. AND 10 AMP. RANGES**



**SPECIFICATIONS**

- ★ **5 A.C.-D.C. VOLTAGE RANGES** from 0-2500 volts at 1000 ohms per volt. 0-10; 0-50; 0-250; 0-1000; 0-2500 volts.
- ★ **6 D.C. CURRENT RANGES.** 0-1; 0-10; 0-50; 0-250 MA; 0-1; 0-10 AMPS.
- ★ **4 RESISTANCE RANGES.** 0-400 ohms (20 ohms center) Shunt Method; 0-100,000 ohms (800 ohms center); 0-1 Megohm (8000 ohms center); 0-10 Megohms (80,000 ohms center). Note: Provisions for mounting ohmmeter power supply (4½ and 45 v. batteries) on inside of case. No external connections necessary.
- ★ **5 OUTPUT RANGES.** 0-10; 0-50; 0-250; 0-1000; 0-2500 volts.
- ★ **5 DECIBEL RANGES** from -10 to +63DB; 0DB; +14DB; +28DB; +40DB; +48DB.

Complete facilities for obtaining all measurement requirements for Service, Amateur, Laboratory, Industrial use. Master Rotary Switch permits speedy selection of all ranges. Large PRECISION 4½ inch square type meter with easy reading scales and large numerals. The base sensitivity of the meter movement, 400 microamperes, permits overlapping resistance ranges up to and including 10 megohms, and A.C.-D.C. voltage ranges at a sensitivity of 1000 ohms per volt.

Ask for the new PRECISION catalog incorporating complete data on this popular unit, as well as all the other PRECISION ENGINEERED test instruments.

**842-L**—Size 7½ x 8½ x 4. Housed in walnut finished wood case with carrying handle. Less Batteries and Test Leads. Net..... **\$21.95**

**PRECISION  
 APPARATUS CORP.**

**821 EAST NEW YORK AVE.  
 BROOKLYN, NEW YORK**

Export Division: 458 BROADWAY, NEW YORK CITY  
 Cables: "MORHANEX"

figures furnished is about three times as good as the 6K7. This does not mean, however, that a 3-to-1 improvement can be realized just by replacing a 6K7 by an 1851. The residual noise in the receiver consists chiefly of two components, one the tube noise and the other the noise resulting from thermal agitation in the first tuned circuit. In a well-designed receiver the thermal agitation noise will be predominant and will be unchanged regardless of the type of tube used so long as the circuit Q is unaffected. Tube improvements, therefore, only affect one source of noise, so that the net gain in signal-to-noise ratio never can equal the ratio of noise between two types; indeed, the better the receiver originally the smaller the improvement that can be made. Nevertheless even a small gain is worth-while for weak-signal reception.

—G. G.

**New Apparatus**

**New 1.4-Volt Receiving Tubes**

Five tubes suitable for operation from a single-cell dry battery have been announced by the Sylvania Corporation. These glass tubes bear the following type numbers: 1A5G, 1A7G, 1C5G, 1H5G, and 1N5G.

These battery-type receiving tubes take only a very small current at the low filament voltage rating. The drain on the "B" battery by a receiver using these tubes is also low.

The 1A5G and 1C5G are power output pentodes; the 1A7G is a pentagrid converter; the 1H5G is a diode-triode for detector and audio service, and the 1N5G is a pentode suitable for an r.f. or i.f. amplifier.

**Original Cast to Present R.O.W.H.**

**T**IME will be turned back in its flight on the night of Sunday, September 4th, at the A.R.R.L. National Convention in Chicago when the original crew of Flint (Mich.) radio amateurs who staged the first R.O.W.H. initiation at the 1923 national convention will reenact the time-honored ceremony.

To recall the spirit of that first performance we can do no better than to quote from the November, 1923, *QST* account:

"The spirit of the ham as we have known him was exemplified to a remarkable degree through the initiation into the Royal Order of the Wouff Hong, held on the 'Night of Mystery.' Even the hard-boiled owl, breathing in the unmistakable sense of dignity, gazed with unblinking eye on the ritual that was here performed. The weird figures within the closely packed circle of spectators would indeed have done justice to a dramatic setting of the Middle Ages. The intangible fraternity—that something which had kept the amateurs together as a solid body—was being shown as in a play. The old-timers were quick to realize

**"MULTI-BAND" TRANSMITTER**

# We Have the New THORDARSON "MULTI-BAND" TRANSMITTER

Featuring  
PANEL BAND-SWITCHING  
and

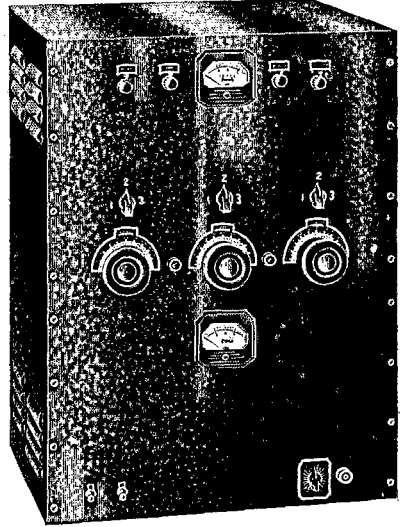

THE NEW UNIVERSAL SPEECH AMPLIFIER FOR HAMS

# CAMERADIO

963 Liberty Ave., Pittsburgh, Pa. • 30 Twelfth St., Wheeling, W. Va.

## DIAL PLATES AND KNOBS BY CROWE Meet the high-quality specifications of the THORDARSON "MULTI-BAND" TRANSMITTER

A new line of tuning dials particularly designed for amateurs and experimenters will be ready soon. These units as well as new dial plates, knobs, tuning devices and other radio components are shown in Bulletin 220. Write for a copy now.

### CROWE NAME PLATE & MANUFACTURING CO.

3701 RAVENSWOOD AVENUE

CHICAGO, ILLINOIS

**BY THORDARSON**

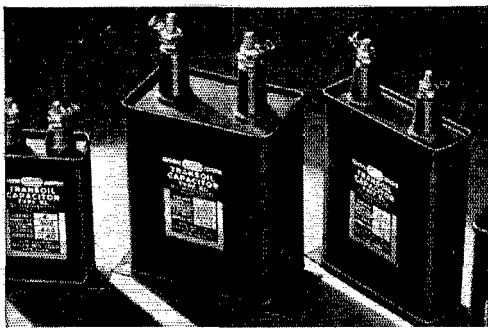

# TRANSOIL

for transmitting

**HIGHEST QUALITY  
OIL CAPACITORS**

Write for Catalog 2-X  
listing complete lines

TRANSOIL—SOLAREX—TRANSMICA

SOLAR  
MFG. CORP.



599 BROADWAY  
NEW YORK CITY



E. H. RIETZKE, Pres. CREI

## It's YOUR Job Today

to prepare for a better  
radio job tomorrow!

### CREI Training Insures Your Future

Don't say you never had the opportunity to get ahead — for here it is! Radio wants you — and needs you — for those important jobs that new equipment and methods have created. But, you must have *training first*. CREI courses in Practical Radio Engineering will give you the ability to qualify for a better job. Today's *your* chance to send for our important story.

● **Right Now . . . Write Now for Free  
Illustrated Catalog**

*This booklet will answer every question and fully describe our courses and 3 plans of study . . . as well as show you how easy it is to pay for them.*

● **One-Year Residence Course begins Sept. 19**



Still time to enroll. Now in our own new building with new equipment and facilities. Write at once for complete details.

**Capitol Radio Engineering Institute**  
Dept. Q9, 3224 16th St., N.W., Washington, D. C.

the impression. That which was needed to fill a certain gap was explained, the reason for the blown tubes, the superhet that would not 'superhet,' the dawgone nights of 'watchful waiting' when fingers itched to swat the key, a faint suggestion of what it all meant, what every man there in the Moon Room was working for—all these were brought out under the spotlight. . . ."

Fifteen years have passed, and amateur radio has changed, and even the ritual of the initiation has been condensed and refurbished—but the spirit has not changed, and it is still the sort of thing that will strike home to the real amateur. T.O.M.'s candle of truth will glow again, and the novice will be led safely through awesome perils, and again Crystal will ward off the shining blades of uplifted axes and blood-stained daggers held in dark and yellow fingers. . . . And again that imitable crowd of Flint old-timers, led by Frank Fallain, will portray in the guise of gentle humor and blood-curdling drama the true spirit of amateur radio.

Will you be there?

### Canada-U. S. A. Contest

(Continued from page 25)

tions from which no logs have been received. W6NEN (San Francisco) says, "The usual sloppy antenna was used in the contest. It is a 133 ft. end-fed affair wrapped around posts and going at all angles. This antenna has been used ever since I got my ticket with unreasonable success." Don't change it, lad, or you will lose your luck. On the other hand, W8KZL-6 (Tucson, Ariz.) used a 500-foot wire for 14 Mc. and a 66-foot doublet for 7 Mc.

For the benefit of those who wondered where all the VE's heard were located, the following might be of interest: Maritime 27, Ontario 134, Quebec 43, Alberta 30, British Columbia 76, Manitoba 33, Saskatchewan 23, making a total of 366 which is 10.6 per cent of all VE calls issued.

MARITIME		GT	30,213	194	54
	Points	ES	30,150	206	60
	QSO's	NA	22,963	193	45
	Sec's	AD	22,734	219	38
VE1KN	4488	EK	22,563	166	46
VE1CW	4350	HE	21,648	191	41
MA	842	9AL	18,159	200	49
KY	3	3DA	17,376	188	48
		ACG	16,284	139	46
		AGX	13,662	128	36
		AET	12,912	157	32
		AQC	8541	127	26
		MI	8502	109	26
		ZE	8465	110	27
ONTARIO					
VE3TR	34,642	222	53		
SF	31,089	244	43		

(Continued on page 108)

### The A.R.R.L. Convention

(Continued from page 44)

broadcasting chains will be on hand for your entertainment.

Sunday morning will be devoted to group meetings and you will be able to find several meetings where your "pet peeve" is being discussed. These meetings will cover DX, traffic, u.h.f., 'phone, c.w., emergency work, N.C.R., A.A.R.S., television and other subjects. Each meeting will have as its chairman the outstanding man in the field,

**WE CAN DELIVER —**

**The THORDARSON  
PANEL BAND-SWITCHING  
"MULTI-BAND" TRANSMITTER**

**FEATURES**

- 100 watts input on all bands.
- Power supply and R.F. section on one chassis.
- Single meter reads all plate currents as well as grid current of the final stage.
- Modulator and power supply on one chassis.

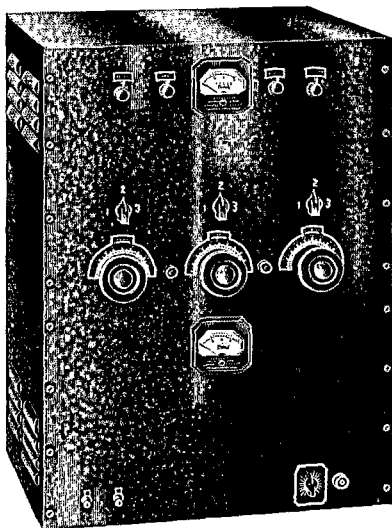

**FEATURES**

- Bands — switched from front of panel.
- R.F. lineup 6L6G-6L6G TZ-40.
- Modulator lineup — 6J7, 6F5, 6F6, 2-6L6's.
- Band-switching feature optional, regular plug-in coils may be used.

Available in foundation unit form with complete instructions for assembly and operation. R.F. and Modulator units are complete with their own power supplies. The illustration shows the R.F. and Modulator units in a standard cabinet.

**UNIVERSAL SPEECH AMPLIFIER FOR HAMS**

Foundation unit and complete parts. Designed to eliminate the trouble usually encountered by the amateur in the building of a phone transmitter. It can be used with a metal screen cover for table mounting.

*All three units fit standard racks or cabinets*

WRITE US FOR BULLETIN SD-378A

ALL PARTS USED IN THESE UNITS AVAILABLE FROM THE

**WEDEL COMPANY Inc.**

**520 SECOND AVENUE - SEATTLE, WASHINGTON**

**BY THORDARSON**

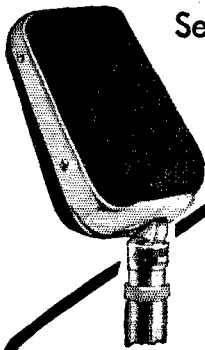

**Self-Locking  
Tilting  
Head**

**NEW  
MULTI-UNIT  
Dual Diaphragm  
CRYSTAL  
MICROPHONE**

An outstanding achievement in microphone construction for night club and public address installations. Maximum amplification without feedback. Cannot be acoustically overloaded. Made in two models. MU-2 constructed with two dual diaphragm crystal units using four diaphragms. MU-4 uses four dual diaphragm crystal units and eight diaphragms. Black and chrome. Complete with three-prong interchangeable locking connector and 25-ft. cable.

**List Prices**

**MU-2 : \$29.50  
MU-4 : 39.50**

Write for Literature



**Astatic Microphone  
Laboratory, Inc.**  
830 Market St.  
YOUNGSTOWN, OHIO  
*Licensed Under Brush  
Development Co. Patents*

**DO YOU WANT TO LEARN  
WIRELESS and TELEGRAPHY?**

A BOOK EVERY AMATEUR  
SHOULD HAVE —

*Send Now*

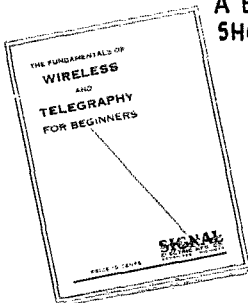

Hundreds of amateurs have learned  
from this book, so can you.

**15¢**  
POSTPAID  
COIN, OR  
STAMPS

This book gives you the fundamentals of wireless and telegraphy. It contains the codes and how to learn them. Mail your order now to:

**SIGNAL ELECTRIC MFG. CO., Menominee, Michigan**

ESTABLISHED  
1892



who will be supported by a talk from other outstanding men. There will be ample time for discussion of problems at the conclusion of each meeting.

Sunday afternoon will be in charge of the League and at that time you will hear from our officers. Particularly interesting to all should be Mr. Warner's report regarding the Cairo Conference. There is to be an "open forum" meeting at which time various League problems will be discussed. It is expected that most of the directors will be here as well as all of the officers.

Sunday evening will be the big banquet with entertainment galore—and no long after-dinner speakers or boring prize drawings. At the solemn hour of midnight the Royal Order of Wouff Hong will gather to initiate into its folds those loyal amateurs who prize the hobby of amateur radio and its traditions. (More about this elsewhere in this issue.)

Monday morning's program will offer an actual demonstration of the action of waves on transmission lines and antennas. There will also be demonstrations of airways equipment including some that Howard Hughes used on his 'round the world flight.

The ladies will be entertained with bridge-teas, luncheons, sight-seeing tours of Chicago, trips through Chicago's shopping district, trips through the various broadcasting stations and, of course, the big Saturday night party and Sunday's banquet.

There will be free trips to and through many of Chicago's leading amateur radio equipment manufacturing plants, speed contests (both high speed press copy and coded groups), trips through broadcasting stations, etc.

The equipment display will be the finest strictly amateur display ever held. Only those companies who are honestly interested in serving the amateur will display. Your favorite apparatus will be shown, so come and see it—make it a point to spend lots of time viewing this display. The manufacturers have gone to a great deal of trouble to bring you this show, feeling that your cooperation deserves only the finest treatment on their part.

Prizes will be limited in number, but all will be worth-while. There will be several transmitters in addition to receivers, large tubes, complete power supply kits, oscilloscopes, etc. There will be no long and tiresome prize drawings. Each prize will have a value in excess of \$25.

Trained ushers have been hired to manage the crowd and see that your reserved banquet ticket assures you the place to which you are entitled. There will be plenty of recess periods for rest and viewing the exhibits. Adequate time has been set aside after each talk for discussion. Speeches are all limited to 45 minutes. The Hotel has extended the use of its many facilities for your entertainment. Chicago's beaches will all be open for swimming. Movies are close at hand. Many restaurants are within easy walking distance of the hotel. Everything has been arranged for your pleasure and your convenience.

*Again it's*  
**AEROVOX**  
*for*  
**CONDENSERS!**

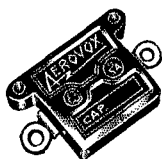

In the specifications for the latest THORDARSON 100-Watt Band-Switch Transmitter, you'll find AEROVOX specified for every condenser required. Thordarson engineers have selected AEROVOX condensers for their master models, as indicated in the illustrations.



In condensers, quite as well as other components required for this mighty fine ham rig, Thordarson designers sought trouble-proof performance. They have made full use of the wider scope of the AEROVOX line which provides the correct condenser for every radio need.



So in building your Thordarson job, use AEROVOX throughout if you want the standard of performance and economy established by Thordarson engineers.

**Ask for DATA...**

See your nearest AEROVOX jobber about the necessary condensers. Ask for copy of latest catalog. Or write us direct.



**SEE . . .**  
 THE NEW  
**THORDARSON**  
 Panel Band-Switching  
 "MULTI-BAND"  
**TRANSMITTER**  
 ON DISPLAY  
**NOW!**

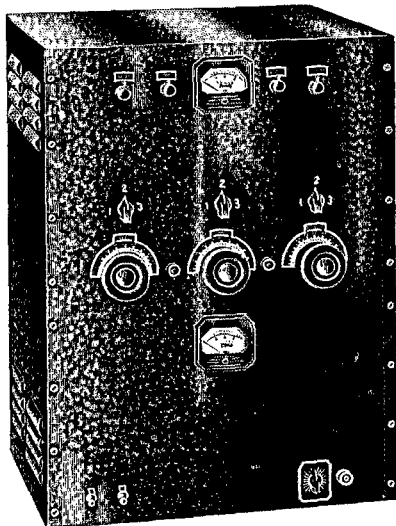

Complete Kits for  
 Transmitter and  
 Amateur Speech Amplifier

**AT**

**RADIO SUPPLY COMPANY**  
 950 South Broadway  
 LOS ANGELES, CALIFORNIA

**BY THORDARSON**



The new edition of Circular 507B is just off the press. It describes and gives prices on 4 new Relays as well as other Ward Leonard automatic controls built especially for the amateur. Send for a copy today.

## WARD LEONARD RADIO SPECIALTIES

### WARD LEONARD ELECTRIC COMPANY

41 South Street, Mount Vernon, N. Y.

Please send me the new Circular 507B.

Name .....

Address ..... Call Signal .....

City ..... State .....

### RADIO COURSES

RADIO OPERATING: Prepare for Gov't License Exam. ●  
RADIO SERVICING: Including Short Wave ● AMATEUR  
CODE ● ELECTRONICS ● TELEVISION ●

Day and Evening classes—Booklet upon request

### NEW YORK YMCA SCHOOLS

4 West 63rd Street, New York City

#### SPECIALISTS IN

### Communications Receiver Servicing

Ship or bring your faulty receiver to us. We are fully equipped to correctly align and service your receiver in our own laboratory.

Micro-Volt per Meter Sensitivity Reports Furnished

Know Your Receiver

Work Guaranteed

Out-of-town inquiries invited

Reasonable Rates

### FEIGHNER TECHNICAL ASSOCIATES

525 Woodward Avenue 22 years in radio Detroit, Michigan

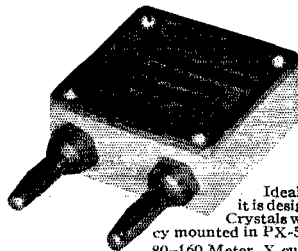

Announcing . . .

The  
Precision Labs.

Type PX-5 Holder

New Low Loss

Construction:

Size: 1 1/4" sq. x 9/16"

Ideal for Amateur or Aircraft use as it is designed to operate in any position. Crystals within .1% of specified frequency mounted in PX-5 holders listed below.

80-160 Meter, X cut...\$3.75 Low Drift...\$4.75

Commercial Crystals 20 Kc. to 20 Mc

Prices on request. FCC Approved.

### PRECISION CRYSTAL LABORATORIES

1211 Liberty St.

Springfield, Mass.

Your League and the Chicago amateurs have worked long and hard to bring you this, the first National Convention to be held in fourteen years, and we now await your arrival in September. This is your chance to meet all the people with whom you have been talking and about whom you have heard or read, and to join with other fellow amateurs for a week-end of fun and information.

—G. L. E.

### The Permatron

(Continued from page 48)

conduct during any part of the cycle. This is the condition existing during keying.

The m.m.f. required for cut-off depends on the plate voltage and the condensed-mercury temperature. For keying, a magnetizing force of about 190 ampere-turns (magnet coil turns times current through the coil in amperes) is sufficient to take care of extreme conditions. Since it is usually more satisfactory to obtain the necessary m.m.f. by using small current and a large number of turns, the recommended specifications call for 5000 turns of No. 34 or 36 wire on a half-inch square silicon-steel laminated core, approximately 1 1/2 inches long on each side of the "U." In Fig. 1, when the key is closed, the magnets are short-circuited. The resistor in series with the magnets limits the current with closed key; its value should be approximately 4000 ohms if a 350-volt d.c. supply is used. The current is of the order of 40 milliamperes, and does not change greatly with keying, hence the resistor and magnets might well serve as the bleeder for the supply.

Permatrons also are equipped with a control grid for the usual electrostatic control circuits. This element may be used for keying if desired, but with magnetic keying it is normally connected to the filament and has no effect on the operation of the tube. However, the grid does make it possible to incorporate both output-voltage control and keying in the same power supply. A circuit for this purpose is shown in Fig. 2. By controlling the time of firing—that is, the particular instant during the a.c. cycle at which the tube starts to conduct—it is possible to make the d.c. output voltage anything between zero and the maximum available when the full a.c. cycle is used. The firing time is conveniently changed by using a.c. on the grid and shifting its phase with respect to the plate voltage. In Fig. 2, this is accomplished by means of  $R_4$  and  $C_3$ , the relative values of which determine the phase of the voltage applied to the grids; the phase difference is zero when  $R_4$  is zero and practically 180 degrees when  $R_4$  is large with respect to the reactance of  $C_3$ . With the grid-voltage supply transformer properly poled, the output voltage is maximum with  $R_4$  equal to zero, and minimum when  $R_4$  is at its maximum setting. The grid voltage required is about 100 r.m.s. Because of the nature of the control action the overall regulation of the supply is

<sup>1</sup> These magnets are available from The Raytheon Manufacturing Company, type number U3372.



**"MULTI-BAND" TRANSMITTER**

**APPROVED BY AMATEURS . . . EVERYWHERE**

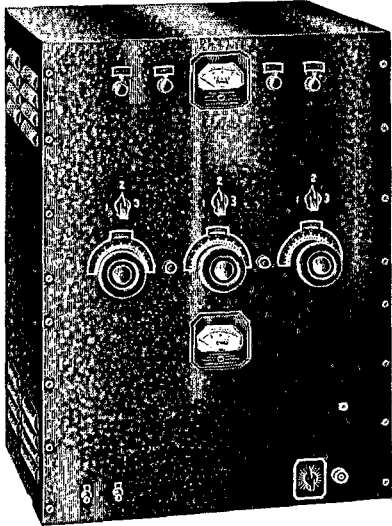

There's nothing "out-of-the-way" about HARVEY'S. . . . Easy to reach from anywhere. . . . Easy to find whatever you want in radio. . . . Pleasant and economical . . . just CONVENIENT to everywhere and EVERYONE, that's all. . . .

**THORDARSON  
MULTI-BAND  
100 WATT TRANSMITTER**

- 100 watts input on all bands.
- Power supply and R.F. section on one chassis.
- Single meter reads all plate currents as well as grid current of the final stage.
- Modulator and power supply one chassis.
- Bands switched from front of panel.
- R. F. lineup 6L6G-6L6G-TZ-40.
- Modulator lineup — 6J7 6F5, 6F6, 2-6L6's.
- Band-switching feature optional, regular plug-in coils may be used.

This self-contained 100-watt "Multi-Band" transmitter is available in "Foundation Unit" form with complete instructions for assembly and operation. Chassis, panels and chassis brackets are supplied completely punched for easy assembly. The entire transmitter requiring but 26 1/4" of panel space may be mounted in any of the standard cabinets or racks available on the market. Only standard parts of nationally known manufacture and highest quality are used throughout. Both the R.F. and the modulator units are supplied complete with their own power supplies. Complete band-switching is accomplished from the front of panel. Approximate price complete including Cabinet, but less Tubes and Crystals . . . . . **\$139.50**

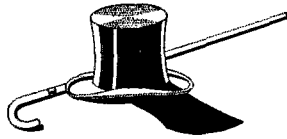

**NOTHIN' HIGH HAT ABOUT US**

We're in business to serve our thousands of radio customers . . . but that doesn't stop us from passing a few pleasant moments with the boys. . . . Come in, even if only to say hello . . . we're never too busy for that. . . .

And if you're also a camera hound . . . you'll surely want to "look us over" . . . We've got all makes, sizes and shapes in our CAMERA department . . . plenty of 'em . . . accessories, too. . . .

And should you want to talk "trade-in" on CAMERA OR RADIO . . . we're ready. . . .

**THORDARSON**

**UNIVERSAL SPEECH AMPLIFIER**

Total approximate price . . . . . **\$27.45**

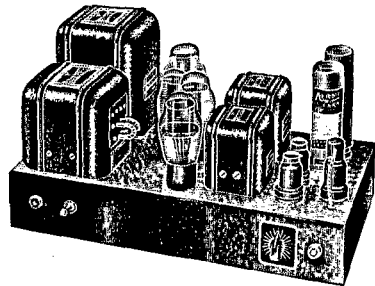

less tubes and metal cover with regular type transformers and 500 Ohm output or Multi-Match driver output.

Designed to eliminate transmitter building troubles for the Ham. The 2A3 Output stage provides ample driving power. Chassis adaptable to rack-and-panel mounting or to conventional chassis type with metal screen cover and bottom. Supplied less panel, but with panel drawing and full instructions included.

OUR *Best* VALUE IS OUR RECORD OF LOYAL SERVICE

**HARVEY**  
*Radio Company of New York*

103 WEST 43rd STREET • NEW YORK, N. Y.

**BY THORDARSON**

Say You Saw It in QST — It Identifies You and Helps QST

## "MULTI-BAND" TRANSMITTER

# SUN RADIO CO.

CAN SUPPLY YOU  
WITH ALL THE PARTS  
REQUIRED TO BUILD THIS  
WIDELY HERALDED  
TRANSMITTER  
AND THE AMATEUR  
SPEECH AMPLIFIER

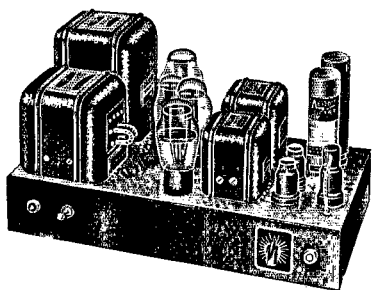

SUN RECOMMENDS the  
"Multi-Band" transmitter  
because of these features

- 100 watts input on all bands
- Power supply and R.F. section on one chassis.
- Single meter reads all plate currents as well as grid current of the final stage.
- Modulator and power supply on one chassis.
- Bands — switched from front of panel.
- R.F. lineup 6L6G-6L6G-TZ-40.
- Modulator lineup — 6J7, 6F5, 6F6, 2-6L6's.
- Band-switching feature optional, regular plug-in coils may be used.

## SUN RADIO COMPANY

AMATEUR HEADQUARTERS SINCE 1922

212 FULTON ST., NEW YORK

The Largest Radio Parts Store in New York

BY THORDARSON

increased as the output voltage is decreased, for a given bleeder resistance and input-choke inductance. This is not a serious disadvantage where the load is steady, but in some applications where the load varies over a considerable range might not be acceptable.

Two types of tubes are being made, one (RM-209) having ratings corresponding to those of the 872 and the other (RM-208) similar to the 866. When grid control of output voltage is used the inverse peak voltage drops from the usual 7500 to 2500 because the delayed firing gives rise to surges. With grid connected to cathode, however, the ratings can be considered practically identical to those of their 872 and 866.

### Hints and Kinks

(Continued from page 48)

The relays used by the author are built on the cores of old audio transformers, and make use of part of the transformer winding in the field circuit. In some cases, the windings of the transformers may be used with no alteration, being inserted directly in the field circuit with a parallel or series resistor used to regulate the current or voltage required to operate the relay. The *E* and *I* laminations of the transformer are stacked separately to form field and armature, respectively, and for the a.c. relay, a brass ring of  $\frac{1}{4}$ -inch by  $\frac{1}{16}$ -inch stock is inserted in a saw slot to form a shorted turn in the end of each pole piece of the *E* laminations. The ring should encircle approximately two thirds of the area of the end of each pole piece. The contacting surfaces of the core and the armature are then carefully fitted together and hinged at one end of the *E* laminations.

Drilling holes in the end of the field laminations and in the corresponding end of the *I* laminations is simplified by use of wood boards clamping the laminations tightly. The drill is thus held in correct alignment when entering the laminations after penetrating the wood support, and in addition the likelihood of breaking drills is reduced by this simple expedient.

This complete protective system, requiring little expense and only a small amount of time for construction, quickly pays for itself in saving expensive equipment and providing operating safety, and gives the operator an accurate warning the instant trouble occurs.

—M. E. Lowrey, W9SRX

—•••—

### Bridge Crystal Oscillator Circuit

AN unusual application of a balanced bridge circuit is shown in Fig. 5. A crystal (equivalent circuit of which is a series resonant circuit) is used as one element of a neutralized vacuum-tube circuit in which grid and plate are coupled through a bridge.

At all frequencies except that at which the crystal is resonant, the circuit is balanced, and oscillation is prevented. The balance of the circuit is obtained by adjusting the condenser  $C_2$  so that the anode-to-grid capacity plus the capacity of  $C_2$  equals the effective capacity of the crystal-

# Now A NEW JOHNSON "Q" BEAM ANTENNA

## For 2 Band Operation!

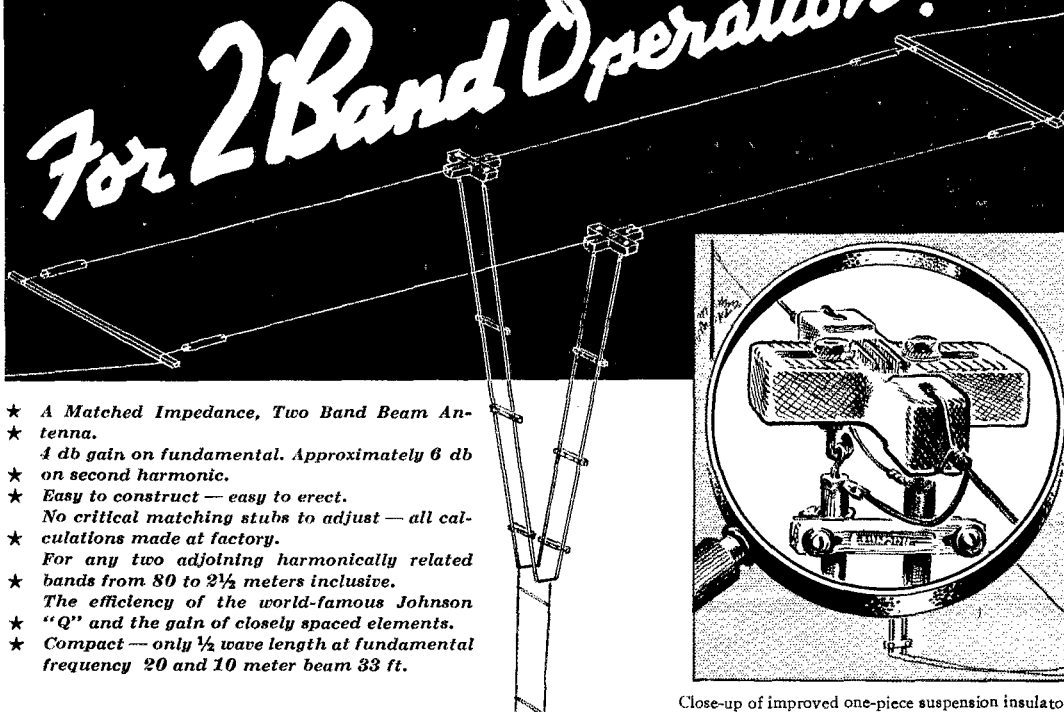

- ★ A Matched Impedance, Two Band Beam Antenna.
- ★ 4 db gain on fundamental. Approximately 6 db on second harmonic.
- ★ Easy to construct — easy to erect.
- ★ No critical matching stubs to adjust — all calculations made at factory.
- ★ For any two adjoining harmonically related bands from 80 to 2½ meters inclusive.
- ★ The efficiency of the world-famous Johnson "Q" and the gain of closely spaced elements.
- ★ Compact — only ½ wave length at fundamental frequency 20 and 10 meter beam 33 ft.

Close-up of improved one-piece suspension insulator!

A COMPACT, 2 Band, Matched Impedance Antenna, consisting of two half-wave Johnson "Q" Antennae, designed for fundamental frequency, spaced ½ wave and fed 180° out of phase with a 600 ohm line — with resulting matched impedances between antenna and transmission line on both fundamental and second harmonic operation.

Present owners of standard Johnson "Q" Antennae can easily convert them to the New Johnson "Q" Beam Antenna with the addition of another "Q" for the same band.

With a new one-piece suspension insulator equipped with slots permitting spacing adjustments of the "Q" bars and taking off the "Q" bars and transmission line in any

direction — new connecting plugs and new clamps for "Q" bar spacing insulators, possibilities of breakage are reduced to a minimum, and the entire antenna is greatly improved mechanically.

Johnson "Q" matching systems are ideal for other types of antennae such as reflector-director systems, two half-waves in phase, harmonic "longwire" radiators and "V" Beams. Tubing for 5, 10 and 20 meter "Q" antennae can be supplied in straight lengths if so desired, instead of coiled.

Watch for the announcement of the "Q" in a Can", a NEW Johnson antenna matching system for use with 40, 80 and 160 meter antennae where the conventional "Q" is mechanically inconvenient.

Ask your jobber or write for Antenna Handbook 102J available soon, describing application of "Q" antennae.



## E. F. JOHNSON CO.

WASECA, MINNESOTA

MANUFACTURERS OF RADIO TRANSMITTING EQUIPMENT

Say You Saw It in QST — It Identifies You and Helps QST

**"MULTI-BAND" TRANSMITTER**

**YOU WILL LIKE  
PANEL  
BAND-SWITCHING**

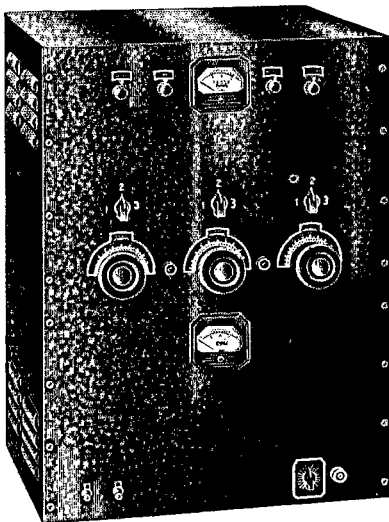

## See the New THORDARSON MULTI-BAND TRANSMITTER

This 100-watt transmitter offers what the amateur wants—a high-quality unit with panel band-switching and many other features.

**NEW AMATEUR SPEECH AMPLIFIER**  
Optional over-modulation control—Adapted to any phone transmitter—R. F. feed-back and Hum eliminated—Standard rack and panel or table model.

Ask for Bulletin SD-378A

**We stock all lines of  
nationally-known parts**

**H. JAPPE CO.**  
46 CORNHILL, BOSTON, MASS.

**BY THORDARSON**

and-holder unit. This capacity balance must accompany accurate center-tapping of the coil,  $L$ .

When the tank circuit composed of  $L$  and  $C_1$  (plus the additional capacity of the series combination of crystal and the parallel combination of  $C_2$  and grid-plate capacity) is tuned to the region of the crystal frequency by means of  $C_1$ , the balanced condition of the bridge is removed, and oscillations are produced.

HA3J, with whom I have proved this, was able to use this oscillator circuit with an output of 8 watts, using a crystal of only  $\frac{1}{25}$ -square inch surface area.

The capacity of the neutralizing condenser is critical, particularly when the circuit approaches resonance with the crystal, and by careful adjustment of this condenser, perfect T9X is obtainable.

This circuit makes possible three important advantages in a triode crystal oscillator: More output at a given value of crystal current; high stability of the crystal oscillator; and high efficiency.

—G. Neu, Box 35, Szolnok, Hungary

### Freshman Marlow

(Continued from page 41)

He passed under the west tower and noticed the shrieking of the wind through its timbers—one hundred and sixty feet tall. The halyard snapped viciously against the members of the giant structure, and a faint chorus of little creaking sounds could be noticed, like little voices, if one listened. What if it should fall? Freshman Bradfield grinned as he ran. Not much danger. The fellows who put those towers up in 1920 didn't put them up to fall!

In the distance, the other tower's faint silhouette marked the pathway. Bradfield pulled his overcoat collar up around his ears and ran on. His breath began to grow short, and he fell into a rapid walk. Too many cigarettes. Funny how quickly a fellow got out of condition.

The howling of the wind through the structure ahead of him sounded cold, cold. It was cold.

Suddenly he stopped short in his tracks.

There was somebody standing in the pathway at the foot of the tower!

It had, somehow, all at once, occurred to him that there was someone there in front of him. Just that quickly. And as he looked closer, he saw that there was.

He felt the short hair on his neck stand. Whipping the flashlight around, he illuminated the person standing there. A cold feeling of something unexpected gripped Bradfield's stomach.

It was a boy about his own age, a freshman, wearing a sky-blue cap, staring unwaveringly at him. He was wearing a grey sweater, the regulation freshman's sweater, with a wide blue outline around the neck. Then he noticed that one sleeve of the sweater was torn, a long ragged tear extending from the shoulder down to his elbow. The frayed rent flapped back and forth in the wind.

Freshman Bradfield took a breath. This was funny aplenty. What was a freshman doing there?

# THE JUDGES HAVE AWARDED THE VERDICT of NEW SALES CHAMPION to the T-40 TZ-40



\$3.50

From the ranks of 40,000 good men and true, the award of NEW SALES CHAMPION has gone to that pair of Wonder Tubes, the T-40 and TZ-40. From every district, Amateurs, Radio Engineers and Parts Jobbers are cheering these newer, better tubes. Radio parts and set manufacturers are adding their support to the pair of tubes which recreated *thrill* in Ham radio. Whether your need is R F or Audio these two tubes will live up to and exceed every claim we have ever made for them. The husky filament and sturdy oversize plate really stand up under overload. Notice the approval and use of these tubes by such LEADING Manufacturers as Bassett—Gross—Temco—Thordarson—Utah—Harvey. COMPARISON SELLS TAYLOR TUBES. Your favorite parts jobber wil tell you why!

ATTEND THE A. R. R. L. CONVENTION AND AMATEUR RADIO EQUIPMENT SHOW Chicago will once more write radio history, when the A.R.R.L. NATIONAL CONVENTION AND THE AMATEUR RADIO EQUIPMENT SHOW is held Sept. 3-4-5 at the Sherman Hotel, Chicago. Ask at our booths for particulars on trips through the Taylor Tubes Plant. See how your favorite transmitting tubes are made.

"More Watts Per Dollar"

Taylor HEAVY CUSTOM BUILT DUTY Tubes

TAYLOR TUBES, INC., 2341 WABANSIA AVE., CHICAGO, ILLINOIS

## **"MULTI-BAND" TRANSMITTER**

**BARTLETT RADIO CO.**  
OF MAINE

PORTLAND - - - - BANGOR  
640 Congress St. 149 Hammond St.

## **2 HAM SHACKS**

HAVE THE NEW  
THORDARSON

## **"MULTI-BAND" TRANSMITTER**

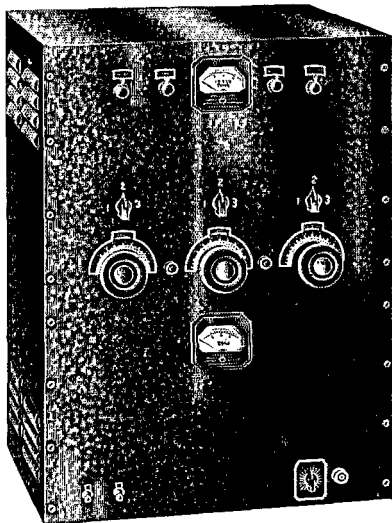

## **You Will Want Panel Band - Switching**

It is the BIG Feature of this  
high-quality transmitter.

*Ask about the*

**UNIVERSAL SPEECH AMPLIFIER**  
designed especially for amateurs

**Complete line of  
HAM EQUIPMENT**

**BY THORDARSON**

This time of the night, too! He had never seen the fellow before. None of the radio crowd, certainly. A feeling of relief came over him. He advanced a step. His eyes narrowed.

"Hello," said Freshman Bradfield.

Then he saw that the fellow's right hand was bandaged. Been in a fight, probably. Got in a scrap with some sops in the dormitory and was spending the night out. Good idea!

The boy did not reply. He stared straight at the light, his face registering no expression whatever. Bradfield noticed his eyes looked peculiar, dreamy, looking 'way off somewhere.

"What are you doing around here, frosh?," Freshman Bradfield asked, noticing disgustedly that his voice was unsteady. "What's the idea?"

No reply.

This freshman must be soused, or something. Knocked goofy. That must be it, he decided. Been in a scrap and got a haymaker under the ear. Out like a light. He remembered reading about something like that once. Fellow wandered around for a couple of days before the Law found him.

Bradfield walked a couple of steps nearer and looked the strange freshman over cautiously, noticing as he came close that his heart was thumping just as it did when he was getting ready to fight somebody. He was an arm's reach away. He wondered if it would do any good to shake the fellow, but something advised against it.

"So you won't talk, eh?," he grunted, imitating with mocking inflection the tone of an officer of the law preparing to obtain a confession.

This fellow was certainly seeing things at a distance. Looking right straight at him, right on through him, and on into town.

Bradfield took a step back and detoured. The freshman turned slowly, facing him. He felt the lifting sensation of his hair behind his ears. Funny about that. He wasn't afraid of this fellow. But there was something so queer about having someone's eyes follow you, eyes that were unblinking, never changing expression.

"What's the matter? I'm not going to hurt you, you mug!" Bradfield exclaimed, grinning. There was no mirth in the grin. It was just something to do.

"Nuts," he said, finally, turning around and continuing on his way. "I'll get Collier or Jug or somebody to come back here and get you," he muttered. "You'll talk then, freshman."

He walked about twenty feet farther and flashed the light back. Still watching him.

The great skeleton of the 7-megacycle rotary beam was just ahead, soaring high above into the darkness. The wind whistled through the tightly-stretched bracing wires and truss-shaped members of the gaunt outline, discordantly wailing. It hummed and throbbed in the darkness, a hundred different voices as the wind buffeted it. He flashed the light along its huge structure, the feeder collector-rings gleaming. The limit switches were in closed position, with the director end pointing north. The tarpaulin was secure all around. All OK.

# 14-TUBE TRAFFIC MASTER



## 5 BANDS COVERING 9.25 TO 565 METERS

### FEATURES

★ 14 Tubes ★ 5 Band Pre-Aligned Tuning Unit  
★ Better than 1 M.V. Sensitivity on all Ham Bands  
★ Large 9" Linear Scale Dial accurately calibrated  
★ Flywheel Tuning on main and Band Spread Dials  
★ "Align-Aire" (Air-Tuned) Coils  
★ Built-in Noise Silencer Circuit ★ B.F.O. with Pitch Control  
★ 3 Gang Precision Tuning Condenser — Ceramic-Insulated  
★ Mono-Unit Crystal Filter Assembly with Phasing Control and Shorting Switch  
★ Electrical Band Spread Condenser.

This 14-Tube Communications Super has the things every amateur wants—sensitivity better than 1 M.V. on the amateur bands—excellent selectivity and high signal-to-noise ratio—a built-in Noise-Silencer—and a dozen other splendid features that make it an outstanding receiver of amateur radio.

The Traffic Master comes to you in complete, easily-assembled form—everything except tubes—with completely assembled Tuning Unit ready for mounting. You can't go wrong with a Traffic Master!

SEE YOUR  
PARTS JOBBER

\$81.90 LESS TUBES  
AND SPEAKER  
PANEL AND CABINET AVAILABLE

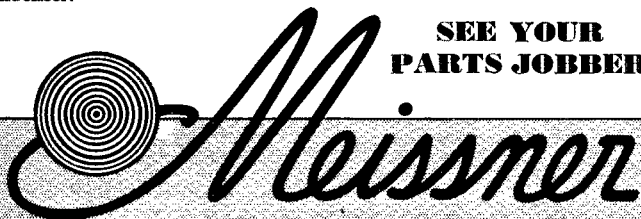

Meissner

MT. CARMEL, ILLINOIS

"A FAMOUS NAME FOR TWO DECADES"

**"MULTI-BAND" TRANSMITTER**

# OHMITE

*Fixed and Adjustable*

## RESISTORS

*Specified for the*

### THORDARSON 100-WATT MULTI-BAND TRANSMITTER

The sturdy dependability of Ohmite Resistance Units again is evidenced in the selection of Ohmite Vitreous-Enameled Fixed Resistors, "Dividohm" Adjustable Resistors, and "Brown Devils" for the R.F. and Modulator Units of the new Thordarson 100 Watt Multi-Band Transmitter, and for the Universa Speech Amplifier.

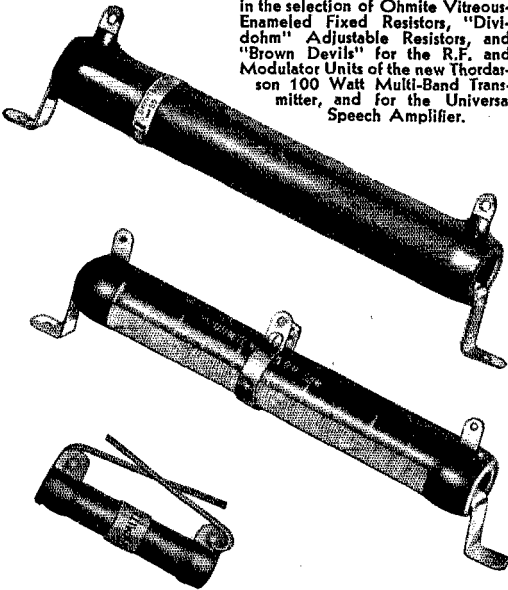

### BE RIGHT with OHMITE

The time-proved ability to stand up under shock and vibration, heat and humidity, have made Ohmite Vitreous-Enameled Resistance Units standard equipment with nationally-known manufacturers of amateur and commercial radio transmitters and receivers. ASK YOUR JOBBER — or WRITE US FOR COMPLETE PARTS LIST and NEW CATALOG 17.

Resistors \* Rheostats \* Band-Switches  
R.F. Plate and Power Line Chokes

### OHMITE MANUFACTURING CO.

4831 W. Flournoy Ave. \* \* Chicago, U. S. A.

**BY THORDARSON**

He retraced his steps a short distance, shining the light ahead. The illumination was feeble.

"This punk is going to get pneumonia out here if he—"

There was a blinding flash of lightning that illuminated the landscape with fierce intensity, followed by a clap of thunder that shook the ground, echoing and rolling away into the distance.

Freshman Bradfield stopped short, staring. His eyes were wide. He shone the light along the path and increased his pace abruptly, coming in a few seconds within view of the tower.

A cold perspiration broke out upon him. He stopped in his tracks, shining the light at the foot of the tower.

There was no one there.

A feeling of fright clutched him. In the glare of the lightning, it had seemed that the freshman had disappeared, but being blinded, he was not certain. Now there was no doubt of it.

Bradfield shone the feeble pencil of light all around, conscious of a feeling of terror of something that he could not understand. He simply could not have got out of sight this quickly. Unless—

He shone the light up the side of the tower and walked around it looking up as far as the light would carry; walked underneath and shone it along the interior. Nothing but timbers crossing and criss-crossing up and up, fading dimly skyward.

It was too much.

He sat down for an instant on one of the tower foundations, exhaustedly, noticing that his breath was coming in gasps. The heavens were lit by a reddish flash and ripped by an earsplitting roar like seacoast guns firing in battery. A few heavy raindrops began to patter around. He did not notice the rain, just sat there staring. Wonderingly, it occurred to him that he had seen no one there at all. Then he shook his head. He wasn't crazy. Plain as day, that freshman standing there, looking at him.

A sound like a sob came from Freshman Bradfield. Suddenly he jumped to his feet and began to run, fell headlong, got up and ran again, the rain beating against his face, hitting him in the mouth. The lighted windows of the shack seemed to recede as he ran, his breath coming hoarsely, his lungs aching. He ran on, unconscious of the water streaming from his face, the dim course of the path with its hollows ankle deep in water; plunging through them heedless of anything but the mad desire to run.

He slowed to a walk as he drew near the shack. His lungs were on fire.

"They'll think I'm crazy," he thought. "Crazy—"

He pushed open the door weakly and stumbled. Parkes looked at him and grinned.

"Didn't get wet, did you, frosh?"

Bradfield flopped into a chair, his breath coming in gasps. He wiped his face with the wet sleeves of the overcoat. He tried to grin but couldn't make it.



# Slap on the **HIGH VOLTAGE**

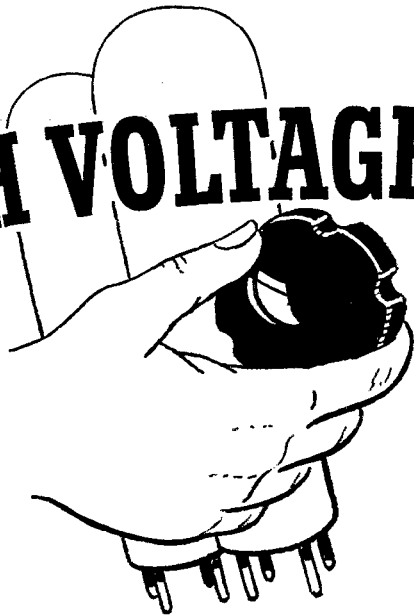

*Tubes with SPEER Graphite Anodes can take it. A user who signs himself "A Ham Since 1903" writes:*

☞ Most important to the amateur radio station owner are economy and efficiency. If the tubes do not stand at least 300% overload, he does not consider them suitable to his purpose.

"A tube having Graphite Anodes gives him these requisites. Graphite Anodes will stand three to four hundred percent overload without puncturing or warping and for these reasons frequency stability is assured. Metal anodes made of such metals as Molybdenum, Nickel and Tantalum WILL bend and warp, consequently giving rise to considerable frequency drift and reduced power output.

"Gassing is greatly reduced by use of Graphite Anodes, which makes for longer tube life. Furthermore the warping of metal anodes, causing poor alignment of tube elements, changes the general characteristics of a tube, a cause of poor matching of circuit impedances, necessitating continual adjustment for correction. ☞

*The writer voices the experience of the rapidly growing hundreds of amateurs who buy and use tubes with SPEER Graphite Anodes. Try them and see for yourself.*



★ SOLD ONLY TO TUBE MANUFACTURERS ★

WRITE US FOR LIST AND ANODE BOOKLET NO. 80

**SPEER CARBON CO., ST. MARYS, PA.**

# SPEER GRAPHITE ANODES

## "MULTI-BAND" TRANSMITTER

**Coto**

# CONTROL WHEELS

*Selected for*

## THE NEW THORDARSON 100-WATT MULTI-BAND TRANSMITTER

*with*

**Band Switching**

*and*

**Universal Speech  
Amplifier**

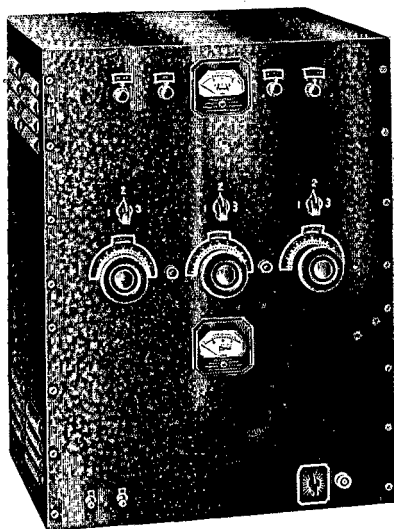

### **Appearance . . . Performance**

Ask Your Jobber about the Coto "Pee-Wee"  
Inductors. *New Types, New Mounting*

RADIO



PRODUCTS

**COTO-COIL COMPANY, Inc.**

229 Chapman St. Providence, R. I.

**BY THORDARSON**

"Run all the way?"

Bradfield nodded.

"Everything OK?"

He nodded again.

"Get over here by the fire, boy!" said the professor, moving his chair back. He smiled as he looked at Freshman Bradfield's wet face. "Get those shoes off and put them up here!"

"In—in a minute."

The professor looked at the bowl of his pipe thoughtfully and cleared his throat preparatory to resuming his interrupted conversation.

"Yes, Collier," he said slowly, "it's a thing that I hate to think about." He shook his head regretfully. "This Marlow was a dare-devil sort of youngster and when they got the halyard jammed in the pulley, he volunteered to climb the tower. You know how it is when you're pulling up an antenna for the first time, watching it go up and up toward the top and then the rope comes off. They had all been working on it steadily since about noon and it had got pretty dark, so they drove some flares in the ground and kept on. You know, these red flares, like they use on the railroad sometimes. And then the halyard stuck.

"It was a night rather like this, cold and windy and rain threatening every minute. Hard wind, coming in gusts that would nearly blow you over. Some of them wanted to wait until daylight but you know how amateurs are; most of them wanted to keep on, climb the tower or do something. Well, this young fellow Marlow wanted to go up. They tried to talk him out of it because he had a bad hand. Cut it on a piece of plate glass. Back in those days they used a United Wireless 'Coffin,' as they called it, and a four-tooth synchronous gap with a disc this big around. Every time the key was closed with the gap out of synchronism, it would tear up three-quarter-inch thicknesses of plate glass like they were pieces of window pane, and this Freshman Marlow had cut his right hand on one of them down under the oil. Bad cut, too. Had it bandaged up. But he went, anyway. About half-way up he got his sweater caught on something and wrestled with it until he got impatient and tore the sleeve out of the sweater. It took him about an hour to get to the top, but he finally got there. We just could see him, 'way up there on top of the tower."

The professor paused and pulled slowly on his pipe.

"He put the halyard back in the pulley—"

Professor Wortham cleared his throat.

"Lord!" he murmured as to himself. "I wish to heaven they had never let him go!" He twisted the heavy class ring on his finger. He continued, louder:

"He lost his balance, I suppose. The wind was terrible up there, of course."

Parkes was silent for a minute, gazing at the fire.

"Did he live long, Prof.?"

"No."

The professor smoked in silence, watching the sparks sail up the black throat of the chimney.

"Every time I look at that far tower over yonder," he said, softly, "I think of that boy."

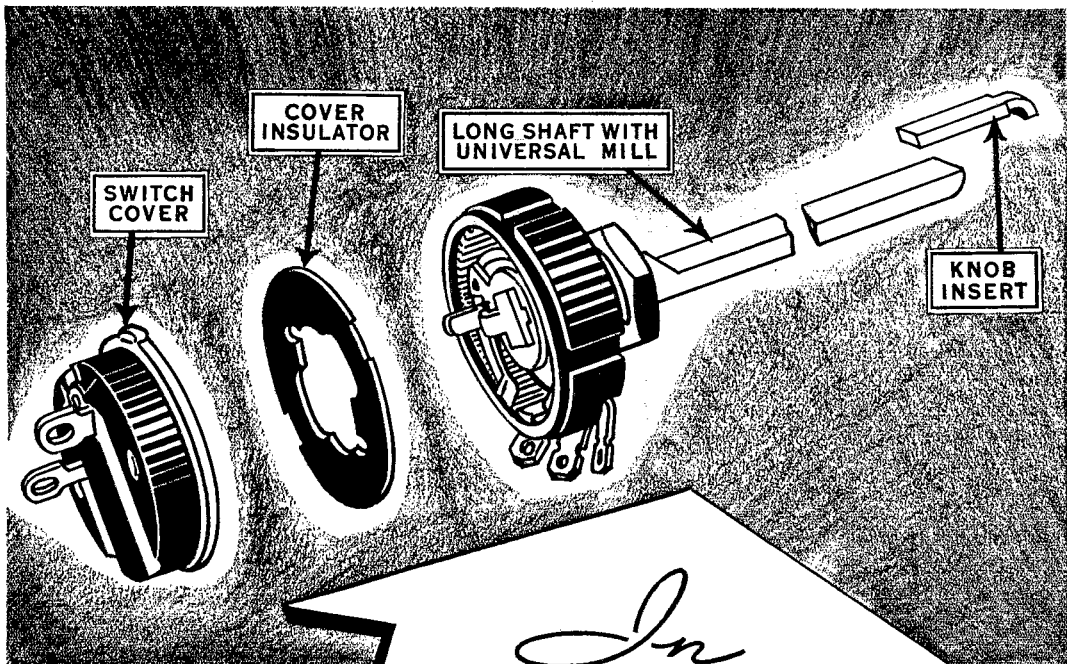

*In*  
**ANSWER**  
*to a*  
**DEFINITE DEMAND**

"Build us a wire wound resistor that's as good as your other products" . . . they asked us time and again. And so we "gave in," with the result that where circuit requirements call for "wire wound," service men have been using the new Centralab Wire Wound Radiohm with remarkable success.

Available at your jobber . . . in dimensions identical with the Standard Radiohm. Be sure to specify Centralab.

**CENTRALAB**  
*Wire Wound*  
**RADIOHM**

CENTRALAB; Div. of Globe Union Inc., Milwaukee

**Features:**

Small size. Bakelite case is  $1\frac{3}{8}$ " in diameter x  $9/16$ " deep.

Available in values from 2 to 10,000 ohms.

Insulated construction — no washers required in mounting.

Regular Radiohm switch covers can be attached.

Dissipates up to 4 watts without damage or change.

Universal shaft for all replacement work.

Close tolerance —  $\pm 5\%$ .

**Chief Applications**

1. Instruments.
2. In radio receivers where very heavy bleeder current passes through unit in cathode and screen circuits.
3. Filament control.
4. Hum control.

In linear curve only.

**"MULTIBAND" TRANSMITTER**

# THORDARSON

100 WATT

## Multi-Band Transmitter

USES



THE WORLD'S STRONGEST SOCKET

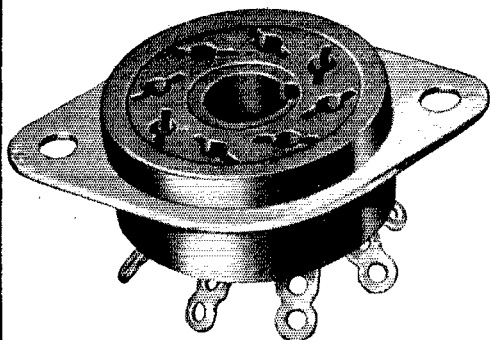

AND

### For real DX Punch in any Transmitter



↑ SOLID COPPER WIRE  
↑ AMPHENOL INSULATING BEADS  
↑ BRAIDED WIRE SHIELD  
↑ BRAIDED COTTON COVER

## use AMPHENOL CO-AXIAL CABLE

NEW CATALOG READY  
SEE YOUR PARTS DISTRIBUTOR

Send today for new Amphenol catalog or see your parts dealer. See us at Chicago Ham Show, Sept. 3-4-5, Sherman Hotel.

**AMERICAN PHENOLIC CORPORATION**

1250 W. VAN BUREN STREET, CHICAGO, U. S. A.

**BY THORDARSON**

### Silent Keys

IT IS with deep regret that we record the passing of these amateurs:

- Leslie Elmer Anderson, W9MKS, Graniteville, Ill.  
Douglas A. Buchanan, VK2ABT, Yerrinbool, N.S.W., Aust.  
A. D. Campbell, ex-VE3YZ, Ridgetown, Ont.  
Eugene P. Chase, Jr., W2KAK, Teaneck, N. J.  
Charles Clemmer, W8QUI, Detroit, Mich.  
Norman L. Dahl, VK2ND, Wahroonga, N.S.W., Aust.  
Harold Gies, W7DTO, Walla Walla, Wash.  
John D. Hertz, W7BRC, Walla Walla, Wash.  
Raymond Howell, ex-W6CID, Modesto, Calif.  
Sgt. James C. Jones, W4SO, Elberton, Ga.  
Harry A. Lince, W8LCL, Allegan, Mich.  
Harold William Lotz, W6NXX, ex-W2BST, Los Angeles, Calif.  
Charles E. Lounsbury, W9ZPC, Denver, Colo.  
Karl D. Sidebottom, W9SYL, Lamar, Colo.

### Grid-Bias Power Packs

(Continued from page 38)

fully loaded, deliver the required bias voltage on the final grid. The current that the transformer should be rated to deliver, and the resistance to use for the common bleeder-grid leak, depends on the total expected grid current.

A study of power supply voltage regulation in this connection shows that the worst regulation occurs when the supply is lightly loaded. Therefore we should never allow a bias supply to drop below a certain load, say 50 ma. Now if we expect to have a total of 50 ma. grid current, we add these values and divide the result into the supply voltage to get the required resistance. The sum of the currents also is the required transformer current rating.

As an example, suppose the supply is rated to deliver 250 volts at the required load of  $50+50=100$  ma. Then  $250/0.1=2500$  ohms, the bleeder resistance. Do not hesitate to load the supply up to its full rating, because the load drops during the time grid current is flowing. Use a 200-watt slider-tap resistor to make voltage adjustments easy.

An interesting thought arises in connection with the current drop in the bias supply. Why not make it duplex and supply the plate of an oscillator also, adjusting the resistance on the bias side until the drop in current exactly balances the rise in oscillator plate current? This should achieve perfect voltage regulation on the oscillator plate and on the grid of the tube being biased. The thought should be worth investigating.

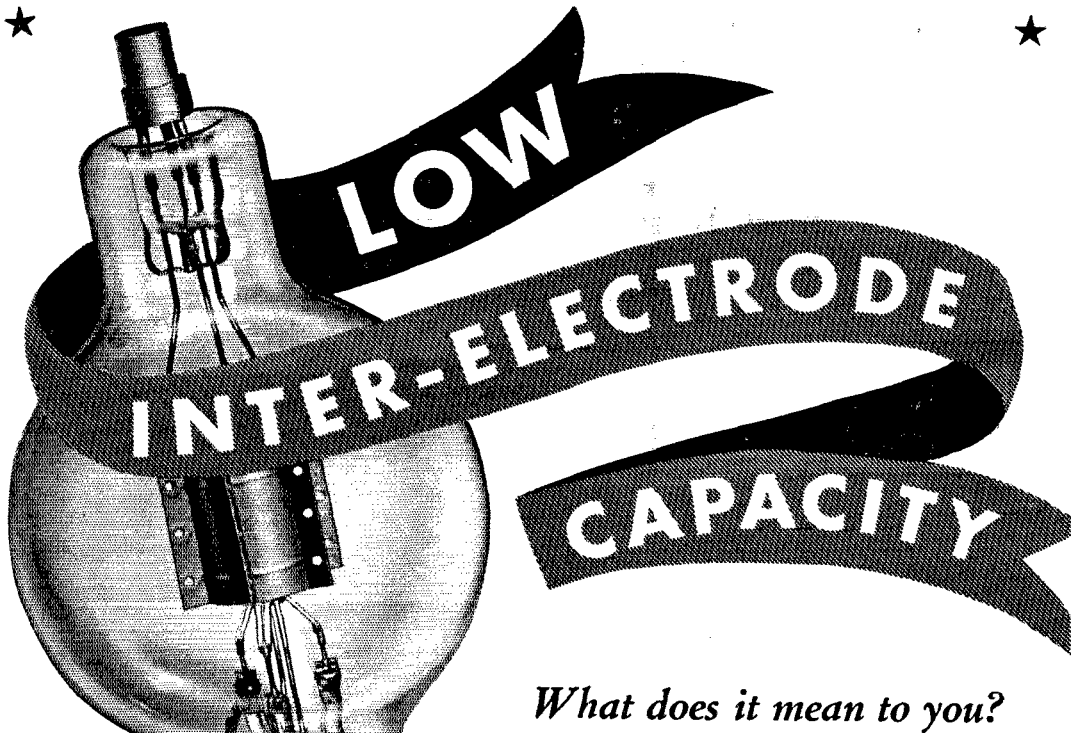

*What does it mean to you?*

**More perfect neutralization... less driving power... freedom from parasitic oscillations... more efficient circuits... higher frequency operation.**

Eimac tubes are more easily neutralized and require less driving power than most high capacity tubes because low capacities have been gained without loss of electrical characteristics. Every radio engineer knows that neutralizing is made necessary only because of the capacity existing between the electrodes of the tubes. This capacity must be offset by the introduction of an extra condenser which is adjusted to reduce the detrimental effect of these inter-electrode capacities.

Providing all other factors are equal, the tube having the lowest inter-electrode capacity will give superior all around performance in any application, being equally efficient for radio frequency or audio frequency. In reality the high capacity tube is a hang-over from the time when 200 meters was the lowest practical wavelength. High capacities are not necessary to obtain low impedance. This fact is proven conclusively by a comparison of the electrical characteristics of Eimac tubes with certain other tubes having extremely high capacity.

Because of their unusual design, Eimac tubes

have the lowest inter-electrode capacity of any tube having equal ratings and capabilities, yet their electrical characteristics are on a par with tubes which have three to five times the grid and plate capacity.

High electrical efficiency... low inter-electrode capacity... tantalum elements... extraordinarily efficient thoriated tungsten filaments... the exclusive Eimac exhaust technique... positive guarantee against tube failure caused by gas. These are but a few of the reasons why you should insist on Eimac tubes for your transmitter. See your dealer or write to the factory for information.

***Eimac***  
**TUBES**

**EITEL-McCULLOUGH, Inc. • San Bruno, Calif.**

# GROSS PRESENTS

## THREE WINNERS

### CB-55 CB-150 CB-250

Fine Radiophone transmitters selling at amazingly low prices

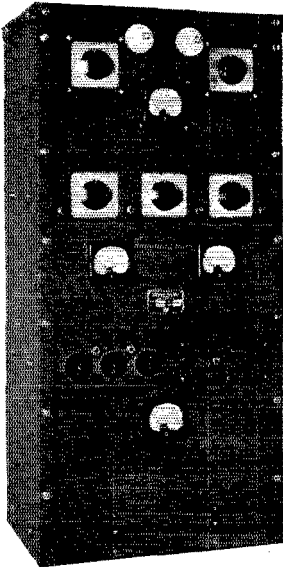

### Gross CB-150

Input — 150 watts

Coils available for 30, 14, 7, 3.5, and 1.7 mc

Class B modulation

All the very latest type tubes used throughout

Completely self contained from mike jack to antenna tuning unit

Descriptive Bulletins on Request

**CB-55 POWER 95 WATTS**

**CB-250 POWER 250 WATTS**

### "THE STANDBY" (2 to 2000 Meters) 3 TUBE A.C. AND D.C. RECEIVER

The Standby was designed to supply a need for a receiver to cover all the amateur broadcast and commercial frequencies (2 to 2000 meters). It will fill the requirements for an all round "Standby" receiver. Super regeneration is used from 2 to 15 meters and straight regeneration on the higher wavelengths up to 2000 meters. Loud speaker reception is possible on most stations.

- Power supply incorporated.
- Individual antenna tuning for high and low wave ranges.
- 1-76 super regenerative detector, 1-6J7 regenerative detector, 1-12A7 audio amp. and rectifier.

#### BULLETIN ON REQUEST

Complete kit of parts less coils, tubes, cab. ....	\$7.59
2-5-10 meter coils (set of 3) .....	.95
9½ to 15 meter coil .....	.39
15-200 meter coils (set of 4) .....	1.30
200-310 meter coil .....	.39
310-550 meter coil .....	.36
350-1050 meter coil .....	.60
1000-2000 meter coil .....	.60
Metal cabinet .....	1.50
Kit of three tubes .....	2.40
Wired and tested in our lab., additional .....	2.00

## GROSS RADIO, INC.

51 VESEY STREET

NEW YORK

Cable Address: GROSSINC

### A DeLuxe Rotary Antenna Structure

(Continued from page 29)

The heads of the rivets should be countersunk. The wood levers R and S are 2" × 4" × 20" long with a 5/8" hole 3 3/4" from the drum end. A three-inch lap of the brake band is extended on the lever, and two 3/16" by 2 1/2" bolts are used through each to hold it. Another pair of 2" × 4" × 10' arms is used to secure additional leverage. The smaller levers are notched to fit the tops of the long levers. The bottom is pulled together by the ropes, spreading the top levers and tightening the band. The leverage obtained is about 144 times, counting the gain in the windlass at the house.

#### THE ROTATING SYSTEM

The antenna used here gives a two-way beam, so the mast only has to rotate 180 degrees for 360-degree coverage. A piece of 1" × 4" × 40" with a 1/2" hole drilled 1" from each end is used as a lever arm, braced with 1" × 4" pieces as shown in Fig. 7. The section D is to take up the rope and complete the pulley action; the side pieces are each 15" long and a block of oak 1" × 4" × 5" is shaped to catch the rope from the pulleys. With 360-degree rotation it would probably be better to use four sections as shown at D and provide a means to keep the rope from slipping off the arms, such as deeper grooves with an extension on the lower side. Then one complete turn of rope fastened to the mast pulley at only one place would be necessary, and if the ropes are kept fairly tight good calibration of the steering wheel is possible. Three-eighths inch manila rope is entirely satisfactory and it can be waterproofed quite simply by boiling it in paraffin. We treated the 250' required here by boiling it in sections; each section for about five minutes is plenty.

The steering ropes go through regular pulleys to an 18-inch home-made wooden pulley mounted on the window casing of the operating room. The steering wheel, inside the window, is from a '29 Ford, although any type will do. The steering shaft should be secured with the wheel so one can be sure the threads will fit. The shaft is sawed off to a length appropriate to go through the casing, and rides in 3/8" × 1 1/4" × 4" bearing plates. One complete turn of the rope around the wooden pulley should be sufficient, but if there is a tendency to slip another can be added or some powdered rosin poured on the drum and rope.

The windlass for the brake rope is 1/2" rod, with a home-made handle on one end for turning. The rod also goes through the window casing, on bearing plates similar to those used for the steering

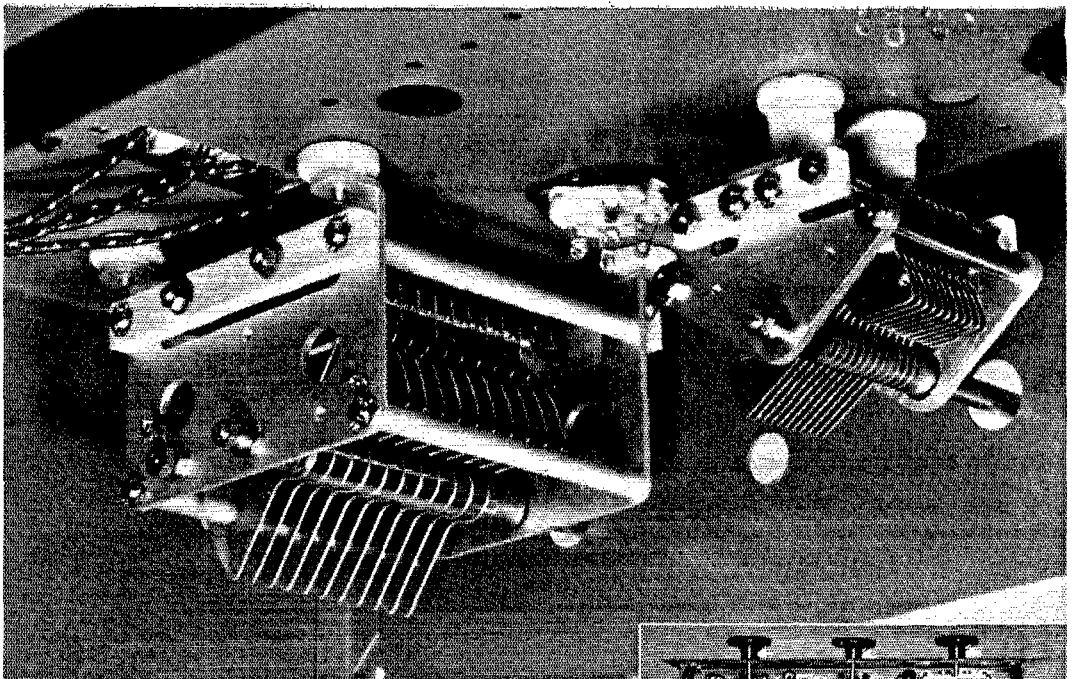

**UNDER THE CHASSIS**  
*in the new*  
**THORDARSON**  
**TRANSMITTER**

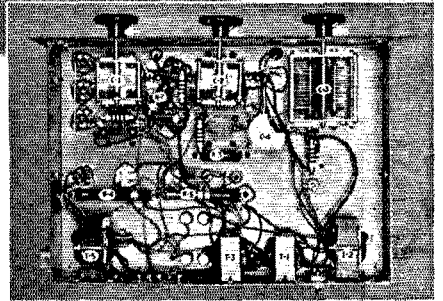

● The convenience and compactness of National Transmitting Condensers are well illustrated by their use in the new Thordarson "Multi-Band" 100-watt Transmitter. Their light weight enables them to be mounted on small insulators. Their small size contributes to efficient layout. Tucked away under the RF chassis, they add to dependability and high performance and make a good transmitter better.

**NATIONAL COMPANY, INC.**  **MALDEN, MASS.**

Say You Saw It in *QST* — It Identifies You and Helps *QST*

# Pick a Winner . . .

In racing that's easier said than done, but with Radio Transmitting Equipment there are more stable factors by which to judge. The UHX-10 and 80-T have consistently led the field since

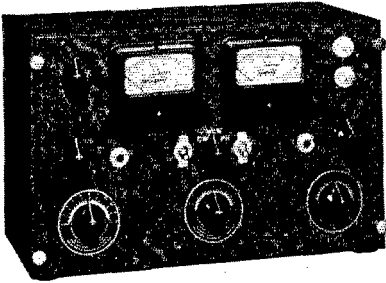

UHX-10

their introduction. They perform equally well in the hands of the novice or the experienced operator. Their blue-ribbon qualities stand out when competition is the keenest. You take no

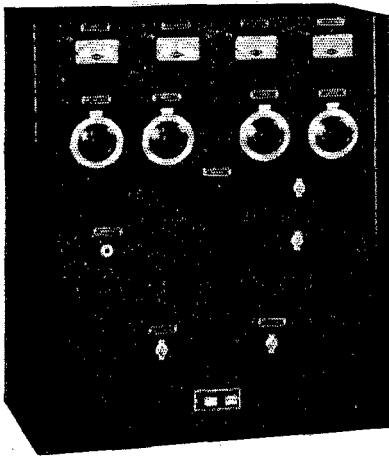

80-T

long shot when you choose what owners call a sure bet. Take a straight tip — Buy Harvey Every Time. We will gladly send you a dope sheet (catalog) if you will write to

★ **HARVEY** ★  
**RADIO LABORATORIES, INC.**

25 Thorndike St. Cambridge, Mass.

102

shaft, with about 5½ inches outside on which to wind the rope. The latter is held by a No. 9 wire loop which passes through a hole in the shaft close to where it enters the casing. A round metal plate about 7 inches in diameter, with eight holes at regular intervals near the circumference, is mounted on the shaft inside the room to act as a locking device; a metal plug inserted in one of the holes holds the windlass at whatever tension may be put on it by winding up the brake rope.

### ARMS

The "X" type of construction for the cross arms, shown in Fig. 1, keeps the center of gravity low. White pine, 1" × 4", is used throughout the arms, the longer sections being 16' long. These are tapered to a width of 2¼" at the outer ends, where the 4½' cross arms are mortised in. A lap of 3 feet is made at L in each section, and it is glued with waterproof glue as well as being nailed. The outside dimension of the bow at the center is 3' and it is held by a ¾" steel bolt, with 1" pipe spacers and washers, and a ¾" by 2" iron brace. No great detail is given of the arm structure, since for any other type of antenna it would probably require modification. The data given so far is flexible enough to help in building other rotary beams, and most amateurs do build their equipment with a great deal of originality once they get a basic idea of what they want. By using aluminum tubing the length of the arms could be shortened considerably, probably to a total length of thirty feet compared to the 40' 8" length used with wire.

Just a little on results obtained using these phased element beams: For the pattern see January *QST*,<sup>1</sup> the angle of radiation is quite low, which is particularly useful when working DX, although it is not so noticeable in working local U.S. stations. Nearly every ten-meter man is familiar with the results obtained by VK2GU, K6MVV, G6DH, HI7G, and others using these small beams.

Recent 55 mile per hour winds were a good test for any antenna system, and this one seemed to take it without damage. Even so, if we were doing it again we should probably build the mast somewhat stronger — just to be sure!

<sup>1</sup> Kraus, "Directional Antennas with Closely-Spaced Elements," *QST*, January, 1938.

### Canada-U. S. A. Contest

(Continued from page 88)

	Points	QSO's	Sec's			
ANE	8178	94	29	DU	168	8 7
WS	7575	112	25	XY	168	8 7
BG	5365	74	37	SG	168	8 7
ALL	5056	79	32	AKK	90	6 5
ARK	4212	55	27	APS	12	2 2
DH	3492	50	24			
IW	3354	47	26			
JO	2961	50	21			
YX	1575	35	15	ALBERTA		
AE	1248	29	16	VE4KI	20,640	169 43
AGC	1125	25	15	NQ	9747	93 38
RF	1057	24	15	BO	9512	117 41
PE	570	19	10	ADW	7803	78 34
HU	264	11	8	ALU	4725	63 25
				FK	2378	42 22
				TY	1980	33 20
				ADD	1080	30 12

Say You Saw It in *QST* — It Identifies You and Helps *QST*



# HOWARD GIVES YOU

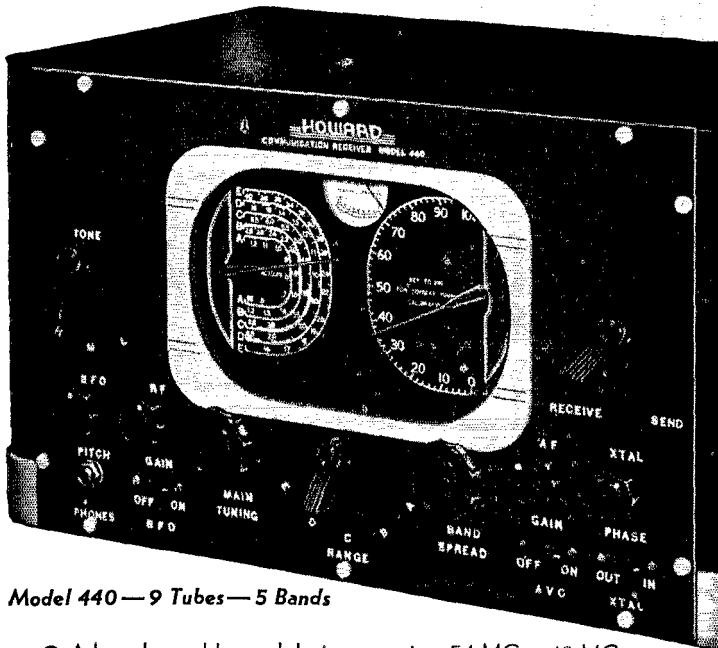

Model 440—9 Tubes—5 Bands

● A brand new Howard design covering .54 MC to 40 MC (7.5 to 555 meters) in 5 bands. For those advanced amateurs and professionals who want the very best up-to-the-minute design in this range, Model 440 we believe is the outstanding buy. Same high performance hairline selectivity circuit as used in the famous Howard Model 450-A. The fully illuminated edge-lighted dial is calibrated for band spread and Straight Line Frequency calibrations for main tuning circuits. The dial also has a finely calibrated band spread re-set or logging scale.

**OUTSTANDING FEATURES:** Continuous coverage, 540 KC—40 MC . . . Ceramic Coil Forms . . . Electric Band Spread. . . Iron Core I.F. Transformer . . . B.F.O. with pitch control . . . S.L.F. Ceramic Insulated Tuning Condensers. . . R.F. on All Bands . . . Calibrated 'R' Meter . . . Crystal filter . . . Marine band available. . . .

**PRICE:**

**Model 440 . . . \$66.50 NET**  
including tubes, but less speaker, less crystal

## OTHER HOWARD MODELS

### Model 430

● **Model 430—6 Tubes—4 Bands—**Frequency Coverage .54 to 40 MC . . . Ceramic Coil forms . . . B.F.O. with pitch control . . . Iron Core I.F. transformers . . . Electric band spread . . . Built-in Dynamic Speaker . . . Headphone jack . . . Accurate direct reading straight line dial. Price Complete with tubes and speaker. **\$29.95 Net**

Longwave . . . 25-cycle and special voltages available  
Prices Slightly Higher West of Rockies and Export

### Model 450-A

● **Model 450-A—12 Tubes—6 Bands—**Frequency Coverage .54 to 65 MC . . . Ceramic Coil Forms . . . Dual I.F. Channels . . . Two S.L.F. Ceramic Insulated Tuning Condensers . . . 47 inches of electric band-spread . . . crystal filter . . . Calibrated 'R' Meter . . . Accurately calibrated direct reading dial. Price . . . with Tubes, less Speaker, less crystal. **\$87.50 Net**

SEE US AT THE CHICAGO HAM FEST—Sept. 3-4-5 Booths 40-41  
AMERICA'S OLDEST RADIO MANUFACTURER

**CERAMIC  
COIL FORMS**



**S.L.F. CERAMIC  
INSULATED  
TUNING  
CONDENSERS**



**ELECTRIC  
BAND  
SPREAD**



**R.F. ON ALL  
BANDS**

*At this  
Price!*

**HOWARD RADIO COMPANY**  
1731-35 BELMONT AVE. • CHICAGO, ILL. • CABLE ADDRESS: HORAD

**BY DEMAND**  
*we repeat*  
**OUR CRYSTAL OFFER**



- *Unmounted*
- *X-Cut*
- *Very Active*

**FREQUENCIES**

7200-7500 Kc.

**99¢**

**SPECIAL HOLDER**  
 PLUGS INTO 5-PRONG  
 SOCKET..... **89¢**

**FREE**

**Our New Fall Catalogue**  
 A POST CARD REQUEST NOW  
 WILL BRING IT TO YOU

**RADIO SHACK**

46 BRATTLE STREET  
**BOSTON**

	Points	QST%	Sec's
<b>BRITISH COLUMBIA</b>			
VE5QP	38,001	256	53
YO	32,604	220	52
QA	25,177	203	45
OJ	19,932	151	44
SW	15,151	138	39
FZ	14,742	117	42
TR	9120	127	40
PO	4568	82	21
PX	4239	97	18
UK	2052	38	18
AG	1980	33	20
RI	12	2	2
<b>MANITOBA</b>			
VE4SH	23,963	187	45
MJ	20,355	156	46
SO	18,428	138	45
TR	12,302	148	42
LZ	5692	60	33
GJ	1035	23	15
<b>SASKATCHEWAN</b>			
VE4ZC	7524	77	33
ABR	5460	76	32
QZ	4374	55	27
<b>QUEBEC</b>			
VE2EE	39,468	353	52
EP	32,220	179	60
FG	23,436	188	42
KM	22,756	195	39
DJ	17,025	137	43
DR	16,758	133	42
AA	8118	85	33
JT	6351	75	29
NT	5628	68	28
OI	4131	51	27
HL	1260	30	14
FF	451	19	13
<b>EASTERN PENNSYLVANIA</b>			
W3BES	16,070	86	7
GPG	14,931	79	7
AIZ	10,017	54	7
GHM	9355	50	7
GDI	4320	40	6
FKO	3285	37	5
ADE	2898	23	7
EEW	1086	19	3
QS	162	6	1
BFL	162	3	2
<b>Md.-Del.-D. C.</b>			
W3FQZ	14,080	75	7
RFQ	9251	50	7
GKZ	4851	38	7
GYQ	3645	27	5
AOO	3456	32	6
<b>SOUTHERN NEW JERSEY</b>			
W3FAX	5994	55	6
BEI	810	15	3
GHF	486	6	3
GHR	216	8	2
AIR	72	4	1
GCU	27	1	1
<b>WESTERN NEW YORK</b>			
W8JTT	12,191	64	7
PWU	7776	48	6
QHX	1440	20	4
RKM	1377	17	3
DHU	198	6	2
<b>WESTERN PENNSYLVANIA</b>			
W8QES	3654	30	7
JSU	3375	25	5
IYI	483	13	2
ASW	27	1	1
<b>ILLINOIS</b>			
W9MUX	16,726	89	7
IU	15,998	82	7
VES	11,434	60	7
WEN	9072	56	6
DQH	5575	30	7
TMU	4374	28	6
YTS	2268	14	6
EUZ	1890	14	5
<b>INDIANA</b>			
W9SBA	12,096	64	7
EGQ	7938	49	6
ABE	6048	32	7
PWZ	4005	45	5
YCZ	810	9	5
<b>MICHIGAN</b>			
W8NJC	7938	49	6
CMH	6930	55	7
BML	540	15	2
<b>OHIO</b>			
W8QOH	8343	53	6
NOT	7497	62	7
BYM	4126	26	6
PBX	3915	29	5
FWY	3132	29	4
BMK	756	7	6
<b>WISCONSIN</b>			
W9VDY	10,962	77	7
VTZ	9398	58	6
W9ZFT	9153	60	6
YCV	1080	10	4
ARE	648	9	4
PTB	18	1	1
<b>SOUTH DAKOTA</b>			
W9FOQ	4117	31	5
VOD	1147	9	5
<b>NORTHERN MINNESOTA</b>			
W9RXL	16,065	85	7
YCR	8424	53	6
<b>SOUTHERN MINNESOTA</b>			
W9VIP	54	2	1
<b>LOUISIANA</b>			
W5KC	5832	36	6
EUK	2295	17	5
<b>MISSISSIPPI</b>			
W5FIT	2565	21	5
<b>TENNESSEE</b>			
W4LN	3038	45	5
<b>EASTERN NEW YORK</b>			
W2EWD	7830	68	5
<b>NEW YORK CITY AND LONG ISLAND</b>			
W2IOP	15,687	89	7
KKR	10,489	56	7
KZF	3240	24	5
KTF	1903	24	3
AOD	1584	22	4
HBO	702	13	2
8QPS-2	27	1	1
2AFZ	18	1	1
<b>NORTHERN NEW JERSEY</b>			
W2JKH	12,002	64	7
WC	7245	59	7
JJE	7020	52	5
GVM	5454	51	6
HUG	5130	39	5
CW	4320	32	5
CKQ	2430	27	5
DSV	1620	12	5
JXJ	891	11	3
HRN	27	1	1
<b>Iowa</b>			
W9YWW	6726	40	7
YXK	5184	32	6
LDH	4860	30	6
YQY	2835	21	5
QVZ	2093	31	5

# BUILD A BETTER TRANSMITTER

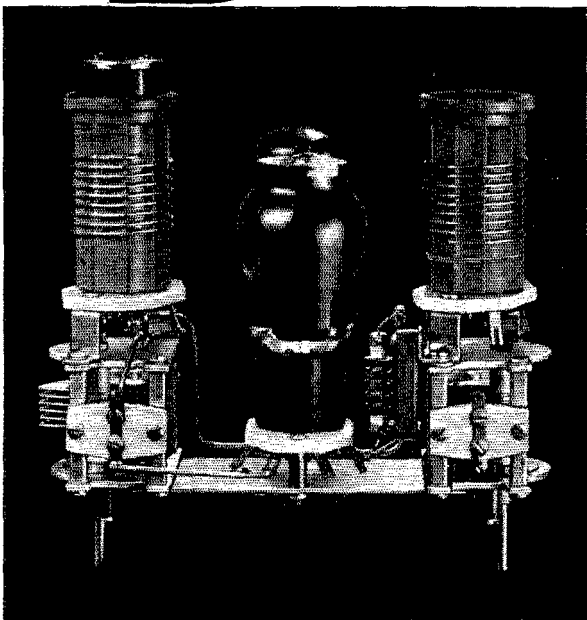

The "OD-10" oscillator-doubler unit is a companion to the "PA-300" and "BD-40". These three, when used together, constitute a highly efficient modern all-band transmitter with up to 300 watts output. The whole transmitter can be built on a single 19" x 15 $\frac{3}{4}$ " standard relay panel and can be assembled and wired in a single evening. Ask your jobber to show you all three of these modern units.

Write Dept. Q-9 for folder describing these new "Foundation Units"

**HAMMARLUND MANUFACTURING CO., INC.**

424-438 W. 33rd Street, New York City

Canadian Office: 41 WEST AVE., NO., HAMILTON, ONT.



# HAMMARLUND

Say You Saw It in *QST* — It Identifies You and Helps *QST*

"OD-10" is the third in a series of Hammarlund foundation units designed to make it easier for the Ham to build his own transmitter. This unit is used in building the crystal oscillator-doubler shown in the illustration. Like the other Hammarlund kits, this one includes all necessary brackets completely drilled and shaped. Just the thing for the beginner who is not experienced in designing transmitters. The completed unit is capable of up to 25 watts output and operation on two amateur bands with a single crystal. Starting with this surefire rig, the beginner can add units to it until he has a complete 300 watt all-band transmitter.

**Birnbach**  
**ONE OF THE MOST**  
**RESPECTED NAMES**  
**IN RADIO**

Respected because there is never any compromise with quality in Birnbach Products; because every one of the 3000 items in the Birnbach Catalog is guaranteed to satisfy; because for 17 years Birnbach has pioneered many new products such as Feed thru Insulators, Serotok, the new Solderless connection for test leads and prods, etc. Before you buy parts to build your new rig Specify Birnbach!

**A FEW BIRNBACH LINES**

- Feed thru Standoff Insulators
- Standoff Insulators
- Cone Standoff Insulators
- 10 or 50 watt sockets
- Jacks, Plugs, accessories
- Test Prods and Leads
- E01 cable
- Stretchless Copper-weld Enamel
- Antenna wire or any of the 3000 other items listed in our catalog.

**BIRNBACH RADIO CO.**  
 145 HUDSON ST. **BIRCO** NEW YORK, N. Y.

**LEARN RADIO**  
**— TELEVISION —**

500 Licensed graduates placed in past 7 years in shipping, broadcasting, aviation, police, etc.; we also teach radio servicing and repairing; new term Sept. 12th, Nov. 7th day or eve., 52-page catalog free, oldest, largest and best equipped.

**MASS. RADIO SCHOOL**  
 18 Boylston Street, Boston

G. R. Entwistle, Pres.  
 Established 1899

R. F. Trop, Treas.  
 Hancock 8184

Now You Can Have a Guaranteed, Licensed  
**CRYSTAL MICROPHONE**

At This Amazing  
 Low Price!

TURNER TORPEDO **\$14.95**  
 MODEL 55 **List**

YOUR voice sounds like "you" with the marvelous new Turner Torpedo. This genuine licensed and guaranteed crystal microphone is built to equal and surpass microphones costing much more. Ultra modern styling steps up the appearance of your outfit. Because it is streamlined and free from peaks you can operate it close to loudspeakers without feedback trouble. Operation is semi-directional. You need no polarizing voltage or input transformers. Crystal cartridge is floated to eliminate noise and breakage. Advanced production methods make this expensive-looking microphone available at an amazing low cost. Guaranteed for one year. Order yours now.

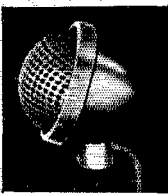

**Free Wiring Diagrams**

These show you how to connect the Torpedo — build an all AC preamplifier, or add a high gain stage to present equipment. Output level — 60DB. Range 50-7000 cycles. 8 ft. cable and side opening coupler. Write today.

**THE TURNER COMPANY**  
 CEDAR RAPIDS, IOWA  
 Licensed Under Patents of the Brush Development Co.

	Points	QSO's	Sec's	
<b>KANSAS</b>				
W9YAH	5265	33	6	
WCB	4455	28	6	
AHR-9	1755	13	5	
VBQ	486	6	3	
<b>MISSOURI</b>				
W9RSO	13,797	76	7	
GBJ	7776	72	6	
QMD	4212	40	6	
WCM	2497	20	5	
<b>NEBRASKA</b>				
W9ZRP	5332	37	6	
DMY	2376	22	6	
<b>CONNECTICUT</b>				
WITS	16,065	85	7	
BIH	310	10	3	
GME	756	14	3	
JBJ	496	6	3	
ACR	162	3	2	
UE	18	1	1	
<b>MAINE</b>				
WILDC	108	2	2	
<b>EASTERN MASSACHUSETTS</b>				
WIRY	8190	66	7	
JEA	2070	23	5	
JCE	1476	21	4	
IYX	1413	18	3	
JYB	590	11	2	
BDV-1	378	7	2	
BDU	378	7	2	
LBV	108	3	1	
ILR	81	2	2	
BOE	54	2	2	
IQO	27	1	1	
<b>WESTERN MASSACHUSETTS</b>				
W1EOB	1755	13	5	
<b>NEW HAMPSHIRE</b>				
W1AVJ	9396	58	6	
BFT	3672	34	4	
<b>RHODE ISLAND</b>				
W1GBO	648	12	3	
LBV	18	1	1	
<b>VERMONT</b>				
W1KOO	567	7	3	
KVB	216	4	2	
<b>IDAHO</b>				
W7GFN	5346	33	6	
<b>MONTANA</b>				
W7EWR	54	2	1	
<b>OREGON</b>				
W7GHB	8707	67	5	
CYU	1458	18	3	
<b>WASHINGTON</b>				
W7CMB	10,044	63	6	
GHL	7776	51	6	
FIV	5333	42	5	
BHW	1845	23	5	
L.D	1255	16	3	
FZB	216	8	1	
<b>HAWAII</b>				
K6CGK	1755	13	5	
<b>SANTA CLARA VALLEY</b>				
W6MLY	9315	62	6	
NCO	6966	43	6	
PBV	648	12	2	
ITH	4220	40	6	
EJA	2970	33	5	
LMZ	2430	27	5	
DHS	270	5	3	
<b>SAN FRANCISCO</b>				
W6NEN	10,044	63	6	
JMR	9553	61	6	
MCU	3240	24	5	
IPH	1800	20	5	
MUF	1620	13	5	
<b>SACRAMENTO VALLEY</b>				
W6AJD	126	4	2	
<b>SAN JOAQUIN VALLEY</b>				
W6MVK	30,145	161	7	
CLZ	2862	27	4	
IWU	72	2	2	
<b>NORTH CAROLINA</b>				
W4ECH	5103	54	7	
DWB	4455	33	5	
ESO	2470	33	3	
OC	18	1	1	
<b>VIRGINIA</b>				
W3AAF	3455	28	7	
FQP	2232	31	4	
<b>WEST VIRGINIA</b>				
W8LCN	2565	29	5	
FTJ	2430	27	5	
JJA	666	19	2	
RJG	36	2	1	
<b>COLORADO</b>				
W9YAD	14,013	87	6	
UEL	3078	29	6	
TSQ	108	3	2	
<b>UTAH-WYOMING</b>				
W6OWV	567	7	3	
PGH	216	4	2	
<b>EASTERN FLORIDA</b>				
W4DIQ	11,242	61	7	
EPT	3982	59	5	
QN	1701	14	7	
DRK	486	6	3	
<b>WESTERN FLORIDA</b>				
W4AXP	54	3	2	
<b>GEORGIA-CUBA-ISLE OF PINES-PORTO RICO-VIRGIN ISLANDS</b>				
W4AMM	3870	44	5	
<b>LOS ANGELES</b>				
W6ONG	1080	13	5	
KSX	810	10	3	
AM	72	2	2	
<b>ARIZONA</b>				
W6LAI	5832	36	6	
8KZL-6	3618	36	6	
5AUI-6	36	2	1	
<b>SAN DIEGO</b>				
W6MTC	4860	45	6	
MUS	3348	31	6	
ISG	1800	20	5	
<b>NORTHERN TEXAS</b>				
W5DQD	5040	40	7	
DWO	2835	21	5	
<b>OKLAHOMA</b>				
W5AQE	9450	50	7	
GTA	2362	18	5	
<b>SOUTHERN TEXAS</b>				
W5FZD	2500	20	5	
GGS	1242	12	4	
<b>NEW MEXICO</b>				
W5HAG	2295	17	5	



*The* A.R.R.L. NATIONAL  
CONVENTION AND AMATEUR  
RADIO EQUIPMENT SHOW

SHERMAN HOTEL, CHICAGO  
SEPT. 3-4-5 1938

*Greatest Ham  
Event of all Time*



## Station Activities

(Continued from page 60)

### CENTRAL DIVISION

**ILLINOIS**—SCM, Leslie M. Dickson, W9RMN—KJY thanks the gang for their FB cooperation the past two years. We're all grateful to him for an excellent job as S.C.M. Sgt. Benfer at 9EC has been transferred to Panama, says 73 to the gang and promises to keep a schedule from K5AA. HPG has been appointed 6th C.A. Radio Aide in place of DOU who resigned. TZQ is new O.R.S. in Waukegan. BEN is proud possessor of a new National band-switching exciter and will be on with a kw. this fall. Looks like the score of the Egyptian Radio Club station, 9AIU, will be right up on top again this year in the F.D. contest. THB now has a 3.9-Mc. Hertz and a 14-Mc. "Q." QOJ, using 10 watts on 7 Mc., gets S8 on both coasts. A "Z" Net is now in operation on the high end of 7 Mc. ZEW invites anyone whose call starts with a Z to join. NHF is looking for used portable equipment. VEE is busy with cipher work. RWS is one of the few who is keeping traffic schedules during the summer. Last call for the A.R.R.L. National Convention at Chicago. See you there.

Traffic: W9EC 230 RWS 118 DDO 47 MRQ 40 VS 32 KJY 34 (WLTK 6) TUV 15 NFL 14 KMN 11 EBX 10 ZEW 5 AA-HQH 4 VEE 3.

**INDIANA**—SCM, Noble Burkhart, W9QG—AEC lost his antenna in a windstorm. AXH received card from Cox of VK2GU. CYQ, QG got back from trip through the Northwest. DBJ is going strong for DX. DHJ is about the only c.w. man in Indiana who handles traffic any more. EGQ is experimenting with small portable transmitter on 7 and 3.5-Mc. c.w. and 1.75-Mc. 'phone. HUV has been trying to work some DX on 56 Mc. MUR will soon have pair of T40's in final. NXU is new ham at Linden. PQQ is rebuilding his rig to 200 watts. PWZ wants more O.P.S. on 28 Mc. to contact. QEI is going hot on 56 Mc., and works everything he hears. RE is new E.C. for Vincennes. SYJ takes the traffic honors this month. TRN has new 250-watt 'phone on the air. UNS has new home-made receiver for all bands and special 28-Mc. super. VMG has been working with Penn. R.R. on emergency program. WMC is moving to Vincennes. YVE applied for O.P.S. With the fall operating season beginning soon, all amateurs should register their station and equipment in the A.E.C. Drop a card to the S.C.M. or 9SYJ for full information. The annual Illinois Indiana Amateur Radio Picnic held July 17th at Turkey Run State Park was a big success with 230 registered, including about 125 hams. I hope to see a lot of you fellows at the convention in Chicago, over Labor Day.

Traffic: W9DHJ 17 LDV 3 SYJ 78 TRN 3.

**KENTUCKY**—SCM, Darrell A. Downard, W9ARU—The S.C.M. spent a week in Michigan. DEQ built up a new rig. PKW left Owensboro to be at WLW for a few months. ELL has been heard on 28 and 14 Mc. WXL has two rigs on the air and needs six states for W.S.A. NOX is a new ham in Ashland. JWE bought a new Sky Buddy. BEW's XYL is visiting California. SFD is putting in an 802 osc., 807 buffer. ALR got a pair of 809's on 3.9-Mc. 'phone and is actually handling traffic!

Traffic: W9EDQ 39 ARU 29 ALR 11 ELL 5.

**MICHIGAN**—SCM, Harold C. Bird, W8DPE—Michigan Eight: AIZ says service on his traffic much better; gets answers to 80% of originated traffic. CMH has been giving the net nice lot of traffic. JUQ has everything ready for coming season except portable. QGD had fine trip to Yellowstone Park. NUV is going to rebuild. IXJ reports by radio. PLC is back from N.C.R. cruise. MQG would like to see Michigan Field Day contest. RRE has been doing nice work on QMN. ROV says MTE is on WTBA. S.S. North American. FX will get the mast up very soon now. DED says NOH and QIN are 28-Mc. enthusiasts. OCC is getting new bug tuned up to burn 'em up this fall. SCS is new reporter. WO is doing nice work to help QMN along. JAH is new O.P.S. DYT is back from N.C.R. cruise and duty at Air Base at Grosse Isle. CSL's brother donated QMN crystal, so now he will have to get on net. NQS' antennas blew down in wind. RRH has rig on 28 Mc. and is hearing lots of DX. ROF is experimenting with "Harmonic Tank Circuit" in QST of February. HKT reports SDH and SCS as new hams, SDH on 28-Mc. 'phone; reports solid contact with PYP who is down in N.Y.C. for summer school; schedule was through 2MT and over land line to PYP. ROV worked CM5GL on 7 Mc. with 25 watts to 6L6 crystal osc. FOV—Genesee County Radio Club had FB 56-Mc. transmitter hunt, also

enjoyed dinner and hamfest at Flushing Country Club. NDL sends his report while aboard the U.S.S. *Dubuque* on cruise. ONK is rebuilding for the coming season. NQ is up at New Baltimore for a month taking in the lake breezes. MPX is still working the South Africans. EWH and GUN are working 7 Mc. during summer. NAV still has 205 in final with 400 watts on 3.9 Mc. DYH says you do not need invitation to belong to QMN. All you need is the QMN crystal for 3663 kc. NGC will be N.C.S. on 9 p.m. net after Oct. 1st. Michigan Nines: GJX is on way to Hollywood, Calif., and is going to school out there. CWR has been on only on RM Nights. IIT schedules YPI daily. Very glad to report the appointments of JUQ, NDL and PLC as R.M. Congratulations. Hope to see you all at QGD at Convention, 73.—Hal.

Traffic: W8AIZ 142 CMH 65 JUQ 64 QGD 60 DPE 36 NUV 29 IXJ 20 RJC 18 PLC 13 MGQ-RRE 11 LSF 7 ROV-FX 6 DED 4 OCC 5 SCS-WO 3 JAH 2 PYT 1 DYH 18. W9CE 16 IIT 15 CWR 1.

**OHIO**—SCM, E. H. Gibbs, W8AQ—Let's make 1938-39 a big season for OHIO Section. BBH leads the section in traffic once more, right through the summer season. EEQ also thrives on summer traffic work. WE shoves a few despite the hot shack. NXN attended Camp Perry with O.N.G. unit. AQ vacationed in W1 area again, taking 10-watt portable along. LCV spends summer on 14 Mc. except for RM Nights. BAH vacationed at Put-in-Bay. Cleveland gang will handle Air Races on 1.8 and 3.9-Mc. 'phone this year. RN on KFMK is looking forward to new season at home QTH. LOF is taking trip to Florida this summer. SCT is a new call in Portsmouth with 6L6 rig on 7190 kc. MQC has been playing with low-power 'phone and c.w. on 3.5 Mc. PUN and FSK handled considerable Marietta Boy Scout Jamboree traffic. ROT, Dial Radio Club of Middletown, with FVW as chief op., set up station at the jamboree and did a fine job keeping the boys in touch with their homes in five states. CVZ is looking for a real good 14-Mc. beam. 89 gang picnic at Clear Lake, Ind., was attended by several Ohio members. KKH built new freq-meter for 14 and 28 Mc. FNX has 200-watt rig under way for fall. HFR, OVL and CDR have been working on a rotary antenna at OVL. MFV is back with another 250TH. DXB has been vacationing in VE3, listening to the gang each evening. PKS is building compact 29-Mc. rig. KNF has new 100-watt rig on 57872 kc. Greater Cincinnati Club had a night club party, July 15th, and is having its annual stag picnic, Sunday, August 28th, at Boone County Harvest Home grounds near Florence, Ky. All hams are invited to a big day's fun. GMI has the 14-Mc. rig perking at last. OZH of Beverly and PBX of Cincinnati are prospective O.P.S. Youngstown's Emergency Coördinator is MJM, just appointed. See you at the National Convention at Chgo., Gang!

Traffic: W8BBH 38 (WLHA 26) PUN 110 EEQ 104 FSK 41 WE 20 CVZ 18 BQN 16 VZ 11 KKH 7 NXN 6 FNX 3 JFC 2 AQ 1. (May-June: W8CVZ 9.)

**WISCONSIN**—SCM, Aldrich C. Kronos, W9UIT—SJF is on 14 Mc. mostly. VDY has been handling considerable traffic on 3.5 Mc. The Dells Region Radio Club made 1800 points in Field Day. Some of the gang have been sending in reports a week to ten days late. Please, fellows, mail 'em on the 16th. ZTP has been vacationing. WSY now has three V beams. ZGD moved to new QTH and is working DX on 56 Mc. NAV is almost ready for some of that 56-Mc. DX. Speaking of 56 Mc., the Milwaukee gang is all going strong. We may get that M.R.A.C. cup back yet. UIT pounds brass all night in the Police Net and then goes home and works the ham rig for five or six hours. Some of the gang have been sending in reports to the S.C.M.'s old address. The new address is printed in the front part of QST. 1KJK/9 is still at Racine and has a 14-Mc. beam. 9ASQ was best man at GKP's wedding; also visited local Duluth and Superior hams. The Superior gang extends congratulations to GKP and new wife; may all your troubles be little ones, Carl. DXI plans taking portable rig on vacation. HDP is on the air again. PSC is getting a pair of T-40's for final. QFL, Eau Claire, works ONI, QIG and WSB consistently on 1.75 Mc. RZY will soon be on with new rig. QQG is acting secretary for local club. Thanks to ONI for the news from Superior.

Traffic: W9VDY 202 1KJK/9 4.

### DAKOTA DIVISION

**SOUTH DAKOTA**—SCM, Dr. A. L. Russell, W9VOD—SEB, R.M.; OXC, O.B.S., O.O. G6QS wants South Dakota for W.A.S.; look for him on 14,016 or 14,100 kc.

daily. QAK finally got parts for the new power supply. To get the most out of your tubes, says USH, tape up the cracks with adhesive. YNW knocked off OA4Q and XE1H with the new 6L6-T20-211 rack-and-panel job. 4FBP, ex-W9WSU, is home for summer vacation. EDX is going classy with P.P. 211's on a 1.75-Mc. 'phone. CRY, YNW and CQK will cruise on the U.S.S. *Paducah* on the Great Lakes this year. CRY has '03A final going. ZRA gets more sock to his final after rebuilding. RDH finally got the bugs out of the T40's. LYO and MRS are new calls in Sioux Falls; look for 'em on 7 Mc. BKK's new 14-Mc. vertical works FB on other bands, too. NJC on 7 Mc. and LRA on 1.75-Mc. 'phone are new hams in Garretson. ZNM had to desert 14 for 1.75-Mc. 'phone to satisfy the XYL, which may be why YNW suggests a new ham term—i.e., "YLing." YEZ is putting up a 3.5-Mc. zepp. RSE borrowed speech equipment and knocked off G5, VK4, and K6 on 14-Mc. 'phone, using 150 watts to an 830B. VOS is trying an e.c. oscillator on 14 and 7 Mc. DKJ is rebuilding his whole rig for 14-Mc. 'phone. ADJ emerged from rebuilding with two rigs, one for 28 and 14 and another for 3.9-Mc. 'phone. YJX is on 1.75-Mc. 'phone. YKY is rebuilding for 28-Mc. 'phone. UAV put up new antenna mast—and then moved. YLB is on 14 Mc. but most tickled over hooking New Hampshire on 3.5 Mc. CJC has a new 28-Mc. 'phone. The Rapid City Club used 1.75-Mc. junk-box 'phones for timing and running off races in the soap box derby there; ADJ, YKY, YJX and YOB each built rigs. QVY took a 6200-mile vacation to the west coast, visiting YOB en route. WYL-9 is new call in Aberdeen; formerly OM2MA, 9SXM; will work 3.5, 7 and 14 Mc. with 100 watts to P.P. T20's. SEB blew his RK25 and is building the July QST exciter. USI, USH and WVN are going nuts over 56-Mc. DX; 400 watts to T55's have knocked over ten states for USI. ZCC decided to let band-switching go until his pocketbook recovers from the new 350-watter. Dust off those 3717 rockers, gang—only a few days now until the traffic season opens!

Traffic: W9VOD 7.

**NORTHERN MINNESOTA**—SCM, Edwin L. Wicklund, W9IGZ—YCR is on 14 Mc. ZGT gets out nicely on 7 Mc. ZGU built a new rack. IFW is building new rig. FUZ is operating and living in a trailer house. QPG is the old reliable on 7 Mc. YKD spent two weeks at Camp Ripley with National Guard. KQA has been playing with 56-Mc. receiver. VTH, our P.A.M., left us to join the Navy. LSC visited your S.C.M.; he plans to rebuild rig in a metal rack. The Arrowhead Radio Amateurs are publishing a newsy little paper, "The Discharge." Now that fall is coming and there will be more activity, I will appreciate your monthly reports.

**SOUTHERN MINNESOTA**—Acting SCM, M. L. Bender, W9YNQ—This is YNQ's first report as Acting S.C.M. We hope you fellows will send in more reports. We would like to build this Section into one of the most active in the League. We can if you will give us your whole-hearted support. Your officers are helpless without it. With the fall season almost on us, we should have a lot of activities with those new and overhauled rigs. So what do you say? Let's go! DCM had his rig on 28 Mc. and got a "heard" card from South America. BP is having a lot of fun on 56 Mc. RWH is spending his vacation in Hollywood and looking over the movie studios. LCT applied for O.R.S. ZAD is Class "A" now. ZSX and ZAD hung up some kind of a record for a long-winded QSO; it lasted 4½ hours. VRY has started his 200-watt 'phone rig. KUI has his 500-watt rig about ready to go places on 28 Mc. The Rochester Radio Club held a picnic at Lake Florence near Stewartville, and considerable trading took place. Once a month they have a swap night. WAO has been "tromping" around on 28 Mc. GLE can sure wind swell filament transformers. FNK worked a priest in Czechoslovakia who had only 1½ watts input. YNQ has a new 6L6G and a T20 rig. FNK and GLE were showing two hams from Jamaica the sights around Rochester. A severe wind storm blew down several skywires around this part of the country. The rain has made it pretty hard on the transmitters located in basements. 73.

Traffic: W9ZAD 1.

#### MIDWEST DIVISION

**IOWA**—SCM, Clyde C. Richelieu, W9ARE—YRO, QUF and TJA are rebuilding. WWY took Class "A" exam. YTJ rebuilt entire station. YQY worked K7 for 6th country. GFQ built 1-kw. rig for Iowa State Centennial. IBR moved to Minneapolis. QGW worked an LU on 28 Mc. ZQW received Class A ticket and W.A.S. B.VY schedules California. CCY is looking for 56-Mc. DX. SEE is on 3.9-Mc. 'phone. QAQ has new 800-watt rig on 1.75 and 28 Mc.

NVF won speed contest at Burlington Hamfest. PJR built high-power 56-Mc. crystal-controlled transmitter for Burlington 56-Mc. hidden transmitter tests, July 25th. WTD is on 28-Mc. 'phone. WMP took 1st prize with his 56-Mc. transceiver. TMY built communication receiver that out-performs most commercial jobs. QVA has new "bug." QGU is active on 56 Mc. with parallel rod osc. QOQ is on 1.75-Mc. 'phone. WNL is new 1.75-Mc. 'phone. CTQ bought ARE's old vertical copper pipes, and plans 28-Mc. beam. FSH received medal of merit from W.C.T.U. for splendid conduct at Burlington Hamfest. ARE built new pre-selector ahead of S-16, and is now working 14-Mc. DX on 'phone. This being my initial report as S.C.M. of Iowa, I want to thank everyone responsible for that nice job of railroading me into the honored position by use of the petition. Hi. In starting my 'work as your A.R.R.L. representative, I want to remind all holders of O.R.S. and O.P.S. certificates that one year is the deadline and these certificates must be endorsed to remain valid. Also want some sign of activity from all A.R.R.L. appointees such as O.R.S., O.P.S., O.O., O.B.S. etc., or I'm going to wield the blue pencil and weed out the dead ones. Can use a couple conscientious men for O.O.'s, who can show necessary qualifications and equipment.

Traffic: W9ZQW 20.

**KANSAS**—SCM, Harry E. Legler, W9PB—Members of the Sunflower Radio Club surprised our Route Manager, UEG, with a birthday luncheon. RAT is back on 4-Mc. 'phone. With a very recently issued call, MKU already has 20 states toward W.A.S. ZAW, a recent A.R.R.L. member, says QER, QXG, UZD, WAM and AEI are all active around Ft. Scott during the summer. AJJ, formerly of Marceline, Mo., is now located at Salina. We welcome him as a very active O.R.S. and A.A.R.S. Reporting Topeka activities, FRC let us know that LVD is new call there. ICV and IIZ are portabing on California vacations. 5CDY is now located there. AMD and CET are on 3.5 and 14 Mc. respectively, and AWP was recent visitor. CMV protests she has not been on 'phone and will not be on 'phone as was reported last month. We regret the misunderstanding of a remark in a letter from her. She is gunning for the guy using her call. On June 26th hams from northeast Kansas and vicinity held a hamfest and field day at Seneca which was promoted by YOS and YXV. Portable rigs of CQC, QGO, UOG, CHE, WQP, DLEK and ZBB were on hand.

Traffic: W9UEG 24 ZAW-MKU 4 LVD 1.

**MISSOURI**—SCM, Letha Allendorf, W9OUD—ARH DXed again—worked G6QS, HR4AF, VQ8AA, VK2AQ, G2QB, VP2AD and CM6DV. QHC, ex-9AFL, worked 30 countries on 14 Mc. RNK has a 6L6 on 1.75-Mc. 'phone. KJK schedules 9BRD. VVX boasts a rotary beam which works. HVT visited GCH in Minneapolis. VMH has been playing chess on 1.75-Mc. 'phone and invites competition for 1.75 or 3.5 Mc., 'phone or c.w. DIC is still at M.U. instead of at home as previously reported. QOB has a new flat-top beam and is going after DX. NIP is new ham on 7 Mc. MYX is preparing to change QTH. QXO is handling traffic for students at M.U. summer term. QCO is still bucking 3.5-Mc. QRN. MDZ and RPC have a new house, due to the old one burning down in March; they operate on 7 Mc. Speaking of vacations—GBJ had a vacation trip—particulars unknown; MRC is planning one into Minnesota. OWQ visited OUD briefly, July 4th; EYM and XYL also visited OUD. QJP has a swell signal on 7 Mc. TGN is RM2/C in U.S.N.R. now and has his kw. rig going from 1.75 to 28-Mc. 'phone and c.w. OUD schedules brother, 5GZG, and sister, SREI, the latter operating 9ERP.

Traffic: W9TGN 134 OUD 109 QXO 32 ARK 4 KIK-HVT-QCO 2.

**NEBRASKA**—SCM, Samuel C. Wallace, W9FAM—EKK completely rebuilt transmitter and has twice power input. EHW is experimenting with 1.75-Mc. 'phone and 14-Mc. c.w. DI built emergency portable transmitter. SDL had bad storm which took masts down; putting up 40-ft. poles now. FFF is new O.R.S. KPA has the annual rebuilding habit. ZFC reports big time at hamfest in Council Bluffs, Ia. WGL hooked J2HQ and immediately following snagged XU8CM; he has Asia for sure now. JED got a T200 and a Meissner Signal Shifter; he will have 750 watts input. YDZ blew all his tubes. N.E. Nebr. Club officers: YMU, pres.; YDZ, secy.; JED, treas. Hamfest at Wayne turned out as well as expected.

Traffic: W9EKK 52 EHW 10 DI 3

(Continued on page 112)

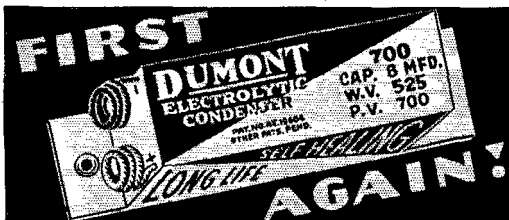

## An Amazing Improvement in Electrolytic Condensers

**NEW! NEW!**

The only Anti-Drift Low-Loss Mica Condensers with silver plates. Literature on request

DUMONT engineers produced and patented the world's first electrolytic condenser in common use today. Same engineers, after five years' research now produce FIRST SUPER HIGH VOLTAGE Electrolytic. Reheals if overloaded or punctured. This patented feature is found only in DUMONT Condensers. Used by U. S. Government — a real test of quality. Used in highest priced radio

receivers, yet sold at very attractive price. Try some today and be convinced. FULLY GUARANTEED FOR 1 YEAR.

Manufactured by

**DUMONT ELECTRIC CO., Inc.**  
 514-516 Broadway, New York

Write for free catalogue, nearest jobber and attractive discounts

World's Leading Mfrs. of Precision Condensers

## RADIO ENGINEERING



RCA Institutes offer an intensive course of high standard embracing all phases of Radio and Television. Practical training with modern equipment at New York and Chicago schools. Also specialized courses and Home Study Courses under "No obligation" plan.

Illustrated Catalog on request

**RCA INSTITUTES, INC.** Dept. ST-38

A Radio Corporation of America Service

75 Varick St., New York 1154 Merchandise Mart, Chicago

## LEARN CODE RIGHT

INSTRUCTOGRAPH tapes send you typical messages Radio or Morse any speed. Easy, practical way to improve. Senior Model \$20.25 (also rented). Junior Model \$12.00 (not rented). Complete oscillator equipment less battery \$6.50. Write for details today.



## INSTRUCTOGRAPH CO.

Dept. Q-9 912 Lakeside Place, Chicago, Ill.

## DON'T BE MISLED!

Erecting a 33-foot self-supporting vertical mast on a rooftop is serious business. A cheap, flimsy product is a dangerous hazard to life and property. That is why ACE antennas reflect their design by competent structural engineers as well as skilled radio craftsmen, in their sturdy, attractive commercial appearance and excellent radiating qualities.

Already scores in use by commercial interests and discriminating amateurs, you too, can experience the satisfaction of a sound and efficient radiator that requires less than a square foot of roof space!

Prices are far below what you would expect to pay for a product of this quality. Order direct from factory.

Type HF-20 — 33-ft. radiator ..... \$19.50 (20-40-80-160 bands)

Type HF-10 — 16-ft. radiator ..... 13.50 (10-20-40-80 bands)

Remit with order or COD on receipt of \$5.00 deposit

**ACE PRODUCTS CO., Manufacturers**  
 Terminal Sales Bldg. Seattle, Washington

Write for data on ACE beam antennas

## Midwest Division Convention

Omaha, Neb., October 29th-30th

OMAHA (Neb.) and Council Bluffs (Ia.) amateurs have banded together to entertain the 1938 Midwest A.R.R.L. Division Convention in Omaha, Saturday and Sunday, October 29th and 30th. Headquarters have already been established in Suite 212, Hotel Paxton, in Omaha.

The first convention of the Seventh Corps Area A.A.R.S. will be held jointly with the Midwest Division Conclave. Sergeant J. W. Hudgins, W9BNT, is A.A.R.S. convention chairman; W. H. "Bill" Graham, W9BNC, general convention chairman.

Both for entertainment conventions will be tied up with Nebraska's famous "Ak-Sar-Ben"! Twenty convention committees are hard at work to make this the "King" of all Midwest Division conventions.

## Rocky Mountain Division Convention

Pueblo, Colo., September 17th-18th

THE Congress Hotel, at Pueblo, Colo., has been chosen as the headquarters for the 12th annual A.R.R.L. Rocky Mountain Division Convention, sponsored by the San Isabel Amateur Radio Association. REMEMBER the dates September 17th and 18th. A good program has been prepared, including plenty of entertainment, stunts, singing and golf and tennis tournaments. A picnic breakfast will take place Sunday morning. The advanced registration fee is \$2.50 if made on or before September 8th. After September 8th, \$3.00 each. Save some money by writing E. S. Buchanan, W9WWB, 1007 West Evans St., Pueblo, Colo.

## Massachusetts State Convention

(N. E. Division)

When: October 15th.

Where: Hotel Bradford. Place: Boston, Mass. Auspices of South Shore and Eastern Mass. Radio Clubs.

## WWV Schedules

EACH Tuesday, Wednesday and Friday (except legal holidays), the National Bureau of Standards station, WWV, transmits with a power of 20 kw. on three carrier frequencies as follows: 10:00 to 11:30 A.M., E.S.T., on 5000 kc.; noon to 1:30 P.M., E.S.T., on 10,000 kc.; 2:00 to 3:30 P.M., E.S.T., on 20,000 kc. The Tuesday and Friday transmissions are unmodulated c.w. except for 1-second standard-time intervals consisting of short pulses with 1000-cycle modulation. On the Wednesday transmissions, the carrier is modulated 30% with a standard audio frequency of 1000 c.p.s. The standard musical pitch A = 440 c.p.s. is also transmitted from 4:00 P.M. to 2:00 A.M., E.S.T., daily except Saturdays and Sundays, on a carrier frequency of 5000 kc., power 1 kw., 100% modulation. The accuracy of the frequencies of the WWV transmissions is better than 1 part in 5,000,000.



# Lucky AMATEUR



Amateurs with a Bliley Crystal in their transmitter don't need to carry a four leaf clover or kiss a rabbit's foot every time they start a schedule. They know that any crystal bearing the name BLILEY snaps into action quickly and gives dependable, satisfactory performance.

There are ten different Bliley Crystal Units for every amateur band from 5 through 160 meters. Each unit is specifically designed for its own particular band, carefully manufactured, and thoroughly tested under actual operating conditions. Every possible test and precaution is made to insure satisfactory performance in your transmitter.

The quartz crystal is the "heart" of any transmitter. It does not pay to take chances—buy BLILEY and be certain. See your distributor today!

## BLILEY CRYSTAL UNITS

# GAMMATRON

*15,280 hours*  
in actual operation

IN COMMUNICATIONS SYSTEM  
OF EASTERN AIRLINES INC.

LONG LIFE-LOW COST  
MEANS MORE  
WATT-HOURS PER DOLLAR

HEINTZ AND KAUFMAN  
SOUTH CALIFORNIA  
SAN FRANCISCO LTD U. S. A.

(Continued from page 109)

## WEST GULF DIVISION

**NORTHERN TEXAS**—SCM, Lee Hughes, W5DXA—EOE is rebuilding. DNE is changing rig and getting better receiver. ECE is active on 1.9, 14 and 28 Mc. FZJ is sending O.R.S. on 7187 and 14,374 kc. FHN is new call in Childress. FNP is active again on 7 Mc. BAM is very busy with N.C.R. work. On trip to Amarillo, EZY met GYW, operator at English Field. Boys, it is time to get those traffic schedules, net and trunk line connections lined up. Let's put this Section on the traffic map.

Traffic: W5EOE 25 DXA 7 BAM 2.

**OKLAHOMA**—SCM, Carter L. Simpson, W5CEZ—DTU maintained schedule with FLU, who had a portable rig at Y.M.C.A. Camp near Davis. ASQ is installing remote control for transmitter. DAK received certificate for having completed RM3c training course in Naval Reserve. With Mert and Duke on furlough, a new operator, Jeff, is holding down schedules at FSK. AIR was in car wreck. FEC returned from Port Arthur, Tex., and is located at Blanchard. FRC landed a job and moved to Transverse City, Mich. HGH and HFW are new hams in Buffalo and Ponca City resp.; the former is using battery powered equipment. FWZ, AXA and BRX are new officers of the Tulsa Radio Club. EGQ has been ill for past 6 weeks, but is now able to get around. HGB and HGJ are new hams in Tulsa. DQV is working 14-Mc. DX. GFT and FRB have been rebuilding. CEB took portable to Colo. on vacation. GZU and GRP are interested in A.A.R.S. See you in Carlsbad, Aug. 25th-27th.

Traffic: W5CEZ 150 DTU 110 ASQ 41 DAK 10 EMD 4 FSK 30 (WLJY 12).

**SOUTHERN TEXAS**—SCM, Dave H. Calk, W5BHO—MN reports the A.A.R.S. putting on a membership drive for the coming season. FDR is building a 70-ft. tower and will have two transmitters, one on 7 Mc. and one on 3.5 Mc. FZD has W.A.C. certificate and needs only Nevada for W.A.S. EWZ worked country No. 21, PK1BX. EZE reports working plenty of DX with 50 watts; ABQ is back on 7-Mc. portable. FNY is knocking 'em cold on 14-Mc. 'phone. GWL is trying for W.A.S. with 50 watts. HAQ works lots of DX. HAP is building for 14-Mc. c.w. with pair of 35T and 250 watts. HFO and HGG are new calls in Houston. OV and FYP report that 56-Mc. signals were heard in Galveston, July 15th; several W8's and W9's were heard. BRC put up new beam antenna. The Galveston Amateur Radio Club held a Field Day and Hamfest, July 3rd and 4th, and everyone had a very good time on the beach.

Traffic: W5OW 1086 MN 242 FDR 163 DLZ 65 FZD 51.

## ROCKY MOUNTAIN DIVISION

**COLORADO**—SCM, Glen Glascock, W9FA—A.A.R.S. activity will commence about Sept. 12th. TDR is plenty busy on convention plans and preparations. TTD, back from Kansas City, is proud possessor of telephone first ticket. WWB, convention chairman, makes preparations and expects a real get-together for the division. ZDZ worked a few K7's and finally hooked K5AQ; ZDZ has been visited by 4FHB, 6JTF, 7GBR, 9JRU and ex9DEW. EGY spends his time constructing a new 110-a.c. or 6-volt d.c. portable emergency rig. C.C.R.A. gang had a swell Field Day. WJJ still hangs to 14-Mc. 'phone work. BRZ has right arm in a cast, due to sprained elbow, but manages to keep the key going and do a little writing with his left hand. SBJ has a Jr. opr. to train now—congrats and best luck, OM. Ex-XU8RR and 9BRZ entertained the Montrose Rotary Club recently with demonstrations and talks about ham radio. FHC is working 1.8, 7 and 14 Mc. FXQ has a radiotelephone first ticket. HHD bought a new high-voltage power supply. JWC handled communications for Y.M.C.A. camp in the mountains near Colorado Springs; he has a new antenna and small transmitter for auxiliary work. JFE bought ZKM's rig. NEH joined the flea-power 1.8-Mc. 'phone gang and is having a grand time. OKY is papering the club-room wall with cards gathered during the Field Day contest. UEK holds schedules on 1.8 and 7 Mc.; he is building a gas-engine-powered a.c. generator for emergency work. UTK has a new 6L6-T40 rig on 7 Mc. YLT is building another e.c. rig using 36-6L6-RK39. YZS is on 7-Mc. operating portable in New Mexico. ZBS has his new 1.8-Mc. 'phone rig tuned up. ZCX continues his DX spree, working all bands from 1.8 to 28 Mc. ZXU is on 3.5 Mc. JVR will have W.A.C. if he can collect cards from the many DX stations he has

worked this year. KKY, on a trip into Illinois, has his rig with him to work portable at stops en route. ZCM received a card stating he had been heard in New York City on 56 Mc.!!! AMS of WDAF is back in Colo. Springs on his honeymoon; he is taking his rig back to K.C. and intends to get on the air there. FXQ, radio sgt. in National Guard at Colo. Springs, demonstrated the Guard's new pack-set transceivers to the club. NWQ is newly licensed man in C.S.; he has Sky Champion receiver and a small transmitter. KAD of Pueblo applied for O.R.S. . . . also JWC of Colo. Springs. Any more? Just drop a line to the S.C.M. SNB, WLJ and ZEF are digging hard on studies for Class A exam. WTW passes along some DX information via the "Ham Rambler," which is the official publication of the San Isabel Amateur Radio Ass'n at Pueblo. Bud Walters has been snagging stuff like VK3AJR, VK3DZ, ZL4DX, YV6AL and YV6B on 28 Mc. KAD snagged his 100th DX station on 14 Mc., and 15 minutes later was heard working VK3ZR. UEL added a couple of new ones to his list when he worked Peru and British Honduras. WTW added 6 new countries, making a total of 64 worked; the new ones were FP8IM South Orkney Is., YL2CD Latvia, ISAB Italy, EL2R Liberia, J8CG Chosen and ZK1AA Cook Islands. ZQK is another DX hound in Pueblo. Thanks to all those sending in reports this month. It is hoped that others will follow the lead and see that their gang is represented in the next report. A card will do the trick, fellows, come on. The N.C.R. gang in Denver is fixing things up at the Old Customs House for the winter activity; tables are about wired and transmitter is in the testing stage of construction. Anyone interested in N.C.R. activities, just drop a line to FA, MKN, PWO or GLI, and information will be sent you. Last, but not least, is official announcement of the Rocky Mountain Division Convention to be held in Pueblo, Sept. 17th and 18th. Registrations made before Sept. 7th—\$2.50 per person, after that date \$3.00. Tickets may be purchased at any of the radio dealers' stores in Colorado or by writing to 9WFW, E. S. Buchanan, 1007 W. Evans, Pueblo, 73. Glen, 9FA.

Traffic: W9ESA 76 TDR 46 (WLJS 47) WWB 31 TDS 25 WZ 24 WJ 20 ZDZ 14 EHC 3.

**UTAH-WYOMING**—Acting SCM, E. E. Parshall, W7CLG—Please, gang, mail your reports direct to me, c/o Salt Creek Electric Plant, Midwest, Wyo., as soon as possible and until a regular S.C.M. is elected. Now they are forwarded to T. J. Rigby in Montana, and I can't make up a report to give you any credit unless I hear from you. Let's see if more of you can't take a few minutes to report just once a month. Use a penny post card, or ask for regular cards, and I will send them to you. 7GEE, Laramie, is putting up new vertical antenna; he just got Class A ticket. Congrats, OM. 7GOH, Midwest, reports long skip on 28 Mc. coming on. 7GHE, Midwest, is heard on 'phone regularly. 7GUX, Midwest, had first outside QSO short time ago. 7CLG, Midwest, attended Casper Radio Club meeting. All Utah hams interested in forming a state emergency net are requested to write 6PKB, Carl C. Adler, 2658 East 72nd South Street, Holladay, Utah, stating their power, frequencies, availability, and equipment. 8FLA, Shenandoah, Pa., is anxious to work Utah for W.A.S. How about arranging a schedule with him, gang?

Traffic: W7CBL 8 AMU 12.

## DELTA DIVISION

**LOUISIANA**—SCM, Eugene H. Treadaway, W5DKR—L.R.M.'s: 5BN, 5DWW, P.A.M.: 5BMM, E.C.: 5FPO, O.O.'s: 5DXX, 5FXX. FXX is doing a swell job as O.O. KC will sail with U.S.N.C.R. to Vera Cruz, Mexico. DGB is getting some FB DX cards. ACA has FB new antenna, 410 feet long. BN worked his first VK. WG reports BMR, BQD, BYX, CTU, CMQ, EB, FVD, GCS and GCM had a swell time on their Field Day trip; 75 stations were worked, making a score of 946. FB, fellows. DAQ is very QRL with N.C.R. duties. GPS has a pair of '10's in final. FSX has a pair of 809's on 28 Mc. GRE is going places with his T40 final. EYS is building another new rig. CXQ will have a swell display at Delta Division Convention. DXX promises big doings at the convention in New Orleans on Sept. 3rd and 4th. CJO has a new FB7 receiver and is building a pre-selector. EBB with his midget transmitter gets out in fine shape. JW enjoys building transmitters. FHH, activities manager of N.O.R.C., wants some ideas and suggestions from the gang, so write the OM, fellows, and lend a hand. FPO is building a 1-kw. rig that will fit in his vest pocket.

## Further Reports on 56-Mc. DX

(Continued from page 22)

W1IZY KOE SI KQF JNX KCS HWW IJ JFF JNC; W8QDU worked W1IFU DPP KXK OE DEI W3GCU W5EHM; W9USH worked W5CSU; W9NY worked W1IZY EHT CSR W2KLZ W3DBC HI VX RL W5PHN W8AGU; W9SQE worked W1HXE JQH CGU IIP OE KXK SI IUI KEK SS JUJ KBQ DPP W2JCY W3AIR GSX DBK RL GMZ W5EHM; W9ARN worked W1KNM IJ KTF JMT SI W2GAH JCY ETN BHD LAH KLV ISY FUZ HGB KDB W3DBC W8JHW.

July 20th—W5EHM worked W8CIR BDG HCG MST NED CMK NOB EUK QKI MSK W3GLV W9QEI FEN; W9USH worked W3GLV HJO FKF W8CIR NED IZJ RYM QNK W9UJE; W9NY worked W5CSU W9CLH; W9ARN worked W2FBA W3GLV W9CLH; W8CIR worked W1SI HXE KXK BDC LAQ CRZ LDM ESZ IZY FZU DFY JMT KOE HTE JLK KPN OF EWM LTM W5EHM AJG CSU W8RV GU.

July 23rd—W4EDD worked W9ZHV; W8QDU worked W5EHM; W8CIR worked W4EDD W5CSU EHM.

July 24th—W1EYM worked W6DNS; W5AJG worked W8VO BDG PWW QKI QDU NKJ JLQ NZ W9VHG CLH ZGD FP FEN YTI; W8JLQ worked W5EHM AJG W6DNS PEX RR IOJ AVR W9LJB; W8QFV worked W5EHM; W6DNS worked W1EYM W5CSU W7FDJ



W1KJT HAS GRABBED A BIG SHARE OF THE DX

His transmitter runs a pair of 6L6's, crystal-controlled, in the final. The receiver is a four-tube superregenerator (with an r.f. stage) and the antenna is a Johnson Q, 55 feet above ground.

8JLQ CIR AGU; W8CIR worked W5EHM CSU W6DNS PEX W9USI NJR VIZ; W8QDU worked W5EEX AJG EHM CSU; W9USH worked W3HGR GMZ AXR W4DUK W8CIR NSS AKV MST RWJ CJL IZG W9WLX; W9ZGD worked W5AJG; W9ARN worked W3EZM W8JHW.

July 25th—W4EDD worked W1JRY KNM W2JCY KLV KXH KHR W3HKM RL AXR GSX AIR DX HPD EZM HJO HJP CYE FPL DBC W8CIR IZG W9ZHB; W8JLQ worked W9USI; W8CIR worked W4EDD W9USI BP OLY; W9USH worked W3HJO EZM FBH HGW FKF GMZ GQS W8LHU NED MWL

IZG RUE CIR VO RPC PWE JLQ OJA QNK MST W9WLX NR; W9NY worked W1BRL W3AIR BZJ; W9LNV worked W2GAH; W9ARN worked W1SI W2KLZ.



ANOTHER OUTSTANDING STATION HAS BEEN W9USI

W9USI himself is here seen at the left, the assistant operating W9USH. The receiver used is a two-tube superregenerator, while the transmitter is a push-pull short-line-controlled rig.

July 26th—W1KJT worked W9VHG; W8CIR worked W5EHM.

July 27th—W4EDD worked W3BYF FOP GQS W5CSU.

July 28th—W6DNS worked W7AQJ.

July 29th—W5AJG worked W8LJP VO.

### MORE REPORTS WANTED

This all goes to show that 56-Mc. DX was reported for almost every day of the month—reported, we said. It seems entirely probable that the band was open in some parts of the country every day and it is evident that much more went on than has been reported. There would have been much more to be said if the most recent log from W5EHM had not ended on the 20th. We take our hat off to Patterson—his was a brilliant showing.

The trailing off of reports towards the end of the month suggests that conditions were on the wane, but this is not necessarily so. Some five-meter DX men have the idea that their DX work is routine stuff these days and that reports are of little consequence. Nothing could be further from the truth. Every report of 56-Mc. DX, even if it has been duplicated thousands of times before, is of particular importance at this time. We make a sincere plea for copies of all logs.

As we have already said, space forbids the publication of the "heard" reports. They are, however, being incorporated in the material under study and have already proved to be of tremendous value.

—R. A. H.

### A.R.R.L. NATIONAL CONVENTION

Hotel Sherman, Chicago

September 3-4-5

# LEARNING CODE SPEED IS EASY!

● The Candler way — the system that has made champions. You too can learn to receive and send code at high speed with the same effortless ease with which you speak and read print. With the Candler method, you make immediate, constant progress, doing away with those long weary hours of fruitless, undirected practice that gets you nowhere. Read what Speed Champion McElroy says about Candler's System. "I could not have maintained my record for speed without the aid of this unique scientific training. Every beginner should learn code RIGHT through this system, and every op. who wants real speed should take it." The Candler System is different, why not find out how you can learn in less time and with less cost.

## FREE!

● BOOK OF FACTS — Candler gives you this big book of invaluable information just for the asking. Write today — find out how quickly and easily you can learn. Write today!



**CANDLER SYSTEM CO.**  
DEPT. Q9, ASHEVILLE, N. CAROLINA

# RADIO

**ENGINEERING**, broadcasting, aviation and police radio, servicing, marine radio telegraphy and telephony, Morse telegraphy and railway accounting taught thoroughly. Engineering course of nine months' duration, equivalent to three years of college radio work. School established 1874. All expenses low. Catalog free. **DODGE'S INSTITUTE**, Day Street, Valparaiso, Indiana

## PRECISION CRYSTALS

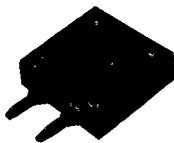

Crystal Holder

Highest quality crystals, one inch square, carefully ground for frequency, stability and maximum output. Be sure of your transmitter frequency — use **PRECISION CRYSTALS**.

Crystals can be furnished with square holder as illustrated (fits G.R. type jacks) or with round holder to plug into tube socket. When ordering be sure to state the type holder desired. G.R. jacks to plug illustrated holder into — 15c pair.

Low frequency drift crystals (Type LTC) supplied within 0.1% of your specified frequency and calibrated to within 0.03% are priced as follows: 1750, 3500 and 7000 kc. bands \$3.50 each. Holder \$1.00. (State type desired.)

'X' cut **PRECISION** Crystals carefully ground for maximum power supplied within 0.1% of your specified frequency and calibrated to within 0.03% are priced as follows: 1750, 3500 and 7000 kc. bands — \$3.00 each. Holder \$1.00. (State type desired.)

'AT' cut crystals for commercial use quoted on at your request. When ordering our product you are assured of the finest obtainable. Now in our ninth year of business.

**PRECISION PIEZO SERVICE**  
427 Asia Street Baton Rouge, La.

## Announcing—The Maxim Memorial (WIAW) Dedication Relay

(Continued from page 46)

'phone): W1DWP, W1EAO, W1SZ. (1.7 Mc.): W1IMV, W1HLE-HSU, W1KAB, W1DAV, W1AQF. (28 Mc.): W1GS, W1BAW. (56 Mc.): W1EYM, W1IJ, W1GYT.

We shall request officials in filing messages to make them of reasonable brevity to facilitate relaying. All stations are asked to follow standard A.R.R.L. message procedure, as given in the Handbook. Most of the messages will directly refer to the dedication of WIAW, the Maxim Memorial Station, on this occasion of H. P. M.'s birthday anniversary. The whole affair carries on the spirit and traditions of amateur radio and every present-day amateur should get a big thrill from taking some part. The "relay" idea was the basis of founding our Association. It still calls for the ultimate in universal cooperation and friendship between amateurs.

Every active amateur, and A.R.R.L. members especially, are invited to participate in this Relay and in that manner in the first official night of operations, dedicating Maxim Memorial Station, WIAW. An article in a future issue will give details on the several antennas and transmitters, and facilities of the new WIAW.

—F. E. H.

## A.R.R.L. NATIONAL CONVENTION

Hotel Sherman, Chicago

September 3-4-5

## A Five-Band Switching Exciter

With 807 Output

(Continued from page 18)

mission would be highly desirable to help maintain proper keying. The unit is, therefore, equipped with a Type 6A8 tube which functions similarly to a converter or mixer tube in a super-het receiver. A separate oscillating circuit is provided for this tube with the frequency controlled from the front panel. A small amount of energy is taken from the plate circuit of the crystal oscillator and mixed in the 6A8 tube to give 465 kc. output in its plate circuit. A coupling lead is then run from the plate of the 6A8 to a point near the grid of the first i.f. tube in the receiver and by adjustment of the control on the front panel continuous monitoring of keying is obtained at any frequency setting of the receiver.

The monitor is coupled to the crystal oscillator for a very excellent reason not apparent at first glance. The crystal oscillator is keyed and in addition runs all the time regardless of whether the crystal or the self-controlled oscillator is being

# 'Super-Pro'

# For Consistent DX!

FRACTIONAL micro-volt sensitivity of "Super-Pro" means "consistent DX". With a 6 to 1 signal-to-noise ratio, sensitivity is better than 1 micro-volt. With such performance even the weakest signal can be received with a minimum of noise. Selectivity is another very important factor in weak signal reception. Here, "Super-Pro" offers variable selectivity (without crystal) from 3 to 16 kc. At 3 kc. a very large percentage of adjacent channel QRM is eliminated and the band width is still wide enough for perfect phone reception. Constant band spread, band switching, crystal filter, A.V.C., shielded input, are just a few of its outstanding features.

Write Dept. Q-9 for Bulletin

**HAMMARLUND MANUFACTURING CO., INC.**

424-438 West 33rd Street, New York City

Canadian Office: 41 West Ave. No., Hamilton, Ont.

- CONSTANT BAND-SPREAD
- VARIABLE SELECTIVITY

## NEW G-E Cylindrical Pyranol Capacitors

NOW you can obtain G-E Pyranol Capacitors in this space-saving shape. They have all the superior qualities of the popular rectangular units—long life, small size, conservative rating, hermetically sealed. Ratings are 2, 3, and 4 mfd—600 volts; 1, 2, 3, and 4 mfd—1000 volts; 0.5, 1, and 2 mfd—1500 volts; 1 and 2 mfd—2000 volts. See your dealer or write for Bulletin GEA-3018. Radio Dept., General Electric, Schenectady, N. Y.

### TELEVISION EXPERIMENTERS!

New Pyranol filter capacitors for television sets are now available. Single-capacity cylindrical units in two sizes—.05 mfd, 4000 volts d.c.; and .03 mfd, 7000 volts d.c. Write for Bulletin GEA-3018.

A clamp is provided for upright or inverted mounting

**GENERAL  ELECTRIC**

900-12

# MEMBERSHIP SUPPLIES

Available only to A.R.R.L. Members

## INSIGNIA OF THE RADIO AMATEUR

In the January, 1920 issue of *QST* there appeared an editorial requesting suggestions for the design of an A.R.R.L. emblem — a device whereby every amateur could know his brother amateur when they met, an insignia he could wear proudly wherever he went. There was need for such a device. The post-war boom of amateur radio brought thousands of new amateurs on the air, many of whom were neighbors but did not know each other. In the July, 1920 issue the design was announced — the familiar diamond that greets you everywhere in Ham Radio — adopted by the Board of Directors at its annual meeting. It met with universal acceptance and use. For years it has been the unchallenged emblem of amateur radio, found wherever amateurs gathered, a symbol of the traditional greatness of that which we call Amateur Spirit — treasured, revered, idealized.

Do You  
Wear the  
A.R.R.L.  
Pin?

THE LEAGUE EMBLEM, with both gold border and lettering, and with black enamel background, is available in either pin (with safety clasp) or screw-back button type.

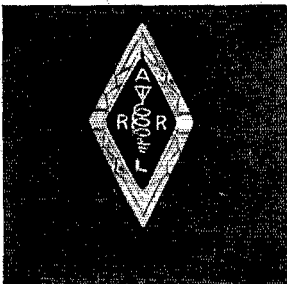

In addition, there are special colors for Communications Department appointees.

- Red enameled background for the SCM.
- Blue enameled background for the QRS or OPS. (Red available in pin type only. Blue may be had in either pin or button style.)

THE EMBLEM CUT: A mounted printing electrotype,  $\frac{5}{8}$ " high, for use by members on amateur printed matter, letterheads, cards, etc.

ALL EMBLEMS PRICED THE SAME

50c postpaid

## STATIONERY

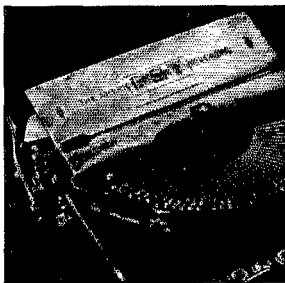

Members' stationery is standard  $8\frac{1}{2}$  x 11 bond paper which every member should be proud to use for his radio correspondence. Lithographed on  $8\frac{1}{2}$  x 11 heavy bond paper.

100 Sheets,  
50c  
250 Sheets,  
\$1.00  
500 Sheets,  
\$1.75  
Postpaid

THE AMERICAN RADIO RELAY LEAGUE  
WEST HARTFORD, CONNECTICUT

used for actual frequency control. If the self-controlled oscillator is being used the crystal selector switch can be set to a 'phone frequency crystal (one seldom used for c.w.) and the monitor set accordingly. Then, band changing or frequency change within any band will not affect the monitor setting and you can hop around to your heart's content without readjusting the monitor. (Ideal when the heat is on in a DX contest!)

## CONSTRUCTION

The top view of the unit shows the general arrangement of parts. The power transformer, filter reactors, capacitors, rectifier tube and regulator tubes which make up the oscillator power supply occupy the right rear corner of the chassis. Directly in front of the regulator tubes is the space for the crystals. The photo shows this space to be rather bare, as the desired number and arrangement of crystals had not been decided upon at the time the picture was taken. However, this space will be taken up with between 12 and 15 crystals. The crystals will all be mounted in small, vertical type plug-in holders, manufactured by the Precision Crystal Laboratory. These holders occupy very little horizontal space and a large number can easily be mounted on a relatively small arc. The space allowed for crystals is large enough to take six standard tube sockets, which allows the use of six crystals in the usual horizontal plug-in holder if desired.

Directly behind the front panel on the right is the crystal oscillator tube and its associated plate coil. The self-controlled oscillator tube, its plate coil and tuning condenser are next in order. In the center of the front panel is the tuning condenser for the monitor oscillator. The monitor oscillator tube and coil are just to the left of the center, back of the front panel. Down the center of the chassis we have the two 6F6 frequency multiplier tubes and their associated plate coils, and ending up at the rear are the four lower frequency output tank coils. The fifth output coil (10 meters) is mounted under the chassis directly on the band-change switch. The 807 output tube can be seen next to the second multiplier plate coil and the output tuning condenser at the rear. The main power-supply transformer, rectifier tube, filter capacitors, and bleeder resistor occupy the left side of the chassis.

All the coils used in the unit are individually shielded, the shielding being similar to that used in modern receivers. This construction was made possible through the cooperation of the F. W. Sickles Company in the design of these coils. Each coil was carefully designed to function properly in its own shield can and is provided with easily accessible terminals which make wiring from coil taps to the band switch and other parts relatively simple.

The view of the under side of the chassis shows the arrangement of sub-chassis shielding and mounting of parts. Each stage is shielded from the others by the bent-up sections of aluminum. These sections not only provide shielding between stages but are made to constitute a sepa-

# DO YOU WANT TO KNOW—



## How to Become a Radio Amateur?

The purpose of this booklet is to tell you, as simply and straightforwardly as possible, what amateur radio is, how one can become an amateur, how to build a simple receiver and transmitter, and how to get on the air.

This *NEW EDITION* of HOW TO BECOME A RADIO AMATEUR contains many more pages which means much more elaborate treatment of the subject. The receiver is a two-tube one and operates either on A.C. or from a battery supply. This receiver may be built for approximately \$12.00. The transmitter described uses a 6L6 crystal oscillator with the power-supply and antenna-coupling unit on the same board, and will operate on any two bands with one crystal, and with proper crystals may be used on any band from 160 through 20 with an output of approximately 10 watts. This transmitter may be built for approximately \$21.00. Information on the various antennas for the different bands is also given. A code-practice oscillator is also described and may be built for a cost of about \$2.25.

**Price 25c** (NO STAMPS PLEASE)

**AMERICAN RADIO RELAY LEAGUE ■ WEST HARTFORD, CONNECTICUT**

**The pioneer is still the leader!**



**Type TL-A Dykanol  
High Voltage  
Filter Capacitors**

Hermetically sealed  
in round aluminum  
containers.  
Conservatively rated.

Imitated,  
Copied—  
**BUT NEVER  
DUPLICATED!**

Write for  
catalog No. 161,  
**FREE** on request.  
1013 Hamilton Blvd., So.  
Plainfield, N. J. Cable  
Address: CORDU.

**CORNELL - DUBILIER**



**ELECTRIC CORPORATION**  
South Plainfield, New Jersey

**AUTOMATIC SENDER \$12.50**

Sends 2 to 70 words a minute. Entirely automatic. Speeds \$13.50 west up reception. Good practise medium for beginners.

**HIGH SPEED RELAYS \$4.50 to \$10**

High-speed Keying, Photo-Cell Amplifier and Sensitive. Only 1" wide and 3 3/4" high. Available in 6, 25, 50, 100, 150 volts.

**MERCURY VAPOR KEYS \$7.00**

If your dealer can't supply you, write us

**Gardiner-Levering Co.** Haddon Heights  
New Jersey, U. S. A.

**LEARN CODE**

the way you'll be using it—  
**by SOUND**



PROBABLY the best way to learn to read code is by listening to code. Probably the best way to learn to send code is by hearing your own sending repeated back to you. With the New All Electric Master Telex Code Teaching Machine you learn code the natural, easy, fascinating way. Only instrument ever produced which records your sending in visible dots and dashes—then SENDS BACK your own key work at any speed you desire. While not designated as standard equipment, Telex is used at many U. S. Army Posts, Naval Training stations as well as the American Telephone & Telegraph Co. Also by practically every private school in the U. S. teaching code; and many foreign governments. We furnish complete course, lend you the New All Electric Master Telex, give you personal instruction with a **MONEY BACK GUARANTEE**—all at a surprisingly low cost per month. Write today for **FREE** catalog Q-9. No obligation.

**"HAM" SPECIAL** Standard Telex— a highly efficient code teacher using heavy specially prepared waxed paper tape, having two rows of perforations. Write for Free folder "Q. T. 9."

We are the originators of this type instrument  
**TELEPLEX CO.** 72-76 CORTLANDT ST.  
NEW YORK, N. Y.

rate sub-assembly including the main band switch, by-pass condenser, chokes, grid leak mountings, etc. This sub-assembly construction made it much easier to mount and wire the various by-pass capacitors and switch sections.

The self-controlled oscillator grid coils are mounted directly to the 3-section switch  $S_3$ , which selects between crystal and self-controlled operation. The 2-section crystal-selector switch is mounted directly below the crystal oscillator tube and plate coil. The main band-change switch has each of its sections located directly below its associated coil, making leads direct and short. The arrangement of tubes, coils and switch sections as well as shielding for the two multiplier and output stages is highly important to keep the unit free from self-oscillation. Too much care cannot be taken in keeping all leads short and in shielding the grid and plate circuits from each other. The two remaining switches shown on the front panel are the power control switches  $S_4$  and  $S_5$ . At the time the photo was taken the 'phone switch  $S_5$  had not been wired to its terminals at the rear of the chassis.

Sufficient terminals were provided to allow metering of all the plate and grid circuits. These metering terminals were found to be very handy during the adjustment period as they provided an easy means of checking what was going on in all parts of the unit.

**OPERATION**

To give a complete picture of the actual operation of the unit a typical set of data was taken and is shown in Table I. No actual output has been included in this table as it was felt that excitation to the output stage measured in the form of grid current was adequate proof of the output that could be expected. Actual output measurements are purely a guess unless made carefully with adequate equipment, while excitation to the output stage grid is something which can be measured accurately. Reference to the published typical operating data, Class C, on an 807 tube shows full output with 50 volts of bias. A 100,000-ohm grid resistor is used in the grid circuit of the 807 output tube and it was found that 0.5 to 0.6 milliamperes of grid current provided full output.

Examining Table I, it can be seen that regardless of which oscillator is used, extremely satisfactory operation and output are obtained on all bands including 14 megacycles. Only when using a 1.75-Mc. crystal is the excitation down to the low limit in the 14-Mc. band and even then entirely satisfactory operation is obtained. To reach 28 Mc. in the final it is necessary to double in that stage and therefore no data in the table changes from that shown for 14-Mc. operation. To produce satisfactory output while doubling to 28 Mc. in the final it was found necessary to have at least 1.5 ma. of grid current in the 807 tube and that more excitation gave still better efficiency. For 28-Mc. operation, the table shows that only 3.5-Mc. crystals or the 1.75-Mc. self-controlled oscillator should be used. Using either of these two oscillator frequencies, roughly 18 watts into a



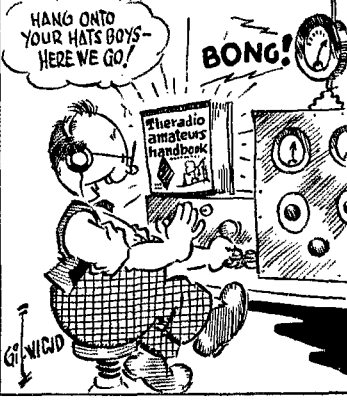
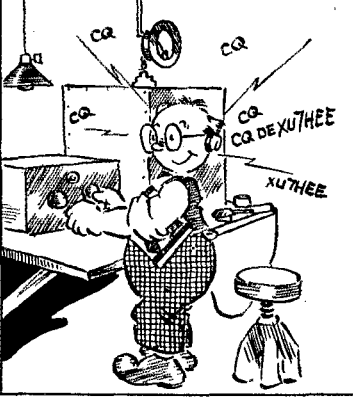
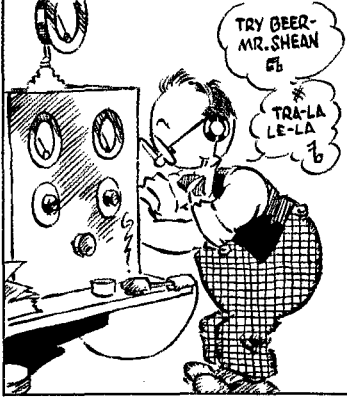
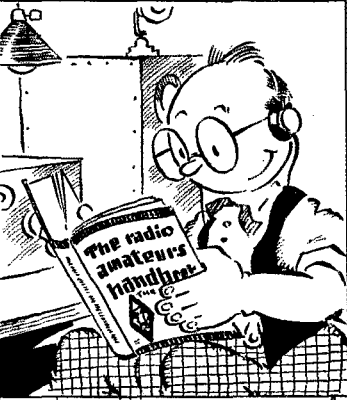
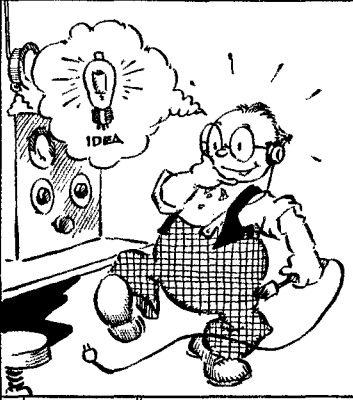
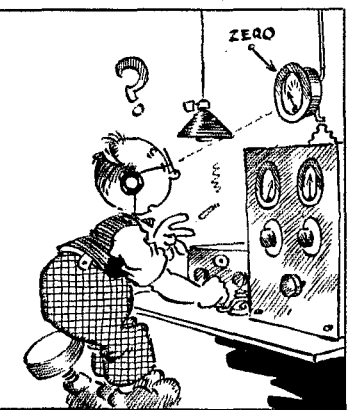
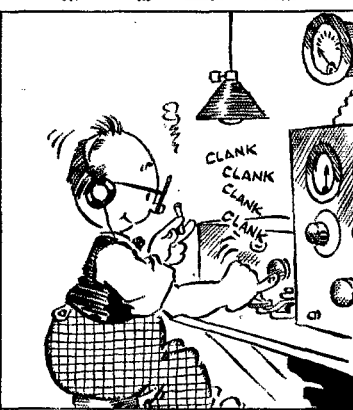

# DX DAN

\$1 postpaid in Continental U. S. A. — \$1.25 postpaid elsewhere  
 Spanish edition \$1.50 postpaid

**American Radio Relay League • West Hartford, Conn.**

# THE RADIO AMATEUR'S *Library*

For some time our advertising in *QST* has carried a by-line reading "Number ..... in the Series entitled Radio Amateur's Library." Many requests have been received for copies of this list and now we present it in *QST* in its complete form — to give a comprehensive picture of our publishing services to the amateur.

No.	Title	Price
1.	<i>QST</i>	\$2.50 per year*
2.	List of Stations	Pre-war Out of Print
3.	Map of Member Stations	Pre-war Out of Print
4.	Operating an Amateur Radio Station (Formerly called Rules & Regulations of Communications Dept.)	Free to members; to others 10c
5.	The Story of The A.R.R.L.	Out of Print See No. 13
6.	The Radio Amateur's Handbook	\$1.00**
7.	The Log	35c each; 3 for \$1.00
8.	How to Become a Radio Amateur	25c
9.	The Radio Amateur's License Manual	25c
10.	Hints & Kinks for the Radio Amateur	50c
11.	Lightning Calculators:	
	a. Radio (Type A)	\$1.00
	b. Ohm's Law (Type B)	1.00
	c. Wire Data (Type C)	50c
	d. Decibel (Type D)	50c
	e. Parallel Resistance — Series Capacity (Type E)	50c
	f. Resistance Calculator (Type F)	50c
12.	Amateur Radio Map of the World	1.25
13.	Two Hundred Meters and Down: The Story of Amateur Radio	1.00
14.	Building an Amateur Radiotelephone Transmitter	25c

\*In the United States and Possessions and Canada.  
Other Countries \$3.00 per year.

\*\*Postpaid in Continental U.S.A. — \$1.25, postpaid,  
elsewhere.

**THE AMERICAN  
RADIO RELAY LEAGUE, INC.**  
West Hartford, Connecticut

lamp load connected to a tuned circuit at the end of a 5-foot link can be expected.

Further study of the table shows the rather peculiar operation which is used when operating self-controlled. The output circuit of the oscillator is adjusted for peak operation at four times the oscillating circuit frequency, which means that when operating on 1.75 and 3.5 Mc. the grid of the first 6F6 tube has a predominance of excitation voltage at either two or four times the actual frequency it is amplifying. As can be seen from the amount of grid current obtained on the second 6F6 tube, however, there is still sufficient fundamental or second harmonic excitation available to allow the first 6F6 tube to do a nice job of amplification. In effect this demonstrates the wide-frequency pass characteristics of the semi-tuned plate circuits used, especially at the lower frequencies.

In actual operation the unit has been used to excite a final amplifier consisting of two 803 tubes in push-pull. Excellent operation has been obtained and the joy of being able to shift frequency at will with practically no effort has been a great thrill. More specifically, for the benefit of the DX man it has been found practical to shift from one end of the 14-Mc. band to the other with no tuning adjustments necessary except on the plate circuit of the 803 amplifier tubes, and even this adjustment was made after actual transmission was started. With the tank circuits of the 807 tube designed for relatively low-*C* operation and with this tube fully loaded, broad tuning results, and by permitting a slight rise in plate current in this tube the full 400 kc. is covered with ease. The grid circuit of the 803 final is also designed for low-*C* operation, and by slight over-coupling to this circuit no adjustment is necessary to cover the 14-Mc. band.

As to how well the unit fulfills the fifth requirement mentioned at the beginning, that of signal quality, general reports by competent observers indicate that the output is T9 and that no difference can be noted between crystal- or self-controlled. During the experimental stage a bad self-controlled note was traced to feed-back from the final 803 amplifier into the oscillator, by means of the supposedly cold inter-connecting power wiring. Proper filtering of these leads removed the trouble and so I am passing this bit of experience along in case others may have similar trouble.

For the first 5 to 8 minutes a drift in frequency will be observed when operating on the 7, 14 or 28-Mc. bands with the self-controlled oscillator. On 14 Mc. this drift amounts to approximately 6 or 7 kc. However, after the oscillator has warmed up, keying or long periods of no transmission will produce very little drift. Actual contacts on 14 Mc. lasting from 15 to 45 minutes have brought the report from the other end that no change in receiver tuning was necessary during the QSO.

In conclusion I might say that in order to check the design, a duplicate unit was constructed by W1BDW and it worked perfectly with only normal adjustments.

# Where to buy it

A directory of suppliers who carry in stock the products of these dependable manufacturers.



**BUTLER, MISSOURI** 211-215 N. Main Street  
Henry Radio Shop

**CHICAGO, ILL.** 833 W. Jackson Blvd.  
Allied Radio Corp.

**CHICAGO, ILL.** 901-911 W. Jackson Blvd.  
Wholesale Radio Service Company, Inc.

**COLUMBUS, OHIO** 203 N. Fourth St.  
Bell Radio Parts Co.

**DETROIT, MICH.** 171 E. Jefferson Ave.  
Radio Specialties Co.

**DETROIT, MICHIGAN** 11845 Woodward Ave.  
Radio Specialties Co.

**KANSAS CITY, MO.** 1012 McGeo Street  
Burststein-Applebee Company

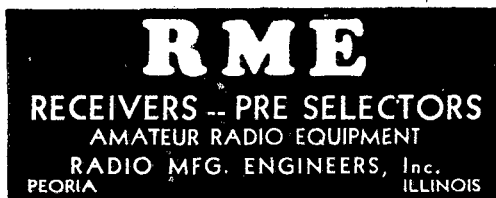

**BUTLER, MISSOURI** 211-215 N. Main Street  
Henry Radio Shop

**CHICAGO, ILLINOIS** 833 W. Jackson Blvd.  
Allied Radio Corp.

**CINCINNATI, OHIO** North Bend Road, Mt. Airy  
Jos. N. Davies

**MINNEAPOLIS, MINNESOTA** 1124-26 Harmon Place  
Lew Bonn Company

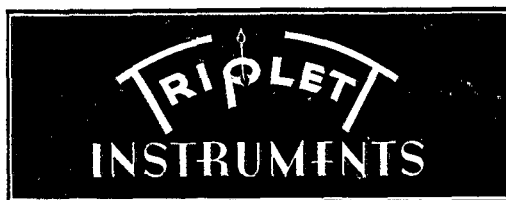

**CHICAGO, ILL.** 833 W. Jackson Blvd.  
Allied Radio Corporation

**CHICAGO, ILL.** 901-911 W. Jackson Blvd.  
Wholesale Radio Service Company, Inc.

**CHICAGO, ILLINOIS** 25 North Franklin Street  
Electric & Radio Supply Co., Inc.

**MINNEAPOLIS, MINN.** 1124-6 Harmon Pl.  
Lew Bonn Co.

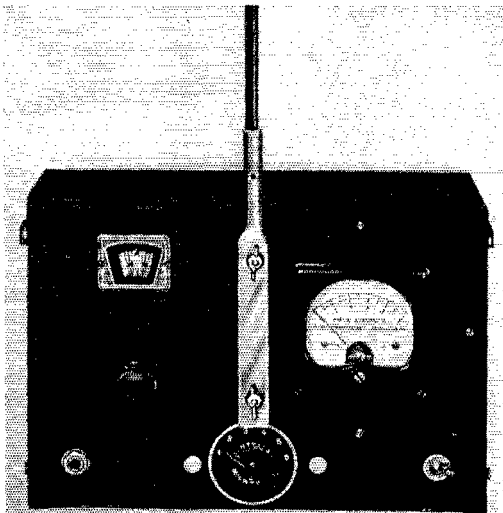

**New . . . POPULAR PRICED  
MULTI-BAND  
FIELD STRENGTH METER**

Write for complete details, specifications and price

**Radio Transceiver Laboratories**

8627 115 STREET RICHMOND HILL, NEW YORK

**RIVALS CRYSTAL FILTER!**

A unique, single-unit, noise- and static-reducing, electro-acoustical device called Selectosphere. Universally adaptable to old and new ham receivers, from trf's to supers. No alterations. Three years proven performance with amateurs, commercials and expeditions. See page 16, Feb. '38, QST. Selectosphere sold direct at \$3.95. Write for "dope."

SELECTOSPHERE CO., BOX 3, NEWTONVILLE, MASS.

**SPECIAL TO AMATEURS**

**Piezo-Electric Crystals — \$2.50 EACH** POSTPAID

Until supply is exhausted . . . we offer 80 meter band crystals unmounted; accurate calibration, excellent oscillators. Limited quantity.

**SCIENTIFIC RADIO SERVICE**

"The Crystal Specialists Since 1925." University Park, Hyattsville, Md.

**College Grade ENGINEERING Credit Courses**

Students qualified to pursue college studies invited to send for 1938 bulletin describing Home Study on the College Level. Academic in character and comprehensive in scope, courses embrace professional fields of Radio, Electrical, Civil, and Mechanical Engineering. University faculty insures high standards of instruction and scholarship.

**NEWTON INSTITUTE OF APPLIED SCIENCE**  
2021-B Raymond-Commerce Building Newark, N. J.

**REMEMBER**

**ONLY UNTIL AUGUST 31**

To take advantage of the special offer of membership-subscription and a copy of the 1938 edition of the "Handbook" for **\$3**

**Norfolk Amateurs Prepare**

(Continued from page 10)

fore should not be tuned using the neon bulb as resonance indicator.

Contacts have been made with haywire antennas at distances up to 100 miles on 1.8-Mc. 'phone. Newport News has been worked with 10 feet of antenna on one of the transmitters, a distance of about 15 miles. QSO's have been carried on around town on 1.8 and 4-Mc. 'phone with nothing but a 25-watt lamp linked to the final as a load, at distances of 1 to 3 miles. With a fairly good 80-meter antenna working against ground, contacts up to 300 miles have been had with 15 to 25 watts input on 4- and 1.8-Mc. 'phone.

The receiver situation is something that cannot be overlooked. One or two of the local hams are fortunate enough to have SW3's, FB7's or similar receivers adaptable for local portable work. For W3EMM's portable set, an a.c.-d.c. Bosch super-heterodyne chassis has been converted by the writers into a battery-operated communications receiver with excellent results. Another receiver is being "operated on" for W3BEK.

W3EMM's receiver was one that was junked by a local radio dealer. The speaker was bad, the dial was broken and the filter condensers were shot. However, the r.f. section and the i.f. coils were in good shape and of fair construction and design. This particular receiver covers from 20 meters through the broadcast band. The band spread is not very good on 7 and 14 Mc. but is satisfactory on 3.5 and 1.75. With a few changes and the addition of a beat oscillator the set really worked well. The plate voltage originally was 105 volts from a 25Z5 rectifier circuit. With 90 volts of "B" batteries the current drain is from 5 to about 12 ma. for the r.f. and detector tubes, the line-up consisting of a 6A8, 6K7 and 6Q7. The output tube is not used on the "B" battery supply. The beat oscillator tube is a 6K7. A small a.c. pack was built up to supply about 130 volts so that the set could be used on a.c. if available, in which case a switch cuts in the 6V6 output tube which drives a 3-inch speaker installed in the cabinet. Judging from the way this converted set works and the low cost of obtaining it and getting it to work as a ham receiver, this idea might be investigated in other localities as a possible source of supply of portable receivers. The receiver was bought for \$3.00 and the cost of re-vamping it made the total cost about \$8 or \$9, including a new dial, metal carrying case and new speaker. The speaker is not necessary, but was put in so it could be used when the set was running from a.c. There are quite a few sets similar to this one that are of good construction and which are adaptable to such a conversion.

Several of these portable rigs have been carried out in the field and operated emergency style, and it looks as if the situation here is well in hand. If we don't have a hurricane or something to necessitate the operation of our portable net, we are going to whip up a storm or two just for the fun of it!

# HAM-ADS

(1) Advertising shall pertain to radio and shall be of nature of interest to radio amateurs or experimenters in their pursuit of the art.

(2) No display of any character will be accepted, nor can any special typographical arrangement, such as all or part capital letters be used which would tend to make one advertisement stand out from the others.

(3) The Ham-Ad rate is 15¢ per word, except as noted in paragraph (4) below.

(4) Remittance in full must accompany copy. No cash or contract discount or agency commission will be allowed.

(5) Closing date for Ham-Ads is the 25th of the second month preceding publication date.

(6) A special rate of 7¢ per word will apply to advertising which, in our judgment, is obviously non-commercial in nature and is placed and signed by a member of the American Radio Relay League. Thus, advertising of bona fide surplus equipment owned, used and for sale by an individual or apparatus offered for exchange or advertising inquiring for special equipment, if by a member of the American Radio Relay League takes the 7¢ rate. An attempt to deal in apparatus in quantity for profit, even if by an individual, is commercial and all advertising by him takes the 15¢ rate. Provisions of paragraphs (1), (2), (4) and (5) apply to all advertising in this column regardless of which rate may apply.

Having made no investigation of the advertisers in the classified columns, the publishers of *QST* are unable to vouch for their integrity or for the grade or character of the products advertised.

**QUARTZ**—direct importers from Brazil of best quality pure quartz suitable for making piezo-electric crystals. Diamond Drill Carbon Co., 719 World Bldg., New York City.

**RADIO** engineering, broadcasting, aviation and police radio, servicing, marine and Morse telegraphy taught thoroughly. All expenses low. Catalog free. Dodge's Institute, Byrd St., Valparaiso, Ind.

**QSL'S, W2SN, Helmetta, N. J.**  
USED receivers. Bargains. Cash only. No trades. Price list 3¢. W3DQ, Wilmington, Del.

**QSL'S**, all colors, cartoons, snappy service. Write for free samples today. W1BEF, 16 Stockbridge Ave., Lowell, Mass.

**CALLBOOKS**—Summer edition now on sale containing complete up-to-date list of radio hams throughout entire world. Also world prefix map, press schedules and new time conversion chart. Single copies \$1.25. Canada and foreign \$1.35. Radio Amateur Club Book, 610 S. Dearborn, Chicago.

**QSL'S**, Cts. Cartoons. Free samples. Theodore Porcher, 7708 Navahoe, Philadelphia, Penn.

**CRYSTALS**, mounted, 80-160 \$1.25, V-cut 40 \$2.25. R9 Crystals, 338 Murray Ave., Arnold, Pa.

**LISTEN** for W9XA, high frequency broadcast station, Kansas City, Mo.

**QSL'S, SWL's**: one color 45¢, two color 60¢ hundred, postpaid. Samples. W1FTM, 268 Piedmont, Waterbury, Conn.

**FOR sale**: transmitter, five meters, 30 watts, 56, 56, 2-47, 2-45, 83, i.c.w., phone. Good condition, R9 reports. Aluminum rack cabinet 12 x 9 x 18. First \$35, takes it. W2GZC.

**QSL'S, QSL's, QSL's**, U.S.A.'s finest. Samples. W8DED, Holland, Mich.

**COMPLETE rig**—FB7X & pre sel, supply, speaker. Xtal 47, pr. 6L6G, 211E final, input 300 w. Write for full particulars. W9JLV, 2817 Lyndale Ave., So., Minneapolis, Minn.

**QSL'S**. Free samples. Printer, Corwith, Iowa.

**WANTED**: Eimac tubes 35T, 50T, 150T, 100TH, 250TH. Ivan Miller, 1314 E. 15th St., Oklahoma City, Okla.

**QSL'S, SWL's**. 100-3 color—75¢. Lapco, 344 W. 39th, Indianapolis, Ind.

**MACKEY**, black, \$4. W2JOW.

**EXCHANGE** station photographs. W5ACA, University, La.

**BARGAINS**: Stamp brings list. W1GPU.

**WANTED**: Experimenters—television. W1GPU.

**QSL'S**, New styles. Free samples. Maleco, 1805 St. Johns Place, Brooklyn, N. Y.

**TANK** coils constructed to your specifications. W2GVX.

**CRYSTAL** transmitter. W8BJO.

**BEGINNERS'** bargain. For those who don't need the very latest dope: 1937 Jones Radio Handbook (formerly \$1.50). Supplement to same (35¢), and Radio Antenna Handbook, first edition (50¢)—while they last, all three for \$1. express collect; postpaid anywhere, \$1.25. Radio 7460 Beverly, Los Angeles.

**NEW Philco 6 v. d.c. or 115 v. a.c. power supplies** for 5-tube sets. Transformer, vibrator, tube, diagram, etc. \$4., three \$10. postpaid. W4BBL.

**FINAL clearance**—Western Electric amplifier parts, condensers, rheostats, switches, audio transformers, condenser microphones, Weston meters—write for new bargain list. National Cine Labs., 20 W. 22 St., N. Y. C.

**FREE** catalog. Y-cut crystals, 75¢. Other cuts reasonable. Also commercial crystals. Fabradio, Batavia, Ill.

**SELL** DuMont 154 oscilloscope, experimental model, \$25. Kennedy receiver, amplifier, \$20. Want Super Pro. W2AEB.

**SELL**: NC101X, Sky Champion, Sky Buddy, SW3, ATR-219 transceiver, 250 watt, phone—c.w. transmitter in cabinet. Miscellaneous parts, tubes, meters, etc. A. J. Arnold, W5WX, Amarillo, Texas.

**SELLING** out—Collins 4A transmitter, 20, 40, 80 meter coils; 40, 80 meter Bliley xtals. Comet Pro receiver; Model 100 Radiola L. S. Speed-X key. \$95. W5DZH, Madrid, N. M.

**MODERN QSL's**, samples. W8BZK, Newark, Ohio.

**FEATURING** popular brands transmitting tubes. Write Loughnane & Co., Decatur, Ill.

**CRYSTALS**: genuine Eidson T9 dependable, powerful X-cut, 40 and 80 meters, \$1.60. Fracture resisting, high activity type, accurately calibrated, fully guaranteed, T9 ceramic holders, \$1.10. Prices postpaid, C.O.D.'s accepted. Various types of fine commercial crystals supplied on order—inquire. Sold by: Henry Radio Shop, Butler, Mo.; Van Radio, 464 E. 117th No. 7, Cleveland, Ohio; Pembleton Labs., Ft. Wayne, Ind.; Casa Edison, Havana, Cuba; Frank Anzalone, 1540 Broadway, Room 1502, N. Y. C., or Eidson's, Temple, Texas.

**QSL'S**—SWL's. New designs. Bargains. Fritz, 455 Mason, Joliet, Ill.

**CASH** for Super with xtal. W6HEZ.

**SALE** on new streamlined double button makes. Write for details Royal Radio, 3303 S. Lowe Ave., Chicago, Ill.

**ANGLE** of radiation definitely controlled—tilting head rotary. Complete drive unit on bedplate, 900:1 compound worm reduction. G.E. quick reversing variable speed ball bearing motor, with Selsyn type magnetic direction indicator, \$25. Ball bearing rotating tilting head assembly, \$15. 14 m.c. director, radiator, telescoping aluminum tubing, \$11. W8ML.

**CRYSTALS**—X-cut, 1750-2000, 3500-4000+ five kilocycles, \$1.50. Spot frequency, \$2.50. Special prices to Army, Navy, Red Cross and other round table nets. Three small 80 meter blanks, including carborundum, \$1.20; holders, \$1. William Threm, W8FN, 3071 Moosewood St., Cincinnati, Ohio.

**TELEPLEXES**, instructographs, nacometers, omnigraphs bought, sold. Ryan's, Hannibal, Mo.

**TRANSFORMERS** of quality. Designed by W8UD. Match all tubes in Class B or AB. 50 watts audio, \$4.95 pair; 100 watts audio, \$7.75 pair. Postpaid in U.S. Guaranteed. For details write W9LXR, Rice Lake, Wis.

**WANTED**: scale-reading 3 phase wattmeter, electric stop watch, late receiver. W6AHI.

**QSL'S**—highest quality—lowest prices. Samples free. Radio Headquarters, Ft. Wayne, Ind.

**MODERN** 300 watt transmitter and receiver for sale. Kenneth Bishop, 230 Kelsey St., New Britain, Conn.

**CRYSTALS**: Eidson's T9 X-cut 40-80 meters, \$1.60. 7301-7500 k.c.'s, \$2. Holders, \$1.10. Fully guaranteed. C.O.D.'s O.K. Buy these from Van Radio, 464 E. 117th, No. 7, Cleveland, Ohio.

**LONGLINES** oscillator. Beautiful workmanship, powerful, stable, inexpensive. Also non-radiating super-regenerative receiver. QSL for bulletins. Paradio, 124 Garrison, Jersey City.

**QSL'S**. Better designs—better stock—better workmanship. Free samples to hams. W2FJE, 101 Hanson Place, Brooklyn, N. Y.

**CRYSTALS**: 80 meter X cuts, \$1.50. Ground to spot frequency, \$2. Mounted beautiful new molded XM6280 holder, 90¢ additional. Ham Crystals, 1104 Lincoln Place, Brooklyn, New York.

**TWO** Dodge generators converted 110 v. a.c., \$35. each. Clive Hubbell, Concord, Cal.

**NATIONAL** NC81X for sale. Absolutely perfect condition. Best offer. W3AMI.

**WHEN** buying amateur equipment whether you pay cash, trade equipment, or buy on terms it's to your advantage to write me. See my other ads. Bob Henry, W9ARA, Butler, Mo.

**BARGAINS**: reconditioned guaranteed receivers shipped on ten-day trial. Practically all models at big savings. List free. Write W9ARA, Butler, Mo.

**BRAND** new in factory sealed cartons: PR-15s, \$99.; ACR-175s, \$89.; Ultra-Skyriders, \$69.; Standard Mac-Bugs, \$5.95.; ACT-20 transmitter at big discount. W9ARA.

**SELL**: Collins 30FXB, 30FX, 32B, 4A; Marine 18-B; other transmitters. List free. W9ARA.

CODE machines rented. W9ARA.

AMATEUR radio licenses, home study course in code and theory—reasonable, efficient, and thorough. Results guaranteed. American Radio Institute, 200 Broadway, N. Y.

NC101X—National. Used one month only. Must sell—\$100. cash. WIEMH.

PERFECT Collins 30FXB 200 watts fone—c.w. complete, tubes, mike, etc., plus All-Star Senior superbet receiver, \$210. cash combination. Darrah Pomeroy, WFEA, Manchester, N. H., WIPD.

FOR sale: 3¼ x 4¼ Graflex, accessories. W8HD (SCM).

# SICKLES COILS

SECURE A COPY OF OUR NO. 939 CATALOG FROM YOUR JOBBER

F. W. SICKLES COMPANY

300 Main Street

Springfield, Mass.

## ● RADIO OPERATOR'S COURSE ●

TELEGRAPHY  
TELEPHONY  
AVIATION  
TELETYPE  
TELEVISION  
TRANS RADIO  
PRESS



PRACTICAL  
EXPERIENCE  
STUDIO —  
TRANSMITTER —  
ANNOUNCING  
TYPEWRITING

Port Arthur College advertises primarily to Radio Amateurs and the training is too technical for the average student who has not selected Radio as his life's work. The opportunities for positions and advancement are unlimited for men who are interested in Radio and who plan to make this their career and are willing to make the sacrifice and effort necessary to master the training. P. A. C. maintains strict collegiate rank — only high school or college graduates are eligible for enrollment.

*If interested in details about Radio Course, write for bulletin R*

**PORT ARTHUR COLLEGE** ■ **PORT ARTHUR (World-known port) TEXAS**



**NEW HOLDER DESIGN**  
15 SECONDS TO  
INSTALL CRYSTAL

For All Bands  
GREATER STABILITY  
Plugs in 5 prong tube socket

Beautiful Appearance

**MODEL AH HOLDER \$1.00** At your dealer or direct

**HIPOWER LOW DRIFT CRYSTALS:**  
within 10 kc. or Choice of stock

AH-10, 1700-3500 Kc. bands \$2.35

AH-10, 7000-7300 " bands 3.90

WRITE FOR NEW LITERATURE

HiPower "Low Drift" Broadcast and Commercial Crystals Are Approved by F.C.C.

HiPower Crystal Co., 2035 Charleston St., Chicago

## VIBRATOR POWER SUPPLY

COMPLETELY FILTERED  
D.C. OUTPUT

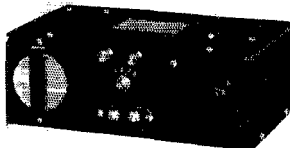

Model 31 — 6 volts DC to 40 watts completely filtered

Unequaled for portable transmitters — giving high output of 35 to 40 watts after filtering. Inexpensive. Engineers for extra long life and heavy duty applications. Variable output ranging from 250 volts D.C. at 50 MA. to 325 volts at 12 MA. Completely filtered for RF interference. Send post card for FREE illustrated and technical catalog. DC to AC Converters recommended by Hallicrafters and other leading manufacturers.

ELECTRONIC LABORATORIES, INC., Indianapolis, Indiana

## A GOOD NAME



... means that users are satisfied. You too, will be satisfied with the perfect performance of dependable Ken-Rad Radio Tubes. Get better results and more enjoyment out of radio with Ken-Rad Tubes.

# Ken-Rad Radio Tubes

KEN-RAD TUBE & LAMP CORPORATION - OWENSBORO, KY.

Manufacturers of all types of radio tubes and Ken-Rad Electric Lamp Bulbs

# Your Nearest Dealer Is Your Best Friend

Your nearest dealer is entitled to your patronage. You can trust him. He is equipped with a knowledge and understanding of amateur radio. He is your logical and safe source of advice and counsel on what equipment you should buy. His stock is complete. He can supply your needs without delay. His prices are fair and consistent with the high quality of the goods he carries. He is responsible to you and interested in you.

Patronize the dealer nearest you — You can have confidence in him

## CHICAGO, ILLINOIS

Allied Radio Corporation  
833 West Jackson Blvd.

Complete standard lines always in stock—W9IBC, W9DDM, W9GEZ

## CHICAGO, ILLINOIS

Chicago Radio Apparatus Company  
415 South Dearborn Street (Est. 1921)

W9RA and W9PST — Amateurs since 1909

## CHICAGO, ILLINOIS

Wholesale Radio Service Company, Inc.  
901-11 West Jackson Boulevard

"The World's Largest Radio Supply House"

## DES MOINES, IOWA

Iowa Radio Corp.  
1212 Grand Avenue  
Complete amateur stock, W9OCG—W9EMS—W9KAY

## DETROIT, MICHIGAN

Radio Specialties Company  
171 E. Jefferson Avenue  
Ham Supplies — National & Hammarlund Sets and Parts

## KANSAS CITY, MISSOURI

Burstein-Applebee Company  
1012-14 McGee Street  
"Specialists" in supplies for the Amateur and Serviceman

## KANSAS CITY, MISSOURI

Radiolab  
1515 Grand Avenue  
Amateur Headquarters in Kansas City

## MILWAUKEE, WISCONSIN

Radio Parts Company, Inc.  
538 West State Street  
Complete stock Nationally Known products

## MINNEAPOLIS, MINNESOTA

Lew Bonn Co.  
1124-26 Harmon Place  
W9BP—W9TLE—W9HOP—W9DKL—W9LEX

## OAKLAND, CALIFORNIA

Offenbach Electric Company  
2085 Broadway  
"The House of a Million Radio Parts"

## SAN FRANCISCO, CALIFORNIA

Offenbach Electric Company, Ltd.  
1452 Market Street  
"The House of a Million Radio Parts"

## SEATTLE, WASHINGTON

Northern Radio Company  
2208 Fourth Avenue  
W7AVC, W7FRF, W7AWP to serve you

## ST. LOUIS, MISSOURI

Van Sickle Radio Company  
1113 Pine Street  
W9OWD invites you to amateur headquarters in St. Louis

## TORONTO, CANADA

A & A Radio Service Supply  
101 Queen Street, West  
Canada's foremost radio supply house

## TORONTO, ONTARIO, CANADA

Wholesale Radio Company, Ltd.  
1133-37 Bay Street  
Canada's Largest Radio Parts Distributors — VE-3XB

## WINNIPEG, CANADA

Electrical Supplies, Ltd.  
306-10 Ross Avenue  
Western Canadian Amateur Headquarters for leading lines

# You Are Protected When You Buy From QST Advertisers

“Advertising for QST is accepted only from firms who, in the publisher’s opinion, are of established integrity and whose products secure the approval of the technical staff of the American Radio Relay League.”

Quoted from QST’s advertising rate card.

Every conceivable need of a radio amateur can be supplied by the advertisers in QST. And you will know the product has the approval of the League’s technical staff.

## Index to Advertisers

Ace Products Company	110
Astatic Microphone Laboratory, Inc.	84
Birnbach Radio Company, Inc.	106
Bliley Electric Company	74, 111
Candler System Company	114
Capitol Radio Engineering Institute	82
Cardwell Manufacturing Corp., Allen D.	76
Centralab	97
Collins Radio Company	Cov. 2
Communication Measurements Laboratory	120
Cornell-Dubilier Electric Corp.	118
Dodge’s Institute	114
Dumont Electric Company, Inc.	110
Eastern Radio Institute	74
Eitel-McCullough, Inc.	99
Electronic Laboratories, Inc.	124
Feighner Technical Associates	86
Gardiner Levering Company	118
General Electric Company	115
Gross Radio, Inc.	100, 122
Hallicrafters, Inc., The	1, 2
Hammarlund Mfg. Company, Inc.	105, 115
Harvey Radio Laboratories	102
Heintz & Kaufman, Ltd.	111
Hipower Crystal Company	124
Howard Radio Company	103
Hygrade Sylvania Corp.	78
Hytronic Laboratories	72
Instructograph Company	110
Johnson Company, E. F.	89
Ken-Rad Tube & Lamp Corp.	124
Kenyon Transformer Company, Inc.	5
Mallory & Company, Inc., P. R.	64
Massachusetts Radio School	106
McGraw-Hill Book Company	70
Meissner Manufacturing Company	93
National Company, Inc.	Cov. 3, 63, 101
New York V. M. C. A. Schools	86
Newton Institute of Applied Science	122
Port Arthur College	124
Precision Apparatus Corp.	80
Precision Crystal Laboratories	86
Precision Piezo Service	114
RCA Institutes, Inc.	110
RCA Manufacturing Company, Inc.	Cov. 4
Radio Mfg. Engineers, Inc.	127
Radio Shack, The	104
Radio Transceiver Laboratories	122
Raytheon Production Corp.	65
Scientific Radio Service	122
Selectosphere Company	122
Sickles Company, F. W.	124
Signal Electric Mfg. Company	84
Solar Manufacturing Corp.	82
Speer Carbon Company	95
Sun Radio Company	116
Taylor Tubes, Inc.	91
Teleplex Company	118
Thordarson Electric Mfg. Company	66, 67, 69, 71, 73, 75, 77, 79, 81, 83, 85, 87, 88, 90, 92, 94, 96, 98
Triplet Elec. Instrument Co., Inc.	68
Turner Company, The	106
United Transformer Corp.	128
Ward-Leonard Electric Co.	86
Yaxley	64



# COMBINATION UNITS

by RME

... Means ...

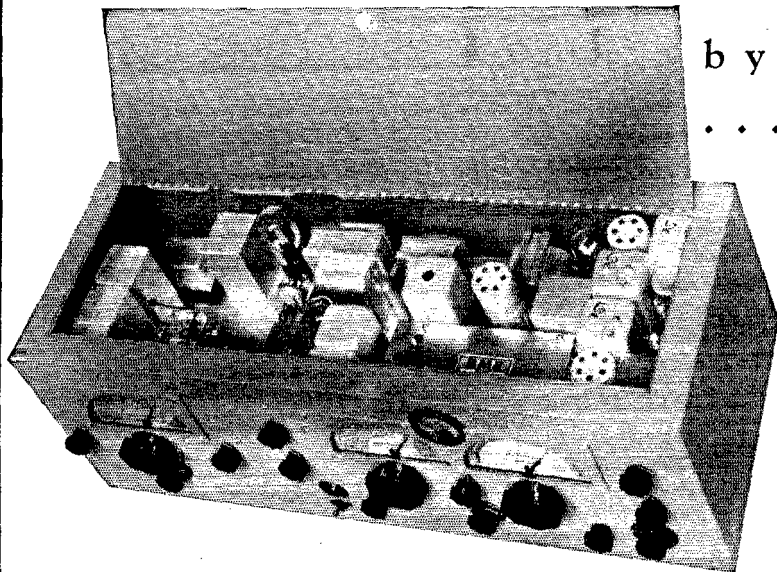

fine, modern performance, with a reputation on the air. Let this be said of your layout this coming year.

(Above)

## RME-69 with DB-20 PRE-SELECTOR

Combined in one cabinet, presenting fine appearance and fine performance. Choice of black or gray crinkle finish. Two chassis mounted in the one housing. Antenna change-over switch standard equipment. A very popular combination.

(Right)

Relay Rack Receiver Combination consisting of RME-69 Single Signal Super Receiver with noise suppressor built in. The 510X Frequency Expander is mounted at the left of the middle panel, and the DB-20 Preamplifier at the right. The 8" permanent-magnet Dynamic Speaker is mounted on the upper panel. A rotary antenna change-over switch is incorporated on both the 510X and the DB-20.

*Details gladly furnished  
on request*

RADIO MFG.  
ENGINEERS, INC.  
111 Harrison Street  
Peoria, Illinois

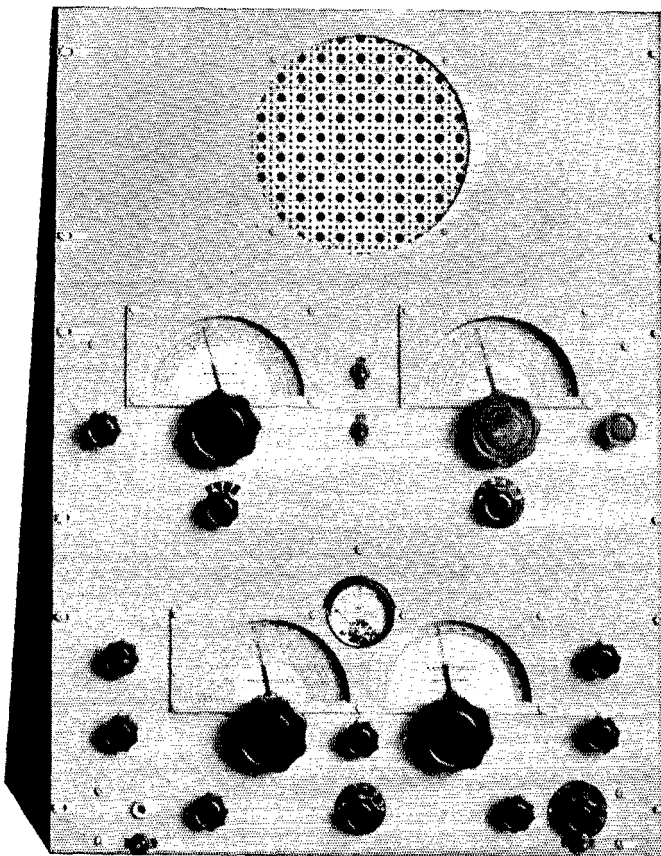

# One of the Best Buys in Transmitter Kits

## HIGH POWER AT LOW COST

BUY EACH SECTION AS YOU NEED IT

Highly efficient stable circuits—Simple to wire—Large etched panels—Modern chrome fittings—Gray crinkle finish—Compare!

### UPPER SECTION

**SX-200** The UTC SX-200 transmitter kit is used in conjunction with the SX-80 or any similar exciter having a power output of 40 watts or more, to form a complete 300 watt CW transmitter. When supplemented by the S-100 modulator it becomes a 200 watt phone transmitter. It will operate on all frequencies up to 30 megacycles and incorporates a highly efficient power supply. Tubes required are two 866A's and four 809's. This unit is supplied completely mounted, ready to wire, including cabinet and accessories, less meter, crystal and tubes.

**Amateur Net Price . . . . . \$43.50**

### MIDDLE SECTION

**SX-80** The UTC SX-80 kit is a complete 80 watt CW unit. Operation on all bands is obtainable with plug-in coils. A rugged power supply is provided. The kit may be used as a complete 80 watt CW unit or as an exciter for a high power final. Tubes required are three 6L6G's and one 83. This unit is supplied completely mounted, ready to wire, including cabinet and accessories, less meters, crystal and tubes.

**Amateur Net Price . . . . . \$37.50**

+

### LOWER SECTION

**S-100 AUDIO AMPLIFIER** The S-100 audio amplifier is an ideal low priced high power unit. 100 watt output is provided with gain sufficient for crystal mike. Dual input and tone control is provided and universal modulation output transformer. Tubes required are one 6J7, one 6C5, two 6F6's, four 6L6's and three 83's. The kit is supplied completely mounted, ready to wire, including all accessories, less tubes and dust cover.

**Amateur Net Price . . . . . \$52.50**

+

**TOTAL COST . . . . . \$133.50**

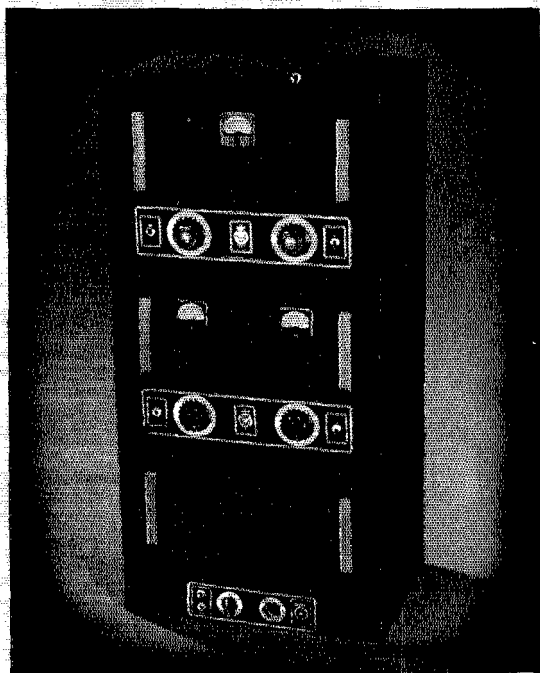

### SX-25

The UTC SX-25 kit represents unprecedented value in a low power transmitter. It employs a crystal controlled oscillator of high power output and stability and will operate on all bands from 160 to 10 meters.

Tubes required are one 6L6G and one 83. The unit is supplied completely mounted with self-contained power supply and antenna tuning condenser, ready to wire, including cabinet and all accessories, less meter, tubes and crystal.

**Amateur Net Price . . . . . \$18.00**

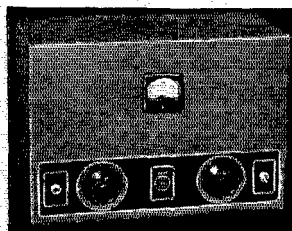

## UNITED TRANSFORMER CORP.

72 SPRING STREET

NEW YORK, N. Y.

EXPORT DIVISION 100 VARICK STREET

NEW YORK, N. Y. CABLES "ARLAB"

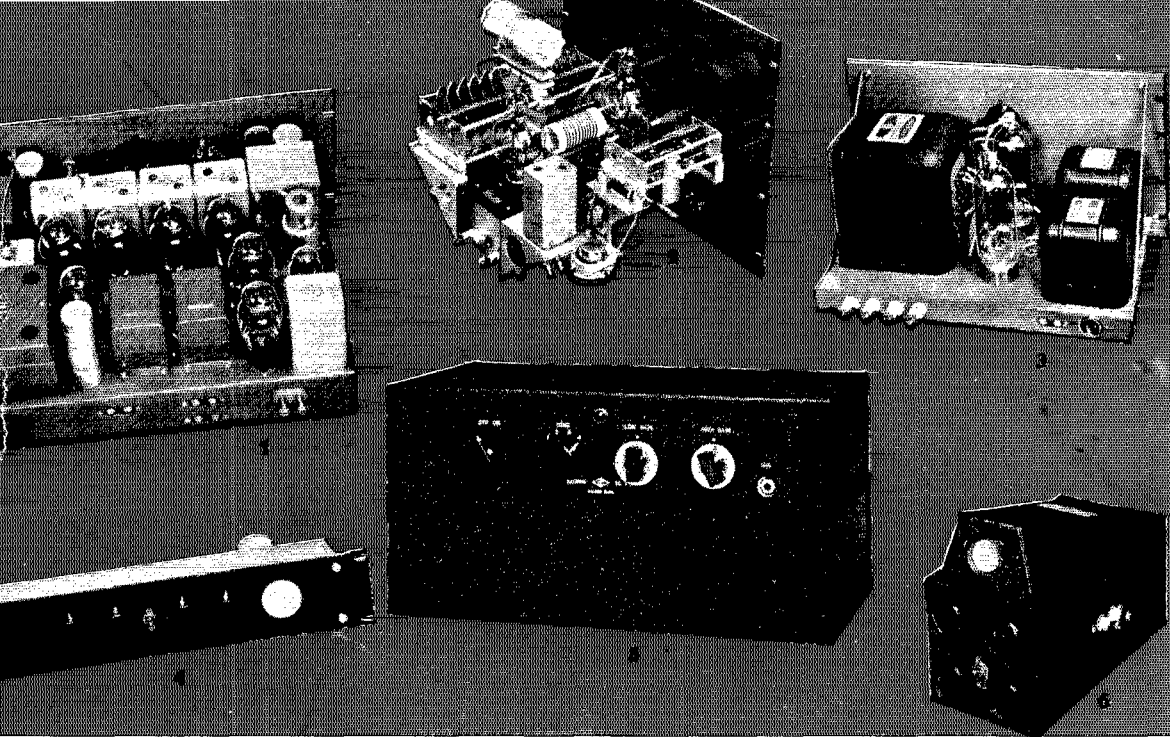

## *This is only a small part of National's complete line of Transmitting Equipment*

**TO SAVE HEADACHES . . .** Completely engineered components such as the NTE Exciter (1) and the NSA Speech Amplifier (5) take most of the grief out of transmitter construction. Both are universal in application, and offer the kind of performance that can be achieved only with the most complete laboratory facilities. Like a good receiver, they represent a long term investment.

Both units incorporate a high gain speech amplifier with 10 watts of push pull 2A3 Class A output for the NTE and 12 watts for the NSA, sufficient to modulate a low power final or drive a high power Class B modulator. The NTE also provides a crystal-controlled oscillator with three frequency-multiplier stages, selected by a push switch on the panel. A control is also provided for selecting any of four crystals, or for tuning a "rubber" crystal.

**TO SAVE HARD LABOR . . .** National

Foundation Units, such as the NT-100PC Buffer and Final (2) and the NT-300PC Modulator take the blacksmithing out of transmitter construction. These chassis come completely drilled, punched, welded, painted, and engraved ready to assemble the parts in place. They are versatile enough to allow the constructor freedom in building to his own particular requirements, yet are based on a standardized design so carefully worked out that even the beginner can proceed with confidence.

**FOR BETTER OPERATING . . .** Oscilloscopes Type CRR (4) and CRM (6) are typical of National's aids to good operating. Type CRR is mounted on a standard 3 1/2" relay rack panel and uses a 2" tube. Type CRM is housed in a small cabinet, and employs a 1" tube. Both have built-in power supplies and 60-cycle sweeps, and both are very low in price.

NATIONAL



COMPANY

# SAVE MONEY

# By Using RCA Transmitting Tubes

## HERE'S WHY WITH THE RCA-809

**YOU SAVE** because your driver stage costs less. For class "C" Telegraphy, two RCA-809's have a power output of more than 100 watts with only 5 watts driving power. An RCA-802 Crystal Oscillator will easily drive two RCA-809's.

**YOU SAVE** because your power supply and amplifier equipment cost less. Since the RCA-809 is a tube of high pervance, you get good performance with low plate voltage. Your transformers, capacitors, and other power-supply equipment cost less.

**YOU SAVE** because the RCA-809 costs less. The RCA-809 is a precision-manufactured Transmitting Tube having exceptionally long life that gives you outstanding performance at a Receiving Tube price: Price \$2.50. Ask your distributor for full information regarding this winner and money-saver, or write to Commercial Engineering Section, Harrison, N. J.

RCA MANUFACTURING CO., INC., Camden, N. J.  
A Service of the Radio Corporation of America

### TYPICAL OPERATION (Class "C" Telegraphy—per tube)

Filament Voltage	6.3	6.3	Volts
D-C Plate Voltage	500	750	Volts
D-C Grid Voltage	-50	-60	Volts
D-C Plate Current	100	100	Milliamperes
Plate Dissipation	25	25	Watts
Driving Power (Approx.)	2.5	2.5	Watts
Power Output (Approx.)	35	55	Watts

Ask your distributor for the new TT-3 Transmitting Tube Manual—Price 25 cents. Contains 192 pages of complete information on all RCA Air-Cooled Transmitting Tubes.

RCA presents the Magic Key every Sunday, 2 to 3 P. M., E. D. S. T. on the NBC Blue Network

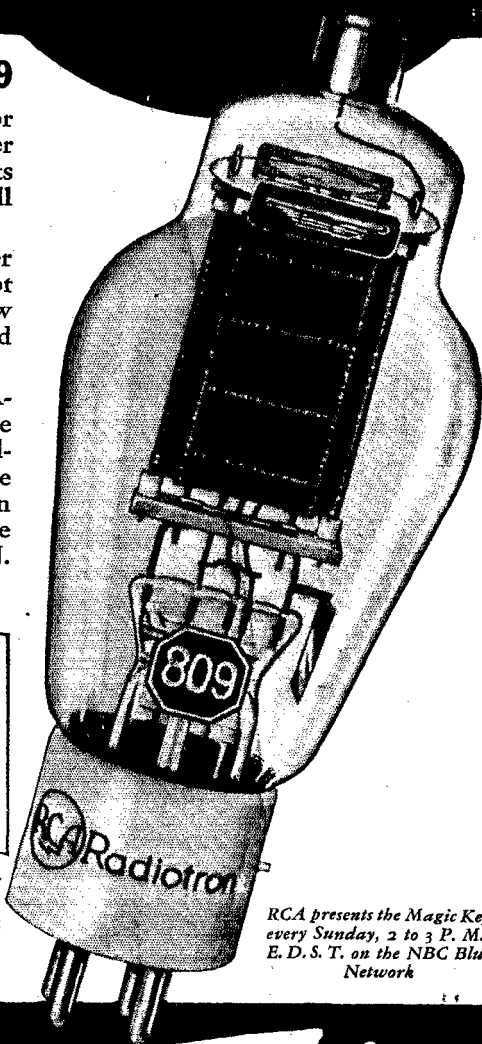

**RCA**  
*Air-Cooled*  
**TRANSMITTING TUBES**

TECHNICAL MANUAL TT-3 PRICE 25 CENTS



# RCA Radio Tubes

FIRST IN METAL—FOREMOST IN GLASS—FINEST IN PERFORMANCE