

QST

January, 1938
25 cents

devoted entirely to

amateur radio

In this Issue—

**A New
Five-Band
Exciter**

**28-Mc.
Crystals
in Operation**

**More on
Television**

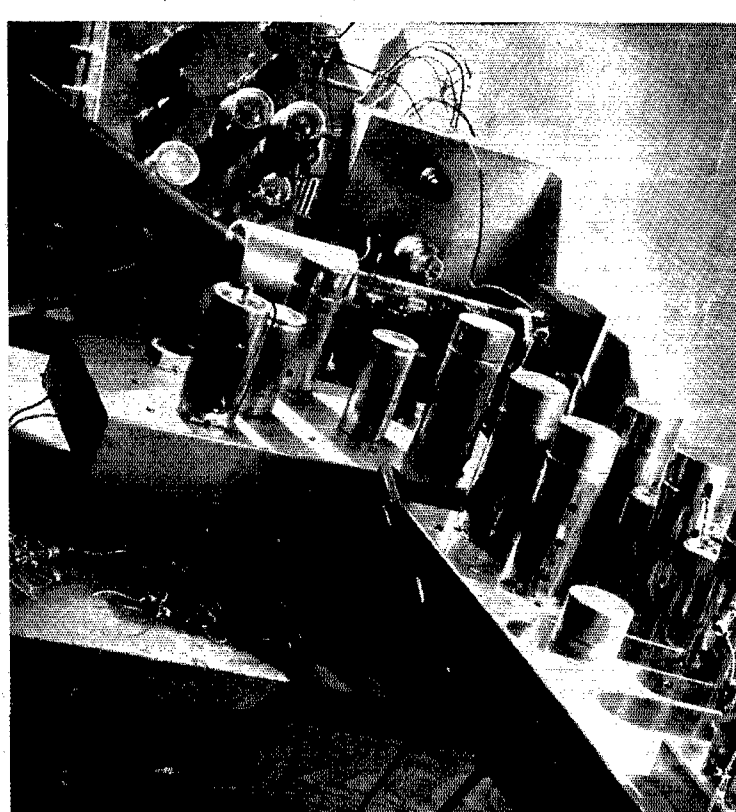

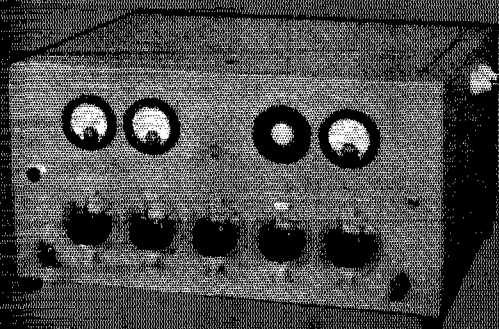

STANDARD CABINET

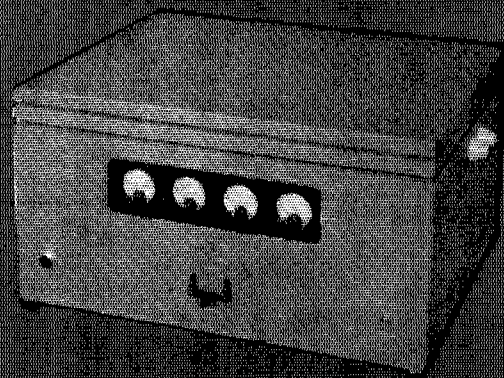

SPRAY-PROOF CABINET

COLLINS 32G TRANSMITTER

The standard 32G Transmitter has met wide acceptance as a general purpose model and is widely used by amateurs and by commercial and government services. This particular size of transmitter finds many varied applications, and, to exactly meet each requirement, Collins Radio Company has expanded the 32 Series design to include specially constructed equipment. Arrangements have been made in the flexible and efficient Collins plant to build this type of set to order embodying combinations of features specified by the individual customer. The cost of such special 32 Series Transmitters is, of course, higher than that of the 32G standard model, but the use of standardized parts and sub-assemblies keeps the price to a very reasonable figure. Thus the user is able to write his own specifications in such detail as:

- ◆ A₁ or A₃ Emission.
- ◆ 20 to 50 watts output.
- ◆ Various frequency ranges between 1.5 mc. and 60 mc.
- ◆ Different frequency changing systems including semi-fixed tuning, plug-in coils and panel switching.
- ◆ Operation from AC power at various voltages and frequencies, or DC power at 12, 24, 32 or 110 volts with self-contained dynamotor.
- ◆ Master Oscillator, or "A" cut crystal frequency control, with or without temperature control.
- ◆ Connections for telephone type or high fidelity microphone or for telephone line.
- ◆ Operating controls on panel or with remote control.
- ◆ Antenna relay.
- ◆ Spray-proof cabinet and shock-proof mountings.
- ◆ Additional Instruments.

CORRESPONDENCE IS INVITED

COLLINS RADIO COMPANY
CEDAR RAPIDS, IOWA NEW YORK, N. Y.: 11 WEST 42 ST.

A page from the hallicrafters Scrapbook

Interior View of WFBR Mobile Transmitters showing 1938 Super Skyrider.

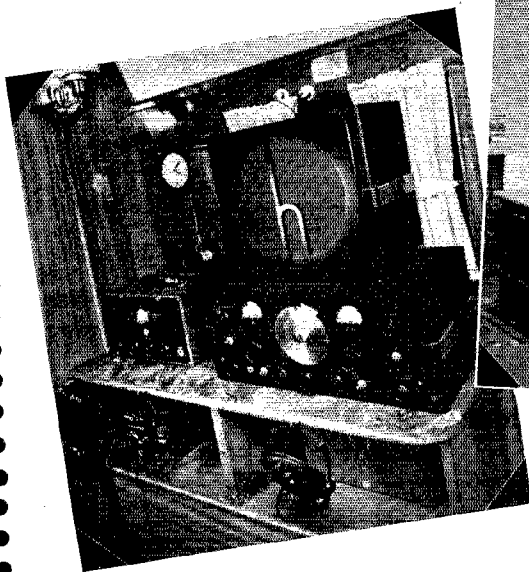

THE CONTROL BOARD OF WFBR, NBC station of Baltimore, Md., showing panel installation of 1938 Super Skyrider.

TED ROGERS—famous short wave radio columnist of the N. Y. World-Telegram spins the dial of his Super Skyrider.



HENRY HOFFMAN, operator for Rev. Father Paul Schulte, "Flying Priest of the Arctic," writes from his post in the Arctic waste—"With the Sky Challenger, low power transmitters were received over a surprisingly long distance, where all other receivers I used this summer in the Hudson Bay failed." Hallicrafters receivers are also used in the MacGregor Expedition now in the Arctic regions.

THUMBING through the Hallicrafters' Scrap Book, one cannot help being impressed by the widespread acceptance of Hallicrafters Communications Receivers. We are proud to show on this page a very few of the outstanding personalities who operate Hallicrafters receivers and their rigs.

the hallicrafters inc.

2611 Indiana Avenue, Chicago, U. S. A. • Cable Address "Hallicraft" Chicago

WORLD'S LARGEST BUILDERS OF AMATEUR COMMUNICATIONS RECEIVERS

Say You Saw It in QST — It Identifies You and Helps QST

Here's another page from the hallicrafters scrapbook

ENRIQUE HIDALGO—Cie fuegos, Cuba—Winner of second prize in the All-Wave B. C. DX contest with his new Super Sky- rider. He says: "The receiver has created a sensation here where it has astonished every new listener."

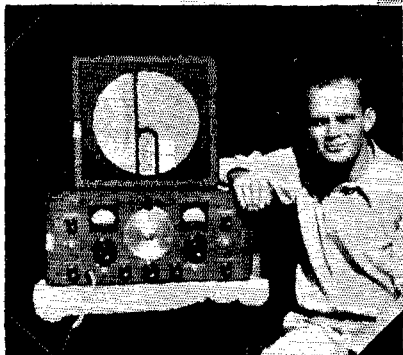

WIKTG—**BEATRICE HOLMAN**, Belmont, Mass.: "The more I operate the Super Sky- rider, the better I like it and I am only too glad to add my word of praise. Am on 10 meters at present and have heard plenty of DX this morning that I never copied before."

W2AM1—**FRANK LESTER**, Bergenfield, N. J., at the controls of his 1938 Super Sky- rider.

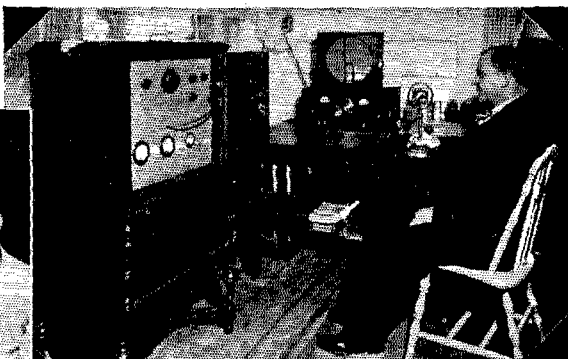

W3DTX—**W. W. KELLUM**, Washington, D. C., says: "I selected the Super Sky- rider because it is one of the best receivers on the market today including price and performance. In a little over a month, I have worked more DX than ever before and have had good receivers in the shack."



THE very fact that Hallicrafters receivers figure so prominently in leading amateur and scientific stations is in itself a testimonial to the merits of these outstanding receivers.

The New 1938 Super Sky- rider installed in the rig of **W2AU, MR. PAUL WANDELL**, Bayonne, N. J.

the hallicrafters inc.

2811 Indiana Avenue, Chicago, U. S. A. • Cable Address "Hallicraft" Chicago

WORLD'S LARGEST BUILDERS OF AMATEUR COMMUNICATIONS RECEIVERS

Say You Saw It in *QST* — It Identifies You and Helps *QST*

QST

devoted entirely to

AMATEUR RADIO

PUBLISHED, MONTHLY, AS ITS OFFICIAL ORGAN, BY THE AMERICAN RADIO RELAY LEAGUE, INC., AT WEST HARTFORD, CONN., U. S. A.; OFFICIAL ORGAN OF THE INTERNATIONAL AMATEUR RADIO UNION

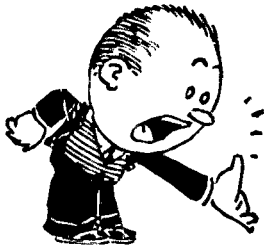

JANUARY
1938

Volume XXII
Number 1



Kenneth B. Warner (Secretary, A.R.R.L.), *Editor-in-Chief and Business Manager*; Ross A. Hull, *Associate Editor*; James J. Lamb, *Technical Editor*; George Grammer, *Assistant Technical Editor*; Clark C. Rodimon, *Managing Editor*; David H. Houghton, *Circulation Manager*; Ralph T. Beaudin, *Assistant Circulation Manager*; F. Cheyney Beekley, *Advertising Manager*; Charles Brunelle, *Assistant Advertising Manager*.

Editorial and Advertising Office:

38 La Salle Road
West Hartford, Connecticut

Subscription rate in United States and Possessions and Canada, \$2.50 per year, postpaid; all other countries, \$3.00 per year, postpaid. Single copies, 25 cents. Foreign remittances should be by international postal or express money order or bank draft negotiable in the U. S. and for an equivalent amount in U. S. funds.

Entered as second-class matter May 29, 1919, at the post office at Hartford, Connecticut, under the Act of March 3, 1879. Acceptance for mailing at special rate of postage provided for in section 1103, Act of October 3, 1917, authorized September 9, 1922. Additional entry at Concord, N. H., authorized February 21, 1929, under the Act of February 28, 1925.

Additional second-class entries to cover sectional editions authorized March 20, 1935. Copyright 1937 by the American Radio Relay League, Inc. Title registered at United States Patent Office.

The Contents

Editorials	9
First A.R.R.L. QSO Party	10
Cairo — Part I <i>A. L. Budlong, W1JFN</i>	11
A Five-Band Exciter with Front-of-Panel Band Changing <i>Donald W. Exner, W8ZU</i>	14
True North from Old Sol <i>A. L. Budlong, W1JFN</i>	18
The New PITC <i>Lew Bellem, W1BES</i>	19
Directional Antennas with Closely Spaced Elements <i>John D. Kraus, W8JK</i>	21
What the League Is Doing	24
A.R.R.L. QSL Bureau	25
56-Mc. Crystal-Control with 28-Mc. Crystals <i>J. M. Wolfskill, W8OKT</i>	26
Silent Keys	30
Circuit Elements in Modern Television Reception <i>Marshall P. Wilder, W2KJL</i>	31
The Strongheart Boys in the Pacific	35
Army Amateur Radio System Activities	36
The Cover	37
The 809	37
Hamdom	38
How Would You Do It?	39
The CCC Takes to the Air <i>William Haight</i>	41
Hints and Kinks	42
I.A.R.U. News	45
Operating News	47
Correspondence Department	55
Standard Frequency Transmissions	94
Standard Frequency Transmissions from W9XAN to be Curtailed	106
Hamads	107
QST's Index of Advertisers	110

Say!
RADIO
AMATEUR



The old year is done
A new year's begun.
And good resolutions
Are made by each one.

Your station works well
DX has been swell
One good resolution
Join your A.R.R.L.



THE BOARD
OF DIRECTORS

BUILDING
AN AMATEUR
RADIOTELEPHONE
TRANSMITTER

An introduction to Amateur Radio-telephony. Written for the man who has a class C or class B license. A companion book to "How to Become a Radio Amateur"

CONTAINS simple description of the process of modulation and principles of good design for 'phone. Description of inexpensive low-power transmitter and modulator, with complete operating instructions plus some antenna dope of particular interest in 160- and 10-meter operation. It tells what a new or inexperienced ham should know before attempting to use 'phone.

25 CENTS POSTPAID
(NO STAMPS PLEASE)

AMERICAN RADIO
RELAY LEAGUE, INC.
West Hartford, Connecticut



RCA



CONTEST BULLETIN

Winners are soon to be announced!

All entries in our contest for amateurs are not in as this is written. Judges will decide on winners as quickly as possible after contest closes.

4 to 1 preference for RCA tubes revealed

4 out of 5 amateurs are reporting on their entries that they use RCA tubes in their transmitter. Some of the reasons for this overwhelming preference for RCA tubes follow. These appear on nearly every entry.

1 *RCA quality is unquestioned.*

2 *RCA tubes give better service.* Many amateurs say that even after years of "savage" use their RCA tubes are still giving excellent performance.

3 *RCA performance is better.* Many cases of balky transmitters being tamed with RCA tubes have been reported.

4 *RCA tubes can take it.* Many amateurs tell us they operate RCA tubes under conditions we do not recommend—yet the tubes perform perfectly. This demonstrates a healthy margin of safety between the ratings and the performance capabilities of the tubes. You get more *watt hours* per dollar when you use RCA tubes.

Thanks —

Thanks for your entries. The information you have given will enable us to render the amateur even greater service in the future.

When buying radio tubes, say "RCA"
— First in Metal—Foremost in
Glass—Finest in Performance.

RCA presents the "Magic Key" every Sunday,
2 to 3 P. M., E. S. T., on NBC Blue Network.

OUTSTANDING AMATEUR FAVORITES

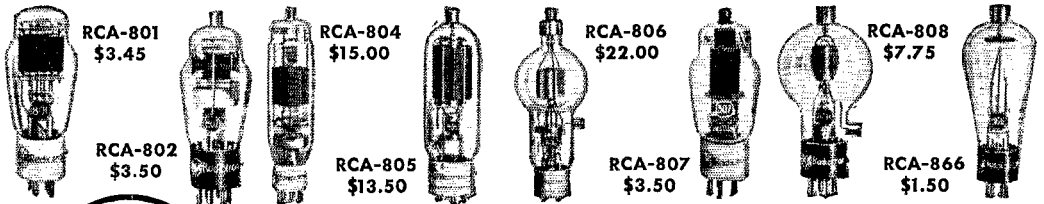

for Amateur Radio

AMATEUR RADIO SECTION

RCA MANUFACTURING CO., INC., Camden, N. J. • A Service of the Radio Corporation of America

Say You Saw It in QST — It Identifies You and Helps QST

Section Communications Managers of the A.R.R.L. Communications Department

All appointments in the League's field organization are made by the proper S.C.M., elected by members in each Section listed. Mail your S.C.M. (on the 16th of each month) a postal covering your radio activities for the previous 30 days. Tell him your DX, plans for experimenting, results in 'phone and traffic. He is interested, whether you are an A.R.R.L. member or get your QST at the newstands; he wants a report from every active ham. If interested and qualified for O.R.S., O.P.S. or other appointments he can tell you about them, too.

<p>Eastern Pennsylvania Maryland-Delaware-District of Columbia Southern New Jersey Western New York Western Pennsylvania</p>	<p>W3QP W3BAK W3BEI W8CSE W8OFO</p>	<p>ATLANTIC DIVISION John Buck Morgan Edgar L. Hudson W. W. Filson Ed Preston Kendall Speer, Jr.</p>	<p>8527 Germantown Ave. 247 E. Atlantic Ave. 10 Lincoln Ave.</p>	<p>Chestnut Hill, Philadelphia Laurel, Delaware Arlington Tully Lowber</p>
<p>Illinois Indiana Kentucky Michigan Ohio Wisconsin*</p>	<p>W9KIY W9QG W9AUI W8DPE W8AQ W9AKT</p>	<p>CENTRAL DIVISION L. John Huntoon Noble Birchart G. W. Mossbarger Harold C. Bird E. H. Gibbs Karl R. Medrow</p>	<p>327 Brandon Ave. R. 4, Box 1 Box 177 R.F.D. 2 405 Broad St. 2201 Winnebago St.</p>	<p>Glen Ellyn Indianapolis Camp Taylor Pontiac Wadsworth Madison</p>
<p>North Dakota South Dakota Northern Minnesota Southern Minnesota</p>	<p>W9RZA W9SEB W9IGZ W9DCM</p>	<p>DAKOTA DIVISION Ernest Bloch Andrew J. Kjar Edwin L. Wicklund Webster F. Soudes</p>	<p>Box 202 221 West Prospect Ave. R.F.D. 3 3549 36th Ave., So.</p>	<p>Thompson Pierre Kensington Minneapolis</p>
<p>Arkansas Louisiana Mississippi * Tennessee</p>	<p>W5ABI W5DKR W5GHF W4DEP</p>	<p>DELTA DIVISION H. E. Vette Eugene H. Treadaway Robert E. Barr. B. G. Lowrey Smith</p>	<p>4415 West 12th St. 2749 Myrtle St. 673 Hillcrest St.</p>	<p>Little Rock New Orleans Lucedale Memphis</p>
<p>Eastern New York N. Y. C. & Long Island Northern New Jersey</p>	<p>W2LU W2AZV W2GMN</p>	<p>HUDSON DIVISION Robert E. Haight E. L. Baumach Fred C. Read</p>	<p>511 South Holmes St. 102 Central Ave. 1014 North Ave.</p>	<p>Scotia Massapequa, L. I. Elizabeth</p>
<p>Iowa Kansas Missouri Nebraska</p>	<p>W0NNM W9PB W9OUD W9FAM</p>	<p>MIDWEST DIVISION Owen Williams Harry F. Legler Miss Letha Allendorf Samuel C. Wallace</p>	<p>108 No. Johnson St. 304 Miami St. 1015 W. 3rd St. Green St.</p>	<p>Iowa City Hiawatha Joplin Clarks</p>
<p>Connecticut Maine Eastern Massachusetts Western Massachusetts New Hampshire Rhode Island Vermont</p>	<p>W1CTI W1FBJ W1IWC W1JAH W1SFT W1HRC W1GNF</p>	<p>NEW ENGLAND DIVISION Frederick Ella, Jr. Winnell A. Ramsdell Sam Gross William J. Barrett Carl B. Evans Clayton C. Gordon Alvin H. Battison</p>	<p>19 Merrill Rd. 1188 Washington Ave. Pleasant St. 239 Columbia St. 89 No. State St. 192 Washington Ave. 1 Central St.</p>	<p>Norwalk Portland Mansfield Hills Adams Concord Providence Windsor</p>
<p>Alaska Idaho Montana Oregon Washington</p>	<p>K7PQ W7EMT W7CRH W7AJV W7WY</p>	<p>NORTHWESTERN DIVISION Richard J. Fox Carl Eichelberger Russell U. Richmond Eugene E. Lovejoy Robert H. Votaw</p>	<p>Box 301 2810 North 26th St. 2513 N. E. Clackamas Route 1, Box 398</p>	<p>Ketchikan Boise Somers Portland Vancouver</p>
<p>Hawaii * Nevada Santa Clara Valley East Bay San Francisco Sacramento Valley Philippines San Joaquin Valley</p>	<p>K6OOE W6BIC W6FBW W6JTV W6SG W6GZY KAIGR W6LPE</p>	<p>PACIFIC DIVISION Harold C. Smith Edward W. Heim Elbert Amarantes Harold J. Burchfield Alan B. Whitaker, Jr. J. L. C. Buckenham George L. Rickard Angelo V. Astone</p>	<p>P. O. Box 150 509 Claremont St. 454 Washington St. 2340 106th Ave. 79 Elmor Ave. 2931-24th St. Box 849 729 Safford</p>	<p>Honolulu Reno San Jose Oakland Mill Valley Sacramento Manila Fresno</p>
<p>North Carolina South Carolina Virginia West Virginia</p>	<p>W4OG W4BOE W3UVA W8HD</p>	<p>ROANOKE DIVISION H. S. Carter Ted Ferguson Charles M. Waff, Jr. C. S. Hoffmann, Jr.</p>	<p>P. O. Box 111 1213 College St. 2914 Monument Ave. 47 Lynwood Ave.</p>	<p>Winston-Salem Columbia Richmond Wheeling</p>
<p>Colorado Utah-Wyoming</p>	<p>W9FA W7COH</p>	<p>ROCKY MOUNTAIN DIVISION Glen Glasscock Townsend J. Rigby</p>	<p>2164 So. Corona St.</p>	<p>Denver Midwest, Wyoming</p>
<p>Alabama Eastern Florida Western Florida Georgia-Cuba-Isle-of-Pines- Porto Rico-Virgin Islands</p>	<p>W4DGS W4DVO W4BSJ *W4PM</p>	<p>SOUTHEASTERN DIVISION James F. Thompson L. A. Connolly Ellis R. Curry Charles W. Davis</p>	<p>102 Narrow Lane Rd. 712 S. Edison Ave. Box 425 2136 N. E. Boulevard Dr.</p>	<p>Montgomery Tampa Madison Atlanta, Ga.</p>
<p>Los Angeles Arizona San Diego</p>	<p>W6GXM W6KFC W6EOP</p>	<p>SOUTHWESTERN DIVISION Don M. Draper Victor C. Clark Harry A. Ambler</p>	<p>4421 West 63 St. 747 E. Polk St. 731 York St.</p>	<p>Los Angeles Phoenix Mission Beach</p>
<p>Northern Texas Oklahoma Southern Texas New Mexico</p>	<p>W5DXA W5CEZ W5BDI W5CGJ</p>	<p>WEST GULF DIVISION Lee Hughes Carter L. Simpson Ammon O. Young Joseph M. Eldott</p>	<p>125 N. Main St. 2010 So. 4th St. 4803 Eli St.</p>	<p>Childress Ponca City Houston Chamita</p>
<p>Maritime</p>	<p>VE1DQ</p>	<p>MARITIME DIVISION A. M. Crowell</p>	<p>69 Dublin St.</p>	<p>Halifax, N. S.</p>
<p>Ontario</p>	<p>VE3SG</p>	<p>ONTARIO DIVISION Fred H. B. Saxon</p>	<p>302 Lee Ave.</p>	<p>Toronto, Ont.</p>
<p>Quebec</p>	<p>VE2EE</p>	<p>QUEBEC DIVISION Stan Comach</p>	<p>780 Brault Ave.</p>	<p>Verdun, P. Q.</p>
<p>Alberta * British Columbia</p>	<p>VE4GD VE5EP</p>	<p>VANALTA DIVISION Jas. Smalley, Jr. D. R. Vaughan-Smith</p>	<p>611 First Ave., N. W. 1221 Burnaby St.</p>	<p>Calgary Vancouver</p>
<p>Manitoba Saskatchewan</p>	<p>VE4BG VE4EL</p>	<p>PRAIRIE DIVISION A. J. R. Simpson Wilfred Skaife</p>	<p>635 Garfield St. 2040 McTavish St.</p>	<p>Winnipeg Regina</p>

* Officials appointed to act until the membership of the Section choose permanent S.C.M.'s by nomination and election.

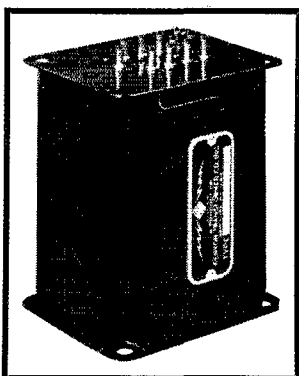

Kandid Ken-O-Talk, No. 2

ONE of the chief sources of audio frequency distortion in the amateur transmitter is the class B modulator stage. By distortion we mean wave form distortion which comprises a fundamental frequency plus harmonics, or integral multiples, of this frequency. Besides giving a signal which is not clear and pleasant to listen to, the harmonics cause spattering over the band and interference. Thus when a tone of 5000 cycles is passed through a modulator giving a strong third harmonic, the carrier is modulated with fifteen kilocycles. The result of this is bad interference with other stations within fifteen kilocycles either side of the carrier. With good audio design such a condition might be entirely eliminated. With the bands as crowded as they are today no good amateur will allow his transmitter to add unnecessarily to the QRM.

To obtain a class B modulator having a low harmonic content, it is first necessary to drive it properly. In order to do this the proper driver tube-transformer combination must be selected. The use of a driver transformer from a low impedance line to the class B grids is *not* to be desired in most cases. When this type of coupling is used it involves the use of two transformers, one from the driver plates to line, and another from line to class B grids. Since in driver transformer design, every effort is made to keep at a minimum leakage reactance, any arrangement such as the use of two transformers where only one is necessary defeats the purpose of this design. This is because all transformers possess a certain amount of leakage reactance which adds when one is used following another. Class B grid circuits are of the low impedance type so it is permissible to run shielded leads for a reasonable distance from the driver transformer to the class B grids. If the distance is so great that a low impedance line is needed, by all means locate the driver tubes at the modulator. Then it is possible to couple the plates directly to the class B Grids through the proper driver transformer.

The last tube of the voltage amplifier may be coupled to a low impedance line through a plate to line transformer. This line will be run whatever distance necessary to a line to grid transformer and so to the class A driver grids. By putting the transformers between two class A stages, instead of between a class A and a class B stage, the circuit is essentially effecting a voltage transfer involving no power. In the voltage transfer circuit leakage reactance is of relatively little importance.

Whenever possible it is best to follow manufacturers recommendations for driver tube combinations and to employ a well designed driver transformer. In cases where something new is being tried out it is always advisable to test the rig with an oscilloscope or listen to it with a monitor speaker to see how it sounds before going on the air.

F. P. KENYON, *President*

The American Radio Relay League



• **T**HE AMERICAN RADIO RELAY LEAGUE, INC., is a non-commercial association of radio amateurs, bonded for the promotion of interest in amateur radio communication and experimentation, for the relaying of messages by radio, for the advancement of the radio art and of the public welfare, for the representation of the radio amateur in legislative matters, and for the maintenance of fraternalism and a high standard of conduct.

It is an incorporated association without capital stock, chartered under the laws of Connecticut. Its affairs are governed by a Board of Directors, elected every two years by the general membership. The officers are elected or appointed by the Directors. The League is non-commercial and no one commercially engaged in the manufacture, sale or rental of radio apparatus is eligible to membership on its board.

"Of, by and for the amateur," it numbers within its ranks practically every worth-while amateur in the nation and has a history of glorious achievement as the standard-bearer in amateur affairs.

Inquiries regarding membership are solicited. A bona fide interest in amateur radio is the only essential qualification; ownership of a transmitting station and knowledge of the code are not prerequisite. Correspondence should be addressed to the Secretary.

HIRAM PERCY MAXIM, FIRST PRESIDENT

OFFICERS

- President*.....EUGENE C. WOODRUFF, W8CMP
State College, Pa.
- Vice-President*.....GEORGE W. BAILEY, W1KH
Weston, Mass.
- Secretary*.....KENNETH B. WARNER, W1EH
West Hartford, Connecticut
- Treasurer*.....ARTHUR A. HEBERT, W1ES
West Hartford, Connecticut
- Communications Mgr.*...F. EDWARD HANDY, W1BDI
West Hartford, Connecticut
- ◆
- General Counsel*.....PAUL M. SEGAL
1026 Woodward Building, Washington, D. C.
- ◆

Address all general correspondence to the administrative headquarters at West Hartford, Connecticut

DIRECTORS

- President*
EUGENE C. WOODRUFF.....W8CMP
234 W. Fairmount Ave., State College, Pa.
- Vice-President*
GEORGE W. BAILEY.....W1KH
74 Webster Road, Weston, Mass.
- Canadian General Manager*
ALEX. REID.....VE2BE
169 Logan Ave., St. Lambert, P. Q.
- Atlantic Division*
WALTER BRADLEY MARTIN.....W3QV
Box 612, Roslyn, Pa.
- Central Division*
R. H. G. MATHEWS.....W9ZN
100 East Ohio St., Chicago
- Dakota Division*
CARL L. JABS.....W9BVH
1822 James St., St. Paul, Minn.
- Delta Division*
E. RAY ARLEDGE.....W5SI
P. O. Box 286, Pine Bluff, Ark.
- Hudson Division*
KENNETH T. HILL.....W2AHC
115 Willow St., Douglaston, L. I., N. Y.
- Midwest Division*
FLOYD E. NORWINE, JR.....W9EFC
120 South Fourth St., St. Louis, Mo.
- New England Division*
PERCY C. NORRIS.....W1BVR
37 Broad St., Westfield, Mass.
- Northwestern Division*
RALPH J. GIBBONS.....W7KV
c/o United Air Lines, Pendleton, Ore.
- Pacific Division*
S. G. CULVER.....W6AN
2962 Russell St., Berkeley, Calif.
- Roanoke Division*
H. L. CAVENESS.....W4DW
State College Station, Raleigh, N. C.
- Rocky Mountain Division*
EDWARD C. STOCKMAN.....W9ESA
618 So. Williams St., Denver
- Southeastern Division*
BENNETT R. ADAMS, JR.....W4APU
1512 Grove Place, Homewood, Ala.
- Southwestern Division*
CHARLES E. BLALACK.....W6GG
443 Main St., El Centro, Calif.
- West Gulf Division*
WAYLAND M. GROVES.....W5NW
c/o Humble Pipe Line, Talco, Texas



THE EDITOR'S MILL

IN another section of this issue (page 100) we undertake to spike a rumor which, as of this writing, had set a considerable portion of the amateur fraternity on its individual and collective ear. In consequence of this rumor and its aftermath, we would like to express a few thoughts on the general subject.

Of all the dire rumors that have arisen concerning amateur radio in the past, we'd say just about every one was founded on ignorance. The present one is no exception. An amateur—a new one, if his call means anything—saw a routine order of the F.C.C. Now, such orders are not always clear in their meaning to the casual reader; after all, they deal with a complicated subject. Our hero in the present case read the order and promptly came to the wrong conclusion regarding some of its statements. Let it be understood, however, that we are not panning him for that. What we do criticize is his subsequent action.

One would think that before "going to town" with the apparent bad news, he'd have undertaken to check with informed sources as to the exact meaning of the order; there were, incidentally, at least half a dozen more-experienced amateurs within telephone call who could have put his fears to rest. But did he do this? He did not. Instead, with the full power of a thousand watts behind his 160-meter 'phone, he blasted the band with his erroneous interpretation, his citation of the F.C.C. docket number giving an appearance of authenticity to his statements, and in very short order indeed he had a great many amateurs upset to a marked degree. We might add that in his eagerness to be first with the bad news he "jumped" the release date given on the order, but we'll let the F.C.C. settle with him for that. At any rate, the resulting furor necessitated a considerable amount of correspondence, some telegrams and a special broadcast by the League, and the hard work of many saner amateurs before it was all quieted down.

We aren't going to make mountains out of molehills on the subject of rumors. We've always had rumors; we always will. Were it simply that they caused a lot of annoyance, we'd not be too greatly concerned; unfortunately, about every once in so often somebody goes off on a tangent over a rumor and starts some real trouble before the true facts are brought out—and we can't have that happening. For this reason, we'd like to

offer a few suggestions for rumor-treatment. They won't hinder the dissemination of real dope—we'd never want that to happen—but they will go far to stop the false in its tracks.

First, when you hear some awful rumor, take it easy; the rumor is *probably* untrue. Rumors have a pretty poor record of performance; about one in a thousand has some real basis in fact. Incidentally, the worse the dope sounds, the more likely it is to be fiction.

Second, remember that if anything of any real moment ever happens to amateur radio, it is dollars to doughnuts that the A.R.R.L. will have known about it plenty of time in advance, and will have issued an official broadcast on the subject, if such a thing is called for.

Third: All A.R.R.L. official broadcasts carry numbers and dates. If some ham says he has the dope "straight from Hq" and can't supply the number and date of the official broadcast that carried the facts, *stop right there* until he comes across, or until somebody else does.

Lastly, if you stumble across some really alarming news, with all appearance of genuineness, and if you don't at the same time know of some official A.R.R.L. broadcast on the subject, get in touch with your nearest A.R.R.L. director or S.C.M. or, perhaps preferably, with League Headquarters, before transmitting the news any further. We are always appreciative of such information and always glad to reply regarding its authenticity. The chances are, of course, that it results from misinterpretation on somebody's part; but this method of checking will promptly bring you full and complete dope—by return wire, if necessary.

In closing, we'd like to make ourselves clear on one point: We have no criticism of any amateur anywhere experiencing sincere concern over any apparently genuine information which may come to his attention regarding amateur radio. We'd be concerned ourselves. We sometimes are, in fact, at rumors emanating from pretty high authority; officialdom is no exception to this rumor business. But we are and will continue to be insistent in our condemnation of anyone who undertakes to pass on anything of this sort without first checking with a reliable and informed source. That type of egg is no friend to his fellow-amateurs or to amateur radio.

A. L. B.

First "A.R.R.L." QSO Party!

January 8th-9th (Sat.-Sun.)—General Call: "ARRL de . . ."—For All Members—To Get Acquainted with All Members—Distinctive Call Insignia Prize Offered in Each League Section¹—Try Your Luck—Start a QSO List—Use Any or All Bands—'Phone or Telegraph in This Activity

THE idea is for members in each Section to chat with as many other A.R.R.L. members (anywhere) as they can. The leading member station in each Section will receive *his own call* in the attractive pin style illustrated as soon as results have been analyzed.

Only A.R.R.L. Members are eligible. It is a family party for all of us members, a brand-new opportunity to find who our fraternity brothers are. CQ calls are out! The way to show you are open for contacts in this party will be to let loose a few well sent calls of "ARRL de . . ." In the course of a contact members will tell each other two things, the name of their Section¹ and the date their membership expires, month and year.

Special log forms (not necessary) will be sent free on request to Hq., or rule your own, just three columns listing *calls, Sections,¹ dates*. In radiotelephone contacts the Section, month and year will be named. No special form is required or suggested, and it's a small part of the conversation. Radiotelegraph members will abbreviate Section names and use four numerals to show membership dates. "Conn 0343" will mean "Connecticut Section, my membership good until *March 1943*" for example. Information to be exchanged in every case comes right off your own *League membership certificate or pocket card*. Members will not enter in either a radiotelegraph or radiotelephone classification. Many hams use both. Scores can be all by one mode, or part telegraph and part voice—and any com-

¹ See complete list of 70 A.R.R.L. field organization Sections, page 6 this issue of *QST*. A call insignia award is also available to the leading member in each continent (outside field organization territory). All members outside the field organization use the name of their continent instead of a section abbreviation. Note that CO-CM, K4-6-7, KA, and VO as well as W-VE members are in the field organization and cannot be also counted under a continental status.

bination of frequencies you like. Advance entry is unnecessary. Just take part and send in the list of members you worked with claimed score.

Starting Time: Saturday, January 8th, 2300 11 P.M. Greenwich; 3 P.M. PST; 4 P.M. MST; 5 P.M. CST; 6 P.M. EST or the equivalent at any point.

Ending Time: Monday, January 10th, 0801 8:01 A.M. Greenwich; 12:01 A.M. PST; 1:01 A.M. MST; 2:01 A.M. CST; 3:01 A.M. EST or equivalent.

Operate *any 20* hours of the 33-hour party. State contest hours you did *not* operate if your score is over 10,000.

Scoring: 1 point for each complete set of information sent; 1 point for each set of data received and logged. No member can be worked to get more than one complete exchange for 2 points. The sum of points will be multiplied by the number of *different Sections* (and continents² outside field organization territory) in which at least one member has been worked and exchange effected. A convenient way to keep record of new and different Sections as you work them is to circle and

number the name of the Section the first time it is written in your list.

A lot of fun assured. See how many members *you* can work on this January Saturday-Sunday weekend. And if you work anybody not a member ask him "why not." We'll make this one of the big annual events if you like it. Try it out and let's have your suggestions, members.

—F. E. H.

² The multiplier is the sum of the number of Sections and continents outside the field organization territory in which at least one A.R.R.L. member is contacted. But a single multiplier times the sum of points gives the score. Example: W6XXX has completed two-way contacts with 57 different stations located in 31 different A.R.R.L. Sections and Europe and Oceania. His multiplier is 33. Score? $2 \times 57 = 114$, $114 \times 33 = 3762$.



CALL PINS WITH PERSONAL CALLS IN THE ABOVE STYLE WILL BE AWARDED IN EACH OF THE 70 A.R.R.L. SECTIONS AND TO THE MEMBER LEADING EACH OF THE SIX CONTINENTAL AREAS

Cairo

How We Got Our Present Bands—What the Cairo Conference Means to Amateur Radio—How It Does Business

In Two Parts—Part I †

By A. L. Budlong*

TO the average person, Cairo, Egypt, is a large city located in the general vicinity of the Nile and vaguely supposed to have something to do with the Pyramids. To the average amateur, it is the 1938 location of that periodic nightmare known as an international radio conference, a place where the "commercials" always triumph and where the amateur always gets gypped out of some more frequencies. There is no question about the gypping business because we now have to operate in certain narrow bands whereas once—as the fable goes—we had everything from 200 meters down, all for our very own.

These ideas are firmly implanted in the amateur mind; they are almost universally accepted as basic fact. Were we to say that we never lost a kilocycle at an international conference, that we still have precisely the same international assignments that we got under the first treaty dealing with high-frequency allocations, that no U. S. law ever gave amateurs an exclusive assignment of the territory from 200 meters down and that neither any U. S. law nor international treaty so much as mentioned amateurs or amateur radio until ten years ago . . . were we to say this and assert that these are facts, it would appear that explanations are in order.

And indeed we think they are. Certainly it is true that the average amateur has only a hazy idea of what we ever had, how we got it, why we have international conferences, and how they do business. What we propose to do here, therefore, is to give a brief factual account of amateur frequency assignments, both domestic and international, from the very first days, and to follow with a short description of the hows and whys of an international conference. Lest some readers see in the timing of the appearance of this article an attempt to pave the way for the acceptance of losses at Cairo, we want to say that this is being written because the Board of Directors ordered it, solely in the belief that the information would be valuable to all amateurs and because it felt it would be more widely read now than at some time when interest in such subjects is not so high. As for what may be done at Cairo, no one knows

—if they did, there would be no point in holding the conference. Apart from that, we anticipate no losses as things look now. So much for that; now to business.

* * *

Part I

A History of Amateur Assignments

WHY do we have to have international agreements on radio? Broadly speaking, there are three reasons:

1. Since stations of one nation are frequently in communication with stations of another nation, it is necessary to have agreements on such operating details as calling procedure, distress signals, call-letter assignments, methods of collecting tolls on radiograms, etc., unless utter confusion is to be encountered when any two stations try to do business over the air.

2. Because it is possible to operate radio stations throughout a wide range of frequencies, it is necessary to agree in advance where the various services will locate themselves in the spectrum, so that stations will know where to find each other.

3. Since radio signals are not confined to the borders of the country in which they originate, international agreements on allocations to services are also necessary in order to prevent chaotic conditions on the air and hopeless interference between services.

The first two were probably the major considerations in the early radio conferences. The third was not so vital in the early days of radio but to-day is extremely important.

Pursuant to the international agreements, each nation, both as a matter of common sense and agreement, arranges its own domestic laws so that they conform to the international commitments. Obviously, it would be silly if the various nations, after carefully working out solutions to their problems, disregarded the remedies by permitting the stations within their borders to operate on some entirely different basis.

Now let us trace the course of all the interna-

* Assistant Secretary, A.R.R.L.

† Part II will appear in February *QST*.

tional conferences and all our own national laws to see how the amateur got taken care of as the laws came along. We'll cover the international treaties first, and then cover our U. S. legislation.

INTERNATIONAL REGULATION

The very first international radio conference, though it doesn't really belong in this story, was held in

1903

It was held in Berlin. It didn't say anything about wavelengths, operating procedure or anything of this sort and was held for only one reason: there was getting to be considerable trouble due to the fact that stations using Blotto Co.'s equipment would communicate only with other Blotto-equipped stations and would turn studiously deaf ears to calls from stations using Bliffsky or other gear. Such nonsense obviously had to be stopped and this first conference, participated in by nine nations (including the United States, which was to participate in all subsequent conferences) was called solely for the purpose of putting an end to such short-sightedness.

The next conference was the one that really started things off. It was held in

1906

Like the first, it took place in Berlin. Twenty-seven nations, or thereabouts, participated. Perhaps it would be well to say right now that the principal objective was the setting up of arrangements to deal with ship-to-shore work, that being the main thing radio was then used for. In fact, the only services defined in the treaty regulations were coastal stations and shipboard stations—a station, presumably, was either one or the other!

Judged by present standards, the conference resulted in a pretty simple treaty and an even simpler set of regulations to go along with it. However, it is of interest to us because it was here that we see the *very first* agreements of any kind on wavelength assignments. These agreements were exceedingly simple: coastal stations open to general public service had to be able to use both 300 and 600 meters; ship stations were to use 300 meters for a normal wavelength but could use others if they did not exceed 600 meters; small boats unable to "get up" to 300 meters were authorized to use "a shorter wavelength"; and finally—get this!—coastal stations, apart from their two specified waves could use *any* wavelength, so long as it was either below 600 meters or above 1600 meters. Had coastal stations in those days wished to use any of the territory represented by our present amateur bands, they were free to do it.

There was no mention of amateurs in the treaty and no provision for them except that if any nation had licensed amateurs at that time

(none did, including our own United States) it presumably would have had to see to it that they stayed below 600 or above 1600 meters.

In addition to these matters, the treaty and regulations specified three-letter calls, limited shipboard power, normally, to a kilowatt, outlined details of hours of service for coastal stations, the posting of "wireless" telegrams, rates, collection of charges, etc., specified the use of the international Morse code for radio work, designated SOS as a distress call and outlined some very rudimentary regs on methods of calling and working.

This second Berlin gathering also decided on the principle of holding similar conferences from time to time and, as a matter of fact, the next was held six years later in London. So we came to

1912

Fifty-two nations from all over the world participated in this London conference; our radio gatherings were beginning to amount to something! Not much was done to change the 1906 treaty and regulations but they were enlarged on somewhat. As before, general public service stations had to be able to use 300 and 600 meters, but now they could also use 1800 meters. Ship stations were 300 and 600 meters. A curious addition to wavelength specifications was that prohibiting stations used exclusively for sending signals designed to determine the position of ships from using a higher wavelength than 150 meters. Here was the first "short-wave" assignment, as such, and it was to radio-bearing stations! However, this was by no means an exclusive assignment, because, just as in the 1906 treaty, any station could use any wavelength (except that the compass stations had to stay under 150) as long as it stayed under 600 or over 1600 meters.

Ship power was still limited, normally, to a kilowatt; additional power could be used if needed, however, for distances over 200 miles or under unusual circumstances. The Q signals came into being. Revisions and additions were made to other operating details but not a great deal of change shows up in this treaty in these matters as compared with the earlier one. Our old friends the coastal stations and shipboard stations were still the only defined services.

At this gathering it was agreed to hold the next conference in 1917, but the Great War and its aftermath upset things so badly that it was fifteen years before another radio conference took place.

1927

The 1927 conference was held at Washington. Nearly eighty nations participated; as of that time, this was the largest international gathering ever held on any subject and the *first* since the advent of "short-waves."

The delegates were confronted with a perfectly stupendous task because of the tremendous strides made in radio development since the previous gathering. All the old concepts of radio had been discarded and new theories evolved; new uses for radio had been found with a resulting terrific enlargement in the number of services; telephony had been developed and had given birth to the broadcasting industry; the short waves had found use. As may be imagined, the conference regulations were numerous and detailed, bearing but little resemblance to those in the former treaties.

Radio services had segregated themselves into dozens of different distinct classes by this time, so the services mentioned in the list of definitions was considerably more detailed. One of the definitions was that of "private experimental stations." There were two subheads to this definition: the first explained that the definition included stations of the kind we now recognize as "experimental"; the second stated that the definition applied also to "a station used by an 'amateur.'" We had arrived.

More than that, the radio spectrum—heretofore virtually wide open to everybody—was now split up into channels, from 10 kilocycles to 23,000 kilocycles, and the various services allotted certain specified channels or groups of channels for their use. And in this table, we amateurs got bands at 1.7 and 3.5 megacycles (shared with the fixed and mobile services) and at 7 and 14 megacycles (exclusive to us). *These bands were precisely the same width as those we have to-day.* Since the regular table of allocations did not go above 23,000 kc. and since we amateurs wanted assignments still higher, special assignments were designated at 10 meters and at 5 meters, jointly for the use of amateur and experimental services; these, also, were the same we now have.

Licenses were required of all amateur operators and it was further stipulated that each such licensee would have to demonstrate ability not only to transmit the continental code but to receive it—"by ear." The code speed required of licensees was left to each country to determine for itself, however.

Of course, the regulations also went into great detail on all other matters such as special signals, a revision of the Q signal list, calling procedure, rates, methods of collection, license requirements (commercial) etc., but we take it for granted that by now our readers are aware that each set of regulations in the international treaties includes these matters and we will not refer to them further. From now on we will treat only those portions of the treaties that deal with amateurs and amateur radio.

Following the Washington conference, came a five-year interval and then the second of the really "modern" conferences, in —.

This was held in Madrid. Very little change was made in the previous treaty or its annexed regulations. Our amateur frequency bands were continued intact. However, we had not been satisfied in the Washington regulations with having the definition of an amateur included only as part of a definition of the "private experimental station" class; at Madrid, therefore, we sought to have amateurs recognized as a separate and distinct class by themselves. The effort was successful and at Madrid, for the first time in an international treaty, we see the amateur service recognized strictly as such.

This takes us through all the international conferences on radio up to the forthcoming Cairo affair which, since it is still in the future, we will talk about later.

NATIONAL REGULATION

We have now shown, very briefly, what has happened from the early days up to the present time in terms of international regulation. During all this time, however, we were confronted with changing laws and regulations on amateur radio here in the United States under the terms of the United States laws, so let us go back now, see what those laws were and what kind of treatment we got under them.

The outstanding thing about early radio law in this country is that it was an awfully long time before we got the first one!

There was no United States radio law in 1903 at the time of the first Berlin international conference already mentioned, nor was there one in 1906, at the time of the second Berlin affair. It might be thought that this country was obligated to have some sort of national law or regulations after the 1906 conference, in order to carry out the agreements made there to which the U. S. had been a party. The reason there wasn't is that, although we had *signed* the treaty, our Senate didn't *ratify* it until six years later; there had been quite a lot of squabbling and disagreement about that treaty, anyway.

So we see the years dragging on through 1906, '07, '08, '09—and still no U. S. law on radio. This doesn't mean that no law was needed; indeed, by the latter part of this period "wireless" was assuming considerable proportions in the daily life of the world. But with no laws here any station, whether amateur, government or commercial, could operate with whatever call, wavelength and power it wished, subject to no regulations whatsoever—and that is precisely what they all did!

In 1910 a very brief law was passed requiring ships of a certain size to carry radio equipment, but it said nothing more than that and has no real bearing in the present discussion. The act was subsequently modified slightly by another

(Continued on page 66)

A Five-Band Exciter with Front-of-Panel Band-Changing

Crystal Switching, Alternative E.C.O. Control, with Special Constructional Features

By Donald W. Exner,* W8ZU

ANOTHER universal exciter!" Right! But here are some ideas if you are a gadgeteer who delights to think up things which add to convenience, flexibility and safety.

The design of a new exciter was the first step in the progress from the old breadboard to rack-and-panel. At the beginning certain precepts were set down as a guide in selecting a circuit and layout.

help to reduce these effects, but the importance of the type of oscillator tube, the circuit and the power supply must not be overlooked. For best frequency stability the oscillator stage should have its own separate power supply, with screen and suppressor voltages tapped from the bleeder. This is better than the use of a dropping resistor for obtaining the screen voltage. Be sure that the

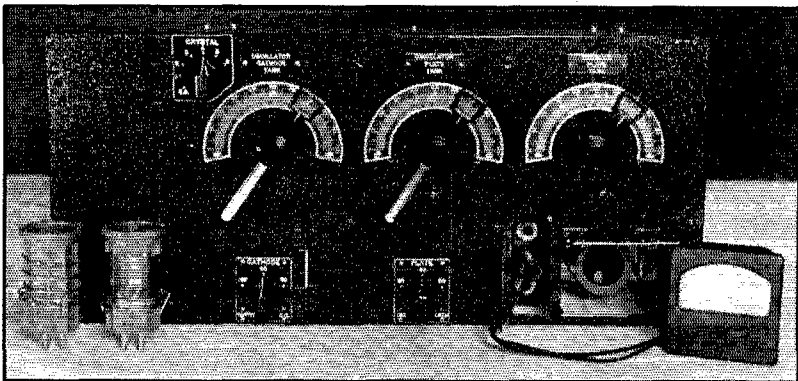

THIS PANEL VIEW OF THE EXCITER SHOWS THE DOORS THROUGH WHICH A METER PLUG AND THE FINAL COILS ARE INSERTED

Band changing is all from the front of the panel. Two of the output coils are shown at the left.

These are given in the author's own order of importance:

1. Safety.
2. Frequency stability.
3. 100% front-of-panel control.
4. Ease of adjustment.
5. Flexibility of circuit.
6. Economy of circuit components.

Safety comes first for obvious reasons. Even frequency stability is of no use to a dead ham. Economy was placed last only because the other items seemed more important.

It goes without saying that frequency stability is the prime object of crystal control. Yet many so-called crystal signals now on the air have as much chirp as a good self-excited rig, and almost as much drift. Crystals of the AT- or V-cut type

110-volt a.c. wiring has sufficient capacity so that load variations, when keying the final stage, do not appreciably affect the input voltage to the oscillator power supply. Frequently a slight chirp in an otherwise good signal can be traced to the use of a long extension cord carrying enough amperes to give the Underwriters heart failure.

If you take pride in your signal you must consider your oscillator as a frequency standard. Commercial frequency standards, almost without exception, employ a well-screened pentode as the oscillator, for excellent reasons. Good screening reduces the plate-to-grid capacity to the point where variations in plate loading, reflected through this coupling, have a relatively small effect on crystal frequency. Pentodes are universally easy to drive. Thus the crystal can loaf, minimizing its heating and the consequent drift. Proponents of the use of triodes as oscillators

*238 Avenue A, Forest Hills, Wilkensburg, Pa.

claim greater output, but this is obtained at the expense of decreased frequency stability, due to higher interelectrode coupling and higher crystal stress. The function of the oscillator as a power-generating device is satisfied when it furnishes sufficient grid excitation to its doubler-buffer tube. Modern beam-type tubes for doublers and buffers have reduced this power requirement to a fraction of a watt, eliminating the power argument for triode oscillators even in portable rigs.

If we assume that this argument is logical, the choice for the oscillator falls on the 89 as a 6.3-volt pentode having sufficient power capability combined with quite good screening.

Among the several beam-power tubes the choice for the amplifier-doubler finally fell on the 6L6G, although the recently-announced RK49 should be better because of the ceramic base. In addition the greater prong separation of the six-prong base allows the use of a socket with better contact construction than that of the octal socket. The 807 was rejected in this case because the top plate lead interfered with a compact chassis layout.

THE CIRCUIT

For normal operation the Tri-tet circuit was selected, chiefly because of its ability to provide good power output on the higher harmonics of the crystal frequency. It also provides excellent frequency stability, and is well known for its reliability in starting a poor crystal. By means of a simple switching scheme it may readily be transformed into an electron-coupled oscillator circuit, or by shorting the cathode tank circuit it becomes the conventional "pentode" crystal oscillator.

Cathode coils for 1.75-, 3.5- and 7-Mc. crystals have been provided, as well as a 1.75-Mc. electron-coupled oscillator coil. A 14-Mc. cathode coil was not included because the excellent frequency-multiplying property of the circuit makes it unnecessary to use a crystal of this frequency. There is really little excuse even for a 7-Mc. crystal, for that matter. By confining the financial investment to 1.75- or 3.5-Mc. crystals a greater range of operating frequencies is made available.

It was desired to avoid the nuisance of neutralizing the amplifier when driving straight through

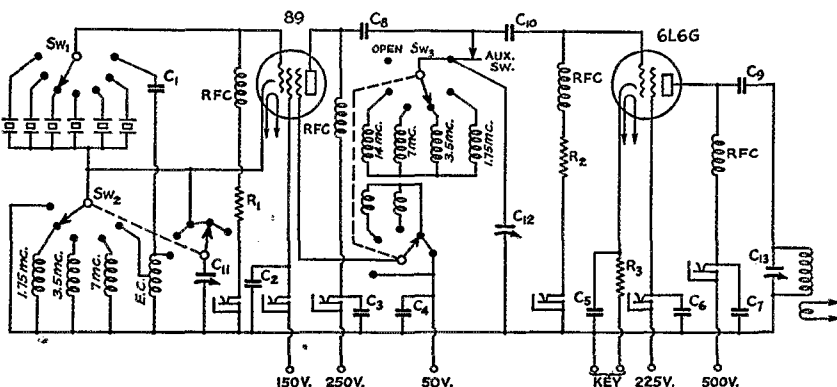

FIG. 1—CIRCUIT DIAGRAM OF THE EXCITER UNIT

- | | | |
|--|--|---|
| C ₁ —250- μ fd. mica. | C ₁₃ —235- μ fd. variable (Cardwell XR-250-PS). | Sw ₁ —11-point single-gang switch (Yaxley No. 1311). |
| C ₂ to C ₉ , inc.—0.002- μ fd. mica. | R ₁ —50,000-ohm, 1-watt. | Sw ₂ —5-point two-circuit switch (Yaxley No. 1215L). |
| C ₁₀ —0.001- μ fd. mica. | R ₂ —35,000-ohm, 2-watt. | Sw ₃ —5-point two-circuit switch (Yaxley No. 1315L). |
| C ₁₁ —260- μ fd. variable (Cardwell MR-260-BS). | R ₃ —200-ohm, 10-watt. | |
| C ₁₂ —475- μ fd. variable (Cardwell XR-500-PS). | RFC—2.5-mh. r.f. choke (National R-100 and Coto CI-11). | |

COIL DATA

- Electron-Coupled Oscillator Coil; 1.75 Mc.: 40 turns No. 20 enamelled, close-wound, tapped 15 turns from ground.
- Oscillator Cathode Coil; 3.5 Mc.: 17 turns No. 20 enamelled, length 1 $\frac{1}{4}$ inches.
- Oscillator Plate Coils; 1.75 Mc.: 35 turns No. 20 enamelled, close-wound.
- 3.5 Mc.: 25 turns No. 20 enamelled, length 1 $\frac{1}{4}$ ".
- 7 Mc.: 11 turns No. 20 enamelled, length 1". Suppressor coil: 7 turns No. 20, close-wound, spaced $\frac{1}{8}$ in. from plate coil.
- 14 Mc.: 8 turns No. 16 enamelled, length 1 $\frac{1}{2}$ ". Suppressor coil: 6 turns No. 16, close-wound, spaced $\frac{1}{8}$ inch from plate coil.
- Amplifier Plate Coils; 3.5 Mc.: 20 turns No. 14 bare, length 1 $\frac{1}{2}$ ".
- Link; 3 turns at ground end.
- 7 and 14 Mc.: 11 turns No. 14 bare, length 1".
- Link; 3 turns at ground end.
- 28 Mc.: 5 turns No. 14 bare, length 1 $\frac{1}{2}$ ".
- Link; 2 turns at ground end.

All coils wound on Hammarlund SWF-4 coil forms, diameter 1 $\frac{1}{4}$ inches. On coils with suppressor feedback, both plate and suppressor sections are wound in the same direction with the inside (adjacent) ends grounded. Links on final coils are wound over the plate coils, supported by "gobs" of Duco cement, temporary spacers being used until the cement hardened.

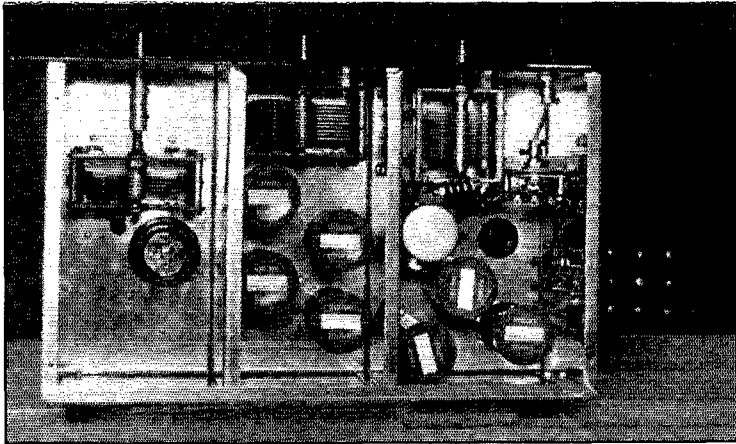

LOOKING INSIDE FROM THE TOP

The crystal switch, together with the 89 and its cathode coils, is in the right-hand compartment. The oscillator plate circuit has its own shielded section, that in the middle.

on the crystal frequency. This requires an untuned impedance coupling between the oscillator plate and the amplifier grid. By using parallel plate feed to the oscillator the plate radio-frequency choke may be used as the coupling impedance when the oscillator plate tank is open-circuited.

Suppressor grid regeneration windings were included in the 7- and 14-Mc. oscillator plate coils to get all the available output on these frequencies when using 1.75- and 3.5-Mc. crystals. This regeneration gives a definite increase in output on the fourth and higher harmonics and a slight improvement even on the second harmonic.

The amplifier-doubler stage is conventional. Because plug-in coils are used, parallel plate feed is called for in deference to Precept No. 1—Safety. Incidentally, the frame of the tank condenser may be mounted directly on the chassis. The 200-ohm cathode bias resistor keeps the plate current within reasonable limits during tuning operations without seriously affecting the d.c. efficiency.

A glance at the wiring diagram will show the switching scheme which allows rapid crystal- or band-changing. This band-switching is satisfactory because the oscillator supplies more power than is necessary to drive the 6L6G, and therefore the ultimate in efficiency is not necessary. Plug-in coils are used in the output tank circuit, however, because efficiency here is essential.

SPECIAL FEATURES

As can be seen from the illustrations, plug-in coils did not necessitate abandoning Precept No. 3, for the coils are changed from the front of the panel by lifting the trapdoor in the lower right-hand corner.

The bottom view, with cover removed, shows how the shielding pocket for this coil was formed. The shielding permits operating the 6L6G with

tuned grid circuit on the lower frequencies if additional output is desired. It may tend to self-oscillate but will lock in with the crystal frequency.

This view also illustrates the details of the two bevel-gear drives which make it possible to locate the band-change switches close to the higher-frequency coil sockets. The switch mounting brackets were cut from 1/16th-inch thick half-hard brass with a hack saw and hand jig saw. The cathode-coil switch should preferably be of the

“shorting” type to avoid interrupting the oscillator d.c. power between points. The plate coil and crystal switches may be non-shorting types, since the only d.c. circuit broken is the 50-volt suppressor supply on the plate-coil switch.

The bottom view also shows how the three meter jacks for each of the two tubes are mounted on Micarta angle brackets at a safe distance behind the panel. Access to the jacks is obtained by lifting the small trapdoors on the front of the panel. The size of the openings and the distance of the jacks back of the panel were chosen to make it virtually impossible to touch the plug tip to a jack sleeve when the operator’s fingers are gripping the metal ferrule of the plug. The jacks are spaced from each other and from the chassis far enough so that they cannot be shorted by the tip of the plug.

The general chassis layout can be seen in the top view. The 89 oscillator tube with its cathode circuits and the crystal change switch occupy the

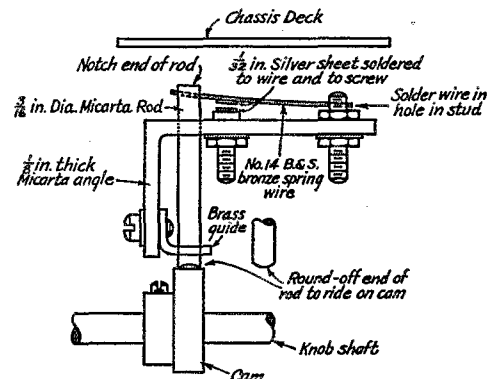
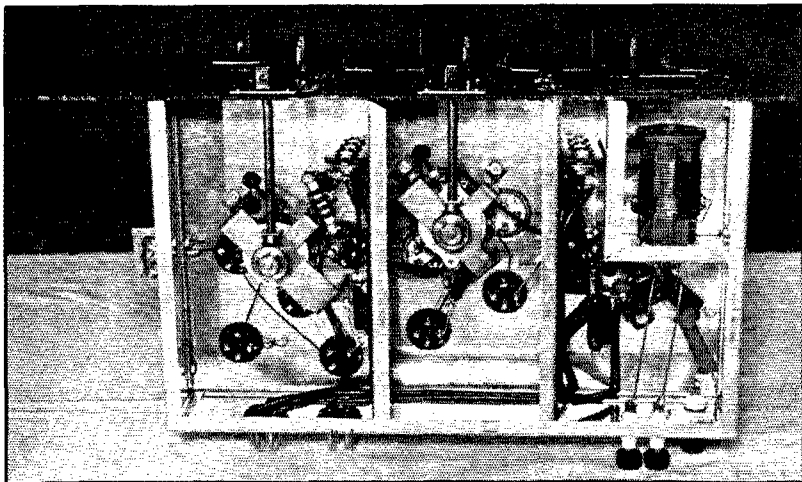

FIG. 2—AUXILIARY CAM SWITCH

As explained in the text, this switch was installed after the photographs were taken.

left-hand compartment. The electron-coupled oscillator coil has been removed for the sake of a clearer picture. Banana jacks for six crystal holders are mounted on a sheet of Micarta and project through cutouts in the end of the chassis. The desired crystal is selected by the switch shown near the top of the compartment. For electron-coupled operation one point of the switch connects a grid condenser into the



THE MECHANICAL CONSTRUCTION IS APPARENT FROM THIS BOTTOM VIEW

The band-changing switches are mounted vertically for short leads to the coil sockets. The gears connecting the switches and operating shafts are standard items, obtainable through practically any hardware store. They are made by the Boston Gear Works, North Quincy, Mass., Catalog No. G-481, 16-tooth pinion and 32-tooth gear, 32 diametral pitch. The $\frac{3}{16}$ " holes are drilled out to fit a $\frac{1}{4}$ " shaft and the hubs are tapped for 6/32 screws.

circuit instead of a crystal. It was impossible to locate the control knob in line with the switch and allow clearance between the knob and the condenser handle. The first arrangement had the knob attached to a short length of $\frac{1}{4}$ -inch shaft which turned in a panel bearing bushing, the shaft being connected to the switch through two ordinary disc-type universal couplings. The offset was so great, however, that the universals quickly broke. They were then replaced by a length of National flexible shafting, which does the job to perfection. The duty on the shafting could be reduced considerably by mounting the switch at a slight angle to eliminate the double curvature. A tip to follow when cutting this shafting: Solder the wires carefully before cutting or they will unravel, but do not let the

solder flow too far away from the point of the cut or some of the flexibility will be lost.

The need for a tube shield on the 89 is debatable although, since one of the cathode coils is quite close to the tube, it probably adds some additional frequency stability. In the 89, of course, the screen grid does not shield the outer surface of the plate, which therefore has appreciable capacity to other nearby circuit elements. The use of the tube shield decreases the output slightly when the oscillator plate tank is open-circuited and the 6L6G is being driven at the crystal frequency. The reason for this will be explained later. In spite of this reduction in output, the power obtained at the crystal frequency is equal to or greater than that at higher harmonics, so that there is no need for increasing it.

The oscillator plate tank occupies the center compartment, with the higher frequency coils located closest to the condenser. The band-change switch is located directly beneath the 7- and 14-Mc. coil sockets. In these two band positions the suppressor feedback coils are connected in, but the other three positions connect the suppressor directly to plus 50 volts. When the 6L6G is operated as an amplifier on the crystal frequency the switch is turned to the open position. This opens the circuit to all of the plate

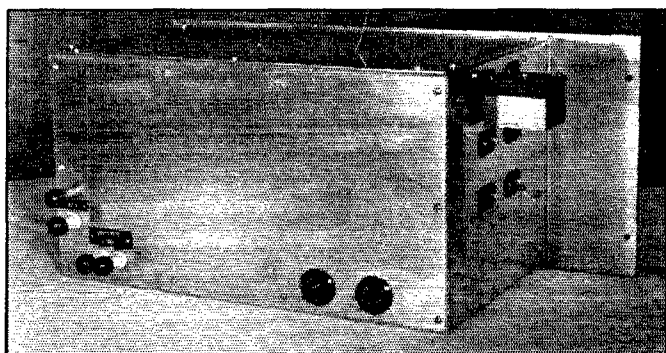

ALTHOUGH CRYSTALS ARE SWITCHED FROM THE PANEL, THEY ALSO CAN BE PLUGGED IN ON THE SIDE WITHOUT REMOVING THE EXCITER CASE

The homemade crystal holder is designed to reduce frequency drift through the use of an exceptionally heavy bottom plate which minimizes thermal fluctuations.

(Continued on page 98)

True North from Old Sol

By A. L. Budlong*

WANT to know where true North is? Simple! Exactly at noon, from your particular locality, the sun is due south and the shadow of your antenna mast or any other convenient vertical pole will lie true north. . . .

Hey, wait a minute! Come back here, durnit . . . you can't just dash out to the back yard like that, watch in hand. It's simple, but it's not that simple.

What time is your watch running on? Ah, we thought so—Eastern Standard. That means 75th meridian time.¹ In this business we have to figure

TABLE I

Apply to Clock Time as indicated by the sign, to get time of true noon

January	1 + 3¾ mins.	July	10 + 5¼ mins.
	10 + 7¾ "		20 + 6¼ "
	20 + 11¼ "		30 + 6¼ "
	30 + 13¼ "		
February	10 + 14¼ "	August	10 + 5¼ "
	20 + 13¼ "		20 + 3¼ "
	28 + 12¼ "		30 + ½ "
March	10 + 10¼ "	September	10 - 3 "
	20 + 7¼ "		20 - 6¼ "
	30 + 4¼ "		30 - 10 "
April	10 + 1¼ "	October	10 - 13 "
	20 - 1 "		20 - 15 "
	30 - 2¾ "		30 - 16¼ "
May	10 - 3¾ "	November	10 - 16 "
	20 - 3½ "		20 - 14¼ "
	30 - 2¾ "		30 - 11¼ "
June	10 - ¾ "	December	10 - 7 "
	20 + 1¼ "		20 - 2¼ "
	30 + 3¾ "		30 + 2¼ "

local noon pretty closely; 75th meridian time is good only if your town is located on the 75th meridian of longitude, a coincidence that probably will not occur very often. If you are east of the time meridian for your particular Standard Time, your "clock noon" occurs before the Standard Time "clock noon"; if you are west of the standard time meridian, your noon is later than theirs. Since we have to have noon exactly for your location, a correction is called for.

There's nothing difficult about it, though: to your Standard-Time noon you apply a correction of 1 minute of time for each 15 minutes of longitude by which your location differs from the longitude of the meridian used for your Standard Time. **SUBTRACT** the correction when you are *east* of the time meridian; **ADD** it if you are *west*.

* Assistant Secretary, A.R.R.L.

¹ CST is 90th meridian; MST is 105th meridian; PST is 120th meridian.

The result is when it will be actual "clock noon" at your place, by Standard Time.

Now grab an atlas, determine your longitude (getting it to the nearest 15 minutes of longitude is plenty accurate enough) and figure the correction. To show how it's done, we'll work an example for West Hartford. The atlas shows us as just about 72° 45' longitude. We run on EST here, which is 75th meridian time, so the difference between our longitude and EST longitude (by subtraction) is 2° 15'. Our correction is going to be a minute of time for each 15' of longitude; this means each whole *degrees* of longitude represents 4 minutes of time (there are 60 minutes to a degree). So 2° 15' of longitude is 9 minutes of time. Got it? OK; now, since our location is east of the time meridian, we subtract the correction from EST noon, giving us 11:51 A.M., EST, when it will be true "clock noon" at West Hartford.

Hold it! . . . hold it! . . . we're still not quite ready to spot that shadow yet! One more very simple correction coming up.

"True noon" is the thing we want, because it is at "true noon" when the sun is at its highest point in the sky, and due south of us. What we've figured out so far is "clock noon" and it is unfortunately a fact, for reasons we won't explain but which we assure you exist, that "true noon" and "clock noon" are one and the same thing on only four days of the year. For the rest of the year, if you compared clock time with so-called sun time, you'd conclude that Mother Earth is a very erratic person indeed; sometimes she apparently goes whooping along and beats the clock to it by as much as sixteen minutes, and at other times she loafs behind and lets the clock get there first. Well, we've got to have "true noon" in our business, so it looks like another correction. You can get it from the table herewith, where we have figured it out for every ten days throughout the year (you can estimate the correction for the days in between without any great difficulty). Add or subtract according to the sign given; the result, in terms of your Standard Time, is when it is actually "true noon" at your location. Incidentally, the four days when no correction needs to be made are April 15th, June 14th, September 1st and December 25th. On those days, your Standard Time, corrected for the longitude difference, is also the time of "true noon"; but only on those days.

Continuing with our West Hartford example, and assuming we want to give this scheme a whirl on January 10th. We find we have to add 7¾ minutes to our watch time in order to arrive

(Continued on page 98)

The New PITC

Modern Radio Equipment for Pitcairn Island

By Lew Bellem,* WIBES

MOST readers will recall with interest the story of W8IGQ's visit to Pitcairn Island as related in these pages some months ago.¹ Those familiar with the history of the rugged years following the settling of Pitcairn in 1790 by Fletcher Christian, Edward Young and his little band of mutineers from H.M.S. *Bounty*, will best understand the priceless inheritance of tenacity and perseverance handed down to this generation of islanders by their forebears. To avoid the punishment awaiting them for mutiny against the British Crown, they sought and found seclusion from the world on this rock-bound South Sea isle. So they remained, undiscovered for 18 years until a chance visit by an American sealing vessel revealed the fate of the *Bounty* and its crew. This period of isolation, broken only occasionally in the decades to follow by a visit from a passing ship, has served to mold a people endowed with a measure of fortitude and resourcefulness, the equal of which would be hard to find.

No real amateur surrounded by his modern radio equipment of to-day could have read that tale of Andrew Young's determination to keep his little island community in touch with ships that passed beyond the horizon without a feeling of pride in classing him as a true ham. Lacking both equipment and power facilities, the spirit of amateur radio has carried Andrew Young, alone and unguided these many years, over obstacles insurmountable to most of us.

Perhaps this story and the legends with which Pitcairn abounds fired the imagination, but certainly a responsive chord was touched by the use of such pitifully inadequate and antiquated apparatus, for then and there was the idea conceived of helping the islanders to obtain modern radio facilities as a tribute to Andrew Young from the American amateur.

With the simple plan to help these folks and a rough idea of what would be needed to build a suitable station for them, manufacturers who could supply the necessary equipment were contacted and the plan explained to them. Without exception, they agreed to make available the apparatus needed, and their enthusiastic endorsement and support of the project as a worthy one paved the way for laying actual constructional plans. Then, and only then, was the size of the job at hand fully realized.

* Chief Engineer, Coto-Coil Co., Inc.

¹ Eurich, "CQ PITC," *QST*, August, 1937.

Since a primary source of power is not available on Pitcairn Island and the use of gasoline is out of the question, the choices of possibilities narrowed to harnessing the wind for supplying energy. Storage batteries of ample capacity must be provided to take care of heavy current demands



THE TRANSMITTER IS A 60-80 WATT C.W.-PHONE JOB

It can work on 600 meters as well as the 40- and 20-meter amateur bands. If the islanders take to amateur radio (it looks as though they won't be able to avoid it!) this rig will give a new country to lots of DX-hunters.

with sufficient reserve to avert a power failure in event of a period of prolonged low wind velocity. As the transmitter and receiver must operate entirely from this battery, plate power in each case would have to be derived from dynamotors. Consideration was next given the frequency or fre-

quencies on which the transmitter should be capable of operation. Since communication on 600 meters with passing ships has been an essential service of the islanders' present equipment, this frequency must be available in the proposed transmitter. Because of the remote location of Pitcairn Island, the choice of a second and third frequency would dictate the use of the 20- and 40-meter amateur bands. The use of 'phone on the two latter bands would be a desirable adjunct,

suitable equipment was commenced in earnest. A 12-volt battery system was chosen in preference to 6-volt to minimize the IR drop in feed wires which would have to carry comparatively heavy currents.

A special 12-volt Parris-Dunn windcharger was first procured to supply the initial power. This unit is capable of an 8-ampere charging rate in a 20-mile wind. Lower velocities produce proportionately lower charging rates, the cutout operating

to protect the battery from discharge when the wind pressure falls below 6 m.p.h. A 12-foot steel tower is included for raising the windcharger with its 8-foot impeller above surrounding objects which might act as windbreaks. Two Willard 6-volt 300-ampere-hour storage batteries provide the necessary reserve for 8-10 hours of continuous operation of both transmitter and receiver. Assuming average wind conditions and operating routine, it should be possible to operate in excess of 10 hours per day without fear of power failure.

The transmitter proper is a 36-inch steel cabinet affair utilizing standard 19-inch panels and chassis. The lower deck embraces an audio amplifier-modulator and a power distribution center for the

750-volt dynamotor and 12-volt battery supply. The audio system is comprised of a Shure Model 70S crystal microphone feeding three stages and transformer coupled to a pair of 6L6 tubes as modulators. Obtaining satisfactory performance from these 6L6's provided a real problem since they were to derive their 450-volt plate supply from a bleeder network and bias from a series cathode resistor. It was found that while poor plate-supply regulation was a hindrance to obtaining a reasonable level of audio output, the real stumbling block was the variable cathode bias. While casting about for a more stable bias supply, it was discovered that there were 12 healthy volts available from the main supply battery, but that the polarity was opposite to that needed since the original design specified grounding the negative battery terminal. Further investigation showed this to be an optional choice so a simple revision in wiring permitted running the 6L6 grid return to negative "A." This change, in combination with a small cathode resistor gave a fairly steady bias of 25 volts even when driving the amplifier beyond its capabilities. Separate 200-watt bleeder networks

(Continued on page 78)

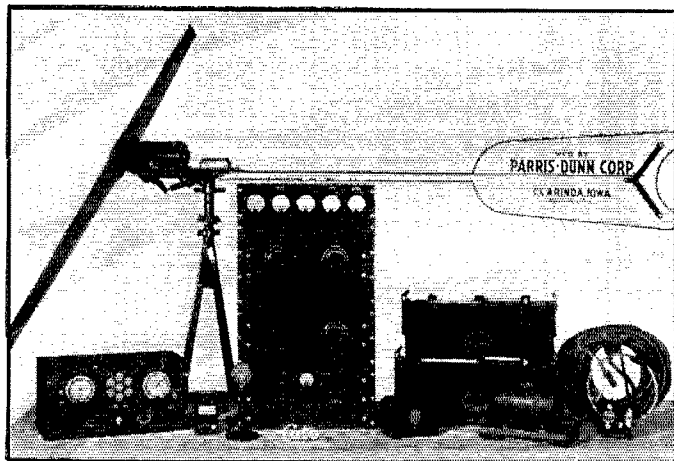

THE COMPLETE SET-UP OF EQUIPMENT FOR THE NEW PITC

Power will be taken from wind-charged storage batteries of ample capacity, high-voltage being obtained by means of dynamotors. The receiver, a t.r.f., covers all wavelengths between 10 and 3000 meters. Testing equipment and plenty of spare parts are included.

providing the additional power demand was not excessive. A suitable receiver for use with such a transmitter would, of course, cover all transmitting frequencies. In addition, it should be sensitive, reasonably selective and include general coverage plus band-spread if possible. Last, but not the least important, it must be conservative of battery drain. All of this equipment should be as simple and foolproof as possible from the standpoint of hooking up and operating, since Andrew Young's experience with tube transmitters is nil and his familiarity questionable.

Through the cooperation of Carl Madsen, W1ZB, who has maintained a schedule with WCFT throughout her world cruise, Mr. Eurich aboard the *Yankee* and bound for the Dutch East Indies, was apprized of the project afoot. In this way W8IGQ was able to furnish suggestions and information regarding conditions on the island as he had found them. Particularly did he stress the importance of high-grade insulation, since the salt air constantly sweeping this mere dot on the Pacific took heavy toll of materials ordinarily found satisfactory.

With these various requirements and restrictions constantly in mind, the job of designing

Directional Antennas with Closely-Spaced Elements

By John D. Kraus,* W8JK

ONE of the simplest and most efficient radiators used on short waves is the horizontal half-wave antenna.¹ Offhand it might not appear that two such antennas would make a good radiating system, if placed parallel to each other a small fraction of a wavelength apart and fed with currents 180 degrees out of phase. It is true, however, that this arrangement forms a simple and very compact directional antenna.

Fig. 1 is a sketch of two half-wave radiators oriented in the horizontal plane as described and placed high above the ground. The spacing may be a small fraction of a wavelength. If the wires

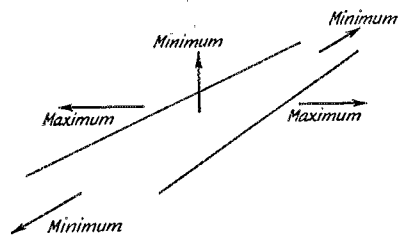

FIG. 1—TWO HALF-WAVE ANTENNAS CLOSELY SPACED AND WITH CURRENTS 180 DEGREES OUT OF PHASE

The arrows indicate the directions in which radiation is a maximum and a minimum.

are not placed too close together, the pair will radiate the same power as would a single half-wave antenna with the same input. But, because of the close-spacing and out-of-phase currents, the direction in which the radiation takes place is profoundly altered. G. H. Brown² was the first to point out the advantages of using such close spacing.

As indicated by the arrows in Fig. 1, the radiation from the pair is very small—theoretically zero—off the ends and also vertically. The radiation horizontally broadside is a maximum and is considerably greater than from a single half-wave antenna fed with the same power.

Fig. 2 shows the close spacing idea applied to a number of practical directive antenna systems. The type of Fig. 2-A is 32 feet long. It has two half-wave radiators spaced one-eighth wave-

length and fed at the center. The cross-over feeds the two radiators 180 degrees out of phase. The feeders connect on at the middle of the cross-over. The radiation from the antenna is maximum in both directions broadside and minimum off the ends. The gain in both directions broadside is as much as or more than in the one preferred direction when a half-wave radiator is used with a reflector one-quarter wavelength behind. Dimensions are given for fundamental operation in the 14-Mc. band. The antenna is actually a multi-band affair, giving approximately the same horizontal bi-directional pattern on 28 Mc. as on 14 Mc., or on any frequency between these two bands. When used on 56 Mc. the horizontal pattern has four lobes. For fundamental operation on 28 Mc. the dimensions of Fig. 2-A should be halved. This smaller array would have about the same bi-directional pattern on both 28 and 56 Mc.

An antenna of about the same size as the one of Fig. 2-A is shown in Fig. 2-B. This antenna is end-, instead of center-fed. An array having two sections, which uses four half-wave elements, is shown in Fig. 2-C. It is 62 feet long. The array of Fig. 2-D has 4 sections or 8 half-wave elements and is 112 feet long. The antennas of Fig. 2-B, C, and D have the bi-directional pattern only on their fundamental frequency—14 Mc. in this case. When operated on 28 Mc. their horizontal patterns will have four main lobes. For fundamental operation on 28 Mc. the dimensions should, of course, be halved.

CONSTRUCTION

To make one of these antennas as a unit so that it may be supported between two poles it is convenient to use spreaders, which, for a 14-Mc. antenna, are about 9 feet long. These may be either of bamboo or 1- by 1-inch strips of wood. A suggested arrangement for a two-section antenna is given in Fig. 3. Since the antenna bears a striking resemblance to one of the "T" or flat-top types popular a decade or two ago, it is called a "flat-top beam."³

The cross-over at the middle of the flat-top is made by using two 6-inch feeder-spreader insulators, one placed horizontally at the center and the other vertically half-way between the center and one end of the wooden spreader. The two-wire feed line comes up from below and con-

*Arlington Blvd., Ann Arbor, Mich.

¹ An excellent treatment of the characteristics of horizontal antennas has been given by George Grammer, *QST*, Nov., 1936, and March, 1937.

² G. H. Brown, "Directional Antennas," *Proc. I.R.E.*, Jan., 1937.

³ J. D. Kraus, "Small But Effective Flat-top Beam," *Radio*, March and June, 1937.

nects on to the cross-over at the horizontal center insulator. In order to get greater separation at the cross-over, the insulators may be made longer by fastening two 6-inch feeder spreaders end-to-end. The wire length at the cross-over is of necessity a few inches more than the spacing. Thus, the wire length at the cross-over of a 14-Mc. antenna (8 feet 8 inches spacing) may be about 8 feet 11 inches.

The line used to support the long wooden spreaders at each end of the flat-top should preferably be of rope. In case a 4-section flat-top is used, a method of accomplishing the additional cross-overs is indicated by dotted lines in Fig. 3. One vertical feeder-spreader insulator is used at the middle of the long wooden spreader. The recommended spacing lengthwise between the sections of the flat-top is about 2 feet.

FEEDING

The main characteristics of a flat-top directional antenna are the closely-spaced elements, about one-eighth wavelength apart, and currents 180 degrees out of phase. All the elements are driven. The spacing is not critical but one-eighth wavelength seems to be about optimum when 180-degree phasing is used, and is recommended. The mutual coupling between closely spaced out-of-phase wires is such that the impedance at the center of the half-wave elements becomes quite small and, inversely, quite large at the ends. Accordingly, the current flowing at voltage nodes is very high.

The dimensions are not critical and the values of Fig. 2 are recommended for use on any frequency in the 14-Mc. band. Compensation is made for any small variations when the antenna is tuned up.

Either Zepp feeders or a matching stub and 600-ohm line can be used to feed the antennas. The Zepp feeders or the stub connect at the

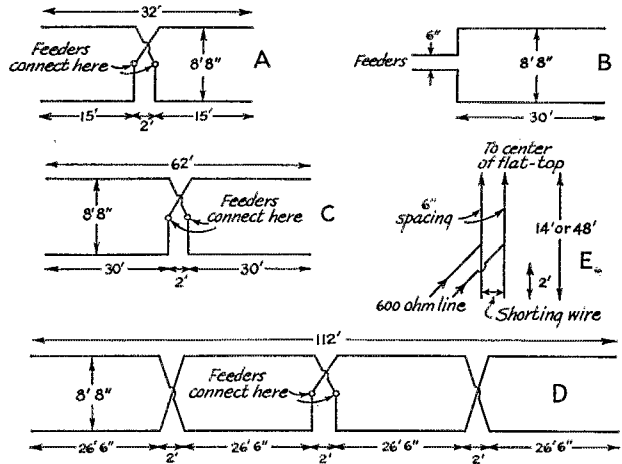

FIG. 2—FOUR TYPES FOR USE IN THE 14-MC. BAND
A and B are single-section types, C a 2-section, and D a 4-section. For fundamental operation on 28 Mc. the dimensions should be halved. Approximate dimensions for a matching stub to feed the 2-section antenna of C are given in E.

center of the cross-over in the flat-top as shown in Fig. 3. The approximate dimensions for a stub to feed the antenna of Fig. 2-C is indicated in Fig. 2-E. With more sections the 600-ohm line will connect farther from, and with fewer sections closer to, the shorting wire on the stub.

Where the line is not over a wavelength or two long, the Zepp type of feed is very practical. It is also convenient if one expects to use the same flat-top beam on a number of bands. For example, the antenna of Fig. 2-A may be series fed on 28 Mc. The feeders in this case would be either one-half or one wavelength long, approximately, since this antenna is fed at a current loop (voltage node) on 14 Mc. A matching stub for this antenna would also be either one-half or one wavelength long on 14 Mc. and about 8 feet either longer or shorter on 28 Mc. The other antennas, Figs. 2-B, C, and D, are all fed close to current nodes as used on 14 Mc. so that matching stubs to feed

them should be either one-quarter or three-quarter wavelengths long. It is often convenient to use a three-quarter wavelength stub as one may be able to adjust it from the ground after the

antenna has been pulled up into place. It is advisable to use good 6-inch spreader-insulators throughout the stub and 600-ohm line.

In adjusting the stub the antenna is shocked from another antenna or from an r.f. line

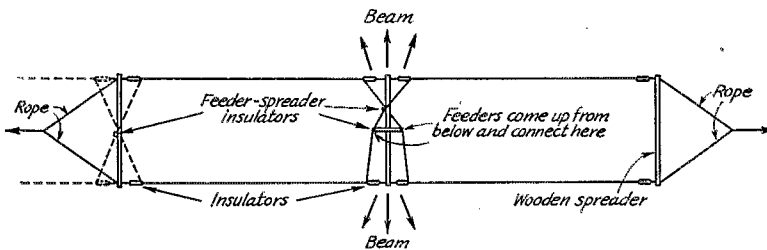

FIG. 3—TOP VIEW SHOWING CONSTRUCTION OF A 2-SECTION ANTENNA WHICH IS POPULARLY TERMED A "FLAT-TOP" BEAM

Method of making cross-over if extra sections are added is shown by dotted lines at left.

coupled loosely to it. The shorting wire on the stub is then adjusted for a maximum of current through the short. The transmission line is next connected on the stub a foot or two above the short and adjusted up or down the stub until the

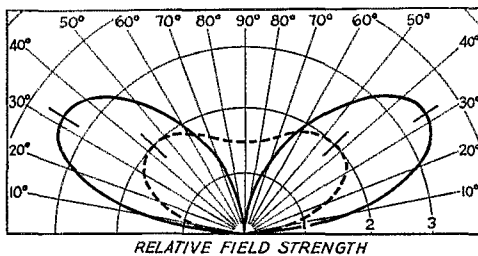

FIG. 4—COMPUTED RADIATION CHARACTERISTICS IN THE VERTICAL PLANE FOR A SINGLE HALF-WAVE ANTENNA (DASHED) AND A 2-SECTION FLAT-TOP (SOLID) BOTH AT A HEIGHT OF THREE-EIGHTHS WAVELENGTH ABOVE GROUND

standing waves along the transmission line are a minimum. A sensitive r.f. current meter (0-200 ma.) equipped with a single turn loop and an insulated hook can be used to slide along one side of the transmission line, so that readings may be made quickly at four or five points along the line spaced about an eighth wavelength apart. Insulation of the antenna and feeders from the transmitter plate supply voltages is, of course, important in any installation.

PERFORMANCE

Because of the out-of-phase currents, the vertical radiation from the flat-top antenna approaches zero. As a result, the maximum radiation in the vertical plane is lowered to a smaller vertical angle. In Fig. 4 the vertical radiation characteristics of a single half-wave antenna (dashed curve) and a 2-section or 4-element flat-top antenna (solid curve) are compared for a height in both cases of three-eighths wavelength above ground. The plane in which the radiation is shown is at right angles to the antennas. The relative field strength is plotted in arbitrary units, and the curves are calculated on the basis of the same power to both antennas. Perfectly conducting ground is assumed, but with horizontal antennas and the height being considered the patterns for ordinary ground would probably be quite similar.

It is apparent from Fig. 4 that the radiation maximum is lowered from about 43 degrees in the case of the half-wave antenna to about 32 degrees for the flat-top. The maximum gain of the flat-top over the half-wave does not occur at these angles, however, but rather at lower ones—15 degrees and less. It is these low angles which are frequently the most effective in long distance communication. The effect of lowering the vertical angle of maximum radiation from a flat-top beam

is most pronounced at heights up to a half wavelength or so above ground. At greater heights the angle of the lowest lobe becomes nearly the same as that for a single half-wave antenna. For 14-Mc. DX a height of three-quarters to one wavelength above ground seems worth while.

Although much of the gain comes through vertical directivity, the horizontal gain is also important. This depends mainly on the number of sections used. Fig. 5 shows the measured horizontal radiation pattern for a single-section antenna (see Fig. 2-A). The maximum radiation is broadside and the minimum is off the ends of the antenna. The radiation is 3 db down at an angle of about 35 degrees off the center line of the beam (broadside). At 70 degrees the signal is over 20 db down, representing a front-to-side signal power ratio of well over 100 to 1. The relative field strength is plotted in decibels, the minimum signal observed being taken as 0 db.

The power gain of a single-section flat-top compared to a single half-wave antenna is over 4 db. When used on its second harmonic the gain

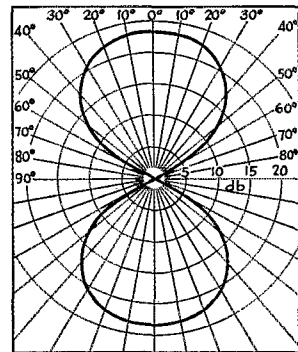

FIG. 5—MEASURED HORIZONTAL RADIATION PATTERN OF SINGLE-SECTION FLAT-TOP ANTENNA

The relative field strength is plotted in decibels.

is about 6 db. The horizontal radiation as measured from a 2-section flat-top (Fig. 2-C) is only slightly narrower, the signal being 3 db down at about 30 degrees off the center. Thus, a 2-section flat-top puts out a very satisfactory signal over an angle of about 60 degrees in each direction broadside, and a usable signal over an even wider angle. The null off the ends, however, is very pronounced. Three 2-section antennas arranged at angles of 120 degrees with respect to each other should give good coverage over 360 degrees. The gain of a 2-section flat-top is over 6 db. A 4-section array would have over 8 db gain and a still narrower pattern than the 2-section type.

A pair of double-Zepp antennas, one stacked one-half wavelength above the other, is a familiar

(Continued on page 37)

What the League Is Doing

League Activities, Washington Notes, Board Actions—For Your Information

Election Results When the Executive Committee of the A.R.R.L. met on November 1, 1937, to examine nominations in connection with this year's elections for director and alternate director, it found that four divisions had returned the former office holders or elected new ones without the necessity for membership balloting, while two divisions and Canada had nominated more than one candidate as director (or alternate) and perforce had to decide the issue by ballot.

Taking up the non-voting divisions first: In the Delta Division no valid nomination was found for any candidate for director, so Director E. Ray Arledge, W5SI, succeeds himself for the next two years under a provision in our by-laws which covers just such cases. For alternate, the only candidate nominated was E. H. Treadaway, W5DKR; he was found eligible and forthwith declared elected as the alternate.

In the Midwest Division it would appear that the gang will have none other than its present director, Floyd E. Norwine, Jr., W9EFC, for his was the only nomination received. He was declared reelected by the committee in the absence of other nominations. No nominations were received for alternate; the incumbent, O. J. Spetter, W9FLG, therefore continues during the next term.

In the Pacific Division, Director Culver, W6AN, who has served his division for the past three years, decided he would not be a candidate for reelection. In his place, the division nominated E. L. McCargar, W6EY, who has attended several board meetings as the Pacific Division alternate; there being no other nominations, "Mac" becomes the new Pacific Division director on January first. Elbert Amarantes, W6FBW, succeeds him as alternate, as the only candidate nominated.

The Southeastern Division seems to prefer its present director and alternate to the exclusion of all others and returned both to office as the only candidates named. Bennett R. Adams, Jr., W4APU, continues as director, therefore, with S. J. Bayne, W4AAQ, as his running mate.

Now for the voting divisions: In Canada an election is taking place for Canadian General Manager to decide between present C. G. M. Alex Reid, VE2BE, and Leonard W. Mitchell, VE3AZ, who opposed Mr. Reid in the election two years ago. Michael J. Caveney, VE3GG, was also nominated but was found ineligible under the terms of the by-laws. For alternate C. G. M.,

petitions were found for two candidates, Alex Lariviere, VE2AB, and John C. Stadler, VE2AP. Both being eligible, they were listed on the ballots. However, subsequent to the mailing of ballots from Headquarters, Mr. Stadler expressed his desire to withdraw. The Executive Committee determined through counsel that the proper procedure in this case will be to disregard the ballots for alternate C. G. M. when all ballots are opened and counted on December 20th, and to declare Mr. Lariviere elected as alternate Canadian General Manager, as the only candidate.

A three-cornered contest is currently taking place in the Atlantic Division between Roy C. Corderman, W3ZD, present director Walter Bradley Martin, W3QV, and Edward L. Thompson, W3CQS. For alternate director, nominations were received for four candidates: Gilbert Crossley, W8YA, Hunter J. Lohman, W8OC, Raymond E. Macomber, W3CZE, and Herbert M. Walleze, W8BQ. The Executive Committee was obliged to declare both Mr. Crossley and Mr. Lohman ineligible under the terms of the by-laws, but ordered Mr. Macomber's and Mr. Walleze's names listed on the ballots for voting by the membership.

Our old friend Carl Jabs had expressed a desire not to be a candidate this year in the Dakota Division elections. To succeed him, three others were nominated: Frank A. Vowles, W9BBL, Earl R. Thornburg, W9EU, and Fred W. Young, W9MZN. Mr. Thornburg was judged ineligible, so the contest is between Mr. Vowles and Mr. Young. For alternate, nominations were received for Adolph A. Emerson, W9ITQ, W. F. Soules, W9DCM, and Fred W. Young, W9MZN. Mr. Young withdrew his name in order to run for director and both Mr. Emerson and Mr. Soules were found ineligible, so there is no election for alternate in the Dakota Division this year.

Counting of the ballots for director and alternate director in the Atlantic Division, for director in the Dakota Division, and for Canadian General Manager, will take place on December 20th. The results will be announced in the February issue, but will also be made the subject of an official broadcast for the week December 20th-27th, so interested members should keep an eye out for the broadcast for immediate news of the outcome.

Habana Although the Interamerican Radio Conference at Habana was expected to last until December 10th before closing,

Secretary Warner had seen the amateur matters through all the initial stages by late November and returned to the United States on November 28th. His report on the conference will be in the next issue. In the meantime, it may be said that as of December first the following actions on amateur matters had been seen safely through committee and were merely awaiting final formal plenary confirmation:

First, everyone expressed complete agreement on the U. S. proposal (OK'd by our Board) to change our 1.7-Mc. band to read 1750-2050 kc. In addition, this and the 3.5, 7, 14 and 28-Mc. bands were affirmed as exclusive amateur through the Americas; the amateur subcommittee even went so far as to recommend that the nations of this hemisphere unite in holding out for the present 7, 14, 28 and 56-Mc. bands as exclusive amateur at Cairo!

The problem of 'phone on 7 and 14 Mc. for our South and Central American neighbors was a tough one, particularly when it came to 7 Mc. South and Central American countries, secure in the knowledge that they had every right to assign 'phone in the amateur bands entirely as they wished, refused flatly to listen to our suggestion that 'phone be barred from 7 Mc. Our efforts to get an agreement on a 100-kc. assignment (as directed by the Board) were met with resistance, initially, unless the assignment were made exclusive to 'phone! Similar resistance was expressed over initial proposals that a 7-Mc. assignment be at one end of the band. The result was a compromise whereby the assignment is 100 kc. at 7050-7150, but non-exclusive. It should be understood that this assignment is solely for the benefit of the South and Central Americans; there will be no 'phone at 7 Mc. for the U. S., Canada or Newfoundland. At 14 Mc. the outcome is an agreement on 14,100-14,300 available for 'phone in the Americas but with no change to be made in the present U. S. 'phone sub-band at these frequencies. The conference also dealt with 'phone in the 3.5-Mc. band, coming out with 3800-4000 designated as available for 'phone (thus confining Mexican 'phones, which now roam the whole band) but with no change contemplated in the existing U. S. assignment.

An outstanding accomplishment was the adoption of a third-party message-traffic agreement by an 11-0 vote in committee; Venezuela, Mexico and Argentina abstained from voting on this because of domestic laws prohibiting any kind of third-party traffic. This agreement, sponsored by the League, carefully steered through the initial stages of U. S. adoption prior to the conference, and further helped by pre-conference correspondence between the League and South American amateur societies, will at one blow make third-party traffic available throughout virtually the entire western hemisphere!

As of this writing, all these matters are still

subject to confirmation in the plenary session; in fact, it is not yet apparent to what extent the participating governments will eventually pledge themselves to carry out any of the conference agreements.

Look for the complete story in the February issue.

(Continued on page 100)

A.R.R.L. QSL Bureau

FOR the convenience of its members, the League maintains a QSL-card forwarding system which operates through volunteer "District QSL Managers" in each of the nine United States and five Canadian districts. In order to secure such foreign cards as may be received for you, send your district manager a standard No. 8 stamped envelope. If you have reason to expect a considerable number of cards, put on an extra stamp so that it has a total of six-cents postage. Your own name and address go in the customary place on the face, and *your station call should be printed prominently in the upper left-hand corner.*

- W1—J. T. Steiger, W1BGY, 35 Call Street, Willimansett, Mass.
- W2—H. W. Yahnel, W2SN, Lake Ave., Helmetta, N. J.
- W3—R. E. Macomber, W3CZE, 418 10th St., N. W., Washington, D. C.
- W4—G. W. Hoke, W4DYB, 328 Mell Ave., N. E., Atlanta, Ga.
- W5—E. H. Treadaway, W5DKR, 2749 Myrtle St., New Orleans, La.
- W6—D. Cason Mast, W6KHV, 423 East E St., Ontario, Calif.
- W7—Frank E. Pratt, W7DXZ, 5023 So. Ferry St., Tacoma, Wash.
- W8—F. W. Allen, W8GER, 324 Richmond Ave., Dayton, Ohio.
- W9—Roy W. McCarty, W9KA, 11 South Michigan Ave., Villa Park, Ill.
- VE1—J. E. Roue, VE1FB, 84 Spring Garden Rd., Halifax, N. S.
- VE2—C. W. Skarstedt, VE2DR, 236 Elm Ave., Westmount, P. Q.
- VE3—Bert Knowles, VE3QB, Lanark, Ont.
- VE4—George Behrends, VE4RO, 186 Oakdean Blvd., St. James, Winnipeg, Manitoba.
- VE5—E. H. Cooper, VE5EC, 2024 Carnarvon St., Victoria, B. C.
- K4—F. McCown, K4RJ, Family Court 7, Santurce, Puerto Rico.
- K5—Norman F. Miller, K5AF, 15th Air Base Squadron, Albrook Field, Canal Zone.
- K6—James F. Pa, K6LBH, 1416D Lunalilo St., Honolulu, T. H.
- K7—Leo E. Osterman, K7ENA, Customhouse, Wrangell, Alaska.
- KA—George L. Rickard, KA1GR, P. O. Box 849, Manila, P. I.

56-Mc. Crystal Control with 28-Mc. Crystals

By J. M. Wolfskill,* W8QKT

WITH the development of high-frequency apparatus and the increased activity on the higher frequencies, the demand for greater frequency stability is rapidly increasing. The need for this stability has long been realized, but the difficulty of obtaining it was often so great that it offset the apparent advantages.

Most amateurs on the 56-Mc. band are still using the self-excited type of transmitter with its attendant frequency modulation; a few have graduated to m.o.p.a.; a smaller group is now using crystal control. The interference problem under these conditions is rather acute in the larger cities, and 56-Mc. reception at any great distance is almost impossible. With the development of 56-Mc. superheterodyne receivers, some of this difficulty is eliminated, but most signals are so badly frequency modulated that superheterodyne reception is unintelligible.

Crystal control is obviously the answer to this problem, and while the transition to it has been taking place for some time, it was only recently

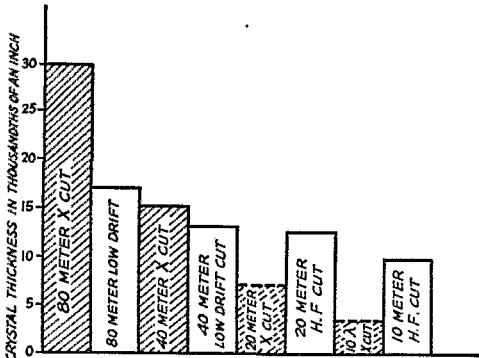

FIG. 1—THICKNESS OF VARIOUS TYPES OF CRYSTAL CUTS

X-Cut crystals for 14 and 28 Mc. are too thin to be practical.

that the many advantages of crystal control at these high frequencies have been fully realized. It is now a well-established fact, proven in numerous tests, that greater distance and more reliable communication is possible with a given amount of power through the use of crystal control. The two most obvious reasons for this are: First, the concentration of carrier power on a single frequency has the result of increasing the transmitter's effectiveness several times over that of a self-excited modulated oscillator of equal power output; and second, the more sensitive and selective super-

heterodyne receiver can be effectively employed. Crystal control on 56 Mc. is no longer a luxury but a necessity, and with the recent developments in high-frequency quartz crystals, it is as easily attained as on 7 or 14 Mc.

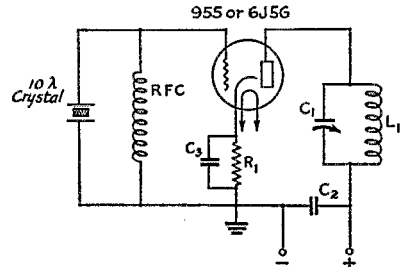

FIG. 2—TRIODE CRYSTAL OSCILLATOR CIRCUIT RECOMMENDED FOR 28-MC. CRYSTALS

L₁—8 turns No. 12 wire, 3/4-inch diameter, turns spaced diameter of wire.

C₁—75-μfd. variable.

C₂, C₃—0.005-μfd. mica.

R₁—200-ohm carbon.

RFC—2.5-mh. r.f. choke (National or Hammarlund).

Plate voltage should be 180 for the 955, 220 for the 6J5G.

The discovery of the principle of harmonic operation and the methods of processing the crystal to accentuate this type of vibration, made possible the development of the HF2 20-meter crystal about two years ago.¹ It not only made possible this unit, but was the forerunner to practical higher-frequency crystals. Working further on this principle to develop a 10-meter crystal, another angle was found which possessed the necessary high activity for harmonic operation, and at the same time had a thickness coefficient sufficiently high to make 10-meter crystals of practical thickness. The new crystal which is cut at this angle has a drift of plus 43 cycles per megacycle per degree C., and will safely carry an r.f. current of 200 milliamperes before objectionable heating results. The scale diagram of Fig. 1 shows the relative thickness of the HF2 10-meter crystal compared to 20-, 40- and 80-meter crystals. Comparison is also made to X-cut thicknesses, the dotted cross-hatching showing that X-cuts in these frequency ranges are impractical.

The new 28-Mc. unit makes 56-Mc. crystal control so simple that it can readily be used in portable and mobile equipment. Even a single low-power tube such as the RK34 can be used, and with the resultant concentration of power on a single frequency, it will have an effective range

¹ J. M. Wolfskill, "Oscillators Using 14-Mc. Quartz Crystals," *QST*, December, 1935.

* Bliley Electric Co., Erie, Pa.

equivalent to a 10- to 15-watt self-excited transmitter.²

OSCILLATOR CONDITIONS

The problem of developing crystals for use at 28 Mc. involved not only the crystal itself, but also the selection of tubes which had the proper characteristics for efficient crystal performance at these high frequencies. Many types of tubes

shown in the circuit diagram. The output on 5 meters with the 802 is 2½ watts, and with the RK23 3½ watts. Slightly greater output can be obtained by using 45 volts positive on the suppressor grid. Beam-power tubes (6L6 and 6L6G) are not recommended for Tri-tet operation because of poor internal screening and tendency towards self-oscillation.

In the design of a high-frequency transmitter, careful consideration should be given to the general layout and construction, and parts being so arranged as to facilitate short direct leads and at the same time to permit maximum shielding and isolating of individual circuits. Grounds should be short and tied to a common bus, and the bus should be strapped to one point on the chassis to prevent closed loops and circulating currents in the ground system. All variable condensers must of necessity be mounted above ground to eliminate the need for a mica condenser in series with the tank circuit. Even low-loss mica condensers introduce considerable loss at the higher frequencies, when required to carry the high circulating tank current. Parallel feed should not be used, at least in the crystal oscillator, because of the difficulty of getting a good choke at these frequencies.

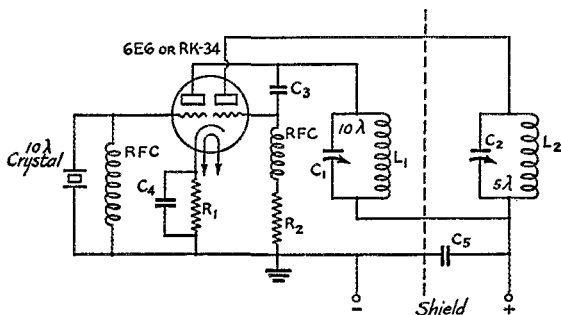

FIG. 3—DUAL-TRIODE OSCILLATOR-DOUBLER FOR 56-MC. OUTPUT

- L₁—6 turns No. 12, diameter ¾ inch, spacing equal to wire thickness.
 - L₂—4 turns No. 12, diameter ¾ inch; spacing twice wire diameter.
 - C₁—75-μfd. variable.
 - C₂—35-μfd. variable.
 - C₃—100-μfd. mica.
 - C₄, C₅—0.005-μfd. mica.
 - R₁—400 ohms.
 - R₂—30,000 ohms.
 - RFC—2.5-mh. r.f. choke (National or Hammarlund).
- Plate voltage for 6E6, 300; for RK34, 325.

tested were found to have such high input capacities that the crystal was effectively shorted out. Others having low feedback capacity and large electrode spacing were equally unsatisfactory. This was especially true of the high-μ and pentode types; pentodes in general are not to be recommended, although good output was obtained with several used in Tri-tet circuits. Best results, however, were secured with some of the newer high-frequency triodes such as the 955, 6J5G, 6E6, and RK34.

Standard triode crystal oscillator circuits are shown in Figs. 2 and 3. The 955 and 6J5G in Fig. 2 are excellent oscillators, giving 1¼ and 2½ watts output respectively on 28 Mc. The 6J5G is to be preferred because of its higher output and lower cost, but either tube will give sufficient output at 28 Mc., in the circuit shown, to drive an 802, RK23, 807, RK39, or 6L6 tube as a doubler. The dual triode circuit shown in Fig. 3 can be used either with the 6E6 or RK34, giving respective outputs of 3 and 3½ watts on 5 meters from the second section acting as a doubler.

Tubes used in the Tri-tet circuit shown in Fig. 4 which gave good output on 5 meters are the 802 and RK23. The coil sizes and circuit constants are

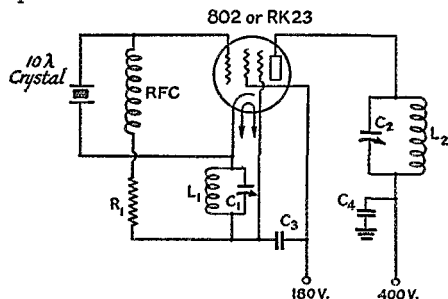
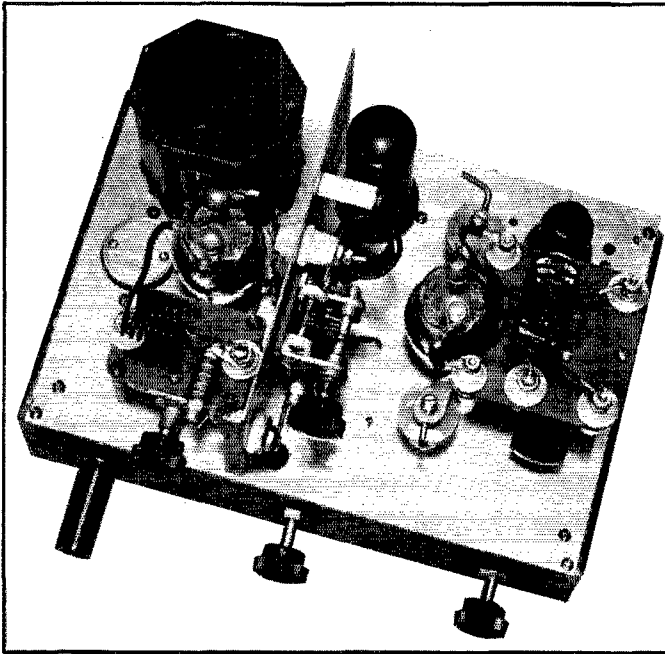

FIG. 4—TRI-TET OSCILLATOR-DOUBLER FOR 56-MC. OUTPUT

- L₁—3 turns No. 12, diameter 1 inch, spaced twice wire diameter.
- L₂—4 turns No. 12, diameter ¾ inch, same spacing.
- C₁—75-μfd. variable.
- C₂—35-μfd. variable.
- C₃, C₄—0.01-μfd. mica.
- R₁—30,000-ohm carbon.
- RFC—2.5-mh. r.f. choke (National or Hammarlund).

Because of the low plate impedance of the triodes used in these circuits, a high-C tank should be used for maximum output. The output is not only increased by doing this, but the stability of the circuit is greatly improved. In fact, pentode stability is approached with the proper circuit constants. This consideration also applies to the cathode or oscillator tank of the Tri-tet circuit, inasmuch as the oscillating portion is essentially a triode. The circuit constants and coil sizes should therefore be adhered to as closely as possible since these have been found to give best results.

² Harry Gardner, "A Simple Breadboard Crystal-Controlled Transmitter for 56 Mc.," *QST*, July, 1937.



AN 18-WATT CRYSTAL-CONTROLLED 56-MC. 'PHONE TRANSMITTER
Two RK34's, with a 28-Mc. crystal, are used in the r.f. section; the audio end consists of a 6C5 and 6L6.

PRACTICAL TRANSMITTERS

The simplicity and ease with which a crystal-controlled 56-Mc. transmitter can be built by using a 28-Mc. crystal is readily apparent from the description of the two rigs given here. About the only restriction in the design of such a transmitter is the limited choice of tubes to be used for the crystal

oscillator. Practically any combination can be used thereafter so long as high-frequency design considerations are followed. The two transmitters to be described here are commendable because of their outstanding performance and higher power output with the small number of tubes used.

Fig. 5 shows the schematic of a portable 18-watt 56-Mc. crystal-controlled transmitter using two RK34's in the r.f. end, with a 6C5 speech amplifier and a 6L6 modulator. The first RK34 acts as the crystal oscillator and doubler, and the second as a push-pull amplifier. The crystal oscillator tank is mounted on the left side of the shield in the photograph, the 56-Mc. doubler tank on the opposite side. The grid tank to the second RK34 is mounted below the sub-base close to the grid prongs, and the final tank above the sub-base on stand-offs close to the plate leads of the tube. This placement of tank circuits makes extremely short r.f. leads. The small neutralizing condensers are mounted on either side of the final tube, the discs being 1 inch in diameter and

- C₁—50- μ fd. variable.
- C₂—35- μ fd. variable.
- C₃, C₄—See text.
- C₅, C₆—0.006- μ fd. mica.
- C₇—200- μ fd. mica.
- C₈, C₉—Special neutralizing condensers, approx. 3 μ fd. See text.
- C₁₀—1 μ fd.
- C₁₁—0.05- μ fd. paper.
- C₁₂, C₁₃—10- μ fd. 35-volt electrolytic.
- C₁₄—0.1- μ fd. paper.
- RFC—2.5-mh. r.f. choke (National or Hammarlund).
- R₁—300-ohm carbon, 2-watt.
- R₂—30,000-ohm.
- R₃—4000-ohm.
- R₄—500,000-ohm potentiometer
- R₅—50,000-ohm.
- R₆—15,000-ohm.
- R₇—500,000-ohm.
- R₈—350-ohm, 10-watt.
- R₉—25,000-ohm carbon.
- R₁₀—2500-ohm, 1 watt carbon.
- T₁—Single button microphone transformer.
- T₂—Output transformer (UTC Type VMO).

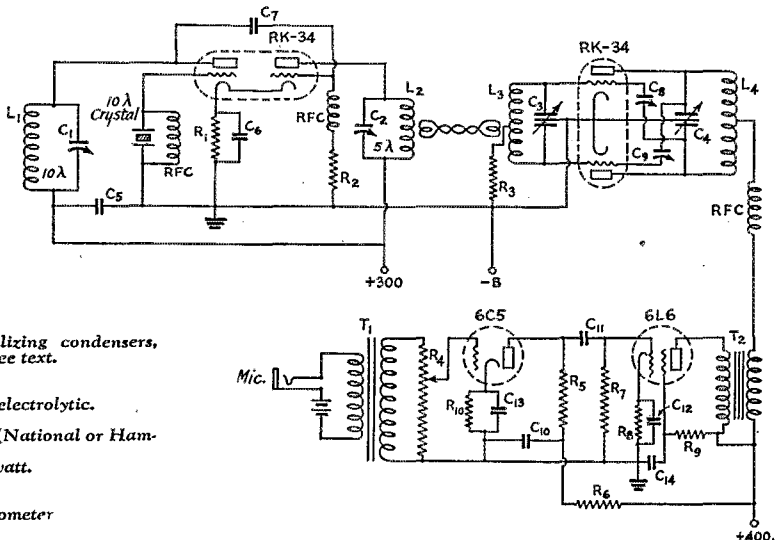

FIG. 5—CIRCUIT DIAGRAM OF THE 18-WATT 56-MC. 'PHONE TRANSMITTER

- L₁—7 turns No. 12, single-spaced, 3/4-inch diameter.
- L₂—5 turns No. 12, triple-spaced, 3/4-inch diameter.
- L₃—6 turns No. 12, triple-spaced, 3/4-inch diameter.
- L₄—10 turns, c.t., double-spaced, 3/4-inch diameter.

spaced about $\frac{1}{8}$ inch when neutralized. These condensers are of special construction to conserve space; however, standard neutralizing condensers can be used. All coil sizes and element values are given in the diagram with the exception of C_3 and C_4 . These condensers were altered slightly to reduce the capacity, since no small split-stator condensers were commercially available. The grid condenser, C_3 , was a single-section single-spaced 7-plate Hammarlund. C_4 was a single-section double-spaced, 9-plate 35 μfd . Hammarlund. The mounting lugs on both these condensers were first securely fastened to metal mounting strips, and the side bars on the stator cut in two. This then gave split-stator condensers with about 15 μfd . per section.

The total plate current drawn by both r.f. tubes when delivering full output is 150 milliamperes, 70 ma. for the crystal oscillator and doubler and 80 ma. for the final amplifier. The heater voltage on these tubes is rather critical, and for proper performance, should be 6.3 volts at the socket. One hundred per cent modulation of the 18 watts r.f. is readily obtained with the 6L6, working as a Class-A amplifier.

A 60-WATT TRANSMITTER

Fig. 6 shows the circuit diagram and photo of

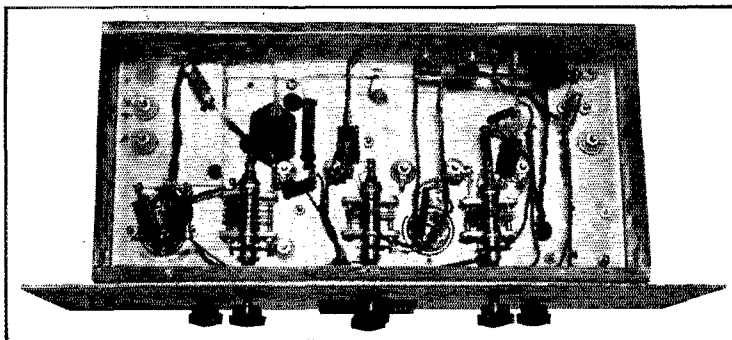

BELOW-CHASSIS VIEW OF THE 60-WATT TRANSMITTER

The tuning condensers mounted below the base are those for the 6L6 grid and plate, and the 35T grid. All circuits are link-coupled.

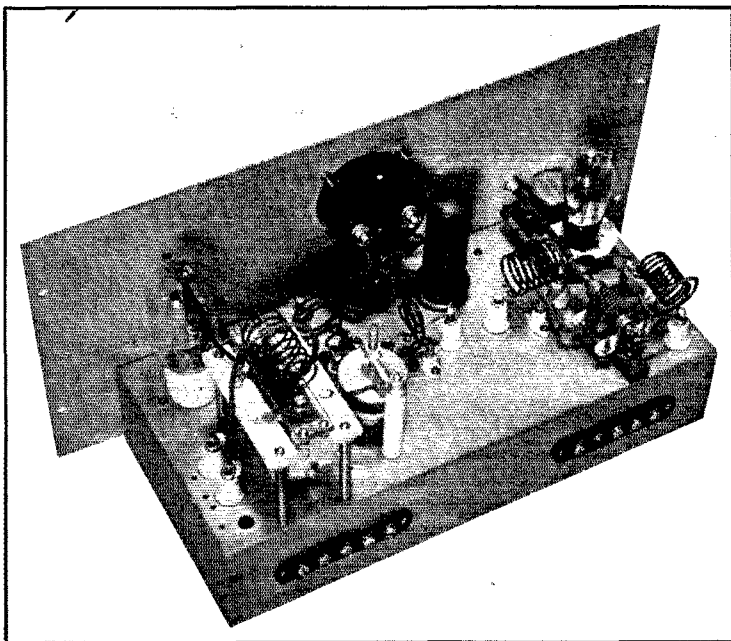

THREE-STAGE 60-WATT OUTPUT 56-MC. CRYSTAL-CONTROLLED TRANSMITTER

Oscillator, 6J5G with 28-Mc. crystal; doubler, 6L6, final amplifier, 35T. This transmitter can be modulated 100% with 100 watts input.

a 60-watt transmitter consisting of a 6J5G as the 28-Mc. crystal oscillator driving a 6L6 tube as the doubler; the output from the 6L6 drives a 35T. Link coupling is used throughout on this transmitter, and about the only precaution to be taken in the tuning is to see that the 6L6 is not too closely coupled to the oscillator. As this tube is easily overdriven, its output will suffer considerably with excessive coupling to the oscillator.

Capacity coupling between tubes was tried in an attempt to decrease the number of tank circuits, but as considerable difficulty was experienced in obtaining proper excitation, link coupling was finally chosen. Under these conditions the 6L6 furnishes ample drive for the 35T. Other tubes tried in place of the 6L6 which gave about the same output included the RK39 and 807.

Neutralization of the 35T presented no problem and all other adjustments were straightforward. The transmitter is metered by a single 0-1 milliamper instrument.

ment, switched across suitable shunts in the grid and plate circuits by means of a 2-circuit 5-position Yaxley switch. Input to the final stage is 100 ma. at 1000 volts with 60 watts output. Plate modulation is used for the final from a Class-B modulating system using TZ20's and 2A3 drivers.

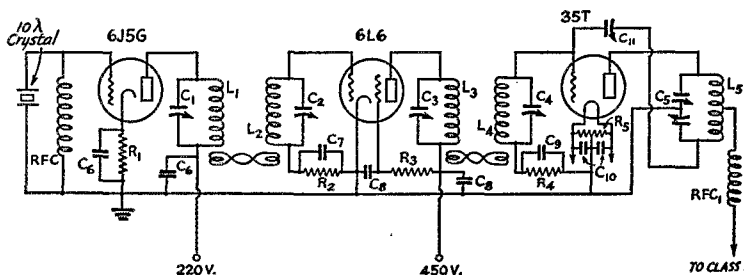

FIG. 6—CIRCUIT DIAGRAM OF THE THREE-STAGE 60-WATT OUTPUT TRANSMITTER

- L1—8 turns No. 12 wire, single-spaced, 3/4-inch diameter.
- L2—7 turns No. 12, single-spaced, 1-inch diameter.
- L3—2 turns No. 12, double-spaced, 1-inch diameter.
- L4—2 turns No. 12, double-spaced, 1-inch diameter.
- L5—6 turns No. 12, center-tapped, single-spaced, 1-inch diameter.
- C1—75- μ fd. variable.
- C2, C3, C4—35- μ fd. variables.
- C5—Split-stator, 35- μ fd. per section (Cardwell).
- C6—0.001- μ fd. mica.
- C7, C8—0.01- μ fd. mica.
- C9—0.002- μ fd. mica.
- C10—0.001- μ fd. mica.
- C11—Neutralizing condenser (National NC-800).
- R1—200-ohm carbon, 1-watt.
- R2—100,000-ohm carbon, 1-watt.
- R3—15,000-ohm wire-wound, 10-watt.
- R4—2500-ohm wire-wound, 10-watt.
- RFC—2.5-mh. r.f. choke (National or Hammarlund).

This transmitter has been in operation for several months, and results were exceptionally good, especially when compared to self-excited transmitters working at the same location.

The results of experiments on five meters with crystal-controlled transmitters of both high and low power, definitely prove that crystal-controlled signals are just about the answer to good 56-Mc. DX.

Silent Keys

It is with deep regret that we record the passing of these amateurs:

- Kenneth Anderson, Moline, Ill.
- George E. Monroe, W1JWR, Auburn, Me.
- B. C. Olson, W8BVG, Erie, Pa.
- Max J. Paulik, OK1XW, Praha-Hloubetin, Czechoslovakia
- Lloyd E. Roath, W7GJA, Coeur d'Alene, Idaho
- Earle L. Tooker, W6HVT, Lemon Grove, Calif.

Corrections

IN the article "Designing the First Stage of the Speech Amplifier" in December QST, the plate bypass condenser (C4) was omitted from Fig. 1 on page 34. It should be connected between ground and the junction of R4, R5 and R6.

In "Hints and Kinks," page 44, Fig. 1, there should be no connection between the bottom of R7 and the 56 cathode. This resistor goes directly from the cathode to the switch. Incidentally, there is no R4 in the diagram; this designation should be ignored in the list of parts.

In the same issue, page 24, fifteen lines up from the bottom in the left-hand column, the reference to condenser C should read "C6."

CHRISTMAS

Greetings

TO ALL HAMS

*from the Crew
at Headquarters*

Strays

A BCL aspiring to enter the amateur transmitting ranks recently wrote us asking if it were true that all amateurs must operate on spark for one year before being permitted to operate 'phone. He added that he thought it a good idea because he had observed that 'phone signals take up much more space than spark signals!

Speaking of ideal locations, W9YBV thinks that W9UWW rates pretty well—he lives on Signal Hill, East St. Louis. If height means anything, though, W4LU on Signal Mountain, Tenn., ought to be tops. All of which leads us to wonder whether San Francisco's Telegraph Hill is good only for c.w., as the name implies!

W9TWC and W9RFA have partially licked the QRM problem on 7001 kc. They zero-beat their crystal oscillators and, keying the oscillator, have perfect break-in operation. Going the break-in boys one better, however, they alternate words of a QSO or CQ. This procedure actually sounds like one station in operation, and has proved to be a novel way of breaking the monotony of ordinary QSO's.

Circuit Elements in Modern Television Reception

An Outline of Basic Circuit Considerations in the Video Receiver*

By Marshall P. Wilder,** W2KJL

IN the first article of this series the basic principles of modern television technique were, discussed with particular emphasis on the character of the transmitted signal. The signal is, of course, an extremely complex affair and though one need not know at this stage exactly how it is transmitted one must have a clear concept of what it is like before attempting to understand how it is unscrambled in the receiver and eventually caused to produce the final picture. In addition to the general make-up of the transmitted signal one must have clearly fixed in mind the fact that it contains modulation frequencies as high as 2.5 megacycles. Since the receiver must pass frequencies up to this extremely high value, its circuit and values will differ very widely from the conventional sound receiver in which one is happy enough to pass frequencies up to 4000 or 5000 cycles.

this converter is then fed to a four-stage i.f. amplifier operating in the region of 10 Mc. This i.f. amplifier must pass a band of frequencies at least 2.5 Mc. wide and this requirement in practice means that very low stage gain will have to be tolerated. From the i.f. amplifier the signal is fed to a diode second detector (without automatic volume control) and from there to a two-stage video amplifier—this being the counterpart of the audio amplifier in a conventional receiver. The signal at this stage is the complete modulation which was impressed on the original carrier. It is, at this point, available for application to the control grid on the cathode-ray tube, to the d.c. restoring circuit and to the synchronizing impulse separator. The sound receiver which would ordinarily accompany this picture receiver may well be a conventional converter feeding a broadcast receiver serving as an i.f. amplifier.

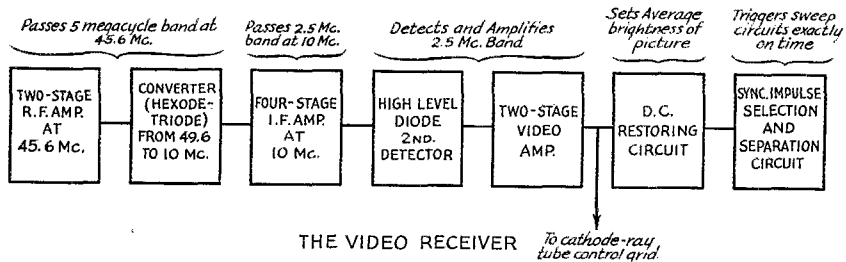

FIG. 1—THE GENERAL LAY-OUT OF A TYPICAL TELEVISION RECEIVER

These component sections comprise only the vision or video receiver. The companion sound receiver, for experimental work, might well be an entirely separate superhet of conventional design. The band widths given are required for maximum detail in the picture. The effect of any reduction from these figures results in restricted picture detail.

At this time we shall discuss the various circuits of a typical modern television receiver with the idea of clarifying the process involved in reassembling the transmitted pictures. The receiver through which we will follow the signal is outlined in Fig. 1. It is a superheterodyne with one or more r.f. stages ahead of the mixer unit in which conventional tubes may be used. As a mixer, a new type of hexode or heptode-triode may be used to advantage. The i.f. output from

For the time being our attention will be concentrated on the picture receiver alone.

We shall now follow the television from the antenna post through the receiver describing, as we go, typical circuits which could be used to perform the various functions. Later we will consider circuit values and their effects. We shall assume a carrier frequency of 45.6 Mc. The behavior of this signal in the r.f. amplifier is what one would ordinarily find in a conventional input amplifier except that the entire band of 5 Mc. occupied by the signal must be passed. This calls for tuned circuits which are heavily loaded with resistance and hence means considerably lower gain than is possible in r.f. amplifiers with which

* Fundamentals of scanning and the make-up of the transmitted television signal were treated by Mr. Wilder in last month's issue.

** National Union Radio Corp., 57 State St., Newark, N. J.

we are already familiar. The band to be passed, it might be mentioned, is a thousand times wider than that passed in a modern high-fidelity b.c.l. receiver. With tubes of the 6D6 type in an amplifier similar to that shown in Fig. 2 one could expect a gain of about 2. Tubes with a much higher transconductance and with low input and output capacities would permit considerably

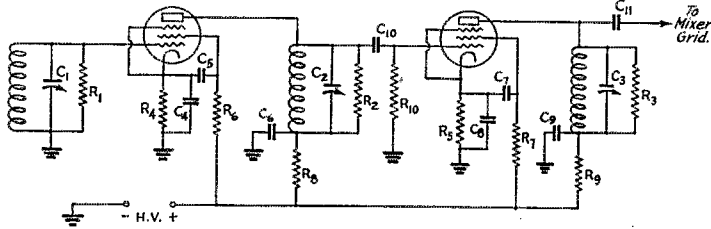

FIG. 2—A PAIR OF TYPICAL R.F. AMPLIFIERS FOR THE VIDEO RECEIVER

- R₁, R₂, R₃—1000 ohms.
- R₄, R₅—To suit tubes used. About 350 ohms for 6K7G.
- R₆, R₇, R₁₀—50,000 ohms.
- R₈, R₉—1000 ohms.
- C₁, C₂, C₃—5 to 40- μ fd. tuning condensers—depending on tuning range desired.
- C₄ to C₆—0.01- μ fd. paper condensers.
- C₁₀, C₁₁—100- μ fd. mica.
- The inductances for the tuning circuits naturally depend on the frequencies to be covered. Ten turns $\frac{1}{2}$ -inch diameter of No. 14 about right for 45-Mc. region.

more gain. Such tubes will probably be available in the early future.

The converter section into which this r.f. amplifier feeds is shown in Fig. 3. This particular arrangement is one based on a new tube, soon to be available from several manufacturers. This tube is a hexode-triode with the triode-section obtaining its emission from an independent portion of the cathode. It is more suitable for this particular service than the conventional mixers but successful operation can be had with, for instance, a 6K7 and a separate oscillator tube. Since the intermediate frequency amplifiers are to be on about 10 Mc., the oscillator will be made to run 10 Mc. higher in frequency than the signal—that is, 55.6 Mc.

The intermediate-frequency amplifier into which this mixer feeds may consist of four stages, each arranged in the manner shown in Fig. 4. This amplifier must pass a band at least 2.5 Mc. wide and the necessary resistance loading across the transformer windings and the design of the transformers themselves inevitably results in relatively low gain. Here again, new tubes with very high transconductance and low input and output capacity are of great benefit in permitting higher amplification. The i.f. amplifier circuit can be seen to be conventional in all respects except in the use of loading resistors across the transformer windings.

Fig. 5 shows the continuation of the circuit from the last i.f. transformer. This transformer feeds a diode second detector and here again a

special tube is called for if optimum performance is demanded. The ideal diode would have an internal resistance as low as 150 ohms. Such a low resistance is made desirable because the load resistance must be of a low value (say, 7500 ohms). This low load resistance is required to reduce the by-passing effect of the capacity of the diode elements which tends to eliminate the higher video frequencies.

The diode detector plate is seen to be connected directly to the grid of the first video stage, this tube and the second video amplifier following again being preferably high-transconductance pentodes similar to those indicated for the r.f. and i.f. amplifier.

In order to amplify the full video frequency band with constant amplitude and with minimum phase shift (the latter consideration to be discussed further), it is necessary to use a low value of plate resistance across the tube. In addition, there must be an inductance of the right value in series with the plate resistance to aid in maintaining the desired amplification at the higher video frequencies. When this inductance and the plate resistor are of the correct value, phase shift is negligible.¹ In this video amplifier, shown in Fig. 6, it will be seen that relatively enormous by-pass condensers are used and that decoupling resistors are incorporated wherever possible.

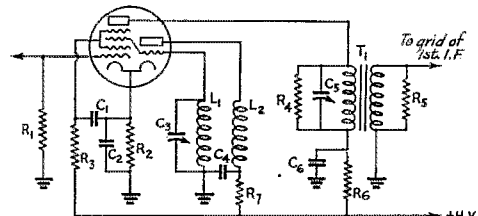

FIG. 3—THE GENERAL ARRANGEMENT OF A HEXODE-TRIODE CONVERTER

- R₁, R₃, R₇—50,000 ohms.
- R₂—To give suitable bias for tube used.
- R₄, R₅, R₆—2000 ohms.
- C₁, C₂, C₄, C₆—0.01- μ fd. paper.
- C₃—10 to 50 μ fd.
- C₅—i.f. trimmer.
- T₁—Special i.f. transformer such as Aladdin Type U100.
- L₁, L₂—Suited for frequency range desired. Eight turns of No. 14 $\frac{1}{2}$ inch diameter would serve for 45-Mc. region.

Single by-pass condensers are indicated on the diagram but in practice it is usually necessary to provide smaller mica-type condensers in parallel with the large units to take care of the higher frequencies. This amplifier must be substantially flat to at least 2.5 Mc. if the full amount of picture detail is to be retained.

The plate of the final video stage is now

¹ "Television," Vol. II, (RCA Institutes Technical Press), Kimball & Seelye, Video Amplifier Design.

capacity-coupled to the cathode-ray tube control grid. Also connected to this grid is the cathode of a diode (preferably of low resistance and low capacity) and across the diode is a resistance of, say, 25,000 ohms. This diode is the heart of the d.c. restorer. Resistor and capacity values in this part of the circuit are of considerable importance and will be discussed in more detail later.

Also connected to the cathode-ray tube grid as shown in Fig. 7, is a triode amplifier feeding the two diodes which form the basis of the synchronizing impulse separator circuit. This triode serves to provide some extra amplitude before undertaking the synchronizing impulse separation and also avoids loading the d.c. restoring circuit. The diode which has its plate connected to the triode plate is so arranged that its cathode is sufficiently positive to prevent any current flow unless the plate is driven back far enough positive. This will only happen on the peak of the signal and as the peaks are the synchronizing impulses, only the synchronizing impulses will pass through this diode—the video signal being excluded.

The high-frequency pulses will appear across the load resistor R_8 and can be applied through C_7 to the high-frequency sweep circuit. Connected across the load resistor is a condenser C_9 which provides an RC circuit serving as a frequency selection or integrating circuit. When the frame synchronizing pulse comes along, the frequency of the synchronizing impulses double and in the serrated portion of the frame synchronizing impulse the charge in the RC circuit R_{13}, C_8 gathers too rapidly for the resistor to discharge the condenser between pulses. Hence the voltage across

R_8 is built up to the point where the plate of the second diode becomes positive with respect to its cathode and current flows through the second diode loading resistor, R_{14} . The resulting low-frequency pulse is then made available through C_4 for the synchronizing of the low-frequency

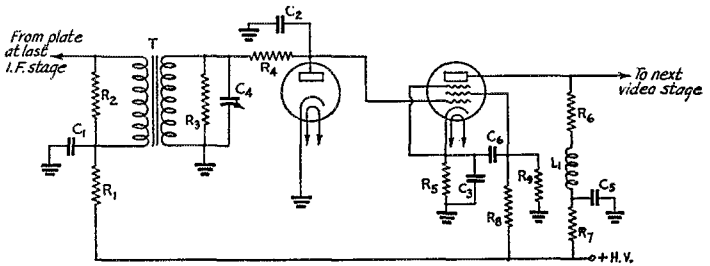

FIG. 5—SHOWING THE DIODE SECOND DETECTOR AND THE FIRST VIDEO FREQUENCY AMPLIFIER

- R_1 —1000 ohms.
 R_2, R_3 —2000 ohms.
 R_4 —7000 ohms.
 R_5 —Suited for tube used—1500 ohms for 6J7G.
 R_6 —3000 ohms.
 R_7 —75,000 ohms.
 R_8, R_9 —To suit tube used. With 6J7G, R_8 could be 250,000 ohms and R_9 eliminated.
- C_1 —0.01- μ fd. paper.
 C_2 —5 μ fd.
 C_3 —50 μ fd.
 C_4 —i.f. trimmer.
 C_5 —2.5 μ fd.
 C_6 —8- μ fd. electrolytic by-passed by 0.01- μ fd. mica.
T—Final i.f. transformer.

sweep. The second diode is prevented from passing current during the high-frequency pulses by having its cathode connected through R_{10} to a point of slightly greater positive potential than that to which the first diode is connected. To reiterate, the high-frequency pulses are of just sufficient amplitude to carry the plate of the first diode sufficiently positive to permit current flow, the resulting drop across R_8 then being made available for synchronizing purposes. When the frame or low-frequency synchronizing impulse arrives and the signal has been integrated in the RC circuit comprising R_8 and C_9 the plate of the second diode will be driven sufficiently positive at this time, and at this time only, so that current will flow through its circuit and the voltage across R_9 be made available for synchronizing.

Now that we have some concept of the various sections into which a television receiver can be divided and the functions of these sections it would be well to proceed with an examination of the values of resistance, capacity and inductance used in the circuit which, together with the characteristics of the tubes used, have such an influence on the performance.

To return to the r.f. amplifier given in Fig. 2, and later to the other sections of the circuit, it will be interesting to outline those features which demand special consideration

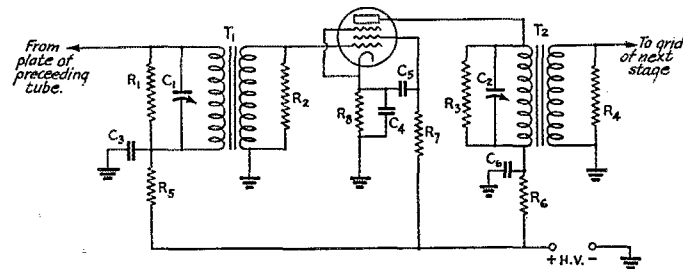

FIG. 4—THE CIRCUIT OF A SATISFACTORY I.F. STAGE

- R_1 to R_4 —2000 ohms.
 R_5, R_6 —1000 ohms.
 R_7 —50,000 ohms.
 R_8 —To suit tube used—350 ohms for 6K7G.
- C_1, C_2 —i.f. trimmers.
 C_3 to C_6 —0.01- μ fd. paper condensers.
 T_1, T_2 —Special i.f. transformers.

and to note the differences between these circuits and those utilized in conventional sound receivers. Firstly, there is no subtle consideration that demands two r.f. circuits. A single stage could serve—the only result being slightly less r.f. gain.

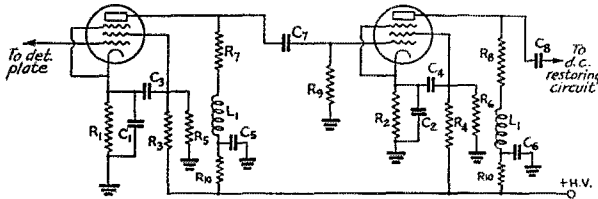

FIG. 6—THE CIRCUIT OF A REPRESENTATIVE TWO-STAGE VIDEO FREQUENCY AMPLIFIER

- R1, R2—To suit tubes used. See previous mention of cathode resistors.
- R3 to R6—See screen dropping resistor of Fig. 5.
- R7, R8—3000 ohms.
- R9—1 megohm.
- C1, C2—50- μ fd. 25- or 50-volt electrolytics.
- C3, C4—8 μ fd.
- C5, C6—2.5 μ fd.
- C7—0.01 μ fd.
- C8—0.03 μ fd.

On the other hand, the receiver might not be of the superheterodyne type and could consist of four or five r.f. stages, feeding the detector directly. With conventional tubes, the values of cathode resistor, screen resistor, decoupling resistors and by-pass condensers will be similar to the usual sound receiver. The only essential difference is in the use of loading resistors across the tuned circuits to provide the necessary wide-band acceptance. As in the remainder of the receiver, the pentode tubes used are of considerable importance and such tubes as the 6D6 or 6K7 are rather limited in their performance. Really suitable tubes for the work would have a transconductance of better than 8000 and the sum of the input and output capacities of the order of 20 μ fd. With such a tube it is possible to obtain a gain of four or five in each r.f. stage as against a gain of 2 with conventional tubes.

We have already mentioned the desirability of a hexode-triode in the converter as shown in Fig. 3. Should a conventional converter be used for preliminary experiment, there would be no essential differences in circuit values to those used for sound reception.

To proceed to the i.f. amplifier, we find the most important feature to be the use of a relatively high intermediate frequency. Special transformers such as the Aladdin type U200 and U100

are suitable. Both the primary and secondary windings must be loaded with sufficient resistance to give the necessary wide band pass. In other respects, the i.f. amplifier, with its by-passing and decoupling is similar to normal practice.

It is at and beyond the second detector that circuit values become unconventional and in many cases critical. Very special attention must be given to the reduction of phase distortion. This type of distortion is not considered of great consequence in ordinary receiving equipment because of the ear's inability to recognize it. The meaning and effect of phase shift is unfamiliar to many of us so it is perhaps best to explain the difficulties which arise if it is present. The difficulties result from any phase shift which is not the same at all frequencies being passed. This means that certain frequencies may arrive at the grid of the cathode-ray tube earlier and other frequencies may arise later than they would if the shift were absent. This would result in some picture elements being displaced and would mean that the edges or outlines of objects may be turned black where they should be light, or even displaced from right to left as much as 8 or ten picture elements. To take as an example a profile

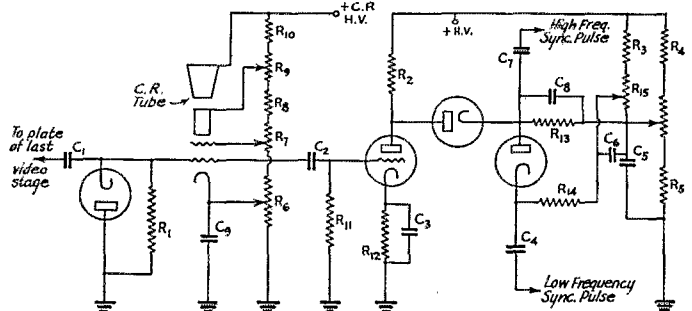

FIG. 7—ONE PRACTICAL ARRANGEMENT OF THE D.C. RESTORING, SYNCHRONIZING SEPARATION AND SELECTION AND C.R. TUBE CIRCUITS

- R1 to R5—25,000 ohms.
- R6—50,000 ohms.
- R7—100,000 ohms.
- R8—500,000 ohms.
- R9—100,000 ohms.
- R10—2 megohms.
- R11—1 megohm.
- R12—To suit tube used. Variable 50,000 ohms suggested.
- R13—15,000 ohms.
- R14—1000 ohms.
- R15—2500 ohms.
- R16—30,000 ohms.
- C1—0.03 μ fd.
- C2—.01 μ fd.
- C3—8 μ fd.
- C4, C5, C6—1 μ fd.
- C7—.0001 μ fd.
- C8—0.0015 μ fd.
- C9—50 μ fd.

of a face, one might find part of the nose moved four or five or perhaps several dozen picture elements to the left or right, a similar displacement throughout the image resulting in very bad distortion. It is not necessary that there be no phase shift. In fact, each stage of a video amplifier should cause a phase shift of 180 degrees. So long as this shift is proportional to frequency, no difficulty will arise. Phase shift can be caused

(Continued on page 68)

The Strongheart Boys in the Pacific

Or

Amateur Wireless to the Rescue

PROLOGUE: The two Strongheart Boys, Horace and Clarence, on an attempted flight to the South Pole, have been forced down on a small island in the South Pacific. Their plane has sunk, but the two daring boys have swum ashore with an all-wave receiver, an all-wave transmitter (minus power supply), a case containing 1502 flashlight cells, provisions for two years and various other things which will be later mentioned. (When anything is described which has not been previously explained, the reader is to assume that it was also brought ashore.)

* * * *

"Ah me," blithely exclaimed Horace, "a pretty pass we have come to, Clarence."

"Not so," said that worthy, his handsome features fixed (as they always are) in a determined expression. "We will yet escape from our perilous plight."

"But how, dear brother?" asked the former, removing the 203A from the transmitter and playfully tapping the glass with a hammer. (As to hammer, reader refer to prologue.)

"Remember the time we were marooned in Madagascar?" (See "Strongheart Boys at the Sesquicentennial.")

"Of course, of course," said Horace excitedly, "the radio will save us. Even if our plane has failed us, due no doubt to the trickery of that bully Sam Snodgrass, radio will save us."

"Quick, then," exclaimed Clarence, "we must lose no time."

"But Clarence," protested Horace, "we have no power supply."

"Ah hah," said the former, "yes we have. Take the burning iron and connect those flashlight cells together."

Horace took the iron and in short time had the cells all neatly soldered together. Just in time, as when he put the iron down he espied the smoke of a distant ship.

"Clarence, Clarence, we are saved. I see a ship. Quick, hook up the rig and give him a buzz."

Clarence sorrowfully shook his head.

"Courage, brother, I cannot call him."

"Why not?"

"My license expires to-day or to-morrow and I can't remember which."

"Then we are lost."

"Not so. Amateur radio will, yes, must save us."

In short order the two brothers connected the batteries to the transmitter. Horace, holding a

burning glass in his hand, focussed the sun's rays on the filament of the 203A. The brilliant sun heated the filament to incandescence. Clarence pressed the key, and then quickly released it. Horace spoke.

"What is it, brother?"

"The plate current is one mil too high."

"What can it be?"

Clarence thought hard and then snapped his fingers.

"Of course. There are too many flashlight cells. There are fifteen hundred and two. That makes the plate voltage 2253, and the *Handbook* says 2250 is the maximum voltage."

The offending cells were removed and the rig again tried. It worked to perfection. Quickly they tuned it into the band with shaking fingers and called CQ. Upon tuning the receiver they heard an answer.

"Saved," said Clarence, "saved by amateur radio."

Again turning on the rig he called the station that just called. Explaining at length their predicament, he asked for help.

"What does he say, Clarence?" asks Horace anxiously.

Clarence turned with woebegone expression.

"He wants to know our Q.R.A."

"Call him again. Tell him we're desperate. Tell him we have food for only two years."

Again Clarence sent forth his plea. Again they listened.

"What does he say?"

"He wants to know if we can hear any DX."

"Tell him again. He must understand, surely amateur radio will not fail us."

Again they sent and again they listened.

"Tell me, Clarence, what does he say?"

"He says 'Please QSL.'"

"It's no use, Clarence. The fates are against us, also the batteries are getting low. Send out an SOS."

With trembling hands Clarence, fighting against time, sent the desperate appeal. As he thumped the last letter the batteries died.

* * * *

Two weeks have elapsed. The brothers are sitting on the sand munching chicken sandwiches when the sound of an airplane is heard. Horace springs to his feet.

"Clarence, Clarence, we are saved."

"Truly, dear brother, as I said, amateur radio has triumphed."

(Continued on page 37)

● ARMY-AMATEUR RADIO SYSTEM ACTIVITIES ●

Around the Clock With WLM

In a remote corner of the War Department Message Center in Washington is located W3CXL-WLM. Its big brother, Station WAR, is in the same room. WAR is known as the solar plexus of the War Department Radio Net. W3CXL-WLM might be termed the nerve center of the Army-Amateur Radio System. The same standards of efficiency required of WAR are also required of W3CXL-WLM. Substantially the same message form and methods of operation are used. There are two transmitters, one on eighty meters, using 500 watts, and one on forty meters, using 900 watts. The transmitters are located at Fort Myer, Virginia, and operated by remote control. A gasoline-electric generator is available for emergency power. The receivers consist of an R.C.A. ACR-175, and two Comet Pro's. A gasoline-electric generator is also available at the operating point for emergency power.

The operation of an amateur station is generally thought of as a hobby with no specific time arranged to get on the air. However, the principle means of training in the Army-Amateur Radio System is the handling of traffic according to Army methods. In order to handle traffic efficiently, regular schedules must be maintained. As most members of the A.A.R.S. operate their stations "in addition to their other duties," there must be a key station that can be contacted each and every day at the appointed time. This duty has fallen principally on W3CXL-WLM.

Two qualified operators are usually assigned to the station. Tricks have to be arranged to run the station and to do the office work incident to the administration of the Army-Amateur Radio System.

One operator comes on duty at 8 A.M. He meets a schedule with an overseas relay station, usually W3ANT-WLMO, to take China, Philippine and Hawaiian traffic, received from a Hawaiian station at an early hour in the morning. After this schedule he turns his attention to office work, consisting of keeping records up to date, writing letters, decoding and encoding cryptograms and preparing the monthly bulletin "PDC" for publication. At 4 P.M. he is through, except on one or two nights when alternate stations take over W3CXL-WLM evening schedules. On these nights, he meets the alternate station at 4 P.M. and sends traffic on hand at W3CXL. This normally consists of twenty-five to thirty messages, which are often cleared within an hour.

Stations which have been acting as alternates are W8YA-WLMA and W3NF-WLML.

W3CXL-WLM schedules usually start at 5 P.M. At this time the other operator reports for duty. He meets the following schedules:

Time	Corps Area	Location of Representing Station
5:00 P.M.	I, II, V	Boston, Governors Island, Columbus, O.
6:00 P.M.	III	Baltimore
6:30 P.M.	Panama	Canal Zone (20-meter schedule)
7:00 P.M.	All	(Sends broadcast on Monday nights only)
7:00 P.M.	VI	Kalamazoo, Mich.
7:30 P.M.	IV	Atlanta, Ga.
8:00 P.M.	Panama	Canal Zone (40-meter schedule)
8:30 P.M.	VII	Omaha, Nebr.
9:00 P.M.	VIII	Fort Sam Houston, Texas
9:30 P.M.	I, II, III, V, VI	Westfield, Mass.; Manhasset, N. Y.; Langley Field, Va.; Columbus, Ohio, and Glenellyn, Ill.
10:00 P.M.	All	Broadcast on Monday nights.
10:00 P.M.	IX	Twin Falls, Idaho, or Los Angeles, Cal.
11:00 P.M.	Hawaiian Dept.	Schofield Barracks, T. H.
12:00 M.N.	Any	

The Armistice Day message which is the subject of a corps area competition each year was broadcast by WLM on November 11th. Complete results are not available at this writing. A matter of interest to all amateurs is the fact that this message was copied by a blind amateur using a Braille typewriter. He is Henry Lehman, W4DWI, in Orlando, Florida. The original copy in Braille was forwarded to the Chief Signal Officer. W4DWI actually constructs and maintains his own radio equipment. He asks a friend to describe a circuit to him, including all values, then he builds up the circuit from memory. The result would be a credit to most amateurs with two good eyes. A letter of commendation tran-

(1)	43 WLMA V 19	
(3)		STATCOLLEGE PENNA 400P OCT 22 1937
(5)	MISS LUCILLE MOORE	
(7)		ONE THREE FOUR EIGHT NEWGUMBERLAND PLACE
(9)		NEWYORK NY
(10)	LETTER RECEIVED FROM MARY WHO	IS IN NEWYORK STOP FAMILY
	JOIN WITH ME IN WISHING	YOU A HAPPY BIRTHDAY
		FRANCES
		WLMA 504P 22

scribed in Braille was forwarded to him by the Chief Signal Officer of the Army.

December QST gave the rules and printed an example of the proper manner to use in A.A.R.S.

messages. Unfortunately the printer didn't do a very good job of following the rules. We are reproducing the example in its proper form and repeating the description and hints for copying messages on a typewriter.

First line: write the number, station of origin, operator's sign and check.

Third line: place of origin, filing time (if any), and date.

Fifth line: the name of the addressee.

Seventh line: one space after the last word of the addressee's name, the address, giving number and street.

Eighth line: name of the city immediately under street and number.

The body of the message starts at the left on the tenth line. Copy ten words to the line. At the end of the fifth, fifteenth, twenty-fifth, etc., word, a double space should be left to aid in counting the check. New York is written NEWYORK, as are all the names of places, and counted one word.

Two lines under the last word of the body appears the signature. If the last word of the body is too far to the right, start the signature two lines down and in the center of the blank. The message is serviced by the receiving operator by placing the call letters of the transmitting station two lines under the signature, followed by the time of receipt and day of the month.

As the message is being copied between the fifth and tenth lines, a new blank may be placed in the typewriter so that upon the removal of the completed message the new blank appears in approximately the right position for the next message. If carbon copies are made, considerable practice is required to get the new blanks in at the proper time.

The Strongheart Boys

(Continued from page 35)

The plane roars low over the island, drops a message, and flies on. Horace races to the spot where the note falls and, picking it up, reads. Clarence comes to a stop behind him, trying vainly to read over his shoulder.

"What does it say, Horace? Does it say that he is sending help? Maybe the U. S. Navy is on its way." (See "Strongheart Boys with Uncle Sam.")

Horace reads aloud.

"Dear OM. Heard you calling at 11:52 E.S.T. Your frequency was 7301. Would appreciate a note saying you will be in the band in the future. Yours for amateur radio. W1 glub glub."

—Robert J. Black, W1EEK

Directional Antennas

(Continued from page 13)

bi-directional array of 4 elements. In many cases, especially where the lower double-Zepp is not

very high off the ground, a 2-section flat-top should give somewhat improved performance, that is, if the flat-top is placed at the same height as the upper double-Zepp of the pair. A 2-section flat-top should also give more gain over a much wider horizontal angle than 4 co-linear half-wave antennas in phase and at the same height above ground.

The small dimensions of the flat-top antenna make it suitable for use in many locations. Through the use of close-spacing the gain is exceptionally good for an array of its size.

The Cover

MODERN television receiving gear may seem simple once you understand the general idea, but it must be admitted that the apparatus doesn't look simple. The mess of aluminumware in the photograph belongs to an experimental vision receiver built a couple of weeks ago by Ross Hull. His objects in building the affair were: To discover if a picture could be had in Hartford from New York (about 105 miles); to see if a haywire rig, built in a hurry from standard parts, could be made to function without breaking any blood vessels, and, to find out whether the whole business of building the set and fiddling with it could be described in ham language as fun. The outcome was a definite "yes" on all counts. Quite fair pictures were received from New York; the receiver functioned after a couple of hours of bug hunting; it was plenty fun. Naturally, the pictures were far from "commercial" quality since the band-width of the receiver had to be sacrificed severely in order to allow enough gain. But at that, they were a bunch of good-looking ghosts walking around the kinescope.

A New Transmitting Tube—the 809

A NEW high- μ , 25-watt plate-dissipation tube, to be known as the 809, has been added to RCA's line of transmitting tubes for amateurs. It can be used at maximum ratings at frequencies up to 60 megacycles in r.f. service, and is designed to operate with good plate efficiency at relatively low plate voltage and driving power. The 809 also is suitable for Class-B audio service.

Tentative characteristics and ratings are given below:

Filament voltage.....	6.3 volts
Filament current.....	2.5 amp.
Amplification factor.....	50
Interelectrode capacitances:	
Grid-plate.....	6.7 μ fd.
Grid-filament.....	5.7 μ fd.
Plate-filament.....	0.9 μ fd.
Max. plate dissipation.....	25 watts
Max. plate input.....	75 watts

In Class-B audio service, two tubes are capable of delivering 100 watts output at 750 volts, using

(Continued on page 106)

H A M D O M



DENVER is his home town, and he has lived there for most of his forty years. Now he represents it, and the rest of the Rocky Mountain Division, on the A.R.R.L. Board of Directors. When you stop to think about it, that's really



quite a fitting thing, for Ed Stockman, W9ESA, knows ham radio from top to bottom and from beginning to end. He started in 1909, and in 1915 had a 1-kw. rotary spark plus an Audiotron. As 9ZD this was among the more famous of early stations. During the war he served in Military Intelligence.

Back on the air in 1925, radio has been part of his daily life ever since. He has been O.R.S., S.C.M., A-1 op, TL, etc. As A.A.R.S. S.N.C.S. for Colorado he holds the call WLJF. Plus some DX, a little five-meter work, and a lot of all-around catch-as-catch-can hamming, his radio life is very full indeed—so full, in fact, that it doesn't leave much time for fishing. Which, we can tell you, is a break for the fish of the R.M. Division.

TIME was when 5ZA was a famous he-man station—winner of the first Hoover Cup for the most outstanding station in 1922, and all that. But now when you speak of W5ZA, you think of Eunice first and Louis second. We suppose



it all goes to prove that old Chinese proverb which says that it's 90% operator and 10% station. Anyway, Louis Falconi got the bug in 1909 and from then on until the law clamped down in 1912 worked as "L.F." The 1/2-kw. Blitzen transformer was purchased and the spark gap was concocted by imitating ship installations.

Just as he became legal with 3HU he got a job as commercial op and roamed the seas on old NLK. After the war came 5ZA. Always in the forefront of technical development, 5ZA had one of the first amateur 'phone rigs, in 1921—and after sixteen years he still thinks there's some-

thing to ham 'phone. We suppose that goes to prove that other old Chinese proverb which says that the voice is mightier than the fist.

WHEN you see the name "CQ Brand" on a box of potatoes or tomatoes, it's no accident. It's simply William Shearman Burkhart's way of saying that he's a ham and proud of it. And well may Bill Burkhart be proud, for as W4DLH he has done a number of notable ham things. Organizer of the first "all-continent round table," holder of the WAC-



in-shortest-time-on-'phone record, his station is a subject for hamtalk wherever 10- or 20-meter 'phone men foregather. He got in the game in 1913, progressed through spark at 8DI, bloomed out on c.w. as 4AAQ—and then busy Florida boom days cancelled ham radio. For several years a real estate subdivision promoter, Bill saw a future in Florida Irish potatoes a few years back and now owns his own packing house. To normal folk, "C-Q Brand" means "consistent quality" potatoes, and to hams it means the same in a clean kilowatt and a rotary beam that works the world.

IF you ask anyone around San Francisco who the best all-around amateur there is, the odds are 100 to 1 that they'll answer, "W6CIS." Ken Hughes started his brass-pounding with 6BHV's 1/2-kw. rotary, got on in 1922 with his own call and a 202 on 200 meters, and has been active ever since. He has been president of the Sacramento Club, has held every office in the San Francisco Club, was C.R.M. for four years in the U.S.N.R., has held down the western terminus of Trunk Line "B," and is now assistant S.C.M. of the San Francisco Section. He never misses an A.R.R.L.



(Continued on page 64)

How Would You Do It?

Transmitter Monitoring Systems

ALL solutions to Problem Number 11 submitted fall into one of two distinct groups, both of which employ an oscillator auxiliary to the receiver. One group includes those systems in which the auxiliary oscillator beats with the transmitter signal to produce an audio beat which is fed into the audio system of the receiver, while the second includes those in which the auxiliary oscillator beats with the transmitter signal to produce an i.f. signal which is fed through the i.f. stages of a superheterodyne receiver.

While the first system is applicable to all types of receivers, the second method has the distinct advantage that the auxiliary oscillator frequency is so far removed from the operating frequency that no interfering signal results from this oscillator which is not true of the audio beat note system where the oscillator frequency is removed only 500 cycles or so from the operating frequency. In some superheterodyne receivers it is probable that care in introducing the auxiliary oscillator signal may be necessary to prevent a slight loss in received signal strength or detuning of the oscillator and mixer circuits.

First Prize Solution

By James S. Clarke, W2QL¹

THE problem which now confronts our hero is one which the writer dismissed for an undue length of time by the well-known scheme of rapidly disabling the lead stage of the receiver and tuning to the transmitter frequency, then, at the end of transmission, reversing the procedure and

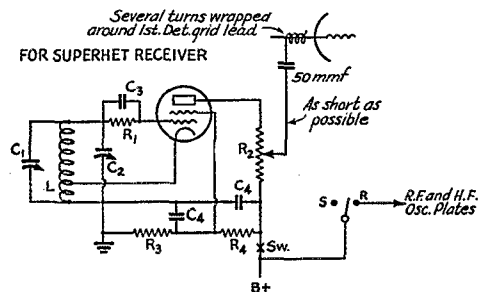

FIG. 1

- L—40 turns No. 24 d.c.c. 1" diameter for 3.5 Mc.
- C₁—15 μfd.
- C₂, C₃—100 μfd.
- C₄—0.01 μfd.
- R₁—0.25 meg.
- R₂, R₄—10,000-ohm.
- R₃—50,000-ohm.

¹ 181 William St., East Orange, N. J.

hoping to find the other fellow before he had completed his identification. The inconvenience of this repertoire certainly needs no comment, nor

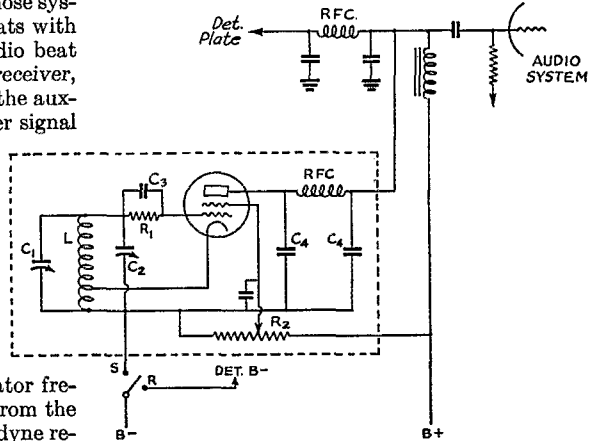

FIG. 2

- L—Dimensions depend upon which band is used for auxiliary oscillator. (See text.)
- R₂—50,000-ohm.
- All other values same as Fig. 1.

does the exasperation that follows when he cannot be located, and yet, that many of us are monitoring in this manner can readily be verified over the air. The probable explanation, as in the writer's case, is that with the general adoption of commercially manufactured receivers, one does hesitate to cut into a well-assembled job and make drastic changes, particularly if he has sacrificed all but the staff of life to get it.

A system conceived under these circumstances and one which has proven to be completely satisfactory is now in operation at the writer's shack. The arrangement, as shown by Fig. 1, consists of an auxiliary oscillator which beats with the transmitter signal and feeds it through the regular i.f. and audio channels. During transmission it is only necessary to cut the plate voltage on the h.f. oscillator and sufficient r.f. stages to give a reasonable signal level. In most cases the existing standby switch may be used. Volume can then be controlled by R₁ and the pitch by C₁, both adjustments being independent of those in the receiver over normal operating ranges. For break-in operation, the switch may be omitted.

This system may be applied to the t.r.f. type of receiver in the manner shown by Fig. 2. The outstanding advantage of this scheme is that the transmitted signal is heard exactly as it is received and for this reason it was selected in preference to the system which simultaneously keys an

audio oscillator. Obviously no switching of the 'phones is necessary since the regular audio components are used for both monitoring and receiving.

In operation it is found that if the auxiliary oscillator is tuned to the opposite side of the transmitter frequency from the h.f. oscillator for the lowest frequency band used, the harmonics will be strong enough to permit operation on all higher bands without changing coils. In the case of the t.r.f. receiver, the monitoring oscillator will be tuned to the highest desirable transmitter harmonic. A switch in the negative B lead of the auxiliary oscillator may be used to eliminate picking up harmonics when covering the inter-band range if an all-wave superhet is used. A very neat installation will result if the monitoring unit is built within a small shield can and located inside the receiver cabinet with the controls for R_1 and C_1 brought out through the panel. A further refinement incorporated at this station has been to provide a changeover switch with an extra pair of contacts to turn the crystal oscillator on and off.

Second Prize Solution

By Gordon Havam, VE3AJB² and William Motherwell, VE3BY³

THE scheme shown in Fig. 3 has been in use by both VE3BY and VE3AJB for about a month, and we are very pleased with it. It seems to answer all the problems of a keying monitor, and is very inexpensive to build.

The double triode tube replaces the usual triode first audio stage. One section works as a single triode amplifier for the receiver, while the signal from the frequency meter-monitor is fed through the other half of the double triode. The frequency meter is the one described in the *Handbook* using a 24-A and a 56. The mixer tube amplifies the signal from the frequency meter, making it quite strong and useful on all the bands required.

In this system there is no switching or coil changing required as the signal in the frequency meter is sufficiently strong on all bands. For break-in operation the scheme is ideal since both the receiver and frequency meter signals come through the audio circuit equally well.

A feature of this circuit is that the strength of the received signal and that of the monitor signal may be adjusted independently.

The great advantage which this scheme has over the ordinary audio keying monitor is that the signal heard is not merely a check on the keying, but also on the actual signal going out over the air. I think its use would do a great deal to reduce

² 30 Second Ave., Ottawa, Ont.

³ 306 Fairmount Ave., Ottawa, Ont.

the number of bad notes on the air. Also, since the frequency meter is calibrated, off-band operation should not occur.

We wish to thank the following for their solutions of the problem: W2IFB, 3FFC, 3GJT, 6KMA, 8FU and VE3VC.

—D. H. M.

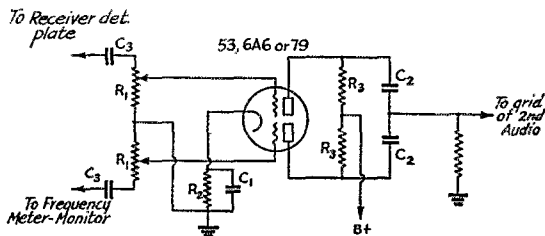

FIG. 3

R_1 —500,000-ohm.
 R_2 —2500-ohm.

R_3 —25,000-ohm.
 C_1 —12 μ f.

C_2 —0.01 μ f.
 C_3 —0.1 μ f.

Problem No. 13

OUR Hero frequently has need for a clip with which to make connections to transmitter coils of the space-wound wire type. To his great annoyance, standard clips made for wire coils have a habit of flopping over, short-circuiting a turn or two of the coil. He also finds that, when using standard "octagonal" ceramic forms, difficulty is experienced in getting the clip to stay on without falling off at the crucial moment.

He believes that surely someone has found a way around the difficulty.

And again the contest rules:

1. Solutions must be mailed to reach West Hartford before the 20th of the publication month of the issue in which the problem has appeared. (For instance, solutions of problem given in the March issue must arrive at *QST* before March 20th.) They must be addressed to the Problem Contest Editor, *QST*, West Hartford, Conn.

2. Manuscripts must not be longer than 1000 words, written in ink or typewritten, with double spacing, on one side of the sheet. Diagrams and sketches may be in pencil, must be neat.

3. All solutions submitted become the property of *QST*, available for publication in the magazine.

4. The editors of *QST* will serve as judges. Their decision will be final.

Prizes of \$5 worth of A.R.R.L. station supplies or publications will be given to the author of the solution considered best each month, \$2.50 worth of supplies to the author of the solution adjudged second best. The winners should, of course, state the supplies preferred.

The C.C.C. Takes to the Air

By William Haight*

PERCHED on a high bluff beside Lake Michigan there stands a little tar-paper-covered building like those found in Civilian Conservation Corps camps throughout the country. Reaching skyward from this humble place is a lead-in wire that unmistakably identifies it as a radio shack.

But it is much more than that. Through the thin wires of that particular lead-in, which looks for all the world like those found in thousands of ham stations, pulses the official business of the entire C.C.C. structure in the three states of Illinois, Wisconsin, and Michigan. That station, WUEL by call, is the Sixth Corps Area control station of Uncle Sam's great civilian conservation army. With a cleared channel on 4300 kc., WUEL maintains regular schedules with District stations at Fort Brady, Sault Sainte Marie, Michigan; Camp Custer, Battle Creek, Michigan; Sparta, Wisconsin; and Jefferson Barracks, Missouri.

Within each district is a net of subdistrict stations, situated out in the country in certain C.C.C. camps themselves. The Fort Sheridan District, for which WUEL serves also as District control station, has radio in its camps at Marseilles, Illinois; Madison, Wisconsin; and Honey Creek, Wisconsin. These are 20 watters; the big brother transmitter at Fort Sheridan uses 40.

Some time ago the C.C.C. radio shack at the historic old Illinois army post became an academy of higher learning for students of the fine arts of short-wave radio operation. Determined that, despite the shifting, changing personnel of the conservation corps, from which the operators of the radio stations are detailed, the radio net must continue to function smoothly, officials organized a school for operators. Under Lieutenant Louis Buttner, the Corps Area radio net officer, the C.C.C. headquarters at Fort Sheridan created a real radio short-course college, complete with dormitory, classroom and adequate faculty. Special selection of eleven enrollees from the 48 companies in the district insured a responsive and capable student body.

The picked students arrived, and were assigned a section of the C.C.C. Headquarters Company barrack in which to live, and to study their homework. They reported for class each day at the schoolroom in the radio shack, located in rear of the operators' room at WUEL. No common schoolroom was this, with twelve sets of headphones and keys plugged in around a large table,

and buzzer, batteries, and switches to make the setup an effective place in which to learn the code.

Graduate of the Marine Corps radio school at San Diego, California, and veteran of high seas wireless as operator aboard the U.S.S. *Minneapolis*, John Borck, WUEL's chief operator, became head professor in the school. Charles Walz, his assistant at the corps area station, and formerly a ham answering to W9MQH in Chicago, was associate professor. Lieutenant Buttner functioned as president of the faculty in this unique miniature radio university.

Learning via buzzerphone practice to take the prescribed 13 words per minute was not the only instruction imparted. Equally important parts of the course were the lessons in the theory of radio, designed to acquaint the enrollees with the operation of their equipment, and in C.C.C. administration. A well-rounded education as camp radio operators was the objective of the school.

Ex-ham Martin Olson of W9MPM, Chicago, delegate from the Skokie Valley camp, was no

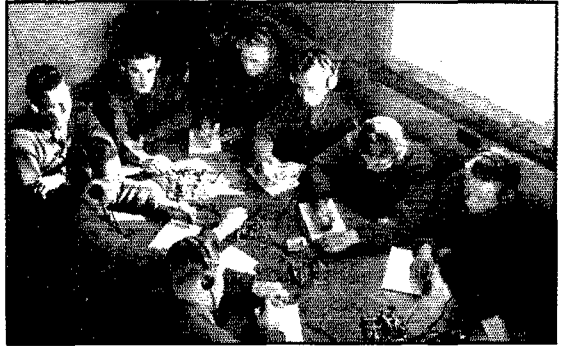

freshman in this school. He entered with advanced standing, being at least a sophomore with his 15 words a minute. His four ham years made him star pupil.

Declaring this first 1937 semester of the radio university of the C.C.C. a great success, the corps officials plan to open up another term shortly, training another class of operators for future use in radio net. Graduates will return to their own camps, not all of which are radio-equipped, to be available for duty wherever they become needed with the discharge of present operators. A preliminary trial of the radio school was held about a year ago when the radio net of the C.C.C. was first established.

The recent flood in the Ohio River Valley put

(Continued on page 86)

*Daily Tribune, Wisconsin Rapids, Wis.

HINTS and KINKS for the Experimenter



Regenerative Detector Circuit for Reducing Interference

THE dual detector circuit shown in Fig. 1 has been used for some time by J. Dawson, W4DNA, St. Petersburg, Fla., and when carefully constructed is capable of reducing interference from an unwanted station. It consists of two identical regenerative detectors so arranged that the currents in the plate circuits cancel when both are tuned to the same frequency. One detector

course be advanced until the detectors go into oscillation. Now turn C_1 to minimum, and if the signal is still heard adjust C_2 until it just disappears; then bring it in again with C_1 . If the ganged condensers are well matched, no further adjustment of C_2 will be necessary.

"Both detectors work on the same half-cycle of the signal, i.e., if one is excited by the positive half-cycle the other grid must be positive at the same instant. One detector receives the desired signal and the other neutralizes the interfering signal. If the interference is on the low-frequency side, tune C_1 toward maximum until the interference is reduced to a minimum, and on the reverse side if the interfering signal is higher in frequency.

"The primary coils are shown connected in parallel, which I have found to be the best connection, although they can be connected in series if desired. There is nothing tricky about the circuit, the most important points being thorough shielding of the two detectors and duplication of circuit components throughout. The circuit itself is a modification of one proposed by Armstrong some years ago."

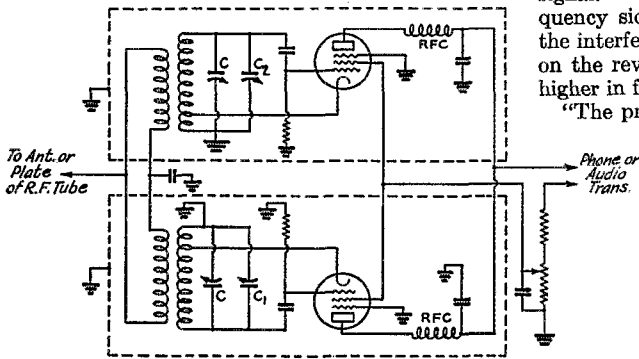

FIG. 1—DUAL DETECTOR CIRCUIT FOR REDUCING INTERFERENCE

Circuit constants are as usual for regenerative detectors. Condensers marked C are 100 $\mu\text{fd.}$ each, ganged. C_1 and C_2 are 35- $\mu\text{fd.}$ variables. Band-spread circuits may be used if desired.

operates in the customary fashion to pick up the wanted signal; the other is used as a "bucker" to balance out an interfering signal.

The two detector circuits are quite normal in every respect, and the usual circuit values are employed throughout. W4DNA's arrangement uses the cathode-tap circuit for regeneration. The grid coils and coupling coils must be exactly the same, as must also the coupling coils or primaries. The input circuit can be a tuned r.f. amplifier or an antenna. The two detectors must be carefully shielded from each other to prevent heterodyning. The condensers marked C are ganged for one-control tuning. C_2 is a vernier tuning condenser in the "bucking" detector, C_1 an equalizing or alignment adjustment in the "active" detector.

As to tuning procedure, W4DNA writes: "Set C_1 at full capacity and C_2 at minimum, then tune in a station. The regeneration control must of

Curing Interference with Old-Style B.C. Receiver

HERE is a change that can be made in certain old-model radios to reduce and in some cases eliminate interference caused by nearby ham transmitters. This change was made on three sets to try to reduce QRM, and it worked out 100 per cent in all three cases. In one case the radio was an old Temple that was getting a one-kw. 'phone all over the dial, and in both other cases the trouble was from c.w. transmitters, clicks and carrier all over the dial. In all three cases the receivers were very close to the transmitters. In one instance it was found that the interference could be heard just as well in the receiver (an old Philco) with the antenna and ground disconnected and the three r.f. tubes pulled out.

The trouble boils down to the fact that in the grid-leak type of detector shown in Fig. 2-A, the grid is practically floating above ground. This makes the tube and its associated wiring sensitive to the rather strong r.f. field when the receiver

happens to be near a transmitter. The plate type of detector, shown in Fig. 2-B, is practically impervious to this type of pickup. In making the change from grid-leak to plate detection it will be necessary to have well-filtered d.c. on the plate of the detector or an increase in hum will result. An extra 8- μ fd. filter condenser probably will be needed at the point where the high voltage is obtained, and in some cases it may be necessary to put an extra choke in the detector plate supply, along with the extra capacity. In the three sets fixed here all that was necessary was the extra 8- μ fd. condenser.

After making this change, it will be necessary to peak the detector trimmer condenser, as the circuit revision will disturb the alignment slightly.

It is a good idea to by-pass both sides of the 110 to ground inside of the chassis with condensers about 0.01 μ fd. Most of the newer sets already

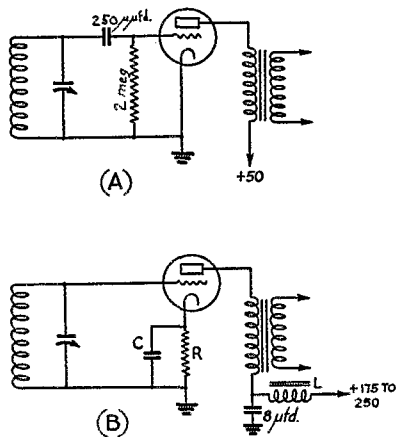

FIG. 2—(A) GRID-LEAK DETECTOR AS USED IN OLD-STYLE B.C. RECEIVERS; (B) PLATE DETECTOR RECOMMENDED TO CUT OUT AMATEUR INTERFERENCE

Changing the type of detection often will cure interference of the "all over the dial" type. Cathode resistor R should be 15,000 to 20,000 ohms; by-pass condenser C, 0.5 to 1 μ fd. The plate-supply choke, L, may not be necessary but, if used, it may be a small low-current high-inductance unit.

have the 110 by-passed, but old-type sets such as ones that would use the grid-leak type of detector very rarely have the 110 filter incorporated. The filter helps to prevent r.f. from getting into the chassis by way of the 110 line.

—Fenton Priest, W3EMM

46 as a Screen-Grid Tetrode

TRANSMITTING tubes being expensive and hard to obtain in Latvia, amateurs in this country use the cheap receiving-type tubes, generally of U.S.A. manufacture, for their transmitters. Special attention is given to the 46, but they have found it to work much better if connected

as a tetrode with some positive bias on the second grid. The idea is originally due to Olgerts Resnais, YL2BB, who tried it in his transmitter. Imme-

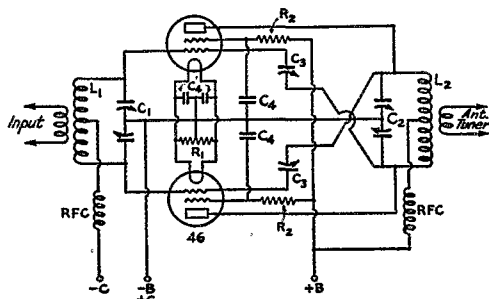

FIG. 3—PUSH-PULL AMPLIFIER USING 46'S AS TETRODES

C_1, C_2 —Split-stator condensers, 35 μ fd. each section.
 C_3 —Neutralizing condensers (see text).
 C_4 —0.002 μ fd.
 R_1 —25 ohms, center-tapped.
 R_2 —100,000 ohms.
 L_1, L_2 —Coils suitable for frequency.

diately, also the writer put it into work. The results are especially good on higher frequencies, 14 to 56 Mc. (This perhaps is partly due to reduced input grid to cathode capacity.) As a straight amplifier or doubler, the tetrode 46 gives better r.f. output with less excitation than the same tube in high- μ triode connection. Although neutralization is still necessary with straight amplification, it is easily accomplished with but a small capacity, two pieces of aluminum, $\frac{1}{2}$ inch by $\frac{1}{2}$ inch, spaced within a distance $\frac{1}{8}$ inch, being more than enough. No traces of secondary emission are ever observed if the "screen-grid" voltage is kept reasonably low, 80 to 100 volts being the best value at 400 volts on the plate. A dropping resistor of 100,000 ohms in the positive "B" supply lead may be safely used. Fig. 3 is the circuit of my push-pull p.a. stage which I use on 28 Mc. with an input of 40 watts.

—Arv. Vitolins, YL2CD

S.A. or Audio Oscillator for U.H.F. Transmitters

FIG. 4 is a diagram of an arrangement I have used for some time and which I believe other hams might find useful. The circuit provides a means of creating an audio tone in the speech amplifier and feeding it into the modulator. This may readily be keyed to provide type A-2 emission on the five-meter band. If it is not keyed, it offers a good method of testing where one spends many hours of talking into thin air while somebody else adjusts directive arrays and what not in an attempt to hear him. In my particular case, I have used it extensively in timing down-mountain ski races by five-meter portable rigs. As the timer

at the bottom of the course presses the key and his watch simultaneously, the tone is heard by the racer at the start and he is thus given a very accurate signal for starting. The sets may then be given over to descriptions of the racer's descent either by the operator at the start or at the finish.

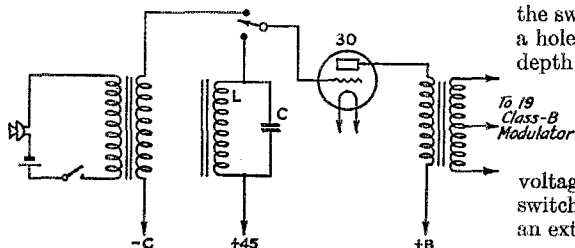

FIG. 4—SPEECH AMPLIFIER OR TONE GENERATOR FOR 5-METER WORK

L—Midget audio choke or primary of small audio transformer.
C—Small condenser to tune to desired tone.

The timer has merely to punch his watch as the racer passes over the finish line.

The s.p.d.t. switch shown provides normal input to the speech amplifier in one position. When thrown to the other position, it biases the speech amplifier grid 45 volts positive through a tuned audio circuit. This amount of bias causes the tube to operate on the negative slope portion of the E_c-I_g curve. Hence the grid circuit operates as an audio dynatron oscillator. This audio voltage controls the plate circuit in the normal manner. It will be found that different tubes require different amounts of positive bias to get them to oscillate properly. The idea, however, should be easily adaptable to any speech amplifier. Some tubes might not be adaptable as a result of too high grid current under the positive bias conditions, which would, of course, damage the tube.

—Millett G. Morgan, W8OTD

Plate-Voltage Control with Combination Transformer

MANY amateurs are not blessed with an abundance of funds, and a nickel saved is that much more towards improving their sets. Most power-supply diagrams show a plate transformer with two or three separate filament transformers. At the same time, most of the low-voltage plate transformers already have two or three filament windings, but they are not used because the boys want separate filament transformers to heat their tubes before plate current is applied.

My plate transformer has several filament windings—enough to heat my two 66 Juniors, as well as the filaments of the tubes in the transmitter. For 25 cents I purchased a heavy-duty

porcelain double-pole single-throw switch, which I mounted on the inside of the power pack near the transformer. I brought the two plate leads from the transformer to one end of this switch and from the other end ran two leads to the rectifiers (Fig. 5). I have an 8-inch length of one-inch wide bakelite strip fastened to the handle of the switch, with the loose end extending through a hole cut in the panel. When I shove in an inch depth on the bakelite strip, the plate switch is open. All I have to do is give the tubes a few seconds to heat up when I first start up the rig, and then pull the strip out, which closes the switch and applies plate voltage. This saves the price of an extra toggle switch for a plate transformer as well as that of an extra filament transformer.

—W. F. Worrell, W5AQD

6L6 Screen Supply

THE 6L6 screen supply system described by W2ALW in March QST¹ can be made still better if four neon lamps (without resistors) are used in series between screen and ground, as a simple dropping resistor can then be used between

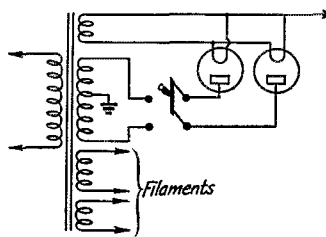

FIG. 5—SWITCHING THE PLATE WINDING ON A COMBINATION TRANSFORMER SO TUBES CAN BE HEATED BEFORE APPLICATION OF PLATE POWER

the high voltage supply and the screen. The original circuit provides no compensation for the regulation of either the power transformer or the screen-supply filter. If the neon lamps are placed between screen and ground, however, they will not only compensate for this regulation, but will actually eliminate the need for a screen supply filter, since the neon lamps act as a very large capacity. Current may be taken from either side of the plate supply filter. The value of the dropping resistor should be low enough to pass about 25 per cent to 50 per cent more current than is required by the screens, in order to keep the lamps glowing. The required voltage drop should be measured with full load on the power supply.

As an example, take the case of a power supply delivering 450 volts at no load and 400 volts at full load. The drop in the resistor should be 100 volts with about 30 mils current, which will pro-

(Continued on page 62)

¹ Page 48, March, 1937, QST.

• I. A. R. U. NEWS •

Devoted to the interests and activities of the

INTERNATIONAL AMATEUR RADIO UNION

Headquarters Society: THE AMERICAN RADIO RELAY LEAGUE, West Hartford, Conn.

MEMBER SOCIETIES

American Radio Relay League
Asociația Amatorilor Romani de Unde
Scurte
Associazione Radiotecnica Italiana
Canadian Section A.R.R.L.
Československí Amatérský Vysílač
Deutscher Amateur Sende-und-Empfangs
Dienst
Experimental Radio Society of Egypt
Experimenterende Danske Radioamatører
Fédération des Émetteurs Belges
Irish Radio Transmitters Society
日本アマチュア無線聯盟 Japan

Liga Colombiana de Radio Aficionados
Liga Mexicana de Radio Experimentadores
Magyar Rövidhullámú Amatőrök Országos
Egyesülete
Nederlandsche Vereeniging voor Interna-
tional Radioamateurisme
Nederlandsch-Indische Vereeniging Voor
International Radioamateurisme
Newfoundland Amateur Radio Association
New Zealand Association of Radio Trans-
mitters
Norsk Radio Relæ Liga
Österreichischer Versuchssenderverband

Polski Związek Krotkofalowcow
Radio Club Venezolano
Radio Society of Great Britain
Rede dos Emissores Portugueses
Reseau des Émetteurs Français
Reseau Luxembourgeois des Ama-
teurs d'Ondes Courtes
South African Radio Relay League
Suomen Radiamatöörlitto r.y.
Sveriges Sandareamatörer
Unión de Radioemisores Españoles
Union Schweiz Kurzwellen Amateure
Wireless Institute of Australia

Conducted by Byron Goodman

Countries:

A year ago this column carried a list of countries, intended to be used by DX men who like to keep track of the number of countries they have worked. We acknowledged at the time that its adoption would depend entirely upon its acceptance by the majority and, surprisingly enough, there were very few criticisms. The average amateur was pleased to have a "yardstick" with which to measure his DX accomplishments, and the comments we did receive were favorable and constructive.

It was recognized, of course, that there had been a few omissions, and that some revision was possible. With this thought in mind, we studied the comments we had on hand, discussed the list at length with representative DX men, got the west-coast slant by collaboration with W6QD, checked with several geographical authorities, and finally arrived at the list we now present. We trust that we have approached still more closely to a universally satisfactory standard of "countries worked." Your comment is invited.

<i>Country</i>	<i>Prefix</i>
Bahrain Islands	V88
Balearic Islands	EA6
Baluchistan	
Barbados	VP8
Bechuanaland	
Belgian Congo	OQ
Belgium	ON
Bermuda Islands	VP9
Bhutan	
Bolivia	CP
Borneo, Netherlands	PK5
Brazil	PY
British Honduras	VP1
British North Borneo	V84
Brunei	
Bulgaria	LZ
Burma	XZ
Cameroons, French	FE8
Canada	VE
Canal Zone	(K5)
Canary Islands	EA8
Cape Verde Islands	CR4
Caroline Islands	
Cayman Islands	VP5
Celebes and Molucca Islands	PK6
Ceylon	V87
Chagos Islands	VQ8
Channel Islands	G
Chile	CE
China	XU
Chosen (Korea)	J8
Christmas Island	ZC3
Cocos Island	TI
Cocos Islands	ZC2
Colombia	HJ
Comoro Islands	
Cook Islands	ZK1
Corsica	
Costa Rica	TI
Crete	
Cuba	CM-CO
Cyprus	ZC4
Czechoslovakia	OK
Danzig	YM
Denmark	OZ
Dominican Republic	HI
Easter Island	
Ecuador	HC
Egypt	SU
Eritrea	
Estonia	ES
Ethiopia	ET
Faeroes, The	OY
Falkland Islands	VP8

<i>Country</i>	<i>Prefix</i>
Aden	
Aegean Islands	
Afghanistan	YA
Alaska	K7
Albania	ZA
Aldabra Islands	
Algeria	FA
Andaman Islands	
Andorra	
Anglo-Egyptian Sudan	ST
Angola	CR6
Argentina	LU
Ascension Island	ZD8
Australia	VK
Austria	OE
Azores Islands	CT2
Bahama Islands	VP7

Country	Prefix
Fanning Island	VR3
Federated Malay States	VS2
Fiji Islands	VR2
Finland	OH
France	F
French Equatorial Africa	FQ8
French India	FN
French Indochina	FI8
French Oceania	FO8
French West Africa	FF8
Fridtjof Nansen Land (Franz Josef Land)	
Galapagos Islands	
Gambia	ZD3
Germany	D
Gibraltar	ZB2
Gilbert & Ellice Islands and Ocean Island	VR1
Goa (Portuguese India)	CR8
Gold Coast (and British Togoland)	ZD4
Gough Island	
Great Britain	G
Greece	SV
Greenland	OX
Guadeloupe	FG8
Guam	K6
Guatemala	TG
Guiana, British	VP3
Guiana, Netherlands (Surinam)	PZ
Guiana, French, and Inini	FY8
Guinea, Portuguese	CR5
Guinea, Spanish	
Haiti	HH
Hawaiian Islands	K6
Heiss	HZ
Honduras	HR
Hong Kong	VS6
Hungary	HA
Iceland	TF
Idni	
India	V1
Iran (Persia)	E1
Iraq (Mesopotamia)	YI
Ireland, Northern	GI
Irish Free State	EI
Isle of Man	I
Italy	G
Jamaica	VP5
Jan Mayen Island	OY
Japan	J
Jarvis Island	K6
Java	PK
Kenya	VQ4
Kerguelen Islands	
Kuwait	
Laccadive Islands	
Latvia	YL
Leeward Islands	VP2
Liberia	EL
Libya	
Liechtenstein	
Lithuania	LY
Luxembourg	LX
Macau	CR9
Madagascar	FB8
Madeira Islands	CT3
Maldiva Islands	VS9
Malta	ZB1
Manchukuo	(MX)
Marianas Islands	
Marshall Islands	
Martinique	FM8
Mauritius	VQ8
Mexico	XE
Midway Island	K6
Miquelon and St. Pierre Islands	FP8
Monaco	
Mongolia	
Morocco, French	CN
Morocco, Spanish	EA9
Mozambique	CR7
Nepal	
Netherlands	PA
Netherlands West Indies (Curacao)	PJ
New Caledonia	FK8
Newfoundland and Labrador	VO
New Guinea, Netherlands	PK6
New Guinea, Territory of	VK9
New Hebrides, British	YJ
New Hebrides, French	FU8
New Zealand	ZL
Nicaragua	YN
Niobar Islands	

Country	Prefix
Nigeria (British Cameroons)	ZD2
Niue	ZK2
Non-Federated Malay States	VS3
Norway	LA
Nyasaland	ZD6
Oman	
Palau (Pelew) Islands	
Palestine	ZC6
Panama	HP
Papua Territory	VK4
Paraguay	ZP
Peru	OA
Philippine Islands	KA
Phoenix Islands	
Pitcairn Island	VR6
Poland	SP
Portugal	CT
Principe and Sao Thome Islands	
Puerto Rico	K4
Reunion Island	FR8
Rhodesia, Northern	VQ2
Rhodesia, Southern	ZE
Rio de Oro	
Roumania	YR
St. Helena	ZD7
Salvador	YS
Sardinia	
Samoa, U. S.	K6
Samoa, Western	ZM
Sandwich Islands	
Sarawak	VS5
Saudi Arabia	
Scotland	GM
Seychelles	VQ9
Siam	HS
Sierra Leone	ZD1
Socotra	
Solomon Islands	VR4
Somalland, British	VQ6
Somalland, French	FL8
Somalland, Italian	
South Georgia	VP8
South Orkney Islands	VP8
South Shetland Islands	VP8
Southwest Africa	ZS3
Soviet Union:	
European Russian Socialist Federated Soviet Republic	U1-3-4-7
White Russian Soviet Socialist Republic	U2
Ukranian Soviet Socialist Republic	U5
Transcaucasian Socialist Federal Soviet Republic	U6
Usbek Soviet Socialist Republic (Uzbekistan)	U8
Turkoman Soviet Socialist Republic	U8
Asiatic Russian S.F.S.R.	U9-0
Spain	EA
Straits Settlements	VS1
Sumatra	PK4
Svalbard (Spitzbergen)	
Sweden	SM
Switzerland	HB
Syria	
Taiwan (Formosa)	J9
Tanganyika Territory	VQ3
Tangier Zone	
Tannu Tuva	
Tasmania	VK7
Tibet	
Timor, Portuguese	CR10
Togoland, French	FD8
Tokelau (Union) Islands	
Tonga (Friendly) Islands	VR5
Transjordan	ZC1
Trinidad and Tobago	VP4
Tristan da Cunha	ZU9
Tunisia	FT4
Turkey	TA
Turks and Caicos Islands	VP5
Uganda	VQ5
Union of South Africa	ZS-ZT-ZU
United States	W [N]
Uruguay	CX
Venezuela	YV
Virgin Islands	K4
Wake Island	K6
Wales	GW
Windward Islands	VP2
Wrangel Island	
Yemen	
Yugoslavia	YT-YU
Zanzibar	



OPERATING NEWS



Conducted by the Communications Department

F. E. Handy, Communications Manager

E. L. Battey, Asst. Communications Manager

THIS month we call special attention to the announcement appearing elsewhere in this issue for the first "A.R.R.L." QSO Party . . . to be held Saturday and Sunday, January 8th and 9th . . . call insignia prizes . . . only bona fide League members eligible. Look into this. See you there!

EMERGENCY OPERATING POLICIES

The season of the year when snow and flood hazards mount to considerable proportions, and when amateur radio communication must be ready to fill in to replace disrupted or overloaded wire communications circuits, is now upon us. Attention is called to the need for *preparedness* of all stations belonging to the amateur service. Emergencies due to individual isolation are important as well as the widespread general disasters which involve the necessity for public relief and welfare work as well as communications problems on a major scale. Be ready to stand by for a *QRR*, and note well that this is a call to be used in the amateur bands *only by a station asking for assistance*.

Progress is reported in the appointment of Emergency Coördinators in communities all over the U. S. A. and Canada. Section Managers make these appointments, and local studies and organization of the amateur service to meet local hazards and problems are going forward through committees of amateurs organized by these Emergency Coördinators wherever sufficient population and amateur activity warrants. Every active radio amateur is invited to register his equipment and availability in the League's Emergency Corps which will be substantially expanded.

About the time you receive this *QST*, all amateurs now registered with the Emergency Corps will receive a re-registration blank. This is an important step in overhauling the field organization's emergency system to give us names and data to refer back to the new Emergency Coördinators, but is the means of dropping from the roster those now inactive who do not re-register availability.

An important fact that should be kept in mind by every amateur is that full individual understanding and coöperation of each amateur is essential to amateur success in any kind of emergency disaster involving amateur radio communications. Interference levels must be kept

down. *Reserves of amateurs* to operate the best stations in shifts must be organized. Many individuals must listen, that the best organized compact nets covering vital points may operate effectively on our low-frequency amateur bands. All amateurs are requested to coöperate to the fullest with the Emergency Coördinators and A.R.R.L. officials to bring about a condition of complete registrations, advance organization, and thorough preparedness. This applies now, in advance of emergency, as well as in time of emergency communication need itself.

All readers are requested to kindly study the following policies which have been recommended for very definite and obvious reasons, and will undoubtedly govern in our next major opportunities to serve the public in emergencies. Such organized planning is to give point to amateur efforts in attempting to establish and successfully handle communications during emergencies of any character and size. The recommendations of A.R.R.L. to the F.C.C. are included in our recommendations to amateurs, as follows:

1. That frequencies at the band edges be utilized for all emergency calls, with emergency present but not yet recognized or generally declared. The idea is to lend point and specification to builders of emergency equipment. This spot on all bands is well covered continuously by receivers. It gives hope to the isolated operator that he can be heard. Such frequencies are suggested as spots for all listeners to hunt for weak signals in any periods in general emergency for taking account of the isolated and making new station alignments.

2. That whenever F.C.C. shall have recognized and declared a general communications emergency exists, 2000-1975, 4000-3975, and 3500-3525 kcs. shall be reserved as emergency "calling" channels . . . prohibited to all stations except for first emergency or QRR calls, and initial or very important emergency relief traffic. All stations using such channels for contact shall as rapidly as practicable shift to inner-band "working and calling" frequencies, to leave these emergency channels clear for important calls of this type.

3. That in the designated and recognized emergency areas, all general amateur stations observe a silent or listening period for the first five minutes of each hour (0000-0005) on all amateur channels (3500-4000 kcs. 1715-2000 kcs.), tuning through the emergency calling and other channels for any QRR or initial-important calls from weak or isolated stations previously unable to effect contact in the interference.

The widest understanding and coöperation is needed to systematize our amateur operating and secure relatively less interference (from unintelligent transmitting) for any future general emergency period. Copy the above numbered points, or cut them out and post in the shack along with other lists of emergency-operating practices that appear in the new A.R.R.L. Handbook, the new

booklet Operating An Amateur Radio Station (10¢ to non-members, on request to members). The application blanks for registering equipment in the League's Emergency Corps are available from your Emergency Coördinator, from the S.C.M. (address on p. 6), or from Headquarters. Every amateur licensed with an active station should "register." These blanks also contain valuable listed operating points and precepts and extra blanks will be sent any licensed amateur for the station record. Our purpose is to have every licensed operator fully aware of every emergency-operating policy so that superlative results can be again recorded when the situation arrives.

Not one amateur but *wants* to do his part in emergency. We call upon clubs and groups everywhere to discuss local organization, to reiterate policies and practices published for mutual information and benefit, and to conduct a local campaign of registrations of all amateurs (whatever frequency band or interest) in the Emergency Corps. Ask us for blanks or further information.

—F. E. H.

PRIZES FOR BEST ARTICLES

The article by Mr. George W. Chinn, W9EUZ, wins the C.D. article contest prize this month. Each month we print the most interesting and valuable article received marked "for the C.D. contest." Contributions may be on any phase of amateur operating or communication activity (DX, 'phone, traffic, rag-chewing, clubs, fraternalism, etc.) which adds constructively to amateur organization work. Prize winners may select a 1938 bound *Handbook*, QST Binder and League Emblem, six logs, eight pads radiogram blanks, DX Map and three pads, or any other combination of A.R.R.L. supplies of equivalent value. Try your luck. Send your contribution to-day!

Notes on Contest Procedure

By George W. Chinn, W9EUZ*

THERE are certain helpful and considerate practices which make for more complete and satisfactory enjoyment of the various League contests. One should strive, first of all, to make the event a pleasant affair for everyone with whom he comes in contact.

One must participate in these contests to experience most fully every one of the many facets of amateur radio experience. Low power and simple equipment should not be considered obstacles to the entry of your station in any operating event. The operator who hesitates to enter because he feels that he is not able to compete with the elaborate equipment¹ used by some of the other contestants is passing up part of his prerogative as a radio amateur. He should be glad of the opportunity to test his equipment to prove that it is able to perform in the manner it should. While he may not run up one of the highest scores, there is, nevertheless, a certain satisfaction to be derived in the accomplishment of a creditable performance with limited time or equipment. Good judgment is a more valuable adjunct of pleasurable operating than is brute force and inconsiderate action.

From the standpoint of the lower powered station it is my firm belief that any amateur in this class should not send a single CQ during a contest. It is much more sensible to listen for signals he can copy well and contact these stations by calling them, rather than clutter up the ether with

useless calls. You will always find a CQ to answer during every contest! How much better it is to be able to hear the fellow you're working than to try and pick your call (in answer to your CQ) from the mass of weak signals and QRM! This brings us to the oft-repeated but seemingly never-learned problem of needless CQ's, especially during the DX contest. Some fellows call CQ DX by the hour, covering up excellent DX. It is in this way that many amateurs acquire a "bad name." If they would spend more time listening and less time sending they would do themselves a great deal more good, and certainly make a lot of us happier!

Contests seem to bring out hidden faults in a station's character. Notes begin to sour, fists begin to sloop, QRM begins to flourish. I think the greatest cause of inaccurate fists during a contest is fatigue. After many hours of sending it is no disgrace for your arm to become tired, and naturally your sending may become sloppy as a result. You can do yourself a world of good by resting as soon as you become over-strained and tired. A lay-off for a short period, while both your body and mind are relaxing, provides a complete change from hard operating, and enables you to re-enter the fray freshened and alert. It is surprising how fast the body can recuperate, so that you do not have to worry about the few points missed! You should enter the contest with an idea of enjoying yourself, rather than to just run up a lot of points in a hurry! Leisurely operating makes for greater enjoyment.

No matter what the results of your endeavor, report to the sponsors of the contest. The League makes the keeping of records as easy as possible. The checks between stations for the purpose of verification are reduced to a minimum and a neat orderly report is possible despite the untidiness of many of us participants! Even though you do not want to be entered in the contest results formally, as a contestant, you should send in the efforts of your activity so that the stations you worked can receive the credit due them. It doesn't hurt, either, to have your call published in QST, for it brings your call to the attention of other amateurs and serves to identify your signal on the air. It classifies yours with established and recognized stations.

Finally, there is the matter of QSL-ing. It should be accepted as a part of the contest, for remember that while a particular card may not mean anything to you, yours may be the one card that the fellow you contacted is breathlessly awaiting. In any event, one should always have the *decency* and *courtesy* to return the compliment of a card which is sent to him first. Even an "old-timer" may need your card to complete his file for some certificate. Take my own instance—while I have been a ham for quite a few years, I still need cards from about twenty-five states for W.A.S.

During the various contests throughout the year, let us attempt to secure the most enjoyment for ourselves by providing for consideration, sensible operation and satisfactory relaxation. More important, let us strive to bring that glow of friendship and contentment to the cheeks of the fellows we are fortunate enough to contact. Let our stations be friendly stations!

¹ EDITORIAL NOTE.—It has been proved time and again that operating ability is a tremendously more potent factor than the equipment itself, even though the best equipment and control arrangement is desirable. See "10% Station, 90% Operator," August 1932 QST.

* 7350 Dorchester Avenue, Chicago, Ill.

Brief

A Bowdoin-Kent's Island Expedition party leaves Lubec, Maine, for Kent's Island in the Bay of Fundy on December 23, 1937. The purpose of the party will be to collect meteorological data, to take a bird census, and to cooperate with the National Broadcasting Company by transmitting several programs over one of the networks. The first broadcast will take place December 30th. The high-power, gasoline-operated amateur 'phone station under the call VE1IN will be used for the broadcasts on a special frequency of 4797.5 kc. The radio staff of the party consists of W1JZM, W2JKE and T. S. McCaleb. Amateurs are asked to look for VE1IN on 4797.5 kc. after December 29th. Weather permitting, the party will return home on January 4th.

Results, October O.R.S.-O.P.S. Parties

South African DX Contest

THE new O.R.S. Party scoring system certainly sent the figures skyward. Topping the list is W6KFC with close to nine million points! W4ABT at the key of W4NC is not far behind. The results of the "millionaires" are given below.

W8LUQ made a new high mark for O.P.S. Parties—an even 7000 points!! Other record scores: W6ITH 5712, W2HNP 5500, W9TTA 4826. See the complete list for details on the leaders.

The October O.R.S. and O.P.S. bulletins announced an All-Season Competition for each group. Activity is at a high level with appointees plugging at the various factors. There's room for more, see your S.C.M.

OFFICIAL RELAY STATION SCORES

Station	Score	Different Stations	Different Sections	Heard	Power	Section
W6KFC	8,955,775	133	52	31	100	Ariz.
W4NC	(W4ABT) 8,691,900	155	55	21	600	N. C.
W1AW(Hal)	6,778,785	148	47	43	150/200/500	Conn.
W1BPT	6,609,940	146	39	39	100/500	N. H.
W7GEE	6,334,083	111	48	17	120/70	Utah/Vyo.
W8OFO	6,061,212	151	51	38	250/400	Wn. Pa.
W9KJY	5,586,768	153	45	28	150/300	Ill.
W1TS	5,431,860	131	49	27	75/300	Conn.
W4DWB	5,370,270	138	43	45	50/85	N. C.
W8KWA	4,815,740	145	45	18	—	W. Pa.

Station	Score	Stations	Sections	Station	Score	Stations	Sections
W3NF	4,815,740	139	39	W3FSP	1,876,171	100	27
W1UE	4,478,880	133	39	W2DXO	1,758,625	91	34
W8LZK	4,426,240	137	45	W1FSD	1,734,566	100	27
W8QAN	4,012,554	140	42	W2GVZ	1,671,000	89	31
W8BPG	3,325,777	117	44	W2HZY	1,595,286	97	29
W3HMLJ	3,116,835	116	29	W3CDI	1,477,988	79	35
W4APU	2,702,384	105	43	W8LII	1,510,400	93	35
VE2DR	2,616,196	118	30	W2JKG	1,497,672	96	36
W8BYM	2,551,934	109	37	W1IP	1,325,730	90	23
W1AFB	2,499,788	—	—	W5DXA	1,246,224	74	38
W9NUP	2,429,322	108	39	W3GCB	1,212,390	81	33
W8ONK	2,408,370	97	42	W8LCN	1,195,560	85	38
W2AHC	2,402,120	101	36	W9TKX	1,175,991	76	37
W9VEE	2,305,654	99	43	W8ACP	1,151,260	70	40
VE3GT	2,237,664	106	37	W8AQE	1,135,578	79	27
W3ADE	2,170,820	100	33	W8JA-X	1,125,140	69	32
W7CRH	2,161,725	73	38	W6GKM	1,101,512	62	36
W3JHB	2,160,527	102	35	W3BYR	1,097,194	82	32
W8JKO	2,123,356	104	40	W9OUD	1,022,480	83	29
W1ITI	2,036,225	108	28	W3BGD	1,018,710	66	32
W3FPQ	1,935,774	100	29	W4DW	1,010,556	76	32
W6IOX	1,878,888	79	42				

OFFICIAL 'PHONE STATION SCORES

Station	Score	QSO's	Sections	Heard	Power	Section
W8LUQ	7000	60	20	50	350	W. N. Y.
W6ITH	5712	42	24	14	100-1000	East Bay
W2HNP	5500	47	20	20	400	N. N. J.
W9TTA	4826	44	19	17	225	Ind.
W2LY	4389	43	19	8	750	N. N. J.
W8MOL*	4212	42	18	12	400	W. Va.
W3BSY	4140	41	20	1	600	Va.
W9KBT	3859	39	17	16	400	Wis.
W1FBJ	3762	37	18	12	200	Maine
W8JFC	3502	38	17	8	100	Ohio

* Two oprs.

Station	Score	QSO's	Sections	Station	Score	QSO's	Sections
W8PUN	3434	38	17	VE8KM	1892	32	11
W8EMV	3392	38	17	W4QI	1728	32	13
W9THB	3344	30	19	W8MOP	1540	20	11
W8CGU	3184	33	16	W9PNV	1488	32	12
W8MAD	3128	32	17	W9SDQ	1456	18	14
W9UNS	3045	33	15	W8BHN	1430	26	11
W9TRN	2805	27	15	W9ACU	1370	21	10
W8KMF	2632	32	14	W3CHB	1365	31	13
W1DWP	2528	26	16	W8CHX	1360	21	10
W8PFM	2520	30	14	W8CDR	1288	25	8
W8HFR	2252	25	14	W1EAO	1233	17	9
W2CBO	2210	28	13	W4DDB	1220	10	10
W9NHF	2160	26	15	W8MZT	1106	14	7
W6LLY	1989	35	13	W6KTB	1056	18	11
W1IMV	1932	21	12	W3RGJ	1040	18	10

AMATEURS throughout the world are invited to participate in the second South African Radio Relay League's International DX Contest to be held on the second and third week-ends of January, 1938.

Dates: January 8th (0200 GT) to January 9th (2200 GT) and January 15th (0200 GT) to January 16th (2200 GT).

General Call: All stations outside of the U. of So. Africa will call "CQ SA Test."

Bands: Any or all amateur bands may be used.

Exchanges: An RST report followed by a selected serial number is to be sent to each contact. Only one contact per band with any one station is permitted on any week-end, but stations worked on the first week-end may also be worked on the second week-end. Schedules must not be arranged either between stations or for other stations.

Scoring: Two points may be claimed for "two way" exchanges, one point for "one way" exchange. South African stations will multiply points gained by total number of countries (or subdivisions) worked. Other stations will multiply by the number of African Zones worked. (Contacts with ships at sea or in port will not be considered.)

Zones: Stations outside of the "Africas" will base their multipliers on the following Zones: ZS1-6; ZT1-6; ZU1-6; CR6; CR7; VQ2; VQ3; VQ8; ZEI; ZNI (Bechuanaland); OQ5 (Congo); FR8 and FB8. U. S. A., Australia, New Zealand, Canada and Argentina will be divided into their respective districts.

Awards: Through the generosity of Mr. G. Ross Kent, ZT6R, a trophy to be known as the "Ross Kent DX Floating Trophy" will be awarded to the member of the S.A.R.R.L. in South Africa who makes the highest score. This will be awarded each year to the highest South African. Certificates will be awarded to the winners (if S.A.R.R.L. members) in each of the African zones. The winner in each district of U. S. A., Australia, New Zealand, Canada and Argentina will receive a certificate, as will the winners in all other countries. No certificates will be issued on winning scores of under 100 points.

Returns: These must reach the South African Radio Relay League Headquarters, P. O. Box 7028, Johannesburg, South Africa, not later than March 15, 1938. The logs should show Date, Station, Time, Freq., Zone, Nr. Sent, Nr. Received, Points, Total.

A.R.R.L. Trunk Lines

ROUTE your traffic via the A.R.R.L. spot frequency all-O.R.S. Trunk Lines. These lines are operating very efficiently, and the operators invite traffic. Each line has a "manager," whose duties are to make sure that each operator keeps schedules, arrange operation to speed message handling time, recommend changes when needed, etc. Each manager makes a monthly report to Headquarters so that necessary action may be taken and records kept up to date. Each A.R.R.L. Section Net has a connection with the Trunk Lines to facilitate deliveries and provide an outlet for the Section.

To make possible the rapid exchange of traffic between the various Trunk Lines, a National Trunk Line Net is maintained on 3670 kc. consisting of one station from each Line. W8KWA is Manager of this net, which meets nightly at 10:30 p.m. E.S.T. Stations in this net are W8KWA (A), W4CXY (B), W1IP (C), W5FSK (D), W8HD (E), W9RVW/W6LMD (F), W9RMN (G), W9UEG (H), VE2LC (I), W9BAZ (J), W9KJY (K), W8HCS (L) and W8OFO (M).

Trunk Line operators deserve the highest commendation for their work. Theirs is not the "here-today-gone-tomorrow" type of amateur operation. Quite the opposite, they are on the job night after night, maintaining schedules, keeping a nationwide traffic system in operation. The A.R.R.L. Trunk Lines represent one of the finest examples of amateur cooperative effort.

The stations on each line, and the frequency on which each line operates, follow:

Trunk "A": 3805 kc., W8LSF, Manager—W2GGW W8KWA W8LSF W9PLL W9GWK W9PTU W9WDM W7CRH W7FCG W7LD (Alternates: W2GGE W8QAN W8LTT W9TYH W9HGG W9RZA W7CEG W7FZB)—New Jersey to Washington.

Trunk "B": 3795 kc., W9DI, Manager—W3BYR W8MHM W9EDQ W4HK W9OUD W9DI W9RVW W6FYR W6CW W6JVG (Alternates: W3EFM W8LZE W9CDA W4CKY W9POB W9EKQ/W9MKN W6GRB W6BIC W6LLW)—New Jersey to California.

Trunk "C": 3665 kc., W3AKB, Manager—W1GOJ W1IP W1WC W1AFB W2OQ W3AKB W3BWT W3GPC W4DW W4DVO W1DDY (Extra) (Alternates: W1EFR W1FFL W1DMF W2IHT W3GAG W4DWB)—Maine to Florida.

Trunk "D": 3865 kc., W4DS, Manager—W4DS W5GHF W5FSK W5FAJ W5DXA W5ZM W6KOL W6NSN (Alternates: W5DNE W5ENI W6OUU)—Alabama to California.

Trunk "E": 3870 kc., W8HD, Manager—W3CIZ W8HD W9ARU W9KCI W9POB W7FFQ W7CWN (Alternates: W3FSP W8OLV W9HBQ W9OUA W9PGA W7FDV)—Maryland to Washington.

Trunk "F": 3827.5 kc., W7WY, Manager—VE5EP W7APS W7WY W7HD W6LMD W6MQM (Alternates: VE5AV W7LD W7WR/ENO W6MGL W6BPU)—British Columbia to Los Angeles.

Trunk "G": 3825 kc., W7COH, Manager—W1ABG W2GTW W8BJO W8JCM W9RNM W9AZR W9WAJ W7COW W7NH W7DUE (Alternates: W1BEF W8CSE W9PLL W7GEE W7FFQ)—Massachusetts to Oregon.

Trunk "H": 3605 kc., W5AAJ, Manager—W9WLI W9FOQ W9RQR W9JAP W9UEG W5AAJ W5GFH (Alternates: W9KLL W9PB)—North Dakota to Mississippi.

Trunk "I": 3690 kc., VE4CM, Manager—VE2LC VE3VA VE3HV VE4AAW VE4CM VE4GE VE5MO (Alternates: VE2LU VE3GT VE4GC VE4CQ VE4WX)—Quebec to British Columbia.

Trunk "J": 3773 kc., W9BAZ, Manager—W9SZL (Extra) W9HPG W9BAZ W4ECP W4AXP W4COB (Alternates: W9AKT W9ARU W4APU)—Wisconsin to Florida.

Trunk "K": 3835 kc., W5CEZ, Manager—W9KJY W9PYF W9FLG W5CEZ W5MN (Alternates: W9RNM W5EGP W5OW)—Illinois to Texas.

Trunk "L": 3615 kc., W9FAM, Manager—W2BCX W2EFG W8MOT W8HCS W9EPT W9NPL W9LXC W9FAM W9EKG W8AXN (Alternates: W2GGE W8GBC W8PSF W9HLO W9KPA W9RVW)—New Jersey to California.

Trunk "M": 3855 kc., W8OFO, Manager—W2HZY W3BKZ W8OFO VE3TM W8LZK W9RWS W9KLI W5GEG W6KFC W6MTS (Alternates: W3EUG/W3GKZ W5DDC VE3OI W5ENI)—New Jersey to California.

Stations on most of the lines operate "as a net." "A" works as a net at 7:15 P.M. EST (eastern stations) and 10:30 P.M. EST (through to west coast). "B": The eastern end (W3BYR W8MHM W9EDQ W4HK W9OUD) meets at 5:00 A.M. EST. The western end (W6JVG W6CW W6FYR W9RVW W9DI) meets at 8:00 P.M. MST. A schedule between W9OUD and W9DI at 8:15 A.M. CST connects the two nets. "C": The northern end, Maine to Pennsylvania, works as net at 6:45 P.M. EST. Southern end works individual schedules, but is arranging net operation. "D": 7:00 A.M. CST Net includes W5GHF W5FSK W5DXA W5ZM W6KOL. 7:30 P.M. CST Net includes W4DS W5GHF W5FSK W5FAJ. "E": Eastern end meets at 8:00 P.M. EST. "F": Entire trunk meets at 6:30 P.M. PST. W7WY W6LMD W6MQM also meet at 8:00 P.M. "G": Coast to coast nets at 6:30 P.M. MST and 9:00 P.M. MST. "H": Lining up as net. "I": Functions on individual schedules. "J": Entire trunk meets at 7:00 P.M. CST. "K": Schedules on this line—6:30 A.M. CST W5CEZ-W5MN; 6:40 A.M. CST W5CEZ-W5OW; 6:50 A.M. CST W5CEZ-W9KJY; 5:30 P.M. CST W5CEZ-W9PYF-W9FLG. "L": Eastern end works as net. "M": Eastern end, New Jersey to Illinois, meets as net at 8:00 P.M. EST. Western end meets later in evening. The cooperation of all operators in preventing QRM on trunk line frequencies at time

schedules are in operation will be appreciated by every Trunk Line Station.

Requirements for Trunk Line Stations: (1) O.R.S. appointment, (2) crystal-controlled transmitter on T.L. frequency, (3) trunk schedules maintained at least five days per week, (4) use of standard A.R.R.L. operating procedure, (5) arrangement for an alternate to handle schedules when necessary. A schedule with a T.L.S. will provide you with a traffic outlet to "most anywhere." Use the trunk lines!

High Sweepstakes Scores

ALTHOUGH it is too early at this writing to announce any official results of the 1937 Sweepstakes Contest, we are able to pass along information on a number of high "claimed scores." It appears that W6ITH has for the second consecutive year worked all A.R.R.L. Sections by two-way radiotelephone during the SS!! And this year there were 70 to work! W6ITH's excellent record will be confirmed when final results are presented, after all logs have been checked. His is the highest score submitted so far by 'phone contestants—48,020; next high W6OCH, 12,366. In the c.w.t. ranks, W3BES smashes through with a claimed 87,937!!! 438 stations worked in 67 Sections . . . this is the highest number of sections so far claimed by any c.w.t. participant. Second high c.w.t. log is from W9FFFU—63,504. A QSL from W2IOP states that his score will be between 70,000 and 80,000. 1936 scores were bettered right and left—everyone is enthusiastic over the '37 SS. Take a look at these claimed scores. Figures show score—stations worked—sections worked: C.W.T.

W3BES	87937-438-67	W3GAU	40455-237-58
W9FFU	63504-388-63	VE1EP	39447-250-54
W8DOD	55584-293-64	W8BGX	39170-210-59
W6KC	54428-304-62	W9MWU	38940-236-55
W9RSO	54990-285-65	W8OKC	38106-222-58
W9VKF	54450-303-60	W2HNH	35461-253-47
W2AYJ	52610-293-60	W5GEY	35235-203-58
W8LAW	52200-300-58	W8BKP	34944-225-52
W1TS	49728-260-64	W1EOB	34632-222-52
W9LEZ	49208-278-59	W6GPP	33855-185-61
W9MUX	47610-267-80	W3EJ	33384-217-52
W3CHH	46500-388-60	W3GDI	33228-213-52
W1AW (Hal)	46482-382-61	W9YCR	32870-193-55
W8AHR	45243-230-66	W4ECZ	32505-198-55
W3BET	43764-264-56	W3ATR	32400-225-48
W9CFB	42639-233-61	W1GME	32332-241-45
W2PY	42510-273-52	W9TMU	31512-207-52
W9CWW	41958-222-63	VE2IN	31164-214-49
W5AQE	40992-244-56	W2GUP	30774-224-46

'Phone

W6ITH	48020-343-70	W6AM	3380- 57-29
W6OCH	12366-129-46	W9BTJ	1890- 36-27
W8FIP	8772- 86-34	W3GDY	1881- 33-19
W9YQN	8858- 65-36	W6BWG	1540- 42-22
W2IUV	6400- 80-40	W1ITI	1176- 28-14
W2JZX	4844- 87-28		

DX Century Club

THIS issue of QST carries a new A.R.R.L. list of countries. It is a longer list than that previously printed, including approximately twenty additional countries. Rule 4 for the DX Century Club is now amended to read: "(4) The A.R.R.L. list of countries (January 1938 QST) will be used in determining what constitutes a 'country.'" This should increase the totals of many a DX Century Club aspirant. It may even put a few into the actual list of members. Check over your countries in accordance with the new list and send in your confirmations.

There are no new club members this month, but a number of new calls will be noted in the "runners-up" group. G6WY increased his total to 115 countries, W8ORA to 113. As soon as you can prove contacts with 75-or-more countries

(Continued on page 53)

How's DX?

How:

In this modern world, there is only one thing you can be absolutely sure of, and that is that somewhere in a January issue of a magazine you'll find someone that insists upon setting down some resolutions for the New Year. Maybe it's because this New England clime is beginning to get us, or simply because it seems like a good idea, but we're going to fall in line and set forth a few personal resolutions. There are of course a million things that could be mentioned. These just happen to be the ones we intend to work on.

This year I resolve that I will:

1. Be so nice and sweet to the DX I work that they can't resist sending me cards. That will help towards the Century Club.

2. Ignore the locals on 7 Mc. to the point where all I'll hear is DX. That will help me towards that 7-Mc. WAC.

3. Make sure my receiver is always right on the nose so that I won't miss any of the weak ones because of misalignment or old tubes.

4. Take a tip from some of the gang and have my antennas at peak performance all of the time, not just for a week or so after they are put up. (And buy a rifle with telescopic sights to shoot down some of the branches that run too near the wires.)

5. Finish up that quick-frequency-change transmitter I've been thinking about for the past two years so that I can consider my station a modern one.

6. Try to talk W3CRA and some of those W4's into going on 160 'phone so that some of the rest of us will have a chance.

7. Quit moaning about my poor location. I've been around enough to know that plenty of fellows with much poorer locations than mine work rings around me.

(Still, it would be nice to be out on a slight rise in the center of a flat plain, with a 2° horizon and room enough for several rhombics plus a rotatable on ten. . . .)

Where:

Just to prove that we have a mean streak, we're going to give you the low-down on HZ5NL. (We *didn't* work him!) Cards to the address he gave have come back marked with the Arabic equivalent of "Not Known," so you didn't work Yemen after all. Time out while we gloat But we do know of cards being received from YI2BA, so don't give up all hope W2CYS gives the QRA of FG8BM (14,365 kc., T4) as Jean Pulcues, rue Downmerge 12, Guadeloupe Since the revised countries list gives two countries in U8 you'll be interested in U8IB (14,360 kc., T8), U8ID (14,450 kc., T8), and UK8IR (14,350 kc., T7), reported by W2CYS, W81WI and W8QQE. QSL via S.K.W. or Radio Committee, Tashkent, Uzbekistan, U.S.S.R. Know where LR7XU, worked by W8HGA, is? Neither do we W8CLS worked U1NP (28,150 kc., T9) at 8:15 p.m., which seems to be too late for the fellow to be in Europe. CLS worked J3FJ for his 28-Mc. WAC If we thought PK6HI (14,270 kc., 'phone) would be on regularly we might stick in a modulator. He's in the Celebes AA5CN (14,415 kc., T7) is in the Tangier Zone, and your card can reach him care CN1CR, Cav. Cristiani Carlo, Italian Consulate, Tangier Zone, Northern Africa W2AAL heard ZA1B (14,100 kc.), but the G's told him that no one is on in Albania, so we don't know if it's phoney or what If you haven't worked Honduras, look for HR5AK (14,000 kc., T7) or HR3A (14,040 kc., T9); and VR2FF (14,080 kc., T8) will give you the Fiji Islands VE2GE reports CR6AE (14,015 kc., T9x) on in Angola and OX2ZA (14,065 kc., T6c) in Greenland SU1EQ's mail is returned. Does anyone know his address? And where is OO4AA (14,375 kc., T9), worked by W1EAO at 11 p.m.?

When:

We haven't much dope on 7 Mc. this month except a rumor that W4DHz got S8 from J2NA on 40 the other morning, and a note from W2IOP reporting QSO's with ZL3FP, G5FA, G8RL, G5DQ, G8VQ, G8CZ, VO4BA and K7CHP during two mornings before the SS Contest. Some more 7-Mc. reports would be welcomed with open arms, as would reports on 3.5-Mc. DX. Last year some of the boys like W2BMX and W8CNC were knocking stuff off right and left on 80 W4CYY is keen enough about 40 to have sent us a nice check to help buy back the band for the DX men. It runs about \$200 a kilocycle, so we still need plenty of contributions.

On 28 Mc. you can just about write your own ticket. W8CLS reports 'phone contacts with SPIHH, FA3JY, SM7YA, CN8AV, FQ8A, and ZU6E, and keeps a regular schedule with VK5KO. VK5KO has just completed his WAS on 10, working 632 different W's to get it W2BHW heard VU2CQ (28,200 kc.) RST579 the other morning W2IXY reports HK1Z (28,110 kc.) on 'phone around 2 p.m., and W8QQE gives TF6C (28,260 kc., T9) and LA4P (28,240 kc., T9) And to cinch the deal, W6JFJ worked 23 countries, had 33 European QSO's, and made WAC during 20 days of operating on 10.

Although 14 Mc. isn't as solid for 24 hours each day as it was, there is still plenty of things and stuff hanging around. Were you on the evening ZP1AX (14,410 kc., T7) first got on the air? He let out a CQ and so many W's called him that he had to ask them to call him again, signing their calls often, and he'd give them group reports. We got tired counting the number of stations he reported. This type of operation brings up the point as to whether or not you can count contacts like that as "two-way." We doubt it, but refuse to get into an argument about it. ZP1AX uses four-half-waves in phase and pours in a beautiful signal, from the standpoint of volume W2BHW is really going after this DX business, and recently accounted for such items as VS7RF (14,330 kc., T9), XU8HM (14,035 kc., T9), XU8RL (14,300 kc., T9) on sked, F18AC (14,085 kc., T9), J2KQ (14,160 kc., T8), VS6AF (14,270 kc., T9), ZC6AQ (14,275 kc., T7b), CR7AW (14,285 kc., T9), and UPOL (14,025 kc., T7) W2AAL contributes J8CF (14,175 kc., T9) and VU2FH (14,145 kc., T9), and W2GTZ kicks through with HS1BJ (14,060 kc.), CN1CR (14,350 kc.), PK1VX (14,360 kc.), KA1CS (14,360 kc., T9), and heard but not worked, XU9HC and XU9MK (14,100 kc.), XU7CK (14,220 kc.), and PK1AI (14,075 kc.) Out west, W6JMR has moved to a new QTH which he likes a lot, even if the DX does come through at odd times. New ones there include VQ4CRO (14,080 kc.), CR7AK (14,085 kc.), CR7AJ (14,260 kc.), and FB8AD (14,300 kc.) W3EMM and W3FQP worked XU8AZ (14,475 kc., T9x) one evening around 6 p.m., and rather doubt his authenticity. We're inclined to think him OK, however W2CYS drops in with VU2FS (14,360 kc., T9), VQ3FAR (14,400 kc., T8), KA1ER (14,320 kc., T9), KA1SL (14,290 kc., T9), PK1BX (14,285 kc., T9) and PK1RI (14,360 kc., T9) On 'phone, the Holden Expedition, VP3THE (13,780 kc.) is scheduled by W2IXY, and comes through well between 8 and 10 p.m., EST W9EF gives VU2FV (14,125 kc.), KA1AN (14,130 kc.), PK1BO (14,170 kc.), FY8AC (14,410 kc.) and VP7NH (13,990 kc.) Down South, W4ELQ worked J2OD (14,250 kc., T9) at 1:45 a.m. CST, and says the U9's (frequency you know where) come through from 9 p.m. to 2 a.m. W8QQE has been busy with such stuff as YT7TJ (14,420 kc., T7), XZ2DP (14,070 kc., T9), XU6SW (14,405 kc., T9), XU3MA (14,070 kc., T9) and FR8VX (14,430 kc., T9).

How:

W3EVT sends in some good pointers on EC oscillators. He says that the way to good stability is with at least 300 μ fd in the cathode circuit, and keeping the cathode tap as close to ground as possible. Clem uses an 802 in his oscillator, and, strangely enough, finds that he gets better harmonic output by using a split-stator tank circuit in the plate.

Out around Los Angeles we found a tendency for the DX men (and there are plenty out that way!) to go in for Q and other efficient types of feed on simple half-wave antennas, strung up as high as they can get them. The idea seems to be to get as good general coverage as possible, instead of confining activity to just a few directions as is done with some of the sharp beams they used.

Who:

We had nice visits with W6QD, W6CUH, W6CXW, W6LYM, and a flock of others. Had a chance to operate at W6QD, and after we had pushed the microphone out of the way and dusted the cobwebs off the key we found that we couldn't work any farther east than W9. But it's all right, because Herb told us, confidentially, of course, that he's working towards a WAN (Worked All Nines) K7RT is old W7RT and is up around Goodnews Bay on the Bering Sea. He says it's a honey location for DX, with everything from 160 down chock-full of stuff. He'll be back this month, so QSL to 1921 Atlantic Street, Seattle, Wash. Johnny acquired a number of hand-carved ivory paper knives which he will be glad to exchange with foreign amateurs in return for representative gadgets. You know, a boomerang or kangaroo from VK, a penguin from Antarctica, a diamond from ZU, etc., etc. W6NKY, the station of the 20-40 Club, made 7680 points during the recent VK/ZL Contest There is a certain insouciance about W2GVZ that gets us. Whereas most fellows count themselves lucky to work Japan for their first Asian, Pat put it off until the other day, when J2JJ gave him his 95th country KA1MD is back in this country, and if he overlooked a QSL for you, he'll be glad to send you one from 727 Chestnut Avenue, Long Beach, Calif. The name is Maurice Corson HS1BJ sends a nice letter, mostly correcting our inadvertent errors about him. First, his QTH is Saladong, not Saladeg. Then, he's not the owner but simply the builder and chief of, the rigs belonging to the Royal Posts and Telegraph Department. He is appointed by the government to carry on ham work because private amateur stations are forbidden in his country. The c.w. rig now runs at 50 watts, and he's looking for South America for a 'phone WAC G2ZP would like some of the South Americans to be on the watch for him on 14-Mc. 'phone and 7-Mc. c.w. W9ALV, with whom we had a nice visit in Kansas City, has been using his 95 watts to good advantage, VU2FV, XU6SW, UP0L, VE5ACS (Resolution Island), YT6MBN, VP4CF, U9MN, VS7RF, and VU2AE being among the latest OX2QY, the McGreggor Expedition, seems to be having a little trouble. He hasn't been heard around here lately W6KUT, whom we also met on our trip, has definitely arrived in the DX ranks. Some of his better ones include YI2BA, K6TE, AU1AU (7100 kc.) at Tomsk, K6TE, F18AC, HR1AA, CR9AC and VS1AA.

There just ain't no more DX. On good authority, via W6HG and W6ADP, we hear of the record-breaking performance of W6DUC on 10. W6ADP says that W6DUC called CQ and signed three times. When he switched over, a weak, hollow, and very creepy spooky-sounding signal was on DUC's frequency. It sent "W6DUC W6DUC W6DUC AR K" just as DUC had done! Apparently it was a long-delayed echo from the outer reaches of space, and ADP had quite a chat with DUC about it, noting each time that the echo would persist after DUC had switched over. It figures out that the signal must have travelled for 15 or 20 seconds, which should set an all-time DX record. At least it sets some kind of a record! (Seriously though, the same phenomena has been observed on several occasions, and has been reported and discussed in the I.R.E. Proceedings and elsewhere. The longest echo reported was something over 4 minutes!)

Contests:

Don't forget the S.A.R.R.L. Contest, to be held the second and third weekends in January. See the rules given elsewhere in this issue.

And while we're at it, we might mention the BERU Contest to be held during February weekends. Remember that this contest is held for the British Empire countries, and for W or other stations not in the British Empire to call BERU contestants simply causes unnecessary QRM and wastes the contestants' time. We'll admit that some of the DX that gets on for the Contest is prime stuff, but the least we can do is give them a break (and curse our luck!).

See you at the first meeting of the Century Club. (We'll be there as a visitor!) —W1JPE

BRASS POUNDERS' LEAGUE

(October 16th-November 15th)

Call	Orig.	Del.	Rel.	Extra Del. Credit	Total
K6OCL	308	115	975	42	1440
W4PL	14	24	1218	10	1266
W6IOX	24	102	932	97	1355
W8ECS	117	200	480	140	937
W6LMD	9	9	912	3	933
W8MOT	380	4	389	4	777
W8KVA	25	55	694	—	774
W8CIZ	47	175	333	165	720
W1HH	110	170	392	38	700
W6THT*	112	210	187	134	693
W8ESA	61	92	430	33	666
W6MGL	6	5	648	1	660
W8OFO	119	85	403	47	654
W1IOT	63	492	77	18	650
W1UE	145	255	108	141	649
W6TMI	59	194	216	178	647
W1AKS	104	172	361	9	646
W6BMC	10	7	614	3	634
W1INU	73	62	496	—	631
W6CXV	64	46	492	19	621
W6JTV	33	171	191	154	609
W8LRF	69	61	396	78	607
W6LLW	44	27	522	4	597
W9FAM	18	23	546	—	587
W9LCX	15	49	10	494	568
W9EKQ	10	28	498	—	536
W8NFL	13	16	494	12	535
W8NFT	6	14	494	12	526
W3BWT	65	61	361	35	522
W1IP	13	22	476	9	520
W1GOJ	52	65	362	32	511
W8QAN	37	48	340	33	508

MORE-THAN-ONE-OPERATOR STATIONS

Call	Orig.	Del.	Rel.	Extra Del. Credit	Total
K6OGD	235	239	1230	125	1829
W5OW	178	403	554	79	1214
W8BT	126	23	519	—	878
K6NXX	366	88	66	52	572

These stations "make" the B.P.L. with total of 600 or over. One hundred deliveries + Ex. Del. Credits also rate B.P.L. standing. The following one-operator stations make the B.P.L. on deliveries. Deliveries count!

W6BQ, 244	W1IOR, 140	W2PF, 104
W6LBB, 178	VE4AAW, 131	W1JCK, 103
W6MQM, 164	W1EMG, 126	W1DMP, 100
W9HPG, 151	W2OQ, 126	W6HH, 100
	W8UK, 105	

A.A.R.S.

Call	Orig.	Del.	Rel.	Extra Del. Credit	Total
W1MA (W8YA)	11	5	785	3	804
W1AM (W7NH)	11	26	459	—	506
W1R (W4IR)	35	143	532	66	776

W1MI (W6GX) made the B.P.L. on 181 deliveries.

MORE-THAN-ONE-OPERATOR STATIONS

Call	Orig.	Del.	Rel.	Extra Del. Credit	Total
W1M (W3CX)	164	179	2084	—	2427

A total of 500 or more, or 100 deliveries Ex. D. Cr. will put you in line for a place in the B.P.L.

* All traffic handled by two-way radiotelephone.

O.B.S.

The following is a supplement to the list of A.R.R.L. Official Broadcasting Stations in October QST (page 50): W1GOJ, W1IMV, W1VF, W5ENI, W9BYV, VE1EV.

(Continued from page 50)

(100 countries rates membership in the DX Century Club), send your confirmations so that you may be listed in *QST*. Those already listed should continue to send additional confirmations as received. With the advent of the new country-list we expect to be kept busy checking claims!

MEMBERS, DX CENTURY CLUB

	Different Countries	
H. A. Maxwell Whyte, G6WY.....	115	
Frank Lucas, W8CRA.....	113	
John Hunter, G2ZQ.....	106	
Jefferson Borden IV, W1TW/W1CMX....	105	
Douglas H. Borden, W1BUX.....	104	
Henry Y. Sasaki, W6CXW.....	101	
Clark C. Rodimon, W1SZ.....	101	

The following have submitted proof of contacts with 75-or-more Different Countries:

W1TS.....	95	W1DUK.....	80
W2GTZ.....	91	W3BES.....	79
W2GW.....	88	VE2EE.....	79
W8OSL.....	88	W6FZL.....	78
E15F.....	88	W8KKG.....	78
HB9J.....	87	G2DZ.....	78
W6GAL.....	86	W1RY.....	77
W9KA.....	86	G5QY.....	77
W1DF.....	84	W2GVZ.....	76
W8JMP.....	84	W9ADN.....	76
W1ZI.....	83	W3BVN.....	75
W9EF.....	82		

STATION ACTIVITIES

CANADA

VANALTA DIVISION

ALBERTA—Acting SCM, Jas. Smalley, Jr., VE4GD—LX has gone with family to the South in an attempt to cure his son of a leg injury. GD is Acting S.C.M. during LX's absence. LQ sends his usual fine report for the Edmonton gang. IZ says Calgary is FB DX location. HT is spending a busy winter DXing. AH again proves the old saying, "The 'phone bug will get you if you don't watch out." PH has returned with big tales of Kalifornia Killowatts. AGZ works East Coast with low power. AEA liked 56 Mc. but the B.C.L.'s didn't. ADW and VJ were heard working hard in SS Test. HJ is getting the bugs out of a new rig. EA gave a talk at the club on NC100X. LQ visited the South gang and had a personal hook-up with the Trunk Line gang, GE and WX. BW plans trying 28 Mc. 'phone. YD is a new O.R.S. JP visited Edmonton. HM has a Johnson "Q." HF blasts 3.5 Mc. with 2 watts. The N.A.R.C. is now affiliated with A.R.R.L. AFT, WJ, TY and GD kept Calgary in the SS picture, with GE more than holding up Drumbeller's end of it. WJ is now W.A.C. on 'phone. TM is rigged up for 28 Mc. AIQ is WJ's XYL; she thinks her 6L6 rig has them all beat. ABZ has a Super Skyriver. AW likes turning the wheel on his signal squirter. Through the efforts of NF the C.A.R.C. has fine new club room on Ninth Ave., East. AEV is on 1.75 Mc. 'phone. SN is using 28 Mc. AKG at Kirkcaldy is reported as Canada youngest ham; he is 13. The father and son station, FI, is now two separate stations with Bob, Senior using the call AEF.

Traffic: VE4GE 20 LQ 10 QK 1.

PRAIRIE DIVISION

MANITOBA—SCM, A. J. R. Simpson, VE4BG—AAW is doing a fine job as Trunk Line Station. South traffic is relayed to 9RZA in North Dakota, west to 4CM at Regina and 4CQ at Waldron, and a long hop east to 3VA at Toronto. The lining up of feeder stations is progressing. Stations interested in handling traffic are requested to get in touch with the S.C.M. or AAW. AHU has been dividing time on 14 and 28 Mc. QO with his FB 'phone moves between 14 and 28 Mc. JE is building a new receiver. TR is back after a long lay-off. TJ finds his rotary beam very successful on DX. GL is making changes in exciter and buffer. IP is making changes

in antenna setup. OK with his 14-Mc. 'phone is back on. QF is in Kansas City. RC is trying 'phone for a change. SB has a pair of 35-T's in the final. SR finds 28 Mc. better than 14 Mc. AG is heard nightly with 3.9-Mc. 'phone. BB at God's Lake puts the company rig on 14 Mc. quite often and keeps in touch with the gang in Winnipeg. DU is building another super. GQ has a pair of T-55's plate modulated. KX has been working plenty of DX on that new Collins rig. RO has been rebuilding power supplies. UX is permanently back in Winnipeg. ZK has been using 'phone on 14 and 28 Mc. ZV has about finished building new rig. The St. James

CANADA

ALL-VE CONTACT CONTEST

January 15, 16, 17, 1938

This contest is sponsored by the VE Operators' Association, and is open to all VE stations. Contacts may be made on any band, either c.w.-c.w., 'phone-'phone, or c.w.-'phone. For proof of contact each station shall transmit the frequency in kcs. being used at the time of contact. No contact may be counted unless frequency is both transmitted and received. The same station may be worked more than once and count as a different station provided the contact is made on another band.

Scoring: For each contact with a station in the same province *one point* shall be counted. For each contact with a station in an adjoining province *two points* shall be counted. For each contact with a station in the second province away *three points* shall be counted, etc. Thus, a VE3 contact with Alberta shall count four points. A VE2 contact with Alberta shall count five points. No contact shall count made with a station in the same town or city, or with a station within a radius of five miles of your town or city. For this contest Newfoundland shall be considered as a province adjoining Nova Scotia on the East. Prince Edward Island shall be considered as between New Brunswick and Nova Scotia. Thus a contact between VE2 and VO shall count five points. The total number of points shall be multiplied by the number of provinces worked, thus the maximum multiplier shall be 10. If not more than 75 watts input is used to the final stage of the transmitter your score after the province multiplier shall be multiplied by 1½. Date, Time, Transmitting Frequency, Station Worked, Province, Frequency Received, and Points shall be the headings of each column on the log to be submitted. Logs must be postmarked not later than January 30th and should be sent to the Secretary, VE Operators' Ass'n, VE3GT, 46 Dunvegan Road, Toronto, Ont. Members of the VE Operators' Ass'n may take part in the contest but shall not be eligible for any prizes.

The contest shall run from 4:00 P.M. E.S.T., January 15th until 3:00 A.M. E.S.T., January 17th, 1938.

Radio Club held open house on Nov. 10th with a large attendance of Winnipeg and St. James amateurs. The M.W.E.A. held its annual meeting and is getting under way for a busy season. On Nov. 26th the Winnipeg Radio Club held dinner and dance. Amateurs in this district are requested to be on the look-out for VE5SY on about 14,000 kc. This is the Wilkins' expedition searching for the lost Russian fiera. The rig is a Collins 45A and a National 100X receiver, operated by Hollick Kenyon, VE4YE. When opportunity permits he will be on this frequency looking for amateur contacts. AEF is keeping 3.5 Mc. hot with his c.w. signals. WW has a new Super Skyriver receiver. TQ will re-build the breadboard lay-out into rack and pane. FN is using a 6L6 exciter unit and schedules GC in Winnipeg three times weekly. Winnipegosis is kept in things by HN, using a '47 crystal driving a 250 final; he schedules Winnipeg three times weekly to AAW on the Trunk Line. AC was a visitor to Winnipeg recently.

Traffic: VE4AAW 210 BG 6.

SASKATCHEWAN—SCM, Wilfred Skafie, VE4EL—The Moose Jaw gang had its first club meeting of the season Oct. 25th and will hold one every second Monday from that date. New officers: pres., Austin Capper; vice-pres., Arthur Chesworth; secy.-treas., Mervin Pickford; act. man., Fred Kyosnish, AIE. UN is active on 14 Mc. EF is using grid modulation on 1.75-Mc. 'phone with 5 watts input. ES is on 14 and 3.9-Mc. 'phone with 40 watts input. WF will be on 14 and 7-Mc. c.w. in near future. PV is looking for vibrator power supply to use with 6V6 crystal osc. ABF is getting out well on 3.5 and 7 Mc. with '01A and vibrator supply. ACC is going to use 53 into '46. VZ is going to build Jones exciter. CQ has been made Alternate Trunk Line operator. LY wishes to be O.P.S.; he uses 6A6 P.P. crystal osc. into '10 into P.P. '10's. Our old timer, Val Mock, now VE5ACO, reports from Hyder, Alaska. "X" marks the spot where your report would have appeared if you had sent it in. UK gets out well on 14-Mc. 'phone but is going to use 6L6 osc. into 807 buffer into two T20's. EL gets out poor to fair on 14-Mc. 'phone. ACR still has a nice burble on his modulation. XL gets out well with grid mod. 14-Mc. 'phone. Manly Haines, 5MQ, wants to be remembered to the old gang in this Section.

Traffic: VE4CM 130 CQ 83 EL 5 KJ 2 MX 1.

MARITIME DIVISION

MARITIME—SCM, A. M. Crowell, VE1DQ—Nova Scotia: MK, the local H.A.R.C. station, is now active. FQ made his first South African 'phone contact. AW received some nice reports from VU land on his 14-Mc. 'phone. DB gets out well on 14-Mc. c.w. EK has been DX hunting in the wee hours. DQ completed the signal squisher, getting 88 from the first G. EP was active in the SS. MF has been doing some brass pounding on 14 Mc. New Brunswick: Interesting dope on the Moncton gang via EV: LP is doing FB with 7 watts input on 3.5 Mc. JU changed QTH to Hillsboro, N. B. We hear from G2AV that GL has been putting the 14-Mc. 'phone over there of late. Nice work, Bill. IJ hits 7 Mc. with a pair of '46's push-pull. IL is rebuilding. EV had a pleasant visit from W2JMH. GI and FF have been transferred to Ottawa. Sorry to lose you, boys. LO, at Woodstock, with 20 watts input from dynamotor to 6L6 tri-tet, jumps into the much-needed traffic breach and is now in line for O.R.S. Interesting dope from the VO boys via VO1W: VO1A has the All-Star 400-watt 'phone and c.w. kit nearly completed. IB is experimenting on low-power 'phone. 1C's rig is 42 crystal and 6L6 with 25 watts. ID has new Super Sky-rider. IG expects to come back now that he is in town again. IH has second Junior operator. Congrats, "Pop." II is doing portable mobile work on 28 Mc. from the car, also active on 14-Mc. 'phone and 7 Mc. IJ is considering to merge with IH on 56-Mc. portable-mobile. 1K is adding an 807 to his 6L6 crystal oscillator and heading for 28 Mc. 1L is now "Daddy." 1M is active on 7 Mc. 1O has gone to Newfoundland Airport and expects to be on the air soon. 1P is active on 14-Mc. 'phone and 7 Mc. 1U has gone crystal-controlled with a 6L6. 1W is using a 6L6 crystal, 6L6 buffer and pair in P.P. final, 60 watts. 1X has 6L6 crystal, 6L6 buffer and pair '10's final, 80 watts on 14-Mc. 'phone. 1Y is working good DX on 14-Mc. c.w. with 10 watts input and Sky-rider. 1Z is settling down to the building of a 6L6 oscillator. 2D expects to be on 'phone this winter. 2J is active on 'phone and 7-Mc. c.w. 2N is on 14-Mc. 'phone occasionally. 2S and 4K hold regular QSO's with each other on 3.5 Mc. Sympathy is extended to 2Z on the death of his XYL. Ish of VO3P was in St. John's for a couple of weeks and visited the N.A.R.A. headquarters as well as the hams. 3X is to be congratulated on his W.A.C., making the second in Nfld. 4A is active on 'phone with his Gross. 4C is on 7 Mc., working 11 daily. 6D (Six ducks) is active on 14-Mc. 'phone with 200 watts. 6B uses crystal-controlled 6L6, modulated by 6L6. The annual Convention of the N.A.R.A. was held at the Octagon on November 11th. All the local hams were present as well as 8X, who came to St. John's to attend. Also present was the Secretary of the Department of Post and Telegraphs. A swell time was had by all—IH drew the 807. Later in the evening he auctioned it off and 1P got it. The Committee

elected to hold office for the following year: 1H, 1K, 1J, 1L 1M, 1Y. At 12 o'clock the gang were invited to 1H.

Traffic: VE1MK 36 LO 14 KB 13.

ONTARIO DIVISION

ONTARIO—SCM, Fred H. B. Saxon, VE3SG—R.M.'s: 3DU, 3GT, 3MB, 3QK, 3TM, 3WK. ABW is going to England as Marconi operator. The Toronto, Hamilton and Brantford gangs will be very sorry to lose Jeff. DU can go places on 3.5, 14 and 28 Mc., but seems to have no luck on 7 Mc. HI is working DX with new vertical antenna. ACO is on again after being off for a year. WM is rebuilding. ADC is on 14-Mc. 'phone. AQF, AQQ, AQJ and AQK are new in London. Welcome, men, and greetings from the whole Section. WP has gone to 14 Mc. KC, TN, GV and AJE are active on 7 Mc. AEV is on 14-Mc. 'phone. DU was a visitor at VZ, WK and SG, also Brantford Hamfest, while on vacation. Incidentally, gang, that Brantford Hamfest was a knockout! HV in Smooth Rock Falls is taking over the northern Ontario link in the Trans-Canada Trunk Line. AJB is carrying a nice bunch of schedules. LB, HP, VU, AGC, AKK, AOG, AQB, APZ, ABV and 9AT are active in Chatham. HP sent in cards for W.A.C. and W.A.S. ANO has 59 crystal osc., 46 buffer-doubler, and '10 final. Latest O.R.S. appointment is "Daddy" Dawes, 3NM, ex-2BB. AMB has 53 crystal osc., 46 buffer-doubler and T20 final with 60 watts in. RB had 23 visitors on afternoon of Brantford Hamfest, and reporter from local paper, who interviewed W8LTU, gave amateur radio a fine write-up. Ex-3FP, now 9BW of Windsor, motored 175 miles to the hamfest and stayed overnight with RB, TM and OI motored down from Leamington for the hamfest. DH has been handling traffic from the MacGregor Arctic Expedition in Greenland. SS is in Toronto studying for commercial ticket.

Traffic: VE3VA 216 SQ 176 AJB 79 WK 66 TM 54 GT 53 OI 50 NM 35 MB 29 AU 28 DH 24 VC 18 VD 12 CP-AND 9 QB 8 PE-ZE 7 LI 5 NC-LG 4 SS 3 DU 1 VE9AL 17.

QUEBEC DIVISION

QUEBEC—SCM, Stan Comach, VE2EE—The Division offers its condolences to VE2BG and family on the death of Tommy's father. New officers of Quebec Radio Club: pres., AB; vice-pres., LE; secy.-treas., HL. AB and EY made a trip to New York and Philadelphia recently. HL erected a couple of new poles. IT is back on the air. DU visited the Quebec gang. NI and his XYL also visited Quebec. BW is back on with increased power. HL was in contact with VE1GR for four and a half hours recently, while five chess players in Quebec tested their skill against five players of the Bluenose Chess Club. Congrats are in order for DR; Bill has a new YL op. The Produced in Canada Exhibition was aided in its Radio Dept. by two ham stations; VE2DN, the French Club, utilized the transmitter from JY, while the S.C.M.'s transmitter did duty for the M.A.R.C. Many messages were handled, and thanks are extended to those who assisted so nobly on the receiving end; they include CA, GA, BG, EX, BO, ID, HL, AG, CH, HT, AB, EC and CX. To the boys who assisted in operating both of the Sun Life stations we extend our thanks also. BU has completed new transmitter, band switching in all stages except the final. LU has been busy handling traffic. HP erected new 40-foot pole in an adjoining field. BO has put up an 8JK beam. EC visited his old home in Grand Mère. G6WQ was visitor at Bo, and Geoff brought him down to see the S.C.M. KM is on 14 Mc. with a nice clean signal. EW built a new modulator. DQ is still getting more than his share of DX. KA is doing well by himself also. AA has a brand-new NC-100X. BV is doing well on 14-Mc. 'phone from Valois. AP has purchased a Comet Super-Pro. AX contemplates using 14-Mc. 'phone again. We understand that CU is due to join the ranks of the Benedicts very shortly. Congrats, John. FY has been keeping schedules with 3NM, and Daddy visited LC and the gang some few weeks ago. IY has bought two T-20's for his final. The doctor has granted HT a permit to operate once again.

Traffic: VE2EE 210 ID 78 CA 27 BG 32 EC 20 AB 24 DR 42 IN 11 BU 9 LU 86 HT 30 KF 25 LC 65.

(Continued on page 84)



CORRESPONDENCE

The Publishers of QST assume no responsibility for statements made herein by correspondents

I.F. and Images

74 Wood St., Pottersville, Mass.

Editor, QST:

Congratulations to George Grammer on his article in September QST, "Pick Your Spot on the Neighbors' Supers." He rang the bell, but did not go far enough. How about picking an i.f. which will not throw an image from any ham band into the b.c. band? It is a well-known fact that there are more amateur stations than any other type in the United States, and it seems that manufacturers should design receivers which would eliminate images from this widespread source.

A well-known manufacturer of communication receivers for amateurs has just announced a new receiver with 1560-kc. i.f. If the advantages of the higher-frequency i.f. are as outstanding as claimed, many manufacturers of all-wave receivers will soon be using it. When b.c. receivers come out with 1560-kc. i.f., may the F.C.C. have mercy on us, because most of the high-power boys on 75 and 80 meters will be tangled with the b.c. gang. Please don't let things get started that way.

An i.f. of 1725 kc. is not far removed from 1560 kc., but we will have no images to bother our neighbors with new receivers. Granted, we will still have harmonic beats, but that is better than beats plus images.

I think A.R.R.L. should get this thought around where it will do the most good.

—S. W. Thomas, W1IXO

On the November Editorial

84 Cortland St., Norwich, N. Y.

Editor, QST:

One of the best editorials I have seen in a long time in the November issue.

I am glad someone has taken a new slant on the subject.

—J. B. Frye, W8IY

De Luz, Calif.

Editor, QST:

Just got through reading your editorial in November QST. Also have read "Adding Ideas to Ham Radio," by W6EP. I think the two go together very nicely. With these two articles as a

foundation stone we should start a movement to put operating on a higher plane. . . .

—E. C. Richman, W6MSN

1150 Bland St., Bluefield, W. Va.

Editor, QST:

Both the regular editorial and the one in the Operating News are extraordinarily good, but how many of the thick skulls are they really going to penetrate? You have probably already heard a mighty chorus of howls from guys incensed at the League ordering them to throw away their old equipment, not understanding the spirit in which it was written. Then, being an incurable pessimist, I can't see how you are going to beat any decent and up-to-date operating practices into the domes of most of the guys.

I read somewhere an editorial on something that made an unforgettable impression on me. It was to the effect that you can take almost any respectable, law-abiding citizen and upon placing him under the wheel of a high-powered automobile, he is automatically transformed into a homicidal maniac, with no thought for anyone else and very little for himself. Sometimes I suspect that a lot of the hams are much the same way when they sit down to their operating tables. Regardless of oft-repeated admonitions, they persist with long CQ's, long calls, no bk-in, overmodulation, highest power for local work, r.a.c. notes, and whatever else they think will bring them results, with no consideration for others and with no understanding that they are really getting nowhere. . . .

Well, what am I going to do about it? Nothing of any importance, of course. The answer, as every intelligent person knows, lies in that (at present) unattainable panacea for crime, alcohol, sex relations, eugenics, religion, and all the other problems that beset humanity—"education of the masses."

For my own part, though, I might mention a few principles which I advocate, and follow fairly closely myself.

First, a realization that it is not necessary to spend a lot of money on a station. If more fellows would take pride in how good a signal they could get out of a few dollars' worth of junk, instead of how fine and powerful a rig they can own, they themselves would be much happier and the rest of the world a lot better off. (On second thought, maybe this doesn't apply to the radio manufacturers!)

Second, a bit of sensible operating. This covers a lot of territory, such as using judgment in calling, using abbreviations and forms where desirable, and at other times using a real conversational style, on voice or any speed code. It also covers another principle which might well stand out by itself. That is, knowing fairly well what is on the band in which you are operating, especially on your own frequency, and never deliberately causing serious interference with anyone. The bands may be pretty well crowded, but there should always be some place you can operate. This doesn't mean a clear channel, but it does cover such things as calling CQ in the middle of an organized net.

Third, attending as many amateur meetings as circumstances can be stretched to permit. This includes belonging to a club if possible. . . .

—E. W. Meador, W9EWM

SWL QSL

1502 West Ave., Austin, Texas

Editor, QST:

Something should be said and *done* about the fast-growing nuisance of cards from short-wave listeners *within the United States*. What started as a legitimate and even laudable way for beginners to break into the game has now become a big-time way for every b.c.l. with an all-wave receiver to obtain a lot of QSL cards to impress his visitors. The s.w.l. card printers, not adverse to the situation, have made things worse by printing and widely advertising cheap, rubber-stamp s.w.l. cards.

There is still some excuse for foreign s.w.l. reports that might let an operator know his signals were getting into a DX point which he had been unable to contact; however, the "signal report" of the American s.w.l. is now merely an excuse for the aggressive demand for a QSL that invariably follows. In the first place, any operator on the higher frequency bands (14 and 28 Mc. are most used by s.w.l.'s) with a ten-watt transmitter and a piece of wire strung out to the back fence knows that his signals will, under decent conditions, reach each coast. Then, too, the s.w.l. always sends his card to the *loudest* instead of the *weakest* signal he can hear, and it has been my personal experience that the majority of the s.w.l. cards I receive are from points *closer* than the station they report my contact with!

Granted, then, that in making a "report" the s.w.l. is simply asking the station operator to do him a favor and give him a QSL card. At first thought a one- or two-cent radio card seems a small enough thing to ask for. But consider my experience (which is only the experience of all other active amateurs) where I receive on an average of from five to ten s.w.l. cards from within the United States every day. Less than ten percent include any return postage, so it becomes evident that cards and stamps to answer all s.w.l. cards would be from three to five dollars every month. The actual expense is only one item, however, and the time necessary to fill out, address, and mail such a stack of cards would make a sizeable dent in my available operating time. It is clearly evident that the "simple request" of the s.w.l. for a card is *not* such a simple matter when considered in its entirety!

It seems to me that the logical thing to do is to discourage such s.w.l. practices by wide publicity in QST in order to prevent the unpleasantness associated with the amateur's necessary refusal to answer such s.w.l. cards. Perhaps if the s.w.l. addict is made to realize just *what* he is asking he will have the courtesy to refrain from making pointless "signal reports!"

—W. T. Caswell, Jr., W5BB

Lima Center, Wis.

Editor, QST:

Am I interested in reports saying I am QSA5 R9 in adjacent places? It is quite obvious that easily half of the cards sent are not for the purpose of helping the amateur concerned but to get a large collection. Only a very few are appreciated and they are not always the DX cards. A case in point: One amateur was trying to get on 20-meter 'phone. He called many and called plenty of CQ's. Cards came in

soon indicating that he had landed on 40 meters and that he was R9 in quite a few places on 'phone. Unusual DX or anything that may interest the amateur in improving his rig are appreciated but 95 per cent of the s.w.l.'s received help only Uncle Sam. . . .

—Clinton E. Gates, W9KBT

53 East 7th St., Holland, Mich.

Editor, QST:

Recently there were a few articles in the Correspondence section regarding the use of W9-SWL on the short-wave listener's cards. I agree 100 per cent with the gang as well as the F.C.C. that this should not be used by short-wave listeners on their cards.

However, here is the entire solution to the matter for all concerned. If short-wave listeners desire to signify their call letter district in which they happen to live they should put on their cards "SWL-W9," or whatever district they happen to be from. Notice the W9 comes last, *not first*. It is entirely wrong to put the W9 first but there can be no objection to it being placed *after* the "SWL."

—Rus Sakkers, W8DED

Manufacturers, Take Note

Wood St., Tuckerton, N. J.

Editor, QST:

In building a new rig one casts a look over available material in his junk box and among his unused parts. That's where the trouble begins. You pick up a condenser and then you check to find its break-down voltage and its maximum and minimum capacity. You pore over the catalogues and look at the pictures, but when you find the condenser pictured and look over the numbers you cannot tell which is which, whether it is 35 $\mu\text{fd.}$ or 50 $\mu\text{fd.}$ or 75 $\mu\text{fd.}$. Ah, you will count the plates! But then when you know the number of plates the specifications in the catalogue give everything but that! The writer has now on the bench two Cardwells, three Hammarlunds, two Nationals and three Buds, but, armed with a book-shelf of catalogues, he has not been able to tell which is which. On the other hand he must find out before he goes ahead with the construction. Please, Mr. Manufacturer, stamp on the condenser—not on the box so quickly lost—the break-down voltage, the minimum and maximum capacities and, if you expect to keep the same system of numbering for more than one season, you might stamp the number also. But, come short-wave or long, magnetic storms or disturbing spots on the sun, please, Mr. Manufacturer, stamp on your condensers the capacities and the ratings.

—H. H. Lippincot, W2DH/S

1715—1800 Dead?

57 Strathcona Ave., S., Hamilton, Ont.

Editor, QST:

I have just finished reading another letter about what should be done with the 1715- to 1800-kc. part of the 160-meter band. There have been many lamentations about there being no activity in that part of the band. It would seem to me that it is about time that some of the kickers bought good receivers. Besides the c.w. that is allowed there the part from 1750 to 2000 is allotted to Canadian amateurs for 'phone.

There are quite a number of fellows active in that part of the band. The fact that it has been branded as dead and that it is exceedingly difficult to contact an American station would lead me to believe that most of the fellows never tune there.

There are several very good reasons why we cannot compete with American stations in the power race, and therefore we feel that we are entitled to that part of the band. Two of the best are: The legal power limit in Canada is 500 watts, and the prices of equipment are much higher in Canada.

So instead of declaring 1715—1800 dead, how about tuning

(Continued on page 58)

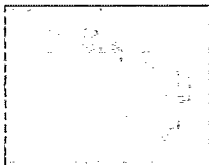

At this season it seems to be the custom for advertisers to show a picture of Santa Claus, preferably climbing down a chimney with a suitably labeled package in his pack. We have never done

much along this line, partly because it is not at all clear to us how the Old Gentleman would manage to climb through an array of antennas at midnight, to say nothing of the reindeer. Yet he does, of course, and if the messages from those arrays tell us anything, he gets a warm reception. From all over the world on Christmas Eve we pick up messages of Christmas Greeting.

So although we do not appoint the Old Gentleman officially as our salesman plenipotentiary it is not because we lack the Christmas feeling. We appreciate his work deeply, and extend to him our best wishes and fullest cooperation.

The little stamp on this page expresses Christmas in print as well as any way we know. Amateur Radio, by eliminating the barriers of distance, expresses Christmas by the spoken word the best way we know. As in the past, we will be on the air Christmas Eve to greet as many of our friends as may be. To those we may not reach, we send our greetings now: Merry Christmas and Happy New Year.

JAMES MILLEN



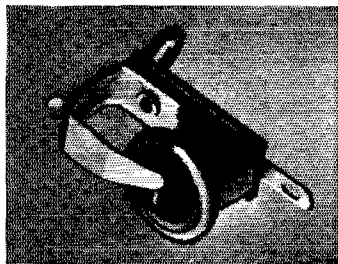

Better Phone Quality — Free!

GROUND the cathodes of the high-gain tubes in your speech simplifier. Stop audio degeneration, lower hum-level and improve audio quality. *Bias your voltage amplifier tubes with Mallory Grid Bias Cells!*

The cost is less than the resistors and condensers required to give anything like equivalent performance with a self-bias circuit . . . so you really *pay nothing* for the improved phone quality!

Use one cell with tubes such as 75, 2A6 and 6F5. Two cells are recommended for tube types 1B5, 57, 77, 6C6, 6J7 and 6Q7.

Mallory Grid Bias Cells are priced at 30c each list. Convenient holders are available, at prices from 10c to 35c each list, for mounting one to four cells. Get them from your Mallory-Yaxley Distributor.

Send a note on your QSL card for a circular on this interesting device. Not recommended for biasing power tubes or oscillators.

P. R. MALLORY & CO., Inc.
INDIANAPOLIS INDIANA

Cable Address—PELMALLO



Correspondence

(Continued from page 56)

there and hearing what is there and giving us a chance to work you and enjoy 160, too.

—J. Camden, VE3GZ

Reminiscing

110 N. Hoynes Ave., Chicago, Ill.

Editor, *QST*:

I have just fallen heir to a stack of historic *QST*'s of the post bellum period, including the "re-opening issue" of June, 1919.

What a laugh one can get out of comparing the "latest spark-gap machine" with the ultra-modern streamlined console rigs of to-day. Also in comparing the organization and workmanship of the slightly amateurish monthly of that time with the ultra-modern professionally-styled magazine of to-day.

Personally I believe the ham of the home-made spark-gap days got more real enjoyment and real knowledge from his unartistic dust trap that was spread out in pieces on the work bench over half the time for repairs and new improvements, and his *QST* with semi-jumbled type and home-made pictures, than we new beginners of to-day do with our commercially-made receivers and transmitters that require no fixing and our *QST* of perfect type, retouched studio photos (Heaven forbid! No photograph appearing in *QST* is, as a matter of policy, in fairness to readers, ever re-touched.—Editor.) and draftsmen's charts and working drawings.

Personally I am finding a much more human element in the *QST*'s of the spark-gap period. Perhaps that is because I was not able to grow up with radio and my knowledge and thought processes are still on a par with the early days.

This is truly a revolutionary era since all the old standards have been discarded, not only in radio, but in all lines of science, art and government, and new ones are attempting to take their places. Psychologically we never remain at rest; we either regress or progress.

Radio has advanced as rapidly as any one of the other modern inventions and *QST* has kept in step.

—Inez de Lhorbe Miller

Good Fortune

P. O. Box 10, Castlemaine, Victoria

Editor, *QST*:

As a foreign amateur it makes me smile to hear the wrangling and arguing that goes on in the ranks of the hams in the U.S.A.

Just what do the fellows want over there? They seem to have everything that a ham could wish—splendid receivers, splendid transmitters and a kilowatt to play with. Within limits they can play merry hell with the neighbor's b.c.l. receiver next door, handle third party messages till the cows come home, and generally act the fool over 14-Mc. 'phone.

They all remind me of the two-year-old youngster who, having seen the moon one bright evening, howls, kicks and fights to get it.

It's a great pity that 85% could not be brought to some out of the way spot where radio parts were 150% dearer than they are in U.S.A., where at least 75% of the parts required were unobtainable, where third-party traffic was prohibited and the maximum input to the final stage was 25 watts. Then, perhaps, they would have something to moan about. Such places do certainly exist and the description is not mere imagination. . . .

—Gordon Weynton, VESXU

Another "Message From Garcia"

Calle 13, No. 97 Vedado, Habana, Cuba

Editor, *QST*:

Was very glad to do your acquaintance in Radio Club last night Sunday evening Mr. Warner. Tnx vy for your kind words. Ese make me a favor when you back up to home. After my letter to Mr. Dixie Jones was impressed into pages of *QST* August issue mani hammers has wrote and messaged me to offering help to breaking and learn the English tongue. I appraise the kindness dully but wid present help I do fb.



CEMENT?.....

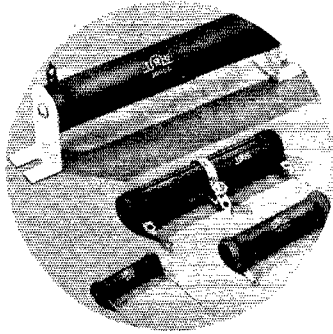

NEW! We at IRC have decided to devote this page each month to a discussion of Ham problems in general and resistance problems in particular. Maybe you will get an idea from it sometime — or

maybe you'll give us an idea that can be worked out for the benefit of the whole gang. At any rate, we shall try to answer two questions in every Ham's mind when he turns to this page:

1. Why do they make it that way?

2. What can I do with it?

WHY? Hams are an inquisitive bunch and are probably wondering why IRC Special Cement is used for coating Power Wire Wound Resistors.

We use it because its coarse finish dissipates heat and does not deteriorate under any reasonable over-load. Remember that, "to radiate heat best, a body must be *dark* in color and *rough* in finish." A light color or glazed finish will run a higher temperature for the same heat dissipation. (Keep that in mind when you "pot" that new transformer you are winding; put it in a dull black case — *not* a shiny chromium can.)

Most glazed coatings contain ingredients which are chemically active in the presence of humidity and require high firing temperatures to harden them. Both of these are harmful to a resistor.

It is an obvious fact that any coil, no matter whether it be an I. F. Coil or a 200 Watt Resistor, should be coated with a material which protects yet never attacks the wire chemically. IRC cement coating does

this particularly well under severe conditions, because it is free from active salts which combine with the moisture in the air to corrode the resistance wire.

By immersing the whole unit in the liquid coating, and *agitating* it while immersed, the cement penetrates to the tiny spaces around the wire and terminals. It is then treated with live steam for many hours. This cures and hardens the coating without subjecting it to the firing temperatures which are necessary in putting a glaze finish on most other coatings.

This *low temperature* processing has advantages:

1. It toughens the unit, bonding the tube, wire and coat together without making them brittle or setting up unusual strains.

2. It makes it practical to *die-cast* a terminal or lead wire in position right around the tube — a real he-man joint.

3. It leaves the terminals with their proper temper, not dead soft and easily broken.

4. It prevents those pin-holes one often sees in other coatings.

Why buy a resistor that's had most of the life baked out of it already? IRC cement coat isn't much on looks, but it's the best thing we've found yet for the job it has to do.

NEXT MONTH: A few Do's and Don'ts for the Ham

INTERNATIONAL RESISTANCE COMPANY

401 NORTH BROAD STREET, PHILADELPHIA, PA.

Say You Saw It in *QST* — It Identifies You and Helps *QST*

Better ANODES Better TUBES

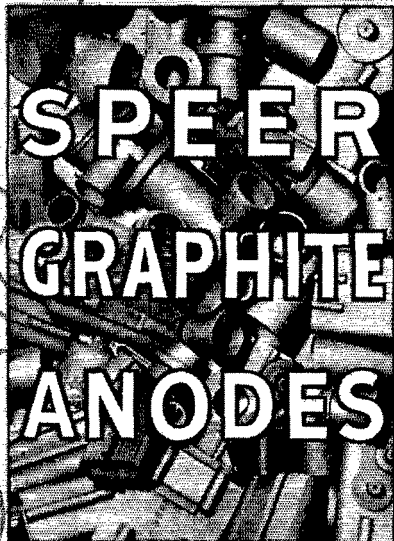

STAND MORE HEAT OPERATE COOLER

Speer Graphite Anodes will not soften, melt, warp or blow out at any temperature whatever. On top of that they run cooler because they dissipate heat more rapidly than any other anode material. Their heat dissipating value is approximately 3 times that of tungsten, 4 times molybdenum, 5 times tantalum and 100 times that of nickel. Buy transmitting tubes with Speer Graphite Anodes. Sold only to tube manufacturers. Write for a list of users and Anode booklet.



SPEER CARBON COMPANY,
ST. MARYS, PA.

7892

Knew ebb in level tide of pocketbook impossible to give thank you to each one and so please give thank you to you kindly.

—S. E. Garcia, CM3AO

Xceptional YL

225 West 37th St., New York City

Editor, *QST*:

Just two years ago I became a licensed ham and like many newcomers made observations of what was said and done on the air.

In most friendly fashion I would say that I took exception to the term "XYL," as it appeared to me to sound like "ex-YL." I inaugurated the use of the term "Xceptional YL" and, each time I used it, I was asked for an explanation.

I feel that if these girls who are our wives will tolerate what they have when the old radio bug bites, then they should be so termed. . . .

In my particular case I am most fortunate that my Xceptional YL is Mrs. W2JZX in her own right, and she is as fully wrapped up in the art as I am.

While writing I would wish to compliment you upon the efficiency of the organization. The longer I have been a member, the more convinced I am of the fact that the F.C.C. is the father of amateur radio and the A.A.R.L. is the mother who nurtures and cares constantly for her children.

—S. J. Grossman, W2JDG

1811 Sunset Blvd., Houston, Texas

Editor, *QST*:

WANTED

Used gas fired Arco boiler and hot water radios, must be in A-1 condition. Reply P. O. Box 272, Houston, Texas.

The above Want-Ad from a Houston paper came to me from the local fire kindler and has me in such a state of agitation that I hasten to inquire whence came this new ether wallpaper. . . .

I have been a ham for the past twenty years and have always paid my bill to the light company for juice consumed to run the rig, and here it seems you sorta get the gas company and the water works together and get all the power you need. How does this dern thing work? How many watts per gallon can a fellow put on the air, and does the water hafta be boiling, or will just luke-warm liquid throw it into a state of oscillation sufficient to put out a CQ? . . .

I guess you wonder why all this intense interest on my part, but you see I work for a pipe-line company that handles natural gas, the Houston Pipe Line Company, and natcherly they are interested in anything that is going to promote the sale of natural gas. If this here contrapshun is just as good as the electrical species, why I wanta go proposition all the brothers here. We must have more than a hundred and fifty hams in Houston from all the key thumps and harmonics a fella hears whenever he turns on his receiver, and if I could just buy up some of these here good A-1 secondhand gas-fired jobs and sorta get the boys in the habit of using gas instead of electricity, the boss might give me a \$2.50 raise and I could subscribe to *QST* for another whole year.

Of course I guess you guys know all about these calorific aqueous apparitil, and if you have any recent hookups please send me full instructions including what size pipe to use and what kind of a valve is best to key it with to stop chirp. It goes to show you how much of a rut a guy will get into. Here these hot-water jobs have been out long enough for them to have a secondhand value, provid'n' they are in A-1 condition, and I never heard of them before. In fact I never knew there was any connection between boiler tubes and radio tubes before. Anyhow, me 'an the gas-house gang are sure interested, and I can't blame that guy with the high-powered post office box from wantin' to buy one, if I find any myself I'll send 'em in so you will know just exactly what this is all about. Only trouble is I don't know when these hot water jobs are in A-1 condition and might send you sompin that would blow up the lab before you could tell what you had.

—Dave Harrell, W5CVQ

***Tip-Top performance with new 'Super-Pro' working 16 hours a day since July"**



* **"THIS receiver is truly an extraordinarily fine instrument,"** says Stanley Wolff, chief operator, New York Herald Tribune wireless station. Mr. Wolff adds, "We are located on the 21st floor — the very top of the building — next to all sorts of electrical machinery, and yet the "Super-Pro" is at all times exceedingly quiet, bringing in the weakest signals with not only extreme clarity, but marked regularity. For instance, during the Amelia Earhart search, signals from the cutter Itasca on duty in the vicinity of Howland Island in the Pacific were heard with remarkable clarity throughout a continuous 12-hour schedule. At all times the signals came through on the loud speaker. The U.S.S. Lexington was heard from the start of her dash to Howland Island and thereafter, while she searched the vicinity of the Phoenix Island group, and still later on while she searched still further west in the vicinity of the Gilbert and Marshall Islands. The reception at all times was excellent. No other receiver has been able to bring in signals so regularly day and night, rain or shine, and continuously for two 8-hour shifts a day."

"Super-Pro" performance is so exceptional because of such outstanding features as two stages of R.F. on all bands; 4 air-tuned I.F.; electrostatically shielded input; electrical band spread;

direct tuning; stand-by switch; relay terminal strip; variable crystal filter, etc. Crystal or standard models for table or rack mounting, or new console for 7½ to 240, 15 to 560, or 15 to 2000 meters.

Complete your quality installation by installing the new "Supr-Pro." Send for the "Super-Pro" bulletin and new "38" catalog for further data! Mail coupon below.

MAIL THIS COUPON!

HAMMARLUND MFG. CO., INC.
424-438 West 33rd St., N. Y. City

- Please send me "Super-Pro" bulletin.
- Please send me "38" catalog.



Name

Address

City.....State.....

Q 1-38



HAMMARLUND

Say You Saw It in QST — It Identifies You and Helps QST



NEW TUBES

RK-11 20 Mu Class C Triode. Filament 6.3 Volts. Plate 750 Volts. Output 55 Watts. Amateur Net Price... **\$2.50**

RK-12 Zero Bias Class B Modulator. Filament 6.3 Volts. Plate 750 Volts. Output 100 Watts. (2 tubes). Amateur Net Price... **\$2.50**

RK-51 20 Mu Class C Triode. Filament 7.5 Volts. Plate 1500 Volts. Output 165 Watts. Amateur Net Price, **\$8.00**

RK-52 Zero Bias Class B Modulator. Filament 7.5 Volts. Plate 1250 Volts. Output 250 Watts. (2 tubes). Amateur Net Price... **\$8.00**

ALSO A NEW **866**:
Amateur Net Price... **\$1.50**

These new tubes, and complete data on them, are available now at your regular dealer—or write the nearest Raytheon office.

RAYTHEON PRODUCTION CORPORATION

55 Chapel Street Newton, Mass.
420 Lexington Avenue New York, N. Y.
445 Lake Shore Drive Chicago, Ill.
415 Peachtree St., N. E. Atlanta, Ga.
555 Howard Street San Francisco, Cal.

Briefs

56-Mc. Tests

In connection with the R.S.G.B. 56-Mc. International Contest (see page 53, Dec. '37 QST) W9FM suggests definite schedules in order to increase the possibility of DX contacts. 10:00 A.M. to 11:00 A.M. EST on each Saturday and Sunday from January 15th to February 27th is the schedule to be observed. G's and other DX stations will transmit during the first 15 minutes, W's during the second 15 minutes, etc. Your call should be transmitted often to aid identification. If QSO's become possible on any date, the schedule should be abandoned.

W9FM suggests the above mainly for Europe and Africa. He proposes that the Australian schedule be at about 4:00 P.M. (your local time) each Saturday and the South American schedule at 4:00 P.M. each Sunday.

W8OKC will run a series of tests on 57-Mc. c.w. every Wednesday during February at 3:00 P.M. EST. Transmitter will consist of a 6L6 osc., using a 28-Mc. crystal, a T220 doubling to 56 Mc., a T55 buffer and a pair of T55's with 450 watts input.

W1KH will transmit on 56.2-Mc. c.w. from 11:00 A.M. to 11:15 A.M. EST each Sunday for the next four months, according to the November T & R Bulletin. He will listen for c.w. replies from 11:15 A.M. to 11:30 A.M. EST.

Amateur radio beat commercial cables and wire services recently on delivery of a message from Hawaii to General Gibbs, former Chief Signal Officer. Originating at K6GGD, the message was relayed by W2BCX to W2OQ, who made delivery before same had been effected by commercial channels.

Hints and Kinks

(Continued from page 44)

vide about 10 mils keep-alive current for the lamps; the required resistance is then 3300 ohms; 3000 or 3500 ohms may be used. At no load, the current through the lamps will be approximately 40 mils with 3300 ohms dropping resistance; the screen voltage, however, will remain at 300 volts. The cost of this system should be even less, since no filter is required.

—Donald Carr, Yellow Springs, Ohio

Hamdom

(Continued from page 38)

activity, whether it's a domestic or DX contest, has placed among the 25 high on the Navy Day broadcast, and still has time to be WAC and go after all the new countries he can get. Right now the rig has a pair of 211's in the final on 80-40-20-10, and just to ensure that he gets enough brass-pounding he holds down a commercial operating job during his spare time.

Circuit Elements in Television

(Continued from page 34)

by misalignment of the i.f. circuits or by improper choice of constants that form RC circuits, either between the internal resistance of the amplifying tubes with the internal capacity of its elements or in the coupling or decoupling circuits employed in the amplifier stages. The time constants of the circuit can be chosen so that they will be short enough or in some cases long enough



DEVELOPMENT LABORATORY KEEP OUT!

On the Way!!!

Soon RME will announce a new development in *ultra high* equipment. This new unit will be a decided step forward in the adaptation of a radio circuit to the reception of frequencies below 10 meters (above 30 megacycles).

We are not quite ready to announce deliveries on this unit nor to give you any details, but from preliminary laboratory reports, you may be assured that the operation of the equipment is far in advance of anything now available.

And this is the best news . . . ALL present owners of RME-69 Receivers will be doubly pleased that their selection of a receiver was a 69. They will be the ones to benefit most from the equipment to be announced. You, too, will want to own an RME-69 in order to take full advantage of the ultra high frequencies.

In the meantime, if you do not have an RME-69 and are contemplating the purchase of a new instrument, we would like to have you fully investigate this high-quality receiver. The RME-69 is *always NEW, always UP-TO-DATE, always MODERN!*

RADIO MFG. ENGINEERS PEORIA ILLINOIS

RME - 69

Beryllium Contacts

FOR HIGHEST CONDUCTIVITY

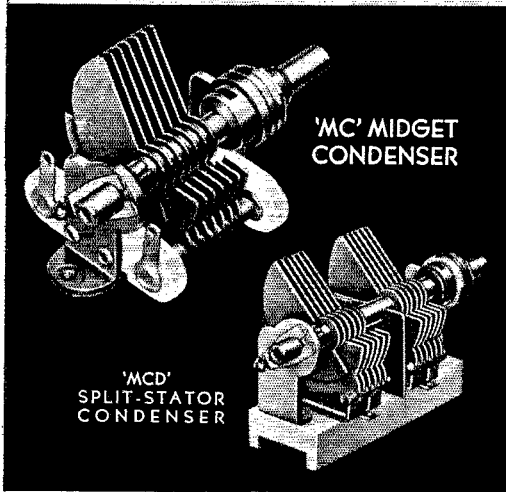

BERYLLIUM copper — that new, exceedingly hard non-corrosive metal with high tensile strength, exceptional wear resistance, and unusually high conductivity — is now used for wiping contacts on the "MC" condensers assuring perfect contact and noiseless operation! To further increase conductivity, and as an added measure of non-corrosive insurance, the Beryllium contacts are silver plated. Thus, you receive double assurance of the tops in efficiency with every "MC" condenser. This and many other important "MC" features are described in the new "38" catalog. Send for your copy today! Mail coupon below

MAIL THIS
COUPON
FOR THE
NEW "38"
CATALOG

HAMMARLUND MFG. CO., INC.
424-438 W. 33 St., N. Y. City

Please mail me new "38" catalog.

Name.....

Address.....

City.....State.....

Q-1

CANADIAN OFFICE: 41 WEST AVE. N.
HAMILTON, ONTARIO

HAMMARLUND

not to cause phase shift over the band which it is desired to pass.

Computation of expected phase shift and methods of experimentally determining its existence² are matters of considerable complexity and discussion of them will have to be postponed.

To proceed to the video amplifier shown in Fig. 6, we find that almost all circuit values are of importance — most of them having a direct influence on the ability of the amplifier to pass the necessary wide band of frequencies with negligible phase shift. The plate load resistor and inductance must be carefully proportioned to take care of high-frequency response and phase distortion while the R and C values in the decoupling circuit have an important influence on the low-frequency response. The coupling condenser C_7 must be substantially non-inductive up to the highest frequency to be passed and the placement of parts with respect to the chassis must be watched carefully to avoid unwanted capacities to ground. It might be mentioned that the decoupling resistors aid the low-frequency response because the reactance of the plate bypass condensers rise as the frequency falls, adding, in effect, the decoupling resistance in series with the anode loading resistance for the low frequencies.³

In the d.c. restoring circuit we find a characteristic of great importance in the time constant of the coupling condenser C_1 and resistor R_1 (Fig. 7). This time constant must be greater than the time required to scan one line and much less than the time to scan one field or half frame. The operation of this circuit could be described in this fashion: The signal appearing in the anode circuit or in the plate circuit of the last video stage will have pedestals riding above the video signal. These pedestals will be rising and falling with the average brightness of the transmitted picture. The higher the amplitude of these pedestals the more negative they will be. Therefore, they will bias the cathode of the diode sufficiently negative so that current will flow from cathode to anode, effectively charging the coupling condenser positive and with it, the grid of the cathode-ray tube. This charging of the coupling condenser will continue until the cathode of this d.c. restoring diode is no longer sufficiently negative to produce any current flow. At this time the average brightness of the background of the picture will have been set. This will require approximately 10 lines of the picture but as the average brightness does not change very quickly, this will be fast enough. Should there be a fall in the pedestal height due to a darker background being transmitted the charge in the coupling condenser will leak off through R_1 until the diode again begins to draw current. Once more equilibrium is reached and the new average brightness of the picture set. So we find the resistor leaking off the charge from the grid of the cathode-ray tube when the amplitude of the pedestal falls and

² "Television Engineering," by J. C. Wilson, page 210.

³ R. L. Freeman and J. D. Schantz, Video Amplifier Design, *Electronics*, August, 1937.

A Challenge by **TAYLOR CHAMPS**

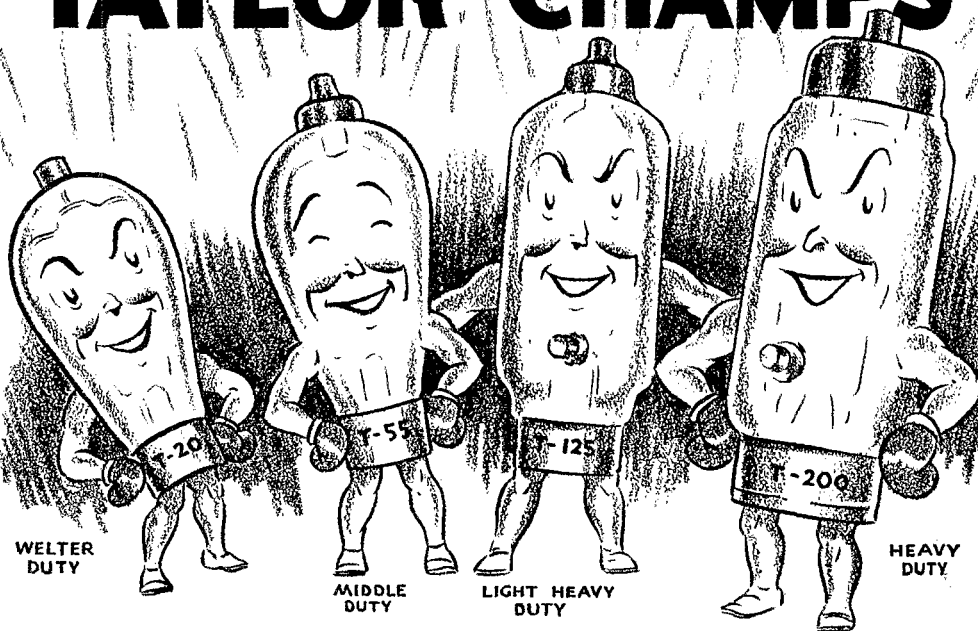

A Real Champion in every class! Open for a battle to a long-life finish in any Transmitter. Wonderful records with a long unbroken string of victories over

Kid QRM, Socko QRN, etc. Easy to excite to full battling strength. Although they are the true Champs they will do their stuff for you at most reasonable prices. Guaranteed to please all. Let the Taylor Champions do your battling and you'll win—every time.



Get the best action from the Taylor Champions. Let the 866's supply the power. Over 25,000 doing valiant work in Rigs the world over. Insist on TAYLOR 866's.

TAYLOR
866
\$1.50

"More Watts Per Dollar"

Taylor HEAVY **CUSTOM BUILT** DUTY **Tubes**

TAYLOR TUBES, INC., 2341 WABANSIA AVE., CHICAGO, ILLINOIS

USE

C.H.T. TRANSFORMERS

FOR...

- APPEARANCE
- PERFORMANCE
- ADAPTABILITY

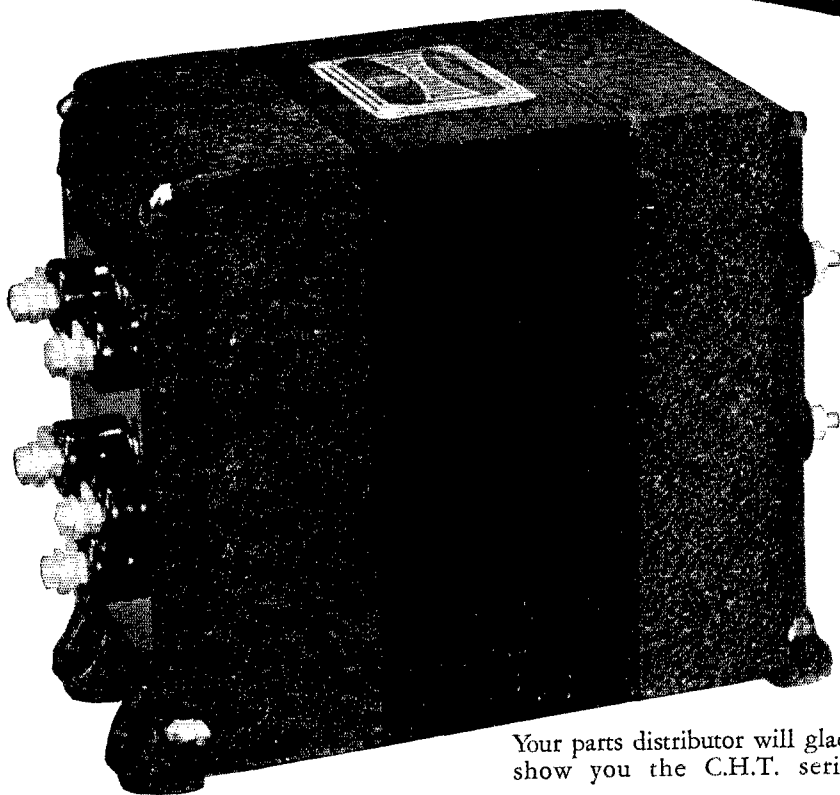

Your parts distributor will gladly show you the C.H.T. series.

THORDARSON ELECTRIC MFG. CO.

500 W. HURON ST., CHICAGO, ILL.

Demand "Power by Thordarson"

WE'RE TRYING TO KEEP UP!

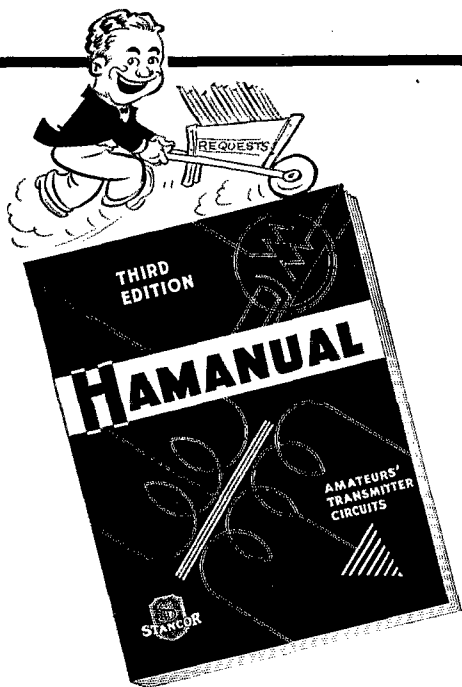

A flood of requests took every copy of the first printing—and then some—but another printing is ready NOW. The Stancor HAMANUAL has all the dope on the Stancor line and there are 16 transmitters on which you should get the low-down.

It's Free! Use the Coupon.

STANDARD TRANSFORMER CORPORATION
850 BLACKHAWK ST. · CHICAGO, ILL.

STANCOR: Please send me, free and postpaid, my copy of the new Stancor Hamanual.

Name

Address

City.....State.....

My jobber is.....

delegated to the Secretary of Commerce and Labor. There were sections calling for the use of a pure and a sharp wave, etc., one requiring listeners to observe the secrecy of messages, provision for punishment of violation of the regulations or the transmission of false distress calls. No individual services were defined except our old familiar stand-bys from international treaties, the coastal stations and ship stations.

This is all fine, but what about wavelength assignments, and particularly that part of the law giving amateurs 200 meters and down? All right, here goes for the wavelength assignments: the 300-meter wavelength was specified for general public service work, per the international agreements of 1906 and 1912. Furthermore, with one exception, all stations were authorized to use any wavelength they chose, provided they stayed below 600 or above 1600 meters—this again, being simply a duplication of the international specification of the time. Now, plenty of readers have by this time noticed that phrase “with one exception.” Yep, that exception is the dusky gent in the woodpile about which there has been so much controversy; that exception is the one that is supposed to have given hams everything from 200 meters down. To end the suspense, we will quote that article, in full. Here it is:

“General Restrictions on Private Stations.

“Fifteenth. No private or commercial station not engaged in the transaction of *bona fide* commercial business by radio communication or in experimentation in connection with the development and manufacture of radio apparatus for commercial purposes shall use a transmitting wavelength exceeding two hundred meters, or a transformer input exceeding one kilowatt, except by special authority of the Secretary of Commerce and Labor contained in the license of the station: *Provided:* That the owner or operator of a station of the character mentioned in this regulation shall not be liable for a violation of the requirements of the third¹ and fourth² regulations to the penalties of one hundred dollars or twenty-five dollars, respectively, provided in this section, unless the person maintaining or operating such station shall have been notified in writing that the said transmitter has been found, upon tests conducted by the Government, to be so adjusted as to violate the third and fourth regulations, and opportunity has been given to said owner or operator to adjust said transmitter in conformity with said regulations.”

(Following this was regulation No. 16, stating that any station of the above class within 5 nautical miles of a naval or military station had to keep under 200 meters and under *one-half* kilowatt in power.)

Well, gang, there she is! And, it may be said, that's all that was said on the subject, in the 1912 law.

Now, did this grant amateurs the exclusive use of the territory below two hundred meters? Alas, it did not! To begin with, this was not a grant of privilege to certain classes of stations; it was, instead, a restriction. Unless certain stations were engaged in transacting business, or developing apparatus in that connection, they couldn't go above 200 meters.

Were amateurs the only ones so restricted?

¹ The third regulation required the use of a “pure wave.”

² The fourth regulation required the use of a “sharp wave.”

★ Only Johnson has it!

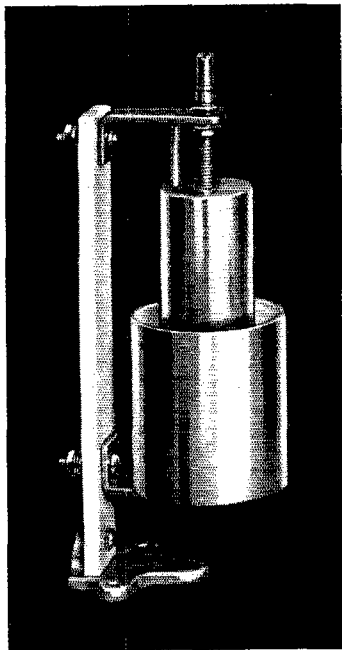

The Johnson Type "N" is the only neutralizing condenser for low C tubes that has all of these important features:

1. Extremely small mounting space.
2. Constant voltage rating over full capacity range.
3. 4 to 1 capacity ratio accommodating an extremely wide assortment of tube types.
4. May be mounted vertically or HORIZONTALLY permitting panel adjustment if desired.

Air-gap width is constant. No change in voltage rating over full range of adjustment. Changes in capacity are effected by moving the inner cup up and down on a micrometer screw.

New design saves space. Drawing shows comparative size of Type "N" and "pancake" neutralizing condenser of same capacity and breakdown rating.

Three sizes of the Type "N" accommodate every type of low C tube popular with the amateur. *And look at the price!*

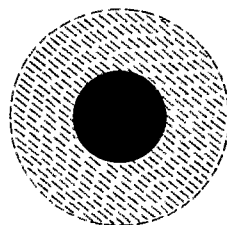

Solid area—Johnson Type 'N'
Shaded area—'Pancake' Type

Cat. No.	To Neutralize	Spacing	Max.	Min.	Cup. Diam.	List
N125	T20, T55, 35T, 808, etc.	.125"	13	2.25	1.35"	\$3.25
N250	805, 100T, T125, etc.	.250"	13	3.0	1.75"	4.50
N375	250T, T200, 806, etc.	.375"	13	3.5	2.2"	6.00

Johnson offers other genuine transmitting condensers of small size. The Types "E" and "F" when used with the Type "N" and other suitable components, permit extremely compact construction as in the amplifier shown. Despite its small size, this amplifier will handle maximum rated input to such tubes as the T55, 35T, etc. All Johnson condensers have heavy aluminum plates buffed and rounded, phosphor bronze spring contacts, Alsmag 196 insulation, and many other expensive features . . . yet you'll find them priced with the lowest.

*For satisfaction in Any Transmitting Condenser
— Get Johnson!*

Ask your Jobber or Write for Catalog 964J

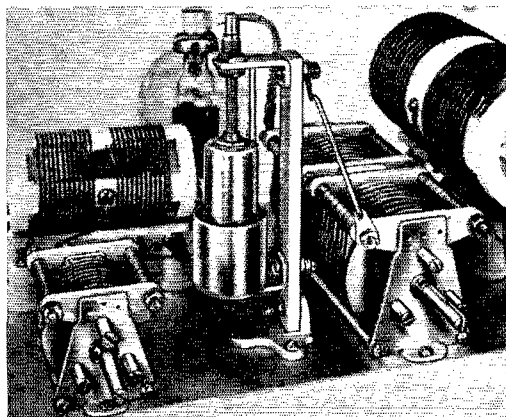

"FREE—Bulletin 201J specifying correct Johnson condensers and other parts for all circuits in the STANCOR HAMANUAL and TAYLOR TUBE MANUAL. Ask your Johnson jobber or write direct."



Export Office: 25 Warren Street
New York, Cable: 'SIMONTRICE'

E · F · JOHNSON · COMPANY

MANUFACTURERS OF *Radio Transmitting Equipment*

● WASECA · MINNESOTA · U.S.A

Say You Saw It in QST — It Identifies You and Helps QST

HARVEY 700-R

The 700-R is a new transmitter comprised of our standard 80-T and 700-A units assembled in a single rack cabinet. Such a combination is especially desirable for present 80-T owners who wish to increase power at nominal cost and for prospective 80-T purchasers who are assured that their first investment will be well protected when higher power is contemplated in the future. The price is very reasonable.

● **Power Output**

— 250 watts,
Phone, 750 watts
CW.

● **R. F. Section**

— 6L6 crystal oscillator, RK-20A modulated amplifier, two Eimac 250-tl as class B linear amplifier.

● **Frequency**

Range— 1500 to 30,000 kilocycles.

● **Speech Amplifier**

— Designed for single diaphragm crystal microphone input.

● **Instruments**

— A complete complement of meters is furnished as well as built-in modulation monitor and carrier shift indicator for constant checking of transmission characteristics.

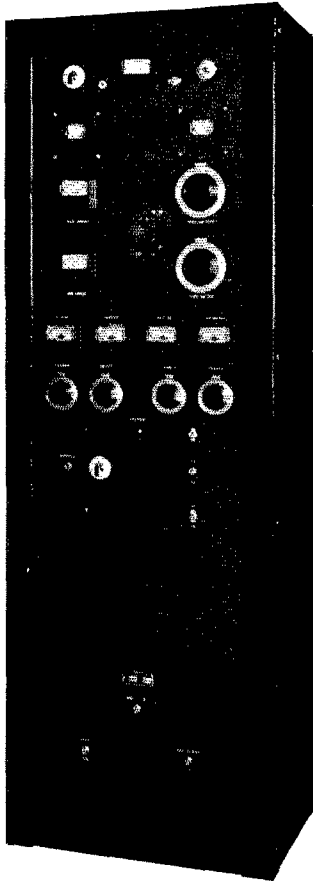

Free Data and Prices on Request



HARVEY RADIO LABS., INC.

25 Thorndike St.

Cambridge, Mass.

Not at all; as a matter of fact, amateurs are not even mentioned, by name. Read the start of the quoted section; it will be seen that the restriction applies equally to private or commercial stations. If this section can be interpreted as granting amateurs "200 meters and down," it also grants certain classes of commercial station precisely the same privilege. However, it is important to note about this time that "private station" and "amateur station" are not the same. As we have already pointed out, the section doesn't mention amateurs as such. To be sure, amateurs at that time were classified as "private stations"—but so were a number of other classes! School and training stations were "private stations." So were most of what we now think of as "experimental" stations. Stations set up by a firm to enable it to conduct its own business between its various branches were private stations. About this time, it becomes apparent that between the broad interpretation of "private station" and the inclusion of that "or commercial" the Fifteenth regulation was meant to apply to virtually every station, unless it was conducting commercial business (or developing apparatus in that connection). Correct! It was!

Nor is that all; we point again to the fact that the section says only that the specified types of station cannot go above 200 meters (or over 1 kw.) without special authority. Well, how about the regular commercial stations that were allowed to operate above 200 meters; could they also go below 200 if they wished? The answer is that they could. The authority is contained in the second regulation, which we quote:

"Second. In addition to the normal sending wavelengths, all stations, except as provided hereinafter in these regulations, may use other sending wavelengths: *Provided* that they do not exceed 600 meters or that they do exceed 1600 meters . . . (there then follows some dope on use of pure and sharp wave) . . ."

The only "except as provided hereinafter" contained in the law was the 15th section already quoted.

Let this, then, be said: the 1912 Law, to the extent that it gave amateurs the territory from 200 meters down, assigned precisely the same privileges, by law, to every other class of station in the country.

Except for a period during the War, when all radio stations were closed down, this is the law which we operated under for fifteen years. Incidentally, since another part of this law stated that stations should state their operating wavelengths in their applications, practically all amateurs before the War and for some years after gave "200 meters" as their operating wavelength, and then tried to edge up higher than that if they could get away with it! As a matter of interest, no amateur license issued in the United States ever stated that the licensee was entitled to use all the territory from 200 meters down.

Although not affecting any very large group of amateurs, special arrangements were effected during this time between the A.R.R.L. and the Department of Commerce whereby certain

Another Eimac Triumph!

A NEW TYPE Thoriated Filament *(Gives Greater Performance)*

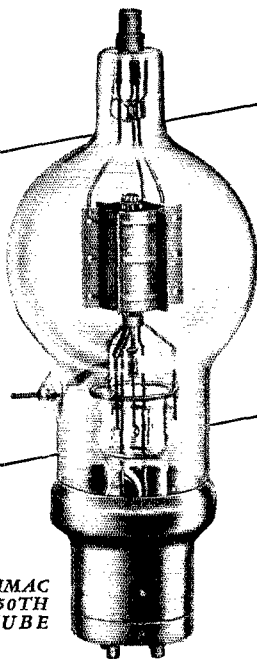

EIMAC
250TH
TUBE

Tube failures led radio engineers to believe that high plate temperatures and high plate voltages placed certain limits upon filament emission. Eimac engineers exploded this myth by proving that poor vacuum was the cause for emission failures. The Eimac exhaust technique and proper use of tantalum, long ago lifted these limitations from thoriated tungsten filament.

But Eimac was not satisfied with this discovery, alone. Certain other negative characteristics still existed in the thoriated filament . . . low ratio of usable to "peak" plate current . . . "cranky" filament voltage . . . tubes going "flat" for no apparent reason. With the issue at hand, unclouded by "erratic getters" and poor vacuum, Eimac engineers soon discovered the "what and why" of these problems. Result . . . the *new type* Eimac thoriated filament, found in 35T, 100T, 250T, 450T, 750T and 1000UHF tubes. This filament, found in the many thousands of Eimac tubes produced during the past year, has definitely eliminated "premature" emission failures.

The unusual properties of this new type thoriated filament, allow Eimac tubes to carry higher ratings, more conservatively, than any contemporary tube of equal physical size. Specifically; the *new type* filament operates at a lower temperature than that employed previously, and all other forms of "cheating," such as under-processing, are avoided. This results in the highest possible thermionic efficiency plus longer filament life and uniformity. In addition, Eimac filament assemblies are distortion proof. Special construc-

tion makes it impossible for filament displacement to alter the characteristics of Eimac tubes.

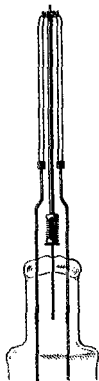

Distortion proof filament
assembly of Eimac 250TH.

Remember the "radical" Eimac design of three years ago? (Now copied by leading tube manufacturers.) And the use of tantalum? (An Eimac development now used by practically all tube companies.)

Well, this new thoriated filament still is exclusively Eimac, and is just one of the subtle engineering triumphs that make Eimac tubes so unusual in performance and stamina.

Eimac TUBES

EITEL & McCULLOUGH, INC. • San Bruno, California



Wishing you
a very merry
Christmas

AND THE HAPPIEST
OF **NEW YEARS!**



"above 200" wavelengths were made available to outstanding relay stations.

We have said that the 1912 law was the only one we had until the Communications Act of 1927 was passed. Now, it is apparent that nothing in the 1912 law creates special bands for the various services (we have quoted all the 1912 law which applied to wavelength grants or limitations), yet it is a fact that, three years before the 1927 international conference, amateurs in the U. S. were assigned specific bands of frequencies in the short-wave spectrum.

How come?

All right—brace yourself, for we suspect this will be news to many—those assignments were not made under law, they had no legal standing, and we had them solely on the basis of temporary and informal agreement with the other radio services of the United States.

Here's the story:

Following the 1912 law, nothing much happened to disturb the tranquility of two-hundred-meter operation until around 1923, when a small group of amateurs (and commercials, too, if we are to be truthful) began going to the wavelengths well below two hundred, to see if they were feasible for communicating purposes. As we now know, they most certainly were, but it took a transatlantic QSO³ to make the average ham believe it, at that time. An interesting sidelight here is that since all amateur stations at that time were required to specify their operating wavelengths, and since these were invariably of the order of 150, 175 or 200 meters, it was necessary for the first shortwavers to get special permission to operate on such wavelengths as 100, 90 and 60 meters—these not having been specified in the licenses!

At any rate, when the short waves began to demonstrate their worth around 1924, everybody in creation made a headlong rush for them. Remember: under the ancient 1912 law, still in effect at that time, every single service in the United States had equal rights with everyone else for the use of the short waves!

Now, keep a firm grip on everything up to this point while we backtrack a couple of years to 1922 to pick up some dope that is going to constitute part of our 1924 picture, when we finally unveil it.

Around 1922 it was apparent to the then Secretary of Commerce (Hoover), who was charged under the 1912 law with the duty of administering radio, that the law was hopelessly inadequate for existing conditions. A new law was badly needed, but Congress, with the same slowness which characterized its belated enactment of the original law, simply couldn't seem to get around to making one. So Secretary Hoover called the first of what came to be known as the "Hoover Conferences" at Washington, participated in by representatives of all the radio interests in the country, to see if some mutual agreements couldn't be worked out and some recommendations for the legislators evolved.

³ IMO-XAM (U. S.) with 8AB (France), Nov. 27, 1923.

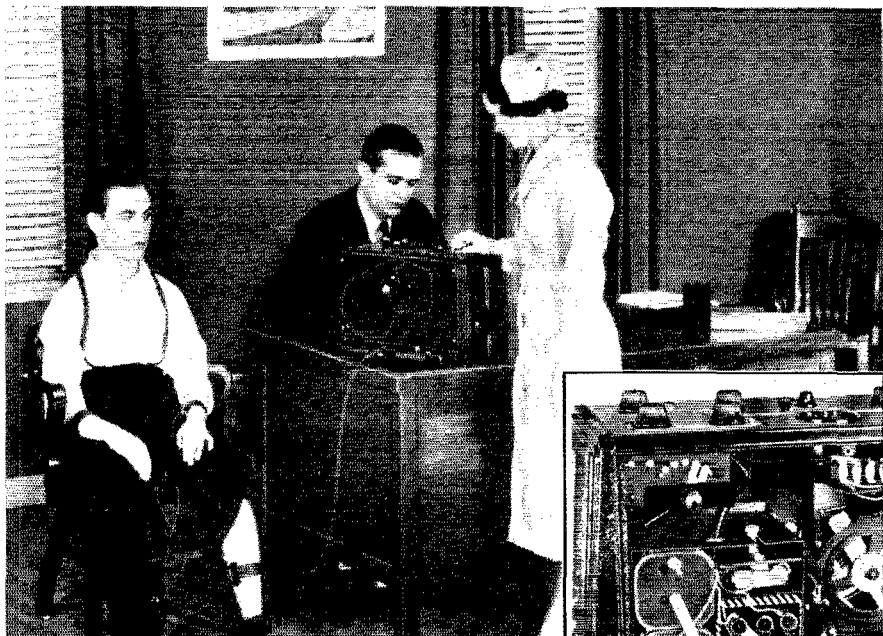
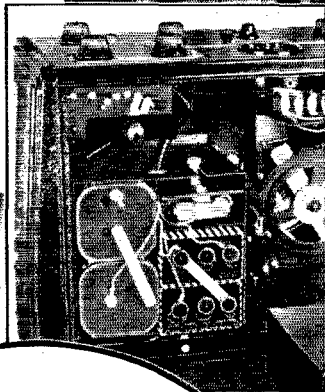

Photo Courtesy G. E. X-Ray Corp.



It Helps Fight Heart Disease with Records *This Electrocardiograph Uses* **Burgess Batteries**

Heart diseases account for a great proportion of the deaths reported annually. Since early and positive diagnosis is of prime importance to successful treatment, this G. E. Electrocardiograph has been found of tremendous value to doctors everywhere. It is a delicate instrument that records on easy-to-read graphs all the complex actions of the heart.

Here, where variables can't be

tolerated, dependable power is absolutely necessary. A representative of the General Electric X-Ray Corporation writes, "For many years, we have used Burgess batteries and find them highly satisfactory for operation of our Electrocardiograph."

You can enjoy the same dependability and economy in your experimental work. The same quality is available to you in all Burgess products.

BURGESS BATTERY COMPANY
 FREEPORT, ILL.

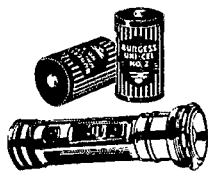

BURGESS



Say You Saw It in *QST* — It Identifies You and Helps *QST*

Thank you, amateurs . . .

for the splendid way in which you received the announcements of our new units. We are proud of the fact that **CARDWELL QUALITY** is recognized and accepted by the field.

. . . and here's another NEW CARDWELL

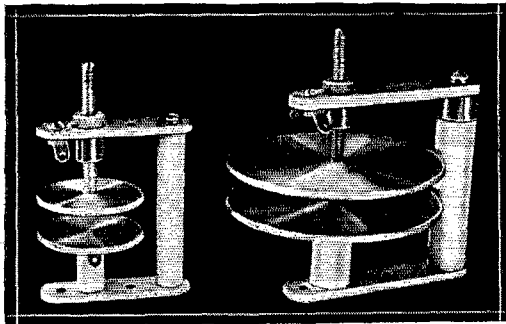

TYPE BDN A companion unit to our smaller Disc Type Neutralizer for Low Capacity Tubes. Type BDN is for use with such tubes as 806, 833, 831, RK-38, RK-36, T-125, T-155, T-200, HK-354, F-108-A, HF-200, HF-300, 150-T, 250-TH, 250-TL, 300-T, 450-TL, etc. . . .
Height, 4 1/4"; Width, 4"; Length, 5"
Capacity range: 2 to 12 Mmfd.

3/4" Aismag pillars; except for nickel silver extra long bearing, metal parts are of satin finish aluminum with fine screw adjustment to eliminate wobble. Convenient double lugs of husky proportions and knurled thumb nut for easy locking. Heavier construction throughout. May be sub panel mounted by using 2 small insulated pillars screwed to holes in top supporting plate, and adjusting the condenser through clearance hole in chassis.

Net to amateurs \$3.00

TYPE ADN with 1/2" Aismag pillars; for such tubes as 808, 834, 852, RK-30, RK-35, RK-37, RK-32, 304-A, 304-B, T-55, 35-T, 50-T, 100-TH, 100-TL, etc. . . . Construction similar to type BDN.
Height, 4 1/4"; Width, 2"; Length, 2 1/2"
Capacity range: .5 to 4 Mmfd.

Net to amateurs \$1.80

TYPE C Flexible Insulated COUPLING

15,000 V. Peak Flashover

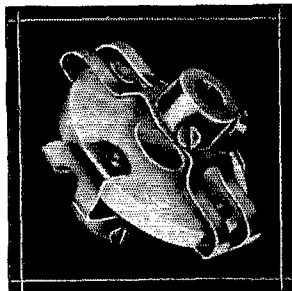

A heavy duty unit for high power variable air condensers or other rotary R.F. units.

Insulation — No. 196 Aismag disc 2 1/4" diameter, 1/4" thick. Maximum overall diameter, 2 5/8"; special steel cup set screws, heavy N.P. brass hubs, permanently staked into thick nickel plated phosphorbronzesprings. Removable bushings to fit 1/4" shafts. Hubs fit 3/8" shafts with bushings removed.

Net \$1.68

TYPE A and B—Couplings for medium power condensers—Type B is the same as type A except that the hubs are reversed to give maximum flashover.

Net to amateurs, each \$3.36

See these units at your dealer.

**THE ALLEN D. CARDWELL
MANUFACTURING CORPORATION**
83 PROSPECT STREET, BROOKLYN, NEW YORK

The first of these conferences, in 1922, didn't do very much so far as we are concerned, except that it recommended enactment of proper legislation to deal with radio, suggested certain amateur frequencies (of no interest to us, at the moment, since they were around 200 meters), suggested a definition for amateurs (the 1912 law had no such definition), and recommended that amateur status be defined by law and amateur wavelength assignments ditto. Another recommendation that will evoke hearty cheers even today was for the creation of amateur deputy inspectors, possibly at a dollar a year, to help out in amateur regulation! Unfortunately, although a number of radio bills were subsequently introduced in Congress, nothing was actually done in the way of legislation to carry out any of these recommendations. Perhaps it was for this reason that the recommendations of the succeeding Hoover conferences actually became regulations by reason of their adoption as such by the Department of Commerce—not with authority of law, however, but purely on the basis of mutual agreement among services. This curious status lasted until the "blow-up" of 1926, of which we shall speak shortly.

The second conference took place in 1923; the short waves had not yet opened up, and the conference recommendations for amateurs were all in the vicinity of 150–200 meters. Amateur radio would have kicked like the dickens if they had been anything else.

The third conference was in 1924; between it and the second the short-wave business had split radio wide open! The 1924 conference was tremendously important, therefore.⁴ However, bear in mind that nothing any of these Hoover conferences did had any actual legal status. The recommendations were nothing more than recommendations; such agreements as were reached were on the basis of mutual understandings between services, temporarily (and illegally) incorporated into the regulations by mutual consent and thereafter observed by all until a new law came along. You see, by this time everyone in radio realized that the wording of the 1912 law was such that the Secretary of Commerce had been given no authority whatsoever to enforce any wavelength assignments other than those set forth in the law itself. When the short waves opened up, every service in the country—government, commercial and amateur—could operate anywhere it wanted to in the short-wave territory, and did, with increasingly chaotic results. The 1924 conference represented an attempt to solve an otherwise impossible situation by means of mutual agreements to be voluntarily respected by all services until the law could come along and catch up. Everybody was perfectly aware that the "regulations" resulting from these agreements were not binding, but everyone knew also that some

⁴ Since the short-waves "broke" several months before the conference, the A.R.R.L. had negotiated several special low-wave bands for amateurs, pending the decisions of the conference. The resulting conference agreements were considerable expansions over the space made available by these temporary assignments.

CAMPBELL'S

329 ADAMS AVENUE
SCRANTON, PA.

Scranton Radio Supply Co.
809 Mulberry Street
Scranton, Pa.

August, 7, 1937

Dear Mr. Mack:

May I take this opportunity to express to you my sincere appreciation for my outstanding success with Centralab products.

We consider quality of parts a major essential in rendering efficient radio service; we obtain this by using Centralab at no greater cost.

I have been, and am, consistently one hundred percent Centralab, and as I am conservative in my expressions, and having used hundreds of Centralab controls, resistors and switches, I highly recommend the use of Centralab products to other radio service men.

Yours sincerely,

J. F. Campbell
RADIONEER



Mr. J. F. Campbell
Radiioneer of Scranton, Pa.

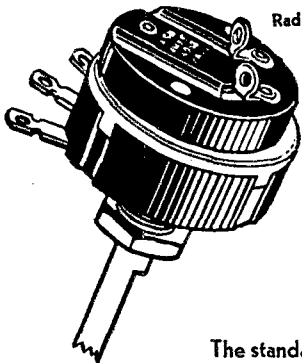

The standard radiohm offering accurate tapers — low noise level — longer life, and better power dissipation

Servicemen . . . jobbers . . . experimenters . . . manufacturers . . . all voice a preference for the smooth, certain, satisfactory service that Centralab Controls offer. For "100%" satisfaction specify CENTRALAB!

Centralab

Div. Globe-Union Mfg. Co., Milwaukee, Wis.

BRITISH CENTRALAB, LTD.

FRENCH CENTRALAB CO.

Canterbury Rd., Kilburn
London, N.W. 6, England

118 Avenue Ledru-Rollin
Paris XI, France

See You Saw It in QST — It Identifies You and Helps QST

'100%
Centralab'

*- thanks Scranton
Radio Supply Co,
for sending
this on!*

CONFIDENCE!



CONFIDENCE —

The unwavering faith of a patient in his doctor — a client in his lawyer — and a buyer in his source of supply.

At **LEEDS**, your problems are entrusted to men whose vast experience immediately becomes yours. Their job is

to furnish advice as to what is best suited for your needs. **LEEDS** invites your inquiry.

New RCA 809 in stock; net.....\$2.50

A BIG SCOOP — The New KENYON TRANSFORMER T-378

Designed for use with two 809's plus a pair of 807's or 802's; 6.3 volts at 2 amps C.T. 2000 volts insulation; net..... **\$3.00**

GENERAL RADIO VARIACS

GOOD REGULATION — Output voltages are independent of load.

SMOOTH CONTROL — The variac can be set to any predetermined output voltage — no steps.

HIGH EFFICIENCY — Very low losses at both no load and full power.

SMALL SIZE — Variacs are much smaller than any other control of equal power rating.

LINEAR OUTPUT VOLTAGE — Output voltages are continuously adjustable from ZERO to full output by a 320 degree rotation of the control knob. Dials are calibrated.

HIGH OUTPUT VOLTAGES — Several variacs supply output voltages considerably higher than line voltages.

SMALL TEMPERATURE RISE — Less than 50 degrees C. for continuous duty.

ADVANCED MECHANICAL DESIGN — Rugged construction — no delicate parts — two or more units may be ganged on one shaft.

Type	Load Rating	Primary Voltage	Current		Output Voltage	Price
			Rated	Maximum		
100 K	2 KVA	115 v	15 a	17.5 a	0-115 v	\$40.00
100 L	2 KVA	230 v	8 a	9 a	0-230 v	40.00
100 L		230 v	4 a	9 a		
200 B	170 VA	115 v	1 a	1.5 a	0-135 v	10.00
200 CM	850 VA	115 v	3 a	7.5 a	0-135 v	17.50
300 CV	850 VA	115 v	5 a	7.5 a	0-135 v	14.50
200 CMH	580 VA	230 v	1.5 a	2.5 a	0-270 v	21.50
200 CMH		115 v	0.5 a	2.5 a	0-270 v	
*200 CUH	580 VA	230 v	1.5 a	2.5 a	0-270 v	18.50
*200 CUH		115 v	0.5 a	2.5 a	0-270 v	

* These types are unmounted.

We carry a complete stock of

RAYTHEON Transmitting Tubes

TAYLOR Transmitting Tubes

RCA Transmitting Tubes

CARDWELL Condensers

HAMMARLUND Condensers

NATIONAL Condensers

Our technical department welcomes your inquiry



LEADS THE FIELD

World Wide Service to Amateurs

45 Vesey Street
New York City

Tel. COlrandt 7-2612

Cable Address: "RADLEEDS"

sort of order was essential in order to continue operating at all.

In many respects, this 1924 Hoover Conference was a modern international radio gathering on a small scale. Every service was present pushing for all the short-wave territory it could get. The "shorts" were so brand-new that nobody had a clear idea of which waves were good for what; for that reason, everyone was out to get all that could be got, from one end of the scale to the other. Without going into detail (details in past *QST*'s for those interested) we may say that the outcome of the 1924 conference was amateur bands as follows:

1500-2000 kc.

3500-4000 kc.

7000-8000 kc. (Whoops!)

14,000-16,000 kc. (Believe it or not!)

56,000-64,000 kc.

It was recommended that the Supervisor of Radio decide whether one license would permit the use of all these bands or whether multiple licenses would be necessary (it was later agreed that one would do the trick). Incidentally, it will be noticed that we here embarked on the idea of maintaining a harmonic relationship, so far as possible. The omission of any ten-meter assignment in the table, however, is not accidental; there was no assignment. The reason for this is that the Hoover series did not extend as far as the ten-meter territory. The 5-meter assignment was incorporated by special request solely because of the fact that a small group of experimenters wished to work there; the same reason applies to a subsequent 400-401 Mc. assignment for beam experiments, made shortly after the conference by the Department of Commerce by special request of the A.R.R.L.

Other bands were assigned to the various other services which wanted space in the spectrum and which, remember, were just as much entitled to it as we were

Since the 1925 conference did nothing to alter this general set-up we will skip over it and say that during 1924, '25 and '26 we operated in the 1924 bands. By mutual agreement, of course.

In the meantime, Congress was being bombarded with requests and entreaties for a new law but was still doing nothing about it. How long this might have gone on no one knows had it not been that in 1926 the so-called "breakdown of the law" came about when a broadcast station which didn't like its assignment on the mutual-agreement basis made a test case resulting in a court opinion denying the Secretary of Commerce the authority to compel stations to observe any specified wavelength assignments (outside the very broad limits previously mentioned in the basic law). Overnight, all the existing regulations which specified definite wavelength assignments were rendered inoperative. It was a tense moment! Would all the radio stations in the country jump their assignments? Well, they could have, but most of them didn't; almost unanimously, the radio world in this country sat tight on its Hoover agreements, one of the most

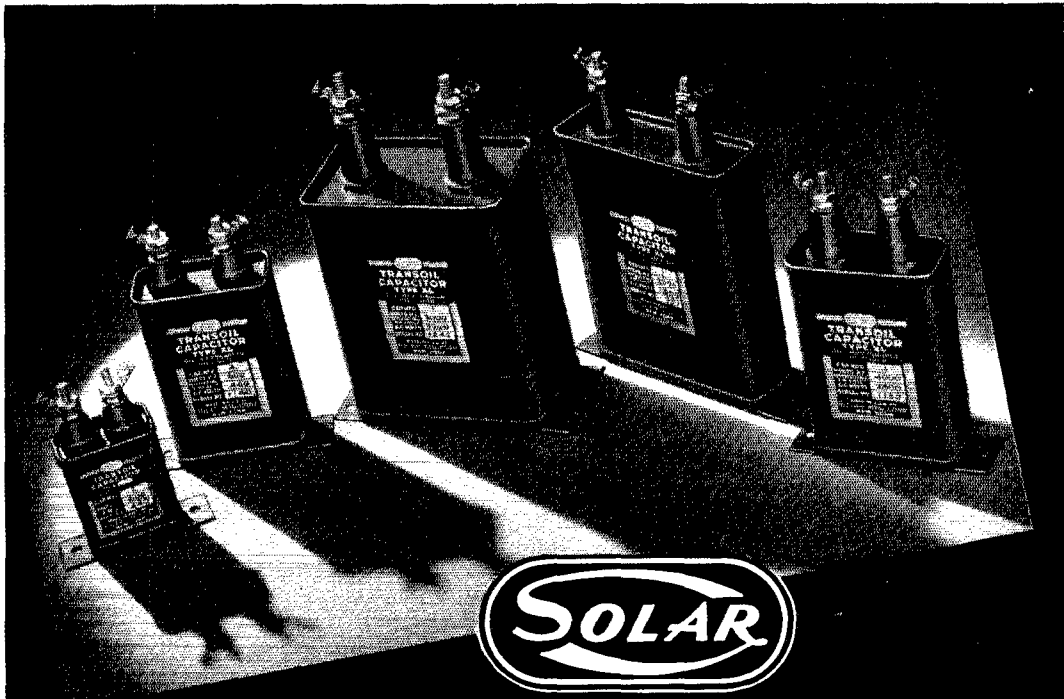

TRANSOIL

for transmitting

HIGHEST QUALITY OIL CAPACITORS

*Ask for new complete
Transmitting Catalog
describing*

TRANSOIL—SOLAREX—TRANSMICA

SOLAR MFG. CORP., 599-601 BROADWAY, NEW YORK, N. Y.

GROSS CP-55 and CB-55 TRANSMITTERS

- Full 95 Watts input ● New Taylor T20 tubes
- Ten Meter operation ● Built-in power supply
- For operation on 10-20-40-80-160 meters
- 3 stages, 42 Osc, 6L6 buffer, 2-T20's in final

KIT \$42.70

Less tubes, meters, crystal — One set coils included in price

The "CP-55" uses the marvelous new T-20's in the output stage. These real transmitting tubes will give outputs and performance not possible with ordinary receiving tubes — their price is very low.

The ideal unit for the beginner, or the "Old Timer" desiring an additional Transmitter for operation on 10 meters, or any other band. In the CP-55 you have available an Xmitter having real power at a marvelously low price.

Compare the construction of the "CP-55" with units selling at many times its price. Only finest components are used such as Cardwell Condensers, Seatite Sockets, IRC Resistors, Cornell Dubilier and Aerovox Condensers, etc.

The CP-55 is converted into a fine RADIOPHONE TRANSMITTER by merely adding an available modulator unit.

Descriptive Bulletin on Request

"GW-55" RF Unit only as used in the CP-55 including one set coils, less tubes, xtal, meters. Kit **\$18.95**
 Two full size surface type meters. \$7.00
 Coils, any amateur band listed in features, per set. 2.85
 Kit of Matched tubes for RF Unit. 6.60
 One 83 Tube for power supply.65

"CB-55"

The Radiophone version of the "CP-55" — Also sensationally low priced. All Bands Including 10 Meters. Bulletin gives Details

NEW! "CB-130"

Radiophone Transmitter, Floor Cabinet Model, 120 Watt-Phone Transmitter.

Bulletin gives full details and amazingly low price

"THE STANDBY" (2 to 2000 Meters) 3 TUBE A.C. AND D.C. RECEIVER

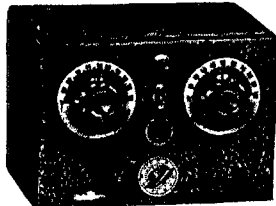

This excellent 2 to 2000 meter receiver is offered with full realization of the present-day need of the amateur for a dependable "standby" receiver which will cover practically all of the radio bands in use today. Super regeneration, which is the most efficient form of detection at these frequencies, is used from 2 to 15 meters. By throwing a toggle switch, straight regeneration and higher wavelengths up to 2000 meters may be had. Throughout the entire tuning range, there are no skips or dead spots. Loud speaker volume is available from practically every station received.

- Power supply incorporated.
- Individual antenna tuning for high and low wave ranges.
- 1-76 super regenerative detector, 1-6J7 regenerative detector, 1-12A7 audio amp. and rectifier.

Complete kit of parts less coils, tubes, cab.	\$7.59
2-5-10 meter coils (set of 3)95
9 1/2 to 15 meter coil.39
15-200 meter coils (set of 4)	1.30
200-310 meter coil39
310-550 meter coil36
550-1050 meter coil60
1000-2000 meter coil60
Metal cabinet.	1.50
Kit of three tubes.	2.40
Wired and tested in our lab., additional.	2.00

GROSS RADIO, INC.

51 VESEY STREET NEW YORK

Cable Address: GROSSINC

remarkable spectacles radio regulation will probably ever see.

However, this upset of the 1912 law had the effect of spurring Congress to the realization of the absolute necessity for a new law and so in 1927, the same year when the Washington International Conference was held (but before that affair), Congress passed the Radio Act of 1927 which not only defined amateurs for the first time in any law, foreign or domestic, but set up a Federal Radio Commission to administer radio matters and gave it the necessary authority to make regulations that would stick. As soon as the commission was created, we got it to assign to us the same wave-bands that had been agreed upon at the 1924 Hoover Conference, except that we had a 10-meter band included.

We are now almost through with the story. Discerning readers may at this point ask how we could get the Hoover bands assigned to us under the 1927 U. S. radio law when our government was a party to (and ratified) the 1927 international treaty which gave us somewhat different territory—specifically, narrower bands at 7 and 14 Mc. The answer is that the 1927 U. S. law went into effect before the Washington conference was held and, further, that the terms of the Washington conference did not go into effect until January 1, 1929. Until January of 1929, therefore, our government let the wider-band specifications stand as U. S. law. On January 1, 1929, however, it immediately amended our amateur regulations to conform strictly to the international agreements.

From that time to the present, through both national and international regulations, we have retained the bands first set up for amateur use in the Washington international treaty of 1927.

This concludes a very rapid and rather brief résumé of our amateur progress in terms of legislation. It is, needless to say, impossible in such an article as this to go into detail or to describe adequately the tremendous part played in all amateur matters by the A.R.R.L. ever since the League's formation. Those interested in details, as well as a thorough treatment of the League's part in amateur legislation are referred to the book "Two Hundred Meters and Down" by Clinton B. DeSoto.

In the next issue will appear a brief outline of the steps leading up to an international conference and a short description of how such a gathering does business.

The New PITC

(Continued from page 20)

are provided on this chassis for the audio system and oscillator. In this way voltage variations appearing across the audio bleeder on modulation peaks cannot affect the oscillator voltage. A three-position selector switch of special design allows the choice of c.w. or 'phone. In the "off" position all filaments in the transmitter are cold; when placed on c.w., only the oscillator and final amplifier filaments are lighted and the high voltage supply to the audio bleeder is opened, eliminating a needless drain on the dynamotor. In the

TODAY'S AMATEURS - TOMORROW'S LEADERS

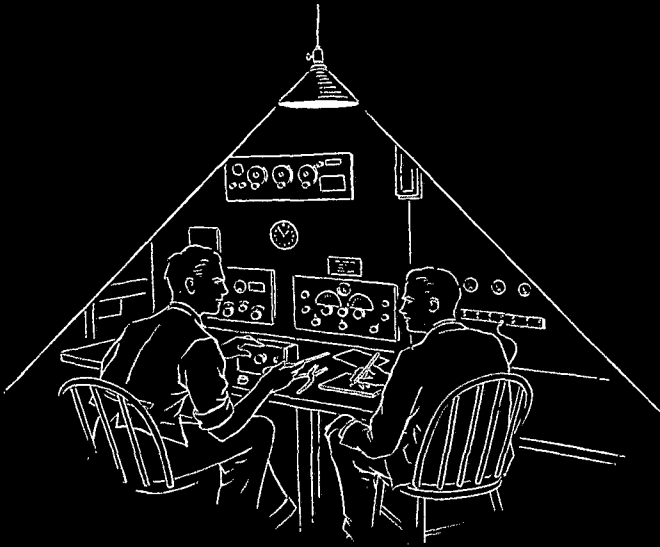

WHEN the amateur sends his messages winging through space, he engages in a creative avocation—forms friendships with distant listeners—and prepares for future leadership in radio.

The interest of the "ham" has far-reaching effects. Ever on the alert for new developments, he is in constant touch with radio progress. Many of the leaders in the radio field today gained their early knowledge as amateurs—and in the ranks of today's amateurs will be found many of tomorrow's engineers and executives.

Like the engineer and executive, the ama-

Say You Saw It in *QST*—It Identifies You and Helps *QST*

teur demands the utmost efficiency in his equipment. His transmitter is small compared to the giant broadcasters—yet his voice reaches the far corners of the globe. Low-loss insulation is an important factor in his success—and Isolantite*, the choice of leading manufacturers of sets and component parts, gives him the efficiency he needs.

*Registered Trade-name for the products of Isolantite Inc.

ISOLANTITE INC.

CERAMIC INSULATORS

Factory: Belleville, New Jersey • Sales Office: 233 Broadway, New York, N. Y.

**Merry Christmas
and
Happy New Year
To Our Friends
from
Milt, Ted,
Walt, Fred
and the Cat**

73 73 73 73 73 73 es 73

A Few Xmas Specials

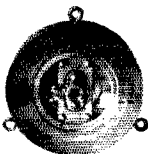

**Broadcast Quality
DB Mike es Trans.
for \$4.95**

This Kellogg 501 mike (formerly \$90 net to studios) is equal to the best carbon we've ever tested — stretched diaphragm, chamber damped, 2¾ lbs. of precision machined mike plus fb transformer.

**More Filter vs Less \$\$
2 mfd any Ham voltage
for \$2.45**



Here's a 2 mfd condenser, unconditionally guaranteed for Ham use — a special Tobie Micranol — been tested at 17,000, a real filter condenser that will take the usual Ham abuse.

**7200 to 7500 KC
"X" cuts 99¢**

Our Christmas load of these FB x cut unmounted xtals has just arrived. Outside of a couple of cracked crystals (funny they won't bend) every one is a high output, active oscillator. Here's ur 10 fone xtal.

**A Real
"Bug"
for \$3.45**

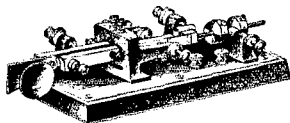

An automatic Kenco "Bug" key with a money refunded guarantee if you are not satisfied within one week of use in your shack. This is not \$20 de luxe job but it works fb es can be keyed properly.

**THE RADIO SHACK
46 Brattle Street, Boston**

"phone" position this bleeder is closed and the oscillator cathode keying terminals are shorted to ground, providing continuous carrier conditions. This method of switching has a further advantage since operation on c.w. would not be encumbered in the event of trouble anywhere in the audio amplifier, the high voltage being automatically removed from the entire system when keying.

The intermediate chassis carries an RCA-807 crystal oscillator tube, using cathode regeneration to give sufficient drive on all bands for high-level modulation. The operating frequency in the 20- and 40-meter bands and that on 600 is established by three Bliley type VP4 crystals ground to 14346, 7245 and 478 kc. respectively. The selection of any one crystal and its associated tank coil is accomplished by means of ganged Ohmite band switches. The 50- μ fd. high-frequency tank condenser is wired from plate to ground so that it is operative on all three bands irrespective of the band switch setting. On 478 kc., however, a 150- μ fd. variable equipped with locking device is located behind the panel and permanently shunted across the tank coil, being automatically picked up by the band switch when choosing this frequency. The 50- μ fd. condenser is brought out to a front-of-panel control for tuning on 20 and 40 meters and provides sufficient capacity to effect resonance on 600 meters when placed in parallel with the 150- μ fd. loading condenser.

The final amplifier occupies the topmost chassis and utilizes an Amperex ZB-120. This particular tube was chosen because of its extremely high μ , necessitating very little bias and driving power. The same arrangement for padding the 600-meter circuit is incorporated in this stage as is used in the oscillator. In the case of the 20- and 40-meter channels provision has been made for individual doublet antennas. Both tanks are equipped with internal variable link coils terminated in Alsimag 196 bushings on the cabinet top. Two half-wave doublets cut to proper length for each band, with 75-foot lengths of Bassett concentric cable attached, are included ready for connection to their respective terminal posts. The 600-meter output is arranged for feeding a Marconi antenna by means of a shunt-tuned antenna pickup coil, coupling between antenna and tank being varied by loosening two wing nuts and sliding the antenna coil mounting. A Triplett Model 341 r.f. meter on the upper panel indicates antenna resonance, the external thermocouple being located in the antenna lead at the rear of the power-amplifier chassis.

All essential circuits are wired to the upper front panel carrying five 3-inch Triplett meters. From left to right in the photograph they indicate S07 plate current, filament voltage, antenna current on the 600-meter channel, ZB-120 filament voltage and plate current. The filament voltage for both these tubes is controlled by rheostats located on the lower power chassis panel, a red line on each voltmeter indicating the proper operating voltage. No series resistance is needed in connection with the 6.3-volt audio tubes since the six tubes are paired up and wired in series-

The New 1938 Edition of the RADIO AMATEUR'S HANDBOOK

TWELVE men, each a specialist in some phase of amateur radio, collaborated four months in the production of the 1938 edition of **THE RADIO AMATEUR'S HANDBOOK**. Virtually thousands of hours of effort have been expended in a thorough-going re-writing of the book. Larger than ever before and still more profusely illustrated, the **HANDBOOK** is without question the most comprehensive ever produced. Further, the selection of the material and its arrangement have resulted in the most understandable presentation. ● Two entirely new chapters have been added — the first a thorough treatment of workshop practice covering the problems faced in working with raw material, assembling and wiring the component parts of station equipment. It includes designs for work benches and operating tables. The second new chapter is devoted to the ever-important field of emergency and portable equipment. Designs are given for the last word in emergency gear and special attention is paid to the power supply problem. ● In response to wide demand, an entirely new chapter has been written on the general subject of fundamental principles. The new chapter is aimed at those individuals, young or old, who have absolutely no knowledge whatever of electrical and radio phenomena but who demand a painless introduction to the subject. ● The remaining chapters have all been vigorously rewritten, involving an entirely new text. Those dealing with apparatus construction have benefitted from a three-months' laboratory program devoted to the design and construction of modern transmitters, receivers and power supplies, incorporating modern tried and proven circuits. In all these circuits and in the equipment built around them, a special attempt has been made to avoid anything freaky or unusual. Indeed, the work has been greatly that of selecting from the maze of good, bad and indifferent circuits only those which comply strictly with modern practice. In contrast to previous editions of the Handbook, many of the apparatus designs were prepared especially for the book and are exclusive to it.

\$1 postpaid in Continental U.S.A.—\$1.25 postpaid elsewhere
American Radio Relay League • West Hartford, Conn.

QUIET PLEASE!

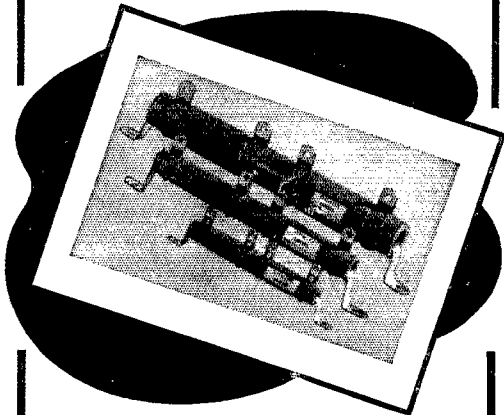

● Keep the neighbors from pounding on your door at midnight. OHMITE Powerline Filter Chokes keep high-frequency out of the power lines. Hook one of these on the input of your rig with a couple of .1 mf condensers and pound brass right through all the crooners on the broadcast bands.

A CHOKE YOU CAN'T BURN OUT!

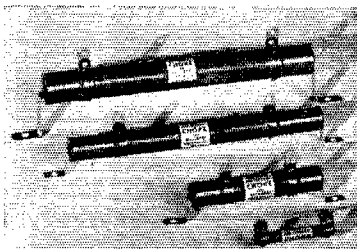

● Single layer solenoids, designed to avoid all resonance in the amateur bands. Moisture-proof, wound on low power factor ceramic tubes, and provided with non-magnetic mounting brackets. — And built to regularly carry a thousand MA!

OHMITE

MANUFACTURING CO.

4331 West Flournoy St., Chicago, Ill.

parallel across the 12-volt supply. This method effects a decided economy in battery drain. The 2-inch meter in the lower panel shows the total milliamperes consumed by the modulation unit while serving as a reference for percentage of modulation.

With a total input of 250 ma. at 750 volts, which is the maximum output of the Pioneer dynamotor used for supplying plate voltage, this transmitter is capable of a measured carrier output of 60 watts fully modulated. The filament-heating current consumed when all tubes are lighted for 'phone operation is 4.1 amperes while

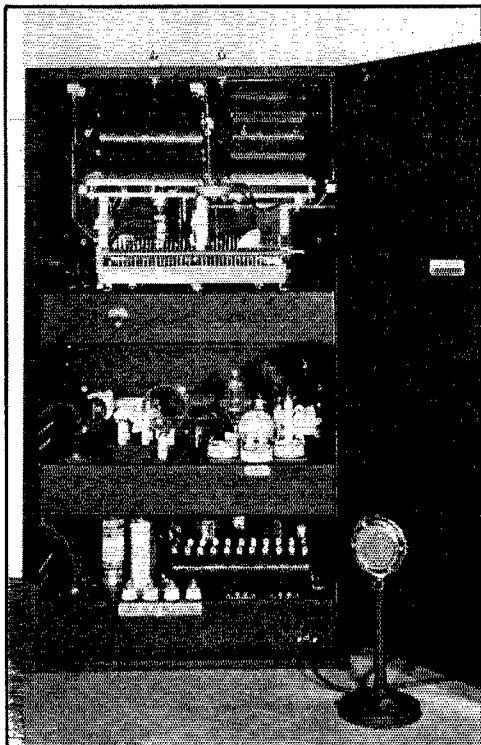

INSIDE THE TRANSMITTER

Audio equipment on the bottom shelf, oscillator in the middle, final at the top. Those 600-meter coils should satisfy those who want plenty of LI

the dynamotor draws a total of 28 amperes under these conditions. Because of a saving of 100 ma. when the modulator is cut out for c.w. operation, the output may be raised to 80 watts by tightening the link coupling to the concentric-feeder cables.

Every precaution has been taken in design, construction and choice of parts to preclude the possibility of breakdown. All resistors and fixed condensers have been chosen so as to operate well below their ratings. Special attention has been given to the question of insulating materials. Mounting post insulators, bushings, terminals and inductor mountings are all made of Alsmag 196. The Cardwell variable condensers used throughout the set have Mycalex supports. Power circuits are carried to each successive deck

(Continued on page 90)

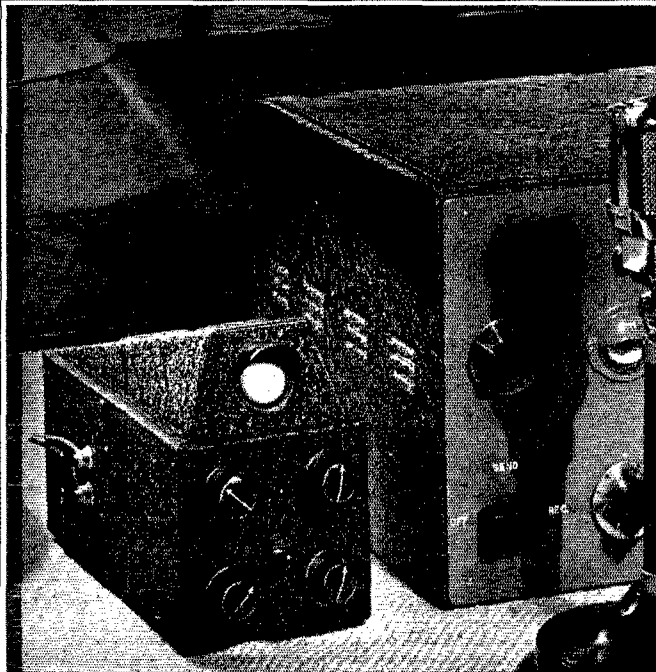

A MINIATURE OSCILLOSCOPE AT A LOW PRICE

The Type CRM Oscilloscope employs the little RCA-913 tube having a one-inch screen. In spite of its small size, this new equipment is thoroughly practical and is quite satisfactory for routine measurements in the amateur station. The circuit includes a power supply with controls for brilliancy and focus, a potentiometer for controlling the amplitude of the horizontal deflection, and a built-in 60-cycle sweep. This latter is particularly convenient as it permits checking transmitter operation with no connection other than a pick-up coil.

NET PRICE \$11.10
Without Tubes

NATIONAL COMPANY, INC.
MALDEN, MASS.

Unconditionally
Guaranteed

**PR
CRYSTALS**

Powerful
Reliable

X cut 7000 KC ± 5 KC . . \$1.85 3500 or 1750 . . \$1.65

Low Drift ± 5KC 40-80-160 2.20

PETERSEN RADIO CO. Ex

W9JRY COUNCIL BLUFFS, IOWA W7AHE

Formerly Omaha Crystal Labs.

Be a Good, Fast Sender

Get a NEW Improved

VIBROPLEX

Semi-Automatic Key



THE BUG trade mark identifies the Genuine Vibroplex

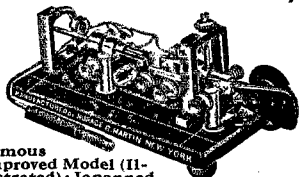

Famous Improved Model (Illustrated) Japanese Base, \$17; Nickel-Plated, \$19. Be popular. A good, fast sender is always popular whenever he comes on the air. The New Improved Vibroplex develops a degree of sending proficiency seldom attained by users of the old type straight key. Don't envy good, fast senders — be one! Get a New Improved Vibroplex semi-automatic key — standard the world over for clarity, speed and sending ease. Easy to learn. Simply press lever

— Vibroplex does the rest. Costs no more than imitations. So why not get the best? Insist on the Genuine Vibroplex. Your old Vibroplex accepted as part payment on a new Vibroplex. Money order or registered mail. Write for FREE catalog.

THE VIBROPLEX CO., INC.
832 Broadway New York, N. Y.

More Distance Per Watt — WITH

**TRIPLET
MODULATION
MONITOR**

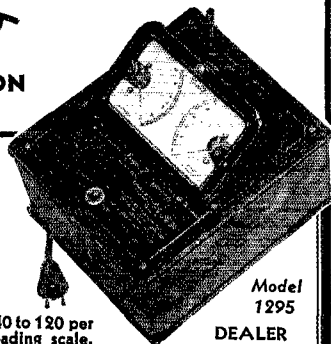

Model
1295

DEALER

Model 1295 Modulation Monitor enables you to tune your transmitter to maximum efficiency thereby saving the power loss of under-modulation. Result — clearer signal to distant stations. For all voice transmitting stations. Modulation from 40 to 120 per cent shown on direct reading scale.

Case is metal with Black Wrinkle Finish. PRICE \$24.83 Etched panels are Silver and Red on Black.

SEE YOUR JOBBER — WRITE FOR CATALOG

The Triplet Electrical Instrument Co.
251 Harmon Dr., Bluffton, Ohio

Without obligation please send me more information on Model 1295

Name

Address

City.....State.....

(Continued from page 54)

ATLANTIC DIVISION

EASTERN PENNSYLVANIA—SCM, Jack Morgan, W3QP—R.M.'s: 3AKB, 3AQN, 3EOP, 8ASW, P.A.M.: 3EOZ, 3AKB has installed new antenna, 3ADE and 3DGC gave the O.R.S. party and SS something to think about. 3BGD reports Beacon Radio Amateurs building emergency Gas-electric plant. 3ECA now is recruiting officer for A.A.R.S.—step right up, fellows. 3GJY hooked Argentina on 6 watts (28 Mc.). 3GMK has brand-new ACR155. 3NF is pinch-hitting for WLM while the boys go YL-ing Friday nights. 3EMI has a new 101X. 8AXH is trying to spear a five-point buck with a 56-Mc. antenna. Advise 8DHT if interested in formation of trancon net on 3629 kcs. 8NNC says owner of nearby summer cottages was advised by ham radio as to extent of damage. 8QXW is ditching his YL in favor of an O.R.S. certificate. 3BRZ is piling up records on 28-Mc. 'phone. 3CXE says SW station s-t-o-r-k QSP'd him a brand-new YL Jr. op. Our congrats.

Traffic: W8ADE 18 3AKB 283 3AQN 30 3BGD 4 3DGC 68 3DXC 2 3ECA 88 3EHZ 6 3ETA 9 3ETM 4 3EJW 185 3GDI 81 3GJY 10 3GMK 32 3NF 526 3EMI 121 3DGM 29 2ITX/3 117 3GUB 23 3QP 51 8ASW 184 8AXH 5 8DHT 196 8EU 16 8FLA 266 8NNC 33 8CDT 19 8QXW 7 8OML 13.

MD., DEL., D. C.—SCM, E. L. Hudson, W3BAK—3CQS, 3CXL: R.M.'s. 3BWT, Chief R.M. EIV has been working plenty of Europeans on 7 Mc. with only 50 watts. FSP has an e.c. osc. GKN blew final just before O.R.S. party, so used exciter for $\frac{3}{4}$ million points. 8JA/3 in SS and O.R.S. contests worked 40 states on 3.5-Mc. band with 3 $\frac{1}{2}$ to 6 watts. ETE has new rig with 200 watts. Ed Day of WLM moved to Kernersville, N. C., where his is 4NG/WLMC.

Traffic: W8CIZ 720 BWT 522 EIV 104 FSP 103 GKN 84 GKZ 17 8JA/3 12 3CDG 11 BAK 10 ETE 9 GXO 3 CXL (WLM 2427) 3DQN (WLMC 225).

SOUTHERN NEW JERSEY—SCM, W. Walter Filson, W3BEI—The S. J. 3700-Kc. A.A.R.L. Net and the A.A.R.S. N. J. State Net are in full winter regalia. ZI keeps 6 daily schedules (except Sun.) and keeps S. J. in touch with North Jersey. DNS moved to P'ville. EJK put up a new 45-foot mast. DNU maintains nightly schedules as well as A.A.R.S. BIR is operating only on 7 Mc. CZN got new RME; he had as a visitor 8GPN of Ithaca, N. Y. FCQ sends first report as O.R.S. BGP, ZX, and BEI are still keeping weekly schedules with K4ENY in the Virgin Islands (ex-W3AN). A big round table was held on Nov. 13th using 7-Mc. c.w. and 14-Mc. 'phone, and comprised BGP, QL, ZX and BEI on 14-Mc. 'phone in contact with K4ENY on 14-Mc. 'phone and VE2LO (ex-W3COT) on 7-Mc. c.w.

Traffic: W8BYR 190 ZI 118 EFM 94 (WLNJ 59) BEI 37 DNU 9 AEJ 3 BIR 4 BO 1.

WESTERN PENNSYLVANIA—SCM, Kendall Speer, Jr., W8OFO—R.M.'s: 8KUN, 8KWA, 8MOT, 8GBC, A.A.R.S. Liaison R.M.: 8UK, N.C.R. Liaison R.M.: 8KOB, New O.R.S.: 8HBG, New O.P.S.: 8NEA, Prospective O.R.S.: 8QXF. QAN is alternating for KWA on both T.L. "A" and Nat'l T.L. Net. Five B.P.L.'s for Western Penna. this month: MOT, KWA, OFO, QAN and WLMA (8YA). MOT has a fine bunch of originations. OFO went B.P.L. on both table and deliveries. UK liked the W. Pa. QSO Contest, the O.R.S. party and SS. CMP attended the hamfest at Auburn, N. Y. JZR, NDE and IOH visited KUN. REE ordered a Utah transmitting kit. REE is a new ham in St. Marys. OKS has a new rig—6L6G osc. with pair of 6L6's final. NEA is running 200 watts on an 'O3A on 1.75-Mc. 'phone. JTT's call for use in Erie is RGN. All traffic work at YA done by George Hart, 3AMR-NF. 8GMZ won first prize in the W. Pa. QSO Contest with 51 contacts. OUH was second with 50; KUN third, 48; FIP fourth, 46; NCF fifth, 45; MIW sixth, 41; IQB seventh, 37; BLQ eighth, 34. MJK and RCQ tied for ninth and tenth with 33 contacts.

Traffic: W8MOT 777 KWA 774 OFO 654 QAN 508 KUN 325 UK 179 GBC 171 NDE 145 IOH 144 DDC 126 KOB 109 CMP 94 AXD 50 GUF 31 YA 40 (WLMA 804) MJK 24 HBG 27 QVQ 6 OKS 5 QXF 2.

WESTERN NEW YORK—SCM, Charles F. Smith, W8DSS—R.M.'s: 8CSE, 8BJO, 8JTT, 8AQE. P.A.M.: 8CGU. Activity in this Section is showing a decided improvement. Here's hoping it continues throughout the New Year. PLA again leads the O.R.S., with CSE a close second. QMR, on vacation, will be active from 4DVO (S.C.M., E. Fla.). GWY carries some nice traffic schedules. DHU reports QWA and RBW new stations in Au Sable Forks. BJO is on with increased power and new receiver.

CGU, our popular P.A.M., enlists the aid of Mrs. CGU in making out his reports and QSL cards. AOR, of Champlain, on 3525 kc. reports he is willing to take traffic for that part of the state. LUQ is to be congratulated on making the highest score in recent O.P.S. Party. KXA is teaching radio to Boy Scout group and High School Club. QGW, with a new five half-wave antenna, got S9 from first VK worked on 'phone. PCU is pounding brass regularly at the University (8YX). QOL is interested in A.A.R.S. and QMJ in O.R.S. PWU and CTX passed O.R.S. exams with high rating. Congrats to them. PKB is looking for recruits for U.S.N.R. LGH, Bill Countryman, is confined at Orwell Sanatorium, Richland, N. Y., for an indefinite period. Let's keep him cheered up with a continual shower of postcards, letters or what have you. Well, this is the last report that I will write for you, as my term of office has ended. I wish to thank all of you in Western New York Section, and especially the O.R.S., O.P.S., P.A.M.'s, R.M.'s and Headquarters staff for the fine cooperation and assistance you have always given me. I hope you will all continue to loyally support our new S.C.M., "Ed" Preston, W8CSE. He is a conscientious worker and deserves your fullest cooperation. The best of luck and happiness to all.—Chas., W8DSS.

Traffic: W8PLA 217 CSE 200 (WLNM 67) FCG 125 DSS 76 QMR 58 GWY 50 DHU 42 BJO 31 CGU 17 AOR-LUQ 4.

ROANOKE DIVISION

NORTH CAROLINA SECTION—SCM, H. S. Carter, W4OG—The Salisbury hams are to be congratulated on the fine meeting they had for the gang. Everyone attending agreed that it was the best meeting ever held since the Floating Club was organized. Thanks, fellows. ESB went into the Sweepstakes on 1.75-Mc. 'phone. DPB finished new rig with T20 final. CYB had H15X as a visitor. BHR reports a new bug and new 101X receiver. DGU renewed his O.P.S. NY is on 28 Mc. with low power. FT is heard working DX of some kind every time you tune across the 28-Mc. band. EC has a vertical antenna working FB on 28 Mc. ETE, a new ham, is constructing a rig for use on 3.5 and 7 Mc. CPT is constructing a bi-push rig for 28 Mc. DW finds time to handle plenty of traffic. BTC, who was in the Navy, is back in Raleigh. ANU is trying to get a 'Phone Net going again. Give him your support, fellows. NG/WLMC is ex-W3DQN, and has been appointed O.R.S.; he is a former operator at WLM. DWB is helping ABT with the Army Net and doing a good job of it. DGV worked a new station (HR5C) in Honduras on 14 Mc. BYA wants to thank 9AR for keeping a schedule with him so he could talk to his son, who is in Chicago. CFR worked hard in the Sweepstakes. EYH, a new ham, is doing good work on 1.75-Mc. 'phone. 4NC is having an Operators Contest which promises to promote operating activity.

Traffic: W4DW 83 ABT 83 DVB 67 AGF 63 BVD 8 BHR 4.

SOUTH CAROLINA SECTION—SCM, Ted Ferguson, W4BQE—DTU has new rig about finished. ALT is active on 3.5-Mc. 'phone. BZQ is working 14 Mc. c.w. BPD has 99 countries and W.A.C.'d eight times during the month. CL is active on 14 and 28 Mc. EVV is a new ham at Pelzer. EOJ is a new ham at Anderson. EBR is active on c.w. DLP is rebuilding. CQU is active on 3.5 Mc. CZA schedules BDT, EQL, CYU and IR. DLE is leaving for the Philippines in Feb. CZN has new rig. Portable 5EBF is now at Luke Field, T. H. EZF, new ham at Liberty, is on 1.75 Mc. DPN is active on 1.75-Mc. 'phone. DYC reports that the Clemson Club station, ETP, is on 3.9-Mc. 'phone. 3FQQ changed QTH to Clemson. BDT is active in A.A.R.S. and is working 3.5-Mc. c.w. FAL is a new ham on 1.75-Mc. 'phone and is a brother of EOZ. BYA plans to take Class "A" soon. DFC is busy with Naval Reserve duties. EDQ is revamping his rig for a 100-TH. CPX is active on 3.5 Mc. DQY is building a beam ant. GB and FQ have 28-Mc. beam ant. The new Palmetto Radio Club officers are BZX, pres.; EOZ, vice-pres.; and DRG, secy. BZX has a new 14-Mc. vertical ant. ERF is operating portable at the University of S. C. CE and BQE attended Central Floating Club meeting at Salisbury, N. C. OK, boys, let's remind everyone to report next month.

Traffic: W4CZA 75, BDT 64 CQU 14.

VIRGINIA—SCM, Charles M. Waff, Jr., W3UVA—P.A.M.: 3AJU—R.M.: 3GPC, 3GJP, 3DQB, 3BJX, 3GTS—FQP and EMM worked XU8AZ, AVR, BSY and 8ATT worked tri-plex, being on 28, 3.9 and 1.75 Mc. respectively; each fed one other station thru his transmitter so that no band-chang-

(Continued on page 88)

BUY Yourself A CHRISTMAS PRESENT

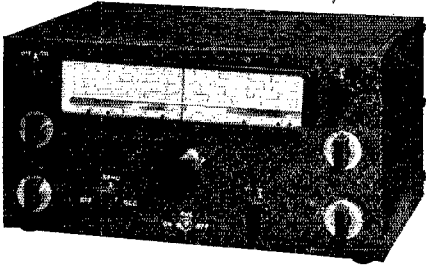

NATIONALS NC-80X and NC-81X

ONLY
\$88.00
Cash Price

(Complete with Tubes, Crystal Filter, 8" P.M. Speaker Chassis)

ONLY \$18.00 Down
\$12.68 a Mo. for 6 Mos.
or \$8.53 a Mo. for 9 Mos.
or \$6.44 a Mo. for 12 Mos.

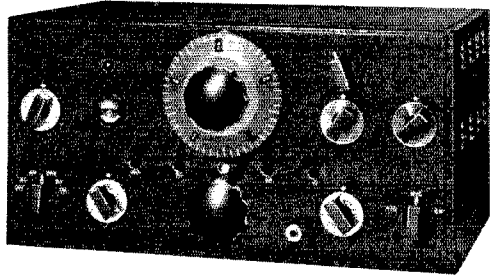

NATIONAL MODEL NC-101X

\$129.00
Cash Price

Complete with Tubes,
Crystal and Speaker

ONLY \$24.00 Down
\$18.58 a Mo. for 6 Mos.
or \$12.50 a Mo. for 9 Mos.
or \$9.47 a Mo. for 12 Mos.

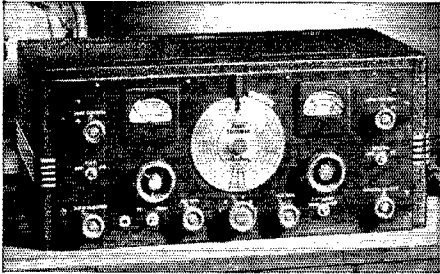

1938 HALLCRAFTER SUPER SKYRIDER

\$123.00
Cash Price

Complete with Tubes,
Crystal and Speaker

ONLY \$23.00 Down
\$17.74 a Mo. for 6 Mos.
or \$11.93 a Mo. for 9 Mos.
or \$9.02 a Mo. for 12 Mos.

ONLY A FEW LEFT! REMARKABLE VALUES

Oil Filled and Oil Impregnated

FILTER CONDENSERS

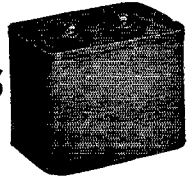

One of the greatest Condenser "buys" ever offered. Well known makes. Finest Quality. Guaranteed at rated voltages. Already sold down to limited supply and going fast. It'll be a long time before you get another "super value" like this!

Order Yours Now! Before It's Too Late!

2 mfd., 2000 V. DC, $4\frac{1}{4} \times 3\frac{1}{4} \times 1\frac{1}{2}$, $1\frac{1}{4}$ lbs. \$1.50
3 mfd., 1250 V. DC, $3\frac{1}{4} \times 3\frac{1}{4} \times 1\frac{1}{4}$, $1\frac{1}{4}$ lbs. 1.25
8 mfd., 2000 V. DC, $5 \times 3\frac{1}{4} \times 3\frac{1}{4}$, $2\frac{1}{4}$ lbs. 2.75
4.4 mfd., 1500 V. DC, $5 \times 3\frac{1}{4} \times 1\frac{1}{4}$, $1\frac{1}{4}$ lbs. 1.75

Buy Your Receiver Now! Pay Later!

Newark offers you a complete selection of all newest amateur receivers . . . standard brands . . . always in stock . . . ready for immediate delivery to you. Newark's Easy Payment Plan permits you to enjoy these receivers now on small monthly payments that you hardly miss. We can supply any amateur receiver you want. We ship 10 days after receiving down payment. Don't wait any longer! Buy a NEW Receiver NOW!

Time Payments on Parts!

Easy Terms on orders for your Parts and Tubes, of \$60.00 or more. Stock up now, pay later!

Send for FREE CATALOG!

Get your copy of the New 1938 Newark Catalog! just released. Hundreds of new items! Bigger Values! Lower Prices! Everything you need! 4-hour service. Save time and money . . . buy from NEWARK!

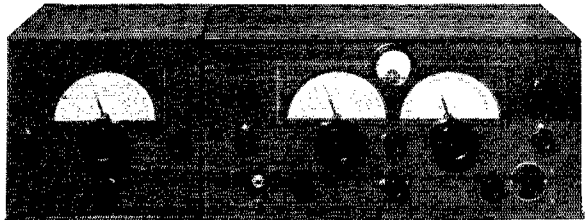

RME 69

Complete with Tubes,
Crystal, and Speaker,
in Cabinet

\$151.20
Cash

DB120 Pre-Selector
\$42.60 Extra

ONLY \$26.20 Down
\$21.94 a Mo. for 6 Mos.
\$14.77 a Mo. for 9 Mos.
\$11.25 a Mo. for 12 Mos.

NEWARK ELECTRIC COMPANY

226 W. MADISON ST. Dept. Q CHICAGO, ILL.

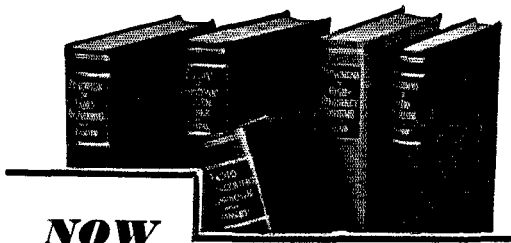

NOW this high-powered radio engineering library

sent to you for 10 days' trial—
at a special price and terms

These books cover circuit phenomena, tube theory, networks, measurements, and other subjects—give specialized treatment of all fields of practical design and application. They are books of recognized position in the literature—books you will refer to and be referred to often. If you are a researcher or experimenter—if your interest in radio is deep-set and based on a real desire to go further in this field—you want these books for the help they give in hundreds of problems throughout the whole field of radio engineering.

RADIO ENGINEERING LIBRARY

—especially selected by radio specialists of
McGraw-Hill publications

—to give most complete, dependable coverage of
facts needed by all whose fields are grounded on
radio fundamentals

For home-study and reference. Contains a revised
selection of books culled from latest McGraw-Hill
publications in the radio field.

5 volumes, 3064 pp., 2000 illustrations

1. Glasgow's PRINCIPLES OF RADIO ENGINEERING
2. Terman's MEASUREMENTS IN RADIO ENGINEERING
3. Chaffee's THEORY OF THERMIONIC VACUUM TUBES
4. Hund's PHENOMENA IN HIGH-FREQUENCY SYSTEMS
5. Henney's RADIO ENGINEERING HANDBOOK

Special Low Price and Easy Terms

Bought singly, the five volumes comprising this library would cost you \$25.00. Under this offer you save \$1.50 and, in addition, have the privilege of paying in easy installments beginning with \$2.50, 10 days after receipt of the books, and \$3.00 monthly thereafter. Take advantage of these convenient terms to add them to your library now.

SEND THIS ON-APPROVAL COUPON

McGraw-Hill Book Co., Inc.
330 W. 42nd St., New York, N. Y.

Send me Radio Engineering Library, 5 vols., for 10 days' examination on approval. In 10 days I will send \$2.50, plus few cents postage, and \$3.00 monthly till \$23.50 is paid, or return books postpaid. (We pay postage on orders accompanied by remittance of first installment.)

Name

Address

City and State

Position

Company QST-1-38

(Books sent on approval in U. S. and Canada only.)

The C.C.C. Takes to the Air

(Continued from page 41)

the radio net to a real test. Tens of thousands of blankets and cots, and countless hundreds of trucks and men from the whole corps area were moved into the flood region. Messages kept the operators constantly at their keys, and the busy antenna wires fairly sizzled. This tremendous movement of men, equipment, and supplies was directed largely by short-wave radio. Some of the stations in the area were themselves sent into the flooded zone for emergency communication.

A real future lies ahead for these operators if the C.C.C. is made permanent, as President Roosevelt has suggested. And, at least, the training and experience these men are gaining will undoubtedly lead many of them straight into the ranks of the hams after their discharge from the corps. This system, now spreading throughout the country in other C.C.C. areas, is one of short-wave radio's most interesting developments of recent years.

Briefs

If you receive some S.W.L. cards from South Africa headed "Natal Mercury Radio Competition" and reporting your signals during the month of December, you will help the S.A.R.R.L. if you acknowledge them. It is an S.W.L. contest conducted by the "Natal Mercury" to promote interest in amateur radio. You can send your verifications to A.R.R.L. HQ where they will be forwarded to the S.A.R.R.L.

Think you have troubles? Listen to this: The entire building housing the Black Diamond Radio Club of Logan, W. Va., was completely destroyed by fire at 9:03 A.M., November 28th. The big 1-kw. rig, which had just been finished the day before, lies in ruins! Total loss amounts to \$5000.

The Twelfth Naval District N.C.R. organization recently held a contact party, believed to be the first such activity held within the N.C.R. ranks. It was a get-together similar to the SS Contest. Points were counted on the number of stations worked, number of N.C.R. Sections and Units worked, etc. A good time was had by all and many of the members of the N.C.R. in the 12th Naval District met their "shipmates" for the first time over the air.

W8QBQ, Buffalo, N. Y., announces a schedule for transmission of code practice on 1815.5 kc.: Each Wednesday from 7:30 to 8:00 p.m. EST. The radio division of the Buffalo Sea Scouts conducts this class with W8IHG operating.

W1BGY lives on Call Street—not a bad QTH for the First District QSL Manager!

In the 1937 August Low Power Contest W3FRB, manned by two operators, scored 150 points . . . 65 contacts, all operation being with self-powered equipment.

In the 1937 June Field Day, the Merrimack Valley Amateur Radio Assn. (Concord, N. H.), using the call W1BFT-1, made contacts with 29 portables and 51 fixed stations, all power obtained from auxiliary sources, total score of 1071. Operators were W1BFT, W1FAB, W1GKE, W1HOV, W1IVU, W1JBA, W1JCA and W1JJD.

The Ohio gang heard of a fellow at London (Ont.) Frison Farm who wants to become a ham when he gets out, so they sent him a Handbook and QST subscription. That should start him on the straight-and-narrow path!

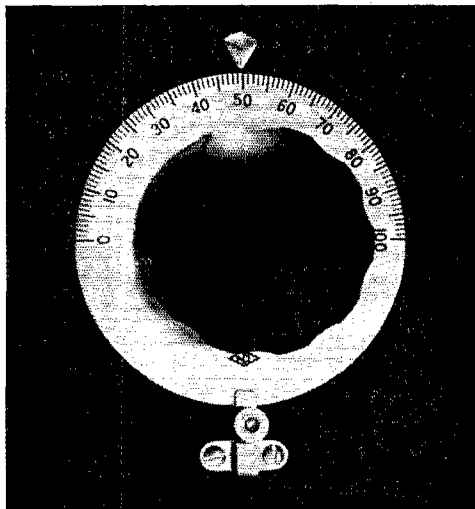

National Type O Dial, complete with index and grounding brush. Net Price... **\$.90**

National Type ODL Lock. Net Price... **\$.30**

NATIONAL COMPANY, INC., MALDEN, MASS.

TYPE O DIAL

THE O Dial has always been distinguished not alone for its appearance, but also for the very thorough way in which the dial scale is insulated from the shaft on which it mounts. For some applications, as in instrument use, it is desirable to ground the dial. For this purpose a small multi-contact brush is now packed with each dial. This device also provides a smooth friction load that makes adjustments steadier.

Where a positive clamp is desired, the new Type ODL Lock is available at a small extra charge. It is positive in action, and tightening it does not disturb fine adjustments, nor mar the fine finish of the dial.

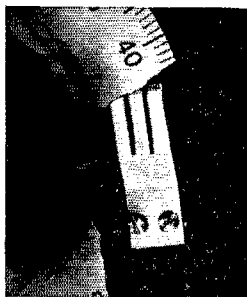

LEARN CODE RIGHT

Tapes for Every Need — Send You Typical Messages by **INSTRUCTOGRAPH**

It's easy and practical to learn or improve your Radio or Morse Code, any speed. Senior model with 10 tapes and Book of Instructions — \$20.25. (Rented at low cost) Junior model with 5 tapes and Book of Instructions — \$12.00. (Not rented). Complete oscillator equipment, less battery, \$6.50. Write for details today.

INSTRUCTOGRAPH CO., Dept. Q-1
912 Lakeside Place Chicago, Ill.
Radio College of Canada
863 Bay St., Toronto

BUY ON CASH OR TERMS: HALLICRAFTER AND R.M. E. SHORT WAVE RECEIVERS, SPEED-X AND VIBRO-PLEXES, Telegraph Instruments.



HOW TO GET BROADCAST QUALITY REPORTS

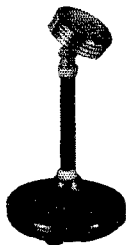

Turner VT-73

Put the new VT-73 on your rig. The resonance is engineered to emphasize the intelligible speech frequencies. You'll cut through QRM much better with a VT-73. It's a light weight combination mike — stand — handle. Anti-resonant cable, tight R.F. shielding, high level and long lived. Order this classy microphone now and enjoy broadcast quality reports.

This and other Turner micro-phones in stock. **\$14.85** Net

NEWARK ELECTRIC CO.

226 W. Madison Street, Chicago, Illinois

Licensed under patents of the Brush Development Co.

MINIMUM CAPACITIES!

Look at the table below and note that the maximum to minimum ratio averages over four to one! No Other Condenser of Similar Maximum Capacity and Airgap Has Such a Low Minimum Capacity. This Means Proper "Q" on More Bands.

Model	MMF. Per Sec. Max.	Min.	MMF. Series Sec. Max.	Min.	Airgap Per Sec.	Length To Coil Bar	Net Price
ABC2425	24	3	13	2	.250 in.	4.6 in.	\$12.90
ABC8825	88	17	46	11	.250 in.	7.1 in.	\$15.95
ABC15925	150	28	80	18	.250 in.	9.7 in.	\$19.10
ABC295	20	5	11	3	.500 in.	5.5 in.	\$14.05
ABC445	44	11	24	7	.500 in.	9.8 in.	\$16.90
ABC965	96	25	50	16	.500 in.	17.8 in.	\$23.55

Two sets of built-in neutralizing plates — \$4.00 net, additional. Complete listings in bulletin

ATKINS & BROWN W6VX W6HB
215 Fourteenth Street, Oakland, California

Say You Saw It in QST — It Identifies You and Helps QST

(Continued from page 84)

ing was necessary for any receiving. BIW is on 14-Mc. 'phone mostly. DDDY is "still rebuilding, studying and looking for a receiver." BRA is op at sea on S.S. *Malchace*. GWQ has a new receiver. AHHK is rebuilding with 100TH final. CFL has an 808 final. 9IMZ/3 is operating portable in Richmond. GKL is putting in a pair of HF-100's. GPV is rebuilding. FMY made about 32,000 points in the SS. FBL is open for schedules with anyone. BFW is back on. GVZ is on 7265 kc. GSG is rag chewing and experimenting. GTS is adding a pair of 860's; he has acted as National Net Control and Third Corps Area A.A.R.S. Control Station; he is new Route Manager. GBC is new D.N.C.S. A.A.R.S. for Va.; he is looking for new members; if interested, write him. FQY is using parallel '46's, 55 watts input, operating in Richmond. GWP worked OX2QY. UVA is using P.P. 807's on 3.5 Mc. DZW is back on with 802's with 33 watts. GPC is busy with traffic schedules. GJP is on 3800 kc. February is the month for the Virginia Floating Club to meet next. What city will extend an invitation? Write the S.C.M.

Traffic: W8GTS 270 (WLQE 149) (WLMG 270) GPC 134 FJ 120 GBC 64 GJP 43 FMY 8 DDDY 4 GUZ-FBL 3 BSY-FQP-GPV 2 GBK-9IMZ/3 1.

WEST VIRGINIA—SCM, C. S. Hoffman, Jr., W8HD—New officers of Mountaineer Amateur Radio Association: Pres., OXO; vice-pres., KGT; secy., KWV; treas., MIP. Wheeling Radio Club elected DYB Corresponding secy. JRL has new Jr. opr! GBF, HGA, HSA, OJI, OLV and QNP have new receivers. OXO built Rotary Beam antenna. HGA worked 93 countries on 125 watts; is new W.A.S. and W.A.C. LXF is new W.A.S. KIU is preparing some papers for I.R.E.L., "Science," and "Journal of the Franklin Institute"; he also schedules VOII. PHY and RDC are building 1.75-Mc. 'phone. MLW is building emergency power supply (Nov. QST). LCN and HGA schedule K5AG. RHM and RRS are new Moundsville stations. OSI and KWI on 56-Mc. 'phone between airplane and ground, during model airplane meet, helped find lost model plane. Clarksburg hams are forming 1.75-Mc. C.W. Ragchew Net, PQQ and PMA are operators at 8YX, where they are going to school. RDD (P.A.M.) would like all active 'phone stations in the State write him relative to the forming of an informal 'Phone Net.

Traffic: W8LXF 12 KIU 7 KYJ 4 LCN 30 OLV 3 PHY 5 QZQ 7 BWK 1 HD 299.

NEW ENGLAND DIVISION

CONNECTICUT—SCM, Frederick A. Ellis, Jr., W1CTI —R.M.'s: 1AFB, 1AXB, 1BHM, 1GKM, 1HSX, 1JXP. P.A.M.: 1EAO. CTI continues to serve as S.C.M. Many thanks, gang. Please note list of appointees above and give them your full cooperation. On request of CJD, his appointments have been put on the inactive list for a year while he is pounding brass on the high seas. Recently appointed as R.M.'s are AXB (3FTK), GKM and JXP. JXP will act as liaison with A.A.R.S. UE leads the Section in traffic, making B.P.L. both ways. The Connecticut C.W. A.A.R.S. Net consisting of AJB, KV, APZ, DMP, FAJ, FE, GMR, ITI, JMY, JXP and JYJ operates daily at 7:30 p.m. on 3640 kc. Reports below show this net handles plenty of traffic. DMP, State Representative, will be pleased to give every assistance to any Connecticut amateur interested in joining A.A.R.S. ITI has three schedules outside of Nutmeg Net period. ES reported during SS contact with the S.C.M. IMV reports KKY in Springfield Hospital for an operation. We all wish you a speedy recovery. OM, 3FTK moved to Stamford and is operating AXB. Welcome, Jim. AMQ took part in his first SS. GKM was appointed R.M. and will examine O.R.S. applicants in the Hartford area. HXZ resigned his O.R.S. and Section Net appointments, and is moving to the West Coast. Sorry to lose you, Stan. AW has a daily QST schedule at 1 p.m., otherwise operates only during League activities. HYF reports a score of 671,466 in O.R.S. party. HTS is all steamed up about a band-switching 'phone-c.w. rig. TD says new rig is nearly ready for a preliminary test. IMV reports following in A.A.R.S. 1.75-Mc. 'Phone Net: CNF, KDK, FOO, IFH, ITM, GIX, IFS, JDW, KKY, IMV, FAJ.

Traffic: W1UE 649 JXP 383 AFB 335 JMY 335 KV 285 (WLGG 29) DMP 218 ITI 162 AJB 157 (WLGG 69) ES 93 IMV 88 KQY 87 HSX 74 BDI-CTI 53 JQD 49 AXB 44 AMQ 37 GKM 35 JYJ 32 JYE-HXZ 21 AW 15 KBJ 12 HYF-IBH 11 APW 5 BNB 3 DWP 2 JTD-JUD 2.

MAINE SECTION QSO CONTEST

Dates: January 15, 1938, 1 p.m. to midnight.

January 16, 1938, 1 p.m. to midnight. EST.

Stations Eligible: Only stations located in Maine Section who send in copies of logs with scores shall be eligible for prizes.

Procedure: Those taking part in the contest shall call CQ MAINE de W1—.

Scoring: Two points shall be allowed for each 'phone or c.w. contact with like station. Five points for 'phone-c.w. contacts or vice versa. Scoring to be confined to contacts between Maine stations.

Frequencies: Any or all bands may be used. Either or both c.w. and 'phone may be used.

Log sheets: Copies of log sheets showing type of emission and band used for each contact (this also applies to station worked), date, time contacted and location of station worked, shall reach the S.C.M. not later than January 20th.

Prizes: There will be prizes for the first three high scorers. Everyone take part, and don't forget to get the log sheets in on time.

MAINE—SCM, Winfield A. Ramsdell, W1FBJ—All Maine hams are urged to participate in the Maine QSO contest. TE has been appointed Emergency Coördinator for the Portland area. JET has been doing fine DX work with low power using only a 6L6 crystal osc. KLH works out well with crystal osc. also. The Portland Amateur Wireless Ass'n was honored on Nov. 9th, by having as its guests four prominent members of the Parkway Radio Ass'n of Boston: IIM, IBS, JDE and XYL and an S.W.L. IIM gave a very interesting talk on the purpose and aims of the New England Club Council, a new organization of which he has been elected president. IBS, president of the Parkway Radio Ass'n, spoke on the merits of the organization and the success a similar council has had in the ninth district. EUL is building a new receiver for 28 Mc. GOJ has added O.B.S. to list of appointments, and made B.P.L. this month. JRS' QTH is now 6 Trowbridge Place, Portland. AQL's new rig is a '47 crystal and '03A final operating on 3660 kc. KOU is a member of the A.A.R.S. Maine Net and sends first report. INW is member of the Humdinger Net. EEY has organized radio patrol in Scout Troop and is able to cover the entire troop on 56 Mc., giving code practice by i.c.w. and news of general interest by voice. Don't forget the all-Maine QSO Party. Talk it up and every station enter.

Traffic: W1GOJ 511 CFO 163 FAP 151 INW 121 KOU 104 IST-ISH 99 FBJ 21 HSE 14 IVV 10 TE 9 DHH 3.

EASTERN MASSACHUSETTS—SCM, Sam Gross, W1IWC—IHI and AKS made B.P.L. both ways. JCK was assigned WLGV. EMG made B.P.L. on deliveries. EPE is new O.R.S. KH attended Midwest Convention at Kansas City. JYJ applied for O.R.S. BMW was appointed intercept watch for N.C.R. JTM is back on 3.5 Mc. BEF is Emergency Coördinator for Eastern Mass. HIL applied for O.P.S. BCF married VE YL. RE is trying new RK-20A on 14 Mc. CGB is building 1.75-Mc. 'phone rig for rag chewing. HXX obtained pilot's license and is now working portable-mobile. JXU has pair of T20's in new rig. KKO is working for W.A.S. ALB is really rag chewing on 28 Mc. ALG has '10 perking on 7 Mc. BSG has new receiver. BSM built new rig and receiver in time for S.S. ERH is finding crystal grinding quite an art. GZI is moving. HA says "14-Mc. 'phone or bust!" INO has new rig on 3716 kc. JIX has new 'phone rig on 28 Mc. JYB is spending forced vacation rag chewing. ALP keeps busy as secretary for S.S.A.R.C. FJN designed and built c.c. mobile rig for Hull Police Dept. R. J. Renton, W1CU, of the F.C.C. gave the S.S.A.R.C. an interesting talk on equipment used at monitoring stations. JNU's QTH: Chelsea Memorial Hospital, 100 Bellingham St., Chelsea; drop him a card. FCU married Fla. YL. IWF put up an "Our Hero" mast. HXE has 12-ft. gong, so be careful when you work him on 'phone! The M.V.A.R.C. membership consists of 70 licensed amateurs and 50 S.W.L.'s. BLO has new Jr. op. The S.C.M. wishes to call the attention of A.R.R.L. members to the League appointments: O.P.S., O.R.S., O.O. and O.B.S. Why not take an active part in the organized field of amateur radio? You will find increased enjoyment in hamming. The Nutz Net operates in the vicinity of 3800 kc. It is primarily a rag-

chewing net, but some traffic is handled. So many of the members of the HI-Q Radio Club of Lynn, Mass., were asked for information on radio by "would-be amateurs," that the club decided to do something about it. They have started a code and theory class meeting before the regular club meeting. JIX is the prof. in charge of the theory, and JYB works the pump handle; 26 have registered; 18-20 reporting at each class. Those in the vicinity of Lynn, who are interested, get in touch with W1P5, Fred L. Burgess, Sec'y, 23 Gordon Rd., Lynn.

Traffic: W1LHI 700 AKS 646 IWC 399 JCK 352 (WLGV 6) EMG 338 INA 250 DMF 190 HWE 155 KCT 111 EPE 109 KH 104 QA 94 AGX 74 JYJ 72 BMW 34 IUQ 31 ASI 16 JTM 15 BEF 13 HXE 10 AAU 8 HKY 6 GLE 5 HIL-BCF-RE-IRV 3 CGB 2.

WESTERN MASSACHUSETTS—SCM, William J. Barrett, W1JAH—IOT made B.P.L.; Heck reports Central Mass. A.A.R.S. Net working fine. IOR made B.P.L. on deliveries. Chet sends dope on Worcester gang: New hams—KUL, KWG, KQH. New officers of Worcester Radio Ass'n—IOR, pres.; JNA, vice-pres.; IZW, sec'y-treas. KOQ and KKM joined A.A.R.S. AZW is keeping nice bunch of schedules. KUQ is new O.R.S. here transferring from Eastern Pa., and reports working K6 over 250 times this year. AJ has portable for A.E.C. work. How about some more of you building 'em? EOB got card from YL2BB after only year and a half. KJK reports 2CQA moved to Springfield and is active on 3.5 Mc. BIV is new O.R.S. in Gardner. AJD is leaving Section to work in Nashua. Lots of luck, Ed, we're sure sorry to have you go. BNL joined A.A.R.S. GJJ is taking a crack at 28 Mc. IEI reports JJO has directive ant. for 56 Mc. IEI is building modulator for 3.9 and 14-Mc. 'phone. COI is digging postholes for new skywire.

Traffic: W1IOT 650 (WLGN 184) IOR 402 BVR 106 (WLG 232) AZW 97 HNE 62 KUQ 58 AJ 42 IZW-EOB 29 KJK 20 JAH 18 DUZ 10 BIV-ISR 8 AJD-BNL-GJJ 2.

NEW HAMPSHIRE—SCM, Carl B. Evans, W1BFT—The New Hampshire State Traffic net (NHN) is operating nightly on 3840 kc, and considerable traffic is being handled. BFT, GMM, TA, ANS, FCI and EDN are active on net at present. GKE got his 50-foot sky-hook up, and is on the air after a lay-off since last spring. KPD is active on 56 Mc. EWF has completely rebuilt in steel relay rack and operates on 28 Mc. most of the time. IMB is trying his luck on 28 Mc. JEH is on 3.5 Mc. with a 6A6 oscillator and 6L6 amplifier. JSL is fed up with hi-power and disposed of his T-200. EAL is now on 56 Mc. acting as a contact between the 3735-Kc. A.A.R.S. Net and the 56-Mc. A.A.R.S. Net. FCI has the new Harvey 700-R on the air. KKT rebuilt in rack and panel and put up a new 45-foot mast. AWU joined the ranks of the Benedicti. Congrats, and best of luck, Red. The M.V.A.R.A. was active in the SS and piled up a club score of around 200,000 points, about double that of last year. IJB is experimenting with grid modulation of an 806 on 3.9-Mc. 'phone.

Traffic: W1IP 520 BFT 253 FFL 187 (WLGB 35) GMM 134 IDY 103 KIN 92 FCI 64 ANS 62 AXL 53 GHT 35 JDP 22 CEA 20 EAL—JGI 17 HTO 11.

RHODE ISLAND—SCM, Clayton C. Gordon, W1HRC—CPI has a temperature-controlled freq. meter, N.C.-101X and RME-69. Harvey 80T on 3.5 Mc. Shure Mike and Webster amplifier, with two 60-foot towers, and a 750-watt c.w. and 500-watt 'phone job under construction; all this at 84 Kenyon Ave., Wakefield. ALJ has two new masts and 3.5-7-14-Mc. c.w. and 14-3.9-Mc. 'phone. FOV has built a "modernistic" cellar studio with beautiful panelling (vouched for by BIT) that's a honey. BIT has new "stick" 45 feet high with GTN and IEG as "master mast raisers." KRQ is a new ham in Westerly on 3.5 Mc. with crystal control and T-20 final. BDS has a new rotary beam antenna which he is using on 14 Mc. GR has also installed a rotary beam for 14 Mc. FAH is back in Providence and has new 4-band band-switching exciter unit. IZO has new 1938 Super-Skyrider. JNO is new O.P.S. HJ has new final with RK-38's on 14-Mc. c.w. BLS will have taken the long one-way trip down the aisle by the time you read this. JNO is trying out 14-Mc. beams. VK5KO must have a lot of friends in U.S.A.—we got two requests for arrangements of schedules for him with R.I. 28-Mc. station and was able to hook up ETD to him in just 48 hours after getting the requests.

Traffic: W1AEG 210 INU 631 GTN 294 KCS 143 INT 76 JUE 94 HRC 63 IMY 59 IQF 29 KTH 28 IZO 27 JXQ 25. VERMONT—SCM, A. H. Battison, W1GNF—KIE is commercial operator at W.Q.D.M., St. Albans. 2EGF visited at FSV. JRU has adjusted his set in the 7-Mc. band. JVS

got married. BNS is operating on 1.7-Mc. 'phone. KTB has his eyes on a new NC-81-X receiver. AVP missed two 50-foot telephone poles for his new antenna. EZ worked hard in the SS. F8V joined A.A.R.S. HEV is installing an 807. The familiar and most welcome signal of BJP has joined us for another season. Ex-8AJS is signing KWG on 14 and 28 Mc. KPH is on 1.7 Mc. KUV visited KVB and KIE. FPS contacted VP4CF, his first foreign station on 14 Mc. BJP visited KRX, DQK, KOO, KTB, BLC, TJ and JZF. IQG, BLC and KOO visited at BJP. ILX wrote us a fine letter and description of his rotary beam antennae. CLL is working in Brandon. KVV is the station of G. Buxton, Rutland. GNF has cancelled his traffic contest with FSV, already having too many irons in the fire. Bob will challenge anyone else to a contest.

Traffic: W1FSV 281 GNF 23 GAE 36 AVP 7.

HUDSON DIVISION

EASTERN NEW YORK—SCM, Robert E. Haight, W2LU—ACB schedules 8ADV every Sunday at 10:30 A.M.; he has been appointed Emergency Coördinator for Schenectady dist. EGF is high traffic man. HEV says KHX has new NC10EX. EOA, eng. at WOR, gave talk at Westchester Amateur Radio Assn. meeting. ALP visited Little Rock Radio Club and attended Kansas City Convention and Auburn Hamfest. GZF reports via T.L. IUR is building 1/2-kw. rig. BDB is rebuilding. HUB is hunting DX. ITK is on 7 Mc. CYW reports 56-Mc. meeting held on air; CYW was control station with 15 stations present in Albany and Troy. BSH surprised the boys by coming on 56 Mc. HYO has new skywire on 56 Mc. KFB is active on all bands. AMM sports new antenna which attracts the hams. KLV has Class B modulator on 56 Mc. JBQ sports new 56-Mc. receiver. KMC operated by YL's of 56-Mc. Radio Club of Albany meets last Tuesday of every month at 8 p.m. at Central Y.M.C.A. GTW, new T.L. station, is back from good ships *Caamo* and *Ponce* (WKCW, WFCB). JQI reports Capitol Dist. Radio Club, with HCS pres., GTP sec., DSK treas., and AWF technical advisor, was launched Oct. 26th. FQG is new O.P.S. FBA and AWF continue friendly rivalry in countries worked, with FBA trailing AWF by 2; both have at least 70 countries to their credit. DSK, KNX and JSQ are consistent performers on 1.75 Mc.

Traffic: W2EGF 216 GZF 57 JWT 170 LU 42 BLU 26 JQI 13 KFB 4 HYC 2 FQG 6

NEW YORK CITY AND LONG ISLAND—SCM, Ed. L. Baunach, W2AZV—KAP is O.O. checking broad signals exclusively on 14 Mc. IXQ is O.P.S. CHK is new O.P.S. in Bellmore. JAD, KIF, KVA and KVH send their first reports. IXY has 1 kw. on 14 Mc. and is covering the British Isles with O.B. IYR works portable in Syracuse during the week-ends. Ex-W2UD of Brooklyn, now O4AAU at Lima, Peru, has been visiting PF on a vacation. JBL has been working hard to get a portable perking at college. EXR operates on 3.5 Mc. only at the present time; watch for bootlegger using his call on other bands. ELK enjoyed the O.R.S. party; 8TZ is his neighbor in Brooklyn. DBQ built an FB 150-watt rig for DJP. JZX is in the A.A.R.S. GDF is getting out at new QTH. FF is building new beam antenna and modulator. IOP was on 'phone but now has a modulator for sale. IHT is building new 56-Mc. rig. APJ is rebuilding for 28 and 56-Mc. portable-mobile in his new car.

Traffic: W2OQ 457 JHB 212 DBQ 186 (WLNB 106) PF 162 DQW 81 IHT 67 EC 43 AZV 42 EYS 32 EXR 15 AHC 11 BYL 9 IOP 9 KIF 8 KCV 7 DXO 6 JZX 5 DOG-KSI-CJT 4 VG-HAK 3 HBO-AA-DLR-FLD-CHK 2 HYL-BKP-ADW 1

NORTHERN NEW JERSEY—SCM, Fred C. Read, W2GMN—GGE has been working hard on his new transmitter. SN has new method of distributing QSL cards, in which addressees of cards received at the Bureau are notified by amateur radiogram. In this way he hopes to distribute about 30,000 cards which have not yet been claimed. Watch for yours. NV lost part of a finger when a new rig on which he was working fell on it. GGW is keeping schedules again. HOZ CMC and JKG are new O.R.S. ICH has new outfit with 53 oscillator and P.P. 2A3 amplifier. GZG has his 211-D working on 14-Mc. 'phone. HLX has the "recording craze." JDO is doing his best to get on 1.7-Mc. 'phone. JOU has half-wave skywire for 1.7 Mc. that crosses two streets! FLB has new 56-Mc. transceiver. Plainfield Radiophone Ass'n gang is appointing a "Get W2HIA on the air" committee.

Traffic: W2JCG 278 HQL 102 (WLNR 119) GGE 109 (WLNQ 90) JUC 62 GGW 35 GMM 26 JKG 12 HOZ 16 CMC 11 BZJ 9 ICJ 8 CIZ 6 CJX 6 IQM 5

for HEAVY GOING!



Porcelain-case mica capacitors for severe service.

Minimum metal in h.f. field.

2000 to 12500 v. D.C. test. .00005 to .1 mfd.

Also rated in current-carrying capacity at h.f.

A still better mica capacitor designed by AEROVOX engineers for the more critical requirements of ultra-short-wave transmission.

Ask

your jobber for copy of latest catalog listing this and other components.



Get on the Air FOR ONLY \$88.00

BUILD THE PROGRESSIVE III
(Send for New Bulletin 50 — FREE)
Fully Equipped - NET

NO "extras" to buy, no time wasted experimenting. You can build the exciter and low power stages of the famous PROGRESSIVE III for only \$88.00. That includes everything needed — tubes, crystal, meter, etc.

Then, when you're ready to add phone or more power, you keep right on building, without tearing down what you've got or discarding parts.

GET READY FOR DX CONTEST

The Progressive III is now pushing through QRM all over the world. You'll want yours for the big DX Contest. It is built with standard parts, obtainable from your jobber. Panels and chassis come completely drilled, with sockets installed. Only a screw driver, pliers and soldering iron needed to assemble it. Complete, easily followed directions in AMATEUR TRANSMITTER MANUAL, 25c from your jobber or Amateur Press, 333 Throop St., Chicago.

GENERAL TRANSFORMER CORP.
1288 W. Van Buren Street
CHICAGO

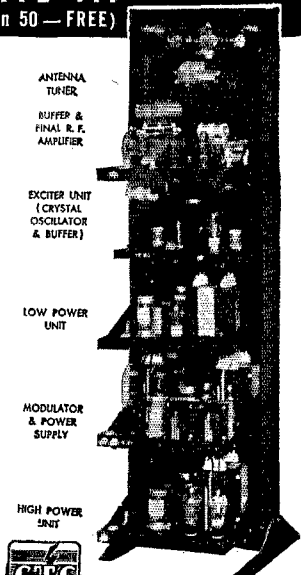

The chassis mount on rack or in metal cabinet

by means of plugs and sockets, allowing each chassis to be readily removed for repairs. All of the flexible wiring and cables use a specially-treated, lacquer-coated wire since ordinary fabric covered wire is often a source of trouble when exposed to moisture.

While all this care and forethought should make failures a remote possibility, it has been anticipated insofar as practical by the inclusion of spare condensers, resistors, brushes for the dynamotor and windcharger, a spare impeller for the latter, an extra crystal microphone and duplicate sets of tubes. To facilitate location of trouble when it inevitably occurs, a Triplett Model 666 Volt-Ohm-Milliammeter has been furnished, making it a simple matter to check the operation of any circuit.

As the receiver aboard the *Yankee* has proved itself capable of outstanding service in the face of adverse climatic conditions in maintaining a schedule with W1ZB, it was deemed advisable to supply a similar set for use with the new transmitter. This choice was further justified since Andrew Young had the opportunity of operating the ship's set during the *Yankee's* stay at Pitcairn. Accordingly, a Sargent battery-operated Model 11-MF, covering all frequencies from 30 Mc. to 100 kc., was procured. This receiver, with a total of four tubes, has one stage of r.f. amplification and adequate bandspread for communication work. A permanent-magnet speaker is built into the cabinet and jacks are provided on the panel for the use of earphones in either the first or second audio stages. The heater-type tubes are lighted from a 6-volt portion of the main battery, the required plate supply of 40 ma. at 200 volts being derived from a Pioneer Genemotor. The receiver and Genemotor add another 5 amperes to the total current demand on the battery. As in the case of the transmitter, spare parts including condensers, resistors, dial lamps, etc., have been furnished so that repairs may be made when necessary.

With the assembly of the transmitter completed, it was subjected to a rigorous test on all bands in an endeavor to detect any defects that might exist. The station was then put on the air under actual operating conditions at WIBES using a frequency of 14,165 kc. and several stations contacted. Using the same antenna, signal reports averaged only two R's under the 1-kw. rig. on 14,166 kc. normally used at WIBES. Under ideal radio conditions such as exist on Pitcairn Island, and avoiding the QRM of the American 'phone band, P1TC should have no difficulty in being heard in every quarter of the globe.

The task of arranging for delivery of all this equipment was quite a problem since there is no established freight or mail service, the island being unimportant commercially. Located midway between South America and New Zealand, 25 degrees south of the equator, it is avoided by cruise ships and freighters alike, because the rocky reefs and sheer cliffs, rising to heights of 1000 feet from the water's edge, provide little incentive for vessels to tarry long off shore. Since the occasional visits made to the island by passing

COMPARE Crystal Performance

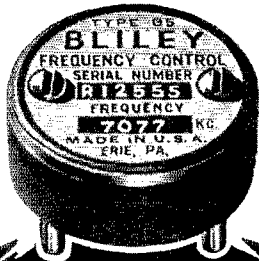

If you really want trouble-free crystal performance, put a B5 Crystal Unit in your transmitter. For 40 meters, the B5 low drift unit excels the world-renowned Bliley LD2 40-meter unit which it now supercedes. In the 20-meter band, the B5 unit combines low drift, high activity and full dependability. \$4.80 buys a B5 40-meter unit. The 20-meter unit costs only \$7.50. See these superior crystal units at your distributors. Bliley Electric Company, Erie, Pennsylvania.

BLILEY B5 CRYSTAL UNIT

GORDON
NAME PLATES

ANTENNA TUNING

A complete line of 122 everlasting, chromium plated name plates for Transmitter, Sound and Test equipment. Available in two sizes. Write for listing and low prices.

GORDON SPECIALTIES COMPANY
440 S. Dearborn Street • Chicago, Illinois

LEARN TO SEND
AND RECEIVE

CODE

Learn to send and receive code signals, like operators on ships at sea and at commercial and amateur land stations. Intercept distress signals, news flashes, bulletins, and dozens of other kinds of interesting radio communications.



machine sends faster, gradually preparing you for top-speed amateur and commercial signals. With the new All Electric MASTER TELEPLEX you learn to send by sending, and the signals you send are repeated back to you, exactly as you sent them, thus enabling you to correct your own errors. We furnish a complete course, lend you the All Electric MASTER TELEPLEX and give you personal instruction with a MONEY BACK GUARANTEE. Send for our new TELEPLEX FOLDER Q1 today. IT'S FREE!

THE "HAM"
SPECIAL

Standard Teleplex — a highly efficient code teacher using heavy specially prepared waxed paper tape, having two rows of perforations. Write for Free folder "Q.1-1."

TELEPLEX CO. 72-76 CORTLANDT STREET
NEW YORK, N. Y.

JUST OUT
PRACTICAL
COURSE OF
INSTRUCTION
IN TELEVISION
For Only \$10

In response to the numerous requests for information and practical guidance in the theory and technique of Television, Sprayberry Academy of Radio has prepared, especially for amateurs, a complete, intensely practical compilation of lessons, data, etc. covering the subject from the very beginning to its present status and future possibilities. Never before has this material been sold separately. Previously it was available only as a part of a well-known Radio Instruction Course selling at many times the price. Now it is offered in newly revised and modernized form for the ham who, already well versed in preliminary Radio work, wants to participate in the Television development opportunity recently offered to the amateurs of the nation. You will find it complete — modern — easy to understand — just what you need for any phase of Television experimentation.

ACT NOW!

Send \$10.00 (entire cost) in check or money order so that we may rush our Complete Course in Television to you immediately. Includes complete set of questions and answers. For further information write:

SPRAYBERRY ACADEMY OF RADIO
75-B University Place, N. W., Washington, D. C.

Buy Yourself a Xmas Gift

LIBERAL TRADE-IN ALLOWANCES

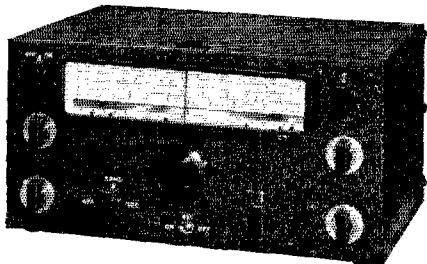

NC No. 80X — Frequency coverage 550 kc to 30 mc in four ranges. Complete with tubes, crystal filter and 8" PM Speaker. Net price..... **\$88.00**

NC No. 81X — Frequency coverage exclusively for amateur bands. Complete with tubes, crystal filters and 8" PM speaker. Net price..... **\$88.00**

HRO Receivers — Table model. Net price... **\$179.70**

Relay rack model. Net price..... **\$192.00**
(in stock)

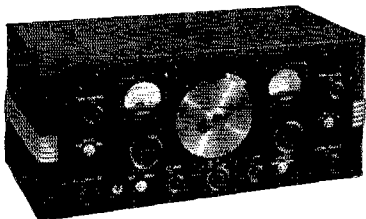

Hallicrafters SX16. Incorporating all the latest features for which these receivers are famous. Frequency range 62,000 to 545 kc. Iron core transformers allow wide range selectivity. Unique band spread which gives over 1000 degrees calibration. Extreme sensitivity. Complete with tubes, crystal and speaker.
Net price..... **\$123.00**

SX17. Two stages of pre-selection; built-in automatic noise silencer, same as SX16 illustrated above, except for noise silencer switch on front panel. Complete with tubes, crystal and speaker. Net price... **\$149.50**



RCA v-cut Crystal mounted in special RCA ceramic holder; frequencies only in 80 meter band; accuracy of calibration .005%. Regular amateur net price \$9.85, our special net price... **\$3.95**

Bliley Crystals. All new types of Blileys in stock; large selection of frequency ranges.

TERMINAL

Radio Corporation

80 CORTLAND STREET, NEW YORK, N. Y.

ships is a "courtesy" service and entirely contingent upon weather conditions, hopes of getting the equipment to Pitcairn depended upon the cooperation to be had from the steamship lines. The facilities of Roche International Export Corporation were enlisted and through their efforts the entire shipment is being forwarded on a no-charge basis. Seven cases are scheduled to leave New York on January 8 from Pier 60 on the Panama Pacific liner *Pennsylvania* to connect with the New Zealand Shipping Company's *Arangitiki*, sailing January 21st from Cristobal for Auckland. If conditions permit a stop at the island on this voyage, the apparatus should be at Pitcairn by the first week in February.

With the equipment on its way to Andrew Young, there remains little more to be told. It is sincerely hoped that the conclusion of this story may signal the opening of a new chapter in the colorful history of Pitcairn Island, a chapter recording pleasant memories of amateur radio friendships the world over. May the amateur in contacting PITC remember that he is treading the sanctity of 147 years of almost absolute isolation. Largely by his conduct will the rest of the world be judged by the islanders.

I wish to thank the various companies listed, whose cooperation and donations of equipment and services have made it possible to bring the original idea to a successful conclusion: Aerovox Corporation, American Lava Corporation, Ampere Electronic Products, Bassett Research Corporation, Bliley Electric Company, Allen D. Cardwell Mfg. Corporation, Coto-Coil Company, Inc., Eby Manufacturing Company, Kenyon Transformer Company, Ohmite Manufacturing Company, Par-Metal Products Corporation, Parris-Dunn Corporation, Pioneer Genemotor Corporation, RCA Radiotron Corporation, E. M. Sargent Company, Shure Brothers, Triplett Electrical Instrument Company, Willard Storage Battery Company, Roche International Export Corporation, Panama-Pacific S.S. Company, New Zealand Shipping Company.

True North from Old Sol

(Continued from page 18)

at true noon.² Adding this to our previously-arrived-at figure of 11:51 A.M., we get 11:58 3/4 A.M., EST, as the time when it will be true noon at West Hartford on January 10th. At that time, the shadow of our vertical pole will lie true north from the pole's base.³

Author's note: This article is intended only for the use of amateurs in the United States and Canada. As a matter of fact, amateurs in the southern portions of our southernmost States will be able to use it only during Winter, Fall and early Spring; elsewhere in the States and Canada it is good any time the sun is out.

² Although the fractions of minutes may seem like carrying things a bit far, it is best to include them. If they worry you, however, you can drop them without much harm, simply making the correction to the nearest whole minute.

³ But only if the pole is vertical in an east-west direction! If it isn't—although most are, near enough, for practical purposes—mark the position of the shadow of the top; a line from this point to the actual top is the desired true north-south line. This line can be "sighted" of course.

Merry Christmas and a Happy New Year

Two great holidays falling together . . . one a day of giving, thinking of the other fellow . . . the second, a day when men think of themselves, take stock, recognize the past year's mistakes and plan for better things in the twelvemonth ahead.

Our own New Year's resolution is very simple. We are resolved to improve our business by serving you better. Having more friends than a year ago, we are planning to have more of the same a year hence.

Insert this amongst your own Resolutions for 1938 . . . to buy your parts and accessories here — to keep our catalog and printed matter where you can reach it when needed — to treat us as your headquarters WITHOUT FEELING THAT YOU HAVE TO BUY EVERY TIME YOU COME IN.

Again . . . Happy New Year!

TERMINAL
Radio Corporation

80 CORTLANDT STREET, NEW YORK, N. Y.

TELEPHONE • BARCLAY 7-0622

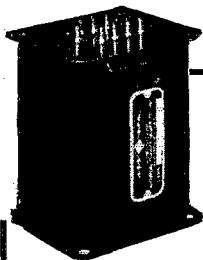

**BE WISE
and
KENYONIZE**

Your
T20, TZ20 and 809

With
**KENYON T-378
FILAMENT TRANSFORMER**

7.5V or 6.3 V 7 A CT 2000 V test

NET PRICE \$3.00

See Your Local Jobber or Dealer for
Bulletin on **T-378**

**KENYON TRANSFORMER
COMPANY, INC.**
840 Barry Street, New York, N. Y.
Export Dept.: 25 Warren St., New York, N. Y.

MEMORANDUM

✓ You need a copy of the
new Bigger-than-ever 1938
Handbook.

✓ You need a binder for
your 1937 *QST's* — and
another for 1938.

JANUARY, 1938

Strays

Bound Volume XXI of *QST*

We have a limited number of Bound Volume XXI of *QST*. This volume is made up in two sections, each containing six issues of 1937 *QST*. Handsomely bound and gold imprinted the complete volume is priced at \$6.00, postpaid.

Standard Frequency Transmissions

Date	Schedule	Station	Date	Schedule	Station
Jan. 7	A	W9XAN	Feb. 4	A	W6XK
	B	W6XK	Feb. 11	A	W9XAN
Jan. 14	A	W9XAN		B	W6XK
	A	W6XK	Feb. 25	BB	W6XK
Jan. 21	BB	W6XK		A	W9XAN
	A	W9XAN	Feb. 26	BX	W6XK
Jan. 22	BX	W6XK	Feb. 27	C	W6XK
Jan. 23	C	W6XK			

STANDARD FREQUENCY SCHEDULES

Time (p.m.)	Sched. and Freq. (kc.)		Time (p.m.)	Sched. and Freq. (kc.)	
	A	B		BB	C
8:00	3500	7100	4:00	7000	14,000
8:08	3600	7100	4:08	7100	14,100
8:16	3700	7200	4:16	7200	14,200
8:24	3800	7300	4:24	7300	14,300
8:32	3900		4:32		14,400
8:40	4000				
Time (a.m.)	Sched. and Freq. (kc.)				
	A		BX		
	6:00	7000			
	6:08	7100			
	6:16	7200			
	6:24	7300			

The time specified in the schedules is *local standard time* at the transmitting station. W9XAN uses Central Standard Time, and W6XK, Pacific Standard Time.

TRANSMITTING PROCEDURE

The time allotted to each transmission is 8 minutes divided as follows:

- 2 minutes—*QST QST QST de* (station call letters).
 - 3 minutes—Characteristic letter of station followed by call letters and statement of frequency. The characteristic letter of W9XAN is "O"; and that of W6XK is "M."
 - 1 minute—Statement of frequency in kilocycles and announcement of next frequency.
 - 2 minutes—Time allowed to change to next frequency.
- W9XAN: Elgin Observatory, Elgin National Watch Company, Elgin, Ill., Frank D. Urie in charge.
W6XK: Don Lee Broadcasting System, Los Angeles, Calif., Frank M. Kennedy in charge.

WWV Schedules

EACH Tuesday, Wednesday and Friday (except legal holidays), the National Bureau of Standards station, WWV, transmits with a power of 20 kw. on three carrier frequencies as follows: 10:00 to 11:30 A.M., E.S.T., on 5000 kc.; noon to 1:30 P.M., E.S.T., on 10,000 kc.; 2:00 to 3:30 P.M., E.S.T., on 20,000 kc. The Tuesday and Friday transmissions are unmodulated c.w. except for 1-second standard-time intervals consisting of short pulses with 1000-cycle modulation. On the Wednesday transmissions, the carrier is modulated 30% with a standard audio frequency of 1000 c.p.s. The standard musical pitch A = 440 c.p.s. is also transmitted from 4:00 P.M. to 2:00 A.M., E.S.T., daily except Saturdays and Sundays,



YOU WILL SEND BETTER CODE— and send it FASTER with CANDLER PERSONALIZED TRAINING

World's Champion McELROY says:

"Practice alone, on any kind of practice set, will not develop a skilled operator. He needs a thorough knowledge of the Fundamentals and Mind Training taught exclusively by the CANDLER SYSTEM. It's the easiest and fastest way I know to learn code or better your speed and technique."

**CANDLER
SYSTEM CO.**
Dept. Q-1
ASHEVILLE, N. C., U. S. A.

One way you can be sure of becoming a skilled operator is to have Walter Candler teach you *personally*. Every good operator must develop Automatic Sound Consciousness. Not until then can he send and receive speedy code without strain or confusion. Don't spend your money and energy trying to acquire professional technique by yourself. That's the hard, uncertain way. The easy, inexpensive and SURE way to code skill is CANDLER *Personalized* training. See for yourself. Mail the coupon.

MAIL COUPON TODAY FOR FREE BOOK

CANDLER SYSTEM CO.
Dept. Q-1, Asheville, N. Carolina, U.S.A.
Send me your FREE book right away! My present speed is..... wpm.
Name.....
Address.....
City..... State.....

American

CRYSTAL MICROPHONES

are being used with enthusiasm by Amateurs and Public Address men throughout the World. Noted for excellent Quality and the Versatility of its mountings.

Licensed under patents of The Brush Development Co.



AG Directional C-5 Non-directional

AMERICAN MICROPHONE CO., Inc., Ltd.
1915 S. Western, Los Angeles, Cal.

SPEED

THE COMPLETE LINE OF TELEGRAPH KEYS

THE LAST WORD

in appearance and performance. One-quarter inch coin silver contacts—well insulated for heavy duty work. All parts chromium plated—choice of black wrinkle or chromium base.
No. 320. Black base..... List \$3.25
No. 321. Chrome base..... List \$3.50
Other models of hand keys from \$1.50 to \$3.50 list— Available at leading jobbers everywhere.

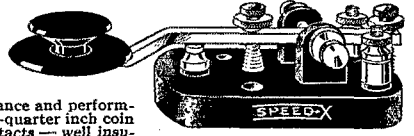

Write for new literature and amateur discounts

646 Jessie St. **LES LOGAN CO.** San Francisco

- ADVANCED ENGINEERING
- PRECISION MANUFACTURE
- PERFECT RECEPTION



Ken-Rad Radio Tubes
KEN-RAD TUBE & LAMP CORPORATION - OWENSBORO, KY.
Makers of Ken-Rad Radio Tubes and Ken-Rad Electric Light Bulbs

RESOLVED FOR 1938

During the next 12 months Sun Radio Company promises to sell only the highest quality, nationally known lines of merchandise at the lowest possible prices and to render the fastest possible service backed by personal attention to your individual needs. To our many friends and customers we pledge these things and extend heartiest greetings for a Happy and Prosperous New Year!

SUN RADIO CO.

SUN STARTS OFF THE YEAR WITH A BANG!

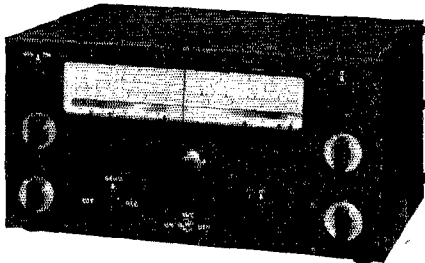

NATIONAL NC-80X and 81X \$88

COMPLETE WITH SPEAKER AND TUBES, NET
We also have in stock for immediate delivery: National HRO, NC100, NC101X and HRO Jr.

— SPECIAL —

RCA TMV 135 "V" Cut, Complete with holder, 3500 Kc to 4000 Kc Only. Limited quantity. Special at. \$3.95

- | | |
|---|---|
| HALLICRAFTER
1938 SUPER-SKYRIDER
Complete \$123.00 net. | STANCOR
Filament Transformers
6.3 volts at 4A. \$1.25
2.5 volts at 10A. 1.14 |
| MILLER PRESELECTOR
With self contained Power Supply, 12 to 200 meters, complete with tubes.
Net. \$24.00 | BLILEY CRYSTAL
Units in stock. A large variety of frequencies.
BC3 — \$3.35 B5 — \$4.80
HF2 — \$5.75 VF1 — \$7.50 |
| RCA ACR111
COMPLETE WITH TUBES AND SPEAKER. . . . \$189.50 | WE CARRY
a complete stock of Stancor Transformers. Write for large FREE Hamannual. |
| 1938 DELUXE MACKEY \$9.50 | |
| WARD LEONARD CHANGEOVER RELAY
110v. AC. Mycalex Insulation. \$5.88 net | |
| TEMCO TRANSMITTERS
In stock. Write for FREE Literature and our Time Payment Plan | |

RADIO CO.

227 Fulton Street, New York, N. Y.
Cable Address: SUNRADIO NEW YORK

on a carrier frequency of 5000 kc., power 1 kw., 100% modulation. The accuracy of the frequencies of the WWV transmissions is better than 1 part in 5,000,000.

A Five-Band Exciter

(Continued from page 17)

coils and at the same time an auxiliary switch, operated by a cam on the switch knob shaft, opens the circuit to the plate tank condenser. Notice that with this switch located as shown, and not in the condenser lead, it does not carry the tank current and, when open, it also opens the circuit through the distributed capacity of the band-change switch.

The cam switch had not yet been added at the time the picture was taken, but the details are shown in the sketch, Fig. 2. The contacts should be silver so that future corrosion will not introduce high resistance at this point. Most jewelers can supply the silver and will be glad to do the soldering job for you if you prefer it. Be sure that he uses "soft" solder, for the heat when using "silver" solder will take the temper out of the wire. Take care to file any solder from the contact face, as it does not make a good contact material.

The panel is 8¾ inches high by standard 19-inch width, of ¼-inch thick hard aluminum sheet. Even with this thickness the door openings were cut out easily with a hand jigsaw. The chassis, of ¼-inch thick half-hard aluminum, is 9 inches deep back of the panel and 14¾ inches long. As the back view shows, room was left at the left-hand end for the crystals so that they need not be unplugged before removing the exciter from the rack. This leaves room at that end of the panel where eventually two card holders will be mounted to contain tabulations of crystal frequencies and condenser settings.

The three doors over the plug-in coil and the meter jacks are hung on small "five and dime" store brass hinges. The hinge pins were knocked out and replaced with one length of bronze wire for each pair of hinges. Torsion springs were wound up from 0.019-inch diameter stainless steel spring wire and slipped over the new hinge pins. About 60 turns wound with tight tension on a piece of the hinge wire will give the right action when installed with a three-turn twist. Be sure to twist them in the direction to tighten the winding rather than to unwind it. For the final touch, file a fingernail groove into the inside edge of each door to assist in opening it.

Coil winding data is given under Fig. 1. Further to simplify the band-changing operation, the amplifier plate coils should be pruned so that each can cover two bands.

COUPLING IMPEDANCE

For operation in the 1.75-Mc. band it is not necessary to open the circuit to the oscillator plate tank condenser if it is turned to minimum capacity. On 3.5 Mc. and higher, however, it is essential. The reason why this is so becomes apparent when we calculate the impedance of the oscillator plate r.f. choke, shunted as it is by the capacities to ground of the associated circuit wir-

My Creed

To give you **SPECIALIZED PERSONAL SERVICE** of genuine value that is not available from other jobbers.

To sell receivers, transmitters, and parts on **TERMS** arranged to suit you with less interest than heretofore charged.

To take your equipment in **TRADE** at a fair value.

To have the most **COMPLETE** stock of amateur equipment and give you quicker **SERVICE**, better **TECHNICAL HELP**, and more complete **INFORMATION** about equipment.

To allow you to **TRY** any receiver for **TEN DAYS** without obligation and to **COOPERATE** with you in every way I can to see that you are entirely satisfied.

COMPARE BOB HENRY'S TERMS WITH OTHERS

Model of Receiver	Cash Price	Down Payment	12-month Payments
RME-69	\$151.20	\$30.24	\$10.81
Sky Buddy	29.50	5.90	2.20
Sky Challenger	69.50	13.90	4.91
Super Skyrider	99.00	19.80	7.11
PR-15	109.50	21.90	7.86
Bretling 14	108.00	21.60	7.75
ACR-155	74.50	14.90	5.38
ACR-111	189.50	37.90	13.51
Super Pro	243.00	48.60	17.30

Similar terms on all Harvey, RCA, Temco, RME transmitters and Stancor, Progressive, All Star kits.

You can reach me by letter, telegram, phone, or visit nearly 24 hours a day, 365 days a year. Write for any information. Your inquiries are invited.

HENRY RADIO SHOP
211 North Main St. Butler, Missouri

Robert Henry
W9ARA

RADIO

ENGINEERING, broadcasting, aviation and radio telegraphy and telephony, Morse telegraphy and railway accounting taught thoroughly. Engineering course of nine months' duration, equivalent to three years of college radio work. School established 1874. All expenses low. Catalog free. **DODGE'S INSTITUTE**, Day Street, Valparaiso, Indiana

PRECISION CRYSTALS

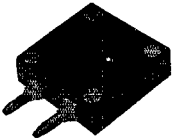

Crystal Holder

Highest quality crystals, one inch square, carefully ground for frequency stability and maximum output. Be sure of your transmitter frequency — use **PRECISION CRYSTALS**.

Low frequency drift crystals (Type L T C) supplied within 0.1% of your specified frequency and calibrated to within 0.03% are priced as follows: 1750 and 3500 kc. bands — \$3.50 each. 7000 kc. band \$4.00 each. Holder \$1.00.

(Holder as illustrated to fit G.R. jacks or round holder to plug into a tube socket can be furnished. G.R. jacks to plug illustrated holder into — \$1.15 pair.)

*'X' cut **PRECISION** Crystals carefully ground for maximum power supplied within 0.1% of your specified frequency and calibrated to within 0.03% are priced as follows: 1750, 3500 and 7000 kc. bands — \$3.00 each. Add \$1.00 if holder is desired.

*'AT' cut crystals for commercial use quoted on at your request. When ordering our product you are assured of the finest obtainable. Now in our seventh year of business.

PRECISION PIEZO SERVICE

427 Asia Street Baton Rouge, La.

Coto LO-LOSS INDUCTORS

D
E
P
E
N
D
A
B
L
E

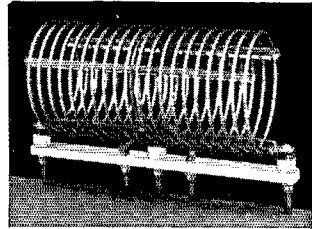

E
F
F
I
C
I
E
N
T

Dependable and efficient communication is of vital importance to any expedition. That is why the MacGregor and MacDonald polar expeditions wisely chose **COTO** products. You too can have this reliability when you select **COTO**.

RADIO



PRODUCTS

COTO-COIL COMPANY, Inc.
229 Chapman St., Providence, R. I.
Export address—100 Varick Street, N. Y. C.

ENJOY BETTER RECEPTION NOW!



THE
NEW
1938
SUPER
SKY-
RIDER

NO NEED TO WAIT WHEN YOU
CAN BUY YOUR NEW RECEIVER ON HINDS
& EDGARTON EASY TIME PAYMENTS

10
DAY
TRIAL

Why be satisfied with inferior reception when, for a small down payment and easily met monthly payments you can enjoy the superior performance of a modern communications receiver? You'll enjoy your dealings with Hinds & Edgerton. Here's what one of our customers says, "I can truthfully say I have never dealt with any company where I enjoyed the transaction as much as dealing with Hinds & Edgerton."

SEE HOW LITTLE IT COSTS TO OWN A NEW RECEIVER

Model	Cash	Down	12 Monthly
SUPER SKYRIDER (less crystal and speaker)	\$99.00	\$18.00	\$7.40
SKY CHALLENGER (less crystal and speaker)	69.50	11.00	5.10
SKY BUDDY (complete)	29.50	5.00	2.30

MAIL THIS COUPON NOW!

W9APY—HINDS & EDGARTON—W9WR 111-3A
19 South Wells Street, (Est. 1914) Chicago, Ill.

Please send me details of your time payment plan and catalog.

Name.....Call.....

Address.....

ing and the oscillator plate itself. If we accept the manufacturers' rating of 2.5 mh. and 1 μfd . distributed capacity for the choke isolated by itself, it has a calculated impedance of slightly over 100,000 ohms at 4 Mc. If we assume an additional circuit capacity of 9 μfd . to make a total of 10 μfd . shunted around the choke, the impedance at 4 Mc. is only a shade above 4000 ohms, while at 7.4 Mc. it becomes approximately 2000 ohms.¹ This combination at 2 Mc. shows a fairly respectable impedance of 10,000 ohms. Decreasing the choke inductance to 1 mh., leaving the circuit capacity at 10- μfd . total, increases the 4-Mc. impedance only to 4700 ohms, and this combination resonates near the 1750-ke. band. Note that *increasing* the choke inductance *lowers* the impedance. This is true because the resonant frequency of the choke and the assumed circuit capacity is *below* the operating frequency. Hence the only real solution is to keep the circuit distributed capacity as low as possible.

Omitting the oscillator tube shield removes about 2 μfd . The wire from the oscillator plate to the amplifier grid should be as short as possible and kept well away from grounded parts except where it has to pass through the compartment walls. The plate blocking and grid condensers C_8 and C_{10} must be mounted on insulating supports or hung on the circuit wiring away from chassis parts. The bottom view shows C_8 fastened against the switch mounting bracket in the center compartment. When this was later hung on the circuit wiring and turned edgewise to the bracket leg the amplifier output in the 3.5-Mc. band increased several watts.

OUTPUT POWER

Sufficient power output can be obtained on all bands from 1.75 Mc. to 28 Mc. to drive any of the modern medium-power final stage tubes. Tests to date with a 3.6-Mc. crystal have produced the following output measurements: 15 watts on 3.6 Mc., 14 watts on 7.2 Mc., 12 watts on 14.4 Mc., and 9 watts on 28.8 Mc. The measurements were made by using a photographic exposure meter in the manner recently described in *QST*. This method measures only the power into the lamp load and does not include the losses in the matching circuit. Since this used coils wound on some pretty junky insulation these losses were undoubtedly high on 14 and 28 Mc., so that the output indicated above is conservative.

A few more turns on the feedback sections of the 7- and 14-Mc. oscillator plate coils and the use of good ceramic forms for the 14-Mc. and 28-Mc. doubler tank coils should improve the output on the latter two frequencies. For best output the feedback coils should have enough turns just to

¹ Actual figures probably are considerably less favorable, since the author's assumed capacities seem somewhat low. The input capacity of a 6L6G alone is nearly 12 μfd . under static conditions; it will show a slight increase when the tube is operating. The 89 output capacity is not given by the tube manufacturers, but comparable tubes show values between 6 and 10 μfd ., so that the total capacity shunting the choke is probably at least 20 μfd . under the best conditions. This will reduce the impedance figures by one-half or more.—
EDITOR.

BIRNBACH GOES TO TOWN

WITH MANY NEW PRODUCTS

NO. 412

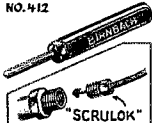

Insulated Scrulok Pin Tip
No. 412. Small compact yet has all the features of old styles. Handle of phenolic resin. Black, red, green, yellow. 1 5/16" overall.
List price each.....12c

Bakelite Pencil Type Test Lead
No. 408. Features the Scrulok solderless connection and non-collapsible Birnbach plug. Black, red, green, yellow. Overall 1 1/2". List each...15c

Banana Type Insulated Plug
No. 404. Features the Scrulok solderless connection and non-collapsible Birnbach plug. Black, red, green, yellow. Overall 1 1/2". List each...15c

Test Prod Handles
No. 417. Features needlepoint tips. Solderless phenolic resin handle. Famous Birnbach Scrulok principle. Red and black only. 4" long.
List each.....20c

No. 418. Same as above only 5" long. List each.....25c

Cone Standoff Insulators

No.	Heights	List
In a complete range	430	10c
of heights, 431J	1 1/2"	15c
Made of 432J	1 1/4"	20c
high grade ceramic.	433	25c
	433J	50c

BIG FREE CATALOG OF 3000 Items
Lists these and many other every day needs.

BIRNBACH RADIO CO.
145 HUDSON ST. BIRCO NEW YORK, N. Y.

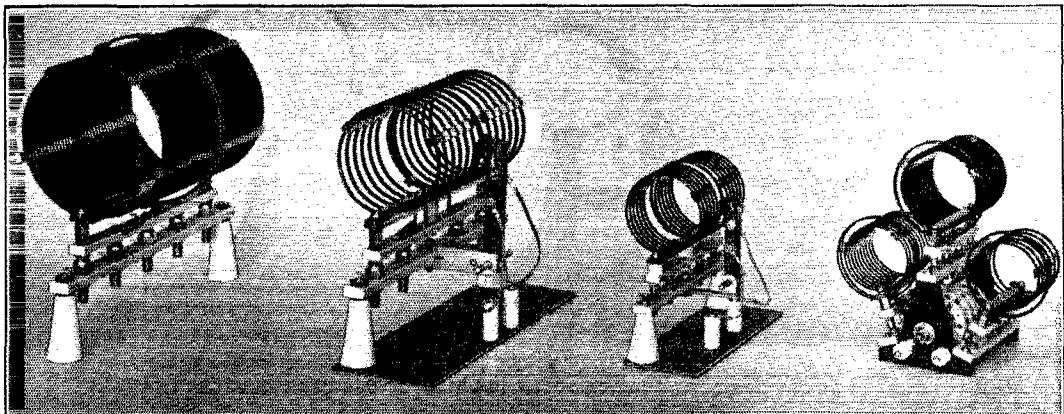

FIRST TO SOLVE ALL YOUR INDUCTANCE PROBLEMS!

B & W "AIR INDUCTORS"

TYPE HDL and HD coils for 1 KW. Type T and TL coils . . . up to 500 watts. Type BX and BXL coils . . . up to 200 watts. Type B and BL coils . . . up to 100 watts.
 TYPE HDVL for 1 KW. TYPE TVL for 250 watts.
 MODEL "B" TURRET COILS. Twenty types. Coils available for the five bands.
 All ceramic materials used are Aisimag 196

- ✓ **FIRST** interchangeable plug-in coils!
- ✓ **FIRST** versatile band-switching turret . . . combining all desirable features of plug-in coils and band switching!
- ✓ **FIRST** truly complete line of transmitting inductors for every application!
- ✓ **FIRST** fixed link coil!
 . . . and B & W was **FIRST** to specialize in transmitting inductors exclusively! "AIR INDUCTORS" are **ENGINEERED** for greater efficiency!

Use Radio's Finest Coils!

BARKER & WILLIAMSON

W3DGP • Radio Manufacturing Engineers • ARDMORE, PENNSYLVANIA • W3GC

RADIO ENGINEERING



RCA Institutes offer an intensive course of high standard embracing all phases of Radio. Practical training with modern equipment at New York and Chicago schools. Also specialized courses and Home Study Courses under "No obligation" plan.

Illustrated Catalog on request

RCA INSTITUTES, INC. Dept. ST-38

A Radio Corporation of America Service

75 Varick St., New York 1154 Merchandise Mart, Chicago

Two-Way Communication

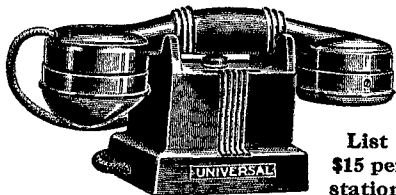

List \$15 per station

Inter-'phones, studio to studio, remote control points, house to garage, hundreds of uses for radio amateurs and others. Positive in operation. Simple to install. Modern in appearance. Any number of 'phones on same line.

UNIVERSAL MICROPHONE CO.
 Microphone Division

Box 299, Inglewood, Calif., U. S. A.

—UNSOICITED Reports on the TR-6A6 Duplex 5 Meter Transmitter-Receiver

"I would not hesitate to recommend them to any other National Guard unit."
 — (sig.) H. T. B., Dorchester, Mass.
 "We have heard W9CLH 160 miles away every night but one from R5 to R9. We also worked W5EHM Dallas and were heard by W2JCV New York."
 — (sig.) W. J. P., Newaygo, Mich.
 "I sincerely believe that I have never seen as fine a 5 meter portable mobile rig as your TR-6A6-M."
 — (sig.) R. P. B., Southborough, Mass.

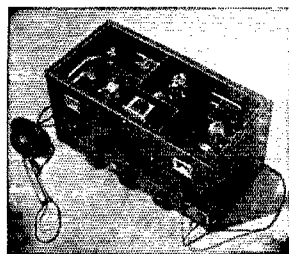

Radio Transceiver Laboratories

5627-115th St.

Richmond Hill, N. Y.



NEW HOLDER DESIGN
 15 SECONDS TO INSTALL CRYSTAL

For All Bands
GREATER STABILITY

Plugs in 5 prong tube socket
 Beautiful Appearance

MODEL AH HOLDER \$1.00 At your dealer or direct

HIPOWER LOW DRIFT CRYSTALS:
 within 10 kc. or Choice of stock

AH-10, 1700-3500 Kc. bands \$2.35
 AH-10, 7000-7300 " bands 3.90

WRITE FOR NEW LITERATURE

Hipower "Low Drift" Broadcast and Commercial Crystals Are Approved by F.C.C.

Hipower Crystal Co., 2035 Charleston St., Chicago

HARVEY'S

CONVENIENT to EVERYWHERE

Announces a new high power, low drift crystal by Bliley ... the B5. At no increase in cost, the B5 will deliver 35% more output than the popular LD2.

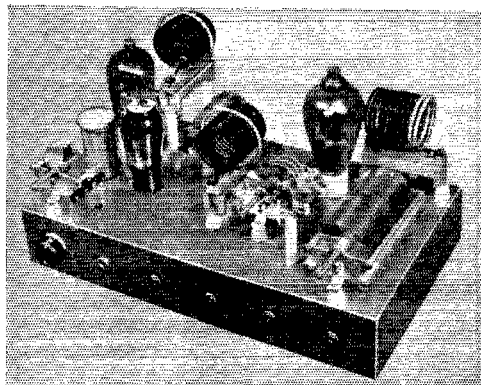

Our famous 6L6-T20-T55 kit (see November Harvey QST ad) can now be supplied for operation on 5 meters. Using one of the new Bliley HF2 crystals, this transmitter will put more than 120 watts of crystal controlled signal on 5.

NET PRICES

Transmitter Kit.....	\$39.95	Taylor 866 Jr.....	\$1.00
Power Supply Kit.....	18.95	RCA 6L6.....	1.35
Low Voltage Kit.....	9.95	RCA 83.....	.96
Taylor T-20.....	2.45	Bliley B5.....	4.80
Taylor T-55.....	8.00	Bliley HF2.....	5.75

IN STOCK! THE NEW CARDWELL TYPE ADN

DISC TYPE NEUTRALIZER for LOW CAPACITY TUBES

such as T-20, T-55, 100-TH, 35-T, 50-T, HF-100, 800, 834, 852, RK-34, RK-35, RK-18, etc. . . CAPACITY RANGE: .5 Mmfd. to 4 Mmfd.

A sturdy condenser with fine screw adjustment to eliminate wobble and a knurled thumb nut for easy locking. CARDWELL QUALITY.

NET PRICE \$1.80 TO AMATEURS

73 FROM — W2GWE — W2IJJ

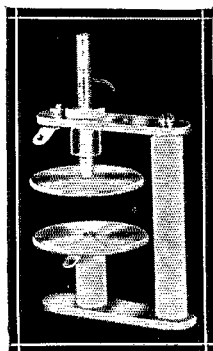

OUR *Best* VALUE IS OUR RECORD OF LOYAL SERVICE

HARVEY

Radio Company of New York

103 WEST 43rd STREET • NEW YORK, N. Y.

CABLE ADDRESS: "HARADIO"

cause weak self-oscillation when the crystal is removed. We suspect, however, that this degree of regeneration will have some adverse effect on the frequency stability, although we have seen no data to confirm this suspicion.

THE CRYSTAL HOLDER

An important item in reducing frequency drift is proper construction of the crystal holder, particularly when the crystal stage is turned off when receiving—a bad practice to follow if you want stable frequency. It is unfortunate that the great majority of the holders on the market neglect the fact that a crystal heats when in operation. Even a low-drift crystal rated at 4 cycles drift per Mc. per degree will produce an annoying beat-note change of 1000 cycles with a 10-degree rise in temperature when controlling a 28-Mc. rig. With X or Y cuts the effect is bad even on the lower frequencies. Most holders surround the crystal with plenty of good heat insulation, molded or ceramic. The holder illustrated with this exciter was modelled after one described in *QST* several years ago. The bottom plate is a block of brass 1 inch thick by 2 inches square upon which the crystal rests directly. The block was hollowed out somewhat underneath to reduce the weight, but plenty of heat conductivity and radiating area was left to keep the crystal near room temperature. The temperature of the average operating shack does not change appreciably during a QSO, and the heavy mass of the block retards the effect of any small changes.

This exciter unit makes a good start for a permanent rack job, since it covers all of the more popular bands with a twist and a plug. It furnishes enough output to use directly on the air as a low-power transmitter while the rest of the rig is growing. And it adds some of that "class" to the shack.

What the League Is Doing

(Continued from page 25)

Rumor During mid-November, misinterpretation of a routine F.C.C. order resulted in widespread circulation of a rumor to the effect that the Commission had inaugurated the principle of "spot frequencies" for all the amateur bands up to 28 Mc., these spot frequencies to be at varying intervals of from 5 to 15 kilocycles and resulting, therefore, in marked reduction of the territory available to amateurs.

The rumor is baseless. It arose, apparently, from inspection of a frequency table showing assignments from 10 kc. to 30,000 kc. in F.C.C.'s new Rule 229. Like all such tables for many years past, the spectrum is shown divided into channels, with assignments by services to specific channels or groups of channels. When the table reached our amateur bands it did not drop the channel system, simply because to have done so would have broken up the progression of the table. However, this does not mean, any more

Do You Know?

- That you may pay a few dollars more for that new receiver from other distributors of amateur equipment.
- That our down payments are the lowest in the country. ● That our finance charges are on a true 6% basis.
- That we have one of the largest stocks in the country. ● That we guarantee you will be 100% satisfied.

FLASH TO ALL AMATEURS . . .

IMMEDIATE DELIVERY ON THE NEWEST 1938

SX-17 SUPER SKYRIDER COMPLETE \$149.50

13 Tubes • 2 Stages Pre-Selection • Automatic Noise Silencer

12" P.M. Dynamic Speaker • Special Crystal Filter • 1000° Band Spread

DOWN PAYMENT ONLY \$14.50

(Total Finance Charge only \$6.75) — Ten Monthly Payments of \$14.17

Don't Compare Our Terms with Others — You're Wasting Your Time

Send 3¢ in stamps for Complete Price List and Terms. National — RCA — RME — Patterson — Breting — Harvey — Temco, etc. Taylor — Raytheon — Eimac — UTC — Thordarson — Utah

DELAWARE RADIO SALES COMPANY

WILLARD S. WILSON — W3DQ

405 Delaware Ave.

ESTAB. 1920

Wilmington, Delaware

SELECTOSPHERE

High Selectivity. Noise and static reducing loudspeaker. Rivals XTL filter reception. Designed for pentode audio output. Approx. 1000-cycle peak. Suitable for TRF or superhet. Approx. 7" high, 4" dia. Black crackle finish. Kit with instructions for assembly and use. Amateur Net \$7.50, shipped post-paid in U. S. Shipping weight 8 lbs. Simple to assemble. Selectosphere Company, Box 3, Newtonville, Mass.

RADIO COURSES

RADIO OPERATING: Prepare for Gov't. License Exam. ● RADIO SERVICING: Including Short Wave ● AMATEUR CODE ● ELECTRONICS ● TELEVISION ●

Day and Evening classes—Booklet upon request

NEW YORK YMCA SCHOOLS

4 West 63rd Street, New York City

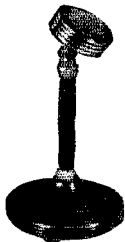

Turner VT-73

YOUR POWER

Increase your power with this new voice transmissions type microphone. Model VT-73 is built for voice and emphasizes the frequencies which give intelligibility. You actually get more power and cut through QRM better with a VT-73. Here is a mike, stand, handle combination with anti-resonant cable and full R.F. shielding. High level means less amplification needed. Order now and enjoy broadcast quality reports. This and other Turner crystal microphones in stock.

\$14.85
NET

HENRY RADIO SHOP

211 North Main Street, Butler, Mo.

Licensed under patents of the Brush Development Co.

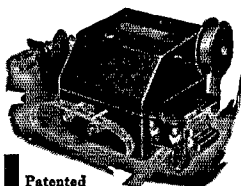

Patented

Save your fist. Let the Automatic Sender raise your stations for you. Repeats calls or messages indefinitely. Length of messages practically unlimited. Sends from 2 to 70 words a minute. Motor driven. Entirely automatic. Built-in tape perforator. Absolute uniformity in spacing of characters. Used with buzzer or oscillator, makes excellent code teacher for novice and speed-builder for the advanced amateur. Complete with 4 rolls of tape and full instructions. No extra equipment needed.

FULLY GUARANTEED

At Last!

A Perfected AUTOMATIC SENDER

\$12.50

Postpaid
in U. S. A.

\$13.50
West of
Rockies
& Canada

A New High-Impedance RELAY

- Faster
- More Compact
- Quieter
- Moisture-Proof
- More Applications

Plug-in base fits UX socket

Only 1 inch wide, 3 inches tall

Ideal for use with vacuum tube. Its quiet operation, compactness, and ability to follow at speeds far above the professional "bug" make it a perfect keying relay. Can be used as a time-delay, and in many other circuits. Available in 6, 25, 50, 100, 150 volts.

\$4.50

to

\$6.00

Postpaid
in U. S. A.

If your dealer can't supply you, write us



Pat. Pend.

Gardiner-Levering Co. Haddon Heights
New Jersey, U. S. A.

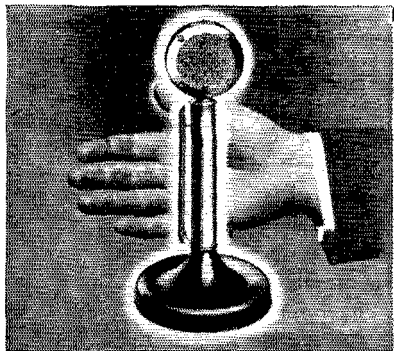

MICROPHONE CONTROL

In the Palm of Your Hand

As new as the New Year . . . Astatic Grip-to-Talk Model CD-104 Microphone. Responds to instant operation of palm-control switch, cutting microphone in or out, at will. Designed especially for air-way ground stations, inter-office, inter-factory, amateur and other high class communicating systems. This is the famous D-104 Microphone mounted on chrome desk standard with telephone black base. Full year guarantee.

LIST PRICE \$27.50

ASTATIC

Astatic Microphone Laboratory, Inc.

Dept. G-5
YOUNGSTOWN, OHIO

Licensed Under Brush Development Co. Patents

than it has meant on similar tables for the past five or six years, that we are restricted to such spot frequencies within our bands. In other words, the status of our bands is unchanged.

Financial Statement

The two "middle" quarters of the year are always the low ones from the League's operating standpoint. During the third quarter ended September 30th, the League showed a loss of some six thousand dollars from current operations. Nearly four thousand of this is attributable to extraordinary expenses incident to the expansion of our headquarters offices (we recently have taken over both floors of the entire building); the resulting loss is about normal for the quarter. At the direction of the Board, a detailed statement is presented herewith:

STATEMENT OF REVENUES AND EXPENSES, EXCLUSIVE OF EXPENDITURES CHARGED TO APPROPRIATIONS, FOR THE THREE MONTHS ENDED SEPTEMBER 30, 1937

REVENUES		
Membership dues	\$12,558.48	
Advertising sales, QST	23,239.33	
Advertising sales, booklets	700.00	
Newdealer sales, QST	10,644.20	
Handbook sales	5,229.79	
Booklet sales	1,996.86	
Calculator sales	388.09	
Membership supplies sales	2,201.87	
Interest earned	656.87	
Cash discounts received	204.53	
Bad debts recovered	20.17	
		\$57,840.19
Deduct:		
Returns and allowances	\$ 3,809.65	
Collection and exchange	80.31	
Cash discounts allowed	337.36	
		\$ 4,227.32
Less decrease in provision for newsdealer returns of QST	208.78	4,018.54
Net Revenues		\$53,821.65

EXPENSES		
Publication expenses, QST	\$16,181.23	
Publication expenses, Handbook	3,960.74	
Publication expenses, booklets	875.35	
Publication expenses, calculators	182.47	
Salaries	23,688.91	
Membership supplies expenses	1,116.02	
Postage	1,808.13	
Office supplies and printing	1,280.58	
Travel expenses, business	1,865.61	
Travel expenses, contact	902.04	
QST forwarding expenses	987.65	
Telephone and telegraph	528.54	
General expenses	907.18	
Insurance	149.84	
Rent, light and heat	930.31	
Provision for depreciation of furniture and equipment	340.71	
General Counsel expenses	250.00	
Communications Dept. field expenses	127.09	
Headquarters station expenses	37.81	
Alterations and repairs expenses	3,769.89	
Bad debts written off	41.10	
Total Expenses		59,929.20
Net Loss before Expenditures against Appropriations		\$ 6,107.55

Get this Christmas Gift FOR YOURSELF

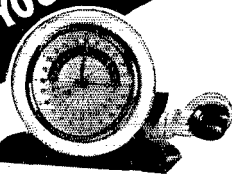

GORDON WORLD DX CLOCK

GMT and Standard Time AT A GLANCE!

Give yourself a *real* treat this Christmas. Get a GORDON World-Wide Electric Clock — the professionally styled lifetime instrument that tells you *instantly* GMT or the local time of stations you contact in any one of the 24 time zones around the globe. No charts. No guesswork. A practical necessity for every station owner. Genuine Waltham self-starting synchronous movement. Available for 110 or 220 volts; 25, 40, 50 and 60 cycle current. 24 hour, colored dials. Base removable for mounting flush in a panel. Only \$9 net at your jobber's. Get yours today! You'll *always* be glad you did.

GORDON SPECIALTIES COMPANY

440 SOUTH DEARBORN STREET • CHICAGO, ILLINOIS

**Radio Operator's
Course
Telegraphy—
Telephony
Aviation**

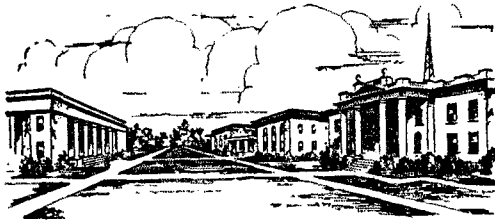

**Practical
Experience
Studio—
Transmitter—
Announcing**

PORT ARTHUR COLLEGE has been teaching Radio for twenty-eight years, and during this time it has never been our policy to guarantee positions to prospective students, directly or indirectly. We believe it wisdom at this time, however, to go on record in our *QST* advertising to say that it is impossible for us to even come near to supplying the demand for Radio Operators received by our Employment Department. We do not mean by this that all students who enroll will automatically secure positions. The demand is for graduates — good men who deserve and are qualified to hold positions. The graduates of our Radio School, so far as we know or can learn, are employed 100%.

It is possible for every student who enters the P. A. C. Radio School and completes the course in keeping with our standards to receive employment as a Radio Operator for our station

K P A C at the transmitter, in the control room, as trans-radio press operator, or announcer, and not only earn more money than he pays for the training but to also continue his training as a post-graduate student in advanced work and prepare himself to secure and hold operating positions in the upper bracket of broadcasting, marine work, announcing, or airways.

Port Arthur College advertises primarily to Radio Amateurs and the training is too technical for the average student who has not selected Radio as his life's work. We know the opportunities for positions and advancement are unlimited for men who are interested in Radio and who plan to make this their career and are willing to make the sacrifice and effort necessary to master our training. P. A. C. maintains strict collegiate rank — only high school or college graduates are eligible for enrollment.

If interested in details about Radio Course, write for bulletin R

PORT ARTHUR COLLEGE - PORT ARTHUR (World-known port) TEXAS

**Another New Aladdin Development!
MULTI-RANGE
TRIMMER
8 Separate Ranges**

Use in place of any adjustable capacity. 8 Separate Ranges permit new adjustments never before possible. The average capacity between each adjacent pair of terminals, except top and bottom plate, is 120 mmfds. By connecting these pairs in multiple, various capacities ranging to 840 mmfds. can be attained. A minimum value of 17 mmfds. is obtained by connecting to top and bottom plates. Write for complete details.

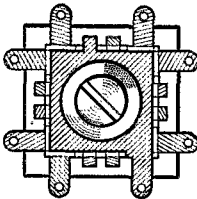

ALADDIN RADIO INDUSTRIES, INC.
466q Superior St. Chicago, Ill.

**SPECIAL TO AMATEURS
Piezo-Electric Crystals — \$2.50 EACH
POSTPAID**

Until supply is exhausted . . . we offer 80 meter band crystals unmounted; accurate calibration, excellent oscillators. Limited quantity.

SCIENTIFIC RADIO SERVICE

"The Crystal Specialists Since 1925." University Park, Hyattsville, Md.

*From Any
Angle*



CORNELL-DUBILIER

Universal Mounting

**DYKANOL
TRANSMITTING
CAPACITORS**

Type TJ-U

Are best!

**FULL DETAILS
AT YOUR DEALER**

**27,685 COPIES of
1938 Edition of**

**THE RADIO AMATEUR'S
HANDBOOK**

Sold in November!

Greatest Handbook yet produced
and the greatest dollar's worth
in the field.

\$1 POSTPAID IN CONTINENTAL U. S. A.
\$1.25 Postpaid Elsewhere • Buckram Bound \$2.50

Have You Your Copy?

American Radio Relay League, Inc.
West Hartford, Connecticut

Where to buy it

A directory of suppliers who carry in stock the products of these dependable manufacturers.



ALBANY, N. Y. Uncle Dave's Radio Shack 356 Broadway

BALTIMORE, MD. 3 North Howard St.
Radio Electric Service Company

BOSTON, MASS. Radio Shack 46 Brattle Street

BOSTON, MASS. 110 Federal Street
Wholesale Radio Service Company, Inc.

BRONX, N. Y. 542 East Fordham Rd.
Wholesale Radio Service Company, Inc.

JAMAICA, L. I. 90-08 166th Street
Wholesale Radio Service Company, Inc.

NEWARK, N. J. 219 Central Ave.
Wholesale Radio Service Co., Inc.

NEW YORK, N. Y. Gross Radio, Inc. 51 Vesey St.

NEW YORK, N. Y. Harrison Radio Co. 12 West Broadway

NEW YORK, N. Y. 100 Sixth Ave.
Wholesale Radio Service Co., Inc.

NEW YORK, N. Y. Terminal Radio Corp. 80 Cortlandt Street

POTTSVILLE, PENN. E. Norwegian & George Sts.
Sylvester Radio & Supply Co., Inc.

READING, PENN. 404 Walnut St.
George D. Barbey Company

READING, PENN. 104 North Ninth Street
Sylvester Radio & Supply Co., Inc.

SPRINGFIELD, MASS. T. F. Cushing 349 Worthington St.

WASHINGTON, D. C. 938 F Street, N. W.
Sun Radio & Service Supply Co.



ALBANY, N. Y. Uncle Dave's Radio Shack 356 Broadway

BALTIMORE, MD. 3 North Howard St.
Radio Electric Service Company

BOSTON, MASS. H. Jappe Company 46 Cornhill

BOSTON, MASS. Radio Shack 46 Brattle Street

BOSTON, MASS. 110 Federal Street
Wholesale Radio Service Company, Inc.

BRONX, N. Y. 542 East Fordham Rd.
Wholesale Radio Service Company, Inc.

BURLINGTON, VERMONT
Vermont Hardware Co., Inc.

JAMAICA, L. I. 90-08 166th Street
Wholesale Radio Service Company, Inc.

MONTREAL, CANADA 285 Craig Street, West
Canadian Electrical Supply Co., Ltd.

NEWARK, N. J. 219 Central Avenue
Wholesale Radio Service Co.

NEW YORK, N. Y. Bruno-New York, Inc. 460 W. 34th St.

NEW YORK, N. Y. Sanford Samuel Corp. 136 Liberty St.

NEW YORK, N. Y. 100 Sixth Avenue
Wholesale Radio Service Co.

NEW YORK, N. Y. Harrison Radio Company 12 West Broadway

NEW YORK, N. Y. 124 E. 44th Street
Grand Central Radio, Inc.

NEW YORK, N. Y. Terminal Radio Corp. 80 Cortlandt Street

PHILADELPHIA, PENN. 10 S. 10th Street
Eugene G. Wile

PHILADELPHIA, PENN. 117 North 7th St.
Raymond Rosen & Company

PHILADELPHIA, PENN. 512 Market Street
M & H Sporting Goods Company

POTTSVILLE, PENN. E. Norwegian & George Sts.
Sylvester Radio & Supply Co., Inc.

READING, PENN. 8th & Elm Streets
Bright & Company

READING, PENN. 104 North Ninth Street
Sylvester Radio & Supply Co., Inc.

SPRINGFIELD, MASS. T. F. Cushing 349 Worthington Street

Where to buy it

A directory of suppliers who carry in stock the products of these dependable manufacturers.

WASHINGTON, D. C. 938 F Street, N. W.
Sun Radio & Service Supply Co.

CONCORD, NEW HAMPSHIRE 80 N. State Street
Carl B. Evans

RME
RECEIVERS -- PRE SELECTORS
AMATEUR RADIO EQUIPMENT
RADIO MFG. ENGINEERS, Inc.
PEORIA ILLINOIS

JAMAICA, L. I. 90-08 166th Street
Wholesale Radio Service Company, Inc.

NEWARK, NEW JERSEY 219 Central Avenue
Wholesale Radio Service Co.

NEW YORK, N. Y. 12 West Broadway
Harrison Radio Company

NEW YORK, N. Y. 100 Sixth Avenue
Wholesale Radio Service Co.

WASHINGTON, D. C. 938 F Street, N. W.
Sun Radio & Service Supply Co.

ALBANY, NEW YORK 356 Broadway
Uncle Dave's Radio Shack

BINGHAMTON, NEW YORK 25-27 Sturges Street
Radio Testing Station

BUFFALO, NEW YORK 216 E. Genessee Street
Dymac Radio

HARTFORD, CONNECTICUT 210 Chapel Street
Stern Wholesale Parts Company

NEW YORK, N. Y. 12 West Broadway
Harrison Radio Company

NEW YORK, N. Y. Terminal Radio Corp. 80 Cortlandt Street

ROCHESTER, NEW YORK 244 Clinton Ave., N.
Radio Parts & Equipment Co.

TRIPLET
INSTRUMENTS

ALBANY, N. Y. 356 Broadway
Uncle Dave's Radio Shack

BOSTON, MASS. Radio Shack 46 Brattle Street

BOSTON, MASS. Selden Radio Company 28 Brattle St.

BOSTON, MASS. 110 Federal Street
Wholesale Radio Service Company, Inc.

BRONX, N. Y. 542 East Fordham Rd.
Wholesale Radio Service Company, Inc.

JAMAICA, L. I. 90-08 166th Street
Wholesale Radio Service Company, Inc.

MONTREAL, CANADA 285 Craig Street, West
Canadian Electrical Supply Co., Ltd.

NEWARK, N. J. 219 Central Ave.
Wholesale Radio Service Company

NEW YORK, N. Y. 100 Sixth Avenue
Wholesale Radio Service Company

POTTSVILLE, PENN. E. Norwegian & George Sts.
Sylvester Radio & Supply Co., Inc.

READING, PENN. 404 Walnut Street
George D. Barbey Company

READING, PENN. 104 North Ninth St.
Sylvester Radio & Supply Co., Inc.

WASHINGTON, D. C. 938 F Street, N. W.
Sun Radio & Service Supply Co.

RAYTHEON
TRADE MARK
AMATEUR TUBES

ALBANY, NEW YORK 356 Broadway
Uncle Dave's Radio Shack

BOSTON, MASS. The Radio Shack 46 Brattle Street

BOSTON, MASS. Selden Radio Company 28 Brattle Street

BOSTON, MASS. 110 Federal Street
Wholesale Radio Service Company, Inc.

BRONX, N. Y. 542 East Fordham Rd.
Wholesale Radio Service Company, Inc.

BUFFALO, NEW YORK 326 Elm Street
Radio Equipment Corp.

DO YOU WANT TO LEARN WIRELESS and TELEGRAPHY?

The 809

(Continued from page 37)

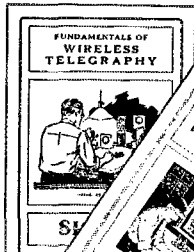

TWO BOOKS EVERY AMATEUR SHOULD HAVE —

Send Now!

10¢ Each
POSTPAID
COIN, OR
STAMPS

Hundreds of amateurs have learned from these books, so can you.

These books give you the fundamentals of wireless and telegraphy. They contain the codes and how to learn them. Mail your order now to: SIGNAL ELECTRIC MFG. CO., Menominee, Michigan

ESTABLISHED 1892



a plate-to-plate load resistance of 8400 ohms. Grid bias should be - volts; maximum-signal plate current (sine-wave signal) is 200 ma. The driving power required is 2.4 watts. The tubes may be operated at zero bias with 500 volts on the plates, and will deliver 60 watts output.

As a Class-C r.f. amplifier, a single 809 will deliver approximately 55 watts output with a plate input of 750 volts at 100 ma. The grid bias should be - 60 volts, and the driving power required is 2.5 watts. For plate-modulated service, the maximum plate voltage rating is 600 volts and plate current 83 ma.; an output of 38 watts can be secured with slightly over 7 watts driving power. These ratings are for 100% modulation.

The 809 is equipped with a four-prong ceramic base and has the plate connection brought out to a top cap. The bulb is dome-shaped. Filament is thoriated tungsten.

Standard Frequency Transmission from W9XAN to Be Curtailed

THE past few years have seen such a marked decrease in the number of reports on A.R.R.L. Standard Frequency Transmissions that the fellows who have been performing this service at W9XAN have about come to the conclusion that the present level of amateur interest does not justify much further expenditure of time and effort on their part. Since 1933 the number of reports received has dropped each year until it is now a negligible figure. The same period has seen a rapid growth in the use of crystal control and with it, perhaps, lessened need for frequent frequency checking. Whatever the cause, the effect is this: Standard Frequency Transmissions from W9XAN are going to be discontinued in the near future unless there is an appreciable and immediate increase in the number of reports received.

For the next few months the "A" schedules (80-meter band) will be continued by W9XAN on Friday nights, all others being dropped. Calibrations for other bands can, of course, be obtained through the use of harmonics of the heterodyne frequency meter. The response to these transmissions will determine whether or not further operation will be justified. It takes time and work to carry on this service, and the fellows who are doing it ask nothing more than your assurance that it is benefiting amateur radio. If you want the transmissions continued, surely it's worth an occasional postcard. Current schedules for both W9XAN and W6XK will be found elsewhere in this issue.

Brief

W6LXY thinks there should be some system to indicate that you are merely looking for a report on your signals and do not care to chew the rag. He suggests, "CQ RO," meaning "CQ Report Only."



OUR new type LMA Amateur Crystal Unit employs a precision cut low drift crystal activity exceeding V cut and capable of handling high RF grid current. 1.7 3.5 7 Mc bands — only \$4.50

Illustration shows type LW20 high frequency unit — type LMA employs same mounting.

Complete description of entire line in our new catalogue.

See your dealer or write direct.

THE VALPEY CRYSTALS
Holliston, Mass.

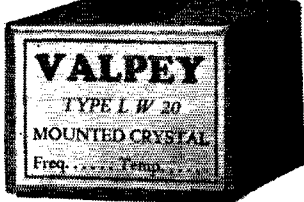

LEARN RADIO

— TELEVISION —

New Beginners' Class Jan. 17th. Send for 48-page catalogue, explains fully, 500 licensed graduates placed in last six years in broadcasting, shipping, police radio, aviation, etc. Oldest, largest and best equipped school in N. E. We teach all branches of radio. Tel. HAN. 8184.

Ten operators placed with Pan-American Airways in one week.

Radio Service Instructions Given

MASS. RADIO SCHOOL
18 Boylston Street, Boston

HAM-ADS

(1) Advertising shall pertain to radio and shall be of nature of interest to radio amateurs or experimenters in their pursuit of the art.

(2) No display of any character will be accepted, nor can any special typographical arrangement, such as all or part capital letters be used which would tend to make one advertisement stand out from the others.

(3) The Ham-Ad rate is 15c per word, except as noted in paragraph (6) below.

(4) Remittance in full must accompany copy. No cash or contract discount or agency commission will be allowed.

(5) Closing date for Ham-Ads is the 25th of the second month preceding publication date.

(6) A special rate of 7c per word will apply to advertising which, in our judgment, is obviously non-commercial in nature and is placed and signed by a member of the American Radio Relay League. Thus, advertising of bona fide surplus equipment owned, used and for sale by an individual or apparatus offered for exchange or advertising inquiring for special equipment, if by a member of the American Radio Relay League takes the 7c rate. An attempt to deal in apparatus in quantity for profit, even if by an individual, is commercial and takes the 15c rate. Provisions of paragraphs (1), (2), (3) and (5) apply to all advertising in this column regardless of which rate may apply.

Having made no investigation of the advertisers in the classified columns, the publishers of *QST* are unable to vouch for their integrity or for the grade or character of the products advertised.

QUARTZ—direct importers from Brazil of best quality pure quartz suitable for making piezo-electric crystals. Diamond Drill Carbon Co., 719 World Bldg., New York City.

RADIO engineering, broadcasting, aviation and police radio, servicing, marine and Morse telegraphy taught thoroughly. All expenses low. Catalog free. Dodge's Institute, Byrd St., Valparaiso, Ind.

QSL'S, W2SN, Helmetta, N. J.

CALLBOOKS—new DX calls, new prefixes, thousands of new W and VW calls, in the Winter, 1937 Radio Amateur Call Book. Sent postpaid \$1.25, or a whole year (four issues) for \$4. (In foreign countries \$1.35 and \$4.35.) Your call and QRA printed in large type \$1 per year. Radio Amateur Call Book, 610 S. Dearborn, Chicago.

QSL'S, all colors, cartoons, snappy service. Write for free samples today. W1BEF, 16 Stockbridge Ave., Lowell, Mass.

COMPLETE training for all amateur and professional radio licenses. New York Wireless School, 14 E. 44th St., N. Y.

USED receivers. Bargains. Price list 3¢. W3DQ, 405 Delaware Ave., Wilmington, Del.

QSL'S. Better designs; better stock; better workmanship. Free samples to hams only. W2FJE, 101 Hanson Place, Brooklyn, N. Y.

VARIABLE condensers calibrated; ten point calibration against General Radio precision standard. For a limited time, \$1.25. W8MYB, Kiamasha, N. Y.

GENERAL Electric dynamotors 24/750 volts 200 mills, \$20. On twelve volts deliver 375. Westinghouse 27 1/2/350, \$10; 200 Watts 900 cycles, \$15; 6-15 volts 500 watts Aircraft, \$10. Simon 500 watt 500 cycles with exciters, \$8. Slightly used, \$6. List. Henry Kienzle, 215 Hart Blvd., Staten Island, N. Y.

THREE months old and going strong. That new R9 crystal and holder \$1.25 in the 80 or 160 band. R9 Crystals, Arnold, Pa.

FOR Sale—100-250 watt broadcast transmitter—high fidelity, 100% modulation approved under F.C.C. rule 132. Send for photo and detailed description. Radio Station WHBI, 100 Shipman St., Newark, N. J.

QSL'S—quality—2 color—\$1. hundred; \$1.75—200. Samples. W8NOS.

SELL—National AGSX rack mounted job with xtal, sprk, pwr supply, coil rack, 6 sets of coils, \$75. Joe Tucker, 715 E. 4 St., Brooklyn, N. Y., W2C8B.

QSL'S. Cartoons. Free samples. Theodore Porcher, 7708 Navajo St., Philadelphia, Pa.

TRADE: large printing outfit for transmitter or receiver. Will sell. Write for details. W4ERN, Sewanee, Tenn.

SELL Halliocrater skybuddy, \$18. W1GBD, E. Sebago, Me.

QSL'S. Free samples. Printer, Corwith, Iowa.

CANADIAN hams: dynamotor 32v./1000v.—225 mills, cost \$120.—best offer takes it. VE2BD, Box 369, Noranda, P. Q.

SELL QST a.c. receiver and power pack, \$6. W1GBD, E. Sebago, Me.

SELL—HRO Jr., R-meter, xtal, noise silencer, tone control, power supply—best cash offer. W8QDU.

SELL 852s, new, \$13.50; 849s, used few hours, \$125.; 110v. a.c. motor generator 1000v., 5 amp. or 500v. lamp generator or set. Make offer KGFXX, Pierre, S. Dakota.

QSL'S, 2 colors, 75¢; \$1.80 for 300. W9DGH, 2005 N. 3 Ave., Minneapolis, Minn.

WANTED: two thousand volt—five hundred milliamperes power transformers, prefer Thordarson; also modulation transformer to modulate one kilowatt pair of 204As, high power equipment trade or sell. R. Kewley, Oconomowoc, Wis.

QSL'S, SWL's. 100—3 color—75¢. Lapco, 344 W. 39th, Indianapolis, Ind.

FOR sale: complete 250 watt phone. Separate speech amp. remote control xtal mike, \$200. Jack Marino, 1939 Hubbard St., Jax., Fla.

QSL cards, neat, attractive, reasonably priced. Samples free. Miller, Printer, Ambler, Pa.

SOUTH American Airline requires amateur to assist with radio construction work. Apply on airmail paper Box B, QST, stating qualifications, salary expected, include photo.

CUSTOM wound precision resistors to your specifications. Voltmeter resistors and ammeter shunts. Dual Engineers, 7621 So. Park, Chicago.

SELL five tube SW receiver, aluminum chassis, tubes, speaker complete as described League Handbook, \$18. W9ARP.

FABERADIO crystals are outstanding values. X cut \$2.25. Y cut \$3.50, A cut \$2.75, Z cut only 75¢. Blanks for particular grinders. Commercial crystals a specialty. Faberadio, Sandwich, Ill.

600 watt 250th final and supply in metal cabinets. All Thordarson, National, Hammarlund, etc. Original cost, \$122. Sell, \$65. Write for list. W9VTP, 4911 Farnam, Omaha, Neb.

QST'S, lots of 'em including war and reopening numbers. Send for list, offers accepted. Twitchell, 1925 Glenwood, Minneapolis, Minn.

WANTED: manufacturer desires to contact exporter or importer of Brazilian quartz for supplies. Send information and prices care Eldson's, Temple, Texas.

TRANSFORMERS—hi-lo primary, secondary, 3150v., 2700v. center-tapped, 350 ma. \$7. Experimental Winding, 250 Washington, Bluffton, Ohio.

AUTOMATIC tape code sender wanted. Ralston, 255 Pomeroy, Pittsfield, Mass.

QSL'S printed right. Samples, prices on request. W2AEY, 338 Elmora, Elizabeth, N. J.

SEASON'S greetings. Fritz will continue printing better QSL's, SWL's during 1938. Samples, 455 Mason, Joliet, Ill.

SCOTT twelve tube allwave receiver. Plug-in coils. Used five years. Excellent buy. Write W8FRC for details.

QSL'S. Beautiful designs. Free samples. Maleco, 1512 Eastern Parkway, Brooklyn, N. Y.

COMPLETE parts for 500 watt xmmitter. ACR-136 receiver. Write for list. W3CUF, W. 15th St., New Cumberland, Pa.

SALE—trade G.E. CG-1200 dynamotor, 24-1500 v. 233 ma. Make offer. Want superhet. W8PH.

WANTED: Leica G F-2. Trade ham equipment. W8GWA.

FOR sale or trade. Complete CW station. Trans 47 crystal osc, 210 buffer, PP210 final. Three Weston meters, Ward-Leonard delay relay, monitor, receiver SW3 d.c. with a.c. for filaments. Vibroplex. Make cash offer or will trade for clarinet, piano accordion, Bell and Howell 16mm camera. H. O. Moore, 987 Lincoln Place, Brooklyn, N. Y.

CRYSTALS: Unconditionally guaranteed. Supplied within five kilocycles. 1715-2000 or 3500-4000 kilocycles, X-cut, \$1.50; A-cut, \$2.25; 7000-7300 X-cut, \$1.85, A-cut \$2.25. Spot frequencies \$1. additional I.F. crystals 465 or 1600 kilocycles, \$3.25. Above crystals supplied mounted molded bakelite holder (fits tube socket) only 75¢ additional. Satisfaction guaranteed. Wright Radio Labs., 5859 Glenwood Ave., Chicago, Ill.

SELLING out: transmitter rack panel, 53, 802, HF100. 750-2000 volt supplies, receiver—Silver 5B, extras, \$65. W2DTC.

SELL complete station, \$40. Rack mounted Gross CW 50 Sargent 11 MA. receiver. Photo—details. Albert Janasen, 570 E. 187 St., N. Y. C.

MEET the gang on 5. Get your copy now of the latest Remco bulletin describing UHF-34 factory built 50-80 mc. transmitter (fone or CW) for fixed station use. See your dealer for complete dope and prices, or postcard to Paradio Sales Co., 124 Garrison Ave., Jersey City, N. J.

TELEPLEXES, instruxtopographs, omnigraphs, typewriters bought, sold. Ryan's, Monroe City, Mo.

QSL'S, W8LQM, 373 E. 17th Ave., Columbus, Ohio.

CHICAGO hams—fully guaranteed, new 100w. tantalum tubes, 10v. fil. \$8. W9HYO.

HALLICRAFTER. W8ANT.

RME. W8ANT.

RECEIVER headquarters. W8ANT.

ALL makes of new and used receivers. W8ANT.

BARGAIN in new filter condensers. W8ANT.

USED air-wound coils. W8ANT.

EQUIPMENT built to order W8ANT.

TRANSFORMERS—500-0-2500, a.c. W8ANT.

ALL lines of new and used amateur equipment bought, sold, exchanged. Write to Southern Ohio's only amateur owned amateur business, Jos. N. Davies, W8ANT, 2767 N. Bend Rd., Sta. A., Cincinnati, Ohio.

SENSATION of radio field. Best articles extracted from all radio magazines. Six issues, \$1; overseas, \$1.25. Radio Digest, 7640 Beverly, Los Angeles.

JANUARY 15th, positive expiration date of holiday subscription rates. Six subscriptions, \$2. each, twelve, \$1.75. U.S.A. and Canada only. Radio, 7460 Beverly, Los Angeles.

BLILEY crystals? Patronize W8DED.

QST or Radio magazine subscriptions accepted by W8DED. (\$2.50 year)

QSL'S? SWL'S? No cheap junk. Free samples? W8DED, Holland, Mich.

THE Crystal Shop offers exact frequencies in 80 and 160 meter AT crystals for \$2.50. BT-cut in 40 and 80 meters, \$2.75. Approximate frequencies are 25¢ less. Hundreds supplied to AARS already. WIBD, Barre, Vt.

QSL'S, 300 one-color cards, \$1. Samples. 2143 Indiana Ave., Columbus, Ohio.

CRYSTALS, X cut, 160-80, +five kilocycles, \$1.50. Spot frequency, \$2.50. Three semi-finished, 80 meter blanks, including carborundum, \$1.20. Holders, \$1., fit GR jacks. William Threm, W8FN, 4021 Davis Ave., Cheviot, Ohio.

SELL: ACR136 \$37.50; ACSW58, National power, 20 coils, RCA speaker \$22.50; Super Seven \$25; DB20 like new; W9ARN, Bartonville, Ill.

COMPLETE one hundred watt phone station. Transmitter relay panels in crackle cabinet, Western Electric mike Halliçrafer receiver. Will sell separately—\$150. takes all. W2CPQ, 24 Westview, White Plains, N. Y.

CRYSTALS: January special: 80M X cuts within five kilocycles, \$1.25. Mounted in bakelite holder, 65¢ additional. Unconditionally guaranteed. Ham Crystals, 1104 Lincoln Place, Brooklyn, New York.

SELL: ACR136 receiver \$35., 20 meter transmitter complete, tubes, xtal. 6A5 osc., 210 buffer, push pull 210s final, metal rack and panel, 4 Jewell meters, 2 Thordarson power supplies, \$65. 160 meter R.F. lineup, 61L osc., 10 buffer, 03-A final, three power supplies, tubes, xtal rack and panel job, \$60. Come and see them. Forester, 8DGL, Monessen, Pa.

SELL one kilowatt fone-CW transmitter at W8AKU. Write for pictures and description. Wm. Brown, 95 Ames St., Rochester, N. Y.

MOTOR-generator: 110 a.c. 50-60 cycles to 500 volts 75 milliamperes plus 7½ volt 2.8 amperes. Ideal transmitter bias or plate supply, \$11. Johnson, 2104 Lincoln Park Ave., Los Angeles.

WANTED: QST's before 1922; ultra-short-wave receiver, transmitter; Morse omnigraph; acoustics books; 17E field telephone. Give price, condition. W2ANB, 76 Brookline Ave., Albany, N. Y.

FOR sale: used tubes and parts. Write for free list. WNAX, Yankton, S. Dakota.

CRYSTALS: There is no substitute for T9 dependability, a tried and proven product, better than ever, satisfaction guaranteed—you must be pleased. Now in our third year of business. Our special grinding process gives greatest harmonic output, resists fracture. Eidson T9 powerful X cut, 40 and 80 meter bands \$1.60, 7301-7500 KC range \$2., spot frequencies \$2.50, prices postpaid. Commercial crystals supplied on order, inquire prices. Those FB T9 ceramic holders \$1.10. COD's accepted. T9 crystals sold by: Henry Radio Shop, Butler, Mo.; Southwest Radio Supply, Dallas, Texas; Pembleton Labs., Ft. Wayne, Ind. T9 crystals or holders sold by: Hieronymus Radio, 88-34 209 St., Queens Village, N. Y. or Eidson's, Temple, Texas.

WANTED: 110 volt, 60 cycle, 2 to 5 kva. generator with exciter, or double-current generator. W4AHY, Box 587, College Sta., Durham, N. C.

SELL reconditioned RME9D entirely complete \$50. Silvertone auto transceiver \$15. Harvey transceiver \$7.50, 1 k.w. 2200v. a.c. power supply \$15. 204A xmitr \$10. Freqmeter monitor \$5. Collins 32B xmitr \$60. W8CMJ.

SELL: Collins 30 FXC W.A.C. on phone 27 times. Guaranteed by manufacturer. W2IXY.

QSL'S—highest quality—lowest prices. Radio Headquarters, Ft. Wayne, Ind.

DOUGLAS Universal Class B transformers. Match all tubes—50 watts audio \$4.95 pair—100 watts audio \$7.75 pair. For details write W9IXR, Weyerhaeuser, Wis.

BUY any new receiver, transmitter, transmitter kit, parts at lowest net prices on my own convenient 6% plan with terms arranged to suit you and less interest cost. Trade in your receiver. Any receiver shipped on ten day trial. Your inquiries invited. Bob Henry, W9ARA, Butler, Mo.

WHEN buying a new receiver, transmitter, or transmitter kit whether you pay cash, trade in your equipment, or buy on terms, it is to your advantage to see my other advertisements in this QST and to write to me, Bob Henry, W9ARA, Butler, Mo.

SPECIAL while stock lasts—brand new in factory sealed cartons—ACR-175s \$89., ACR-155s \$59. W9ARA, Butler, Mo.

WILL ship on ten day trial: HRO \$129.70, NC100X \$99., NC100 \$89., ACR-175 \$69., PR16C \$64., Breting 12 \$64., AGS \$49., S9 Super-Skyrider \$39., ACR-136 \$39., SX4 Super Skyrider \$34., FB7X \$28., FB7A \$23., All Star complete, \$17.50, RSR Clipper \$17.50, other used sets. List free. W9ARA, Butler, Mo.

UP your power 3 DB. E-20 speech amplifier—automatic volume compression permits actual hundred per cent modulation. No fear of overmodulation. Input crystal or other high impedance mike. Horizontal or vertical rack mounting. 500 ohms output—drives up to 1 k.w. rig. Complete 8 tubes 6L6 output full 20 watt \$27.50 net. Full technical dope. Write Linn Engineering Co., Box 457, Cedar Rapids, Iowa.

SELL: Toba receiver, 60 watt phone & CW xmitr and equipment. W21EB, 116 Highpoint Ave., Weehawken, N. J.

SALE: Collins 250 watt 160 meter phone or CW transmitter. Velocity mike class B modulation carbon plate tube final. Transmitter first W.A.S. 160 meter phone. \$350. complete. W4EEB, Athens, Ga.

FOUR stage ¼k.w. CW xtal 4 band transmitter 852 amplifier. Beautiful rack with self-contained power supply. DX 5 continents. Sacrifice—first \$125. Money order. George Papuk, W8KWU, Grant Town, W. Va.

SWAP: radio gear for 35 MM sound pictures. Want musicales and comedies for my private collection. Can use advertising film if has music, story, or scenic with good sound. What do you need? Bob Smith, Radiolab, W9LD, 1515 Grand Ave., Kansas City, Mo.

SELL: ultra Skyrider with matched speaker, \$80. f.o.b., perfect condition. Bargain for 5 and 10 meter phone operation. Holt, W4TE, Warrenton, N. C.

WILL someone give discarded receiver, transmitter, parts. Schweitzer, 4109—18 Ave., Brooklyn, N. Y.

P. O. No. 1254

Ad. No. 3



Here's How YOU
Can Get Into

... RADIO ENGINEERING!

CREI home-study training is available to every ambitious man who realizes that Technical Training is the surest and quickest way to Success in Radio. Constant new developments make Radio a profession of specialists... and affords the man with adequate modern training the opportunity to get ahead. CREI can help YOU as we have helped others out of routine jobs into well-paying positions with a definite future. Let us tell you how!

WRITE FOR FREE ILLUSTRATED CATALOG

Every ambitious man who wants to get ahead in Radio should read "The CREI Tested Plan for a Future in Practical Radio Engineering," 48 pages—just off the press—sent FREE on request!

Write for Your Copy Today!

CAPITOL RADIO
ENGINEERING INSTITUTE
NEW YORK CITY Dept. Q-1, 14th and Park Road
29 Broadway WASHINGTON, D. C.



Your Nearest Dealer Is Your Best Friend

Your nearest dealer is entitled to your patronage. You can trust him. He is equipped with a knowledge and understanding of amateur radio. He is your logical and safe source of advice and counsel on what equipment you should buy. His stock is complete. He can supply your needs without delay. His prices are fair and consistent with the high quality of the goods he carries. He is responsible to you and interested in you.

Patronize the dealer nearest you—You can have confidence in him

ATLANTA, GEORGIA

Wholesale Radio Service Company, Inc.
430 West Peachtree Street, N. W.
"The World's Largest Radio Supply House"

BALTIMORE, MARYLAND

Radio Electric Service Co.
3 N. Howard St.
Everything for the amateur

BOSTON, MASS.

Wholesale Radio Service Company, Inc.
110 Federal Street
"The World's Largest Radio Supply House"

BRONX, NEW YORK

Wholesale Radio Service Company, Inc.
542 East Fordham Road
"The World's Largest Radio Supply House"

BUFFALO, NEW YORK

Radio Equipment Corp.
326 Elm Street
W80BK — Ham, service and sound equipment

BUFFALO, NEW YORK

Dymac Radio
216 E. Genesee Street
Complete Line Ham and BCL Equipment Cl. 2080

ELMIRA, NEW YORK

Miller's Radio Shack
205 Railroad Avenue
Fine equipment for amateurs

JAMAICA, L. I.

Wholesale Radio Service Company, Inc.
90-08 166th Street (Merrick Road)
"The World's Largest Radio Supply House"

MONTREAL, CANADA

Canadian Elec. Supply Co., Ltd.
285 Craig St., W.
Quality parts and equipment for discriminating buyers

NEWARK, N. J.

Wholesale Radio Service Company, Inc.
219 Central Avenue
"The World's Largest Radio Supply House"

NEW YORK, N. Y.

Gross Radio, Inc.
51 Vesey Street
Fair dealings plus fair prices. Anything in radio

NEW YORK, N. Y.

Wholesale Radio Service Company, Inc.
100 Sixth Avenue
"The World's Largest Radio Supply House"

NEW YORK, N. Y.

Harrison Radio Company
12 West Broadway
"The Friendly Ham Supply House"

PHILADELPHIA, PENNSYLVANIA

Eugene G. Wile
10 S. Tenth Street

Complete Stock of Quality Merchandise

PROVIDENCE, RHODE ISLAND

W. H. Edwards Co.
32 Broadway
National, Taylor Tubes, Hallicrafters. Complete amateur supply house

RICHMOND, VIRGINIA

The Arnold Company
527 W. Broad Street
W3EHL—"The Virginia Ham Headquarters"—W3FBL

ROCHESTER, NEW YORK

Radio Parts & Equipment Co.
244 Clinton Avenue, North
Complete stock amateur-BCL parts. Standard discounts

You Are Protected When You Buy From QST Advertisers

“Advertising for QST is accepted only from firms who, in the publisher’s opinion, are of established integrity and whose products secure the approval of the technical staff of the American Radio Relay League.”

Quoted from QST’s advertising rate card.

Every conceivable need of a radio amateur can be supplied by the advertisers in QST. And you will know the product has the approval of the League’s technical staff.

The Advertisers

Aerovox Corporation	90
Aladdin Radio Industries, Inc.	103
American Microphone Company, Inc.	95
Astatic Microphone Laboratory, Inc.	102
Atkins & Brown	87
Barker & Williamson	99
Birnback Radio Company, Inc.	98
Bliley Electric Company	91
Burgess Battery Company	73
Candler System Company	95
Capitol Radio Engineering Institute	108
Cardwell Mfg. Corp., Allen D.	74
Centralab	75
Chicago Radio Apparatus Company	93
Collins Radio Company	Cov. 2
Cornell-Dubilier Corporation	103
Coto-Coil Company, Inc.	97
Delaware Radio Sales Company	101
Dodge’s Institute	97
Eitel & McCullough, Inc.	71
Gardiner-Levering Company	101
General Transformer Corporation	90
Gordon Specialties Company	91, 102
Gross Radio, Inc.	78
Hallcrafters, Inc., The	1, 2
Hammarlund Mfg. Company, Inc.	59, 64
Harvey Radio Company	100
Harvey Radio Laboratories, Inc.	70
Henry Radio Shop	97, 101
Hinds & Edgerton	98
Hipower Crystal Company	99
Hygrade Sylvania Corporation	66
Instructograph Company	87
International Resistance Company	59
Isolantite, Inc.	77
Johnson Company, E. F.	69
Kenyon Transformer Company, Inc.	7, 94
Ken-Rad Tube & Lamp Corporation	95
Leeds	76
Logan Company, Les	95
Mallory & Company, Inc., P. R.	58
Massachusetts Radio School	106
McGraw-Hill Book Company	86
Mims Radio Company	92
National Company, Inc.	Cov. 3, 57, 83, 87
Newark Electric Company	85, 87
New York Y. M. C. A. Schools	101
Ohmite Manufacturing Company	82
Petersen Radio Company	83
Port Arthur College	103
Precision Piezo Service	97
RCA Institutes, Inc.	99
RCA Manufacturing Company, Inc.	Cov. 4, 5
Radio Mfg. Engineers, Inc.	63
Radio Shack, The	80
Radio Supply Company	101
Radio Transceiver Laboratories	99
Raytheon Production Corporation	62
Scientific Radio Service	103
Selectosphere Company	101
Signal Electric Mfg. Company	106
Solar Manufacturing Corporation	79
Speer Carbon Company	60
Sprayberry Academy of Radio	91
Standard Transformer Corporation	68
Sun Radio Company	96
Taylor Tubes, Inc.	65
Teleplex Company	91
Terminal Radio Corporation	92, 93
Thordarson Electric Mfg. Company	67
Transmitter Equipment Mfg. Company	111
Triplett Electrical Instrument Co., The	83
United Transformer Corporation	112
Universal Microphone Company, Ltd.	99
Utah Radio Products Corporation	72
Valpey Crystals, The	106
Vibroplex Company, The	83
Wilson, Willard S.	101
Yaxley	58

TEMCO TRANSMITTERS

Are Now Demonstrated
and Sold by Leading Dealers

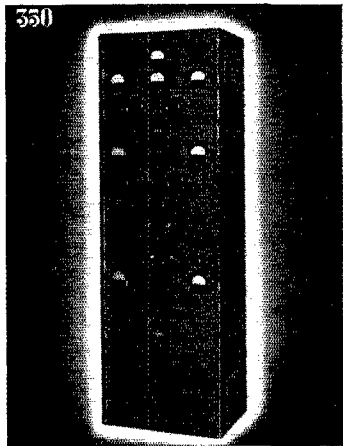

Right—Front
view of Temco
'100'

Left—Front
view of Temco
'350'

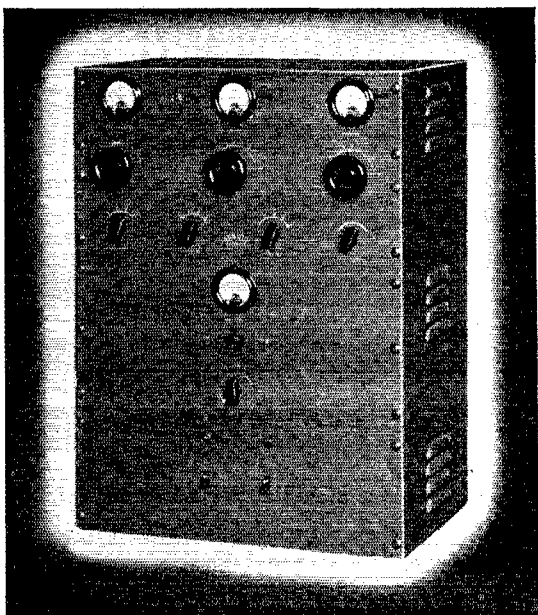

The consistently superlative performance of Temco Transmitters has led many to believe that such quality was beyond their financial means. But today many leading dealers chosen by Temco can tell you how you may purchase a Temco on a liberal time payment plan to meet your budget requirements.

Temco advanced engineering includes band-switching exciter units, automatic plug-in chassis, high-fidelity audio response, efficiency over entire wave-length range, etc., brings all the advantages of ultra modern transmitter design which insures the user against the hazards of premature obsolescence.

See your dealer today for complete details or write for complete illustrated technical information.

Partial List of Recent Temco Installations

Models 100 and 350

G6WT W3GOL
G5HK W3CKO
HRI W2KR
W3DBG
W2KIQ

Models 600 and 1000

SM55V W8KBJ
PY1DI W2JKQ
W2AD W5OMJ
W2IWT W1CND

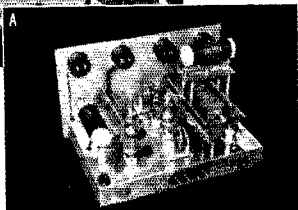
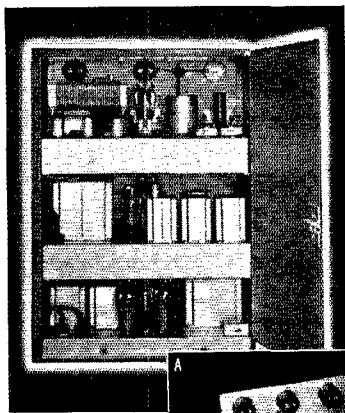

Left — Rear view of Model '100'. A — Intermediate and power amplifier chassis of model '600' illustrating exclusive Temco plug-in chassis construction. B — Underside view of A illustrating superlative wiring details and careful mechanical construction which is typical of all Temco Transmitters.

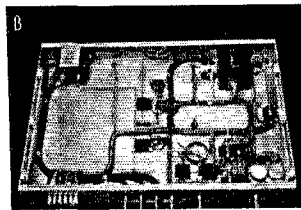

Transmitter Equipment Manufacturing Co., Inc.

130 CEDAR STREET • NEW YORK, N. Y.

Designer and Manufacturers of Radio Transmitting and Accessory Equipment

When Better Transformers Are Made



WILL MAKE THEM . . .

Year after year, UTC has led in many important new developments in transformer design. Of course they have been imitated. But only in UTC are you sure of getting these latest developments.

1933

HIGH PERMEABILITY CAST SHIELD
(Top and Bottom Mount)
HUM BALANCED COIL STRUCTURE

Used by UTC in practically all High Fidelity designs, hum bucking and hum balanced transformers and high permeability cast shields are now accepted as standard practice in the transformer field.

1934
VARITONE

The UTC VARITONE is an audio device permitting equalization, in any audio amplifier or receiver, of the low end—high end—or low and high end simultaneously. Amateurs also use the VARITONE for reception of CW and to reduce extraneous static or whistles.

1935

ULTRA COMPACT AUDIO UNITS

Developed originally for Aircraft and Hearing Aid Devices. In 1936 an entire series of these units were released for Broadcast and Amateur applications. Ultra Compact audios are Hum BALANCED—WEIGH FROM 4½ to 5½ OUNCES and are guaranteed ±2db from 30 to 20,000 cycles.

1936
VARIMATCH

The UTC series of VARIMATCH transformers released in 1936 were the culmination of three years of development following the UTC series of Universal Chokes. The six types of VARIMATCH units will match the plate load of any modulation tube to any RF stage. Due to the unusual design principles involved, imitations fall far short of the UTC VARIMATCH units in efficiency and frequency response.

1937
TRI-ALLOY SHIELDING

The combination of Linear Standard frequency response and internal TRI-ALLOY magnetic shielding is a difficult one to approach. That is why these units are used by G.E., R.C.A., Philco, Western Electric, Westinghouse, M.G.M., Walt Disney studios, other discriminating commercials, Broadcast Stations and leading amateurs.

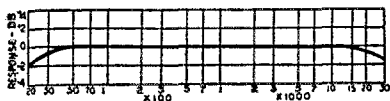

Flat from 30 to 20,000 cycles . . .
a goal for others to shoot at.

WRITE for the new UTC broadcast bulletin describing transformer, equalizer and amplifier components for every broadcast and recording application.

Imitation is the sincerest form of flattery

UNITED TRANSFORMER CORP.

72 SPRING STREET

NEW YORK, N. Y.

EXPORT DIVISION 100 VARICK STREET NEW YORK, N. Y. CABLES: "ARLAB"

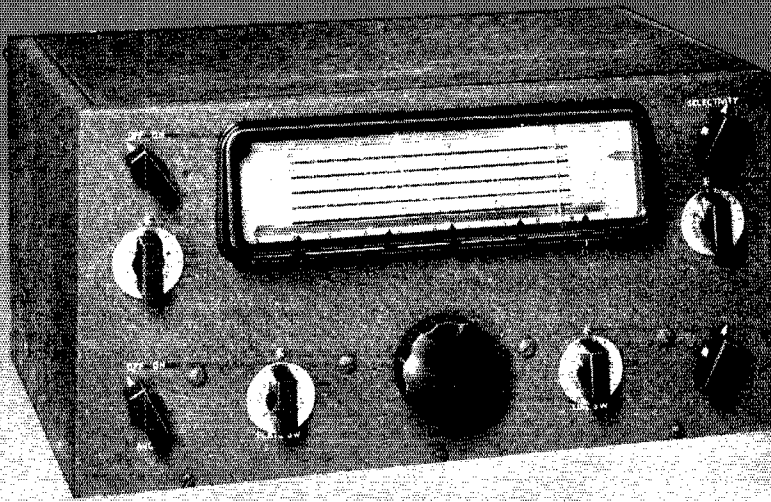

In these few short months the NC-80X and NC-81X receivers have become part of the National tradition. Their advanced circuit details, including the wide-range crystal filter and high IF frequency for image rejection, have brought a new standard of performance to the low priced field. Their thoroughbred construction keeps that performance consistently high. And their convenience makes operation swift, accurate, and tireless.

NATIONAL COMPANY, INC.

NATIONAL NC-81X

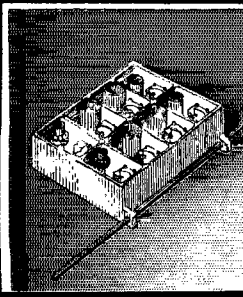

130 WATTS OUTPUT* WITH 1.5 WATT DRIVING POWER

NEW RCA BEAM POWER TUBE

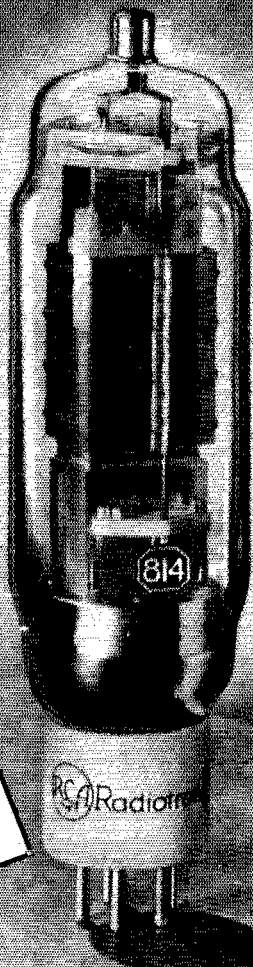

\$17.50

Check These Features

Beam Power construction for High Power Sensitivity—Saves you money through the use of low-price tubes in the exciter.

No neutralization required with well shielded circuits—Saves you money through elimination of an expensive neutralizing condenser.

High power output with high efficiency—Saves you money in terms of antenna watts per dollar.

Rugged RCA construction—Built to take it—Saves you money by giving long, trouble-free life.

Full power input to 30 megacycles—Gives you flexibility for band-switching transmitters.

Features that will appeal to the discriminating amateur are described in RCA-814 Bulletin.

ASK FOR YOUR COPY

RATINGS—CLASS "C" TELEGRAPHY

D-C Plate Voltage	1250 Volts
D-C Screen Voltage	300 Volts
D-C Grid Voltage	-300 Volts, Max.
D-C Plate Current	150 Ma.
Plate Input	180 Watts Max.
Plate Dissipation	50 Watts Max.
Filament Voltage	10 Volts
Filament Current	3.25 Amperes

For those amateurs and experimenters who require moderate high power and desire the utmost in circuit efficiency, the new RCA 814 will be found to be unexcelled. It is a husky tetrode of the filament type for use as an r-f amplifier, frequency-multiplier oscillator, and grid- or plate-modulated amplifier. Plate connection through a separate seal at the top of bulb and a ceramic base insure low interelectrode capacitances and excellent insulation.

**For Class "C" Telegraphy conditions.*

RCA presents the "Magic Key" every Sunday, 2 to 3 P. M., E. S. T., on NBC Blue Network.



Radio Tubes

FIRST IN METAL
FOREMOST IN GLASS
FINEST IN PERFORMANCE

RCA MANUFACTURING CO., INC., Camden, N. J. • A Service of the Radio Corporation of America