

QST

January, 1937
25 cents

devoted entirely to

amateur radio

In this issue—

Building an
Oscilloscope
With the
New 913

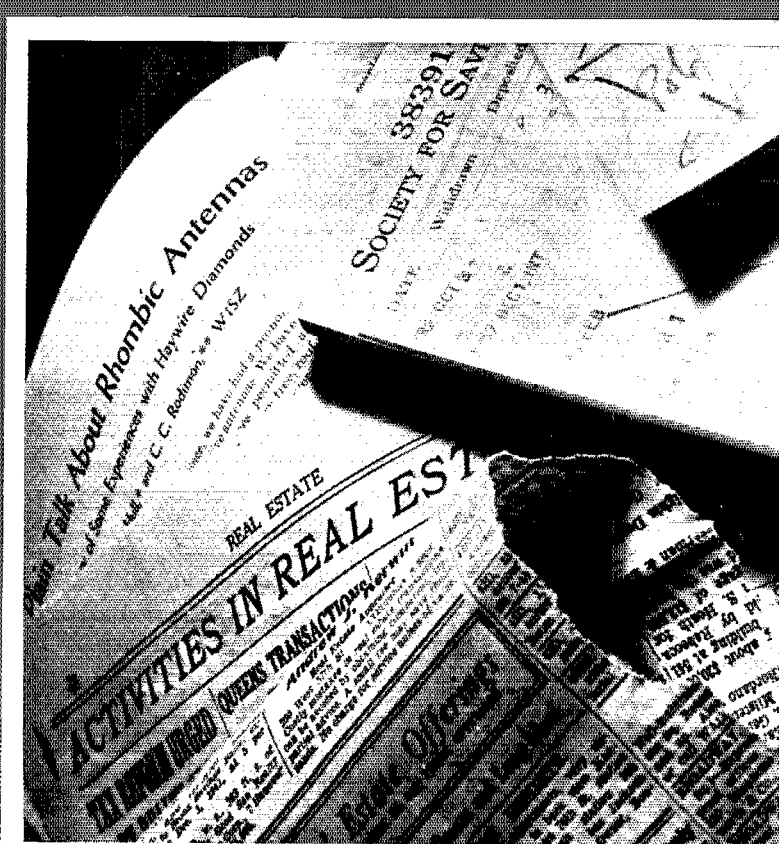

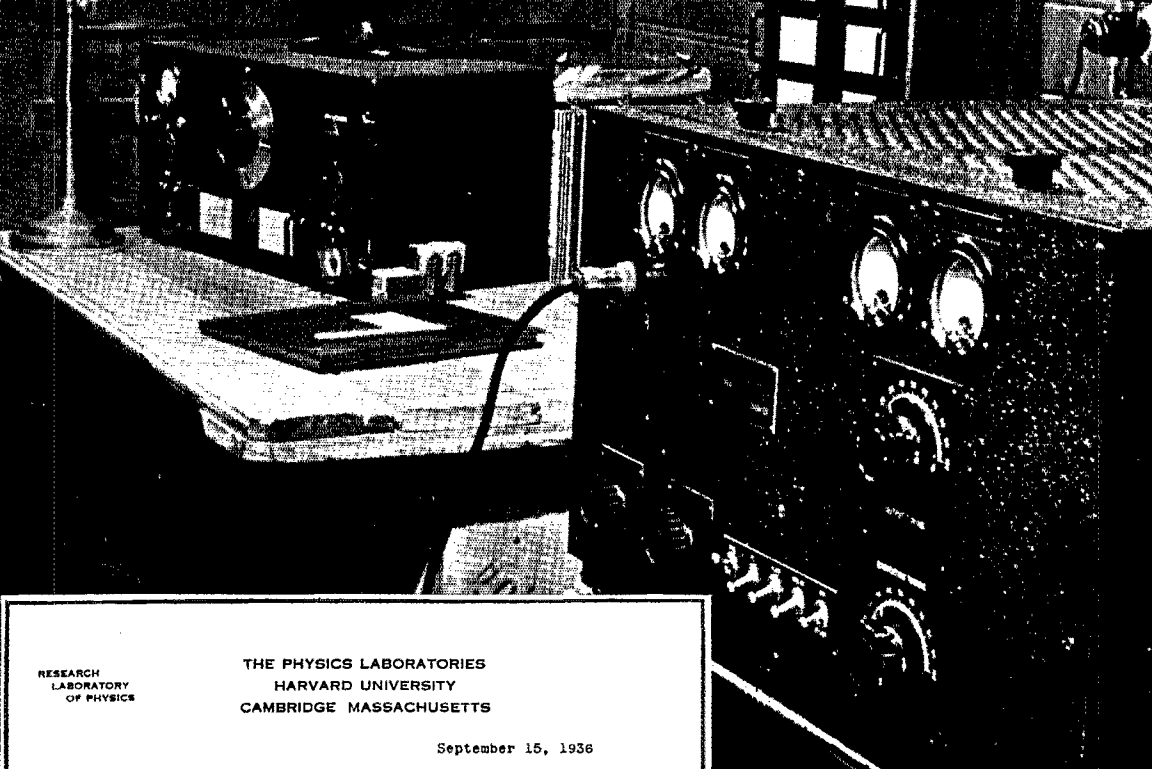

RESEARCH
LABORATORY
OF PHYSICS

THE PHYSICS LABORATORIES
HARVARD UNIVERSITY
CAMBRIDGE MASSACHUSETTS

September 15, 1936

Mr. Arthur A. Collins
Collins Radio Company
Cedar Rapids, Iowa

Dear Mr. Collins:

You will doubtless be interested in the following report of the performance of the 45A transmitter which was used on the Harvard University-Massachusetts Institute of Technology eclipse expedition.

Our geographical position was most unfavorable for United States signals, since they had to pass near the north magnetic pole. As a result, even the high-powered commercial stations were audible less than an hour each day. This made it impossible for us to communicate regularly direct with the United States. One fone and five cw contacts with the United States were all that were made during the months of operation. However, the transmitter was used a very great deal sending traffic to England and Sweden, whence it was relayed to the United States. Reliable schedules were set up and considerable traffic handled. Nearly all this was done on fone, as it was possible to cover all of Europe with a R8 to R9 fone signal on 14 mc. During our efforts to establish satisfactory traffic routings, contacts were made with amateurs in 28 countries and all continents except South America. Our call, URAD, was very well known in Europe by the time we left.

We were frequently complimented on the good quality of our voice reproduction. In many cases the transmitter was identified as a "Collins job" before we mentioned it, largely for this reason. The 45A transmitter seems to be widely and favorably known among the European operators.

We found the plug-in coil arrangement very handy, particularly the inclusion of the antenna coupling coil in the plug-in section. The inductive neutralization was found to be stable and easy to adjust.

The ease with which we could communicate with the "outside world" was a great convenience and satisfaction to those of us on the expedition.

Yours truly

H. Selvidge
Instructor in Communication Engineering

HS:A

URAD



AN INTERESTING
LETTER ON THE PER-
FORMANCE OF THE
45A AT AK-BULAK IN
THE KAZAK REPUB-
LIC, NEAR OREN-
BURG, U. S. S. R.



Collins Radio Company

CEDAR RAPIDS
New York
11 West 42nd St.



IOWA, U. S. A.
Mexico City
Edificio "La Nacional"

PRECISION

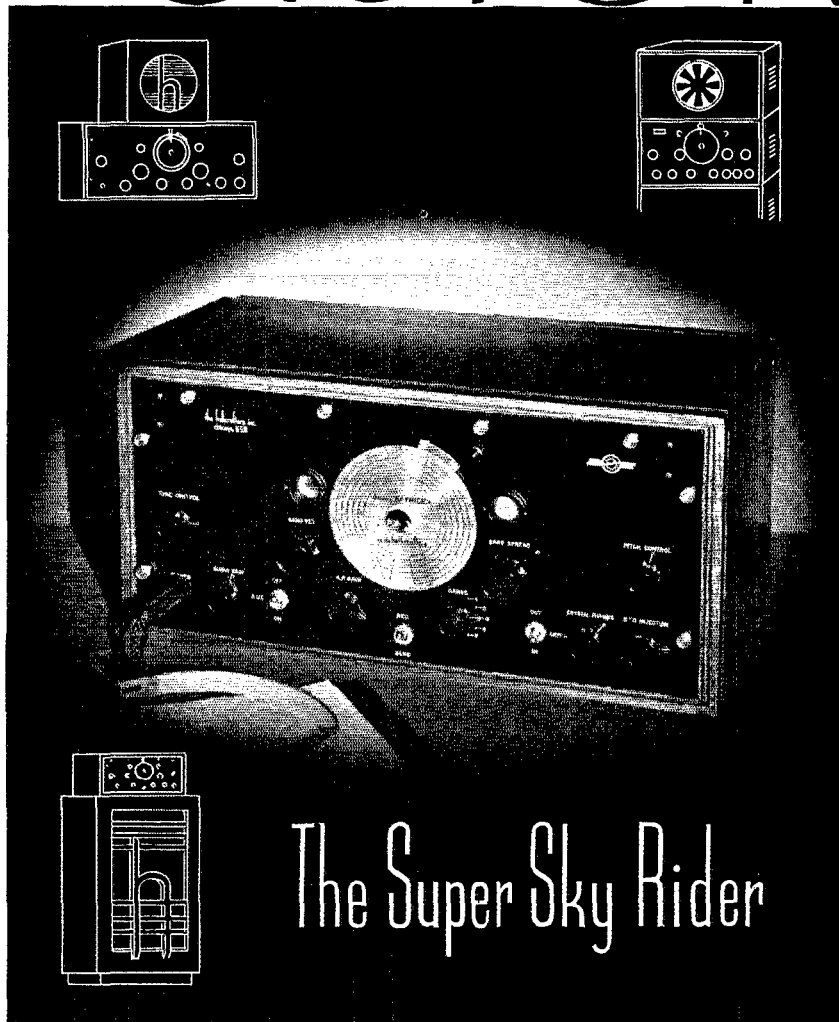

The Super Sky Rider

All
Hallicrafters
Receivers Now
Available on Time
Payments through
Your Jobber

PRECISION — the one word above all others that most eloquently describes the construction of a communications receiver.

Precision is engineering design — in the exacting specifications of every component part — in every step of assembly — in the specially built test equipment, so precise, so accurate, that its use is limited to only the most sensitive and selective of receivers.

Precision permeates every thought of the designer of a communications receiver — every action of the builder. In such a spirit, to such ideals, Hallicrafters Receivers are conceived and built.

A Solid Walnut Copper-lined cabinet with speaker cabinets of individual and console types to match, are now available for the Super Sky Rider

the hallicrafters inc.

2611 Indiana Avenue
CHICAGO, U. S. A.

Cable Address: "Livex," N. Y.

Say You Saw It in *QST* — It Identifies You and Helps *QST*

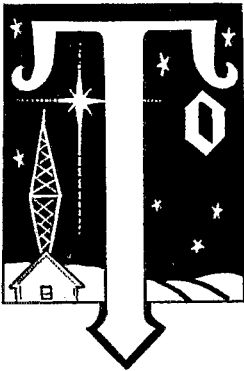

THE MEMBERS OF THE A.R.R.L.

During these closing days of the year, we find ourselves with a tendency to overlook the ordinary routine of business in contemplation of the broad panorama of 1936. No such reflection is possible without becoming acutely conscious of the splendid support given this organization by the radio amateurs — support which adds further incentive to our determination to build the finest communications receivers ever made available to the amateur.

This seems a fitting time to make known our gratitude for this recognition of our efforts, and to extend, on behalf of ourselves and our dealers, to every radio amateur, our best wishes for the happiest holiday season they have ever had, and for a prosperous year to come.

THE HALLICRAFTERS

W. J. Halligan
President

ALABAMA
Birmingham: E. E. Forbes & Sons, 403 W. 20th Street

CALIFORNIA
Long Beach: Scott Wholesale Radio, 222 E. 4th Street
Los Angeles: Radio Television Sup. Co., 1701 Grand Avenue
Los Angeles: Pacific Radio Eng., Inc., 729 S. Main Street
Los Angeles: Spero Radio Sup. Co., 1000 S. Broadway
Oakland: Radio Supply Co., 2085 Broadway
Oakland: Electric Supply Co., 12th & Fallon Street
Oakland: E. C. Wenger Co., 1020 Oak Street
Pasadena: Dow Radio Supply Co., 1439 E. Colorado Street
Fresno: DeJannat Co., 2501 Tulare Street
San Jose: Radio Specialties Co., 156 W. San Fernando St.
San Francisco: I. S. Cohens & Sons, 1025 Market Street
San Francisco: Offenbach Elec. Co., 1452 Market Street
San Francisco: San Francisco Radio Exchange, 1284 Market Street

COLORADO
Denver: The Auto Equipment Co., 14th at Lawrence
Pueblo: L. B. Walker Radio Co., 809 N. Main Street

CONNECTICUT
Bridgeport: De'Elia Elec. Co., 1330 Fairfield Avenue
Bridgeport: Hatry & Young, 195 Cannon Street
Hartford: Radio Inspection Serv. Co., 227 Asylum Street
Hartford: Stern Wholesale Parts Co., 210 Chapel Street
New Haven: Congress Radio & Batt. Co., 207 Congress
New Haven: Hatry & Young, 86 Meadow Street

DELAWARE
Wilmington: Delaware Radio Sales Co., 495 Delaware

D. of C.
Washington: National Elec. Sup. Co., 1328 New York Ave., NW

FLORIDA
Miami: Thurow Radio Distr. Co., 23 12th Street
Tampa: Thurow Radio Distr. Co., 110 E. Cass Street

GEORGIA
Atlanta: Wholesale Radio Serv. Co., 430 Peachtree St., NW
Columbus: Radio Elec. & Serv. Co.

IDAHO
Twin Falls: Wright Radio Products

ILLINOIS
Belleville: Lurtz Elec. Co., 10 N. 1st Street
Chicago: Allied Radio Corp., 833 W. Jackson

Chicago: Chicago Radio Apparatus, 415 S. Dearborn
Chicago: Hinds and Edgerton, 19 S. Wells
Chicago: Midwest Radio Mart, 520 S. State Street
Chicago: Montgomery Ward & Co.
Chicago: Newark Elec. Co., 226 W. Madison

Chicago: Wholesale Radio Serv. Co., 901 W. Jackson
Peoria: Klaus Radio & Elec. Co., 707 Main Street
Pana: United Elec. Sup. Co.

INDIANA
Indianapolis: Van Sickle Radio, 34 W. Ohio
Peru: Clingman Radio Supply
Terre Haute: Hulman & Co.

IOWA
Des Moines: Iowa Radio Corp., 1212 Grand
Sioux City: Warren Elec. Co., 647 Water Street

KENTUCKY
Louisville: Universal Radio Supply, 715 S. Seventh Street

LOUISIANA
New Orleans: Shuler Supply Co., Box 237
Portland: Radio Serv. Lab. of Me., 574-A Congress
Portland: Bartlett Radio Co., 642 Congress Street

MARYLAND
Baltimore: Radio Elec. Ser. Co., 3 N. Howard Street
Baltimore: Wholesale Radio Parts Co., 312 W. Redwood

MASSACHUSETTS
Boston: H. Jappe Company, 46 Cornhill
Boston: Radio Shack, 46 Brattle Street
Boston: Sager Elec. Sup. Co., 201 Congress
Boston: Tremont Elec. Sup. Co., 10 Brokton
Brokton: Ware Radio & Supl. Co., 913 Centre Street
Brookline: Harvey Radio Lab., 12 Boylston
New Bedford: Ware Radio & Sup. Co., 813 County
Pittsfield: Pittsfield Radio Co., 44 West Street
Springfield: T. F. Cushing, 349. Worthington
Worcester: H. Jappe Company, 37 Mechanic Street

MICHIGAN
Ann Arbor: Purchase-Radio, 331 S. Main Street
Detroit: Radio Specialties, 171 E. Jefferson
Detroit: Radio Equipment Sales, 11845 Woodward Avenue
Detroit: Serlin Stores Corp., 1419 Broadway
Detroit: Rissi Brothers, 5031 Hamilton Avenue
Flint: Shand Radio Specialties, 203 W. Kearsley Street
Lansing: Norge Sales & Serv., 2009 E. Michigan

MISSOURI
Butler: Henry's Radio Shop, 211 N. Main Street
Kansas City: Burstein-Applebee, 1012 Main Street
St. Louis: Gordon Radio Co., 927 Pine Street
St. Louis: Walter Ashe Radio Co., 1100 Pine Street

MINNESOTA
Duluth: Northwest Radio, 109 E. First Street
St. Paul: Hall Elec. Co., 386 Minnesota St.
St. Paul: Low Bonn Co., 506 Robert Street
Thief River Falls: The Larson Company

NEBRASKA
Lincoln: Leuck Elec. Co., 1364 S. 33rd Street
Omaha: Radio Accessories, 2855 Farnam Street

NEW HAMPSHIRE
Dover: H. Jappe Company, 450 Central
Manchester: Radio Serv. Lab. of N. H., 1187 Elm Street

NEW JERSEY
Atlantic City: M & H Sporting Goods Co., 1709 Atlantic Avenue
Elizabeth: Radio Shop of Eliz.
Newark: Wholesale Radio Serv. Co., 219 Central Avenue
Newark: Aaron Lippman & Co., 246 Central Avenue

NORTH CAROLINA
Asheville: Freck Radio Sup. Co., 38 Biltmore Street
Charlotte: Radio Sup. Co., Inc., 218 W. Fourth Street
Charlotte: Shaw Distr. Co., 205 W. 1st Street
Fayetteville: Hunter Bros. Inc., 467 69th Street

NORTH DAKOTA
Fargo: Dakota Elec. Sup. Co., 123 Broadway
OKLAHOMA
Oklahoma City: Southern Sales Co., 130 W. 3rd Street
Tulsa: Radio Inc., Box 226, 219 S. Boulder
Ponca City: The Major Sales Co.

OREGON
Portland: Radio Sup. Co., 210 SW Alder
Portland: United Radio Sup., 203 SW 9th Avenue

RHODE ISLAND
Providence: W. H. Edwards Co., 32 Broadway

SOUTH CAROLINA
Columbia: Dixie Radio, 1714 Main Street

SOUTH DAKOTA
Sioux Falls: Power City Radio Co., 224 S. Main Street

TENNESSEE
Memphis: Oryll Bros. & Co., 505 Tennessee
Memphis: Richman Crosby Co., 223 S. Front Street

TEXAS
Austin: J. R. Reed Music Co.
Dallas: Wilkinson Bros., 2501 Commerce
Dallas: Southwest Radio Sup., 107 S. St. Paul Street
Houston: R. C. Hall, 738 E. 16th Street
Lubbock: R & R Radio Sup. Co., Inc.

UTAH
Salt Lake City: Radio Sup., Inc., 46 Exchange Place

VIRGINIA
Norfolk: Radio Sup. Co., 408 Monticello
Norfolk: Newport Radio Equip. Co., 615 Boush Street
Richmond: Newport Radio Equip. Co., 527 W. Broad Street

WASHINGTON
Seattle: Seattle Radio Sup. Co., 2319 Second Street
Seattle: Wedel Co., Inc., 520 Second Street
Seattle: Northern Radio, 2208 4th Avenue
Spokane: Spokane Radio Co., 611 First Street

WISCONSIN
Milwaukee: Radio Parts Co., 332 W. State Street
Madison: Radio Parts Co., 1214 Regent Street

NEW YORK
Albany: Ft. Orange Radio Distr. Co., 356 Broad
Brooklyn: H. Sylvesters Elec. Shop, 61 Willoughby
Buffalo: Kronson Serv. Co., 423 E. Genesee Street
Buffalo: Radio Equipment Corp., 326 Elm Street
Glensville: Adirondack Radio Serv., 40 Clyde Street
Jamestown: Jamestown Philco Sales, 303 W. 3rd Street
New York: Davaea City Radio, 62 Cortlandt Street
New York: Gross Radio Inc., 51 Vesey Street
New York: Harvey's Radio Shop, 103 W. 43rd Street
New York: Harrison Radio Co., 12 W. Broadway
New York: Sun Radio, 227 Fulton Street
New York: Wholesale Radio Serv. Co., 100 6th Street
Rochester: Howe & Rogers, 68-70 Stone Street
Rochester: Radio Parts & Equip., 244 Clinton
Schenectady: M. Schwartz & Sons, 712 Broadway
Syracuse: W. E. Berndt, 111 S. State
Utica: Vaeth Elec. Co., 701 Varick Street

OHIO
Akron: Brighton Spg. Goods Co., 110 E. Market Street
Canton: Armstrong Radio, 210 N. Walnut
Cincinnati: Steinberg's Inc., 633 Walnut
Cincinnati: Radio Supply Co., 224 E. Sixth Street
Cincinnati: United Radio Inc., 1103 Vine Street
Cleveland: Northern Ohio Labs., 2073 W. 85th Street
Cleveland: Progress Elec. Co., 6207 Broadway
Cleveland: Radio Servicemen's Sup., 519 Huron
Cleveland: Winteradio, Inc., 3014 Lorain Avenue
Columbus: Bell Radio Parts Co., 61 E. Goodale
Dayton: Standard Parts Co., 25 N. Jefferson
East Liverpool: Hausfeld Radio, 413 First Avenue
Toledo: Toledo Radio Specialties, 337 10th Street
Toledo: H & W Auto Acces. Co., 715 Adams
Youngstown: Ross Radio Co., 325 W. Federal Street

PENNSYLVANIA
Allentown: Allentown
Allentown: Hollenback's, 2221 8th Avenue
Erie: Jordan Radio Co., 1019 E. 5th Street
Erie: John W. Duncombe, 1011 8th Street
Erie: Warren Radio Co., 1119 State Street
Philadelphia: M & H Sporting Goods Co., 812 Market
Philadelphia: Consolidated Radio Corp., 612 Arch
Philadelphia: Herbach & Rademan, 438 Market Street
Philadelphia: Radio Elec. Serv. Co., Cor. 7th & Arch
Pittsburgh: Hamburg Bros., 963 Liberty Ave.
Pittsburgh: Tri State Radio Equip. Co., 403 Penn Avenue
Pittsburgh: E. J. Tidings, 114 9th Street
Reading: Geo. D. Barbey Co., 404 Walnut Street
Williamsport: Williamsport Radio Serv., 302 Locust
Shamokin: Miller & Jones



Say You Saw It in QST — It Identifies You and Helps QST

QST

devoted entirely to

AMATEUR RADIO

PUBLISHED, MONTHLY, AS ITS OFFICIAL ORGAN, BY THE AMERICAN RADIO RELAY LEAGUE, INC., AT WEST HARTFORD, CONN., U. S. A.; OFFICIAL ORGAN OF THE INTERNATIONAL AMATEUR RADIO UNION

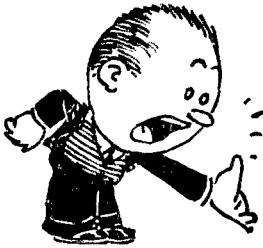

JANUARY

1937

Volume XXI

Number 1



Kenneth B. Warner (Secretary, A.R.R.L.), *Editor-in-Chief and Business Manager*; Ross A. Hull, *Associate Editor*; James J. Lamb, *Technical Editor*; George Grammer, *Assistant Technical Editor*; Clark C. Rodimon, *Managing Editor*; David H. Houghton, *Circulation Manager*; F. Cheyney Beekley, *Advertising Manager*; Charles Brunelle, *Assistant Advertising Manager*.

Editorial and Advertising Offices

38 La Salle Road
West Hartford, Connecticut

Subscription rate in United States and Possessions and Canada, \$2.50 per year, postpaid; all other countries, \$3.00 per year, postpaid. Single copies, 25 cents. Foreign remittances should be by international postal or express money order or bank draft negotiable in the U. S. and for an equivalent amount in U. S. funds.

Entered as second-class matter May 29, 1919, at the post office at Hartford, Connecticut, under the Act of March 3, 1879. Acceptance for mailing at special rate of postage provided for in section 1103, Act of October 3, 1917, authorized September 9, 1922. Additional entry at Concord, N. H., authorized February 21, 1929, under the Act of February 28, 1925.

Additional second-class entries to cover sectional editions authorized March 20, 1935. Copyright 1936 by the American Radio Relay League, Inc. Title registered at United States Patent Office.

The Contents

Editorials	7
Amateur Radio on the Harvard-M.I.T. Eclipse Expedition <i>H. Selvidge, W9BOE</i>	9
The Governors-to-President Relay Boosting the Output of the Low-Powered Transmitter <i>Vernon Chambers, W1JEQ</i>	12
The 807 as a Crystal Oscillator <i>John Stiles, W8PNL</i>	13
Henry B. Joy	18
What the League Is Doing	19
Silent Keys	20
A 913 Oscilloscope with Linear Sweep <i>J. B. Carter</i>	21
How Would You Do It? (Contest Announcement)	22
Some Practical Inverse Feedback Circuits for Audio Power Amplifiers	25
Field Day Results	26
What They Don't Know Won't Hurt 'Em <i>J. L. Evans Jr., W2BBK, W3BJN</i>	28
A 50-Watt Rack-Mounted 'Phone Using Beam-Type Tubes <i>R. E. Herbert and Steve Tunder, W8QCF</i>	31
Wide-Range Resonance-Type Frequency Meters with Sensitive V.T. Indicators <i>Wolcott M. Smith</i>	32
A Few More Receiving Tubes <i>OZ4G, 6H5, 25L6</i>	35
An Inexpensive 160-Meter 'Phone for Local Rag Chews <i>Walter van B. Roberts, W3CHO</i>	37
Dual-Triode Phase Inverters as Push-Pull Audio Drivers <i>Curtis R. Hammond</i>	38
About R.F. Voltage and Current Ratings of Mica Trans- mitting Condensers	40
An Optical Pyrometer for Measuring Tube Plate Dis- sipation <i>A. D. Mayo Jr., W4CBD/9</i>	43
Note on Auto-Transformer Design <i>T. W. Hopkinson, W3AVR</i>	44
With the Affiliated Clubs	45
Testing Transmitting Tubes <i>T. M. Ferrill, W5CJB</i>	46
A Tuning-Fork Tone Generator of Simple Construction <i>Charles W. Carter, W3EZZL</i>	47
Amateur Radio Stations	49
I.A.R.U. News	50
Hints and Kinks for the Experimenter Note on Decoupling Circuits—An Impedance Bridge —Twisting Heavy Guy Wires—Audio Oscillator Keying Monitor Without Relays—Kink for Solder- ing Coil	52
A.R.R.L. QSL Bureau	54
Operating News	56
Correspondence Department	57
Midwest Division Convention	63
Central Division Convention	76
Standard Frequency Transmissions	78
The Seventeenth Pacific Division Convention	82
Roanoke Division Convention	84
The Southeastern Division Convention	88
Vanalta Division Convention	88
Book Review	90
Ham-Ads	94
Index of Advertisers	123
	126

Announcing

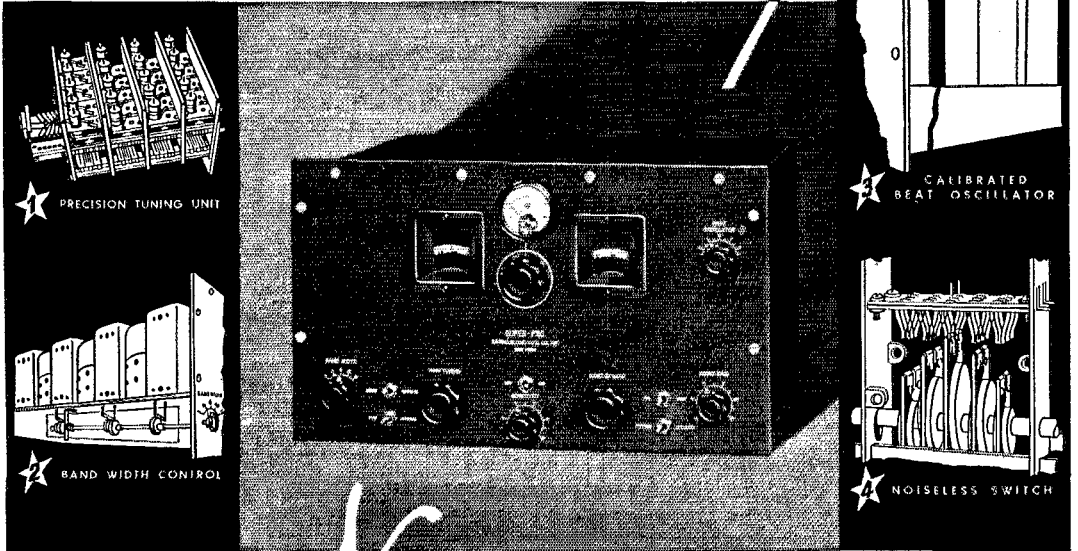

THE *New* "SUPER-PRO"

HAMMARLUND now introduces an outstanding receiver that provides a new high in efficiency — the "Super Pro," "100" series — for .54 to 20.0 megacycles.

With this new "Super Pro" you can now continuously vary the selectivity from 3 to 16 kc. by means of a directly calibrated "Band Width" control on the front panel. At last, no more guess work!

For C.W. the new "Super Pro" also has a beat oscillator control directly calibrated from 0 to 2.5 kilocycles on either side of zero beat. Audio gain and sensitivity gain controls are also graduated to facilitate accurate tuning.

A crystal model is also available. This model affords selectivity from a knife-like point desired for C.W. to a wider degree of selectivity required for practical phone reception.

Another major feature is the band spread system with a 12-gang condenser which spreads each amateur band over practically the entire dial. High frequency broadcast channels are similarly spread for extra easy tuning.

The exclusive "Super Pro" cam-operated knife-switch is noiseless, jar-proof, and fool-proof! Within

the precision tuning unit are 20 laboratory adjusted tuning coils on Isolantite bases, a four-gang main tuning condenser, and a 12 to 1 ratio direct reading dial, calibrated in megacycles and kilocycles, accurate to within 1/2%.

The sensitivity of this new receiver using 16 tubes, eight metal and eight glass, is so great that weak signal reception is limited only by the noise pick-up of the antenna system.

Write today for the special new "Super Pro" bulletin, with further details and illustrations. Mail the coupon below!

HAMMARLUND MANUFACTURING CO., INC.	
424-438 W. 33rd St., NEW YORK	Q-1-37
<input type="checkbox"/> Check here for new "Super Pro" bulletin. <input type="checkbox"/> Check here for new "37" Hammarlund General Catalog.	
Name	
Address	
City	State



Section Communications Managers of the A.R.R.L. Communications Department

All appointments in the League's field organization are made by the proper S.C.M., elected by members in each Section listed. Mail your S.C.M. (on the 10th of each month) a postal covering your radio activities for the previous 30 days. Tell him your DX, plans for experimenting, results in phone and traffic. He is interested, whether you are an A.R.R.L. member or get your QST at the newsstands; he wants a report from every active ham. If interested and qualified for O.R.S., O.P.S. or other appointments he can tell you about them, too.

Eastern Pennsylvania Maryland-Delaware-District of Columbia Southern New Jersey Western New York Western Pennsylvania	W3EZ W3BAK W3ZX W8DSS W8OFO	ATLANTIC DIVISION James M. Bruning	339 W. Lancaster Ave.	Haverford
		Edgar L. Hudson Carroll D. Kentner Charles Smith Kendall Speer, Jr.	1107 Park Ave. 310 E. Walnut St.	Laurel, Delaware Collingswood Oneida Lowermer
		CENTRAL DIVISION L. John Huntoon Arthur L. Braun G. W. Mossbarger Harold C. Bird E. H. Gibbs E. A. Cary	327 Brandon Ave. 530 East Morris St. Box 177 R. F. D. 2 300 High St. 3922 No. 19th Pl.	Glen Elyn Indianapolis Camp Taylor Pontiac Wadsworth Milwaukee
Illinois Indiana Kentucky Michigan Ohio Wisconsin	W9KTY W9TE W9AUH W8DPE W8AQ W9ATO			
North Dakota South Dakota Northern Minnesota Southern Minnesota	W9OEL W9SEB W9OWU W9DCM	DAKOTA DIVISION Hartwell B. Burner Andrew J. Kjar Leonard Hofstad Webster F. Soules	257 Prospect Ave. 3549 36th Ave., So.	Hope Pierre Elbow Lake Minneapolis
Arkansas Louisiana Mississippi Tennessee	W8ABI W5DWV W5CWO W4DEP	DELTA DIVISION H. E. Vette W. J. Wilkinson, Jr. J. H. Weems, Jr. B. G. Lowrey Smith	2918 West 15th St. 1523 Laurel St. P. O. Box 244 673 Hillcrest St.	Little Rock Shreveport State College Memphis
Eastern New York N. Y. C. & Long Island Northern New Jersey	W2LU W2AZV W2FOP	HUDSON DIVISION Robert E. Haight E. L. Baunach Charles J. Hammersen	511 South Holmes St. 102 Central Ave. 92 Claremont Ave.	Scotia Massapequa, L. I. Verona
Iowa Kansas Missouri Nebraska	W9NNM W9PB W9CJR W9FAM	MIDWEST DIVISION Owen Williams Harry E. Legler J. Dewey Mills Samuel C. Wallace	108 No. Johnson St. 304 Miami St. Box 205 Green St.	Iowa City Hiawatha Mount Vernon Clarks
Connecticut Maine Eastern Massachusetts Western Massachusetts New Hampshire Rhode Island Vermont	W1CTY W1CDX W1ABG W1JAH W1BFT W1HRC W1GNF	NEW ENGLAND DIVISION Frederick Ellis, Jr. John W. Singleton Albert N. Giddis William J. Barrett Carl E. Evans Clayton C. Gordon Alvin H. Battison	19 Merrill Rd. 73 Allen St. 128 Crawford St. 239 Columbia St. 80 No. State St. 206 California Ave. 1 Central St.	Norwalk Wilton Lowell Adams Concord Providence Windsor
Alaska Idaho Montana Oregon Washington	K7PO W7NH W7CRH W7AIV W7WY	NORTHWESTERN DIVISION Richard J. Fox Nellie H. Hart Russell U. Richmond Eugene E. Lovejoy Robert H. Votaw	Box 301 Box 6 5013 N. E. Clackamas Route 1, Box 398	Ketchikan Twin Falls Somers Portland Vancouver
Hawaii Nevada Santa Clara Valley East Bay San Francisco Sacramento Valley Philippines San Joaquin Valley*	K6EWO W6BIC W6BBW W6JTV W6SG W6DVE K6AGR W6LPE	PACIFIC DIVISION Atlas O. Adams Edward W. Heim Elbert Amarantes Harold J. Burchfield Alan D. Whittaker, Jr. Geo. L. Woodington George L. Rickard Angelo V. Astone	21st Infantry Brigade 309 Claremont St. 475 So. 11th St. 2240 106th Ave. 79 Elinor Ave. 716 Redwood Ave. Box 849 729 Safford	Schofield Barracks Reno San Jose Oakland Mill Valley North Sacramento Manila Fresno
North Carolina Virginia West Virginia	W4OG W3UVA W8KKG	ROANOKE DIVISION H. S. Carter Charles M. Waaf, Jr. Dr. Wm. H. Ribeldaffer	115 Crafton St. P. O. Box 1212	Winston-Salem Univ., Charlottesville Lost Creek
Colorado* Utah-Wyoming	W9FA W7COH	ROCKY MOUNTAIN DIVISION Glen Glasscock Townsend J. Rigby	2164 So. Corona St.	Denver Midwest, Wyoming
Alabama Eastern Florida	W4DGS W4ASR	SOUTHEASTERN DIVISION James F. Thompson William C. Shelton	2248 S. Arlington Ave. 556 Westmoreland Drive *Hillcrest", P. O. Box 652 1517 East Brainard St.	Birmingham Daytona Beach Pensacola
Western Florida Georgia-So. Carolina-Cuba- Isle-of-Pines-Porto Rico- Virgin Islands	W4MS W4CE	Edward J. Collins Bannie L. Stewart		
Los Angeles Arizona San Diego	W6GXM W6LVG W6EOP	SOUTHWESTERN DIVISION Don M. Draper C. C. Day Harry A. Ambler	4421 West 63 St. "La Posta Quemada" 4101 Hamilton St.	Los Angeles Vail San Diego
Northern Texas Oklahoma Southern Texas New Mexico	W5BII W5CEZ W5BDI W5CGJ	WEST GULF DIVISION Richard M. Cobb Carr L. Simpson Ammon O. Young Joseph M. Eldott	Box 185 2010 So. 4th St. 4803 Eli St.	Dodd City Ponca City Houston Chamita
Maritime	VE1DQ	MARITIME DIVISION A. M. Crowell	69 Dublin St.	Halifax, N. S.
Ontario	VE3SG	ONTARIO DIVISION Fred H. B. Saxon	302 Lee Ave.	Toronto, Ont.
Quebec	VE2EE	QUEBEC DIVISION Stan Comach	780 Brault Ave.	Verdun, P. Q.
Alberta British Columbia	VE4LX VE5EP	VANALTA DIVISION Alfred D. Kettenbach D. R. Vaughan-Smith	635 Garfield St. 1221 Burnaby St.	Winnipeg Vancouver
Manitoba Saskatchewan	VE4BG VE4EL	PRAIRIE DIVISION A. J. R. Simpson Wilfred Skafie	71 Thelmo Mansions 2040 McTavish St.	Winnipeg Regina

* Officials appointed to act until the membership of the Section choose permanent S.C.M.'s by nomination and election.

The American Radio Relay League



THE AMERICAN RADIO RELAY LEAGUE, INC., is a non-commercial association of radio amateurs, bonded for the promotion of interest in amateur radio communication and experimentation, for the relaying of messages by radio, for the advancement of the radio art and of the public welfare, for the representation of the radio amateur in legislative matters, and for the maintenance of fraternalism and a high standard of conduct.

It is an incorporated association without capital stock, chartered under the laws of Connecticut. Its affairs are governed by a Board of Directors, elected every two years by the general membership. The officers are elected or appointed by the Directors. The League is non-commercial and no one commercially engaged in the manufacture, sale or rental of radio apparatus is eligible to membership on its board.

"Of, by and for the amateur," it numbers within its ranks practically every worth-while amateur in the nation and has a history of glorious achievement as the standard-bearer in amateur affairs.

Inquiries regarding membership are solicited. A bona fide interest in amateur radio is the only essential qualification; ownership of a transmitting station and knowledge of the code are not prerequisite. Correspondence should be addressed to the Secretary.

HIRAM PERCY MAXIM, FOUNDER

OFFICERS

President.....EUGENE C. WOODRUFF, W8CMP
State College, Pa.

Vice-President.....GEORGE W. BAILEY, W1KH
Weston, Mass.

Secretary.....KENNETH B. WARNER, W1EH
West Hartford, Connecticut

Treasurer.....ARTHUR A. HEBERT, W1ES
West Hartford, Connecticut

Communications Mgr....F. EDWARD HANDY, W1BDI
West Hartford, Connecticut

General Counsel.....PAUL M. SEGAL
1010 Shoreham Building, Washington, D. C.

Address all general correspondence to the administrative headquarters at West Hartford, Connecticut

DIRECTORS

President
EUGENE C. WOODRUFF.....W8CMP
234 W. Fairmount Ave., State College, Pa.

Vice-President
GEORGE W. BAILEY.....W1KH
74 Webster Road, Weston, Mass.

Canadian General Manager
ALEX REID.....VE2BE
169 Logan Ave., St. Lambert, P. Q.

Atlantic Division
WALTER BRADLEY MARTIN.....W3QV
Box 612, Roslyn, Pa.

Central Division
EDWARD A. ROBERTS.....W8HC
2699 Endicott Rd., Shaker Heights, Cleveland

Dakota Division
CARL L. JABS.....W9BVH
1822 James St., St. Paul, Minn.

Delta Division
E. RAY ARLEDGE.....W5SI
P. O. Box 286, Pine Bluff, Ark.

Hudson Division
KENNETH T. HILL.....W2AHC
115 Willow St., Douglaston, L. I., N. Y.

Midwest Division
FLOYD E. NORWINE, JR.....W9EFC
120 South Fourth St., St. Louis, Mo.

New England Division
PERCY C. NOBLE.....W1BVR
37 Broad St., Westfield, Mass.

Northwestern Division
RALPH J. GIBBONS.....W7KV
c/o United Air Lines, Pendleton, Ore.

Pacific Division
S. G. CULVER.....W6AN
2962 Russell St., Berkeley, Calif.

Roanoke Division
H. L. CAVENESS.....W4DW
State College Station, Raleigh, N. C.

Rocky Mountain Division
RUSSELL I. ANDREWS.....W9AAB
1867 So. Lafayette St., Denver, Colo.

Southeastern Division
BENNETT R. ADAMS, JR.....W4APU
1512 Grove Place, Homewood, Ala.

Southwestern Division
CHARLES E. BLALACK.....W6GG
443 Main St., El Centro, Calif.

West Gulf Division
WAYLAND M. GROVES.....W5NW
c/o Humble Pipe Line Co., Neches, Texas



THE EDITOR'S MILL

AS THE eventful year 1936 pulls its switches and coasts into history, it seems to us that it would be a good idea to cast a surveying eye back over the twelve months, take a look at what has happened and see where we are. It should be not only interesting but helpful in adjusting our perspectives. It is wholesome for every mortal to pause occasionally and take stock of his situation. It is with this feeling, then, that we blow the whistle and at double-time the events of 1936 again march briefly across the pages of *QST*.

While our story for the year is large with triumphs, the saddest event in the history of amateur radio occurred in middle February with the sudden passing of our much-loved founder and president, Hiram Percy Maxim, W1AW, and our estimable vice-president, Charles H. Stewart, W3ZS. Despite our successes in other fields, we are left with an ineffable feeling of loss in the passing of these splendid friends and leaders of our art. In May, as every amateur knows, Eugene C. Woodruff, W8CMP, and George W. Bailey, W1KH, succeeded to these respective offices.

Practical operating achievement and public recognition thereof made immense strides in 1936. The Great Flood of March produced, in fourteen eastern states, the greatest emergency in the history of our country and the greatest communication need of all times. Amateur radio operators met the responsibilities of the hour with flying colors. It was the most complete, spectacular and important demonstration of the public utility inherent in the amateur service in our notable history of such experiences. Invaluable work was also recorded in southern tornadoes, a Canadian mine disaster, and in Florida hurricanes and Texas floods. Attention was focussed on the importance of preparedness, amateurs became conscious of the need for possessing special apparatus for emergency work, and steps were taken to expand the A.R.R.L.'s Emergency Corps. Two successful field days were held, combining an outing with the testing of portable equipment. Routine traffic performance included valuable contact with several expeditions, as in the past. Service through the nationwide network of all-O.R.S. spot-frequency trunk lines was speeded by the creation of a national trunk-line

net and through the inauguration of scores of section and local A.R.R.L. nets. It was a great year for placing emphasis on the high usefulness and value of amateur communication and amateur operators to their communities.

Interest in operating competitions was keener than ever. Besides announcements in coöperation with foreign societies, great variety was offered in A.R.R.L. contests for different groups. Only the highlights can be mentioned here. The ultimate in contact opportunities was given the fraternity through A.R.R.L.'s Eighth International DX Contest and the Seventh Annual Sweepstakes—the biggest events for testing stations, making operators top-notch, and providing just plain fun. The DX tests proved the most successful in history. In the "SS" a goal looked forward to for years was realized when at last one man worked all 69 A.R.R.L. sections in the short space of two week-ends! (W6ITH, O.P.S., did this on 'phone, using the 1.8- 3.9-, 14-, 28-, 56- and 112-Mc. bands!) Keen rivalry marked many an operating battle in O.R.S. and O.P.S. groups during the year. The use of low-frequency bands continued extensive, but 14-Mc. interest, occupancy and results increased substantially. With minor exceptions, DX conditions were the best ever, and many new W.A.C.'s were earned. The 28-Mc. band came into its own, with results equal to 14-Mc., the lower level of QRM inviting regular occupancy. The period of hailing 28-Mc. results with mouth agape gives place to stable occupancy, as this member of our family of bands takes on a real load of stations the world over—whenever, as now, solar conditions permit. Five-meter DX history was made in May, when the ionosphere misbehaved and permitted intercommunication between many middle-western and eastern amateurs. Interest in u.h.f. advanced, with frequency-stabilization technique to the fore. Clubs in several large cities developed methods to control 56-Mc. bootleg work, protecting the interests of members and the reputation of the fraternity.

The year was ushered in with announcement of a new W.A.S. objective. About 230 certificates were issued operators submitting proof of working forty-eight states. During the year the A.R.R.L. message form was changed to meet present-day requirements for fast accurate work. The F.C.C.

increased the minimum qualifications for amateur operating to thirteen words per minute, a step widely acclaimed throughout amateur ranks. The year is closing with organized activity at a higher level than ever before, and with renewed interest in the Rag Chewers Club and in general fraternizing. The limits and goals for amateur operating in the future—who can name them?

In the field of technical progress, the year not only brought substantial refinement in previously-established technique but also saw the introduction of a number of new practical aids to better communication. In receiver development the trend to increased use of superheterodynes has continued, both on the ordinary high frequencies and on ultra-high frequencies as well. Further improvements in receiver selectivity have been accomplished, particularly in single-signal sets employing the crystal filter circuits introduced in 1932 and '33. New circuits accomplishing a marked advance in reducing interference from "man-made" static have been especially significant, particularly the noise silencer developed in the A.R.R.L. laboratory and announced early in the year (February 1936 *QST*). Heterotone c.w. telegraph reception, giving the advantages of modulated c.w. transmission to aid in copying code, was another A.R.R.L. development (November), and the diversity-type receiver was introduced for amateur use with simplified single-control tuning (May). General receiver development was aided by the manufacture of new receiving tubes in both glass and metal types.

In transmitter development, the introduction of new-type transmitting tubes has resulted in simplification of r.f. and audio circuit design with improved flexibility and better performance. The most notable step in this direction came with availability of the beam power tubes, first in an audio receiving type (6L6), and later in r.f. transmitting types (807 and RK39). Further additions also were made to the line of transmitting pentodes, and several more efficient triode types made their appearance. Reasonably-priced low-temperature-coefficient quartz crystals have encouraged the trend toward crystal control, especially on the ultra-high frequencies, a number of crystal-controlled 28- and 56-Mc. designs being the result. New tubes especially developed for power use on frequencies ranging well above 300 Mc. have encouraged transmitter development in that region with simplification of circuit construction, as in the "trough-line" oscillator (September), and the attainment of greater power output with multi-tube arrangements (October).

Antenna development has been principally in the achievement of a better knowledge of the actual behavior of simple radiators (November) and in increased application of directional systems, a number of which were described throughout the year. Practical knowledge of wave

propagation on amateur high- and ultra-high frequencies has been considerably furthered. Continued study of ultra-high-frequency wave propagation between Boston and West Hartford has given further proof of the bending in the lower atmosphere first described in June 1935 *QST*. Improvements also have been made in auxiliary apparatus, especially in measuring equipment using cathode-ray tubes.

With returning national prosperity and interesting new apparatus, radio trade increased mightily, bringing added advertising income to A.R.R.L. publications which was immediately reflected in a greatly-increased number of reading pages. *QST* contained 1322 pages for the year, a new high mark, averaging 110.7 pages a month (and we don't count covers) for twelve issues. The new *Handbook*, out in November, went over two pounds in weight, sold twenty-five tons of copies in its first month. A complete history of amateur radio was published for the first time, the story from the inception of the art down to the present day, an invaluable record.

On the Washington front it has been an active year, although accompanied by no changes in legislation governing us and but minor modifications in our regulations. No international conferences were held but the year was large with preparations for coming conferences, the technical meeting of the C.C.I.R. at Bucharest next year and the administrative conference at Cairo in 1938. A.R.R.L. actively participated in the preparations made for these conferences by the United States government. At the direction of the Board of Directors, the League made a determined endeavor to secure more frequencies for the amateur at Cairo but was unsuccessful in having such a suggestion incorporated in the United States proposals. Taking advantage of every legal means for reconsideration, three minority reports and appeals for review were taken to successively higher planning organizations, and arguments renewed in each case, to be met by the united opposition of every other American radio interest. We pause here to point out that this is in no sense a discriminatory action against us as amateurs but reflects the feeling of virtually every other radio interest and of all the government agencies that safety for the present allocations at Cairo lies only in a policy of leaving everything strictly as it is: despite the demonstration of need for more space by every service, only ourselves and the broadcasters eventually pressed for a change in the allocations, and both requests were overwhelmingly voted down. As the year ends, then, there is increasing amateur recognition of the hard fact that we shall probably have to rely upon further improvements in our technique for the relief we seek.

In June, one of the most extensive hearings in the history of communications regulations was

(Continued on page 74)

Amateur Radio on the Harvard-M.I.T. Eclipse Expedition to Siberia

By H. Selvidge,* W9BOE

ON June 19, 1936, there occurred an eclipse of the sun, visible along a path of totality stretching from Greece across Siberia to Japan. Many expeditions from various countries were located along the path to make scientific observations, and the Harvard University-Massachusetts Institute of Technology expedition was one of these. Readers of *QST* will probably be interested in its activities on account of the large amount of radio equipment which was carried.

The expedition included two groups: One, the party of astronomers; and the other, the radio section. The astronomical members were interested in making spectrograph studies of the corona of the sun during the eclipse. The radio party was also to make scientific observations. These were measurements of the various changes in the ionosphere during the eclipse. The general problem of measurements of this kind was well discussed in the September *QST*,¹ and will not be described in detail here. Suffice

it to say that we are particularly interested in ionosphere measurements during an eclipse, since then the ultra-violet light from the sun is cut off suddenly, and affords better opportunities for studying its ionizing effects than during sunrise and sunset hours. It has long been supposed that the ultra-violet light was the cause of the ionization in the upper atmosphere, but some have held that there might be other agencies, and further checks were desirable to settle this point. Measurements were made during the eclipse of 1932² in New Hampshire by Cruft Laboratory of Harvard University, and the ones of this year were designed to add further data to that already obtained. This was desirable, since the measuring technique had been considerably improved since 1932.

Measurements were made by the fixed-frequency and variable-frequency methods. Examples of virtual height records obtained by these

* Cruft Laboratory, Harvard University, Cambridge, Mass.

¹ G. W. Kenrick, "The Kennelly-Heaviside Layer," *QST*, Sept., 1936.

² R. W. Woodward, "Amateur Observations During the (1932) Total Eclipse," *QST*, Jan., 1933.—Editor.

two methods are shown in the previously mentioned paper.¹ There were two transmitters used for the fixed frequency work. Each used an exciter with two 53-type tubes and one RK23. Each crystal-controlled exciter unit drove a final amplifier using two RK23's. A simpler rig would have worked for a single frequency, but a great deal of flexibility was desired, both for the expedition work and for future use. These transmitters could work in the 80-, 40- and 20-meter amateur bands

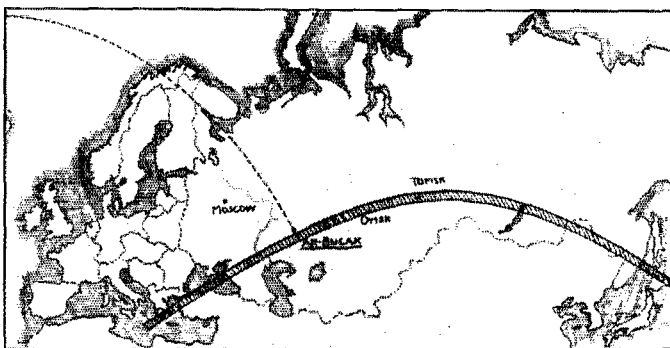

LOCATION OF THE EXPEDITION IN THE PATH OF THE ECLIPSE

if desired. They were modulated with a pulse modulation from a thyatron circuit, but could be rapidly changed over for c.w. operation. The variable-frequency transmitter was designed to cover the range from 2 to 8 Mc. in a continuous sweep without having to change any coils, with single-dial control, and constant output over this range. This was accomplished by an oscillator using two 852's with the tank coil consisting of a variometer (wound of 1/4-inch copper tubing) ganged with the tank condenser. The frequency was changed by a motor drive which could be operated from the receiving position, normally about three-quarters of a mile from the transmitters. The pulses for this transmitter were furnished by a motor-driven chopper.

The receiving equipment included three FB7 receivers with pre-selectors for the fixed frequency work, and an HRO Junior for the variable frequency receiver. There were also various motor-driven photographic recorders for recording the virtual heights.

COMMUNICATION EQUIPMENT

In addition to the measurement equipment, we

carried two transmitters and receivers for communications work. The party was to be stationed at the town of Ak-Bulak on the eclipse path, and the radio equipment was to be set up there, in the town, where power was available. A Collins 45A transmitter was provided for communication purposes and it was planned to try to keep a regular schedule with W1XJ at the laboratory in Cambridge, Mass. It was also to be used to communicate with the astronomical camp, eight miles from town. This transmitter was equipped for operation on the 80-, 40- and 20-meter amateur bands, as well as on two experimental assignments in the vicinity of 17 and 24 meters. We hoped that with this variety of frequencies available we would have few communications difficulties. More of that later.

At the astronomical camp we had a Western Electric 19A aircraft transmitter. This is a small two-tube crystal-controlled set with 15-watts output on c.w. and 5 watts on 'phone or m.c.w. It was powered by a dynamotor run from storage batteries. This transmitter uses two of the WE307A tubes, and is unusual in that the r.f. amplifier tube is modulated directly with the microphone transformer in its suppressor grid, and uses no audio amplification. At the radio camp the communications receiver was a National HRO and at the astronomical camp a Hammarlund Super-Pro was used. This latter was also used for the reception of time signals for checking the astronomer's chronometers.

As we expected to find ourselves in a rather primitive section of the world, we had to take along all conceivable kinds of supplies, and we had all sorts of spare parts for everything that might possibly break down. For example, we tried to take at least two spares for every tube needed. Our radio equipment used 98 tubes of 35 different types. And with the exception of two receiving tubes broken on the return trip, we did not have a single tube failure or casualty. This speaks well for our present day tubes, as our poor voltage regulation put a severe strain on our equipment. Much of it was running 24 hours a day. However, line voltage fluctuations blew the input condensers on nearly all of our low-voltage power supplies, and after using up all our replacements we operated all our low voltage filters with choke input.

We had to take various supplies such as wire, insulators, pole climbers, soap, solder, photographic chemicals, tools, glue, fans, bedding, shoestrings, lights, sand and emery paper and hundreds of other items such as those. We did not depend upon getting any supplies at the eclipse

site, with the exception of food. However, we provided a small quantity of canned food, just in case we didn't get along on the Russian food, but these food supplies turned out to be merely appreciated luxuries and not at all necessary, as we were well fed.

Our apparatus and equipment was packed in some 37 boxes, lined with tarpaper to help keep them dry. On the way over, one of our party was on the spot whenever the boxes were transferred from one boat or car to another, and each box was checked off as being present. Large numerals were painted on each box to facilitate this operation. This procedure was a fine insurance against loss of equipment and mental equilibrium, and is highly recommended. The only time we failed personally to check our

equipment (once on the return trip) it was put on the wrong boat.

COMMUNICATION DIFFICULTIES

We sailed from New York on April 8th and arrived at Ak-Bulak the second week in May. We passed through Leningrad on the first of May, and saw the huge parade which is held on that day. We then went by rail to Ak-Bulak via Moscow. The publications which were sent out in advance describing the eclipse sites had said that at Ak-Bulak we would find a local power plant delivering 220 volts a.c. at 50 cycles. We had expected to find large voltage variations and so took along numerous tapped transformers, as well as variable auto-transformers (Variacs). But you can imagine our consternation when we arrived in Ak-Bulak and found that there was nothing but d.c. in the town. The embarrassed authorities got busy and rounded up an a.c. generator from a nearby town and belted it to a big diesel engine which ran the local grain mill. The mill was shut down for the duration of our stay, and a transmission line was strung for our supply.

A month had elapsed before this arrangement was completed, and in the meantime we had run some of our receivers on batteries and made a very discouraging discovery. European signals were very plentiful on the 20-meter band, but except for about an hour in the morning (0100 G.T.) it was impossible to hear any W stations. Even then, they were quite weak, and often several days would go by without any being heard. This was with a directive antenna pointed toward the U.S. East Coast. Even the high-powered American short-wave broadcasting and commercial stations were seldom heard. This was probably on account of the signals having to pass near the north magnetic pole. We had expected that this

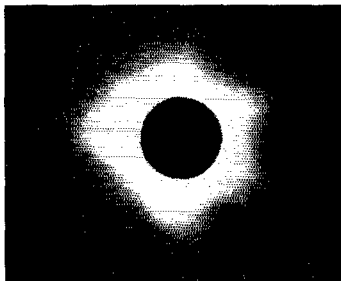

A SHOT OF THE ECLIPSE TAKEN BY THE AUTHOR

would give us trouble, but not nearly so much as we experienced.

As a result of this discovery, we did not try to maintain any schedule direct with the laboratory station, W1XJ, but turned to amateur radio. Fortunately we were prepared for this difficulty, having previously obtained permission from the Soviet government to communicate with stations in other countries for the purpose of relaying messages in the event we were unable to communicate directly with our laboratory station. The U.S.S.R. government was very generous to us in these matters, granting all our requests for frequencies, calls, etc., without question. The portable transmitter UAST operated from the astronomical camp on 7 Mc., while outside traffic was handled in the 14-Mc. and on the 45A via amateur radio relays. The 45A transmitter signed URAD on 'phone and UIBWF on c.w. Since we found that we could cover Europe with an R8-9 'phone signal, most of the traffic was handled by

voice. This facilitated making the relay arrangements, since we could more fluently explain our requests for message relays. In this connection we wish to thank the many amateurs whose calls we cannot mention, who risked official disfavor to help us get our traffic into the United States. These included amateurs in England, Germany, Ireland, Japan and Egypt. Fortunately we can publicly thank one of our outstanding relay stations, SM5SX in Stockholm, Sweden, whose operators lost many hours of sleep to help us out. In order to diminish the magnitude of the risks run in our behalf, we tried to limit the messages as much as possible to those immediately concerning our technical work.

There were many of these, on account of difficulties occasioned by our late start because of the power trouble.

During our stay in Ak-Bulak we were on the air from about May 20th to June 25th. During that time we worked 28 countries and all continents but South America. Doubtless we could have worked it also, if we had had time, but most of our contacts were made in an effort to get a satisfactory traffic schedule set up, and we did not have very much time for rag-chewing. We worked into the United States on six occasions with six different stations, including our laboratory station W1XJ. Five of the contacts were on c.w., the other on 'phone with W2MJ. We have since had

several reports of our 'phone signals being heard in this country. We were located in Asia by about 20 miles, and as a result helped several amateurs to get their WAC 'phone certificates. Usually we would hear more American 'phone stations than American c.w. stations on the 20-meter band.

LAYER-HEIGHT MEASUREMENTS

Our measurements went on 24 hours a day, through the eclipse, and for a week afterward. The day of the eclipse and the day following, (June 19th and 20th) there was a world-wide magnetic storm which caused nearly all signals to drop out at our location. The storm also affected the records taken during the eclipse, as it decreased the ionization in the layers. However, this effect was mostly noticeable on the higher frequencies, and the eclipse effect was beautifully shown on the low-frequency records and to a lesser extent as the frequency was increased. But the storm by no means destroyed the value

of the records, as was feared. A preliminary analysis of these records verifies previous assumptions that the ionization is almost entirely caused by ultra-violet light and that any effect of radiation traveling at speeds other than the velocity of light is small. That is to say, the radio effect reached its maximum at the same time as the optical eclipse. It might be added that this checks the data which were taken during the eclipse of 1932.² We were also fortunate in having good weather for the astronomical observations. The radio measurements, however, did not require that the sky be clear, and the weather was not one of the radio party's worries.

Except for the aforementioned difficulties with our power supply and filter condensers, the radio apparatus gave little trouble.

The transmitter room caught on fire the last morning of operation, but little damage was done. The fire was extinguished by the night operator who sensed trouble and pedaled his bicycle madly over the three-quarters of a mile to the transmitter room when the power failed. The receiving equipment for the measurement work, as well as all the communications equipment, was set up in a baggage car placed on a siding, along with the private railroad car which was our home for two months. The transmitters were located in a mud house at the power station at the grain mill.

After the party broke camp and packed, we



THE VARIABLE FREQUENCY TRANSMITTER SET UP AT AK-BULAK

took a trip up the Volga by steamer, and then declared a vacation and split up our group, each member returning home according to his inclination and the state of his pocket book. Some of us stopped and visited some of the friends we had made on the air from Ak-Bulak. And so another page in the long history of amateur radio was finished.

The combined expedition was headed by Dr. Donald H. Menzel of the Harvard Observatory, who is also W1JEX. The radio party was under the direction of Prof. H. R. Mimno of Cruft Laboratory, who was unfortunately unable to make the trip, but kept in touch with us via radio. The members of the radio party were Paul

(Continued on page 59)

The Governors-to-President Relay

January 19th (5 p.m. E.S.T.) to January 20th (5 p.m. E.S.T.)

THE President of the United States will be inaugurated on January 20, 1937. This will be the fifth opportunity in the history of amateur radio for amateurs to relay messages successfully from the governors of each state and territory to the chief executive of the nation, on the occasion of his inauguration. The Washington Radio Club's president, W3ER, tells us that plans have been concluded for the receipt of the messages and delivery to the president. The line-up of Washington club stations is the most extensive ever!

Every active U. S. amateur with a station on the air should be interested in helping in this relay. The messages will all start from designated amateur stations at 5 p.m. E.S.T. (4 p.m. C.S.T., 3 p.m. M.S.T., 2 p.m. P.S.T.) January 19th. The relay will continue until the same hour January 20th. At its conclusion all messages received in Washington will be delivered at the White House. Plans have been made to start the traffic at the same time from all forty-eight states and the territories right at the start of the relay.

Help us to show President Roosevelt that amateur radio communication is responsibly conducted, that our communication facilities are both prompt and accurate and that we operators know our stuff 100%. All hams are cordially invited to cooperate in the relaying of these dozens of messages that will be converging on Washington, D. C., on this occasion. Some of the governors' messages will be long ones. Polish up your station equipment and "make it a night" January 19th. Handle messages whenever you can, but be ready to QRX and assist in copying, as well as QSP, if QRM or other difficulties appear.

Here are some suggestions for effective working: (1) Make calls short, breaking them with listening periods. (2) Listen more than transmit. (3) "CQ east," or call ORS or trunkliners who are on the job if you are out in the wide-open spaces and have the all-important message to move. (4) Keep going; help Washington stations all you can in looking for messages until they are all "in the bag."

Washington stations will CQ GPR de W3— each time before they comb the bands for G.P.R. traffic. Here is a list of Washington radio club stations standing ready to receive your messages (sent us by radio from W3BWT-W3ER).

W3BWT 3548 kes.	W3ESP 14,060-14,376	W3GGX 7004-14,008	W3FQR 7030-7115
W3ER 7060-14,010	W3FYJ 3535-14,374	W3FQB 7060-14,332	W3GKU 3504-7008
W3CDQ 7040	W3EUI 3587-7174	W3AWS 3550-7005-14,290	W3EUG 3800
W3FGG Any 14-Mc. freq.	W3DXJ 7110	W3CYO 3852.5	W3CIZ 3850
W3FYD 7171-7290	W3CZE (any band) (14.245	N3EEN 3790	W3EZN 7290
W3GGA 14,223	fone/cw)	W3FPQ 3610-7065	

In addition, regular W1INF (Hq) schedules will be set aside the Tuesday night of the relay to enable scheduled stations, as well as Hq. to assist. W3BWT will be the key station, as in the successful '33 relay, with W3CDQ, W3EMO and W3CJT assisting.

Reporting: send A.R.R.L. complete copies of the message(s) you handle in connection with this relay promptly, please. Show time received, time forwarded, and both, or all stations with whom handled. A file of traffic showing the consecutive handling of the message of each state is essential, so we can show complete routes, and give you full credit for your work in QST.

—F. E. H.

¹ Each Section Manager in whose territory there is a state capitol is designating an amateur to approach and secure the message from his governor. It will be addressed to President Roosevelt for transmission in the relay. We are depending on each operator so designated by his SCM to do his level best to get a message and see it started on its way properly.

Boosting the Output of the Low-Power Transmitter

A T55 Final Stage for the Popular Four-Band Type 10 Rig

By Vernon Chambers,* W1JEQ

WHEN the 47-46-10 low-powered rig was described in August 1936 *QST*, the statement was made that with the addition of one or more tubes, a decided increase of power could be had. With this thought in mind an experimental final stage was rigged up to determine what type tube could be satisfactorily driven by the Type 10 and yet give a worthwhile increase of power over the existing layout. The T55 stepped up and presented itself with rated output increase of around 130 watts, bringing the final power to the neighborhood of 160 watts. A few very minor changes in the driver (the 47-46-10 combination) permit efficient operation on four bands, with the entire rig perking from 3.5 Mc. to 14.4 Mc. with the use of only one 3.5-Mc. crystal. The driver has proved popular enough to win a place in the 1937 edition of the A.R.R.L. *Handbook* and therefore we feel that the addition of the T55 stage will meet the requirements of those desiring an economical power increase.

The photograph shows that the final is a single-ended affair with not too many parts to necessitate going on a spending spree. With the exception of the grid and filament by-pass condensers, the plate lead r.f. choke and the grid leak, all of the gear is mounted and wired on top of the baseboard. The panel and baseboard measurements are 10½ by 19 inches and 10½ by 17 inches respectively. Tempered Masonite is used for panels and bases throughout the entire transmitter. The plate and grid tuning condenser frames are grounded, thus permitting their

mounting on the panel without fear of hand capacity effects. To eliminate the possibility of a dangerous shock, the plate meter jack is placed in the negative high-voltage lead. The two tuning condensers are each centered between the top and bottom of the panel and four inches in from the outer edges. The meter, which serves for both plate- and grid-current readings, is centered in the middle of the panel and slightly up from the bottom. The tube socket can then be put in the exact center of the baseboard, leaving enough room between the tube and tank circuit for the neutralizing condenser which is supported by a small stand-off insulator. The grid and plate coils are set up directly back of their respective condensers.

Coupling between the driver and the final grid circuit is easy with the aid of two jack-top feed-through insulators set into the baseboard in the rear of the grid-coil, with their jacks placed on the under side of the base. A link consisting of a length of twisted pair with a set of G.R. plugs fastened to one end may be plugged into the jacks very conveniently. Two jack-top stand-off insulators are mounted at the plate end of the tank coil of the amplifier. These insulators are wired in parallel with a pair of binding posts mounted at the rear edge of the baseboard. The link, which can be made of self-supporting wire of a diameter to fit inside the coil or else of a flexible wire wound around

the coil, is also equipped with a set of G.R. plugs which plug into the insulator jacks. A five-screw terminal strip, to the rear of the grid circuit, serves as a connecting point for fila-

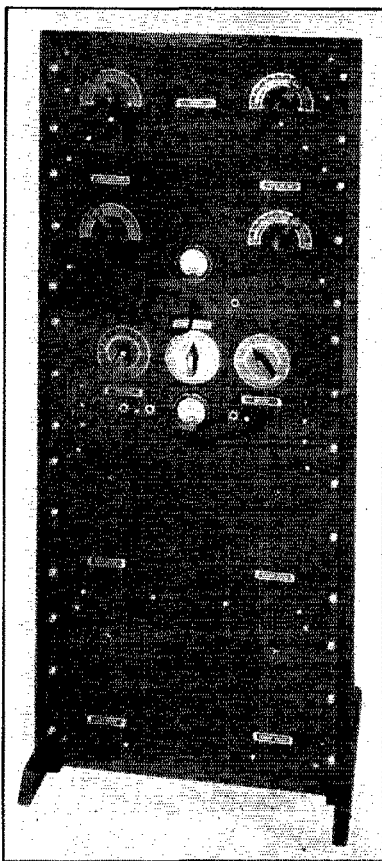

THE COMPLETE TRANSMITTER WITH ITS POWER-BOOSTING T55 STAGE THE SECOND UNIT FROM THE TOP

**QST* Laboratory Assistant.

ment, grid and ground external connections. Positive high-voltage is brought to a feed-through insulator located at the rear and center of the unit.

Two small right-angle brackets of the ten-cent store variety hold the panel and baseboard together while two lengths of half-inch brass strip reach from the panel's top edge to the corners of the baseboard. It is not a bad idea to purchase

done by making temporary connections to the jacks at the time of construction and then later fixing them permanently after the right polarity has been determined.

THE DRIVER

As mentioned previously, a few minor changes have been made in the driver to adapt it to the job of driving the final. These changes consist of

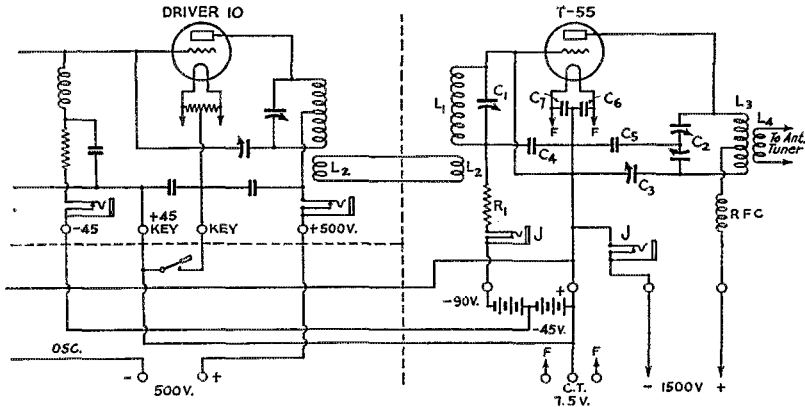

FIG. 1—CIRCUIT OF THE T55 AMPLIFIER

L_1 to L_4 —See coil table.

C_1 —105- μ fd. receiving type variable grid condenser (Cardwell MR 105 BS).

C_2 —210- μ fd. split-stator tank condenser (Cardwell XT 210 PD).

C_3 —5- μ fd. neutralizing condenser (Cardwell NA 5 NS).

C_4 —0.01- μ fd. mica receiving condenser.

C_5 —0.001- μ fd. 2500-volt mica transmitting condenser.

C_6 , C_7 —0.002- μ fd. mica receiving condensers.

R_1 —3500-ohm 10-watt resistor.

RFC—2.5-mh. r.f. choke (National Type 100).

enough of the angles and brass strip to supply the needs of all of the units, since they are all supported in the same fashion with the exception of the driver which, because of its compactness and sturdiness made this method unnecessary. In the driver's case, two angles of about twice the size of the others, mounted at the very front edges of the baseboard, add all the support needed. Of course the driver baseboard dimensions are the same as those given in the previous article; but for one who plans to build the entire rig from scratch it would be a better idea to make this base the same size as all the others.

Underneath the base and held by one of the machine screws holding the tube socket in place, a five-lug terminal strip is mounted. The filament connections are made to the two end lugs while all leads at ground potential are brought to the center lug. The two extra lugs on the strip can be clipped off, thus leaving a little insulation between the filament leads and those going to the center tap. The small Carter jacks, used to enable the use of one meter for both plate and grid purposes, have three connection points on them. One of these points has a positive indication on it. This is connected to the center terminal. When wired into the circuit, the connections are made to the points on either side with care to prevent the meter from reading backwards. This is best

a new panel measuring 8 by 19 inches and a change in the Type 10 circuit. The circuit as it now stands is shown in Fig. 1 and is also described in Chapter 9 of the new edition of the A.R.R.L. Handbook. To allow better efficiency for operation at 14 Mc. (since the Type 10 is now used as a doubler at that frequency) we have added 25,000 ohms to the grid-leak and also have added eight turns to the 14-Mc. doubler coil. With these extra turns on the coil the grid lead from the 10 to the 46 is moved from its original position to the very end of the new winding. This has been done to load up the 46 in order to get a little more excitation. A 250- μ fd. condenser is put in parallel with the grid coupling condenser for the same purpose. As quite a few of the fellows have already built this rig, we did not want to cause them to rebuild their coils in order to adapt this unit to the T55, so the links from the exciter coils to the final are therefore made by merely winding a few turns of insulated No. 18 wire around the coils of the Type 10 tank circuit and equipping their ends with a set of G.R. plugs.

The plugs then fit into a pair of jack-top stand-offs which are wired in parallel with two binding posts in the same fashion as those of the final. This insulator and binding post set-up is arranged in a half-circle around the driver coil socket. A twisted pair is then run from the binding

posts to the link jacks of the final stage. The number of turns needed for these links is shown in the coil chart. Another change concerns the meter jacks. Originally the four jacks ran in this order: Nos. 1, 3 and 4 for the reading of the plate currents of the respective stages, with No. 2 acting as a plate voltage switch for the doubler. These have been rearranged so that Nos. 1 and 2 are in the oscillator and doubler plate circuits, No. 3 is in the 10 grid circuit, and No. 4 is in its plate lead.

COILS

Almost all that need be said about the various coils and links has already been told with the exception of those of the final. For this circuit a set of Barker and Williamson coils of the BX series is used. These coils are constructed for work with neutralized amplifiers operating at powers up to 200 watts and are rigid affairs complete with center-taps. Their dimensions are given in the coil table. Since the driver and grid links are wound on the coil forms, this leaves only those of the final tank circuit to think about. A single turn of No. 12 wire, with G.R. plugs at its ends, does the trick nicely. If the link is wound of a diameter slightly smaller than that of the coil with which it is to be used, it will be found that a change of coupling can be made by decreasing or expanding its diameter. The link, of course, fits inside the final coil and is made with leads just long enough to allow the turn itself to be placed at the center of the coil.

POWER SUPPLY

Fig. 2 shows the amplifier power supply and also the primary connections to that of the driver, the idea being to show the proper way in which to connect all of the primaries together, thus enabling a row of toggle switches on the operating table to control the various units from the operat-

REAR VIEW OF THE COMPLETED ASSEMBLY

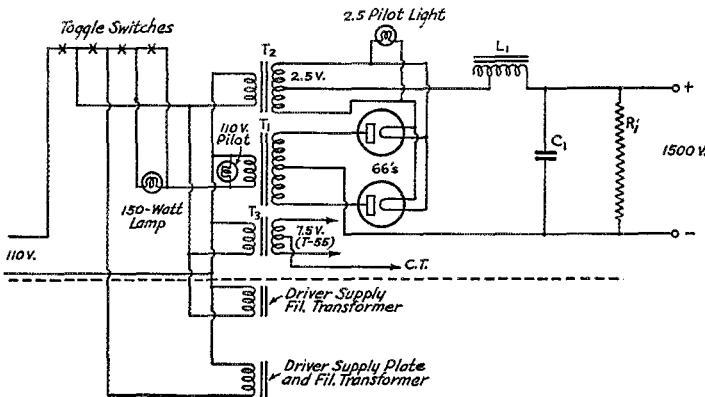
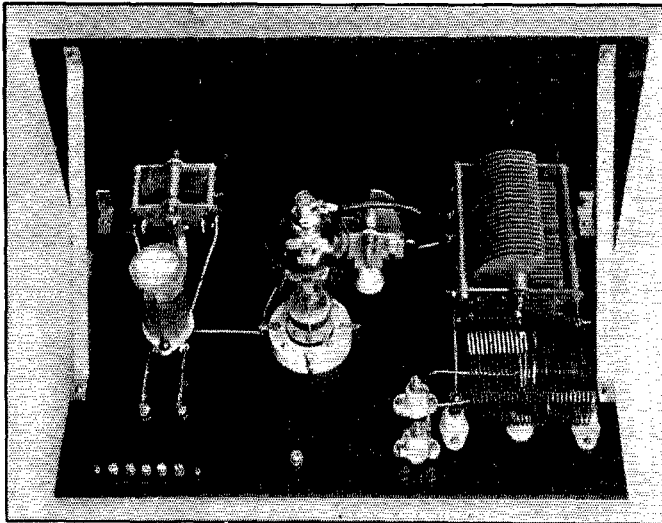

FIG. 2—THE POWER SUPPLY CIRCUIT

- L_1 —10-henry 200-ma. smoothing choke (U.T.C. Type PA-102).
- C_1 —2-ufd. 1500-volt filter condenser (Aerovox 1505).
- R_1 —100,000-ohm 50-watt bleeder resistor (Ohmite).
- T_1 —1500-volt c.t. 250-ma. plate transformer (U.T.C. Type PA-116).
- T_2 —2½-volt c.t. 10-amp. filament transformer for two 66's (U.T.C. Type PA-34).
- T_3 —7½-volt c.t. 6.5-amp. filament transformer (U.T.C. Type PA-122).

ing position. The front view of the transmitter shows the two supplies at the bottom of the rack, with the final supply at the bottom and the driver's next up. Both panels are 10½ by 19 inches, the high voltage supply base being 10½ by 17 inches, while that of the driver is 7 by 17 inches. The same can be said for this base as that of driver unit; that is, if one is building the whole outfit from scratch the best idea is to make the

various units of the same size and at least large enough to allow freedom for arranging and wiring. The lamp-base shown is for the insertion of a 150-watt bulb for the purpose of reducing power during adjustment and tuning of the final. Four pilot lights are wired into the two supplies, one for each plate and filament circuit of each unit. With the exception of the large plate supply, all of the pilot lights are wired to 2.5-volt filament



THE FINAL STAGE VIEWED FROM THE REAR
The grid input circuit is at the left, the plate tank at the right.

circuits. The low-voltage plate transformer has an extra 2½-volt winding which serves for the pilot light of that circuit. For the high-voltage supply, a 110-volt light is used, which is inserted in the primary leads. Both units are supported in the same fashion as the other stages. To reinforce the mounting of the T55 supply, the brass strips are fastened to the corners of the two transformers located at the rear of the base. This helps to keep some of the weight off the Masonite base-board. It will be noticed that the filter choke of this unit has three taps on it. These taps, numbered 1, 2 and 3, are not all used. The d.c. input goes to tap No. 2 and the output is taken from tap No. 3. This arrangement gives all the filtering needed, but should an extra condenser be desired it

Grid Coil Specifications (L1)					Links
Freq.	No. Turns	Wire	Length Winding	Diameter	(L2)
1.7 Mc.	59 c.w.	No. 24 d.c.c.	11/16"	1¼"	9 turns c.w.
3.5 "	34 "	"	15/16"	"	7 " "
7 "	20 s.d.w.	"	¾"	"	2 " "
14 "	6 "	"	¾"	"	2 " "
Plate Coil Specifications (L3)					(L4)
1.7 Mc.	32 "	No. 14 enameled	3¾"	4"	2 t. 3" diam.
3.5 "	28 "	"	"	3"	1 t. 2½" diam.
7 "	18 "	"	3	2½"	1 t. 2" diam.
14 "	10 "	"	2¼"	2"	1 t. 1½" diam.

"C.w." indicates turns close-wound; "s.d.w." indicates turns spaced diameter of wire. The grid coils are wound on Hammarlund SWF 4 coil forms. The grid links are spaced from the main winding by 3/16-inch. To add a larger amount of capacity to the tank circuit on 14 Mc., the B&W BX 20 coil is cut down to 10 turns. No. 12 enameled wire is used for link coils L4.

may be connected from tap No. 1 to ground. The two T55 filament leads and the transformer primary leads are brought to a five-screw terminal strip mounted on top of the base with the aid of small angle brackets. If a three-screw strip is mounted at the left end of the driver supply, and the primary connections made to that, the two supplies can then be wired together directly at the rack, providing more convenient wiring of the toggle switches and the a.c. lines.

THE ANTENNA TUNER

Prescribing the "best" antenna tuner for one to use is like a doctor trying to cure a patient by correspondence. Therefore we shall not go into a great amount of detail about this particular one, except to say that it is the tuner described on page 196 of the A.R.R.L. *Handbook*. It is interchangeable, making possible its use either as a series or parallel combination. The picture of the back of the transmitter shows most clearly its layout, and the circuit is shown in Fig. 3. The tuner may be used with either a single-wire or a two-wire feed antenna system, this being made possible by the switch shown in the diagram. Unless a fairly heavy switch is used it is a better idea to substitute a pair of small copper clips, as is done here. Since operation from 3.5 Mc. to 14 Mc. only was planned, the coil used is not quite as large as that which would be needed to include 1.7 Mc. For that reason the coil specified is the same as that in the *Handbook*. Of course, every ham has his own ideas about his pet antenna system, so for that reason the reader is referred to the variety of systems described in the A.R.R.L.

is first tuned to resonance. The thing to aim for is the transfer of full excitation to the final grid circuit. The grid current of the final amplifier should be about 40 ma. This may require slight

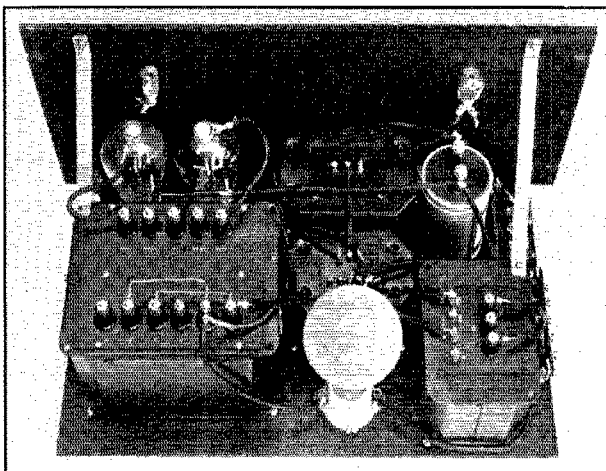

THE 1500-VOLT POWER SUPPLY FOR THE FINAL STAGE
The 150-watt lamp is used to drop the primary voltage of the plate transformer for tuning-up and adjustment.

readjustment of the links on driver plate and final grid coils. Care must be taken to prevent overloading the driver by overcoupling. A good thing to keep in mind is that a link of a few turns tightly coupled is more effective than one of many turns loosely coupled. When the proper adjustment has been found we next tackle the neutralizing of the final. Without plate voltage on the T55 and with its load disconnected, a neon bulb is held to the plate end of the tank coil. The circuit is then tuned to resonance (indicated by maximum r.f. glow in the bulb). The neutralizing condenser is then rotated until the r.f. is reduced as much as possible with the plate tank condenser readjusted to resonance. This procedure is continued until the very minimum indication of r.f. in the plate tank is had. These adjustments may throw the grid circuit off slightly and therefore this circuit must be rechecked from time to time. When coupling the antenna tuner, the safest method is to do so using low power; that is, with the 150-watt lamp in series with the plate transformer primary. When the tuner has been adjusted for best loading of the final at reduced plate voltage, the full high voltage may be applied. It will be found that when the tuner is adjusted for amplifier plate current of 50 ma. (indicated on the plate milliammeter) using the low power, the application of the full high voltage will bring the total plate current of the T55 up to around 150 ma., the rating for the tube. The correct coupling for proper loading may be ad-

(Continued on page 39)

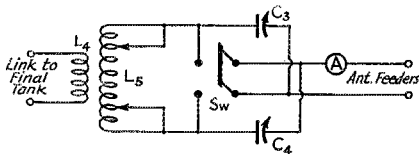

FIG. 3—CIRCUIT OF THE ANTENNA TUNER

L₅—2 turns No. 12 wire, diameter 2½ inches.
L₆—24 turns No. 12 wire, turns spaced to occupy a winding length of 3½ inches. Coil diameter 2 inches.
C₃, C₄—300-μfd. variable transmitting condensers.
With Sw connected, tuning condensers are in parallel.
With Sw disconnected, condensers are in series.

Handbook. Any of the various systems will serve when applied in the correct manner.

FINAL TUNING

With the various coils, complete with their links, plugged in their proper places, the driver

The 807 as a Crystal Oscillator

By John Stiles,* W8PNL

THE advent of the 807 chased this particular radio bug into a huddle with himself and friends. The general idea of beam power is very interesting—as expressed in the 6L6, at any rate. This, coupled with a special beam-power high-frequency tube like the 807, was just too much for Scotch instinct to neglect. Accordingly, herewith are pictured the desires, the methods, and the results.

First, primary desire was a high degree of reliability and efficiency. Second was the necessity for starting small and yet being able to add on later with a maximum of economy and a minimum of change. To these requirements, the 807 is an almost perfect answer. The desire for reliable local work, that is, three- or four-hundred miles consistently, led to a choice of a straight pentode circuit such as has been previously outlined in *QST* for the 6L6. Also, it led to a choice of the 80-meter band.

The circuit of Fig. 1 shows the particular values chosen after a long series of eliminations. No attempt has been made to design the best possible job for all 807's. For this particular tube, however, and the particular antenna (a full wave

tion to satisfactory operation. Nor were they found to be different from the values used with the 6L6. The two critical items are C_2 , between the grid and plate, and the connection between

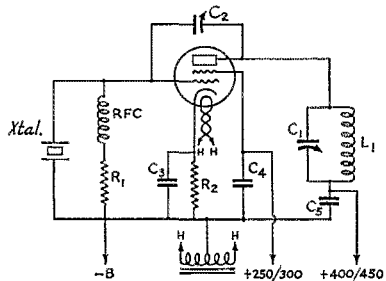
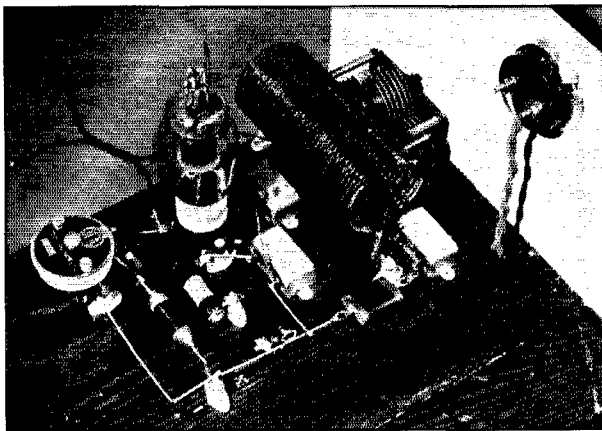

FIG. 1—CIRCUIT OF THE 807 OSCILLATOR

- C_1 —100- μ fd. variable.
- C_2 —6 to 8 inches of all-rubber lamp cord, pulled apart to give optimum capacity.
- C_3, C_4, C_5 —0.01 μ fd., 500-volt.
- R_1 —13,000 ohms, 2 watt.
- R_2 —400 ohms, 10 watt.
- RFC—Short-wave choke.
- L_1 —30 turns No. 12 enamelled, turns spaced diameter of wire coil diameter $2\frac{1}{4}$ inches. Wound on celluloid strips cemented with Duco cement.



THIS TETRODE OSCILLATOR USING THE 807 MAKES AN EFFECTIVE LOW-POWER 3.5-MC. TRANSMITTER

It can, of course, also be used to drive a following amplifier or doubler. The antenna coupling coils were removed to show more clearly the arrangement of parts. Note the lampcord coupling condenser, C_2 , in Fig. 1.

Zepp) every value of E, I, L, C and R has been checked and double-checked and found to give the most stable power in the antenna. With the exceptions of two items, the constants were not found to be particularly important in their rela-

* ex8DDV, 8UF, Clarkson College, Potsdam, N. Y.

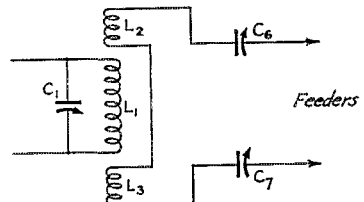

FIG. 2—ANTENNA COUPLING FOR ZEPPE FEEDERS

- L_2, L_3 —Each 10 turns same as L_1 . Coupling about $\frac{1}{2}$ inch at each end.
- C_6, C_7 —350- μ fd. receiving-type variables.

heater center-tap and the low-bias side of the cathode (ground). Operation was successful without C_2 , though it has an important bearing on power input and efficiency. But do not operate your tube without a permanent connection between heater center tap and cathode. This connection wants to be on the oscillator side of the key if center tap keying is used. If this

connection is not made, the tube will spark across the stem when the key is open.

The photograph of the oscillator was taken with antenna coils removed to illustrate better the compact and solid layout obtained. C_2 in the present job is about six inches of the all-rubber

lamp cord sold at dime stores. This cord easily pulls apart to vary the capacity. It is probably not as efficient as it should be, but it does the job very nicely. A lot of worthwhile "rigging around"

large enough to carry the entire load current. Naturally, the value of the rheostat and condenser will vary with individual conditions. Later, cathode keying was tried as shown in Fig. 4 and was also found to be very satisfactory. The b.c. receiver in the next room doesn't hear a single click. In both cases, the relay worked much better when placed at the actual point of breaking the circuit. When a long lead was used to the relay, the r.f. circuit became balky and unsatisfactory. Cathode keying is probably best for quick and successful operation. How-

(Continued on page 48)

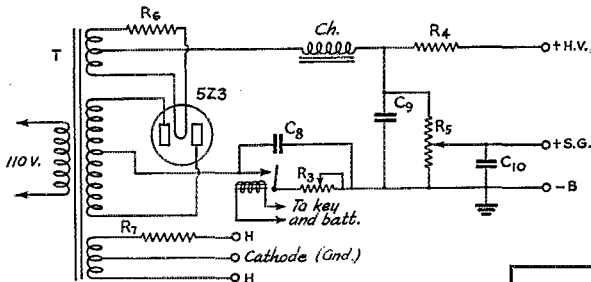

FIG. 3—DIAGRAM OF POWER SUPPLY, SHOWING ONE METHOD OF KEYING

- T—550-volt b.c.-type transformer having 1100-volt center-tapped high-voltage secondary and two 7.5-volt filament windings
- C₈—0.005 μfd.
- C₉, C₁₀—3 μfd. 500-volt
- Ch—30-henry (commercial rating) 100-ma. filter choke
- R₃—50-ohm, 200-ma. rheostat
- R₄—3500 ohms, 10 watt
- R₅—15,000-ohm 50-watt voltage divider
- R₆, R₇—2-ohm adjustable resistors set to drop voltage to correct value for 5Z3 and 807

can be done by setting C₂ at some value and then tuning the antenna and plate circuits for maximum stable power output. Care must be used not to feed too much power into the crystal circuit, however, or else!

For those interested, Fig. 2 shows the antenna coupling and tuning circuit. No points of special interest were noted. Small diameter coils of this

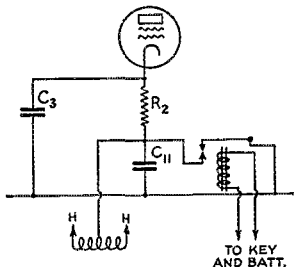

FIG. 4—CATHODE KEYING CIRCUIT

Values correspond to those previously given except for C₁₁, which is 0.01 μfd. R₂ may be placed in series with relay contacts to improve key-click elimination.

type have to be placed quite close together for good coupling, present value being about 1/2 inch on either end.

Fig. 3 shows the power supply with an early keying arrangement. At this time, the keying relay, a rewound auto generator cut-out, was connected immediately beyond the high voltage center tap. With this connection, and the simple (and temporary) key click filter shown, very good reports were obtained. The rheostat used must be

Henry B. Joy WSIA-W8IO-WIAHM

HENRY B. JOY, 71, WSIA-W8IO-WIAHM, one of the founders and past-president of the Packard Motor Corp., died of heart disease on November 6th at his home on Grosse Pointe Farms, Michigan.

Characterized by the *Detroit News* as "capitalist, industrialist and outstanding citizen," by the *Free Press* as "business executive, banker, automobile pioneer, soldier, patriot," Mr. Joy was one of the foremost figures in the automotive world from that day just at the turn of the century when he founded the Ohio Automobile Co. (incorporated in 1902 in Detroit as Packard) until his death, when Henry Ford and other leading men in the industry served as honorary pallbearers.

Well known also was he for his amateur radio activities, in which he was almost equally a pioneer. His stations at his home, on his farm near Selfridge Field, and, at one time, on his yacht, were consistently on the air, with either Mr. Joy himself or Arthur Grolz, W8DK, at the key or microphone. One of his conversational habits was the narration of anecdotes derived from his ham operating experiences. His mechanical bent caused him to do much of the constructional work at his stations with his own hands.

Henry B. Joy was perhaps amateur radio's most prominent recruit from the world of industry and finance, and one of its best friends. We can be proud and grateful that the record of his life is embellished with his work in our cause. Jointly with W8DK we say, "His key is silent, but the spark of his memory will live on forever."

What the League Is Doing

League Activities, Washington Notes, Board Actions—For Your Information

Examination Schedule

The F.C.C. announces its schedule of amateur examinations for 1937. Consult the following list when you need to know when and where examinations will be held. Where exact dates or places are not shown, information may be obtained, as the date approaches, from the Inspector-in-Charge of the district. It should be noted that *no examinations are given on national holidays or state holidays.*

DISTRICT NO. 1

Boston, Mass., 7th Floor, Customhouse, every week day except Thursday.

DISTRICT NO. 2

New York City, 1024 Federal Bldg., 641 Washington St.; Tuesdays, Thursdays and Saturdays.
Schenectady, N. Y., some time in March, June, September and December.

DISTRICT NO. 3

Philadelphia, 1200 Customhouse, 2nd and Chestnut Sts.; every Wednesday.

DISTRICT NO. 4

Baltimore, Fort McHenry; Wednesdays and Saturdays.

DISTRICT NO. 5

Norfolk, Va., 402 New Postoffice Bldg.; every Friday.
Winston-Salem, N. C., February 6th, May 8th, August 7th, November 6th.

DISTRICT NO. 6

Atlanta, 411 Federal Annex; Tuesdays and Fridays.
Nashville, Tenn., February 19th, May 21st, August 20th, November 19th.

DISTRICT NO. 7

Miami, 12 New Federal Bldg.; each Monday and Friday by appointment.
Jacksonville, June 4th and November 5th.

DISTRICT NO. 8

New Orleans, 326 Customhouse; every Monday; other days by appointment.
Little Rock, Ark., April 13th and September 14th.

DISTRICT NO. 9

Galveston, Texas, 209 Prudential Bldg.; by appointment only.

DISTRICT NO. 10

Dallas, 464 Federal Bldg.; every Tuesday.
Oklahoma City, February 19th and 20th, May 21st and 22nd, August 20th and 21st, November 19th and 20th.
San Antonio, March 12th and 13th, June 11th and 12th, September 10th and 11th, December 10th and 11th.
Albuquerque, N. M., May 1st, November 1st.

DISTRICT NO. 11

Los Angeles, 1105 Rives-Strong Bldg.; Mondays and Saturdays.
Phoenix, Ariz., some time in April and in October.

DISTRICT NO. 12

San Francisco, 328 Customhouse; Class A, daily; Class B, Mondays.

DISTRICT NO. 13

Portland, Ore., 207 New U. S. Courthouse; every Friday.
Boise, Idaho, some time in April and in October.

DISTRICT NO. 14

Seattle, 808 Federal Office Bldg.; every Friday.
Butte, Mont., some time in May and in November.
Spokane, Wash., some time in May and in November.

DISTRICT NO. 15

Denver, 538 Customhouse; first and third Saturdays of each month.
Salt Lake City, some time in March and in September.
Billings, Mont., some time in April and in October.

DISTRICT NO. 16

St. Paul, Minn., 927 Main P. O. Bldg.; first Saturday of each month.
Bismarck, N. D., some time in April and in October.

DISTRICT NO. 17

Kansas City, Mo., 410 Federal Bldg., first and third Saturdays of each month.
Des Moines, January 8th and 9th, April 9th and 10th, July 9th and 10th, October 8th and 9th.
St. Louis, February 12th and 13th, May 14th and 15th, August 13th and 14th, November 12th and 13th.

DISTRICT NO. 18

Chicago, 2022 Engineering Bldg.; every Saturday.

DISTRICT NO. 19

Detroit, 1025 New Federal Bldg.; every Saturday.
Cleveland, some time in January, April, July and October.
Cincinnati, some time in February, May, August and November.
Columbus, Ohio, some time in March, June, September and December.

DISTRICT NO. 20

Buffalo, 514 Federal Bldg.; first Friday of each month, and other days by appointment.
Pittsburgh, some time in March, June, September and December.

DISTRICT NO. 21

Honolulu, Aloha Tower; Mondays and Saturdays.
Some time in the month of July, amateur examinations will be held at Hilo; Wailuku, Maui; Lanai City, Lanai; Kaunakakai, Molokai; and Lihue, Kauai; also additionally at Hilo in December.

HEADQUARTERS

Washington, D. C., F.C.C. offices; every Thursday.

— — — —

Financial Statement The routine operations of the League showed a gain, for the third quarter of the year, of \$1590.92 before expenditures against appropriations. This is perhaps a little better than normal for that season of the year, the low period in income. The first and last quarters of the year are the big ones from the standpoint of business affairs in A.R.R.L. For the information of mem-

bers, and at the instructions of the Board of Directors, the operating statement for the third quarter is here printed:

STATEMENT OF REVENUE AND EXPENSES, EXCLUSIVE OF EXPENDITURES CHARGED TO APPROPRIATIONS, FOR THE THREE MONTHS ENDED SEPTEMBER 30, 1936

REVENUES	
Membership dues	\$12,525.02
Advertising sales, <i>QST</i>	20,521.54
Newdealer sales, <i>QST</i>	11,225.32
Handbook sales	6,357.48
Booklet sales	1,922.88
Calculator sales	553.97
Membership supplies sales	2,112.54
Interest earned	769.71
Cash discounts received	196.32
Bad debts recovered	6.00
	\$56,190.78
<i>Deduct:</i>	
Returns and allowances	\$ 3,444.70
Increase in provision for news-dealer returns of <i>QST</i>	161.30
Collection and exchange	9.90
Cash discounts allowed	321.38
	3,937.28
Net Revenues	\$52,253.50
EXPENSES	
Publication expenses, <i>QST</i>	\$14,023.04
Publication expenses, Handbook	3,967.40
Publication expenses, booklets	583.66
Publication expenses, calculators	319.54
Salaries	21,980.07
Membership supplies expenses	1,114.42
Postage	1,791.47
Office supplies and printing	1,280.88
Traveling expenses	1,538.49
<i>QST</i> forwarding expenses	739.40
Telephone and telegraph	542.18
General expenses	731.14
Insurance	137.04
Rent, light and heat	805.40
Provision for depreciation of furniture and equipment	259.30
General Counsel expenses	435.53
Communications Dept. field expenses	93.93
Headquarters Station expenses	19.91
Bad debts written off	299.78
	50,622.58
Total Expenses	50,622.58
Net Gain before Expenditures against Appropriations	\$ 1,590.92

Cairo Notes

Readers of *QST* are aware that when the Allocations Committee of the group preparing the United States proposals for the Cairo Conference rejected the A.R.R.L.'s request for an increase in amateur frequencies, the League filed a minority report with the main committee, which similarly rejected it by a vote unanimous except for our voice. The League then took an appeal to the Federal Communications Commission, which had the duty of reviewing the work of the committees and transmitting the recommendations to the Department of State. The F.C.C. also rejected our appeal and transmitted the report of the committees without recommendation for an increase in amateur frequencies. We have now to

report that the League has taken a final appeal to the Department of State itself, asking for a review and further consideration of our case. This is now pending, the results not yet known.

Meanwhile we have word from Canada that the Dominion government has rebuffed a similar request for an increase in the amateur bands filed by Canadian General Manager Reid and recently reported in this department. While the Canadian government will not support an increase in amateur frequencies, it undertakes to support rigidly the present bands and will also oppose any change in our u.h.f. bands above 28 Mc.

Washington Notes

All of U. S. amateur radio is now operating under three-year card licenses. The total of valid station licenses on September 30th last was 47,063, a slight gain over the figure of 46,850 at the close of the fiscal year, June 30th. The number of valid operator licenses closely approaches the figure for stations, on September 30th being approximately 46,300.

Everyone is awaiting the pronouncement of the F.C.C. concerning the allocation of frequencies above 30 Mc., and it is expected that there will be some news soon. Our stake in the matter relates particularly to our desire for a 112-Mc. band exclusively for amateurs, and our interest in the protection of our 56-60-Mc. band. The Commission also has under consideration a revision of the relations governing portable operation by amateur stations, and some clarification of these rules is to be expected in the near future.

Silent Keys

It is with deep regret that we record the passing of these amateurs:

- William E. Brentlinger, W9NTP, Terre Haute, Ind.
- Harold E. Cherry, W8GDE, Galion, Ohio.
- Guy M. Ferguson, W2BJA, Albany, N. Y.
- George L. Hax, Jr., W9OLG, Kansas City, Mo.
- Ralph Ingalls, W7CAT, Payette, Idaho.
- Louis R. Isaacs, W6CAD, Alameda, Calif.
- Dr. E. C. Jenkins, W5EYQ, Rotan, Texas.
- Horace Howard Johnson, W7EUR, Rogue River, Ore.
- N. R. Jewell, W8ITO, St. Joseph, Mich.
- Henry B. Joy, W8IA-W8IO, Grosse Pointe Farms, Mich.
- Cecil H. Twohig, W2DTA, Woodside, N. Y.

in adapting it in many instances to existing rack-and-panel transmitters with a minimum of trouble. The tubes used in this circuit, in addition to the 913, are a Type 6X5 rectifier tube, an 885 gas triode for the saw-tooth oscillator and a Type 58 pentode tube for the current-limiting device

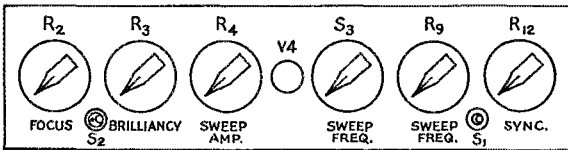

FIG. 2—CONTROL PANEL ARRANGEMENT OF THE OSCILLOSCOPE UNIT

which maintains a constant charging current to the condenser. The inclusion of this tube provides exceptional sweep uniformity for output voltages up to approximately 80 per cent of the supply.

The power supply includes a power transformer and a separate filament transformer. The filament transformer is optional. The 58 tube may be replaced by a 78 or 6K7

tube, and the filament operated from a six-volt storage battery or any isolated source of six volts, a.c. or d.c. The filament transformer is mounted inside the chassis below the power transformer. Only a single rectifier tube is used to supply both the 913 and sweep-circuit d.c. voltages, using the two halves of a full-wave 6X5 rectifier tube as separate half-wave rectifiers. This is a novel method of obtaining two separate rectifiers with a single tube. Filtering is accomplished by condensers alone, as shown in the diagram, since both the 913 and the sweep circuit have low-drain requirements and ripple is not important. The 913 bleeder and voltage-divider circuit is also entirely conventional. The tap changing switch, S_1 , on the transformer allows changing the d.c. output to the 913 from 425 to 300 volts, allowing for more sensitive operation of the tube on the lower voltage, which is usually sufficient for good brilliancy of the image of the tube screen.

The sweep circuit is also entirely conventional except for slight changes which permit operation at a d.c. voltage of about 200 volts.

MECHANICAL LAYOUT

In what follows, when we speak of left- and

right-hand side of the chassis, it will be with the consideration that we view the apparatus from the panel side—that side which has the tube screen and controls on it—and that the bottom of the rack panel is that side with the switches, S_1 and S_2 , on it. The apparatus is designed so that the power supply and sweep circuit arrangements are at opposite ends, to avoid stray pickup as much as possible, and thus minimize the necessity for shielding. The power supply circuit, with its two transformers and tube, is at the left. The sweep circuit, with its two tubes and synchronizing transformer, is at the right. The Type 6X5, 58 and 885

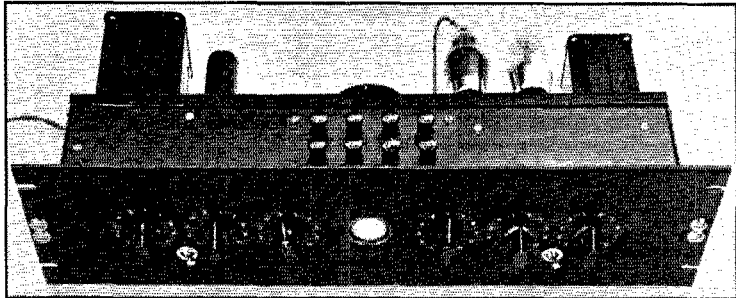

THIS COMPLETE OSCILLOSCOPE UNIT CAN BE BUILT FOR ABOUT TWENTY DOLLARS

The various components visible are identified in the text.

tubes are mounted in the conventional sub-panel manner, but the 913 cathode ray tube is mounted so that its screen comes flush with the panel front. This necessitates a large hole in the rear of the assembly to allow the tube socket to project behind. This permits mounting the socket on a disk of bakelite so that the tube may be rotated for

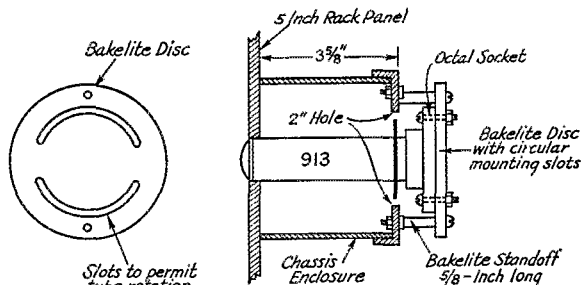

FIG. 3—MOUNTING FOR THE 913 CATHODE-RAY TUBE BEHIND THE PANEL

obtaining alignment, horizontal and vertical. The layout of controls on the rack panel is as follows:

First, the accelerating voltage control R_2 , then the biasing voltage control R_3 . Between R_2 and R_3 , and below them, is the a.c. line switch, S_2 . Next in the lineup is the sweep amplitude control,

R_4 , followed by the screen of the c.r. tube. On the right of the tube the first control is the sweep-frequency control switch, S_3 . Next is the sweep-frequency resistance control, R_9 . Between R_9 and R_{12} is the transformer tap-switch S_1 . R_{12} , the last control on the panel, is the synchronizing potentiometer.

The terminals for the deflecting plates, sweep output and synchronizing are brought out at the top of the chassis above the 913 tube. This arrangement of controls further minimizes the need for shielding; the experimental model shown was not shielded at all, and showed very little pick-up effect.

METHOD OF OPERATION

To place the unit in operation, connect to the 115-volt 60-cycle line, and snap switch S_2 to the "on" position. Short both sets of deflecting plate terminals. By adjustment of R_2 and R_3 , a small well-focused spot of sufficient brilliancy is easily obtained. Do not use too brilliant a spot and do not allow a brilliant spot to remain stationary on the screen, since this may cause permanent injury to the fluorescent material. When these operations have been completed, shut off the apparatus and connect the sweep circuit to one set of plates. The other set of plates should be shorted to avoid pickup. A line should now appear on the screen, but if it does not adjustment of S_3 and R_9 may be necessary to start the sweep circuit oscillating.

When the line appears, disconnect the sweep from these plates and connect it to the other set of plates. Short the unused set of plates. This will swing the line through 90° ; observe on which set of plates the best deflection is obtained, and use

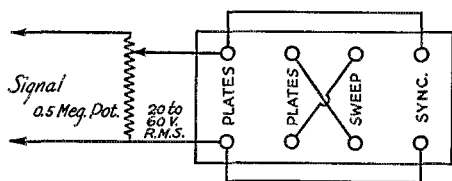

FIG. 4—CONNECTIONS FOR OBSERVING AN AUDIO-FREQUENCY SIGNAL VOLTAGE

this set of plates for the sweep circuit connection so as to obtain maximum sweep amplitude. A signal voltage for observation may now be connected to the other set of plates, after the short has been removed. It is well to note here that both sets of plates have a common connection and therefore it is a good idea to test for grounds before applying a signal. The terminal layout is shown in Fig. 1.

If the line of sweep on the fluorescent screen is not horizontal, rotating the tube socket of the 913 at the rear of the assembly (Fig. 3) will make it so.

SIMPLE CIRCUITS FOR USING THE OSCILLOSCOPE

To observe an audio signal, connect the signal input to "plates," as shown in Fig. 4, through a

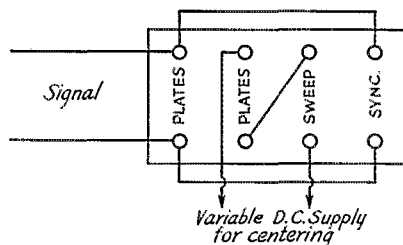

FIG. 5—BIAS ARRANGEMENT FOR CENTERING PATTERN

high-resistance potentiometer if it is necessary to reduce amplitude. Connect the "sweep" terminals to the other set of "plates." Adjust R_2 and R_3 for best focus. Adjust S_5 and R_9 until a stationary pattern is obtained on the screen. On S_3 the sweep-frequency range is from 5 cycles on Point 1 to 10,000 cycles on Point 5. Point 6 is used only for very high frequencies. Control R_9 gives fine adjustment of these steps. When a more or less

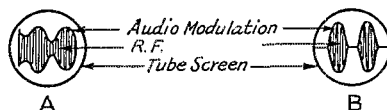

FIG. 6—TYPICAL MODULATION PATTERNS WITH SYNCHRONIZED LINEAR SWEEP

stationary pattern has been obtained, adjust R_{12} until the pattern is locked (does not drift) by the synchronizing action. Should it be found that for some reason the pattern is off to one side of the vertical axis, the arrangement of Fig. 5 may be used to center it.

This circuit is also useful for determining percentage modulation by the modulated envelope method. The r.f. modulated signal is applied to plates as above, and the audio frequency signal is fixed by the sweep frequency. Thus a modulated pattern will appear as shown in Fig. 6. It is best to have a single-tone modulating signal. Example A illustrates about 30 per cent modulation, while example B illustrates about 150 per cent modulation (over-modulation).

The terminal connections for obtaining the familiar trapezoidal modulation pattern is as shown in Fig. 7. The pattern developed is as shown in Fig. 8. Pattern A shows under-modulation, while B shows over-modulation. In both cases the r.f. modulation envelope and the a.f. modulating voltage are in phase, which is a condition not always found in practice. A condition where they are out of phase and under-modulated is shown in C. The elliptical shape of top and bottom indicates the out-of-phase relation.

(Continued on page 108)

How Would You Do It?

Announcing a Monthly Practical Problem and Gadget Contest—With Prizes An' Everything

THE ham is an ingenious cuss by very nature. One can't visit any amateur station without finding evidence of clever improvisations either in the construction of individual components or in the manner in which the whole station is put together. Rarely do two amateurs solve the same problems in the same fashion. The solution is always a contribution of some worth to the amateur game at large.

The difficulty is that many of the gadgets, ideas and procedures are buried at the source. Only in rare cases do they benefit the game by being put into general circulation. This is the state of affairs which led us to plan a monthly contest in which some one practical problem is offered, the originators of the most useful and novel solutions being awarded prizes—the solutions themselves being given circulation in *QST*. Of course, the particular problem offered may or may not have been encountered in the experience of the contestant. This does not debar him from cranking up his think box and cooking up a proposed solution. Indeed, some of the problems will be so broad in scope (such as the planning of a station layout) that the solution will find no exact parallel in any amateur experience.

The purposes of the contest, then, are to give recognition and wider circulation to the ingenious ideas of practical, honest-to-goodness, operating amateurs; to disclose new and better ways of doing old jobs; lastly, to provide some interest and sport for those long evenings when one's favorite band is misbehaving.

Unfortunately, contests must have their rules. Here they are, in the simplest possible form:

1. Solutions must be mailed to reach West Hartford before the 20th of the publication month of the issue in which the problem has appeared. (For instance, solutions of problem given in the January issue must arrive at *QST* before January 20th.) They must be addressed to the Problem Contest Editor, *QST*, West Hartford, Conn.

2. Manuscripts must not be longer than 1000 words, written in ink or typewritten, with double spacing, on one side of the sheet. Diagrams and sketches may be in pencil, but must be neat and legible.

3. All solutions submitted become the property of *QST*, available for publication in the magazine.

4. The editors of *QST* will serve as judges. Their decision will be final.

Much as we should like to give a silver cup with platinum trimmings to the winners, we have decided to do the more practical thing of offering \$5

worth of A.R.R.L. station supplies or publications to the author of the solution considered best each month, \$2.50 worth of supplies to the author of the solution adjudged second best. The winners have the privilege, of course, of stating the supplies preferred.

Problem No. 1

THE amateur owns a 200-watt c.w. and 'phone transmitter arranged in space so restricted that both the transmitter and receiver must be located quite close together and within a few feet of the antenna lead-in. As is usual in such instances, our operator has had frequent trouble from burned out first cathode resistors in the receiver and greatly reduced life of the first r.f. tube. Something must be done to protect the receiver during transmission. Some simple, inexpensive and practical method is required without the introduction of an extra switch to be thrown at each changeover. Already, our hero has installed a relay to throw the small directional antenna from transmitter to receiver. Also, he is in the habit of switching off the plate voltage of the receiver during transmission. He is willing to purchase an inexpensive relay of some kind (should that really solve his problem) but he would much prefer to build any necessary gadgets providing they do not demand more than the few simple tools available in his work-shop. The receiver is a well-known commercial product with the conventional low-impedance input. Our amateur is a little slow on the uptake—he insists on having a clear explanation and complete sketches of anything he hopes to assemble.

GET GOING

This contest is in the nature of an experiment. There is the probability that it will provide us all with a wealth of ideas and information. But it will do so only if you fellows are *actively* interested. Drop the idea that your solution can't possibly be as good as the other fellow's. It is almost certain to be better.

— R. A. H.

Some Practical Inverse Feedback Circuits for Audio Power Amplifiers*

Improved Output Voltage Regulation With Reduced Harmonic Distortion

WHEN power output and distortion characteristics of the final stage of an a.f. amplifier are to be determined, it is customary to replace the loudspeaker by a fixed resistance of suitable value. Actually, a loudspeaker does not present the same impedance to an output tube at all audio frequencies. At the resonant frequency of the speaker, which is usually less than 100 cycles, the impedance of the speaker is high and resistive. At higher frequencies, the impedance of the speaker increases with frequency, because the voice coil has inductive reactance. Unless the variable effects of such a

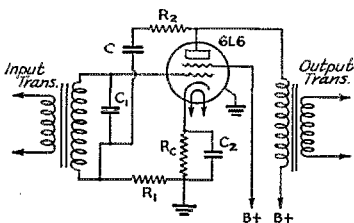

FIG. 1—SINGLE-TUBE INVERSE FEEDBACK CIRCUIT

- C—0.1 μ fd. or larger.
- C₁—0.001 to 0.002 μ fd.
- C_a—Cathode-resistor by-pass condenser.
- R_c—Cathode resistor.
- R₁—5000 ohms for 10% inverse feedback.
8330 ohms for 16.6% inverse feedback.
- R₂—45,000 ohms for 10% inverse feedback.
41,670 ohms for 16.6% inverse feedback.

load are reduced by a low-resistance output tube, low frequencies "hang-over" and are accentuated by resonance effects in the speaker; high frequencies are accentuated by the rising impedance characteristic of the speaker.

The internal resistance r_p of an output tube shunts the plate load Z_1 . When r_p is appreciably less than Z_1 , large variations in load impedance do not appreciably affect the output voltage, because the variable load impedance is shunted by the comparatively low resistance of the output tube. Hence, when a low-impedance triode is used in the output stage, the effects of the variable speaker impedance are reduced. When the internal resistance of the output tube is high compared to the load impedance, the effects of variable speaker impedance may seriously impair quality. This latter condition exists when tetrode or pentode-type output tubes are used without compensating circuits.

* From Application Note No. 64, RCA Radiotron Division, RCA Mfg. Co., Inc. (Aug. 26, 1936).

Inverse feedback circuits can be used in a.f. power amplifiers to decrease distortion and to lower the plate impedance (improve the output voltage regulation). The circuits of a practical single-tube and of a push-pull amplifier using partial inverse feedback are shown in Figs. 1 and 2, respectively. Resistors R_1 and R_2 , and condenser C are connected in series; the combination is connected from the plate of each tube to ground. Nearly all the a.c. voltage developed across the load appears across R_1 and R_2 when the capacitance of C is high. Of this voltage, that due to $R_1/(R_1 + R_2)$ is applied in series with the input-signal voltage; this ratio is defined as the per cent degeneration, n . With any per cent degeneration, the tube acts as though its normal internal resistance r_p were shunted by a resistance $1/(n g_m)$, where g_m is the transconductance of the tube. The input signal required for rated output is approximately

$$E_d = E_o \left(1 + \frac{n g_m R_1}{1 + R_1/r_p} \right),$$

where E_o is the input signal required for rated output without inverse feedback. The distortion with inverse feedback is approximately

$$D_d = \frac{D_o}{1 + \frac{n g_m R_1}{1 + R_1/r_p}},$$

where D_o is the distortion without inverse feedback. The transconductance of the tube is not changed by the addition of this type of degeneration.

The cathode resistor, R_c , has the same value with and without inverse feedback, because electrode voltages are not changed when this circuit is used. Also, the load impedance into which the tube operates should not be changed when inverse feedback is added. The load resistance that is optimum without degeneration is also optimum with degeneration. Therefore, in order to use inverse feedback in some receivers, it may be necessary only to install R_1 , R_2 , and C .

CIRCUIT PRECAUTIONS

Although the inverse-feedback circuits of Figs. 1 and 2 offer certain advantages, the following precautions should be observed in the design and use of these circuits in order to avoid the possibility of instability, oscillation, or a marked divergence from expected results.

1. A conventional resistance-coupled input circuit cannot be used with this type of degenerative circuit, because the input-signal voltage must be in series with the feedback voltage for proper operation.

2. It may be desirable to connect small fixed condensers, C_1 , across each secondary of the input transformer in order to avoid the possibility of oscillation due to leakage inductance and shunt capacitance in the input-transformer circuit. It is advisable to determine by test whether or not these condensers are necessary.

3. The blocking condensers (C in Figs. 1 and 2) should be placed between R_1 and R_2 , as shown. When placed between R_2 and plate, the circuit may oscillate because of the capacitance of C to grid.

4. It might appear that the primary of the output transformer could be tapped at the proper point or that a tertiary winding could be used to obtain the necessary feedback voltage. Attempts to use such schemes may be unsuccessful because of phase shifts due to leakage inductance.

5. This type of circuit is not suitable for use in amplifiers that are designed for grid-current operation, because the relatively high values of R_1 cause appreciable grid-circuit distortion.

RESULTS OF OPERATING TESTS

Inverse feedback reduces the power sensitivity of an amplifier. In circuits having this feature it is, therefore, desirable to use an output tube that has high power sensitivity in order to obtain normal power output with reasonable signal voltage. For this reason, the 6L6 tube is well suited for use in this type of circuit. Preliminary tests indicate that the shunting effect on a speaker load by two type 6L6 tubes with 10 per cent degeneration is comparable to that which can be obtained by two low-resistance triodes in a similar circuit without degeneration. At the same time, the power sensitivity of the 6L6 amplifier is approximately twice that of the triode amplifier and the inherently high efficiency of the Type 6L6 tube is retained. In one test, a push-pull amplifier using two Type 6L6 tubes without degeneration was set up under the following typical operating conditions:

Plate voltage, 400 volts; screen voltage, 300 volts; grid bias, -25 volts; plate-to-plate load, 6600 ohms.

With a peak grid-to-grid signal of 50 volts, the power output was approximately 34 watts at 2 per cent distortion. When 10 per cent degeneration was added, using the circuit of Fig. 2, an output of 34 watts was obtained from the tubes at the grid-current point with approximately 1 per cent distortion; grid current flowed with a peak grid-to-grid signal of 130 volts. No changes were made in electrode voltages or circuit constants.

The frequency characteristics of a typical amplifier with and without inverse feedback and

with several values of shunt condensers for the same signal input indicate that the rise in power output at the resonant frequency of the speaker decreases and the high-frequency response flattens considerably when this form of degeneration is used. The effect of the shunt condensers, C_1 , on frequency response is small, as the secondaries of the input transformer have low impedance.

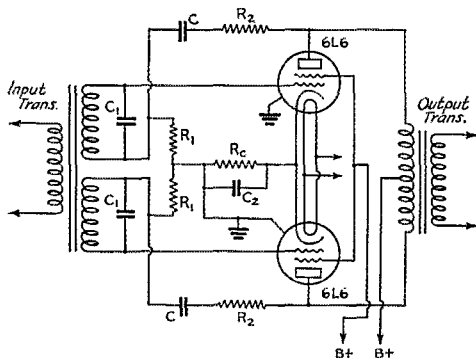

FIG. 2—PUSH-PULL STAGE WITH INVERSE FEEDBACK

Capacitance and resistance values are the same as in Fig. 1.

Oscillograms indicate the damping action of an inverse-feedback circuit when a short-impulse signal is fed to the grids of a push-pull amplifier and the output tubes are connected to a loud-speaker through an output transformer; the voice coil of the speaker is connected to a cathode-ray oscilloscope in order to observe the wave form of the voice-coil voltage. A slowly decaying output voltage results without degeneration while a more rapid decay is obtained with 10 per cent degeneration. A slight further improvement is obtained by using 16.6 per cent degeneration.

These studies show that nearly the same amount of damping of a speaker load can be obtained from Type 6L6 tubes with 10 per cent degeneration as from good low-impedance triodes without degeneration. However, for approximately the same input-signal voltage and B-supply power, about twice the power output can be obtained from two 6L6 tubes as from two good triodes.



In the diagram of the NC-100 receiver, Fig. 1, page 31, December *QST*, condenser C_{22} , the heater by-pass on the high-frequency oscillator, should be returned to ground instead of to the cathode.

In Part II of W2BRO's article on the 6E5, November *QST*, the formula on page 26 should be

$$R_s = \frac{E_s R_k}{E_k}$$

August '36 Field Day

THE special August 1936 A.R.R.L. Field Day, held following insistent demands of participants in the June affair for "a second '36 F.D.," met with much enthusiasm. Numerous clubs and other groups, as well as many individuals, took advantage of the opportunity to combine

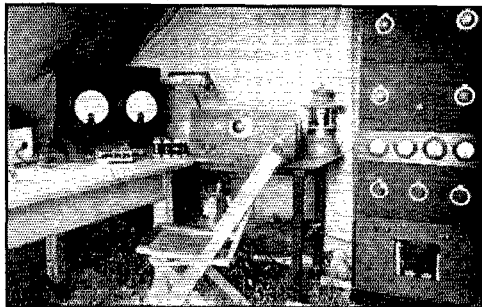

OPERATING POSITION INSIDE THE TENT AT W4CDC-4

The Chattanooga Amateur Radio Club takes its portable-emergency work seriously and tested in the Field Day a rugged outfit suitable for severe service in real emergencies.

the fun of real outdoor radio activity with the more serious problem of testing portable/emergency equipment. The set-ups ranged from high-and medium-powered transmitters, getting their juice from rugged portable power plants, to single-tube rigs powered from hand-driven generators or "B" batteries.

Scoring was the same as in the June doings, each contact counting one point, the total number of points being multiplied by 2 or 3, depending on whether either or both transmitter and receiver were independent of commercial power sources. Another multiplier of 3, 2, or 1 applied for plate powers falling between 0-20, 20-60, and 60-1000 watts respectively. The majority of participants operated in the lowest power classification and very few depended on commercial mains for power.

The two leading clubs in the June F.D. were reversed in order in August, the Northern Nassau Wireless Association taking first place with 1224 points. These chaps again operated from Poundridge Reservation, near Cross River, Westchester County, New York. All power was obtained from a gasoline generator, and the input to the final stage on all bands used (28, 14, 7 and 3.5 Mc.) was 18 watts. 136 contacts were rolled up by bands as follows: 57 on 3.5; 52 on 7; 26 on 14; 1 on 28.

Bowing to the N.N.W.A. group, the York Road Radio Club placed second with a score of 1152 . . . 128 QSO's. Apparatus was the same as used in June, transmitter employing a '47 oscillator and '46 amplifier. A different location was tried, however, Baederwood Park, Abington, Pa.

The Hamilton Amateur Radio Club crew, operating under the call VE3KM three miles north of Waterdown, Ontario, managed to make third place in spite of a series of storms which "put the wet blanket on the whole works." The lads picked quite an appropriate QTH because the "Water" sure did come "down"! Operation was on 7 and 3.5 Mc., the latter coming in for most of the work. The outfit used a '47-RK25. Twelve 6-volt batteries kept the 12-volt to 500-volt genemotor running.

The South Hills Brass Pounders and Modulators (W8CKO-8) was second in number of QSO's—132—and fourth in standing among clubs. Clattys Driving Range, Mt. Lebanon, one of the highest points in Allegheny County, Pa., was chosen for the portable location. The transmitter used a 53 crystal oscillator, 841 buffer, 803 final running at 55 watts. 130 contacts were made on 7 Mc. with this rig, 2 contacts on 56 Mc. with a transceiver. Among the eight operators at W8CKO-8, W8QAN made 57 of the contacts. In



W4DVK, W4PL, W4DUS, W5CPX AND W4DIJ, THE "NIGHT SHIFT" AT W4CDC-4, PORTABLE STATION OF THE CHATTANOOGA (TENN.) AMATEUR RADIO CLUB LOCATED ON THE FARM OF W4PL

the June F.D. the S.H.B.P. & M. made about 60 contacts, 10 of which were on 56 Mc.

Leading the non-club groups come W1IGK and W1IQZ, operating W1IGK-1 set up in a tent in the Maine woods. The tent was made of an old mainsail from a sloop, and in spite of a drizzling rain they succeeded in keeping dry. 67 different

stations were worked, the bulk of operation being on 3.5 and 7 Mc. with one contact thrown in on 14 Mc. The transmitter was a single "ten" in TNT circuit; filament lighted from 6-volt battery, plate power furnished by a Genemotor, 30 ma. at 250 volts, or 7.5 watts. Receiver was a 57-56 combination using 180 volts of B batteries and 6-volt battery for the filaments.

The highest single operator score is that of W8IFD, who operated portable at the Kalamazoo Y.M.C.A. camp, about 140 miles north of Kalamazoo and 15 miles east of Hart, Mich. All work was on a single frequency—3824 kc. 54 stations were QSOed for 486 points. P.P. 6A6 crystal oscillator pushing P.P. 6A6 final amplifier constituted the transmitter. Plate supply was a 300-volt Genemotor running from a 6-volt storage battery. Filament supply also came from a storage battery. Input to the final was 19.5 watts. A t.r.f. receiver was used with 78-77-37 combination. 135 volts of "B" batteries supplied the plate juice, storage battery lighted the filaments. Two handicaps noted by W8IFD were "electrical storms and lack of crystals for both ends of the band."

During the June Field Day the Chattanooga Amateur Radio Club was on with a low-to-medium-power outfit, 50 watts input to a '10 final. For the August event the gang decided to use just as powerful an outfit as could reasonably be called portable, an outfit such as might be needed in event of a real emergency. The photographs herewith show the results of the "Chattanooga" efforts in preparing a "heavy duty" set-up. The emergency power supply consisted of a Delco engine with a built in 1¼-kw. 110-volt d.c. generator on the same shaft as the flywheel. The d.c. output from this went to the motor generator. Two field rheostats gave control over the a.c. output, while varying the speed of the engine varied the frequency. By juggling all three they were able to get very steady 60-cycle, 115-volt a.c. at the station, located some 100 yards away. The receiver was a ham-built super, described in April 1936 QST. The transmitter was a standard rack job using 53 crystal-'10-P.P. 50-T's final,

run at 175/200 watts during the F.D. Electric light was available while the engine was running, a flashlight to refill the tank with, and a gasoline lantern (note it in the photo) "just in case . . ." As for results: Operating under as nearly as possi-

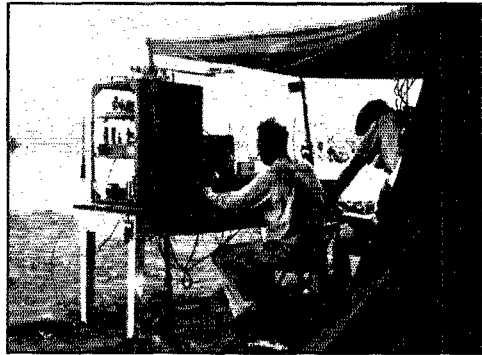

W9CJC-9 IN ACTION

This set-up was manned by members of the Black Hills Amateur Radio Club of Rapid City, South Dakota.

ble the same conditions as in June, about 35% more stations were worked, with uniformly better reports. Much can be said in favor of "high-powered emergency outfits," even though the "transportation" problem becomes more severe. In a real emergency it is usually possible to secure a truck or other means of transportation, and the additional power is usually most welcome under trying conditions.

The Black Hills Amateur Radio Club set up W9CJC-9 in a cornfield east of Rapid City, So. Dak., including portable camping equipment and a gasoline power plant. 14-Mc. 'phone and 7-Mc. c.w. were used. . . . W9AWC-9 was operated by the Sedalia (Mo.) Amateur Radio Club in a cabin 40 miles from Sedalia, 6 miles from the nearest power line. A hand-driven generator powered the 3.5-Mc. set, a 12-to 750-volt d.c. motor generator ran the 7-Mc. rig. Filaments and the receiver were operated from storage batteries. . . . A 6L6 crystal oscillator with 400 volts of "B" batteries was used by W6JRZ-6 on 3.5 and 7 Mc. on Mt. Wilson. A 56-Mc. transceiver took care of operating on "5." . . . The W4NC (Winston-Salem A.R.C.) gang set up on the Yadkin River, about 20 miles from Winston-Salem, at a welcome spring. Power supply was an Austin motor pulling a 5-kw. generator, which furnished power and lights. . . . The Amateur Transmitters Association of W. Pa. operated under the call W8CUG-8, making the affair a general club outing. Transmitter was a c.c. 59 driving a '45 on 3.5 Mc. Receiver was an SW3 using battery supply. The transmitter power plant consisted of a small marine gasoline engine driving a 110-volt a.c. generator. Another generator, also driven with the gas engine, furnished lights, and kept the filament and excitation battery charged. Location was atop a hill out in the country back of Emsworth, Pa. . . . The Moncton Amateur Radio Club operated portable VE1DC on the shore of the Northumberland Straights at the mouth of Buftonche Bay, 35 miles northeast of Moncton (see photo). 'Phone and c.w. was used with an input of 40 watts on 3.5, 7 and 14 Mc. Seven operators worked in shifts through Saturday evening and night, and Sunday. Weather: damp—rain all day Sunday. . . . W6MGJ-6 of the Helix Amateur Radio Club used a 6A6 osc.-6A6 buffer-'10 final with 60 watts input. Power supply was ½-h.p. Briggs and Stratton gas engine driving a 500-volt generator and a low-voltage battery charging gen-

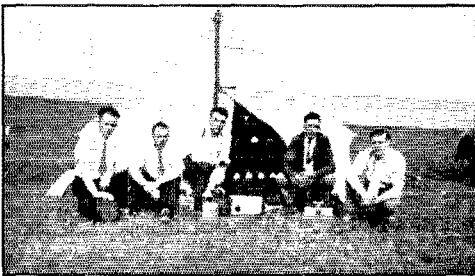

THE MONCTON (N. B.) AMATEUR RADIO CLUB GANG PICKED A WIDE-OPEN SPOT FOR THE FIELD DAY ACTIVITIES

Several of the crew are pictured, left to right: VE1DC, VE1EV, VE1GI, VE1CX, VE1IL.

erator. "B" batteries were used on the receiver. . . . Says VE4PQ, Secretary of the Saskatoon Amateur Radio Club, "We feel that after the experience gained in the past couple of Field Days, we should be capable of handling any emergency. . . . W4CFD, W4AGI and W4AAR, representing the Southside Amateur Radio Club of Atlanta, Ga., took portable equipment to Jackson's Lake, some 50 miles southeast of Atlanta, and there operated W4CFD-4. Transmitter was a single 6A6 in an oscillator-doubler circuit working on 14, 7 and 3.5 Mc., powered by a Genemotor giving 180 volts at 50 mills. . . . The 13 operators and "generator engineers" at W9FI-9 (West Towns Amateur Radio Club of Maywood, Ill.) had a big time in spite of a 900-cycle generator whine in their battery receiver preventing accumulation of a large score. . . . After much scouting around town to gather the necessary gear, the Chester Radio Club delegation (W3BKQ-3) set up at Kaoli Lake, about ten miles from Chester, Pa. They used a 6L6 crystal oscillator with 12½ watts input, 6-volt battery for filament, dynamotor for plate supply. . . .

450 volts of "B" batteries supplied the plate supply for an 802 Tri-tet used on 710 kc. by the W9VTO-9 gang at Detweiler Park, about five miles from Peoria, Ill. . . . W6GCM-6 was manned by W6MNR and W6GCM (Plantz and Bush), and they say, "We are not as green as our names!" On 3.5 Mc. they used a 6L6 c.c., and on 7 Mc. an '01A Hartley. . . . W6MYK worked the most stations of those in the single-operator group—total of 64. He used a portable transmitter, built for medium-power QRR work, self-contained in a steel case. . . . From W4RO-4: "This was our first F.D. participation, but it won't be the last. . . . I know we are not up with the winners in points made, but we are close to the top in the amount of pleasure we got out of it. . . . and, too, we learned a lot about what it takes to put a rig in the field and make it earn its cakes." The high-

light for the 4RO gang was working K6 and K7 with the portable layout. . . . W8FNN-8 used 1.75- and 3.9-Mc. 'phone and 7-Mc. c.w., with best results on 3.9 Mc. Transmitter was 53 oscillator, two '45's par., modulated by pair of 2A3's, crystal mike. . . . "Thunderstorms soaked me completely, QRN kept me down, lightning so severe nothing doing even on 56 Mc. Sat. night; set up twice, but storms took me back under cover!"—such is the sad story of W2QY. . . . W3BZE-3 was operated at Boy Scout Camp, Chesterfield Courthouse, Va., by W3BZE and W3EVN. Rig was an '01A TNT with 8 watts from 250-volt m.g. Receiver: 78-76, battery-powered. . . . The six operators at W9AIW-9 worked 64 stations using two complete crystal-controlled rigs (one each for 14 and 7 Mc.) with a 50-wattier in the final of each. . . . VE2LC used a vibrator and storage battery to obtain power to run his 42 crystal oscillator; receiver was 78-76. . . . VE3BY and VE3AJB operated VE3BY's regular portable, a single 42 crystal oscillator, powered by a Philco vibrator and 180 volts of dry batteries—receiver was a 6C6-76 outfit in the same box as the transmitter. Operation was at Woodridge, on the Ottawa River. . . . The VE2BK gang got all set up on a mountain in northern Quebec and ready to go when, a half hour later, it started to rain! But a good time was had in spite of the moisture. . . . The set-up at W2HLB-2: Umbrella tent with a.c. equipment, card table and cot. Pup tent about 200 yards away on small open hill with 3.5-Mc. antenna to nearby woods, 6 "B" batteries, blankets on ground, battery-operated receiver and transmitter. Rain and QRN (lightning, hordes of spectators (little boys wanting to know all about crystal receivers). . . .

Field Days have taken a very definite place in amateur radio activities and thoughts are already turning to "the next." It is not too early to plan and build your portable/emergency outfit for the 1937 June F.D.

—E. L. B.

AUGUST FIELD DAY SCORES

Club Station	QSO's	Score*
W2DXO-2 Northern Nassau Wireless Association ¹	136-A	1224
W3AJF/KF-3 York Road Radio Club ²	128-A	1152
VE3KM Hamilton Amateur Radio Club ³	68-A	612
W8CKO-8 South Hills Brass Pounders and Modulators ⁴	132-AB	538 t
W9CJC-9 Black Hills Amateur Radio Club ⁵	55-B	330
W9AWC-9 Sedalia Amateur Radio Club ⁶	49-AB	306
W4CDC-4 Chattanooga Amateur Radio Club ⁷	99-C	297
W6JRZ-6 Glendale Amateur Radio Club ⁸	27-A	243

* The "power classification" used in computing the score is indicated by A, B, or C after the number of QSO's shown. A indicates power up to and including 20 watts (multiplier of 3); B indicates power over 20 up to and including 60 watts (multiplier of 2); C indicates over 60 watts (multiplier of 1). More than one letter means that at different times different power inputs fell within different classifications. An R or T after the score indicates that receiver or transmitter were supplied from the public mains; no indication after scores where work was entirely independent of mains, r or t is used where only part of operation used mains supply.

Club operators: ¹ W2AOL, W2ICO, W2GZS, W2DJO, W2DDU, W2HQJ, W2BWC, W2DUA, W2DXO, W2AYJ, ² W3QV, W3AJF, W3BYS, W3AYH, W3GKS, W3CTB, W3DGC, W3DLH, W3DMF, W3EEV, W3EIC, W3EPC, W3ERF, W3ETM, W3EWO, W3FNN, W3FJQ, W3KF, W3PG, W3QS, Frank Hauler. ³ VE3KM, VE3GZ, VE3JL, VE3HT, VE3VZ, VE3DO, VE3VJ, VE3JU. ⁴ W8QAN, W8LCI, W8KUZ, W8OKF, W8OVP, W8EYZ, W8AIG, W8CKO. ⁵ W9ADJ, W9CJC, W9POP, W9TZJ, W9YJX, W9UAV, Earl Shirly, M. J. Jones, Clifford Hall. ⁶ Operators names not reported. ⁷ W4PL, W4CBA, W4CDC, W4DVK, W4DUS, W5CPX, W4DIJ. ⁸ W6KBB, W6JRZ. ⁹ Operators names not reported. ¹⁰ W8CFR, W8BBV, W8QEL, W8MTK, W8NCD, W8SBO, W8KME, W8AYV, W8CUG, Sam Nickhazy. ¹¹ W4CYC. ¹² VE1DC, VE1EV, VE1EI, VE1CX, VE1IJ, VE1JU, VE1FF. ¹³ E. Harris, N. Balli, C. Bolts, J. A. Barnett, K. Hallett, R. Dobler, V. A. Milton. ¹⁴ VE4PQ, VE4QZ. ¹⁵ W4CFD, W4AGI, W4AAR. ¹⁶ W9FI, W9VH, W9AYE, W9KZV, W9MAH, W9SCH, W9VYQ, W9WHB, W9WUN, W9WUO, Charles Remus, Jim Johnson, Robert Syverson. ¹⁷ W3DGM, W3ATK, W3BIL, W3BFG, W3DRQ, W3CWQ, Duck Temple.

W4NC-4 Winston-Salem Amateur Radio Club ⁹	26-A	234
W8CUG-8 Amateur Transmitters Association of W. Penna. ¹⁰	26-A	234
W4DJP-4 Chattanooga Amateur Radio Association ¹¹	25-A	225
VE1DC Moncton Amateur Radio Club ¹²	47-B	188 T
W6MGI-6 Helix Amateur Radio Club ¹³	28-B	168
VE4AAA Saskatoon Amateur Radio Club ¹⁴	18-A	162
W4CFD-4 Southside Amateur Radio Club ¹⁵	17-A	153
W9FT-9 West Towns Amateur Radio Club ¹⁶	9-A	81
W3BKQ-3 Chester Radio Club ¹⁷	7-A	63

INDIVIDUAL AND GROUP SCORES

W1IGK-1 W1IGK-W1QZ	67-A	603
W8IFD-8 W8IFD	54-A	486
W9VTO-9 W9VFI-W9IAG	53-A	477
W4RO-4 W4CWJ-W4CVB-W4RO-Ed Bettis	67-B	402
W6MVK-6 W6MVK	64-B	384
W5FRC-5 W5FRC	43-B	258
W2DEN-2 W2DEN-W2FQV-W2HGX	28-A	252
W3BZE-3 W3BZE-W3EVN	24-A	216
W8FNN-8 W8FNN-W8MDU-W8NQX-W8MQA-Andrew Tomek	22-A	198
VE2BK VE2KH-VE2JK-VE2BK	18-A	162
W3EHW-3 W3EHW-W3FQZ-W3GAC-W3FRB-W3EJB	16-A	144
W8OFO-8 W8OFO	16-A	144
W6GCM-6 W6GCM-W6MNR	15-A	135
W1KB1-1 W1KB1	40-A	120 RT
VE2LC VE2LC	13-A	117
W8DPY-8 W8DPY	11-A	89
VE3BY VE3BY-VE3AJB	9-A	81
W9AIW-9 W9AIW-W9KGX-W9AOG-W9FNO-W9JPA-W9LPZ	64-C	64 RT
W1FGO-1 W1FGO	7-A	63
W2QY-2 W2QY	7-A	63
W9IPK-9 W9OQV-W9GIZ-W9IPK	7-A	63
W7RT-7 W7RT	6-A	54
W2HLB-2 W2HLB-W2HYQ-W2IKR	6-A	48 RT

(Continued on page 98)

What They Don't Know Won't Hurt 'Em

A Tale of Woe

By J. L. Evans, Jr.,* W2BBK, W3BJN

ONE fine weekend during the summer I am out visiting my old sidekick, W3BXI. Now this particular period of days is the hottest which has ever hit the old Dutch town of Lancaster for many a moon, so that, after trying vainly to work anything but nines, we decide it would be a noble idea to depart in the general direction of downtown in search of a few cooling glasses.

In short, we are soon installed behind a weather-beaten table down in Louie's refreshment emporium, wondering whether it might not be a good idea to take up stamp collecting for the remainder of the summer months. This and other arguments contrive to absorb our attention until late in the evening when the crowd has begun to drop off and things are beginning to be a little quiet. Then, not wishing to be the cause of any overwork for poor tired Louie, we get up and kind of saunter over to the counter, where we can be served with less effort and a little more QRQ. It is while we are waiting for the seventh round that the whole thing starts.

We are in the middle of a discussion about 40 vs. 20 when the door opens slowly and a little woe-begone creature enters. Now this guy who comes in is indeed a pitiful figure. He is dressed in coat and trousers which don't match and which haven't seen the tailor's for at least a year come last Michelmas. A couple of forlorn buttons hang precariously from the coat by a few threads. He is unshaven and tattered, and his shirt—well, all in all, he's pretty much of a mess.

Now, his appearance alone is enough to attract attention. While the elite of local society do not frequent Louie's, still his clientele is fairly respectable, and their voices are hearty. But the thing which makes us notice this bird is that while he is standing waiting for his order, his fingers are busy tapping on the surface of the mahogany and they are tapping out what Lou and I are quick to recognize as nothing but the old favorite bromide, a "CQ DX."

Naturally enough this makes us very curious indeed, so that I presently turn to the stranger and say to him kindly, "Brother, are you a ham, too?"

With this, he turns around as if shot and his face lights up as if it was an '01A with a half-kw. input. "Pal," sezze, "did I hear you say you were a ham? What is going on in radio these days? How are the J's coming through on 20?"

So we tell him. And in no time at all we are back at our table in the corner and this weird specimen is pouring out his tale of woe in our large and sensitive ears.

"Friends," he sez, "once I was a happy man. I was married to a lovely creature, and my antenna was laying down an R9 sig down in the Aussie country. J's and ZT's floating through the air with the greatest of ease slid right down the doublet at old W3ZZZ.

"But the little woman didn't care for radio, and many and hot were the arguments which raged. Pretty soon I began to see that we were getting nowhere by arguing, so I said to myself, 'Homer, this is nothing to be doing.' Then I went into a huddle with myself and came out with the proper play." And with this he pulls his coat around him like, all of a sudden he was somebody again.

"Now, I decide to be clever. Every day I subtly slip the YF a little inside dope on radio, and in no time at all, I am beginning to get her interested. From there, it is only a step until she is learning the code, at which work she makes remarkable progress. One day the pride of my heart gets her license, and I think to myself, 'Ah, here is bliss indeed,' as she sits by my side as we work DX and chew the fat with the local boys.

"Now all this time the DX contest is approaching. So we polish up the haywire and raise the input to the 852's and everything is in fine shape to garner the certificate for the district. The day the contest does begin, I rush home early, to get in at the crack of the gun.

"But when I get there, wifey is already seated at the rig, and there is no supper on the table. The baby is howling for his bottle and there is a pile of dirty dishes in the sink. So I timidly walk up and remove one fone and whisper in her ear, 'Darling, how about some supper?'

"'Homer,' she replies tartly, 'if you do not quiet down I will miss this PY.'

"So all during the contest I eat in restaurants and hire a woman to watch the baby, meanwhile wondering if the little woman will find that XU I have been laying for on 14,328 kc. She does, and plenty more, so that it takes her an extra three days to compute the score.

"Now, that is only the beginning. She enters the Aussie-Zedder DX contest and the Sweepstakes and a couple dozen more things like that,

* 1026 S. 48th St., Philadelphia, Pa.

(Continued on page 110)

A 50-Watt Rack-Mounted 'Phone Using Beam-Type Tubes

By R. E. Herbert,* W8NMY and Steve Tunder,** W8QCF

WITH the advent of the new audio-frequency beam power tubes there was immediate demand for a similar tube for radio-frequency applications. Some of us have spent many hours experimenting with the 6L6

meet the strenuous requirements of the r.f. power service there have recently appeared the new 807 and RK-39, incorporating the up-to-date beam features of the 6L6. These tubes have a ceramic base and top-cap plate connection.

After experimenting with this new type it was found to work beyond our expectations, and the more we work with it the greater is our enthusiasm over it. The rig to be described uses a pair of parallel 807's in the final, modulated by a pair of

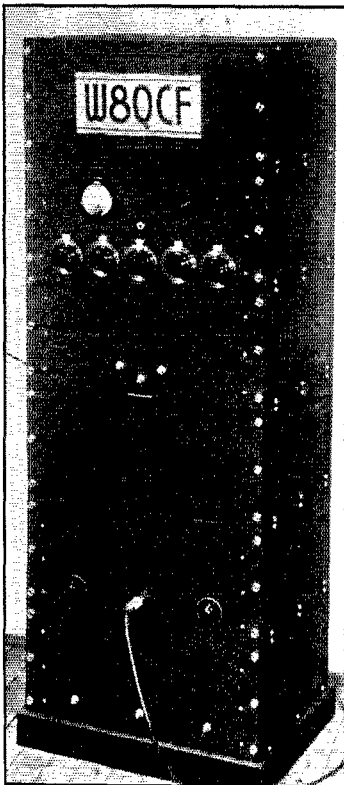

FRONT VIEW OF THE TRANSMITTER

A pair of 807 beam-type tubes in the final stage is modulated by a pair of 6L6's Class-AB.

tube for r.f., and have found in many instances that there were certain drawbacks to the metal type in r.f. circuits. Later the 6L6G tube was introduced, which helped the amateur, since it was less troublesome to neutralize, more stable and less critical of circuit conditions. However, to

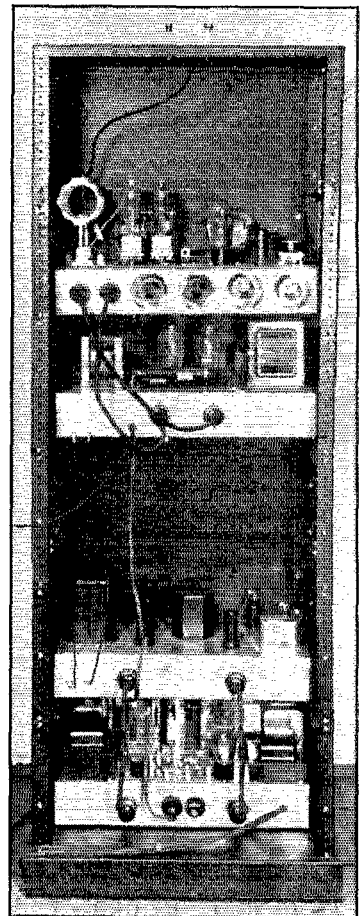

REAR VIEW OF THE TRANSMITTER SHOWING THE RACK ASSEMBLY OF THE UNITS

* Bud Radio, Inc., 1937 East 55th St., Cleveland, Ohio.

** 519 Huron Rd., Cleveland, Ohio.

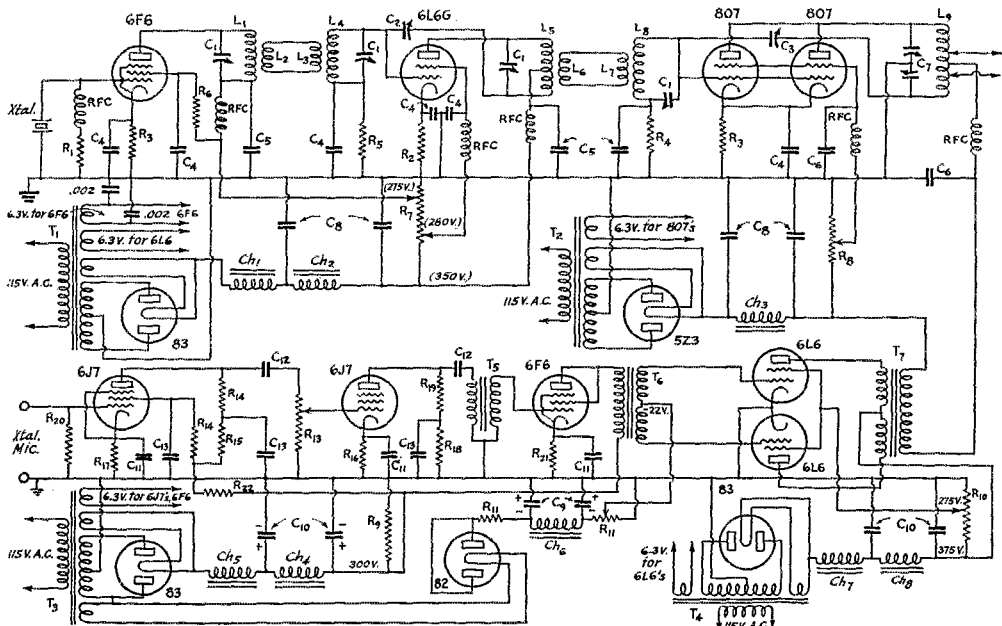

FIG. 1—COMPLETE CIRCUIT OF THE 'PHONE TRANSMITTER

- R.F. Section:**
C₁—100- μ fd. midget condensers (Bud No. 905).
C₂—16- μ fd. neutralizing condenser (Bud No. 311).
C₃—15- μ fd. neutralizing condenser (Bud No. 565).
C₄—0.01- μ fd. 600-volt paper condensers.
C₅—0.002- μ fd. 600-volt paper condensers.
C₆—0.002- μ fd. mica condenser.
C₇—100–100- μ fd. split stator transmitting condenser (Cardwell MT100GD).
R₁—25,000-ohm 2-watt.
R₂—400-ohm 10-watt.
R₃—200-ohm 10-watt.
R₄—7500-ohm 10-watt.
R₅—10,000-ohm 2-watt.
R₆—50,000-ohm 2-watt.

- RFC**—2.5-mh. chokes.
R.F. Power Supplies:
T₁—800-volt c.t. power transformer with 5-v. and two 6.3-v. windings (U.T.C. UH-5).
T₂—900-volt c.t. power transformer with 5-v. and 6.3-v. winding (U.T.C. UH-4).
R₇—25,000-ohm 75-watt divider (Ohmite).
R₈—25,000-ohm 100-watt divider (Ohmite).
Ch₁—150-ma. swinging choke (U.T.C. CS-42).
Ch₂—10-h. 150-ma. choke (U.T.C. CS-41).
C₈—8-8- μ fd. 600.
Audio Power Supplies:
T₃—800-volt c.t. power transformer with 2.5-v., 5-v., and 6.3-v. windings (U.T.C. UH-4).

- T₄**—900-volt c.t. power transformer with 5-v. and 6.3-v. windings (U.T.C. UH-5).
Ch₄—10-h. 150-ma. choke (U.T.C. CS-41).
Ch₅—150-ma. swinging choke (U.T.C. CS-42).
Ch₆—250-h. 15-ma. choke (U.T.C. PA-45).
Ch₇—200-ma. swinging choke (U.T.C. CS-304).
Ch₈—10-h. 300-ma. choke (U.T.C. CS-301).
C₉—8-8- μ fd. 600.
C₁₀—8-8- μ fd. 550-v. electrolytic (Aerovox GGL-5).
R₉—25,000-ohm 50-watt divider (Ohmite).
R₁₀—25,000-ohm 75-watt divider (Ohmite).
R₁₁—3000-ohm 10-watt resistor (Ohmite).

- R₁₂**—7500-ohm 25-watt resistor (Ohmite).
Audio Section:
C₁₁—10- μ fd. 25-volt electrolytics.
C₁₂—0.25- μ fd. 400-volt paper condenser.
C₁₃—0.1- μ fd. 400-volt paper condenser.
R₁₃—0.5-meg. vol. control.
R₁₄—0.5-meg. 1-watt.
R₁₅—0.25-meg. 1-watt.
R₁₆—2000-ohm 1-watt.
R₁₇—5000-ohm 1-watt.
R₁₈—30,000-ohm 1-watt.
R₁₉—50,000-ohm 1-watt.
R₂₀—3-meg. 1-watt.
R₂₁—400-ohm 10-watt.
R₂₂—20,000-ohm 5-watt.
T₅—3-to-1 audio transformer (U.T.C. CS-1).
T₆—Class-AB input transformer (U.T.C. PA51AX).
T₇—Class-AB output transformer, push-pull 6L6 to 2500 ohms.

COIL DATA

	1.75 Mc.	3.5 Mc.	7 Mc.	14 Mc.	28 Mc.
L ₁ , L ₄ , L ₅ , L ₈	80 t. No. 24 d.s.c., close-wound	40 t. No. 24 d.s.c., spaced to fill 1 1/4" length	20 t. No. 18 enam., spaced to fill 1 1/4" length	9 t. No. 18 enam., spaced to fill 1 1/4" length	5 t. No. 18 enam., spaced to fill 1 1/4" length
L ₂ , L ₃ , L ₆ , L ₇	3 turns	2 turns	2 turns	2 turns	1 turn
L ₉	44 t. No. 10 enam., 4" diam., spaced diam. of wire	23 t. No. 10 enam., 3" diam., spaced diam. of wire	13 t. No. 10 enam., 2 1/2" diam., spaced diam. of wire	6 t. No. 10 enam., 2 1/2" diam., spaced diam. of wire	4 t. No. 10 enam., 2 1/2" diam., spaced diam. of wire

Coils L₁ and L₄ are wound on 1 1/2-inch diameter four-prong forms (Bud No. 125), and are interchangeable. Coils L₅ are wound on 1 1/2-inch diameter five-prong forms (Bud No. 126). Coils L₈ are wound on 1 1/2-inch diameter six-prong forms (Bud No. 310). Coils L₉ are wound on grooved Isotex forms (Bud No. 393, 4-inch diameter; and No. 376, 3-inch diameter; and No. 383, 2 1/2-inch diameter). Link turns are at "ground" ends of L₁, L₄ and L₈; and around centers of coils L₅.

6L6's, and gives the easiest and most effective 50-watt output that we have seen.

The complete job is built in one of the new adjustable-height relay racks that has recently appeared on the market. In the rear view it will

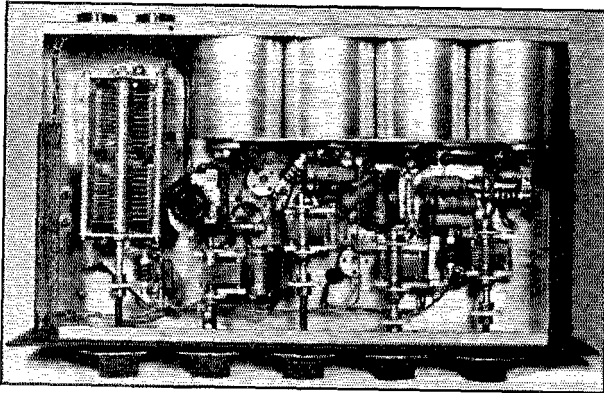

THE SHIELDED PLUG-IN COIL ARRANGEMENT IN THE BOTTOM OF THE R.F. UNIT

be noted that there are two sections of the six that as yet have not been used, these being reserved for future additions. While sections of various heights are available in these extended racks, six of the 8 $\frac{3}{4}$ -inch sections were used, because this left even spacing between all units and also brought the rack to the height we wanted, which is 5 feet 7 inches.

The first unit consists of a 6F6 pentode oscillator, 6L6G doubler-buffer, and the pair of parallel 807's in the final amplifier. An unusual feature of this r.f. section is that the coils are mounted horizontally under the chassis, each in its own shielded compartment. The links, as well as the coil windings, are wired to the coil bases. All coils are easily accessible for changing from the rear of the shelf. This method of mounting coils allows extremely short leads between coils and condensers, and plenty of room is left on the top of the chassis for correct placement of tubes, crystal, and final tank coil, making the net result of the arrangement conducive to good efficiency. The method used in mounting these coils was to drill four holes in the rear of the chassis 2 $\frac{1}{2}$ inches in diameter. Behind each of these holes is mounted the shield can measuring 3 inches in diameter by 3 $\frac{1}{2}$ inches deep, with a hole cut in the top to accommodate the socket for the coil mounting. By doing this it was possible to make the coils easily accessible for changing and still keep them well shielded from one another.

R.F. CIRCUIT FEATURES

Referring to the diagram of Fig. 1, the set-up uses a 6F6 pentode crystal oscillator link-coupled to a 6L6 buffer-doubler, which in turn is link-coupled to the 807 final. The hook-up of the

crystal stage is practically self-explanatory. It is merely the conventional circuit for any pentode oscillator. Cathode bias is used, since this limits the plate current flowing when the crystal is not in oscillation. The tap on the voltage divider supplying the oscillator B-plus is so adjusted as to allow the oscillator to furnish the necessary driving power to the 6L6 on the highest frequency to be used, the plate voltage being about 275 volts in this case.

The 6L6, it was found, works very nicely as either a buffer or doubler, since it is not necessary to put very high plate voltage on it to furnish the small amount of driving power required for the 807 stage. The only thing that is critical about this stage is to make sure that the screen voltage is correctly proportioned to the plate voltage. In this case the plate voltage was 350 volts and the screen tap on the voltage divider was set so that the screen had approximately 280 volts on it. If the screen voltage is too low, it

will be found that the output of the 6L6 stage is materially decreased; while if the screen voltage is too high, a steady climbing of the screen-grid current will be noted during operation. Hence it is well to insert a meter in the screen grid lead when adjusting the voltage to make sure that the screen current remains steady.

Cathode bias is also used in the 6L6 buffer-doubler stage, and in the 807 stage. The values of grid and cathode resistors specified in Fig. 1 seem to satisfy all conditions. Care was taken to place chokes in all plate and screen leads, and by-pass condensers were used freely throughout the circuit. It was found that the small extra expense and effort was richly rewarded in the freedom from trouble experienced when the rig was put in operation; and since that time its consistency of operation has been very good.

The section directly below the r.f. unit contains the two power supplies for the r.f. It may seem a rather useless expense to some to use two separate supplies for the r.f. unit, but in this way it was possible to use the smaller transformers which are easily procured and also eliminated any possibility of instability in the crystal and buffer-doubler stages resulting from modulation of the final amplifier.

THE AUDIO UNIT

The speech-amplifier consists of a 6J7 high-gain input stage driving another 6J7, triode connected. This two-tube amplifier works into the 6F6 triode-connected driver stage, which in turn drives the two push-pull Class-AB 6L6 modulator tubes. The grids of these two tubes are biased approximately 22 volts negative, making them run as

(Continued on page 128)

Wide-Range Resonance-Type Frequency Meters with Sensitive V.T. Indicators

Constructional Details of Two Practical Models

By Wolcott M. Smith*

IN THE course of frequency, inductance, or capacity measurements, a resonance-type "wavemeter" with a sensitive vacuum-tube resonance indicator is often as practically accurate for the work as a theoretically more accurate heterodyne instrument and frequently is more positive than the latter where confusion of harmonics is possible.

Temperature affects any tuned circuit's constants, so that compensation or correction for variation is needed for a high degree of accuracy with either type. High- Q circuits and a sensitive detector make the resonance meter closely approach the heterodyne meter in practical accuracy. It has the advantage of direct reading, thus eliminating spurious beats and occasional guess-work.

During construction of two such meters recently a highly sensitive detector was employed. The tuned circuits were designed with a comparatively good Q and rather large fields. These considerations resulted in a highly sensitive and sharply resonant meter of wide utility. For instance, at 6.0 Mc. with coupling to give 10% meter deflection, reaction of the resonance meter on the circuit under test caused the latter's frequency to change only 10 or 20 cycles.

In checking this the frequency-meter coil was 30 inches from the small oscillator's coil. These results are believed to be at least as good as obtainable with commercial units now available. With careful construction, simplicity, stability, and long battery and tube life are characteristic.

The photographs illustrate types which have been built, one a small laboratory model which covers from 1.0 meter to 600 meters. The coils are wound 3 inches in diameter and 1 inch long, except at the highest frequencies. Large fields re-

quire single-turn windings for the two or three smallest coils. The large model was built for production work. Its range is 80 kc. to 20 Mc. with 5 coils. Because of the wider frequency ranges, the coil forms differ from those of the small unit. Accuracy is lower, of course, since there is seven times the kc. coverage per dial division.

The constructor who wishes to build one of these frequency-meters should consider dimensions carefully. The small unit is easier to use while the larger is easier of construction. Plenty of battery space is preferable to too little. A metal case about 6 inches wide, 7 inches high and 12 inches long is excellent. Standard dry-cell "A" batteries and a small 22½-volt "C" battery readily fit into one end. Room is left at the other end for tube, meter, and condenser.

The control panel, which is approximately 6

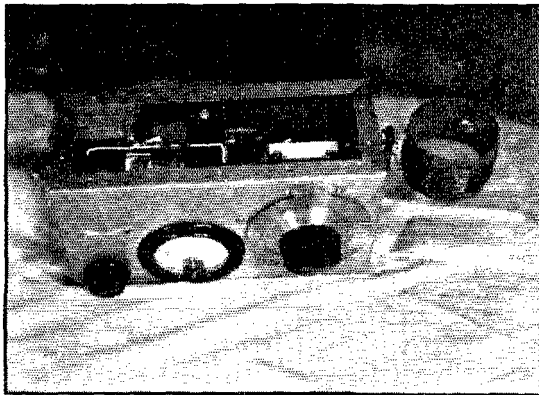

PANEL VIEW OF THE LABORATORY PRECISION MODEL RESONANCE-TYPE FREQUENCY METER

inches by 12 inches, should be laid out for convenient operation. Keep the tuning condenser near the coil jacks to shorten leads. Place the rheostat where its knob is out of the way when tuning. Keep the grid lead to the tube short. If possible, place the meter so that the eye catches its needle movement simultaneously with the dial setting. Make the case rigid and use a rugged tuning condenser and coils.

Battery straps must be made to fit each individual case. Several types of small "A" and "B" batteries are available for such services. They must be held in place firmly to prevent shorts or destruction of tube or meter. If necessary, place a baffle type shield between the meter and battery compartments.

V.T. INDICATORS

Fig. 1-A, B, C, D shows several detector arrangements. Others were used but proved too inferior to warrant comment here. For high-frequency work the 954 and 955 tubes were found

*F. W. Siskles Co., Springfield, Mass.

FIG. 1—RESONANCE-METER CIRCUITS WITH DIODE AND TRIODE INDICATOR ARRANGEMENTS TESTED

The triode types are preferable, as explained in the text, especially with the "acorn" tubes. Typical circuit values are as follows:
 L—See coil table
 C—50- μ fd. straight-line-frequency condenser (General Radio Type 568-K).

- C₁—100- μ fd. mica fixed
- C₂—0.001- μ fd. mica fixed
- R—25-ohm filament rheostat with switch
- R₁—30- to 50-megohm leak resistor
- A—Filament battery, 1.5-volt for Type 30 or 32 tubes, 4.5-volt for Type 954 or 955 tubes
- B—Small 22.5-volt type "B" battery
- M—0-200 d.c. microammeter

superior to any of the older types. Above 15 Mc. their superiority was marked. Fig. 1-A is the original diode detector. Its sensitivity is good but, unfortunately, such a rectifier loads the tuned circuit so that tuning is broad. It is useful enough, though, so that it is employed commercially.

Circuits B, C, D eliminate this loading and are much more sensitive than any diode. Should a tetrode or pentode be used, the screen and suppressor are tied to the plate to form a triode.

Essentially, the indicator is a triode voltmeter. The variation from standard practice lies in the control of initial electron current. This is effected by cathode or filament temperature control, or emission control, rather than by variation of grid bias or plate voltage. In operation the initial plate current is set to 150 to 200 microamperes by operation of the filament rheostat. As a signal is tuned in, grid bias is developed, by rectification in the grid circuit, across the high leak. This bias reduces the plate current greatly when the "B" voltage and the cathode temperature are right.

Fortunately, a 22½-volt "B" supply fills the bill for the units tried and cathode temperature is readily controlled. Excessive "B" voltage requires too-low temperatures for the cathode and the plate pulls all the available electrons regardless of grid-voltage conditions. Too-low a "B" supply requires excessive cathode temperatures and space charge prevents satisfactory grid control. The best plate voltage lies between 18 and 25 volts. Battery and tube life are no problem, as both are operated far below normal ratings.

The circuit of Fig. 1-D has no added leak across the grid condenser. To prevent sluggish action in the indicator, keep the

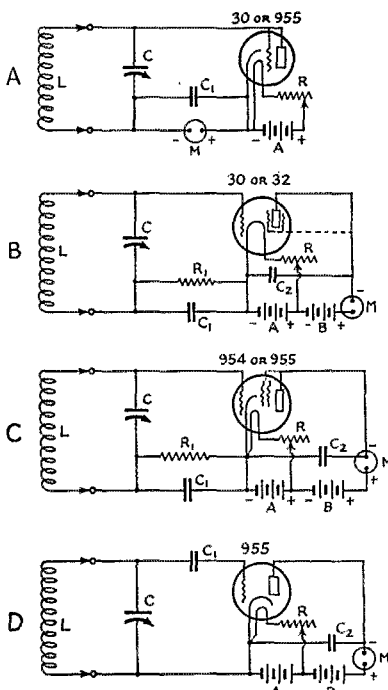

deflection to 50 microamperes from initial value. This holds the grid condenser discharge time within reasonable limits. The detector thus arranged is so sensitive that it may be necessary to keep one or two hundred feet from the transmitter and antenna when tuning to resonance with the fundamental frequency. A 30-microampere deflection occurred, for instance, 15 feet from the oscillator alone at WIES.

COILS AND CALIBRATION

Coil construction is relatively simple. The coil table can be followed or an *A.R.R.L. Lightning Calculator* will do the work quickly and accurately. In any case, keep the diameter large and the wire spacing about 75% of the wire diameter. If possible, use tubing which is properly threaded for each coil; otherwise, wind string or heavy cord as a spacer and leave it there.

COIL TABLE						
Coil	Range	Diam. Winding Length		Wire	Turns	L
A	160 to 300 Mc.	Bar between the two plugs				0.007 μ h.
B	84 to 160 Mc.	2"	Nil	Tubing	1	0.058 μ h.
C	44 to 84 Mc.	2"	1"	2. Tubing	2	0.23 μ h.
D	23 to 44 Mc.	2"	2"	2.5 Tubing	5	0.83 μ h.
		3"	1"	3. Tubing	3	0.83 μ h.
E	12 to 23 Mc.	2"	2"	4.5 No. 10 en.	9	3.0 μ h.
		3"	1"	5.5 No. 10 en.	6	3.0 μ h.
F	6.7 to 12 Mc.	2"	2"	8.4 No. 15 en.	17	10.0 μ h.
		3"	2"	6. No. 12 en.	12	10.0 μ h.
		3"	1"	10. No. 16 en.	10	10.0 μ h.
G	3.4 to 6.7 Mc.	2"	2"	15.7 No. 20 en.	31	35.0 μ h.
		3"	2"	11.4 No. 18 en.	23	35.0 μ h.
		3"	1"	19. No. 22 en.	19	35.0 μ h.
H	1.8 to 3.4 Mc.	2"	2"	31. No. 24 en.	62	132.0 μ h.
		3"	2"	22. No. 18 en.	44	132.0 μ h.
		3"	1"	37. No. 24 en.	37	132.0 μ h.
I	.95 to 1.8 Mc.	2"	2"	57. No. 28 en.	114	455.0 μ h.
		3"	2"	41.5 No. 26 en.	83	455.0 μ h.
		3"	1"	69. No. 30 d.s.c.	69	455.0 μ h.
J	.50 to .95 Mc.	2"	2"	109. No. 34 s.s.c.	218	1680 μ h.
		3"	2"	81. No. 30 s.s.c.	162	1680 μ h.
		3"	1"	134. No. 36 s.s.c.	134	1680 μ h.

This table is good only for tuning capacity of 15 to 65 μ fd. It is calculated at 16 or 17 to 60 μ fd. approximately, in order to allow reasonable overlap between ranges.

Bake the coils thoroughly dry and give them several coats of radio-frequency lacquer, preferably "Victron." Coil supports, jack insulators, and tube socket should be "Victron" sheet, although a good grade of bakelite is satisfactory. Single-turn coils of tubing should be lacquered to prevent corrosion.

Calibration can be taken from any calibrated source of r.f. power. An oscillating detector in zero-beat with a known source will serve. In this way the Bureau of Standards or the A.R.R.L. Standard Frequency stations can be used. Lecher wires are best at the ultra-high frequencies. *But keep the frequency-meter coil well away from all other circuits and objects during calibration and use.*

The parts cost, even when buying everything, should be under \$35.00. Commercial units with

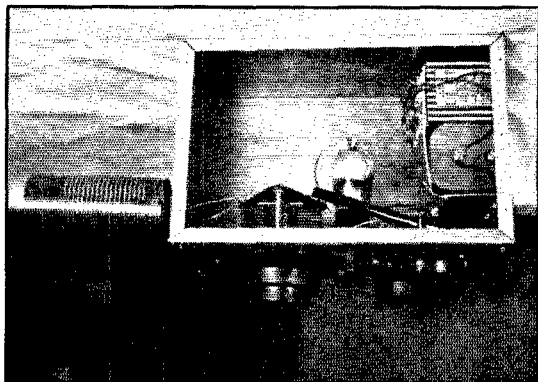

VIEW OF THE PRODUCTION TYPE INSTRUMENT ILLUSTRATING THE INTERNAL CONSTRUCTION

the diode detector net about \$100.00 when completely calibrated. The persistence of calibration can be made as good as with any other type by proper care in construction. A well-built job will last a long time if handled with even reasonable care.

There are many uses for these meters. Among them are such special jobs as checking harmonic content in the transmitted wave, antenna guy-wire oscillation, pickup in light and power wiring, relative field strength, etc. The detector alone, with the condenser set at minimum, makes a nice a.c. peak voltmeter. Because of the extreme sensitivity, much can be accomplished which other frequency-sensitive devices cannot touch—making this type meter a welcome addition in any amateur shack.

Strays

That 50-cycle undertone which identified the southern California 6's has largely disappeared since the changeover to Boulder Dam 60-cycle juice in the L.A. area. Thus time works another change.

A Few More Receiving Tubes—6V6G, OZ4G, 6H5, 25L6

THE current month has seen the addition of three new tube types to the receiving list. The 6V6G, a beam power tube designed for applications where the 6L6 would be uneconomical, has been announced by Ken-Rad; Raytheon has two new types in the OZ4G rectifier and the 6H5 electron-ray tube; and a "110-volt" beam tube, the 25L6, is added to the RCA line.

The 6V6G

Built particularly with automobile radio in mind, the 6V6G is a high-efficiency tetrode of the beam type, capable of giving high output with comparatively low filament and plate currents. Characteristics and operating conditions are given below:

Heater voltage.....	6.3 volts
Heater current.....	0.45 amp.
Amplification factor.....	218
Plate resistance.....	52,500 ohms
Mutual conductance.....	4100 micromhos
Total plate and screen dissipation.....	12.5 watts

Class-A Amplifier, Single Tube

Plate voltage.....	250 volts
Screen voltage.....	250 volts
Grid voltage.....	12.5 volts
No-signal plate current.....	45 ma.
Full-signal plate current.....	47 ma.
No-signal screen current.....	4.5 ma.
Full-signal screen current.....	6.5 ma.
Load resistance.....	5000 ohms
Power output.....	4.25 watts
Self-biasing resistor.....	240 ohms

Under the operating conditions outlined above, the second-harmonic distortion is 4.5 per cent, and the third harmonic 3.5 per cent.

Push-Pull Class-AB Amplifier

Plate voltage.....	250	300 volts max.
Screen voltage.....	250	300 volts max.
Grid voltage.....	-15	-20 volts
No-signal plate current*.....	70	78 ma.
Full-signal screen current*.....	79	90 ma.
Full-signal screen current*.....	5	5 ma.
Load resistance (plate to plate).....	10,000	8000 ohms
Power output.....	8.5	13 watts

* For two tubes.

Total harmonic distortion, 4 percent; third harmonic, 3.5 per cent. The 6V6G has the octal base with glass bulb. Pin connections are the same as for the 6L6G.

The OZ4G

The OZ4G is a full-wave gas-filled rectifier developed for use in vibrator-type "B" supplies for automobile receivers. The voltage drop is essentially constant over the usable load-current values.

(Continued on page 112)

An Inexpensive 160-Meter 'Phone for Local Rag Chews

By Walter van B. Roberts,* W3CHO

IT IS usually inconvenient to reduce power and shift bands on the "big rig" for local rag chewing on 160-meter 'phone, so that a small separate low-power transmitter is a useful adjunct to an amateur station. At any rate, the writer wanted such a little 'phone transmitter and decided to see what could be done with standard

employed at the input of the final stage, to permit adjusting the excitation, and to make it possible to tune the final grid to a harmonic of the oscillator. The set has not yet been operated this way (on a harmonic), however.

Three flashlight cells mounted inside the cabinet act as microphone batteries, the microphone plugging into a socket at one end of the cabinet. A single-pole single-throw toggle switch puts voltage on the filaments, while a double-pole single-throw toggle simultaneously closes the microphone circuit and applies voltage to the rectifiers for transmitting. A pair of pin jacks on the front panel permits a milliammeter to be plugged into the final plate circuit for adjustment. These jacks are shown shorted, since the milliammeter is not necessary once the rig is tuned up. The a.c. power lead comes out the right end of the cabinet, where another pair of pin jacks is located, one

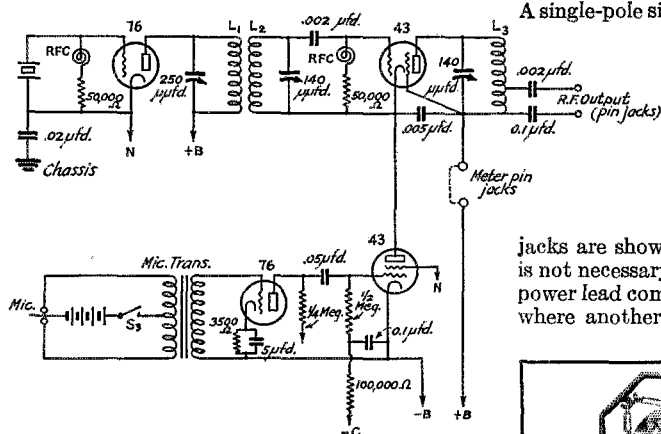

FIG. 1—CIRCUIT OF THE R.F. AND AUDIO SECTIONS OF THE 160-METER RAG-CHEW 'PHONE

L₁—Crystal oscillator plate coil, 35 turns No. 22 d.c.c., 1½-inch winding length.
L₂—Final grid coil, 45 turns No. 26 d.c.c., 1½-inch winding length.
L₃—Final plate coil, 55 turns No. 20 d.c.c., 2½-inch winding length.

All coils are wound on 1½-inch diameter forms. L₁ and L₂ are wound end-to-end on the same form with ½-inch separation between coils.

Switches S₂ and S₃ are a single d.p.s.t. toggle.

receiving equipment. After a few experiments the circuit of Figs. 1 and 2 was built into a small receiver cabinet as shown in the accompanying photos. It will be observed that by using a 25Z5 as a voltage doubler, the necessity for a power transformer was eliminated, while series modulation avoids any modulation transformer or choke yet gives the same sort of results as ordinary plate modulation. Thus the only parts required are such as can be bought cheaply in almost any radio store. The plate input of the 43 final r.f. stage is about 30 ma. at 100 volts, so that the output is of the order of two watts. The 43 being a screen-grid tube does not require neutralization, at least on the 1.75-Mc. band. A separate tuned circuit is

*155 Hodge Road, Princeton, N. J.

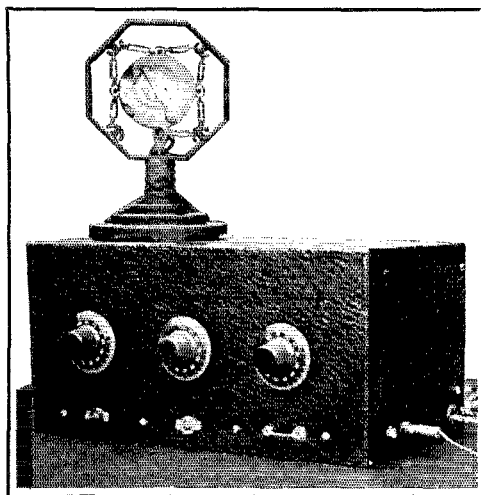

THE QRP 'PHONE RIG FOR LOCAL RAG CHEWING IS BUILT IN A RECEIVER CABINET

Expensive power supply equipment is eliminated by use of a voltage-doubling rectifier circuit and series filament operation.

connected to the chassis through a large condenser and the other connected through an r.f. by-pass condenser to a clip that may be attached

to any desired part of the final tank coil. The output is taken from these jacks.

More recently a modified 6L6 has come out for operation in transformerless sets. It is called the 25L6 and at zero grid potential has about twice the plate current of a 43, while plate current cut-off is produced by about half the grid voltage required by the 43. It would appear that

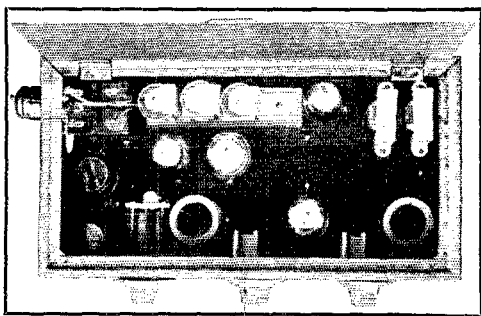

A PEEK INTO THE TOP OF THE TRANSMITTER CABINET REVEALS NEAT AND UNCROWDED ASSEMBLY

this new tube should work better in the transformerless transmitter than the 43. Although there has not been opportunity to try this new tube, it is unlikely that much change would have to be made in adapting the set to use a 25L6, since the heaters are the same.

However, due caution should be exercised in making the changes required by the greater current, for instance, in the bias supply for the mod-

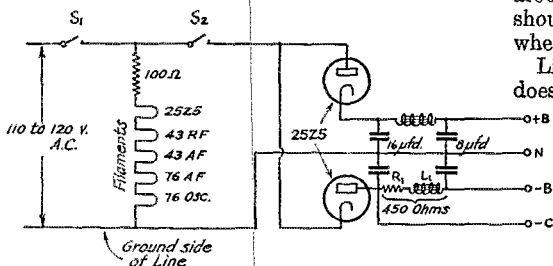

FIG. 2—THE TRANSFORMERLESS POWER SUPPLY CIRCUIT

A total resistance of approximately 450 ohms was found correct for L_1 and R_1 in series, but it may be preferable to use a variable resistor for R_1 and adjust bias to make the d.c. voltage drops between plate and cathode of each 43 about equal when the final amplifier is excited and tuned but not modulated.

ulator, grid leak for the final, etc. Perhaps it would be best to use cathode resistor bias for the modulator, since only about 8 volts are needed. It seems likely that about four watts carrier output could be realized with this tube—which will be more than a mere local rag chew job would need, considering all the R9 reports received up

to twenty miles distance in daytime on 160 'phone with the 43's 2-watt output.

This little rig, used on the 1.75-Mc. band with a quarter-wave antenna worked against ground, gets R9 reports at 10 to 20 miles, and has even been reported R7 at 70 miles, all daytime. At night there are usually too many strong signals on this band to do much in the way of finding out what it can really do on DX. Its chief merit is that it is cheap and can be left all connected up so that by merely switching the antenna from the big rig to the little one and throwing on the power, you are ready for local work.

Eclipse Expedition

(Continued from page 18)

B. King, Jr., W2BWF-W1GSH; H. Selvidge, W9BOE; John Alvin Pierce, ex1EB now W1JFO, and E. P. York, all of Cruft Laboratory; and Jackson Cook of M.I.T. The journey of the radio group was made possible through the generosity of RCA Communications, Inc. A complete list of many others who assisted in making the expedition possible is contained in the official report of the expedition in *The Technology Review*, November, 1936.

Boosting Output of L.-P. Transmitter

(Continued from page 17)

justed by bending the tank link coil until the tube is operating at 150 ma. input. Remember, though, that there's enough voltage floating around to qualify the operator for "Silent Keys" should he forget to disconnect the plate voltage when making any of these tank coil adjustments.

Little more need be said—except that the rig does get out. And who can deny that that's what we are after?

Strays

Here's a way to settle one of life's minor annoyances—the question of whether or not the soldering iron is really "on" when it doesn't heat up as you think it should.

Hold the wooden handle against your ear; if you hear a hum the current is on. If not, look, to the plug or socket; the circuit is open somewhere.

W1BDF is seriously considering the purchase of one of those "field strengthening" meters advertised in September *QST* (page 85). If it were only as simple as that!

Judging by some of the sounds heard during the Sweepstakes, a good many of the gang must have been under the impression that Rule 382 was suspended for the duration of the contest.

Dual-Triode Phase Inverters as Push-Pull Audio Drivers

Characteristics and Practical Operating Data for Typical Amplifier Combinations

By Curtis R. Hammond*

THE new beam-power tubes have created the demand for a simple push-pull driver having the desirable characteristics of low distortion, high gain, and wide frequency response. The phase inverter type of driver incorporating two triodes fills the above requirements with the additional advantage of low cost as a result of the reduction in the number of com-

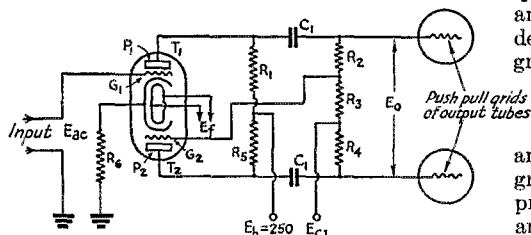

FIG. 1—THE DUAL-TRIODE PHASE-INVERTER CIRCUIT

Circuit values and operating conditions for different types of tubes are given in the table.

ponent parts necessary. In applications where a minimum amount of space is available, the double triode is of special advantage.

The theory of the phase inverter is not difficult and can be explained simply as follows: In the circuit of Fig. 1, E_{ac} develops a voltage across R_1 that also appears across R_2 and R_3 . The voltage across R_1 is 180° out of phase with E_{ac} , and if a portion of this voltage is fed to G_2 the resulting voltage output of P_2 in R_5 is in such phase relation that the grids of the output tubes, driven by P_1 and P_2 , are in the proper phase relation for push-pull operation.

To drive the output tubes properly the grid swing to each tube must be equal. To obtain this condition the voltage output of T_1 and T_2 must be equal. This is accomplished by dividing the output of T_1 with the resistors R_2 and R_3 so that the ratio of the voltage across R_3 to the total voltage across $R_2 + R_3$ is equal to the reciprocal of the amplification of the triode T_2 . Although

T_2 and T_1 do not have to be similar triodes, for any combination the above ratio must hold true. In many applications it is desirable to use a high-gain triode for T_1 and a low-gain tube for T_2 . The circuit of Fig. 2 shows the two-tube phase inverter.

The tube complement for the inverter stage is usually chosen to give the particular gain required with the limitations imposed by the plate and grid resistor values. For example, a driver is desired with medium gain to drive push-pull grids that can tolerate a maximum grid-return resistance of 50,000 ohms. This value is then that of R_4 and also the sum of the resistances R_2 and R_3 . Conventional resistance-coupled amplifier theory for the calculation of plate and grid resistors would limit the plate resistor to approximately one-half the value of the grid resistor, and R_1 and R_5 would therefore have to be approximately 25,000 ohms. The parallel impedance of these two resistors is 16,700 ohms and the plate resistance of a tube to operate satisfactorily with this load should be less than 8,000 ohms (approximately). The types 6C5, 56, 76, 6R7, 6A6, 53, 6N7, would be satisfactory if the voltage output

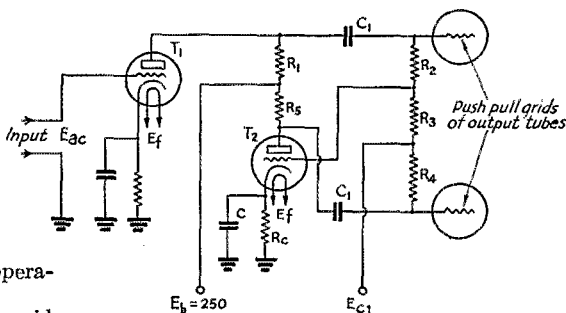

FIG. 2—PHASE-INVERTER CIRCUIT USING TWO SEPARATE TRIODES

T_1 is usually a high-gain triode and T_2 a low-gain triode, although T_1 may be a pentode in cases where high amplification is desired. The gain of T_2 is kept low so that the ratio $R_3/(R_2+R_3)$ can be maintained at some fixed value.

need not be too large. For low distortion and a high-voltage output the 6E6 would be better. The choice in any case depends upon the results desired.

*Ken-Rad Tube and Lamp Corporation, Inc., Owensboro, Ky.

Having selected a tube for the inverter, the gain can be calculated and R_2 and R_3 evaluated from the relation,

$$\frac{R_3}{R_2 + R_3} = \frac{1}{\text{Gain}}$$

The stage gain can be calculated by graphical methods with the aid of a plate current family or by using the equation

$$\text{Gain} = \mu' = \frac{\mu R_L}{R_p + R_L}$$

R_L is the parallel resistance of the plate resistor and the grid resistor of the following tube, while R_p and μ are plate resistance and amplification factor at the operating point. Published values of μ and R_p can be used with fair accuracy, provided that the plate load is not more than three times the plate resistance of the tube and the bias low enough that the operating point is not in the region of crowded plate current curves.

Typical operating conditions have been chosen and the various circuit components evaluated for several typical phase inverter tubes. The data are assembled in the table and show, in addition to circuit component values, the approximate

gain per triode, maximum output volts, operating bias, and plate current for each system.

TWO-TUBE COMBINATIONS

The component values for single tubes listed in the chart may be used to determine operating conditions for the inverter tube of a circuit similar to that of Fig. 2. In such a circuit, T_1 can be a high-gain triode or pentode and T_2 can be one of the low-gain triodes of the chart. The high-gain values of R_5 , R_2 , R_3 , R_4 and C_1 should be used. The value of R_6 should be twice that listed for R_6 in the chart.

As a typical example, a type 75 high- μ triode may be used for T_1 and a Type 76 used for T_2 . The high- μ tube could use a 0.25-megohm plate resistor with the sum of R_2 and R_3 equal to 0.5 megohm. The 0.5-megohm grid return resistance is especially desirable because the inverter tube high-gain values in the chart give 0.5 megohm as the grid resistor. The values of R_5 , R_2 , R_3 , R_4 and C_1 can then be taken directly from the chart. The plate current, gain, and other characteristics are also applicable.

If two dissimilar triodes are used, individual bias resistors and by-pass condensers are not

OPERATING CONDITIONS FOR SIMILAR TRIODES

Tube Type	R_6	R_1 R_5	R_2	R_3	R_4	C_1	Gain Per Triode	**Peak Output Volts E_o Approx.	Grid Bias Volts	Plate Current Per Triode
*6A6 53 6N7 6N7G	3,000	250,000	481,500	18,500	500,000	0.1 μ fd.	27.0	128	- 3.2	0.53 Ma.
6A6 53 6N7 6N7G	670	25,000	46,700	3,230	50,000	1.0 μ fd.	15.5	95	- 3.5	2.6 Ma.
6E6	1,500	25,000	40,000	10,000	50,000	1.0 μ fd.	5.0	125	- 15.0	5.0 Ma.
2-76 2-56	2,250	50,000	455,000	45,000	500,000	0.1 μ fd.	11.0	169	- 9.0	2.0 Ma.
79	3,000	250,000	489,000	11,000	500,000	0.1 μ fd.	47.0	124	- 2.0	0.33 Ma.
*2-6C5 2-6C5G	1,710	50,000	464,300	35,700	500,000	0.1 μ fd.	14.0	146	- 6.5	1.9 Ma.
2-6C5 2-6C5G	980	25,000	45,000	5,000	50,000	1.0 μ fd.	10.0	114	- 6.5	3.3 Ma.
*2-6R7 2-6R7G	1,600	50,000	458,000	41,600	500,000	0.1 μ fd.	12.0	143	- 7.0	2.2 Ma.
2-6R7 2-6R7G	750	25,000	44,750	5,250	50,000	1.0 μ fd.	9.5	95	- 6.0	4.0 Ma.

*High gain values.

** Maximum output obtained with a nominal amount of distortion. The output for 5% total harmonics is somewhat less than this value.

necessary. The cathode of the tube T_1 , which is normally a high-gain tube using a low value of bias, may be connected to a tap on the cathode resistor of T_2 . The resistance from the tap to ground would normally be low and the only by-pass condenser necessary would be that across the total resistance.

For several types, two operating conditions are

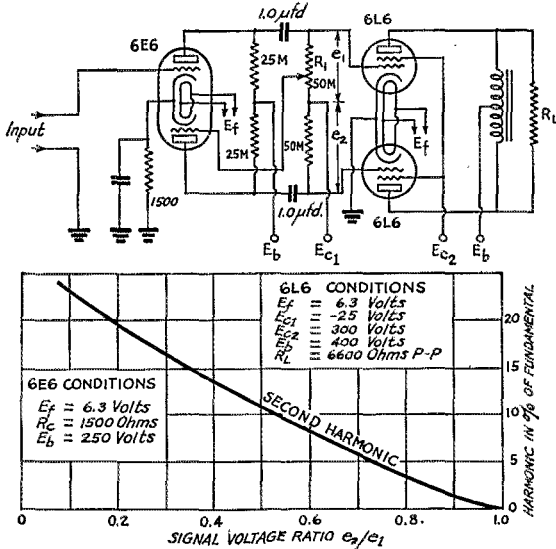

FIG. 3—SHOWING THE CHANGE IN DISTORTION FOR UNBALANCED SIGNAL TO GRIDS OF PUSH-PULL CLASS-AB 6L6 STAGE; e_1 AND e_2 BEING THE SIGNAL VOLTS TO THE 6L6 GRIDS

The signal voltage ratio e_2/e_1 is varied by the volume control R_1 . Each 6L6 develops a second harmonic that is cancelled because of the push-pull connection. If e_1 and e_2 are unbalanced, the second harmonics in the load are not cancelled.

shown. For these types a high-gain condition is given and low-gain constants are shown that allow a grid resistor of only 50,000 ohms to be used. Although this condition results in a much lower gain than is normally obtained, it makes possible the use of the phase inverter to drive fixed-bias Class-A and Class-AB output systems that use 50,000-ohm grid return resistors. The 6L6, for example, can be operated push-pull Class-AB with fixed bias to give 34 watts of undistorted output. This condition limits the grid return resistor to 50,000 ohms and any one of the drivers listed for operation with $R_4 = 50,000$ may be used.

BALANCE IMPORTANT

Experience with phase inverters has shown that the high-gain types using tubes such as the 79 or 6N7 are not always satisfactory because of unbalance of the two triodes. On production lines the high-gain inverter is difficult to balance because resistors R_3 and R_2 must be held to a very close

tolerance. Also, at high frequencies the tube and circuit capacitances in shunt with resistors disrupt the balance that may exist at low frequencies.

The degree of unbalance that may be tolerated depends upon the type of output tubes used. Output tubes that are over-biased usually develop a high second harmonic in each tube that is cancelled because of the push-pull connection. Class-AB systems whose operation is restricted to negative grid regions come in this class. But phase-inverter drivers must be balanced at all frequencies if undistorted output is desired. The curve of Fig. 3 shows the distortion that results from an unbalanced signal to the grids of Class-AB 6L6's. The distortion is second harmonic and results from the fact that one tube is driven to a greater output than the other. The Class-AB 6L6 system is typical of push-pull output tubes that develop a high second harmonic in each tube. Amplifiers of this type must be balanced or the second harmonic generated in each tube will not be canceled.

The 807 as a Crystal Oscillator

(Continued from page 19)

ever the center-tap arrangement probably allows more latitude in key click filters and has the advantage of being electrically behind the entire filter system.

As to results and operation, very little more could seem to be desired. Power inputs varied from 24 watts to 40 watts with varying values of plate voltage and plate-grid condenser C_2 . In comparison with the 6L6, the 807 appears to offer a greater stability and efficiency. It does not want to draw as much power as the 6L6 but does give more stable power output in the antenna. It offers definitely greater advantages at the higher frequencies. In other words, the results completely fulfilled the desires and exceeded the expectations. Later additions of power in this shack will certainly see the 807 in operation as oscillator or amplifier or both. Beam power means economy and results to the ham. In the short time in operation, the RST reports have all been of the 599X or 589 variety. Sufficient signal strength and stability have been shown to work through a surprising lot of QRM.

Strays

In the description of the 6L6 Tri-tet in November *QST*, mention of C_5 in the diagram on page 36 was inadvertently omitted. It is a 100- μ fd. midget, the condenser itself being a Cardwell Type ZU-100-AS.

About R.F. Voltage and Current Ratings of Mica Transmitting Condensers

THROUGH the years of blowing condensers in power-supply filter circuits, hams have learned pretty well the lesson of how to decide on condenser voltage ratings for that particular job. But when it comes to picking out a blocking or by-pass condenser of suitable ratings for r.f. circuits, a good deal of fog exists. As a means of clearing up this situation, we give below some extracts from material prepared by the engineering department of Aerovox.¹

Mica condensers are employed mostly for by-passing plate, screen, grid or filament circuits. The required rating for these condensers has been a mystery to many and few understand why it is necessary, for instance, to employ condensers with a 5000-volt rating when the highest voltage applied to the plates of the tubes is only 1500 volts.

There is also a widespread belief that the mica condenser can stand the maximum a.c. working voltage regardless of frequency, which is very far from the truth. All condensers heat up somewhat because of the current flowing through them. This current is out of phase with the impressed voltage, it is true, and serves to charge and discharge the condenser all the time. However, there is some heating caused by ohmic loss from current flowing through the terminals and the plates, and there are some dielectric losses which are transformed into heat. Consequently, there is a definite limit to the amount of current the condenser can carry, or rather to the power which can be dissipated by a condenser. This power remains approximately the same for all frequencies, but since the reactance of the condenser varies, the permissible current varies with frequency and with the capacity.

There are, therefore, two maximum ratings to the mica condenser, neither of which should be exceeded. The first is the voltage rating; the second is the current rating, which varies with frequency and capacity.

At certain frequencies one will be limited by the voltage rating only because that limit will be exceeded before the maximum current rating has been reached; this happens at low frequencies and for small values of capacitance. However, at higher frequencies and for higher capacitance the current increases for the same applied voltage and soon it is the current rating which is the first to be exceeded. This happens at high frequencies and practically always at frequencies employed by amateurs. In these cases the condenser is badly overloaded when the applied voltage is still far below the maximum voltage rating.

In order to use mica condensers intelligently, the designer must determine the current, voltage and frequency to which they will be subjected, and then he should determine which condenser will be satisfactory for the purpose. When the condenser is subjected to both a.c. and d.c. vol-

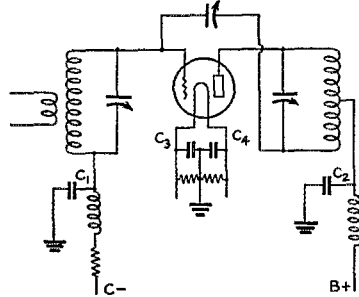

FIG. 1

tages, the sum of the d.c. voltage plus the peak a.c. voltage should not exceed the d.c. working voltage rating.

Determining the amount of current actually flowing through a by-pass condenser or the voltage across it will no doubt be the hardest task for the amateur. These quantities can either be measured or calculated. Since most amateurs have a radio-frequency ammeter, it is a good plan to place such a meter in series with the by-pass condenser in question in order to measure the current. It is true that the insertion of the ammeter changes the conditions somewhat but it would give an approximate idea.

The vacuum-tube voltmeter is another means for determining the voltage or the current. Measure the voltage across the condenser with the v.t. volt-meter and calculate the current by the equation:

$$I = \frac{2\pi f C E}{1000}$$

where f is in kc.

C in microfarads

E in volts,

I in amps.

The cathode-ray oscilloscope also can be used as a measuring instrument. Connecting the vertical plates across the condenser one can measure the height of the pattern, which can be read in volts when the sensitivity is known. The current can then be calculated as before.

When measurement is not feasible, calcula-

(Continued on page 116)

¹ From *Aerovox Research Worker*, October, 1936.

An Optical Pyrometer for Measuring Tube Plate Dissipation

By A. D. Mayo, Jr.,* W4CBD/9

IN ORDER to get an accurate check on the plate efficiency of a grid-modulated 211, an optical pyrometer was designed in its simplest form, built from the junk box, and found to give excellent results.

A pyrometer is a device to measure high temperatures. An optical pyrometer has a known variable, the amount of current needed to light a filament, changed to correspond to an unknown by sighting at the unknown right through the filament and adjusting so that the filament outline disappears. In this application the necessity of bothering with temperatures and currents is eliminated, since we can plot the scale of a rheo-

mine how much of the kilowatt is coming out of the final.

All of the parts are mounted on an elongated wooden box made up of four pieces of "apple" box material $\frac{1}{4}$ by 2 by 10 inches, and left open at the ends. Along the top of the box a piece of resistance wire 9 inches long, having a resistance of about 2 ohms, is stretched and secured to the wood by brass machine screws. Above this is mounted a length of square brass rod equipped with a slider to contact the resistance wire. Machine screws passing through $\frac{1}{2}$ -inch bakelite cubes secure the slider to the box at the ends. A flashlight bulb is mounted in a socket inside the

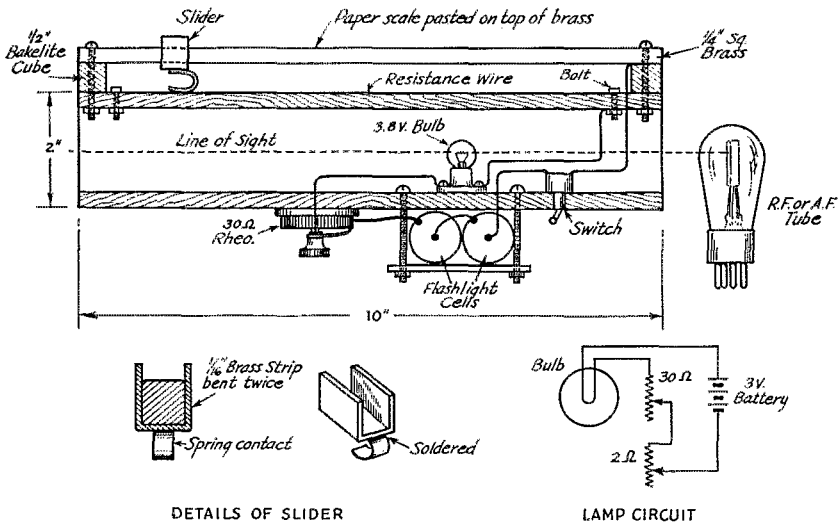

FIG. 1—SKETCH OF THE ASSEMBLY AND CONNECTIONS OF THE SIMPLE OPTICAL PYROMETER FOR MEASURING PLATE DISSIPATION

stat directly against tube dissipation watts. Once this relation has been established and charted, it becomes a matter of only a few seconds to determine the dissipation of a tube operating in the transmitter.

The use of the instrument is limited, however, to operating conditions where the tube shows noticeable color. For this reason it is not applicable to equipment using carbon- or graphite-plate tubes at or near their rated input. Some fellows using 852's or Eimacs may find it useful to deter-

mine how much of the kilowatt is coming out of the final. The scale which is to be read is laid off on a piece of heavy paper and then cut to a width of slightly less than $\frac{1}{4}$ inch. Then it is pasted along the top of the square brass rod. If the brass has a polished finish it may be necessary to roughen with a course round file or wood rasp

(Continued on page 86)

*Engineering Department, Burgess Battery Co., Freeport, Ill.

Note on Auto-Transformer Design

By T. W. Hopkinson,* W3AVR

A FEW months ago there appeared in *QST* an article on using the auto-transformer for voltage control.¹ Included was a description of how to make an auto transformer from an old broadcast-set power transformer. It may be that some of us will want to build one to handle more power than the primary of an old b.c. transformer will stand, or to get more voltage variation as well as better efficiency. It is the purpose of this article to show how simple it is to design an auto transformer to meet one's specific needs. This is most easily done by an example.

Suppose we have a plate supply transformer that gives 1000 volts each side of center-tap and we wish to drop the voltage to 700 volts each side for reduced power operation—or we may wish to use the transformer permanently in a 700-volt power supply. Since only one side of the secondary is utilized at a time, our calculations will be made from one-half secondary to primary. First find the primary voltage necessary to give a secondary voltage of 700. The secondary to primary ratio is:

$$\frac{1000}{110} = 9.1.$$

The primary voltage necessary to give 700 volts in the secondary is:

$$700 \times 9.1 = 77 \text{ volts.}$$

Next, determine the primary current from the secondary current, which say for example is 300 milliamperes.

Primary current = turns ratio \times secondary current

$$9.1 \times .3 = 2.73 \text{ amperes.}$$

(To check, $2.73 \times 77 = .3 \times 700 = 210$ watts.)

The primary current will actually be a little higher than 2.73 amperes because of magnetization current and iron losses. However transformers of this size should work at efficiencies of 90 per cent or better and for all practical purposes the current as determined above is correct.²

* Box 361, Charlottesville, Va.

¹ Blitch, "An Improved Method of Voltage Control," *QST*, August, 1936.

² The calculation as outlined above will be accurate only when the current figure used is the r.m.s. value, and only when the load is purely resistive. These conditions are satisfactorily met in the case of filament transformers. However, the peculiar conditions under which plate-supply transformers work modify the usual assumptions with respect to the current flowing in primary and secondary. The secondary volt-amperes can be calculated to sufficient accuracy by the formula

$$\text{Sec. VA} = \text{Total } E_{rms} \times I \times 0.75$$

in the case of choke-input filters (See Power Supply Chapter *The Radio Amateur's Handbook*) and in the case of condenser-input filters by the formula

$$\text{Sec. VA} = \text{Total } E_{rms} \times I \times 1.11$$

where Total E_{rms} is the total secondary voltage (not simply

Referring to Fig. 1, the auto transformer, T_a , must deliver 77 volts across AB at 2.73 amperes for the primary of T_p .

The number of turns per volt to be used on T_a can be found from the formula:

$$N = \frac{1}{4.44 \times f \times B \times A \times 10^{-8}}$$

where

f = frequency in cycles

B = Maximum flux density, which is 50,000 lines per square inch for transformers of this size. For larger transformers of this size. For larger transformers of this size might be used to control the line voltage of a 500- to 1000-watt transmitter, 60,000 lines per square inch may be used.

A = Cross section of the core in square inches.

For example, let us assume a core having a cross section of three square inches, which is the size of some of the larger b.c. transformers.

$$N = \frac{1}{4.44 \times 60 \times 50,000 \times 3 \times 10^{-8}}$$

$$= \frac{1}{13,310,000 \times 3 \times 10^{-8}}$$

$$N = \frac{1}{0.4} = 2.5 \text{ turns per volt.}$$

Total turns on $T_a = 115 \times 2.5 = 288$ turns.

Taps should be brought out for 110 and 105 volts to compensate for line voltage variations. These would be made at 275 and 263 turns respectively.

Since 77 is 67% of 115 ($\frac{77}{115} = .67$) the number of turns in AB is:

$288 \times .67 = 193$ turns, or $2.5 \times 77 = 193$ turns.

The total current delivered to the load is divided in the two sections of T_a and the current in each section is inversely proportional to the turns ratio of the two sections. The current in section BC is:

$$2.73 \times .67 = 1.83 \text{ amperes}$$

(Continued on page 114)

one-half secondary) and I is the d.c. load current. In small transformers it is customary to assume losses of about 10%, so that the primary VA would be about 10% higher than the secondary VA. Primary current can be calculated by dividing the primary voltage into the primary VA.

In the above example, therefore, the use of these formulas would bring about the following result, with a choke-input filter:

$$\text{Sec. VA} = 1400 \times 0.3 \times 0.75 = 315 \text{ volt-amperes}$$

$$\text{Primary VA} = \text{Sec. VA} + 10\% = 350 \text{ VA, approx.}$$

$$\text{Primary current} = \frac{350}{115} = 3.04 \text{ amp.}$$

With a condenser-input filter, the resultant currents would be still larger because the factor 0.75 increases to 1.11.

With the Affiliated Clubs

TOGETHER with all other forms of amateur radio endeavor club activities are reaching a seasonal peak. More and more organizations are bending their efforts toward the elimination of illegal operation in their areas and the establishment of reliable emergency facilities for their communities. Through well-prepared newspaper articles various clubs are bringing about a better understanding of amateur radio by the general public. A keener spirit of fraternalism is encouraged by club-sponsored state bulletins, hamfests, QSO parties, contests, etc.

In South Dakota the Miller Amateur Radio Club publishes a paper, "The Transmitter," which is mailed to every amateur in the Dakotas. This club is also originator of the fraternity "Kadosmah" of which there are now some 350 members. . . . The Tri-States Radio Club of Port Jervis, N. Y., completed a club house and is now comfortably situated in its new quarters. . . . Robert C. Lydon, W8KSY, Secretary-Treasurer of the Detroit Amateur Radio Association, writes, "With high hopes we are planning a program of fun and service which shall encompass those phases of amateur communication which have proven of sound value and the mainstay for so long in this, the most fascinating of hobbies. A 'one spot net' using 3656 kc. has been established by the Association in Lower Michigan, and traffic is moving through our state freely and fast from origin to destination." . . . The D.A.R.A. has published a monthly bulletin for five consecutive years. . . . Beginners in St. Louis, Mo., have a real friend in the Mound City Radio Amateurs. This club has two rooms in the Sherman Park Community Center, a city institution—one room is used as a class room where free instruction is given under club auspices; the other room is the club room, where a 500-watt c.w. rig and 250-watt 'phone rig is in operation on 3.5, 7 and 14 Mc. under the call W9YMA. Several hundreds of fellows between 14 and 18 years of age are being helped by this club's efforts. . . .

— — — —
W6SV

By Richard F. Barrett, W6CFK

THE Santa Clara County Amateur Radio Association of San Jose, Calif., is preparing for increased public service and at the same time perpetuating the name of its most distinguished member, the late Col. Clair Foster, W6HM.

When the Colonel closed his shack in the summer of 1935 for his annual vacation trip to British Columbia it was for the last time. In October

death found him at Denver, Colo., where he had rushed when stricken ill as he prepared to return home. As his friends recovered from the shock of his death, it became a natural speculation as to what would be done with the expensive equipment, which, sending out impulses from the shack among the pines of Carmel-by-the-Sea, had made the colonel's vigorous personality known the world over. Then, through Ralph Heintz, W6XBB, of Heintz & Kaufman, San Francisco, good friend of the Colonel, it was learned that Mrs. Foster desired to give to his home club, The Santa Clara County Amateur Radio Association, not only HM's radio equipment but all the curios he had collected as a result of his widespread operation.

The club was gratified but stumped by the need of a place to house the gift, having no regular rooms of its own. Inquiries were launched.

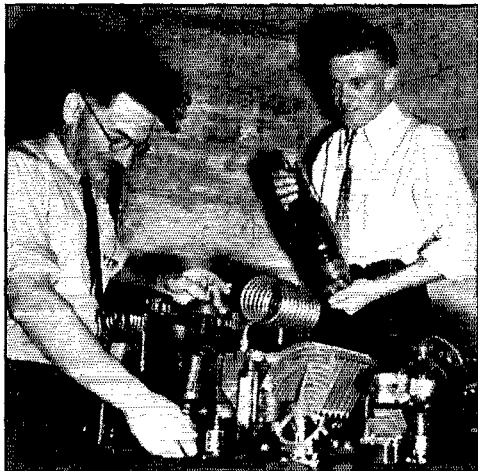

W6XJ AND W6NRG ABOUT TO FIRE UP THE W6HM RIG AT ITS NEW LOCATION SIGNING W6SV

The place that seemed most obvious was the city's new Municipal Auditorium, an earthquake-proof structure completed last spring after an expenditure of approximately \$675,000. In designing the building the architect had provided a copper-covered tower near the southeast corner for two reasons: first, to provide an outlet for the main exhaust fan and second, to balance the stage loft at the rear, giving the California-Spanish style structure dynamic symmetry, as he called it. After the fan was installed below and the motor to run it, there was ample empty space remaining. Like a famed Mormon leader

(Continued on page 108)

Testing Transmitting Tubes

A Practical Method of Checking the Emission of Doubtful Bottles

By T. M. Ferrill,* W5CJB

THE heart of a transmitter is the vacuum tube, and the heart of the vacuum tube is the cathode—in the case of the medium and high power tubes, the filament. The efficiency and output of an amplifier or oscillator stage is directly dependent on the condition of the tube filaments. A new transmitting tube has a filament which, when heated to operating temperature by the application of its rated voltage, emits electrons at an adequate rate for the proper operation of the tube. An old tube—that is, one which has been operated from several hundred hours to a thousand hours or more, perhaps to the full life of the tube—may have the same appearance when properly heated as the similar new tube. It allows a plate current to pass, although it may not be as large a current as in a new tube.

The average amateur is not so fortunate as to have a spare set of expensive new tubes similar to those in his transmitter; hence it is seldom convenient to compare new tubes with those in use to determine their condition and efficiency. He may assume that the tube in the r.f. final amplifier of his transmitter is operating as efficiently as it should, when in reality he is having to drive the stage harder and use more plate voltage to get as much current to flow in the plate circuit than he would with a normal tube. The efficiency of the stage is much lower than it should be. Many amateurs purchase used tubes, thinking that they are making a large saving, when actually the tubes have filament emission far below the normal value for the particular type, their useful life having already been spent, making them almost completely worthless. Many amateurs have had the misfortune to purchase a used transmitting tube, building at considerable expenditure of time and expense a transmitter designed specifically to make use of the tube, only to find it has been worn out by long use or improper operation. Since it is impossible to determine the condition of a tube by simply making a continuity test of the filament, and since it is often too inconvenient or nearly impossible for an owner to test his transmitting tubes by comparison with new tubes or by operating the tubes in another transmitter in such a way as to determine accurately their condition and reliability, it is the purpose of this discussion to point out a method of testing transmitting tubes.

It is usually convenient to test small tubes—

those up to and including the Type 210—in tube checkers designed for receiving tubes. For larger types of tubes used in transmission, however, other means must be resorted to. In making this test, the filament must first have its rated voltage applied at the filament terminals, for which purpose either a battery with a rheostat or a variable source of a.c. voltage must be obtainable, together with a suitable voltmeter connected at the terminals of the tube for adjusting the voltage under load to the rated value. Other essentials for proper testing include a source of known d.c. potential applied to the grid and so arranged that the grid may be made positive, zero potential, or negative, with respect to filament; a source of plate current at variable voltages; and means for measuring the various voltages and the plate current. In addition, provision should be made for applying such potentials as are required to the screens of tetrodes and pentodes. A basic diagram of the arrangement applied to a triode is shown in Fig. 1.

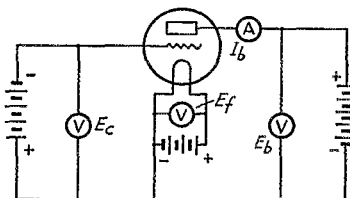

FIG. 1—A SIMPLE CIRCUIT FOR TUBE TESTING

The plate current which should result from the application of a number of fixed grid potentials and any plate voltage (under load) can easily and quickly be found by referring to the family of plate-characteristic curves obtainable from tube-manufacturers for the different types of transmitting tubes in common use. By testing the tube at two widely different grid voltages, it is easy to determine whether the grid properly controls the plate-current flow. This eliminates the possibility that the emission seems large in the first trial as a result of the tube being gaseous.

One interesting phenomenon which has probably troubled a large number of amateurs and other operators results from the use of a rather questionable tube in a newly built transmitter. Having already tested the oscillator and all the intermediate power amplifiers, the operator pro-

*State College, Miss.

ceeds to apply the plate voltage to the final amplifier, which contains the questionable tube, and finds the plate current proper, in resonance and out, loaded and unloaded; but upon allowing the stage to operate for several minutes with the final stage using medium plate current, it is found that the current gradually decreases, until the current

for large tubes should include a prolonged, medium-intensity plate current flow which will cause a tell-tale reduction of emission if the tube is worn out.

A testing arrangement applicable to almost any transmitting triode, tetrode, or screen-grid pentode, is shown diagrammed in Fig. 2. A small, tapped-secondary transformer, designed for use with toy electric trains, is a very convenient source of filament voltage, as the usual type is provided with a tapping and switching arrangement which provides voltages up to 15 in very small steps, and is rated at 75 to 100 watts. Heating the tubes with direct current from a battery is too expensive and inconvenient; hence the use of a.c. transformer filament supply. Any type of filament transformer of adequate power and voltage may be used if it is provided with suitable means of adjusting the voltage applied through a satisfactory range. Ratings of resistors and ranges of volt meters used in the circuit of Fig. 2 are not all given,

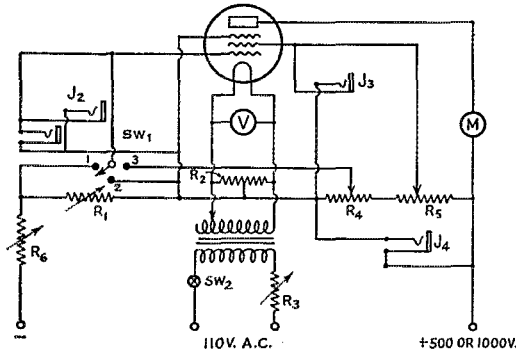

FIG. 2—A PRACTICAL TEST CIRCUIT FOR TRIODE AND MULTIELEMENT TRANSMITTING TUBES

R_1 —1000-ohm variable or tapped resistor.
 R_2 —100-ohm center-tapped resistor.
 R_3 —40-ohm variable resistor.
 R_4, R_5 —Values and watt-ratings dependent on range of tubes.
 R_6 —50-watt semi-variable, 4000-ohm.
 SW_1 —3-point tap switch.
 SW_2 —S.p.s.t. power switch.
 V —0.15 a.c. voltmeter.
 M —0.200 or 0.300 d.c. milliammeter, depending on tube plate current rating.
 J_1, J_2, J_3, J_4 —Jacks for d.c. voltmeter.
 Notes: J_3 and R_5 may be omitted if only triodes are to be tested.

at which it stops decreasing and remains constant is but a fraction of the original plate current which seemed proper. The natural assumption of the operator is that he has made some serious error in the design or construction of the amplifier, and that as a result the tube has been seriously injured. A simple explanation of this behavior is as follows: While working on the preceding stages, making the little changes and adjustments which are necessary to make the finished product give best results, the final tube has been in place, operating with filament power applied. The cumulative effect of these heatings of the filament with no plate or grid voltage application is a very temporary rejuvenation of the tube filament to normal activity, so that when the plate voltage is first applied to the tube, it operates just as a good tube would. A tube of extremely low emission which is "at the end of its trail" may be restored to normal activity by the application overnight of filament voltage only. Its restored emission is very temporary, however, and a plate current of constant voltage and medium intensity flowing through the tube only a few minutes will reduce the filament to its low-emission state. Since this is true, a complete test

since there is such a wide range of individual needs, different amateurs having entirely different sizes of tubes. Naturally, the larger the tubes to be checked, the more expensive suitable resistors will be, since higher heat dissipation in the resistors will result.

In Fig. 2, SW_1 is a single-pole three-position switch for applying a negative, zero, or positive potential to the control grid. In position 1, the grid is negatively charged and the grid voltage is varied by means of R_1 ; in position 2, the grid potential is zero; and in position 3, the grid is positively charged and its voltage is adjusted by means of R_4 . If the tester uses a.c. filament supply as shown, and grid-return connections are made to the electrical center in the filament circuit, add $(+) \frac{\text{filament voltage}}{2}$ to the grid voltage specified

in a family of plate-curves, if the voltage applied to the filament in making the curves was d.c.

The apparatus shown in Fig. 2 is shown connected to a five-element tube. When a tube with fewer grids is tested, the respective grid connections are simply left open at the tube socket.

Take the Type 860 tube as an example, and begin by referring to all obtainable data on the tube. Install the tube in the tester and adjust the voltage on the filament to 10 volts, allowing the tube 15 or 20 seconds to reach a normal filament temperature. Now, from the graph of a family of plate-characteristic curves, it is found that 500 volts is applied to the screen, and this voltage will accordingly be used in each of the trials made in testing the tube. Next, it is found that with a control grid voltage of +25, the plate current should be 100 ma. when 800 volts are applied to the plate. By a simple application of Ohm's Law, we find that the plate dissipation under these conditions would be 80 watts, a safe power for this

(Continued on page 118)

A Tuning-Fork Tone Generator of Simple Construction

By Charles W. Carter,* W3EZL

THE tone generator to be described generates a sine wave of constant frequency. Primarily this particular one was made with the idea of feeding the output directly into the microphone circuit of a radio-telephone transmitter for the purpose of making adjustments through the various stages while checking the r.f. output with an oscilloscope. It was also desired as a source of standard frequency for determining unknown frequencies by the Lissajous figure method. The generator performs these two functions.

makes a nice note to listen to when keying a c.w. transmitter. However, I know of no way to adapt it for this work without the use of a relay.

A typical circuit arrangement is shown.

The tone generator makes use of a tuning fork as a source of steady frequency. The idea is very old and, in more expensive forms, is used in many laboratories. The low cost and ease of construction have not been brought to the attention of the amateur and this probably accounts for the lack of use of the instrument.

The tuning fork is a 5th octave *C* having a pitch of 523.3 cycles and can be purchased from most large music dealers for seventy-five cents. The fork is rigidly mounted by means of heavy angle clips to a hardwood base. On either side of the fork at the open end is mounted a head 'phone which constitute grid-circuit and plate-circuit electromagnets. These 'phones are of the dollar variety with a thin aluminum case. The threaded part of the case has been cut off to allow the pole pieces to project. The clearance between the pole pieces and the fork is slightly less than $\frac{1}{16}$ inch. When connected as shown in the diagram of Fig. 1, any type of triode tube can be used with success. The output transformer is an ancient two-button microphone transformer.

Vibration of the fork prong nearest the grid circuit electromagnet produces e.m.f. which is amplified by the tube and, in turn, results in plate circuit reaction which sustains oscillation at a rate determined by the pitch of the tuning fork.

The tuning fork is usually self-starting in this location, probably because of ever-present vibrations from heavy traffic nearby; however, it may be necessary to strike it lightly to start it in other locations. Seven seconds are required for the volume to reach full intensity. Very little audible sound is made and when running with low plate voltage, it may be inaudible to the ear direct. In order to generate the purest wave form, the plate supply should be either from batteries or from a well filtered rectifier supply. The plate voltage should be as low as is consistent with the desired volume.

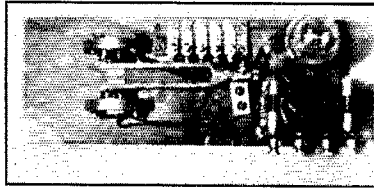

THE TUNING-FORK OSCILLATOR ASSEMBLY

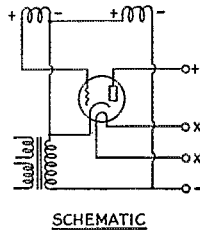
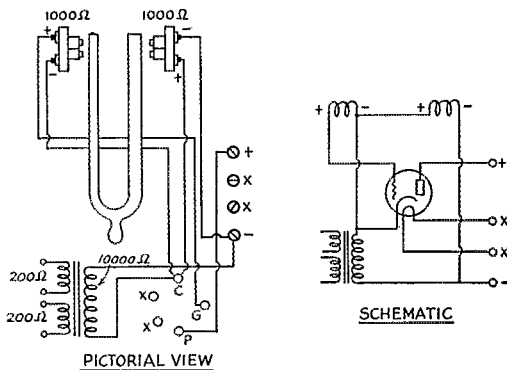

SCHEMATIC

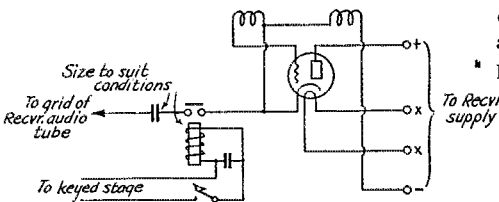

AS A KEYING MONITOR

FIG. 1—CIRCUIT DETAILS OF THE TONE GENERATOR

Some of the other uses suggested for this type of generator are: Frequency generator for a capacity bridge; source of tone for m.c.w. work (keying may be done in the output circuit.) It also

* 808 Prince St., Alexandria, Va.



Amateur Radio STATIONS



W8POQ, Cleveland, Ohio

W8POQ is owned and operated by Ralph K. (Bunny) Rex, Chairman of the Board of Directors of The Diebold Safe and Lock Company of Canton, Ohio. The station is located at the Rex residence in Cleveland, Ohio.

The owner's interest in amateur radio goes back to the early days when Bunny Rex, with his

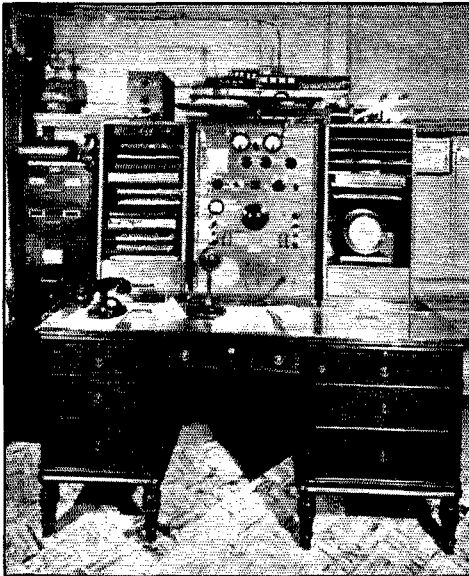

W8POQ

collection of spark coils, tuners and coherers, was one of the few local amateurs competing with the commercial stations for supremacy of the ether.

The press of business submerged his amateur activities, but the radio bug apparently had bit deeply, for in 1936 Mr. Rex, in conjunction with Mr. Lear of The Lear Development Laboratories, designed his present transmitter for his yacht at Miami, Florida.

Space being an important consideration in the design, the entire transmitter including power supplies and an HRO receiver is mounted in a cabinet thirty inches high, twenty inches wide and fifteen inches deep.

The r.f. section consists of a 6A6 crystal oscillator and harmonic generator, one 6A6 for additional harmonic generation on higher frequencies, a single 59 buffer amplifier driving an RK-28, suppressor-grid modulated. Ten crystals supply a total of twenty-eight frequencies on four bands on a minute's notice. Interlocked switches with pretuned tank circuits take care of this problem nicely.

The audio section comprises a 6A6, pentode connected, which is resistance coupled to a 6B5 modulator suitably coupled to the suppressor grid circuit of the RK-28.

Relays are provided for quick break-in operation with the well known push-to-talk method being used.

At the time this is being written plans are under way for a new one kilowatt transmitter of the very latest design. It is rumored that the new transmitter will switch bands at the snap of the fingers.

—W8FHE

— — — —

W2EVV, Jackson Heights, Long Island

SAYS Perry Driggs, W2EVV, "New York City hams are not only faced with b.c.l. trouble but with the space problem as well." How he has solved the last part of it is shown in the accom-

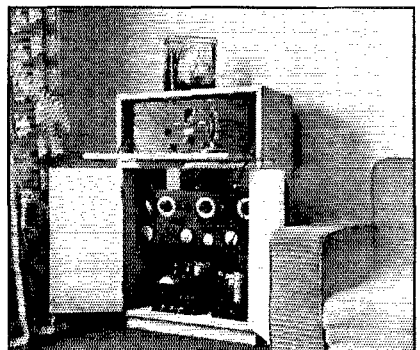

W2EVV

panying photographs. It strikes us as being a pretty snappy arrangement for the station which must be concealed in a living room.

The cabinet houses everything—receiver,

transmitter, modulator, and two power supplies. It was home-made for the purpose, having doors opening to permit the operator to get at the transmitter, and a hinged panel which serves as an operating desk when not closed up to conceal the receiver. To make the cabinet harmonize with its surroundings, it was given a coat of white enamel, then antiqued with burnt umber.



W2EVV? WHO WOULD GUESS IT?

The trim is unfinished black walnut. Dimensions are 38 inches high, 24 inches wide, and 15 inches deep.

As for the equipment itself, the transmitter consists of a 47 oscillator, 46 doubler, and two 46's in parallel in the final. The speech end includes a double-button mike working into a 58 resistance-coupled to a 46, which in turn drives two 46's in Class-B. Separate 400-volt power supplies are used for the r.f. and audio ends. R.f. power output is about 25 watts. A voltage-fed Hertz antenna is used. The receiver is a Hammarlund Comet Pro.

The rig has been on the air only a short time, since the present location is of recent acquisition. W2EVV formerly operated a similar 46 rig on 160-meter 'phone and a 100-watt job on 40- and 20-meter c.w. when the station was located at Bayside, Long Island, where considerably more space was available.

W6NZ, San Francisco, Calif.

THIS business of making radio apparatus blend in with furniture apparently is getting a good deal of amateur attention these days. W6NZ, owned by Sydney J. Fass, San Francisco, is an excellent example of the way the station can be dressed attractively. Such a rig should pass the inspection of the most critical of XYL's.

W6NZ has separate cabinets for receiver and transmitter, reconstructed from b.c.l. cabinets of 1926 vintage and painted antique ivory to match the other furniture in the room. This is a good tip for others who have no liking for building their

own—these cabinets can be purchased quite cheaply nowadays and are remodelled easily.

The transmitter, built on a metal rack with metal panels, has a 47 oscillator and RK-20 amplifier, using the circuit given in August, 1935, *QST*. The oscillator and amplifier occupy the middle section. Behind the lower panel is the power-supply equipment, giving 400 volts for the oscillator and 1000 for the amplifier. The top panel contains antenna-tuning apparatus. The transmitter works on 3.5 and 7 Mc. with several crystals; bands and crystals are switched from the front of the panel. The input to the RK-20 is 100 watts.

The receiver is an ACR-175, equipped with a Lamb noise silencer. The latter, incidentally, takes out the racket from the transmitter so effectively that noiseless break-in is possible even on the transmitting frequency. A doublet antenna, 33 feet on each side, has been found to be very satisfactory for reception on all frequencies.

W6NZ has been associated with radio for a long time: amateur from 1909 to 1911, commercial operator from 1911 to 1917, in Navy during the War, with many crossings to Europe on cargo and troop transports, resumed amateur radio in 1924 and has been active ever since. He has been in the Naval Reserve since 1925, and holds the rank of lieutenant. A good deal of the station activity is in connection with N.C.R. work.

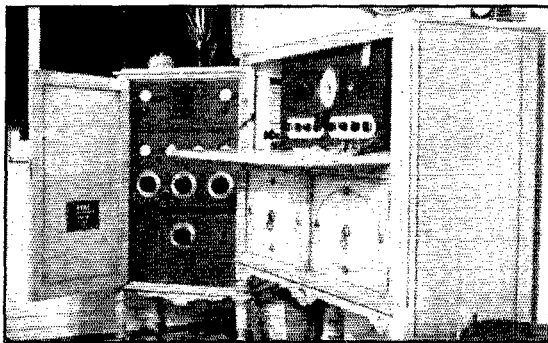

W6NZ

W6NZ also has been Radio Chairman for Navy Day for the 12th Naval District for the past three years.

The station is located on top of Telegraph Hill, one of San Francisco's highest spots, and overlooks the Golden Gate.

Strays

Bound Volume XX of *QST*

We have a limited number of Bound Volume XX of *QST*. This volume is made up in two sections, each containing six issues of 1936 *QST*. Handsomely bound and gold imprinted the complete volume is priced at \$5.00, postpaid.

• I. A. R. U. NEWS •

Devoted to the interests and activities of the

INTERNATIONAL AMATEUR RADIO UNION

Headquarters Society: THE AMERICAN RADIO RELAY LEAGUE, West Hartford, Conn.

MEMBER SOCIETIES

American Radio Relay League
 Associazione Radiotecnica Italiana
 Canadian Section A.R.R.L.
 Československi Amatér Vysílací
 Deutscher Amateur Sende-und-Empfangs
 Dienst
 Experimenterende Danske Radioamatører
 Irish Radio Transmitters Society
 日本アマチュア無線聯盟
 Liga Colombiana de Radio Aficionados

Liga Mexicana de Radio Experimentadores
 Nederlandsche Vereniging voor Internationaal Radioamateurisme
 Nederlandsch-Indische Vereniging voor Internationaal Radioamateurisme
 New Zealand Association of Radio Transmitters
 Norsk Radio Relæ Liga
 Oesterreichischer Versuchssendeverband
 Polski Związek Krotkofalowców
 Radio Club Venezolano

Radio Society of Great Britain
 Rede dos Emissores Portugueses
 Réseau Belge
 Réseau des Emetteurs Français
 South African Radio Relay League
 Suomen Radioamatööritto r.y.
 Sveriges Sandareamatörer
 Unión de Radiomisores Españoles
 Union Schweiz Kurzwellen Amateurs
 Wireless Institute of Australia

Countries:

This department is going to overrun its allotted space this month, anyway, so we haven't much time for introductory comment. We suggest you turn to page 40 of the October, 1935, issue of *QST* for the background (it was a piece called "How to Count Countries Worked," you may remember).

Yes, that's the subject. "How to count countries worked. . . . In that discussion we set forth how ordinary counting methods led one into no end of trouble, and then set forth a more or less simple rule for arriving at a total figure for legitimate countries worked. That is, we thought it was simple. Some of the gang have since registered disagreement. Finally, we slid gracefully (?) out from under the question of actually making a list of all the countries of the world by citing the plain fact that one could easily reach a total of six or seven hundred—and there weren't enough pages available in *QST*!

There came a time, though, when Fate caught up to us—when we could no longer elude the problem—when we had not only to actually list the countries of the world for ham purposes but also to boil the list down to a reasonable figure (a reasonable figure being, say, a couple of hundred). The instrument in the hands of Fate which brought about this pretty pass was the new A.R.R.L. Map of the World. On that map, like any good map, countries had to be shown. Not only did they have to be shown on the map, with a different color to each country (no simple problem in itself, with sixty times as many countries as colors!), but there had to be an indexed reference list at the bottom.

The connection between this map list and an "official list of countries, etc." was obvious. It offered a perfect vehicle for the general popularization and appreciation of a suggested standard list—not a perfect list, for no such list could be perfect, since inevitably there will be different persons who will be dissatisfied with different aspects of it—but at least a generally-recognized standard to which everyone could refer and use as a start for further argument.

And so we present to you not an "official list of countries," since "official" presumes general sanction and that can come only with time, but a list that we feel is just about as complete as could be made, fair to the DX man from the standpoint of giving credit where credit is due, and certainly a very definite starting point. Only official prefixes are included, so don't worry about the absence of "K5," "OM," etc.

We would like to help towards the acceptance of a standard of "countries worked." Our contribution follows. Your comment is invited.

Country	Prefix
Abyssinia, see Ethiopia	
Aden	
Aegean Islands	
Afghanistan	YA
Alaska	K7
Albania	ZA
Aldabra Islands	
Algeria	FA
Andaman Islands	

Country	Prefix
Andorra	
Anglo-Egyptian Sudan	ST
Angola	CR6
Arabia, see Saudi Arabia	
Argentina	LU
Ascension Island	ZD8
Australia	VK
Austria	OE
Azores Islands	CT2
Bahama Islands	VP7
Bahrain Islands	V88
Baleareic Islands	EA6
Baluchistan	
Barbados	VP6
Bechuanaland	
Belgian Congo	ON
Belgium	ON
Bermuda Islands	VP9
Bhutan	
Bismarck Archipelago	
Bolivia	CP
Borneo, Netherlands	PK5
Brazil	PY
British Cameroons, see Nigeria	
British Honduras	VP1
British North Borneo	VS4
Brunei	
Bulgaria	LZ
Burma	
Cameroons, French	FE8
Canada	VE
Canal Zone	
Canary Islands	EA8
Cape Verde Islands	CR4
Caroline Islands	
Celebes and Molucca Is.	PK6
Ceylon	VS7
Chile	CE
China	XU
Chosen (Korea)	J8
Christmas Island	ZC3
Cocos Islands	ZC2
Colombia	HJ
Comoro Islands	
Cook Islands	ZK1
Corsica	
Costa Rica	TI
Crete	
Cuba	CM-CO
Curaçao and Netherlands West Indies	PJ
Cyprus	ZC4
Czechoslovakia	OK
Danzig	YM
Denmark	OZ
Dominican Republic	HI
Eastern Island	
Ecuador	HC
Egypt	SU
Eritrea	
Estonia	ES

<i>Country</i>	<i>Prefix</i>	<i>Country</i>	<i>Prefix</i>
Ethiopia (Abyssinia)	ET	Nicaragua	YN
Faeroes, The	OY	Nicobar Islands	
Falkland Islands	VP8	Nigeria (British Cameroons)	ZD2
Fanning Island	VR3	Niue	ZK2
Federated Malay States	VS2	Non-Federated Malay States	VS3
Fiji Islands	VR2	North Borneo, see British North Borneo	
Finland	OH	Norway	LA
Formosa, see Taiwan		Nyasaland	ZD6
France	F	Ocean Island, see Gilbert & Ellice Islands	
French Cameroons, see Cameroons		Oman	
French Equatorial Africa	FQ8	Palau (Pelew) Islands	
French Indochina	FI8	Palestine	ZC6
French Oceania	FO8	Panama	HP
French West Africa	FF8	Papua Territory	VK4
Galapagos Islands		Paraguay	ZP
Gambia	ZD3	Persia, see Iran	
Germany	D	Peru	OA
Gibraltar	ZB2	Philippine Islands	KA
Gilbert & Ellice Islands and Ocean Island	VR1	Phoenix Islands	
Goa	CR8	Pitcairn Island	VR6
Gold Coast (and British Togoland)	ZD4	Poland	SP
Gough Island		Portugal	CT
Great Britain	G	Portuguese India, see Goa	
Greece	SV	Principe & Sao Thome Islands	
Greenland	OX	Puerto Rico and Virgin Islands	K4
Guadaloupe	FG8	Reunion Island	FR8
Guam	K6	Rhodesia, Northern	VQ2
Guatemala	TG	Rhodesia, Southern	ZE
Guiana, British	VP3	Rio de Oro	
Guiana, Neth. (Surinam)	PZ	Roumania	YR
Guiana, French, and Inini	FY8	St. Helena	ZD7
Guinea, Portuguese	CR5	Salvador	YS
Guinea, Spanish		Sardinia	
Haiti	HH	Samoa, U. S.	K6
Hawaiian Islands	K6	Samoa, Western	ZM
Hejaz	HZ	Sandwich Islands	
Honduras	HR	Sarawak	VS5
Hong Kong	VS6	Saudi Arabia	
Hungary	HA	Seychelles	VQ9
Iceland	TF	Siam	HS
Idni		Sierra Leone	ZD1
India	VU	Socotra	
Inini, see Guiana, French		Solomon Islands	VR4
Iran (Persia)	EP	Somaliland, British	VQ6
Iraq	YI	Somaliland, French	FL8
Ireland, Northern	GI	Somaliland, Italian	
Irish Free State	EI	South Georgia	VP8
Italy	I	South Orkney Islands	VP8
Jamaica and Cayman Islands	VP5	South Shetland Islands	VP8
Japan	J	Southwest Africa, see Union of South Africa	
Java	PK	Soviet Union	U
Kenya	VQ4	European States	U1-7
Kerguelen Islands		Asiatic States	U8-9-0
Korea, see Chosen		Spain	EA
Laccadive Islands		Spitzbergen, see Svalbard	
Latvia	YL	Straits Settlements	VS1
Leeward Islands	VP2	Sumatra	PK4
Liberia	EL	Surinam, see Guiana, Neth.	
Libya		Svalbard (Spitzbergen)	
Liechtenstein		Sweden	SM
Lithuania	LY	Switzerland	HB
Luxembourg	LX	Syria	
Macau	CR9	Taiwan (Formosa)	J9
Madagascar	FB8	Tanganyika Territory	VQ3
Madeira Islands	CT3	Tangier Zone	
Maldivo Islands	VS9	Tannu Tuva	
Malta	ZB1	Tasmania	VK7
Manchukuo		Tibet	
Marianas Islands		Timor, Portuguese	CR10
Marshall Islands		Togoland, British, see Gold Coast	
Martinique	FM8	Togoland, French	FD8
Mauritius	VQ8	Tokelau (Union) Islands	
Mesopotamia, see Iraq		Tonga (Friendly) Islands	VR5
Mexico	XE	Transjordan	ZC1
Midway Island	K6	Trinidad and Tobago	VP4
Miquelon & St. Pierre Islands	FP8	Tristan de Cunha	ZU9
Monaco		Tunisia	FT4
Mongolia		Turkey	TA
Morocco, French	CN	Uganda	VQ5
Morocco, Spanish	EA9	Union Islands, see Tokelau Islands	
Mozambique	CR7	Union of South Africa	ZS-ZT-ZU
Nepal		United States	W (N)
Netherlands	PA	Uruguay	CX
Netherlands West Indies, see Curacao		Venezuela	VV
New Caledonia	FK8	Virgin Islands, see Puerto Rico	
Newfoundland and Labrador	VO	Wake Island	K6
New Guinea, Neth.	PK6	Windward Islands (Grenada)	VP2
New Guinea, Territory of	VK9	Wrangel Island	
New Hebrides, British	YJ	Yemen	
New Hebrides, French	FU8	Yugoslavia	YT-YU
New Zealand	ZL	Zanzibar	VK1

HINTS and KINKS for the Experimenter



Note on Decoupling Circuits

By Franklin Offner, W9FTO

CIRCUIT decoupling has caused many designers and builders of amplifiers considerable trouble. The author himself had not a little grief with one particular circuit, and as we know several others having had the same trouble, we feel a few words on the subject might be valuable. This is especially true as the circuit has appeared in most technical radio publications. To get down to cases, the guilty circuit is that shown in Fig. 1-A. The so-called "decoupling network," composed of R_d and C_d , is supposed to keep the grid

circuit, and were quite chagrined to find that there was no noticeable effect upon removing C_d completely! Then the light dawned. Although the network evidently keeps point Y (Fig. 1-A) at cathode potential (for a.c.), to avoid degeneration we must apply the signal between the grid and a point at cathode potential—but here the signal is being applied between X and Z, and Z has the whole degenerative voltage developed across R_k between it and the cathode. (Anyone not satisfied with this proof can work out the circuit equation, which will be found to give the same result.) If the signal were applied between X and Z, everything would be fine, but to accomplish this, we must use transformer coupling (Fig. 1-B). However, if we wish to keep resistance coupling and cathode resistor bias we must by-pass R_k directly, as at Fig. 1-C. C_k should be large enough to keep the cathode at ground a.c. potential, for the signal is effectively being applied between grid and ground. In general, 5 to 25 μ fd. is adequate for good low-frequency response in audio amplifiers, depending upon the value of resistance used at R_k .

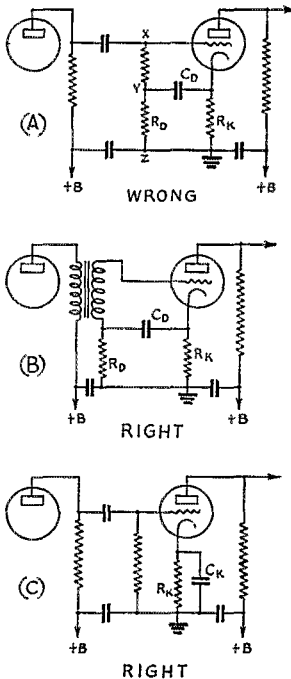

FIG. 1—THE WRONG AND RIGHT OF DECOUPLING CIRCUITS

bias constant over an audio cycle and, by this filtering out of the voltage appearing across R_k , prevent degeneration. To this end, the product $R_d C_d$ is made large compared to the period of the lowest frequency to be passed, and as R_d may be made large, a fairly small capacity is supposed to suffice at C_d . We built an amplifier using this

An Impedance Bridge

FIG. 2 is the circuit of an impedance bridge which I am sure many a ham would be able to use. I use it myself for balancing up LC circuits in the r.f. stages of receivers and for many similar purposes. The idea is to make up, say, the antenna coil and r.f. coupling coil of a short-wave super and connect one to each end of the bridge. If or when the inductances are equal there is no reading on the vacuum-tube voltmeter. Ganged condensers can be treated in the same way and checked right over their full scale. It is surprising what can be done in a tracking stunt like this. I have a super lined up with two r.f. stages and if you bend a grid lead out of shape it affects the a.v.c. meter.

A good method of checking is to use two resistances, one of 1000 ohms, fixed, and one variable of 1500 ohms. Connect the 1000-ohm standard to one pair of terminals (as 1 and 2) and the variable to the other pair; then find the point of balance on the 1500-ohm variable. Then if these are connected in series with the coils, condensers or resistors to be matched, you can tell at once whether it is a case of "too much or too little."

But before any measurements are made the bridge itself *must be balanced exactly*. This can be done by shorting terminals 1 and 2 together and 3 and 4 together. Make all coils alike and bring

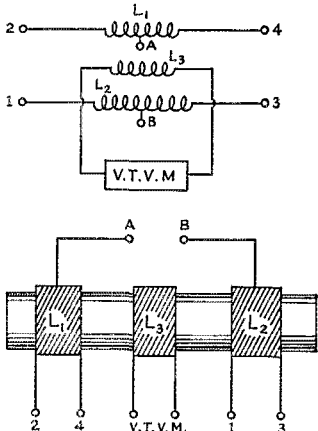

FIG. 2—AN IMPEDANCE BRIDGE USEFUL FOR MATCHING COILS AND OTHER MEASUREMENT PURPOSES

L_1 and L_2 are each 30 microhenrys, center-tapped; L_3 is the same without the center-tap. Various coil dimensions to give an inductance of 30 microhenrys can be secured by reference to the Lightning Calculator, Type A. For one-inch diameter tubing, a 30- μ h. coil will have 32 turns of No. 30 d.s.c. or s.c.c. wire. It is advantageous to keep the coils small in the interests of maintaining circuit balance.

the circuit to balance by adjusting the coupling. The layout and leads should be as symmetrical as possible; a suggested arrangement is shown in the lower part of the drawing. The frequency I use, applied between terminals A and B, is approximately 500 kc. Don't forget body capacity when using the bridge. View it from a distance.

—Maurice J. Kirk,
Jamestown, S. Aust.

Twisting Heavy Guy Wires

THE business of twisting guy wires on to egg and antenna insulators becomes a tedious and difficult process when the wire size is large,

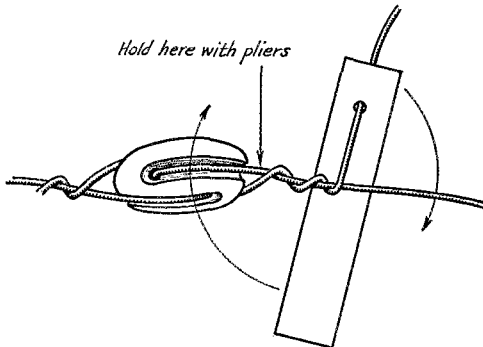

FIG. 3—USING A SIMPLE LEVER FOR TWISTING HEAVY GUY WIRES

as in the case with some of the high masts now in vogue. A labor- and time-saving device that is as simple as it is useful can be made from a piece of heavy iron or steel with a single hole, about twice the diameter of the wire, drilled about a half-inch in from one end. The wire is passed through the insulator, given a single turn by hand, and then held with a pair of pliers at the point shown in Fig. 3. By passing the wire through the hole in the iron, and rotating the iron as shown, the wire is quickly and neatly twisted, resulting in a junction that will satisfy the most meticulous.

—WJPE

Audio Oscillator Keying Monitor Without Relays

SOME months ago an audio oscillator powered from and keyed with the crystal oscillator was described in these pages. A somewhat similar scheme, but adaptable to any keyed stage in the transmitter, has been suggested by Frank Clark White, W8GPF. He writes:

"The advantages of listening to an audio note which is keyed at the same time the transmitter

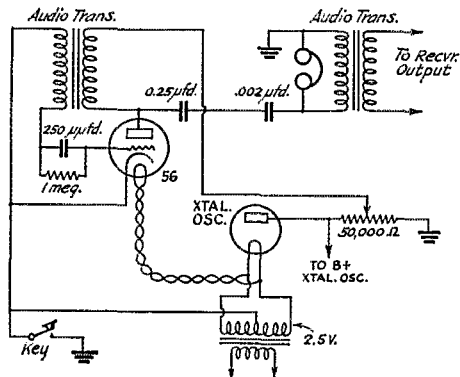

FIG. 4—AN AUDIO OSCILLATOR FOR KEYING MONITORING WHICH CAN BE KEYED WITHOUT RELAYS SIMULTANEOUSLY WITH THE TRANSMITTER

Practically any type of interstage audio transformer can be used. The tone of the oscillator can be varied to some extent by changing the value of the grid condenser or leak.

is keyed have been pointed out by many operators. For the ham who is just getting used to his mechanical key or the old-timer who sends at high speed and likes to hear his sending ripple in his ear, the system has universal appeal. In all of the QST articles I have read on this subject most fellows have approached the subject by using two 'phone jacks, one for the audio oscillator output and one for receiver output. Variations of this are the d.p.d.t. switch which shifts the cans from the audio oscillator to the receiver, and so on. One good system employed spare contacts on the keying relay which shifted the 'phones from one

output circuit to the other. In the composite transmitter of the Goodyear Tire and Rubber Company at Wingfoot Lake our chief engineer, Mr. Birdsall, approached what I would call the utopian in this problem of what commercial radio calls 'howlers or side tones.' A keyed audio note is dumped into the 'phones when you are sending without having to touch a switch. It works in all cases. Those who cut the plate power on their receivers or those who use break-in operation can use this system.

"As shown in the diagram, Fig. 4, the audio oscillator employs a 56 which is keyed in the cathode circuit. The cathode lead is connected to the side of the key which is intermittently grounded as you key the center tap of your transmitter. The output of the 56 is fed through a 0.25- μ fd. condenser to the audio transformer, which can be any old audio transformer which does not attenuate the output from your receiver too much. None of the circuit constants are critical and the plate voltage of the 56 as well as the filament voltage can be obtained by tapping into the crystal oscillator stage."

It can be observed readily from the diagram that the audio oscillator can be connected to any keyed stage so long as the power supply for that stage has a bleeder from which a suitably low voltage can be tapped.

— — — —

Kink for Soldering Coil Prongs

SOLDERING wires in coil form pins is one of those jobs we like least to do, one of the reasons being that it's usually hard to make the solder stick to the pin unless the latter is heated almost to the point where it softens the form, a second being the fact that excess solder and rosin have to be scraped off afterwards. Fig. 5 shows how a simple "alteration" can be made to a soldering iron to simplify the process considerably. A hole about twice the diameter of the pin and about $\frac{3}{16}$ -inch deep is drilled in the copper

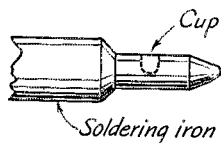

FIG. 5—DRILLING THE SOLDERING IRON FOR SOLDERING COIL PRONGS

point. This is then filled with solder. When coil prongs are to be soldered, the iron is fastened horizontally in a vice, the prongs given just a touch of flux and then dipped in for a second until the solder bites in. The wire should be clipped off rather short, leaving about a sixteenth inch projecting from the pin, before soldering. After the job has cooled a little so that the solder has set, the excess flux can be wiped off with a rag wet with alcohol.

One tip—the iron should be big enough so that

the solder in the cup will be good and hot. If the iron is too small, a scum will form over the surface and some of it may collect on the outside of the pin.

The suggestion comes from W1HRX.

A.R.R.L. QSL Bureau

FOR the convenience of its members, the League maintains a QSL-card forwarding system which operates through volunteer "District QSL Managers" in each of the nine U. S. and five Canadian districts. In order to secure such foreign cards as may be received for you, send your district manager a standard No. 8 stamped envelope. If you have reason to expect a considerable number of cards, put on an extra stamp so that it has a total of six-cents postage. Your own name and address go in the customary place on the face, and *your station call should be printed prominently in the upper left-hand corner.*

W1—J. T. Steiger, W1BGY, 35 Call Street, Willimansett, Mass.

W2—H. W. Yahnel, W2SN, Lake Ave., Helmetta, N. J.

W3—R. E. Macomber, W3CZE, 418 10th St., N. W., Washington, D. C.

W4—B. W. Benning, W4CBY, 520 Whiteford Ave., Atlanta, Ga.

W5—E. H. Treadaway, W5DKR, 2749 Myrtle St., New Orleans, La.

W6—D. Cason Mast, W6KHY, 423 East E Street, Ontario, Calif.

W7—Frank E. Pratt, W7DXZ, 5023 So. Ferry St., Tacoma, Wash.

W8—F. W. Allen, W8GER, 324 Richmond Ave., Dayton, Ohio.

W9—George Dammann, W9JO, 319 Sherman Ave., Evanston, Ill.

VE1—J. E. Roue, VE1FB, 84 Spring Garden Rd., Halifax, N. S.

VE2—W. H. Oke, VE2AH, 5184 Mountain Sights Ave., N. D. G., Montreal, P. Q.

VE3—Bert Knowles, VE3QB, Lanark, Ont.

VE4—Dr. J. J. Dobry, VE4DR, Killam, Alberta.

VE5—E. H. Cooper, VE5EC, 2024 Carnarvon St., Victoria, B. C.

K4—F. McCown, K4RJ, Family Court 7, Santurce, Puerto Rico.

K5—John J. Carr, K5AV, 78th Pursuit Squadron, Albrook Field, Canal Zone.

K6—James F. Pa, K6LBH, 1416D Lunalilo St., Honolulu, T. H.

K7—Frank P. Barnes, K7DVF, Box 297, Wrangell, Alaska.

KA—George L. Rickard, KA1GR, P. O. Box 849, Manila, P. I.



OPERATING NEWS



Conducted by the Communications Department

F. E. Handy, Communications Manager

E. L. Battey, Asst. Communications Manager

FLASH! A.R.R.L. Official 'Phone Station W6ITH, operated by D. R. Tibbetts in the East Bay Section worked all 69 Sections in the League's Field Organization on 'phone in the short space of two week ends in the recent "S.S."!!!!!! 223 stations were contacted in 69 Sections (including Alaska, P.I., Hawaii, etc.) making 30,774 points in 35 hours work, with 1,000 watts power. W6ITH found the different 'phone bands useful in the following order for making this record 'phone performance:

28	Mc.....	111 contacts
14	Mc.....	46 contacts
3.9	Mc.....	38 contacts
1.9	Mc.....	14 contacts
56	Mc.....	14 contacts
112	Mc.....	1 contact

All contacts were two-way 'phone. This objective of all 69 A.R.R.L. Sections in an "SS" and O.R.S.-O.P.S. parties has been approached on c.w., but never accomplished before on either c.w. or 'phone. It took *operating* to get those SS-exchanges across. **Congrats, W6ITH!**

About message count: Everyone is invited to claim full credits for messages handled by amateur radio in monthly reports to A.R.R.L. SCMs, including the new "additional delivery credit" that was explained in August '36 *QST* (p. 37). Let us get this counting plan straight. The basis of A.R.R.L.'s count has always been that a message counts *one* in the total each time it is handled *by radio*. (Classify as *originated* each message you start at your station, as *delivered* each that ends its radio journey by reaching the addressee through your station, as *relayed* those received by radio and forwarded by radio counting a possible two points for each completed relay.)

An *extra delivery credit*, in addition to the above, should now be reported for all deliveries requiring an *additional* means or effort of the delivering operator, such as when a radiogram is delivered in person, by mail, telephone, messenger or other external means to an operator, station, or individual not on the premises of the delivering station. New "station activity report" forms are available to any amateur on request. Whether you handle messages or not, a report giving latest station dope, your frequency, operating hours, skeds, 'phone chews, DX, experiments, etc., will be welcomed by your SCM. A report from *every active ham*, every mid-month, is desired. Whether you are a League member or not—report, so

your work can count for amateur radio. If you delivered messages for other than those manning your station, don't forget to report those, both as "deliveries" and again under "extra delivery credits."

No message should be considered as "handled" until radio acknowledgment (QSL) of same is received with full entry of handling data on the traffic for purposes of record.

About word count and checking messages: Yea, bo, every message does bear a check *this* season. FB, gang. The burden of our remarks at this time will be to the effect that "what good is a message check" when they start if receiving and handling operators don't use that check and "argufy" about the count when words are noted missing! The best way to check the count with ease (and it is easy when you develop the knack) is to copy five, or ten, or fifteen words to the line, at any rate spacing them as they come, *in groups of five*. When you get to the signature it is then only necessary to glance at the number of such groups and multiply, adding any words left over, to get the check. Then when you confirm the word count, and not before, is the proper time to QSL (acknowledge or receipt for) the message, after which acknowledgment it may be counted as handled by both participating stations.

Don't hesitate to ask the sending operator about the word check. If it isn't right use of "QTB" will make it right or explain the discrepancy in short order! It adds to the fun of handling 'em to *do it right* in every such respect, too. One or two reminders about word count may be in order. (See full explanation this subject in the *Handbook* chapter on Message Handling.) Some ops have been trying to count each letter either in a call, or a standard abbreviation as one each. *Mixed figures and letters do count* that way. But not only do standard terms, sent together like a.m., p.m., o.k., FOB, NCS, ARRL, QTA and the like count as one word, but "groups of letters which are not dictionary words . . . count at the rate of five letters or fraction thereof to a word." HHCARA counts as two words. *Any letter combinations of five characters or less count "one"!* We note errors in some calls coming through many relays. This can be avoided by sending code words or always repeating unusual letter combinations as transmitted. For example:

Send W6LMD as either WATCH SIX LOVE MIKE DOG or W SIX LMD, IMI LMD.

But use such precautions! We got one message that should have been signed "Wightman" as W EIGHT MAN!! Hi. When numbers are in the text, count a word for each numeral, whether it stands for some abbreviation or not. 73 counts as two words—4321 is four words, and so on. To sum up: (1) Count by copying in groups of five as they come in. (2) Challenge checks before QSL. (3) Watch accuracy!

Interference: Several foreign amateur stations have been reported by the American Telephone and Telegraph Company as near the 14,440-ke. channel assigned to GBW, Rugby, England, and causing interference at different times. This 14,440-ke. channel is used extensively at this time of the year for transoceanic telephone service. All U.S.A. and Canadian amateurs working stations whose frequencies fall outside the 14-Mc. amateur band (most particularly those near 14,440!) are requested to advise such stations of the interference possibilities in connection with GBW. Trouble is reported also on reception of GFD, Bermuda, 10,052 kc. and LSN, Buenos Aires, 21,020 kc. Caution regarding attention to frequency observance is urged on all amateurs at this time, as we enter another season of active operating. *Checking all ham stations for possible harmonics and parasites* is also the part of wisdom.

—F. E. H.

Results, N. E. Birthday Party

Director Noble, W1BYR, A.R.R.L. New England Division, reports the following scores in the New England Birthday Party held October 10th and 11th (details on page 64, October '36 QST). Stations whose calls are underlined are leaders in their respective sections.

W1UE, 13,120; BFT, 9300; EOB, 7250; GME, 3900; EAO, 3550; GNF, 3230; TS, 2970; FE, 2860; LKM, 2640; IP, 2430; FSV, 2380; IEU, 1820; BVR, 1750; ABG, 1690; JMY, 1690; GKM, 1680; BEF, 1650; IIN, 1400; EMG, 1330; FFL, 1330; HYF, 1210; CTI, 990; QW, 880; JAH, 750; INF, 720; GOJ, 675; AXN, 650; IAV, 650; HKK, 620; ITI, 600; AUY, 520; SW, 495; GVV, 270; IWC, 270; IJW, 175; DIE, 150; EBY, 150; EFR, 140; CFO, 125; DLX, 100; HKY, 100; (Vermont station who forgot to give his call—72); JFV, 20; (JFN reported participation but gave no score).

Number reporting from each section: Connecticut, 16; Eastern Mass., 10; Western Mass., 5; Maine, 4; New Hampshire, 4; Vermont, 4; Rhode Island, 1. W1UE, the high scorer, contacted a total of 82 stations. At the time of his 71st QSO, ages averaged 28.5 years. Many of the fellows reported interesting instances—such as working fellows whose birthdays were the same as theirs.

High Sweepstakes Scores

FROM the SS Contest logs already received the following "claimed scores" above 20,000 have been tabulated. A new record was established in the '36 SS by W6ITH, who worked all 69 A.R.R.L. Sections—all two-way 'phone!! W3BES appears to have established a new high QSO's-per-hour SS record. He was leading man in QSO's (563) in the 1935 SS, which was a 90-hour affair. In the 1936 40-hour contest, he worked 403 stations, a performance equal to 161% of his 1935 results (10 QSO's per hour in '36 against 6.3 per hour in '35). And now for the high claimed

scores already in, W6KFC and W3BES running almost neck-and-neck for highest honors. Figures show score—stations worked—sections worked:

W6KFC	51708-278-62	W7EK	28320-236-60
W3BES	51456-403-64	W2PY	27864-216-43
W9LLW	47415-274-58	W9WV/9	27103-159-57
W4CYC	43828-240-61	VE3JT	26255-223-59
W5KC	43725-265-55	W5CPB/5	26175-125-50
W9RSO	43200-240-60	W9TJF	25996-164-53
W6HJT	40507-254-55	VE3AEM	25915-222-39
W1TS	39406-211-63	W8OKC	25650-171-50
W8KUN	39273-247-53	W3FTK	25380-188-45
W2HJK	36375-243-50	W6LCA	25245-165-51
W9ELL	34844-281-62	W8NLQ	24763-184-60
W4PL	34692-207-56	W2BXA	24700-238-52
W6ITY	34427-198-59	W6LDJ	24255-148-55
W1RY	34426-195-59	W9CFB	24219-156-54
W8AQ	33858-257-66	W9EGQ	24150-161-50
W9VKF	33390-210-53	W8FIP	23664-204-58
W1APU	32661-191-57	W2GUP	23557-175-45
W1INF (Hal)	32306-281-58	W2IOP	23355-173-45
VE3ACS	31248-187-56	W5DGP	23166-143-54
VE4OC	31164-186-56	W8QQB	22605-137-55
W6ITH (Phone)	30074-223-69	W9GIL	22518-209-54
W9TWC	30654-203-62	W8OYK	22388-193-58
W4BOU	30108-194-52	W9PNE	22260-140-53
W9RBN	29925-263-57	W7CRH	21546-127-57
W9EYH	29415-187-53	W5DQD	21230-193-55
W9CWW	29400-175-56	W5CUX	21226-134-53
W1UE	28957-215-45	W1ENW	20725-171-41
VE3GT	28840-191-51	W3ADE	20700-150-46
		W9MGV	20272-133-51

Of these, the following worked over 200 stations. W3BES worked 403; W1INF (Hal) and W9ELL each worked 281, W6KFC 278, W9LLW 274, W5KC 265, W9RBN 263, W8AQ 257, W6HJT 254, W8KUN 247, W2HJK 243, W4CYC 240, W9RSO 240, W2BXA 238, W7EK 236, VE3JT 223, W6ITH 223, VE3AEM 222, W2PY 216, W1UE 215, W1TS 211, W9VKF 210, W9GIL 209, W4PL 207, W8FIP 204, W9TWC 203.

The following worked 55 or more Sections. W6ITH (Phone) leads with 69 Sections! W8AQ 66, W3BES 64, W1TS 63, W6KFC 62, W9ELL 62, W4CYC 61, W7EK 60, W8NLQ 60, W9RSO 60, W1RY 59, VE3JT 59, W6ITY 59, W1INF (Hal) 58, W8FIP 58, W8OYK 58, W9LLW 58, W1APU 57, W7CRH 57, W9RBN 57, W9WV/9 57, VE3ACS 56, VE4OC 56, W4PL 56, W9CWW 56, W5DQD 55, W5KC 55, W6HJT 55, W8QQB 55.

Attention, R. C. C. Applicants

Applications for membership in the Rag Chewers' Club (see page 52, Dec. QST) are arriving at Headquarters in every mail. Interest is high. Two important factors in the rules for R.C.C. membership are being overlooked by many of the applicants. First, it is necessary that the "ragchew" (of at least one half hour duration) be with an amateur who is already a member of the club. Second, it is necessary for both the applicant and the club member worked to submit confirmation of the contact to the Rag Chewers' Club, A.R.R.L., West Hartford, Conn. Be sure the member worked sends in a confirmation of the "chew" . . . and send in your application with necessary details immediately following the contact.

Early members of the R.C.C. who are still active on the air are requested to send a QSL card or message to Headquarters with this information so that they may be included in the active Roster.

— . . . —

Hams who have been listening to the fine ham program broadcast by KMTR, Los Angeles, 570 kc., each Saturday, 1 A.M. PST, will be interested in the announcement received from SCM Draper, W6GXM, that this has been changed to Sunday mornings, 1 A.M. PST. All radio amateurs are invited to listen.

— . . . —

W9PWU, Arvada, Colo., is sending code practice on 1940 kcs., Tuesday and Friday at 7 P.M. and Sunday at 2 P.M.

QRR Preparation

By H. J. Burchfield, W6JTV, SCM.

PROCRASTINATION has been the downfall of many a well-intentioned project. Let us not leave 'til tomorrow that which should be done to-day. With this failing in mind a group of fellows in Oakland, California, have done something about it. The plan followed seems to be the most likely and workable so far thought of. Two separate organizations have undertaken two objectives in the line of preparedness. The Oakland Radio Club have gone ahead with the idea of developing fool-proof five-meter mobile communication, where power may be utilized from storage batteries. Another local group known as The Society of Amateur Radio Operators (or S.A.R.O.) has made strides in emergency a.c. powered 160-meter 'phone communication, alternating 80-meter c.w., working from the harmonic of their 160-meter crystals.

The SARO has three complete a.c., 110-volt emergency powered rigs (two more in process of construction). Their combination 160 and 80 rigs are practically all of the same construction, so that any operator will be entirely familiar with any station. A pair of tens, modulated with a pair of 46's in Class B is used. The power supply consists of new Briggs-Stratton gas engines, one-half to one horse power, driving rewound Dodge generators that in turn furnish a.c. for transmitters and receivers. The power supplies are light, so that two men can transport them by hand. With these rewound jobs we get 400 watts running self excited, and as much as 800 watts running with separate field excitation. 400 watts of a.c. at 110 volts is plenty when things are in a jam, when the power-mains are down and no power of any kind is available.

The five-meter mobiles are usually transceivers, with which economy of operation is combined with extreme flexibility of frequency control. Usually of the better and more advanced type, the super-regenerative receivers will cause little or no QRM by a transmitted signal when the rigs are on the receive side.

The 160-meter rigs are set up in the closest possible location to the center of trouble. A five-meter stationary set-up is assigned to each of these lower frequency stations. The mobiles are assigned to their nearest fixed set-up as determined by geographical location. (Several of the mobiles are dry-battery operated so the rigs may be carried bodily to where they are needed.) The 160-meter stations are of course in contact with each other over far greater distances than possible with five meters. That means practically a whole large city may be covered with three to five major stations.

An example of what is possible: A falling building may have injured many inmates; a mobile five-meter rig is available. A message is flashed to the nucleus station; this is passed on to the 160-meter operator. He in turn gives it to the station at relief headquarters, from which point Red Cross workers can proceed at once to the scene with medical supplies. Laborers to clear debris, police protection, or other requirements can be sent without delay. If rising waters endanger a temporary hospital set-up, word may be dispatched by five meters and 160 meters to headquarters, where the necessary workers can proceed with the evacuation. Another. A certain Red Cross Official's advice or presence may be required at another point than that at which he is working. Word is passed from headquarters to his known nearest 160 station, thence by five-meter 'phone to the mobile five working in that vicinity, who in turn dispatches a Boy Scout messenger to find the desired official. Other instances could be cited as to the value of the system, but use your own imagination. Telephone lines down, power cut off, roads torn up, repeated seizures of the earth in the offing, another tornado due, demands for this and that, envision the whole thing for yourself. Prepare for the worst and pray for the best.

Communication outside the stricken section of the country has been thought of and taken care of. This has been turned over to the U. S. Naval Communication Reserve in its entirety. With their already existing network, a corps of trained operators at the keys in various localities, their work needs no enlarging. Well-equipped, with emergency power

for their larger transmitters, and their splendid training and "esprit de corps" that their work will be well done goes without saying.

Fellows, may I point out the fact that the amateur is a "service." His only excuse for being on the air in the minds of the powers-that-be is that his work is a training for essential military communications defense and as the logical means of emergency communication in time of the ever recurrent natural disasters. Prepare to-day to be ready as opportunity offers to maintain the reputation of our amateur service! Will you be ready as operator, and with equipment, when the emergency comes?

Briefs

W1GTX has had a favorable response of interest shown in organizing a college net. It is planned to include the following: C.C.N.Y., W2HJ; Bethany College, W8PME-ANU; Purdue Radio Club; Univ. of Virginia, W3GFM-W3UVA; Wesleyan, W1GTX; Okla. A. & M.; U. of Ky.; Geo. Washington Univ.; and Lehigh. Interested operators at additional institutions of learning are requested to note the plans (Sept. QST, page 47) and drop a line to Ev Gladding, Box 77, Wesleyan Station, Middletown, Conn., at once to be included in the organization.

--- . . . ---
"The national elections, now past, remind me that in 1928 and 1932, the first election returns to be turned in, in the U.S.A. were handled by ham radio. The votes were from New Ashford, Mass. The Berkshire Brass Pounders of Pittsfield did the job, and in 1932 worked as follows: W1AZW and W1BKG set up 3.5-Mc. c.w. and 1.75-Mc. 'phone outfits in the school house—the polling place. On the other end were W1VC on 1.75 and W1EFM on 3.5. Conditions were terrible and the 'phone couldn't be pulled through, so the first returns were received by c.w. on 3.5-Mc. W1AZD at the local newspaper office took care of the news end of it."

—W1EFM

--- . . . ---
W5FLE operating at W5YJ raised VE4ND. The VE commented that it was really something since he was in *Swift Current*, Sask., while W5YJ is in *Stillwater*, Okla.1



MEDAL PRESENTED BY PRESIDENT WOODRUFF AT THE A.R.R.L. CENTRAL DIVISION CONVENTION

Engraving on the reverse side reads, "Presented to Dr. Lee de Forest by The Radio Amateurs in appreciation of his contributions to the science of radio. Chicago, Sept. 6, 1936."

How's DX?

How:

Another month rolls around with its good and bad tidings of things DX, but before we get too deeply involved in the news end we would like to propose a little discussion of an ever-present problem. It is one that whets the appetite of many a DX man, old-timer or aspiring, but the records reveal that a solution has never been reached. It is simply this: Why are certain locations infinitely better than others from a DX standpoint? Why do some stations, such as W8CRA, F8PZ, ZS2A, old XU1U, and others, put in signals day after day, when stations in the same locality don't come through except when conditions get better? If it is the type of antenna they use, why can't the results be duplicated in almost any location, simply by resorting to the same kind of antenna? If it is brute power, how come the results of some of the stations in the medium-power bracket? Or if it is location (which seems to be the people's choice), what is there about certain locations that makes them so superior to others, even nearby ones? In other words, what we need is some rule of thumb that can be used in picking a location, without going to the involved business of conducting listening tests. Up to the present time, the answer has been, "Your guess is as good as mine." Let's improve on that a little.

Where:

Biggest feather in the cap of any amateur at about this time is, of course, a QSO with Spain. Dana Atcheley, W1HKK, reports hearing EA1BS (7045 kc.) on November 16th at 7:30 p.m., but the laurels go to John Bueck Morgan, W3QP, and John Roué, VE1FB, who worked EA4AP (14,385 kc., T5) on December 1st. Quoting from W3QP's letter, "He said no skeds as he cannot always get power when he wants it, but to pass word along to ask boys to QRX for him—may have press or other traffic. Says heavy bombardment, no winner yet!" EA4AP, you know, is said to be operated by newspapermen at the American Embassy in Madrid So that some of you can sleep nights, and add a legitimate country to your list, here is the dope on EL2A, née UN2A. Worked by many, his rocking signal has led many to think him a phoney. Far from that, EL2A is the station of Hank Gould, ex-W8BIS, and is located at Monrovia, Liberia. With 500 watts, and a Yagi antenna with three reflectors and five directors, his T8 signal is S9 all over the U. S., and may be found at 14,400 kc. from 8 to 10 p.m., E.S.T. Your cards may be sent via A.R.R.L., or in an envelope to John Cooper, Government Radio Station ELA, Monrovia, Liberia. (Thanks, W8ZY, W1CA, W2BMX and W2JGR) A nice bit of DX is NX2Z, operated by OZ2Z at Hochstetter Foreland, East Greenland, worked on 14 Mc. by W9AJA at 1:40 p.m., C.S.T. QSL via the E.D.R., Copenhagen YLAO (6990 kc., T8) is operated by YL2AB You can help VE2GR if you let him know the QRA of F7GC (14,375 kc., T9x), worked during October at 2:30 a.m.

Ed Smith, W8LWI, sends the QRA of PZ1AL: E. C. Van Leeuwen, Costerstraaete 84, Paramaribo, Surinam. And W3EUV corrects the address of YR5OR to G. Wenzel, Petrosam, Rumania.

When:

Ten meters has slowed up a trifle but is still capable of handing you some good ones if you have the time. W9BPU worked TF3R and YT7MT during early November to bring his country total up to 76. VK3YP was worked at that unusual time of 8 a.m. The Asians are still a good bet, with J2LU, J2IS, J2IN, and J3FZ reported worked by W2DTB. On the west coast, W6CIS adds J2CE and J3DC to that list G5QY, via W9WC, sends in a long list of 28-Mc. stations worked. Of interest to U. S. amateurs are YR5IG, YR5OR, FASCR, FV8AB, U2NE, and PY1BR.

G5QY thinks the contact with PY1BR on October 24th is the first G-PY QSO on ten. Check?

Twenty meters is following W6CUH's cycle well, and the upswings bring their usual good results. VE2AX sends a mouth-watering list, including PK1PK, KA1MD, J2ME, J3CR, XU8OP, J3DE, J3FI, U9ML, and XU6SW worked, and VS1AA, V87RF, VU2CQ, VU2LJ, XU2FB, XU8AG, J8CA, J8CF, U9SK, and U9MF among those heard W9PTW reports working ZE1JR (14,050 kc., T9x) and ZT2Q (14,120 kc., T9x), with ZT2Q his nomination for most consistent African. If it's Africa you need, ZU6AF (14,300 kc., T9x) is on nearly every night around 1 a.m., E.S.T. W6CIS worked him at 8:20 a.m., P.S.T., so he must stay on all day W2HHF sends in a swell list—it's a pity we can't give them all. Here are some of the more choice bits: VK9BA, New Guinea (7150 kc., T7), heard at 3 a.m.; CN8AH, CN8NB, CN8MB, afternoons at 14,420 kc., T7; FK8AA (14,380 kc., T7); CR4AR (14,380 kc., T7), 4 p.m.; J8CF (14,270 kc., T9) and MX2B (14,390 kc., T7), 7-8:30 a.m.; PX1B (14,420 kc., T7), 9 p.m.; VQ3FAR (14,120 kc., T9), afternoons and evenings; VE5NO, Baffin Land, (14,020 kc., chirpy T9); VQ8AA (14,400 kc., RAC), 10 p.m.; VQ8Z, St. Helena (14,450 kc.); VR2AB (14,420 kc., RAC) 10 p.m.; ZB1J and ZB1H (14,300 kc., T9); ZB1E (14,050 kc., T9); SV1KE (14,360 kc., T9) 4 p.m. When you work all those we'll give you some more VE1FB contributes YV3AV (14,325 kc., T8x) and VP7NI (14,400 kc., T7), and adds that if you want a station in Northwest Territory, look for VE5TV (14,300 kc., T7) VU2AM (14,350 kc., T9) was worked at 8 a.m. by W6CIS, who reports J3FZ (14,100 kc., T9) at 5:30 p.m., an unusual time, and XU8SM (14,100 kc., T9) at 8 p.m.

If you work your DX on 'phone, here are some timely tips from Tibbatts, W6ITH: VK9GU (28,120 kc.), ZL1CD (28,520 or 28,640 kc.), J2IS (28,200 kc.), who speaks English well, LU9AX (28,040 kc.), and K7PQ and K7FDE, all come through well during the late afternoon. 6GLK (28,040 kc.) comes through around 8 a.m. On twenty, ZS4J (14,306 kc.), ZS2X (14,370 kc.), ZU6P, and KA1BF (14,155 kc.) are heard in the morning, and ZU6P and LU5AN (14,306 kc.) can be worked during the early evening.

Who:

Apparently Van, ZU1T, has recovered from his operation, if 28-Mc. QSO's with W3BRZ and W6JN are any indication. We're glad to hear it The Baron Munchausen returns, or at least his ghost walks. H. R. Gebhardt, W8SR, tells of a 28-Mc. contact with F8WQ, with no antenna connected! The report was 449, which went to 589 with the antenna on. Now he wants to know who will be the first to WAC without an antennal! It's nice work if you can get it, if you will pardon a cliché Amateur radio has its problems, at that. For example, power is 30 cents per kilowatt in British Honduras, so VP1WB must be content with receiving tubes (41's) and 220 volts d.c. from the mains On the other hand, life in British North Borneo can be complex, too. G. C. Cawood, VS4CS, writes, "Everything is not all beer and skittles out here in the jungle. A few weeks ago I came home to find a monkey climbing out the window of the shack with my portable transmitter, while most of the receiver was already scattered about the room. Two days ago I walked in as a fowl walked out, and going to the rig I discovered a nice, warm egg plonk in the center of the works. A wrecked field coil and the variable condensers trodden down to maximum capacity were proof of the trouble the YL had taken before depositing the hen-fruit W6CUH has not had much time recently, but FR8VX brought his "countries worked" total up to 126. He says he is going to revise his country count on the basis of the new A.R.R.L. DX Map, which "I think is a great idea, and so does everyone out here" Myron E. Terry, XU8MT, is sure QSP is not a lost art, even if it does involve

a little 14-Mc. 'phone DX. Quoting from his letter, "I originated a message from a man critically ill in Shanghai asking advice from his doctor in San Francisco. The first route was XU8MT-KA1BH-W6CUU-W6ITH. But skip and QRM were playing peculiar tricks, and but for the help of many others the messages would not have gone through and come back. . . . VS8AQ told KA1BH I was calling, and filled in when BH could not hear me. W6KW was standing by when W6CUU had difficulty contacting San Francisco. W6IZB relayed the first reply. KA1ME relayed replies and arranged subsequent skeds. W9BEZ offered to help W6CUU to contact San Francisco, and stood by ready. KA1RR telephoned to KA1BH that I wanted to make further contact. VU2LZ called and offered to contact San Francisco. VS6AH was standing by in case VS8AQ should have to close down. . . . Listeners in Cape Town and the British Isles have sent me full transcripts of some of my transmissions during this hook-up." From Roy McCarty, W9KA, we learn that VS6AQ is going home to Scotland where he will be on with a "G" call in 1937. Stan of VS6AQ would like to send his very sincere thanks to all "W" stations with whom he has spent many happy hours Add description-defying signals: the strange, whispering signal of VE4UV and his Ford-coil plate supply.

WAC:

Latest 'phone WAC's: OK2AK, Hans H. Plisch; ON4AP, Robert Godefroid; PK3ST, J. H. A. Steenmeyer; PK4AU, J. C. Hopman; VE1CR, C. Reg. Rogers; VE2GA, Joseph A. Robertson; W6EJC, Burton N. Carrick; ZE1JM, W. G. Weyland Some nice work was done by Fenton Priest, W3EMM, according to a note from W3UVA, Virginia SCM. On November 22nd he worked, in eight hours, VK5AW, LU7ET, VU7FY, HI7G, G2NH, and ZU6P, all 'phone contacts. A short time later he worked a VE, giving him WBE in twelve hours W2DNG tells of some nice work by Willard Bohlen, W2CPA, who on a crowded Sunday (October 18th) worked VK7LZ, VQ4KTB, VS8AA, OZ8JB, FR8VX, SV1KE, LU4BH, U9MF, K6BHL, FB8AF, ZT6AU, and several W's. Another South American would have given him two WAC's in one day. Not bad, sub Latest low-power WAC is to Richard Weber, W5FBQ, who made it with 30 watts input to a 45 final.

—W1JPE

The Horse Traders Association

Operating on the 56-Mc. band in Connecticut and Massachusetts is a group of some 70 or 80 amateurs known as the Horse Traders Association. Organized by a group of five amateurs in January, 1936, the Association has met with tremendous success. The purposes and activities of the Horse Traders Association are here explained. Purposes and code of ethics: (1) For all-around betterment of five-meter signals; (2) To slight no one; (3) To work all stations who call you provided you hear them; (4) To improve our rigs so as to transmit better signals; (5) To establish a network

The General Traffic Hour

The daily period 6:30-8:00 p.m. (your local time) has been designated the "General Traffic Hour." All Official Relay Station appointees have been requested to keep this period, working general with all amateurs. Trunk Line Station appointees are likewise requested to work general during this period. In this manner operators who are unable to maintain regular schedules or whose operating time is limited may get on the air from 6:30-8:00 p.m. and clear their traffic through O.R.S. and T.L.S. who keep schedules on established traffic routes. Make use of this period so that delivery of traffic and dependability of service may be improved. Give your traffic to stations signing "ORS" or "T.L.S." "CQ TFC" is the general call for the "traffic hour." Directional CQs will also be found useful during this period.

Code Speed Contest

On Monday January 11, 1937. WLM/W3CXL will broadcast a speed contest. All amateurs whether A.A.R.S. members or not are invited to participate. The contest will start at 9 p.m. E.S.T. WLM/W3CXL will use automatic equipment and sufficient power to reach most states. The frequencies 6990 and 3497.5 kcs. will be used simultaneously.

Speeds from 20 to 60 w.p.m. in jumps of 5 words per minute will be used. Each transmission will be five minutes and will be clear text. Each speed will have different text. Words will be counted on the basis of five letters to the word. The contest will be run according to the following rules:

1. Anyone having a valid amateur license is eligible.
2. Only one report can be turned in by each participant. Pick out the speed which you are sure is correct.
3. Solid copy for one minute anywhere in the five minute transmission will determine your qualification.
4. A.A.R.S. members send their copies to their Corps Area Signal Officer. Non members send their copies to the nearest Corps Area: (I—C.A., Boston; II—C.A. Governors Island, N. Y.; III—C.A., Baltimore, Md.; IV—C.A., Atlanta; V—C.A., Ft. Hayes, Ohio; VI—C.A., Chicago; VII—C.A., Ft. Omaha, Neb.; VIII—C.A., Ft. Sam Houston, Texas; IX—C.A., Presidio, San Francisco, Calif.).

A.A.R.R.L. will give letters of commendation to League Members who stand highest in each Area.

of Horse Traders from New York to Boston; (6) To create good fellowship and at all times act as gentlemen over the air; (7) To trade horses, soap, grid leaks and standing waves with any member, letting your conscience be your guide as to how you stick the other horse. Requirements for membership: Applicants must work five Horse Trader stations or an equivalent of fifty miles; each five miles counting as one station worked. Applicants must send a card to WIMY or W1FLQ expressing their desire to become a member and listing Horse Traders worked. Applicants must attend a meeting to be initiated before becoming a full member. Meetings are held over the air each Tuesday night starting at 7:30 EST. Other meetings (in person) take place each two months at a location voted by the majority. Horse Trader cards are available to all initiated members. There are no dues, no by-laws and no fights. Each member pays his own way at the shindigs. Officers: W1FLQ, pres.; W1JTF, chairman of board; WIMY, general mgr.; W1QP, 1st vice-pres.; W1JGO, 2d vice-pres.; W1AEY, secy.; Mrs. W1AEY, asst. secy.; W1JLK, treas.; W1JN, bus. mgr.; W1BEC, asst. bus. mgr.; W1XCX (Lt. Joyce, Mass. State Police), chief hay pitcher. Other members: W1DVI FEF HZK DVH DSV JQM BXB FMM ADZ IPV FOG CGS JPB FVR IWL HQZ EFW IKX ACJ BAP FME HVX IJ CSC KK EDL GSV AUK FUE DDP EWI HHA JHM FHN HDF GYT IMF JAM HMO AWW JRV EJO EWD EKY EUG BRL HMB GDC AWW Jr. BKO APJ EBO EFN KAY JRI W2AIU. Honorary members: W1HDQ AIY DE1 FZA XO XT BUE JPE DIZ DLJ CJE. During the flood in March, '36, members of this Association rendered valuable assistance. Maintaining regular organization on 56 mc., the Horse Traders Association is prepared to again perform service in any future disasters.

W6MVK, W.A.S. No. 98, went on the air for the first time on October 7, 1935, and worked his 48th state on February 11, 1936, a total of four months, four days on the air. He is interested to know if any holder of W.A.S. has had a license a shorter time than he.

The article by Mr. Joseph A. Mullen, WIASI, wins C.D. article contest prize this month. Each month we print the most interesting and valuable article received marked "for the C.D. contest." Contributions may be on any phase of amateur operating or communication activity (DX, 'phone, traffic, rag-chewing, clubs, fraternalism, etc.) which adds constructively to amateur organization work. Prize winners may select a 1937 *Handbook*, six logs, six message files, six pad blanks, or equivalent credit toward other A.R.R.L. supplies. Send your contribution today! —F. E. H.

Deliveries via 56 Mc.

By Joseph A. Mullen,* WIASI

NO ONE can doubt that the A.R.R.L. Trunk Line System is now one of the most well organized communication nets in the country. The lines are well systemized and thoroughly reliable. But a TIS may relay a message to a station located in the city of destination and *that* station for some reason fail to deliver. This is one of ham radio's oldest problems. The writer has originated messages and listened to their progress right into the city of delivery yet the parties never received the messages.

While SCM of Eastern Massachusetts a study of this problem was undertaken. The causes are many. Among them are some cost to the individual for 'phone calls and postage (if much traffic for mail delivery) but more important the matter of personal interest, initiative and responsibility of the operator accepting the message. All hams should want to make ham radio useful to someone besides themselves. The idea of doing useful work on 56 Mc. and getting stations near addressees in our big cities goes together. At last an idea was hit upon that looked quite promising. This was the organization of 56 Mc. stations to take care of local deliveries. Clubs were visited and the matter talked up. The idea was presented at hamfests and a surprising amount of interest was shown especially by the fellows who were working on "five" exclusively. Soon the project was well under way.

The number of reporting stations took a big jump as did the number of deliveries. 3.5 Mc. traffic men began this cross band feature. Many built new five-meter rigs just for this purpose. Some of these stations became interested in traffic work well enough to build 3.5 Mc. stations and get into the game in earnest.

Charts were plotted to ascertain the changes being wrought by this new phase of traffic work and in every case they showed remarkable possibilities. The cost of deliveries at the writer's station decreased 42% the first month.

One of the greatest advantages of this system is the speed factor. One may sit for an hour looking for a station in the general direction of the delivery point and then not hear one. With a five-meter rig at your elbow, very frequently you will spot a station right in the town where the message is going. The greater portion of the five-meter gang will get a big kick out of taking a message from some far distant point on a cross band contact. It frequently happens also, that the delivery via 56 Mc. will also net an answer to the message. More than likely you will be able to relay it over the same channel from which the original came. Lots of fun, especially in doing a real service via our 56-Mc. set up!

It's worth a try fellows and you can rest assured you will not regret using it for a while.

With the O.P.S.

EXPERIMENTAL and constructional factors count 50% in the all-season contest in the Official Phone station group. W8EDR, W9HQH and others have points on record in this direction and we suspect other "dark horses" will appear in the finals. Operating factors count another 50% (QSOs and DX count 20%, log and station records 10%, and three quarterly OPS Parties another 20%). In the first of three quarterly tests W8LUQ, W9HSE, W8LJZ, and others (see list below) stand high. That O.B.P. Trophy is a whopper

* 218 Jamaica Way, Jamaica Plains, Mass.

BRASS POUNDERS' LEAGUE

(October 16th—November 15th)

Call	Orig.	Del.	Rel.	Extra Del. Credit	Total
W1BTG	7	15	881	—	903
W3EOP	37	13	822	—	877
W8FMH	11	34	804	—	849
W8MNN	65	127	846	74	812
W7DUE	24	51	678	37	790
W1HTO	354	81	348	—	733
W9AJJ	163	76	483	3	725
W4PL	36	45	596	28	705
W1UE	59	152	439	55	705
W5CEZ	80	84	514	15	693
W8JTT	48	53	572	20	693
W3CIZ	50	57	566	—	673
W8PVS	73	30	512	26	641
W1TP	12	23	594	12	641
W8RMT	15	49	530	38	632
W3BWT	143	60	339	50	592
W8KUN	24	30	525	—	579
W3FTK	36	31	508	—	675
W6IOX	19	72	410	71	572
W8KWA	13	54	504	—	565
W3EZ	23	68	428	34	553
W6KFC	13	17	495	10	535
W1HWE	165	116	234	—	515
W2HZY	15	14	464	20	513
W2BCX	12	7	490	—	509
W2HYC	24	42	360	20	506
W8ILH	10	54	441	—	505
W6CDD	148	24	331	—	503

MORE-THAN-ONE-OPERATOR STATIONS

Call	Orig.	Del.	Rel.	Extra Del. Credit	Total
KAIHR	593	476	622	—	1691
W6OW	158	332	800	276	1566
KAIHR*	415	345	564	—	1324
W8BNT	158	466	472	—	1096
W8IY	102	142	507	—	752
W8XXL	11	17	680	—	388

These stations "make" the B.P.L. with totals of 500 or over. Many "rate" extra credit for one hundred or more deliveries. The following one-operator stations make the B.P.L. for delivering 100 or more messages; the number of deliveries is as follows: Deliveries count!

W1FRO, 180	W1LNF, 148	W1IZW, 107
W2KI, 172	W6ITV, 137	W6NQM, 101
W9IGI, 168	W2JBL, 114	

A.A.R.S. STATIONS

Call	Orig.	Del.	Rel.	Extra Del. Credit	Total
W1VH (W6BMC)	20	17	501	—	538
W1MT (W6GXM)	93	192	243	—	528
W1NF (W2BCX)	5	10	504	—	519

WLY (W6RJ) made the B.P.L. for delivering 107 messages.

MORE-THAN-ONE-OPERATOR STATIONS

Call	Orig.	Del.	Rel.	Extra Del. Credit	Total
W1LM (W3CXL)	123	170	2023	—	2321

A total of 500 or more, or just 100 or more deliveries will put you in line for a place in the B.P.L.

Station	QSOs	Sections Heard	Score	Power	Section
W8LUQ	36 + 2	18	22	4212	400 W. N. Y.
W9HSE	24 + 20	20	1	4020	90 Ind.
W8LJZ	32 + 2	16	18	3296	... Ohio
W2HNP	27 + 29	24	2	2810 (6816)*	160 No. N. J.
W9TTA	31 + 1	14	12	2576	100 Ind.
W8FIP	33 + 9	14	3	2534	... W. Pa.
W1AVP	11 + 6	24	8	2232	... Vt.
W2CBO	26 + 1	14	10	2170	500 E. N. Y.
W8KNF	28	12	17	2088	110 Ohio
W4CYB	25 + 1	14	7	2016	250 N. C.

Call	QSOs	Power	Score	Call	QSOs	Power	Score
W8JFC	26 + 2	100	1728	W8AAR	12 + 1	150	770
W8MOL	22	350	1632	W8MOP	16	150	756
W8HFR	24	100/350	1562	W8CDR	17	40	707
W8KMK	22 + 2	200	1536	W9ACU	10 + 3	20	510
W8BRZ	18	150	1352	W8LAW	9	275	399
W8CGJ	21	200	1155	W8NYY	4	250	384
W8EAO	14 + 2	150	1128	W2IKV	10	200	378
W1DWP	16	70	1080	W1GZL	4	75	376
W8NXX	21 + 1	100	1008	W9GZY	9	150	355
W4QI	16	100	816	W8JTT	11	35	285

and a beauty, and goes to the best all-around Official 'Phone appointee who adds up points to acquire the best percentage on all counts! An "extra" bulletin was mailed all O.P.S. in

(Continued on page 93)

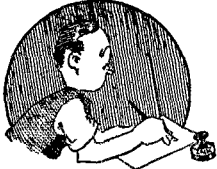

CORRESPONDENCE

The Publishers of QST assume no responsibility for statements made herein by correspondents

Mostly About 160-'Phone

P. O. Box 481, Westwood, N. J.

Editor, QST:

In my estimation, the soundest bit of thinking that has yet been put in print is the letter from W5AL in the November issue. And if all the boys who are tooting their horns to make 160 a Class-A band, will sit down and soak up the little bit of advice offered by W5AL, they will readily see that no matter in what Class you put 160 the condition will still remain. . . . Most b.c.l.'s will cooperate when trying to solve the problem of this type QRM, but I will agree that there are exceptions to the rule. There isn't much that can be done in these cases except to sit tight and see what happens, *if the ham is within his or her rights*. The average ham has sunk a young fortune in the building of his rig and he, too, would like to get some enjoyment out of a thing which he has made his hobby. It is true that a station may operate on reduced power which does a lot to help remedy the QRM situation and there are times when 40 watts will do as good as 400. But if all the solutions that have thus far been given for the elimination of the BCL QRM, I think I am safe in saying that W5AL's idea would outweigh them all. Let's see some more letters like it.

—J. George Murcken, Jr., W2CFK

1 Evergreen Ter., Cumberland, Md.

Editor, QST:

. . . W8KSY . . . is just like about 10,000 other hams in this country, never satisfied. What is going to happen to the ham bands is that the F.C.C. is going to get sore and tired of the hams always fighting and take the whole thing away. If they did we would have nobody to blame but ourselves. So the Class A boys want 160 now! A couple of months ago they wanted part of the 40-meter band. . . .

W5AL is right—the present b.c.l. sets aren't perfect. The trouble with the present line of sets is that they are just made to sell. Ask any serviceman that. Any guy that knows anyways half about radio knows that you can't buy a 20-tube set for fifty bucks without getting gyped somewhere. . . .

—Robert O. Slemmer, W3ETE

521 E. Lafayette St., Fayetteville, Ark.

Editor, QST:

I wish to give a "pat on the back" to W5AL for his constructive letter on coping with the b.c.l.

QRM problem as it is very helpful and, while not a panacea, it has presented the best methods so far.

By all means I wish to give a healthy "kick in the pants" to whoever brought up the argument for Class A for 160, regardless of which side of the fence they are on. . . . I have noticed that most of these arguments begin in the fall of the year just after a hot summer, and it seems to me that they are inspired by the after-effects of the summer heat. Let's call a halt on these controversial arguments that get us nowhere and devote the pages of the Correspondence Section to *constructive* suggestions such as W5AL, W3FAR, and others for improving our conditions *without restricting any group of hams who are sincere in their efforts*. . . .

—Lester Harlow, W5CVO

EDITOR'S NOTE.—Similar sentiments are expressed by Orley J. Corkwell, W8IAL; Bruce H. Hart, W9YOO; M. C. Bartlett, W9JHY; and U. O. Sanders, W8LTC.

18030 Waltham Ave., Detroit, Mich.

Editor, QST:

Having just retired as S.C.M. of Michigan Section, feel free to express my views on Ham Radio Enemy No. 1, c.w. vs. 'phone, without fear of harming the Section spirit.

This constant wrangling is doing amateur radio no good—both with the public and with the gang itself. Every year about this time the 'phone boys get going. They want more frequencies. . . . Petitions are made up. . . . The grapevine functions. The c.w. men get worried—drop their skeds, dig down into their jeans and send out the other side of the story with petitions to be signed. All this at a cost in dollars and cents and of perhaps greater importance in energy that could be put to constructive use. . . .

The plan we have worked out to put a stop on this hate-producing energy-wasting yearly argument is quite similar to the thoughts put forth by our good friend W8KSY in a recent QST letter. With the F.C.C. reporting practically all their trouble with ham radio is through the inexperienced 160-meter men, we suggest that the 80-meter 'phones be moved to 160 with only Class A licensees allowed to operate. . . .

. . . The 80-meter band for 'phone as it now stands is NG. Every one agrees to that. The DX-hounds have moved to 20. Its DX capabilities

over the 160-meter band was the reason given for giving 'phones space on the 80-meter band in the first place. With the present congestion DX is impossible except in rare cases.

Re 160-meter men at present. A lot of the boys are capable (don't forget also that the more capable ones are perhaps Class A licensed) but something should be done to stop the thousands of new hams from becoming the *voice* of amateur radio (to the b.c.l.) when they haven't had time to get the spirit of the thing properly into their skulls. That's no reflection on anyone's ability—we must realize that a thorough understanding of this game takes much thought and we all know that the new fellow is so wrapped up in licenses, new rigs, theory and new calls that he can't possibly absorb any of the other angles on amateur radio—there are too many of 'em!

Can you imagine a year going by without a cross word between 'phone and c.w. men—a Board meeting without c.w./'phone as the main issue—traffic men putting in a full season on the nets—'phone men not thinking up . . . sarcastic things to say about the c.w. man—more harmony throughout the whole structure of hamdom? A more solidified front against the powers that be (man, do we need that!)? We could go on for hours—but if you'd like to kill this "disease" at its source separate the 80-meter 'phones from the c.w. men and watch the results. Let your Director know.

—Kenneth F. Conroy, W8DYH

2533 Olinville Ave., New York, N. Y.

Editor, QST:

I have read the various comments made in QST concerning Class A operation on 160 meters and . . . I find that the Class A ops on 160 meters are too carefree and do not show much ham spirit. I am speaking of the hams in general, as there are some exceptions.

From what I have read and heard, I make the following suggestions for a trial:

1. That the 75-meter amateur 'phone band be given the privileges that the 160-meter band have at present.
2. That the 160-meter band be given the privileges of the present 75-meter band.

In this manner I think that the "sloppy" operating of the 160-meter gang will be eliminated, and the Class A ops, will be given the chance to show their fine operating skill on 160, without getting any QRM from the "lids." . . .

—J. Santangelo

Coronation QSL

102 Third St., Kirkland Lake, Ont., Can.

Editor, QST:

I would like to present to Canadian hams through the pages of QST a suggestion that was given me during a talk with VE3QB. . . .

How about a special QSL card for next year in honor of the coronation of England's King? I think that it would be fitting to show our loyalty to the Crown in some manner, and I do not know of any way that it could be shown to the world at large at a smaller cost than that.

I suggest a card with a royal red background, the call in royal blue, and across the top in royal gold the wording, "Special Coronation Year QSL," with a crown on each side of the wording, it in gold also.

There is the idea, gang. What response do I hear from you? We want to make it snappy, as next year is just around the corner.

—C. C. Dunlop, VE3AGM

He Condemns Spanish News

10 Bridge St., New York, N. Y.

Editor, QST:

I severely condemn your insertion of news relating to Spain in the I.A.R.U. section of the December issue of QST. In this section you print information obtained from a German amateur which states that EA4AO had been executed

by the Loyalists as well as all the other U.R.E. official organization. This information, as it appears, will be read by thousands of American radio amateurs who, in some cases, will receive an entirely wrong impression of democracy's fight against Fascism in the Spanish republic. You unknowingly, or intentionally, published a report sent to you by a German, a Nazi without doubt, whose sole purpose was to create just that which I mention above.

If you are a careful reader of newspapers you should, by this time, know of the brutality of the Fascist forces in their bombardment of Madrid—the murder of women and children—in their desperate attempt to smash the government which the Spanish people democratically elected.

Henceforth you should, as a matter of justice, ignore all information received from Fascist sources. In the January issue of QST it will be well for you to insert another article in the I.A.R.U. section which should describe the murder of Spanish people in Madrid by the Fascists, as an atonement. If you care nothing about human beings you can mention the destruction of Spanish amateur stations in Madrid by Fascist shells.

I am, at this time, also sending a letter protesting against your report about Spain to Mr. Eugene C. Woodruff and to an American organization in this city which is helping Spanish democracy.

—Robert Kreisinger

Error's Note.—No one could fail to condemn QST for injecting itself into external political affairs, either national or international. We exist to present the news of amateur radio—not to censor, interpret, or embellish that news. It is not our province to tell of the progress of the internecine struggle in Spain, nor to evaluate the merits of either cause. It is, and will be, our purpose to present every scrap of information, including every report and its source, that we are able to secure. In this connection, the attention of Mr. Kreisinger and others who may have overlooked it, is directed to the "Flash!" on page 43 of the same issue.

'Phone—29—30 Mc.?

Wharton, Texas

Editor, QST:

. . . I wonder how many of you think we can keep the 20 Mc. to 30 Mc. part of the band without using it? My guess is, not over a year or so longer.

Those of you who are active on ten know that if occupancy continues in the future as it has lately, we will need the whole 2000 kc. before another two years has passed. The c.w. operator will not use the 29 Mc. to 30 Mc. part of the band simply because there is no one in it. Why not put the 'phones in that part of the band? I operate 'phone, mostly, and cannot think of any reason why this should not be done. If it is done that part of the band will be occupied immediately. It is not necessary for the change to be expensive. The old crystal can be ground down in a few minutes and new ones are inexpensive. . . .

—Clarence Vick, W5DUQ

Special Five-Meter Licenses

1204 S. Richmond, Tulsa, Okla.

Editor, QST:

In this city, and probably many others, there are numerous unlicensed 5-meter operators. While most of them are knowingly violating the rules of the F.C.C., they continue to operate, month after month, and year after year. Many state they are endeavoring to gain the necessary code speed to take the Class B exam, but few really attempt it.

The members of this club believe steps should be taken to bring such illegal operators within the law, in the hope of later making them full-fledged hams. Therefore, we suggest the following:

1. An additional class of amateur exam should be provided which should consist of a light exam on 5-meter theory and permit operation on the 5-meter band only.

(Continued on page 68)



WE WHO devote our working hours to amateur radio find that the holiday spirit comes very easily. Perhaps this is because the stuff that amateur radio is made of is not so much engineering as good fellowship. Night and day the air is laden with messages of friendliness, addressed to all

who listen. Personal as the spoken word and swift as thought, CQ links the world in genial fellowship. . . . Sometimes when we look at Christmas cards we wonder why their artists had to turn back the calendar so far to catch the Christmas spirit. If we were to draw a symbol of Christmas fellowship, our card would not show a snow-bound stagecoach, but a simple home-made antenna silhouetted against a transparent midnight sky. Perhaps a blanket of clean white snow upon the ground to erase for this quiet moment the scars of man's labor on the earth. Perhaps a single lighted window glowing in the dark to mark where a solitary man joins greetings with unmet friends. Goodwill to men. . . . For us, we hope this picture will be a reality and not a symbol. May all who listen hear our "Hail and Godspeed!" on Christmas Eve! And to those who may not hear our greetings then, we send them on this page by proxy. Merry Christmas, Everybody!

JAMES MILLEN





The RIGHT COMBINATION at your fingertips

Here's some light on that SELECTOR SWITCH PROBLEM, you Knight of the soldering iron.

If the circuit calls for more lugs than a centipede has feet scam over to your jobber, and make up your own SELECTOR SWITCH' . . . thousands of different combinations possible with a CENTRALAB Kit at his place.

SWITCHES FOR

- Analyzers
- Output Meters
- R F Oscillators
- Tube Checkers
- Decade Boxes
- Capacitance
- Resistance
- Ham Equipment
- P A Work
- Volt-Ohm-Am Meter
- Radio Receiver Replacements
- A F Oscillators

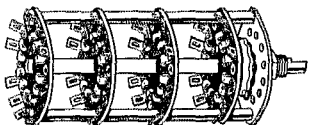

Centralab

Milwaukee, Wisconsin

British Centralab, Ltd.
Canterbury Rd., Kilburn,
London N.W. 6, England

French Centralab Co.
118 Avenue Ledru-Rollin,
Paris XI, France

Correspondence Dept.

(Continued from page 64)

2. Those passing said exam should be designated by a numeral instead of an alphabetical call.

3. The term of such a license should be for not more than six months or a year, and not be renewable.

4. If during the term of the license, said operator has not passed a regular Class B or C license, he is legally through with amateur radio.

5. Such special licensees should be admitted to full voting membership in A.R.R.L. in an effort to give us a better rating in Washington.

Then, too, with more users, the 5-meter band should be doubly hard to take away from us. We would appreciate seeing the reaction of other clubs and individuals in this column.

—C. P. Zimmerman, Sec.-Treas.,
Tulsa Amateur Radio Club

Skin Effect Law Appealed

2913 Griffin Ave., Richmond, Va.

Dere Eddie:

Wot we want to know down here is: Who cured wire of skin effect at h.f. and when?

We notice in ur October number on page 34: "Braid of any form is to be avoided in the tank circuit, as this material has very high radio frequency resistance."

Now if we bin wasting kilowatts down here due to the misguided idea that braid is a good r.f. conductor due to increased area and skin effect, please set us right.

Now wot gets us sore down here is these here Haywire Hanks, wid a sig like a locoed buzz saw, St. Vitus dance from the shoulder down and the weights on their new bug pushed all the way back to their elbows, which sends stuff that they cudn't copy fer a new HIRO!

And these pimplyous young squirts that answer 30 per CQ's before they get out of the 15 per class is just as bad.

—A. M. Leake, W3BCI

EDITOR'S NOTE.—No law has yet repealed effect of skin effect. However, practical research has shown that skin effect in braid differs from skin effect in a solid or insulated-strand conductor (such as Litz). Neither "fish nor fowl," separate strands in braid are not insulated nor are they in perfect electrical contact. Result: Losses. If you want to shield plate or grid leads effectively at high r.f., don't use braid; use copper tubing.

M.D. Net

Veteran's Administration Hospital,
12th Ave. and E St., Salt Lake City, Utah

Editor, QST:

Since being interested in this radio game it has occurred to me that an organization of M.D. hams would be fun if there were enough of them interested in it.

Dr. C. A. Sherman, W9SVC, and the undersigned would be glad for any such to communicate with either one of us; and if there prove to be enough we will undertake to get them together on the air in some fashion.

We had in mind something on the order of a round-robin, with perhaps all on the same frequency, once or twice a month. . . .

—C. F. Sherman, M.D., W6NFWL

California Kilowatts Move East

1026 S. 48th St., Philadelphia, Pa.

Editor, QST:

I am thinking of taking up stamp collecting. The reason? Last week I heard two hams chatting pleasantly along on 75-meter 'phone. The first chap said he was running 1750 watts (count 'em!). The second came right back and said that 1750 watts was nothing—he was running 2500 watts, and the tubes weren't even heating up.

(Continued on page 78)

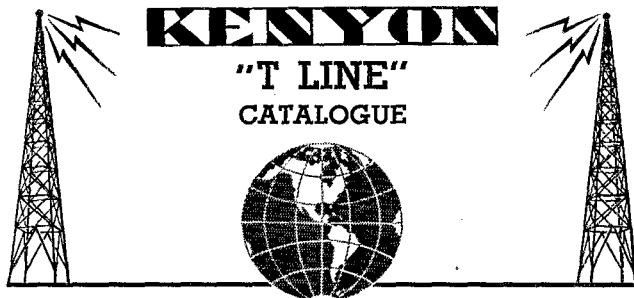
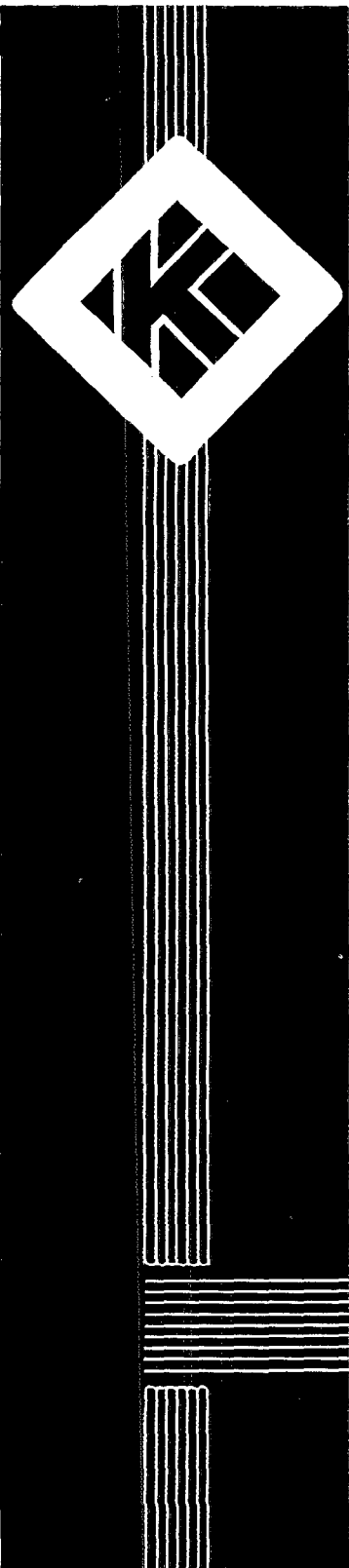

A CATALOG OF
AUDIO AND POWER COMPONENTS FOR
AMATEUR TRANSMITTER AND
PUBLIC ADDRESS SYSTEMS

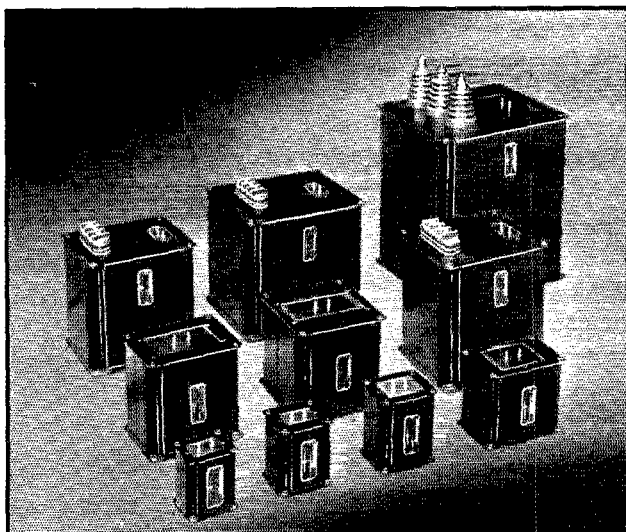

**IF YOU'RE WISE —
YOU'LL KENYONIZE**

KENYON TRANSFORMER CO., INC.

840 BARRY STREET, NEW YORK, N. Y.

**Export Department:
25 Warren Street
New York, N. Y.**

**Cable Address:
SIMONTRICE—NEW YORK**

KENYON AMATEUR TRANSMITTER AND PUBLIC ADDRESS COMPONENTS

Kenyon engineers have designed this complete line of audio and power transformers and reactors to make possible a popular priced line particularly suited for amateur transmitter and public address use.

Refinements in design and controlled production result in units which are unapproachable for quality in material of this price range.

Each unit is housed in a metal case finished in a durable black eggshell enamel presenting a pleasing appearance to suit exacting commercial requirements. This case also acts as an electrostatic and electromagnetic shield.

Universal mounting facilities permit all units to be top or bottom mounted to chassis or panels.

With the exception of the high voltage units which are provided with glazed ceramic insulators all units are provided with sturdy solder lug terminals.

KENYON TRANSFORMER CO., INC., NEW YORK, N. Y.

T LINE DIMENSIONS

Mounting Dimensions			Overall Dimensions		
Case	ML	MW	Length	Width	Height
1A.....	2 ¹ / ₃₂	1 ⁹ / ₁₆	2 ⁷ / ₁₆	2	2 ⁷ / ₈
2A.....	2 ¹ / ₈	1 ¹³ / ₁₆	2 ³ / ₄	2 ³ / ₈	3 ³ / ₁₆
3A.....	2 ⁷ / ₁₆	1 ¹⁵ / ₁₆	3 ¹ / ₁₆	2 ⁹ / ₁₆	3 ⁵ / ₈
4A.....	3 ⁷ / ₈	2 ⁷ / ₁₆	4 ¹ / ₂	3	3 ⁷ / ₈
5A.....	4 ⁵ / ₁₆	3 ³ / ₁₆	5	3 ⁷ / ₈	5
6A.....	4 ¹ / ₂	4 ³ / ₁₆	5	5 ¹ / ₈	5
7A.....	5 ¹ / ₂	4 ³ / ₁₆	6 ⁵ / ₁₆	5 ³ / ₁₆	6 ³ / ₈
8A.....	5 ³ / ₄	4 ¹³ / ₁₆	6 ⁹ / ₁₆	5 ¹¹ / ₁₆	7 ¹ / ₈
9A.....	6 ¹⁵ / ₁₆	5 ³ / ₄	7 ³ / ₄	6 ⁵ / ₈	7 ³ / ₈
10A.....	8 ⁵ / ₈	7 ¹¹ / ₃₂	9 ¹ / ₂	8 ¹ / ₄	10 ⁵ / ₈

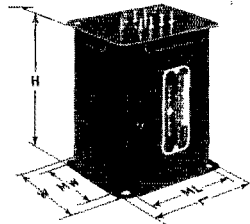

INPUT TRANSFORMERS

Type	Description	Case	List Price
T-1	Single or double button microphone to one grid. Input — 400-300-200-100-50 ohms. Hum bucking type.....	1A	\$4.00
T-2	Multiple line to one grid. Input — 300-333-250-200-125-50 ohms. Hum bucking type.....	1A	4.00
T-3	Multiple line to P. P. grids. Input — 500-333-250-200-125-50 ohms. Hum bucking type.....	1A	4.00
T-4	Detector plate, high impedance pickup; or double button microphone to single grid.....	2A	5.00

LINE TRANSFORMERS

T-25	Line to line matching transformer. Primary — 500-200-50 ohms.....		
	Secondary — 500-200-50 ohms.....	2A	5.00
T-27	500 or 200 ohms to 15-8-4 ohms — Level 15 watts.....	3A	5.00
T-28	500 or 200 ohms to 15-8-4 ohms — Level 30 watts.....	4A	6.00
T-29	500 or 200 ohms to 15-8-4 ohms — Level 60 watts.....	5A	9.00

CLASS "A" INPUT TRANSFORMERS

T-51	Single Class A Plate 56, 76, 6C5, 77 (triode) 6C6 (triode) etc. to single Class A. Grid. Ratio 1:4.....	1A	3.50
T-52	Single Class A Plate 56, 76, 6C5, 77 (triode) 6C6 (triode) etc. to P. P. Class A Grids. Ratio 1:4.....	1A	3.50
T-53	Detector plate or single button microphone to single grid.....	1A	3.50

For portable applications use open type KA114M. List Price \$2.25

T-54	P. P. Class A plates 56, 76, 6C5, 77 (triode) 6C6 (triode) etc. to P. P. Class A Grids. Ratio 1:1.8 (total pri. to total sec.).....	2A	4.50
T-55	Single Class A Plate 56, 76, 6C5, 77 (triode) 6C6 (triode) etc. to single Class A Grid. Ratio 1:3.....	2A	4.50
T-56	Single Class A Plate 56, 76, 6C5, 77 (triode) 6C6 (triode) etc. to P. P. Class A Grids. Ratio 1:2 (total pri. to total sec.).....	2A	4.00
T-57	Single Class A Plate 56, 75, 6C5, 77 (triode) 6C6 (triode) etc. to single Class A Grid. (Ratio 1:2). Hum bucking type.....	2A	5.00
T-58	Single Class A Plate 56, 76, 6C5, 77 (triode) 6C6 (triode) etc. to P. P. Class A Grids. Ratio 1:2 (total pri. to total sec.). Hum bucking type.....	2A	5.00

CLASS "AB" AND "B" INPUT TRANSFORMERS

T-251	Single 53, 6A6, 56, 6C5, etc. to P. P. 53, 6A6, etc. (Single 53, 6A6, etc. in P. P.).....	2A	4.50
T-252	Single 30, 49, 89 to P. P. 19, 30, or 49's.....	1A	3.50

For portable applications use open type KR19. List Price \$1.50

T-253	Single 46 or 59 to P. P. 46's or 59's, 6F6's, etc.....	2A	4.50
T-254	Single 45, 6F6, 2A5, 42 etc. to P. P. 6F6, 45's, 2A5's, 42's, etc.....	2A	4.50
T-255	P. P. 56, 76, 6C5, 53, 6A6, 6N7 to P. P. 6L6's.....	2A	4.50
T-256	P. P. 56, 76, 6C5, to P. P. 45's, 2A3's, 6F6's, etc.....	2A	4.50
T-257	P. P. 45's to P. P. Parallel 46's.....	2A	4.50
T-258	P. P. 45's to P. P. 800's.....	3A	5.00
T-259	P. P. 2A3's to P. P. 203A's, 838's, etc.....	4A	6.00
T-260	P. P. parallel 2A3's to P. P. H.D. 203A's, P. P. Parallel 838's, etc.....	4A	8.00
T-271	P. P. 45's, 2A3's, 6F6's (triode) to P. P. Class AB: 6L6's.....	3A	5.00

CLASS "A" OUTPUT TRANSFORMERS

Type		Case	List Price
T-101	Single Class A Plate 56, 76, 6C5, 77 (triode) 6C6 (triode) etc. to 500 or 200 ohms	1A	\$3.50
T-102	P. P. Class A Plates 56, 76, 6C5, 77 (triode) 6C6 (triode) etc. to 500 or 200 ohms	1A	3.50
T-103	P. P. 45's, or 42's to 500-200 or 15-8-4 ohms	2A	5.00
T-104	Single 2A5, 6F6, 89, 47 etc. to 500-200 or 15-8-4 ohms	2A	4.50
T-105	P. P. 2A5, 6F6, 89, 47 etc. to 500-200 or 15-8-4 ohms	2A	5.00
T-106	P. P. 6B5, 2B6, to 500-200 or 15-8-4 ohms	3A	5.50

CLASS "AB" AND "B" OUTPUT TRANSFORMERS

T-301	P. P. 45's, 2A3's (Class AB) 6L6's (Class A) to 500-200 or 15-8-4 ohms. Primary 5000 or 3000 ohms	4A	6.00
T-302	P. P. 6N7, 53, 49's, 19 to 500-200 or 15-8-4 ohms	3A	5.50
T-303	P. P. 46, 59's, 6F6's (triode or pentode) 2A5's, 42's to 500-200 or 15-8-4 ohms. Primary 10,000 or 6000 ohms	4A	6.00
T-304	P. P. Parallel 45's, 2A3's to 500-200 or 15-8-4 ohms Primary 1500 or 2500 ohms	4A	8.00
T-305	P. P. Parallel 46's, 59's, 6F6's, (triode or pentode) 2A5's, 42's to 500-200 or 15-8-4 ohms. Primary 5000 or 3000 ohms	4A	8.00
T-317	P. P. 6L6's Class AB ₁ (6600 or 3800 ohms — 34 watts) to 500-200 or 15-8-4 ohms	4A	8.00
T-319	P. P. 6L6's AB ₂ (6000 or 3800 ohms — 60 watts) to 500-200 or 15-8-4 ohms	5A	8.50

MODULATION OUTPUT TRANSFORMERS

T-451	Class B 6N7, 53, 6A6, RK34, to 5000 or 3000 ohms. Max. Sec. D.C. 100 M.A.	2A	4.50
T-452	Class B 19, to 5000 or 3000 ohms. Max. Sec. D.C. 50 M.A.	1A	3.50
For portable application use open type KR19M. List Price \$1.50			
T-453	Class AB 2A3's, 45's or Class A, 6L6's to 5000 or 3000 ohms. Max. Sec. D.C. 130 M.A.	4A	8.50
T-454	Class B 46's or 59's, 6F6's (triode or pentode) 2A5's, 42's etc. to 4000-6000-8000 ohms. Max. Sec. D.C. 140-100-75 M.A. Primary 6000 or 10,000 ohms	4A	8.50
T-455	Class B — 210's to 5000-7000-9000 ohms. Max. Sec. D.C. 180-150-130 M.A.	5A	10.00
T-456	P. P. Parallel 45's or 2A3's Class AB to 5000-7000-9000 ohms. Max. Sec. D.C. 150-100-75 M.A.	5A	10.00
T-457	P. P. Parallel 46's, 59's, 6F6's, (triode or pentode) 2A5's, 42's etc. to 3000-5000-7000 ohms. Max. Sec. D.C. 220-160-120 M.A. Primary 3000 or 5000 ohms	5A	10.00
T-465	P. P. 838's, 203A's to 4000-6000-8000 ohms. Max. Sec. D.C. 400-320-270 M.A.	7A	25.00
T-470	P. P. H.D. 203A's to 4000-6000-8000 ohms. Max. Sec. D.C. 500-400-350 M.A.	8A	42.00
T-490	Single 2A5, 42 or 6F6 grid modulation transformer to grid modulate 203A's, 211's, etc.	2A	4.50
T-491	Single 45 grid modulation transformer to grid modulate 203A's, 211's, etc.	2A	4.50
T-458	P. P. 801's to 5000-7000-9000 ohms. Max. Sec. D.C. 150-135-110 M.A.	6A	12.50
T-460	P. P. 800's to 6000-8000-10,000 ohms. Max. Sec. D.C. 200-175-150 M.A.	6A	15.00
T-492	Grid or suppressor modulation transformer — P. P. 45's to 10,000 ohm load	3A	5.00
T-459	P. P. 6L6's Class AB ₂ to 2500-5000-7000 ohms. Max. Sec. D.C. 300-250-200 M.A.	5A	8.50

FILTER REACTORS

Type No.	Inductance Henries	Max. M.A.	D.C. Resistance	Insulation Test	Case No.	List Price
T-155	290	10	4700	1000 V.	2A	\$4.00
T-158	*350	10	10000	1000 V.	3A	4.50
T-156	30	25	800	1000 V.	1A	3.00
T-157	20	50	200	1000 V.	1A	3.00
T-153	30	90	350	1000 V.	3A	3.50
T-154	15	165	210	1000 V.	3A	4.00
T-152	10	200	100	1000 V.	3A	4.00
T-164	14	250	135	1500 V.	5A	9.00
T-166	11	300	125	1500 V.	5A	9.00
T-159	12	500	77	1500 V.	6A	12.50
T-165	10	150	275	3000 V.	3A	4.00
T-168	13	250	125	3000 V.	5A	10.00
T-160	11	300	120	3000 V.	5A	10.00
T-167	11	400	80	3000 V.	6A	12.00
T-175	10	200	140	5000 V.	4A	7.00
T-176	10	300	110	5000 V.	5A	11.00
T-178	10	400	90	5000 V.	6A	15.00
T-177	12	500	95	5000 V.	7A	18.00

*Center tapped.

SWINGING REACTORS

Type No.	Inductance Henries	Max. M.A.	D.C. Resistance	Insulation Test	Case No.	List Price
T-517	15-45	90-20	350	1000 V.	3A	\$3.50
T-515	10-25	165-30	210	1000 V.	3A	4.00
T-506	5-20	200-30	100	1000 V.	3A	4.00
T-507	7-25	250-50	135	1500 V.	5A	9.00
T-510	6-19	300-30	125	1500 V.	5A	9.00
T-511	5-20	170-20	275	3000 V.	3A	4.00
T-508	7-26	250-50	125	3000 V.	5A	10.00
T-514	5-20	300-50	120	3000 V.	5A	10.00
T-516	5-20	400-50	80	3000 V.	6A	12.00
T-509	6-19	200-30	140	5000 V.	4A	7.00
T-512	5-15	300-30	110	5000 V.	5A	11.00
T-513	5-18	400-50	90	5000 V.	6A	15.00
T-521	6-21	500-60	95	5000 V.	7A	18.00

PLATE TRANSFORMERS

Type No.	Primary	A.C. Secondary Volts	D.C. MA.	Case	List Price
T-664		740-0-740	150	5A	\$8.00
T-655	*Tapped	460-0-460	250	5A	9.00
T-656	*Tapped	740-0-740	300	6A	12.00
T-657	†Tapped	900-0-900	800		
		900-0-900	200	7A	26.00
T-658	†Tapped	520-0-520	175		
		570-0-570	175	7A	21.00
		570-0-570	175		
T-654	†Tapped	490-0-490	250		
		630-0-630	250	8A	30.00
		630-0-630	250		
T-659	†Tapped	520-0-520	350		
		570-0-570	350	8A	30.00
		570-0-570	350		
T-665	*Tapped	1180-0-1180	250	7A	22.00
T-666		1460-0-1460	350	8A	26.00
T-667		1460-0-1460	500	9A	34.00
T-660		1460-0-1460	500		
		630-0-630	900	9A	38.00
T-661		2080-0-2080	200	7A	22.00
T-662		2080-0-2080	300	8A	30.00
T-663		2360-0-2360	600	10A	70.00

*Primary tapped to increase the above secondary voltages approximately 25%.

†Primary tapped to increase the above secondary voltages approximately 30%.

‡Primary tapped to increase the above secondary voltages approximately 12.5% and 25%.

PLATE AND-FILAMENT TRANSFORMERS

Type No.	Sec. Volts	D.C. MA.	F1	F2	F3	F4	Case No.	List Price
*T-249	235-0-235	20	6.3 V.-.6A. CT.	6.3V.-.9A. CT.			2A	\$4.50
*T-245	320-0-320	40	5 V.-3 A.	6.3V.-2 A. CT.			3A	5.00
†T-201	0-75	70	5 V.-2 A.				2A	4.50
*T-205	350-0-350	75	5 V.-2 A.	6.3V.-3 A. CT.			4A	6.50
*T-206	325-0-325	100	5 V.-3 A.	6.3V.-3 A. CT.	6.3V. 2A. CT.		5A	8.50
T-212	420-0-420	125	5 V.-3 A.	6.3V.-3 A. CT.	2.5V. 4A. CT.		5A	9.50
T-214	420-360-125-0-360-420	150	5 V.-3 A.	2.5V.-3 A. CT.	2.5V. 5A. CT.	6.3V.-3 A. CT.	5A	10.00
*T-244	425-0-425	165	5 V.-3 A.	6.3V.-3 A. CT.	6.3V. 3A. CT.		6A	12.00
*T-248	425-0-425	165	5 V.-3 A.	2.5V.-6 A. CT.	2.5V. 6A. CT.		6A	12.00
T-213	520-110-0-520	180	5 V.-3 A.	2.5V.-3 A.	6.3V. 3A. CT.	6.3V.-3 A. CT.	5A	11.50
T-215	360-125-0-360	200	5 V.-3 A.	2.5V.-3 A. CT.	2.5V. 10A. CT.	6.3V.-2.1A. CT.	5A	11.50
T-247	590-0-590	200	5 V.-3 A.	6.3V.-3 A. CT.	6.3V. 3A. CT.		5A	12.00
T-216	520-85-0-520	250	5 V.-3 A.	2.5V.-3 A.	6.3V. 3A. CT.	6.3V.-3 A. CT.	6A	13.00
†T-207	{ 0-275-375	10	6.3V.-.6A.	6.3V.-1 A.	2.5V.-1.4A.		3A	4.00
	{ 0-180	6						
†T-202	0-150	20	6.3V.-.6A.				1A	4.00
†T-220	125-0-125	200	5 V.-3 A.				4A	6.00
T-246	625-0-625	250	5 V.-3 A.	6.3V.-3 A. CT.	6.3V. 3A. CT.		6A	13.00

*Indicates unit designed for condenser input to filter.

†For RCA 913 Midget Cathode Ray Tube.

‡For oscillators, wave meters, etc.

§For bias supplies.

(All other units should be used with choke input.)

FILAMENT TRANSFORMERS

Single Winding

Type No.	F1	F2	F3	F4	Case No.	List Price
T-352	2.5 V.-10 A. CT. 2000 V. Test				2A	\$4.00
T-354	5 V.-3 A. CT. 2000 V. Test				2A	4.00
T-351	6.3 V.-3 A. CT. 2000 V. Test				2A	4.00
T-353	7.5 V.-4 A. CT. 2000 V. Test				2A	4.00
T-357	5.25 V.-12 A. CT. 2000 V. Test				4A	6.00
T-358	5.25 V.-20 A. CT. 2000 V. Test				5A	8.00
T-360	2.5 V.-10 A. CT. 5000 V. Test				3A	6.00
T-365	10 V.-4 A. CT. 5000 V. Test				3A	6.50
T-361	10 V.-8 A. CT. 5000 V. Test				4A	8.00

Two Windings

T-366	2.5 V.-10 A. CT. 5000 V. Test	2.5 V.-10 A. CT. 5000 V. Test			4A	8.00
T-363	10 V.-6.5 A. CT. 5000 V. Test	10 V.-3.25 A. 5000 V. Test			5A	9.00
T-362	11-12 V.-8 A. CT. 5000 V. Test	10-11 V.-3.5 A. CT. 5000 V. Test			5A	11.00

Three Windings

T-364	2.5 V.-8 A. CT. 750 V. Test	2.5 V.-8 A. CT. 750 V. Test	5 V.-6 A. 750 V. Test		4A	7.00
T-356	6.3 V.-3 A. CT. 750 V. Test	5 V.-4 A. CT. 3000 V. Test	5 V.-8 A. CT. 3000 V. Test		4A	9.00
T-355	5 V.-3 A. CT. 4000 V. Test	5 V.-3 A. CT. 4000 V. Test	5 V.-6 A. CT. 4000 V. Test		4A	7.50
T-375	2.5 V.-5 A. CT. 6000 V. Test	2.5 V.-5 A. CT. 6000 V. Test	2.5 V.-10 A. CT. 6000 V. Test		4A	9.00

Four Windings

T-373	2.5 V.-5 A. CT. 750 V. Test	5 V.-3 A. 750 V. Test	7.5V.-3.25 A. CT. 3000 V. Test	7.5 V.-8 A. CT. 3000 V. Test	5A	9.00
T-374	2.5 V.-5 A. CT. 750 V. Test	5 V.-3 A. 750 V. Test	6.3 V.-3 A. CT. 3000 V. Test	7.5 V.-8 A. CT. 3000 V. Test	5A	9.00
T-370	6.3 V.-3 A. CT. 750 V. Test	6.3 V.-3 A. CT. 750 V. Test	2.5 V.-4 A. CT. 750 V. Test	5 V.-3 A. 750 V. Test	4A	7.50
T-371	5 V.-3 A. 750 V. Test	6.3 V.-3 A. CT. 750 V. Test	6.3 V.-3 A. CT. 750 V. Test	7.5 V.-8 A. CT. 2500 V. Test	5A	8.50
T-372	5 V.-3 A. 750 V. Test	5 V.-3 A. CT. 750 V. Test	6.3 V.-3 A. CT. 750 V. Test	7.5 V.-4 A. CT. 2000 V. Test	5A	8.50
T-367	6.3 V.-5 A. CT. 2000 V. Test	6.3 V.-5 A. CT. 2000 V. Test	5 V.-6 A. CT. 2000 V. Test	5 V.-3 A. CT. 2000 V. Test	5A	9.00

Five Windings

T-377	F1 5 V.-3 A. 2000 V. Test	F2 5 V.-6A. 2000 V. Test	F3 6.3 V.-1 A. CT. 2000 V. Test	F4 6.3 V.-5 A. CT. 2000 V. Test	F5 6.3 V.-5 A. CT. 2000 V. Test	5A	9.5
-------	---------------------------------	--------------------------------	---------------------------------------	---------------------------------------	---------------------------------------	----	-----

Prices subject to change without notice

Our new 64 page transmitter manual contains complete up-to-date transmitter circuits ranging in size from 5 watts to one kilowatt.

14 pages are entirely devoted to full page Ken-O-Grafs which cover most of the calculations used in radio in a modern and painless method.

This book which should be in the possession of every amateur is no subterfuge for a catalog.

To obtain your copy see your local dealer or send 25 cents in coin or stamps to

KENYON TRANSFORMER CO., INC. 840 BARRY ST., NEW YORK, N. Y.



III
**TRANSMITTER
 CONSTRUCTION
 & PERFORMANCE**

ANNOUNCING TEMCO - A NEW STANDARD OF EXCELLENCE

Model 1000: 1
 Kcs input, push-
 pull, HP 100's
 Class C stage.

Model 100: 100
 watts input.

Also
 includes
 P.A.D.,
 automatic
 NBC or BC
 switching
 circuit,
 driver for
 TEMCO
 1000 watt
 cathode ray

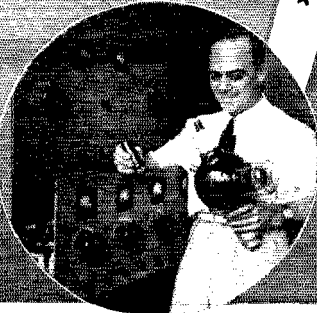

The new line of TEMCO transmitters from 100 to 1000 watts, offers many new features resulting in increased efficiency and convenience of operation. Compare these salient features ■ **Band switching up to and including grid circuit of final amplifier stage** ■ **Automatic plug-in chassis with conduit-protected inter-cabling** ■ **Full remote control** ■ **Complete relay protection** ■ **Separate hi-fidelity speech amplifier unit including 2 channel mixer** ■ **100% high level modulation** ■ **6 position crystal selector switch** ■ **Operation from 1.7 mc. to 30 mc.**

Complete and illustrated technical data sheets on these as well as TEMCO Transmitters of 350 and 500 watts input will be sent on request. Address inquiry attention W2KR.



Transmitter Equipment Manufacturing Co., INC.

130 CEDAR STREET • NEW YORK, N. Y.

Designers and Manufacturers of Radio Transmitting and Accessory Equipment

Announcing!

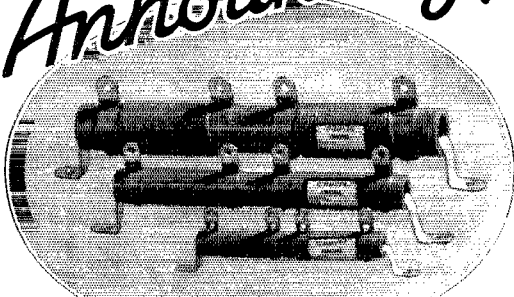

OHMITE POWER LINE CHOKES

FOR PREVENTING INTERFERENCE FROM HIGH FREQUENCY CURRENTS

★ Again OHMITE is first with the latest! These new solenoid-wound power line chokes score bull's-eyes in two directions—first in preventing high frequency currents from going out over power lines from radio transmitters, and second, in preventing high frequency currents from coming in over power lines to radio receivers. They are not recommended for use in preventing interference of audio frequency.

★ The three Ohmite Power Line Chokes shown in the illustration at the top of this page are designed primarily for amateur transmitter use. The Z-20 Choke, rated at 5 amperes, is designed to take care of low-powered transmitters. The Z-21 Choke is rated at 10 amperes and is recommended for use in medium-powered transmitters. The Z-22 Choke is rated at 20 amperes and is designed for use on high-powered transmitters. For transmitters or other high frequency apparatus drawing more than 20 amperes, special chokes can be made up to specifications.

★ On account of its small size the Z-20 Choke is also specially suitable for use on radio receivers—in preventing interference from nearby high frequency sources from coming in to such sets over the power lines. For this reason this choke is particularly desirable to use in working duplex in amateur radio station operation.

★ An Ohmite Power Line Choke and condensers, serving as a filter, is shown in the diagram above. The condensers may be 0.1 microfarad units, rated at approximately twice the line voltage. For further information on these new Ohmite Power Line Chokes see your dealer or send for Bulletin 105.

OHMITE

MANUFACTURING COMPANY

4831 Flournoy St.

Chicago, Ill.

Manufacturers of Resistors and Rheostats of All Types

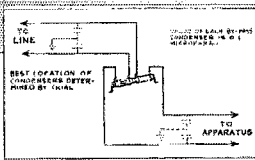

Correspondence Dept.

(Continued from page 66)

This week on the same band I heard a well-known W8 in a perplexed mood complaining in Italian to a friend that his tubes were showing color when he ran 'em at 1500 watts, while they ran perfectly cool when he ran 'em at 1500 watts.

And to top it all off, to-night two of the kilowatt boys discussed at length the terrific QRM being caused by another ham who was on their frequency and running a good solid kilowatt of his own.

This latter discussion terminated with the remark to the effect that "Well, when kilowatt bucks kilowatt I guess nothing much gets through."

I am asking you, Mr. Editor, is this a system?

I figure that with my little half-kilowatt bottle in hock, I can buy a couple of rare Abyssinian stamps or get a good b.c.l. receiver. At least, the high-powered stations on the b.c. bands put on some good entertainment.

—Larry Evans, W2BK/3

Lightning on Ten

Room 1020, Civic Center Bldg., Los Angeles, Calif.

Editor, QST:

I noticed a rather odd phenomenon on the 10-meter band during a recent thunderstorm that may be of interest.

At the time of observation, I was working a 'phone station in the 8th district with R8 signals both ways. The weather had been cloudy with some rain for the past 12 hours. As the warm front of the storm approached from the east (directly in the path of our signals) it developed several lightning flashes and heavy thunder. The lightning was quite some distance away and produced the usual static crack in the receiver with no effect on the R8 signal. After a pause of possibly two to five seconds the R meter on the Breifing receiver started a dance that about took it out of its mounting. The R8 signal went up to about R10 and with a rapid fade to 0 and back to maximum. This condition of a very rapid fade continued until the thunder was heard audibly. This same condition repeated itself following each flash of lightning during the entire afternoon and only effected the eastern signals with the K6's coming through unaffected.

The above noted condition was possibly a result of the turbulent condition of the lower atmosphere caused by the heavy vibration of the thunder clap—or sumpin—signals bent in the atmosphere, etc. Hi!

This condition may have been observed before but it was a new experience to me and I am passing it to you in case it should bear checking.

—Maurice E. Kennedy, W6BGC, W6KQ

Ham Binges

465 Franklin Ave., Hasbrouck Heights, N. J.

Editor, QST:

What do you think of the enclosed clipping?

I think it's too bad a few use such poor judgment, especially after several warnings issued through QST.

Why should we amateurs stand for it? I would suggest any one hearing such make a complete log of it and get as many witnesses as possible. Then send it to A.R.R.L. to be published or to be used as the Board deems it best.

The writer is not a dry, but I do enjoy the privilege of amateur radio.

—Charles Ratcliffe, W2DMN (W1INS)

EDITOR'S NOTE.—The clipping referred to is an excerpt from Zeh Bouck's column in the *New York Sun* for Saturday, October 17th. It reads:

"We tuned in the other evening to our first ham binge—a ham binge being a jollification when two amateurs get together and stage drinking parties on their respective ends of the ether. We're happy indeed to learn that the amateurs can find some useful way in which to spend their time between floods and hurricanes. However, we fear that some of them may turn out to be has-beenges—as the language used during the latter portions of the parties is not always in accord with the F.C.C. rules and regulations. The festivities start with a few 'hi hi's,' getting high higher and ending up by being hi hilarious. The hams apparently drink nothing but gin and ginger ale preferably without ginger ale. (Along

Taylor

HEAVY

CUSTOM
BUILT

DUTY

Tubes

TAYLOR'S GREAT T-55 AGAIN CRASHES THROUGH!!

Once more Taylor takes pleasure in announcing new and improved ratings for the champion transmitting tube — the mighty T-55. Taylor has led the way. The ideal of "More Watts Per Dollar" has given the amateur quality tubes at the prices Taylor pioneered. We are proud of your loyalty and pledge our continued adherence to this policy.

T-55 ONLY \$8.00

LOOK—CHARACTERISTICS—LOOK

Class "B" Audio Push Pull Operation

Filament Voltage.....	7.5
Filament Current, amps.....	2.0
Mutual Conductance Micromhos	2200
Amp. Factor.....	20

Class "B" Operating Conditions

Plate Voltage.....	1000	1250	1500
Plate to plate load, Ohms.....	6900	9400	12000
Average D. C. Plate Current— 2 tubes.....	.285	.280	.275
Grid Voltage, appr.....	45	55	65
Static Plate Current (per tube) Mils. appr.....	20	20	20
Power Output Watts....	175	225	275

Class "C" Tube Characteristics

Max. Plate Volts Unmodulated D. C.....	1500
Modulated D. C.....	1500
Max. D. C. Plate Current M. A.....	150
Max. D. C. Grid Current M. A.....	40
R. F. Output Watts	
75% Efficiency.....	168

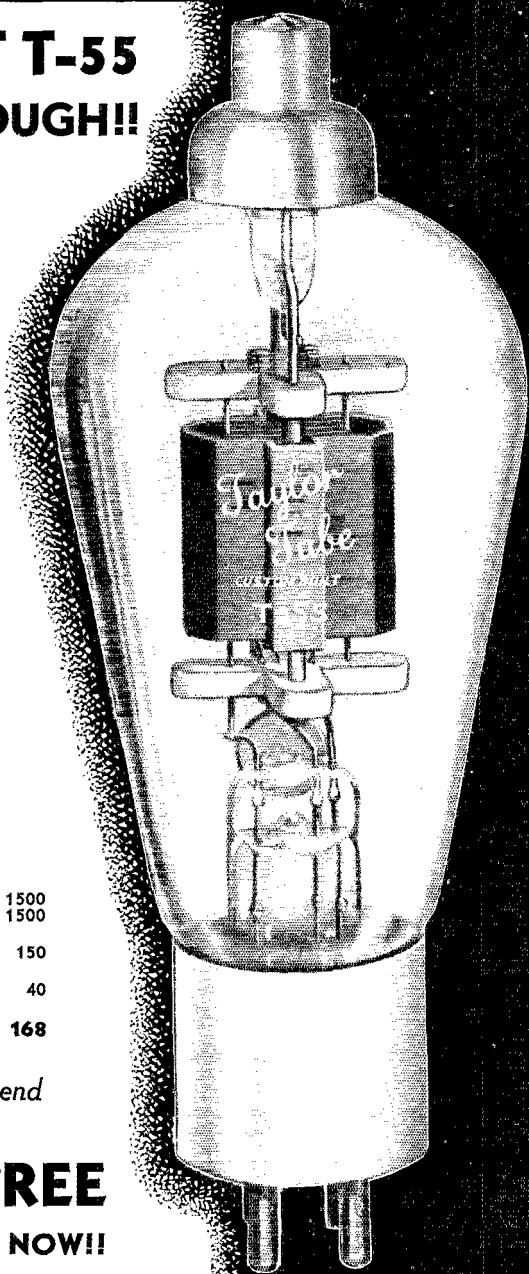

All leading radio parts distributors recommend
TAYLOR TUBES

FREE Big new TAYLOR TUBE catalog and handbook No. RN **FREE**

See your parts distributor or write us **NOW!!**

"More Watts Per Dollar"

TAYLOR TUBES, INC., 2341 WABANSIA AVE., CHICAGO, ILLINOIS

NEW- ECONOMICAL- GET 120 WATTS AUDIO POWER from push-pull parallel — $\left\langle \begin{matrix} 6L6 & 6L6 \\ 6L6 & 6L6 \end{matrix} \right\rangle =$ TUBE COMBINATION

The JEFFERSON laboratory has engineered an amplifier circuit which delivers 120 watts of audio power using the above tube combination.

Development of this circuit was prompted by the success of the JEFFERSON 60 watt P.P. 6L6 amplifier published a few months ago, which, for the first time, made it possible to realize the full output of these tubes.

Every amateur will be interested to learn how easy and economical it is to construct this amplifier and get 120 watts of audio power.

Send for Bulletin PA-13. JEFFERSON ELECTRIC COMPANY, Bellwood (Suburb of Chicago), Illinois. Canadian Factory: 535 College St., Toronto.

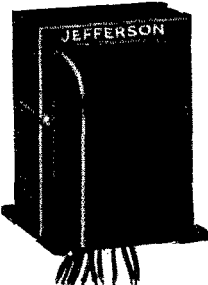

Plate Transformer
No. 465-261
For 120-Watt Amplifier

JEFFERSON TRANSFORMERS

Jefferson Electric Company
Bellwood, Illinois

Send full information on circuit and Jefferson Transformers for the 120-watt Audio Power 6L6 Tube combination.

Name

Address

City and State

The Wine Trail: Please note and do something about it.)"

QST is appalled to learn (1) that such are hams' drinking habits, (2) that such is their drink. Needless to say, this practice cannot be too emphatically condemned, nor can its individual and collective danger be over-emphasized.

Thanks also to others sending in this clipping, and a word, by-the-way, to all readers: A.R.R.L. maintains no press-clipping service. We depend on ham friends throughout the country for clips from newspapers and other publications concerning ham matters. It is greatly appreciated, therefore, whenever items of ham publicity, whether favorable or otherwise, are forwarded to us.

107 Berteau Ave., Elmhurst, Ill.

Editor, QST:

... Another great black eye to the amateur is these drinking parties over the air. This surely gives the broadcast public a bad opinion of amateur radio. Then when a little b.c.l. trouble comes up he dislikes the amateur more and so he writes the F.C.C. about the condition and when we ask for more frequencies they say we can't have them because we cause too much trouble to the broadcast listening public. ...

—Robert B. Schmidt, W9SZO

The Editor's Mill

(Continued from page 8)

held by the F.C.C. in Washington, where every radio interest was required to display what uses were being made of its frequencies and what its requirements were for satisfactory service in the future. A.R.R.L. staged a comprehensive presentation for the amateur which was widely hailed as the most instructive demonstration presented by any service. Representing weeks of work by staff members, and illustrated by colored charts, it dramatically told the vast national merits of organized amateur radio with heavy emphasis on its contributions to the art and to the community; it graphically displayed the state of our congestion and incontrovertibly established the reality of our need for more frequencies; it made substantial contributions to ultra-high-frequency knowledge which are claimed as useful in the eventual allocation to services of the frequencies above 30 Mc., and clinched the case for a continuing family of amateur bands in the u.h.f. region—an issue on which no announcement had been made as the year approached its end.

A.R.R.L. headquarters kept constant contact with Washington during the year, adjusted scores of small difficulties. In a test case on the portable regulations the League successfully defended a member accused of violation, precipitating a clarification of the portable regulations which is soon to appear. During the year the number of licensed amateur stations in the country increased about 3%, passing the 47,000 mark.

In the Dominion of Canada, amateur development kept strictly apace that of the States. It has had a flourishing year, attaining the greatest numbers in its history. Excellent relations between Canadian amateur radio and the government at Ottawa were maintained by the League's Canadian General Manager, but the administration refused to embrace the desire of Canadian amateurs for more frequencies at Cairo, the same as did the United States government.

In the world of international amateur radio,

Season's Greetings to all our Friends



Type 50-TK Transmitter

Fifty watts output from the final push-pull 6L6 stage. The tube line-up is 59 Tri-tet crystal oscillator, latest type quadrupling circuit, link coupling used, fixed neutralization. Panel, 8 3/4" chassis 8". Complete in kit form with one set of \$23.95 coils.

Type 50-TB Transmitter — Wired by our Laboratory, \$31.95. Power supply 500-PB is used with the 50-TB. Additional coils for the 50-TK, \$3.00 per set.

Combination Type 50-TBC Transmitter — Crystal and holder, 59 and two 6L6G tubes, Sylvania. \$37.15

Type 50-C — as above, complete with 500-PB power supply and 83 tube. . . . \$51.00

LEEDS BAND WAGON SPECIALS

Made on chassis with protecting grill. 32 watt high fidelity push-pull 6L6 amplifier, high and low impedance input — 2% distortion. Output impedance 2, 4, 6, 8, 15 v.c. 200 and 500 v. line. \$28.75

Same 32 watt amplifier with modulation transformer (will modulate 64 watt P.T. load) \$31.75

Set of 6 matched Sylvania metal tubes, \$4.49

1 Wright DeCoster No. 1590 — 12" speaker, \$7.80

1 Astatic D-104 microphone. \$13.23

1 Floor stand (adjustable 67") \$3.95

COMPLETE SOUND SYSTEMS

32 watt amplifier, two No. 1590 WDC speaker, Astatic crystal microphone, and 2-20" sound projectors. \$68.95

SPECIAL — 11 watt 6L6 amplifier, high and low impedance input. \$14.50

Set of 4 matched Sylvania metal tubes, \$2.73

Complete 11 watt unit, tubes, Wright DeCoster No. 990 speaker, Bell projector, crystal microphone. \$39.95

NOISE SILENCER ADAPTERS are a great help on reducing natural static too. LEEDS "QUIET CAN" and "SILENT CAN" also provide freedom from ignition noises and afford an ideal arrangement for push to talk phone and break-in CW.

LEEDS "Quiet Can" for receivers with 2 IF stages; complete with tubes and instruction. \$7.95

LEEDS "Silent Can" illustrated herewith, for receivers with 1 IF stage; complete with tubes and instructions \$9.95

RELAY RACKS RACK PANELS BASES AND DEMI BASES

for sizes, complete descriptions and prices, see our advertisement in November issue

We Are Headquarters for the Following

Hammarlund — Meisner — Alladin — Triplett — Littelfuse — United Transformer — Cornell-Dubilier — Thordarson

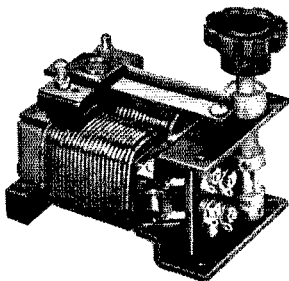

GENERAL RADIO Variac Transformers

A wonderful line voltage control, that is smaller, more convenient to use and furnishes high current over a narrow voltage range.

Type 70-B — 115 v. at 2 amps. \$10

Type 80-B — 115 v. at 7.5 amps. . . . \$15

Write for Bulletin 67-Q for complete data

Here are two handy G.R. forms for that multiband transmitter.

Type 677-U — 21 turns, 2 1/2" diameter, resonant on 3.5 mc with 100 mfd. capacity; shipping weight 2 lbs. Price. \$50c

Type 677-Y — 30 turns 4" diameter, resonant 1.7 mc with 100 mfd. capacity; shipping weight 3 lbs. Price. \$75c

Also 7-pin base to fit above forms at 70c and a matching base with jacks at 65c.

G.R. 247M — .00025 condensers. . . . \$49c

G.R. Amateur accessories always in stock

AEROVOX OIL IMPREGNATED CONDENSERS

1 mfd. 1000 v. . \$1.59 1 mfd. 1500 v. . \$1.67
2 mfd. 1000 v. . 1.97 2 mfd. 1500 v. . 2.30
4 mfd. 1000 v. . 2.85 1 mfd. 2000 v. . 2.09
2 mfd. 2000 v. . \$2.79

Electrolytic and tubular condensers in stock

TRIPLETT METERS

All standard ranges; 0-10 to 0-1000 MA 3 1/2" bakelite case. \$3.75
2" bakelite case. \$2.94

READRITE milliammeters 15 to 400 mills; any range, each. \$9c

TRIMM 2000 ohm phones. \$1.80

4000 ohm. \$2.25

TRIMM featherweight. \$5.88

DX 20,000 ohm imp. \$2.65

WESTERN ELECTRIC, type P-11. . . . \$3.95

ALL SYLVANIA RECEIVING TUBES at 50% off list price



LEADS THE FIELD
World Wide Service to Amateurs
45 Vesey Street
New York City

Tel. Cortlandt 7-2612
Cable Address: "RADLEEDS"



Important Announcement

On Our NEW LD-5 Mounted Crystals

These low drift plates, factory sealed in the new LEEDS metal holder are outstanding from the standpoint of stability, accuracy, high output and low cost. Low Drift — 5 cycles per million per degree. Accuracy of calibration — better than .05%. Orders filled plus or

minus two kc. of specified frequency. Last but not least, the price of the mounted crystals, anywhere in the 160 80 and 40 meter band is only . . . \$3.50

Money back guarantee if you are not completely satisfied.

LEEDS type A.L. metal crystal holder, as illustrated above, fits standard 5-prong socket. \$9c

NATIONAL

NC 100 — NC 100 X and 101 X
Hammarlund "Pro" and "Super-Pro"
Sold on time at cash prices in Metropolitan area. No down payment.
Liberal allowance on your old set.

We carry the complete line of NATIONAL and HAMMARLUND.

NAVY TYPE TELEGRAPH KEY

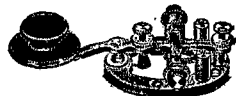

List \$3.60. Navy knob — 1/4" Tungsten contacts. While they last. \$1.15
With regular knob. \$95c

HAMMARLUND "STAR" MIDGET CONDENSERS

A dandy variable condenser for receiving, transmitting, short wave tuning, verniers, etc., — the usual Hammarlund high quality, at unusually low prices.

Type	Mmf	Price
SM-15	15	.50
SM-25	25	.50
SM-50	50	.53
SM-100	100	.59
SM-140	140	.73
SM-35-X	35	.59
SM-50-X	50	.73

H & H VITREOUS ENAMEL ADJUSTABLE RESISTORS

complete with 1 slider

100 w. 6 1/2" x 1 1/2" \$1.15
500 — 1000 — 2500 — 5000 ohm. . . . \$1.30
10,000 to 25,000 ohm. 1.36
30,000 — 40,000 — 50,000 ohm. . . . 1.49
60,000 — 75,000 — 100,000 ohm. . . . 1.55
200 w. 10 1/2" x 1 1/2" 1.75
500 to 10,000 ohm. 2.00
15,000 to 100,000 ohm. 2.40
Extra taps, each. \$9c

TAYLOR Custom Built and **RAYTHEON** Transmitting Tubes in Stock
Write for Folder

The record is 100% perfect. Thousands of microfarads of LEEDS OIL FILLED CONDENSERS are in use without one case of failure.

1 M F	1000 volt D.C. working	\$.10
2 M F	1000 volt D.C. working	1.45
1 M F	1500 volt D.C. working	1.45
2 M F	1500 volt D.C. working	1.95
1 M F	2000 volt D.C. working	1.75
2 M F	2000 volt D.C. working	2.45

LEEDS has the most complete line of Antenna Wire found in any shop. Hard and soft drawn wire — enameled copper — tinned copper — tinned wire — any length, at lowest prices.

**CAN YOU
KEEP UP—**



**WITH THE FAST
CODE OPERATORS?**

MAYBE you can send from 12 to 20 words a minute but — how fast can you receive? Do the "speed merchants" run away from you and leave you hopelessly behind?

You can learn to handle code as smoothly as the best "op" on the air — right at home — and in an amazingly short time. Literally thousands of code experts — amateurs and commercial — are Candler trained.

With this system you learn code the right way — by sound. You are taught to coordinate mind and hand properly, to read code as easily as you do print — to copy behind with absolute confidence. And best of all — Candler's instruction is inexpensive.

Write today for the Free Book of Facts! Learn what World's Speed Champion McElroy and other code experts have to say about the Candler System. Ask any skilled operator about the Candler System! Who knows, it may be the start of a well paying career for you as a commercial operator.

**Three FAMOUS CANDLER COURSES
Recommended by Every Code Expert**

**SCIENTIFIC
CODE COURSE**
for beginners. Teaches all the necessary code fundamentals scientifically.

**HIGH SPEED
PROFESSIONAL
TRAINING**
for operators who want to prepare themselves for the commercial radio field.
Candler trained

**TELEGRAPH
TOUCH-TYPE-
WRITING**
for those who want to become expert in the use of the "mill," in receiving fast stuff by touch!

operators are in demand for attractive commercial jobs.

CANDLER SYSTEM CO.
DEPT. A-1 ASHEVILLE, NO. CAROLINA

MAIL THIS COUPON TODAY!

CANDLER SYSTEM CO.
Dept. A-1, Asheville, North Carolina
Please send me Free Book of Facts

Name.....
Address.....
City..... State.....
Code Speed..... wpm

the year 1936 was one of notable accomplishment. The International Amateur Radio Union added two new member-societies to its roster, bringing the total to 27. Its strength and prestige in international affairs mounts steadily. More than 700 W.A.C. certificates were issued by the Union through the year. Extensive preparations for the 1937 Bucharest C.C.I.R. meeting and preliminary discussions for the 1938 Cairo conference were carried on during the year. In preparation for the C.C.I.R., the Union contributed technical studies on several of the questions on the agenda of which amateurs have a peculiar knowledge, and plans were made for active representation at the conference itself by the adoption of an arrangement wherein the member-societies of the Union share the costs of amateur participation. Practically without exception there was increase in both the numerical strength and the organizational activity of the member-societies. Evidential of one phase of this enhanced activity is the growing number of international contests being sponsored by various societies—a new manifestation of the thoroughly universal international spirit of amateur radio around the world.

— . . . —

As the year draws to a close and this issue of *QST* slips into the mail, we at A.R.R.L.-I.A.R.U. headquarters would like to embrace this opportunity to send to every ham our warmest wishes for a Merry Christmas, a Joyous New Year, health and plenty, and complete success in radio endeavors! Here's to 1937!

K. B. W.

Midwest Division Convention

DEMONSTRATION of RCA's new X-488 "multitube" for amateur transmitters held the spotlight at the annual Midwest Division convention at the Hotel Kansan, Topeka, Kan., October 17th and 18th, with Prof. Adolph Munster, of Ivanhoe college, Harrisonville, N. J., as demonstrator.

Enthusiasm ran riot when Dr. Munster explained that with this new tube "you will need only one tube between power main and antenna, for this tube is a rectifier, an oscillator and a one-kilowatt amplifier, all in one envelope. It will be sold to the general amateur at only \$25."

Then an amateur stepped forward—he fumbled—and the tube, the only one of its type in existence, crashed in a thousand pieces on the floor!

Dismayed gasps changed into a roar of laughter as the convention realized it had been hoaxed.

Starring in his characterization of an eminent scientist, Dr. Munster, was Art Kimball, ex-9RY, of Topeka, staging a comeback in the "ham" game after many years' absence. The tube was specially manufactured for the Kaw Valley Radio Club, Topeka, convention hosts, by RCA-Radiotron, Inc., of which company John C. Warner, former Topekan, is vice-president.

But that was the only hoax in a busy-two-day program. Technical talks in general sessions were

Actual Modulation Percentage Shown on Direct Reading Scale

TRIPLET

MODULATION MONITOR

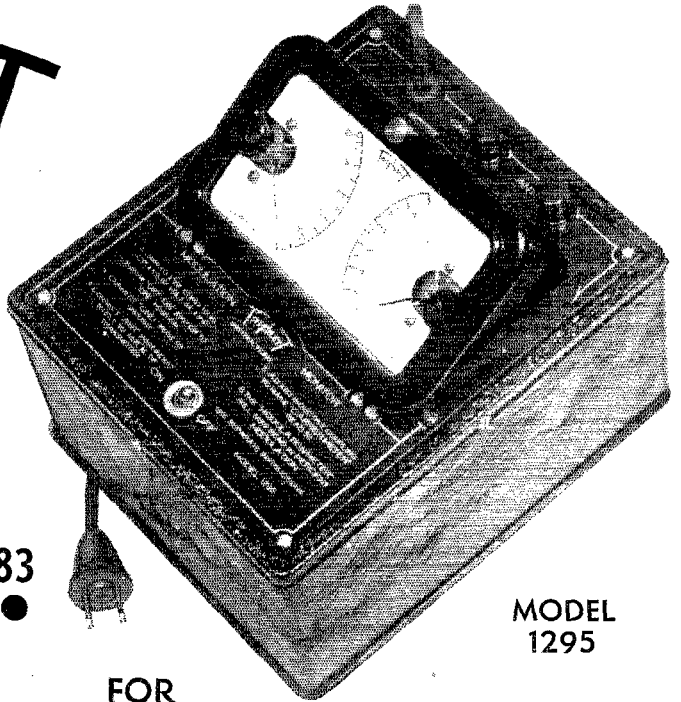

Dealer
Price \$24.⁸³

MODEL
1295

FOR

All Voice Transmitting Stations

● Eliminates the uncertainty of depending on the ear, variation of antenna ammeter or the loop and light in determining carrier shift and percentage of modulation. Actual modulation percentage is shown on direct reading Triplet twin precision instrument.

Scale indicates modulation from 40 to 120 per cent. All readings in peaks. Visual information on second dial provided for carrier reference level for the modulation test and also to check carrier shift during modulation. All uncertainties regarding final adjustments on the transmitter eliminated with the use of Triplet's Modulation Monitor. Prevents monkey chatter, cross talk and B.C.L. interference. Factory calibrated and no further calibration needed.

Model 1295 Modulation Monitor, complete with necessary accessories. Dealer Price.....\$24.83

THIS IS A TRIPLET
MASTER UNIT

See the Modulation Monitor at your jobbers. Triplet manufactures a complete line of Precision Radio Testing Equipment and Precision Electrical Measuring Instruments for the Amateur and Experimenter. Complete information available on request.

SEE YOUR JOBBER—WRITE FOR CATALOG



THE TRIPLET ELECTRICAL INSTRUMENT CO.
251 Harmon Ave., Bluffton, Ohio

Without obligation please send me more information on

Model 1295 Modulation Monitor.

I am also interested in.....

Name.....

Address.....

City.....State.....



"Five continents with only 140 watts input ..."

SAYS HAROLD P. CHANDLER, W3AKE

"I replaced my 203A with the Amperex HF100 and by doing so increased my DX fifty percent, also my percentage of QSO's ... running your tube at the same input with much less excitation. In 1 1/2 hours, on 20 meter phone, I contacted ZS6AJ, Johannesburg, South Africa; HK3RC, Colombia, South America; G6WD, Glasgow, Scotland; VE5OT, Vancouver, British Columbia; VK4CG, VK2MY, Australia ... 5 continents with only 140 watts input ..."

"NO DIRECTIONAL ARRAYS OR SPECIAL ANTENNA ..."

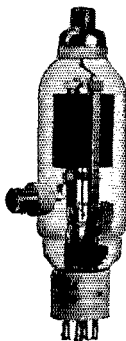

High μ
High Gm
High voltage handling ability
High frequency oscillator
High power output

LOW IN PRICE

New
**AMPEREX
HF100**

This tube delivers a satisfactory power at ultra high frequencies and is, in addition, a remarkably efficient modulator and amplifier both in the amateur and broadcast bands.

\$10

AMPEREX
ELECTRONIC PRODUCTS, INC.
79 WASHINGTON STREET, BROOKLYN, N. Y.

outstanding, with H. F. Pitzer, of Kansas City, Mo., field engineer for RCA, demonstrating a talk on "X-Raying Amateur Transmitters With the Cathode Ray Oscillograph"; W. A. Beasley, W9FRC, of the host club, presenting a paper, "Your Sky Wire and Mine," prepared for the convention by R. S. Kruse, W1FG, of Guilford, Conn.; Jay Wilcox, W9CUN, of Kansas City, Mo., discussing "The Doherty Circuit, Bell Laboratories' New Linear Amplifier"; and Clark C. Rodimon, W1SZ, of League headquarters, discussing "New Developments in Amateur Radio."

Floyd E. Norwine, Jr., W9EFC, St. Louis, Mo., Midwest Division director, was in charge of the League business session. O. J. Spetter, W9FLG, Topeka, alternate director, was introduced.

Norwine announced appointment of Beasley, W9FRC, Topeka, and William Graham, W9BNC Omaha, as assistant directors for Kansas and Nebraska, and reported League activities and plans, reviewing board actions. F. K. Tiffany, N9DEB, K.V.R.C. president, conducted convention sessions. The midnight initiatory ritual of the Royal Order of Wouff-Hong, staged by the O.B.P., Kansas City, was featured.

To H. B. Unruh, W9AWP, of Wichita, was presented the Kansas Wouff-Hong trophy for 1936, the Wichitan having been voted by fellow Kansas "hams" as the state's outstanding amateur operator for the year.

Wichita will be host to the Kansas state convention next spring; the H.A.R.C. and O.B.P., Kansas City, Mo., will be hosts to the Midwest Division convention next fall.

—N9DEB

The 1936 Central Division Convention

OVER Labor Day week-end at the invitation of the Chicago Area Radio Club Council, nearly 1600 amateurs gathered in the Sherman Hotel, Chicago, for the 1936 Central Division Convention.

Saturday morning was given over to registration and visiting the equipment show. Some very interesting movies of League headquarters and officials and other conventions were shown by our director. The program officially started at 1:00 P.M. with introductions of the newly-elected president and vice-president of the League by Director Roberts. Both Messrs. Woodruff and Bailey made short but interesting talks on the League and its future. After a short recess, the gang re-convened for an "open forum" session. By acclamation the convention adopted resolutions prepared by a committee appointed some weeks in advance by the convention management, intended to inform the director of division opinion on matters of the day. The resolutions called for splitting the Central Division to make a new division of Wisconsin and Illinois; moving A.R.R.L. headquarters to Chicago; appropriating more funds for membership contact by director and alternate director in the Central Division; sending "Sumner B. Young, W9HCC, or some

How's Your Voltage Control?

Auto Transformers by THORDARSON *keep you within regulations*

Watch your plate input power. Auto transformers by Thordarson assure you steady reliable power at all times.

Raise or lower primary supply voltage instantly. Correct line voltage fluctuation. Prevent equipment "burn outs." Adjust and test at low voltage. Work local at big power savings.

Three sizes for all requirements. Tapped at 60, 80, 90, 100, 110, 120 and 125 volts.

Free - Free - Free

Catalogs No. 400 and No. 500 from your supplier or write factory.



THORDARSON ELECTRIC MFG. CO.

500 W. HURON ST., CHICAGO, ILL.

Demand "Power by Thordarson"

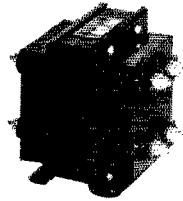

Type T-8211
Capacity V. A. 500
List Price \$10.00

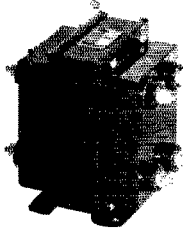

Type T-8212
Capacity V. A. 1000
List Price \$15.00

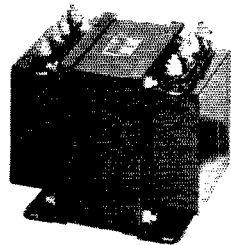

Type T-8213
Capacity V. A. 2000
List Price \$20.00

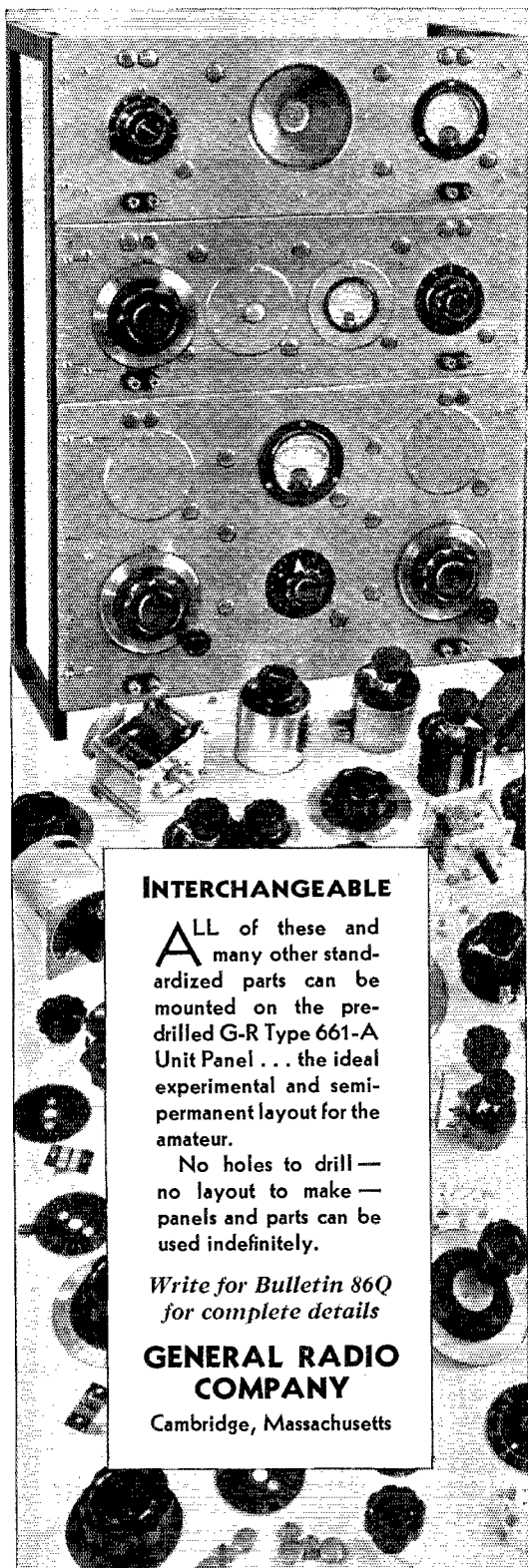

INTERCHANGEABLE

ALL of these and many other standardized parts can be mounted on the pre-drilled G-R Type 661-A Unit Panel . . . the ideal experimental and semi-permanent layout for the amateur.

No holes to drill —
no layout to make —
panels and parts can be
used indefinitely.

Write for Bulletin 86Q
for complete details

GENERAL RADIO COMPANY

Cambridge, Massachusetts

one of his calibre" as a third member of the amateur delegation to the Cairo Conference; making funds available for conferences of director, alternate, assistants and S.C.M.'s; holding the next meeting of the Board in Chicago.

Saturday night was turned over to Mr. Thorne Donnelley and his W9PZ Club as a general "get-together" and "meet-your-neighbor" night. Stars from the broadcasting studios were there to entertain. Over 25 barrels of beer helped make the evening a success. The hotel estimated an attendance of over 2300 at this party. Prizes were also given away.

Next morning, though not very early, the A.A.R.S., N.C.R., Phone, C.W., Traffic, DX and Five-Meter groups, under the leadership of a notable from each field, discussed problems peculiar to their particular phase of ham radio. W2AMJ, W9ZN, W9KA, W9AA, W9CGV, W9KJY and Maj. Elliott were presiding officers.

Sunday afternoon, Ted McElroy, world's code-speed champion, gave an amazing demonstration of high-speed copying and water drinking. John Reinartz gave his usual interesting talk. Following a short recess, Fritz Franke's "inside" dope on the operation of airways radio, and Boyd Phelps and his "dry" humor, together with demonstrations of new and novel apparatus, had the gang on the edge of their seats.

Sunday evening produced the crowning event of the entire affair—the banquet. When the last course was finished, Toastmaster Mathews, W9ZN, began the program. A.R.R.L. officials and other notables were introduced—some said a few words, but more often they simply took a bow. Dr. Lee de Forest, well known to all amateurs as the inventor of the radio tube, gave a most engrossing account of his experiences. Immediately thereafter, Dr. Woodruff, on behalf of the Chicago Area Radio Club Council, presented Dr. de Forest with a medal bearing the inscription, "Presented to Dr. Lee de Forest by the radio amateurs in appreciation of his contributions to the radio science," applauded by the entire delegation.

George Givot, the "Grik Ambassador," and his famous College Inn band, amused the audience with wise-cracks and singing and comedy acts. A magician mystified the crowd with his sleight-of-hand tricks. Eugene Hubbell, W9ERU, was presented with a beautiful trophy in recognition of victory in the code-speed contest held earlier in the day. Hubbell copied 52.7 w.p.m. with only one error. "Dr. Anton Carlson," introduced as "SM-I-TH" from Stockholm, Sweden (who was "Alex Christiansen of Chicago and never saw Sweden"), had the gang rolling in the aisles. At the conclusion of the festivities, prizes were awarded, some of the larger ones being half-kilowatt tubes, several receivers, and a grand prize of a half-kilowatt transmitter.

Although arising late again Monday morning, the delegates found many events still scheduled. Mr. Mims, W5BDB, described his "signal squirter." Dr. Andrew and Mr. Vandervier were highly applauded for their technical talks.

(Continued on page 82)

EIMAC PRESENTS THE 100T AND 250T TUBES

FEATURES

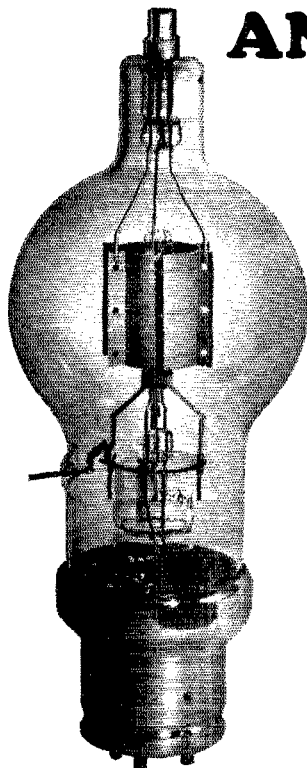

EIMAC 250T

And of course sparkling clear bulbs, perfect vacuum, perfectly aligned elements, plus EIMAC's guarantee of complete freedom from gas released thru accidental overload.

- ▶ **IMPROVED ANODE CONNECTOR**
Eliminates high losses present in common type of connectors. Consists of three solid copper bars terminating in a solid copper button. Button does not touch glass allowing free circulation of air around stem.
- ▶ **IMPROVED GRID DESIGN**
Vertical bar grid. High μ plus a real saving in grid driving power.
- ▶ **IMPROVED THORIATED TUNGSTEN FILAMENT**
Much higher thermionic efficiency plus longer life.
- ▶ **PRACTICAL FILAMENT SUPPORT**
Allows perfect filament alignment, prevents filament distortion without the use of ceramic insulators.
- ▶ **STILL GREATER GRID INSULATION**
Improved stem allows greater r.f. grid voltages essential for efficient power frequency multiplication.
- ▶ **IMPROVED GRID CONNECTOR**
Solid tungsten rods reduce r.f. losses nearly 50% at this point.
- ▶ **IMPROVED PERFORMANCE**
Subtle refinements in manufacturing technique and in tube design have given these new EIMAC tubes truly startling performance capabilities.

RATINGS

250TL (low μ)

250TH (high μ)

Fil. 5 v; Fil. Cur. 10.5 amps; Plate volts 1000 to 3000; Plate cur. 350 milliamperes; Plate diss. 250 watts.

Class "C" output up to 800 watts (75% eff.)

Class "B" audio (Two tubes) 1000 watts.

Net \$24.50

100TL (low μ)

100TH (high μ)

Fil. 5 v; Fil. cur. 6.5 amps. Plate volts 1000 to 3000; Plate cur. 225 milliamperes; Plate diss. 100 watts.

Class "C" output up to 400 watts.

Class "B" audio (two tubes) 425 watts.

Net \$13.50

The 250TH and the 100TH (high μ) are preferred over the 250TL and the 100TL (low μ) for practically all work especially class "C" r.f., Class "B" audio, and frequency multiplying circuits because of the ease in which the high μ tubes are excited.

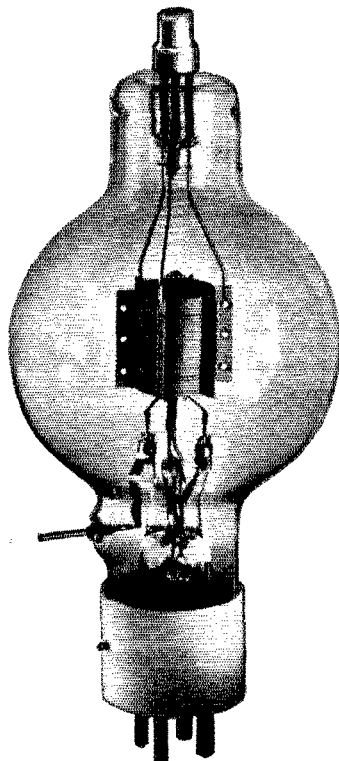

EIMAC 100T

EITEL-McCULLOUGH, INC.

San Bruno, California, U. S. A.

Say You Saw It in *QST* — It Identifies You and Helps *QST*

Now—a high-powered—

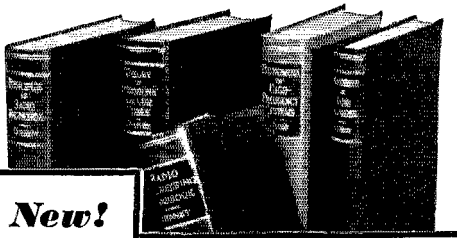

New!

The Library now comprises a revised selection of books culled from latest McGraw-Hill publications in the radio field.

**RADIO
ENGINEERING
LIBRARY**

— especially selected by radio specialists of McGraw-Hill publications

— to give most complete, dependable coverage of facts needed by all whose fields are grounded on radio fundamentals

— available at a special price and terms

These books cover circuit phenomena, tube theory, networks, measurements, and other subjects— give specialized treatment of all fields of practical design and application. They are books of recognized position in the literature — books you will refer to and be referred to often. If you are a researcher or experimenter — if your interest in radio is deep-set and based on a real desire to go further in this field — you want these books for the help they give in hundreds of problems throughout the whole field of radio engineering.

5 volumes, 3064 pages, 2000 illustrations

1. Glasgow's PRINCIPLES OF RADIOENGINEERING
2. Terman's MEASUREMENTS IN RADIO ENGINEERING
3. Chaffee's THEORY OF THERMIONIC VACUUM TUBES
4. Hund's PHENOMENA IN HIGH-FREQUENCY SYSTEMS
5. Henney's RADIO ENGINEERING HANDBOOK

Special Low Price and Easy Terms

Bought singly, the five volumes comprising this library would cost you \$25.00. Under this offer you save \$1.50 and, in addition, have the privilege of paying in easy installments beginning with \$2.50, 10 days after receipt of the books, and \$3.00 monthly thereafter. Already these books are recognized as standard works that you are bound to require sooner or later. Take advantage of these convenient terms to add them to your library now.

SEND THIS ON-APPROVAL COUPON

McGraw-Hill Book Co., Inc.
330 W. 42nd St., New York, N. Y.

Send me Radio Engineering Library, 5 vols., for 10 days' examination on approval. In 10 days I will send \$2.50, plus few cents postage, and \$3.00 monthly till \$23.50 is paid, or return books postpaid. (We pay postage on orders accompanied by remittance of first installment.)

Name

Address

City and State

Position

Company QST-1-37
(Books sent on approval in U. S. and Canada only.)

The 1936 Central Division Convention

(Continued from page 80)

Dr. Woodruff's "Bag o' Tricks" was received with the usual enthusiasm. The convention officially closed at 1:00 P.M. to allow those who came from long distances to return home and "put the kids in school" the next morning. Many stayed over, however, to visit N.B.C. studios, attend various outside events, or chew the fat with others.

A special program was arranged for the women which included, at the expense of the Council, a theatre party, card parties, and a troupe of professional dancers.

The trade show, at which over \$80,000 worth of strictly amateur apparatus was on display, was open all during the Convention. Practically all of the leading manufacturers had displays and many new items were introduced. This trade show was the largest exhibition of amateur apparatus ever assembled.

—W9KJY

Standard Frequency Transmissions

Date	Schedule	Station	Date	Schedule	Station
Jan. 8	B	W9XAN	Jan. 29	A	W6XK
	B	W6XK	Feb. 5	B	W9XAN
Jan. 13	C	W9XAN		B	W6XK
Jan. 15	B	W9XAN	Feb. 10	C	W9XAN
	A	W6XK	Feb. 12	B	W9XAN
Jan. 20	BB	W9XAN		A	W6XK
Jan. 22	BB	W6XK	Feb. 17	BB	W9XAN
	A	W9XAN	Feb. 19	BB	W6XK
Jan. 23	BX	W6XK		A	W9XAN
Jan. 24	C	W6XK	Feb. 20	BX	W6XK
			Feb. 21	C	W6XK
			Feb. 26	A	W6XK

STANDARD FREQUENCY SCHEDULES

Time (p.m.)	Sched. and Freq. (kc.)		Time (p.m.)	Sched. and Freq. (kc.)	
	A	B		BB	C
8:00	3500	7000	4:00	7000	14,000
8:08	3600	7100	4:08	7100	14,100
8:16	3700	7200	4:16	7200	14,200
8:24	3800	7300	4:24	7300	14,300
8:40	4000		4:32		14,400

Time (a.m.)	Sched. & Freq. (kc.)
6:00	7000
6:08	7100
6:16	7200
6:24	7300

The time specified in the schedules is local standard time at the transmitting station. W9XAN uses Central Standard Time, and W6XK, Pacific Standard Time.

TRANSMITTING PROCEDURE

The time allotted to each transmission is 8 minutes divided as follows:

- 2 minutes—QST QST QST de (station call letters).
 - 3 minutes—Characteristic letter of station followed by call letters and statement of frequency. The characteristic letter of W9XAN is "O"; and that of W6XK is "M."
 - 1 minute—Statement of frequency in kilocycles and announcement of next frequency.
 - 2 minutes—Time allowed to change to next frequency.
- W9XAN: Elgin Observatory, Elgin National Watch Company, Elgin, Ill., Frank D. Urie in charge.
W6XK: Don Lee Broadcasting System, Los Angeles, Calif., Harold Perry in charge.

Standing by with an RME-69

Roaming the radio channels far and near . . . from South America's lands of romance to Alaska's midnight sun . . . always alert to answer emergency's call . . . that is the Radio Ham.

RME is proud of its contribution to the radio amateurs' hobby in the RME-69 . . . a laboratory-engineered, highly-selective receiver. When coupled with the DB-20 Pre-selector, it segregates messages that would come in as unintelligible signals on most ordinary receiving sets.

Write for Bulletin 69

Radio Mfg. Engineers, Inc.
Peoria, Illinois

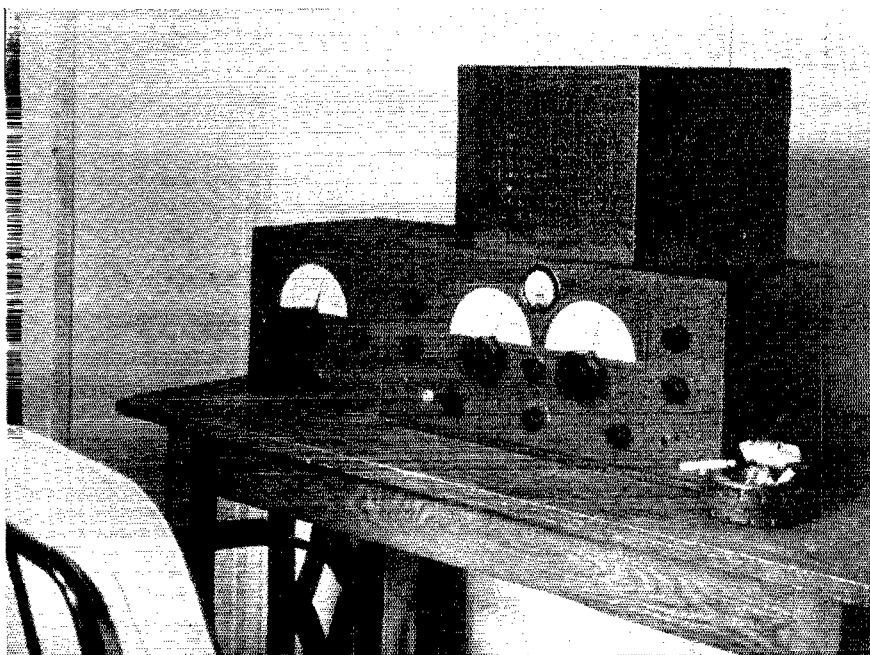

INTRODUCING

The

Utah

ADD-A-UNIT AMATEUR TRANSMITTER KIT

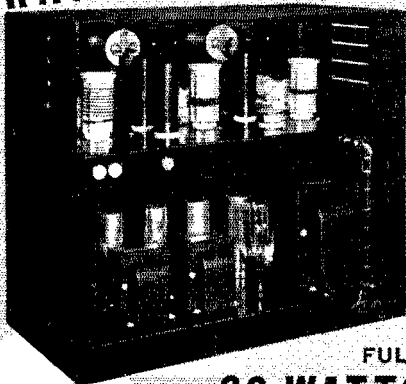

\$49.75

**TWICE THE OUTPUT
AT TWO-THIRDS
THE COST.**

**FULL
80 WATTS
INPUT**

**A C W TRANSMITTER
that operates on 20-40
80 and 160 Meter Bands**

**MODERN—POWERFUL
EFFICIENT—EASILY ASSEMBLED**

BUILD this Utah Add-a-Unit Transmitter yourself! Here's your opportunity to obtain a 80 Watt input C. W. Unit at an amazingly low cost. Every part you need, with the exception of meters, tubes and crystal, the complete equipment for a fraction of the cost of an assembled unit. It's a new, simple circuit, easily assembled.

Build this unit, and you have a powerful 60 Watt output C. W. Transmitter complete with built-in power supply to which you can add other units that will be available in kit form so that eventually you can have a complete Half K. W. phone transmitter at a fraction of the cost you would otherwise pay.

It's the greatest value in a Transmitter Kit ever offered.

Write for complete information TODAY!

UTAH RADIO PRODUCTS CO.

CHICAGO, U. S. A.

TORONTO

Ontario, Canada

BUENOS AIRES

(Ucea Radio Products Co.)

15 YEARS OF LEADERSHIP

Schedules for WWV

EACH Tuesday, Wednesday and Friday (except legal holidays), the National Bureau of Standards station WWV will transmit on three frequencies as follows: noon to 1:00 p.m. E.S.T., 15,000 kc.; 1:15 to 2:15 p.m., 10,000 kc.; 2:30 to 3:30 p.m., 5000 kc. On each Tuesday and Friday the emissions are continuous unmodulated waves (c.w.); and on each Wednesday they are modulated by an audio frequency. The audio frequency is in general 1000 cycles per second.

The Seventeenth Pacific Division A.R.R.L. Convention

CALIFORNIA is a land apart from all others—like no other, distinctively itself. It hangs upon the walls of the world like a flame of jeweled tapestry, a sky of turquoise over it, warm with the glow of sun by day, and soft and tender with the moon and stars by night.

With warm tropical breezes singing their way through trees, where watts drop gently out of transmitters, with the cool breeze of the blue Pacific Ocean peacefully rolling onto glistening white sands, we come across the beautiful city of Oakland, the home of the Oakland Radio Club, Inc., host to the 17th Pacific Division A.R.R.L. Convention which convened at the Hotel Leamington on September 5th, 6th and 7th.

It was voted by the Chamber of Commerce, City of Oakland and Alameda County, the Hotel Leamington, Police Department, etc., the most ideal and best organized convention ever to visit our fair city. Our Club alone spent nearly \$4000 for the entertainment and pleasure of our visitors, besides the many thousands of dollars spent by the guests themselves, we were still able to stay out of the red financially. Four other hotels were called upon to take care of the mass of humanity which came from the plains of Texas, Missouri, Oregon, Washington, Utah, Nevada, Arizona, Hawaii, California, and last but not the least, Byron Goodman from Connecticut.

Over 700 visitors from outside of the Bay District brought our attendance to around a thousand. Our Bay cities were to blame that we did not reach our goal of 1500, as there were more from Los Angeles than from San Francisco, which is only 5 miles from our convention.

It was necessary to charter 16 private coaches to take care of our sight-seeing trips on Sunday afternoon. The brewery trip on Saturday afternoon will long be remembered with private chartered coaches busy all afternoon with taxi service. Our two dances, especially the one held on Sunday evening, were gorgeous affairs. Soft, sweet music from a ten-piece orchestra, with beautiful lighting effects and all the food one could eat, made this a gala event.

Our guest speakers were outstanding; all the usual convention highlights were successful and displays of the manufacturers were stupendous. On Monday evening a thousand persons started to fill the beautiful Scottish Rite Temple on Lake Merritt for our final banquet, the last evening of our Convention, a sight never to be forgotten will



In Ancient Style Modern Burgess Portable Power Comes to Ak-Bulak

When the Harvard University—M.I.T. solar eclipse expedition went to Ak-Bulak, U. S. S. R., the most modern equipment available was taken with them. Included in this equipment was a complete supply of Burgess Batteries for radio apparatus and for the operation of timing relays in the astronomical spectrograph.

Thus, in a remote corner of the world, was contrasted "B. C.-type" transportation with twentieth century communication and scientific

apparatus. And so, too, is shown the fact that when science travels into unknown places, it puts its faith in proved equipment like Burgess portable power.

The same economy and dependability are built into every Burgess Battery. There is a special Burgess design for every purpose so that you, too, can work with the same dependable power supply used by the famous scientists.

BURGESS BATTERY COMPANY
Freeport, Illinois



BURGESS



Say You Saw It in QST—It Identifies You and Helps QST

WHEN WE SAY

'LIGHTNING'

We're thinking of that funny stuff that comes zooming out of the skies, right through the QRM, lighting up everything in a flash!

AND WHEN WE SAY

LIGHTNING CALCULATORS

We mean that these gadgets bring an answer right through mathematical QRM just like that — in a clear flash!

Type A, \$1.00 Type B, \$1.00

For problems involving frequency, inductance and capacity, in design of radio frequency circuits. Direct reading answers for size of coils and condensers for any range between 400 kc. and 150 mc.

Gives direct reading answers to calculations involving current, resistance, voltage and power with scale for resistance of copper wire and scale for calculating decibel gain or loss.

Type C, \$.50 Type D, \$.50

More information on electrical conductors than you could find in a book full of tables.

Gives decibel gain or loss when input and output voltages, currents or power are known.

Type E, \$.50 Type F, \$.50

Direct reading total resistance of resistors connected in parallel, and total capacity of condensers connected on series.

Permits measurement of resistance, from 1 ohm to 1 megohm by use of a voltmeter. Makes an ohm-meter of your voltmeter.

Prices include postage from the

AMERICAN RADIO RELAY LEAGUE
West Hartford, Connecticut

linger in the minds of those who were fortunate to attend at least this one great function. The long tables, beautifully decorated in a form of a "T" with lighting effects, were a sight never before seen at a ham convention. No one even started to eat until the last person was seated. As the delightful food was being served, to the astonishment of the gathering the lights grew dim and the stage curtain slowly drew apart, and, to the guests' amazement, soft, dreamy dance music filled the hall to the tune of a 12-piece orchestra, which continued during the whole dinner. Then a regular stage show was presented to the enjoyment of all under the direction of a well-known radio Master of Ceremonies, popular from coast to coast. Prizes! Prizes! Prizes! There was almost one for everyone present; in fact, it took almost three hours to dispense them.

This convention will go down in history as the greatest, most enjoyable and colossal amateur convention ever to be held in the world. There was not five cents' worth of damage, and the conduct of all present was marvelous. It was a different, new-type convention. Everyone seemed to be pleased and happy at all times, with all the beautiful surroundings and environment, and with everything starting on time all were interested. The usual noise and disheartening conditions which prevail at so many conventions were absent. It was truly an everlasting tribute to the Oakland Radio Club, Inc., and a monument for the American amateur.

—WGTI

Strays

In typical ham style VK2GP, taking the family and a portable out for a picnic, arrived on the scene only to discover that while there were plenty of spares for the set (including a soldering iron) most of the important edibles had been left at home!

— . . . —

W9TE says the next time you find a small piece of sand-paper is needed when the stores are all closed, raid the kitchen and swipe the OW's match box. The strip of sanded surface will do quite well in a pinch.

BRAZILIAN QUARTZ CRYSTAL

Largest and most varied stock of Brazilian quartz crystals in the United States. Finest quality suitable for manufacturing piezo-electric crystals, lenses, and prisms. Shipments received regularly from our Brazilian Branch. Also in stock tourmalines for making crystals to control the higher frequencies and quartz for fusing purposes.

BRAZILIAN TRADING CO., INC.
377 Fourth Avenue New York City
Murray Hill 4-2891

FOOLS GOLD

••• Just as this unfortunate gold miner is doomed to bitter disillusionment, so will the "fools gold" (false economy) of cheap variable condensers, prove to be a "delusion and a snare."

CARDWELL CONDENSERS

INEXPENSIVE IN THE LONG RUN, ARE MORE EFFICIENT AND LAST FOREVER

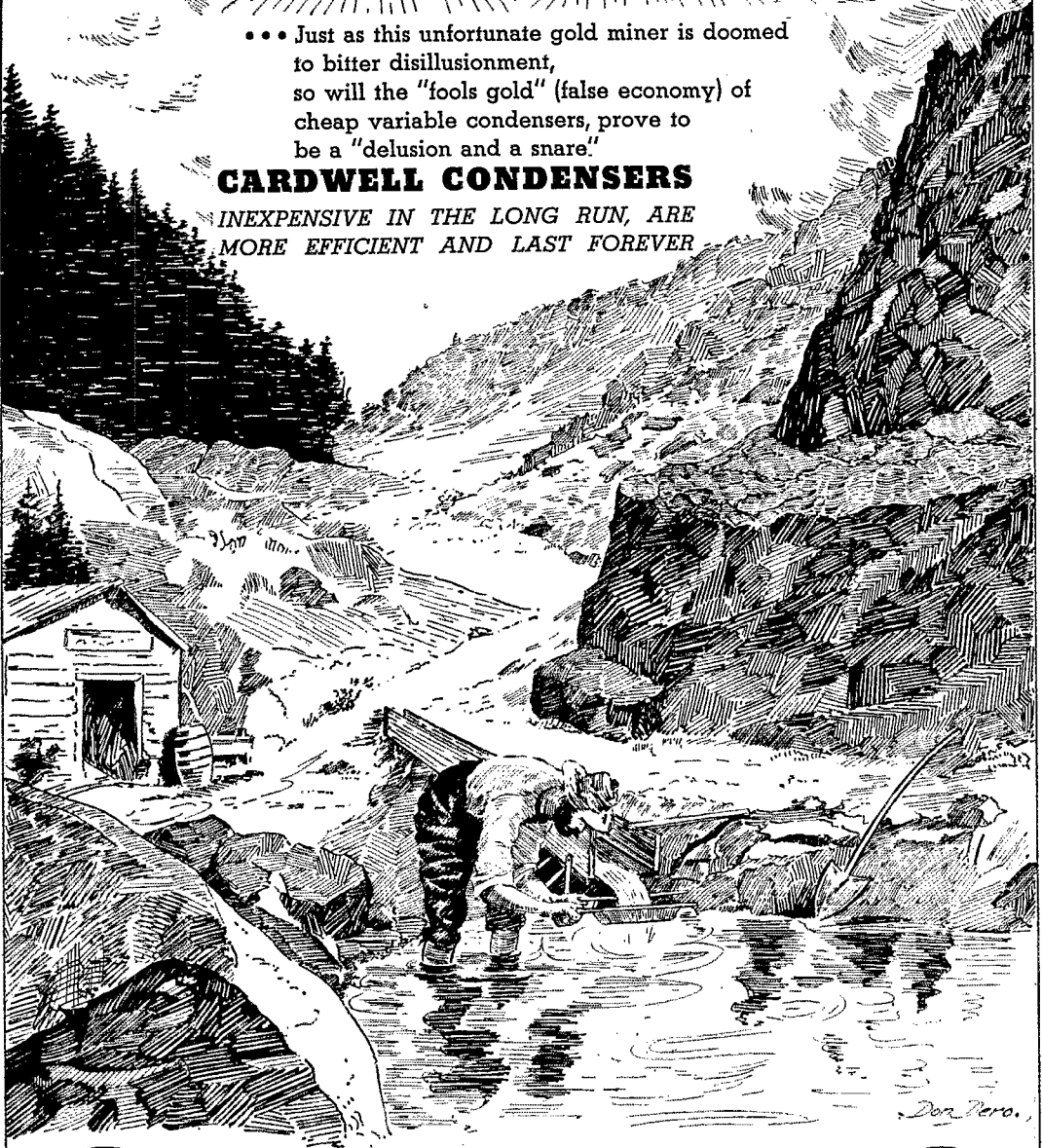

Have you our Handy Amateur Net price bulletin H-7-8, with tabulated data on every condenser an Amateur needs? Your QSL or postcard will bring it, pronto

THE ALLEN D. CARDWELL MFG. CORPORATION

85 PROSPECT STREET, BROOKLYN, N. Y.

Use the

CATALOG SECTION

of your

HANDBOOK—

in it you will
find more complete
data on many QST-adver-
tised products.

The Catalog Section of
the Radio Amateur's
Handbook is the world's
most complete en-
cyclopedia of depend-
able equipment
for high-frequency
radio communication.

Watch for
this insignia
in advertisements:

HANDBOOK
PAGES
[525-536]
CATALOG
SECTION

It means more complete
data are to be found on
the indicated pages of
the Handbook Catalog
Section.

Roanoke Division Convention

THE Roanoke Division Convention sponsored by the Mountaineer Amateur Radio Association, held in Clarksburg, W. Va., August 28th and 29th, was a great success.

There was a prize for everyone attending and some left over. Some hams were lucky enough to win two prizes. The prizes included four communications-type receivers, plenty of transmitting tubes, condensers, microphones and other radio equipment.

The program started off at 9:30, Friday morning, with registration. At 1:30 the welcoming address was given by J. Philip Clifford, Prosecuting Attorney of Harrison County. At 2:00 p.m. there was a talk on antennas by Robert Eubank, W3WS, Chief Engineer of radio station WRVA, Richmond, Va. At 3:00 p.m. the entire crowd went to the site of the new 1000-watt WMMN transmitter at Monongah, W. Va., and enjoyed a very fine ox-roast and program. Friday night was spent by attending a dance and floor show at the Waldo Hotel, with free beer to all the hams.

Saturday's program started off at 10:00 a.m. with an A.A.R.S. and U.S.N.R. meeting. At 1:30 a talk was given by Prof. A. N. Friend, W8LIU, of West Virginia University at Morgantown, W. Va., on the "C" layer and its effect on long-distance radio transmission, then came a talk on transmission lines by Frank Key, W3ZA, Assistant Director of A.R.R.L., Roanoke Division. At 4:30 p.m. Prof. H. L. Caveness, W4DW, Director of A.R.R.L. Roanoke Division, spoke on League affairs.

The banquet started at 6:30 p.m. with Prof. H. L. Caveness as toastmaster. There were also a few short talks given during the banquet by the SCM's of Virginia, West Virginia and South Carolina. The banquet ended with the prize drawings, which was what everyone was waiting for.

The ladies had an entirely separate program except for the ox-roast, banquet and prizes. They enjoyed a Bingo Party with prizes, a shopping tour, a theatre party, and of course the dance.

Those not attending sure missed a fine convention, but here's hoping we will all meet at the A.R.R.L. Roanoke Division Convention to be held at Richmond, Va., next year.

— WSJRL

The Southeastern Division Convention

THE Southeastern Division Convention opened at the Suwannee Hotel, Saturday morning, Sept. 5th, with a welcome talk by Mayor John S. Smith. Delegate A. A. Hebert from Bradenton replied in the name of the A.R.R.L. President Carson of the St. Pete Amateur Radio Club then introduced Ben Adams, our director, who gave us a talk on the problems of the A.R.R.L. Board and some ideas advanced by the League at the F.C.C. Hearings, where the amateur presentation was a model of completeness. After the presentation of a resolution to Mr. Adams in



Special Values

The Receivers listed below are the best money can buy. Our Time Payment Plan, at the new low rates, makes it easy to own one. Compare our rates with others. THE EASY WAY. Send in your Down Payment with your order. Sets will be shipped as soon as credit is okayed. Entire Transaction one week. Try us.

NATIONAL—NEWARK LEADS AGAIN!

Plenty of Band Spread for the Hams

The New National NC-101 X. \$125.00 Complete

Five band spread ranges . . . 1.7 to 2.0 megacycles, 3.5 to 4.0 megacycles, 7.0 to 7.3 megacycles, 14.0 to 14.4 megacycles, 28.0 to 30.0 megacycles. Automatic Plug-in coils, Permanent Calibration, Micrometer Dial. Amplified, Delayed A.V.C. Power output 10 Watts. C. W. Oscillator. Crystal Filter. Built-in Power Supply. 12 Tubes—10" Speaker. Complete with speaker. **\$125.00.** On Time Payments Listed Below.

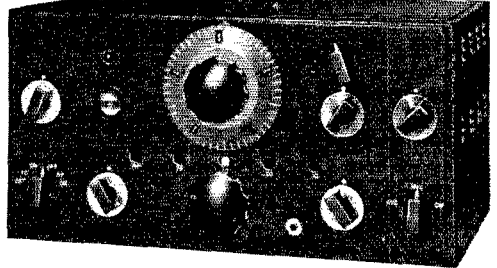

... National NC-100 (not illustrated) . . . the "Perfect" Super-Het! Amazingly selective, high sensitivity, low noise level. A wonderful performer. Full coverage, individual built-in plug-in coils, shifted by knob on front panel, 540 to 30,000 KC coverage in 5 ranges, 12 tubes, one stage RF, two IF, P.P. Pentode 10 w. audio output. Full AVC circuit. Built-in power supply. Single and double antenna connections. Latest type crystal filter. "Electric Eye" tuning indicator. Large, latest type Dynamic Speaker in cabinet to match. See Prices below.

Watch Our List of Specials Grow

TRANSFORMERS

Thordarson No. 16878 Plate and Filament Transformer, 600-0-600 V. at 200 MA 2 1/2 V. at 10 amp. 5 V. at 3 amp. 7 1/2 V. at 3 amp. . . . \$2.45
High Voltage Transformer, 1000-750-500-0-500-750-1000-300 MA. 3/4 x 4 3/4 x 5 1/2 . . . \$5.95

These transformers are heavy cast iron frame open mounting type. Heavy insulation. Heavy Kockbestos leads. Fully Guaranteed.
1600-1335-0-1335-1600 A.C. R.M.S. 1250-1000 V. DC—400 MA, 7" w. x 6" d. x 5" h. . . . \$13.25
1950-1600-0-1600-1950 A.C. R.M.S. 1500-1250 V. DC—500 MA, 8 1/2" w. x 7" d. x 7" h. . . . \$17.50
2350-1950-0-1950-2350 A.C. R.M.S. 2000-1500-0-1500-2000—500 MA, 8 1/2" w. x 7 1/2" d. x 11" h. . . . \$22.50

Filament Transformers

If you like to save money on quality merchandise here's some real bargains. 2500 2.5 Volts 10 Amps—2500 Volts Insulation—No. 2510 . . . \$0.95
6.3 Volts, 3 Amps—1600 Volts Insulation—No. 63S . . . \$0.95
7.5 Volts, 3 Amps—1600 Volts Insulation—No. 75S . . . \$0.95

CHOKES

18 Henries, 125 M.A., \$1.15
A real quality choke. Resistance 130 Ohms. No. NS115. . . . \$1.15
Thordarson No. 16877 Heavy Duty Choke. 15 Henries at 250MA. . . . \$1.95

(Prices and Terms on These and Other Sets Listed Below)

	Cash Price	Down Payment	6 Months Payments	9 Months Payments	12 Months Payments
NATIONAL NC-101X complete.	\$125.00	\$25.00	\$17.74	\$11.93	\$9.02
NATIONAL NC-100 complete with tubes and speaker.	\$118.10	\$23.10	\$16.90	\$11.37	\$8.59
NATIONAL NCX-100 complete with tubes, crystal and speaker to match.	\$140.60	\$25.60	\$20.26	\$13.64	\$10.36
NATIONAL HRO less power supply and speaker.	\$167.70	\$37.70	\$27.78	\$15.35	\$11.69
NATIONAL HRO with power supply.	\$183.60	\$43.60	\$24.46	\$16.51	\$12.57
RCA—AGR-175 complete receiver, speaker separate.	\$119.50	\$24.50	\$16.90	\$11.37	\$8.59
RME-69 complete with tubes, crystal, speaker housed in baffle.	\$134.90	\$29.90	\$18.58	\$12.50	\$9.47
HALLICRAFTERS SX-11 speaker in cabinet \$12.00 extra.	\$99.50	\$24.50	\$13.52	\$9.09	\$6.87

We will have new receivers, as released by manufacturers, on our deferred payment account. Full details of any set listed, mailed immediately upon request.

Oil Filled, Oil Impregnated FILTER CONDENSERS

All well known makes. Guaranteed at rated voltages. A "lucky" purchase of a 10,000 lot enables us to offer a few remaining items at these low prices. Hurry before they're all gone!

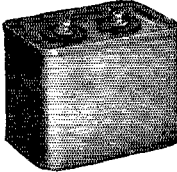

Cap.	Voltage	Size	Weight	Price
1 mfd.	2000 V. DC	5 x 3 1/4 x 1	1 1/4 lbs.	\$1.25
2 mfd.	2000 V. DC	5 1/4 x 3 1/4 x 2 1/2	3 lbs.	1.50
8 mfd.	2000 V. DC	5 1/4 x 3 1/4 x 4	4 lbs.	2.75
9 mfd.	3000 V. DC	5 1/4 x 3 1/4 x 11	9 lbs.	7.25
(including 2 1/2" bakelite standoffs)				
4.4 mfd.	1500 V. DC	5 x 3 1/4 x 1 1/2	1 1/2 lbs.	1.75
5 mfd.	1500 V. DC	3 1/4 x 3 1/4 x 1 1/2	1 1/2 lbs.	1.90
5.2 mfd.	1500 V. DC	5 x 3 1/4 x 2 1/2	2 1/2 lbs.	2.00
10 mfd.	1500 V. DC	5 x 3 1/4 x 3	3 1/2 lbs.	2.75

Use the 10 mfd. for perfect filtering in class B modulation Power Supply.

ORDER DIRECT FROM THIS AD—NOW

Receivers listed in this ad are best values anywhere. Order today on EASY TERMS. Send your down payment with order. Set will be shipped immediately upon approval of your credit. Entire transaction in 1 week. No red tape. Full details of any item, with complete NEW CATALOG FREE upon request.

EIMAC	Bliley Crystals
35T . . . \$8.00	BC3 . . . \$3.95
50T . . . \$13.50	LD2 . . . \$4.80
150T . . . \$24.50	HP2 . . . \$6.50



Taylor Tubes

866 . . . \$1.65
756 . . . 4.95
203B . . . 7.50
203A . . . 12.50
814 . . . 18.50
822 . . . 18.50
T200 . . . 21.50

High Frequency Tubes

T55 . . . \$8.00
T155 . . . 19.50

Write for Free Complete Taylor Catalog

FREE JUST OUT! BIG NEW CATALOG!

Big Bargains in Parts, Equipment and Supplies for Hams, Servicemen and Dealers. Lowest wholesale prices. Write quick!



NEWARK ELECTRIC COMPANY

226 W. MADISON ST. Dept. Q CHICAGO, ILL.

Build Your Own

CONDENSER BANKS



Any desired voltage and capacity combination. Units clamped or taped together. And you save much money.



Quality paper sections such as used in best quality condenser blocks.



Black varnished paper wrappings. 8" insulated leads. High-melting-point compound sealed.



Short units (SU); Medium units (MU); Long units (LU).

200, 400, 600 and 1000 v.

.1 to 4 mfd. for short units. .5 to 2 mfd. for medium and long.

New Catalog! More pages. More items. More choice. Write for copy, also sample of monthly Research Worker.



MR. E. H. RIETZKE



PRESIDENT OF CREI

Are You Prepared for Tomorrow?

The "lab" problems of yesterday are the commonplace equipment today! A few years ago very small minimum frequency deviation and high percentage modulation were in the "lab" stage. Today, they are compulsory . . . and today new developments are forecasting new problems for tomorrow.

INSURE YOUR FUTURE BY INCREASING YOUR ABILITY

New developments demand trained men. Facsimile transmission is HERE . . . Television is not far off. Are you equipped with the necessary training to cope with tomorrow's equipment? Being a good man today does not necessarily mean that you will be tomorrow. Start training now!

WRITE FOR A FREE COPY OF THE CREI "TESTED PLAN" FOR RADIOMEN — an informative booklet for men not satisfied with their present status in the radio field.

CAPITOL RADIO ENGINEERING INSTITUTE

Dept. Q-1
WASHINGTON, D. C.
14th and Park Road

NEW YORK CITY
29 Broadway



regard to the appointment of O.O., the business session came to a close. Following this session a very interesting talk on "Applications of the Cathode Ray Oscillograph to the Amateur Transmitter" was given by C. J. Faulstich, W4CXL, of the RCA Manufacturing Company, Field Engineering Staff.

After a noon recess, a talk that proved especially interesting to those living near the tropical waters was given by Wayne Mason of the Engineering Dept. of the University of Florida, the title being "Radio as an Aid to Storm Detection." He told of problems of instantaneous checking between the Florida institution and the Puerto Rico station and gave some information on the communications equipment in use. This led to a talk on antennas in which many attending asked questions.

In the evening a banquet was served in the ballroom of the hotel, made more colorful by the attendance of thirty-one members of the Naval Communication Reserve of the 7th Naval district, here for their inspection. Phil McMasters, outgoing SCM of East Florida, served as toastmaster, introducing Mr. Hebert, Mr. Adams, incoming SCM Bill Shelton, and the officers of the Naval Reserve. Music and entertainment were by one of the popular teams heard over WSUN. At the conclusion of the banquet the Reserve inspection was held. Those not taking part attended the dance at the Coliseum. At midnight an initiation was held in the Royal Order of the Wouff Hong.

At eight o'clock Sunday morning, meetings of the various nets were held. We must confess that the meetings were poorly attended. At 10 a.m. the party moved to the U. S. Coast Guard Air Base and station NOF where the new-type dial remote-control transmitters were demonstrated, those interested were allowed to inspect the coaxial-cable-fed spike antennas and were shown the emergency power plant, as well as the large rescue planes in which radio equipment was being installed. Afternoon recess the party met in front of the hotel for a tour of inspection of WSUN-WFLA. Leaving the station at Bayview, the party progressed to Clearwater where they were the guests of Donald Roebing. Later, the crowd left for the Jungle Beach Club where prizes were drawn, supper was served and contests conducted. W4CWR was voted the most hen-pecked ham in the division when Ben Adams awarded his wife the prize in the rolling-pin throwing contest. After a beach dance those that were able left for home.

—W4BCZ

Vanalta Division Convention

THE largest gathering of radio amateurs ever assembled in Western Canada, the A.R.R.L. Vanalta Division Convention, was held in Vancouver, B. C., August 28th, 29th and 30th.

Commencing with an informal gathering in the Georgia Hotel, convention headquarters, Friday

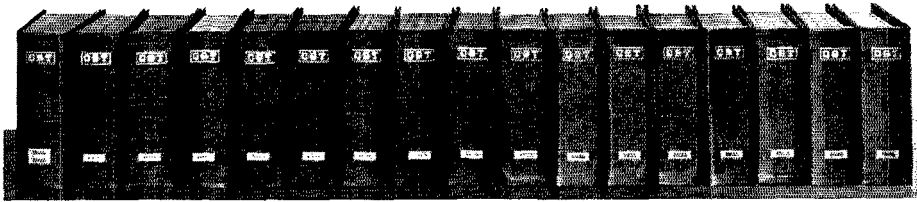

..... WE CAN HELP *You*

TO

Fill the Holes in Your QST Files

The December, 1936, issue of *QST* marked its twenty-first anniversary. It especially reminded us of the increasing value of back copies. You will note from the list below that copies covering the first ten-year period (1915-1924) are no longer available. Vol. 1, No. 1 in particular, and other pre-war copies in general, are so rare that they command high prices when available. Copies issued since the war (beginning with the June, 1919, number) up to the beginning of 1925 are becoming increasingly rare — as soon will be many of the copies from 1925 on. In fact, as the list shows, many since 1925 are already out of print.

(SUBJECT TO CHANGE)

1925 copies — (except Jan., Mar., May and July)	\$2.00
1926 copies — complete	2.50
1927 copies — (except January, July and October)	2.25
1928 copies — (except Jan., Feb., Mar., Aug., Sept.)	1.50
1929 copies — complete	2.50
1930 copies — (except January, February and July)	2.25
1931 copies — (except November)	2.50
1932 copies — (except Feb., July, Aug., Sept., Oct.)	1.75
1933 copies — (except January and February)	2.50
1934 copies — complete	2.50
1935 copies — complete	2.50
1936 copies — complete	2.50
1937 copies — as issued, each 25c — complete year	2.50

Single Copies, 25c Each, and Yearly Sets at
Price indicated, Postpaid
Foreign add 50c for Yearly Sets

TO

Keep Your QST's In Order

The value of your *QST* file for reference purposes will depend entirely upon how readily you can find the issue which you want, and the appearance of the station will depend upon how you keep them. The binder fills both of these needs. Designed to hold twelve issues of *QST* and an index, it permits the copies to be placed in as they are received, or removed at will without mutilating the copies. It is a binder that you can be well proud of, and with each binder is furnished a set of labels, with the year marking, so that you can designate your yearly files. The binder is available only in the United States and its possessions, and the price is \$1.50, postpaid.

THE AMERICAN RADIO RELAY LEAGUE
West Hartford, Connecticut

HAMS WANTED

who have tried various I-F systems to improve selectivity and sensitivity and who are now ready to try Genuine ALADDIN Polyiron radio components.

Occasionally we have inquiries as to where ALADDIN Polyiron transformers may be obtained. Being new and somewhat higher priced due to the great care used in the selection of materials as well as in manufacturing, they are not universally sold by all dealers as yet.

If your particular dealer does not handle ALADDIN Polyiron transformers, write to us; you will be told where ALADDIN Polyiron products may be obtained in your vicinity; if no dealer is at hand, you will be told how you may obtain ALADDIN Polyiron components by direct shipment from the factory.

Your letter will be treated confidentially, you will not be solicited; you will receive full information.

We will send you a booklet telling WHY and HOW to use ALADDIN Polyiron components; the booklet contains technical data that you will like to have.

Aladdin Radio Industries, Inc.
466q W. Superior Street, Chicago, Ill.
LICENSEE OF JOHNSON LABORATORIES, INC.

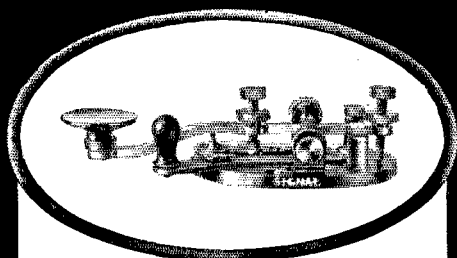

FOR RAPID TRANSMITTING

This telegraph key M-100 is preferred by skilled operators and beginners. The base, equipped with binding posts, is brass with lacquer finish — key lever nickel plated. Furnished with platinum contact points. List price \$3.00.

SIGNAL's line of Wireless Keys, Telegraph Instruments and Wireless Practice Sets is complete. Send for our bulletin.

SIGNAL ELECTRIC MFG. CO.
Menominee, Michigan, U.S.A.

SIGNAL
MANUFACTURERS OF ELECTRICAL PRODUCTS

evening, when over fifty delegates registered, the convention was an assured success. Mr. and Mrs. Reinartz dropped in. Byron Goodman, W1JPE, Assistant Secretary, A.R.R.L., and numerous other delegates from Alberta, interior B. C., Washington, Oregon, and California gathered. An interesting ragchew and general get-together wound up the first evening.

Saturday morning saw a large crowd in the hotel ballroom for an informal ragchew and registration. At 1:30 p.m. the introduction of the distinguished guests and visitors took place, amongst those introduced being Byron Goodman, W1JPE; John L. Reinartz, W1QP; Don C. Wallace, W6AM; Wm. Miller, W7AAN; Asst. Director Northwestern Division and E. J. Amarantes, W6FBW, S.C.M., San Jose, Calif. The communications meeting opened with D. Vaughn-Smith, S.C.M., in charge. Mr. Smith placed emphasis on the handling of traffic through reliable O.R.S. and O.P.S. stations. Mr. Goodman gave an interesting talk on the Amateur Emergency Corps and told the gang of some of the happenings during the floods last spring. Adjourning in the early afternoon a large number of the delegates drove out to Lulu Island to visit the Canadian Government Automatic Radio Station, VAI.

The evening session opened with a banquet at 7:30 p.m., with Ted Corley, VE5BC, as toastmaster. Toasts to the King, the President of the U.S.A., the A.R.R.L., the technical writers and the manufacturers, were followed with short talks by representative members of the various radio clubs from surrounding districts. George Peckham, W7ABD, thrilled the gang with vocal selections between speeches. An impressive moment was the period of silence called in respect to our late President, Vice-President, and Col. Foster. Two hundred delegates stood in absolute quiet with bowed heads.

Although unable to be present at the convention, Dr. Hocking, VE5FG, was the recipient of the B.C.A.R.A. annual trophy cup, given for meritorious service to humanity. A 20-meter Biley crystal was also given as a permanent keepsake.

Following the banquet a dance was held which proved beyond doubt that the radio amateur is not lacking in the social arts. The prize drawings which lasted until the wee small hours made a perfect finish to the second day for many of the gang.

Sunday morning found a good crowd on the Court House steps for a photograph, following which came the technical meeting. Don C. Wallace spoke on directional antennas and telephone patch panels. John L. Reinartz, W1QP, held the interest of the gang with a lecture and demonstration of his new oscillator and doubler circuits for all bands. Byron Goodman spoke on late developments of single side-band transmission. The meeting adjourned at noon to allow everyone ample time to have lunch and catch the steamer for Bowen Island which sailed at 2 p.m.

After a very interesting cruise through Van-

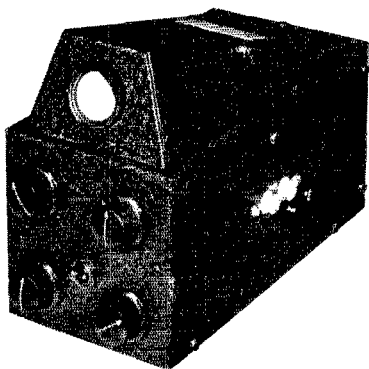

A MINIATURE OSCILLOSCOPE AT A NEW LOW PRICE

The new Type CRM Oscilloscope employs the little RCA-913 tube having a one-inch screen. In spite of its small size, this new equipment is thoroughly practical and is quite satisfactory for routine measurements in the amateur station.

The circuit is essentially the same as in the larger CRO, and includes a power supply with controls for brilliancy and focus, a potentiometer for controlling the amplitude of the horizontal deflection, and a built-in 60-cycle sweep. This latter is particularly convenient as it permits checking transmitter operation with no connection other than a pick-up coil.

Although the larger Type CRO Oscilloscope will remain the preferred equipment for the amateur station, the little CRM gives excellent results where size and cost are important considerations.

NET PRICE \$11.10

Without Tubes

SPECIFICATIONS

Tubes: RCA-913 with 1" screen and 6X5 rectifier.

Size: 4 1/8" x 6 1/8" x 8", not including knobs and binding posts.

Controls: Focus, brilliancy and sweep amplitude.

Sweep: 60 cycle sweep built-in, with provision for external sweep of any type.

Net Price: Type CRM, \$17.45 with tubes, \$11.10 without tubes.

At Right:

The Type CRO Oscilloscope with 3" screen. Net Price \$17.70, without tubes.

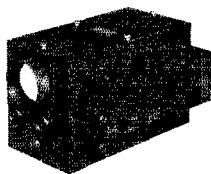

NATIONAL COMPANY, INC.

*Build
This*

STANCOR NEWCOMERS RIG!

**The Ideal
Transmitter for the Beginner
or Newcomer in Amateur Radio**

THIS compact CW Rig having 40 watts output can be built complete with tubes for less than \$40.00. This makes it an ideal Rig for the Amateur who is looking for a unit that is efficient, inexpensive, easy to build, and easy to operate. In its construction, nothing except Standard parts, obtainable from your parts dealer, are used.

This efficient Rig is designed so that a buffer stage may easily be added, thereby making it a suitable RF section for a phone Rig.

The circuit utilizes the new 6L6 tube as a straight oscillator and a Taylor 825 as a straight Amplifier.

Send for complete information today. Mail the coupon for full details.

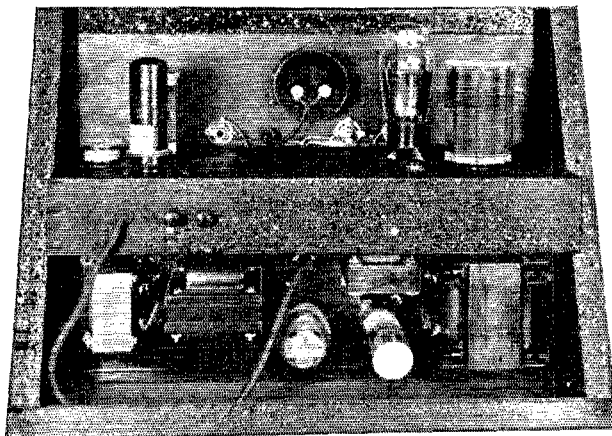

*Your Jobber
Recommends*

**STANCOR
TRANSFORMERS**

**THIS
COUPON
BRINGS**

Circuit Diagram
Operating Instructions
Technical Data
Templates for Panels

**STANDARD TRANSFORMER CORP.
854 Blackhawk Street, Chicago, Ill.**

Please send me complete information and templates for the STANCOR 40 Watt CW Rig for which I enclose 25c.

Name.....
Address.....
City..... State.....

WE OFFER—

Specialized personal service of genuine value that is not available from other jobbers.

Time sales of all receivers and transmitters with terms arranged to suit you and 6% interest charge. We finance our own paper.

Complete stock of all amateur apparatus at net prices. Export orders given individual attention too.

TRADE IN YOUR RECEIVER

All receivers shipped on ten day trial. You need send but \$5.00 with order, balance C.O.D. These receivers in stock:

RME-69s complete	\$134.90
DB-20 signal intensifiers	39.95
The new 1937 Breting 14s	99.00
RCA ACR-175s	119.50
The new 1937 Super Pro when ready	238.14
Hallcrafters Sky Buddys	29.50
Hallcrafters Sky Chiefs	44.50
Hallcrafters 1937 Super Skyriders S-11	89.50
Hallcrafters Ultra Skyriders S-10	99.50

TRADE IN YOUR TRANSMITTER

All Collins, Harvey, RCA, RME, All Star transmitters at net prices. Sold on terms to suit you with two years to pay and 6% interest charges.

HENRY RADIO SHOP

211-215 North Main Street

BUTLER, MISSOURI

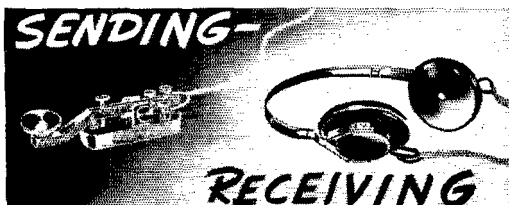

with the same Antenna

The Ward Leonard Radio Frequency Relay automatically changes over the antenna for receiving or sending. It is another item designed and built for the

convenience of the amateur radio enthusiast. The entire group of Ward Leonard radio specialties are described in Bulletin 507B. Send for a copy today.



Ward Leonard Radio Frequency Relay is also convenient for switching directional antennae.

WARD LEONARD RADIO SPECIALTIES

WARD LEONARD ELECTRIC COMPANY

South St., Mount Vernon, N. Y.
Please send FREE Bulletin 507B.

Name

Street

City and State

Call Signal

94

Say You Saw It in QST — It Identifies You and Helps QST

cover's beautiful inland sea, through Burrard inlet and Howe sound, 159 of the gang arrived at 3:30 p.m. for an afternoon of ball games, tug-of-wars, swimming and prize distribution. The VE's took the honors from the W's in the ball game but the visitors regained their standing in the tug-of-war. The cruise in the moonlight was fully enjoyed by all, the skipper of the steamer even entering into the spirit of the occasion by blowing "CQ" on the whistle as the ship pulled out of dock. Community singing nearly blew the sides out of the steamer as she pulled into the galaxy of neon and electric lights which flood Vancouver's harbor. Arriving in Vancouver at 10:30 p.m., a general disbursement took place with all in attendance voting the convention a big success and looking forward to another in the very near future.

—VE5DD

BOOK REVIEW

Old Wires and New Waves, by Alvin F. Harlow. 548 pages, including index and bibliography, 71 illustrations. Published by D. Appleton-Century Co., New York City. Price, \$5.00.

As naive and credulous a piece of reporting as one may expect to see in the field of supposedly authentic historical research has come to us in the form of a book entitled, "Old Wires and New Waves," by Alvin F. Harlow, who "in his boyhood may actually have seen the famous James brothers," also author of "Old Towpaths," "Old Post Bags," "Old Waybills," and "Old Bowery Days."

The volume is jacket-blurbed as the "fascinating story of communication from the first signal drums . . . to the present-day miracles of television and scrambled radio telephony." It begins with the connubial delinquencies of Queen Clytemnestra, unfaithful spouse of King Agamemnon in the days of Troy, and ends with a description of the New York city telephone office. Between is a voluminous recital of all the names and most of the events in the development of signalling by flares and semaphores, and of the telegraph and telephone and their numerous complex relatives. Two chapters and part of a third deal with the history of "wireless." It is with these that we are concerned.

There will be many of those intimately associated with radio who will find fault with these chapters. They constitute a conglomeration of errors, omissions and commercial propaganda. The author obviously contented himself in the main by substituting for research the handouts of communications company publicity men, the perusal of commercial house organs, and the acceptance in full without discrimination, segregation or evaluation of the traditional distortion of radio history written as commercial representatives would like to have seen it made. The lack of technical knowledge of radio is painfully evident. It makes itself known in such inconsistencies as an inability to differentiate between "inductive" telegraphy and "wireless" telegraphy, in the spawning days of the art.

The treatment of amateur radio is, to us, as may be expected, particularly unsatisfactory. The early amateur is characterized as an "even worse" element in the "state of virtual anarchy" that is said to have existed. A number of old incidents of propaganda, most of them since disproved and discredited, or at the most unproved, are rehashed; the cruel hoax and amateur radio are made synonymous. Despite defensive warring prior to 1912 ". . . the amateurs lost. Again, as in the case of movie censorship and Prohibition, unbridled liberty had become license and slain itself." The examples seem to us most apt! Concluding the treatment of amateur history, one learns that the amateurs who volunteered and became wireless operators during the world war spread the news of the value of the short waves. "Today, waves as low as five meters in length are being used!"

The New 1937 Edition of the RADIO AMATEUR'S HANDBOOK

FOR FOUR MONTHS OUR TECHNICAL AND EDITORIAL GROUPS WORKED ON THE REVISION AND ELABORATION OF THE RADIO AMATEUR'S HANDBOOK FOR ITS 1937 EDITION. MANY IMPORTANT TECHNICAL DEVELOPMENTS DURING THE PAST YEAR AND SWEEPING CHANGES IN OPERATING TECHNIQUE AND METHODS CALLED FOR ENLARGEMENT OF THE BOOK AND REWRITING OF ALMOST ALL CHAPTERS. SOME IDEA OF THE EXTENT OF THE REVISION MAY BE HAD FROM THE FACT THAT TWO HUNDRED NEW ILLUSTRATIONS ARE INCLUDED, MOST OF THEM BEING PREPARED ESPECIALLY FOR THIS NEW EDITION. ● SPECIAL ATTENTION HAS BEEN GIVEN TO THE NEW DEVELOPMENTS IN NOISE SILENCERS FOR SHORT-WAVE RECEIVERS AND TO THE NEW TECHNICAL TRENDS IN CIRCUIT DESIGN. A WEALTH OF NEW MATERIAL IS ADDED TO WIDE FIELDS OF TRANSMITTER PLANNING, CONSTRUCTION AND ADJUSTMENT. THE CAPABILITIES OF THE NEW TUBES ARE EXPLOITED TO THE FULL IN THE TRANSMITTER DESIGNS PRESENTED. EXTENDED SPACE IS ALSO GIVEN TO THE EVER-IMPORTANT SUBJECT OF ANTENNAS, THE NEW IDEAS IN COUPLING METHODS BEING TREATED IN PARTICULAR DETAIL. THE ULTRA-HIGH FREQUENCIES COME IN FOR A BIG SHARE OF THE SPACE ALSO, NEW AND ADVANCED EQUIPMENT BEING DETAILED TO ILLUSTRATE THE NEWER TRENDS IN THIS RAPIDLY-GROWING FIELD. ● AS IN PREVIOUS EDITIONS FULL ATTENTION HAS BEEN GIVEN TO CHARTS AND TABLES OF GENERAL INFORMATION FOR THE RADIO ENTHUSIAST; THE VACUUM TUBE TABLES, FOR EXAMPLE, OCCUPYING SEVENTEEN PAGES AND BEING, WITHOUT DOUBT, THE MOST COMPLETE AND DETAILED TUBE LIST EVER PUBLISHED. ● THE BASIC PURPOSE OF THE HANDBOOK IS TO PRESENT A COMPLETE TREATMENT OF EVERY PHASE OF MODERN AMATEUR RADIO FROM ELEMENTARY THEORY THROUGH ADVANCED PRACTICAL APPLICATION, WITH EMPHASIS ALWAYS ON IDEAS AND METHODS THAT HAVE SHOWN THEIR WORTH IN THE FIELD. THIS NEW EDITION, WE FIRMLY BELIEVE, WILL FULFILL THIS PURPOSE MORE EFFECTIVELY THAN ANY OF ITS PREDECESSORS.

\$1 postpaid in Continental U.S.A.—\$1.25 postpaid elsewhere
Buckram Bound \$2.50

American Radio Relay League • West Hartford, Conn.

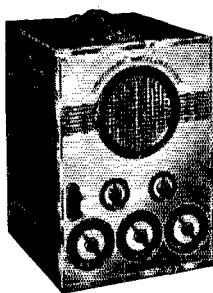

NEOBAM OSCILLOSCOPE FOUNDATION KIT

KIT — Ready to build **\$24.50**

COMPLETELY assembled ready to operate **\$40.00**

"Makes Sound Visible"

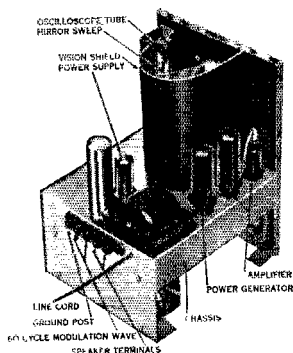

Easily constructed kit — ideal for experimenters and radio amateurs. *Makes sound visible.* Checks modulation, locates distortion. Excellent for amplifier, microphone and speaker response. Something new in audio measurement. FOUNDATION KIT includes cabinet, etched chrome front panel, chassis, visor shield, front and rear terminal strips, special power and output transformers, vari-speed scanning motor, mirror and special neobeam tube. Makes a deluxe job and high grade instrument for only \$24.50. Order today or write.

SUNDT ENGINEERING COMPANY

(Affiliate of Littelfuse Laboratories)

4246 Lincoln Avenue

Chicago, Illinois

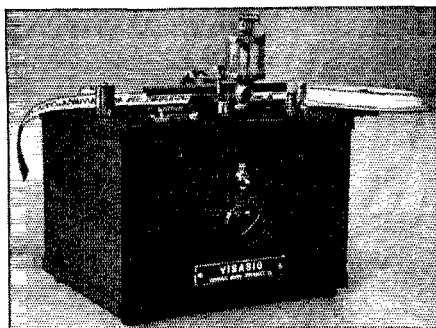

VISASIG Full Automatic Siphon Tape Recorder

for Amateur and Commercial use

Will record code signals from the air up to and in excess of 100 WPM. Use it to make a record of your own fist or the fellow's you work. Make a permanent record from your receiver of weather reports, press news, speed contests, etc. See how it helps improve your fist!

VISASIG — with electrically driven tape puller complete in one unit. **\$49.00**

VISASIG — without tape puller. . . **\$35.00**

PRICES F.O.B. NEW YORK CITY

Commercial Station Managers and Executives write for particulars of professional 200 WPM model

UNIVERSAL SIGNAL APPLIANCES

64 West 22nd Street New York City

Visasig Blueprints \$1.00

Later on the once-despised amateurs—"whose morals have improved in the past quarter century"—are given further treatment as heroes, are accoladed "the world's champion Boy Scouts." Several instances of amateur emergency accomplishment—taken from Earl Jerome's excellent "Minute Men of Radio" in *Reader's Digest*, an authoritative article written with word-by-word assistance by A.R.R.L.—conclude the chapter on heroes.

So much for the relatively insignificant treatment of amateur radio. Let there be no misunderstanding: We have no intention of dismissing the book as valueless. As a historical reference work on the development of radio its value is negative. But it is interesting, well-written, absorbing entertainment. To read it with a background of factual knowledge of the subject on which to base qualifications is an enjoyable experience. For instance: "[In 1912] . . . amateurs and even some professionals rose up in furious protest all over the land. The old rugged individualism had its back to the wall again. Hearings were held by a Congressional committee; and when the Navy told of the impossibility of getting necessary business done because of amateur interference, certain of the amateur witnesses retorted by reading transcripts of conversation which they had picked out of the air, between naval officers or sometimes between officers and women—cheap gossip, intrigue, assanations, amatory trivia, stuff which caused more red faces in the Navy than it had known in many a day—not to mention reprimands and discipline."

Hi!

—C. B. D.

An Optical Pyrometer for Measuring Tube Plate Dissipation

(Continued from page 44)

to make glue hold. One hundred divisions take up about 9 inches on the scale. A turn of No. 28 wire looped around the slider sides and pushed down to touch the scale will serve as a convenient

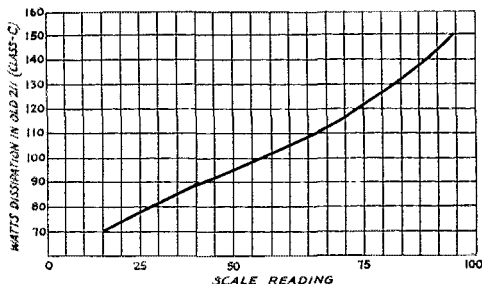

FIG. 2—TYPICAL CALIBRATION CURVE OF PYROMETER SCALE READINGS PLOTTED AGAINST PLATE DISSIPATION WATTS

(This curve will not fit your apparatus, and you'll have to run your own.)

pointer for indications. Note that two rheostats are used, one 30 ohms and one about 2 ohms. These values were determined experimentally; or, rather, it should be said that they were on hand and worked, so they were used. Some preliminary work with a bulb and milliammeter showed that the range of current we should expect was from 130 to 150 milliamperes. It was necessary to provide some means, therefore, of adjusting the current roughly and then using a vernier scale for readings. Resistance wire from several old rheostats was tried in turn and some selected which gave the desired current change along approximately 8 inches of length.

Calibration of the device is made as follows; assuming its use on an r.f. amplifier:

(Continued on page 102)

SELECTIVITY, DX, Without The Noise—



LOOK at These
Features:

- Coil Switching
- All-Wave Band Spread
- Built-in Power Supply
- Jensen Dynamic Speaker
- R.C.A. Tubes
- Fully Calibrated Dial
- Phone Jack
- Break-in Switch
- R.F. Gain Control
- Regeneration
- Antenna Trimmer
- Large Knobs

Sargent Model 11 Tuned R.F. Receiver

The Most Vital Question of All— HOW SELECTIVE IS IT?

In the crowded condition of the amateur bands the prime consideration in any successful receiver is SELECTIVITY. A receiver that cannot cut through the powerful locals, eliminate the R.A.C. notes and tune in DX on adjacent channels will not satisfy the requirements of the modern amateur operator. Model 11 meets these demands satisfactorily. For the C.W. man we can promise selectivity comparable with that of multi-tube receivers without

crystal—a standard of performance exceptional in a tuned r.f. receiver. Combined with this selectivity will be found the extreme sensitivity and low noise level characteristic of the regenerative tuned r.f. circuit—a combination radio operators have sought for years. On C.W. the WEAK SIGNAL response—meaning DX—is, we believe, greater than on receivers of other types. The noise level, in the receiver itself, is practically non-existent. On phone and broadcast Model 11's performance is only a shade less surprising, and it is extremely good on these also. An all-around radio operator's receiver.

Model 11 Net Prices for 110 V. 60 cycles operation

Model 11-UA, UNIVERSAL tuning range, 9.5 to 20,000 meters	\$75.00
Model 11-MA, MARINE tuning range, 9.5 to 3,750 meters	\$54.00
Model 11-AA, AMATEUR tuning range, 9.5 to 850 meters	\$46.00

Prices include power supply, speaker and R. C. A. tubes

Model 11 is available in all A.C., D.C. and battery voltages

IMMEDIATE DELIVERY

Write for full description

E. M. SARGENT CO., 212 9th St., Oakland, Calif.

Announcing Sargent Crystal Set for Marine Work

Not only complies with the new regulations on shipboard but is a rugged, reliable set designed for the purpose. Tunes 550 to 1400 meters. Selective and sensitive—of real value when the tube receiver is out of commission.



OK2AK

GAMMATRONS WIN ON
BOTH SIDES OF THE WATER!

Hans Plisch, OK2AK, winner of W VE...DX contest for Czechoslovakia with 46,560 points.

A new 20-page brochure is now available containing data for the latest Type 154 Gammatron as well as a revision of the Type 354 Gammatron literature. Request the new Catalog 5357.

HEINTZ AND KAUFMAN
LTD.
SOUTH CALIFORNIA
SAN FRANCISCO U. S. A.

Operating News

(Continued from page 68)

December in addition to the regular A.R.R.L. quarterly O.P.S. publication coming this month which will have dope on the January 23/24 doings in detail. Every operator of a good 'phone station should qualify as O.P.S. and get this dope. If not lined up write your S.C.M. for the information and the address of your nearest Phone Activities Manager.

Official Relay Station Doings

THE results in the October O.R.S. Party, the first in the all-season O.R.S. competition, speak for themselves in the following tabulation! Two competition months have now gone by. The first traffic totals to count a possible 50% toward the W4NC-Trophy appear in this issue, and the B.P.L. shows who is standing highest in this department of the contest. In the Party W3EOP came out on top—191 worked in 51 Sections and the only scores to top 50,000. W9IU was right up neck and neck, working 190 ORS, 6 OPS and 57 Sections for 46,552 points and only the adjustment for "central-eastern" ease of working sections and stations on a 5:4 basis put him second, W4NC, W8JTT, W1BFT, W7BSU, W6KFC etc. were next in the high ten—but read the list yourself. It gives the power, stations, sections, and score. Next O.R.S. Party is scheduled for January 23rd-24th . . . don't miss it.

Station	QSOs	Sections	Heard	Score	Power	Section
W3EOP	191	51	65 + 10	50167	400	E. Pa.
W9IU	190 + 6	57	65 + 16	46552	Ind.	
W4NC	159	51	69 + 15	41919	300	N. C.
W8JTT	147	49	75	37413	50	W. N. Y.
W1BFT	166 + 3	38	54 + 1	35302	500	N. H.
W7BSU	101 + 1	47	35	34815	800	Mont.
W6KFC	102	47	72	34805	50	Ariz.
W8KWA	162	49	61 + 2	33042	150/650	W. Pa.
W3NF	149 + 2	37	80 + 15	33004	...	E. Pa.
W1UE	144	40	71	32640	50	Conn.

Call	QSOs	Power	Score	Call	QSOs	Power	Score
W8KNB	144	35	28868	VE2DR	120 + 1	150	22671
W1EZ	139 + 1	90	28314	W4BOU	110 + 3	100	22594
W1GME	125	70	27846	W1INF	105	250	22068
W3FTK	135	90	27749	W3ADE	104	100	21420
W1TS	112	50/250	27559	W8AQ	121 + 2	...	21344
W5DEJ	127 + 1	125	27468	W2AHC	107	300/580	19754
W8BYM	136	150	27000	W6LMD	66	70	19722
W2HZY	127 + 2	60	26893	W2IBT	108	50	19520
W8OFO	144	400	25890	W2DXO	113 + 4	300	18844
W8IUY	131	75	25883	W7DUE	99	250	18537
W9BAZ	110 + 5	100	24570	W7CRH	60	30	18165
W8KUN	129	100	24531	W8QAN	98 + 2	300	17442
W9ENH	106 + 2	150	22968	W2HYC	105	200/240	16680

The Haywire Net

W9PVZ, A.R.R.L. Colorado R.M., reports on the Haywire Net (self-styled by the net members). This net is composed of the following stations operating every night at 6:00 P.M. PST on 3795 kc.: W6JVG, San Francisco, Trunk Line "B"; W6ETJ, Boulder City, Nev., T.L. "B"; W6GQC, Salt Lake City, T.L. "B"; Asst. Director, NCR, A.A.R.S.; W6LMD, Sonoma, Calif., T.L. "F"; A.A.R.S.; W6KDI, Cedar City, Utah, A.A.R.S.; W7DUE, Portland, Ore., T.L. "G"; R.M., A.A.R.S.; W9PVZ, Denver, Colo., T.L. "B"; R.M., NCR, A.A.R.S.; W7EBQ, Alternate for W7DUE. This net, through connections with A.R.R.L. trunk lines and other well-established traffic routes, is able and willing to clear traffic to all parts of the U. S. and to Hawaii, Guam and the Philippines. Any station having traffic to clear is invited to break in on the net at any time, or contact any individual station at any other time.

Field Day Scores

(Continued from page 30)

W1CGY-1	W1CGY	19-B	38 RT
W3GAD-3	W3GAD	3-A	24 RT
W9BTJ-9	W9BTJ	11-B	22 RT
W9ESM-9	W9ESM	4-A	12 RT
W1HDQ-1	W1HDQ	1-A	9
W9WVF-9	W9WVF	1-A	9
W2HRT-2	W2HRT	2-A	6 RT
W6AM-7	W7RT	2-C	2

N.C.R. Invites Amateurs

Lt.-Comdr. B. C. Furrington, U.S.N., District Communication Officer of the Third Naval District, writes that at a recent meeting of amateurs someone mentioned that coercive tactics were being used in obtaining members for the N.C.R. in Western New York. It is possible that this report is based on some misinterpretation of a recruiting effort that may have been over-enthusiastic. At any rate, the D.C.O. asks us to call the attention of all hams to the fact that threatening or coercive action is not authorized in asking amateurs to join the N.C.R.

All amateurs, however, are invited to join, if they wish, as the N.C.R. is of direct benefit and interest to radio men in the following several respects: (1) Identification with the United States Naval Service. (2) The opportunity to so prepare one's self as to receive the best possible assignment in case of a national emergency. (3) Temporary training duty of two weeks yearly with pay at a Naval Radio shore station or aviation base, or a two weeks' cruise if and when funds permit. (4) The opportunity to learn Navy Radio Procedure and communication methods. (5) Interesting weekly drills by radio. (6) Advancement in rating when properly qualified. (7) The opportunity through liaison with the American Red Cross as well as the Navy and Naval Reserve communication systems to perform valuable service in time of a local emergency. (8) New friendships and new contacts with men interested in the communication field.

Further information on the N.C.R., and the address of the individuals to see about N.C.R. in any of the several Naval Districts, will be forwarded in response to inquiries sent A.R.R.L. by letter or radiogram.

N. N. J. QSO Party Results

W2CAY won first prize, a type 354 Gammatron tube, in the annual QSO Party of the Northern New Jersey Section held on May 8th, 9th and 10th. All amateur bands were used, 3.5-Mc. c.w. being the most popular with 1.75 and 56-cM. 'phone following in order; 64 stations turned in reports—and a good time was enjoyed by all. W2CAY made contacts with 104 stations in 41 different towns, rolling up a score of 23,288. W2GUM was a very close second, working 97 stations in 46 different towns, and winning an Astatic crystal microphone with his 22,448 points. Thirty prizes were awarded in all and went to the following: W2CAY 23,288, GUM 22,448, GFW 18,312, HEB 15,300, ENZ 14,630, IAT 14,616, GON 14,025, GFF 13,755, IMB 13,532, GQX 12,614, HNP 11,484, GGE 10,956, CW 10,725, GGW 10,626, BZJ 10,590, HJC 10,400, JFC 10,150, CFW 9,913, GAB 8903, FBZ 8848, HHC 8752, GMF 8644, HEG 8525, IAY 8235, IBR 8176, HTX 7668, FOP 7160, IUW 7088, HVM 7020, ECO 6786.

STATION ACTIVITIES

CANADA

MARITIME DIVISION

MARITIME—SCM, A. M. Crowell, VE1DQ—VE1GL, R.M., hits a nice total this month, making the ole '46 take 75 watts and like it. HH is now R.M. for P.E.I. and main contact for Island traffic. EC says QRM from hams, harmonics and headaches. EV claims rig going fine—pair 301's final. HJ has 100 watts to an 800. BZ is back on 3845 kc. HX has rebuilt the rig and has been doing some work on new superhet. EY still schedules W1AJ. EX has just been thru a rebuilding spasm. JB is quite active on 3.5 Mc. CO is working big DX on 28 Mc.—reports via FR and HH. AP is QRL chasing QRM. AF is going to spend the winter in Florida. BD has been QRL service work. AC got the new 6L6 on the air. BE is QRL making ginger ale. CW has QSO'd all districts on 7 Mc. with 6L6, and 250 volts. JG gets out FB on 3.5 Mc. FR is using a pair of 31's in final—was visited by ER when in port on RCMP cutter. GS is ready to bust the ether after a long QRX. JU is coming on strong. KH (VO1C) is now on from Halifax QTH using 2A5 crystal osc.—pair 2A5's buffer and pair tens in final. AW is changing QTH and going to have an FB ham location this winter for big DX. ET threatens to go in this year's DX contest in a big way as soon as he returns from comm'l job; he is

QUEBEC DIVISION

rebuilding to steel rack and panel. The Halifax Amateur Radio Club is going ahead with plans for a swell new club house. Quite a number of new members were contacted through registering at the Club's booth at the recent Provincial exhibition. The New Brunswick gang is asked to look for GU and EV who will be glad to help you "Report via Radio." HH, Charlottetown; EC, Dartmouth; GL, Halifax are all on the air between the 13th and 16th of each month to help swell this report. Come on, gang, let's go.

Traffic: VE1GL 174 HH 92 EC 87 GU 54 EV 42 HJ 2 XE 1.

VANALTA DIVISION

ALBERTA—SCM, Alfred D. Kettenbach, VE4LX—JK has moved to Vancouver and will be on with new VE5 call soon. EO got FB report from Africa. HM is active on four bands, and knocking over the Europeans on 'phone. CY and SW are going strong on their nightly QSO's. PM, GS and TM are working lots of DX. KZ worked his African. AX is busy building 28-Mc. rigs for airplanes. FC's work is taking him away from home. The Calgary Club had a very enthusiastic meeting, there being forty-five present. A very instructive and entertaining series of meetings are being planned for this winter by the executive. GD is working with 28-Mc. rigs. LA is getting FB results with his 28-Mc. rig. JJ is going strong on 14 Mc. BW is heard nightly on 3.9-Mc. 'phone. EO is giving the gang fine service as Official Broadcasting Station!

Traffic: VE4LX 59 GE 38 WX 27 QK 10 AF 9 AAZ 4 EO 3.

BRITISH COLUMBIA—SCM, D. R. Vaughan-Smith, VE5EP—VE5CC now merrily knocks off DX. AE often runs into Victoria. CH is good at getting out of town jobs; he is going strong on 3.9 Mc. QC is another ham afloat. DY has fun with peanut tube! EC finds RK-23 FB on 28 Mc. GB got himself a Ball-and-Chain Oct. 28th. Ask HP about his 150T's! DV sees lots of 7DGY. HR made W.A.C. at last. FB, Ron. OQ has tens coming up! IC has potent plans for ½ kw. BO is fond of 7 Mc. OK is Victoria's top traffic man. FW is new President of Victoria Club. KN had bad dose of pneumonia but is now on the road to recovery. VE5EC, Victoria, reports he has many unclaimed QSL's. Shoot him a self-addressed stamped envelope and get those missing DX cards. Victoria Short Wave Club's new executive: VE5FW, VE5JC, VE5DY, VE5EC and VE5IC. The B.C.A.R.A. re-elected their last years' officers!

Traffic: VE5CC 12 AE 4 HP 21 DV 4 OQ 7 IC 4 BO 7 OK 20 EP 54.

ONTARIO DIVISION

ONTARIO—SCM, Fred H. B. Saxon, VE3SG—R.M.'s: 3GG, 3GT, 3MB, 3TM, 3WX, 3SG. P.A.M.: 3NX. This being my first report, fellows, I hope you will bear with me. I must, first of all, thank the numerous hams who sponsored my nomination for this job. My one big wish is that you will all give me the same support that you gave Jon Perdue and Sam Trainer before him. Thanks, gang. NO is on from new QTH. KT, ZE and OI are all considering O.R.S. The Queen City Club gang wants to know where yours truly reads his QST. Well, it is this way . . . every minute counts now. HV has his O.R.S. and is doing good work. CG is rebuilding and will be looking for schedules and O.R.S. appointment. ABW is looking for good Western Ontario outlet for T.L. "I" traffic destined for Central States. DU and WK have resurrected their old schedule. EI, Strathroy, visited SX and FK, Toronto, and while at FK helped install one of Jim Lamb's noise silencers. PV is back again after a lay-off of a year. WK has nucleus of splendid net going now, made up of DU, London, HV, Smooth Rock Falls, MA, Ottawa, QB, Lanark. WK ties in with VE2BU, Montreal. More section coverage is desired and any ham interested can get further info' from WK or SG. ZE is playing around with 6L6's and has got to stage where he talks to himself. TM is rebuilding with higher power, RK23 and RK28; he also has new QTH. The Queen City Club, Toronto, is sponsoring the VE/W contest next April. MJ gave very interesting talk and demonstration before Wireless Association on 56- and 28-Mc. The Cardinal Club had talk on P.A. systems by Mr. Tanner of Northern Electric.

Traffic: VE3MB 78 WK 60 UO 54 SG 17 DU 12 ZE 8 KT 6 PL 5 DJ-AID 4 GT 2 VE9AL 20.

QUEBEC—SCM, Stan Comach, VE2EE—Winter weather brings much increased activity on the air. The SS Contest started with a good attendance in this Division, a few dropped out but many were in at the finish. Reports to date list DR as the top man in Quebec with over 33,000 points. Fine work, Bill. Appointees to the A-1 Operator Club now include BB, LC, BU, EE for C.W. and DX for 'phone. LQ arrived in Montreal for a short visit. FU is now located in Labrador. BE, EE and IO were guests at a meeting of the Club Canadien Francais de la T.S.F. New O.R.S.: IN and KM; the former has finished his new rig with a pair of 35 T's. Our Trunk Line is broken out West but our R.M. clears traffic through the National Trunk stations W8KWA, W9PDE or W9LH all on 3670 kc. It would be appreciated if locals would keep this channel clear after 11 p.m. HH is using a 6L6 oscillator. HL is on 3.5-Mc. 'phone. AX is as usual hearing plenty of DX; Gordy has worked two XU stations. BG has been keeping a schedule with HK1GK in Baranquilla, Colombia. DA is a regular on 3.5-Mc. 'phone. DD is back in Grand Mere building a new rig. IY has also bought a Sky-Buddy. DU has completely recovered from his recent operation. DX has new QTH. GX has been heard on 28-Mc. 'phone. JY has purchased the latest Sky-Rider receiver. EX was using a water-cooled tube in the SS Contest. HM is using the latest in crystal mikes. CR has rebuilt his modulator and has a very FB signal on 14 Mc. JJ has an ACR-175. News is scarce this month. Your S.C.M. is not clairvoyant. I can only print what I hear about. Kindly do your bit and send in news items. See all, hear all and tell the S.C.M. everything.

Traffic: VE2AB 44 BU 51 DR 350 DG 374 HT 81 EC 39 JK 7 EE 20 LC 35 HH 50.

PRAIRIE DIVISION

MANITOBA—SCM, A. J. R. Simpson, VE4BG—Full resumption of winter activity has taken place, most notable being the nice traffic totals for this period. AG tops the list. VG keeps consistently on with his schedules. More stations of this type are needed. GC, an old-timer on the traffic end of things, will be handling the Trunk Line with AG helping. BB was a visitor to Winnipeg a short time ago and is now back North operating. CD was also a visitor and has returned to his operating post. DU keeps after the DX with new antennas. EK is heard consistently on 14-Mc. 'phone. ER finds the 6L6's a problem. FS finds a pair of RK20's FB. GL has up a new antenna. IP is all set for a busy season. The LH brothers keep the 14-Mc. 'phone busy. LL has the new antenna up and is heard on 14-Mc. 'phone with FB quality. MW is making several changes in the rig, MY is acquiring an XYL. NI finds plenty of DX on 28 and 14 Mc. and is busy Class B modulating the transmitter. NM keeps on 14 Mc. NT is heard on 28-Mc. 'phone. OK finds 56 Mc. a busy band. QA has a strong 14-Mc. 'phone signal. QC has difficulties making an RK23 perk on 14 Mc. Nov. 2nd at 4:00 p.m. a small Indian boy fell on a hot stove burning one eye and was instantly blinded. There is no doctor on the reserve and AEB put his station on 7 Mc., about seven watts power. In immediate answer to his QRR, ZC at Moose Jaw came back. AEB gave the dope to ZC, who wired to Portage La Prairie. The Indian Agent at Portage La Prairie phoned a doctor at Ste. Rose du Lac, nearby to Reedy Creek P.O. The doctor was able to reach the injured Indian boy in time to save the sight of the other eye. FB work, AEB and ZC. Also on Oct. 17th in answer to AEB's CQ, FN was able to relay AEB's request for a nurse which resulted in saving the life of a baby. AEB sends his belated thanks to FN. AEB has also handled QSP's for Winnipeg fliers.

Traffic: VE4AG 114 GC 87 VG 16.
SASKATCHEWAN—SCM, Wilfred Skaife, VE4EL—There's an old saying that a person gets just what he pays for, and this applies also to this Section report. If you fellows do not send in the news, I cannot put it in this report. So wake up and let me have the news. XM put up a new Zepp antenna. IM is a new ham at Yorkton. HC was transferred back to Manitoba. FM is building new Osc.-Amp. rig. DI made his twelfth consecutive QSO weekly with Van. on 14-Mc. 'phone. BD worked a ZL on 28-Mc. 'phone. It has been suggested that this section have a local traffic net on a spot frequency, c.c. How about it, boys? Those interested write in.

Traffic: VE4UL-DI 28 EL 7.

HUDSON DIVISION

EASTERN NEW YORK—SCM, Robert E. Haight, W2LU—HYC worked HB9Y on 3.5 Mc. and needs 9 states for W.A.S. LU enjoyed 'phone QSO from 2CBO's with YL cousin in Mass. 3R0 is operating at club, HON. CC has had 1200 QSO's with VK5HG. 2JWT is new O.R.S.: J-ust W-atch T-traffic! QY, BCR and LYG are new N.C.R. members. JSL sells R.C.A. and Philco radios for station expenses. Colo. and Idaho are needed at HCM for W.A.S. and Asia for W.A.C. HNH will have a 6L6 crystal osc. perking by 1937. With the passing of Guy Ferguson, W2BJA, Nov. 11th, Amateur Radio lost a real Ham, who took Amateur Radio seriously. Guy kept the Capitol city well covered with his traffic activities. For the past five years BJA has been Chief R.M., O.R.S., O.O. and T.L.S. on trunk "C". QY reports CIF back on 3.9-Mc. 'phone. VP started Morse Code classes for N.C.R. Unit. CJS reports sad news of death of W2BJA. ITK keeps Kingston's ham activities covered. HUM and IVS are in Florida for the winter. BDB is building new 1/2 kw. rig. JFE gave up 1.75-Mc. 'phone. IUR is rebuilding. HUB goes out as radio repairman. Listen to the new speed key of JRM. SZ is operating in 7 Mc. with 150 watts input to a '52 and on 14- and 28-Mc. 'phone with 170 watts into '03A. ISQ is new O.R.S. on 3.5 Mc. O.R.S.-O.P.S.-R.M., please note!—If you wish to remain in good standing, you must report to the S.C.M. every month on the 16th. Check on that endorsement date. With the closing of 1936 E.N.Y. average is low. Let us bring back our standing and make 1937 a record year. Your S.C.M. extends to all hands his best wishes for a Happy and Prosperous New Year.

Traffic: W2HYC 506 LU 47 HON/AZX 18 CC 14 JWT 11 QY 9 JSL 5 HCM 3 HNH 1.

NEW YORK CITY AND LONG ISLAND—SCM, E. L. Baunach, W2AZV—KI can be heard daily on trunk line "C" at 7:00 p.m. on 3665 kos. DBQ is conducting a technical page in the A.A.R.S. bulletin each month. HGO has Florida schedules. EXR is looking for reliable schedules. IOW got on the air Friday the 13th and blew his filter condensers. HSV entered his first SS contest with 25 watts input. IHT has his 6L6's working FB on all bands. EVA is still looking for QTH's. HRA received his radiotelegraph second class. IBT can be heard on 56 Mc. with a pair of '45's in TNT. ELK is adding a pre-selector to his FBXA. AHC had HCIFG as guest during his stay in N.Y.C. ELB sends his first report in three years; he is now a member of N.C.R. JFP operated portable on 56 Mc. in Brooklyn. APV is secretary of Hudson Division Radiophone Association and would like to hear from all 'phone men who are desirous of joining for the improvement of conditions on the 'phone bands. JBJ is starting a Radio Club at the Y.M.H.A. at Washington Heights, 178 Street and Fort Washington Avenue. All those interested should drop him a line. HWS operates JIP of the Collegiate School Radio Club and has several members ready to take exams for operators licenses. AZV worked 25 stations the first day on the air at his new QTH. JBL can't get his antenna to operate on 3.5 Mc. DXO says AYJ boasts another Jr. op., Nov. 7th, 9 lbs. DPQ who operates HCAAE expects to be home by Christmas. IOP was active in SS but could not work a Nevada station for W.A.S. At the Brooklyn Tech. open school night there were over 2000 visitors at the station (CXN); the club officers are HNS president, IOP vice pres., JGH operator. ITX is operating at Lehigh University and wants a schedule for 6:30 to 7:30 a.m. daily on 3652 kos. BGO finds the A.A.R.S. more interesting than ever. DOG passed his 200th QSO with 8CQA. A '34 Buick keeps BSR off the air. GDF worked 70 stations in the SS. PF is going on a visit to Miami, Florida, Nov. 26th to Dec. 15th. BMG rebuilt his rig and as usual had to shoot a few bugs. CSO sends his report from Balboa, Canal Zone where he has been commercial operating for the past 19 months. OQ operates daily on 3710 kos. at 8:00 p.m. Regular operating frequencies: BDN 3506, EYS 3512, HBO 3720, FF 3550 (CW) 14240 ('phone).

Traffic: W2KI 352 IBT 306 JBL 242 BMG 208 OQ 153 DBQ 107 (WLN93) PF 79 GDF 43 AZV 42 FF 35 HGO 21 DXO-BDN 20 EXR-HBO 16 EYS-IHT 17 AHC-BGO 9 ITX 6 ADW-GES-AA-BIK-DLR-ENS-HRA-BYL 5 DBV-BKP 4 ELK-DUG 2 HKO 1 TOP 2 CXN 75.

NORTHERN NEW JERSEY—SCM, Charles J. Hammersen, W2FOP—HZY worked HB9Y during SS contest. GGW is kept busy with his schedules. HOZ is doing fine work in the N.N.J. net. HNP is working up a traffic net on 1.75 Mc. GVZ is rebuilding three rigs at one time. HQL is new member of the N.N.J. QSP club. HXI has new '03A in his rig. ICJ is joining the N.C.R. CGG finds that '10's won't

take 950 volts. BZJ was appointed executive officer of Unit 4, N.C.R. ECO works K5AG regularly. IAP needs 8 more states for W.A.S. DPA won \$10 in radio club DX contest. HFT says wind didn't do his feeders any good. HFB is busy grinding crystals so he can QSY quickly. IDE is on the station staff of 8YA at Penn. State College. Central Jersey Radiophone Club elections: BZR president, LV vice pres., HNX secretary, 3DKX treasurer. 2HNX is having problem whether to put an 860 or '03A on the air. CEJ is busy working his YL's transmitter. JLL is only YL ham in Linden working 1.75 and 3.5 Mc. IJE reports he is not on 14 Mc.; must be bootlegger. LLF has worked plenty of DX. IRW is still chewing the rag on 1.75 Mc. IRX is on 7 Mc. The arrival of a YL at JKW keeps him off the air. GON blew his power supply. GCV is going back to the breadboard style rig. IDZ just eloped. IYU and IKD both have an infected toe. R.F.? HMU finally got on 'phone. JZW, ex-9YGY, is now resident of Elizabeth. HTX will soon be portable from Cornell. Orig. T.C.R.A. is having contest to see how many towns can be worked containing the first letters of the members first names. FFY is having neutralizing trouble. HLX is working his final as doubler with 10 watts input. GYY's first contact on 14-Mc. 'phone was CO2KL. JOU is building 1.75-Mc. 'phone in rack and panel. IBZ copies code all day at R.C.A. and spends evenings pounding brass. IMB is experimenting with television with IIA. JAB is to install crystal filter in his home-made super. JDY is still satisfied with 7-Mc. DX. DAG is BT2 at Plainfield Y.M.C.A. GZG has new 2A5-6L6 exciter unit. 3LT may soon be back to his old QTH. RN and JC are having fun on 1.75 Mc.; they live a block apart. FSI plans new P.P. 56-Mc. 'phone. FBG is still on 28-Mc. 'phone working much DX. Plainfield Radiophone Associations Vigilantes silenced unlicensed 1.75 Mc. 'phone signing "W2JCH of Old Bridge, N.J."

Traffic: W2BCX 509 (WLNF 519) HZY 513 GGE 450 GGW 291 HOZ 281 GAS 164 HNP 145 GVZ 132 FOP 125 HQL 127 HXI 93 ICJ 66 IQM 56 CGG 52 BZJ 50 HBQ 37 HCO 22 ECO 20 IAP-CIZ 12 CXJ 4 DPA 3 HFT 2.

ROANOKE DIVISION

NORTH CAROLINA—SCM, H. S. Carter, W4OG—I would like to take this opportunity to remind the gang that my term as S.C.M. expires March 1, 1937, which is not far off, so be thinking about who you want for the next S.C.M. You will soon have to make nominations for this job, so don't overlook this fact. Fort Bragg: DXG is using low power on 7 mc. CZB is trying to get his rig on 7 mc. CEB and CGM let their licenses expire. CVQ is experimenting with QRR transmitter, and is working on 14-Mc. e.w. most of the time. Tarboro: CCH made a DX ham out of DCL. Greensboro: MR reports a new shack and almost has his new rig ready to move in. Raleigh: BRT is QRL school, but finds time to get on the air and handle some traffic. DW has 6L6 oscillator and says it does the work of his '47 and '46. The Raleigh Radio Club has affiliated with A.R.R.L. EBA is control for N.C.R. Mount Holly: CYY again leads the state in traffic total; he reports that he is now W.A.S. No. 184; he lost a bet on the election to AGF. Louisville: BIP is QRL B.C.L. service work. East Flat Rock: EKM is a new ham, and has been on since October 10th; he is 19 years old and does all his work on 3.5 Mc. Warren Plains: BHR is on for traffic and rag-chew some, but is QRL B.C.L. service. Warrenton: BVD is spending 90% of his time on DX. Lincolnton: EIIY is a new ham and is putting up a pair of 60-foot poles for his new antenna. Winston-Salem: DWB has some good schedules and is handling plenty of traffic. 4NC's new rig is finished, and will be on display at the Floating Club Meeting. BOH is president of Club for 1937. DVU is vice-president. Wilmington: CPT has a new kind of work and will not have to travel now; he is trying to get on 28 Mc. US is active on 7 Mc. BPL has moved to Spartanburg, S. C., to work for WSPA. The gang gave him and his wife a great send-off; he had been married secretly since May. Congratulations, OM, even if it is late. BQZ is still doing good work on 14 Mc. DYT is negotiating for a receiver. EEL is getting out well on 7 Mc. With the 'phones: CXO expects to be home from the Sanatorium by the first of the year. DLY talks to him from Belmont each night. QI sends out the Official Broadcasts at 9:30 a.m. each Sunday. Listen in on 3910 kc. for the latest dope. DKF is getting up a new antenna to help his 1.75-Mc. 'phone. DOR has 20 watts on 1.75 Mc. BYE experiments most of the time. DKH is president of senior class in high school. CYB reports traffic and 95% of time is rag-chewing. DGU reports trouble in power supply, but is back on the air now. 4CYY

says if those needing Nevada QSO will write W6KCQ/HGL/NYY they will fix you up. W6KVQ is on 7146 kcs., NYY on 3690, HGL on 3660. 6UO will be on 3.9-Mc. 'phone later.

Traffic: W4CYY 182 DW 84 ABT 30 DWB 21 AEH 18 CVQ 17 AGF 16 BRT 14 BHR 9 CJN 8 CYN 5 BVD-QI-BIP 2.

VIRGINIA—SCM, Charles M. Waff, Jr., W3UVA—BPI is putting in an 807. AJA's shack is undergoing a house cleaning. FFC is operating mobile on 56 Mc. FBL travels about the state a bit. EHL got in the SS. FQO is at college in Georgia. EMA worked a VK at 1:30 P.M. on 14 Mc. BJX has a new ACR-175 receiver. BFW has moved to Richmond. FEM will have a new operator soon. GJP schedules 9MLA every Sat. BIW has a new rig on 28 Mc.; he'll be on 'phone soon. DDY is trying out different self-excited rigs on 28 and 14 Mc. DWE is rebuilding from "stem to stern." AKN is helping to organize an Emergency Net. AIJ has the Virginia 'Phone Net going every Sunday at 2:30 P.M., freq. is 3920 kc. FGW worked ZS4J for his first So. African. RL is putting 50 watts into a pair of 6L6's. BZ reports 28 Mc. active. MQ was in SS. KU works nights at WTAR. CQW has a bunch of schedules. BYA now has a Class A license; he's using a pair of 50-T's, with 1/2-kw. input. FZG is getting a Sky-Chief receiver and a T-55 for his final. GBK worked his first real DX. BIG schedules AIJ and helps with the Virginia 'Phone Net. ELJ is working 14 and 7 Mc., trying to work Asia. DGT is operating portable on 1.75-Mc. 'phone. FQY took Radiophone First examination. FQO is getting lots of DX cards. BSB worked an SU at noon on 14 Mc. FTC needs only 7 states for W.A.S. FJ was in SS. GOP is new ham in Richmond. BSM has a new ACR-175 receiver. DQB took exams for West Point. FE is on 14 Mc. in Hampton. EMM worked VU7FY on 14-Mc. 'phone—called, raised, worked, and signed off, all on 'phone! FB. EMM also worked ZU6P on both 28 and 14-Mc. 'phone. DJC gets out FB with his 211's on 3.5 and 7 Mc. GBC has two rigs, each with a ten final. UVA is no longer in U. of Va. Anybody want to hire an S.C.M.? Hi. GLV has just about finished his 1-kw. 'phone and e.w. rig for 1.75 Mc. FXL is going to 28-Mc. 'phone. FPL is attempting schedules on 56 Mc. with G6LK and G2MV. EZL is on 14- and 3.9-Mc. 'phone. IISM/3 is on at Charlottesville.

Traffic: W8BYA 193 AKN 147 DJC 144 FJ 39 BJX 26 GJP 5 EMA 2 AIJ 1 RL 3.

WEST VIRGINIA—SCM, W. H. Ribeldaffer, W8KKG—PZT has a new baby girl. MZD has a new Harvey rig to drive a pair of 150T's. KKG is on with a pair of 354's and first QSO was with VS7RF (the new diamond antenna did it). JRL got his card from VS7RE. KWI has a new T200 going on 14 Mc. OJL finally got a new pole transformer in front of his house. ONP has a new Gross CW25 rig. OFD is putting up a 260-foot antenna. KXV considered buying a house by the hospital in his town. MIS and NTV represented Grafton at the M.A.R.A. feed in Fairmont. QBS was accused of being a bootlegger by a W2 when the three-letter Q calls came out. LS has a new RME-69. PHY is working 7 Mc. with considerable success. LXF has a new 8-tube super. PSR has a SXII Super Sky rider. FQB reports from Schenectady that G.E. has a lot of nice ham rigs laying around. JKN is working 75% of calls on 7 Mc. with a 67-foot antenna with 66-foot feeder, 11 feet off center. ASI worked U2AE and SM6UJ. PME is having trouble with a 4000-volt line 6 feet from his receiver. MZT is new O.R.S. HWT is doing justice with his WLHG call. ELO is back on the air at last. HD is back in traffic game with a dandy total this month. NAU schedules JQP. PTJ joined Emergency Corps. PZP is working 1.75-Mc. 'phone.

Traffic: W8PTJ 13 ATT 10 NAU 18 KXC 5 OXO 4 HD 49 LI 16 ELO 11 HWT 39 ANU 5 PSR 31 LXF-PHY 4 AKQ 7 KKG 42 MCL 78 MCR 28.

NEW ENGLAND DIVISION

CONNECTICUT—CSM, Fred A. Ellis, Jr., WICTI—CTI was made Alternate Director for New England in non-contested election. Thanks, gang. Both number of reporting stations and amount of traffic handled doubled and then some over last month. In a month and a half of operations the Nutmeg Net has become a very smooth running organization UE and INF made the B.P.L. AFB attends both trunk "C" and Nutmeg Net. DMP is active in A.A.R.S. work. GTX has three schedules and is looking for more. GKM has a keen interest in A.A.R.R.L. activities. ITI was in the SS. HSX got O.R.S. again. TS has special rig for Nutmeg Net. BDI makes tape records of amateur stations. INP

added RK20 to 6L6, 125 watts now. JMY has a new Mac-Key. GME had an operation and will be off the air for several weeks. We all wish Rus a speedy recovery. IMV works Army net on 1.75 Mc. JXP received his O.R.S. appointment, BFS is still in the rebuilding stage. APA won RME-69 at Hudson Division Convention. JLL worked his first CM2. DLX has a new job out of town. AVB works DX on 14 Mc. with indoor antenna. The rig at KFN stopped dead just before the SS. Tough luck. Your S.C.M. appreciates the co-operation shown by sending reports in on time. Traffic reports of 19 stations were received via Nutmeg Net this month. The Net held a very successful meeting at Wesleyan University Sunday, Nov. 29th. Twenty-one were present and several problems ironed out. Thanks to GTX for providing meeting place.

Traffic: WIUE 705 INF 418 AFB 357 DMP 246 GTX 144 GKM 138 ITI 127 CTT 68 DOW 66 HSX 68 TS 64 BDI 60 INP 55 JMY 54 GME 37 IMV 34 JXP 30 BHM 26 HYF 22 HXZ 19 BFS-JWG-APA 15 JTD 13 GVV-KFN 12 JUD 11 FNM 7 KBJ-JJL 5 DWP 2 BQS-BNB 1 DLX 3 BIH 3.

MAINE—SCM, John W. Singleton, W1CDX—BTG takes the traffic honors again this month. He's a hard man to beat. GOJ, our chief R.M., comes in second with a fine total. INW is right on Perley's heels; he has improved his receiver and it is working fine now. ISH has a fine total. IST is after several prospects for O.R.S. and hopes to land them. CDX blew his best 50 watter—damn it. AFA was hard at work during the SS. HSD reports KEZ new ham in Millinocket. DHH is W.A.C. as soon as the QSL's arrive. JRS has a new rig and it is perking fine. KEN has new crystal rig going fine using 6L6 Tritet and '10 final. The Pine Tree Traffic Net is operating nicely five nights a week on 3590 kc. The net is composed of the following stations: GOJ, INW, IST, ISH, HSD, BWR and CDX. Get set for Main Section traffic contest which will start Jan. 16th and continue for three months.—Prizes and all. The stations handling and reporting the most traffic win.

Traffic: W1BTG 903 GOJ 316 INW 306 ISH 78 IST 68 CDX 53 AFA-HSD 15 IKC 4 DHH 3 JRS 2.

EASTERN MASSACHUSETTS—SCM, Albert N. Giddis, W1ABG—HWE won first month of O.R.S. competition. AKS just missed B.P.L. IHI has new Gammatron 154 for high-frequency work. AGX applied for O.R.S. QA reported for first time. ABG is busy answering CQ's of a new daughter! IWC is doing a fine job as new R.M. BEF is link in Merrimack Valley Emergency Net. DMF is building new 89-802-RK36 job. KH is now W.A.C. on 28 Mc. ASI gave a fine talk at the M.V.A.R.C. JNU received 28-Mc. report from Hawaii. EPZ is putting out a nice signal on 3.5 Mc. BMW blew amplifier plate transformer. HWZ handled message for Army player. QW is coaching basketball team. JTI is experimenting with antennae and would appreciate DX reports. GGB is working in Maine. WV worked FR8VX for 90th country. ALP says power needed in SS contest! ALB worked U2NE on 28 Mc. SW worked OE4AH on 7 Mc. GMD is putting action into the P.A.M. job. Complete list of A.R.R.L. appointees in the Eastern Massachusetts is as follows: R.M.'s: FRO-IWC-QW-DDE. P.A.M.: GMD. O.R.S.: ABG-ASI-KH-HWZ-BEF-ZQ-RE-EKK-HWE-FRO-HCH-BMW-QW-DDE-IWC-JSK-AKS-DMF. O.P.S.: GMD-BR-GEX. O.O.'s: BMW-ZW-JTI-GEX-FZH. O.B.S. ASI-CCX-BEF-SB-JSK. T.L.S. ABG-FRO. There must be many more operators and stations possessing the necessary qualifications for any of the above appointments. Why not write the S.C.M. and get the "lowdown"? The S.C.M. wishes to express his appreciation for the fine cooperation given him by the non-A.R.R.L. members of the Section, 73.

Traffic: W1HWE 515 AKS 482 IHI 386 (WLGs 104) AGX 332 JCK 250 FRO 223 QA 159 ABG 148 IWC 144 BEF 124 DMF 15 RE 95 ZQ 83 (WLG 226) KH 78 ASI 74 HKK 73 JNU-EPZ 42 JSK-BMW 24 CIK 16 AKE 11 HKY-JID 10 HWZ 9 QW 95 HCH 13 EPE 4 GGB 6 SW 1. (Sept.-Oct. W1EMG 195).

WESTERN MASSACHUSETTS—SCM, William J. Barrett, W1JAH-IOT, IZW and IOR come thru with nice totals. IZW making B.P.L. on deliveries. BVR has new teaching position in Westfield. FB, Perce. The N.E. Division Director's Net meets each Friday evening at 6:30. JAH is getting grey trying to get action and reports from this gang. Hi. AJD complains about power lines going dead at schedule time. EOB is trying his hand at DX between N.C.R. drills. AJ is new O.R.S. Congrats, Ralph. He still schedules NY1AA. ISN is putting rig on 14 mc. COI has 6L6 e.c. crystal band switching exciter perking, with new 28-Mc.

(Continued on page 104)

10,000 HAMS CAN'T BE WRONG



IN
THEIR
CHOICE
OF
THE
D-104
CRYSTAL
MICROPHONE

SEE
Your
Jobber

Over 10,000 amateurs in every part of the world enthusiastically endorse their Astatic Model D-104 Crystal Microphone—because of excellent frequency response in the "speech range," high output, freedom from microphonics, resistance to atmospheric conditions and rugged construction. List Price \$22.50

A STATIC
MICROPHONE LABORATORY, INC.
YOUNGSTOWN, OHIO

Licensed
under Brush
Development
Company
Patents

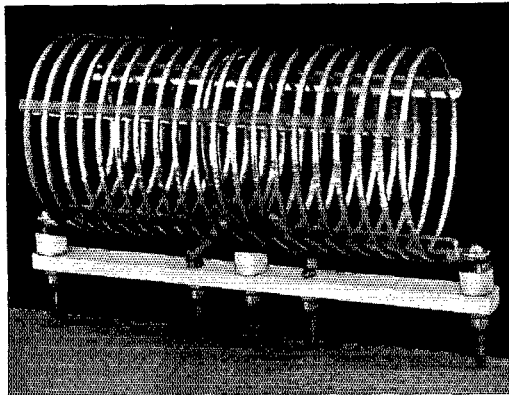

Coto

LO-LOSS INDUCTORS

Now available with internal LINK COILS and STEATITE terminal bars. Made for Antenna, Tank and Buffer circuits and for all bands with uniform mounting centers for each type.

STEATITE MOUNTING BASES

Use a COTO Steatite Mounting Base equipped with stand-off insulators and jacks for a lo-loss, quick and accurate plug-in assembly.

Available at all leading jobbers or
write for descriptive bulletin

RADIO



PRODUCTS

COTO-COIL CO., Inc., PROV., R.I.

An Optical Pyrometer for Measuring Tube Plate Dissipation

(Continued from page 95)

1. The tank coil is shorted out and excitation removed.
2. The bias is reduced slowly until the tube plate barely begins to show color.
3. The bulb in the pyrometer is lighted, with the slider set a few degrees above the zero end of the scale, and the large rheostat adjusted so that the bulb filament is barely brighter than the tube plate.
4. By means of the slider adjustment, the filament of the bulb is brought down in brilliancy until it cannot be seen against the plate. (The indication is very sharp; if the filament is too bright or too dim it will stand out clearly, but will disappear entirely when properly adjusted.)
5. Plate voltage, plate current, and slider scale reading are recorded for this adjustment.
6. The input is increased in steps by reducing the bias and readings taken at each step. (Remember that it is possible to melt plates out of tubes—even 210's.)
7. A graph is made, showing plate dissipation (watts) plotted against slider reading. The plate dissipation is equal to the input, since we have taken measures to keep any power from getting out.

Power (watts) = Plate volts × plate current (amps.)

By referring to the graph it is possible to determine dissipation at any value between the maximum and minimum values plotted.

If it is desired to determine tube efficiency, the following formula is used:

$$\% \text{ Eff.} = \frac{\text{Input (watts)} - \text{dissipation (watts)}}{\text{Input (watts)}}$$

The power output to the tank coil is Input (W) - dissipation (W).

If the large rheostat is moved, the readings will be shifted one way or the other along the scale. If the batteries weaken materially so that the large rheostat must be decreased in order to light the bulb, new data should be secured and the device recalibrated.

With the Affiliated Clubs

(Continued from page 46)

when he led his band into Utah, club members said figuratively, "This is the place."

Although city officials seemed favorable, it took something else to get the project started. The "something" was one of those happy coincidences that doesn't dare turn up in fiction. The Red Cross-American Legion Disaster Relief Corps was puzzling over the establishment of an emergency communication system in case another earthquake such as that of 1906 should visit the region. Harry Engwicht, W6HC, charter member of the club, was delegated to confer with Corps leaders.

What could be more appropriate than an

(Continued on page 106)

Avoid QRM

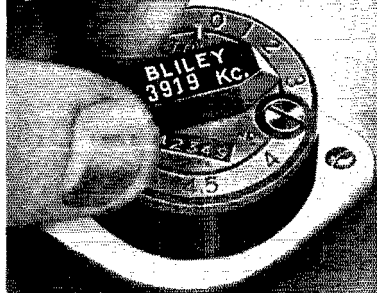

**BLILEY Type VFI
VARIABLE CRYSTAL UNIT**

Use Variable CRYSTAL CONTROL

1. Frequency of crystal can be varied over a range of approximately 6 Kc. at the 80-meter fundamental.
2. Variations up to 12 Kc. possible when doubling and 24 Kc. when quadrupling to 20 meters.
3. Crystal has frequency drift not exceeding 4 cycles/Mc./°C. Frequency adjustments do not affect the operating stability.
4. Unit fits 5 prong tube socket and may be mounted in any position. It can be used to replace crystal units now in use.
5. Price, within 5 Kc. of specified minimum frequency, \$8.00; to exact integral specified Kc., \$10.00. (Furnished only for the 80-meter band.)

Ask your distributor for your copy of the 1937 Bliley Catalog describing the complete line of Amateur Crystal Units and General Communication Frequency Units from 20 Kc. to 25 Mc.

BLILEY CRYSTAL UNITS

AMATEUR RADIO *Map of World*

I.A.R.U. — W.A.C. Divisions

All known districts and sub-divisions

Six colors and black

Principal cities of the world

Countries designated by prefixes

180 prefixes in large red letters

U. S. inspection districts and examining points

230 countries indexed

2% accuracy for distance measures in miles and kilometers

Time zones — legal and Greenwich

30"

40"

**PRICE
\$1.25
POSTPAID**

**A. R. R. L.
W. HARTFORD
CONNECTICUT**

(Continued from page 101)

antenna, four half waves in phase. Storm brought down BNL's antenna, so until new QTH is established he is on 7 Mc. ZB added country No. 83 this month, besides schedule with WCFT daily. P.A.M. GZL has new NC100X and NCRO oscilloscope. He is looking for more O.P.S. in West. Mass. How about it, 'phones? Fellows, if you want news in this column, it's up to you to kick in with some dope, cuz I'm no mind reader. Just a card, whether or not you handle traffic, will do the trick. Incidentally, how about some traffic activity? It's getting to be an event to hear a West. Mass. traffic handler.

Traffic: W11OT 408 IZW 403 IOR 386 BVR 97 (WLG 175) JAH 85 AJD 35 EOB 14 AJ 13 GZL 12.

NEW HAMPSHIRE—SCM, Carl E. Evans, WIBFT—The second drill of the New Hampshire Emergency Network was held the second Sunday of November with increased attendance. Twenty stations in fifteen different towns were contacted on the three different nets. Hereafter this drill will be held first Sunday of each month at 11:00 a.m. Any and all stations are welcome. Spot frequencies now being used are 3840, 3735 and the 3.9-Mc. 'phone band. Write the S.C.M. for details. AXW is selling out due to illness in the family. ARW has been hunting up in Canada. CFG is very QRL radio service work in spare time. GKE and HOV are getting to be crack pistol shots. EAW is rebuilding his 28-Mc. transmitter. IP hopes that traffic keeps moving. IDY is rebuilding. ARE has changed his QTH to Boston for the winter and may be heard on 3.5-Mc. c.w. ANS, FFZ and EAL report very faithfully every month but forget a few news items. IDQ is building a new portable rig to take to Florida with him this winter. GTY burned out his plate transformer. APK has a new 6L6 oscillator. IVU has rebuilt his superhet and found that adequate shielding has a lot to do with good receiver performance. BFT now is using an HRO receiver. HOU is making a few changes in his transmitter. IJB has taken his class A exam. JQX is now on 3.5 Mc. with 12 watts input. JJD has a 6L6 oscillator feeding directly into the antenna. JCA schedules JBA/4 in Florida every morning. JVJ is applying for O.R.S.

Traffic: W1HTO 733 (WLG 20) IP 641 BFT 261 FFZ 103 GMM 63 IDY 38 EAL 29 KAW 17 CEA 10 AVJ 2.

RHODE ISLAND—SCM, Clayton C. Gordon, W1HRC—First off I want to thank GTN (R.M.) for battling for me last month while I was a "Goofer" climbing Mt. Wash'n and other hills. JPJ is certainly bringing up Rhode Island's traffic standing, and still has time to QSO HB9Y on 3.5 Mc. (HB9Y was my first Trans-Atlantic QSO, on 3.5 Mc., two years ago and what a thrill it was, too). JPJ is also dabbling with 28 and 14 Mc. He wants more schedules. KCS has gone on a crystal buying spree. DDD now sits in on Trunk Line "C" and has new job. BJA was in SS contest and is on 7 and 3.5 Mc. now. IPU wants a ship to come in so can rebuild rig. ILO is fed up with 7 Mc. and claims to have gone back to 14 Mc. for good. (Who ever went on any band for good—find out the time they are good for what you want, and use 'em all). BVI has new Junior Op. HJ is working VK's in afternoon on 14 Mc. c.w. and also PKIMO. JNO has built metal tube super that works FB, and has applied for new call for Dorchester while up there attending school. The Prov. Radio Ass'n had an official visit from the Parkway Radio Ass'n recently at which time the New England Radio Club Council idea was presented to them and very favorably received. Other Rhode Island Radio Clubs are urged to inquire from the Parkway Radio Ass'n, 17 St. Peter St., Jamaica Plain, Boston, Mass., regarding this Club Council idea. HRC is preparing to join Emergency Corps and has portable receiver capable of battery operation and parts for same kind of transmitter. ETD is getting on 28 Mc. with 6L6 e.c. osc., 41 buffer and T-55 final. Happy New Year, fellows.

Traffic: W1JPJ 445 (WLGW 15) IEG 233 (WLGK 95) GTN 150 KCS 102 DDD 15 BJA 5 IPU 4 ILO 2.

VERMONT—SCM, Alvin H. Battison, W1GNF—C.R.M.: 1FSV. R.M.'s: 1JHK, 1EZ. P.A.M.: 1AVP. FSV is again high traffic man. FFS pounds out Official Broadcasts with a fine fist and note. GAZ has throat infection. DAQ is the proud father of a baby boy. AAK has a new HRO. Middlebury College has formed a radio club with 25 members; they are using the call DNR for the present. ATZ has a very fine note. GAE has been acting as Postmaster; he is also experimenting with antennae. GAN is building a 250-watt 'phone and c.w. transmitter. IRO applies for O.P.S. and is building new 150 watt rig. AHN is busy writing ads;

he claims Windsor is Vermont's liveliest town! BJP contacted many Asians and sent photos of his fine station. JHK is studying the possibility of a police net. ERJ is altering a theatre sound installation. FN contacted U9MI for his 14 Mc. W.A.C. ELR is W.A.C. on 28 Mc. c.w. and needs only Oceania for his 'phone W.A.C. KDV, a flood control engineer, is a new amateur in Brattleboro. ERV is rebuilding for 1.9-Mc. 'phone. DPO has a new 100-watt transmitter. GNF had an RK20 pop! EZ contacted HB9Y on 3.5 Mc. AD is back on c.w. again. CUN is busy repairing B.C.L. sets. BD is still grinding the hours away. ATF keeps Sun. a.m. schedules regularly. Our thanks to Mr. Parker for the fine director of Vermont's amateurs.

Traffic: W1FSV 326 GNF 96 JHK 76 GAE 16 EZ 3 DPO-AHN 2. (Sept.-Oct. W1JHK 34).

ATLANTIC DIVISION

EASTERN PENNSYLVANIA—SCM, James M. Bruning, W3EZ—R. M.'s: 3AKB, 3AQN, 3EOP, 3ASW. The Eastern Penna. Traffic Band is growing nicely. If you have not yet acquired a Band Crystal (between 3640 and 3665 kc.), better get one soon. See next QST for details of Eastern Penna. Traffic Band "Party." First prize—14-Mc. Bliley mounted crystal. 3BRZ continues as one of our most active all band, c.w. and 'phone stations. 3BGD netted nearly 4000 points in the first 9 hours of the S.S. 3EOZ (P.A.M.) examined and approved 3BBV for Official Phone Station appointment. 8OML modernized his station with 6L6 driving parallel RK-20's at 200 watts, and a new RME-69. 8ASW (R.M.) manages to keep on the air in spite of his new job. Greetings to 2ITX/3 from N.Y.C.-L.I. Section who will be with us for a while. 3GDI has been grinding crystals to have a good one for the PATB. 3GHP is progressing nicely with his code speed. 3AGK is working night shift. 8NNO had more transmitter trouble but is still optimistic. 3DXC is new O.R.S. 8NPQ applied for O.R.S. 3FLH (lucky guy) sends his first report and casually mentions three QSO's with MXZB! 3MG spent 100% of time ragchewing this month. 3IU burned up his receiver. 3EUP made his first South American contact. 3FBJ is going after the DX in his spare time. 3EU operates on 3607 kc. when he is able to be on. 3EPJ is completing a new receiver. 3CZS has been using a pair of T55's as Class B Modulator with fine results. Gang, send your congrats to 8FLA. Old "Polly" got married on Thanksgiving Day and says he doesn't expect any QRM from the YF. Just wait till he wakes up, hi! 8HKS is doing fine work as a new O.R.S. 8DIG keeps on the air every day. 3EOP is up to his neck in schedules and is gasping for air. Air or ether? 3ADE is rebuilding final stage in his 7-mc. 3GMK wants a schedule with Princeton, N. J. 3EEP continues active. 3AQN (R.M.) likes the PATB very much and says his traffic is moving faster than any time in his previous experience. 8MRQ went to Ft. Howard A.A.R.S. convention and also to the Auburn hamfest. 8ERK is another hustler, always busy. 3AKB (R.M.) celebrated Armistice Day by erecting a new 14-Mc. antenna. SUV dug right in and is making good as a real O.R.S. 3EYV worked his first W7 in his first O.R.S. party! These parties have other valuable features in addition to letting first class operators get together! 3ETM still likes the electron coupled oscillator better than the crystal exciter. 3FXZ (Mrs. 3MG) keeps a schedule three days per week with K6NXD. 3EZ talked to New Zealand for half an hour with his 25 watt baby phone (P.S. QSA5!).

Traffic: W3EOP 877 (WLBQ 212) EZ 553 EWJ 182 ETM 77 FXZ 61 AKB 50 AQN-EBP 23 GMK 18 ADE 17 AGK 10 GHP 9 GDI 7 EOZ 3 BRZ-BGD 2 DXC 1 W8FLA 123 (WLBQ 110) UV 55 DIG 50 EKG 43 MRQ 42 HKS 17 NNC 11 ASW 5 OML 4. W2ITX/3 6. W3CB (WLQI 27).

MARYLAND-DELAWARE-DISTRICT OF COLUMBIA—SCM, E. L. Hudson, W3BAK—R.M.'s: 3CQS, 3CXL, 3EOU, Chief R.M.: 3BWT. P.A.M.: 3WJ. EZN will have a new rig on the air soon. CWE is reporting from college in Michigan; he has been elected Pres. of Mich. Tech. Radio Club. EHW worked 150 stations first week in SS. CDQ is working 28 mc. and finds it plenty hot. GKT is located at the Ferris Industrial school near Wilmington, Del.) FBQ worked 33 countries on 7 Mc. FQE has a fifty watt in his final. GAU has a new NC100X and is using 100 watts input to a pair of tens. EPD of Snow Hill, Md., has obtained a position in Phila. with a radio parts store. ANP, Roland Hudson, one of the several operators from BAK is

attending the Penna. Military College in Chester, Pa., and is keeping a temporary schedule, with the OM back home at HAK; they are using portable call of FOG; FOG and AXF are working together in getting the station working. AED at Ocean City, Maryland, is building a kw. rig for all bands. DOG is completely rebuilding his transmitter. 3FDJ, Secy.-Treas. of the Mike and Key Club sends news of the doings over Baltimore way. The Mike and Key Club resumed operation for the 1936-1937 season with reelection of officers: President 3FAM, Vice-Pres. 3DBM, Secy.-Treas. 3FDJ, Entertainment Chairman 3GR. The club is planning another Hamfest to excel last years' grand success. AUC, WA and DBK are knocking 'em off on 28 Mc. FAM and EVK of 1.75 Mc. fame are planning to go on 14-Mc. 'phone. FAM expects to run a kw. to a pair of 150T's, modulated with '03A's. AYS and CDZ are adding to their scores of new countries worked on 14-Mc. c.w. GBJ, GFI and GLJ are a few of the new hams on 1.75-Mc. 'phone. The boys are still waiting for GJW, Miss Dolly Colla of Radio Electric, to start that brand new ticket to work with a transmitter on the air; she is Baltimore's only YL opr. so far as is known to us.

Traffic: W3CXL 588 (WLM 2321) SN 752 BWT 592 CLZ 673 BEZ 242 EZN-PPQ 11 CWE 8 CQS 6 EHW 3 BAK 1.

SOUTHERN NEW JERSEY—SCM, C. D. Kentner, W3ZX—The South Jersey Radio Ass'n entertained a crowd of 150 at its November meeting. John Reinhart, 1QP, was the speaker of the evening. FTK, FBM, BYR, EFM and DQO report via Net. FTK, with 14 6-day schedules will start on Trunk Line "M" this month. BWR has new QTH, new Breting receiver, new transmitter, and new YF, and says he expects to go to town at last. EEQ hopes to arrange work to make Net more regularly. O.R.S. XKL got Class A ticket (tsk, tsk!). ZI will be back on Net after transmitter renovation. BIR's traffic was on 56 mc.; he says the Trenton boys are thinking of getting up a net on this band. DNU adds two more schedules to his list, and says he is getting more heard cards from Europe. FXM is on 14 Mc. with a 6L6 tri-tet crystal and is aiming at 1000 contacts in his first year on the air.

Traffic: W3FTK 575 FBM 29 BYR 60 DQO 40 EEQ 17 ZI 166 EKL 37 AEJ 11 BO 35 BIR 4 DNU 75 BEI 32 ZX 50.

WESTERN NEW YORK—SCM, Charles Smith, W8DSS—R.M.'s: 8BJO, 8AQE, C.R.M.: 8JTT. P.A.M.: 8CGU. The highlight of the month was the well attended hamfest held in the Osborne Hotel, Auburn, N. Y., sponsored by the Finger Lakes Transmitting Society. One hundred and fifty amateurs from miles around enjoyed the banquet, the speaking and especially the prize drawings. The speakers included, among others, Doctor Woodruff, Pres. of the A.R.R.L., Johnny Long of WHAM and the S.C.M. of W.N.Y., 8DSS. The station contest held by the club was won by 8BFG. Congrats. OM. The contest judges were 8DSU, DT and DSS. The old reliable JTT shows the gang how to make the B.P.L. Congrats, Roger. MQX and CSE ran a close race for individual traffic honors. FUG and GWY were next on the list with very nice totals. Ex-9AJV now 8MSL reports for first time in W.N.Y., has a real score and desires O.R.S. R.M. BJO will soon have his net operating on 3725 kcs. OAG is out after W.A.S. and more schedules. JQE and GWT will be going very soon. GUG should have O.R.S. OXI and OCH (second opr.) are rebuilding for 14 Mc. DHU had a good time during the O.R.S. party. HTT should get lots of traffic from JTT. QHX works Europe plenty and also contacted HR7WC. KXA reports Ex-2E2C located in Canandaigua and signing 8QGW on 3.9 mc. 'phone. FMH has renewed O.P.S. CGU wants more work examining prospective O.P.S. The Central N.Y. Radio Club of Syracuse started the season with a bang by holding its first monthly dinner and smoker. The new officers are: QGS, Pres.; PXA, Vice-Pres. and PU reelected Secy. Don't forget the W.N.Y. QSO Party Dec. 26th-27th, open to all stations, C.W. or 'phone. The call will be "CQ W.N.Y." CU there, gang, 73.

Traffic: W3JTT 693 MQX 263 CSE 231 FUG 54 GWY 50 MSL 23 BJO 22 OAG 17 JQE 13 GUG 9 DHU-0CH 6 HTT 5 LGV 2 KXA 1.

WESTERN PENNSYLVANIA—SCM, Kendall Speer, Jr., W8FO—R. M.'s: 8GUF, 8KWA, 8MOT. ANNOUNCEMENT: 8YA, Crossley of State College, has been appointed assistant director for Central Pennsylvania and 8OO, Lohman, of McKeesport, assistant director for

Western Pennsylvania. Please address any communications for your Director, Brad Martin, 3QV, via either Crossley or Lohman, which ever is nearest. The W.P.A. QSO contest which closed November 8th was quite successful. Much thanks and credit go to Fred H. Stiening, W8FIP, O.P.S. for helping make it a success. Fifteen prizes totaling over sixty dollars, donated by various radio clubs and jobbers, will be awarded within the next few days. CUG leads with forty-eight contacts. The high scorers in order are as follows: CUG, NCJ, IQB, OKP, KUN, PLM, NTJ, MIW, OJS, MOT, QAN. Over one hundred and fifty amateurs attended the Beaver Valley Amateur Radio Club Hamfest and Banquet on November 14th at Aliquippa. Correction: Credit goes to 8QAN for helping make the S.H.B.P. & M. booth at the County Fair a success. Prospective O.R.S.—JSU, PIX, OSI, Prospective O.P.S.—PX, New O.R.S.—DDC. Real activity is being shown in the two O.R.S. W.P.A. Section nets controlled by KWA and MOT. KUN and KWA make the B.P.L. this month. KUN says he made B.P.L. without a flood. Hi. QAN uses a Johnson 20-Q antenna for 3.5 mc. work. OFO is replacing condensers for 600 watts. MOT hopes to head W. Pa. in the S.S. UK wants all A.A.R.S. to become O.R.S. (Fine idea, Pat, and that goes for the N.C.R.). KBM liked the ten-minute "rag chew" rule in the contest. CJB is making 56-Mc. tests from an airplane over the Shenango Valley, Youngstown and New Castle. MHE says the new QTH on a nice hill and 250 watts on the '03A are FB. JSU was elected President of the Radio Club at Pitt University. MWV wants the N.C.R. to show more activity on 3610 kcs. JZN has joined the N.C.R. DGL has duraluminum vertical antenna on 14 Mc. MIW is taking his traffic on the mill. AXD says his radio time is limited by work. OSI is going on 3.5 Mc. CHT has the 803 transmitter with suppressor modulation working swell. LGD is joining the A.A.R.S. OAJ is building a superhet. BVP worked a VK on his third 'phone contact. EZP is quite interested in hunting. AOE has left the C.C.C. (8LUM). KCV is rebuilding. JSS is making quite a name for himself at M.L.T. JSY has left for Florida with a 150T rig installed in a trailer. FIP is instructing a class in radio at the Pennsylvania School for the Blind.

Traffic: W8KUN 579 KWA 565 QAN 476 OFO 314 MOT 273 KNB 193 UK 155 KBM 129 ADY 102 FIX 76 NDE 46 IUY 44 CMP 43 CJB 30 DDC-KOB-MHE 29 JSU 27 MWV 25 JZN 24 CUG 23 DGL-MIW 11 IOH 9 AXD-EHX 4 OSI 3 IQY 2.

CENTRAL DIVISION

MICHIGAN—SCM, Harold C. Bird, W8DPE—R.F.D. 2, Pontiac, Mich. W9PDE, Joe Lessard, Ass't S.C.M., Box 223, Munising, Mich. MICHIGAN EIGHTS: LHH finally got his W.A.S. and is now going for W.A.C. and traffic. NXX had great time in SS contest; to start off, his mast broke as he was about to begin contest. FX is busy with new transmitter and new car. DED wants to sell his rig and build new one. Write him for particulars. DSQ has been having tough time, first transmitter failed then he got sick. Hope OK now. KNP-RR is very busy trying to get stations for state net. BMZ says A.A.R.S. is coming fine. GQZ has increased power. FTW is very busy with A.A.R.S. net and Mich. net, also new job. KSY has moved and no place to put ant. NDL is new O.R.S. at Flint. IFE says frequency congestion around Waltham Avenue very bad, suggests using flash-lights. ARR sends nice report and schedules. ICM has new super. NIV says new job is keeping him busy. JKO expects to visit sunny Calif. soon. NQ's mast blew down. MV got his crystals mixed and got pink ticket. NGC is having trouble getting new rig to come down on 3655 state net freq. LTT is taking over LSF schedules on alt. weeks on trunk "A." BRS is still working on the new rig. SEI reports from Lansing, says seven ops. there, wants schedules. LSF is so busy with job has to pass up nets on alternate weeks. QGD is putting up new mast. COQ, new reporter, handled traffic on N.C.R. nets. NQI keeps nice schedules on Mich. net and N.C.R. PXY wants O.R.S. Ye S.C.M. went hunting rabbits but just got sore muscles. SILENT KEYS: It is with deep regret that we report the passing of two of the Michigan, one very old timer and one comparatively newcomer, W8IA and W8ITO. Both were taken suddenly during the last month. MICHIGAN NINES: PCU reports leaving the Island in week or two and discontinuing activities for winter. CWR says Ironwood gang is planning to attend hamfest at Duluth. CE reports new station, YU in U.P. PDE is still plugging away on T.L. "M" and Nat'l Net. FB, Joe.

NEW BIRNBACH X'mitting sockets AT LOW PRICES

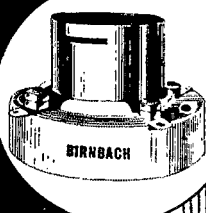

featuring

- SIDE WIPING CONTACTS
- BRASS, NICKEL PLATED SHELL
- HIGHLY VITRIFIED, LOW ABSORPTION BASE
- ALL BRASS HARDWARE
- LOW PRICES

No. 434, 50 watt. \$1.25 list ea. No. 435, 10 watt. 90c list ea.

SPECIAL LOW PRICES IN LARGE QUANTITIES

Improved Cone Standoff Insulators

Made of STEATITE, the better ceramic. Complete range of heights. Condenser, coils, tube sockets, etc., can be mounted with minimum labor. White glaze.

No.	Heights	List	See your jobber. If he cannot supply you, write direct to Dept. Q-1.
430	3/8"	10c	
431	1"	15c	
431J (Jack Type)	1"	90c	
432	1 1/8"	90c	
432J (Jack Type)	1 1/8"	95c	
433	2 3/4"	25c	
433J (Jack Type)	2 3/4"	50c	



BIRNBACH RADIO CO. INC.
145 HUDSON ST. BIRCO NEW YORK, N. Y.

With the Affiliated Clubs

(Continued from page 108)

emergency station ever ready to serve the community in hour of need as a memorial to Colonel Foster, a man who had given of himself so generously for the benefit of others?

On August 23rd five members of the club made the 50-mile trip to Carmel, taking a truck and trailer belonging to Lloyd Saxon, W6EEX, and a large Cadillac sedan belonging to Willis Clayton, W6JTE, secretary of the club. Other members of the party were: Al Clark, W6MUC; C. W. Jacklin, W6LXJ, and the writer. At Carmel the party was met by Mr. Heintz, who supervised operations and said the shack was to be stripped completely. A glance about showed the equipment to include a three-kilowatt Kilbourne-Clark ship generator and a five horsepower motor to run it. The transmitter, a variety of receivers and boxes and closets of miscellaneous meters, tubes, crystals, wire and other odds and ends, not to mention a stuffed alligator and a handsome antelope head which friends had sent the colonel from far corners of the earth were all there, as well as the colonel's log books, which are being carefully preserved.

Thanks to the good strong backs of Clark, Saxon and Jacklin the generator and motor were finally loaded into the trailer, with Bill Clayton and the writer offering helpful suggestions and getting in the way at the psychological moments. The transmitter was disconnected and loaded with less difficulty. It comprised of a '47 crystal oscillator, two '10 stages into a pair of '10's, into a pair of '52's feeding a pair of 204A's in the final. These items, together with the miscellaneous parts and apparatus filled the car, truck and trailer to capacity. By mid-afternoon the party headed homeward to San Jose after making the acquaintance of Charles Guth, W6NAL, Carmel traffic officer and a good man to know.

At its regular meeting the following evening the club moved into its new quarters, the generator being "hiked" up five flights of stairs by a larger crew. President Roy Pinkham appointed Clark, chief operator, Jacklin as technician and Harry Engwicht to supervise installation.

The club is now turning its attention to the organization of a five-motor net to serve as a field organization feeding the central station, W6SV. That call, by the way, has long been held by the club. A drill will be held in cooperation with the Disaster Relief Corps when arrangements have been completed. The club is also considering ways of making the station a memorial to Colonel Foster and a museum of early radio developments. The colonel's collection included tubes and equipment long obsolete and rarely seen. San Jose is also rich in relics of radio's formative period due to the experiments of Charles D. Herold and others.

Vigilance Committee

The Plainfield Radiophone Association of Plainfield, N. J., has a Vigilance Committee for the purpose of eliminating a number of unlicensed

THEY
NEVER
LET YOU DOWN



In three short years, CORNELL-DUBILIER X'mitting condensers have established themselves in "Ham" circles as the most dependable X'mitting condensers obtainable.

Such dependability is not accidental — X condensers are Dykanol impregnated, sturdy, compact, and embody the wealth of engineering knowledge gathered during a quarter of a century of condenser research and manufacture.

For your condenser requirements, insist on C.D.'s. They never let you down. Ask your jobber, or send for catalog No. 133A.

PAPER • MICA • DYKANOL
WET and DRY ELECTROLYTICS

CORNELL-DUBILIER CORP.

1013 Hamilton Boulevard
Sec. Plainfield, N. J.

CORNELL-DUBILIER

A NEW HI-LEVEL MICROPHONE FOR VOICE TRANSMISSION

Model VT-73

- LIST—
- MIKE
 - STAND
 - PLUG
- \$27.50**



See it at your jobbers

The Model VT-73 is a complete microphone unit — stand — handle — anti-resonant cable, heavy shielded plug, and a mike unit that is built just right for Voice Transmission.

It is tremendously efficient at voice frequencies. The level is high — minus 55 DB.

Your feedback troubles are gone with this microphone. The cable does not resonate at used radio frequencies. The complete unit can be used as a desk or hand mike. It is a light weight assembly you can hold for hours without effort. The microphone head is adjustable to any position. To assure 100% shielding a plug of machined brass, chrome finished is included.

Here is a classy commercial piece of equipment. It will bring your rig up-to-date.

THE TURNER COMPANY - Cedar Rapids, Iowa

Licensed under Patents of the Brush Development Company

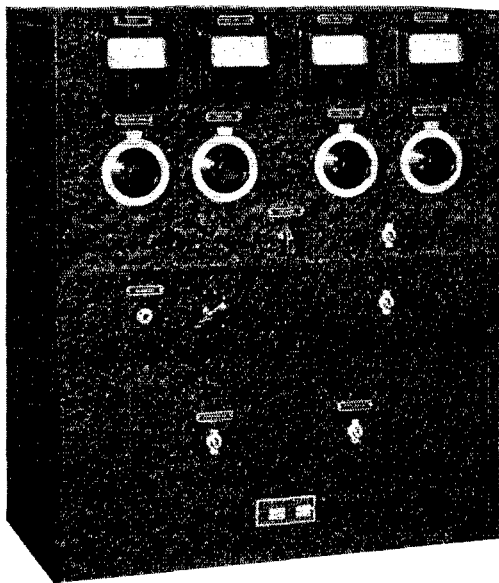

80-T TRANSMITTER

1500 TO 30,000 KILOCYCLES

- ONLY 3 TUNED CIRCUITS
- ANTENNA MATCHING CIRCUIT
- EXCITATION CONTROL
- PHONE — CW SWITCH
- 4 FULL SCALE METERS
- SEPARATE OSCILLATOR SUPPLY
- NEW 6L6 OSCILLATOR
- 3 TYPES OF KEYING AVAILABLE
- NO NEUTRALIZATION
- 125 WATTS INPUT

The 80-T is but one of a complete line of transmitting units varying in power output from 50 to 400 watts and bearing the name HARVEY which is your guarantee of satisfaction.

HARVEY RADIO LABORATORIES, INC.

12 BOYLSTON STREET, BROOKLINE, MASSACHUSETTS

TIME PAYMENTS AVAILABLE

Boost Your Signal

with a "Q"

(JOHNSON TYPE "Q" ANTENNA)

DON'T handicap your transmitter with an inefficient antenna system. Wasted watts can't help your signal.

You're sure of antenna efficiency with the famous Johnson "Q". Adaptable for half-wave, long-wire harmonic or directional arrays. Full information in Bulletin 100Q from any Johnson Distributor or direct.

Ask also for Catalog 961 which shows our complete line, including antenna materials such as insulators, feeder spreaders, and Enameled Copperweld (high tensile strength) Wire.

Export Office: 25 Warren St., New York, N. Y.
Cable: "SIMONTRICE"

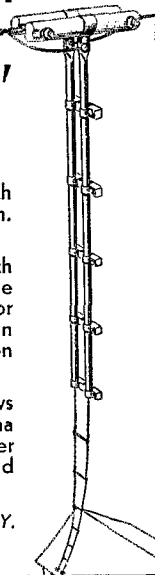

E. F. JOHNSON COMPANY
MANUFACTURERS OF *Radio Transmitting Equipment*
 WASECA MINNESOTA U.S.A.

PREFERRED BY ALL TRIMM LEADS

with the most complete headset line in the world. Thousands of operators are using TRIMM phones because they are assured of a reliable source of supply and service.

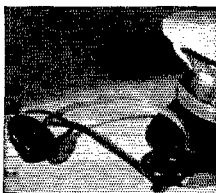

TRIMM RADIO MFG. CO.
 1770 W. Berneau Avenue, Chicago
 Illinois, U.S.A.

RADIO COURSES

RADIO OPERATING: Prepare for Gov't License Exam. ●
RADIO SERVICING: Including Short Wave ● **AMATEUR CODE** ● **ELECTRONICS** ● **TELEVISION** ●

Day and Evening classes—Booklet upon Request
NEW YORK YMCA SCHOOLS
 4 West 63rd Street, New York City

SICKLES COILS

ALL TYPES OF RF AND IF WINDINGS

Manufactured by

F. W. SICKLES COMPANY

300 Main Street

Springfield, Mass.

transmitters operating on 56 Mc. and other bands in that area. Two such stations operating on the 56-Mc. band have been located and silenced, the owners being warned to cease operation until they secured the necessary licenses. One of these stations had been operating under the call "W2FVH of Dunellen." The legal owner of W2FVH was an operator at an airport in Pennsylvania! The other station had been operating from a location in Westfield, N. J., and possessed an elaborate and efficient installation, better in fact than outfits owned by many licensed Hams! Both of these stations were located by the monitoring of the band, the cooperation of other amateurs and the use of mobile equipment. Several other illegal stations in the vicinity are under observation and it is hoped will soon be silenced. Direction finding equipment is available for use on the lower frequency bands. Poor quality signals, harmonics, B.C.L. and interference from phone stations on the various bands also come under the work of this committee. Receivers fitted with field-strength meters and portable carrier-shift indicators and linear monitors are available for observation and correction of these cases.

The 913 Oscilloscope

(Continued from page 24)

It may be necessary, as mentioned before, to reduce the a.f. voltage by means of a potentiometer in order to get the pattern on the screen. The r.f. input can be adjusted by varying the coupling

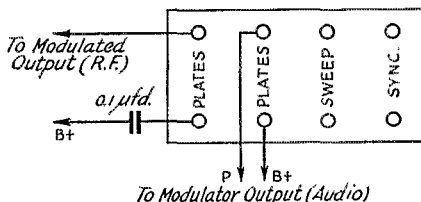

FIG. 7—TERMINAL CONNECTIONS FOR TRAPEZOIDAL MODULATION PATTERN WITH SINUSOIDAL SIGNAL SWEEP

between the r.f. plates (vertical) and the transmitter output.

GENERAL POINTERS

Whenever there is present a d.c. voltage which tends to move the pattern from center, it is only necessary to insert a condenser in one leg of the signal connection to remove this effect. For usual practice it is well to have the plates (each set) bridged by a 10-megohm resistor to avoid open circuit charging effects on the plates.

If a less expensive circuit for the sweep is desired, at the sacrifice of linearity, the filament transformer and 58 tube may be omitted, and the plate connection on the 58 joined to the cathode terminal with a 50,000- to 100,000-ohm resistor. This is not as satisfactory as the com-

THE OUTSTANDING CHOICE OF DISCRIMINATING AMATEURS . . . the SUPER SKY RIDER

● With its many outstanding improvements in performance and operating convenience, the 1937 Super Sky Rider is arousing intense enthusiasm among amateurs. Everyone operating this outstanding receiver for the first time is amazed at its marvelous selectivity and sensitivity, at the ease with which it can be timed with the direct calibrated micro-vernier dial and generous band spread.

We unhesitatingly recommend the Super Sky Rider as the greatest value in amateur radio today. Enjoy perfect short wave reception while you pay for your Super Sky Rider, on easy time payments.

Stop in and see it, or write for complete information.



- 11 Tubes — 9 of them metal.
- 40 M. C. to 535 K. C. in 5 Bands.
- 338 degree main tuning dial.
- Electro-Mechanical Band Spread.
- 14 Watts Undistorted Output.
- Direct Calibration Tuning — No Charts or Tables.

- Field Strength Indicator.
- Improved 10 meter performance.
- Single Signal Crystal Action.
- 465 K. C. Iron Core I. F. for improved selectivity.
- Ceramic Insulation.

SX-11 Crystal and Tubes	\$99.50	SKY BUDDY ULTRA SX-10 with Crystal and Tubes	\$114.50
SX-11 with 12" P.M. Speaker	\$111.50	SKY CHIEF SX-10 — Crystal Tubes and 12" P.M. Speaker	\$126.50

INTERNATIONAL PLATE TRANSFORMERS

We recommend these companion transformers as representing real value — quality has not been sacrificed — rather the volume increased greatly to make possible these low prices. Fully cased in black crystal finish steel.

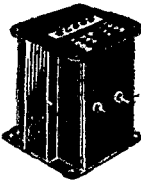

Model 2000—300 mills 750—1000 each side	\$5.95
Model 3000—300 mills 750—1000—1500 each side	\$8.95

International Chokes FULLY CASED

Swinging	Smoothing	
5/25—200 mill		\$2.50
5/25—300 mill		3.75
5/25—500 mill		6.50
12H—200 mill		2.50
12H—300 mill		3.75
12H—500 mill		6.50
Cased 2.5A—12A—866 Tube		1.50

TRIPLETT METERS

3" Bakelite Case	2" Bakelite Case
0-5 to 300M. \$3.75	0-5 to 1000M. \$2.92
0-15 ACV. . . 3.75	0-15 VAC. . . 2.92
0-150 ACV. . . 4.55	0-150 VAC. . . 3.75

Sweeping the Country! TAYLOR TUBES

T-55	\$8.00	T-155	\$19.50
T-50	4.95	T-814	18.50
T-203B	7.50	T-200	21.50
T-822	18.50	HD-203A	17.50
T-845	12.50	HD-866	1.65

SEND FOR CATALOGUE

INTERNATIONAL RELAY RACK

Standard six-foot steel rack drilled to 1 1/4—1/2". Screws furnished. **\$13.50**

NEVER OBSOLETE UTC Varimatch Units

from **\$4.80** to **\$42.00**

It will pay to investigate

We carry a complete line of **UTC**

IMMEDIATE SERVICE
MAIL ORDERS FILLED — SEND M.O.

STILL LEADING! PYRANOL

2 MFD. 2000-VOLT FILTER CONDENSERS

Guaranteed 2 Years Unconditionally

Not one has blown in service over the last 18 months and we KNOW that many are being used consistently on voltages 200% in excess of their rating. Don't take our word for it. Ask the ham that owns some.

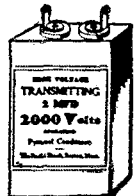

\$2.90

We are pleased to present the entire BRUSH line of sound cell crystal microphones and phones at 40% discount. Send for literature.

The **MAC-KEY** **\$7.95**

Baldwin Phones **\$2.50**

Raytheon RK39 **\$3.50**

At the Shack you will find the largest and most complete stock of amateur gear in New England. Among the lines stocked are UTC — Birnbach — Triplett — Weston — Raytheon — Johnson — Burgess — Brush — Amperite — Astatic — Taylor — Tobe — Cardwell — Dunco — and these represent only part of the stock

46 BRATTLE STREET

THE RADIO SHACK

BOSTON, MASS.

Say You Saw It in QST — It Identifies You and Helps QST

How Old Is Your ? LICENSE MANUAL ?

You know that the F. C. C. makes frequent changes in amateur regulations? That many of these changes deal with the rules for getting new licenses and renewals? That when the regs are changed, the appropriate questions are changed in the license examination, and the answers have to be different?

▶▶▶▶ To keep pace with these changes, The Radio Amateur's License Manual is frequently revised. It is now in its seventh edition. Moreover, each copy is, when necessary, accompanied by a change sheet summarizing any changes that have been made since it went to press. ▶ The License Manual is as invaluable to the practising amateur as it is to the aspirant—but only if it is the current edition.

American Radio Relay League
West Hartford, Connecticut

RADIO ENGINEERING



RCA Institutes offer an intensive course of high standard embracing all phases of Radio. Practical training with modern equipment at New York and Chicago schools. Also specialized courses and Home Study Courses under "No obligation" plan.

Illustrated Catalog on request

RCA INSTITUTES, INC. Dept. ST-37

75 Varick St., New York 1154 Merchandise Mart, Chicago
Recognized Standard in Radio Instruction Since 1909

FASTEST WAY TO LEARN CODE

Easy, Fascinating—LEARN BY EAR to be a GOOD OP.

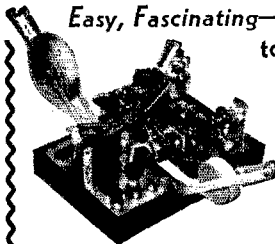

The New All Electric Master Teleplex Code Teaching Machine is exactly what thousands are looking for. No experience needed. Ideal for beginners—steps up WPM for ALL Ops. There is no guess work with Master Teleplex, because it records your sending in visible dots and dashes. You SEE and HEAR exactly how you are making your

signals. You learn code the way you'll be using it—by SOUND. Complete course included at no extra charge. Used by many schools and several governments for teaching code. Low cost, easy terms. MONEY BACK GUARANTEE. Send now for booklet Q-1, no obligation. Post card will do.

The "Ham" Special Standard Teleplex—a highly efficient code teacher using heavy specially prepared waxed paper tape, having two rows of perforations. Write for Free folder QT-1.

We are the originators of this type instrument

TELEPLEX CO. 72-76 CORTLANDT STREET
NEW YORK, N. Y.

plete circuit described, but will give usable sweep voltages. The rest of the circuit remains the same.



A



B



C

FIG. 8—TYPICAL TRAPEZOIDAL MODULATION PATTERNS

That of C represents out-of-phase signal voltage input, which should not occur when the audio voltage is taken from the modulator's output circuit.

For further circuits the reader may refer to RCA Cathode Ray Tube Manual and Rider's The Cathode Ray Tube at Work.

What They Don't Know Won't Hurt Them

(Continued from page 51)

and all the while I am getting hungrier and hungrier for some good home cooking, and the baby is making his permanent home at my mother-in-law's."

He sighs like an old-time blacksmith's bellows, and sadly bows his head.

"Right now, fellows, she is busy winning the DJDC contest, and I am in the doghouse again."

Now this guy's story touches our hearts and we invite him to have a couple more and then come over to BX1's and have a listen around the band. But he thanks us and declines, and the last we see of him, the poor fellow is shuffling off down the street. As he reaches the corner, he turns, and with a tear in his eye yells back, "Remember, boys, it is better to argue and operate than not to pound the brass at all. What they don't know won't hurt 'em!"

To this epitome of wisdom we gently agree, and as we wend our way homeward I begin to think about what the gentleman has said.

So when I get back home on Monday, I take the code practice set which I have bought for the little woman and throw it out into the ashcan in the backyard, along with the copy of "How to Become a Radio Amateur" which she has on the kitchen table. And now we are still arguing about radio on Monday, Wednesday and Fridays, and I am working DX on Tuesday, Thursday and Saturdays and we are both comparatively well satisfied.



A disgusted ham wants to nominate a certain W6 as Champion CQ Hound, his claim to the title resting on a series of 58 CQ's (from time of starting the count) then two signs and another batch of 51! If anyone wants to try beating this record, we suggest putting one hand on the tank coil and a bare foot on the filament transformer before starting.

NEUTRALIZING CONDENSERS

National pioneered the unusual design of these neutralizing condensers. Widespread use has proved the soundness of their principle and the honest quality of their construction. All sizes have both plates insulated by Isolantite, and have heavy aluminum plates machined to a smooth rounded edge.

Three sizes are offered. The smallest (Type NC-800, Net Price \$1.80) is suitable for the RCA-800, EIMAC 35T, 50T and similar tubes. The next larger size (Type NC-150, Net Price \$3.60) is for tubes like the HK-345, RK-36, 150-T, 300-T and 852. The largest size (Type NC-500, Net Price \$6.00) is suitable for the WE 251A and similar tubes.

The chart at the left shows the capacity in mmf. for various settings of the spacing between the plates.

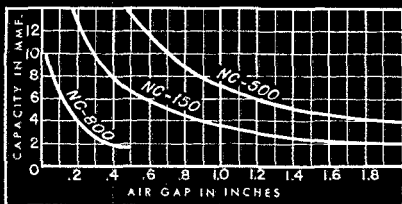

NATIONAL COMPANY, INC.

T. R. McELROY

WORLD'S CHAMPION RADIO TELEGRAPHER

23 Bayside Street, Boston, Mass.

MAC KEY @ \$7.95 a real speed key.
 MAC KEY DELUXE @ \$15.00.
 MAC CORD @ \$1.00 speed key cord.
 MAC CASE @ \$3.95 speed key case.
 MAC OSC @ \$3.95 ac/dc oscillator. Tone control.

If u hv Mac Key wri me fo xmy ipt & drsb lfn.
 All my stuff emcy gad best pduts obl. 73 Mac.

Power
X cut

O. C. L.
Control Crystals

High
Output

Unconditionally Guaranteed

7000 KC ± 5 KC . . \$1.85 3500 or 1750 KC . . \$1.50
 ATCUT — 40-80-160 2.25

OMAHA CRYSTAL LABORATORIES

Jobbers write: W9JRY, NORTH PLATTE, NEBR, W9CFM

Radio Operator's
Course
Complete in
Telegraphy—
Telephony



Practical
Experience
Studio—
Transmitter—
Announcing

P. A. C. is an endowed, educational institution — not privately owned, not operated for profit, maintaining college rank. The Radio Course consists of the maximum knowledge necessary to secure Commercial Telegraph Second-class and Radio Telephone First-class government licenses. The course includes Police and Aeronautical Radio, Service, actual experience in Wireless Code, Radiophone, Announcing, Microphone-Studio Technique. We are authorized to teach RCA texts. You receive practical studio experience in our commercial broadcast studios located in the administration building, and experience as an operator on K P A C (500-Watt Commercial transmitter located on the campus, owned and operated by the college), and inter-departmental marine communication experience.

If interested, write for Bulletin R

PORT ARTHUR COLLEGE

PORT ARTHUR (World-known port) TEXAS

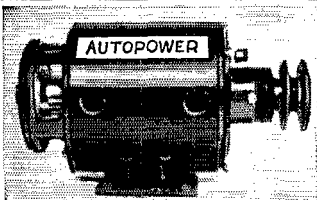

TURN SCRAP INTO MONEY

The new "1937" edition of "AUTOPOWER" with all the original specifications and many new ones is now off the press. The book is plainly written and illustrated — the instructions easy and simple. Change auto generators into practical A. C. and D. C. generators and motors, with voltage from 2 to 1,000 volts, for power, light, welding, radio, sound, etc. No experience nor special tools needed to make these economical changes. Generators can be driven by wind, water, fan-belt, etc. Already used and endorsed by thousands. Send for your copy today. Price only \$1 postpaid.

AUTOPOWER, INC. Dept. P. 414 S. Hoyne Ave., Chicago



Say You Saw It in QST — It Identifies You and Helps QST

NEW AND SPECIAL

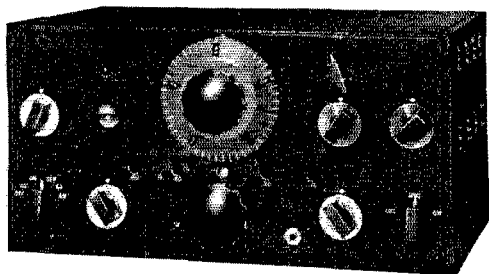

THE NATIONAL NC-101X

Here is the band-spread National NC-100. Lots of what you asked for. 5 well-spread amateur bands, speaker, chassis, tubes, S-S crystal, etc. Net to the amateur only \$125.00. Terms if you prefer.

LEADING THE PARADE

RCA 866	\$1.75
RCA 807	3.90
RCA 808	10.00
RCA 913, 1" Cath. Ray	5.60
Amperex HF-100	10.00
Taylor T-55	8.00
TAYLOR 866	1.65
Thor 6L6, 60 w, Modu. Tr.	5.88
Thor 6L6 Input Tr.	2.21
RCA 6L6 Tubes	1.18
Aerovox 2 mf. 2000 v. oil	2.80
Aerovox 2 mf. 1000 v. oil	1.97
AEROVOX 2 mf. 1500 v. oil	2.30

Rack-Panels of Tempered Masonite are strong, durable, handsome. Standard sizes and slotting. 7 unit \$1.25 net, etc. Or cut to specified sizes, 75c sq. foot, net. Black Crackle Finished.

THORCASED-T6878

600 v. 200 ma.
File 7 1/2-2 1/2-5...\$2.45
Thor. Ck. T6877
12 Hy. 250 ma..\$1.95

National NC-100

Hallicrafter
AGR-175
RME-69
Hammarlund

TIME PAYMENTS FOR CONN. HAMS

HATBY & YOUNG

HARTFORD — 203 ANN STREET
NEW HAVEN — 86 MEADOW STREET
BRIDGEPORT — 195 CANNON STREET

Radio Since 1912

New Tubes

(Continued from page 37)

No heater supply is required. Operating conditions are as follows:

D.C. voltage output	300 volts max.
D.C. output current	30 ma. min.
	75 ma. max.
Peak plate current	200 ma. max.
Starting voltage	300 volts peak, min.
Voltage drop (dynamic)	24 volts average

The characteristics of the tube are independent of the operating temperature. As is usual with gas-filled tubes, there is some tendency to generate r.f. noise, which can be eliminated by proper filtering and shielding.

The OZ4G has a miniature glass bulb with small octal base. Pin connections are as follows: Pins 1 and 7 no connections; Pin 8, cathode; Pin 3, anode; Pin 5, anode. Pins 2, 4 and 6 are omitted from the base.

The 6H5

The 6H5 is a third member of the indicator-tube group, the other two being the 6E5 and 6G5. The 6H5 is similar to the 6G5 except that the current to the target is controlled by a grid tied to the cathode within the tube instead of by emission saturation as in the 6G5. The addition of the grid gives an "hour-glass" effect to the pattern, since a fixed 90-degree shadow appears opposite the controlled shadow. Characteristics and operating conditions are as follows:

Heater voltage	6.3 volts
Heater current	0.3 volts
Plate supply	100 200 250 volts
Triode plate resistor	0.5 1.0 1.0 megohm
Target voltage	100 200 250 volts
Target current (app.)	1.5 3.5 4.5 ma.
Grid voltage for zero shadow angle	-8.0 -10.5 -22.0 volts
Grid voltage for 90-degree shadow angle ..	0 0 0 volts

The 6H5 is identical with the 6G5 in size and basing. It also has the same pin connections.

The 25L6

The 25L6 is a new all-metal beam tube for use in the output stage of a.c.-d.c. receivers, giving an output of slightly better than 2 watts with 110 volts on the plate. The efficiency and power sensitivity are high. In the operating data given below, it will be noted that slight changes in the grid bias and load resistance will produce marked changes in the character of the distortion, although the total distortion does not vary greatly. Characteristics, ratings and operating conditions are as follows:

Heater voltage	25.0 volts
Heater current	0.3 amp.
Plate voltage	110 110 110 110 volts max.
Screen voltage	110 110 110 110 volts max.
Grid voltage	-7.5 -7.5 -8 -8 volts
No-signal plate current	49 49 45 45 ma.
Max-signal screen current	55 51 52 48 ma.
No-signal screen current	4 4 3.5 3.5 ma.
Max-signal screen current	8 10.3 8 10.5 ma.

New! **EIMAC 100T**
A Swell Tube!
\$13.50

SUN RADIO CO.
15 YEARS OF RADIO RELIABILITY
227 Fulton Street, Cor. Greenwich Street
New York City, N. Y.

New! **RCA 808**
Tantalum Plate
200 W. Input
\$10.00

SPECIAL!

Stancor Plate Transf. 1000 V. & 750 V.
Tap. 300 M. A. **\$5.85 net**

THE NEW BILEY V F 1 IN STOCK FOR IMMEDIATE DELIVERY \$8.00

EIMAC TUBES IN STOCK

SUN POWER CRYSTALS

40 M. **\$1.95** 80 M. **\$1.50**

MAGNAVOX P. M. SPEAKERS

6" **\$3.95** 8" **\$4.95**

600 M. A. R. F. CHOKES **.88c**

TRIPLET OVER MODULATION METER & INDICATOR **\$24.83**

BRUNO VELOTRON MIKE, \$11.76

RK 39 IN STOCK **\$3.50**

UTC VARIMATCH CLASS "B" IN STOCK — VMI-VM2-VM3, 4, 5.

AMPEREX H F 100 **\$10.00**

CRYSTAL FILTER I.F. TRANSFORMERS

Any Frequency **\$2.35**

JOHNSON 50 W. SOCKETS **.88c**

MAC OSCILLATOR **\$3.95**

RCA 913 **\$5.60**

THORDARSON 250 M. A. CHOKE

..... **\$1.95**

NEON TUNING WAND **.98c**

BRUSH CRYSTAL PHONES, \$5.28

200 W. RESISTORS **\$1.69**

NATIONAL RECEIVERS IN STOCK

IMMEDIATE DELIVERY

NC 100 **\$118.10** HRO **\$167.70**

NC 100X **\$140.60** HRO JR. **\$99.50**

Write for Free Bulletin

HALLICRAFTERS

Super Skyrider, \$89.50 Sky Chief **\$44.50**

Ultra Skyrider, \$99.50 Sky Buddy **\$29.50**

Write for Information Regarding Our Easy Payment Plan!

HAMMARLUND NEW SUPER PRO

SP110X **\$255.78**

RME 69 IN STOCK

NATIONAL NC101X AMATEUR RECEIVER

This receiver is Designed for Ham Frequencies and

Has Many Features: Crystal Filter, Complete

Band Spread, 12 Tubes, Self Contained Power

Supply Complete with Speaker **\$125.00**

TAYLOR TUBES

We Have At All Times A Complete Stock On Hand

866 **\$1.65** T155 **\$19.50** 822 **\$18.50**

T55 **\$8.00** 756 **\$4.95** 211C **\$12.50**

MEISSNER ALL-WAVE RECEIVER KITS

Complete Stock at All Times. Write for Catalog

WE ARE EXCLUSIVE DISTRIBUTORS FOR STANCOR TRANSFORMERS

Free Amateur Handbook on Request

We are offering a Voltmeter, Wired & Self

Contained, Range 3,250 & 750V.—0—200,000 Ohms.

This Unit Contains Very Good Parts and is a Bargain.

Complete with Test Leads, While They Last, \$5.95

Mail Orders Promptly Filled

SPECIAL!

Oil Impregnated Xmitting Condensers

1 1000V **\$1.10** 1 1500V **\$1.45**

2 1000V **\$1.50** 2 1500V **\$2.00**

4 1000V **\$2.00** 4 1500V **\$2.25**

1 2000V **\$1.75** 3 3000V **\$2.50**

2 2000V **\$2.45** 2 3000V **\$4.95**

4 2000V **\$4.65**

866 FILAMENT TRANSF. \$1.18 net

MAGKEY **\$7.95**

STANCOR PLATE TRANSF. \$7.50V.

— 200 M.A. **\$2.88**

A Real Bargain

6.3V. Filament Transformer 6 AMP. **\$1.14**

GUARANTEED SUN 801. **\$2.95**

RCA-ACR 175 **\$119.50**

UNIVERSAL "K" MIKE **\$1.75**

NOISE SILENCER UNIT — Self Contained Power Supply. Less Tubes

..... **\$6.76**

RAYTHEON 6L6 G. **\$1.18**

BUD 50 W. SOCKETS **\$1.50**

COMPLETE STOCK OF DUNCO, WARD LEONARD & GUARDIAN RELAYS, ALL TYPES.

RCA 807 **\$3.90**

GIANT COIL FORMS **42c**

UNIVERSAL VELOCITY MIKE

..... **\$15.23**

JOHNSON "O's" IN STOCK **\$15.96**

NEON OSCILLOSCOPE KITS **\$1.96**

COMPLETE STOCK OF RCA, RAYTHEON, AMPEREX TRANSMITTING TUBES.

HARVEY RADIO COMPANY OF NEW YORK

FLASH!!
TWO 866's
99 Cents

Quantity Limited — Act at ONCE — Guaranteed to be Perfect.

CONGRATULATIONS

to George Grammer of QST on such a FB rig as presented on page 28 of December QST. Harvey is pleased to offer the kit as shown in the write up, complete with tubes and valvpy VM2 xtal and coils for any band, \$18.95. Power supply for above 4-band xmit complete with tube and cable, \$7.95.

New GOTO inductors with and without links in stock at all times.

BILEY xtals, type VF1 new low drift variable frequency unit—equal to over twenty separate old style xtals, \$8.00.

TYPE HF2 — The answer to the ultra high problem — a 14 mc xtal that can take a beating and like it — thicker than most 7 mc xtals — mounted in victrol G and carrying Biley dependable guarantee — only \$6.50.

Mail Your Orders for Immediate Shipment to HARVEY RADIO COMPANY, 103 West 43rd Street, New York City

Buy your receiver the painless way—time payments arranged. Hallicrafter's, National, RME, RCA, Hammarlund, carried in stock and on demonstration. Liberal allowance on your old receiver.

Harvey Radio Company is pleased to announce its large line of equipment is now complete with the addition of a large stock of Biley xtals and National parts and receivers at lowest prices.

NEW

Twin 15 Oscilloscope

Complete and ready to go at the sensationally low price of

\$15.00

Comes complete with new RCA 913 and RCA 80 tubes, self contained power supply made of highest quality parts such as UTC, Cornell, Du-bilier, IRC, Centralab. The first dozen hams to order this instrument will receive them completely wired and tested in our labs. To the next dozen hams, we will give free a copy of the RCA Book on Cathode Ray tubes. The uses of this little rig are unlimited.

In these Oil-Impregnated and specially processed Transm-itting Condensers, amateurs will find a happy balance of Economy and Quality. Designed to fill the demand for a low priced condenser, no effort has been spared to embody in it every modern engineering advancement. Quality ... High Performance ... Dependability.

QUALITY AT AN UNHEARD OF PRICE!

1000 Volts, D. C. Working Voltage
1 mfd. **Special \$1.10**
2 " **Special 1.50**
4 " **Special 2.00**
1500 Volts, D. C. Working Voltage
1 mfd. **Special \$1.45**
2 " **Special 2.00**
4 " **Special 3.25**

NEW Harvey Xformers

Model A — 750/1000v. A.C. 300 m.a. **\$5.70**
Model B — 1000/1250/1500v. A.C. 300 m.a. **\$7.35**
Model C — 1500/2000/2500v. A.C. 300 m.a. **\$11.95**
Model D — 1000/1250/1500v. A.C. 500 m.a. **\$11.75**
Above transformers are all housed in attractive cases and may be mounted on bread board or metal.

2000 Volts, D. C. Working Voltage
1 mfd. **Special \$1.75**
2 " **Special 2.45**
3000 Volts, D. C. Working Voltage
1 mfd. **Special \$2.50**
2 " **Special 4.95**

Hermetically sealed in steel containers, beautifully black japanned, these compact condensers do credit to the most pretentious transmitter. Provided with high, glazed porcelain insulated terminals. A Real Condenser at a Really Low Price.

"Hi-Power" Signals!

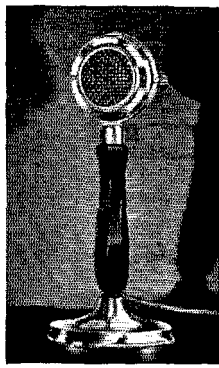
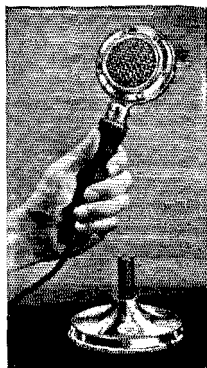

For Hi-Power Signals that boost your messages through noise and static, use a Shure "Communications Type" microphone . . . the original speech microphone that gives you **DOUBLE POWER** on important speech frequencies.

Note the special features of the Shure 70SK "4-Way Utility" Communications Model! Gives you instant change from Desk to Hand microphone, without tools or bother. Easily adapted, too, for Stand Mounting or Ring Suspension.

See your Jobber or write for Bulletin 139QB

Licensed under patents of the Brush Development Company

SHURE MICROPHONES
SHURE BROTHERS • MICROPHONE HEADQUARTERS
215 WEST HURON STREET • CHICAGO, U. S. A.

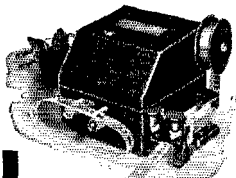

At Last! A Perfected AUTOMATIC SENDER

Save your fist. Let the Automatic Sender raise your stations for you. Repeats calls or messages indefinitely. Length of messages unlimited. Sends from 2 to 70 words a minute. Motor driven. Entirely automatic. Built-in tape perforator. Absolute uniformity in spacing of characters. Used with buzzer or oscillator, makes excellent code teacher for novice and speed-builder for the advanced amateur. Complete with 4 rolls of tape and full instructions. No extra equipment needed. If your dealer can't supply you, write us.

only
\$12.50

Patent
Pending
in U. S. A.

MONEY-BACK GUARANTEE

Gardiner-Levering Co. Haddon Heights, New Jersey, U. S. A.

NEW LOW PRICES

BECAUSE of the large number of inquiries we have received, we are offering the following units at a greatly reduced price.

Type CMA, completely mounted, plugs into 5-prong tube socket, or G.R. Jacks. AT cut, frequency drift compensate near zero. 2004Kc's, 2096Kc's, and 3105Kc's within 2Kc's, net each \$12.00. Five or more units all on the same frequency, net each \$9.60.

Type VM2 mounted crystal in the 1.7 — 3.5 — 7 Mc bands, within 2Kc net each \$4.00. Five or more units, all on the same frequency, net each \$3.20.

Any of the above type crystals mounted in our mycalex broadcast crystal mounting, \$7.50 each additional.

Order direct from this ad or see your dealer

THE VALPEY CRYSTALS

377 SUMMER STREET

MEDWAY, MASS.

Plate resistance (app.)	10,000	10,000	10,000	10,000 ohms
Transconductance	3200	3200	3000	8000 micromhos
Load resistance	1500	2000	1500	2000 ohms
Distortion				
Total harmonic	11	10	13	11.5 per cent
Second harmonic	10	3.5	12	4.5 per cent
Third harmonic	4	8.5	4.5	9.5 per cent
Power output	2.1	2.2	2.2	2.2 watts

The 25L6 is the same physical size as the 6F6, has a 7-prong octal base with pin connections the same as for the 6L6. The tube would appear to be of interest in low-power transmitting applications for those in the d.c. districts, or for light-weight portables operating from a.c. without a power transformer. It has the high power sensitivity which is characteristic of the 6L6.

Auto-Transformer Design

(Continued from page 46)

The current in section AB is:

$$2.73 \times .33 = .90 \text{ amperes}$$

The size wire to use in each section can be determined from a wire table. The *Handbook* advises using 1500 circular mils per ampere; however, I find that 1000 c.m. per ampere will carry the current without heating:

Based on 1000 c.m. per ampere, No. 20 wire should be used in the section AB and No. 17 wire in section BC. The cost of the wire for this particular transformer would be about a dollar, and the core can be procured from a service man free,

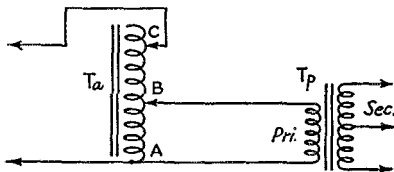

FIG. 1

or at a maximum cost of two bits. Remember that the larger the core the smaller the amount of wire needed. The amount of wire necessary for any particular job can of course be estimated from the number of turns used, size of core, number of layers, etc. If you are new at winding transformers the information in the *Handbook* is very helpful, and should be read before construction is attempted.

The transformer described here is merely used as an example to show how easily an auto transformer can be designed.

If voltages between 76 and 115 are to be taken from this transformer, taps between could be made on the winding between B and C at the proper intervals to get the desired potentials, provided the wire in this section is made larger to carry the increased current flowing between the tap and end C.

The auto transformer has many uses and, at the low cost necessary to build one, should be of considerable value to any amateur station.

Buying a New Transmitter? . . .

SPECIFY G-E PYRANOL CAPACITORS

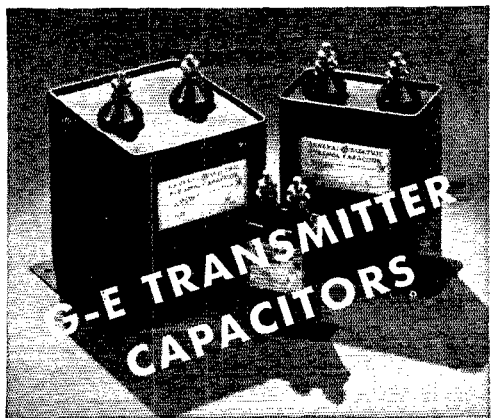

Be sure that your new rig contains G-E capacitors —because they will stand the gaff of hard service through long periods of use. G-E capacitors have these outstanding advantages.

1. They are all treated with Pyranol—a new General Electric synthetic material that assures permanence of their high dielectric strength and operating characteristics.
2. Every unit must pass a high-voltage test of double rated voltage + 1000. You can operate them continuously at 10 per cent above rated voltage.
3. They are hermetically sealed and leak-tested under vacuum.
4. They are very small in size, and fireproof.

Transmitter Manufacturers: See your nearest G-E office for more information about G-E capacitors, or write Radio Dept., General Electric, Schenectady, New York.

360-120

GENERAL ELECTRIC

Two Hundred Meters and Down

The Story of Amateur Radio

By CLINTON B. DESOTO

THERE'S a new topic of conversation in amateur radio these days. It starts off with the question: "Have you read Clint DeSoto's new book on ham history? 'Two Hundred Meters and Down', you know?"

And from then on almost anything may develop — swapping of reminiscences over the good ol' days — memories of things long past and long forgotten, nostalgic trifles dredged up by this fascinating and absorbing account of amateur radio from its earliest days to its present grand estate.

You owe it to yourself, as an amateur, to learn from this book the fundamental why's and wherefore's of amateur radio. You owe it to yourself, as an individual, to provide yourself with the evenings of thrilling entertainment surging between the attractive gold-lettered deep red covers of "Two Hundred Meters and Down: The Story of Amateur Radio."

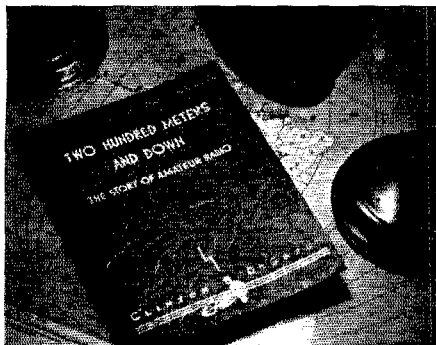

\$1 postpaid

Approximately 200 Pages, 90,000 Words, with Durable Imitation Leather Red Paper Cover

DE LUXE EDITION, bound in blue cloth, \$2.00

AMERICAN RADIO RELAY LEAGUE, West Hartford, Conn., U. S. A.

BRUSH Headphones

● Meet every headphone requirement. They bring in weak signals strong and clear and will handle excessive volume without overloading. Response 60 to 10,000 cycles. No magnets to cause diaphragm chatter. Specially designed cases minimize breakage. Light in weight. Only 6 oz., complete with headband and cords. A quality product at a low price. Details, Data Sheet No. 10. Copies on request. Send for one.

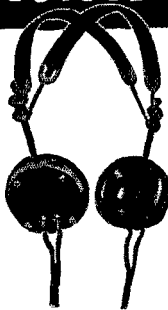

The **BRUSH** DEVELOPMENT COMPANY
1120 ELECTRIC CLEVELAND, O.
MICROPHONES • MIKE STANDS • TWEETERS • HEAD PHONES • LOUD SPEAKERS



**NEW
HOLDER
DESIGN**
15 SECONDS
TO INSTALL
CRYSTAL

For All Bands
**GREATER
STABILITY**

Plugs in 5 prong
tube socket
**Beautiful
Appearance**

MODEL AH HOLDER \$1.00

At your dealer or direct

HIPOWER LOW DRIFT CRYSTALS:
within 10 kc. or choice of stock

AH-10, 1700-3500 Kc. bands \$2.35

AH-10, 7000-7300 " band 3.90

write for new Literature

Hi-power "Low Drift" Broadcast and Commercial
Crystals Are Approved by F.C.C.

Hi-power Crystal Co., 2035 Charleston St., Chicago

LEARN RADIO

New Classes Now
Forming! Send for 40-
page catalog, explains

fully, 300 licensed graduates placed in past 4½ years in broadcast-
ing, shipping, police radio, aviation, etc. We teach all branches.
Oldest, largest and best equipped school in New England. Equipped
with Western Electric sound and broadcasting equipment and RCA
marine transmitter. Course prepares for United States Govern-
ment telegraph or telephone license.

MASS. RADIO SCHOOL, 18 Boylston Street, BOSTON

LYNCH GIANT KILLER CABLE

OF NEW AND IMPROVED DESIGN
AVAILABLE DECEMBER 1

An Exclusive Product of
LYNCH DIVISION

L. S. BRACH MFG. CORP.

World's Largest Makers of Antenna Systems and Accessories
NEWARK, N. J. U. S. A.

R.F. Voltage and Current Ratings

(Continued from page 45)

tion of the current or voltage becomes necessary. Referring to Fig. 1, which is the diagram of an r.f. power amplifier stage, C_1 , C_2 , C_3 and C_4 are usually mica condensers. The preferred size seems to be 0.002 μ fd. The current flowing through C_2 is equal to the r.f. current flowing through the tube, and this same current must also flow through C_3 and C_4 in parallel. Therefore, C_2 passes twice as much current as C_3 and C_4 . Approximately, the current through C_2 will not exceed 0.7 times the direct plate current.

On the other hand, one may consider the tube as a generator with a voltage of mu times the applied grid voltage. This voltage is applied to a circuit consisting of the tube's a.c. resistance, the equivalent resistance of the tuned circuit, the reactance of C_2 , and that of the two condensers C_3 and C_4 in parallel. When all these impedances are known the current can be calculated. Since the condenser reactances are small compared to the other quantities, no great error will be introduced by ignoring the by-pass condensers and considering only the tube and the load in series. The tube's a.c. plate resistance can be obtained from the manufacturer's ratings* and can also be taken from a family of plate characteristics. The equivalent resistance of the parallel tuned circuit is given by the equation

$$R_1 = \frac{CR}{L}$$

where R_1 is the equivalent resistance of the circuit and R is the r.f. resistance of the coil plus the r.f. resistance of the tuning condenser.

Plate by-pass or blocking condensers, provided they are of any reasonable size (500 μ fd. or more), are not called upon to withstand much r.f. voltage, even with high-power amateur transmitters at the lower frequencies. It is safe, therefore, to use condensers rated for the maximum d.c. plate voltage, allowing the usual factor of safety. However, where condensers are called upon to carry r.f. current of the order of amperes (as might be the case when fixed condensers are put in series with direct-coupled feeders for insulation purposes, or inserted in tuned circuits for blocking purposes) it will be necessary to consult the manufacturer's current and voltage ratings before selecting a suitable condenser. Remember, too, that grid coupling condensers in capacity-coupled circuits are called upon to withstand the driver plate voltage plus the amplifier bias voltage, in addition to carrying considerable r.f. current.

—G. G.

* This value applies only in audio applications. The r.f. plate resistance is considerably different from that obtained by static measurement. Likewise, it is difficult to determine the value of R in the equation which follows, in r.f. circuits. The first method of calculation is to be preferred for r.f. power amplifiers.—EDITOR.

A WORD OF APPRECIATION

It is gratifying to be able to report that "business is good at Terminal." And while we admit that this condition is partly due to our policy of "Service and a Square Deal," we recognize that it could not be possible were it not for the large number of "Hams" who are keen enough to recognize that Terminal is a good

place to shop for radio supplies. To those who have already "discovered" Terminal, and to those who during 1937 will join our growing family of satisfied customers...

The Season's Greetings

TERMINAL



High Voltage
Oil Impregnated Condensers
D.C. Working Voltages

	1000	1500
1 mfd.	\$1.10	\$1.45
2 mfd.	1.50	2.00
4 mfd.	2.00	3.25
	2000	3000
1 mfd.	\$1.75	\$2.50
2 mfd.	2.45	4.95
4 mfd.	4.65	

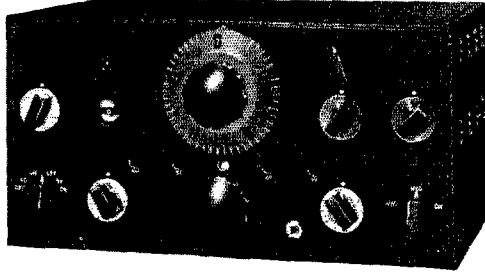

In the NC 101X, you will find the same precision manufacture which is so distinguishing a feature of all NATIONAL receivers. The standard NC-100 tools and the standard HRO laboratory test equipment are used in the production and testing of these "strictly amateur" receivers. The fact that in tooling for the production of NC 101X, it was necessary to make only the blanking die for the "trick" condenser, accounts for the low price. Here is the special band spread receiver which you have awaited. It has FIVE BAND SPREAD RANGES.

Complete with tubes, crystal filter,
10" dynamic speaker..... **\$125.00**
IN STOCK FOR IMMEDIATE DELIVERY

TERMINAL

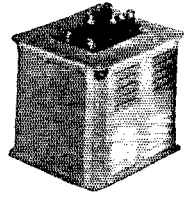

CASED HIGH VOLTAGE
300 MA. TRANSFORMERS

750/1000 each side.... \$5.70
1000/1250/1500..... 7.35
1500/2000/2500..... 11.95

ALL PURPOSE METAL CABINETS

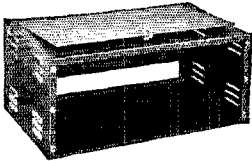

May be had in single, double, triple and quadruple units. They give your rig that "professional" look.

Single Unit (illustrated).....	\$4.50
Double Unit	7.90
Triple Unit.....	8.25
Quad Unit	11.85

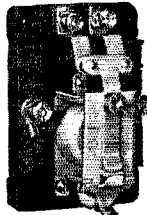

Dunco Midget
Keying Relay

Midget size — suitable for speeds up to 40 words per minute. Large fine silver button contacts assure long life and easy replacement.

TYPE ABTXI — S.P.D.B. Front Contact — 6 Volts A.C. or 110 Volts A.C..... **\$3.85**
We also stock the DUNCO RADIO RELAY.

RA1 or RA3, \$2.00

TERMINAL CASED TRANSFORMER

600 Volts each side of C.T.
200 MA.
2½ Volts 10 Amps.
5 Volts 3 Amps.
6.3 Volts or 7½ Volts 3 Amps..... **\$2.95**

NATIONAL TYPE CRM OSCILLOSCOPE

Same circuit as standard type CRO (including 60 v. sweep) uses 913 Tube.
Less Tube..... **\$11.10 net**
913 Tube..... **5.60 net**
IMMEDIATE DELIVERY

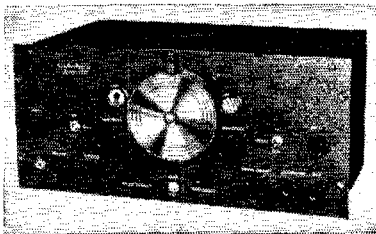

HALL-CRAFTER
SUPER
SKY
RIDER

S11 — less crystal.....	\$89.50 net
SX11 — with crystal	99.50 net
Permanent Magnet Speaker (in case)...	12.00 net

SKY BUDDY \$29.50 SKY CHIEF \$44.50

RME 69
Complete with tubes.
\$123.80

Speaker in Cabinet.
\$11.10

DB20 by RME.
Complete with tubes.
\$39.90



TERMINAL RADIO CORP.

80 CORTLANDT ST.
BILL FILLER

★ W2AOQ ★

NEW YORK, N. Y.
ADOLPH GROSS

ANNOUNCING

Type HFM

Mobile Crystal Control

for 5- and 10-Meter

PHONE—CW—ICW

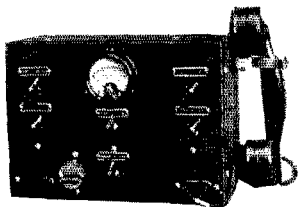

Excellent Exciter for Fixed Stations on All Frequencies using our plug-in coils. Size 7½ x 10 x 5 inches.

The Ideal Gift

Type TR-6A6

Duplex Transmitter-Receiver as advertised in Nov. Dec. issues QST. Net \$39.75



PROPOSITION FOR DEALERS

RADIO TRANSCEIVER LABORATORIES

8627 115th Street, Richmond Hill, New York

"The Crystal Specialists Since 1925"

PIEZO-ELECTRIC CRYSTALS

Guaranteed Accurate to BETTER than .01%

SCIENTIFIC RADIO SERVICE

UNIVERSITY PARK, HYATTSVILLE, MD.

Why 100,000 Operators

New

GENUINE MARTIN

JUNIOR

Weight 2¾ lbs.

ONLY \$10

Smaller and more compact. Large contact points. Black japanned base. A low priced key with world famous Vibroplex quality.

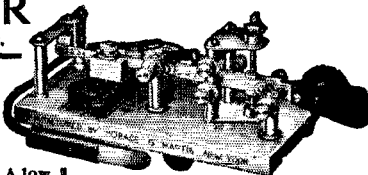

More than 100,000 experienced Radio and Morse operators prefer the Vibroplex key because its semi-automatic style produces a higher quality signal

... a more uniform style of sending proficiency seldom attained by users of the regulation telegraph key. So if you want the best, be sure to insist on the Genuine Martin Vibroplex key. Accept no substitute. Order yours TODAY! Money order or registered mail. Other models \$17 and \$19. Write for FREE Illustrated Catalog.

FREE

Catalog

The Martin Vibroplex

THE VIBROPLEX CO., INC.

832 Broadway

New York, N. Y.

118

Say You Saw It in QST — It Identifies You and Helps QST

Testing Transmitting Tubes

(Continued from page 48)

tube. Now adjustments of the resistors must be made in small steps, beginning with low voltages, until the voltages are as specified for this trial. When the voltages are all checked, the plate current reading is noted and the tube is allowed to continue operation under these conditions for several minutes, in order to show whether the filament emission will decrease with operation. A good point on a second curve is now selected, say the 800-volt point on the -25-volt curve. With the controls readjusted to these new voltages, the screen having been checked following the changes in the other adjustments, the plate current is noted as before. Whether the tube complies with its rated characteristics, and the divergence from those characteristics, will readily show its actual condition.

It sometimes occurs that a good tube is momentarily subjected to an overload, with the result that its filament emission is lost temporarily. In many cases, the tube may be restored to its normal emission by the application of its rated voltage, or a voltage up to 20% higher than its rated voltage (grids and plate are left disconnected throughout this process) until the normal activity of the filament is restored.

Such a test as the one outlined above (with the 860 tube as an illustrative example) should give the operator a complete and accurate knowledge of the condition of a tube. Common-sense care should be used in making these tests, of course.

Strays

Hams who like to build measuring equipment will be interested to know that a new type of precision plug-in resistor, inexpensively priced, is now available. Rated at an accuracy within 1/10 of 1 per-cent, the units are mounted in a standard 4-prong tube base, and can be obtained in selected resistance values, suitable for bridge purposes, from 1 to 10,000 ohms. They are made by the Clarostat Manufacturing Company, Brooklyn.

A note from W9DOS which may be of help to FB-7 receiver owners who use their own power supplies: With the full tube complement in place, the filament voltage drop through the cable is about three-tenths of a volt, which, with a transformer giving only 2.5 volts to start, makes the voltage at the tubes too low for really good operation. W9DOS cut off about three feet of the cable and mounted his power supply on a shelf underneath the operating table. This brought the filament voltage up to the rated 2.5, and made the receiver sound like a new one.

The old ham spirit: When the filament transformer arced over and the insulation caught fire at N3BVG, the NCR Armory station, N1EZV and N8KOX kept blowing out the flames while N3CBF continued his QSO with W3AKG and arranged for a sked at a later date under more favorable conditions!

THE RADIO AMATEUR'S LIBRARY

For some time our advertising in QST has carried a by-line reading "No..... in the series entitled Radio Amateur's Library." Many requests have been received for copies of this list and now we present it in QST in its complete form — to give a comprehensive picture of our publishing services to the amateur.

<i>No.</i>	<i>Title</i>	<i>Price</i>
1.	QST	\$2.50 per year*
2.	List of Stations	Pre-war Out of Print
3.	Map of Member Stations	Pre-war Out of Print
4.	Operating an Amateur Radio Station (Formerly called Rules & Regulations of Communications Dept.)	Free to members, to others 10c
5.	The Story of The A.R.R.L.	Out of Print See No. 13
6.	The Radio Amateur's Handbook	\$1.00**
7.	The Log	35c each, 3 for \$1.00
8.	How to Become a Radio Amateur	25c
9.	The Radio Amateur's License Manual	25c
10.	Hints & Kinks for the Radio Amateur	50c
11.	Lightning Calculators:	
	a. Radio (Type A)	\$1.00
	b. Ohms Law (Type B)	\$1.00
	c. Wire Data (Type C)	50c
	d. Decibel (Type D)	50c
	e. Parallel Resistance — Series Capacity (Type E)	50c
	f. Resistance Calculator (Type F)	50c
12.	Amateur Radio Map of the World	\$1.25
13.	Two Hundred Meters and Down: The Story of Amateur Radio	\$1.00

* In the United States and Possessions and Canada. Other Countries \$3.00 per year.

** Postpaid in Continental U.S.A. — \$1.25, postpaid, elsewhere.

THE AMERICAN RADIO RELAY LEAGUE, INC.
West Hartford, Connecticut

Where to buy it

A directory of suppliers who carry in stock the products of these dependable manufacturers.

ASTATIC
Crystal Microphones and Pickups
ASTATIC MICROPHONE LABORATORY, Inc. YOUNGSTOWN, O.
Pioneer Manufacturers of Quality Crystal Products

NEWARK, N. J. Wholesale Radio Service Co., Inc. 219 Central Ave.
 NEW YORK, N. Y. Harvey's Radio Shop 103 W. 43rd St.
 NEW YORK, N. Y. Wholesale Radio Service Co., Inc. 100 Sixth Ave.
 PHILADELPHIA, PENN. Eugene G. Wile 10 S. 10th Street

super skyrider
hallycrafters
ultra skyrider

ALBANY, N. Y. Uncle Dave's Radio Shack 356 Broadway
 BALTIMORE, MD. Radio Electric Service Company 3 North Howard St.
 BOSTON, MASS. Radio Shack 46 Brattle Street
 HARTFORD, CONN. Radio Inspection Service Co. 227 Asylum Street
 NEWARK, N. J. Wholesale Radio Service Co., Inc. 219 Central Ave.
 NEW YORK, N. Y. Gross Radio, Inc. 51 Vesey St.
 NEW YORK, N. Y. Harrison Radio Co. 12 West Broadway
 NEW YORK, N. Y. Harvey's Radio Shop 103 W. 43rd St.
 NEW YORK, N. Y. Wholesale Radio Service Co., Inc. 100 Sixth Ave.
 READING, PENN. George D. Barbey Company 404 Walnut St.
 SPRINGFIELD, MASS. T. F. Cushing 349 Worthington St.

RCA *Amateur Products*

ALBANY, N. Y. Uncle Dave's Radio Shack 356 Broadway

BALTIMORE, MD. Radio Electric Service Company 3 North Howard St.
 BOSTON, MASS. H. Jappe Company 46 Cornhill
 BOSTON, MASS. Radio Shack 46 Brattle Street
 BURLINGTON, VERMONT Vermont Hardware Co., Inc.
 CAMDEN, NEW JERSEY Radio Electric Service Company 811 Federal Street
 GREENWICH, CONN. Mead Stationery Company 252 Greenwich Ave.
 HARTFORD, CONN. Radio Inspection Service Co. 227 Asylum Street
 MONTREAL, CANADA Canadian Electrical Supply Co., Ltd. 285 Craig Street, West
 NEWARK, N. J. Wholesale Radio Service Co. 219 Central Avenue
 NEW YORK, N. Y. Bruno-New York, Inc. 460 W. 34th St.
 NEW YORK, N. Y. Sanford Samuel Corp. 136 Liberty St.
 NEW YORK, N. Y. Wholesale Radio Service Co. 100 Sixth Avenue
 NEW YORK, NEW YORK Harrison Radio Company 12 West Broadway
 NEW YORK, NEW YORK Grand Central Radio, Inc. 124 E. 44th Street
 PHILADELPHIA, PENN. Eugene G. Wile 10 S. 10th Street
 PHILADELPHIA, PENN. Raymond Rosen & Company 117 North 7th St.
 PHILADELPHIA, PENN. M & H Sporting Goods Company 512 Market Street
 PHILADELPHIA, PENN. Radio Electric Service Company 3125 N. Broad Street
 PHILADELPHIA, PENN. N.E. Corner 7th & Arch Streets Radio Electric Service Company
 PITTSBURGH, PENN. Cameradio Company 603 Grant Street
 READING, PENN. Bright & Company 8th & Elm Streets
 ROCHESTER, NEW YORK Radio Service Shop 244 Clinton Avenue, N.
 SPRINGFIELD, MASS. T. F. Cushing 349 Worthington Street
 SPRINGFIELD, MASS. S. S. Kresge Radio Department 1540 Main Street
 WASHINGTON, D. C. Sun Radio & Service Supply Co. 938 F Street, N. W.

Where to buy it

A directory of suppliers who carry in stock the products of these dependable manufacturers.

RME
RECEIVERS -- PRE SELECTORS
 AMATEUR RADIO EQUIPMENT
 RADIO MFG. ENGINEERS, Inc.
 PEORIA ILLINOIS

- ALBANY, NEW YORK 356 Broadway
 Fort Orange Radio Distributing Co.
- ARGYLE, NEW YORK
 Harper Richards Radio Service
- BINGHAMTON, NEW YORK 25-27 Sturges Street
 Radio Testing Station
- BUFFALO, NEW YORK 216 E. Genesee Street
 Dymac Radio
- HARRISBURG, PENN. 35 South Cameron Street
 Hall's Radio Company
- HARTFORD, CONNECTICUT 210 Chapel Street
 Stern Wholesale Parts Company
- NEW YORK, NEW YORK 12 West Broadway
 Harrison Radio Company
- PITTSBURGH, PENNSYLVANIA 603 Grant Street
 Cameradio
- ROCHESTER, NEW YORK 244 Clinton Ave., N.
 Radio Service Shop

RAYTHEON
TRADE MARK
AMATEUR TUBES

- ALBANY, NEW YORK 356 Broadway
 Uncle Dave's Radio Shack
- BOSTON, MASS. 46 Brattle Street
 The Radio Shack
- BOSTON, MASS. 28 Brattle Street
 Selden Radio Company
- BUFFALO, NEW YORK 326 Elm Street
 Radio Equipment Corp.
- CONCORD, NEW HAMPSHIRE 80 N. State Street
 Carl B. Evans
- NEWARK, NEW JERSEY 219 Central Street
 Wholesale Radio Service Co.
- NEW YORK, N. Y. 12 West Broadway
 Harrison Radio Company
- NEW YORK, N. Y. 103 W. 43rd St.
 Harvey's Radio Shop

NEW YORK, N. Y. 100 Sixth Avenue
 Wholesale Radio Service Co.

Use **SHURE**
MICROPHONES
Microphone Headquarters

- ALBANY, N. Y. Uncle Dave's Radio Shack 356 Broadway
- BOSTON, MASS. H. Jappe Company 46 Cornhill
- BUFFALO, N. Y. Radio Equipment Corporation 326 Elm St.
- NEWARK, N. J. 219 Central Avenue
 Wholesale Radio Service Company
- NEW YORK, N. Y. Harrison Radio Co. 12 West Broadway
- NEW YORK, N. Y. 100 Sixth Avenue
 Wholesale Radio Service Company
- READING, PENN. 404 Walnut Street
 George D. Barbey Company
- SPRINGFIELD, MASS. T. F. Cushing 349 Worthington Street

TRIPLET
INSTRUMENTS

- ALBANY, N. Y. Uncle Dave's Radio Shack 356 Broadway
- BOSTON, MASS. Radio Shack 46 Brattle Street
- BOSTON, MASS. Selden Radio Company 28 Brattle St.
- MONTREAL, CANADA 285 Craig Street, West
 Canadian Electrical Supply Co., Ltd.
- NEWARK, N. J. 219 Central Ave.
 Wholesale Radio Service Company
- NEW YORK, N. Y. 100 Sixth Avenue
 Wholesale Radio Service Company
- PITTSBURGH, PENN. 603 Grant Street
 Cameradio Company
- READING, PENN. 404 Walnut Street
 George D. Barbey Company

DON'T READ THIS

IF YOU LIVE IN PETROPAVLOVSK OR KHABAROVSK

Smart hams in all USA districts have purchased new equipment on the DEL*RAD payment plan. Write at once for complete price list and details. Down payments as follows—

New NC-101X.....	\$13.75
NC-100	13.00
NC-100X.....	15.50
HRO	18.45
1937 Super Pro.....	26.75
RME 69.....	13.00
Breting 14.....	11.50
1937 Super Sky rider.....	10.25

Time Payments on Transmitters and Parts Orders

A-1 Used Sets 50% to 75% Off Original List Prices

W3DQ has been a ham since 1910, and takes a personal interest in your radio problems. Reasonable trade-in allowance for your old receiver.

WILLARD S. WILSON—W3DQ
DELAWARE RADIO SALES Co.
 405 Delaware Ave., Wilmington, Delaware

The "G" Beam Transmitter

All parts, chassis and lay-outs in stock for the "G" Beam Transmitter described in the December, 1936, *QST*, page 23.

Write for Prices on Phone or C.W.
 Units. Write for New 1937 Catalog,
 Now Ready.

M & H Sporting Goods Co.
 512 MARKET ST. PHILADELPHIA
 1709 Atlantic Ave. Atlantic City



Supplies rectified D.C. power for operating relays, solenoids and remote controls. Available in voltages ranging from 6 to 24 volts, rated at 2 to 15 amps. Operates on 110 volt A.C. Write for complete information.

ELECTRICAL PRODUCTS CO.
 6331 RUSSELL STREET - DETROIT, MICH.

GULF RADIO SCHOOL

Radiotelegraphy Radiotelephony
 Radio Servicing

SECOND FORT } 1007 Carondelet Street
 U. S. A. } NEW ORLEANS, LA.

A 50-Watt Transmitter

(Continued from page 54)

Class-AB modulators, a separate bias rectifier furnishing this voltage. With the separate 400-volt supply, all the audio power needed is furnished to modulate the usual 70- to 75-watt input to the modulated amplifier. The screen tap on the voltage divider must be adjusted to give approximately 275 volts on the screen grids of the modulator tubes, since this seems to be the correct value for best operation. The input circuit is intended for use from a crystal microphone, but sufficient gain is provided so that practically any type of microphone could be adapted easily to the circuit.

By use of two power supplies in the audio portion of the transmitter it is possible to obtain a.c. voltage from the amplifier power supply transformer to furnish separately rectified bias voltage for the 6L6 modulator tubes. The filter of this bias supply consists of a resistance input instead of the usual choke input, and the bias is adjusted to the correct value by a tap on the 7500-ohm load resistor.

The adjustment of the transmitter is comparatively easy and so a detailed description of the procedure is not necessary. It is the same as for other multi-stage phone transmitters. The neutralizing capacity needed for the buffer and final stages is very small, but this small amount was found very necessary for correct operation of the transmitter. As always, care should be taken to match the modulating impedance of the final amplifier to the output requirements of the modulator. In this case a "vari-match" output transformer is used. As mentioned previously, all bias and screen voltages should be adjusted first of all, because a good bit of the successful operation of the rig depends on this one point. In tuning, all currents are read by one meter in conjunction with a switching arrangement in the particular set-up shown, but this is not shown in the diagram since every ham has his own ideas as to how he wants to do the job. Suffice to say that any one of the usual metering methods is quite suitable for this layout.

In actual operation the transmitter gives a very pleasing account of itself. Practically every state has been worked in the first weeks of operation, and it has done its share of DX work also. The speech quality is reported as exceptionally fine, which is probably attributable to the full-sized transformers used and also to the generous use of filters and by-pass condensers. Another point worth noting is the fact that, dressed up in its rack with chromium-plated dials, the transmitter gives a very pleasing appearance, which goes a long way toward making operation more enjoyable.



W8OCU reports that W9NZW lives at 559 Interference Street. Ur sigs FB OM but QRM bad!

HAM-ADS

(1) Advertising shall pertain to radio and shall be of nature of interest to radio amateurs or experimenters in their pursuit of the art.

(2) No display of any character will be accepted, nor can any special typographical arrangement, such as all or part capital letters be used which would tend to make one advertisement stand out from the others.

(3) The Ham-Ad rate is 15c per word, except as noted in paragraph (4) below.

(4) Remittance in full must accompany copy. No cash or contract discount or agency commission will be allowed.

(5) Closing date for Ham-Ads is the 25th of the second month preceding publication date.

(6) A special rate of 7c per word will apply to advertising which, in our judgment, is obviously non-commercial in nature and is placed and signed by a member of the American Radio Relay League. Thus, advertising of bona fide surplus equipment owned, used and for sale by an individual or apparatus offered for exchange or advertising inquiring for special equipment, if by a member of the American Radio Relay League takes the 7c rate. An attempt to deal in apparatus in quantity for profit, even if by an individual, is commercial and takes the 15c rate. Provisions of paragraphs (1), (2), (4) and (5) apply to all advertising in this column regardless of which rate may apply.

Having made no investigation of the advertisers in the classified columns, the publishers of QST are unable to vouch for their integrity or for the grade or character of the products advertised.

QUARTZ—direct importers from Brazil of best quality pure quartz suitable for making piezo-electric crystals. Diamond Drill Carbon Co., 719 World Bldg., New York City.

RADIO engineering, broadcasting, aviation and police radio, servicing, marine and Morse telegraphy taught thoroughly. All expenses low. Catalog free. Dodge's Institute, Byrd St., Valparaiso, Ind.

NATIONAL—Hammariund, RCA-RME used sets, 60% off list. W8DQ, 405 Delaware Ave., Wilmington, Del.

QSL's, W2SN, Helmetta, N. J.

CLASS B transformers—Universal for two or four 46's, 61.6's, 210's, 800's, etc., \$7.75 pair postpaid. 70 watts audio from 46's, 100 watts from 10's. Write for details. W8UD, Douglas, Mich.

CALLBOOKS—new DX calls, new prefixes, thousands of new W and VE calls, in the Winter 1936 Radio Amateur Call Book. Sent postpaid \$1.25, or a whole year (four issues) for \$4. (In foreign countries \$1.35 and \$4.35.) Your call and QRA printed in large type \$1 per year. Radio Amateur Call Book, 610 S. Dearborn, Chicago.

PORTABLE enclosed steel racks. Circulars? W6DZL.

QSL's, SWL's and Cardograms, new designs. Stamp for samples. Powell, 3271 Upas Street, San Diego, Calif.

METTER Repair Service—Accurate and expert work. Typical prices. Milliammeters shunted to different range, with new scale; hairsprings repaired and hands straightened; \$1.50—\$2.00. Send your meter in for estimate. Braden & Apple Co., 305 Park Dr., Dayton, O.

AMATEUR radio licenses, complete training. Resident and correspondence courses. Every graduate a licensed operator. N. Y. Wireless School, 1123 Broadway, N. Y.

QST back numbers 1916 to 1933. I.R.E. 1924 to 1935. Bell Tech. Journal 1923 to 1936. All complete. Write for details. Fred Maroo, 1099 Jeannette, Deplains, Ill.

VACUUM pump, combination mechanical and diffusion, vacuum of .001 micron or better. Ideal for making vacuum tubes, neon signs, etc., \$55. Westinghouse oil condensers, 3300 working voltage, 1.1 mfd., \$5 each. Western Electric 10 amp. 5 conductor baseboard receptacles and plugs, two complete units mounted on bakelite base \$2.50 per set. H. Robinson, 5507 Lincoln Ave., Chicago, Ill.

SELL, trade several barber's electric clippers. Want short wave apparatus, prefer receiver—or what. Glenn Watt, Chanute, Kansas.

204-A. Excellent condition. Best offer takes it. W1KFC, 19 Pearl St., Newton, Mass.

CALL pins for lapel or vest—rhodium plated—very neat say satisfied customers. \$1.50. W2CZR.

SELL, trade small hand press, Webster Sampson amplifiers. Sky rider Gross Eagle tuned frequency receivers. Want larger receiver. Glenn Watt, Chanute, Kansas.

QSL's. Free samples. Printer, Corwith, Iowa.

SELL—Gross Eagle tubes and coils, \$8. Jans super gainer, 80 meter coils, tubes, \$15. A-1 condition. W8COD.

CUSTOM built ss superhet. One RF stage—18-200. Power supply, speaker, cabinet. Complete \$48. Dr. C. R. Crosby, Framingham, Mass.

QSL's. World's finest. Variety. Samples? (stamp). W8DED, Holland, Mich.

4-204A, 2-849, 212D, swap for lathe, receiver, or what. W1COX.

BUILD your own transformers. Plate or filament. Data on windings, ratings, forms. Various sizes from 5 to 5000 volts. Specification print \$1. Ensell Radio Lab., Warren, Ohio.

QSL Printing Service. Cartoons. Free samples. Theodore Forcher, 7708 Navajo St., Philadelphia, Penn.

QSL's—SWL's, 75¢ a 100, 3 color, samples. Lapco, 344 W. 39 St., Indianapolis, Ind.

WHITNEY Testing Set, Wheatstone Bridge—perfect condition. Write Ella Voleur, 1105 W. Broadway, Muskogee, Okla.

QSL's. 300 one-color cards, \$1. Samples. 2143 Indiana Ave., Columbus, Ohio.

WANTED: bombarder for vacuum tubes, 1 1/4 size or larger. Slocum, 1734 P. St., N.W., Washington, D. C.

CRYSTALS: Special: 80M power X, within five kilocycles, \$1.50. V, ten cycle coefficient, within five kilocycles, \$2.25. Either type mounted HC-10 holder, 95¢ additional. Catalog. Ham Crystals, 1104 Lincoln Place, Brooklyn, N. Y.

BETTER QSL's—SWL's. Samples. Fritz, 203 Mason, Joliet, Ill.

QSL's. Finest in country. Free samples. Maleco, 1512 Eastern Parkway, Brooklyn, N. Y.

P. A. System. June QST circuit, new. Best offer. W9GKH.

TRADE A cut crystals for burned out meters. W9ARE.

SELL Late FBXA 10-20-40 coils, 5897AB pack, Magnavox PM-speaker, complete. Best cash offer. W9GBT.

FOR sale—Hallicrafter Sky Buddy—new—\$22 f.o.b. K. Blamey Columbia, Penn.

WANTED: 852, 2-204A and sockets must have high emission. T.6735 mod. transformer or equivalent—for cash. R. Kewley, Oconomowoc, Wis.

CRYSTALS—guaranteed, 80-160, Y \$1; A \$1.50. Postpaid. Roy Scherman, 4433 N. Kibourne, Chicago.

FOR sale: Collins 4-A 25 w. complete with 40 meter coils, Biley xtal and tubes. Guaranteed O. K. Price, \$49.50. W3FTC.

QSL's—best yet. New designs. Samples, prices on request. W2ABY.

FEDERAL F-108-A, excellent condition, best offer over \$10; Delta AD13, \$6; Weston bakelite type 425 5 ampere thermos, \$4.50; hand-set and stand, \$5. W2CMTY.

CRYSTALS in small round bakelite plug-in (socket) mountings. X-cut: 160-80m, \$1.75, 40m, \$2. AT or V-cut, near zero drift, 160-80m, \$2.25, 40 m, \$2.50. Free gift. Moneyback guarantee. C.O.D. if desired. Premium Crystal Co., Box 2250-A, Kansas City, Mo.

BEST offer gets it. 32 volt motor and generator 1000 volts 500 mls. 2-852's, \$15. Eimac 50T, \$9. 200 watt modulator 2-830B's and Thordarson output, \$20. W4BMR.

WESTERN Electric 4-D broadcast monitoring receiver with 1-C loop, 2-B antenna tuning unit, 25-B power amplifier, 18 and 36 inch speakers, 509-W head set—\$50 cash. L. M. Clark, 222 Audubon Drive, Snyder, N. Y.

WANTED—FB7 coils. W6MYK, Carrier 25, Phoenix, Arizona.

TRANSCEIVERS: two factory built 5-M transceivers at bargain. Complete, batteries, tubes, mikes, etc. W5FRB, Carter, Okla.

RESPONDING to over 500 requests, we again offer those 95¢ crystals. Holders, 60¢. AT cut mounted, \$2.35. White Radio Lab., Standpoint, Idaho.

OFFER \$5 for good copy December 1916 QST with both covers. Sumner B. Young, Maplewoods, Wayzata, Minn.

WANT Ace multi-crystal holders. Sell Eastman Vollenda camera and case, f3.5, 1/500, cost \$46—take only \$30 cash. Sharpe, Box 25, Knoxville, Tenn.

HILET transformers 2 1/2 KW, \$39. Send for circular. Leitch, Park Drive, W. Orange, N. J.

FOR sale cheap: Philco converter, Stuart Warner converter, 4 tube AC TRF receiver, W7BBI.

CRYSTALS: Eidson T9 X cut, dependable—powerful. Ground to resist fracture. Accurately calibrated, close frequency supplied: 40, 80, 160 meters, \$1.50 postpaid, fully guaranteed. Superlapped T9 ceramic plug-in holders, \$1.10 postpaid. C. O. D. orders O. K. Eidson's, Temple, Texas or W2GWS, 88-34 209 St., Queens Village, N. Y.

WANTED: Used A.C. receiver with power supply. T. Kwapien, Box 7, Thompsonville, Conn.

CRYSTALS: Zero cut. Guaranteed to compensate at near zero without oven. 80-160 meters, \$1.85. Forty meters, \$2. Holders 75¢ postpaid. Fisher Lab., 4522 Norwood St., San Diego, Cal.

MILLIAMMETERS—triple-range Jewells. W9SXF, 1139 N. 23, Lincoln, Neb.

VIBROPLEXES bought, exchanged. Rebuilds, \$6. New large base, \$9. Frank Lydeard, 14 Temple, Mattapan, Mass.

PR16C. Used 6 months, perfect condition. Bargain—\$70 cash. Selling out. M. E. Spangler, 215 S. DeKalb St., Shelby, N. C.

HUNDREDS of new and rare electrical items, replacement parts and supplies. Send 10¢ for new 60-page wholesale catalog. Autopower, 408 S. Hoyne, Dept. P, Chicago.

\$30 gets my 146 QST's, June 1922 to Nov. 1935—almost complete. Joe Vivian, 519 Broadway, Logansport, Ind.

SELL—DeForest 511A's, same characteristics as 511 except 7 1/2 volt filament \$3.50 ea.; 511's @ \$5 ea. 572 rectifiers \$3. ea.; 575 rectifiers, same as 572 except double current capacity @ \$4 ea. Some of these tubes have never been used, others slightly. All guaranteed good. D. C. Akers, W2FL, 181 Greenwood Ave., East Orange, N. J.

QSL's. Better designs; better stock; better workmanship. Free samples to Hams only. W2FJE, 143 DeKalb Ave., Brooklyn, N. Y.

QSL's—Special introductory offer extended. Finest quality—lowest prices. Radio Headquarters, Ft. Wayne, Ind.

LEAVING radio, bargain list sent. Complete sets. Miscellaneous parts. Adams, 1336 Greenleaf, Chicago.

CRYSTALS: X-cut, 80m \$1.10, 40m \$1.40. AT's 160-80m \$1.60. V-cuts, 80-40m \$1.75. Guaranteed perfect oscillators. Large round moulded bakelite plugin holders 90¢. C. O. D.'s accepted. Star Crystal Co., 1324-J Georgia, Kansas City, Kansas.

PERSONALITY plus. QSL's. The most reasonable photo card ever offered to amateurs. Free samples. Foto-QSL, 628 Briar Pl., Chicago.

NEW National NC100A receivers. W8ANT.

USED RCA 860. W8ANT.

Two used 50T's. W8ANT.

USED RK20. W8ANT.

NEW 42A—\$10. W8ANT.

NEW receivers. W8ANT.

USED receivers. W8ANT.

ALL lines of new and used amateur supplies bought, sold, exchanged. Write to Southern Ohio's only amateur owned amateur business. Jos. N. Davies, W8ANT, 2767 N. Bend Rd., Station A, Mt. Airy, Cincinnati, Ohio.

DYNAMIKE—Quality microphone, \$9.95. Response flat, 40-10,000 CPS. High impedance. No cavity resonance. Output 69 D. B. 4 lbs. Free circular. Electro-Dyne Mfg. Co., Benton Harbor, Mich.

SELL or swap 15hy 400 ma chokes. W6MQD.

WANT H. V. power supply or parts, two Eimac 150T's. Sell or swap 212D's, 204A's, 852, 211, RK20. W8IV, Argyle, N. Y.

CRYSTAL mikes, crystal and diaphragm mounting assembled ready for shielding and use, \$4. Tibbetts Labs., Camden, Maine.

TRANSMITTERS constructed. Superior workmanship. State requirements fully. Howard Radio, 5526 Lake St., Chicago.

BREITING 12, used very little, absolutely like new, \$69, all letters answered. W8ESA, Saginaw, Mich.

SELL new T-6411-xformer, \$10; new NC-25 condensers, pair, \$3; motor-generator 500 volt 400 ml FB for Class B wid no filter, \$15; complete fone xmitter rack es panel 150 watts, no junk, \$150. W5APW, Chico, Texas.

QSL's—2 color—\$1 hundred. W8NOS.

HAMMARLUND Comet-Pro with crystal. Coils from 19 to 550 meters. For sale, \$75. Excellent condition. W3DPU, Philadelphia, Penn.

CRYSTALS: Unconditionally guaranteed, small X cut, 80-160 meters, within ten kilocycles, \$1.35. Approximately 1", spot frequency, \$2.50. Small X cut, 80 meter semi-finished blanks, including carborundum. While they last, three for \$1.20. Dust-proof plugin holders, 85¢. Wm. Threm, W8FN, 4021 Davis Ave., Cheviot, Ohio.

CALL letters on aluminum plate 1/4" x 2" x 6 1/4" for car license or transmitters, 75¢. two \$1.25. QSL's, SWL's cards. Attractive. Samples (stamps). W8ESN, 1827 Cone, Toledo, Ohio.

TRANSFORMER—2000 watt 3000 each side, \$17. Frank Greben, W9CES, 2012 S. Peoria St., Chicago, Ill.

TELEPLEXES, omnigraphs, vibroplexes. Bought, sold, traded. Ryan Radio Co., Monroe City, Mo.

CANADIANS. 1937 catalog. New items—bargains. Complete stocks and listings. Get yours now. Canada's foremost radio supply house. A & A Radio Service Supply, 101 Queen St., W., Toronto, Canada—363 Richmond St., London, Ontario.

COMPARE Before You BUY QUALITY and PRICE OF BUD RADIO PRODUCTS

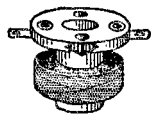
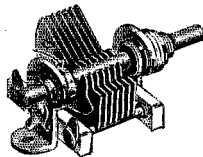

Secure Them from Your Jobber
Free 32-Page Catalog Sent You Upon Request

BUD RADIO INC. CLEVELAND OHIO

LEARN CODE RIGHT — the Practical, Easy Way —

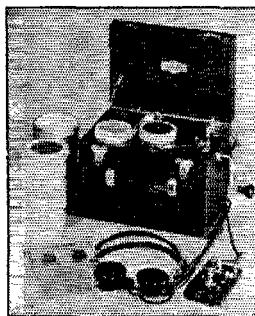

Instructograph

Radio amateur code exams now require 30% more speed. And experts agree: "It pays to learn from a perfect teacher — Instructograph." It's easy to become a real operator when you can practice Radio or Morse at your convenience — at any speed you want. Comes in two models — Senior or Junior Economy. You may buy or rent, at low cost. Just send post-card for complete details now to —

INSTRUCTOGRAPH CO.
Dept. Q-1

912 Lakeside Place Chicago, Illinois
Representatives for Canada
Radio College of Canada, Ltd.
868 Bay Street, Toronto

PRECISION CRYSTALS



Crystal Holder

Highest quality crystals one-inch square, carefully ground for frequency stability and maximum output. Be sure of your transmitter frequency — use PRECISION CRYSTALS.

'X' cut PRECISION Crystals carefully ground for maximum power supplied within 0.1% of your specified frequency and calibrated to within 0.03% are priced as follows: 1750, 3500 and 7000 kc. bands — \$3.00 each. Add \$1.00 to above price if plug-in, dustproof holder is desired. (Holder as illustrated to fit C.R. jacks or round holder to plug into a tube socket can be furnished.) G.R. jacks to plug illustrated holder into — \$1.50 pair.

Low frequency drift crystals (Type LTC) having a drift of less than 5 cycles per million per degree C. are supplied at the following prices: 1750 and 3500 kc. bands — \$3.50 each; 7000 kc. band — \$4.00 each. Holder \$1.00.

AT cut crystals for commercial use quoted on at your request. When ordering our product you are assured of the finest obtainable. Now in our sixth year of business.

PRECISION PIEZO SERVICE
427 Asia Street Baton Rouge, La.

Your Nearest Dealer Is Your Best Friend

Your nearest dealer is entitled to your patronage. You can trust him. He is equipped with a knowledge and understanding of amateur radio. He is your logical and safe source of advice and counsel on what equipment you should buy. His stock is complete. He can supply your needs without delay. His prices are fair and consistent with the high quality of the goods he carries. He is responsible to you and interested in you.

Patronize the dealer nearest you—You can have confidence in him

ALLENTOWN, PENNSYLVANIA

Radio Electric Service Co.
1024 Hamilton Street
Complete stocks transmitting equipment

PITTSBURGH, PENNSYLVANIA

Cameradio Company
601-3 Grant Street
"Ham" Headquarters for Pennsylvania-Ohio-W. Virginia

BALTIMORE, MARYLAND

Radio Electric Service Co.
3 N. Howard St.
Everything for the amateur

PHILADELPHIA, PENNSYLVANIA

Eugene G. Wile
10 S. Tenth Street
Complete Stock of Quality Merchandise

BUFFALO, NEW YORK

Radio Equipment Corp.
326 Elm Street
W80BK — Ham, service and sound equipment — W80LB

PROVIDENCE, RHODE ISLAND

W. H. Edwards Co.
32 Broadway
National, Taylor Tubes, Hallicrafters. Complete amateur supply house

BUFFALO, NEW YORK

Dymac Radio
216 E. Genesee Street
National, RCA, Eimac, etc. Standard discounts Cl. 2080

PROVIDENCE, RHODE ISLAND

Kraus & Company
89 Broadway
Everything for the amateur and serviceman

MONTREAL, CANADA

Canadian Elec. Supply Co., Ltd.
285 Craig St., W.
Quality parts and equipment for discriminating buyers

ROCHESTER, NEW YORK

Radio Service Shop
244 Clinton Avenue, North
Complete stock amateur-BCL parts. Standard discounts. W8NUC

NEW YORK, N. Y.

Gross Radio, Inc.
51 Vesey Street
Fair dealings plus fair prices. Anything in radio

SYRACUSE, NEW YORK

Roy C. Stage, W8IGF
Complete stock of standard Ham & BCL parts
Standard Discounts. Free technical service

PHILADELPHIA, PENNSYLVANIA

Consolidated Radio Corp.
612 Arch Street
Ham receivers, Transmitting tubes, Collins transmitters, etc.

SPRINGFIELD, MASS.

S. S. Kresge Company
1540 Main Street
Standard discounts on standard lines.
Advisory service: W1JQ, W1FOF

PHILADELPHIA, PENNSYLVANIA

Radio Electric Service Co., Inc.
N. E. Cor. Seventh & Arch Sts.
All nationally-advertised lines in stock

WHEELING, WEST VIRGINIA

Cameradio Company
30 Twelfth Street
Complete stock of amateur Equipment at standard discounts

You Are Protected When You Buy From QST Advertisers

“Advertising for QST is accepted only from firms who, in the publisher’s opinion, are of established integrity and whose products secure the approval of the technical staff of the American Radio Relay League.”

Quoted from QST’s advertising rate card.

Every conceivable need of a radio amateur can be supplied by the advertisers in QST. And you will know the product has the approval of the League’s technical staff.

For Your Convenience QST’S INDEX TO ADVERTISERS IN THIS ISSUE

Aerovox Corporation	90
Aladdin Radio Industries, Inc.	92
Amperex Electronic Products	78
Astactic Microphone Laboratory	102
Autopower, Inc.	111
A.R.R.L. Amateur’s Book Shelf, The	109
Back Copies & Binders	91
Calculators	86
Emblem	112
Handbook	95
How to Become a Radio Amateur	109
License Manual	110
Map	103
Message Blanks	113
Radio Amateur’s Library	119
Two Hundred Meters and Down	115
Birnbach Radio Company	106
Biley Electric Company	103
Brach Manufacturing Co., L. S.	116
Brazilian Trading Company, Inc.	86
Brush Development Company	116
Bud Radio, Inc.	124
Burgess Battery Company	85
Candler System Company	76
Capitol Radio Engineering Institute	90
Cardwell Manufacturing Corp., Allen D.	87
Central	113
Cohen’s Sons, I. S.	113
Collins Radio Company	Cov. 2
Cornell-Dubilier Corporation	106
Coto-Coil Company, Inc.	102
Delaware Radio Sales Company	122
Eitel-McCullough, Ltd.	81
Electrical Products Company, Inc.	122
Freck Radio & Supply Company	113
Gardiner Levering Company	114
General Electric Company	115
General Radio Company	80
Gross Radio, Inc.	127
Gulf Radio School	122
Hallcrafters, Inc., The	1, 2
Hammarlund Manufacturing Company	4
Harvey Radio Company	113
Harvey Radio Laboratories, Inc.	107
Hatry & Young	112
Heintz & Kaufman, Ltd.	97
Henry Radio Shop	94
Hipower Crystal Company	116
Instructograph Company	124
Jefferson Electric Company	74
Johnson Company, E. F.	108
Kenyon Transformer Company	67, 68, 69, 70
Leeds	75
Massachusetts Radio School	116
McElroy, T. R.	111
McGraw-Hill Book Company	82
M & H Sporting Goods Company	122
National Company	Cov. 3, 65, 93, 111
Newark Electric Company	89
New York Y.M.C.A. Schools	108
Ohmite Manufacturing Company	72
Omaha Crystal Laboratories	111
Port Arthur College	111
Precision-Piezo Service	124
Radiolab	117
Radio Mfg. Engineers, Inc.	83
Radio Shack	109
Radio Supply Company	109
Radio Transceiver Laboratories	118
RCA Institutes, Inc.	110
RCA Manufacturing Company	Cov. 4
Sargent Company, E. M.	97
Scientific Radio Service	118
Shure Brothers	114
Sickles Company, F. W.	108
Signal Electric Manufacturing Company	92
Standard Transformer Corporation	93
Sun Radio Company	113
Sundt Engineering Company	96
Taylor Tubes, Inc.	73
Teleplex Company	110
Terminal Radio Corporation	117
Thordarson Electric Mfg. Company	79
Transmitter Equipment Mfg. Company	71
Trimma Radio Manufacturing Company	108
Triplet Electrical Instrument Company	77
Turner Company	107
United Transformer Company	128
Universal Signal Appliance Company	96
Utah Radio Products Corporation	84
Valpey Crystals	114
Vibroplex Company	118
Ward Leonard Electric Company	94

NEW!!

CW-50—Uses 6L6 Tubes

FB for 30 MC
Output — 50 watts
42 osc., 6L6 Buffer
2-6L6 amp.

Coils can be supplied for 30, 14, 7, 3.5, and 1.7 MC Bands. Complete Kit, with one set Coils, less tubes and crystal..... **\$16.95**

Descriptive Bulletins on request

RECEIVER HEADQUARTERS!

We Are Authorized Distributors

RME 69, complete with tubes... \$134.90
RME DB-20 RF amp-selector... 39.95
Hallcrafters Sky Buddy complete 29.50
Hallcrafters Ultra Skyriders S-10 99.50
Hallcrafters Super Skyrider S-12 99.50
Hallcrafters Sky Chief complete 44.50
Hammarlund Super Pro..... 223.44

Come in for demonstration. Liberal allowances on your old set. Time payments arranged

GROSS CASED POWER TRANSFORMERS

650 v. ea. side C.T. 350 ma. fila. 2-7 1/2 v. C.T. and 1-5 v. will give 500 v. with choke input using 83 or 523 tubes. You can run your entire R.F. and class B off this trans..... \$5.95
750 v. ea. side C.T. 300 ma. fila 2-7 1/2 v. C.T. and 1-5 v..... \$5.95
750-1000 v. ea. side of C.T. 300 watts \$6.95
850-1350-1500 v. ea. side of C.T. 400 watts..... \$8.95
(The ideal job to give 750-1000-1250 v. D.C. with choke input)
850-1350-1500 v. ea. side of C.T. 550 ma..... \$12.50
1500-2000 v. ea. side of C.T. 800 watts. \$11.70

Cased Combination Filament Transformers
2 1/2 v. C.T. 10 amps. for 866's.
10 v. C.T. 7 amps. for '50's or '52's.
10,000 Volt Insulation..... \$3.25

Thordarson Cased Transformer, 600 volts each side of C.T. 200 ma 2 1/2 v. 10 amps. C.T. 5 v. 3 amps. 7 1/2 v. 3 amps. C.T..... \$2.45
Thordarson Choke, 12 H. 250 ma. \$1.95
We carry the complete Thordarson line at 40% and 2% from list price.

MOUNTED CENTER TAPPED FILAMENT TRANSFORMERS

2 1/2 v. 8 a — 2 1/2 v. 3 a — 5 v. 3 a... \$1.29
2 1/2 v. 4 a — 7 1/2 v. 2 1/2 a — 7 1/2 v. 2 1/2 a... \$1.29
2 1/2 v. 4 a — 5 v. 3 a — 7 1/2 v. 2 1/2 a... 1.29
5 v. 3 a — 7 1/2 v. 2 1/2 a — 7 1/2 v. 2 1/2 a. 1.29

Filament Transformers shielded in metal cases, center tapped secondaries
2.5 Volt 10 amperes for 866's..... \$2.25
10 to 12 Volts at 8 amperes..... 2.25

SENSATIONAL ANNOUNCEMENT

Gross Radio, realizing the needs of the ham for a real crystal, brought pressure to bear on Premier Laboratories, caterers to Government, Laboratory, Broadcast, and other commercial users of fine exact crystals.

Premier crystals now available at prices you pay for ordinary crystals. Formerly these crystals could only be bought by the lucky few able to pay the regular price 2 to 2 1/2 times our price.

When you buy Premier crystals, you are getting the finest crystals money will buy, real power oscillators, full size approx. 1" x 1" (not small chips, etc.), expertly finished and guaranteed accurate calibrations.

Mounted in new No. 400 Holder of new PL-39 with hand-lapped plates. Available exclusively from Gross Radio in New York. Supplied for the 40-80 meter bands at a new low price.

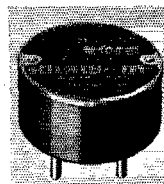

Within 5 KC of specified KC \$4.35

GROSS TRANSMITTER KITS

CW-25 Output 25-30 watts (Crystal Controlled). Complete kit less tubes and crystal..... **\$14.95**
P-25 power supply kit for above — 450 volts at 200 MA..... **\$11.00**

CW-60

(Uses New Eimac 35T)
Output—100 watts. Crystal Control Transmitter

Coils can be supplied for 30, 14, 7, 3, 5, and 1.7 Bands. Complete Kit, with one set Coils, less tubes and crystal..... **\$20.95**

Descriptive Bulletins on request

NEW!! HOYT BAKELITE CASE HOT WIRE ANTENNA METER

3 1/2" Across Flange, Mounts through 2 1/2" hole. Scale Length 1 1/4". Ranges: 0/1.5; 0/3; 0/5 Amps..... \$3.20

Aerovox Oil Impregnated Condensers

1 mfd. 1000 v..... \$1.59
2 mfd. 1000 v..... 1.97
4 mfd. 1000 v..... 2.85
1 mfd. 1500 v..... 1.67
2 mfd. 1500 v..... 2.30
1 mfd. 2000 v..... 2.09
2 mfd. 2000 v..... 2.79

6L6 modulation output transformer, P.P. plates to 3000, 4500, 6000 ohms (30 watts)..... \$3.65
6L6 General P.A. output transformer P.P. plates to 2, 4, 9, 15, 500 ohm lines (30 watts)..... \$2.95

Big Haynes Rig Checker, complete.. \$17.54
Little Haynes Rig Checker, complete 9.65
Triplett Modulation Monitor, complete..... 24.83
New Mac Key Bug..... 7.95
New Vibroplex Junior Bug..... 10.00
New Amerex H F 100 Tube..... 10.00

200 WATT VITREOUS RESISTORS With Variable Sliders

1000 ohms.
2500 ohms.
5000 ohms.
10000 ohms.
15000 ohms.
25000 ohms.
35000 ohms.
50000 ohms.
60000 ohms.
80000 ohms.
100000 ohms.

YOUR CHOICE

\$1.50 each

MODULATORS

30 Watt (Beam Power) 4 Stages — \$29.50

60 Watt (Beam Power) 4 Stages — \$42.50

See December Issue Page 69 for Complete Information

TAYLOR Custom Built TRANSMITTING TUBES

T55 — 55 watt plate dissipation..... \$8.00
T155 — 155 watt plate dissipation... 49.50
T200 — 200 watt plate dissipation... 21.50
866 Mercury Vapor Rectifying tube.. 1.65

EIMAC UNSURPASSED TRANSMITTING TUBES!

Performance — Ruggedness — Power — Price

Eimac 150-T (Output 150 to 450 Watts) \$24.50
Eimac 100-T (Input 2500 v.—225 ma.) \$13.50
Eimac 35-T..... 8.00

RAYTHEON TRANSMITTING TUBES

RK-10..... \$3.50	RK-28..... \$38.50
RK-15..... 4.50	RK-30..... 10.00
RK-16..... 4.50	RK-31..... 10.00
RK-17..... 4.50	RK-32..... 12.00
RK-18..... 10.00	RK-34..... 3.50
RK-19..... 7.50	RK-36..... 14.50
RK-20..... 15.00	RK-100..... 7.00
RK-21..... 5.00	841..... 3.25
RK-22..... 7.50	842..... 3.25
RK-23..... 4.50	866A..... 5.00
RK-24..... 2.25	872A..... 18.50
RK-25..... 4.50	

Raytheon RK-37 (Power Output 60 W.) \$8.00
Raytheon RK-38 (Power Output 225 W.) \$14.50
Raytheon RK-39 (Beam Power tube) \$3.50

NEW R. C. A. TUBES

New R.C.A. 913 Cathode Ray Tube. \$5.66
New R.C.A. 808 Tube..... 10.00
New R.C.A. 807 Tube..... 3.90

SPECIAL

6L6G..... \$8.85
6L6..... .85
6L6G with Isolantite base..... 1.75

20% DEPOSIT WITH ALL C. O. D. ORDERS

REMIT BY M. O. INCLUDE POSTAGE

Cable Address: GROSSINC

GROSS RADIO, INC., 51 VESEY STREET, NEW YORK CITY

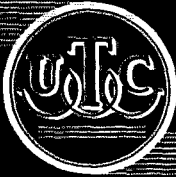

Most Complete Transformer
Line in the World

QUALITY • RELIABILITY

UTC VARIMATCH input and output transformers will match any modulator tubes to any RF load . . .

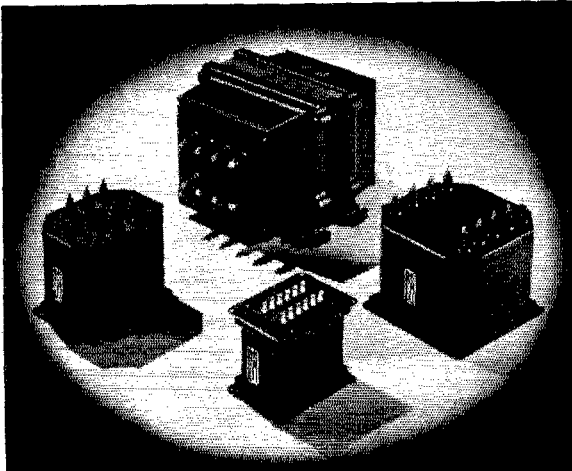

See for yourself . . .

Tubes in Push Pull	Plate Voltage	P to P Load	Approximate Audio Power in Watts	Driver Tubes	UTC Input	UTC Output
RK-30, 800	1000	12500	100	4S	PA 52 AX	VM-3
3S-T	1000	10000	115	2A3	" 53 AX	VM-3
3S-T	1250	12500	130	2A3	" 53 AX	VM-3
RK-18	1000	12000	100	2A3	" 53 AX	VM-3
RK-31	1000	13600	110	2A3	" 53 AX	VM-3
845	1250	8800	105	4S	" 52 AX	VM-3
825	850	8000	80	4S	" 52 AX	VM-3
756	850	6750	100	4S	" 52 AX	VM-3
50-T	1250	10000	135	2A3	" 53 AX	VM-3
203-A	1000	6900	200	2A3	" 53 AX	VM-4
242, 211						
838	1000	7600	200	2A3	" 53 AX	VM-4
830-B	1000	7600	175	2A3	" 53 AX	VM-4
805	1250	6700	300	2A3	" 53 AX	VM-4
50-T	1500	15000	175	2A3	" 53 AX	VM-4
50-T	2000	20000	250	2A3	" 53 AX	VM-4
203-A, 242, 2-H	1250	9000	260	2A3	" 53 AX	VM-4
808	1500	18300	200	2A3	" 53 AX	VM-4
T-55	1000	10000	175	2A3	" 53 AX	VM-4
T-55	1250	12000	250	2A3	" 53 AX	VM-4
HF-100	1000	7000	200	2A3	" 53 AX	VM-4
HF-100	1250	8800	250	2A3	" 53 AX	VM-4
HF-100	12000	300	2A3	" 53 AX	VM-4	
HF-100	1750	16000	350	2A3	" 53 AX	VM-5
805	1500	3200	370	2A3	" 53 AX	VM-5
204-A	2000	8800	600	845 or 4-2A3's	" 238 AX	VM-5
HK-354	2000	15000	400	2A3	" 53 AX	VM-5
HK-354	3000	25000	650	4-2A3's	" 238 AX	VM-5
150-T	1500	8000	350	4-2A3's, 845	" 238 AX	VM-5
150-T	2000	10400	500	4-2A3's, 845	" 238 AX	VM-5
150-T	2500	14000	650	4-2A3's, 845	" 238 AX	VM-5
HD-203-A	1750	9000	500	4-2A3's	" 238 AX	VM-5
822	2000	9000	500	4-2A3's	" 238 AX	VM-5
HF-200	2000	11200	500	4-2A3's	" 238 AX	VM-5
HF-200	2500	16000	600	4-2A3's	" 238 AX	VM-5
HF-300	2000	9600	650	4-2A3's	" 238 AX	VM-5

The Varimatch transformer will not only match PRESENT available modulator tubes, but any tube that may be released at a FUTURE date. All you have to decide is the DC input to your RF stage. Then just pick the VARIMATCH output transformer that will handle the maximum audio power required. The secondaries of all Varimatch transformers are designed to carry the Class C plate current.

VM-3 Will handle any power tubes to modulate a 100 to 250 watt Class C stage. Maximum audio output 125 watts. Net to Hams . . . **\$12.00**

VM-4 Will handle any power tubes to modulate a 200 to 600 watt Class C stage. Maximum audio output 300 watts. Net to Hams . . . **\$19.50**

VM-5 Will handle any power tubes to modulate a 450 watt to 1 KW plus, Class C stage. Maximum audio output 600 watts. Net to Hams. **\$42.00**

VARIMATCH INPUT TRANSFORMERS

PA-52AX Push pull 45, 59, 2A3 or 6L6 plates to 2-46 Class B grids. Push pull 45, 59, 2A3 or 6L6 plates to 4-46 or 59 Class B grids. Push pull 2A3's to 2-841, 35T, 50T, 756, 825 Class B grids. Net to Hams . . . **\$3.90**

PA-53AX Push pull 42, 45, 50, 59, 2A3 or 6L6 plates to two 210, 801, RK-18, 35T or 800 Class B grids. Push pull 2A3 plates to two 838, 203A, 50T, 35T, 211A, 242A, 830B, 800, RK-18, 801, 210, 55T, HF100 Class B grids. Net to Hams . . . **\$4.50**

PA-238AX Push pull parallel 2A3, 45, 50, 59 or 6L6 to four 805, 838, or 203A Class B grids. Push pull parallel 2A3, 45, 50, 59, 6L6 or two 211A, 845 plates to Class B-204A. HF-300 or 849 grids. Push pull parallel 2A3, 45, 50 or two 50-T, 211-A, 845 plates to Class B-150-T, HD-203-A or HF-200 Class B grids. Net to Hams . . . **\$10.50**

UTC ULTRA COMPACT UNITS

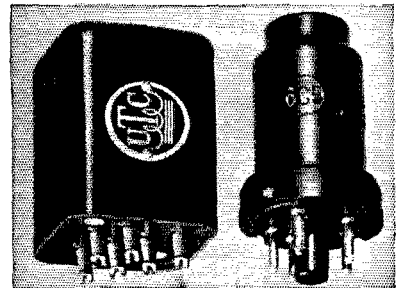

UTC Ultra Compact units are the smallest wide range audio units in their class. The frequency response is ± 2 DB from 30 cycles to 20,000 cycles; weight approximately 5/8 oz. These units employ a full hum balancing coil structure to effect minimum hum pickup. Net prices vary from \$6.00 down.

See these units on display or obtain UTC bulletins to complete listings and information, from your favorite distributor.

UNITED TRANSFORMER CORP.

72 SPRING STREET NEW YORK, N. Y.

EXPORT DIVISION - 100 VARICK STREET NEW YORK, N. Y. CABLES: "ARLAB"

THE TML — ACTUAL SIZE

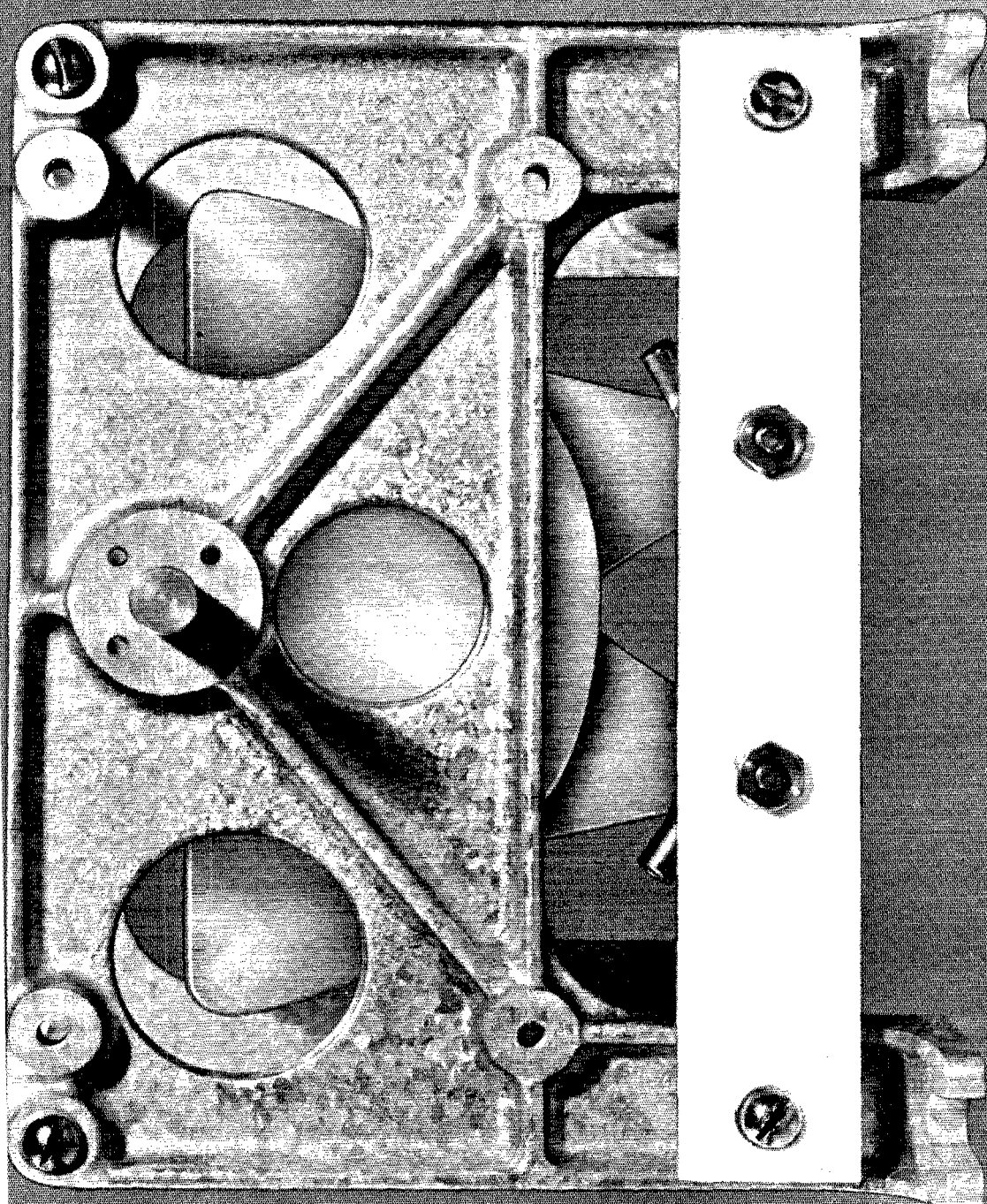

This actual size picture of the TML gives some idea of its ruggedness, its high voltage-handling ability, its thorough fitness for heavy duty jobs. Its price is right, too:—\$9.90 Net for the 50 mmf. 15,000-V. model. Another National product your dealer is proud to show you.

NATIONAL COMPANY, INC.

RCA-913 ... brings Oscillograph equipment within the reach of all!



RCA-913 actual size,
Amateur's net \$5.60

HERE'S a brand-new cathode ray tube, only $4\frac{3}{4}$ inches long, that is of tremendous value to amateurs, engineers and experimenters. RCA-913 is a high-vacuum, low-voltage electrostatic type with all metal construction and a fluorescent screen nearly one inch in diameter.

The 913 is ideal for use where a larger tube would be unsuitable. Its low price, convenient size, plus the fact that the 913 requires only a simple power supply (operates at a maximum of 500 volts and gives good images at voltages as low as 250) makes it particularly suitable for portable equipment, and a highly desirable unit to be built permanently into the transmitter for checking operation and modulation monitoring. Your supplier has the 913 in stock.

RCA presents the Metropolitan Opera every Saturday afternoon. Also "Magic Key of RCA" every Sunday, 2 to 3 P.M., E.S.T. Both programs via NBC Blue Network



for Amateur Radio

Address Amateur Radio Section, RCA Manufacturing Co., Inc., Camden, N. J.
A service of the Radio Corporation of America