

QST

December, 1936
25 cents

devoted entirely to

amateur radio

In this Issue—
**Using the
New Beam
Transmitting
Tubes**

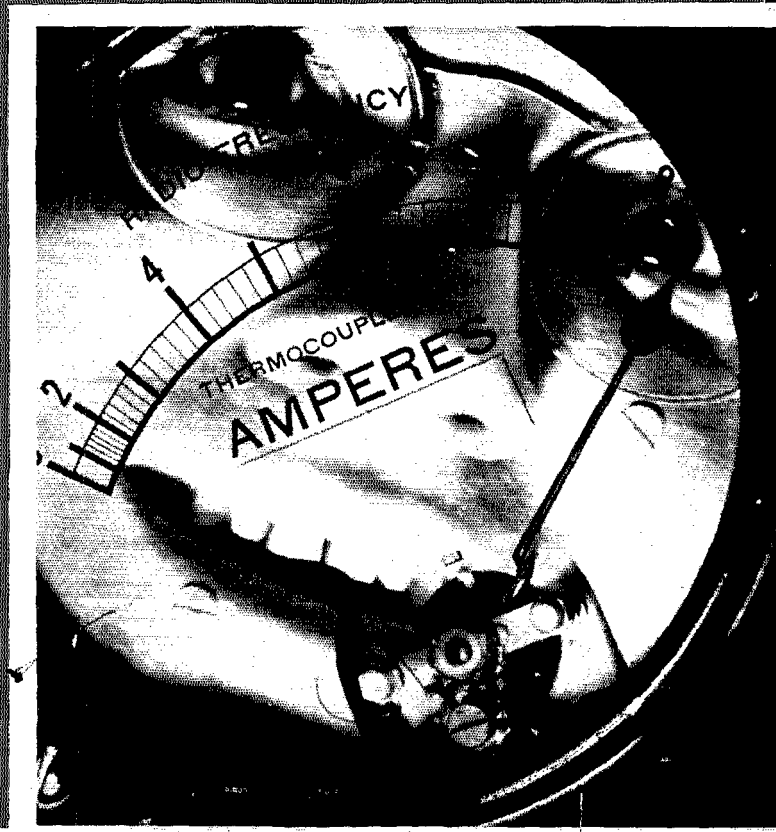

30FXC for 5, 10 and 20 Meter

The 30FXC transmitter can be supplied with the new 10X R-F Unit to amateurs who are particularly interested in the higher frequencies. The 10X R-F Unit requires the same panel space as the 10M unit ordinarily supplied but it employs a special tube and circuit arrangement adapted to the higher frequencies. The tubes are:

- 1—C100A Oscillator
- 1—6L6 First Frequency Multiplier
- 1—6L6 Second Frequency Multiplier
- 2—6L6 Third Frequency Multiplier
- 2—C800 or 2—C101 Power Amplifiers

The frequency range of the type 10X R-F Unit is 10 to 60 megacycles. The nominal plate input to the C800's in the final amplifier is 150 watts, giving an output of 100 watts at the lower radio frequencies and 60 to 75 watts at the highest radio frequency. The output circuit of the 10X R-F Unit is similar to that of the 10M and may be used with non-reactive high frequency lines, or it may be supplied with a matching network. Frequency change can be accomplished by means of plug-in coil assemblies. Both the grid circuit and the plate circuit of the final amplifier are tuned by front panel controls. All dials, including the oscillator and frequency multiplier stages are fitted with locks for fixing the position of the tuning condensers.

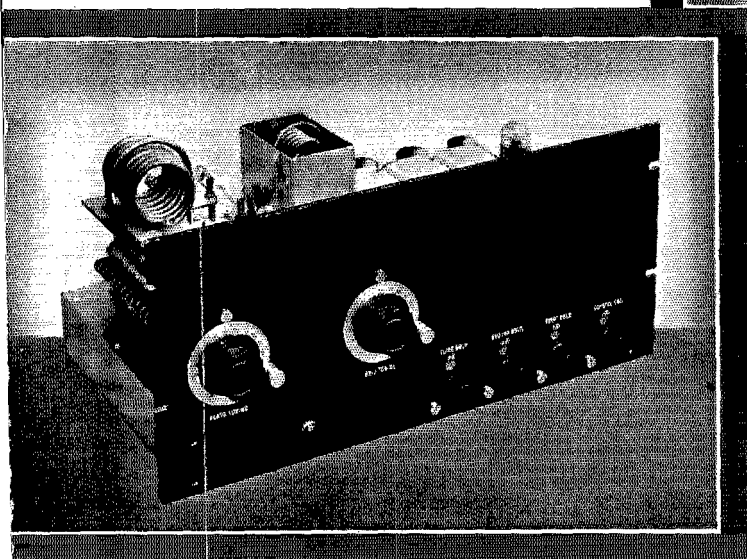
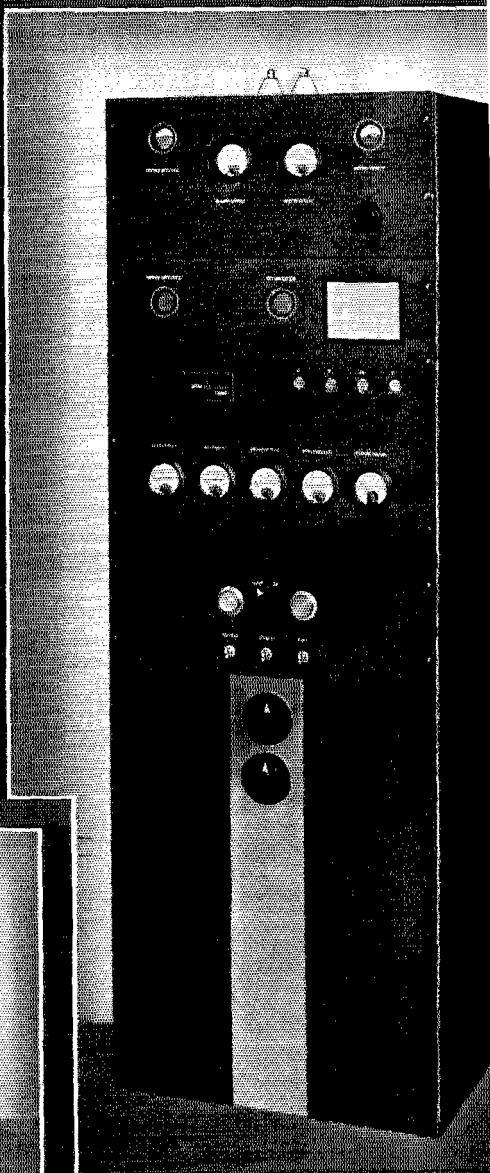

The standard 30FXC with 10M R-F Unit frequencies between 1.5 mc. and 30. Power output on phone or CW is 175 w. The 10X special high frequency unit illustrated in inset.

Collins Radio Company

CEDAR RAPIDS
New York
11 West 42nd St.



IOWA, U. S. A.
Mexico City
Edificio "La Nacional"



Band Spread Isn't All— It's TRUE SELECTIVITY that Counts!

Of what use is Band Spread alone in a communications receiver when true selectivity is lacking? There's ELECTRICAL Band Spread in the Super Sky Rider instead of mechanical band spread. This, combined with the Super Sky Rider's fine selectivity, makes an ideal combination.

However the principal advantage of the Super Sky Rider is its TRUE SELECTIVITY, (Total Band Width 12 K C at 1000 times down as compared with 20 K C in many communications receivers. With Crystal Filter, selectivity is even finer*). Tuning is so sharp, that nearly 50% more clear channels are available with the Super Sky Rider.

It is this true selectivity, with its other great new features that make the Super Sky Rider outstanding among communications receivers. See it at your jobbers today or write for complete information.

- | | | |
|-------------------------------------|--|---|
| ★ 11 Tubes, 10 of them metal. | ★ Direct calibration tuning — No charts or tables. | ★ 465 K. C. iron core I. F. for Improved selectivity. |
| ★ 40 M. C. to 535 K. C. in 5 bands. | ★ Field strength indicator. | ★ Ceramic insulation. |
| ★ 338 Degrees main tuning dial. | ★ Improved 10 meter performance. | ★ *Measurements made at I. R. E. standard frequency, 1000 K. C. |
| ★ Electro-mechanical band spread. | ★ Single signal crystal action. | |
| ★ 14 Watts undistorted output. | | |

The rich new solid walnut Super Sky Rider (Copper Lined) shown in the illustration above is now available at your jobbers

ALL HALLICRAFTERS RECEIVERS NOW AVAILABLE ON OUR TIME PAYMENT PLAN

the hallcrafters inc.

2611 INDIANA AVENUE

CHICAGO, ILL.

AMERICA'S LEADING MANUFACTURER OF COMMUNICATION RECEIVERS

TO EVERY AMATEUR—

WE RECOMMEND the NEW 1937 SUPER SKY RIDER

NOW AVAILABLE On Our TIME PAYMENT PLAN

BECAUSE we have operated the Super Sky Rider, because we have seen it built — and because we are exclusively a receiver house and feel ourselves competent to judge performance — we can enthusiastically recommend the Super Sky Rider to every amateur as one of the finest communications receivers obtainable.

Hinds & Edgerton, through our location in Chicago, are in excellent position to render prompt service on any of the Hallicrafters marvelous line of communication receivers. Mail the coupon below, for our complete Free catalog and details of our favorable time Payment Plan.

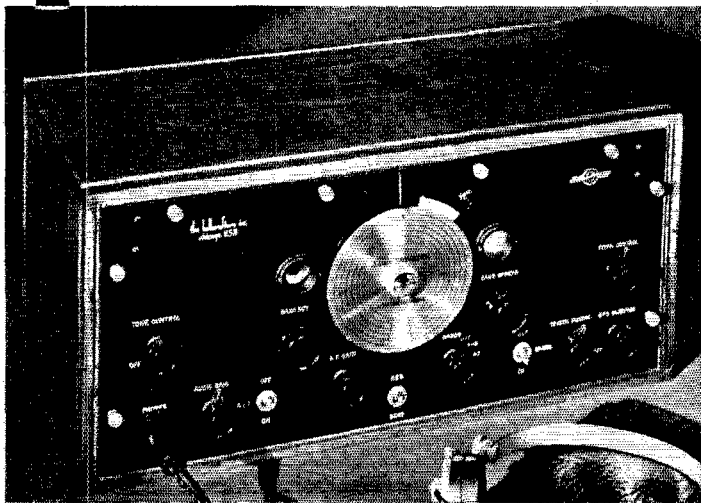

**FEATURES
THAT MAKE THE
SUPER SKY RIDER
THE OUTSTANDING
COMMUNICATIONS
RECEIVER OF THE YEAR**

- 11 Tubes, 10 of them metal.
- 40 M.C. to 535 K.C. in 5 bands.
- 338 Degrees main tuning dial.
- 14 Watts undistorted output.
- Direct calibration tuning — No charts or tables.
- Field strength indicator
- Improved 10 meter performance.
- 465 K.C. iron core I.F. for improved selectivity.

TIME PAYMENTS

Buy your new Hallicrafters receiver on Hinds & Edgerton's Time Payment Plan — small down payment and easy monthly payments — write at once for details!

MAIL THIS COUPON!

HINDS & EDGARTON

ESTABLISHED 1914

19 SOUTH WELLS ST. CHICAGO, ILLINOIS

Gentlemen: Please send me complete details of the New 1937 Hallicrafters Line and the Hinds & Edgerton Time Payment Plan.

NAME _____

ADDRESS _____

CITY _____

STATE _____

OPERATED BY W9APY AND W9WR



devoted entirely to

AMATEUR RADIO

PUBLISHED, MONTHLY, AS ITS OFFICIAL ORGAN, BY THE AMERICAN RADIO RELAY LEAGUE, INC., AT WEST HARTFORD, CONN., U. S. A.; OFFICIAL ORGAN OF THE INTERNATIONAL AMATEUR RADIO UNION

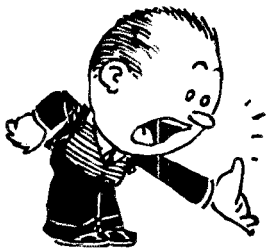

DECEMBER

1936

Volume XX

Number 12



Kenneth B. Warner (Secretary, A.R.R.L.), *Editor-in-Chief and Business Manager*; Ross A. Hull, *Associate Editor*; James J. Lamb, *Technical Editor*; George Grammer, *Assistant Technical Editor*; Clark C. Rodimon, *Managing Editor*; David H. Houghton, *Circulation Manager*; F. Cheyney Beekley, *Advertising Manager*; Charles Brunelle, *Assistant Advertising Manager*.

Editorial and Advertising Offices

38 La Salle Road
West Hartford, Connecticut

Subscription rate in United States and Possessions and Canada, \$2.50 per year, postpaid; all other countries, \$3.00 per year, postpaid. Single copies, 25 cents. Foreign remittances should be by international postal or express money order or bank draft negotiable in the U. S. and for an equivalent amount in U. S. funds.

Entered as second-class matter May 29, 1919, at the post office at Hartford, Connecticut, under the Act of March 3, 1879, Acceptance for mailing at special rate of postage provided for in section 1103, Act of October 3, 1917, authorized September 9, 1922. Additional entry at Concord, N. H., authorized February 21, 1929, under the Act of February 28, 1925.

Additional second-class entries to cover sectional editions authorized March 20, 1935. Copyright 1936 by the American Radio Relay League, Inc. Title registered at United States Patent Office.

The Contents

Editorials	9
Columbia Announces Annual Award	10
An Inexpensive Five-Band Low-Power Transmitter <i>George Grammer, W1DF</i>	11
A Versatile Crystal-Controlled U.H.F. Transmitter <i>Walter H. Grosselfinger, W2ATQ and Thomas Prosser</i>	17
What the League Is Doing	27
Operating Notes on the Transmitting-Type Beam Power Tube	28
A Moving Coil Tuning System for the High-Frequency Receiver <i>James Millen, W1HRX</i>	30
An All-Band 'Phone Transmitter Using Beam Power Tubes <i>G. Mathis, W3BES and J. B. Carter</i>	32
Rebuilding a Commercial-Type Condenser Microphone for Practical Ham Use <i>Robert S. Coe, W1CBG</i>	35
Miniature Cathode-Ray Tube Announced	37
A.R.R.L. Copying Bee — December 11th	38
Circuit Design of a Modern Amateur U.H.F. Superheterodyne <i>Karl Miles</i>	39
Amateur Radio Stations <i>W1HRX</i>	41
Hints and Kinks	
Cathode Ray Oscilloscope Switching Circuit — A Voltage Quadrupling Circuit — A Different Keying Monitor Arrangement — Negative Bias from the Plate Power Pack	44
Dixie Jones' Owl Juice	46
The 1936 VK/ZL DX Contest — First Scores	46
Calls Heard	47
I.A.R.U. News	48
Operating News	49
Correspondence Department	59
Silent Keys	66
New Amateur Tubes — Types 154, 807, RK-39, 808.	96
A.R.R.L. QSL Bureaus	108
Circulation Statement	108
Standard Frequency Transmissions	110
Delta Division Convention	112
Hamads	117
QST's Index of Advertisers	120



Bowdoin-Kent's Island Expedition Reports:

"Aid Secured.. Under Most Trying Conditions — a Tribute to Burgess Portable Power"



Burgess Batteries for communication and lighting service and for operating scientific apparatus on Bowdoin-Kent's Island Expedition.

W. A. O. Gross (left), director of the Bowdoin-Kent's Island Expedition. But he continued

—"Aid was secured by communicating with five-meter transceiver which was operated for a very long time under

"Expedition boat lost in dense fog—unable to reach base on Kent's Island"—so runs radiogram received from

most trying conditions—power source—Burgess Batteries—this incident constitutes a real tribute to your product."

Safety in time of danger—a friend in time of need—Burgess Portable Power meets all emergencies. Choice of experienced scientists and amateurs—best for your own radio and experimental work.

BURGESS BATTERY COMPANY
Freeport, Illinois



BURGESS



Taylor **HEAVY CUSTOM BUILT** DUTY Tubes

Compare —before you buy

Ultra High Frequency Tubes — Medium Power

Characteristics	TAYLOR T-55	TUBE A	TUBE B	TUBE C	TUBE D	TUBE E	TUBE F
Plate Dissipation Watts	55	35	75	50	35	60	35
Rated Watts Input	225	150	300	262	150	160	144
Price	\$8.00	\$8.00	\$13.50	\$12.50	\$8.00	\$10.00	\$10.00

Ultra High Frequency Tubes — High Power

Characteristics	TAYLOR T-155	TAYLOR T-200	TUBE 1	TUBE 2	TUBE 3	TUBE 4
Plate Dissipation Watts	155	200	150	150	200	100
Rated Watts Input	600	700	600	600	825	170
Price	\$19.50	\$21.50	\$24.50	\$24.50	\$35.00	\$16.40

— and be sure of

“More Watts per Dollar”

**TAYLOR
Carbon Anodes**

Taylor Carbon Anodes can be run at red heat without injury to filament emission but Taylor Carbon Anodes will not show any color when run at the rated plate dissipation.

ALL LEADING RADIO PARTS DISTRIBUTORS Recommend Taylor Tubes

Get your copy of the New Taylor Tubes Combined Catalog and Handbook No. RM from your favorite distributor or write to us . . . **FREE**

TAYLOR TUBES, INC., 2341-Q Wabansia Ave., CHICAGO, ILLINOIS

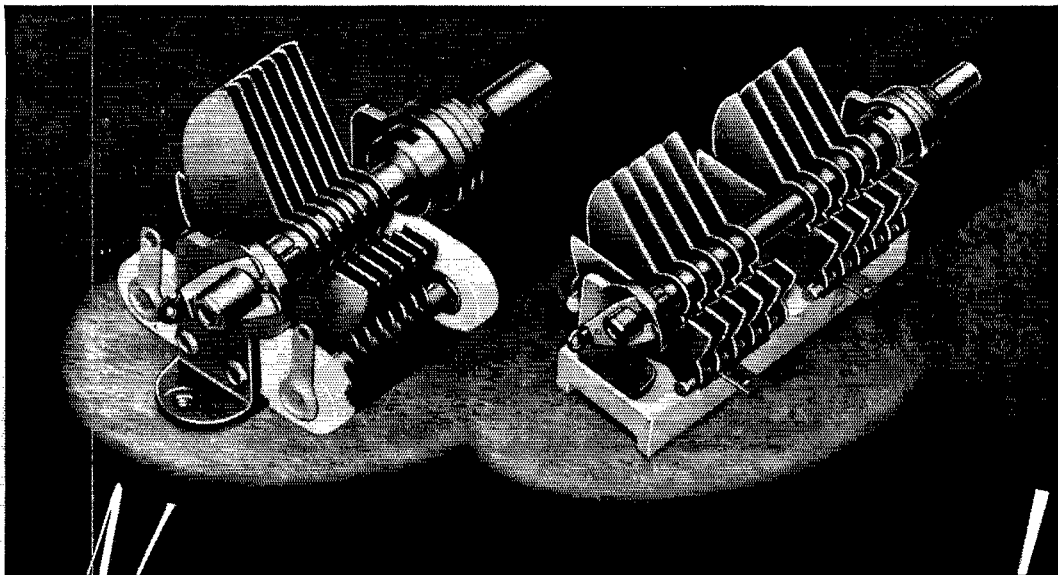

New MIDGET CONDENSERS!

HAMMARLUND proudly presents a new, complete series of "MC" variable condensers with exclusive features that set a new and dominant standard for condenser design.

Single and split-stator types use cadmium plated, soldered brass plates and Isolantite insulation to assure lowest losses

and highest efficiency under all conditions of temperature and humidity. Strictly noise-free operation, even at the ultra-high frequencies, is insured with a new split type rear bearing plus a new noiseless, silver plated Beryllium wiping contact.

Available in 27 different sizes — single and split-stator models — 20 to 325 mmf. — midline or semi-circular plates — single hole panel and base mounting. Illustrated above, are the "MC" single type with midline plates, and the "MCD-MX" split-stator type with double-spaced midline plates.

A special leaflet completely describing these new "MC" condensers has just been prepared and will be sent to you, free of charge. Just mail the coupon below.

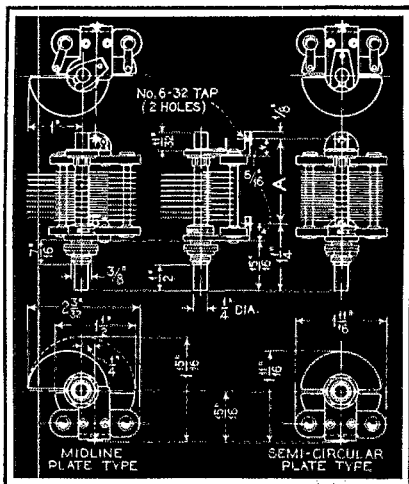

HAMMARLUND MANUFACTURING CO., INC.
424-438 W. 33rd St., New York City Q-12

- Check here for new "MC" leaflet.
- Check here for new Hammarlund "37" Catalog.

Name

Address

.....

HAMMARLUND'S 25TH YEAR



Section Communications Managers of the A.R.R.L. Communications Department

All appointments in the League's field organization are made by the proper S.C.M., elected by members in each Section listed. Mail your S.C.M. (on the 16th of each month) a postal covering your radio activities for the previous 30 days. Tell him your DX, plans for experimenting, results in 'phone and traffic. He is interested, whether you are an A.R.R.L. member or get your QST at the newsstands; he wants a report from every active ham. If interested and qualified for O.R.S., O.P.S. or other appointments he can tell you about them, too.

Eastern Pennsylvania Maryland-Delaware-District of Columbia Southern New Jersey Western New York Western Pennsylvania	W3EZ W3BAK W3ZNX W8DSS W8OFO	ATLANTIC DIVISION James M. Bruning Edgar L. Hudson Carroll D. Kentner Charles Smith Kendall Speer, Jr.	339 W. Lancaster Ave 1107 Park Ave. 310 E. Walnut St.	Haverford Laurel, Delaware Collingswood Onida Lowber
Illinois Indiana Kentucky Michigan Ohio Wisconsin	W9KJY W9TFE W9AUH W8DPE W8AQ W9ATO	CENTRAL DIVISION L. John Huntoon Arthur L. Braun G. W. Mossbarger Harold C. Bird E. H. Gibbs E. A. Cary	327 Brandon Ave. 530 East Morris St. Box 177 R.F.D. 2 300 High St. 3922 No. 19th PL	Glen Ellyn Indianapolis Camp Taylor Pontiac Wadsworth Milwaukee
North Dakota South Dakota Northern Minnesota Southern Minnesota	W9OEL W9SEB W9OWU W9DCM	DAKOTA DIVISION Hartwell B. Burner Andrew J. Kjar Leonard Hofstad Webster F. Soules	257 Prospect Ave. 3549 36th Ave., So.	Hope Pierre Elbow Lake Minneapolis
Arkansas Louisiana Mississippi Tennessee	W5ABI W5DWV W5CWO W4DEP	DELTA DIVISION H. E. Vette W. J. Wilkinson, Jr. J. H. Weems, Jr. B. G. Lowrey Smith	2918 West 15th St. 1523 Laurel St. P. O. Box 244 673 Hillcrest St.	Little Rock Shreveport State College Memphis
Eastern New York N. Y. C. & Long Island Northern New Jersey	W2LU W2AZV W2FOP	Hudson Division Robert E. Haight E. L. Baunach Charles J. Hammersen	511 South Holmes St. 102 Central Ave. 92 Claremont Ave.	Scotia Massapequa, L. I. Verona
Iowa Kansas Missouri Nebraska	W9LEZ W9PB W9CJR W9FAM	MIDWEST DIVISION Phil D. Boardman Harry E. Legler J. Dewey Mills Samuel C. Wallace	325 Kirkwood Blvd. 304 Miami St. Box 205 Green St.	Davenport Hawathia Mount Vernon Clarks
Connecticut Maine Eastern Massachusetts Western Massachusetts New Hampshire Rhode Island Vermont	W1CTI W1CDX W1ABG W1JAH W1BFT W1BRC W1GNF	NEW ENGLAND DIVISION Frederick Ellis, Jr. John W. Singleton Albert N. Giddis William J. Barrett Carl E. Evans Clayton C. Gordon Alvin H. Battison	19 Merrill Rd. 73 Allen St. 128 Crawford St. 239 Columbia St. 80 No. State St. 206 California Ave. 1 Central St.	Norwalk Wilton Lowell Adams Concord Providence Windsor
Alaska Idaho Montana Oregon Washington	K7PQ W7NH W7CRH W7AJV W7WY	NORTHWESTERN DIVISION Richard J. Fox Nellie H. Hart Russell U. Richmond Eugene E. Lovejoy Robert H. Votaw	Box 301 Box 6 5013 N. E. Clackamas Route 1, Box 398	Ketchikan Twin Falls Somers Portland Vancouver
Hawaii Nevada Santa Clara Valley East Bay San Francisco Sacramento Valley Philippines San Joaquin Valley*	K6EWO W6BIC W6FBW W6FTV W6SG W6DVE KAIGR W6LPE	PACIFIC DIVISION Atlas O. Adams Edward W. Heim Hibert Amaranes Harold J. Burchfield Alan D. Whitaker, Jr. Geo. L. Woodington George L. Rickard Angelo V. Astone	21st Infantry Brigade 509 Claremont St. 475 So. 11th St. 240 16th Ave. 79 Elinor Ave. 716 Redwood Ave. Box 849 729 Safford	Schofield Barracks Reno San Jose Oakland Mill Valley North Sacramento Manila Fresno
North Carolina Virginia West Virginia	W4OG W3UVA W8KKG	ROANOKE DIVISION H. S. Carter Charles M. Waff, Jr. Dr. Wm. H. Ribedaffer	115 Crafton St. P. O. Box 1212	Winston-Salem Univ., Charlottesville Lost Creek
Colorado Utah-Wyoming	W9FA W7COH	ROCKY MOUNTAIN DIVISION Glen Glasscock Townsend J. Rigby	2164 So. Corona St.	Denver Midwest, Wyoming
Alabama Eastern Florida	W4DGS W4ASR	SOUTHEASTERN DIVISION James F. Thompson William C. Shelton	2248 S. Arlington Ave. 536 Westmoreland Drive "Hillcrest", P. O. Box 652 1517 East Brainard St.	Birmingham Daytona Beach Pensacola
Western Florida Georgia-So. Carolina-Cuba- Isle-of-Pines-Porto Rico- Virgin Islands	W4MS W4CE	Edward J. Collins Bannie L. Stewart	 C.C.C. Co. 4466	 York, S. C.
Los Angeles Arizona San Diego	W6GXM W6LVG W6EOP	SOUTHWESTERN DIVISION Don M. Draper C. C. Day Harry A. Ambler	4421 West 63 St. "La Posta Quemada" 4101 Hamilton St.	Los Angeles Vail San Diego
Northern Texas Oklahoma Southern Texas New Mexico	W5BII W5CEZ W5BDI W5CGJ	WEST GULF DIVISION Richard M. Cobb Carter L. Simpson Ammon O. Young Joseph M. Eldodt	Box 185 2010 So. 4th St. 4803 Eli St.	Dodd City Ponca City Houston Chamita
Maritime	VE1DQ	MARITIME DIVISION A. M. Crowell	69 Dublin St.	Halifax, N. S.
Ontario	VE3SG	ONTARIO DIVISION Fred H. B. Saxon	302 Lee Ave.	Toronto, Ont.
Quebec	VE2EE	QUEBEC DIVISION Stan Comach	780 Brault Ave.	Verdun, P. Q.
Alberta British Columbia	VE4LX VE5EP	VANALTA DIVISION Alfred D. Kettenbach D. R. Vaughan-Smith	635 Garfield St. 1221 Burnaby St.	Winnipeg Vancouver
Manitoba Saskatchewan	VE4BG VE4EL	PRAIRIE DIVISION A. J. R. Simpson Wilfred Skalte	71 Thelmo Mansions 2040 McTavish St.	Winnipeg Regina

* Officials appointed to act until the membership of the Section choose permanent S.C.M.'s by nomination and election.

The American Radio Relay League



• T

HE AMERICAN RADIO RELAY LEAGUE, INC., is a non-commercial association of radio amateurs, bonded for the promotion of interest in amateur radio communication and experimentation, for the relaying of messages by radio, for the advancement of the radio art and of the public welfare, for the representation of the radio amateur in legislative matters, and for the maintenance of fraternalism and a high standard of conduct.

It is an incorporated association without capital stock, chartered under the laws of Connecticut. Its affairs are governed by a Board of Directors, elected every two years by the general membership. The officers are elected or appointed by the Directors. The League is non-commercial and no one commercially engaged in the manufacture, sale or rental of radio apparatus is eligible to membership on its board.

"Of, by and for the amateur," it numbers within its ranks practically every worth-while amateur in the nation and has a history of glorious achievement as the standard-bearer in amateur affairs.

Inquiries regarding membership are solicited. A bona fide interest in amateur radio is the only essential qualification; ownership of a transmitting station and knowledge of the code are not prerequisite. Correspondence should be addressed to the Secretary.

HIRAM PERCY MAXIM, FOUNDER

OFFICERS

- President*.....EUGENE C. WOODRUFF, W8CMP
State College, Pa.
- Vice-President*.....GEORGE W. BAILEY, W1KH
Weston, Mass.
- Secretary*.....KENNETH B. WARNER, W1EH
West Hartford, Connecticut
- Treasurer*.....ARTHUR A. HEBERT, W1ES
West Hartford, Connecticut
- Communications Mgr.*...F. EDWARD HANDY, W1BDI
West Hartford, Connecticut
- ◆
- General Counsel*.....PAUL M. SEGAL
1010 Shoreham Building, Washington, D. C.
- ◆

Address all general correspondence to the executive headquarters at West Hartford, Connecticut

DIRECTORS

- President*
EUGENE C. WOODRUFF.....W8CMP
234 W. Fairmount Ave., State College, Pa.
- Vice-President*
GEORGE W. BAILEY.....W1KH
74 Webster Road, Weston, Mass.
- Canadian General Manager*
ALEX REID.....VE2BE
169 Logan Ave., St. Lambert, P. Q.
- Atlantic Division*
WALTER BRADLEY MARTIN.....W3QV
Box 612, Roslyn, Pa.
- Central Division*
EDWARD A. ROBERTS.....W8HC
2699 Endicott Rd., Shaker Heights, Cleveland
- Dakota Division*
CARL L. JABS.....W9BVH
1822 James St., St. Paul, Minn.
- Delta Division*
E. RAY ARLEDGE.....W5SI
P. O. Box 286, Pine Bluff, Ark.
- Hudson Division*
KENNETH T. HILL.....W2AHC
115 Willow St., Douglaston, L. I., N. Y.
- Midwest Division*
FLOYD E. NORWINE, JR.....W9EFC
120 South Fourth St., St. Louis, Mo.
- New England Division*
PERCY C. NOBLE.....W1BVR
37 Broad St., Westfield, Mass.
- Northwestern Division*
RALPH J. GIBBONS.....W7KV
c/o United Air Lines, Pendleton, Ore.
- Pacific Division*
S. G. CULVER.....W6AN
2962 Russell St., Berkeley, Calif.
- Roanoke Division*
H. L. CAVENESS.....W4DW
State College Station, Raleigh, N. C.
- Rocky Mountain Division*
RUSSELL J. ANDREWS.....W9AAB
1867 So. Lafayette St., Denver, Colo.
- Southeastern Division*
BENNETT R. ADAMS, JR.....W4APU
1512 Grove Place, Homewood, Ala.
- Southwestern Division*
CHARLES E. BLALACK.....W6GG
443 Main St., El Centro, Calif.
- West Gulf Division*
WAYLAND M. GROVES.....W5NW
c/o Humble Pipe Line Co., Neches, Texas

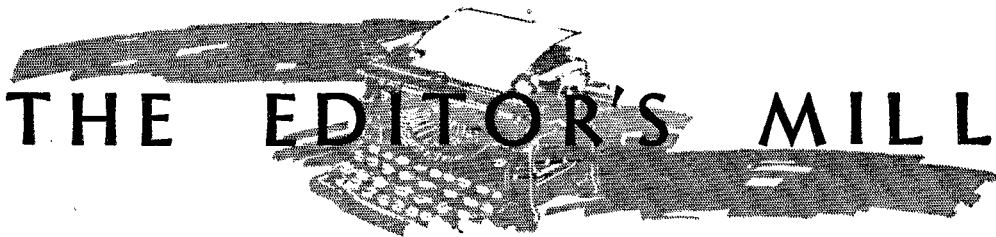

THE EDITOR'S MILL

WITH this issue *QST* comes of age. Twenty-one years ago this month, in December of 1915, the early members of the American Radio Relay League received their first copy, a little blue-covered magazine of twenty-two pages. Our League itself is older, having been formed in the spring of 1914. The rapid growth of the relay idea soon made it imperative to have some means of regular contact between the members. Dedicated to this need, the first issue of *QST* was subtitled the December Radio Relay Bulletin. Our League of those days having almost no finances of its own, the magazine appeared as the private venture of Clarence D. Tuska and the late Hiram Percy Maxim, our secretary-editor and president of that time. Announcing now the attainment of our majority, we are proud to say that *QST* is the oldest radio magazine in this country and, as far as we are aware, the oldest in the whole world.

Our earliest years were hectic but immensely interesting. The avidity with which American amateur radio received a magazine of its own was inspiring. The office of our youthful editor, a college student, was in the attic of his home, the work done after class hours. The printing was done by the father of another local amateur. The finances were elementary: the month's receipts had been so much, the membership list had now grown to so many, how many pages would this much money print? Thus *QST* straightway attained respectable proportions and was firmly ensconced as the amateur's own magazine. When an issue came off the press, the early officers of the League and the members of their family would devote an evening to wrapping the issue, a job which was regularly done on a table in Mr. Maxim's library. The copies were then put in a mail bag, tossed into Mr. Maxim's car, and driven to the post office. What a far cry from today, when a considerable staff works the month long on the job and when machinery spins for days to grind out tons and tons of copy for readers everywhere!

The owner of a complete set of *QST*'s may well be proud of them. Filling nearly five feet of bookshelf, they truly constitute the five-foot shelf of amateur radio knowledge. They are a history of our entire movement, a record of its traditions, a textbook of its technical practices. So great is the amateur appreciation of *QST* that the early files

have attained a considerable money value. Our Circulation Department has long had no copies prior to 1925 and we do not deal in the older copies, but we notice a brisk trade in them in "Ham-Ads." Our first issue is now a collector's piece and seems to command a price of about \$15.00, the whole of Volume I at least \$30.00, the pre-war issues generally several dollars apiece, the earlier post-war issues at least a dollar apiece, while a complete file is easily worth around \$200.00. Of course this is just a sidelight but one that we think our readers may find interesting.

Since the war, *QST* has been owned by the League itself, that is to say, by the members of the League. A place where they may foregather for the discussion of triumphs and problems alike, it has been built largely by their own contributions. Certainly it may be said that it has been built altogether by that splendid spirit which is amateur radio's. Since 1925 it has also been the official organ of the International Amateur Radio Union. Today it is read by nearly every amateur in America, by innumerable foreign hams, and copies find their way to almost every civilized spot on the globe. It will be found in every laboratory worthy of the name, including many a one of a foreign government.

When amateurs first began to work internationally, there were many persons who believed that this relationship would lend great impetus to the movement for an international auxiliary or synthetic language which could be readily mastered by peoples of every tongue. We ourselves thought so in those early days and devoted much study to the question. The project failed completely, for a rather astounding reason, and we don't know but that it then and there sounded the death knell of the auxiliary language movement. The explanation now sounds simple: As amateurs sprang into existence in other countries, following the early transatlantic successes, they found it imperative to read *QST* as a guide to successful practice. As a result of this need to read and understand *QST*, countless thousands of foreign amateurs have acquired a satisfactory working knowledge of English. It is indeed called "*QST* English." Thus English has become indisputably the language of international amateur radio. We have ourselves met and conversed in English with scores of foreign amateurs who as-

sert that their knowledge of the language came solely from the study of *QST*! (What a responsibility, considering the way we hams are tempted to mutilate our mother tongue!)

We have perhaps talked too much about ourselves but it is supposed to be our privilege on this birthday. Because of the unique nature of *QST* as a medium through which amateurs everywhere may cooperate, *QST* has been happily

privileged to contribute substantially to the advance of our art. Carrying the torch in many an uphill struggle, endeavoring always to conduct ourselves in terms of the greatest good to the biggest number, we have participated in many profound changes in amateur radio. We renew our pledge to strive ever onward to even greater things, and with your continued help we'll do it!

K. B. W.

Columbia Announces Annual Award to be Given America's Outstanding Amateur Radio Operator

WILLIAM S. PALEY, president of the Columbia Broadcasting System, has announced the offer of a permanent award to be presented annually to that individual who, through amateur radio, in the opinion of an impartial Board of Awards, has contributed most usefully to the American people, either in research, technical development or operating achievement.

Mr. Paley has designated the American Radio Relay League as the permanent custodians of the award. Upon it will be engraved each year the name of the winner of the award. A smaller replica will be presented to the individual selected as the winner by an impartial board of experienced authorities on amateur radio activities.

Five noted men have been selected to serve on this Board of Award, it was announced by Mr. Paley on October 17th. The members of the board are Rear Admiral Cary T. Grayson, chairman of the American Red Cross; C. P. Edwards, director of radio for the Canadian Department of Marine; Anning S. Prall, chairman of the Federal Communications Commission; J. H. Dellinger, chief of the radio section of the United States Department of Commerce's National Bureau of Standards, and A. E. Kennelly, professor emeritus of electrical engineering at Harvard University.

All members of the board are experienced authorities on amateur radio activities and their recommendations will be followed by Columbia in presenting the annual award of merit to the nation's most outstanding amateur operator.

This action was taken because Mr. Paley felt that the useful service which amateur operators had rendered to stricken communities during the flood disasters in the early part of 1936 was only a single example of the very great contribution they have made to radio communication as it exists today. For the purposes of the award only persons living in the United States and Canada will be considered eligible. Such an arrangement

will make possible a thorough and fair survey of accomplishment without regard to national boundaries but within a single geographical unit.

When Mr. Paley announced the original plan for the award he expressed the hope that members of the board would not look upon their duties as being in the nature of selecting the winner in a contest, but would endeavor to recognize outstanding work and experimentation done by amateurs and acknowledge meritorious service to the American people and to the advancement of radio communication.

"In the development of major industries, as in the growth of sports," he said, "the amateur precedes the professional; and we in commercial broadcasting owe a debt of gratitude to those thousands of experimenting enthusiasts who first broke the ground in the limitless field that is radio to-day. The great progress that the amateurs have made in the past 20 years has been an inspiration to us in our particular sphere of endeavor. In establishing this annual award, I wish it to be an acknowledgment of the valuable contribution which amateur radio operators in the United States and Canada have made to radio science and communication, as well as to the public service which they have rendered in times of emergency."

Mr. E. K. Cohan, Director of Engineering of the Columbia Broadcasting System, a member of the American Radio Relay League since its earliest days, made the announcement of the award, on behalf of Mr. Paley, at the Chicago Convention of the A.R.R.L. before thousands of amateurs assembled from all parts of the United States and Canada.

The exact nature of the award itself is at present in process of determination. Seven young sculptors of distinctive merit have been selected to submit their concepts and interpretations of a design for the trophy. Each is giving very considerable thought to the design in an effort to develop something distinctly in the spirit of amateur radio communication.

Inasmuch as it will take several months to collect and examine the data and recommendations on which the award will be based, it is not anticipated that the selection of the winner will be made prior to March 15th.

An Inexpensive Five-Band Low-Power Transmitter

A 20-Watt Output Rig Suitable for C.W. or Plate-Modulated 'Phone

By George Grammer,* W1DF

SELECTING a design for a low-power transmitter capable of operating both c.w. and 'phone on all regular communication bands is not altogether easy. When it becomes necessary to balance cost of tubes, apparatus, and power supply against simplicity, ease of operation and power output (especially modulated power output), some careful figuring is required in order to reach a satisfactory conclusion.

Probably the great majority of low-power transmitters average a power input of about thirty watts. At this power level a very effective transmitter could be built up using a small transmitting pentode as the output tube—but a 500-volt plate supply would be required, and there would also be the necessity for special arrangements should plate modulation be used. Furthermore, it is doubtful if any appreciable saving in apparatus would result, since to cover a number of bands with one crystal practically the same number of tuned circuits is required regardless of the tube line-up.

In planning the transmitter to be described, therefore, it seemed to us that the most economical way to get effective performance, both c.w. and plate-modulated 'phone, on all five bands was to use inexpensive receiving tubes, provide as many stages as might be necessary to give adequate excitation for the final amplifier on all bands, and use straightforward, time-tried circuits. Although there are four stages in all, the transmitter is fundamentally simple both in

design and operation, and its performance has justified the reasoning behind it.

As we have intimated, the necessity for 'phone operation was a consideration in the design of the set. The description of the modulator, however, will be left for a later issue, the present article being confined to the transmitter itself, an antenna coupler, and the power supply.

THE TRANSMITTER CIRCUIT

The circuit diagram is given in Fig. 1. The crystal oscillator tube is a 41, used in the standard pentode circuit. The output of this tube may be fed either to a 41 doubler connected as a high- μ triode, or to a 41 neutralized amplifier-doubler also used as a triode, but with the screen tied to the plate. The doubler stage is used only when it becomes necessary to operate the final amplifier on a frequency four times that of the crystal. The final stage uses two 42's in push-pull, used as triodes with screens and plates tied together.

Considering now some of the individual features of the practical circuit diagram, it will be observed that parallel feed is used on all three driving stages. This was done because, since it was deemed desirable to build the whole transmitter on a metal sheet to obviate grounding difficulties and unwanted interstage couplings, it permitted mounting most of the tuning condensers directly on the metal base and eliminated the need for the insulation which series feed would have required. Parallel feed has the incidental advantage that there is no danger of accidental

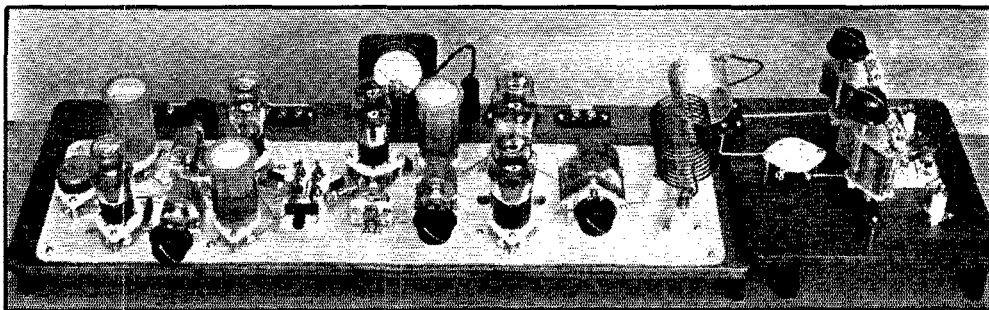

A LOW-COST 20-WATT FIVE-BAND TRANSMITTER USING RECEIVING TUBES

Built in breadboard style, this rig has four stages, one of which can be cut in or out as needed, and can be plate-modulated on any regular communication band on which radiotelephony is permitted. The antenna-tuning and coupling apparatus, a separate unit, is at the right.

shock should a condenser shaft and the metal base be touched simultaneously. Series feed is used in the final stage, but in this case, the rotor of the split-stator condenser is grounded so that the d.c. appears only at the stator plates.

Since pentode oscillators often are a bit "touchy" about the load to which they are connected, provision is made for tapping the plate coil, L_1 , at a point suitable for feeding into either of the two tubes which may follow the oscillator. This procedure permits obtaining maximum output from the oscillator without overloading.

A double-pole double-throw switch, S_w , cuts the doubler in and out of the circuit. When thrown to the lower position, the oscillator output feeds into the doubler grid and the plate output of the doubler is fed into the grid of the third 41 which we will call the "driver" for purposes of identification. Series grid feed is used on both doubler and driver, the grid leak in each case being connected across the grid coupling condenser. When the switch is in the upper position, the oscillator is connected to the driver and the grid of the doubler is grounded. Since the doubler is connected as a high- μ triode, its plate current drops to a negligible value under these conditions and it is therefore unnecessary to shut off its plate supply.

The driver tube is partly cathode-biased through the use of R_6 , which is by-passed by C_{11} . The purpose of this is to hold down its plate current under conditions when it is not excited, since with the screen tied to the plate the μ is rather low. The high- μ connection could be used here, but the alternative method is preferable for a number of reasons, among them being the fact that the low- μ connection is more suitable for working directly into the grids of the final stage without provision for an impedance step-down.

Series grid feed is used in the final stage. A grid

leak, R_5 , is used to give automatic bias with excitation; a pair of terminals also are provided for the use of additional fixed bias, if this is deemed desirable. Keying is in the amplifier cathode circuit. In the amplifier plate circuit, a pair of terminals is provided for the introduction of modulation; these must be shorted for c.w. operation. The amplifier is cross-neutralized in the usual way.

Jacks for reading plate current are available in the plate-feed circuits of all four stages.

One last point about the circuit diagram: Bypass condenser C_{10} , connected between positive B and ground on the plate-supply side of the doubler plate choke, may not be absolutely necessary, but in the practical transmitter made some improvement in the performance of the doubler. Its probable function is to ground any r.f. which might leak by the plate chokes, all of which meet at the common positive high-voltage lead. It will be noted that all of the tubes in the set are operated at the same plate voltage.

THE PRACTICAL TRANSMITTER

The transmitter is built in breadboard fashion, the baseboard measuring 26 by $8\frac{1}{2}$ by $\frac{1}{2}$ inches. Runners along the ends, $1\frac{1}{4}$ inches high, provide room underneath for mounting miscellaneous parts. A sheet of thin aluminum, 24 by 6 inches, runs along the front part of the baseboard; all r.f. parts are mounted above or below this sheet, which serves as a ground.

The order of parts above the base is as follows: Starting at the left, first in line is the socket for the crystal oscillator. Next, to the front, is the socket for the oscillator tube; continuing in line are the oscillator plate condenser, C_1 , and coil, L_1 . To the rear, directly in back of the oscillator tube, is the doubler plate coil, L_2 ; to its right is C_2 , with its shaft pointing to the rear, and then the doubler

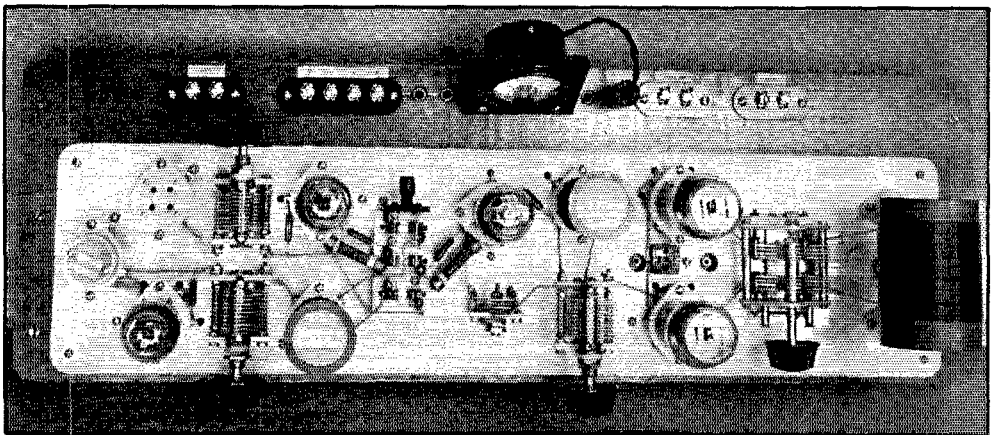

A PLAN VIEW OF THE TRANSMITTER WITH THE 1.75-MC. COILS IN PLACE

The location of the various components is discussed in the text.

tube socket. The doubler cut-out switch is next in line, to the right of the doubler tube and L_1 . Next, to the front, is the driver neutralizing condenser, C_{15} , with the driver tube directly behind it. To the right of the driver tube is its plate coil, L_3 ; in front of L_3 is the driver plate tank condenser, C_2 . These are followed by the two tubes of the final amplifier, then the final plate tank condenser, C_4 , and last, the plate tank coil L_4 .

Inspection of the photograph will show the placement of the few remaining parts above the baseboard. The plate blocking condensers, C_6 , C_7 , and C_{12} , for the oscillator, doubler and driver tubes respectively, are mounted by their wire leads close to the plate prongs on the tube sockets. The doubler and driver grid condensers, C_3 and C_9 , are likewise close to the proper socket prongs and to the movable arms of the switch to which they are connected. The grid leaks, R_3 and R_4 , are mounted close to the condensers. The final amplifier cathode by-pass condenser, C_{14} , is between the two tube sockets. The oscillator feedback condenser, marked C in the diagram and shown dotted between oscillator plate and grid, is of very small capacity and is made by bringing a short length of No. 14 tinned wire near the lead between the oscillator tube grid prong and the crystal socket. It can be seen in the top-

connected to the plate circuit is about $1\frac{1}{2}$ inches long. This condenser may not be needed, although the grid-plate capacity is so low in the 41 that it may be difficult to get a low-frequency crystal,

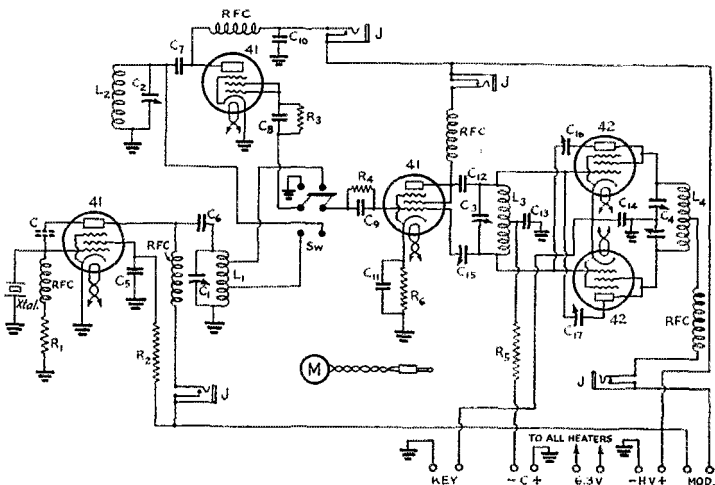

FIG. 1—CIRCUIT DIAGRAM OF THE LOW-POWER TRANSMITTER

- C —Feedback condenser (see text).
 C_1, C_2, C_3 —100- μ fd. midget variable (National ST-100).
 C_4 —Split-stator condenser, 100 μ fd. per section (National TMS-100D).
 C_5 —0.01- μ fd. paper, 400. C_{15}, C_{16}, C_{17} —15- μ fd. midget (Cardwell ZR-15-AS).
 C_6, C_7 —250- μ fd. mica. R_5 —7500 ohms, 10-watt.
 C_8, C_9 —100- μ fd. mica. R_6 —600 ohms, 2-watt.
 C_{10}, C_{11} —0.002- μ fd. mica. R_7 —50,000 ohms, 2-watt. J—Single closed circuit jacks.
 C_{12} —250- μ fd. mica. R_3, R_4 —10,000 ohms, 2-watt. M—0-100 d.c. milliammeter, small size.
 C_{13}, C_{14} —0.002- μ fd. mica. R_1, R_2 —50,000 ohms, 2-watt.

especially one ground for 1.75 mc., to oscillate without it.

All above-board wiring is of No. 14 tinned copper wire. Grounds are made directly to the metal sheet by the shortest possible connections. The switch, Sw , is a standard product which comes furnished with a fibre cross piece. This has been removed and replaced by one home-made from bakelite in the interests of better insulation for the r.f. which the switch must carry.

Terminal strips for the various connections are mounted along the rear edge of the baseboard. The plate milliammeter, mounted on the small bakelite panel fastened to the baseboard with angle brackets, is at the rear center, with the plate jacks on either side. The latter are mounted underneath the board, and project into holes through the base so that the meter plug goes in vertically. There is

thus no danger of shock from touching the jacks.

The arrangement of parts underneath the baseboard is shown in another photograph. By-pass condensers and r.f. chokes are mounted as closely as possible to the above-board circuits to which

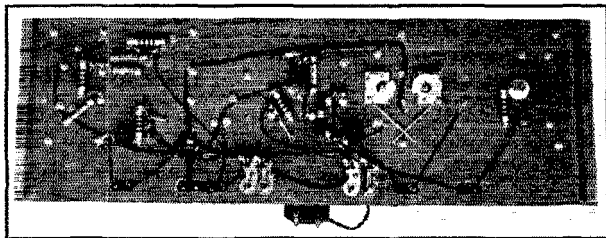

WIRING AND PARTS BELOW THE BASEBOARD

Chiefly bypass condensers, r.f. chokes and resistors. The only r.f. components are the neutralizing condensers for the final stage.

view photograph. A connection is brought from the stator plates of C_1 to an unused prong on the crystal socket, and the wire "condenser" is soldered to the same prong. Separation between the two wires is about $1/16$ inch, and the wire

they belong, and r.f. ground leads are short. Since all of the components on top of the board are fastened to the base by means of machine screws running through the board rather than by wood screws, plenty of ground connections are available. To mount the plate-current jacks, holes are drilled in the flat metal parts and the jacks fastened down by short wood-screws.

The neutralizing condensers for the final stage are mounted underneath the board as shown. Connections to these condensers are made as symmetrical as possible. None of the leads or metal parts of the condensers touch the wood; the condensers are mounted by means of wood screws running through the holes in the Isolantite end plates, and are held above the board by short tubular spacers. The condenser shafts project through holes in the baseboard so they can readily be adjusted from above by means of a screwdriver.

Chokes, condensers and resistors are as a general rule mounted on small bakelite lug strips except for those connections which go direct to ground. To avoid leakage, no r.f. leads are allowed to touch the wooden base, all holes through which such leads are run being drilled large enough to allow plenty of clearance. The plate feed connection for the final stage is made through a jack-top porcelain feed-through insulator.

Referring once more to the top of the baseboard, it will be noted that C_3 , the driver tank condenser, is mounted on porcelain standoffs (the particular ones used are National Type GS-1 with the metal parts removed). This is necessary to insulate C_3 from the metal base, since both sides of the condenser are at high r.f. potential because of the neutralizing circuit.

THE ANTENNA COUPLER

A satisfactory system of antenna coupling for any transmitter, whether low- or high-power, always is a problem, especially when it is not known in advance what type of antenna is going to be used. The coupler illustrated in the photograph is a compromise outfit, particularly adaptable to use with antenna systems involving a ground connection or tuned feeders. It is essentially simple, consisting of a pickup coil, a pair of tuning condensers, and a switch for connecting the condensers either in series or parallel with the coil and feeders. Provision also is made for the insertion of loading inductance, should it be needed, by means of the four-prong socket on the coupler baseboard. The circuit diagram is given in Fig. 2.

The arrangement is such as to permit variable

inductive coupling between pickup coil and final-amplifier tank coil. The coupler baseboard measures 9 inches wide by $8\frac{1}{2}$ inches deep; the runners underneath are $1\frac{3}{4}$ inches high so that the left-hand edge of the baseboard can slide over the transmitter baseboard without touching it. The left-hand runner is $1\frac{1}{2}$ inches from the edge of the baseboard. The pickup coil, L_1 in Fig. 2, is mounted on a $1\frac{3}{4}$ -by- $2\frac{1}{2}$ -inch platform of bakelite which projects off the edge of the board and is in turn mounted on a wooden riser which brings the axis of the pickup coil to the same height as the axis of the final tank coil in the transmitter.

Coupling between the two coils can readily be varied by moving the antenna-coupling unit about so that the spacing between the two coils can be changed. The general view of the set shows moderately-close coupling between the two coils.

Should link coupling be preferred to inductive coupling, the pickup coil may be omitted from

the antenna coupler, the antenna coil and its link being wound on a four-prong form and plugged into the socket on the base. Identical links would then be used at both transmitter and coupler end. Some amateurs may prefer this method to the inductive coupling shown, especially if it is desirable to locate the antenna coupler some distance from the transmitter.

The fibre strip on the series-parallel switch should be replaced by a bakelite strip, just as was done with the switch in the transmitter.

The two tuning condensers are mounted on a half-inch wide bakelite strip 7 inches long, which in turn is mounted somewhat above the wood. This avoids any possible leakage through the wood, a precaution which is not hard to take.

POWER SUPPLY

The power supply needs little comment, since it is quite conventional in design. Inexpensive receiving-type components are used throughout. The particular transformer specified has just about the right power capacity and voltage output to run the whole rig without difficulty, being loaded to about rated capacity when all four stages are working. Using either an 83 or 83-V rectifier, the output voltage is approximately 380 under full load. No bleeder is used, the chief reason for its omission being to avoid overloading the transformer. A light bleeder of about 50,000 ohms might be used to discharge the condensers when the transmitter is out of operation, if desired, although normally the condensers will discharge through the tubes in the transmitter when the primary power is shut off.

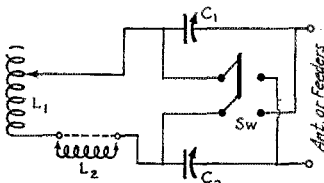

FIG. 2—THE ANTENNA COUPLER CIRCUIT DIAGRAM

- C_1, C_2 —250-mfd. variable (National TMS-250).
- L_1 —12 turns No. 14 bare wire, diameter 2 inches, spaced to occupy length of $1\frac{3}{4}$ inches.
- L_2 —Depends upon antenna system, if used. See text.
- Sw—Double-pole, single-throw midjet knife switch.

To avoid the expense of a separate filament transformer, the filament winding on the power transformer is used to supply the heaters of the tubes in the transmitter. During stand-by periods between transmissions, therefore, the power supply must be left "on" in order to keep the tube heaters up to temperature. The simplest switching method is to open and close the negative connection between the power supply and transmitter, a system which, while perfectly satisfactory from an operating standpoint, places quite a strain on the filter condensers during stand-by periods when the power supply is delivering no current. Electrolytic condensers with ordinary surge ratings will not stand up under this treatment; special condensers with high surge ratings *must* be used. The particular condensers specified have been found to be satisfactory in this service. We do not recommend the paper replacements for electrolytics because, although they are satisfactory from the voltage standpoint, a paper replacement for an 8- μ f. electrolytic has considerably lower capacity and the filtering is inadequate.

OPERATION

Considerable flexibility is possible in the method of operating the transmitter to get output on various bands. Recommended combinations are given in the table below:

Crystal Osc. Freq. Mc.	Doubler Freq. Mc.	Driver Freq. Mc.	Amplifier Freq. Mc.
1.75	Cut out	1.75	1.75
1.75	Cut out	3.5	3.5
1.75	3.5	7	7
1.75	7	14	14
3.5	Cut out	3.5	3.5
3.5	Cut out	7	7.0
3.5	7.0	14	14
3.5	14	28	28
7.0	Cut out	7.0	7.0
7.0	Cut out	14	14
7.0	14	28	28

From this table it can be seen that the "doubler" may be used either as a doubler or quadrupler, and the "driver" as either a straight amplifier or doubler. For working on the band next above that in which the crystal frequency lies, it is recommended that the driver be used as a doubler rather than to use the regular doubler and feed the driver as a straight amplifier; the excitation to the final stage is about the same with either method and cutting out the doubler is simpler from the operating standpoint.

With quadrupling in the second stage, quite good output can be obtained from the final stage

at eight times the crystal frequency. The excitation for the final is lower, of course, than with successive doubling in each stage, and this procedure is therefore recommended for c.w. work only, not for 'phone. However, it offers a ready means for working four bands with one crystal. If the builder is the holder of a Class-B license, opera-

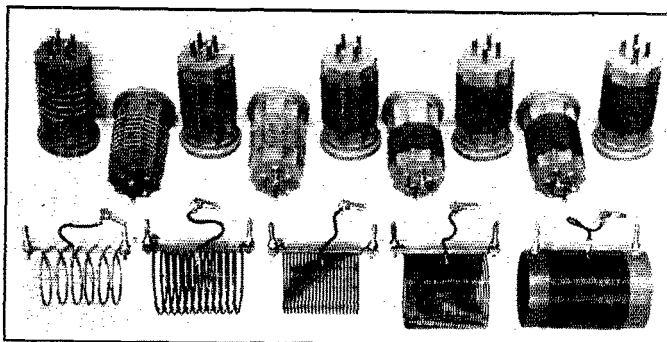

COMPLETE SET OF COILS FOR ALL FIVE BANDS

Note the flexible center-taps on the final-amplifier tank coils in the foreground. The G. R. plugs on these leads are inserted in a jack-top feed-through insulator on the baseboard.

COIL DATA

	Freq. Mc.	Diameter Inches	Length Inches	No. of Turns	Wire Size	Tap
L ₁	1.75	1½	1½	55	24	26 & 38
	3.5	1½	1½	29	18	20 & 29
	7.0	1½	1½	15	18	9 & 15
L ₂	3.5	Use L ₁ for same frequency				
	7.0	"	"	"	"	"
	14.0	1½	1½	8	18	None
L ₃	1.75	1½	1½	60	24	Center
	3.5	1½	1½	40	18	Center
	7.0	1½	1½	18	18	Center
	14.0	1½	1½	10	18	Center
	28.0	1½	1	4	18	Center
L ₄	1.75	2½	2¾	56	18	Center
	3.5	2½	2¾	32	16	Center
	7.0	2	2½	22	16	Center
	14.0	2	2¾	12	12	Center
	28.0	2	2¾	6	12	Center

NOTE.—Taps are counted from lower (ground) end of coil. Higher taps on L₁ go to grid of driver through Sw; lower taps to grid of doubler, also through Sw. L₁, L₂ and L₃ are wound on Hammarlund bakelite plug-in forms, four prong. L₄ for 1.75 Mc. is wound on bakelite tubing; for 3.5, 7, and 14 Mc., the coils are Barker and Williamson Nos. 80A, 40A and 20A respectively, with taps soldered to center turn. L₄ for 28 Mc. has turns cemented to celluloid strips. Turns on all coils should be spaced evenly to fill the length specified above.

tion on 160 and 10 meters on 'phone, and on c.w. on all bands, can be carried out satisfactorily with only two crystals. The frequency of the first should be between 1,800 and 1,950 kc., and that of the second between 7,000 and 7,075 kc. or between 7,125 and 7,200 kc. These frequencies will be satisfactory for doubling into the successively higher-frequency bands, and will avoid the Class-A 'phone assignments.

TUNING ADJUSTMENTS

Tuning is not a complicated process, although it should be carried out with care. Connect the power supply and key, and connect jumpers across the external bias and modulation terminals. If a second d.c. milliammeter of about 0-50 or

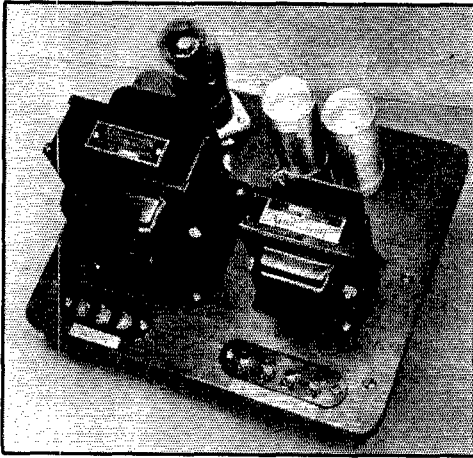

THIS POWER SUPPLY TAKES CARE OF THE WHOLE TRANSMITTER

Low-cost receiving-type components are used. The rectifier is an 83-V.

0-100 range is available, it may be connected to the bias terminals to measure grid current in the final stage. Useful accessories for tuning are a small neon bulb, a thin stick whittled at the end to serve as a screwdriver for adjusting the neutralizing condensers (the use of such a tool rather than a regular screwdriver avoids unwanted capacity effects), and a 'phone plug which is left open.

The first step is to get the oscillator working. With the crystal and the proper oscillator plate coil in their sockets, open the doubler switch, *Sw*, and insert the meter plug in the oscillator plate-current jack. Put the dummy plug in the driver plate-current jack; this will open the driver plate circuit and prevent the tube's drawing excessive plate current during the adjusting process. The key should be open to perform the same job for the final stage. Now turn *C*₁ down slowly from maximum capacity until the oscillator plate current dips from its non-oscillating value of about 50 milliamperes to about 10 or 15 milliamperes, indicating oscillation.

Assuming that the driver tube is to be operated on the same frequency as the oscillator, insert the proper coil in its place circuit and, without changing any of the plugs, close *Sw* in the rear position (in the photograph, upper position in Fig. 1). Closing the switch probably will cause the oscillator to stop, so *C*₁ must be returned to make it

start again; the proper condenser setting will be found at a lower value of capacity. Touch the neon bulb to the grid of the driver and adjust *C*₁ for maximum glow. The driver is now ready for neutralizing.

To neutralize the driver, touch the neon bulb to one side of *C*₃ and rotate *C*₂ slowly until the bulb glows. Tune for maximum glow, then adjust the neutralizing condenser, *C*₁₅, to cause a reduction in glow. With each adjustment of *C*₁₅, readjust *C*₃ to maximum glow, which indicates that the tank circuit is in resonance with the crystal frequency. It probably also will be necessary to readjust *C*₁ slightly to keep the oscillator at maximum output, since changing *C*₃ and *C*₁₅ will change the oscillator tuning slightly. Continue the process until a setting of *C*₁₅ is found at which it is impossible to get the neon bulb to glow for any setting of *C*₃. This point of neutralization is quite sharp, and moving *C*₁₅ slightly in either direction will cause the glow to reappear. Once the correct setting of *C*₁₅ is found, it need not be changed for various bands provided the driver plate coils are wound carefully with uniform spacing between turns, and providing the taps on the coils are on the center turn.

Once the driver is neutralized, the meter plug may be transferred from the oscillator to the driver jack. Rotate *C*₂ until the driver plate current drops to its lowest value, which indicates resonance. This minimum plate current at resonance should be about 10 to 15 milliamperes with the key open; with the key closed it should rise to

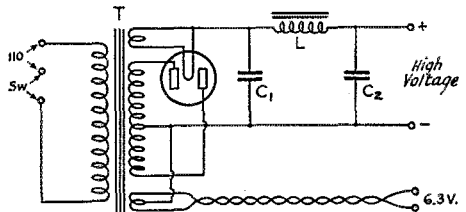

FIG. 3—POWER SUPPLY DIAGRAM

T—Power Transformer, 375 v. each side center-tap, with 6.3-volt and 5-volt windings. (Thordarson T-7062).

L—Filter choke; 8.75 henrys at 150 ma. (Thordarson T-1700).

*C*₁, *C*₂—8-μfd. high-surge electrolytic condensers (Malory UR-187).

about 30 ma.; the exact value will depend upon the band on which the transmitter is operating. There should be a substantial neon glow at the grids of both final-amplifier tubes.

To use the driver as a doubler, insert the proper plate coil in the socket and tune *C*₃ as before, leaving the neutralizing condenser untouched. The plate-current dip should be about as with straight amplification. In both cases, the plate-current with *C*₃ set off resonance should be in the neighborhood of 70 or 80 ma.

(Continued on page 66)

A Versatile Crystal-Controlled U.H.F. Transmitter

A Compact 100-Watt Design for 14-, 28-, and 56-Mc. Operation with Automatic Control Including VODAS for 'Phone

By Walter H. Grossefinger,* W2ATQ, and Thomas Prosser**

THE progress of amateur communication on the ultra-high frequencies has been aided greatly during the past few years through the development of more efficient circuit components. The radio transmitter described here makes use of two of these by incorporating vacuum tubes designed expressly for ultra-high-frequency operation.

The WE306A vacuum tube is a pentode of the filamentary type having low internal capacities and a center-tapped filament which adds to the efficiency by effectively reducing the inductances in the filament circuit. The WE305A, a four-element screen-grid tube, provides an efficient amplification medium on the three bands for which the transmitter was designed. The final amplifier operates at an efficiency of 55-75% depending upon the frequency band used. Normal input to the final amplifier is 160 watts.

Stability of the carrier is maintained to better than 0.04% of the specified frequency regardless of temperature, humidity or modulation, by the use of a low-coefficient quartz plate ground to seven megacycles. One quartz plate is satisfactory for the three frequency bands on which the transmitter operates. Plug-in coils were used where mechanical design did not interfere with the efficiency of the circuit arrangement.

An outstanding feature of the unit is its simplicity of operation with the "Voice Operated Delayed Amplification System" (VODAS). The "VODAS" is an adaptation of the system used in commercial telephone circuits and defined "Voice Operated Device Anti-Sing."¹ This system is inferior to commercial types but is satisfactory for amateur service. The entire radio transmitter is placed in an operating condition by pressing one of the control buttons located either at the remote position on the speech amplifier or on the rectifier unit. The key switch provides for the selection of either of three types of operation, "VODAS-CW-Manual." In either operating position, circuit and relay adjustments are so arranged that relays operate to ground the antenna and open the plate supply voltage on the receiver before the radio-frequency carrier is

applied to the antenna; it is not necessary in the "VODAS" position to make any manual circuit changes while operating the communications system. As an added protection to the receiver, a neon tube is placed between the grid of the first tube and ground. In the "CW" position, the telegraph key operates the necessary relays and performs the same function. For the "Manual"

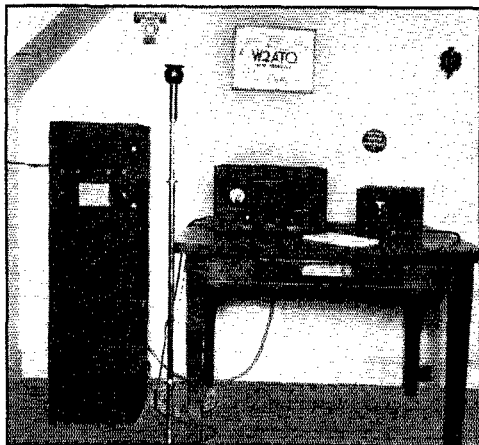

FIG. 1—THE COMPLETE TRANSMITTER (AT THE LEFT) IN ITS HOME LOCATION AT STATION W2ATQ

The speech amplifier unit, with the superhet receiver at its right, is on the operating table.

position the key on the speech amplifier is moved to "Manual" to apply the carrier and place the receiver in a non-operative condition. Keying at 30 w.p.m. with break-in is accomplished. Return to the "CW" position operates the receiver and shuts off the transmitter carrier; that is, if the telegraph key is not operated. The entire transmitting system is shut off by C-bias failure or pushing either of two stop buttons, one located on the transmitter and the other on the speech amplifier.

The stability of the transmitted carrier justifies the use of the new commercial u.h.f. radio receivers which are certainly far too selective to receive the present frequency-modulated radio transmitters on the 56-megacycle amateur band.

* 2473 Elm Place, N. Y. C.

** 542 Eastern Parkway, Brooklyn, N. Y.

¹ "Sing" is expounded as audio feedback.

The audio frequency characteristic of the entire transmitting system is uniform to within 2 db over the 50- to 11,000-cycle range. The acoustic fidelity was not measured. The distortion factor measured at 400 cycles with a General Radio

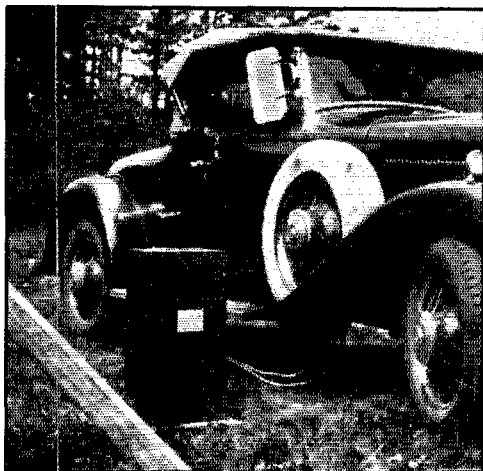

FIG. 2—ON PORTABLE LOCATION FOR FIELD-STRENGTH TESTS AT MANORVILLE, LONG ISLAND, N. Y.

distortion factor meter is 4% at 85% modulation.

We consider this unit "portable" only because we have been using it for such work. It weighs 400 pounds complete. However, it was simple to "break down" the units and transport them. The transmitter has traveled both in automobiles and boats with equally successful results. Thus far it has seen little amateur service, having been used mainly in field strength measurements in the vicinity of 56 megacycles. The photo of Fig. 2 was taken on portable location at Manorville, Long Island, New York, where most of the tests were conducted. A double-voltage generator (900 volts d.c.—110 volts a.c.) was driven by the auto engine and connected to it by a single-plate disc clutch. The clutch arrangement allowed the car to be used without running the generator. Since about 4 horsepower are required to drive the generator, a disconnecting provision is quite an asset.

THE RADIO-FREQUENCY UNIT

The chassis model of the radio-frequency unit, for which the circuit is given in Figs. 4 and 5, was constructed entirely of cardboard prior to a satisfactory solution of apparatus placement and shielding problems encountered. Drawings for the metal model were then made and the transmitter became an actuality. The material for the chassis

and shielding is $\frac{1}{16}$ -inch soft aluminum which can be bent in either direction without fear of cracking. All drillings were made before assembly and a $\frac{3}{8}$ -inch lip was bent on each piece of shielding wherever it butted against another piece. All component parts of the shielding were fastened with 6-32 binder-head brass machine screws, nuts and shake-proof lock washers. They were cadmium plated to maintain uniformity of appearance and to prevent corrosion. The chassis proper consists of thirteen individual pieces. Those adjacent to the WE305A tubes were given a high polish to aid in heat deflection. (See Fig. 3.) Much concern will probably be given to the compactness of the radio-frequency unit. It could probably be spread out to cover half of a relay rack, but this is neither necessary nor desirable. "Hot" leads are kept as short as possible and proper shielding improves the efficiency of the transmitter. (See Figs. 6 and 7.) No trouble was experienced as the result of heat in the modulator unit. However, in the radio-frequency section it was found desirable to use forced draft ventilation on the WE305A vacuum tubes when the transmitter is operated in a constant-carrier position. This was accomplished by the installation of a small blower placed in the r.f. unit under the 3rd amplifier tank circuit. Large Fahnestock clips connect to the studs at the top of the WE305A tubes to aid heat radiation. The transmitter has been in continuous operation for a twelve-hour period during which time field strength measurements were made at 100% modulation at the

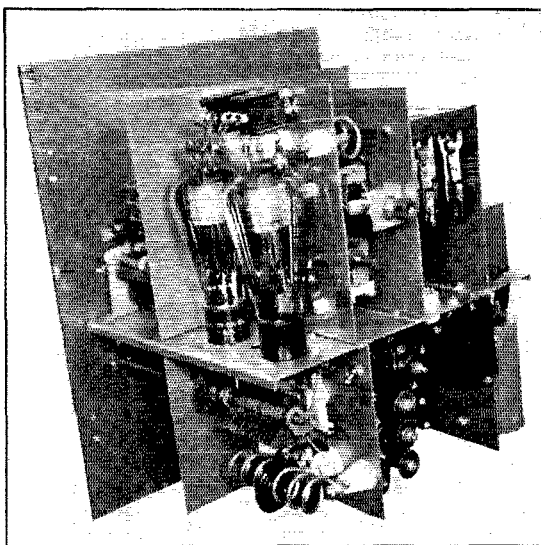

FIG. 3—THE R.F. UNIT VIEWED FROM THE RIGHT SIDE. THE COMPONENTS ARE IDENTIFIED IN THE TEXT

portable location in Manorville, Long Island, New-York. The tuning was periodically checked

and found stable at all times without readjustment.

The frame of the r.f. unit serves two purposes. It forms a sturdy mounting for the transmitter and with its cover completes the shielding of the radio-frequency unit. It is constructed of $\frac{1}{16}$ -inch by $\frac{3}{4}$ -inch extruded aluminum angle, fastened at the corners with gusset plates and

$\frac{3}{8}$ -inch diameter were punched in the covers to provide ventilation for the vacuum tubes and the resistances mounted in the voltage-divider compartment. This method of ventilation was preferred to screening because greater mechanical protection is afforded. Ventilating facilities were carefully planned, as the covers form a very vital part of the shielding system, particularly in the

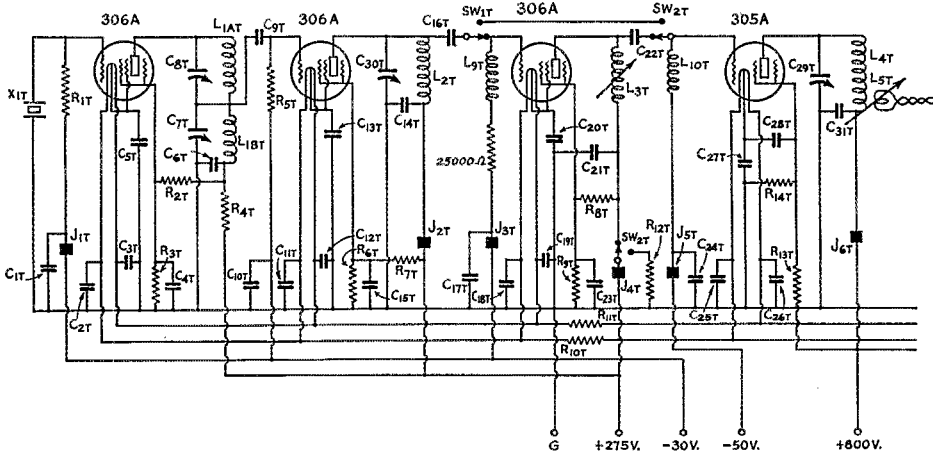

FIG. 4—CIRCUIT OF THE OSCILLATOR AND TWO DOUBLER STAGES OF THE R.F. UNIT

- | | | | |
|---|--|---|---|
| $L_{1a}T$ to L_{8T} , inc.—See coil table. | C_{27T} —0.005- μ fd. | C_{32T} —0.001- μ fd. | R_{3T} —100,000-ohm. |
| L_{9T} to L_{12T} , inc.—R.f. choke coils (Ohmite). | C_{28T} —0.001- μ fd. | C_{34T} —0.002- μ fd. | R_{4T} —1000-ohm. |
| C_{1T} to C_{6T} , inc.—0.002- μ fd. | C_{29T} —35- μ fd. | M_{1T} —2.5 amp. thermocouple meter (meter external). | R_{5T} —20,000-ohm. |
| C_{7T} , C_{8T} —50- μ fd. | C_{30T} —25- μ fd. | SW_{1T} —S.p.d.t. toggle switch. | R_{6T} , R_{7T} , R_{8T} —10,000-ohm. |
| C_{9T} —0.001- μ fd. | C_{31T} , C_{32T} —0.001- μ fd. | SW_{2T} —D.p.d.t. toggle switch. | R_{9T} —50,000-ohm. |
| C_{10T} to C_{21T} , inc.—0.002- μ fd. | C_{33T} —35- μ fd., each section. | SW_{3T} —D.p.d.t. toggle switch. | R_{10T} , R_{11T} —0.65-ohm. |
| C_{22T} —0.001- μ fd. | C_{34T} —0.002- μ fd. | R_{1T} —100,000-ohm. | R_{12T} —9000-ohm. |
| C_{23T} to C_{26T} , inc.—0.002- μ fd. | C_{35T} to C_{38T} , inc.—0.005- μ fd. | R_{2T} —20,000-ohm. | R_{13T} —25,000-ohm. |
| | C_{39T} —0.001- μ fd. | | R_{14T} —15,000-ohm. |
| | C_{40T} , C_{41T} —0.002- μ fd. | | R_{15T} —20,000-ohm. |
| | C_{42T} —35- μ fd., each section. | | R_{16T} —100,000-ohm. |
| | | | R_{17T} —25,000-ohm. |

$\frac{1}{8}$ -inch aluminum rivets. It would be advantageous to substitute structural aluminum $\frac{1}{8}$ -inch thick because of the tendency of the lighter extruded stock to warp when riveted. Two pieces of angle iron fastened at right angles on a bench will facilitate in maintaining squareness when drilling and assembling the frame. The gusset plates were made from $\frac{3}{32}$ -inch half-hard aluminum sheet.

The covers for the frame were made of $\frac{1}{16}$ -inch half-hard aluminum sheet. Perforations of

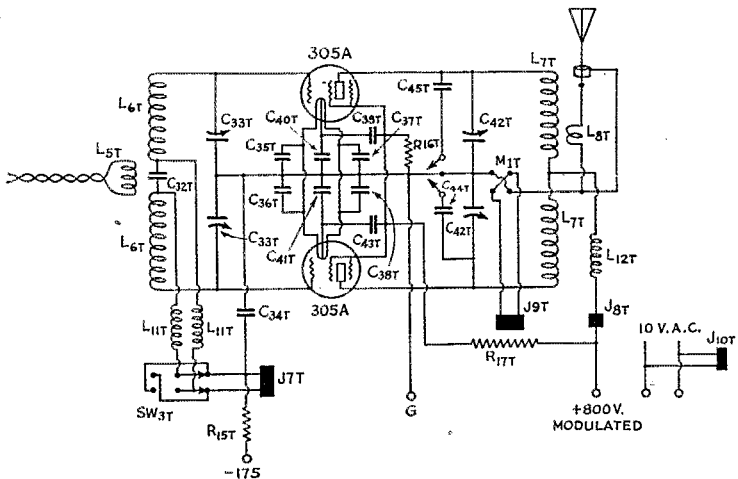

FIG. 5—THE PUSH-PULL FINAL AMPLIFIER CIRCUIT CONSTANTS ARE GIVEN UNDER FIG. 4

final amplifier where a slight unbalance may cause erratic operation and consequently shorter tube life with a resultant loss in efficiency. A small trap door is provided for the meter-jack

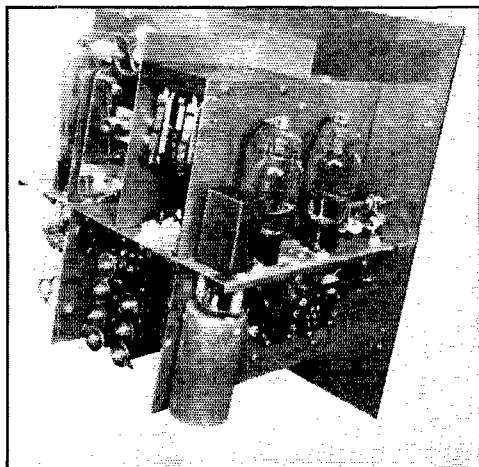

FIG. 6—THE R.F. UNIT VIEWED FROM THE LEFT SIDE, SHOWING THE CRYSTAL OSCILLATOR AND HARMONIC AMPLIFIER

mounting plate. This door allows access for the measurement of the oscillator grid current, the second amplifier grid current, the third amplifier (buffer) grid current and p.a. grid current. Filament voltage is also checked at this opening, as is the antenna current, the plate current of the first harmonic amplifier, second harmonic amplifier, third amplifier and power amplifier.

Measurement of the grid current of either of the final amplifier tubes is possible through a toggle switch mounted at the rear of the chassis. A $\frac{1}{16}$ -inch aluminum crinkled finished mat covers the $\frac{1}{8}$ -inch aluminum panel. The entire unit is fastened to the frame by four thumbscrews shown mounted on the front panel. Small photo-etched plates identify each control adjustment. A photostat copy is provided on the front panel describing the adjustment and voltage—current constants for the 56- 28- and 14-Mc. bands.

The absence of dials or hand wheels may not appeal to some amateurs. However, screwdriver adjustments are a distinct advantage in portable work and less likely to disturbance by other than the operator. The front view of the unit (Fig 1) exposes the tuning and coupling controls. Beginning at the lower left and proceeding in a clockwise direction, these are the harmonic-amplifier tuning, first harmonic amplifier, second harmonic amplifier, power amplifier grid coupling, third amplifier plate tuning and power amplifier grid tuning controls. The power amplifier plate tuning control is reached through a similar opening at the rear of the transmitter. The antenna

coupling is pre-set, whereas the link coupling is adjustable at the 3rd amplifier tank. The chart located under the controls designates the setting for the three frequency bands mentioned.

The oscillator-harmonic tuning unit, L_1 , plugs in just below the quartz plate mounted next to the oscillator tube, Fig. 6. From left to right in this view are harmonic tuning condenser, the first harmonic amplifier tank coil, L_3 (not inserted), and switch Sw_1T . On the upper shelf, left to right, are the quartz plate, WE306A oscillator, WE306A first harmonic amplifier and first harmonic amplifier plate tuning. The output of the first harmonic amplifier is directed through Sw_1T to either the second harmonic amplifier grid, or the third amplifier, depending upon the frequency to be transmitted. As yet no suitable 14-Mc. quartz plate has been found to act as a satisfactory substitute for the 7-Mc. quartz plate

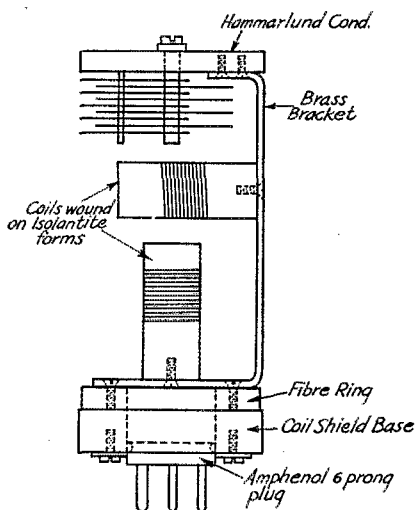

FIG. 6-A—CONSTRUCTION OF OSCILLATOR-HARMONIC TANK UNIT

in the frequency multiplication system here used. Although it is possible to quadruple to 56 Mc. in the second WE306A, higher efficiency is realized by doubling and using an additional WE306A as a doubler to 56 megacycles. The WE306A which operates on 56 megacycles is mounted in an inverted position underneath the second harmonic amplifier tank coil.

An interesting feature of this tuned circuit is the absence of a tank condenser and is illustrated in Fig. 8. As will be noted from the illustration, tuning is accomplished through a screw arrangement which compresses or expands the coil. The transmitter when used on 14 and 28 megacycles does not utilize this stage; consequently, it was not necessary to arrange the tank coil for removal. In addition to the switch (Sw_1T) mentioned, Sw_2T is required to connect the grid

of the third amplifier to either the plate tank of the first or second harmonic amplifiers. The third amplifier (buffer) provides excitation for the two WE305A tubes, through link coupling, in a push-pull circuit operating with an efficiency of 55% at 60 megacycles.

Sw_2T performs three operations; it connects the bleeder resistor across the B-supply when the second harmonic amplifier is not used, and selects the excitation from either the first or the second amplifier. The insertion of a bleeder resistor is of importance in maintaining constant the "B-C" supply load.

To prevent flashover of the power amplifier tuning condenser the antenna circuit is loaded by a 60-watt lamp during preliminary tuning adjustments; and QRM is eliminated. The shielding on one side of the power amplifier serves two purposes; on 14 Mc. this shield acts as one side of a condenser formed by two polished, rounded-edge aluminum plates placed $\frac{3}{16}$ -inch from the shielding. They may be seen in Fig. 6.

Connection to the two plates is made through link switches which add 25 $\mu\text{fd.}$ to each of the power-amplifier tank condensers. These capacitances are indicated as $C_{42}T$ in Fig. 5.

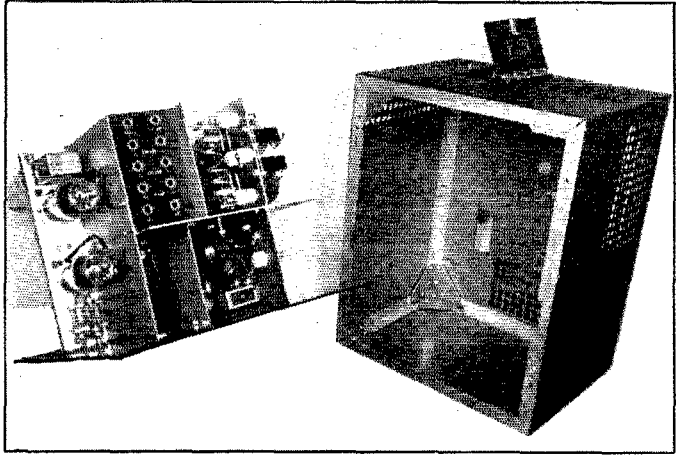

FIG. 7—TOP VIEW OF THE R.F. UNIT AND ITS CASE

THE MODULATOR UNIT—"VODAS" OPERATION

Containing the Class "A" prime modulator consisting of two WE276A vacuum tubes, this

COIL DATA FOR R.F. UNIT
(7-Mc. Band Crystal)

Output Freq.	$L_{1a}T$	$L_{1b}T$	L_2T	L_3T	L_4T	L_5T	L_6T	L_7T	L_8T
56 Mc.	$\frac{3}{4}$ " d. 12t #22 d.s.c.	$\frac{3}{4}$ " d. 8t #18 d.s.c.	$\frac{3}{4}$ " d. 4t #16 silver-plated copper	$\frac{3}{4}$ " d. 3t #14 silver-plated copper	1" d. 3t #9 silver-plated copper	$\frac{1}{4}$ "- $1\frac{1}{4}$ " pancake 3t #12 copper	1" d. 3t #9 silver-plated copper	1" d. 3t #9 silver-plated copper	$\frac{1}{4}$ "- $1\frac{1}{4}$ " pancake 3t #12 copper
28 Mc.	Same as above	Same as above	$\frac{3}{4}$ " d. 4t #16 silver-plated copper	Not used	1" d. 7t #9 silver-plated copper	$\frac{1}{4}$ "- $1\frac{1}{4}$ " pancake 3t #12 copper	1" d. 7t #9 silver-plated copper	1" d. 7t #9 silver-plated copper	$\frac{1}{4}$ "- $1\frac{1}{4}$ " pancake 3t #12 copper
14 Mc.	Same as above	Same as above	1" d. 20t * #16 silver-plated copper	Not used	1" d. 15t * #12 silver-plated copper	$\frac{1}{4}$ "- $1\frac{1}{4}$ " pancake 3t #12 copper	1" d. 15t * #12 silver-plated copper	1" d. 15t * #12 silver-plated copper	$\frac{1}{4}$ "- $1\frac{1}{4}$ " pancake 3t #12 copper

* Wound on R39 rod with groove machined to retain wire.

unit, shown in Fig. 9, also houses the B-C supplies and the VODAS circuit. In the operative position, the relay S_1M grounds the point "X" on the combination B-C power supply. By so doing, the three WE306A vacuum tubes in the transmitter are supplied with higher B voltage and normal C bias. At the same time the bleeder current plus

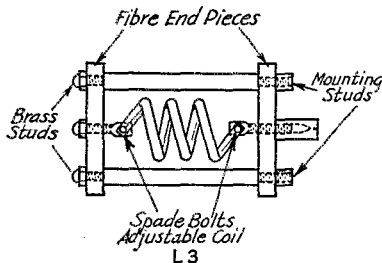

FIG. 8—CONSTRUCTION OF THE 56-MC. DOUBLOR TANK COIL

the 125-ma. plate load flows through the C bias resistor developing the normal C-bias voltage for the entire radio-frequency unit. The relay S_1M is operated by the key switch located on the front of the speech amplifier, when in the "Manual" position, or indirectly by the telegraph key in the "CW" position. When in the "VODAS" position, S_1M is operated by the fast-operate-slow release relay S_2M , which is also a part of the modulator unit. Relay S_2M operates in conjunction with the audio amplifier system.

A 200-ohm line connects the speech amplifier with the Class-AB modulator. The Class-AB input transformer is arranged for either a 200-ohm or 500-ohm line. The output of the speech amplifier being 200 ohms, only one winding is required. The extra winding is utilized in conjunction with a Rectox rectifier, which rectifies the voltage developed across it and supplies voltage to the pulsing relay S_3M (polarized). Relay S_3M , in turn, applies 24-volt d.c. to relay S_2M , intermittently; it in turn supplies 24-volt d.c. to relay S_1M , which reduces the bias to the transmitter and places the radio frequency carrier on the air. At the same instant, 24-volt d.c. is applied to a relay in the radio receiver, which grounds the antenna and removes the plate voltage from the first three vacuum tubes. It is understandable that speech impulses from the loudspeaker associated with the radio receiver, or local noises, will carry through the microphone and speech amplifier to the pulsing relay, thereby operating the transmitter. This is prevented by a "VODAS" sensitivity control (R_{29S}) mounted on the front of the speech amplifier and adjusted by the operator to prevent such occurrences. The control relays are so arranged that instantaneous operation takes place on the first voice impulse. Their operation is so rapid that no loss of speech results. After the first voice impulse, relay S_2M holds in

the operating position for 1,200 milliseconds before releasing. It is admitted that this system is not very practical when the signal is received by a super-regenerative receiver such as is used by most amateurs on the five-meter band, but only because of the high inherent hiss level in the radio receiver. When the signal is intercepted by a superheterodyne receiver, such high noise output is absent.

Because of its weight, the modulator unit is built into a welded steel frame, cadmium dip finished to prevent corrosion. The side panels consist of 16-gauge sheet steel, black crinkle finished on the exterior and aluminum finished on the inside.

The front panel is removable to allow for adjustment of the C-bias voltages. Two jacks are arranged in the side of the unit for measuring the plate current of each WE276A vacuum tube. Relay S_4M included in this unit prevents the application of plate voltage to any of the vacuum tubes in the r.f. unit when the B-C power supply is inoperative. Relay S_1S in the speech amplifier unit is interconnected with S_4M to provide additional protection. This is necessary because the two WE276A tubes receive their bias voltage from the speech amplifier supply and an oversight by the operator in turning on the speech amplifier

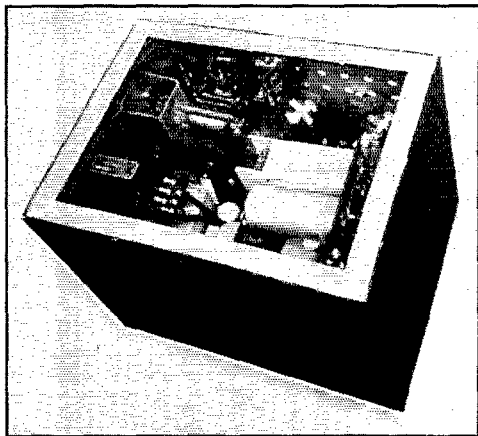

FIG. 9—THE MODULATOR UNIT

would result in damage to the two WE276A tubes.

The weight of the modulator unit complete is approximately 60 pounds. All cables terminate in the back of this unit; that is, those from the rectifier, r.f. unit and speech amplifier. Connections are made quite simple by the use of Jones plugs, which are suitable for handling the voltages used. A resistance is wired in series with the filament of the WE276A tubes to compensate for the slightly higher filament voltages, made necessary by the voltage drop in the wiring and plug con-

nections between the modulator and the r.f. unit. The modulators easily modulate the two WE305A push-pull final amplifier tubes 100%.

THE MAIN POWER SUPPLY

The main power supply for the transmitter was given careful consideration before construction as

the 30-henry 500-ma. choke coil and 4 μ fd. filter circuit. A glance at the rectifier circuit shows the bleeder resistor connected before the choke coil. This is a distinct advantage, because the choke coil is subjected to less load and therefore is not likely to become saturated. In this case the choke coil is rated well within its current carrying

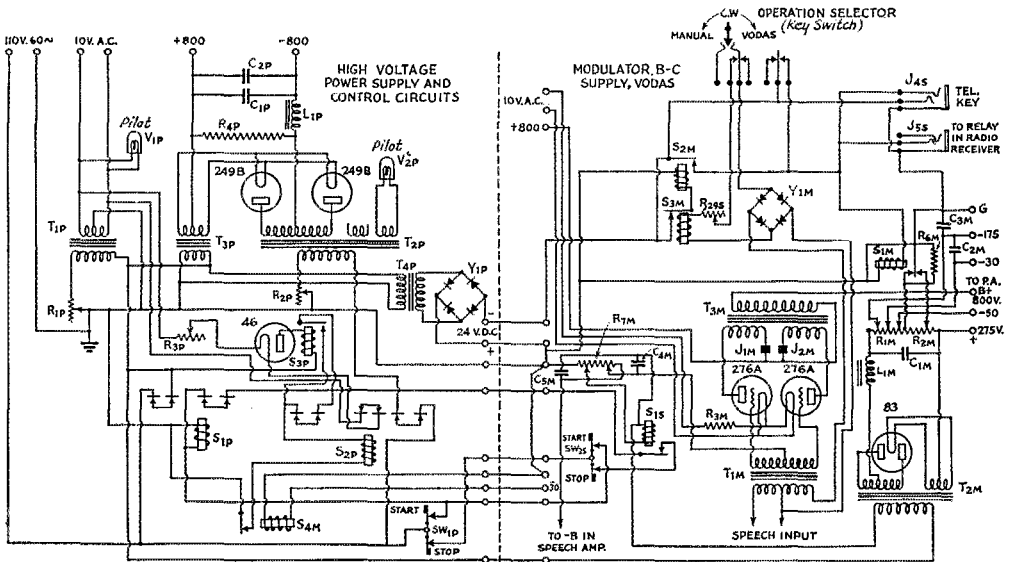

FIG. 10—MODULATOR AND POWER SUPPLY CIRCUITS

- | | | | |
|--|--|---|---|
| T ₁ P—12-volt 250-watt filament transformer. | C ₁ P, C ₂ P—2- μ fd. 2000-volt filter condensers. | Y ₁ M—Rectox rectifier. | R ₂₀ S—20,000-ohm. |
| T ₂ P—1500-1500-volt 600-watt plate transformer. | V ₁ P, V ₂ P—12-volt Mazda lamps. | S ₁ S, S ₁ M—5-ma. d.c. relays. | R ₆ M—50,000-ohm. |
| T ₃ P—2.5-volt 60-watt filament transformer. | S ₁ P, S ₂ P—110-volt a.c. relays (Allen-Bradley). | S ₂ M—30-ma. d.c. lag relay. | R ₇ M—5000-ohm. |
| T ₄ P—30-volt transformer. | S ₃ P—10-ma. d.c. relay. | S ₃ M—1-ma. polarized relay. | T ₁ M—Class-B input transformer 200-ohm/500-ohm. |
| R ₁ P, R ₂ P—500-watt carbon-pile rheostats. | Y ₁ P—Rectox rectifier. | C ₄ M—2- μ fd. condenser. | T ₂ M—650-650/5-volt transformer. |
| R ₃ P—25-ohm rheostat. | Sw ₁ P, Sw ₂ S—Motor control switches (Cutler Hammer). | C ₁ M—4- μ fd. | L ₁ M—20-henry 200-ma. choke. |
| R ₄ P—20,000-ohm resistor. | | C ₂ M, C ₃ M, C ₅ M—2- μ fd. | T ₃ M—Class-B modulation transformer. |
| L ₁ P—30-henry 500-ma. choke. | | R ₁ M—2000-ohm. | S ₄ M—5-ma. d.c. relay. |
| | | R ₂ M—20,000-ohm. | |
| | | R ₃ M—0.1-ohm piece of Michrohme wire. | |

a great deal of equipment had to be placed into a very small space. As illustrated in Fig. 11, the entire unit is unusually small when one considers the number of components contained therein. The frame is made of one-inch angle iron welded in the corners and cadmium plated to resist corrosion. Where necessary, steel strips are spot welded to the frame to hold the various relays, Rectox rectifier and the two carbon-pile variable resistors necessary to control the filament and plate voltages of the transmitter.

Again Jones plugs are used to connect to the other units. A 110-volt socket is provided as the inlet for the 60-cycle supply. A 12-volt 250-watt filament transformer supplies the filaments of all the vacuum tubes in the radio-frequency unit; a 1,500-volt transformer supplies the necessary voltage to the WE249B hot-cathode mercury-vapor rectifiers operating full-wave and feeding

capacity and it was really unnecessary to connect the bleeder resistance in this manner except to retain good design practice. Within this unit is also the rectifier filament transformer and the 24-volt Rectox unit which supplies the relays mounted in the various units. Two pilot lights indicate the condition of the power system; one lights with the filaments of the vacuum tubes and the other when the plate voltage is turned on.

A 46 tube functions as the time delay device in conjunction with a small relay. Circuit conditions are such that the following sequence takes place when depressing the start button: Relay S₁P is energized, holds itself in position and applies 110 volts to the filament transformer; the 46 tube lights at the same time as the other tubes in the transmitter, since it is supplied by the same source of voltage. In series with the filament is a rheostat known as the time-delay speed control, so

named because it regulates the speed at which the filament of the 46 tube lights. This can be controlled over a 0-15 second period and has proven most satisfactory. When the 46 tube has attained an operating condition, the 110-volt rectified a.c. flows through the relay S_3P which operates the plate supply relay S_2P . As S_2P assumes its full travel, it breaks the filament circuit of the 46 tube, replacing it to a cold condition (ready for the next delay action), "makes" a holding contact and applies the 110 volts to the plate transformer primary. Depressing the stop button breaks the relay circuits and replaces the trans-

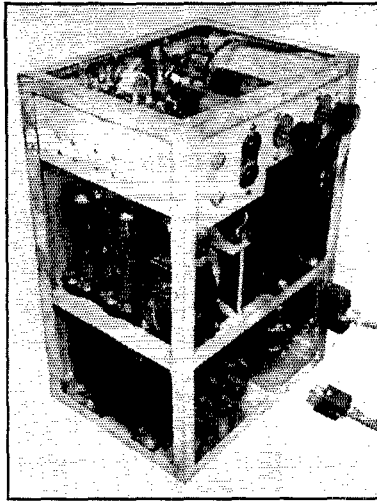

FIG. 11—THE MAIN POWER SUPPLY UNIT

mitter to a ready-to-operate condition. It should be mentioned that this sequence is not attainable if the safety relays connected in series with the stop switch are not in the operate position. Explanation of their function is given in the individual units in which they are located. There is one obvious weakness in the power supply; the carbon-pile resistors vary considerably with temperature. However, in order to conserve space their use was required.

As in the modulator unit, the exterior is black crinkle finished with aluminum spray interior. The perforated screen on the tube side of the rectifier facilitates their

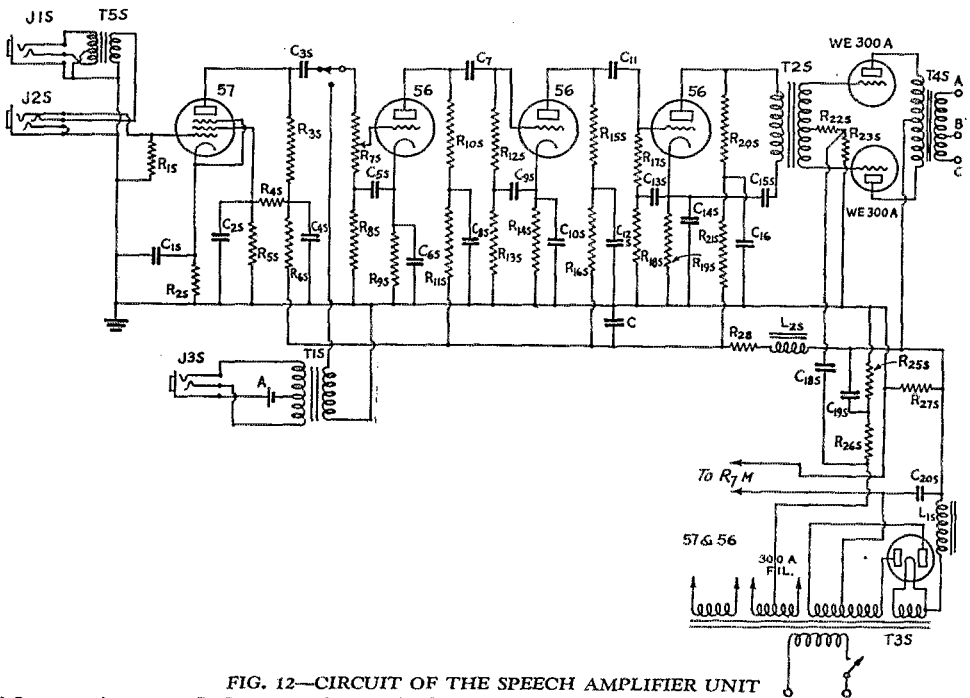

FIG. 12—CIRCUIT OF THE SPEECH AMPLIFIER UNIT

- R_{1S}—5-megohm
- R_{2S}—3000-ohm
- R_{3S}—0.25-megohm
- R_{4S}—0.1-megohm
- R_{5S}—50,000-ohm
- R_{6S}—50,000-ohm
- R_{7S}—50,000-ohm, variable
- R_{8S}—0.1-megohm
- R_{9S}—3000-ohm
- R_{10S}—50,000-ohm
- R_{11S}—10,000-ohm
- R_{12S}—0.5-megohm

- R_{13S}—0.1-megohm
- R_{14S}—3000-ohm
- R_{15S}—50,000-ohm
- R_{16S}—10,000-ohm
- R_{17S}—5-megohm
- R_{18S}—0.1-megohm
- R_{19S}—3000-ohm
- R_{20S}—0.1-megohm
- R_{21S}—10,000-ohm
- R_{22S}—25,000-ohm
- R_{23S}—50,000-ohm
- R_{24S}—50,000-ohm
- R_{25S}—500-ohm

- R_{26S}—60-ohm
- R_{27S}—40,000-ohm
- R_{28S}—5000-ohm
- C_{1S}—1- μ f.
- C_{2S}—1- μ f.
- C_{3S}—0.5- μ f.
- C_{4S}—8- μ f.
- C_{5S}—1- μ f.
- C_{6S}—8- μ f.
- C_{7S}—0.5- μ f.
- C_{8S}—8- μ f.
- C_{9S}—1- μ f.
- C_{10S}—8- μ f.

- C_{11S}—0.5- μ f.
- C_{12S}—1- μ f.
- C_{13S}—1- μ f.
- C_{14S}—8- μ f.
- C_{15S}—0.5- μ f.
- C_{16S}—8- μ f.
- C_{17S}—0.5- μ f.
- C_{18S}—1- μ f.
- C_{19S}—16- μ f.
- C_{20S}—8- μ f.
- T_{1S}—Double button mike to grid.
- T_{2S}—3:1 interstage.

- T_{3S}—600-600, 2.5-volt, 5-watt, 250-watt.
- T_{4S}—Output transformer, to 200-ohm line.
- T_{6S}—Input transformer (dynamic mike).
- L_{1S}—20-henry 300-ma.
- L_{2S}—10-henry 80-ma.

placement. Four steel bolts threaded into the four corners of the frame are adjustable for levelling purposes.

SPEECH AMPLIFIER

Mechanically the speech amplifier, shown on the operating table in Fig. 1, consists essentially of three parts; the chassis, panel and box. The chassis proper is constructed of $\frac{3}{32}$ -inch soft aluminum bent to form a "dishpan," the corners of which are welded. Because of the size of the stock used, it was necessary to use soft aluminum. After all punchings and cutouts were completed, the chassis was sand-blasted. Later it was heat treated to increase its rigidity, necessary because of the weight of the components. The box and panel were constructed of 14-gauge sheet steel. The panel and rear of box are of similar construction, being bent to form shallow pans $\frac{1}{2}$ -inch deep, the corners of which are welded. The back was spot welded to the box proper which is made of one piece bent to form a rectangle, welded at the junction of the two ends. Reinforcing ribs were welded on the inside of both top and bottom of the box. The front panel is connected by two $\frac{3}{32}$ -inch formed brackets. The front panel is covered by a mat on which all the designations are engraved. Aluminum was used for the chassis, since it was decided that stray fields would be held to a minimum.

All of the mechanical design follows good standard practice. Protective finishes have been applied in accordance with the specific requirements of the various components. The outside of all of the units was given a black crinkle finish baked on. The entire finishing job was done at one time to assure uniformity of appearance. All screws, nuts and washers used are brass, cadmium plated, as is the steel framework.

ANTENNA SYSTEM

Some very efficient and yet simple coupling arrangements have been devised for use with the various antennas constructed. Concentric lines were chosen for transmission in all cases because their losses are extremely low, about 2 db per 1000 feet. Since the impedance of a concentric line constructed of $\frac{3}{8}$ -inch de-oxidized refrigerator tubing and No. 14 gauge wire is about 70 ohms, it is obvious that it would be desirable to connect this at the center of a half-wave antenna. The coupling unit used in the tests on Long Island was constructed in the field with the aid of a plumber's soldering copper and material available in any



FIG. 13—THE CAR ANTENNA MOUNTED FOR PORTABLE OPERATION

auto supply store. This antenna system is illustrated in Fig. 12. The antenna was constructed of $\frac{3}{8}$ -inch hard brass tubing into which was telescoped a $\frac{1}{2}$ -inch tube arranged so that it could be tuned and adjusted to the proper frequency and then clamped into place by a set screw. A yard-arm 10 feet long was installed on the mast supporting the antenna and found to be the most satisfactory solution for the erection of a vertical system.

Fig. 13 shows the antenna mounted on the bumper of the automobile. It has given very satisfactory mechanical and electrical performance regardless of the fact that the car was driven at close to maximum speed at various times. The sketch of Fig. 14 shows the simple constructional details.

The antenna consists of a steel fishing pole $\frac{1}{4}$ -wave long mounted in a "beehive" insulator supported on a 2-foot section of $\frac{1}{2}$ -inch brass tubing and is fed by a concentric line. The an-

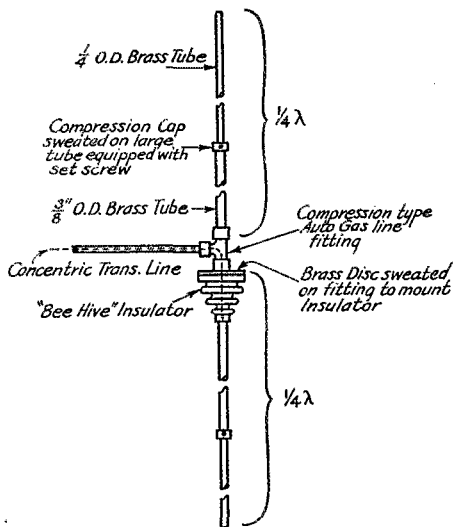

FIG. 14—CENTER-FED DOUBLET FOR 56-MC. OPERATION ON PORTABLE LOCATION

tenna is made in three sections for simple removal when not in use.

Adjustment of the antenna was accomplished with the aid of a field-strength meter completely shielded and connected to the end of the transmission line. A piece of wire was substituted for the steel fishing rod and was cut down until maxi-

imum strength was indicated on the rectifier-microammeter used as the indicating device. This was later replaced with the fishing rod cut to length.

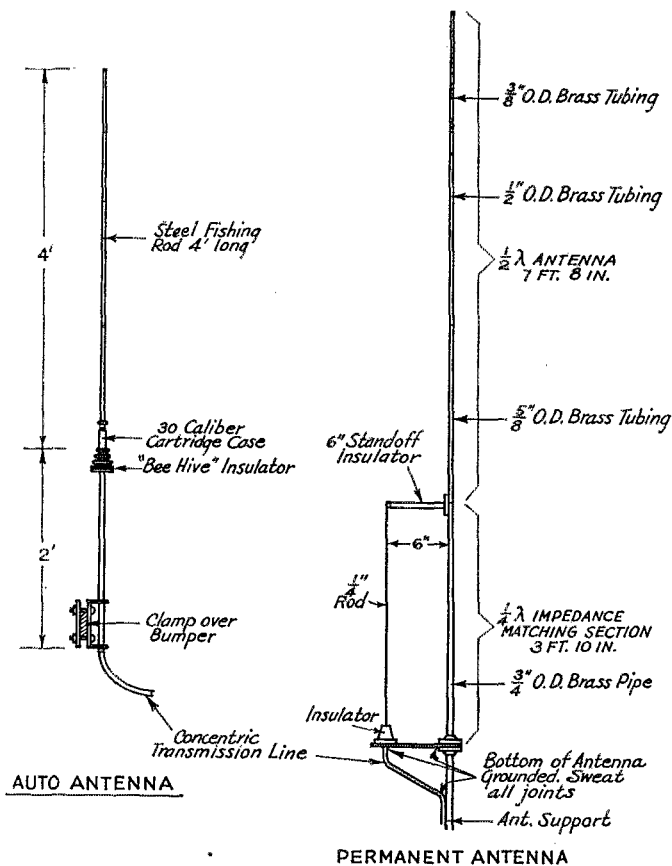

FIG. 15—CONSTRUCTIONAL DETAILS OF THE CAR ANTENNA
 FIG. 16—CONSTRUCTIONAL DETAILS OF THE PERMANENT ANTENNA FOR FIXED LOCATION
 It uses a quarter-wave matching section with concentric transmission line feed.

A more practical arrangement for permanent installation² in a congested section of New York City was considered desirable. This is shown in Fig. 15. It consists of a $\frac{3}{4}$ -wave section of brass pipe with a $\frac{1}{4}$ -wave matching section mounted 10 inches to one side and fed by a concentric transmission line. Since the end of the antenna is grounded, it also affords additional protection against electrical storms.

TUNING PROCEDURE

The 56-Mc. coils are inserted as indicated in the table and the 46 time delay tube is removed

²"Antennae Terminations," by W. C. Tinus, *Electronics*, August, 1935.

from its socket to prevent application of the high voltage to the buffer and power amplifier tubes. The speech amplifier is turned on by turning the "VODAS" sensitivity knob, located at the right

side, so that the relay S_1S is energized to allow operation of the control circuits associated with the radio transmitter. Depressing the start button on the speech amplifier or transmitter unit operates the relay S_1P , thereby lighting the filaments of all the vacuum tubes and applying B-voltage and C-bias for the oscillator and harmonic amplifier stages. Moving the key to the "Manual" position removes the high bias from the oscillator and harmonic amplifier vacuum tubes and places them in operative condition. The grid milliammeter plug is inserted in the oscillator grid circuit jack and the oscillator tank condenser located in the bottom of the oscillator coil is adjusted for maximum current. The grid meter plug is then inserted in the first harmonic amplifier grid circuit jack and the oscillator tank harmonic circuit is tuned for maximum grid current. It is advisable to recheck the oscillator tank condenser before proceeding with further adjustments. Insert the grid meter into the second harmonic amplifier grid circuit jack and tune the plate tank circuit of the first harmonic amplifier for maximum grid current indication. The grid meter is now inserted in the grid circuit jack of the third amplifier or buffer circuit, again tuning for maximum

grid current by adjustment of the second harmonic amplifier tank circuit. Plate voltage may now be applied to the buffer and power amplifier stage. The same grid meter used for previous adjustment is inserted in the power amplifier grid circuit and the plate tank of the third amplifier is tuned for maximum indication.

If the link tuned circuit is badly out of adjustment, it may be necessary to use the plate milliammeter for resonance indication in this circuit. In most cases this was found necessary upon the installation of a new set of coils whose characteristics were not known. It should be remembered that as soon as grid current flows in the power

(Continued on page 118)

What the League Is Doing

League Activities, Washington Notes, Board Actions—For Your Information

Elections What promise to be the "largest" elections in A.R.R.L. history are being held this month, when eight divisions are choosing directors and alternates. At this writing it seems that there is to be a contest in practically every division and we expect that something like 11,000 ballots will be mailed out from League headquarters. The Committee of Tellers and its staff will have a very busy day cut out for it on December 21st, when the ballots are opened and counted. There will be a special broadcast of election dope from WIINF that evening.

Code Exams Not only must the applicant for an amateur license copy correctly for at least one minute at thirteen words per minute; he must also demonstrate his ability to send without error at that speed. In some of the examining offices the testing of sending speed is a new thing. Every amateur going up for examination should be prepared for it. We mentioned in *QST* a few months back that a candidate would be accorded up to three opportunities to transmit without error at thirteen w.p.m. This does not mean that three separate tests are given the applicant, with an announcement by the Inspector that the candidate has failed Trial No. 1 and will now commence Trial No. 2. It is all done in one effort. The candidate starts, sending from copy, and the Inspector holds a stop-watch on him. If he proceeds without error, he is stopped after a minute and told that he has passed. If he makes an error, the Inspector resets the stop-watch to zero, saying nothing but commencing the count again. In the event of another error he does the same thing. If, somewhere in these three attempts, the candidate can send his sixty-five consecutive characters without error within a minute, he is passed. If he makes a mistake a third time before he has sent correctly for a full minute, he is flunked. It is therefore possible for all three trials of an applicant to be made within, say, a half minute, if the errors come too close together. To pass the exam, the applicant must send a full minute without a mistake.

By the way, the fellows in Alaska, Guam and Puerto Rico will be interested in knowing that the Class B amateur examination is now ready for them at their usual examining point. Heretofore the Army and Navy communications people, cooperating with the F.C.C., have made the Class A examination available in those places, since personal appearance was required; now through

the cooperation of the same agencies the Class B exam is also to be given. We understand that the Class C examination may still be taken by residents of these regions who do not wish to work Class A 'phone, but both pride and some more practical considerations dictate a preference for the Class B where it can be taken.

Mailing QST Flat

QST comes to you this month mailed flat without a fold, realizing a dream of years. For a long time back, the magazine has been folded vertically when wrapped for mailing. It made a secure package that carried *QST* safely to the most remote corners of the world but, unfortunately, left an ugly crease down the front cover and frequently made it difficult to straighten out the magazine. We have always been disappointed at the unfavorable comparison in appearance of members' copies and newsstand copies. We have frequently tried flat mailing, but it has never before seemed secure. Now after considerable experimenting and the acquisition of some special machinery, we believe we have it licked. If it doesn't work out, of course we'll go back to folding, but we hope that we can now deliver your copies in better condition. Our circulation manager would be interested in knowing your reactions to the new method and particularly to have reports of any unfavorable results that are noticed from the change.

Collected Rottenness

How would you fellows like to see all of the "Rotten" stories of The Old Man gathered into a book something like De Soto's history and selling for about a buck? Since the passing of Mr. Maxim we have received many suggestions from old-timers that this be done. We have just been reading over the stories. We find them immensely interesting and amusing, but we are of course examining them from the background of amateur experience through the days in which the stories were written. Good old T.O.M. and the Wouff Hong! Boy, what a story! But what we do not know is whether the amateurs who did not live through those days would be interested in owning such a book. Of course we think the thing is practically priceless, but then we're prejudiced and we simply do not know. The editor would consider it a great favor if members who feel an interest in the subject, one way or the other, would be so kind as to drop him a postcard with some expres-

(Continued on page 70)

Operating Notes on the Transmitting-Type Beam Power Tube

An Experimental Exciter-Low-Power Transmitter Using the 807

CHARACTERISTICS and ratings of the new 807, transmitting counterpart of the 6L6, are given elsewhere in this issue. The tube offers the advantages of 25-watt output at a plate supply voltage not exceeding 400 volts, and the ability to operate efficiently with very low driving power—two features which do not need further comment. When early models of the tube were received, the chief point of interest

below deck to prevent any stray coupling to the output circuit from this source. The plate tank circuit for the 807 was mounted on top of the chassis and was therefore completely isolated from the input circuit. As a means of preventing coupling between the plate tuned circuit and the grid wire running down through the tube a shield, high enough to reach the bottom of the plate, was placed about the lower portion of the tube as indicated in the photograph. With this set-up it seemed fairly certain that any feedback would have to be through the tube itself.

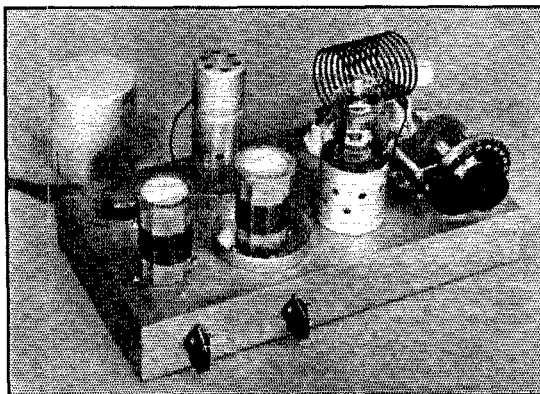

THE 89-807 UNIT WITH OSCILLATOR PLATE-COIL SHIELD REMOVED

An output of 25 watts at 400 volts is easily obtainable on all bands on which the 807 can be used as a straight amplifier.

Careful tests show that with shielding of this nature the tube has no tendency to oscillate at frequencies up to and including the 7-Mc. band; it functions as a true screen-grid amplifier. On 14 Mc. it will self-oscillate after a fashion, but usually with negligible power output. When separately excited, however, it settles down nicely and behaves like any normal amplifier, showing no tendency to go off on its own—this, too, when driven by the *fourth* harmonic of a Tri-tet oscillator operating at a very low power level. On the whole, therefore, we have found no occasion for attempting to neutralize the tube, which is fortunate, because it is always a rather messy job to neutralize a tube with such low grid-plate capacity.

was whether or not the grid-plate capacity was low enough to enable operating the tube without neutralization, its rated value of 0.2 μfd . seemingly being about on the border line. To settle the question, we built up the little rig shown in the photographs, giving the tube the advantage of all the shielding that would be necessary with other types of tubes.

Previous experience with the small transmitting pentodes had indicated that one of the chief causes of self-oscillation was capacity coupling between the input circuit and the plate of the tube—often overlooked in comparison to the more obvious possibility of magnetic coupling between the input and output circuits external to the tube. To prevent the possibility of either type of coupling, therefore, a metal chassis was used as a base for the unit, and the coil connected to the grid circuit of the 807 was shielded. The tuning condenser for this coil was mounted

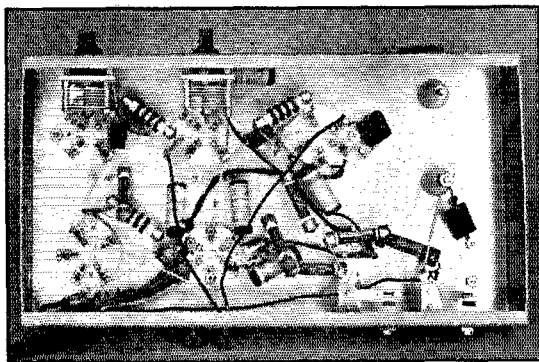

A VIEW UNDERNEATH THE CHASSIS
The arrangement of parts is explained in the text.

One thing we like about the 807 is the fact that it is an excellent frequency multiplier, showing nearly as good efficiency when doubling as

when operating straight through. For doubling, somewhat higher bias is desirable than for straight amplification, although the value seems to be rather non-critical in either case. A 50,000-ohm grid leak is about right for doubling, 20,000 for straight amplification; the straight-through output is cut only very slightly with a 50,000-ohm

in all cases. With the oscillator plate circuit, L_2C_2 , tuned to the fourth harmonic of a 3.5-Mc. crystal and the 807 doubling to 28 Mc., the output was somewhat more than ten watts with a plate input of about 30 watts. With a 7-Mc. crystal, doubling in the oscillator plate and doubling again in the 807 stage, the output was better than 15 watts on

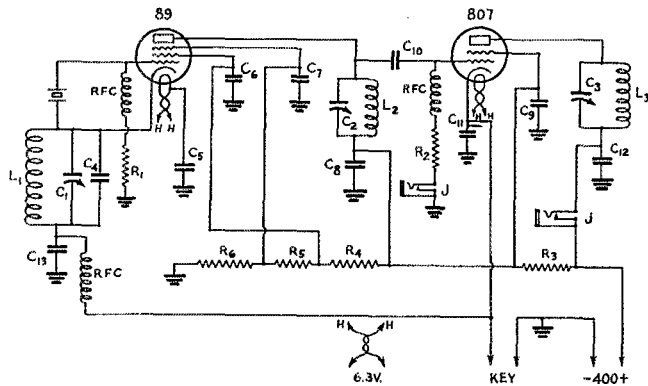

FIG. 1—CIRCUIT DIAGRAM OF THE 89-807 UNIT

- C_1, C_2 —75- μ fd. midjet variables (Cardwell ZU-75-AS).
- C_3 —100- μ fd. variable (Cardwell MR-105BS).
- C_4 —100- μ fd. mica.
- C_5, C_6 , inc.—0.01 μ fd. paper, 400-volt.
- C_7 —50- μ fd. mica.
- C_{11}, C_{12} —0.002- μ fd. mica.
- C_{13} —500- μ fd. mica.
- R_1, R_2 —50,000-ohm, 2-watt.
- R_3 —3500-ohm, 10-watt.
- R_4, R_5 —25,000-ohm, 2-watt.
- R_6 —10,000-ohm, 2-watt.
- RFC—Radio-frequency choke.
- J—Single closed-circuit jack.

leak, however, so that the higher value might just as well be used for both purposes. With this leak resistance, a grid current of about 2 milliamperes gives optimum operation.

In the circuit shown in Fig. 1, the driving tube is an 89 Tri-tet, operated at 250 volts. Even with this low voltage on the plate of the oscillator, no difficulty at all was experienced in getting the rated tube output of 25 watts from the 807 on either 3.5, 7 or 14 Mc., using a 3.5-Mc. crystal in

The latter performance could be duplicated with a 3.5-Mc. crystal by using higher voltage on the oscillator. The tube shows better doubling efficiency when going from 7 to 14 Mc., as would be expected, the actual output being approximately 20 watts with an input in the neighborhood of 35 watts.

In all cases the tube was operated at or below the normal ratings, since the low-voltage possibilities are most appealing. Although the maximum plate voltage rating is set at 400, it is quite possible that no damage would be done by going a bit higher—say to 500—provided the screen voltage is kept down to the rated figure of 250. It should be pointed out, however, that the insulation in the tube is not designed to hold very much more than the rated voltages.

THE PRACTICAL TRANSMITTER

As we already have said, the unit shown in the photographs was constructed primarily to get some practical information on operating the tube, but when we got through we found we had a very acceptable low-power transmitter, capable of working nicely on four bands with a single crystal. With an inexpensive power supply (such as the one described in connection with the low-power transmitter elsewhere in this issue) for c.w. work, it is equivalent to the ordinary rig using a type 10 at five or six hundred volts, requires fewer stages for the same output on as many bands from the same crystal, and requires no neutralizing. Complete break-in is possible, since the oscillator and amplifier are keyed simultaneously. The all-metal construction may be a drawback in some cases, but the shielding indicated is not only desirable but necessary. However, regular breadboard construction on thin sheet metal would serve the same purpose.

The metal chassis (Bud) measures 7 by 13 by 2 inches. On the top, at the front, are the oscillator cathode coil L_1 , oscillator plate coil L_2 in its shield (Hammarlund Type CS-3), the 807, and the plate tank condenser C_3 . Along the rear are the crystal socket, 89 oscillator tube, and the plate

(Continued on page 70)

COIL DATA

- L_1 —3.5-Mc. crystal: 16 turns No. 18 enamelled wire, coil length 1 inch
- 7-Mc. crystal: 9 turns No. 18 enamelled wire, coil length 1 inch
- L_2 —3.5 Mc.: 33 turns No. 18 enamelled wire, coil length 1 1/2 inches
- 7 Mc.: 14 turns No. 18 enamelled wire, coil length 1 inch
- 14 Mc.: 8 turns No. 18 enamelled wire, coil length 3/4 inch
- L_3 —3.5 Mc.: 32 turns No. 16, coil length 2 3/8 inches, diameter 2 1/2 inches
- 7 Mc.: 22 turns No. 16, coil length 2 1/2 inches, diameter 2 inches
- 14 Mc.: 12 turns No. 12, coil length 2 3/4 inches, diameter 2 inches
- 28 Mc.: 6 turns No. 12, coil length 2 3/4 inches, diameter 1 1/4 inches

L_1 and L_2 are wound on Hammarlund forms, diameter 1 1/2 inches. The 3.5, 7 and 14 mc. coils at L_3 are Barker & Williamson types 80A, 40A and 20A, respectively.

Turns on all coils should be spaced out to meet the specified coil length.

A Moving-Coil Tuning System for the High-Frequency Receiver

A New Approach to the Coil Changing Problem in Multi-Band Sets

By James Millen,* WIHRX

SO MANY of the important advances in radio design have been initially accompanied by great disadvantages, that at times it has seemed that progress has been backwards. Thus pentode tubes and Class-B amplifiers made possible great economies in material, but at first appeared to threaten such a loss of audio quality that pessimists freely predicted that the industry was going to the bow-wows. It didn't, of course. Almost immediate technical improvement so reduced inherent defects that pentode and Class-B amplifiers are at least comparable in audio quality to the time-tried Class-A triode systems at the present time.

Amateur radio is in the throes of just such a change at the present time. For many years plug-in coils have served us faithfully. Slow but

coils. Likewise, there is no excuse for not guiding coils into position and holding them there with sufficient precision to insure exact duplication of calibration.

With the advent of "all-wave" receivers, intended for the casual broadcast listener, some sort of coil switching became necessary. Obviously, the set had to be self-contained; and also obviously, it had to have emphasis placed on convenience. On the other hand, the general public was not familiar with high-frequency communication receivers, and so was not unduly critical of the over-all performance. If they could get G5SW or 2RO now and then, everything was OK. Judged by amateur standards, some of those early receivers were pretty terrible performers.

For all their shortcomings, they were compact and they were convenient. Consequently, the question was soon raised whether these advantages could not be incorporated in an amateur receiver without sacrificing performance in any way. The answer was, probably yes; "probably", because the proof of the pudding is in the eating, and so far as we know no commercially available receiver with knob-controlled range changing equals in all respects the performance of the best plug-in coil receivers now in use. We say "yes", because the solutions to the problems involved are in sight.

By its very nature, the coil switch has inherent disadvantages, and these can best be discussed by taking a specific example. Six years ago a high-frequency converter equipped with a coil switch was designed. This switch was considered to be of very advanced design at that time, and in fact compares favorably with most now in use. There were a number of

things wrong with it, however, and a discussion of its failings will throw light on the whole problem. To check off the points in its favor, the shielding between stages was excellent, the switching mechanism rugged and dependable, dielectric losses were low, coils and trimming condensers were mounted close to the switch contacts, making leads as short as possible, coils were not unduly crowded and accessibility of all

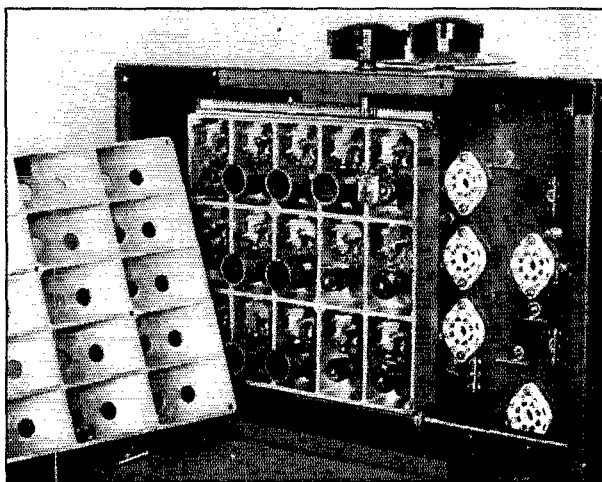

COVER PLATE REMOVED FROM THE COIL ASSEMBLY TO SHOW THE ARRANGEMENT

Each coil unit is individually shielded.

continual improvement has brought their design to a degree of electrical perfection which other means of coil changing has not equalled. They allow close grouping of coil, condenser, and tube, with efficient shielding wherever needed. They permit coils and shields of generous proportions to be used. Contacts of rugged design and positive action are taken for granted with well engineered

* Middleton, Mass.

parts was adequate. Against it may be cited the fact that idle coils were not isolated, calibration was not permanent, and the design was not flexible. To explain these points a little, the fact that idle coils are not isolated is objectionable because absorption losses are present. As originally designed, the converter had a pronounced dead-spot whenever it was tuned near the natural frequency of one of the idle coils, even though the positions of the coils were chosen for minimum coupling. This very common defect of coil switches was largely eliminated in the case of the converter by having additional switch arms short-circuit the offending coils.

Calibration was uncertain because slight changes in the position of the switch arms caused appreciable variation in the distributed inductance and capacity of the tuned circuits. As a result, the converter actually could be tuned through a limited range by slight movement of the range-changing knob! This defect could be eliminated, of course, by providing a positive locking device for the switch arms. It could have been done six years ago, but in those days nobody cared very much. Many modern broadcast sets still have the same defect, and apparently for the

stance, may require four coils for each range, "airtight" shielding, air dielectric trimming condensers, and short h.f. leads, to mention only a

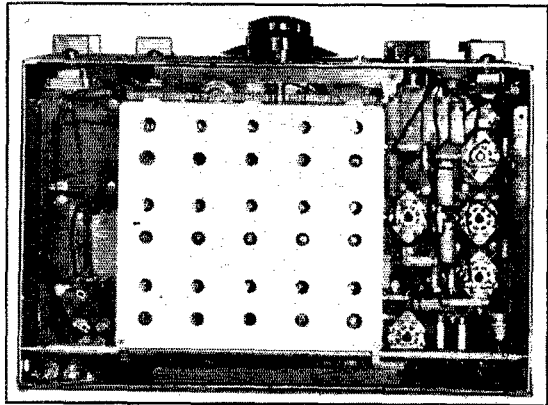

BOTTOM VIEW OF THE FINISHED RECEIVER ASSEMBLY SHOWING THE MOVING COIL SECTION COMPLETELY SHIELDED

few of the more obvious necessities. These features could not be built into a switching system such as that described without running into a lot of trouble. The most promising arrangement of

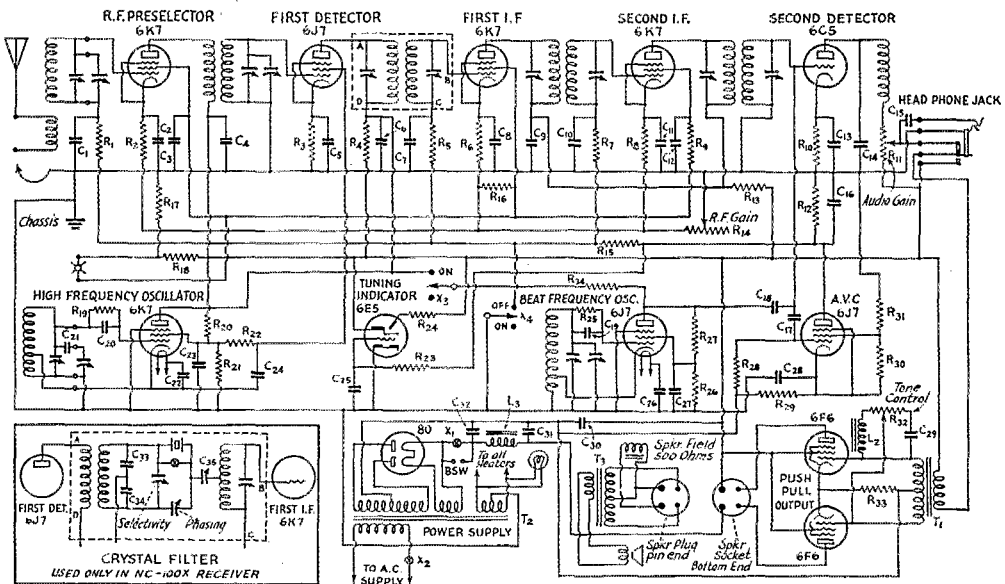

FIG. 1—SCHEMATIC CIRCUIT OF THE NC-100 RECEIVER IN WHICH THE NEW-TYPE COIL CHANGING SYSTEM IS USED

same reason—but the b.c.l. does not care. The third defect was lack of flexibility. By this we mean that the arrangement cannot be readily adapted for use in up-to-date receivers. A high-performance receiver, such as the HRO for in-

this type seems to be a layout similar to the "mousetrap" type attenuators used in standard signal generators. This attack on the problem seems to hold some promise, but there are many

(Continued on page 74)

An All-Band 'Phone Transmitter Using Beam Power Tubes

By G. Mathis,* W3BES, and J. B. Carter**

THE beam power tubes, although not very old, have become very popular among the amateur fraternity. Previous articles in *QST* have shown their adaptability to amateur use in both audio and r.f. circuits. This article describes a complete all-band 'phone transmitter using the new tubes in both modulator and r.f. sections.

Previous experience with the metal 6L6 has not always been satisfactory, but no difficulties were encountered with the glass prototype. In addition to the use of the 6L6G, two of the new RK-39 beam power type tubes are utilized in the r.f. power amplifier, where they are vastly superior to the receiving-type beam tubes. The tentative ratings of this tube were considerably exceeded without the plates showing any trace of color; furthermore, arcing between tube elements was entirely lacking even when potentials of 1000 volts were applied momentarily to the plate. This

than usual, thereby assuring a high degree of frequency stability. Only when using the fourth harmonic of the oscillator was it found necessary to increase the oscillator plate voltage to approximately 400 volts.

The output of the buffer stage is inductively coupled to the grid of the Class-C RK39's. When used on 1.75 Mc. a small air condenser is inserted in the form of this coil, without which the size of the combined buffer plate and amplifier grid coil would be all out of proportion. The grid coil of this final stage is similar to the old TNT circuit and is wound according to the same rules. For economy, a single condenser is used in the plate circuit of the final stage. This necessitates insulating the tank condenser from the grounded chassis. A split-stator condenser with grounded rotor might be used to better advantage because of the cross neutralization. This will simplify neutralizing for all frequencies once the neutralizing adjustments have been correctly made on one frequency.

Since this transmitter is primarily for 'phone use, cathode biasing is used on the buffer and amplifier stage. This type of bias was found to be entirely satisfactory and economical as well as fool-proof. Inasmuch as the radio-frequency section of this transmitter proved to be relatively free from trouble and presented no problems, the following hints and precautions should be carefully observed.

The Tri-tet cathode coil should have as few turns as possible, as has been repeatedly mentioned in these columns. Of prime importance is the necessity of disconnecting the screen voltage of the beam tubes whenever the plate potential is off. This condition is likely to exist when neutralizing. This difficulty may be easily overcome by inserting a double-pole switch in the screen and plate leads to these tubes.

No specifications for coil data are included because they do not differ from similar transmitters that have been described in these pages.

¹ See Chapter 9 of the 1937 *Radio Amateur's Handbook*.

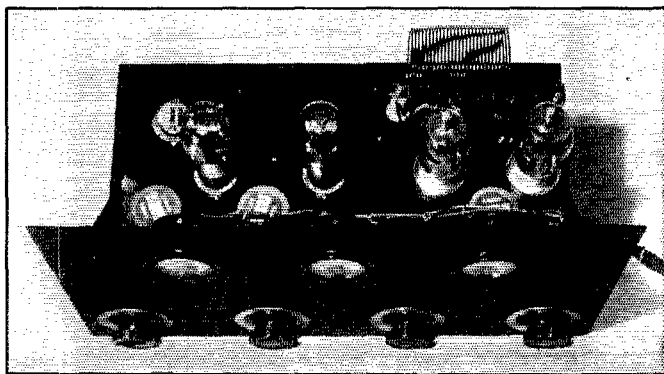

THE BEAM-TUBE R.F. UNIT USING 6L6G TUBES IN THE OSCILLATOR AND BUFFER STAGES, AND A PAIR OF RK-39'S IN THE PUSH-PULL FINAL AMPLIFIER

no doubt is attributable to the difference in the structure of the tubes. Interelectrode capacitance is also reduced by bringing the plate terminal out of the top of the glass bulb, thereby making this an ideal tube for high-frequency use.

The radio-frequency section consists of a 6L6G crystal-controlled Tri-tet oscillator which is capacitively coupled to a similar tube in the buffer stage. This stage provides plenty of excitation to the RK-39 Class-C stage and permits the oscillator to be operated at lower voltages

*M. & H. Sporting Goods Co. Philadelphia, Pa.

**Kenyon Transformer Co., Inc., New York, N. Y.

The modulator system of this amplifier provides a gain of 120 db and a power output as great as 90 watts. This output exceeds the manufacturer's rating but no appreciable amount of distortion was noticeable. The construction of this unit makes provision for either a crystal or high-impedance velocity microphone, or a single- or double-button carbon microphone. For crystal microphone or high-impedance velocity type, input is directly coupled to the grid of the first 6C5 which is resistance-coupled to the second 6C5. The input transformer for use with a carbon microphone goes to the grid of the second 6C5. The volume control is at the grid of this tube which is resistance-coupled to the third 6C5 voltage amplifier. This tube is transformer-coupled to the 6N7 operated in push-pull.

The transformer used is of the driver type for reasons which will be seen later.

The 6N7 stage employs a novel

method of obtaining good driver performance with a small tube. In order to reduce the effective plate resistance and obtain good audio regulation at the grids of the 6L6's, inverse feedback is used from the plates to the grids of the 6N7. The

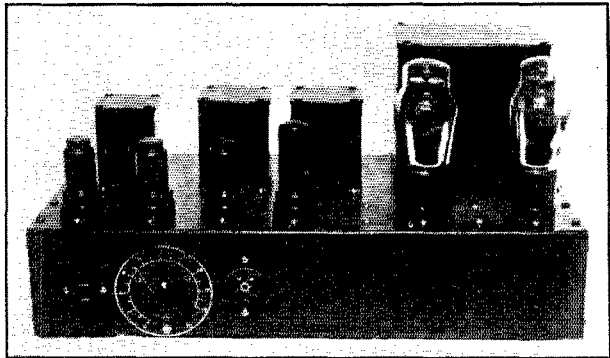

THE HIGH-GAIN AUDIO UNIT USES A PAIR OF 6L6G TUBES IN THE PUSH-PULL CLASS-AB MODULATOR WITH AN INVERSE FEEDBACK CIRCUIT IN THE 6N7 DRIVER STAGE TO IMPROVE DRIVER VOLTAGE REGULATION

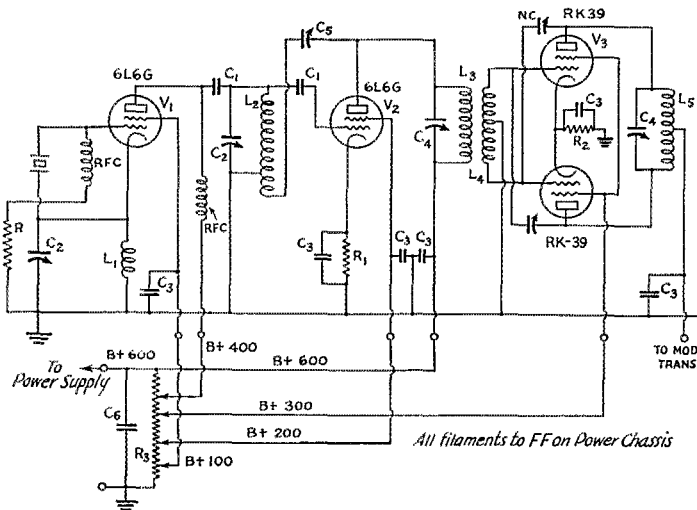

FIG. 1—CIRCUIT OF THE R.F. UNIT USING BEAM POWER TUBES

Coils correspond with those of similar circuits previously described.

A 100- μ fd. air padding condenser (Hammarlund APC-100) is used in the L75-Mc. coil, as mentioned in the text.

- C1—100- μ fd. fixed condenser (Sprague).
- C2—140- μ fd. variable condenser (Hammarlund MC-140S.)
- C3—0.01- μ fd. 1500-volt by-pass condensers (Sprague SW-11).
- C4—70- μ fd. double spaced condensers, sections in parallel (Hammarlund MCD-35SX).
- C5—15- μ fd. neutralizing condenser (Hammarlund SM-15).
- C6—6- μ fd. 1000-volt filter condensers.
- CN—Hammarlund Type MEX trimmers with top plate bent up to reduce minimum capacity.
- R—100,000-ohm 1-watt grid leak.
- R1—400-ohm 10-watt resistor (Electrad LHJ-400).
- R2—200-ohm 10-watt resistor (Electrad LHJ-200).
- R3—30,000-ohm voltage divider (Electrad 10AV-30,000 with 2 extra clips).
- RFC—2.1-millihenry r.f. chokes (Hammarlund CHX).

amount of feed-back necessary to effect good regulation in the driver system is not extremely critical. It may be varied from 8 to 16% depending somewhat on the other constants of the circuit. The reason for using the driver transformer for this stage is to provide good regulation at the grids of the 6N7, when the grids are driven slightly positive. With these two precautions in the driver stage—namely, the use of a driver transformer and inverse feed-back—power sufficient to drive the 6L6G tubes to 160% of the maximum power output may be obtained.

The 6L6G modulator tubes are transformer-coupled to the Class-C load with a transformer having three different secondary impedances available to match various loads.

Exceptionally good regulation is afforded for the critical screens of this stage with a 6N7 tube. The novel application of this tube provides a practical solution in an economical manner. The

usual method of stabilizing the voltages for the screens is to use a bleeder carrying heavy current.

This is expensive and not as efficient as the aforementioned system. An entirely separate rectifier

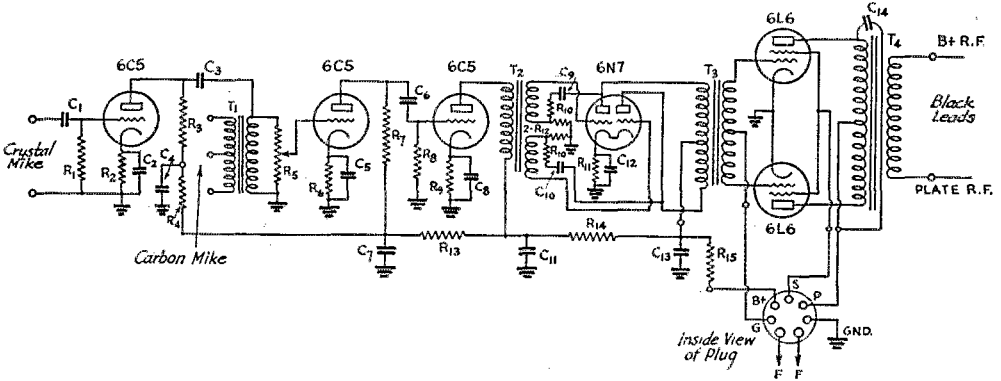

FIG. 2—CIRCUIT OF THE AUDIO UNIT

- | | | | |
|---|--|---|--|
| R ₁ —250,000-ohm 1-watt. | R ₁₂ —25,000-ohm 1-watt. | C ₆ —0.1- μ fd. paper. | C ₁₄ —0.01- μ fd. paper. |
| R ₂ —5000-ohm 1-watt. | R ₁₃ —50,000-ohm 1-watt. | C ₇ —4- μ fd. 450-volt elec-trolytic. | T ₁ —Microphone input transformer (Kenyon T-1). |
| R ₃ —50,000-ohm 1-watt. | R ₁₄ —1000-ohm 5-watt. | C ₈ —10- μ fd. 25-volt elec-trolytic. | T ₂ —Interstage transformer (Kenyon T-251). |
| R ₄ —50,000-ohm 1-watt. | R ₁₅ —5000-ohm 1-watt. | C ₉ —0.025- μ fd. paper. | T ₃ —Driver transformer (Kenyon T-255). |
| R ₅ —250,000-ohm volume control. | C ₁ —0.1- μ fd. paper. | C ₁₀ —0.025- μ fd. paper. | T ₄ —Modulation transformer (Kenyon T-459). |
| R ₆ —5000-ohm 1-watt. | C ₂ —10- μ fd. 25-volt elec-trolytic. | C ₁₁ —8- μ fd. 450-volt elec-trolytic. | |
| R ₇ —50,000-ohm 1-watt. | C ₃ —0.1- μ fd. paper. | C ₁₂ —10- μ fd. 25-volt elec-trolytic. | |
| R ₈ —250,000-ohm 1-watt. | C ₄ —2- μ fd. 450-volt elec-trolytic. | C ₁₃ —8- μ fd. 450-volt elec-trolytic. | |
| R ₉ —1-megohm 1-watt. | C ₅ —10- μ fd. 25-volt elec-trolytic. | | |
| R ₁₀ —200,000-ohm 1-watt. | | | |
| R ₁₁ —550-ohm 1-watt. | | | |

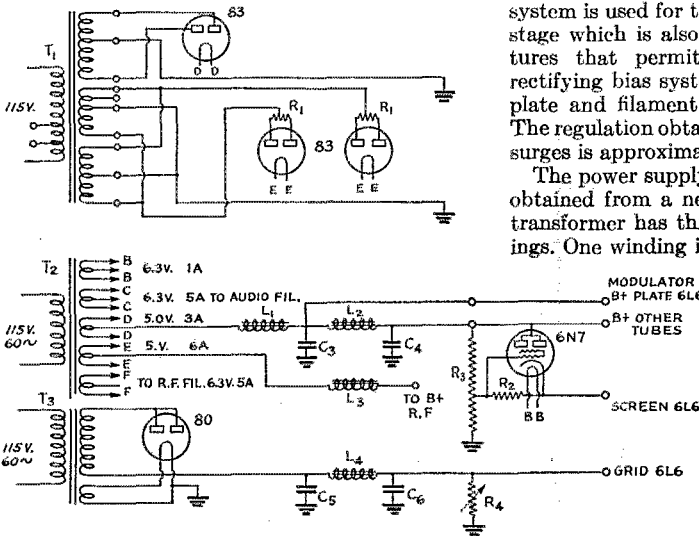

FIG. 3—THE POWER SUPPLY CIRCUIT

- | | |
|--|---|
| L ₁ —Swinging choke, 5-20-henry 200-ma. (Kenyon T-506). | condensers. |
| L ₂ —Filter choke, 10-henry 200-ma. (Kenyon T-152). | R ₁ —200-ohm 25-watt c.t. |
| L ₃ —Filter choke, 11-henry 500-ma. (Kenyon T-159). | R ₂ —1000-ohm 5-watt. |
| L ₄ —Filter choke, 30-henry 90-ma. (Kenyon T-153). | R ₃ —20,000-ohm 50-watt. |
| C ₃ , C ₄ —4- μ fd. 1000-volt filter condensers. | R ₄ —1000-ohm 25-watt. |
| C ₅ , C ₆ —8- μ fd. 450-volt electrolytic | T ₁ —Triple-winding plate transformer (Kenyon T-654). |
| | T ₂ —Multiple-winding filament transformer (Kenyon T-377). |
| | T ₃ —Bias supply transformer (Kenyon T-201). |

system is used for the bias of the Class-AB audio stage which is also one of the contributing features that permit such large outputs. This rectifying bias system consists of a combination plate and filament transformer and one choke. The regulation obtained at maximum grid current surges is approximately only 1%.

The power supply for the audio and r.f. end is obtained from a new type of transformer. This transformer has three different secondary windings. One winding is used for the audio unit and the other two windings are connected in parallel for the r.f. section. A single 83 is used for the audio and two similar tubes for the rest of the transmitter. This supplies 400 volts for the modulator and 600 volts for the r.f. section. Voltage adjustments may be obtained by means of three taps on the primary of this transformer. Each tap provides a change in voltage of 12%. The inclusion of this type transformer is highly desirable, since the drain afforded by the Class-C stage in 'phone operation helps stabilize

(Continued on page 76)

Rebuilding a Commercial-Type Condenser Microphone for Practical Ham Use

Revising the Head Amplifier for A.C. Operation with Metal Tubes

By Robert S. Coe,* W1CBC

IF YOU are one of those individuals who like to spend a lot of time on the audio end of your 'phone rig, the following may be of interest; namely, rebuilding one of the professional types of condenser microphones of the era of 1930, so as to eliminate the necessity for batteries and to increase the output to a more practical level for ham use.

The microphone and pre-amplifier unit in this case is one of the well-known RCA types (Model AA-4088), which as originally designed uses Type 864 d.c. tubes with a six-volt filament battery, and gives an output (with three stages) of about -35 db, a level quite low for ham use where the builder wishes a minimum of apparatus and a maximum of quality and results. Of course the first thing to do is to get the mike. This may be done by getting in touch with a broadcast station that is installing later type studio equipment. The microphone and pre-amplifier unit here was purchased for about fifteen dollars, a good value. The frequency characteristic is approximately flat over the audio range necessary for good quality, and while perhaps not up to the present broadcast standards of high fidelity, it is undoubtedly superior to that of many microphones in use today.

The pre-amplifier in its original form, as already mentioned, is quite low in output to be really practical for ham use, since -35 db across the load into which this unit is intended to work (250 ohms) represents a voltage swing of only about 0.02 volt. This is quite readily overcome by a little simple rebuilding, after which the level of the pre-amplifier output is brought up to about -10 db, an increase of around 25 db over the output of the original arrangement. The output im-

pedance of the new arrangement is also of a much higher value; in fact, high enough to feed directly into the grid of the first stage of the speech amplifier. The voltage swing represented by an output level of -10 db at this higher impedance is of the order of 2 volts on normal talking in a quiet conversational tone of voice. (Not shouting like a circus barker.) This level was checked on a voltmeter designed for the purpose.

The tubes used in the new arrangement are 6C5's (metal) with their heaters operated directly on a.c. The plate supply can be obtained from a tap off the speech amplifier power supply, with the addition of a little more filtering. The additional filter can consist of two small filter chokes, an 8-8- μ fd. filter condenser, and the correct dropping resistor to

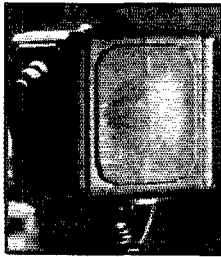

THE STANDARD CONDENSER MIKE MODERNIZED AS DESCRIBED IN THIS ARTICLE

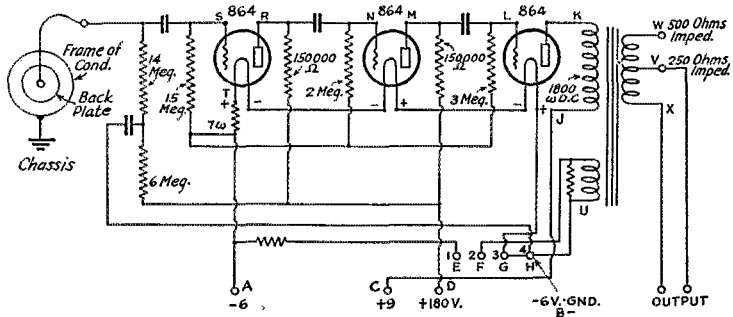

FIG. 1—ORIGINAL CIRCUIT OF PRE-AMPLIFIER

give the required voltage. (180 volts at 2.5 ma.) The chokes and resistor can be quite small with the low current drain of only 2.5 ma. (With some tubes it might go as high as 3.5 ma.)

An unusual thing was discovered while eliminating hum from the heater circuits of the 6C5's; namely, that the heaters would work equally as well on 2.5 volts as with their normal rating of 6.3 volts, insofar as this particular circuit was concerned, the only difference being that they took longer to warm up. With 6 volts a.c. there was a slight trace of hum which disappeared entirely when the heater voltage was dropped down

*15 Ware Ave., West Hartford, Conn.

It is desirable to make a new cable, consisting of three separately shielded pairs, braided or otherwise fastened together. Such an arrangement will prevent possible intercoupling between circuits and at the same time will prevent r.f. pickup in the audio system when the mike is used in the vicinity of the transmitter. One pair would carry the output, one the plate supply, and one the a.c. heater supply. It is advisable to incorporate the

(Continued on page 78)

Miniature Cathode-Ray Tube Announced

Type 913, with Metal Construction,
Soon Available

TECHNICAL data on the little metal-tube brother of the 906, some months in the works, has at last been released by RCA, and we may expect that the tubes themselves will be available in the very near future. This new small-size cathode ray tube, to be known as the type 913, is in a metal envelope like that used for the 6L6, except for the glass viewing screen at the end. It has the standard octal base. The screen diameter is approximately one inch. The 913 has the same element arrangement as the 906, and therefore will do all that the larger tube will do, although on a smaller scale.

The 913 is a high-vacuum tube of the electro-static-deflection type, capable of operating at low voltages. A brilliant image can be obtained with an anode voltage as low as 250 volts. Characteristics and ratings are as follows:

Heater voltage.....	6.3 volts
Heater current.....	0.6 amp.
Interelectrode capacitances:	
Control electrode to all others....	10.5 μ f.
Deflecting plate D1 to plate D2....	3.6 μ f.
Deflecting plate D3 to plate D4....	4.3 μ f.
Anode No. 2 voltage.....	500 volts max.
Anode No. 1 voltage.....	125 volts max.
Grid voltage.....	Never positive
Grid voltage for current cut-off*.....	-90 volts app.
Peak voltage between Anode No. 2 and any deflecting plate.....	250 volts max.
Fluorescent-screen input power per sq. cm.....	5 mw. max.
Typical operation:	
Anode No. 2 voltage.....	250 500 volts
Anode No. 1 voltage (app.).....	50 100 volts
Grid voltage adjusted to give suitable spot	
Deflection sensitivity:	
Plates D1 and D2.....	0.15 0.07 mm/v. d.c.
Plates D3 and D4.....	0.21 0.10 mm/v. d.c.

The 913 has an 8-pin octal base, with pin connections as follows:

Pin No. 1—Anode No. 2, deflecting plates D2 and D4, and shell

* With approximately 100 volts (to focus) on Anode No. 1.

Pin No. 2—Heater and cathode
Pin No. 3—Anode No. 1
Pin No. 4—Deflecting plate D1
Pin No. 5—Grid
Pin No. 6—Deflecting plate D3
Pin No. 7—Heater

Pin No. 8—Tied inside tube to Pin No. 1

Numbering is according to the RMA standard method, given in the *Handbook*.

A typical circuit diagram for use with the tube is given in Fig. 1. With this tube, as with other cathode-ray tubes, normal operation is with Anode No. 2 (and therefore the positive terminal of the high-voltage supply) grounded. This places the heater and cathode at power-supply voltage above ground, and in cases where a small broadcast-type power supply transformer is used, care should be taken to see that the heater winding is well insulated. At the voltages used on 913, probably any of the small transformers can meet this requirement without difficulty. Whenever possible, it is desirable to operate the tube with the shell grounded so that danger of accidental shock

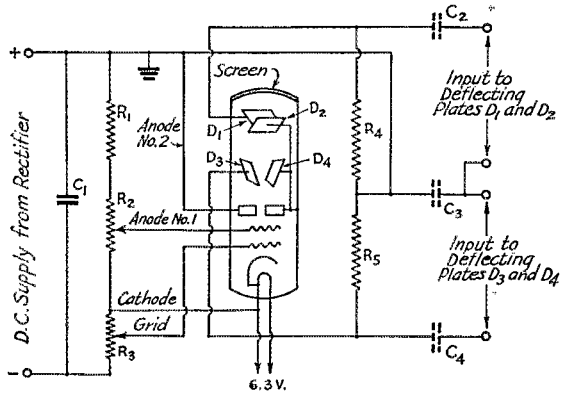

FIG. 1—TYPICAL CIRCUIT DIAGRAM FOR USE WITH THE TYPE 913 CATHODE-RAY TUBE

C₁—Filter condenser, 4 to 8 μ f.

C₂, C₃, C₄—0.1- μ f. paper (needed only when negative terminal of power supply is grounded).

R₁—130,000 ohms, 2 watts.

R₂—40,000-ohm variable.

R₃—30,000-ohm variable.

R₄, R₅—1 to 10 megohms.

can be avoided. However, if the tube is incorporated in a receiver and works from the regular power pack, grounding of the shell will not be possible and it becomes necessary to make an insulating mounting for the tube. A length of bakelite tubing completely enclosing the tube is recommended in such case. When operating with the shell "hot," the insulating condensers C₂, C₃ and C₄ are necessary; they may be omitted, however, when the tube is operated with a separate power supply which permits grounding the shell.

With this little tube, a really inexpensive cathode-ray oscilloscope for the amateur is in sight. We understand the price on the 913 is to be less than five dollars, which would bring the cost of a homemade job with all features an amateur needs down below the \$10 mark.—G. G.

A.R.R.L. Copying Bee—December 11th



A MEDALLION award by the League will be presented to the winner or to as many as submit perfect copies! Like the previous Bees this will give hams a chance to try copying some unusual word combinations, figure groups, and simple punctuation. There may be trick words, or misspelled words, sent in no particular sequence. It's an excellent opportunity to check up on our personal operating ability. Are we as good at the basic business of knowing our code stuff as we think we are? A new feature that will be of genuine interest to every participant: The League will return all papers (except winners) with a copy of the transmitted texts to each participant with a *confidential rating*. This report on standings will be made as soon as feasible after the closing date for mailing of copies. Transmissions will all be between 50 and 100 words in length. The sending will be by tape at about 25 words per minute. It will be a test to *copy what you hear*.

The following stations, all using "automatic" equipment, have been selected in the different time zones, and each will transmit different text. Care will be taken to make all messages equally difficult by different words, word order, errors, etc. It will be worse than useless to try to correct or compare messages. However, we urge everybody that knows the code *at all* to take part. Send in *whatever you get*, however little that may be. Check on your own proficiency and have some good fun at the same time.

In addition to the confidential rating you will receive you have a chance to win, and *all* participants will be mentioned in the report in *QST*. The schedule of transmissions for Friday night, December 11th:

In addition to the confidential rating you will receive you have a chance to win, and *all* participants will be mentioned in the report in *QST*. The schedule of transmissions for Friday night, December 11th:

Station	Frequency	E.S.T.	C.S.T.	M.S.T.	P.S.T.
W1INF (W. Hartford).....	3825/7150 kcs.	9:15 P.M.	8:15 P.M.	7:15 P.M.	6:15 P.M.
W2AYN (New York).....	7290 kcs.	9:15 P.M.	8:15 P.M.	7:15 P.M.	6:15 P.M.
W9UZ (Chicago).....	7003 kcs.	10:15 P.M.	9:15 P.M.	8:15 P.M.	7:15 P.M.
W9BAZ (Louisville).....	3810 kcs.	10:15 P.M.	9:15 P.M.	8:15 P.M.	7:15 P.M.
W6CIS (San Francisco).....	3504 kcs.	11:15 P.M.	10:15 P.M.	9:15 P.M.	8:15 P.M.
W6AM (Long Beach).....	7250 kcs.	11:15 P.M.	10:15 P.M.	9:15 P.M.	8:15 P.M.

The rules for taking part in the copying bee:

- (1) Any amateur operator, not having access to the tape or transmission copies, and copying wholly by ear, is eligible.
- (2) Mark one copy as your "best"; only this one copy shall count, but report all the above stations that you can hear to us. Keep copies other than your "best" to check yourself when we mail out the official texts to you.
- (3) Print your name, call signal, and address plainly on each entry.
- (4) Send in *original* copies. Re-copying messages *invariably* introduces errors and detracts from credits.
- (5) Copies must be mailed bearing a postmark in the year 1936 to be counted. Mail at once or within five days to make sure.
- (6) Every contestant must certify he has not been employed as a commercial or government radio, Morse or cable operator in the last year. This is strictly an amateur contest. The following exceptions, however, shall be eligible: (a) Holders of commercial licenses without experience under same. (b) Such holders (phone licensees or technical attendants) whose duties have not been telegraph operating within one year.

The transmitting stations will each send V's and identify themselves for ten minutes before scheduled times above. All amateurs are requested to note the frequencies listed and try to cooperate by keeping silence on these channels during copying bee transmissions, which start at the time indicated. Here's luck in the copying bee, and remember, write down *just what you hear*. If the transmission or what you can get is fragmentary, send it in just the same, so you receive credit, and we can send you the official texts for your examination.

—F. E. H.

Circuit Design of a Modern Amateur U.H.F. Superheterodyne

By Karl Miles*

IN DESIGNING a superheterodyne receiver for use in the ultra-high-frequency bands, there were certain fundamental points that had to be considered.

1. Image rejection.
2. Ability to receive self-excited 'phone transmitters, even those of the transceiver type.
3. The suppression of automobile ignition and similar types of noises.
4. The use of conventional tubes for length of life.
5. Stability and ease of operation.

When all these points were considered it was seen that a cheap receiver could not be built to do the job. So, in order to design a receiver from a practical point of view, more than just the ultra-high-frequency spectrum had to be included. Frequencies up to about 5 Mc. enter into the picture of a commercially practical ultra-high frequency receiver. In this range we must consider selectivity to a much greater extent than is usable, for instance, on the five-meter amateur band, where transceivers and "wobulation" are the rule rather than the exception.

THE I.F. SYSTEM

Starting back to the first of the list as given, we find, from former experience, that when using a stage of r.f. on the 14-Mc. band satisfactory image rejection is achieved with an i.f. frequency in the neighborhood of 465 kc. Therefore, in order to attain approximately equal image rejection on the 56-Mc. band, we would have to go four times 465 or 1,860 kc. This drops us right in the middle of the 1.75-Mc. amateur band.

We know that as the resonant frequency of a circuit is increased, the losses mount and the selectivity of the circuit is markedly lessened. In deciding to which side of the 1.75-Mc. amateur band we should move our intermediate frequency, it looked like a better bet to accept the higher degree of selectivity offered around 1,600 kc. than it would be to accept i.f.'s in the neighborhood of 3,000 kc., which would give slightly better image rejection but markedly less gain.

* The Hallicrafters, Inc., 2617 Indiana Ave., Chicago, Ill.

Tests were made on the Q of different coils, both air- and iron-core, and on different shapes of coils. It was found that the coil having the highest Q was one wound with 10-44 Litz, $1 \frac{1}{16}$ of an inch wide, on a Polyiron core.

After the design of the coil was decided upon work was begun on the losses in i.f. trimmers. It was found that there was a marked difference in the total efficiency of the circuit with compression-type trimmers when different makes, different kinds of the same make and even different trimmers of the same kind and make, were used. Apparently compression mica trimmers which ran satisfactory at 465 kc. would not prove satisfactory on the line at 1,600 kc. Air trimmers were investigated and were found to have less losses, as would be expected.

From commercial practice in the design of i.f. units, considering stability of setting and capacity, Sickles dual air trimmers with each section consisting of a fixed air minimum and a small air variable and having the two sections electrically

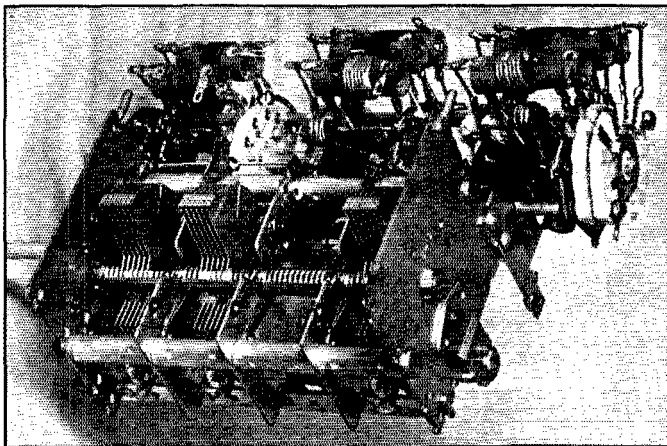

THE COIL-SWITCHING TUNING SYSTEM OF THE ULTRA-SKYRIDER RECEIVER WHICH INCORPORATES THE DESIGN FEATURES DESCRIBED IN THIS ARTICLE

shielded from each other, proved the most satisfactory. Since the circuits are less selective at 1,600 kc. than at 465 kc., it proved advantageous to go to two stages of i.f. in order to accomplish selectivity in the neighborhood of that which is arrived at with one stage of iron-core i.f. at 465 kc.

Now, having achieved selectivity which is

satisfactory for the reception of stable transmitters, we must do something to allow the reception of the boys who have "wobulation." After numerous measurements of frequency shift from modulation on 56-Mc. transmitter were made, it was discovered that any transmitter which deserved the name of even "fair" stayed within a 100-ke. band. Work was then begun on our 1,600-ke. i.f. system to develop a method whereby the noise of the selectivity curve at 2 times down could be broadened out to approximately this width. Different methods of expansion were tried. The continuously variable expansion type was found to have an advantage in that intermediate degrees of expansion could be accomplished. However, the movement of leads in this type, when the coils were moved, had the effect of upsetting the tuning because of capacity and inductive changes. This effect is much more noticeable at 1,600 kc. than it is at 465. The resistance expansion type was tried and gave a very nice nose, but the losses introduced by the resistance were too great since the sensitivity of the total system changed about 500 to 1.

Another method of expanding the i.f. selectivity is by means of a third coil in the i.f. transformer unit, wound very close to the primary and ar-

to the primary, different degrees of overcoupling or expansion are achieved.

When the next door neighbor comes on with his transmitter the selectivity can be improved to allow working close to his frequency with the sacrifice of some degree of understandability of the other fellow. In order to take advantage of this feature, expansion of the i.f. selectivity is made in three stages: "sharp," for the reception of stable oscillators, with very good selectivity; "medium," which gives understandable signals from self-excited jobs and still gives a fair degree of selectivity; and "broad," which gives very understandable signals from frequency modulated transmitters. This last is very useful when looking for that elusive answer to your CQ in that the set is broad enough to make this a "stand by" position. The band thus can be covered more quickly without skipping over some station that is calling you.

No modern high-quality communication receiver is built without a crystal filter. In normal work we find, particularly in the ham bands, that the stations are so close together that separation without single-signal selectivity is practically impossible. In the crystal circuit, we have gone to the method where the center tap of the input

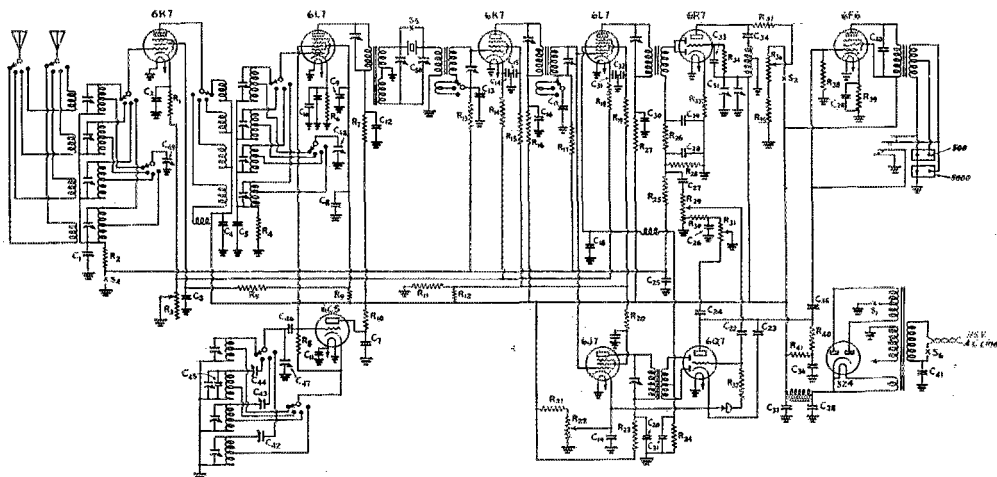

FIG. 1—CIRCUIT OF THE COMPLETE RECEIVER WHICH RESULTED

Note that the diode section of the 6Q7 tube furnishes the noise rectifier elements of the silencer while its triode section constitutes the first audio amplifier.

ranged with a switch so that it can be cut in and out of the secondary circuit. When it is in the circuit the percentage of coupling between primary and secondary is very high and overcoupling results, broadening the i.f. without materially affecting the gain. When this coil is cut out of the circuit by use of the switch, normal selectivity at just less than optimum coupling is achieved. By varying the number of turns and the percentage of coupling of this third coil in respect

circuit is taken from the coil and the output of the crystal filter is fed into a transformer, the primary of which is designed to match the crystal impedance. The secondary is tuned, with a step-up ratio.

IGNITION NOISE SILENCING

One of the other considerations in the design of an ultra-high frequency receiver is the suppression of interference of the nature of auto-

(Continued on page 80)



Amateur Radio STATIONS



WIHRX, Middleton, Mass.

THE ordinary amateur who is fortunate enough to have both summer and winter locations usually has his main transmitter at the winter place and uses a portable in the summer, especially if the summer place is a farm without electric power. Not so WIHRX; here the customary procedure is reversed. The power-less summer location boasts a one-kilowatt 'phone transmitter, while the winter-time QRA gets the benefit only of a low-power rig!

WIHRX is owned by James Millen, well known to the fraternity as the author of several *QST* articles and of those little talks which appear in each issue somewhere about page 57. The winter location of the station is in Malden, Mass.; in summer the scene is moved to a farm near Middleton, Mass., some twenty miles north of Malden. The "farm" is really one in name only, since no attempt is made to cultivate the soil of the hills which roll about the landscape. During the past few years much time and effort have been expended in remodelling the Colonial farmhouse and in installing equipment which will bring to the site all the conveniences of the city—but without benefit of the power line some distance away. Gasoline is the answer.

A fair-sized bungalow, some hundred yards from the house, combines the functions of radio station, recreation room, and guest house. One of the photographs shows the setting, another shows part of the interior of the main room. The location, despite the fact that it is high and decidedly clear, has not proved itself to be particularly "hot" for getting out, but compensation is to be found in the pleasant surroundings which make it just about an ideal spot for operating. Besides, there is lots of room to put up antennas which will overcome the effects of the rocky New England soil, which presumably is at fault.

Getting down to equipment, the transmitter is divided into two sections, one a complete low-power transmitter, the other a high-power amplifier and modulator. The low-power outfit occupies the left-hand relay rack of the pair at the right in the photograph. The output stage uses a pair of RK-20's in push-pull, driven by a fixed-tune exciter similar to the one described in November, 1935, *QST*.¹ A variable air-gap crystal holder is used in this unit to provide frequency variation over the 20-meter 'phone band, in which most of the operation is carried on. Below the r.f. units in the rack is a Collins 7-C speech amplifier, used either to modulate the suppressors of the RK-20's or to drive the Class-AB modulator for the high-power stage when the latter is in use. Power supplies for the r.f. section also are contained in this rack.

The right-hand rack of the pair contains the

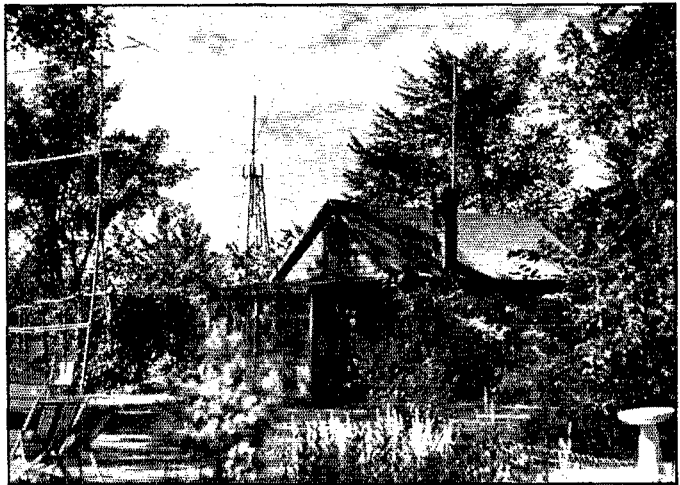

WIHRX, WITH ITS DISTINCTIVE ANTENNA ARRAYS, MAKES AN ATTRACTIVE PICTURE

When radio falls in the summer time a swimming pool, just out of the photograph to the left, offers a welcome change from QRM.

HRO receiver, oscilloscope, loud-speaker, and a panel for spare coil boxes. A shelf suspended from

¹ Millen, "A Quick-Switch 'Phone Transmitter for Two-Band Operation," *QST*, November, 1935.

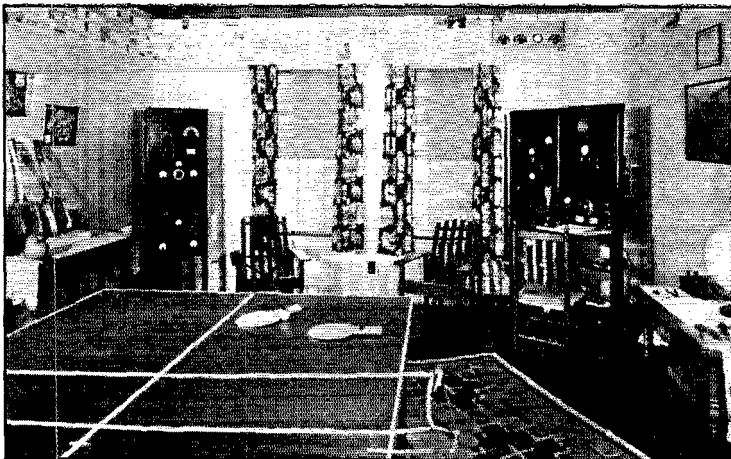

THE OPERATING ROOM IS ALSO A RECREATION ROOM

In such surroundings, the temptation is to let someone else do the operating!

field when the latter is running; these serve the double purpose of starting the gas engine and also carrying the lighting load when the transmitter is not being used.

Plate supply for the high-power unit is taken from a separate machine, consisting of a 3000-volt d.c. generator (salvaged from a nearby broadcast station when

the rack below the receiver serves as an operating table. Below the table there are open shelves for holding miscellaneous apparatus.

The high-power amplifier and modulator are mounted on the rack in the left-hand corner in the station photograph. A rear view of this assembly is given in another photograph. The Class-C amplifier, at the top, is link-coupled to the low-power transmitter; a pair of W.E. 251-A tubes is used in push-pull in this stage. The modulators are 851's, operated Class-AB. With this tube line-up there is plenty of reserve power-handling capacity all along the line; nothing needs to be worked hard even when running a full kilowatt input.

Of particular interest about this installation is the method of obtaining power to run the transmitter. Power supply equipment for the low-power set, and also for lighting the filaments of the tubes in the high-power end, is designed for operating from 110 volts, 60 cycles. A gasoline-driven 110-volt generator, housed in a fireproof cubicle some distance from the station, takes care of this load and in addition handles the lights for both station and house. To get rid of ignition noise, the line from the generator to the station is run in lead-covered cable, buried a few inches in the earth. A bank of storage batteries, totalling about 32 volts, is kept charged by being connected across the generator

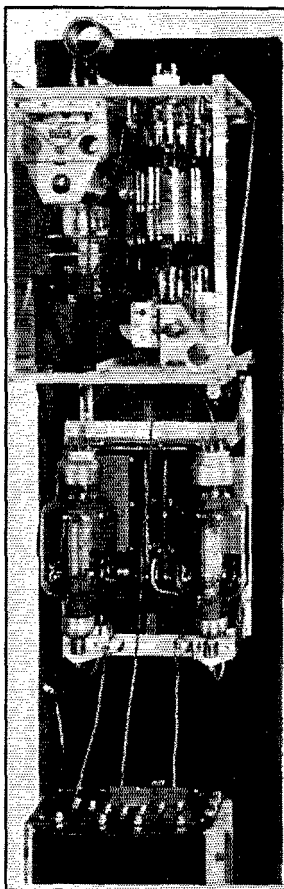

A REAR VIEW OF THE KW. AMPLIFIER-MODULATOR

The transformer at the bottom is not a pole pig but the audio coupling transformer!

the latter changed over to rectifying equipment) directly coupled to an old four-cylinder Chevrolet motor. The generator and its driving engine are mounted on an iron-girder framework and housed in a weather-proof box just outside the operating room. The machine is shown in one of the photographs. Controls for the starter, throttle and spark are brought in to the operating position. This supply is operated only during transmission, since it makes considerable noise, both electrical and audible. The throttle gives the operator easy control of the plate voltage; one simply "steps on it" for more voltage! A separate radiator is being installed inside the operating room to be connected to the motor during cold weather so that the heat developed will be put to good use.

The receiver is operated entirely from batteries, using 6-volt tubes, with a regular storage battery for the filaments and heavy-duty "B's" for the plates.

Ultra-high frequency equipment is installed at the end of the operating room. The five-meter rig is one which has given good service for several years, using a push-pull oscillator with a pair of 800's, modulated by Class-B RK-18's. Reception is handled by either an SRR or One-Ten receiver. On five meters, excellent contacts have been made many times with West Hartford, a distance of about 120 miles.

The view of the outside of the station gives a glimpse of the two transmitting antennas. The structure at the left of the picture is the five-meter directive array, consisting of four half-wave vertical radiators spaced a half-wave apart, with four parasitically-excited reflectors. This is the rig whose photograph has appeared in recent editions of the *Handbook*. The 20-meter antenna is a simpler array of the same general type, using two vertical antennas spaced a half wave apart, with reflectors a quarter-wave behind. The excited antennas are fed at the center through Q bars, with a non-resonant transmitting line connecting to the transmitter.

The tower which holds the 20-meter antenna is a self-supporting wooden affair 34 feet high, with a 4 by 4 mounted in the center at the top. The essential constructional details are given in the drawing. The platform at the top is readily reached by means of ladders. The antennas and

reflectors hang from four bamboo poles of the proper length to give the desired spacing between elements; these poles are fastened to the 4 by 4 near the platform and are guyed to the top as shown in the photograph. Weighted ropes at the bottoms of the wires keep them vertical. Installa-



THE HIGH-VOLTAGE GAS-ENGINE-DRIVEN GENERATOR WITH COVER REMOVED FROM THE HOUSING

This machine is started and stopped from inside the station going "on" only during transmission.

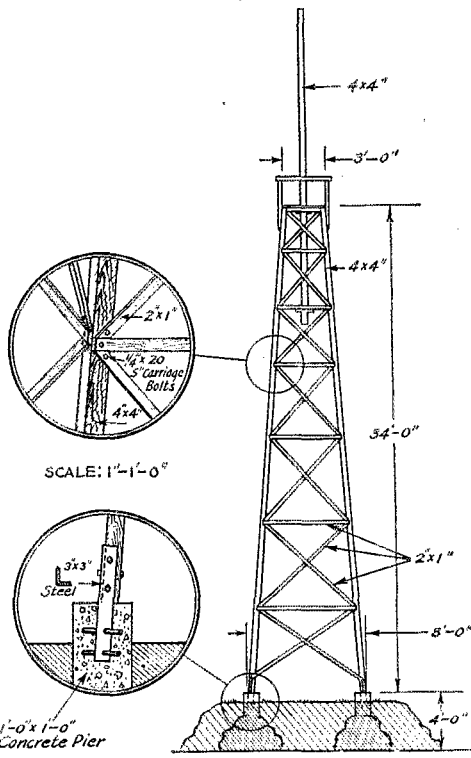

SCALE: 1" = 4'-0"

DETAILS OF THE SELF-SUPPORTING WOODEN TOWER

A tapering tower of square cross-section, made with 4 by 4 corner posts and 1 by 2 cross pieces.

tion of this simple directive system has notably improved the performance of the station, since results were not at all satisfactory with a simple antenna of the single-wire type.

In the winter time, when snow and ice make the farm practically inaccessible, the low-power transmitter and the receiving rack are set up among the civilized comforts of Malden. Using a 20-meter Johnson Q mounted vertically on an unguyed 2 by 4 set in concrete with a 2 by 2 extension at the top to keep the lower end of the antenna off the ground, the set gets out quite well on 20-meter 'phone, even though the power output is only about 40 watts with suppressor modulation.

Flash!

Just before going to press, we received a letter from Neil Werner, W9AJA, telling of a QSO with a station signing "EA4AP." The operator at EA4AP said the station was being run on American property by Associated Press men in Madrid. During the 25 minute QSO Werner was told that the original EA4AP was dead, but it was believed that EA4AO had escaped to France. Conditions in Madrid were serious; the shortage of food and war material was becoming apparent, and numerous air raids were occurring each day.

Believed to be authentic, the signal of EA4AP was T6 at 14,395 kc.

HINTS and KINKS for the Experimenter



A Cathode Ray Oscilloscope Switching Circuit

By C. T. Read, W9AA

THE switching arrangement shown in Fig. 1 has been in use by the writer for several weeks and has proved very satisfactory. It is used here in connection with a National HRO receiver and CRO oscilloscope but could be adapted to any type superheterodyne receiver and oscilloscope.

The diagram is self-explanatory. The switch used is an ordinary 4-pole double-throw anti-capacity switch with one pole idle. In the transmitting position the oscilloscope is connected for trapezoid or rectangular patterns, depending on whether the audio input or an a.c. sweep is used on the horizontal plates. The tuned tank circuit should be resonant with the transmitter frequency and the r.f. input adjusted by means of

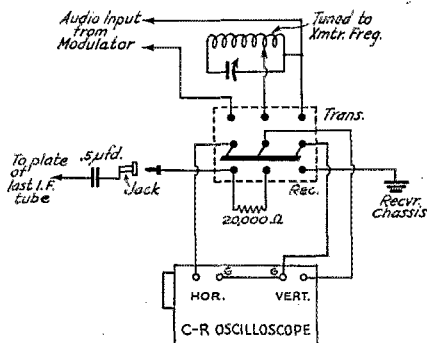

FIG. 1—SWITCHING CIRCUIT TO USE THE CATHODE-RAY OSCILLOSCOPE FOR CHECKING BOTH TRANSMITTER AND RECEIVED SIGNALS

A triple-pole double-throw switch is required. On transmission the wedge-shaped pattern is secured; on reception the circular pattern.

the tap to give proper vertical deflection. Never adjust the size of the pattern by detuning the tank, as it will give a distorted picture.

In the receiving position it is connected according to the directions issued by the National Company. A small jack-top feed-through insulator can be put through the back of the receiver and the 0.5 μ f capacitor mounted between it and the plate of the last i.f. tube. With the G.R. plug removed from the jack the operation of the receiver is not affected in any way. When the wire leading to the switch and oscilloscope is

plugged in, it is necessary to retune the last intermediate stage because the capacity of the wire to ground detunes it. When using the switch to change from the receiver to the transmitter, however, no retuning is necessary since the capacity is in the wire, not in the oscilloscope.

In checking the modulation of a received signal no sweep circuit is used, the 20,000-ohm resistor putting the horizontal and vertical plates out of phase and producing an oval pattern on the screen. An unmodulated carrier will describe a thin line oval in shape. As modulation is increased the thickness of the line increases until at 100% the oval becomes a solid pattern. Over-modulation produces a bright spot in the center of the oval. This check of course is only accurate on comparatively strong signals free from QRM, as interference and fading will show over-modulation when none exists. However, an accurate check usually can be secured on any signal over R6 by waiting for a quiet moment.

The receiving position can be used to check hum level on unmodulated carriers and key clicks on c.w. transmitters by using a 60-cycle sweep on the horizontal plates. With this arrangement a perfect signal produces a rectangular pattern on the screen. Any a.c. component in the signal will produce curves in the top and bottom of the rectangle, making a concave or convex figure and sometimes a figure 8 at the top and bottom.

Keying patterns may be observed with the 60-cycle sweep by watching the screen intently while a series of dots or high-speed keying is being transmitted. Proper keying will show long V shaped lines running from the middle to the top and bottom of the rectangle. As the keying becomes more abrupt the slope of these lines becomes steeper. With bad clicks the lines become practically vertical and transient surges may be seen above and below the main pattern.

An hour's observation on any of our amateur bands will convince anyone that we need a good housecleaning. A large number of our 'phone stations are still overmodulating, and the percentage of a.c. hum and key clicks in some so-called T9 signals is truly amazing.

A Voltage Quadrupling Circuit

THE circuit of Fig. 2, contributed by Frank Dickey, of San Antonio, Texas, is an arrangement using four rectifiers and four filter con-

densers to get quadruple d.c. voltage from a low-voltage a.c. source. It is an extension of the voltage-doubling principle already familiar to amateurs.

The fundamental schematic is shown in the upper diagram, while a practical circuit using a pair of 25Z5 rectifiers is given in the lower drawing. Four 8- μ fd. electrolytic filter condensers are used for building up the voltage. Additional filter could, of course, be incorporated in the circuit by

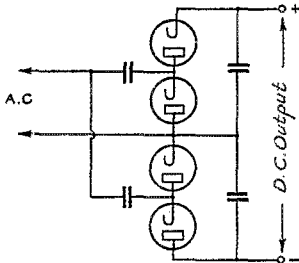

FUNDAMENTAL CIRCUIT

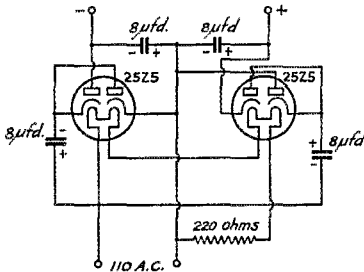

PRACTICAL CIRCUIT

FIG. 2—VOLTAGE QUADRUPLING CIRCUIT USING 25Z5 RECTIFIERS WORKING FROM THE 110-VOLT LINE

This circuit will deliver about 500 volts under a load of 40 ma.

adding a choke and putting an additional condenser section across the output. A test of this circuit showed a no-load d.c. voltage of 600; at a 40-ma. drain the terminal voltage was approximately 500 volts.

A Different Keying Monitor Arrangement

FIG. 3 is a diagram of another of the seemingly endless suggestions for monitor keying. The particular advantage of this system is that absolutely no connection need be made to the receiver, and that no retuning of any monitor is necessary when the transmitter frequency is changed. The idea was prompted by the fact that the keying relay had an extra, unused set of contacts, although of course it might be possible to hook the setup directly in with the key carrying the os-

illator plate current, without use of a relay.

The monitoring device is a small oscillator tuned to 454 kc., (the i.f. frequency of the re-

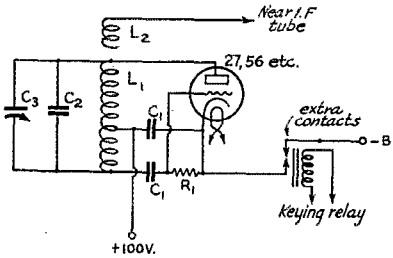

FIG. 3—R. F. KEYING MONITOR CIRCUIT

- L₁—R. F. coil from old b.c. set, tapped near center
- L₂—Few turns loosely coupled to L₁
- C₁—0.005 μ fd. (not critical)
- C₂—500- μ fd. fixed mica
- C₃—500- μ fd. variable
- R₁—200,000 ohms

ceiver) and loosely coupled to one of the i.f. stages by a wire wrapped around the coil of the monitor oscillator and then brought in the back of the receiver to within a few inches of the grid lead to one of the i.f. tubes. This seems to provide adequate pickup for a good signal in the speaker or 'phones, but will not cause any interference in nearby receivers of the same i.f. frequency, because when the pickup wire is removed the oscillator is no longer audible in the receiver.

The oscillator was easily constructed in a few minutes using a 27 tube, with an old tapped r.f. coil from a b.c. set. This was padded up to the i.f. frequency with a fixed 0.0005- μ fd. condenser, and tuned with a 0.0005 variable which easily hits the i.f. range at about half capacity or so. The circuit is the simple series-fed Hartley, and the voltage was most easily obtained here from the suppressor grid of the 59 Tri-tet. It could just as easily be obtained in numberless other ways, since the drain is only a few ma. Pitch is easily adjusted to suit the operator, and since the oscillator is very high-C no drift has been experienced, even in several hours' operation.

As our receiver is not blocked except when very close to the crystal frequency, the receiver is left as is when sending. However, the r.f. gain control can be turned down to shut out other signals or prevent blocking.

—Thomas Friedman, W8FPL

Negative Bias from the Plate Power Pack

MOST schemes for obtaining bias without a separate supply, achieve their object by sacrificing plate voltage—as in the case of cathode bias, tapping up on the bleeder, etc.—or else involve grounding the positive of one of the low-voltage supplies, thus making a clean cut tie-in of

the various negatives impossible and necessitating the exercise of care in grounding and shielding.

The method diagrammed in Fig. 4 involves none of the difficulties mentioned above since practically a separate bias supply is made available without the need for a separate transformer. The additional parts can, as usual, be found in the average junk box, and what isn't there can be purchased for a few cents from the local dealer.

The equipment pressed into service at the writer's station comprises an 82, a midget b.c.l. choke, a questionable electrolytic 8- μ d. condenser, and an old tapped b.c.l. voltage divider of about 10,000 ohms. With 350 volts a.c. input the unit delivers 270 volts of negative bias, more than ample for a pair of 10's. One of the taps is utilized to advantage and the resulting 150 volts soars about 20% with grid current flowing.

The particular transformer in the rig which is picked to do the work should be one which provides sufficient secondary voltage (center to either end) to give more than the bias desired for the stage in question. To provide bias for a pair of 10's or 802's the crystal supply transformer should fill the bill nicely.

There are, of course, limitations in its application as with all economy schemes. The chief concern in this case appears to be the possibility of overload because of the added bleeder drain through one side of the transformer. This, however, would be true only if we were trying to use a

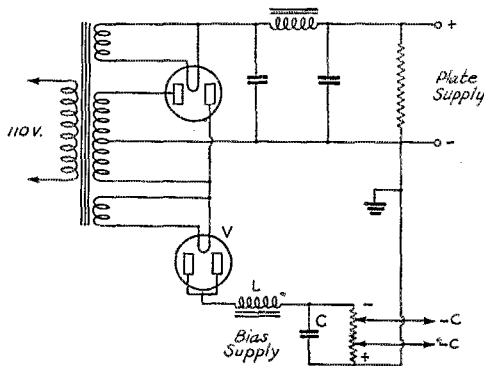

FIG. 4—PLATE AND BIAS SUPPLY FROM ONE TRANSFORMER

L—12-30 henry midget choke
 C—4-8 μ d. filter condenser of suitable voltage rating
 R—Tapped bleeder, 10,000 ohms or more
 V—Rectifier tube with inverse peak rating suitable transformer voltage

very low resistance bleeder in the interest of good bias regulation. When grid current flows, however, it tends to cancel the heavy bleeder current. In short, if you must use this stunt to bias a pair of 150T's to Class C, use a high resistance bleeder and a couple of 45's as bias voltage regulators as described in *QST* some time ago.

Additional stages may be biased from the same supply providing that the total grid current through the bleeder is not so high as to result in excessive soaring. An 802 and a pair of tens can be supplied with ease. Adequate r.f. filtering must, of course, be provided.

—R. Bassett, W2EAR

This method is used in some receiver and speech-amplifier applications (see Lund and Howe, "Considerations in Speech-Amplifier Design", January, 1936, *QST*), and has at various times been suggested in these pages for transmitting. The utility of the method deserves that it again be brought to the attention of those who do not have the equipment or space for a separate bias supply.—Ed.



DIXIE JONES' OWL JUICE

I GETS a nice letter from a scholarly gentleman in England who says I am coming in swell over there on 20 meter fone from W4SM, which is my other call, and that I am QSA 5 and R 9 with all kinds of mojulation and thanks for the entertainin' talk I made on the Spanish revolution and how's tricks in America by now. Hah! In fact hah, hah. I betchoo that burns up old Buck Taylor, and Doc, and Pat, and Martin, and Tony, and George, and Aubrey and Jimmy Long and all them big fone nabobs. They hafta spend years seques-terin' nickels away from the OW, and smokin' rat tail stogies, and skimpin' along and doin' without the life givin' vitamins contained in hootch to git together enough scads to buy a mojulator, and then when they git it they gotto bust a vest button to get across the Ohio river. Whereas, W4SM, which never had a mojulator and ain't even had a xmitter for two years can get nice dx easy as pie. Cw efficiency, I calls it.

—W4IR of the "Dixie Squinch Owl."

The 1936 VK/ZL DX Contest — First Scores

UNUSUALLY good conditions during the first three week-ends in October resulted in a great deal of activity in the VK/ZL DX Contest, sponsored by the Wireless Institute of Australia. On the east coast, VK and ZL stations could be contacted during almost all of each 26-hour period. The 28-mc. band was good for several hours each week-end, giving many of the ten-meter gang a chance to run up good scores, since ten was the only band on which repeat contacts were allowed. Although the signals on 7 mc. had

(Continued on page 88)



CALLS HEARD

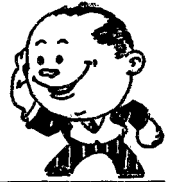

W3FAR, John J. Michaels, North Wales, Penna.

(28-Mc. Band)
September 17th-20th

g6dh on4jb g6qz g6rh g2pl g2hx g6bs g5la g2hg d4ort
d4auu d4rvc d4fnd ok1aw hb9ao oz3jn sm7uc zslh f8ob
f8wk f8ov f8ef f8va e8ib pa9qz pa9ax pa9zk pa9un hi7g
vp2at vp5mk lu7az xelam xelay xelcm lu9ax lu9bv lulep

**W6JMR, Walter H. Smith, 106 Ridge Rd.,
Fairfax, Calif.**

(14-Mc. Band)

August 1st-September 7th

d3dbn d3dxu d4akk d4aoo d4bbf d4buf d4hcf d4ijh d4iui
d4pau d4vrr d4ycf e15f e15g e18g f8dc f8fk f8ro g2io g2jf
g2mv g2tm g2uj g2wq g2xz g2zy g5bj g5df g5jf g5ju g5kt
g5li g5ni g5nq g5ov g5pp g5vr g5ws g5tw g5vb g5wi g5yh
g6bm g6cl g6dh g6hw g6lk g6nx g6qx g6rb g6vx g6xw
g6yo haf1, haf4h haf4k hb9bd hb9x la3j ly1hb oelfc o3fl
ob3np ob3oi ob5nr ok1kl ok2hx ok2rs on4ch on4hc on4hm
os2b os2m os5m pa0az pa0lr pa0no pa0nw pa0rn pa0sd
pa0vb pa0yq pa0zk sm6sc sm6su sm6sv sm6wl sm7yn
sp1de sp1hk u2ne yt7vn yt7dx

W8OSL, Julius Wengler, South Heights, Penna.

August 19th-27th

kalmd j3cr j3fi j8ca j8cf pk1bx pk1cr pk1pk pk1gw pk3bm
pk1jr vq8aa vq8ae vq8af vq8mb vq8ra vu2cq vu2eb vu2bm
vu7fy xu3fk xu8rl

**G6YL, Miss B. Dunn, Felton, Northumberland,
England**

(28-Mc. Band)

2-tube receiver

wlahi wlavv w1bjp w1bux w1cfd w1dbe w1df w1dze
w1ewd w1ewf w1hio w1hqz w1hwp w1iob w1ih w1nw
w1ra w1vw w1ze w2aq w2axx w2bcr w2byp w2byr w2cuz
w2dtt w2dza w2emv w2fba w2gjh w2gjk w2grd w2hee
w2hri w2tp w2uk w3air w3auc w3biw w3bny w3bvn w3ckt
w3dbx w3dqz w3dra w3emm w3enx w3eob w3erj w3fed
w3fmq w3ghs w3md w3pc w3si w4ada w4ah w4ajy w4auu
w4bbp w4bbr w4bzw w4tr w5afx w5ahj w5ahm w5bdb
w5bee w5bts w5ehm w5fcm w5fde w5fhj w5gw w5sl w5vv
w5wg w6cuh w6dob w6flm w6gri w6grx w6jnr w6kdb w6kd
w6kip w6ksi w6qg w7amx w7fla w8agu w8ano w8biq
w8cho w8cjm w8clm w8dvw w8euk w8jfc w8jin w8jlg w8kh
w8jrl w8lvr w8mmh w8nwl w8nwy w8nk w9aby w9aeh
w9apx w9bht w9cvt w9cx w9ddk w9dku w9dvr w9flh
w9fqc w9huv w9ism w9kpd w9lf w9lki w9min w9ovu
w9spb w9tjf w9tmm w9uhe w9uit cn8aa cn8mj cn8mq
cplac ct3ab fa8bg fb8ab k5ay lu3dh lu7ax lu9ax oa4j oa4b
py2cu py2dc py5qd suljt sulsg ve2be ve2de ve2ee ve3du
ve3er ve3kf ve3mj ve3tv vl3bq vl3cp vl3yp vk4ei voln
vp8ps zeljj zelju zslh zsz2 sz2j sz2b sz6k sz6m sz6s sz6y
zslc zu5b zu6p

**W1DF, WIJPE, W1SZ, W1TS—A.R.R.L. Hq.
West Hartford, Conn.**

(14-Mc. C.W.)

mx2b j2lu j2lo j2hq j2me j3cr j3de j3fi j5cc j8ca j8cf xula
xulv xu8op xu8rl vu2au vu2cq vu2hg vu2yb vu7fy kalib kalmd
vslaa vslal v7rf v8aa pk1bx pk1mo pk1pk pk1ra pk3bm
pk6ak u9al u9as u9mf vq8aa os1br fr8vr

(14-Mc. 'Phones)

pk1gu pk1mv pk1mx j5cc kalbh kalme vu2bg zeljr

**G6TD, J. R. Tuck, 36 South Ave., Stoke Park,
Coventry, Eng.**

(14-Mc. Band)

July-October

fk8aa hf1lv j2kj j2lu j3cr j5cc j8cf k5ac k6gnw k7fer
kalus kalky ny1aa pk1md u8ec u9mf u9ml ve4ig ve4jv
ve5ec vs7rf vu2aj vu2by vu2cg w5bmd w5evj w5egr w5ehm
w5af w6gnz w6hcf w6jbo w6kzl w6mt w6tj w7mb xu3fk

**Robert Muguet, 58 rue de Verdun, Meudon, S. &
O., France**

(14-Mc. 'Phones)

September

co2au co2mj co2qq co2wz co8cx co8vz ce3fm ce3gd fa3jy
ft4ag ft4al hi7g hi5x kulme la1g lu1ua lu4bh lu5cv ny2ae
oa4ab pk1mx py1ay py1bw py1eq py2ck py2ej py3aw
py8ib pz1aa sm6sx sm7uc sulch sulsg sulst ti2fg velar
velbc velbh velbr velcm velcr velde velim velsg ve2am
ve2be ve2bg ve2ca ve2kr ve2ga ve2nc ve3ag ve3bb ve3bk
ve3df ve3ib ve3jo ve3po ve3qs ve3yy ve4qb ve4bf vk2cd
vk2hb vk2st vk3zz vk6aa vp7na vpr voli vo4y w1axa
w1ber w1blo w1chg w1cpz w1ddm w1fg w1ged w1gpa
w1gpe w1gix w1ich w1iig w1iro w1lik w1as w1qm w1qv
w2ag w2au w2ba w2bh w2bfb w2bfd w2cls w2csp w2dh
w2eug w2mg w2oj w2zc w2byp w3bbb w3bth w3bqp w3by
w3cby w3ckn w3eo w3exp w3flh w3md w3ams w4als w4awe
w4cr w4cyb w4dip w4dgv w4ebw w4fq w4to w5bdb w5eag
w6ah w6eim w8alr w8bbo w8bfd w8bk w8bw w8gyu
w8gwu w8gr w8jyu w8li w8mpx w8mwx w8obx w8cp
w9abf w9ags w9bde w9bsb w9cvm w9fru w9mcd w9sp
w9obx w9uvc w9zb w10xda vu2bg xe2ah xe2h xe2fm yn1hs

**W2HFF—Liscum Diwen, 524 Riverside Drive,
New York, N. Y.**

(7-Mc. Band)

Call letters in bold face type indicate 'phone

ae8ad celao cn8mb cn8me cn8mi cn8nm cn8mp cn8ms
cn8pr cn8seg cr6ad c2a ca8ac ea8ae ea8af en8ah ea8al
ea8an ea8ao ea8gce ea8vb f3ocb fa8bg fa8er fa8eng fa8ih
fa8jo fa8pw ft4ab ft4af ft4ag he1fg he1fs he1jw he2ev he2jm
hj3ajh hrlaa iliz j2ce j5cb ka1ab kalcm kalhr ka4jv ka9wx
k7alq k7ez k7pq om2dm om2rx pk3jj pk5cg pz1pa sm7rv
sulch sx3a td1aa u2ne vk6ae vk6dl vk6fo vk6hf vk6hw
vk6mo vk6or vk6rh vk6rl vk6sa vk6ar vk6vm vk6wk vk9ba
vr2wf vs6ak xfa2 xoh2fj xoh2hu xula yhlrv yi6ff yi2bb
za3a zb1h zcls zd1d zp1ab xz5 zza1 zza2 zza3

(14-Mc. Band)

ea8af ea8ao ea8lv fk8aa fm8d fr8vx holfj j2gx j2hg j2jj
j2kj j2ll j2lu j2me j2mh j3cr j3dv j4ct j5cc j6cc j8cf k7anm
k7fer k7pq k7ua k7vh k7zzk kaljr kallb kalmd mx2b
pk1bx pk1jr pk1ra pk2ko pk3bm pk3st px1b pz1aa pz1pa
sm6sx sulch sulsc sulrk sulro su1sg sulst sulss su2ga
su2np su3ab su3eh su5nk su6hl sx3a tf3ag tf3c tf3g tf3lx
tf5c tg2ai u6ah u6se u8aa u9ac u9mf ue3el uk3cs vq5kad
vq8aa vr2ab vr2yv vs6ae vs6ak vs6aq vs6ax vu2bg vu2cq
vu7fy xu8op xu8tm

**W2BND, Ben Braunstein, Aboard S. S. Washing-
ton at Dock in Hamburg, Germany**

(14-Mc. 'Phones)

October 2d

w1ajz w1bqq w1we w2mj w2zc w2cls w2elo w2foa w2hfs
w2huq w3md w3lm w3pe w3fih w3bth hi5x hclfg ny2ae
(Continued on page 90)

• I. A. R. U. NEWS •

Devoted to the interests and activities of the

INTERNATIONAL AMATEUR RADIO UNION

Headquarters Society: THE AMERICAN RADIO RELAY LEAGUE, West Hartford, Conn.

MEMBER SOCIETIES

American Radio Relay League
Associazione Radiotecnica Italiana
Canadian Section A.R.R.L.
Československá Amatérská Vysílací
Deutscher Amateur Sende-und-Empfangs
Dienst
Experimenterende Danske Radioamatører
Irish Radio Transmitters Society
日本アマチュア無線聯盟
Liga Colombiana de Radio Aficionados

Liga Mexicana de Radio Experimentadores
Nederlandsche Vereeniging voor Internationaal Radioamateurisme
Nederlandsch-Indische Vereeniging voor Internationaal Radioamateurisme
New Zealand Association of Radio Transmitters
Norsk Radio Relé Liga
Oesterreichischer Versuchsenderverband
Polski Związek Krotkofalowcow
Radio Club Venezolano

Radio Society of Great Britain
Rede dos Emissores Portugueses
Reseau Belge
Reseau des Emetteurs Français
South African Radio Relay League
Suomen Radioamatöörlitto r.y.
Sveriges Sandareamatörer
Unión de Radioemisores Españoles
Union Schweiz Kurzwellen Amateure
Wireless Institute of Australia

Conducted by Byron Goodman

Colombia:

On October 29th amateur radio achieved another great victory. The scene of that victory was the Republic of Colombia; the combatants, the *Liga Colombiana de Radio Aficionados* and certain elements in the government opposing the granting of licenses to radio amateurs. The L.C.R.A. won. In a "surprise finish," near the end of the session, following a period when it looked as though all were lost, the Senate of Colombia on the night of the 29th rushed through legislation recognizing the rights of amateur radio in that country.

The story behind that victory is long, the struggle bitter. For many years Colombia has enjoyed the distinction of being one of the only two nations on earth actively hostile to amateur radio, the other being Italy. In both countries this attitude flowed from specific personal animosities. In Colombia the all-powerful *Ministry of Correos*, possessor under the Colombian fiscal law of a complete monopoly over all forms of radio communication, for years refused to recognize the right of private participation in any radio activity of any kind. All services—broadcasting, as well as amateur—suffered equally under the situation. Yet, despite determined opposition, this iron grasp was maintained dominant over a period of years.

The year 1933, it can now be recognized, marked the beginning of the end. It was in that year that the L.C.R.A. was formed, with its major objective the securing of amateur rights in Colombia. In 1934 it achieved its first major victory—winning the support of the Army. So interested did the Ministry of War become that it sent one of its officers to I.A.R.U. Head-

quarters, to learn the facts of amateur radio throughout the world. In 1935 another step forward was achieved; a committee of the L.C.R.A. waited upon the President of the Republic and enlisted his aid to their cause. But despite a maximum of intra-governmental pressure the Minister of Telegraphs remained adamant. All attempts to secure a relaxation of the monopolistic point of view ran up against a stone wall.

It became increasingly clear that legislative redress was the only solution. With the aid of the President a bill was drafted providing for the creation of a national radio-communications commission, consisting of a chairman appointed by the President and representatives of the Ministry's of Telegraph, War and Education, as well as one representative each of commercial broadcasting, commercial radiotelegraph and radiotelephone, and of amateur radio. It was a good bill, and it early won the approval of a majority of the Congressmen. But powerful opposition still prevailed.

Most damaging was the attitude of the press. Fearing competition on the part of commercial broadcast stations, provided for in the bill, newspapers fought the act bitterly. Inasmuch as until recently the Congress had been shackled by press control, this was a decided handicap. Another powerful group of opponents were the foreign commercial communications companies, with which the Colombian government monopoly did business on the basis of special privilege contracts—Marconi, Telefunken, etc. This group was particularly opposed to amateur radio, an attitude they also display—although less successfully—in their own countries.

To all this opposition must be added a general

ignorance on the part of government officials concerning radio problems in detail. An example of this is the confusion that sprang up concerning the broad definition of radio communication, as covering all forms of radio activity. The Minister of Telegraphs was very nearly successful in forcing upon a helpfully-disposed but bewildered Senate an interpretation of provisions of the Madrid treaty and the Colombian fiscal law which regarded all types of radio communications, including broadcasting and amateur, as identical with revenue-producing two-way telegraph or telephone work.

There is no need to elaborate further on the maze of opposition that existed. Suffice it to say that, step by step, with commendable perception of the problems involved and their solutions, in a campaign characterized by unusual energy and the competent application of political and legal strategies, the officers of the L.C.R.A. won the fight. Particular credit goes to Dr. Ferdinand Carrizoza, past president, and Rafael Tamayo, existing president, and, most of all, to Italo Amore, indefatigable competent honorary secretary of the L.C.R.A. To them and to their associates, heartiest congratulations. Through them, amateur radio today celebrates its latest triumph—a new recognition, another stepping-stone to the pinnacle of international prestige.

—C. B. D.

Spain:

Despite attempts to secure information through European amateurs and American newspaper correspondents in Spain, authentic information concerning the situation of Spanish amateurs is lacking up to the time of going to press. Rumors are rife. From a German amateur comes a report, unconfirmed by other sources, that EA4AO, ex-EAR96, preëminent Spanish DX amateur, has been executed by Madrid loyalists. A further rumor is that all the U.R.E. official organization has been similarly dealt with. Throughout Europe ring charges and counter-charges of non-neutral amateur activities. A Barcelona amateur accuses other Spanish stations of Soviet propaganda activities. In Portugal an official decree has closed down all amateur stations, on a neutrality-preserving basis. Strife rings the change, and amateur radio dances to the tune. . . .

Applicants:

Recently received applications for membership in the I.A.R.U. are from the *Liga de Amadores Brasileiros de Radio Emissao* (Brazil) and

the Newfoundland Amateur Radio Association.

The I.A.B.R.E. is well established in Brazil; calls and licenses are granted by the government through the society.

Newfoundland had no radio society until the formation of the N.A.R.A., but a keen personnel is rapidly rounding the organization into form. All communications should be addressed to the Secretary: Eric S. Holden, P. O. Box 650, St. John's, Newfoundland.

Applications for membership are presented to the Union in the semi-annual Calendars, and the result of the voting is known after a five-month voting period.

Argentina:

Amateur radio goes none too well in Argentina at the present time. From LU3JC we learn that some difficulty is being experienced with license renewals. Applications for renewal are received, a written examination given, but no license is forthcoming. Many calls have already been removed from the lists.

LU7AZ, via W4EG, tells of the Argentine system of identifying calls and districts. The first letter following the number in the call is the key to the district, e.g., "A," "B," and "C" show the station to be in the city of Buenos Aires, "D" and "E" the Province of Buenos Aires, etc.

Here and There:

Germany: From the D.A.S.D., W. Slawyk, D4BUF, writes: "The DASD-DJDC proved a surprising success. There were nearly 800 stations participating, among which were about 300 'W' stations. We wish to thank all American amateurs for the support they gave our first contest" The headquarters society was privileged to entertain Wolf E. Franzok, D4GZF, Clemens Panet of the German Broadcast system, and Hubert Underberg, second operator at D4ZOI, during October

New Zealand: The 85- to 105-meter band formerly allotted to the Radio Emergency Corps has been curtailed to assignments of 2870-2930 kc. and 3350-3400 kc. because of increased domestic commercial need, according to L. G. Petrie, N.Z.A.R.T. General Secretary *Denmark:* Former E.D.R. Secretary Ahrent Flensborg, OZ1D, succeeds James Steffensen, OZ2Q, as president of the Danish Society. Steffensen has been particularly active in I.A.R.U. affairs, presenting many worthwhile ideas for the advancement of the Union

(Continued on page 84)



J. M. DE CORDOVA,
EA4AO, EX-EAR96, OUT-
STANDING SPANISH
DX OPERATOR



OPERATING NEWS



Conducted by the Communications Department

F. E. Handy, Communications Manager

E. L. Battey, Asst. Communications Manager

Ten Meters: The 28-Mc. band is giving a generally fine performance to judge from recent DX reports. Our only plea with respect to it now is that hams use the *whole* 28- to 30-Mc. band! While the interference does not yet reach the levels noted on low-frequency bands, there are some complaints noted. Our suggestion is that stations working c.w. DX the world over use the 29- to 30-Mc. part of the band more—then QRM-free work will be possible for telegraph operators (29-30 Mc.) and 'phone (28-29 Mc.) with fewer complaints from either. It appears as quite natural that this band should exhibit a few "growing pains" until the degree of occupancy by 'phone reaches proportions that give this the self-exclusiveness common to 'phone allocations elsewhere.

'Phone Message Handling?' Phone operators as a rule have never "gone for" message handling in a big way, perhaps because rag chewing is the major 'phone objective. In A.R.R.L. transcons of years gone by c.w. telegraphers led in accuracy, while 'phone showed superiority with respect to speed in some of the tests. Results depended on the degree of practice and skill in operating, on organized system in tackling the relaying problem, and on location of most stations participating in relays in groups close to one frequency, or one part of the band, for most favorable work. Brass-pounders of course get lots of practice in handling traffic with system and dispatch; they get their fun that way. Voice stations in the past have been handicapped by having operators whose experience in handling record communications has in some cases been allowed to lapse so full inherent "speed" possibilities could not be realized. But of late, while 'phone operators have not by any means reported traffic in volume, there have been signs of many individual instances of useful 'phone message handling. It will never be our policy to take the part of a reformer, to encourage traffic groups to work DX, or DX groups to work 'phone, 'phone groups to change their basic interest to traffic, or any other combination. A.R.R.L. Communications Department policy is to assist all amateur groups and interests along the line of natural interest. Along that line, A.R.R.L. OPS will be trying out a new form, a special tool to help improve experimental adjustments and operating policies, about the time this appears in print.

We started to call attention to the fact that more instances of exchange of record communications are taking place by 'phone than in past years. This is undoubtedly for the best. We invite all stations to report this work so they (and ham radio) may be credited. We want to call the attention of all 'phone operators to the correct technique for highest accuracy, use of repeats and word lists, and system, such as exemplified in operations in airways, police and telephone systems where voice operating standards are high. See page 360 of the *new A.R.R.L. Handbook* or pages 319-320 of the '36 edition for good procedure and word lists—and be sure to use a *complete* message form if and when you handle traffic. It goes NR-CALL-CK-PLACE-TIME-DATE-ADR-TEXT-SIG. More 'phone mets and activities are desired. See the 'Phone Activities Manager in your A.R.R.L. Section; give him suggestions for what you want to see for activities, period to get together on the air etc. Tell him you are ready. Ask your SCM or Hq. to line you up with your PAM if you don't know who he is.

Be ready for Public Service and Emergencies: General attention to development of operating ability to make our work more effective in all communicating branches of amateur radio is continuously necessary—and special attention to the handling of record communications makes for superlative operators with high general proficiency. Nets, trunk lines, and schedules cover the country, both c.w. and 'phone, and automatically maintain amateur radio's readiness for any sort of emergency that may strike any part of the nation, at the same time operating proficiency is held at the peak through regular systematic work. League members have reason to be proud of the organized operating system that this year bids fair to outperform all previous attempts. The whole system is of course the sum of the parts, individual hams, members of nets, trunks, ORS, OPS, RMs, PAMs, SCMs, etc., each one with a fine individual responsibility to make every sked click may not only take pride in their work, but deserve the thanks of all our fraternity for carrying forward the "public service" tradition of amateur radio, to higher levels in individual and group readiness to serve.

In the emergencies of last season certain inadequacies in the operating abilities of new men belonging to both c.w. and 'phone ranks were

made apparent. We have a substantial annual turnover in ham ranks . . . and without self-interest and training in systematic lines of work the booster for either mode of communication cannot find himself either accurate or speedy in handling telephone or radio circuits. In an emergency such men haven't "what it takes" to take over an important radio circuit with any volume of communications. They may make good messengers or supplementary aids, but the vital radio links take skilled operators, else the penalty of garbles and delays, inadequate station records etc. It is not to argue the relative merits of c.w. and 'phone that we write. That each has its important place has been demonstrated. This is just to suggest that in getting our fun out of the game, all of us, whether able to go in for hamming in a big way or not, and whatever our pet branch of the hobby, ought to make a station practice of handling a few good messages—enough to know correct form, and be able to *write down* a communication properly and accurately—else where do we all stand when opportunities to do this in a big way for ham radio occur? It is unfair to yourself to be able to help only as a messenger or aide to a station in emergency, and unfair to others to *pull down* an otherwise splendid average performance by unduly slow and inaccurate operation with chances of illegible results. More and more, however, operators tired of so-called rubber-stamp "73-cul" QSOs are turning to organized phases of amateur work that combine operating fun, more QSOs in limited operating time, strong personal friendships, with constructive building of personal communicating abilities.

—F. E. H.

Briefs

The South Hills Brass Pounders & Modulators third annual hamfest was held in Pittsburgh, Pa., Sunday August 2d. It was slated to open at noon, but long before that time out-of-town visitors started to arrive, W8LJZ of Mantua, Ohio, being the first at 8:00 A.M. They kept coming until the registration cards showed a total of 787 paid admissions! This was one of the largest ham gatherings ever held in the Pittsburgh area. There were many present who did not register, among them being wives and children, so the full attendance is estimated as being ever greater than 787. The numerous prizes distributed had a cash value of nearly \$1500. It is hardly necessary to say that everyone enjoyed the affair!

Life Saved by Amateur Radio

The alertness of Elmer Asselin, and S.W.L., who is a shut-in, residing at 4330 Iberville St., Montreal, was responsible for the saving of a human life. Gerard Fournier, 25-year-old lumberjack, was flown from the backwoods to rest comfortably in a Montreal hospital after a tree fell on him, breaking his back. On the evening of October 3d, Elmer Asselin, who passes away the long hours, during which he of necessity must remain in bed, by listening to amateurs, heard VE2GB, Berthierville, Que., calling "CQ Montreal Emergency" on 'phone. Asselin immediately had his father telephone to VE2HT, O.P.S., who lost no time in diving into his shack and throwing the receiver and transmitter on the air. He heard VE2HL of Quebec City calling "CQ Montreal." Contact was made and it was

learned that Fournier, the injured man, was at the shack of Dr. Rivard, VE2BW, at Clova. Contact was established with the doctor and, at his request, authorization was obtained to transport Fournier to Montreal by plane. The plane left Clova at 7:30 A.M. while Doctor Rivard was again QSO VE2HT. At the hospital officials stated that the prompt action in bringing the injured man to Montreal was responsible for saving his life. Congratulations to all who had a part in this work.

Hams Afloat

W8FFK is now operating on the Steamer *Ashtabula*, WBDG, running between Ashtabula, Ohio and Port Burwell, Ontario. W8EJY left the S.S. *Grand Island*, KFNA, for college; the new operator on that ship is W8CGI. Ex-W8OT is with the Coast Guard at Buffalo. "Gil," W1CJD, served as operator on a two weeks' run of the S.S. *Atecas*, KDAK. W8CLL when last heard from was operating aboard the Tug *Sulphite*, KENQ, which is in the pulpwood trade on the Great Lakes; rig consists of a 1/2-kw. spark with conventional detector and two-step receiver. W8CEU is on the Great Lakes operating KFMM, the *John W. Boardman*. VE2BP keys the 1 1/2-kw. rotary gap on the S.S. *Ford Strathcona*, GMSK. W1JL was last reported as pounding brass on the S.S. *City of St. Louis*, WFCP. Equipment is a Marconi P-4 2-kw. spark and an RCA ET-8003 tube job. The latter has an output of 50 watts and uses four '10's in self-excited p.p. circuit. An old-timer, Thos. W. Braidwood, 3UZ of pre-war days, 3BA after the war, is returning to the air as W3GLH. Commercial operating has kept him from ham radio for the past seventeen years, during which he has been on 4 freighters, 7 tankers, 7 passenger ships and 2 yachts—five years on the latter. His latest ship is the S.S. *Vacuum*, KUTS.

Pikes Peak Celebration

Due to the opening of the Pikes Peak Highway, Colorado Springs staged a mammoth celebration during which the Pikes Peak Amateur Radio Association took part by covering most of the events by 56 mc. On June 27th the modern version of the Pony Express left Cheyenne headed for Colorado Springs, and the car accompanying the pony express rider was equipped with a 3.5-7 mc. c.w. rig as well as a genemotor powered 56-mc. transmitter and receiver. The a.c. generator which operated the c.w. equipment went haywire, putting the whole burden of communication on the 56-mc. equipment. W9YAE on top of Pikes Peak contacted W9HDI, who was operating the mobile equipment about 40 miles north of Colorado Springs and maintained contact until the express reached Colorado Springs. W9YAE relayed the information on the location of the riders to W9NRZ, who was operating the 56-mc. station in the Chamber of Commerce building in Colorado Springs. The 56-mc. equipment in the car and on the Peak was designed and built by W9HDU. Practically every member of the P.P.-A.R.A. assisted in putting over the job of furnishing communication for the Pony Express. Denver hams assisted by securing information on the location of the riders between Cheyenne and Denver and relaying it on to W9YAE on the Peak. W9PWU at Arvada also rendered valuable assistance. On June 28th, 56 mc. also played an important part by covering the foot race up Pikes Peak. This the gang also covered in grand shape.

KA1AN, Official Observer, had the Chinese Vice Consul in Manila out to his station and showed him how the Chinese commercials were using our amateur bands, especially 7 mc. The Vice Consul promised cooperation with the amateurs and stated that he was sending a cablegram to his home government requesting that the interfering stations be ordered off the amateur bands. Re QRM: In addition to the Chinese commercials we are still having trouble from some radiotelephone stations in the Dutch possessions to the south of us, but so far I have not been able to determine the calls.

—KA1GR, SCM, P. I.

An interesting radiophone test has been made on 14 mc. between VK2ABD (Sydney, Australia) and my station, W6LLQ (Pacific Fallsades, Calif.). After contacting a great number of Australian radiophones during the past six months, I selected VK2ABD for a test on extremely low power as the signal from his station is one of the best under normal circumstances. At 11:30 p.m. PST on August 11th, VK2ABD reduced his normal power of 30 watts to .54 watts, being 135 volts at 4 m.a. The quality was still excellent, and on normal power was S9 plus; on .54 watts the signal dropped to a varying strength of S5 to S8, but perfectly readable at all times. The test was made in the presence of two witnesses at my station and in the presence of VK2XS at the VK end. I think this is an outstanding record of some sort.

—Henry M. Harris, W6LLQ.

The Rag Chewers' Club

THE Rag Chewers' Club made its initial bow in June, 1925. Designed to encourage more friendly contacts and to discourage the "Hello-Good-bye" type of QSO, it has done much to bond together those operators interested in honest-to-goodness rag chewing over the air. Membership is still open and a supply of classy membership certificates are on hand for those who qualify. Follow the rules here outlined and make your station eligible to sign "RCC." Present club

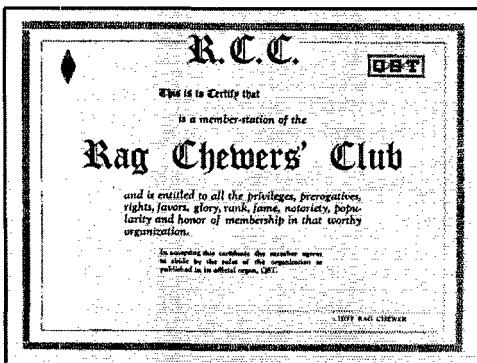

members are urged to sign "RCC" after each call so that those wishing to join may identify you and take steps to get "initiated."

How to get in:

1. "Chew the rag" with a member of the club for at least a solid half-hour. This doesn't mean a half-hour spent in trying to get a message over through bad QRM or QRN, but a solid half-hour of conversation or message handling.

2. Report the conversation by card to the Rag Chewers' Club, A.R.R.L., West Hartford, Conn., and ask the member station you talked to to do the same. When both reports are received you will be sent a membership certificate entitling you to all the privileges of a Rag Chewer.

How to stay in:

1. Be a conversationalist on the air instead of one of these tongue-tied infants who don't know any words except "cuagn" or "cul," or "QRU" or "nil." Talk to the fellows you work and get to know them.

2. Operate your station in accordance with the radio laws and A.R.R.L. practice.

3. Observe rules of courtesy on the air.

4. Sign "RCC" after each call so that others may know you can talk as well as call.

How to get out:

1. Call a fellow and then say something like, "W7 nil hr Om cul 73".

2. Call anybody if you are so dumb that you can't make some conversation.

3. Fail to QSP promptly a single message—either by radio or by mail.

4. Call CQ more than five times without signing, or call lengthy CQ's without listening for answers.

Need New Mexico for W.A.S.? W6FRR, Conchas Dam, N. Mex., is on 14 mc. every morning from 6 to 8 M.S.T., 14,390 kc. He will gladly arrange schedules on 14 or 7 mc. with anyone needing his state for W.A.S.

South African DX Contest

THE S.A.R.R.L. is staging a world-wide DX Contest in January, 1936. Serial numbers with RST report followed by three self-assigned figures are to be used by each operator. The contest will start Saturday, January 2d, at 0400 GT, running through Sunday, January 3d to 2200 GT, and will be resumed on the following three week-ends at the same time. African stations include the following: ZS1 to 6; ZT1 to 6; ZU1 to 6; CR7, CR8, VQ2, VQ3, VQ8, ZE1, FB8, ON4 and FR8, a total of 27 African zones.

Two points will be counted for exchange of numbers between stations, four points for 28-mc. exchanges. U.S.A., Australia, Canada and New Zealand will be divided into their districts. A multiplier will be used. DX stations will multiply points earned in contacts by number of African zones worked. African stations will multiply points by countries and by the divisions mentioned. A handsome trophy to the world's highest scorer and a certificate to winners in each country or subdivision.

The above information was received from ZU6E by W6KBD, as well as pertinent details coming from ZU6P via W4AUU.

A.R.R.L. Elections Via W1INF

As soon as the results are known in the elections for A.R.R.L. Director and Alternate they will be transmitted to the entire O.B.S. system (see page 118, Oct. QST) for radio transmission during the following several days.

In addition, the information will be addressed directly to members by W1INF on the following expansion of the daily 8:30-10:30 p.m. EST O.B.S. transmissions:

Monday, December 21st—simultaneous tape transmissions on 3575, 7150 and 14,300 kc.

7:30 p.m. EST 20 wpm
8:30 p.m. EST 20 wpm
9:30 p.m. EST 20 wpm
10:30 p.m. EST 15 wpm
11:30 p.m. EST 20 wpm

Tuesday, December 22d—simultaneous tape transmissions on 3575, 7150 and 14,300 kc.

8:30 p.m. EST 15 wpm
9:30 p.m. EST 20 wpm
10:30 p.m. EST 25 wpm

W6GRL was declared the winner in the A.R.R.L. 1936 DX Contest in the Los Angeles Section on the strength of his 57,222 points. His nearest competitor was operator H. Y. Sasaki at W6CXW with 45,305.

W9NTP writes an amateur radio column for his local paper and is interested in exchanging clippings with other amateur radio column writers. His address: Wm. E. Brentlinger, 1625 South 11 Street, Terre Haute, Ind.

How's DX?

How:

How's DX? Did you ever hear anyone say it was good? No; at least not until that elusive station had faded out, or the other fellow had worked him first. At that, it's perhaps a justifiable attitude, since DX is one of the most highly specialized forms of competition in amateur radio. And the prize usually goes to the fellow with the patience to sit down and comb the band, edging up to high-powered locals in the search for a weak signal that means the empty-umth country in the ninth continent. Then you switch the antennas around until you find which one he peaks on, and you give him a blast, key arcing and transformers groaning. . . .

Where:

How many times have you worked a rare one, only to find that you had no way of confirming the QSO, since the QRA was not known? Never? Then you are lucky. Take the case of Charles Koppe, W8CHO, for example. He worked VR2NB on the 4th of October (14,300-ke. RAC) at 10 A.M., E.S.T. VR2NB, according to the international prefixes, should be in the Fiji Islands, but he gave his QRA as "Sandakan," which is in British North Borneo (VS4). The answer, of course, is that VR2NB is now VS4CS FM8F, worked by W9RBI on October 13th at 12:30 P.M. (14,260 kc., very a.c. 'phone), is not so bad, probably a brand-new station in Martinique. RBI was his first W9 contact But the lad who is in a quandary, an old, deserted quandary with tall, steep sides, is Harry Whiting, W2JXH. He worked MF7C on October 17th at 6:30 P.M., and MF7C said Harry was "RST339 hr in Bulltravia"! Clever, of course, but the vote around here for originality goes to the ship op, somewhere in the Pacific, who used to sign "B4UP." Nice call! Other funny-men include the one recently signing "FB7XA." Sounds like a commercial plug

Some legitimate calls and QRA's, courtesy of W8IWI: PZ1AB, Otto Groman, Todenbreestir, 5, Paramaribo, Dutch Guiana, and VR4JD, J. Davis, Berande Guadalcanal, via Tulagi, British Solomon Islands. And W4CXY gives the address of SU1TM: T. Marshall, 432 Rue Enofal, Sidi Gaber, Alexandria, Egypt.

When:

Ten meters, the old unpredictable, breaks in again with the news you like to hear. Number 1 bet, of course, is Asia, with VU2AU outstanding. He has been worked by W1AAK, W1DUK, W1KH, and W4AUU. T9 at 28,175 kc. he comes through on the east coast from 7 to 11 A.M., E.S.T. He has a 'phone, too, if you're looking for a 'phone WAC Another nice one is U9AZ at Toms, worked at 10 A.M. by W1WV. Look for a T4 signal around 28,450 kc. . . . Apparently the VK's just don't care when the band should be open. VK3YP and VK4AP are on until after midnight down under—and W3ZX and W5DXA have worked them at that time W3ZX reports a flock of Europeans on ten; and W4AUU has a nice worked list, including ZE1JZ, ZE1JU, VK3YP, VK4AP, VK4EI, ON4CJJ, ZS1H, ZT6M, ZU1C, ZU6P, OH7ND, OH7NF. Heard were ZT2B, VK3BD, VK3BQ, VK3CP, FA8BG, FT4AB On the West coast, Joe Horvath of W6GPB reports G5JW, G5SY, G5ML, G6NJ, ZS1H, and LU9AX The rotatable beam still works for W6JN, ZS1H and G6IR answering his CQ's the other morning.

Twenty has been a little spotty, but there is still plenty to be worked FR8VX, in Reunion Island, is back again. At the high-frequency limit of the band, his 20 watts input to a 46 pushes out a good signal via a half wave Zepp. Look for him at around 23-24 GMT. A good contact, since he is the only station there A. E. Smith, W8IWI, who reports FR8VX, also says that VS8AA, Bahrain Island, was worked at 0300 GMT. RAC at about 14,320 kc., 8AA takes his radio seriously, S8 with only 25 watts, the first thing he did was to test antennas! VS8AA is the station of J. W. Faithvul, but it is also operated by Roy Fleming, W6DQD-BZS, over there for two years with an oil company, according to Charlie Perrine, W6CUH Charlie reports 14 mc. still standing up well for European DX, 22-24 GT being the best time out there. It must be getting a little tame though, since he has had over 600

European contacts this year! New countries for him include VQ3FAR, VQ8AE, and UN2A (No. 124). UN2A, T8 at 14,405 kc., puts in a wallowing signal, with 100 watts working into an end-fire array Larry Le Kashman, W2IOP, reports contacts with VR2AG at 10 P.M., PK1PK at 7 A.M., KA1MD at 11:40 A.M. The thorn in Larry's side,

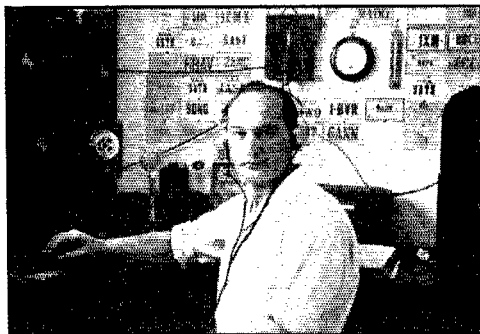

JOHN M. DAVIDSON, ZE1JR, WHOSE 14-MC. 'PHONE SIGNAL HAS BEEN COMING THROUGH REGULARLY THE PAST FEW MONTHS
A real old-timer, he signed FO1SR in 1919, made his c.w. WAC in 1926, and his 'phone WAC in 1935.

however, is ZD8A, S6 almost any morning but tough to raise A few for the East coast gang: KA1BH, on 'phone, comes in from 7-8 A.M. E.S.T. at 14,130 kc.; VU2AU, 14,050 kc., T9, 12 noon; PK6AK, 14,320 kc., T9, 11 A.M.; VS1AA, 14,050 kc., T9, 2 P.M. . . . John Crawford, W9VPG of Indianapolis, has been keeping his 10's warm. In the region between 14,200 and 14,300 kc. he found J2CC, J2LL, J2LU, J2KJ, J2NB, J2HQ, J3F1, J3CR, and J5CC. Other stations worked include KA1AP, SU1SG, 11ZZ, FB8AB, ES5C, ZP2AC, and YR5VC.

Who:

From W6AC and W6MCQ in San Francisco we learn that Van, ZU1T, is seriously ill at a hospital in Cape Town, having a lung collapsed. He is anxious to get back on the air with his new 50T transmitter, and says to look for him on the old frequencies with more sock shortly. We all wish you a speedy recovery, Van Fellows like George Heitzman, W7AHX, deserve a hand. How many would have the fortitude to crank a Ford engine every time they called or worked someone? Yet George does just that since, with no a.c. available, a Ford engine-driven generator is the only way he can get power for his '10 final. It prevents his working break-in or coming back fast but—DX: WAC and 35 countries; cost: about 20 cents per morning. And now no cracks about, "OK, let George do it!" From W5FIO we learn that U3AG in Moscow needs QSO's with Vermont and Kentucky for his W.A.S. Look around 14,420 kc. for a T9 signal Not for W.A.S., but because he is ex-W9DZL, OA4AB is looking for contacts with stations in Utah and South Dakota. Look for him on 14,064 kc. in the evening and early morning. Full QRA is: D. P. Wilkes, care Cerro de Paseo Copper Corp., Oroya, Peru The VK/ZL contest brought forth some commendable performances. Jerry Mathis, W3BES, worked 47 VK-ZL stations in 7 hours on October 4th; Clark Rodim, W1SZ, worked 61 over a 24-hour period on October 24th Dick Sears, W8LIR, sends a note of encouragement to the low-power 'phone merchants. During September, Dick had 39 contacts with VK 'phones, nearly all of them good rag-chews. The power used was 80 watts to push-pull 10's. Outstanding signals reported are VK2IQ, VK2ACO, VK2AZ, VK3ZZ, VK7JB, and VK3MR. Mornings up to 8 A.M. E.S.T. is the time Speaking of 'phone, F. C. Clark, ZE1JS, hears many of the W6 'phones rapping in S8 or so, and suggests they listen in the c.w. portions of the 14-mc. band once in a while The first HBE (R.S.G.B.'s "Heard British Empire" award)

ssued to a W station went to Art Braaten, W2BSS. He has worked 29 British Empire countries Carol Dohner, W3FHY, is hard to convince. "Dx by the Calendar" said Labor Day would be ripe for a vacation because of a "DX minimum," but Carol worked his first F8 that day, and eleven new countries the following week. And just when a certain W1 was using the DX Calendar for an alibi!

WAC:

Newest 'phone WAC's go to Marvin Thoreau, VE5OT, and John Kraus, W8JK. W8JK's beam must be boring a groove right through Java, PK1MX, PK1BX, PK1JR, PK1PU, PK1VM, and PK3ST having been contacted on two-way 'phone Is W1AAK the first W1 to complete a 2S-mc. 'phone WAC? He made it in early October F8KJ has his ten-meter WAC Bob King, W7ETK, made WAC in 73 minutes, tops in the Seventh District as far as we know. The contacts were with OH3NP, LU7EO, J2MH, W1GR, ZS2AH, and ZL1KE Add low-power WAC's: Brice Anderson, W9PNE, with 40 watts to a pair of 45's in the final; and Lorentz Morrow, W9VKF, whose submitted cards averaged an S7 report, although his final boasts only a pair of 46's W8KXX, in his WAC application, says: "Local power company very disappointed to know I am eligible, but XYL very pleased. She says it is nice to have me back in the family again."

—W1JPE

— —

The article by Mr. Harold J. Burchfield, W6JTV, wins C.D. article contest prize this month. Each month we print the most interesting and valuable article received marked "for the C.D. contest." Contributions may be on any phase of amateur operating or communication activity (DX, 'phone, traffic, rag-chewing, clubs, fraternalism, etc.) which adds constructively to amateur organization work. Prize winners may select a 1937 Handbook, six logs, six message files, six pad blanks, or equivalent credit toward other A.R.R.L. supplies. Send your contribution today!

—F. E. H.

QRR

By Harold J. Burchfield,* W6JTV

AHARASSED Red Cross official sitting at his desk, candle light showing the care lines on his face, a dead telephone beside his arm. Outside the flood waters rising by the hour. Already cut off from his outside ties by the rising waters which had inundated the roads, stopped the trains, uprooted the telegraph and telephone poles, cast the city into total darkness. The howling wind, driving the heavy rain against the glass. Truly in a position not to be envied. With the knowledge that many were homeless, sick, hungry, wet and shivering with cold, the hospitals without light and insufficient medical supplies for the growing list of injured. Cut off from his all important outside communication. Plenty of men to help, but not knowing where they would be most needed, because the all-important line of inter-city link of message service entirely disrupted. Not knowing which way to turn, to bring order from the rising babel outside. Lost children, hysterical women, crazed and injured men, all needing attention, but no way of coordinating his forces.

A knock at the door, a shouted "Come in," the door opens and two very ordinary men enter, letting in a gust of wind-torn rain. Each carrying a heavy box. Outside they go again, to reënter with a tarpaulin-covered gasoline motor and a generator, probably revamped from an old starter motor. One goes back out with a coil of wire, crosses the street, climbs a telegraph pole, and makes one end of the wire fast. Unrolling the wire as he comes down the pole, he crosses the street and runs the other end of the wire through a hole in the window. In the meantime the other had gotten the gasoline engine started, with the exhaust running under the opened window to clear out the gas fumes. A few cables

from one box to the other, a panel dropped from the front of each, showing a few meters, dials, and other mysterious gadgets. The RC official taking it all in as the two men go about their work, calmly and efficiently. A switch is turned on, the gas engine takes on a higher note as a load is thrown on it. A small light over one of the panels glows brightly, casting its brightness on one of the dropped panels. A few seconds twiddling with the dials, and from a speaker comes the clear notes of a CW station somewhere "outside." Then another switch thrown, the gas engine begins to labor as a telegraph key is depressed in the well-known dots and dashes of the Continental Morse Code. "QRR QRR QRR de W9—QRR QRR QRR de W9"—the signal goes out over the stretch of wire across the street. The switch returned to "receive" position. Now the speaker is strangely silent as the operator tunes back and forth across the band. That "QRR" has silenced the band as though someone had pulled a gigantic switch, stopping power to all those hundreds of transmitters somewhere over the horizon. The operator turns to the official and a roomful of people from whose faces much of the worry has magically disappeared. "Standing by for orders, and any messages you may care to send, sir." They begin to shower on his small desk, messages asking for aid of all kinds, medical supplies, food, tents for the homeless, messages to loved ones outside the stricken area. Contact is quickly made with another amateur some hundreds of miles away, a good operator, one who can get in touch with the State Capitol. Within a few hours as dawn approaches a plane's motor is heard overhead, circles a few times, and drops several parachute loads to the earth below. Antitoxins, bandages, surgical instruments, food. They must be lowered by parachute for the roads are all under water, as are the fields, and there is no place for him to land. Soon another plane shows in the distance, then two more. Their loads soon dropped, they return to their base of supplies for more.

In the meantime others in the city have been busy, five-meter rigs have been set up at strategic points, and these are quickly utilized to take the place of the out-of-commission telephone system. Even with the efficiency of the modern telephone repairmen, they can work so fast and no faster. In the meantime communication in and about the stranded community was of the utmost importance. Organizing and directing search parties to go through the wrecked homes, looking for those who may have been pinned under falling débris, bringing a lost child back to the arms of its hysterical mother, calling for a doctor to help some person too injured to be moved without medical aid, giving the repair crews assistance in ordering and obtaining emergency material for repairs to the AC mains, and to the illuminating gas pipe lines. By evening things were well under control, feeders had been attached to another source of electricity, and a limited amount of power was available, tents had been erected for the homeless, kitchens had been established to feed the workers and the destitute, some 'phone service had been restored, but still the tireless amateur was at his post, still the main communication link with the "outside." For forty-eight hours they stayed there, handling an uncountable mass of traffic, both by voice and CW.

Fellows, the above is not an actual happening, but many of you who read this can think of many an actual parallel!

Since the amateur has a definite status as a "service," he must live up to it. That "Service" as applied to the amateur rests on two essentials. From amateur radio proficient operators are available in time of national emergency such as war. Time and again we have proven our ability in time of local disaster such as in the above little story. We must be prepared for any emergency that may arise. All well and good to work the DX, to experiment with new circuits, talk over the air with some unseen friend, exchange "73" with a European or a VK or ZL. But don't forget, our place in the sun must be maintained by SERVICE.

To that end provide yourself with suitable low-drain receivers and transmitters of the highest efficiency, make arrangements to get, or have in your possession, an emergency power supply, preferably AC, make emergency skeds, have relief operators available for watches. "BE PREPARED."

In any disaster, relief measures must be centered around communications, and there are no others available, except

* S.C.M.: East Bay Section, 2240 106th Ave., Oakland, Calif.

those drawn from the ranks of radio amateurs, with their various ramifications, the League's Emergency Corps (A.E.C.), the U.S.N.R., and the A.A.R.S., as well as the various organized nets. This is to suggest that every ham give real thought now to the part he might or might not be able to play in case of fire, hurricane, flood, earthquake or other form of emergency disrupting wire communication and power lines! Build your set against such eventuality. Register your equipment and availability in advance with the A.E.C. Contact the city fathers, the Red Cross, the phone company, the power company, Scouts, motorcycle clubs, and public and private officials with whom you could and would serve. Explain amateur radio, ask opinions about the volume, destination and relative importance of communications so we amateurs can plan our networks against the eventuality!

Gulf Coast Storm Net

THE Gulf Coast Storm Net terminated its fourth season of activity on October 18th. Operations will again begin in the latter part of May, 1937. This Net was organized in 1933, and though no serious occasions presented themselves the Storm season always found the Net Stations prepared to render Public Service.

The Galveston Amateur Radio Club, sponsor of the Storm Net, is proud of its record and aims to make the Net bigger and better. The area covered extends from the mouth of the Rio Grande River to Pensacola, Fla.

The highlight of the wind-up of the Net activities this year is the awarding of a Silver Loving Cup to the Net Station which, in the opinion of the G.C.S.N. Committee, is most worthy of the award. This Cup will become permanent property of the winner and is awarded this year on the basis of drill attendance and spirit of coöperation with the Net activities. The award is known as the "W5DAQ Storm Net Cup," and the donor is J. Allen Swanson, Jr., W5DAQ, of New Orleans, La. The winner of the Cup for 1936 is C. J. Shaughnessy, W5DJU, of Port Arthur, Texas, who has established an almost 100% drill attendance record.

During the active months, drills are held every Sunday morning beginning at 9:30 CST and ending at 11:30 CST. These drills are held on two frequencies. From 9:30 until 9:55 A.M. operation is on 3610 kc., and from 10:00 A.M. to 11:30 A.M. on 7220 kc. Most of the Net Stations have supplied themselves with crystals for these frequencies and a very good attempt is made to make it "one spot" operation. When a disturbance is reported in the Gulf, two drills daily are held, one between 12:30 P.M. and 1:00 P.M. and the other at 6:30 P.M. to 7 P.M.—at this time the latest Weather Bureau news is sent QST to all Net Stations by the Galveston Net Control or Key Station. As the disturbance nears the coast, Net Stations are asked to send their local weather and barometer reports to the Key Station where it is recorded for distribution to any Net Station who requests it. All Net Stations try to keep themselves supplied with emergency apparatus and power supply.

The Key or Control Station this season was operated by the writer, W5BTK, operating on the before-mentioned frequencies. Net Stations are as follows: In Texas—W5BBR Point Isabel, W5FZV Corpus Christi, W5CVQ Houston, W5BEH Galveston, W5FDI Beaumont, W5CNA Harlingen, W5DPS Gulf, W5BTK Galveston, W5DJU Port Arthur, W5EPL Raymondville, W5BD Angleton, W5ENX Galveston, W5BUZ Port Arthur, In Florida—W4MS Pensacola. In Louisiana—W5BUK Burtwood, W5DAQ New Orleans.

—Wm. Scharpwinkel, W5BTK.

O.B.S.

The following is a supplement to the list of A.R.R.L. Official Broadcasting Stations in October QST (page 122): W3EOP, W4BMM, W4CIQ, W4EEE, W6EQM, W7CRH, W7FL, W8CVF, W9JZJ, W9NUF, W9OEL, W9VTG.

W7KY, W. V. D. Allingham, is trustee for club station W7YK. A case of reversed identity. Hi.

PAØ DX Contest

The N.V.I.R. announces a PAØ DX Contest to be held on the following week-ends: Dec. 12/13; 19/20, 1936; 26/27; and Jan. 2/3, 1937, from each Saturday at 1940 GT until Sunday at 2040 GT.

Each PAØ station will give a code group which must be confirmed via QSL card. Only one contact with each PAØ will be permitted during each week-end, unless the contact takes place on another band. The station in each country that contacts the greatest number of PAØ's will be awarded a certificate.

Code Practice Schedules

Additional code practice volunteers: W8JYO, Lima, Ohio, transmits code lessons each Tuesday and Friday from 5:30 to 6:00 P.M. EST on 1933 kc. W8PBP, Pontiac, Mich., transmits on Wednesdays and Fridays, 7:00 to 7:30 P.M. CST on 1765.5-kc. Starting December 15th and continuing until February 1, W9BSP/W9UA, Olathe, Kansas, will transmit code practice daily from 7:30 P.M. to 8:30 P.M. on 1903 kc. This station will be remembered for an excellent series of code lessons a few seasons ago. We welcome these new Code Practice Stations and wish them every success.

The first year Engineering Class of Columbia University comprises 14 men. Of them, 5 are hams: W1FTA, W2DJQ, W2GUL, W2GVX, W2ISL.

BRASS POUNDERS' LEAGUE

(September 16th—October 15th)

Call	Orig.	Del.	Rel.	Extra Del. Credit	Total
K6OGD	285	1176	246	—	1707
W7DUE	18	39	794	—	922
W5CEZ	74	80	554	30	738
W5MN	54	199	442	—	695
W2EGF	62	47	546	19	674
W6KFC	32	53	527	39	651
W1BTG	57	49	455	—	561
W3RBA	19	38	436	—	541
W2HZY	33	17	452	22	524
W6LLW	19	36	450	14	519
W9SGP	43	48	424	—	515
W9ALI	108	39	368	—	515
W9PVZ	42	82	378	—	502

MORE-THAN-ONE OPERATOR STATIONS

Call	Orig.	Del.	Rel.	Extra Del. Credit	Total
W9BNT	139	659	990	—	1788
W9NT*	976	417	—	—	1393
W5FPO	150	96	550	—	796

These stations "make" the B.P.L. with totals of 500 or over. Many "rate" extra credit for one hundred or more deliveries. The following one-operator stations make the B.P.L. for delivering 100 or more messages; the number of deliveries is as follows: Deliveries count!

W9MEH* 253	W6MQM 136	W5GBC 116
W6GRA* 218	W7APS 135	W3CFL 112
W9TBR* 168	W1INF 119	W2HYC 104

A.A.R.S. STATIONS

Call	Orig.	Del.	Rel.	Extra Del. Credit	Total
WLMI (W6GXM)	109	173	512	—	794
WLNF (W2BCX)	18	23	613	—	654

MORE-THAN-ONE-OPERATOR STATIONS

Call	Orig.	Del.	Rel.	Extra Del. Credit	Total
WLJ (W5OW)	132	594	754	51	1531
WLM (W3CXL)*	77	114	1222	—	1413
WLM (W3CXL)	101	157	945	—	1203
WLU (W9BNT)	38	19	670	—	727

A total of 500 or more, or just 100 or more deliveries will put you in line for a place in the B.P.L.

* August-September.

A.R.R.L. A-1 Operator Club

THE A.R.R.L. A-1 Operator Club was organized in May, 1933, to promote and encourage a high calibre of operating in the amateur bands. Membership has increased constantly until it now totals 695 of amateur radio's best operators.

Nomination by two operators who already "belong" is necessary before any operator is admitted to membership. A complete and up-to-date list of A-1 Operator Club members is given here—nomination by any two of these operators will make you eligible for membership.

It is not sufficient to be merely a "speed king" to rate membership among the "A-1 Operators"—you must be an "all-round good operator" with consideration given to general keying, voice technique, procedure, copying ability, judgment and courtesy. The Club is open to all active radio amateurs, both 'phone and c.w., in any country of the world. Operating qualifications alone are considered without regard to membership in A.R.R.L. or any other society.

Members of the A-1 Operator Club are forever on watch for candidates for membership. Make your operating the kind that will bring you to the attention of the members! Nominations are made carefully, members being warned against permitting personal friendships and the like to carry any weight in making selections.

It is hoped that eventually the A-1 Operator Club will number in its ranks every amateur operator who lives up to a high standard of operating technique. Only if you do that, bearing in mind the several points considered, can you hope to join the ranks. Watch your operating at all times! Supplements to the membership roster appear in QST from time to time as new members are admitted.

A-1 OPERATOR CLUB ROSTER

C.W.: W1ABG AFB AGA AJ AJB AJL AMG ANC APR APW ARB ATJ ATO BB BD BDI BEF BEU BHM BIT BLI BMP BMW BNC BUX BVP BYW BZI (Alma, Elaine, Helen & FS) CDX CFG CHF CJD CPT CRA CRP CTI DAV DDK DF DGG DKO DOW DJK EBM EBT EF EFA EH EOB ERQ ES EVJ FH FIO FRO GC GKM GOG IP KH LZ MK (Hal) OR QW SB SZ TS UE VB VS WV WZ ZQ, BVR.

W2ACD AEN AEY AGL AHC AIQ AWL AYN BAS BCX BFB BG BGO BHZ BJA BJP BJX BMX BPH BPY BZZ CC CHK CO CWC CWK DBE DBQ DRV EBM EGF ETH EVA EWQ EYQ FFL FIS GNK GOX HEG KI LU LW OC PY QY SC SN UL VH WP ZC.

W3ADE ADM AHD AKB AKN ALX AMR ANH AQN ARV ATJ ATY BAI BBB BEY BGI BJX BKQ (MW & BNS) BND BNH BWL (ED & CJ) BYA BYS CAH CDG CFL CL CLV CMJ COO CQS CTD CVU CWE CXL (ED, CB, YB, YX, HC & White) CXM DD DEH DFK DML DSC DXG DZ EOP EZ FJ GE GS HC LA MC MG NF NO NR NT (RC) OK OM OZ QN QP QV SN (FX) WO WS WU ZD ZI.

W4ABT AFM AG AGR AJX AKH ALK ANZ AVD AVT AYE AYV BNI BOU BOZ BRK BTU CBY CE CEN DW EC EG ET GL HA JR KK LL MI MO MU OI (Dave & Mac) PL QL TO UT ZH.

W5AAX AJF ALZ ANU AQ ATF AUL AVF AVG AYZ BED BII BKH BMI BMU BQZ BZR CEL CEZ EB ENI MN NW OW (H) SI VQ ZC ZD.

W6AAN AJP AKW ALU AM AOJ AOR BJF BLP BMC BPM BPO BSV CDA CGJ CKO CRF CUH CUU CVL CXW DEP DKN DPJ DVD DZN EGS ELU ENV ETL ETM EWB EXH FEX FII FRN FS FVU GXM HT IIK KGO LM MV OJ PQ (CV) QA RJ SN UD UO WB ZG.

W7AAT ASN AWH AXJ BAA BB BJB BME BMF BRU CRH DL DUE FL KO SO.

W8AJE AKV APC APQ AQ ARX AVK AZI BAH BAS BBH BGY BHK BJO BKE BKH BME BMG-BMK BQ BRC BTI BTK BWL BWT CAT CCD CDK CEO CEU CFR CGS CLQ CMI CPE CPY CQA CRA CSE CUG CVS DBX DDS DED DHC DHU DLG DNX DSA DSS DVC DVL DWB DYH DYZ DZ DZP EDG EEZ EGI EIK ELJ EPY EQC ESY EUY EVC FCB FDY FEY FFK FGV FLA FTW FWX FX FYF GB GBB GBC GBF

GEG GLX GOD GFS GQB GRZ GSO GUC GUF GUX GZ HB HCS HD HGG HSH IOR IWT JAK JE JES (Paul) JIN JM JO JTT KD KJW KKG KQK KR KWA MAH OB OE PL PP QT SS UV UW VD VP YA.

W9ABE ACL AET AIO AMB AND APY ASV AUH AZN BAZ BBP BBS BCF BCX BKJ BKK BNA BWJ CDA CFL CGV CNE CRT CSI CSY CTP CUY CYD DDE DEF DEI DFF DGS DHA DI DMY DNU DOU DQT DXY DZW/GP EEW EFC EGU EHW EJC EKY ENH EPJ ERU ESA ESU EW EWO FA FAA FAM FFD FLG FO FP FQ FQA FFW FWF FXU GCX GDU GJQ GJX HJC HML HPG HSK HSN HTU HUM HUY HVA HYR IFD IFZ ILH IOL IYA JRK JZY KG KJY KKT KNZ LCX LEZ LHQ LW MCC MUW MZD NJS OLC OX PDE PLM RHM RMN RYD TA UZ VDQ VS YB (Booth/8DDDF-PV).

K4BU KD RJ K6AJA AUQ COG EWQ K7AOA PQ.

VE1DR 1EP 1ER 2BB 2B 2LC 3AU 3CP 3GT 3HA 3JI 3NO 3WA 3WK 4AG 4B 4BZ 4DK 4HM 4MW 5AM 5EO 5EU 5FG 5GT 5HC 5HP 5HQ 5HR.

Phone: W1AQM AUJ AVK CCZ SZ W2BYM DC JN TP W3AHR AVL AXT BUY CNY DF DQ NK WX ZA W4JB OC RV TR W5AOT ZA W6CIN ONE KT ZH W8AJA AOM APN CPC DLD FEE KIR LUQ RD W9CJJ CPD DRD VE3JI K6FJF.

Foreign: D4ARR EA1AS 4AO 4BE EI3B E8EO 2MA 2ZQ 5QY 5YH J2GW 2GX NY1AB (Van & Mac) OK1AW PA0DC JO LL QK VK2AP 2BP 3ML 3NG 5HG VP5PZ ZL1FT 4AO 4FK 4FR.

LAST MINUTE ADDITIONS

C.W.

W1ABQ AF APX AV BFT BPO CH CMX CNU CPS DVW HX JTD KL KV

W2AMP ARY BCR CJP ELK GWE TP

W3ABA AG AIR BDF BES BFH CDQ CWL ER ETM EVT KU SI UVA

W4AJY AKN AXU DAI MR MS UX

W5BFA CEN BDE CPB CIJ DLD DZU OW (RL)

W6ADP DUG DVV GAL GRL GRX HLJ HRY IOX KFC QD

W7AMX BRU BSU COX TS

W8AJL CIO CNZ DFH DZU ESY INQ KKG KZZ OFO

W9ADN CAA CJR EGG FJV FVM GNU HUO JUC

KEH LLN LUC NDB

K4BRN SA

K6HZI

VE2EE 3QK 3TM 4GP 4MH

PHONE

W5ZX W5BDB UN W9ARE VE2DX

FOREIGN

CE7AA 3Q3AAA EA4AV EI5F FASBG F8SAB F8EX 8GG 8TQ 8WB G2PL 2Y 5BY 5ZZ 6NF 6RV 6VP 6WU 6WY 6YQ 5UR HB9AQ 9J J2HG K5AC AM KA1AN LA1G LU1EP OE1ER 1FH OH3NP OK2AK 2OP ON4AU 4AC PA6XF PK3ST PY1AW 2BX SM6UA SP1DE SU1CH 1SG U3QE VK2EO 3MR 2WL 4AP 5WG VQ4CRL XE1AA 1AM 1AY ZE1JJ ZL4AO ZS1H 2A

OBSERVERS' HONOR ROLL

Cairo Commercial Occupancy Survey For October 1936

6000-8000 kcs.

W. R. Faries Lawrence L. Simmons Peyton R. Randolph

21,000-21,900 kcs.

W. R. Faries W2HCO

ELECTION NOTICES

To all A.R.R.L. Members residing in the Sections listed below:

(The list gives the Sections, closing date for receipt of nominating petitions for Section Manager, the name of the present incumbent and the date of expiration of his term of office.) This notice supersedes previous notices.

In cases where no valid nominating petitions have been received from A.R.R.L. members residing in the different Sections in response to our previous notices, the closing dates for receipt of nominating petitions are set ahead to the dates given herewith. In the absence of nominating petitions from Members of a Section, the incumbent continues to hold his official position and carry on the work of the Section subject, of course, to the filing of proper nominating petitions and the holding of an election by ballot or as may be necessary. Petitions must be in Hartford on or before noon of the dates specified.

Due to a resignation in the San Joaquin Valley Section, nominating petitions are hereby solicited for the office of Section Communications Manager in this Section, and the closing date for receipt of nominations at A.R.R.L. Headquarters is herewith specified as noon, Tuesday, December 15, 1936.

Section	Closing Date	Present SGM	Present Term of Office Ends
Arkansas	Dec. 1, 1936	Henry E. Velle	Dec. 15, 1936
Louisiana	Dec. 1, 1936	W. J. Wilkinson, Jr.	Dec. 15, 1936
Quebec	Dec. 1, 1936	Stan Comach	Dec. 14, 1936
Ga.-S. C.-Cuba-I. of P.-P. R.-V. I.	Dec. 1, 1936	Bannie L. Stewart	Dec. 14, 1936
San Joaquin Valley	Dec. 15, 1936	Vernon C. Edgar
Oklahoma	Dec. 15, 1936	Carter L. Simpson	Feb. 15, 1936
Hawaii	Dec. 15, 1936	Atlas O. Adams	Apr. 23, 1936
Indiana	Dec. 15, 1936	Arthur L. Braun	July 19, 1936
San Francisco	Jan. 5, 1937	Alan D. Whitaker, Jr.	Jan. 18, 1937
Manitoba*	Feb. 1, 1937	A. J. R. Simpson	Feb. 15, 1937
No. New Jersey	Feb. 1, 1937	Charles Hammersen	Feb. 15, 1937
Idaho	Feb. 15, 1937	Nellie Hart	Mar. 1, 1937
No. Carolina	Feb. 15, 1937	H. S. Carter	Mar. 1, 1937
Western Fla.	Mar. 10, 1937	Edward J. Collins	Mar. 21, 1937

* In Canadian Sections nominating petitions for Section Managers must be addressed to Canadian General Manager, Alex Reid, 169 Logan Ave., St. Lambert, Quebec. To be valid such petitions must be filed with him on or before the closing dates named.

1. You are hereby notified that an election for an A.R.R.L. Section Communications Manager for the next two year term of office is about to be held in each of these Sections in accordance with the provisions of By-Laws 5, 6, 7, and 8.

2. The elections will take place in the different Sections immediately after the closing date for receipt of nominating petitions as given opposite the different Sections. The Ballots mailed from Headquarters will list the names of all eligible candidates nominated for the position by A.R.R.L. members residing in the Sections concerned. Ballots will be mailed to members as of the closing dates specified above, for receipt of nominating petitions.

3. Nominating petitions from the Sections named are hereby solicited. Five or more A.R.R.L. members residing in any Section have the privilege of nominating any member of the League as candidate for Section Manager. The following form for nomination is suggested:

(Place and date)

Communications Manager, A.R.R.L.
38 La Salle Road, West Hartford, Conn.
We, the undersigned of the A.R.R.L. residing in the Section of the Division hereby nominate as candidate for Section Communications Manager for this Section for the next two-year term of office.

(Five or more signatures of A.R.R.L. members are required.) The candidates and five or more signers must be League members in good standing or the petition will be thrown out as invalid. The complete name, address, and station call of the candidate should be included. All such petitions must be filed at the headquarters office of the League in West Hartford, Conn., by noon of the closing date given for receipt of nominating petitions. There is no limit to the number of petitions that may be filed, but no members shall sign more than one.

4. Members are urged to take initiative immediately, filing petitions for the officials for each Section listed above. This is your opportunity to put the man of your choice in office to carry on the work of the organization in your Section.

—F. B. Handy, Communications Manager

ELECTION RESULTS

Valid petitions nominating a single candidate as Section Manager were filed in number of sections as provided in our Constitution and By-Laws, electing the following officials, the term of office starting on the date given.

Tennessee	R. G. Lowrey Smith, W4DEP	Oct. 14, 1936
Ontario	Fred H. Saxon, VE3SG	Oct. 15, 1936
Michigan	Harold C. Bird, W8DPE	Oct. 15, 1936
Philippines	George L. Rickard, KA1GR	Oct. 15, 1936

In the Mississippi Section of the Delta Division, Mr. J. H. Weems, Jr., W5CWQ, and Mr. T. M. Ferrill, Jr., W5CJB, were nominated. Mr. Weems received 25 votes and Mr. Ferrill received 18 votes. Mr. Weems' term of office began October 1, 1936.

In the Kansas Section of the Midwest Division, Mr. Harry E. Legler, W9PB, and Mr. A. E. Unruh, W9AWP, were nominated. Mr. Legler received 66 votes and Mr. Unruh received 59 votes. Mr. Legler's term of office began October 20, 1936.

CANADA

MARITIME DIVISION

MARITIME—SCM, A. M. Crowell, VF1DQ—EC has been giving the new Skyrider a tryout on traffic. GL is now Trunk Line "I" station and is still working on the new rig. HH has the schedules all lined up for the winter, including EC, GU, 2JU and W1JTC. HJ, although QRL studies, manages to handle a few and send in the regular report. GU is a reliable man in line for O.R.S. soon. CO is building a new 3.5-mc. rig. AP is putting tens in his final for 'phone. BD has been very QRL service work. AC is building a new rig. AF plans to go South for the winter. FR at last is going to QRO. BE is putting in a few licks on the rig—getting it ready for winter. CW gets FB results from his 61.6. JG is QRL CJGS, but is going to be on 3.5 mc. this winter. BZ is all set for the active season on 3.5 mc. EY schedules W1AY. IA still is QRP with the battery rig. HX has been bitten again with a rebuilding streak. GH had a station at the Lunenburg Expo.; he rebuilt two transmitters, 250 watts on 3.9 mc. and separate 250-watt on 14 mc. GC rebuilt his receiver. JK uses a '47 crystal osc. and a '45 amp. BL has his receiver perking to his satisfaction at last. GS is ready to hit the air as soon as he gets skyhook; he is planning 61.6 osc. BB performed swell service as one of the star ops. at the H.A.R.C. booth with VE1AW at the N.S. Exhibition; he is now keeping ET hot during Walt's absence on the Lady Nelson. FB, QSL Manager for this district, is back on the air. EP, after getting the W.A.C., went off the air to rebuild. DW is on 3.9-mc. 'phone regularly. CU has been spending more time on c.w. lately. AR has been working quite a bit on 14-mc. 'phone. GR is rebuilding to higher power and new Class B transformers. EO works 3.9-mc. 'phone from Portuguese Cove. AG is still making the all-battery 3.9-mc. 'phone go places and is getting a new receiver. AW and DQ are getting new receivers again. Congratulations are in order for the excellent manner in which the Fair Committee of the H.A.R.C. handled their booth and exhibit at the N.S. Provincial Exhibition. We believe especial orchids are due AW for the swell way his station performed during the entire week. Hundreds of visitors to the booth were given their first opportunity to talk on the air and obtain a favorable impression of the local amateur fraternity. Some score or more registered as prospective hams. We also wish to thank the countless stations who, during contact, addressed the crowds 'round the booth and (thru the P.A. system) gave interesting dope and information on our hobby. Route Manager Bill Horne, GL, says there is now no excuse for any active station in our Section not getting mention for creditable work. Report with your station. Any T.L. or net station will QSP to the S.C.M. or R.M. Let the gang know what you're doing and why. Report your work each month on the 16th.

Traffic: VE1EC 73 GL 67 HH 53 HJ 11 GU 30.

QUEBEC DIVISION

QUEBEC—SCM, Stan Comach, VE2EE—Early fall wind storms resulted in a general overhaul of skywire supports; quite a few antennas crashed during the first blizzard. HT, GB, HL and BW did a fine piece of emergency relay work, thanks to the alertness of an S.W.L. EC has been transferred to La Perade. II has been touring the States this summer; he has visited 262 hams in 6500 miles; that must be a record; four more states and Sarge could apply for his W.A.S. (Walked All States—hi.) DR has altered the rig to permit break-in. GO is handling regular traffic schedule with W1IQR. JK received cards from both his J's. IT at Beaupre puts a very consistent signal into this vicinity. MA has moved back into Ontario and has his old call, 3SA. MP is a newcomer located at Farnham. HH sent the S.C.M. a nice set of photos of the shack. Traveling has interfered with traffic at LC. BB purchased a new receiver. AP is working on transmitter for BB. KN is rebuilding. When clear of the Trunk Line activities DG snoops around for DX and other things; Doc needs an Asian for his W.A.C. and all with a single "Ten." DU is back on the air after a summer traveling thither and yon. The Club Les Amateurs Canadiens Francais de la T.S.F. recently celebrated its first anniversary. Congrats, may it see many more. LP has worked VE5 on 1.75-mc. 'phone. KZ is experimenting on 56 and

112 mc. HV is still keeping schedules on 1.75 mc. nightly. FZ has built a new rack. JY is contemplating purchase of a new receiver. HG is grid modulating an '03A on 3.5 mc. ID spent part of his vacation attending the Convention at Schenectady and won a 211 tube. IP is rebuilding with 6L6's. BH is experimenting with a battery-operated rig using four 30's as the final. AG is using 'phone on 1.75 mc. Congrats to IN on winning that scholarship. FB, Ed. LJ has finished his new receiver, crystal filter and everything. BE and BG are keeping schedules with VP7NA. EE has been playing around with antennas. G5GQ was in Montreal for one night and paid the S.C.M., a visit in company with 2BB; the gathering consisted of G5GQ, VE2HP, BB, LJ, LV and EE. BO has a 6L6 kicking the pants off a '46. HI. EW has received his new rack, an FB job. FY is using the Comach Antenna Coupler. CA is using a Taylor 756 as buffer-doubler and doing a fine job on 28 mc. AH is building to a pair of 55T's. HP has purchased a Johnson "Q" for 14 mc. EP and GE have both been transferred out of the Province; we'll be hearing you, fellows. BE was guest speaker at a recent meeting of the M.A.R.C. Quite a few of the boys turned out to hear the lecture on Television by Dr. Zworkyin. KM, IU, JD and IN have applied for O.R.S. Your S.C.M. was highest Canadian scorer in recent International DX tests. DM is using a single wire-fed antenna now, but DQ doesn't think much of the idea. It would be interesting to know how many countries the DX men have worked; send in your reports and we will compare notes.

Traffic: VE2HH 31 EC 17 HT 57 BU 69 AB 11 GO 33 JK 207 BB 197 JJ 8 DR 105 DG 278 LC 12 EE 14.

VANALTA DIVISION

ALBERTA—SCM, Alfred D. Kettenbach, VE4LX—EO is exchanging stamps with other amateurs. RY now has three ops (brothers). AES is new ham at Irma. CN is rebuilding. DC is getting a pair of 35T's. LQ and QX are alternating for Edmonton on Provincial net. LG is now on 14-mc. 'phone. HM is on 28 mc. and working FB DX. BW is on 3.9-mc. 'phone as usual. TA, Medicine Hat, visited the Edmonton gang and took FB pictures. ZP is back from the North for a month's vacation. AEA handled QRR from Spirit River when all wires were down on account of snow-storm. The gang wishes to express its deepest sympathy to JP on the passing of his mother. JJ now on 14 mc. has a new 56-foot FB mast. Route Manager GE has the Provincial Net going; they are giving FB service, distributing traffic. WX is new O.R.S. QX has new pair of 35T's. The Edmonton Radio Club meets second Saturday of each month at BW's store; IQ, pres.; EA, vice-pres.; ADD, secy. ABH is working lots of DX on 14 mc. HQ has FB new transmitter. OD is on 14-mc. 'phone. LA is going strong on 28 mc. We are pleased to report that Mrs. SW has recovered from her illness and has returned home.

Traffic: VE4LX 54 GE 23 QK-WX 7 EO 6 HM 24.

BRITISH COLUMBIA—SCM, D. R. Vaughan-Smith. VE5EP—The V.S.W.C. expects to have a new club house before very long. North Shore Club plans cooperation with B.C.A.R.A. for this winter season. Collingwood boys have completed renovations and purchased new rig which will operate under club call. New Westminster Association meets regularly at the Y.M.C.A. B.C.A.R.A. is just about ready to christen the new RK-20 transmitter and have planned active season with technical talks of interest to all. II is doing his darndest to cram half kw. into his 211's. NB is now operating with a model note! RS is back on 7 mc. with crystal. JL hit home port for 3 weeks holiday. HC pulls the pins at Taylor Windfall for the winter and expects to stay in Vancouver for a while at least. FG is still key station for northern flea-power rigs. Nice going, Doc. EU boasts of his "super" DX on Comm. rig. LV is also back in port for a well-earned rest. DM crashed the silence in Nanaimo for a QSP to Vancouver! HP can't seem to find a final tuning condenser that will stand the pep of his 150T's! OT claims W.A.C. three times on 14-mc. 'phone, also first VE-VS6 QSO ('phone). HQ claims first VE5 W.A.S. Think you have it, Gordie. KC is having lots of fun on 14-mc. 'phone collecting S.W.L. cards. EO is mighty proud of his 35T doing a man's job in his final. FW seems to be getting around. New calls: TW, Prince Rupert; SR, Vancouver; FB,

Vancouver. "Mae" of KS, Armstrong, misses Hubby who is working at Hanna, Alta.; her chief worry seems to be she has no one to cut kindling; any volunteers? OK gets out of bed to keep schedule. Nice going, Torch. NG is wondering how she can QSY her crystal to get around some of that 7 mc QRM we hear so much about. 28-mc. enthusiasts report conditions hot on that band. Let's hear more about it next month, please. "The B.C. Amatecher" will celebrate its second birthday with the November issue. Active, reliable amateurs are badly needed to fill Trunk Line posts. Publeese shoot in your traffic next month, gang! 73.

Traffic: VE5OK 18 FG 62 KS 12 DM 2 HC 16 AX 2 NF 19 EP 33.

PRAIRIE DIVISION

MANITOBA—SCM, A. J. R. Simpson, VE4BG—The outstanding event of the last month was the amateur booth at the radio show held at Winnipeg. The M.W.E.A. put on a fine exhibit and provided the main interest for the crowds that attended the show. VG keeps active on 7 and 14 mc. and has a weekly schedule with MH at Biggar, Sask. SS announces the arrival of a new junior YL operator, also is busy rebuilding the rig into a rack and panel arrangement and at present is heard with a T55 final. ED is putting out a strong signal on 14 mc. with a 211 final and works Europe and VK's consistently. AG has finished rebuilding the outfit into a smaller rack and panel job and it looks very FB. BQ is back on the air with a low-power rig until he can get some high power lined up once more. DU still keeps well up in front with the DX. EK is heard consistently on 14-mc. 'phone. GL is moving to new QTH and is planning a new skyhook to put out his sigs from a pair of T155's. GQ is busy rebuilding with a pair of T55's in the final. IP is about ready to go again, having overcome his receiver difficulties. KX has a new Johnson Q antenna and finds it to be FB; he also is acquiring a new Hallcrafters s.s. crystal receiver. LH is busy putting out a very FB 'phone signal on 14 mc. MW has that receiver built and is now trying to get his rig perking properly on 14 mc. MY has finished rebuilding his transmitter but is shortly going to be married, so will not be heard for some time yet. NI keeps 14 and 28 mc. hot with his very FB 'phone and is working his share of the DX. NM keeps consistently on 14 mc. with 'phone and c.w. and works FB DX. QA is devoting all his time to 14-mc. 'phone. NT is moving to new QTH and checking over the rig after the radio show. QC is back from that hunting trip and will be heard on 14 mc. QF has acquired a rack and is busy making the necessary changes from the old one. QV is putting out a strong 'phone signal on 14 mc. RO is all settled at new QTH and has a new tower for his antenna. ZK is heard daily. TV from The Pas was on a vacation to Winnipeg and found time to visit some of the old gang. The Winnipeg Radio Club has been organized with club rooms at 299 Young St., Winnipeg. They are busy putting in a transmitter and receiver and furnishing the club rooms. Other clubs desiring to exchange correspondence are requested to drop a line.

Traffic: VE4VG 9 SS 6 ED 16.

SASKATCHEWAN—SCM, Wilfred Skaife, VE4EL—RF, PQ and QZ are active on 28 mc., the latter working four continents on that band in the past month. YX is heard occasionally on 7 mc. TW is putting T55 in final of new rig. MB worked a new continent by snagging an SU on 14 mc. IM is back pounding brass on ham bands with par. '52's in Hartley. FD on 14 mc. RJ and TN on 3.9 mc. keep Saskatoon 'phone activities going. RJ is new president of S.A.R.C. UL visited VE1EX (N. S.); he also visited 4AT who is planning 'phone for this winter. YC hopes to be on 1.75-mc. 'phone again soon. WF's new QTH is not so good for radio. FM gets perfect note after long struggle. XM returned from Calif. where he had good time among the W6's. KJ, with harvesting finished, returned to 3.5 mc. New ham station at Yorkton: IM. XL seems to have plenty of time when copying 30 on the mill. DI still keeps his Sunday noon Vancouver QSO's on 14 mc. BD is doing well on 28 mc. CQ is open for more traffic schedules. EL is having some success on 14-mc. 'phone. The Regina Club got away to a good start for the winter season at a banquet where all officers were elected.

Traffic: VE4CQ 17 PQ 5 EL 4 QZ 2.

(Continued on page 98)

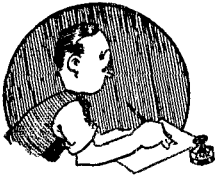

CORRESPONDENCE

The Publishers of *QST* assume no responsibility for statements made herein by correspondents

On Planned Use

10 Maple Pl., Irvington, N. J.

Editor, *QST*:

I read with interest your October editorial on the planned use of our bands employing engineering principles. Your exposition of the problem was very complete, in my opinion. However, I violently disagree with the idea of an essay contest in order to collect opinions. We suffer from too many opinions and too few facts. You may get opinions, to be sure, from such a contest, chiefly I believe from non-engineering sources. When we are ill we call a doctor, not a blacksmith. It seems to me that engineers should be consulted on a problem that is strictly an engineering one. An impartial unbiased allocation of 'phone and c.w. within our band limits can only be accomplished by such means.

The first thing that an engineer requires before attacking a technical problem is the collection of as many facts as possible pertaining to it. I would like to point out that no data of real value is available at the present time. If we have a collection of facts concerning the habits of the amateur as regards hours and frequencies and several other factors, then and only then can we start to improve things, working on a tangible base instead of guesses or opinions.

The League's withdrawal of the request to increase the size of the 75-meter sub-band is a case in point. The reasons given are all right as far as they go. Here again we have an opinion developed by the Board that the band should be widened backed up by extremely sketchy facts, to say the least.

If we continue in the belief that no changes should be made unless unanimous amateur opinion is necessary we might as well consider the bands permanently frozen in their present state. There will always be objections to any change regardless of great benefits to the majority. However, I feel that most amateurs are fair-minded and if they are shown the actual facts in any given situation they will stand back of any action the Board of Directors may take.

I would like to point out that the seven members of the F.C.C. are not necessarily engineers. In this respect they are similar to our own Board. However, the similarity ends immediately on technical problems because the F.C.C. maintains a competent engineering staff whose opinion is carefully weighed on engineering matters. I be-

lieve I am correct in stating that the Board in all its history has made no effort to secure opinions from the dozens of competent engineers who are also active amateurs. Even if they had the engineers' opinions would be of little value because of the lack of facts on which to work.

The League's business has of course been conducted in excellent fashion as evidenced by its continued growth and world-wide prestige. In this respect my hat is off to the Board of Directors for their display of foresight and good business judgment. Business ability is not a gauge of engineering ability, however, and successful operation of the League business does not qualify the Board members as engineers. The results prove this to be true. Apparatus development in the hands of the Headquarters staff has advanced amazingly. Our frequencies in the hands of the Board are a Topsy-like growth that engenders an increasing dissatisfaction which is on the increase.

No criticism is of value without constructive suggestions. If our technical progress insofar as apparatus is concerned kept pace with our progress in frequency allocation we would still be using rotary gaps and one-tube receivers. We don't have to stew in our own juice in the present manner if engineering horse sense is applied to our greatest problem in place of an "it can't be helped" attitude.

Let us have a complete accurate survey of all of our bands as a starter. Let this material be placed in the hands of engineers. I suggest that one 'phone and one c.w. man be appointed by each divisional director. Let these men thresh out the problem and let their conclusions then be presented to the Board of Directors for action. Let the survey results and the Board's decisions be published in *QST*. I am sure that every fair-minded amateur will get on the band wagon instead of rocking the boat and improved conditions together with a greatly improved *esprit de corps* will result.

—D. A. Griffin, W2AOE

1253 Washington Ave., Wisconsin Rapids, Wis.
Editor, *QST*:

... The editorial in October *QST* ... is certainly a thought in the right direction. When we start dividing up the bands, why not go all the way? Several changes won't cause any louder squawk than one change in the present

regulations. We are all agreed that conditions on our bands are bad and we want something done about it. Let's do those things that best satisfy the majority, because you can't please 'em all any way. Why not make all rigs crystal controlled after a certain date? (It worked out fairly well when p.d.c. became a requirement.) If c.c. is good for the broadcast band it's good for us. Until we get those additional frequencies we are after, let's widen out the middle of our bands and make use of those frequencies that are now blotted out with broad, rough, wobbly signals. The cost of c.c. is about the same as the antiquated p.p. 10's, and most hams end up with a crystal rig anyway. Reduce the QRM and the kw. boys will be more willing to reduce power, thereby further reducing the QRM. While I am strictly c.w., I realize what the 'phone men are up against, and if we clean up our c.w. bands we will have more frequencies, and I think the 'phones are entitled to some of them, but this cleaning-up business goes for the 'phone bands also. Let's . . . quit laying a book on the key for 15 minutes while we tune the rig, especially at night.

Then why not kill this Class C license except for shut-ins? The present Class C boys will make the grade so it won't work a hardship on our brother hams, but it will stop some of the new ones from learning the code on the air. If the F.C.C. is hard up and afraid to ask for expense money, let's help them get some of that free money in Washington so the RI can afford to travel around to conduct exams, like he did years ago, so the new hams won't have to go 125 miles for a license. In 1931 there were 22,739 licensed amateurs and *QST* said the bands were "groaning under the load." The bands are way past the groaning stage now with 46,850 hams, so what will it be in another 5 years? *QST* also says, "The secret of keeping interference at a standstill while the number of stations increases is for technical development to keep pace with the growth in amateur radio." Then why not limit the new licenses to the number of cancelled licenses each year until we find out how to make 1 kc. do what 10 are doing now? We have plenty of good smart fellows in this organization who can work us out of the present mess, so why not all pull one way and help them instead of fighting amongst ourselves—let's cut out the dog-fight and lick this thing before it licks us. Let's do something now.

—Ira A. Williamson, W9RLB

EDITOR'S NOTE.—Without in any way affecting the force of W9RLB's arguments, it should be pointed out that in essence the numerical stability of which he speaks has been achieved. The variation in the number of station licenses extant has been less than 3% during the past three years. The actual change in activity has probably been greater, due to deadwood in the files with 3-year licenses, etc., but at any rate a reasonable equilibrium exists. As to making 1 kc. do what 10 are doing now, compare technical practice of 1931 and 1936, with s.s. receivers, almost-universal c.c., etc., in 1936!

1135 Terrett Ave., Alexandria, Va.

Editor, *QST*:

The editorial carried in the October issue of *QST* gives the amateur much food for thought. Planned use of our amateur frequencies is indeed a problem of vital concern to all, and intelligent study should be invited and encouraged, in order that some sort of a plan most beneficial to the veteran as well as the novice, to high-powered stations and low, could be worked out.

That some such plan is needed is evidenced by the ever increasing number of new stations appearing each month. [EDITOR'S NOTE.—Many new stations, yes, but the 40% annual turnover must also be remembered.] We also know that this number will continue to increase as time goes on, and unless something is done within the next year or two chaos will surely reign supreme in the few frequencies allocated for amateur operations.

Two of the suggestions mentioned in the editorial in my opinion are very noteworthy, and I am in favor of the adoption of both. That is, a station should be required to have some arrangement for reduction of power when full power is not necessary to carry on successful communication; and

all crosstown "confabs" should be carried on on the ultra-high frequencies. . . .

—Francis M. Becker, W3GJP

Absecon, N. J.

Editor, *QST*:

The editorial by K. B. W. in October *QST* struck me as being the sanest and surest method of alleviating some of the QRM. . . .

—Eugene "Red" Sykes, W4BRB

119 Woodstock Rd., Southbridge, Mass.

Editor, *QST*:

This fact should cause more thought about your October editorial. On the morning of October 13, 1936, about 7:38 A.M., I contacted WIGAN. We had a QSO for ten minutes when I had to leave my house. I was using an input of less than .75 watts on 'phone.

I contacted WIERG, E. Douglas, this noontime and WIDWP, New Milford, Conn., also Q5 RS.

It seems that in the absence of QRM results are satisfactory. The antenna, by the way, was very poor. It was a Zepp of incorrect length. The feeders were almost touching the ground. What waste of power is going on!

—Edward Kaszynski, W1HSK

"Harmonic Couplers"

Rocky Mount, N. C.

Editor, *QST*:

. . . I note with interest an epistle by a Kansas ham who advises against the use of impedance matching networks in antenna coupling circuits, with the reason that such coupling circuits as ordinarily used in amateur transmitters will increase harmonic radiation.

It is funny the number of gadgets the average ham will read about and immediately build, thinking he will have something superior to time-proven circuits. But the fact remains that in this case someone has been grossly misinformed, as the only practical value of an antenna-coupling unit is to reduce harmonic output; the matching network being nothing more than a low-pass filter.

We all agree that it isn't so nice to get in bad with the F.C.C., but I believe if Mr. Kansas will see that his antenna unit is working properly, he will have less, and not more, harmonic radiation.

—Paul Dillon, W3GN-WEED

EDITOR'S NOTE.—The significant phrase in the above letter is "working properly." Correctly adjusted so that it constitutes a pure resistance load at fundamental resonance, the pi-section filter displays capacitive (short-circuiting) reactance to harmonics. If mistuned on the inductive side of resonance, however, inductive reactance is offered harmonics, and they are frequently transmitted with equal or greater efficiency than the fundamental. Regrettably, this condition of mistuning is not invariably apparent, and is quite frequently regarded as the normal mode of operation. Therein lies the danger of low-pass antenna-coupling filters.

Bread on the Waters

Damariscotta, Maine

Editor, *QST*:

The more we observe the average present-day ham the more we are tempted to recount some of the old time experiences in order to enlighten some of the "brethren." Our text to-day is that you can't just sit on the band wagon and ride continuously without wearing out the guy that's doing the pushing, and while we're on this subject it's a

(Continued on page 68)

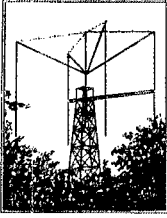

TO MANY, the particular joy of amateur radio is sending a readable signal over as great a distance as possible. The obvious way to do this is to increase the power of the transmitter. This method works very nicely up to a certain point, — that point being when the legal limit of 1 KW is reached. There are rumors that the method is used even beyond that point, for now and then one hears of the “California Kilowatt,” a unit that is measured by the operator’s conscience instead of a wattmeter.

In any case, there is really no need to resort to such devices. In this country at least, the legal limit is on the input, not the output, so that any increase in last stage efficiency results in a perfectly permissible gain in output power. Doubtless the law was written the way it was to encourage higher efficiency.

The subject is quite timely, for the recent development of new triodes designed to work into high impedance load circuits permits a much higher plate efficiency than possible with older arrangements. Output is materially increased. To be sure, more driving power is required to get maximum output with high impedance loads. But what of it? If plenty of signal, — all the law allows, — is what you are after then excitation is a minor problem. The legal watts are the ones that are precious.

However there is another even more effective way to increase the signal. That is to use some sort of directional antenna. Personally we never cease to be astonished at the results obtained by their use. Recently we had very disappointing results with our transmitter connected to a conventional antenna. Disappointing is hardly the word to use, for the only result of calling CQ was one contact. W1SZ and W1DF who later spent an unfruitful evening laboring over the rig evidently considered this contact a major miracle, for they promptly sent us a special richly-engraved WOS* Certificate. After that experience we decided that the location must be poor, and set out to build a 1 KW affair using the high efficiency triodes mentioned above. We also built a directional 4-element vertical array. The antenna was finished before the transmitter, so we connected up a little 15 watt exciter to try it out, and pulled in R-9 reports from the Middle West. Maybe our location *is* poor, but the array certainly does push the signal out. And it certainly does pull signals in, too. We have proved, to our own satisfaction at least, that a good array is 10 db better than a flat top for reception.

Incidentally, vertical arrays of the type shown in the drawing have much to recommend them. Directional antennae such as the W.E. “Diamond Array” give splendid results but they are so big that the amateur is somewhat at a disadvantage in trying to use them. The system shown above is mounted on an umbrella-like frame of bamboo, and is light and compact enough to be rotated easily on a pivot. The tower shown above is somewhat pretentious, but probably the peak of the barn roof would do just as well as a place to mount the array.

When orienting a directional antenna, do not take bearings from a flat map. Use a globe, and stretch a thread around it from the location of your station to the point you want to reach. Great circle paths are deceptive. For instance, here in New England the beam must be aimed *North* of West to put the signal in Australia. You can win a bet on that one any day, and it is easy money.

* WOS — Worked One Station

JAMES MILLEN



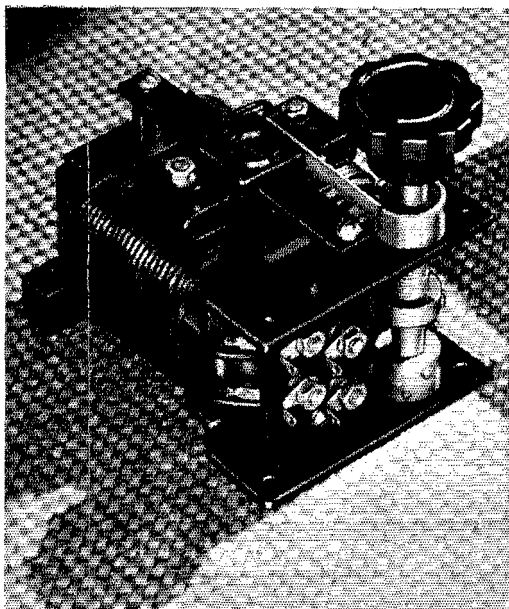

A NEW LINE-VOLTAGE CONTROL

- Maintains Line at 115 Volts
- Less Expensive
- Smaller
- More Convenient to Use

THE Type 70 and Type 80 Variac Transformers are new designs of our continuously adjustable transformers. Wound on a rectangular transformer-type core with a double slider making contact with the top layer of wire on each leg of the core, the new Variac Transformers furnish high-current control over a narrow voltage range.

Two models are especially suited to amateur and experimental use for maintaining the line voltage constant.

Type 70-B supplies a constant output of 115 volts at 2 amperes maximum, when used on line voltages fluctuating between 100 and 125 volts, 50-60 cycles.

Type 80-B supplies a constant output of 115 volts at 7.5 amperes maximum when used on a line fluctuating between 90 and 130 volts, 50-60 cycles.

Type 70-B..\$10.00 Type 80-B..\$15.00

Write for the new VARIAC BULLETIN No. 76-Q for complete data on a large number of models

GENERAL RADIO COMPANY
30 State Street Cambridge, Mass.

Bread on the Water

(Continued from page 60)

good plan to remember that, as a rule, "You can't get out any more than you put in," and it's a mighty good idea to get behind organized authority like A.R.R.L. and pull together like we did in the old days.

In the back yard of 69 High St., Portland, Maine, there was a regular ham radio station owned by Everett ("Nemo") Spencer Rogers. The station was in operation years before licenses were issued. Some of the gang who grew up in radio there were "Nemo" (now W1GE); Conrad T. Beardley, who was known as "Hunker" and who is now an engineer at R.C.A. (W1DZU); Harold Wish, "Bonehead," whose cartoons have appeared in *QST*; and yours truly.

It will interest you fellows to know that in those days we joined right in the regular commercial business. We would contact European steamers coming into port and report their positions and docking time to Western Union who would forward same to the company's offices and the whole business accepted as official—but of course without pay to us.

This story concerns the time that William Howard Taft was president of the United States. It seems that for some reason or other he was riding around on the *Mayflower* and decided to make a visit to Portland, Maine. As they were proceeding up the coast we contacted them and later heard an official message routed through old WBF, addressed to Senator Hale at Portland. Briefly, the message requested the senator to meet the President at the dock in the morning at a rather early hour. We knew the senator was at his summer home at Falmouth Foreside and we reasoned that, by the time the message was transferred over the wires and reached Portland and the messenger had tried to deliver it at his city residence, it would be some time before the important information reached him.

In a garage directly back of the shack was an "old faithful" Cadillac. This car had a serial number less than 100. It was one of those old buggies where you walked up a ladder in the back and cranked on the side. It had a handle to steer with and it was a regular volcano when it got going. Begoggled and determined, with the message in one hand, part of the gang started out in the chilly night air to deliver the message at once.

The trip of several miles was uneventful but upon arrival everyone in the house had retired and we stirred up quite a commotion before the object of our visit was comprehended. The senator appeared in time and the import of the situation slowly but surely dawned upon him. It meant a heap of work for him in calling all the dignitaries together and needless to say there was not much sleep in that household the remainder of the night.

When he realized the service that had been so cheerfully given to assist him he was overcome with gratitude and he thanked the gang over and over. He said, "Boys I don't know how to thank you, but if the time ever comes when I can return the favor do not hesitate to call on me."

Many years passed, and in 1921 we hams were having a devil of a time with legislation intended to cut us down. Yours truly at the time was A.D.M. of New England. A.R.R.L. was pulling like heck to hold what we had, but all of us were concerned. As I meditated the possibility of any little bit I could do to help that old incident came to mind. I immediately wrote a letter to Senator Hale, who was chairman of the Committee on Naval Affairs which at that time held our destiny in its hand. I appealed to him urgently, telling him I was one of the gang that helped him out when President Taft came to Portland so many years ago and asked him if he remembered.

Boy, oh boy! The letter I received in reply I shall never forget. It was very cordial—but I only saw three precious words: "Yes, I remember." All at once the Senate Committee on Naval Affairs came out with a vengeance for the ham and we saved the day.

I do not for one instant believe that the fate of the legislation was determined solely by my letter but I do believe the "bread cast upon the waters" so long ago did return.

In my humble mind there seems to be an outstanding moral to this story. It prompts me to suggest that we focus our minds and apparatus on service to the people and communities where we live. Cut out all this eternal arguing and pull together as a solid gang back of A.R.R.L. Then the future—the bands and the privileges—will take care of themselves.

—H. W. Custer, W1IIE

Special—

Recently I made an extensive trip around the country, during which time I discussed with many amateurs their receiver problems.

The enthusiastic interest in a special band spread receiver the laboratory designed for me some time ago, leads me to believe that such a receiver would be welcomed by many amateurs.

Therefore, we have made a limited number of these special receivers which are now available through your regular National dealers.

The price* is unusually low, because the standard NC-100 tools as well as the standard HRO laboratory test equipment are used for the production and testing of these strictly amateur receivers, the only new tooling being the blanking die for the "trick" condenser plates necessary for Straight Frequency Line tuning over the calibrated band spread ranges.

James Miller

NC-101X

FEATURING:

FIVE BAND SPREAD RANGES

- 1.7 to 2.0 megacycles
- 3.5 to 4.0 megacycles
- 7.0 to 7.3 megacycles
- 14.0 to 14.4 megacycles
- 28.0 to 30.0 megacycles

AUTOMATIC PLUG-IN COILS

PERMANENT CALIBRATION

MICROMETER DIAL

AMPLIFIED, DELAYED A.V.C.

POWER OUTPUT 10 WATTS

C.W. OSCILLATOR

CRYSTAL FILTER†

BUILT-IN POWER SUPPLY

12 TUBES

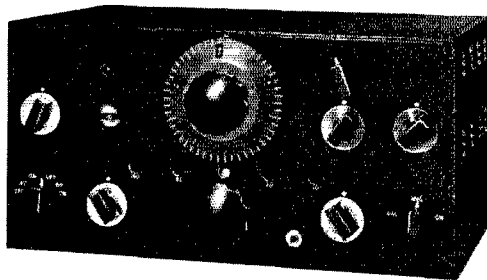

* Retail price, complete with tubes, crystal filter,† 10" dynamic speaker chassis, etc.,
\$125.00

† U. S. Patent No. 2,054,757

NATIONAL COMPANY, INC.



SLEEP SWEETLY

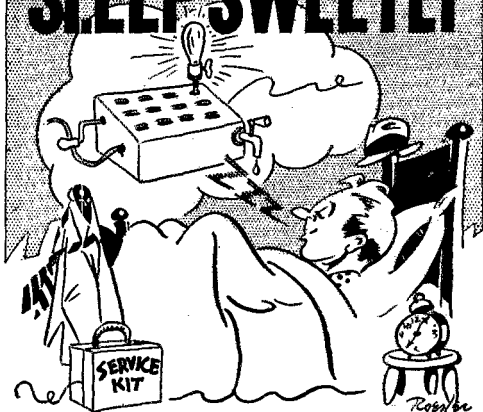

Centralab comes to the rescue
with its New

SELECTOR SWITCH

When you fall asleep, dead to the world from fatigue, trying to dope out how in blazes you're going to get all those dizzy connections right on that new analyzer... take it easy... CENTRALAB'S new SELECTOR SWITCH KIT, with thousands of combinations will ALWAYS solve your problem. See your jobber today.

SWITCHES FOR

- Analyzers
- Output Meters
- R F Oscillators
- A F Oscillators
- Tube Checkers
- Decade Boxes
- Capacitance
- Resistance
- Ham Equipment
- P A Work
- Volt-Ohm-Am Meter
- Radio Receiver Replacements

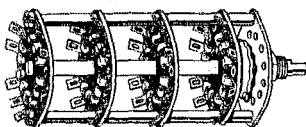

Centralab

Milwaukee, Wisconsin

British Centralab, Ltd.
Canterbury Rd., Kilburn
London N.W.6, England

French Centralab Co.
118 Avenue Ledru-Rollin,
Paris, XI, France

**VOLUME CONTROLS
FIXED RESISTORS**

Signing

1000 Kensington Rd., Grosse Pointe, Mich.

Editor, *QST*:

Although I am a new ham I have been noticing the great waste of time in QSO's due to signing each time the parties switch from one to the other.

... When break-in is used, you can discuss each item and get rid of it and as soon as any part of the QSO is lost or not understood you can break-in and get it straightened out. All this will reduce the time of QSO's for the matter transmitted.

Everybody does not have a receiver which will permit break-in nor as I see it is this necessary.

I see no reason why in ordinary communication we cannot use the same system. For example, suppose after establishing contact with a station I ask a question and sign "K." He can come right back and answer and in turn say his word or two and sign "K." The only time when we have to sign the calls is at the end of the transmission.

Rule 384 states that the only time you have to sign is at the end of each transmission. The only ambiguity lies in the definition of the word "transmission." Rule 386, in regard to logging, indicates clearly enough that "transmission" means the QSO in its entirety.

... With 'phone and with c.w. break-in it is permissible to refrain from this constant signing, and logically there is no reason why an ordinary c.w. should be burdened with signing a dozen times or so in a single QSO. ...

—Fred Sutter

EDITOR'S NOTE.—In following this suggestion, note should be taken of the additional requirement that stations sign at least once every 15 minutes. In other words, sign at the end of each QSO or at least every 15 minutes, omitting calling at the beginning and end of each "come-back."

Going to Europe?

John Bright St., Birmingham, 1, England

Editor, *QST*:

Whilst in the States, I found a tremendous number of hams and their wives who wished to visit Europe, particularly England, and I suggested to one or two of them that it need not be anything like as expensive as most of them had thought, particularly if a large group could come over together. All of those to whom I spoke received the idea favorably, and in contacts over the air I am getting a tremendous number of inquiries as to whether anything has been done about this.

This visit would not only cement the already growing friendship between British and American amateurs but would provide facilities for many who could not otherwise afford the journey. In addition to this, it would be excellent publicity in Europe, making the European countries much more radio conscious than they are at the present time. ...

A lot of the organization would have to be done at the American end but in order that I may have further data to enable me to get in touch with the shipping companies and obtain the lowest possible rate, I would like to know who is interested in the proposition, the number who would like to come and the most suitable date for them to make the trip. It is suggested that the length of time to be spent in this country should be of the order of 7 to 10 days. ... I would also like a volunteer at the American end to look after the arrangements over there, if the scheme goes through.

—W. H. D. Nightingale, G5NI

Strays

W2DTE's contribution in connection with the restoration of cheap milliammeters (p. 37, September *QST*) brings to mind a method I have used successfully for a long time. When the meter magnet becomes demagnetized by reason of overload, remove the magnet from the meter and rub it vigorously for a few seconds on a small horse-shoe magnet—the 10-cent store variety—with the

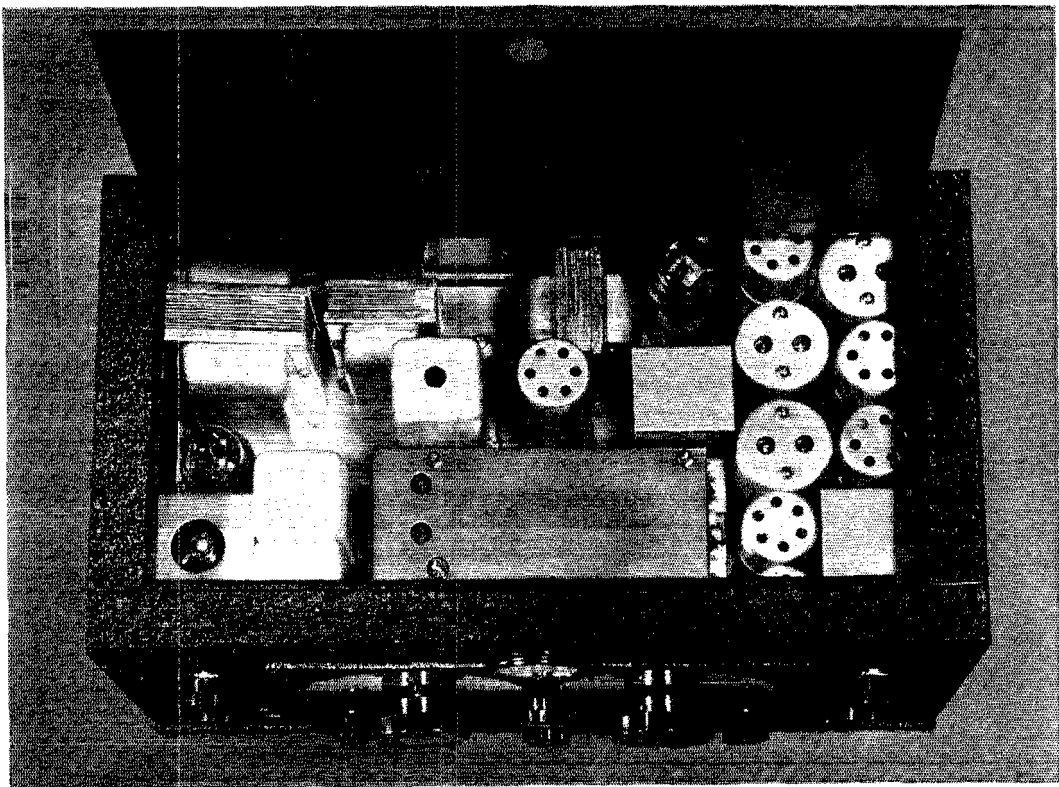

ask any amateur!

It's what you find under the cover that counts. The critical attention to detailed construction . . . the employment of component parts of highest grade and quality . . . the rigid laboratory checkup on every receiver . . . above all, the guaranteed satisfaction to the owner . . . makes the RME-69 Single Signal Super the logical choice.

Write for Bulletin 69

RME-69

RADIO MFG. ENGINEERS, INC.
306 First Ave. Peoria, Ill.

"AIN'T IT THE TRUTH?"

Condensers can be purchased from reputable manufacturers; it does not pay to "economize" by buying a cheap high-voltage condenser. Although the first cost of a good condenser may be higher, it will last indefinitely if not abused. Poor condensers may work for a time, but eventually will "blow" and have to be replaced. Failure of a high-voltage condenser may also mean the destruction of the rectifier tubes.

The Filament...

● These...
 "It does not pay to 'economize' by buying cheap high voltage condensers," says the ARRL Handbook, and no "Ham" can quarrel with the logic of that assertion.

CORNELL-DUBILIER

CONDENSERS have earned a world-wide reputation for dependability. They are extensively used by the United States Army, Navy, Signal Corp and other Government departments... they are specified by communication engineers, and utilized by all leading broadcast stations. Thousands of "Hams" know and use CORNELL-DUBILIER CONDENSERS. You'll find them in all transmitting installations where dependability is of utmost importance.

Insist therefore upon C-D CONDENSERS — they never "let you down" — they will prove to you that QUALITY condensers are MORE ECONOMICAL, in the long run!

STANDARDIZE ON CORNELL-DUBILIER DYKANOL TRANSMITTING CONDENSERS

Dykanol impregnated and filled in hermetically sealed containers, these capacitors can be safely operated at 10% above rating, without injury to condenser.

- 1 mfd. 1000 volts, D.C. \$3.00 list
- 2 mfd. 1000 volts, D.C. 4.50 list
- 1 mfd. 1500 volts, D.C. 3.75 list
- 2 mfd. 1500 volts, D.C. 6.25 list
- 1 mfd. 2000 volts, D.C. 5.25 list
- 2 mfd. 2000 volts, D.C. 8.00 list



Write today for Catalog Number 133A listing and describing in complete detail the TJ Dykanol Transmitting series and other famous C-D transmitting capacitors.

Available at all C-D authorized distributors

Dykanol, Mica, Paper, Wet and Dry Electrolytic

CORNELL-DUBILIER

1013 HAMILTON BLVD.

SO. PLAINFIELD, N. J.

open end of the meter magnet facing the open end of the horse-shoe magnet. This is quick and convenient.

—W5ELC

Silent Keys

It is with deep regret that we record the passing of these amateurs:

- L. E. Bassett, W4LL, Cedartown, Ga.
- Charles E. Bates, W6JWX, Los Angeles, Calif.
- Henry A. Farnham, W3ASO-WLMC, Washington, D. C.
- Jack Fleming, Victoria, B. C.
- Hugh Graham Gordon, W5DDW, Duncan, Okla.
- C. T. Hanavan, Los Angeles, Calif.
- Ora Ice, W9VVT, Indianapolis, Ind.
- Chas. R. Jacobsen, W3GCX, Chatham, N. J.
- Joseph Jonassen, W7FXQ, Ferndale, Wash.
- Edith M. Maxwell, W6EYE, Santa Paula, Calif.
- Dana McNeil, ex-9CLS, Pierre, S. D.
- David W. Richardson, ex-3XM, Mt. Kisco, N. J.
- H. V. Routzong, W8ICF, Gettysburg, Ohio
- Robert Sanchen, W3BZP, Chester, Pa.
- John Skov, W9PJU, Albert Lea, Minn.
- Edward J. Sporka, W9MXX, Chicago, Ill.
- William A. Tebben, W2BBA, Ridgewood Plateau, N. Y.
- Dr. Leslie A. Wilson, Cameron, Mo.

An Inexpensive Five-Band Low-Power Transmitter

(Continued from page 16)

To adjust the doubler, again insert the dummy jack in the driver jack and set the oscillator going as before. Then insert the meter plug in the doubler jack and, with the proper plate coil at L_2 , rotate C_2 until the plate current dips, indicating resonance at the harmonic. The doubler cannot be operated on the same frequency as the oscillator, since it is not neutralized. The plate-current dip should be from about 40 ma. to 20 ma. (with the driver tube in its socket), when the doubler is tuned to twice the crystal frequency. When quadrupling, the dip will be quite small, but the neon bulb should glow when touched to the grid of the driver. Make certain when quadrupling that L_2C_2 is tuned to the fourth and not the third harmonic; usually both will be found on the same coil. The fourth is of course the one at the lower-capacity setting of C_2 . The driver tube is tuned in the same way when operating from the doubler as when being excited directly by the oscillator.

To adjust the final stage, get the oscillator and

AT LAST, A RADIO YOU CAN'T TUNE WRONG!



Focused Tone

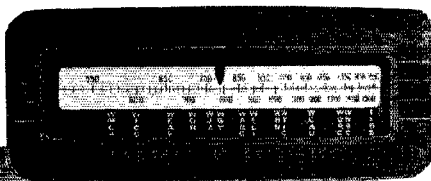

Perfect Tuning . . Perfect Tone . . Automatically!

Set the dial of the new G-E Radio off tune—as nine out of ten people do without knowing it—and you'll get the surprise of your life. Instantly, the new G-E automatically shifts itself into hair-line tuning. And, simultaneously, the amazing new G-E Colorama Dial changes from red to green to tell you "here's your station perfectly tuned—every note true and clear."

Everything about the new G-E is thrilling and amazing. It's a Personalized Radio—with a Custom-tailored Dial. Your local station letters flash on when you tune in. No more hunting up kilocycle numbers. The new G-E gives you silent tuning, too. You can switch from one program to another without a single squeal, squawk, or screech. But the biggest thrill of all is the life-like, flawless tone of the new G-E.

See and hear—for yourself—radio's newest marvel. Stop in soon at the G-E Radio Dealer's nearest you. Let your ears decide whether any other radio, at any price, can equal the tone and performance of the greatest radio G.E. has ever built.



GLADYS SWARTHOUT—glamorous star of the Metropolitan Opera—Radio—and the Movies—because stations are marked by letters as well as kilocycles.

MODEL E-101

Ten G-E Metal Tubes. 540 to 18,000 kc. • Colorama Dial • AFC • Local Station Personalizer • Sentry Box • 8-inch Stabilized Dynamic Speaker • Sliding-rule Tuning Scale • Music-speech Control • Ten watts output.

\$84.95 (Eastern List)

The new General Electric comes in 31 handsome models—priced from \$22.50 to \$750.00 (Eastern List).

You'll always be glad you bought a G-E

GENERAL  **ELECTRIC**
Radio

For Metal Tube Renewals, Specify G-E

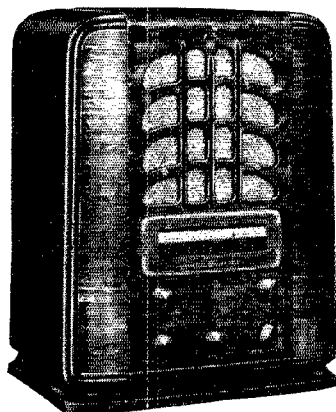

RESEARCH KEEPS GENERAL ELECTRIC YEARS AHEAD

"... It is absolutely the easiest tube on the American market to drive ..."



"... Any of the fellows getting ready to revamp the old rig and want to hear the HF100 just give us a call."

THAT'S WHAT THESE BOYS OF W4AZK SAY ABOUT THE

AMPEREX HF100

Read the rest of this unsolicited letter . . .

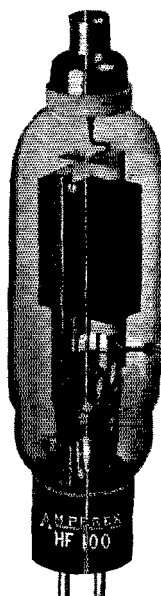

\$10

(Note: 260 watts of output can be obtained with 2 watts of driving power.)

"... Below are some of the reports received and stations worked in one evening from eleven o'clock PM to six o'clock AM and in a location very unsatisfactory for DX. The figure after the call letter indicates the signal strength as reported to us by that station. An input of 200 watts was used at 14160 kc.

W6ISH-9	VE4CW-8
VE1BR-9	F811-9
W6FGU-8	T12DC-7
W7AOT-8	G2MV-7
G2NO-8	VP9R-8
F3EO-8	VE2BG-9
G6AH-8	T12CR-7
VK5LL-7	T15JJ-8

This was two weeks ago and we are having the same consistent reports come in. We cannot say too much for the HF100 as we believe it to be a tube that cannot be beat."

Very truly yours,

David S. Traer
Lewis M. Maddox
W4AZK

CHARACTERISTICS

Filament Voltage 10 Volts
Current 2 Amps.

Amplification Factor 23
Grid to Plate Transconductance @ 100 ma.
4200

Direct Interelectrode Capacitances:
Grid to Plate 4.5 uuf.
Grid to Filament 3.5 uuf.
Plate to Filament 1.4 uuf.

Write to our Engineering Department
for Complete Data

AMPEREX

ELECTRONIC PRODUCTS, Inc.
79 WASHINGTON STREET - BROOKLYN, N. Y.

driver into operation, and insert the proper plate coil at L_4 . Leave the key open. Touch the neon bulb to the connection at one end of L_4 and rotate C_4 until the glow appears, indicating resonance. The neutralizing condensers, C_{16} and C_{17} , should both be set at minimum capacity. Now increase the capacity of both neutralizing condensers in equal steps, a little at a time, readjusting both C_4 and C_3 as each change is made, just as was done in the case of neutralizing the driver tube. The procedure is the same, except that in this case two neutralizing condensers instead of one have to be moved. When the correct settings are found, the neon bulb will not glow when C_4 is swung through resonance. The neutralizing condensers should be set at approximately equal capacity; if, on completing the job, it is found that one is at high capacity and the other at low, the whole procedure should be gone through again until the amplifier is neutralized with equal capacity settings of C_{16} and C_{17} . The bottom-view photograph of the transmitter indicates approximately correct settings for neutralization.

After the final stage is neutralized, the meter plug may be inserted in the amplifier plate jack and the key closed. Rotate C_4 to find resonance, again indicated by minimum plate current. With the amplifier plate circuit off resonance, the plate current will be considerably over 100 milliamperes and the meter will go off scale; at resonance the plate current should drop to 10 ma. or less on all bands except 28 mc. where it may be slightly higher.

When the adjustments described above have been carried out, the transmitter is ready to go on the air.

ANTENNA TUNING

Since the process of transferring r.f. power from the transmitter to the antenna depends so much upon the type of antenna used, it is not possible to give definite instructions as to tuning. The reader is referred to the antenna chapter of the *Radio Amateur's Handbook* for detailed information on antennas and tuning systems. We can, however, describe the general method of using the coupler.

With the transmitter tuned up and the key closed, and with the feeders connected to the antenna coupler, move the coupler pickup coil into the vicinity of the amplifier tank coil and try various settings of the antenna tuning condensers to obtain a rise in amplifier plate current. With tuned feeders, it will not ordinarily be necessary to use the loading coil (L_2 in Fig. 2), hence the socket can be shorted by plugging a piece of heavy wire in the prongs, or by having available a blank coil form or old tube base with a jumper soldered in the prongs.

It is best to start with loose coupling, causing only a small rise in amplifier plate current. Tune the antenna circuit to exact resonance, and then increase the coupling until the amplifier draws a current of about 80 or 85 milliamperes. Avoid using such close coupling that there is considerable reaction between the antenna and amplifier tuning adjustments. The loading coil may be necessary in some cases where parallel tuning is

! RECEIVER HEADQUARTERS !

We Are Authorized Distributors

RME 69, complete with tubes	\$134.90
RME DB-20 RF amp-selector	39.95
Hallcrafters Sky Buddy complete	29.50
Hallcrafters Ultra Skyriders S-10	99.50
Hallcrafters Super Skyrider S-12	99.50
Hallcrafters Sky Chief complete	44.50
Hammarlund Super Pro	223.44

Come in for demonstration. Liberal allowances on your old set. Time payments arranged.

GROSS TRANSMITTER KITS

CW-25 Output 25-30 watts (Crystal Controlled). Complete kit less tubes and crystal	\$14.95
P-25 power supply kit for above —450 volts at 200 MA.....	\$11.00

CW-60 (Uses New Eimac 35T)
Crystal Control Transmitter
OUTPUT: 60-100 WATTS

COMPLETE KIT, LESS
TUBES AND CRYSTAL

\$20.95

New! L66 Beam Power (30 Watt) Modulator

- 4 stages (2-6J7, 1-6C5, 2-6C5, 2-6L6, 1-5Z3)
- Push Pull driver for high fidelity
- Built-in output modulation transformer (3000, 4500, 6000 ohms)
- Self bias
- Crystal or ribbon microphone inputs

A companion unit to the larger L-60 modulator retaining all of its features which results in broadcast quality with initial economy and operation. Self bias with 100% power supply regulation permits clean output of 30 watts. Will 100% plate modulate transmitters with up to 60 watts input. Mixing inputs for crystal and velocity microphones. A tone control in a special compensation circuit always insures proper frequency attenuation. May be supplied on request with output impedances of 2, 4, 9, 15, 500 ohms for public address work.

Completely wired and tested in our lab., less tubes	\$29.50
Kit of matched Sylvania tubes	\$5.50

New! L60 Beam Power (60 Watt) Modulator

- 4 stages (1-6J7, 2-6C5, 2-76, 2-6L6, 1-45, 1-83)
- Push Pull second stage and driver for high fidelity
- Two channel, high and low gain high impedance inputs
- Built-in modulation transformer
- Fixed bias

This beam powered 60 watt modulator will 100% plate modulate transmitters with up to 120 watts input. The built-in modulation transformer will match R.F. loads of 5000, 8000, and 10,000 ohms. On special order we can supply this unit with output impedances of 4, 8, 15, 500 ohms for general public address work.

A two channel input permits full output with mixing from a crystal, ribbon or carbon mike. The tone control provided is used to attenuate voice or music frequencies to suit the requirements of best modulation. Chassis size: 19" x 11" x 4 1/2". Weight 50 lbs. Built-in extra heavy duty power supply.

Completely wired and tested in our lab., less tubes	\$42.50
Matched set of Sylvania tubes	\$5.50

New! Single 5B5 (6Watt) Amp.

- 3 high gain stages
- Crystal mike input
- Gain and tone controls
- Tubes used 6J7, 6C5, 6B5, 5Z4

A versatile and high quality amplifier combining all the desirable features yet at a very reasonable price, is now offered for your use. High gain, sufficient for full output from a low level crystal mike with noiseless high fidelity output.

Complete kit of parts less tubes ..	\$8.50
Wired and tested in our lab., less tubes	10.95
Matched set of tubes	3.50

New! P.P. 6B5 (20 Watt) Amp.

- 3 High gain stages (last two in push pull)
- Crystal or Ribbon mike input
- Gain and tone controls

May be used as a driver for high powered modulators. A clean gain of 126 D.B. permits full undistorted high fidelity output from either a ribbon or crystal mike. Tube lineup: 1-6J7 input stage, 2-6J7 P.P. driver stage output, P.P. 2-6B5 with phase inversion, 1-80 rectifier.

Complete kit of parts less tubes ..	\$16.95
Wired and tested in our lab., less tubes	20.70
Matched set of tubes	5.10

Keying Relay

will operate on one dry cell. Can be used as Single Pole Single Throw or Single Pole Double Throw. Sturdy construction, has 1/4" diameter Solid Silver Contacts. Compares favorably with expensive types. Special. **59c**



SPECIALS

6L6 modulation output transformer (30 watts)	\$3.65
6L6 General P.A. output transformer P.P. plates to 2, 4, 9, 15, 500 ohm lines (30 watts)	2.95
6L6G85
6L685
6L6G with isolantite base	1.75
New RCA 807	3.90
New Raytheon RK 39	3.90

NEW! "THE STANDBY" (2 TO 2000 METERS) 3-TUBE A.C. AND D.C. RECEIVER

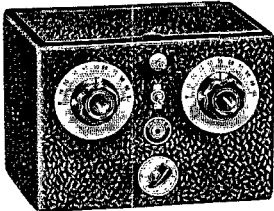

This excellent 2 to 2000 meter receiver is offered with full realization of the present-day need of the amateur for a dependable "standby" receiver which will cover practically all of the radio bands in use today. Super regeneration, which is the most efficient form of detection at these frequencies, is used from 2 to 15 meters. By throwing a toggle switch, straight regeneration and higher wavelengths up to 2000 meters may be had. Throughout the entire tuning range, there are no skips or dead spots. Loud speaker volume is available from practically every station received.

- 1000 to 1 tuning ratio ● Super regeneration below 15 meters
- Instant change over from straight to super regeneration
- Power supply incorporated
- Individual antenna tuning for high and low wave ranges
- 1-76 super regenerative detector, 1-6J7 regenerative detector, 1-12A7 audio amp. and rectifier

Complete kit of parts less coils, tubes, cab.....	\$7.59
2.5-10-meter coils (set of 3)95
94 to 15 meter coil39
15-200 meter coils (set of 4)95
200-310 meter coil39
310-550 meter coil39
550-1050 meter coil60
1000-2000 meter coil60
Metal cabinet	1.50
Kit of three tubes 2.40	
Wired and tested in our lab., add. 2.00	

WRITE IN FOR FREE NEW CATALOG ON HAM AND P.A. EQUIPMENT

20% DEPOSIT WITH ALL C. O. D. ORDERS

REMIT BY M. O. INCLUDE POSTAGE

Cable Address: GROSSINC

GROSS RADIO, INC., 51 VESEY STREET, NEW YORK CITY

"EVEREADY"

presents
two Record-smashing
"Layerbilt" values



The Famous 486
"LAYERBILT"

at a new low price \$1.98



The New

"SUPER LAYERBILT"

The longest-lasting "B" Battery ever offered at only \$2.25

Genuine "Eveready Layerbilt" "B" Batteries, famous for years for *extra long service*, now cost but a few cents more than ordinary, wasteful, short-lived, old-fashioned round-cell "B" batteries. You can now buy genuine, exclusive "Layerbilt" "B" Batteries for *less* than many makes of round-cell battery. And "Layerbilt" now gives you the new, crack-proof cushion top in addition to the advantages of patented "Layerbilt" construction. Take advantage of "Layerbilt" extra long life. At these new low prices, you can't afford not to . . . whether you buy the standard 486 "Layerbilt" or the new Super "Layerbilt," the world's longest-lasting heavy duty "B" battery.

Standard "Eveready" Round Cell "B" Batteries are priced from \$1.00 to \$1.59.

NATIONAL CARBON COMPANY, INC.

General Offices: New York, N. Y.

Branches: San Francisco, Chicago

Unit of Union Carbide  and Carbon Corporation
The words "Eveready" and "Layerbilt" are trade-marks of
National Carbon Company, Inc.

Prices slightly higher in Far Western States

used on the lower-frequency bands, depending upon the feeder length.

With everything working properly, the power output of the amplifier will be in the vicinity of 20 watts or slightly more with a plate current of 80 milliamperes. This is about as much plate current as should be drawn with tubes of this type, especially if 'phone is to be used.

What the League Is Doing

(Continued from page 87)

sion of their feelings in the matter. He would be as interested to hear from those who affirmatively feel that it would *not* be a good idea as from those who favor it. If it can be indicated that the League press would recover its costs in publishing the book, the job will probably be done.

Canada Canadian General Manager Alex Reid this autumn made an excellent presentation on behalf of Canadian amateurs before the committees of the Dominion government preparing for Cairo. The petition recited the work of amateur radio and its benefits to the Dominion and requested the expansion of the 7-mc. and 3.5-mc. bands to 7000-7500 kc. and 3500-4500 kc., respectively. The amateur proposals have been taken under consideration by a committee on frequency allocations, whose report has not yet been announced.

Operating Notes on the Transmitting-Type Beam Power Tube

(Continued from page 88)

tank coil, L_2 . Below the chassis and directly below their respective coils are the oscillator cathode tuning condenser C_1 and plate condenser C_2 . These are midget condensers of the type which are insulated from the chassis, essential in this case. C_3 is mounted on small feed-through insulators to insulate it from the chassis.

The below-chassis view shows the arrangement of the remaining parts in the circuit diagram. R.F. wiring is of No. 14 tinned wire; ordinary push-back wire is used for the power leads. The power supply voltages are carried into the unit by means of a cable. The jacks at the rear (bottom in the photograph) are for measuring grid and plate currents in the 807 stage; these currents were of particular interest to us, but it might be as well to provide a third jack for oscillator plate current. The double binding-post assembly is for the connections to the key. Grounds in all cases are made directly to the chassis with short leads. Needless to say, the plate-current jack must be insulated from the chassis. To provide a suitable amount of capacity for the oscillator cathode circuit, C_1 is shunted by C_8 , a fixed mica condenser.



Then I Tried Air-tuned Aladdin Polyiron Transformers In This Circuit

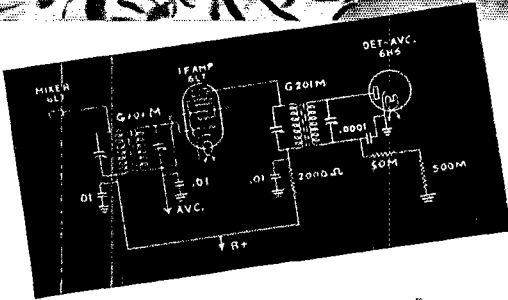

That was the turning point! Only those of us who have actually experienced the effectiveness of these "I-f's" can realize the complete satisfaction derived in picking up and separating the signals when they are coming in. The technical data sheet 536 is obtainable upon forwarding your QSL card which includes performance curves, circuit diagrams, etc.

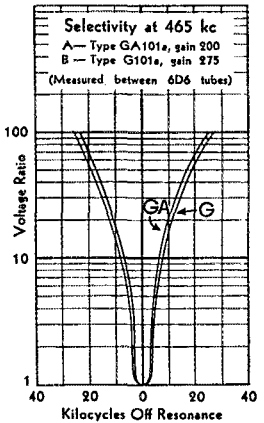
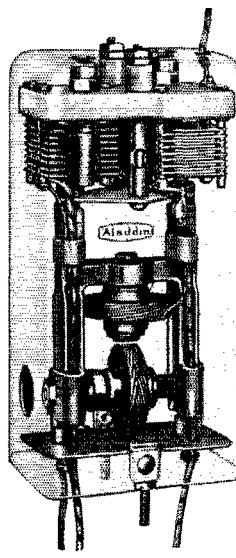
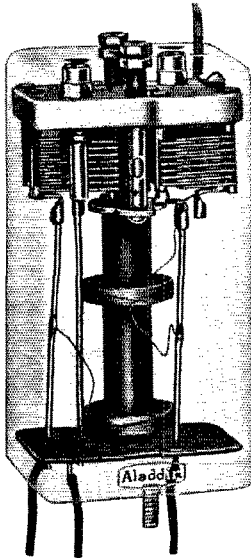
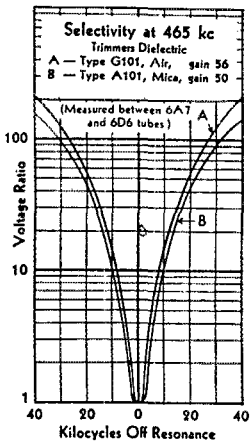

- Fixed Coupling Air-tuned I-f's**
- Type G101M 465 Kc Converter List Price \$5.50
 - Type G201M 465 Kc Diode List Price 5.50
 - Type G101c 465 Kc Crystal Input List Price 6.25

- Adjustable Coupling Air-tuned I-f's**
- Type GA101M 465 Kc Converter List Price \$6.50
 - Type GA201M 465 Kc Diode List Price 6.50
 - Type GA100c 465 Kc Crystal Input List Price 7.25

ALADDIN RADIO INDUSTRIES, INC.

466-Q West Superior Street

Chicago, Illinois

Licensee of Johnson Laboratories, Inc.

These devices manufactured under one or more of the following U. S. Letters Patents:
1887380, 1940228, 1978568, 1978599, 1978600, 1982689, 1982690, 1997453, 2002500
2005203, 2018626, 2028534, 2032580, 2032914, 2035439. Other patents pending.

Now—a high-powered—

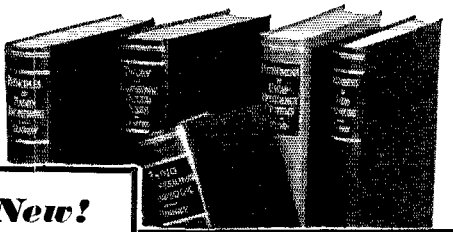

New!

The Library now comprises a revised selection of books culled from latest McGraw-Hill publications in the radio field.

**RADIO
ENGINEERING
LIBRARY**

- especially selected by radio specialists of McGraw-Hill publications
- to give most complete, dependable coverage of facts needed by all whose fields are grounded on radio fundamentals
- available at a special price and terms

These books cover circuit phenomena, tube theory, networks, measurements, and other subjects—give specialized treatment of all fields of practical design and application. They are books of recognized position in the literature—books you will refer to and be referred to often. If you are a researcher or experimenter—if your interest in radio is deep-set and based on a real desire to go further in this field—you want these books for the help they give in hundreds of problems throughout the whole field of radio engineering.

5 volumes, 3064 pages, 2000 illustrations

1. Glasgow's **PRINCIPLES OF RADIO ENGINEERING**
2. Terman's **MEASUREMENTS IN RADIO ENGINEERING**
3. Chaffee's **THEORY OF THERMIONIC VACUUM TUBES**
4. Hund's **PHENOMENA IN HIGH-FREQUENCY SYSTEMS**
5. Henney's **RADIO ENGINEERING HANDBOOK**

Special Low Price and Easy Terms

Bought singly, the five volumes comprising this library would cost you \$25.00. Under this offer you save \$1.50 and, in addition, have the privilege of paying in easy installments beginning with \$2.50, 10 days after receipt of the books, and \$3.00 monthly thereafter. Already these books are recognized as standard works that you are bound to require sooner or later. Take advantage of these convenient terms to add them to your library now.

SEND THIS ON-APPROVAL COUPON

McGraw-Hill Book Co., Inc.
330 W. 42nd St., New York, N. Y.

Send me Radio Engineering Library, 5 vols., for 10 days' examination on approval. In 10 days I will send \$2.50, plus few cents postage, and \$3.00 monthly till \$23.50 is paid, or return books postpaid. (We pay postage on orders accompanied by remittance of first installment.)

Name.....

Address.....

City and State.....

Position.....

Company..... QST-12-36
(Books sent on approval in U. S. and Canada only.)

Cathode keying is used on both tubes. The cathode of the 807 is bypassed to ground through C_{11} ; in the case of the oscillator, the lower end of the cathode tank circuit is similarly bypassed through C_{13} . The r.f. choke in the keying lead from C_{13} is simply a precaution to prevent the key from trying to become part of the oscillator circuit. This system has been found to work very satisfactorily, giving clean keying with no tendency to chirp when C_1 is set correctly. For eliminating key clicks, it might be preferable to use fixed bias on the amplifier, to cut off the plate current without excitation, and key only the oscillator.

A voltage divider, consisting of R_3 , R_4 , R_5 and R_6 in series, supplies the proper voltages to the tube elements when a 400-volt plate supply is used. With the resistor values given, the measured voltages under operating conditions were as follows: oscillator plate and amplifier screen, 250 volts; oscillator screen, 100 volts, oscillator suppressor, 50 volts.

Tuning on any band is relatively simple. Adjustment of the Tri-tet oscillator has been covered many times in *QST* and the *Handbook*, and the usual method should be followed. If an 80-meter crystal is used and the plate circuit, L_2C_2 , is to be tuned to the fourth harmonic, care must be used to pick the right harmonic, since both the third and fourth can be hit on the same coil. With the constants given, grid current to the 807 should be about 2 ma. on the second harmonic and in the vicinity of 1 ma. on the fourth. The 807 plate current should dip to a very low value (10 ma. or less) when C_3L_3 is tuned to resonance. Loading the plate circuit to make the tube take about 90 milliamperes should give the rated tube output of 25 watts.

It so happens that with C_3 and L_3 as specified, any two adjacent bands can be covered without changing coils, the lower-frequency of the two being found near maximum capacity on C_3 and the higher-frequency near minimum capacity. If the 807 is used as a doubler on the higher-frequency band, shifting from one band to the other is simply a question of readjusting C_3 , no coil changing being necessary.

All in all, the 807 looks to be a good tube for the low-power transmitter or for excitors. We could wish that a little more internal shielding was incorporated in the structure to eliminate the tendency toward oscillation on 14 Mc. although, as already pointed out, this tendency has no real disadvantages in practical operation. It has been said that tubes of this type, because of their extremely high power sensitivity, are prone to parasitic oscillations, particularly of the type involving the screen circuit. In the rig shown, no tendency of this sort developed. Should parasites be present, however, the recommended cure is to insert a non-inductive resistor of about 100 ohms in series with the screen right at the tube socket and on the screen side of the bypass condenser. This will have no measurable effect on the normal plate output.

G.G.

1895

THORDARSON

1937

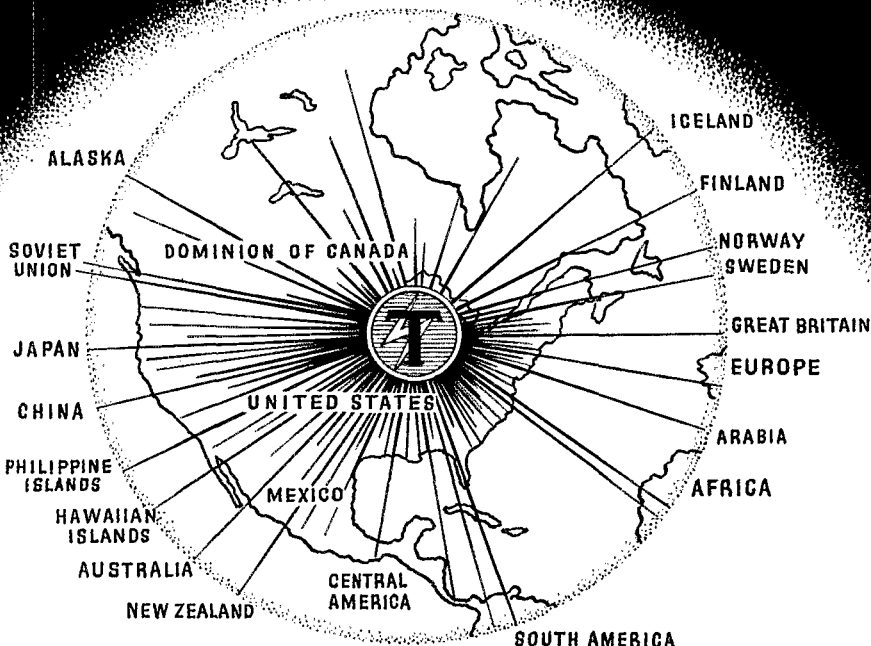

WORLD WIDE ACCEPTANCE

THE universal distribution pictured here is a tribute to Thordarson's manufacturing and sales policies. Untiring creative effort, precision manufacturing, ethical sales policies and reliable service have built a tremendous back-log of goodwill among jobbers, dealers, servicemen and amateurs all over the world.

Thordarson constantly is producing refinements in transformer construction. In 1936 Thordarson developed Tru-Fidelity—long the ideal of radio engineers and

sound technicians. It is this type of leadership that perpetuates the strong bond of loyalty between Thordarson and its customers.

The demand for "Power by Thordarson" reaches from New York to California, from Canada to South Africa, from Siam to England. We are deeply appreciative that our efforts have received this world-wide acclaim. To jobbers, dealers, servicemen and amateurs we pledge a continuation of Thordarson leadership and extend a sincere wish for prosperous years to come.



THORDARSON ELECTRIC MFG. CO.

500 W. HURON ST., CHICAGO, ILL.

Demand "Power by Thordarson"



say these
TUBE MANUFACTURERS

The makers should know! They state **definitely** that for maximum efficiency and long life of transmitting tubes, the filament power supply must be **accurately** controlled. Too much power shortens the life of the tube. Too little cuts down the output.

Accepted practice specifies an OHMITE power rheostat in the transformer primary — to avoid unbalancing the secondary. A special bulletin with complete diagrams is available without charge. Get it from your dealer or write to OHMITE.

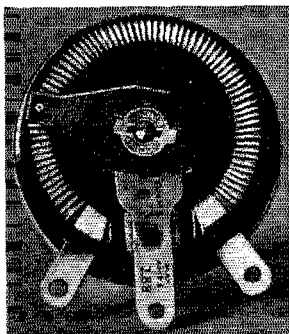

OHMITE

MANUFACTURING CO.

4931 Flournoy Street

Chicago, Illinois



HANDBOOK
PAGES

518-519

CATALOG
SECTION

OHMITE AMATEUR HANDBOOK

Revised enlarged second edition contains 24 pages of useful data and information on bandswitching, power supplies, modulators, filament control, etc. From your dealer, or sent 10c postpaid.

Moving-Coil Tuning System for the High-Frequency Receiver

(Continued from page 31)

difficulties to be ironed out, of which high manufacturing cost is the most obvious but not the most vexing.

In the meantime, there is another straightforward attack. Suppose we make a cast aluminum box, divided by partitions into as many shielded compartments as necessary. Into each compartment put one h.f. coil, together with its air dielectric condenser. This accomplishes at one stroke the air-tight shielding between ranges and between used coils and idle coils. It provides room for efficient coils and low-loss condensers. The next problem is short leads. Easy. Move the coils, shield and all, until the desired set is brought close to the tuning condenser. And lastly, for permanence of calibration, provide an accurate mechanical track for the coils to slide on, and a positive detent to lock them into position on the track.

This brings us back right where we started, of course. We are using plug-in coils after all, and the coil switch is still an unsolved problem. But we have the convenience we were after, since a knob on the front panel of the receiver makes instant coil shifts. And we have a self-contained, compact unit.

Let's see what this looks like in an actual receiver. Two views of the under side of the receiver show the arrangement. The coil shifting mechanism is clearly shown in both views. One side of the coil shield slides on a steel rod finished to close dimensions. The other edge of the assembly is supported by a track machined in the shield itself. A rack and pinion provide a means of moving the coils by a knob on the front of the set. Trimmers are reached through small holes in the shield.

There are several details that the illustration does not show. Metal rubbing against metal causes objectionable noise in high-gain high-frequency receivers. The insulated bearings in tuning condensers point the way to the solution; the coil shield likewise runs on insulated bearings. Suddenly breaking the h.f. circuits causes crashes in the loudspeaker. Experiment proved that removing the screen voltage from the r.f. tubes would make the set "dead", and that it would die quietly. Accordingly, small switches shut off the screen voltage while coils are being shifted. Accurate positioning of coils after range changes is accomplished by the design of the contacts themselves, which are of the double side-wipe type with four-point contact. Since there are fifteen of them, their combined wrap-around effect locks the coils into exact position with unmistakable finality.

As it stands, the moving-coil mechanism gives a pretty good answer to the problem of coil changing. It retains plug-in coils with all their usual virtues, and adds compactness. But only the future can tell whether it is the final answer.

The tuning system, while all-important, is not

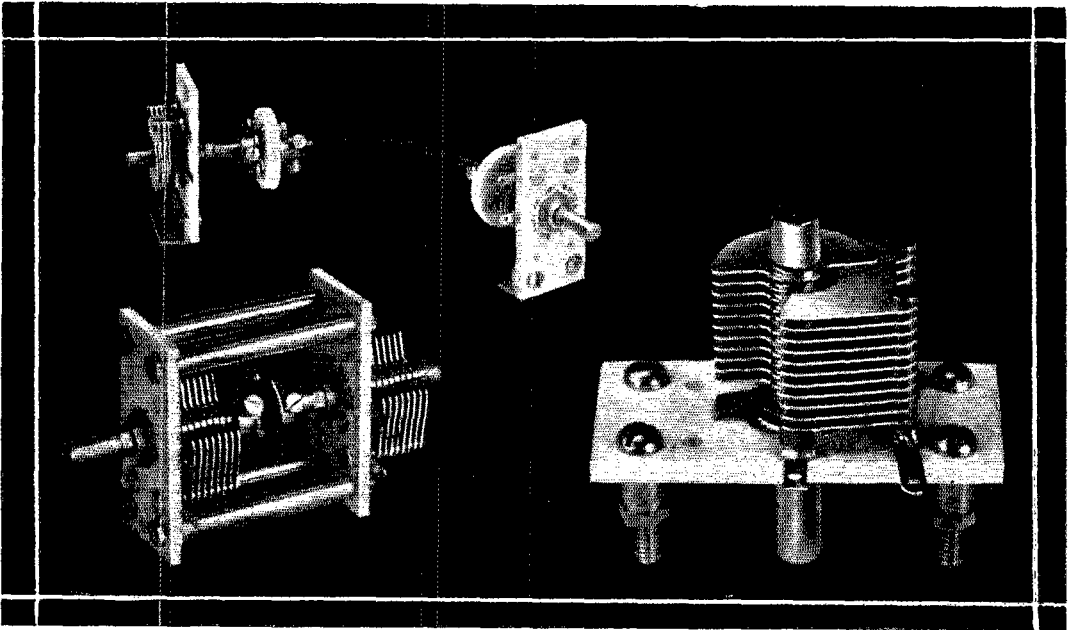

— — *for Unusual Layouts!*

The type UM Ultra Midget Condenser is designed for use in ultra high frequency receivers, transmitters or exciters where a small efficient padding or tuning condenser is needed. Its wide acceptance for such use is founded on its small size for mounting in shield cans, on its shaft extensions on each end of the rotor for convenient ganging, and on its universal type of mounting. These features when used in conjunction with our flexible couplings (a few from our complete line are illustrated below) make a unit that is easily adaptable to unusual layouts. At the right in the illustration above, is one model of the UM condenser (a balanced stator model is also available): At the left are two of the many convenient methods of mounting and ganging. Other features include a staked and soldered construction which, together with the "self locking" rotor design, makes the UM condenser virtually proof to vibration. Prices are extremely low, ranging from \$.75 (net) for the 15 mmf size to \$1.14 (net) for the 100 mmf size.

◆ NATIONAL COMPANY, MALDEN, MASS. ◆

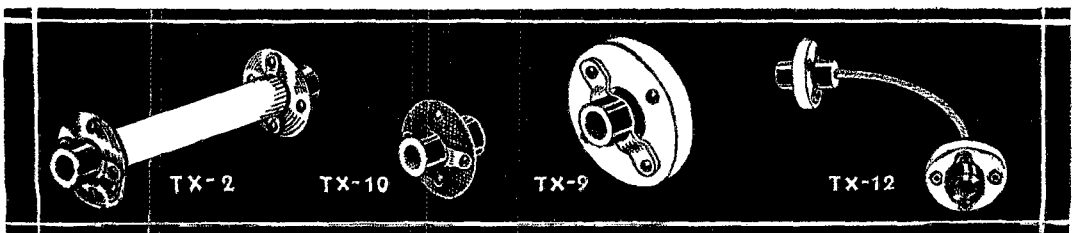

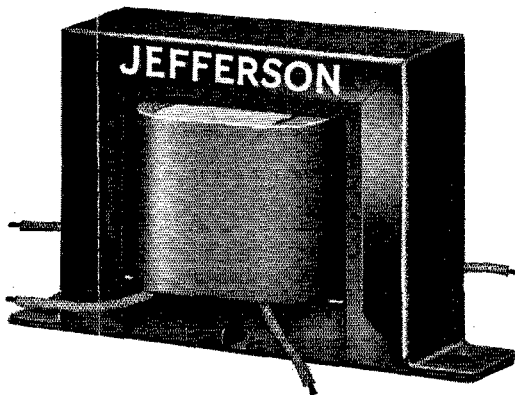

Conservative Ratings Mean Extra Service ... Better Results

You get full secondary voltage under load always—with Jefferson Transformers. They have the in-built stamina,—the quality materials,—the conservative ratings to give you far more than you expect under all operating conditions.

**Jefferson Filament Transformer
No. 464-201—Your Cost only \$1.20 Net**

A leader in filament transformers—Jefferson quality throughout, at so reasonable a price—2.5 volts CT at 12 amperes 7500 volt insulation test. Suitable for use with '66 tubes . . . Try this model and ask your jobber for catalog, describing the complete Jefferson Line of Filament, Plate Supply, Microphone, Modulation, Power, Output and Input Transformers and Chokes.

Get the best results—good tone quality on phone sets—steady notes on CW,—distance, and real satisfaction by selecting your transformers from the Jefferson Line . . .
JEFFERSON ELECTRIC COMPANY,
Bellwood (Suburb of Chicago), Illinois.
Canadian Factory: 535 College Street,
Toronto, Canada.

JEFFERSON TRANSFORMERS

Jefferson Electric Co.
Bellwood, Ill.

New Amplifier Diagram
—Free. 6L6 60-watt
Amplifier.

Send amateur Radio Catalog 361R and new 6L6 Amplifier Diagram to

Name

Address.....

City and State.....

all of the receiver. The schematic circuit of the NC-100 receiver in which the moving-coil system is used is shown in Fig. 1. In this diagram only one of the tuning-coil range units is shown, for the sake of simplicity in illustrating the circuit principles. In addition to the r.f. pro-selector, first detector and high-frequency oscillator, the circuit comprises two high-gain i.f. stages using air-core transformers, a triode (cathode-drop biased) second detector, pentode amplified a.v.c. using plate rectification, separate c.w. beat oscillator, and two audio stages, the second of which is of the high-output push-pull pentode type. There is also a cathode-ray tuning indicator (6E5) controlled from the a.v.c. circuit. A heavy-duty power supply is built in the same chassis and there is a separate speaker unit.

A crystal filter unit with controllable bandwidth and rejection is optional in place of the first i.f. transformer, between the first detector and first i.f. amplifier. Its circuit is given in the lower left-hand corner of the diagram. With this additional feature the wide range of selectivity from that required for good quality broadcast reception to that necessary for pulling signals out of the QRM on the amateur bands is made available.

'Phone Transmitter Using Beam Power Tubes

(Continued from page 34)

the voltages through a constant current drain. Furthermore, with one unit layout is simplified and mechanical difficulties are avoided.

Great care has been exercised in the construction of this circuit to make it economical and easy to assemble with a minimum of kinks to iron out. No special precautions are necessary in constructing the r.f. section.

In the modulation section all stages are isolated by de-coupling resistors and by-pass condensers. Because of the high gain it is advisable to shield completely all leads over one-inch long. The shields of these leads should be connected together and grounded to a common point. Care should also be taken to mount the input transformer at a distance of five or six inches from the driver and output transformer.

Some of the difficulties previously encountered with 6L6G tubes may be eliminated if the foregoing precautions are observed. In Class-AB use, because of the great power output and amplification of these tubes, it is imperative that no high-frequency surges be impressed on the grids. If this happens arc-over inside the tubes or at the socket may result. Until everything is properly working it is advisable to shunt a 0.01- μ f. condenser between each grid and ground to by-pass these surges. If a microphone is connected or disconnected to the input of the amplifier, the gain control must be turned down; otherwise, the surge may cause damage to the tubes.

Beam power tubes should never be operated in any position except vertical. The beam effect of

THE EIMAC 35T

THE ANSWER TO THE AMATEUR'S PRAYER
THE **EIMAC 35T** FILLS EVERY REQUIREMENT
OF YOUR PRESENT OR FUTURE TRANSMITTER

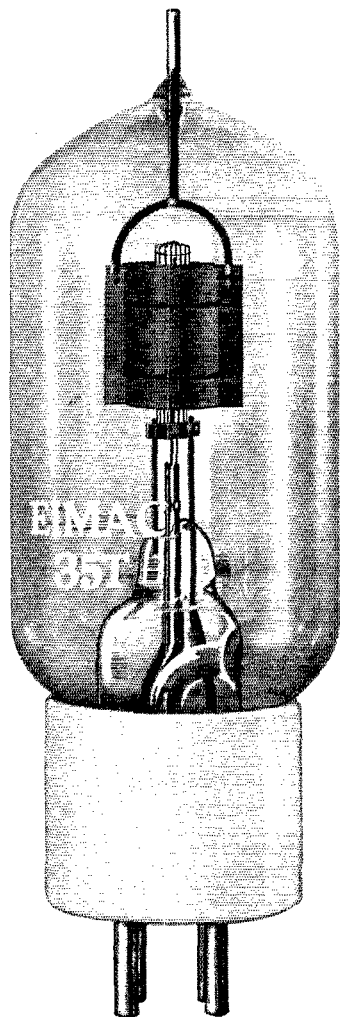

EIMAC 35T
Actual Size

► CLASS "C" R. F.

Single tube rated at 170 watts output. Users report nearly double this output under overload conditions. Two tubes give $\frac{1}{4}$ kilowatt output with only 1100 volts on the plate. Push-pull 35Ts give 200 watts output on 5 meters. (High mu simplifies bias problems and saves on excitation power.)

► CLASS "B" AUDIO

A pair of 35Ts give 235 watts of Class "B" audio output with practically no distortion. (High mu simplifies bias requirements.)

► CRYSTAL OSCILLATOR

High mu plus extremely low interelectrode capacities makes possible 40 to 60 watts output from a single 35T as a crystal oscillator. Low value of RF crystal current. Conventional circuit with only one tuned circuit.

► FREQUENCY MULTIPLICATION

60 watts output with 60% plate efficiencies when quadrupling with a single tube. 100 watts output when doubling. (Excellent electrical characteristics makes "trick" circuits unnecessary.)

The EIMAC 35T does not have to be "nursed." Accidental momentary overloads of two, three, or four times the "normal" plate dissipation will not release gas from the tantalum electrodes exhausted by EIMAC'S exclusive pumping process.

GET YOUR **EIMAC 35T** TODAY FROM YOUR LEADING DEALER

EITEL - McCULLOUGH, INC.

San Bruno, California, U. S. A.

Say You Saw It in *QST* — It Identifies You and Helps *QST*

HERE'S WHY YOU'LL LIKE THE NEW 1937 SUPER SKYRIDER



Band Spread Condenser is built in the main tuning condenser, reducing the number and length of leads and increasing the efficiency of the tuned circuits.

465 K C Iron Core I. F.'s increase sensitivity and selectivity in the 2 I. F. Stages.

Single Signal Crystal action if desired.

Air Trimmable R F's and STEATITE sockets make set more stable and efficient.

Illuminated Band Spread and Main Tuning Dial covering

338° arc, permitting more accurate logging.

Duo-Micro-Vernier Band Spread with operating frequency always shown.

Improved 10 Meter Operation

Doublet or Conventional Antenna can be used.

Beat Frequency Oscillator and Injector allows oscillator signal to be adjusted to optimum value for the strength of incoming signal.

14 Watts Undistorted Output.

I Make It Easy to Own a New Receiver

When you deal with HENRY Radio Shop you are dealing with an amateur who knows your needs, a graduate E.E. from M. I. T. and an organization dealing with amateurs for seven years. Satisfaction always guaranteed or your money refunded without question. All receivers shipped on 10 day trial.

● PERSONAL SPECIALIZED SERVICE that you get nowhere else. Write, wire or phone any time of the day, any day of the year.

● TIME PAYMENTS on the Hallicrafters or Henry

Plan with only 6% of the unpaid balance for all interest and finance charges.

● TRADE-INS—Your present receiver will bring a liberal trade-in allowance on a 1937 Hallicrafters Receiver.

HENRY RADIO SHOP (W9ARA)

211 NORTH MAIN ST.

BUTLER

MISSOURI

these tubes is dependent on the exact line-up of the grids. If they operate in a horizontal position it is possible that the grids will sag out of position as a result of the extreme internal heat. This will cause the tubes to operate as ordinary tetrodes rather than as beam power amplifiers.

Rebuilding a Commercial-Type Condenser Microphone

(Continued from page 37)

grounded sides of both the output and the plate supply as part of their respective pairs inside the shields, rather than to depend entirely upon the shields for this function. The three shielded coverings should be well bonded electrically at several places along the cable length and the bond at

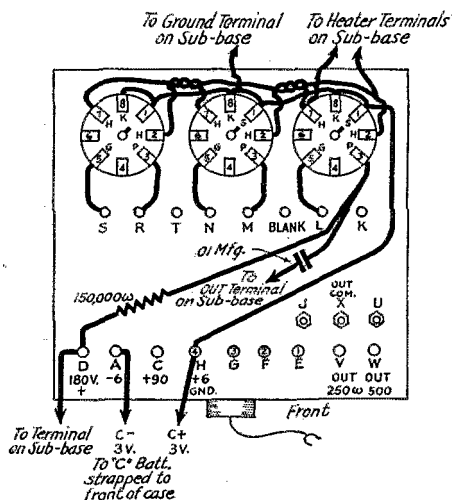

FIG. 4—REVISED WIRING OF THE PRE-AMPLIFIER WITH 6CS METAL TUBES

the mike end should be strapped to the chassis. This will automatically be done where the regular cable anchor included as part of the mike chassis is clamped directly onto the shields. A ground from the pre-amplifier should be strapped to the mike chassis and the opposite end of the cable shields should be strapped to the speech amplifier chassis and ground. An early ground may or may not be necessary, depending upon location and arrangement of the speech amplifier.

There seem to be a great many ham 'phones on the air to-day that have good carriers and are not over-modulated but which have poor audio quality. Some don't seem to have any highs over a thousand cycles, which of course makes them hard to understand. They sound as though there were large barrels placed in front of the mikes and as if the operators were speaking their pieces from the opposite ends of the barrels. Then, too, there is the ham who sounds as though he had placed an audio filter in his speech amplifier and was cutting off everything except perhaps a thousand cycles.

ARE YOU A RADIO CONNOISSEUR?

If So

“BE WISE AND KENYONIZE”

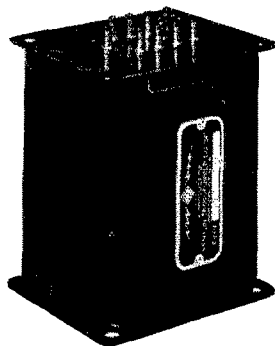
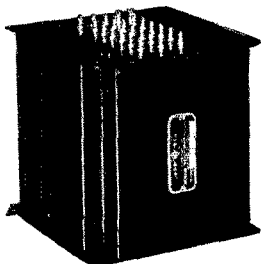
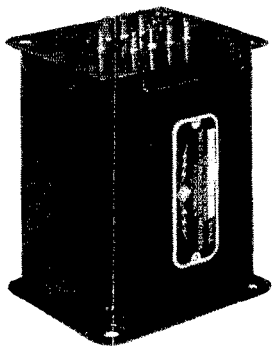

After two years of extensive research we are proud to introduce our new “T” components which are the most complete and up-to-date transformers — advanced in design, economical, efficient and completely reliable. This line is designed to satisfy the demand for a quality product for P. A. work and amateur transmitter use at a new low price.

New exclusive Kenyon features:

Adaptability to all needs is provided by the new durable black egg-shell finish case that permits top or bottom mounting!

Input Transformers

Multiple line input transformers provide perfect coupling for single and double button microphones. These transformers are provided with hum cancellation windings which permit mounting them on the chassis of high gain amplifiers!

Output Transformers

All output transformers for P. A. applications include 500 and 200 ohm windings for matching transformers, and windings of 15, 8 and 4 ohms for speaker voice coils!

Modulation Transformers

Modulation output transformers for transmitters are provided with tapped secondaries which adequately carry the full Class “C” current without saturation!

Combination Plate and Filament Transformers

An electrostatic shield is incorporated between the primary and secondary of plate and filament transformers for P. A. and low power transmitters.

Filament Transformers

A large variety of single and multiple filament winding transformers provide filament supply for all types of tube combinations.

Plate Transformers

Kenyon plate transformers are designed to meet the rigid requirements imposed in amateur service. Many of these units incorporate the exclusive Kenyon triple and dual windings.

Ask your local dealer for a free copy of the first issue of the new 16 page monthly magazine “THE KENYON ENGINEERING NEWS.” Also our new catalog.

Our new transmitting manual contains complete up-to-date transmitter circuits ranging in size from five watts to one kilowatt. Fourteen pages are entirely devoted to full page “Ken-O-Grafs” which cover most of the calculations used in radio in a modern and painless method. This book is no subterfuge for a catalog. To receive your copy send 25 cents in coin or stamps.

Address your inquiries to Chief Engineer, Amateur Dept.

KENYON TRANSFORMERS CO., INC.
842 Barry Street **New York, N. Y.**

“Our complete catalogue of transmitting components will appear in the January issue.”

Actual Modulation Percentage Shown on Direct Reading Scale

TRIPLET MODULATION MONITOR

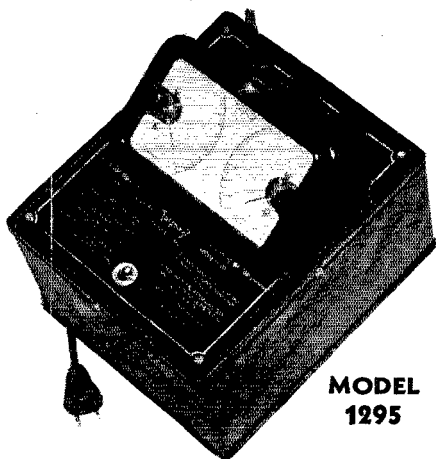

MODEL 1295

**Dealer Price \$24.83
for All Voice
Transmitting Stations**

Eliminates the uncertainty of depending on the ear, variation of antenna ammeter or the loop and light in determining carrier shift and percentage of modulation. Actual modulation percentage is shown on direct reading Triplet twin precision instrument.

Scale indicates modulation from 40 to 120 per cent. All readings in peaks. Visual information on second dial provided for carrier reference level for the modulation test and also to check carrier shift during modulation. All uncertainties regarding final adjustments on the transmitter eliminated with the use of Triplet's Modulation Monitor. Prevents monkey chatter, cross talk and B.C.L. interference. Factory calibrated and no further calibration needed.

**Model 1295 Modulation Monitor — Complete with \$24.83
necessary accessories. Dealer Price.....**

THIS IS A TRIPLET MASTER UNIT

See the Modulation Monitor at your jobbers. Triplet manufactures a complete line of Precision Radio Testing Equipment and Precision Electrical Measuring Instruments for the Amateur and Experimenter. Complete information available on request.

SEE YOUR JOBBER ■ WRITE FOR CATALOG



THE TRIPLET ELECTRICAL INSTRUMENT CO.
2512 Harmon Drive, Bluffton, Ohio.

Without obligation please send me more information on

Model 1295 Modulation Monitor.
 I am also interested in

Name.....

Address.....

City..... State.....

It would seem that if a ham is going to spend enough to bother with 'phone, he would be better off with perhaps less power and a better sounding rig, which would mean spending a little more for the pickup and audio equipment than for the r.f. end of the rig. The average c.w. ham has come to the point to-day where he believes in quality of signal first, with quantity second, and there should be the same motive with regard to 'phone, even though it's only a three-watt rig on five meters.

Circuit Design of Modern U.H.F. Superhet

(Continued from page 40)

mobile ignition and other discharges of similar type which are prevalent in the communication-frequency bands. Looking over the problem from this angle, receivers were built up similar to the S.I.G. described by Ross Hull in *QST*,¹ that is, a superheterodyne with super-regenerative second detector. This type of detector discriminates against ignition interference. The set worked fine on 'phone signals, but when a beat oscillator was added results were far from satisfactory on c.w. telegraph signals. Another drawback was that it entailed a sacrifice of selectivity in the second detector circuit, this circuit being very broad. Still another drawback, in the multi-range receiver, was the presence of harmonics of the quench oscillator.

Then different types of noise reducing circuits were tried. Some of the audio limiting devices proved fairly satisfactory, while others that had been described were complete flops. The main trouble with audio limiting devices is, as J. J. Lamb has pointed out in *QST*,² that the second detector and audio circuits receive shock excitation which causes undesirable secondary effects.

About this time, *QST* released the information on the noise silencer which works in the i.f. system.² Having been at Hartford while some of Jim Lamb's work was under way, the writer had seen and heard the results obtained. This system was given a trial and proved successful. The 1,600-kc. i.f. offered advantages in this system over those obtained at 465 kc. One of the requirements is a short time constant of the diode resistor and capacity. At 1,600 kc. only about one-fourth of the diode load capacity is required for equivalent r.f. filtering, which allowed us to make our time constant about 4 times as fast, thus stepping up the action of the silencer and making it more effective than the 465-kc. type.

Numerous transformers feeding from the 6J7 noise amplifier to the diode rectifier were tried and measurements were made of the efficiency of the circuits in relation to the over-all set operation. It was found that the full-wave diode transformer for the noise silencer should have gain in excess of that used to feed the diode second detector. In practice, the noise-silencer

¹ "A New Receiving System for the Ultra-High Frequencies," by Ross A. Hull, *QST*, Nov. and Dec., 1935.

² "A Noise-Silencing I.F. Circuit for Superhet Receivers," J. J. Lamb, *QST*, Feb., 1936.

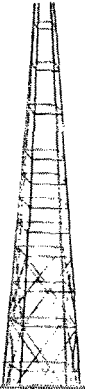

Michael F. Morrissey, Chief of Indianapolis Police; President, Indiana Chiefs of Police Association.



Captain Robert L. Batts, Head of Radio Division, Indianapolis Police; Past President, Association of Police Communication Officers.



APPROVED BY THE INDIANAPOLIS POLICE DEPARTMENT

Indianapolis was one of the pioneer cities in this country in the use of police radio. Its subsequent low crime record proves its foresightedness. Indianapolis assures the complete efficiency of its system by equipping its police cars with Delco-Remy Special Service Generators.

These Delco-Remy generators provide the reliable service and the high output so essential in police work. Police departments of many cities have found this to be true. Amateurs, too, find that Delco-Remy High-Output Generators provide ample current for two-way radio service and experimental work in their own cars.

Any Branch or Electrical Service Station of United Motors Service will be glad to analyze your problem, and recommend the proper generator and current and voltage regulator for your use.



United Motors Service is the official distributor of Delco-Remy products, including all service parts for Delco-Remy starting, lighting, and ignition systems.

Delco-Remy

ANDERSON, INDIANA

Say You Saw It in QST — It Identifies You and Helps QST

Lightning Calculators

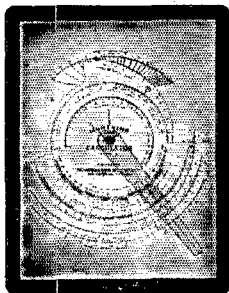

by
A.R.R.L.

THE various LIGHTNING CALCULATORS are ingenious devices for rapid, certain and simple solution of the various mathematical problems which arise in all kinds of radio and allied work. They make it possible to read direct answers without struggling with formulas and computations. They are tremendous time-savers for engineers, servicemen, amateurs and experimenters. They are highly accurate and computations made by them have greater mathematical accuracy than can be measured by ordinary means. Each CALCULATOR has on its reverse side detailed instructions for its use; the greatest mathematical ability required is that of dividing or multiplying simple numbers. You will find LIGHTNING CALCULATORS the most useful gadgets you ever owned.

LIGHTNING RADIO CALCULATOR—Type A (\$1.00) is for solution of problems involving frequency, inductance and capacity, in design of radio frequency circuits from high-powered transmitters to simple receivers. Gives direct reading answers for size of coils and condensers for any frequency or range between 400 kc. and 150 mc.

LIGHTNING OHMS LAW CALCULATOR—Type B (\$1.00). Gives direct reading answers to calculations involving current, resistance, voltage and power with scale for resistance of copper wire and additional supplemental scale for calculating decibel gain or loss. Answers three separate kinds of problems: Finding value of current, voltage, power or resistance, when any two are known; finding resistance or voltage drop in any wire or circuit or resistor; finding decibel gain or loss in amplifiers or circuits. Answers accurate within commercial tolerances.

LIGHTNING WIRE DATA CALCULATOR—Type C (50c). Puts at your fingertips more information on electrical conductors than you could find in a book full of tables: Such as resistance per foot, per mile, per meter, pounds per foot, per ohm, miles per thousand ohms, current carrying capacity, turns per inch, turns per square inch, diameter in mills for all B. & S. and Stubbs gauges, for all kinds of wire such as copper, aluminum, nichrome, manganin, etc.

LIGHTNING DECIBEL CALCULATOR—Type D (50c). Gives direct reading answers in decibel gain or loss in four kinds of problems: When input and output voltages are known; when input and output currents are known; when input and output power are known; when input voltage to the receiver and assumed output level are known.

LIGHTNING PARALLEL RESISTANCE—SERIES CAPACITY CALCULATOR—Type E (50c). Gives direct reading answers for total resistance of two or more resistors connected in parallel, and gives direct reading answers for total capacity of two or more condensers connected in series.

LIGHTNING RESISTANCE CALCULATOR—Type F (50c). Permits measurement of any resistor, from 1 ohm to 1 megohm by use of any voltmeter and any voltage source. Makes an ohm-meter of your voltmeter.

Postpaid from

AMERICAN RADIO RELAY LEAGUE
West Hartford, Connecticut

diode transformer was designed to have a gain about $2\frac{1}{2}$ times that of the diode transformer feeding the second detector. This noise-silencer diode transformer, instead of being sharp, should be fairly broad. While this system does not silence all noises, as some of the more popular descriptions are prone to indicate, it is about the nearest answer to an operator's prayer. Its use allows operation through those noises which, in practice, make a signal completely unreadable.

HIGH-FREQUENCY CIRCUITS

On a choice of tubes for the input circuits, the acorn types 954 and 955 looked very good because of low internal capacities and short leads, which make for gain on the ultra-high frequencies. Some 50 of these tubes were run through tests and their characteristics taken. Then the tubes were put on a live test rack. At the end of 100 hours their characteristics were again taken and about 60% of them were found to have changed appreciably from original measurements. The G_m , which had originally varied about 40% from rating, was now varying as much as 90%. Four of the tubes had burned out. At the end of another 100 hours, measurements were taken on the remaining 46 tubes and it was found that only three of the tubes had characteristics near normal and 18 more had burned out. This proved to our laboratory force that for a commercial communication receiver these tubes were not as yet developed to a satisfactory point.

While it was possible to get r.f. gains of 4 to 6 in the 56-Mc. band, it was also possible with 6K7's, by keeping their leads short, to get gains of from 2 to 3, and with the 78 to get gains of from $1\frac{1}{2}$ to 2. This made only a difference of 6 db in the total gain of the set. Another thing that was in the favor of the metal tubes over the acorn or 78 tubes was that the 6L7 allowed coupling the signal-frequency oscillator to the first detector without the trouble involving interlocking which is very prevalent at ultra-high frequencies. From the foregoing, it will be seen that metal tubes deserved choice over the acorn tube for a practical communication receiver.

After having decided on what tubes to use in the r.f. and first-detector stages, the next problem was the design of an efficient tuned circuit for the ultra-high frequency band, and of the coupling from the antenna to this circuit and from the plate of the r.f. tube to the grid of the 6L7. Checking over previous work on the ultra-high frequencies, it was found that coils of rather large diameter and heavy wire had been used, but that in most cases these had been used where only one tuned circuit was employed and where no consideration of other circuits was involved. Measurements were taken of some of these coils and the Q ran from 250 to 350. In fact, one coil which looked very good, being made of tubing, was measured and surprisingly its Q was not as good as that of coils made of solid wire of a smaller diameter. This led to further investigation of different size coils and sizes of wire, and it was

The New 1937 Edition of the RADIO AMATEUR'S HANDBOOK

FOR four months our technical and editorial groups worked on the revision and elaboration of the Radio Amateur's Handbook for its 1937 edition. Many important technical developments during the past year and sweeping changes in operating technique and methods have called for enlargement of the book and re-writing of almost all chapters. Some idea of the extent of the revision may be had from the fact that two hundred new illustrations are included, most of them being prepared especially for this new edition. ● Special attention has been given to the new developments in noise silencers for short-wave receivers and to the new technical trends in circuit design. A wealth of new material is added to wide fields of transmitter planning, construction and adjustment. The capabilities of the new tubes are exploited to the full in the transmitter designs presented. Extended space is also given to the ever-important subject of antennas, the new ideas in coupling methods being treated in particular detail. The ultra-high frequencies come in for a big share of the space also, new and advanced equipment being detailed to illustrate the newer trends in this rapidly-growing field. ● As in previous editions full attention has been given to charts and tables of general information for the radio enthusiast; the vacuum tube tables, for example, occupying seventeen pages and being, without doubt, the most complete and detailed tube list ever published. ● The basic purpose of the Handbook is to present a complete treatment of every phase of modern amateur radio from elementary theory through advanced practical application, with emphasis always on ideas and methods that have shown their worth in the field. This new edition, we firmly believe, will fulfill this purpose more effectively than any of its predecessors.

\$1 postpaid in Continental U.S.A.—\$1.25 postpaid elsewhere
American Radio Relay League • West Hartford, Conn.

Help

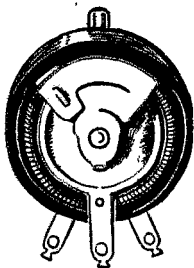

For The AMATEUR

UNDER-VOLTAGE
and over-voltage on
the filament shorten the life of transmitting
tubes.

Apply exactly the right values with the aid
of new-type Electrad Power Rheostats.

Full ranges of resistance values in 25, 50 and
150-watt ratings. \$4 to \$10 each list.

Write Dept. Q-12 for Complete New
Catalog of Resistors for All Purposes



NOW — ON TIME PAYMENTS

the NEW 1937 SUPER SKY RIDER



We have the New Super Sky Rider, the communications receiver that amateurs are talking about all over the country. With eleven tubes, high sensitivity and remarkable selectivity, a new 338° micro-vernier dial, Iron Core I. F. Transformers and other outstanding new and exclusive features, it is the leading communications receiver of the year. Enjoy the performance of this outstanding receiver while you are paying for it.

**LIBERAL TRADE-IN ALLOWANCES
ON ACCEPTABLE RECEIVERS**

Trade in your present set on a new 1937 Hallicrafters receiver. Liberal allowance granted.

COME IN TODAY OR WRITE FOR FULL INFORMATION

WALTER ASHE Radio Company
11th & Pine St., St. Louis, Mo.

discovered that the Q of a coil wound with two turns of No. 13 tinned copper wire and having $\frac{3}{8}$ -inch inside diameter, with spacing of $\frac{3}{64}$ inch between turns, gave us a Q of over 450. The work done along this line showed that for maximum efficiency, even at the ultra-high frequencies, a coil should have about the same length as its diameter. A coil of about these "square" proportions worked in very nicely in the general layout of the receiver. Because it was small it had small external fields, and being wound with a wire which can be handled much easier than tubing, it proved a more practical coil from the commercial point of view. In the design of those coils we have gone to No. 14 tinned copper because of slightly greater ease in handling and availability.

In the matter of coupling the antenna to the r.f. stage, the general practice has been to use capacity coupling. Measurements were taken comparing capacity coupling and inductive coupling, and in contradiction to former practice, inductive coupling was found to give better gains. (This was later checked and verified by an independent laboratory.) The same was found true on the r.f. stage. The primary winding was four turns of No. 28 d.c.c. wire in each instance. The whole coil was wound on the small form and dipped in "Q-Max-3" to prevent corrosion and moisture absorption.

The oscillator was of the heater type with the grid of the oscillator directly connected to grid No. 3 of the 6L7. With this type of oscillator it was found that, on the ultra-high frequency band over which it tuned, the output was approximately constant even when no special precaution was taken to load the circuit critically. One reason for this may be that as the frequency decreases the load upon the oscillator is lessened, the input impedance of the 6L7 becoming higher as the frequency is decreased. In tracking the ultra-high frequency band, advantage was taken of the small (0.002- μ f.) a.v.c. by-pass condensers on the r.f. and antenna stages. The oscillator was made to track on the low-frequency side of the signal frequency, where it is in phase with the incoming signal on the mixer grid and not out of phase as is ordinarily the case on the high-frequency side. This leads to greater sensitivity as the result of slight regeneration rather than degeneration, as so often is the case in ultra-high frequency receivers.

It was found that in switching from band to band, appreciable losses were incurred in the first laboratory models of the set. Checking through to find out where these losses were, it was found that they occurred in two places: In the leads from the variable condenser to the switch and from the switch to the coil, and in the bakelite sections of the switch. This matter was taken up with the switch manufacturer and isolantite sections were supplied. The tuning system was then worked out so that the contact arm of the switch was connected directly to the stator of the variable condenser and the lugs on the coil forms were soldered directly to the contact lugs on the switch. Thus extra leads in this part of the circuit

New

Special Values

The Receivers listed below are the best money can buy. Our Time Payment Plan, at the new low rates, makes it easy to own one. Compare our rates with others. THE EASY WAY. Send in your Down Payment with your order. Sets will be shipped as soon as credit is okayed. Entire Transaction one week. Try us.

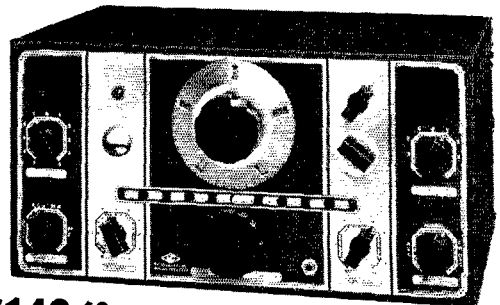
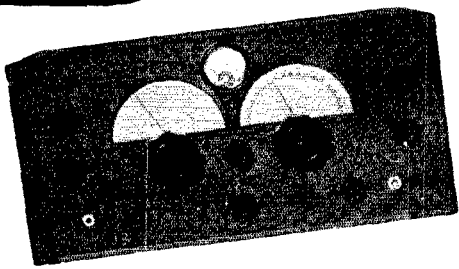

RME 69, Complete with Speaker \$134.90

Continuous band-spread tuning on six bands from 9 to 550 meters. The amateur bands are grouped for a minimum amount of tuning. New, large, improved dials. Built-in monitor for both phone and C.W. 19 in. long, 10 1/4 in. deep and 9 in. high. Has calibrated micro-volt "R" meter. Electrical band-spreading. Uses nine 6.3 volt tubes. Has single signal crystal filter (Billey 456 Kc.) as standard equipment.

\$140.60 Complete NCX 100

... National NC-100 ... the "Perfected" Super-Het! Amazingly selective, high sensitivity, low noise level. A wonderful performer. Full coverage, individual built-in plug-in coils, shifted by knob on front panel. 540 to 30,000 KC coverage in 5 ranges. 12 tubes, one stage RF, two 1F, P.P. Pentode 10 w. audio output. Full AVC circuit. Built-in power supply. Single and double antenna connections. Latest type crystal filter, "Electric Eye" tuning indicator. Large, latest type *Dynamic Speaker* in cabinet to match.

Watch Our List of Specials Grow TRANSFORMERS

Thordarson No. 16878 Plate and Filament Transformer, 000-0-600 V. at 200 MA 2 1/2 V. at 10 amp. 5 V. at 3 amp. 7 1/2 V. at 3 amp. . . . \$2.45
 High Voltage Transformer, 1000-750-500-0-500-750-1000-300 MA. 3 1/4 x 4 1/4 x 5 1/4 . . . \$5.95

These transformers are heavy cast iron frame open mounting type. Heavy insulation, Heavy Rockbestos leads. Fully Guaranteed.
 1600-1335-0-1335-1600 A.C. R.M.S. 1250-1000 V. DC—400 MA, 7" w. x 6" d. x 8 1/2" h. . . . \$13.25
 1950-1600-0-1600-1950 A.C. R.M.S. 1500-1250 V. DC—500 MA, 8 1/4" w. x 7" d. x 7" h. . . . \$17.50
 2350-1950-0-1950-2350 A.C. R.M.S. 2000-1500-0-1500-2000—500 MA, 8 3/4" w. x 7 1/4" d. x 11" h. . . . \$22.50

Filament Transformers

If you like to save money on quality merchandise here's some real bargains.
 2.5 Volts 10 Amps — 2500
 Volts Insulation — No. 2510. . . . \$0.95
 6.3 Volts, 3 Amps — 1600
 Volts Insulation — No. 635. . . . \$0.95
 7.5 Volts, 3 Amps — 1600
 Volts Insulation — No. 735. . . . \$0.95

CHOKES

18 Henries, 125 M.A., \$1.15
 A real quality choke. Resistance 130 Ohms.
 NS115. . . . \$1.15
 Thordarson No. 16877 Heavy Duty Choke. 15 henries at 250MA. . . . \$1.95

(Prices and Terms on These and Other Sets Listed Below)

	Cash Price	Down Payment	6 Months Payments	9 Months Payments	12 Months Payments
NATIONAL NC-100 complete with tubes and speaker.	\$118.10	\$23.10	\$16.90	\$11.37	\$8.59
NATIONAL NCX-100 complete with tubes, crystal and speaker to match.	\$140.60	\$25.60	\$20.26	\$13.64	\$10.36
NATIONAL HRO less power supply and speaker.	\$167.70	\$37.70	\$22.78	\$15.35	\$11.69
NATIONAL HRO with power supply.	\$183.60	\$43.60	\$24.46	\$16.51	\$12.57
RCA — AGR-175 complete receiver, speaker separate.	\$119.50	\$24.50	\$16.90	\$11.37	\$8.59
RME-69 complete with tubes, crystal, speaker housed in battle.	\$134.90	\$29.90	\$18.58	\$12.50	\$9.47
HAMMARLUND SUPER PRO, complete with tubes, crystal and speaker.	\$241.00	\$51.00	\$32.92	\$22.29	\$16.98

We will have new receivers, as released by manufacturers, on our deferred payment account.
 Full details of any set listed, mailed immediately upon request.

Oil Filled, Oil Impregnated FILTER CONDENSERS

All well known makes. Guaranteed at rated voltages. A "lucky" purchase of a 10,000 lot enables us to offer a few remaining items at these low prices. Hurry, before they're all gone!

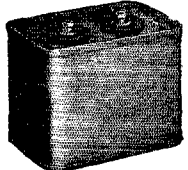

Cap.	Voltage	Size	Weight	Price
1 mfd.	2000 V. DC	5 x 3 1/4 x 1	1 1/4 lbs.	\$1.25
2 mfd.	2000 V. DC	5 1/4 x 3 1/4 x 2 1/2	3 lbs.	1.50
8 mfd.	2000 V. DC	5 1/4 x 3 1/4 x 4	4 lbs.	2.75
9 mfd.	3000 V. DC	5 1/4 x 3 1/4 x 11	9 lbs.	7.25
(including 2 1/2" bakelite standoffs)				
4.4 mfd.	1500 V. DC	5 x 3 1/4 x 1 1/4	1 1/4 lbs.	1.75
5 mfd.	1500 V. DC	3 3/4 x 3 1/4 x 1 1/4	1 1/4 lbs.	1.90
5.2 mfd.	1500 V. DC	5 x 3 1/4 x 2 1/4	2 1/4 lbs.	2.00
10 mfd.	1500 V. DC	5 x 3 1/4 x 3	2 3/4 lbs.	2.75

Use the 10 mfd. for perfect filtering in class B modulation Power Supply.

ORDER DIRECT FROM THIS AD — NOW

Receivers listed in this ad are best values anywhere. Order today on EASY TERMS. Send your down payment with order. Set will be shipped immediately upon approval of your credit. Entire transaction in 1 week. No red tape. Full details of any item, with complete NEW CATALOG FREE upon request.

EIMAC
 35T...\$8.00
 50T...\$13.50
 150T...\$24.50

Billey Crystals
 BC3...\$3.95
 LD2...4.80
 HF...6.50



Taylor Tubes
 866...\$1.65
 750...4.95
 203B...7.50
 203A...12.50
 814...18.50
 822...18.50
 1200...21.50

High Frequency Tubes
 T55...\$8.00
 T155...19.50

Write for Free Complete Taylor Catalog

FREE JUST OUT! BIG NEW CATALOG

Big Bargains in Parts, Equipment and Supplies for Hams, Servicemen and Dealers. Lowest wholesale prices. Write quick!



NEWARK ELECTRIC COMPANY

226 W. MADISON ST. Dept. Q CHICAGO, ILL.

Say You Saw It in QST — It Identifies You and Helps QST

MR. E. H. RIETZKE



PRESIDENT OF CREI

● There's Always a BETTER Job for a BETTER Man!

If you're satisfied and content with your present job, you won't be interested in CREI . . . but, if you're ambitious and can see the bright opportunities that lie ahead in Radio for specialized men who have been *Technically Trained* . . . then, CREI can help you as it has helped others out of routine jobs into top positions in the Radio industry.

"Invest" One Cent Now . . . Write Today for FREE Illustrated Catalog

It will explain our Home-Study course and how easy it is to pay for it. Your inquiries are invited.

CAPITOL RADIO ENGINEERING INSTITUTE

Dept. Q-12

WASHINGTON, D. C.
14th and Park Road

NEW YORK CITY
29 Broadway



Radio Apparatus, Sets, Tubes... Transformers, Test Equipment, Etc.

NOW TO BE SOLD ON EASY TERMS

No Down Payment

Write for Details and for New 1937 Radio Catalog

M & H Sporting Goods Co.
512 MARKET ST. PHILADELPHIA
1709 Atlantic Ave. Atlantic City

LEARN CODE RIGHT — the Practical, Easy Way —



Instructograph

Radio amateur code exams now require 30% more speed. And experts agree: "It pays to learn from a perfect teacher — Instructograph." It's easy to become a real operator when you can practice Radio or Morse at your convenience — at any speed you want. Comes in two models — Senior or Junior Economy. You may buy or rent, at low cost. Just send post-card for complete details now to —

INSTRUCTOGRAPH CO.
Dept. Q-12

912 Lakeside Place Chicago, Illinois
Representatives for Canada
Radio College of Canada, Ltd.
868 Bay Street, Toronto

were eliminated. These two changes made a marked improvement in the gain of the r.f. and antenna stages at ultra-high frequencies.

It will be seen in the circuit diagram of the set (Fig. 1) that the variable tuning condenser is only across a portion of each secondary, while the grid circuit of tube is across the full secondary. It was found that a better match of the input impedance of the tube can be arrived at by this method and that higher gains accordingly are secured. On the band which covers from 38 to 19 Mc. the tap is made at about $\frac{3}{8}$ of the total inductance, while on the band which covers from 21 to 10 Mc. it is made at about $\frac{1}{4}$ of the total inductance.

The antenna primaries are of the low-impedance type and both leads of the primary are brought to binding posts for doublet antenna connection. An extra binding post connected to the chassis is provided so that when a single-wire lead-in is used, one side of the primary may be connected to the chassis, while the other side of the primary is connected to the antenna. Field tests have shown that with some antennas and at some locations stronger signals are received by connecting one post to the chassis, while at other times better results have been obtained by leaving this post disconnected from the chassis and connecting this terminal to a good ground. It has even proved advantageous when using large antennas to connect a small variable condenser (100 $\mu\text{fd.}$) in series to ground, and at other times to connect it in parallel with the other primary terminal and to tune the input circuit.

Another innovation is a control on the i.f. beat oscillator for varying its strength. When beat oscillator voltage is made approximately the same strength as the incoming signal, the signal-to-interference ratio may be improved. Also, when receiving weak signals, the "hiss" resulting from noise components beating with the oscillator voltage in the second detector can be reduced to a point where it cannot be heard; but if the beat oscillator were left at this strength, even a medium-strength signal might block the beat oscillator. So by varying the strength of the beat oscillator, more favorable combinations can be obtained.

The audio system is conventional. The output tube, a 6F6, is connected to an output transformer which is arranged for either a 5,000-ohm speaker or to feed into a 500-ohm line. No plate current flows through the circuit so that magnetic, permanent-magnet dynamic, or electro-dynamic speakers may be used.

VK-ZL Contest

(Continued from page 48)

fair strength, the ease with which stations were contacted on the two higher-frequency bands, coupled with the fact that no multiplier was allowed for multi-band operation, confined most of the activity to the 14- and 28-mc. bands.

Directive antennas were the order of the day. W3EVT used 3 half-waves in phase on 28 mc.

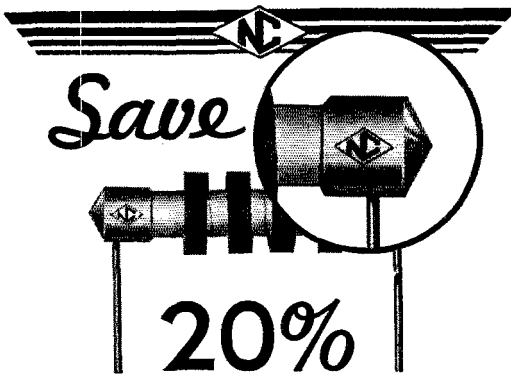

Increased production —
 due to ever increasing demand for this unequalled R.F. Choke, enables us to pass on to you a saving of twenty percent of its former price. This National type R-100 Choke, ideal for high frequency transmitters and receivers, is now available at a new net price — \$.36 each.

NATIONAL COMPANY
 MALDEN, MASS.



DID YOU KNOW —

That you may have all or any of your equipment
 CUSTOM BUILT TO YOUR SPECIFICATIONS
 At a most reasonable cost?

We invite your inquiry
 COMMUNICATIONS DEVELOPMENTS CO.
 3670 Ames Avenue, Omaha, Nebraska

MEMORANDUM

- ✓ You need a copy of the new Bigger-than-ever 1937 Handbook.
 - ✓ You need a binder for your 1936 *QST's* — and another for 1937.
- Xmas suggestion — give a membership-subscription or a new Handbook.

DECEMBER, 1936

and 2 half-waves in phase on 14 mc., W6FZL used a properly-oriented long wire (500'), W6HX had a pair of stacked doublets, and W9TB, W1TW, W1SZ, and W1JPE were using unterminated rhombic antennas. W2DTB used the tests as a proving-ground for his antennas, trying out different combinations each week-end. VK3EG had two "V" beams, 10 wavelengths on a side on 14 mc., operating simultaneously, although their fire was directed on two courses 30 degrees apart. Although power was not overlooked as a means to a good score, antennas were given more consideration than ever before.

A few exceptionally well-operated VK/ZL stations using break-in cut the contact-time down to a minute or so, permitting a large number of contacts-per-hour in some cases. Outstanding at W3BES were VK3EG, ZL4AO, VK3MR, VK3CQ, VK2HF, VK6SA, VK2AE, VK2DA, and VK3CP. But the general opinion of the operators in the United States is that the majority of the VK/ZL stations called "Test" and "CQ" for much longer periods than was necessary. In one morning W3BES worked 47 stations; W9TB worked 56 the first week-end; W3SI worked 50 during one 7-hour period, and W1SZ worked 67 during his first week-end. W1SZ would probably have been the highest in his district if he had operated more than just the last two week-ends of the contest.

A word about the probable winner, VK3EG. He had 750 contacts, 180 of them with Europe, and he totalled 75 countries. All European countries except Spain and Bulgaria were contacted during the contest! VK3EG was high man in the event last year, and won this year's B.E.R.U. contest.

A scarcity of VK6, VK7, and ZL4, coupled with the complete absence of VK8 and VK9 stations, served to limit some of the scores of stations in this country. The Australian 'phone stations, who have been coming through well lately, either went to c.w. for the contest or didn't enter, since 'phone operation during the contest brought no worth-while returns.

Although we were unable to obtain complete returns on the contest, the following list will serve to indicate some of the high-scoring stations operating during the contest. The Australian scores are via VK3OC-W1SZ.

Station	Contacts	Points
W1FH.....	85	5420
W1JPE.....	104	6050
W1SZ.....	97	5700
W1TW.....	56	3800
W2DTB.....	85	5340
W3BES.....	133	7310
W3EVT.....	146	7230
W3SI.....	109	6580
W5EHM.....	239	8542
W6CIS.....		4900
W6FZL.....	209	8320
W6HL.....	193	8430
W8BTI.....	90	6180
W8ZY.....	117	6800 (approx.)
W9IJ.....	190	
W9TB.....	212	8440

1936

Troubles



CAN BE

OVERCOME

IN

1937

With

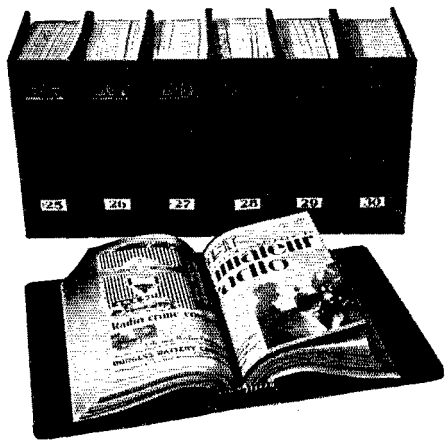

QST

BINDERS

priced at

\$1.50

postpaid

(Not available outside of the United States and Possessions)

(One set of yearly labels (1921-1940) provided with each binder)

American Radio Relay League
West Hartford, Connecticut

TYPE OR-5 TRANSMITTER

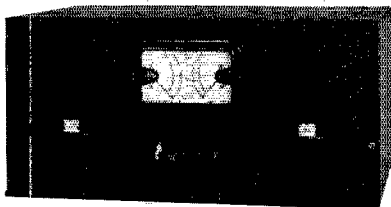

60 WATTS OUTPUT*



One of the unique refinements of the OR-5 TRANSMITTER is the extremely flexible arrangement of "plug-in" crystal, buffer or doubler stages.

*Excellent operation on ten meters at slightly reduced output

\$97.50 Less Tubes and Crystal

Write for illustrated descriptive booklet

OTTAWA RADIO COMPANY
OTTAWA, ILLINOIS



Electropak

Supplies rectified D.C. power for operating relays, solenoids and remote controls. Available in voltages ranging from 6 to 24 volts, rated at 2 to 15 amps. Operates on 110 volt A.C. Write for complete information.

ELECTRICAL PRODUCTS CO.

6531 RUSSELL STREET - DETROIT, MICH.

Why 100,000 Operators

New

**GENUINE
MARTIN**

JUNIOR

Weight 2 3/4 lbs.

ONLY \$10

Smaller and more compact. Large contact points. Black japanned base. A low priced key with world famous Vibroplex quality.

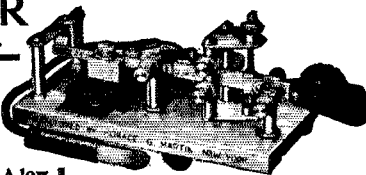

More than 100,000 experienced Radio and Morse operators prefer the Vibroplex key because its semi-automatic style produces a higher quality signal . . . a more uniform style of sending

. . . 50% easier manipulation and a degree of sending proficiency seldom attained by users of the regulation telegraph key. So if you want the best, be sure to insist on the Genuine Martin Vibroplex key. Accept no substitute. Order yours TODAY! Money order or registered mail. Other models \$17 and \$19. Write for FREE Illustrated Catalog.

FREE
Catalog

THE VIBROPLEX CO., INC.

832 Broadway

New York, N. Y.

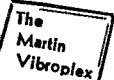

Station Countries Points

VK2AE	55	133,000
VK2LZ	51	115,000
VK3EG	75	250,000
VK3MR	45	110,000
VK4BB	54	127,000
VK4YL	48	105,000
VK5FM		160,000
ZL1DV		150,000

Complete returns will be given as soon as they are received from the W.I.A.

—B. G.

Calls Heard

(Continued from page 47)

Gen. Armando Bocalatte, 77d Cpg. 1° Batt. Trasmisssioni, Italian East Africa

(14-Mc. Band)
September 26th

wlbye wlab w3vk w3gke w8dff w8dgo w8itn w8kje w8lun w8paz

W4BRB/S, Eugene Sykes, Absecon, N. J.

(14-Mc. Band)
August

pk1gw j3cc j3fd j2lu j2cc

(56-Mc. Band)
September 22nd-23rd

w1eer w1cdr w2xf w2xk w2gij w2awr w2bym w2ahr w2mo w2ihr w2ixy w2hej w3azg w3axr w3bfb w3fvr w3bsj w3fpe w3efb w3fjh w3dnx

VE5OT, M. H. Thoreau, Vancouver, B. C.

(14-Mc. Phones)

ce1bc ce3an ce3dg ce3en ce2ke ce2ll ce7cx ce8rq ce8yb (3.9 mc.) g5is g5ml g6lk hh2b hh5pa bi4f hi5x hi7g hk1z hpl1 kalak kalbh kalme kalrr lu4bh lu5es lu6ap hy2ae oa4r oa4aa oa4ag oa4ak om2bc on4vk pk1mx pk3au pk3st pk4ur py2ba ti2re ti3av ti5jj vp2cd vp6fo vp9r vs6ak vs6aq zsb1 zult

W6WO, Leonard T. Robinson, 322 1/2 West 42nd Place, Los Angeles, Calif.

(14-Mc. Band)
August 15th-October 1st

cr7zs fb8ad fb8af u8ag u9al vs1al vs2ag vs7fr zelij zeljn zeljs zslal zslah zslax zslid zulic zult zsz2n zsz2v zsz4u zsz5v zsz5z zt5v zu6b zu6l zu6af zsz6t zt6s zt6y zt6ak zt6aq zt6ay

W9SPB, Bob Millholland, 5157 Winthrop Ave., Indianapolis, Ind.

(28-Mc. Band)
September 11th-17th

w6bam w6boy w6bjp w6bpd w6csi w6dhs w6duc w6fal w6gex w6gei w6gal w6hb w6hjt w6iox w6fmy w6kbb w6klu w6kth w6ltp w6up w6dqt w6g w6mps w7avv w7dsz w7lup lu9ax oa4j ve5gi vp5gm vk3yp vk4ap xelam xelay xelom xz2bb zelij zslh dzfnd oh7nd on4jb

(28-Mc. Phones)

w6ewe w6iox w6idv w6etx w6mbd w6mmq w6mtj w6nct w6nis w6lyy k4ddh k6mrv

W9JNB, Bob Sinnott, 1537 39th St., Rock Island, Ill.

(28-Mc. Band)
September 13th-October 13th

d3dcr d4xjf ei8b f3qq f8ef f8eo f8kj f8wk fb8ab g2yl g5oj g6lk g6vx g6wy lu6ax lu9ax k6mrv k6urf celhf oh7nf

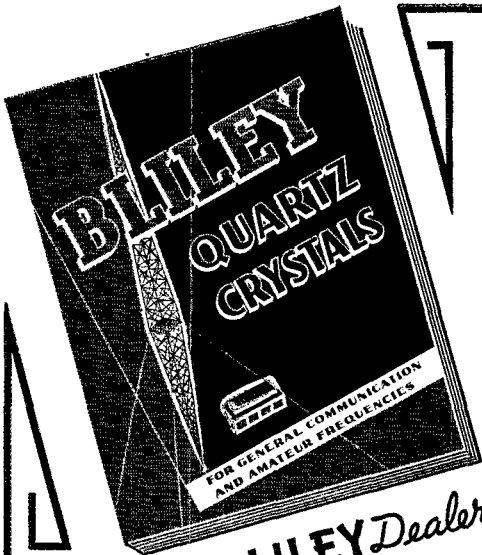

Your BLILEY Dealer has a copy for you

New BLILEY CRYSTAL UNITS, OVENS, HOLDERS

DESCRIBED IN THE BLILEY 1937 CATALOG

Four additional products for the amateur . . . an enlarged and more complete technical section which covers crystal fundamentals, circuits, etc. . . . a new variable pressure holder for commercial crystals and a full description of General Communication Frequency Crystals from 20KC. to 25MC. . . . Broadcast units . . . Police units. All these and more are included in the 1937 Bliley Catalog just off the press. You can't afford to be without one—it's a handbook on crystal control. Get your copy today!

BLILEY ELECTRIC CO. ERIE, PA.

BLILEY CRYSTAL UNITS



Your Jobber Recommends



NEW EDITION

LATEST TRANSMITTER DESIGNS

Complete specifications for nine tested transmitter circuits, ranging from the smallest beginner's rig to the most elaborate design. Also seven modulators and speech amplifiers with variable output impedances.

All circuits include complete specifications, listing transformers, inductances and values of all component parts. It's a complete handbook on transmitter design.

Send for it today, the supply is limited. Mail the coupon, your copy will be mailed immediately.

MAIL THIS COUPON

STANDARD TRANSFORMER CORP.
854 BLACKHAWK STREET, CHICAGO, ILLINOIS

I am enclosing 25c for Second Edition Stancor Transmitter Manual

NAME _____ CALL _____
 ADDRESS _____
 CITY _____ STATE _____

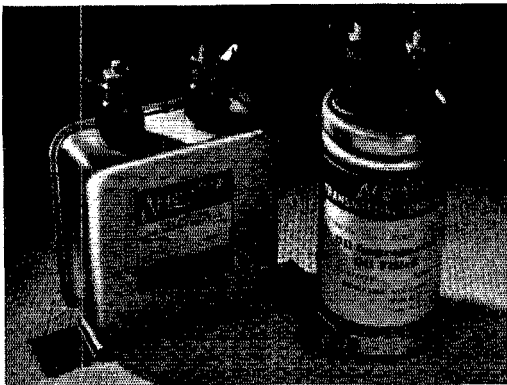

Take Your Pick

Square job for compact banks.

600, 1000, 1500, 2000 and 2500 v. 1, 2 and 4 mfd.

Round job for lowest cost. Handy mounting ring.

1000, 1500 and 2000 v. 1, 2 and 4 mfd.

Either round or square can transmitting condensers. Oil-impregnated oil-filled paper jobs for continuous, economical, trouble-proof service. Mass produced for new low prices. ● Send for new catalog.



on4nc on4jb oklaw oz2m ve5ec ve5gi ve5hr vk2gu vk3yp vk4ap vu2au xelay xelcm ym4aa zeljj zslh zt2b zu5b

W9ARIH, Bob M. Simmons, Milan, Mo.

(14-Mc. 'Phones)

September 1st-October 15th, 1936

ce1ew ce3ao k6npy hh2b ti2bc vp8yb hi5x ce3aw hi7g vp9r lu4bh co2hy co8bc co6om co2ky co8yb co2ra ny2ae lu6ke

(14-Mc. Band)

k7pq fa8da lu8en lu6ad lu7az lu3ev lu8ad lu9bv vk4lo vk3jx vk2ak vk5wr vk4hr vk2px vk3gf vk2qe vk7jb vk3gv vk6fo vk6kg vk2ft vk3gq vk3mr vk2ny vk2hv vk3cp vk3kx on4pa cp3aa cp1gb py8ae py2ar py8ag py2cw py5qd py2ck py1bg vp1wb vp1jr ce3aa ti2lr ti2fg ti2ea ti2tao cm8mc cm7ai cm8ah cm8je cm8rq ok2ra ok2op o77ec oh3oi oh1nl f8gq f8oq f3au f8fb f8eo d4yji g2bd g6xr g2tm g2ax g5jx g2ax g6cj g6qx g5yb g5bj g2zq g5vb g6ah g6bs g6xl g2io g6rb g5df g5kg g6zu g6ks g5gq g6ox hh5pa hhlip k6lej k6kcn haf4h ei5f ei9j ilkn ilir vp5ae yu7dx fb8ad vq8ae vq8aa vq8af cn8mb pa0qq pa0on z1ldi z1zgo z1lhy z1zqa z1lke z13kg z1zds z14fk z1zce z1zpv z1zcp z1zdn z1zbp z1zgn z1zoc z1zab z1zap z1lbc z1llm z1zhr z1lck z14ae z1zqt z1ldv ka1md sp1ba sm5vj zu6p vp4tj vp4th vp4tm yv6ae os1br

W8JFC, Elmer Rahmes, RFD No. 1, Sharonville, Ohio

(28-Mc. Band)

d3edk d3ese d4fnd d4gff d4mdn d4ort d4qet d4xjf d4xqf d4qbt d4smo f3kh f3le f8eb f8eo f8kj f8ns f8pk f8wq f3dn f8cp f8ef f8ob f8rr f8vo f8wk fa8cr fb8ab g2gq g2hx g2rd g2rs g2xc g5qf g5qy g5ri g5rs g6wp g6cw g6dh g6ir g6nj g6oy g6qx g6wn g2hg g2mv g2xd g2yl g5kj g5oj g6vu g6go g6gr g6wd ei8b haf3d ilit ilkn oa4j oelcr oelfh oe7ej oh7nc oh7nd oh7ni ok1aw ok2ma ok2mv ok2op on4cjj on4jb on4nc on4au on4br on4fj on4fe oz2m pagas pagkw pagqq pagun pagak pagxd lu3dh lu6ax sm6wl sm7uc vk2lx vk3bq vk3cp vk3eg vk3hm vk3yp xelay xelam ym4aa vp5gm zslh zt2b zt6m zt6ak zule zu6e zu9a ch8mi z1ldv z1lgx z1zbp

(28-Mc. 'Phones)

f3gr f8ii f8pk f8mg f8vs g2ao g5vu g6dh g6vx g6lk g6qb k4ddh k6mvy k7pq lu9ax oeljh on4ap pagdk zt6ak zt2b vk2gu

W1COI, H. J. Nuttal, 40 Melrose St., Adams, Mass.

(28-Mc. Band)

September-October

sm7uc fa8bg fa8cr fb8ab k4rj oa4j lu9ax lu7az lu9bv lu6ax lu1ep xelam xelay xelcm vp4tm vp5gm f3dn f8ef f8hs f8wq f8eo f3gg f8kj f8mm f3og f3jd f8qj f8eb g5yv g2hx g2pl g5fv g2hg g2xd g6yq g2nm g5ri g6qc g6hj g6zu g5is g6go g6qs g2qt g6wn g5vu g6rb g6ir g2tm g6nf g5by g6hn g2sc i1kn pa0zk pa0az pa0oq pa0apx pa0kw vp2at zslh zstt zule zut6 zt6ak zt6y zeljj zelju on4nc on4jb on4ap on4au on4cjj hb9aw hb9ay su2jt ei8b k5ay ti2ea d4auu d4dgd d4wbt d4fnd d4dlc d4ltn d4ort d3dsr d4xjf d4xcg d4buf d4qet oeljh oelcr oe7ej on8mq cn8mi oz7kg ym4aa ok1aw ok2op ok2mv nylaa vk2gu vk3yp volj z1zbp z1lgx

(28-Mc. Band)

September 10th-October 7th

wlwf w1cwr w1avv w1lh wlwr w1wv wliob wlicw w1jle wlakk w2hhr w2dtb w2dng w3air w3bvm w3ccu w3aqi w3dbx w3aed w3exz w3epr w4byy w4auu w4ajy w4drz w5ehm w5dqd w5afx w6ju w6jnr w6grx w8ann w8ktv w8ano w8dps w8hsp w8nk w8dvw w8iwg w8jfc w8jrl w8btc w8eyt w9kjc w9pte w9min w9lf w9ny w9jbn w9dtb ve2ee ve3kf cn8mq zslh xelay lu7az oa4j suljt fb8ab oh7nc oh7nd oh7nf oh7ni

T1KN, Florence, Italy

(14-Mc. Band)

wliib w1jle widhi w1gbo wkad w1sn w2gvs w2hhg w2bmt w2cyn w2iyo w2ctn w2axz w2iug w2jep w2kp w3fuo w3ano w3ghd w2iis w3cbm w3fls w6cdx w8bfg w8cks w8dod w8eis w8au w8dfh w3bwb w9rge w9spb velbk ve2js velde ve3ni ve3kj ve4nm py2ck py8ag py2cw cx1cc ny2ae xelay k5ag k5ay hb5pa k4rj pk1bx pk1vm pk3kc j8ef j3de hslpj vu2ep vu2aj zc6aq tf3ce vq2rs vq8ae zsxz zsga cr9ab vk2xc vk2my

REVISED PRICES! "GO-DEVIL" STANDARD

DE-LUXE \$6.00

STANDARD \$4.50

BEAUTIFUL SEMI-AUTOMATIC KEYS FOR REAL EFFICIENT SENDING ABSOLUTELY GUARANTEED

It will be worth your while to send for full-size photo and information GO-DEVIL INSTRUMENT CO. POUGHKEEPSIE, N. Y.

AMPLIFIER FOUNDATION KITS

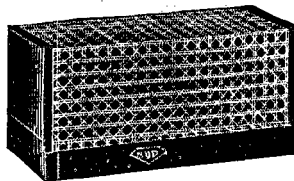

STEEL CHASSIS BASES METAL CABINETS

RELAY RACKS METAL PANELS

BUD MAKES THEM ALL

ASK FOR THEM AT YOUR JOBBERS

If you have not received our NEW catalog write for same

BUD RADIO, INC.

1937 E. 55th Street, Cleveland, Ohio

DOUBLE POWER!

For doubly effective phone work, select the microphone especially engineered for speech transmission — the famous SHURE "Communications-Type" Crystal Microphone. The special response characteristic **DOUBLES** your POWER on important intelligibility speech frequencies, producing clear . . . crisp . . . powerful signals that "boost" your message through noise and static. No amplifier or transmitter changes required. The "Communications-Type" performance is also available in an economical, flexible microphone with 4-Way Utility convenience.

Model 70S (at left). "Communications-Type" Crystal Microphone. The best known speech microphone — an original Shure development — widely used in commercial and amateur stations. Complete with integral desk mount and 7 ft. of cable. List Price. **\$25**

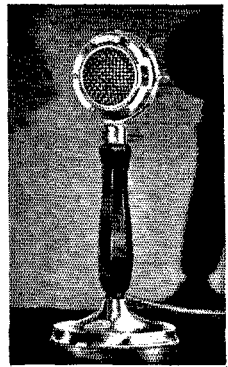

4-WAY UTILITY

Model 70SK (at right). This "Communications-Type" 4-Way Utility Crystal Microphone gives you 4 microphones in one! A Desk instrument for home use and a portable Hand microphone for field work — complete in one economical unit . . . plus adaptability for Stand Mounting or Ring Suspension. Complete with special handle, adapter, base, "Quickway" hooks and cable. List Price. . . . **\$26**
4-Way Utility microphones are also available in

General Purpose Crystal and Carbon types. Complete as listed for 70SK.

Model 70HK. General-Purpose Crystal Microphone for high quality reproduction of speech and music. List Price. **\$27.50**

Model 10BK. An economical Two-Button Carbon Microphone for general amateur and P.A. use. List Price. **\$12**



Crystal Microphones licensed under patents of the Brush Development Company. Shure patents pending.

SHURE MICROPHONES
SHURE BROTHERS • MICROPHONE HEADQUARTERS
215 WEST HURON STREET • CHICAGO, U. S. A.

See your Jobber
or write for Bulletin
139QA now!

Don't be a "LID"

SPEED UP YOUR CODE with the Celebrated CANDLER SYSTEM

AMATEURS instinctively avoid poor operators on the air. If your code is lame and halting — hard to read — you'll have more and more trouble getting answers to your CQ's.

Why not improve your code? It can be done so easily with the same Candler System that trained the youngest and fastest operators of all time. With it you get started right, and once started, your speed is scientifically developed with amazing rapidity and with astonishingly little practice.

The Candler advanced course of professional Training is for operators trying for their commercial tickets. This course develops your ability to read code by sound as easily as you read print by sight, to copy behind and use the touch system on your "mill." Read what code Champion McElroy has to say about the Candler System of Code Instruction.

Send for the Candler "Book of Facts" explaining this amazingly simple system of developing code speed. Don't be a "lid" any longer. Write Candler Today!

Send for **FREE "Book of Facts"**

CANDLER SYSTEM

Dept. Q12, Asheville, North Carolina

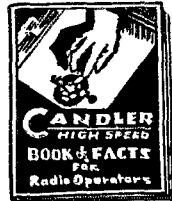

Three FAMOUS COURSES that have made Champions

SCIENTIFIC CODE COURSE for beginners. Teaches all the necessary code fundamentals scientifically.

HIGH SPEED TELEGRAPHING for operators with speed from 12 to 35 wpm. who want championship speed and technique.

TELEGRAPH TOUCH-TYPE-WRITING for those who want to become expert in the use of the "mill," in receiving fast stuff by "touch!"

CANDLER SYSTEM
Asheville, North Carolina

Q12

Please send your **FREE "Book of Facts"** to:

Name.....
City.....State.....

Herby Haman sez ...

Has been borrowing my GAMMATRON so much I thought I'd better give it to him!



HEINTZ and KAUFMAN
SOUTH SAN FRANCISCO CALIFORNIA U. S. A.

vk2as vk2ny vk2px vk2lw vk2ks vk2el vk2ae vk3dg vk3ar
vk3dp vk3gv vk3ml vk3jk vk3oc vk3se vk3cp vk3an vk3uh
vk4do vk4el vk4hf vk4wh vk5ax vk5ca vk5su vk3uf vk7lb
vk7jb zl1bc zl1ke zl1ds zl1di zl2lb zl2lx zl2ds zl2cw zl2fx
zl2oq zl2jq zl2bu zl2bp zl2hr zl3kg zl3ab zl3ah zl3gn zl4fo
zl4ck zl4fs zl4fk zl4bq

I.A.R.U. News

(Continued from page 49)

... . . . *Netherlands*: M. Smit relinquishes his position as Traffic Manager of the N.V.I.R. to J.F.A. Verzijl, PAQKZ, 86 Pr. Hendriklaan, Utrecht *South Africa*: Yardley Beers, W3AWH, renewed a friendship established in London last year when he was QSO ZS2F (14,070 kc., T6x) the other day. ZS2F was among the DX gang told of in Yardley's "Ingang, BERU, and All That!" in February QST *Egypt*: If you have social aspirations, and have already worked OE3AH, ON4HM, XU2BHH, and the others, you might look for the newly-licensed station of Prince Mohammed Abdul Monnen of Egypt *Switzerland*: The U.S.K.A. held a contest somewhat similar to the "Field Day" contests of the R.S.G.B. and A.R.R.L., only they called it "National Mountain Day," and when they say "mountains" in Switzerland they aren't fooling! Heights as high as 2000 meters were scaled, with the added encumbrance of portable radio gear. Winners were HB9V, HB9AM, and HB9J, in that order

QSL Bureaus:

The A.R.I. wishes to draw your attention to the fact that all cards intended for Italy should be sent only via the A.R.R.L., and not through any other amateur body. Because of the situation in their country, Italian amateurs must be careful not to disclose their identity.

The New Zealand QSL Bureau is now: N.Z.A.R.T., P. O. Box 374, Dunedin, New Zealand.

Please change the October QSL Bureau list to read:

Estonia: V. Suigusaar, Erne t. 13-3, Tallin.

Java: Ir. J. M. van Heusden, Burg. Coopsweg 28, Bandoeng, Netherlands East Indies.

Kenya: Radio Society of East Africa, Box 570, Nairobi.

Portugal: R. E. P., Rua Dos Saparteiros 159-3, Lisbon.

Tanganyika: see Kenya.

Uganda: see Kenya.

(Thanks to G6YL.)

Phenomenon:

G6DH asks an interesting question. He wonders if anyone else has observed a peculiar "hissing" which occurs on the high frequencies, anywhere between 10 and 56 mc., lasting from 5 seconds to

(Continued on page 96)

QUALITY FIRST!

• EVERY •

TYPE TR-6A6 DUPLEX TRANSMITTER-RECEIVER

Contains the Following:

- CARDWELL or BUD Isolantite air condensers
- CROWE illuminated dials and drives
- CABINET and Escutcheonssecond to none
- C.T.S. controls for volume and regeneration
- EBY sockets, outlets and jacks
- ERIE new ceramic shell resistors
- F.M.C. mica condensers rated 1000 v.
- JENSEN five inch dynamic speaker
- OHMITE Brown Devil 10 watt resistors
- R.T. LABS, famous 6E6 unity coupled oscillator — 10 watts output
- SOLAR and AEROVOX condensers rated twice applied voltage
- U.T.C. famous class B audio — Output 10 watts U.P.O.

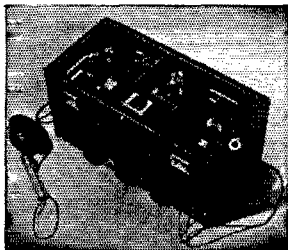

TR-6A6 FIXED or MOBILE
Complete 56-60 or 30-41 Mc. Station

COULD YOU SELECT BETTER COMPONENTS?

A BARGAIN at \$39.75 net F.O.B.

RADIO TRANSCIVER LABORATORIES

8627-115th Street, Richmond Hill, N. Y.

There's a Satisfying Ruggedness about a Cardwell

The "T" type illustrated is the TJ-200-UD,
one of a series of standard units in this class.

Airgaps of .168" to .500" are available, in both single and double section types

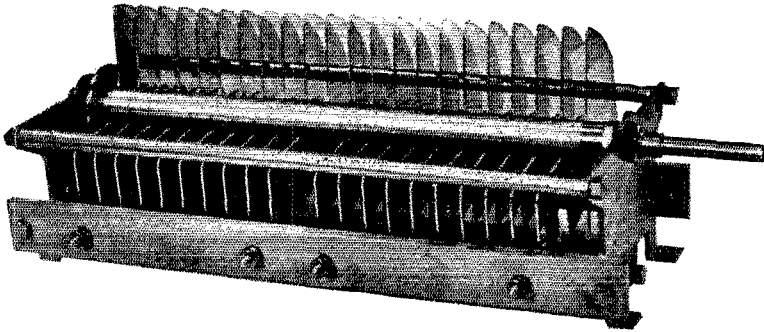

All "T" type units incorporate the following constructional features:

Mycalex Insulation, 3/8" Stainless Steel Shafts, Heavy Nickel Plated Brass End Plates, incorporating sturdy Mounting Feet. Massive heavy current type nicked phosphor bronze, Double Finger Rotor Contactor and thick buffed and polished plates with rounded edges. Corona shields which provide additional protection against hysteresis losses in the mycalex stator supports.

*Hundreds of additional types and sizes are available for every power and purpose
Send your Q S L card or ordinary postal for the new net price bulletin on 100 different types
particularly suited to the discriminating amateur*

THE ALLEN D. CARDWELL MANUFACTURING CORPORATION

83 Prospect Street, Brooklyn, N. Y.

Be
WISE



Meissnerize

Use **MEISSNER QUALITY COILS**
throughout and your receiver
will glisten and sparkle with un-
usual brilliance and excellence.

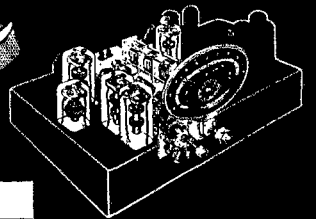

Our new bulletin No. 510 contains the most complete coil listing ever presented.
Copies are obtainable at all leading supply houses or directly from us.

MEISSNER MANUFACTURING Co.

Mt. Carmel, Ill.

Radio Operator's
Course

Complete in
Telegraphy—
Telephony

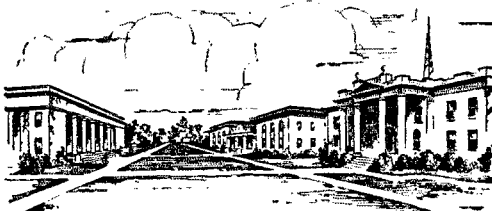

Practical
Experience
Studio—
Transmitter—
Announcing

P. A. C. is an endowed, educational institution — not privately owned, not operated for profit, college rank maintained. Course consists of maximum knowledge necessary to secure Commercial Telegraph Second-class, and Radio-telephone First-class government licenses. Course includes Wireless Code, Radiophone, Announcing, Microphone-Studio Technique, Service, Police, and Aeronautical Radio. We are authorized to teach RCA texts. At the completion of course you receive practical studio technique experience in our commercial broadcast studios located in the administration building, and experience as an operator on K P A C (500-Watt Commercial transmitter located on the campus, owned and operated by the college), and inter-departmental marine communication experience.

If interested, write for Bulletin R

PORT ARTHUR COLLEGE

PORT ARTHUR (World-known port) TEXAS

NOW!

**GTC HI-LO
Power Trans-
formers —
with three
tremendous
new advan-
tages!**

HI OR LO Power at the Snap of a Switch

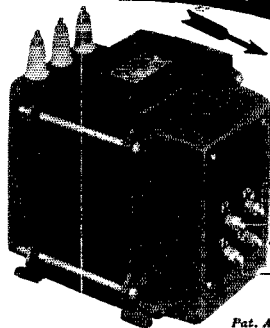

1. Now you can conveniently, safely reduce the power in tubes while tuning. Panel-controlled!
2. You eliminate waste of power. You tune with low power — then snap — and the soup's on!
3. Switch is in the 110 volt lead when you use GTC transformers — not in the high voltage lead, which is susceptible to arcs.

Pat. Applied for

SENSATIONAL NEW BOOK YOU NEED

"Progressive" Transmitter Guide, published by the Amateur Press, 1800 W. Harrison St., Chicago, now includes 32 page Supplement on "Progressive II" with 14 illustrations, 8 circuits, and 8 working drawings, 25c net postpaid. (15c for Supplement only). Bulletin form 35 free for the asking.

GENERAL TRANSFORMER CORP.

518 S. Throop Street Chicago, Illinois

RADIO ENGINEERING



RCA Institutes offer an intensive course of high standard embracing all phases of Radio. Practical training with modern equipment at New York and Chicago schools. Also specialized courses and Home Study Courses under "No obligation" plan.

Illustrated Catalog on request

RCA INSTITUTES, INC. Dept. ST-36

75 Varick St., New York 1154 Merchandise Mart, Chicago
Recognized Standard in Radio Instruction Since 1909

PRECISION CRYSTALS



Crystal Holder

Highest quality crystals one-inch square, carefully ground for frequency stability and maximum output. Be sure of your transmitter frequency — use PRECISION CRYSTALS.

*'X' cut PRECISION Crystals carefully ground for maximum power supplied within 0.1% of your specified frequency and calibrated to within 0.03%, are priced as follows: 1750, 3500 and 7000 kc. bands —

\$3.00 each. Add \$1.00 to above price if plugin, dustproof holder is desired. (Holder as illustrated to fit G.R. jacks or round holder to plug into a tube socket can be furnished) G.R. jacks to plug illustrated holder into — \$.15 pair.

Low frequency drift crystals (Type LTC) having a drift of less than 5 cycles per million per degree C. are supplied at the following prices: 1750 and 3500 kc. bands — \$3.50 each; 7000 kc. band — \$4.00 each. Holder \$1.00.

*'AT' cut crystals for commercial use quoted on at your request. When ordering our product you are assured of the finest obtainable. Now in our sixth year of business.

PRECISION PIEZO SERVICE

427 Asia Street

Baton Rouge, La.

5 minutes. It is somewhat similar to the hiss of a receiver going into oscillation. He likens it to the effect produced by charged rain or snow falling on the antenna, except that it is not so staccato. He sets forth the theory that it might be produced by a shower of charged particles, possibly from the sun, since he has noticed it only during the day. Comment on this phenomenon is invited.

Strays

Note from W3MG re panels: "In a recent transmitter I used $\frac{3}{16}$ -inch Celotex Tempered, which is practically the same as Masonite. A good grade of Jade Green Enamel was used, giving three coats and rubbing the gloss of each coat with pumice on a damp cloth. After the final rubbing down the panels were waxed and rubbed well. The final finish is a velvety finish of medium shade, very durable and easily cleaned.

"If there are any razzberries on the green, just try it once with black meters, dials and knobs and see if the XYL won't let you put the rig in the parlor! A medium shade of gray would also look well; or if you insist on black, the same finish will look like bakelite."

W9LQE wishes he could collect a tax for every unnecessary use of "there" by so many of the 'phone fraternity. How about a levy on "and-uh," too?

New Amateur Tubes

Types 154, 807, RK-39, and 808

TUBE manufacturers have been busy with development work during recent months, the result being a number of new types which have recognizable advantages for amateur work. Recent additions to the many varieties now available include high-frequency type triodes of medium power capabilities, and some transmitting versions of the 6L6.

HK-154

The Type 154, made by Heintz and Kaufman, falls in the 50-watt plate dissipation class, and is particularly adapted to working with optimum efficiency at moderate plate voltages. It is a medium-mu, tantalum-plate tube with fairly low interelectrode capacitances. A single tube is rated to deliver 200 watts at 1500 volts, the maximum rating, as a Class-C amplifier, and a pair of them in Class-B can give an audio output of 250 watts at the same voltage. Preliminary ratings and characteristics are as follows:

Filament voltage	5.0 volts
Filament current	6.5 amp.
Plate dissipation	50 watts.
Max. plate voltage	1500 volts
Max. plate current	175 ma.
Max. grid current	30 ma.
Plate resistance	1750 ohms
Amplification factor	6.7
Interelectrode capacitances:	
Grid-to-plate	5.9 μ fd.
Grid-to-filament	4.3 μ fd.
Plate-to-filament	1.1 μ fd.

(Continued on page 100)

ALADDIN

MAY HAVE HAD HIS LAMP — BUT DID IT LIGHT UP IN SO MANY PLACES?

Taylor

CUSTOM BUILT

Tubes

Will light the way for BETTER and MORE NUMEROUS QSO's. Compare the rating and plate dissipation of the various Taylor Tubes and you will be convinced of their SUPERIOR OUTPUT. They are GUARANTEED to "Take It." Exceptionally easy to drive.

If you have not received a copy of the latest TAYLOR 31 PAGE CATALOGUE, come or write for one.

Full of real information

COMPLETE STOCK OF FAMOUS TAYLOR TUBES ALWAYS ON HAND

T-55

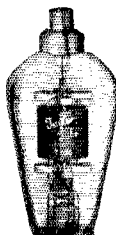

CHARACTERISTICS Type T-55			
Fil. Volt., volts		7 1/2	
Fil. Cur't, amps		3.25	
Class "C" Osc. and Power Amp.			
Max. Op. Plate Volts	Cl. C	Osc.	
Unmod. DC, v.	1500	1250	
Mod. DC, v.	1500	1000	
Max. DC Plate Cur. mls.	150	125	
Max. DC Grid Cur. mls.	40	40	
Max. Plate Dissipation, w.	55	55	
Max. RF Grid Cur., amps	5	5	
RF Output, w.	168	66	

Price \$8.00

Our Taylor Prices

Type	Price
756	\$4.95
203B	7.50
822	18.50
845	12.50
872	12.00
203A	12.50
814	18.50
T-200	21.50
H.D.203A	17.50

* How much did you pay for yours?

T-155

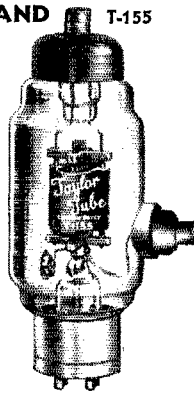

CHARACTERISTICS Type T-155	
Fil. Volt., volts	10
Fil. Cur't, amps	4
Interelectrode Capacities	
Plate to Grid, mmf.	3
Grid to Fil. mmf.	2.5
Plate to Fil. mmf.	1
Class "C" Osc. and Power Amp.	
Max. Oper. Plate Volt	*3000
Max. DC Plate, mls.	* 200
Max. DC Grid, mls.	* 60
Max. Plate Dissipation watts	155
Power Output, watts	450

Price \$19.50

TAYLOR HEAVY DUTY 866's.....\$1.65

MAIL ORDERS FILED . . . SEND MONEY ORDER

PYRANOL CONDENSERS

2 MFD.—2000 VOLTS **\$2.90**

In two years we have not been called upon to replace one condenser due to failure in service. This is the best reason why you should decide on the PYRANOL. *Pyranol is your guarantee.*

STANDARD RELAY RACKS

Beyond Comparison
Not just another rack of odd design but the lowest priced Rack ever offered that included all the standard features that made the rack you wanted so high priced.

- Sturdy steel channel frame.
 - Drilled and tapped for 10/32 screws.
 - Holes spaced at 1 1/4" and 1/2".
- (This is the only standard for 19" panel.) **\$13.50**

RACK PANELS

BLACK CRACKLE

1 1/2 x 19.....	\$5.4
3 1/2 x 19.....	.60
5 1/4 x 19.....	.69
7 x 19.....	.72
8 3/4 x 19.....	.96
10 1/2 x 19.....	1.17
12 1/2 x 19.....	1.38
14 x 19.....	1.59
15 3/4 x 19.....	1.77

RACK CHASSIS

10 x 17 x 3..... **\$1.05**

WING BRACKETS
Per pair..... **\$6.00**

CIRCLE CUTTER (Small) \$1.25
CIRCLE CUTTER (Large) \$1.95

HALLICRAFTERS

- SX-10 with speaker xtal..... \$126.50
- SX-11 with speaker xtal..... 111.50
- COMMERCIAL speaker xtal... 126.50
- SKY CHIEF (complete)..... 44.50
- SKY BUDDY (complete)..... 29.50

ITEMS OF INTEREST

- Dunco Keying Relay 25-6 v..... \$2.00
- Triplet 3" Bakelite Case Mill Meter..... 3.75
- Triplet 2" Bakelite Case Mill meter..... 2.92
- Astatic D104 Crystal Mike..... 13.50
- Brush Crystal Mikes — 40% Discount
- Bruno Velotron Velocity Mike..... 12.00
- UTC Varimatch Transformers
- UTC 616 Beam Kit Pak 1..... 45.00
- Raytheon RK 20..... 15.00
- Raytheon RK 35..... 8.00
- Raytheon RK 23..... 4.50
- Raytheon RK 36..... 14.50
- Eimac 150T. \$24.50. 35T. \$8.00
- HK 354. \$24.50. HK 154..... 12.50
- Amperite HL Imp. Velocity Mike 13.50
- Biley LD2 xtal \$4.80 20 M. xtal 6.50
- Valpey 40-80-160 M MTD xtal..... 3.00
- Aladdin Iron Core IF's..... 1.80
- Aladdin Iron Core IF's Air trim..... 3.30
- Bud 50 Watt Socket..... 2.50
- Baldwin "C" Phones..... 2.60
- Brush xtal Phones..... 5.40
- Ohmite 200 Watt Resistors
- Ohmite 5 to 10 M Ohms..... 1.80
- Ohmite 15 to 100 M Ohms..... 2.10
- Ohmite 160 watt-5 to 10 M Ohms 1.50
- Ohmite 160 watt-15 to 50 M Ohms 1.74
- RCA 802..... 3.90
- RCA 801..... 4.50
- RCA 866..... 1.75

DUBILIER 2 MFD CASED CONDENSERS. 90c
They will stand 1000 v.

RADIO SHACK

46 BRATTLE ST.
BOSTON MASS.

INTERNATIONAL PLATE TRANSFORMERS

- Model 2000 — 1000 and 750 volts each side of C.T. 300 Mills **\$5.95**
- Model 3000 — 1500, 1000 and 750 volts each side of C.T. 300 Mills..... **\$8.95**

INTERNATIONAL CHOKES

- SMOOTHING — SWINGING — CASED
- 12 H-200 M... \$2.50 5/25 H-200 M. \$2.50
 - 12 H-300 M... 3.75 5/25 H-300 M. 3.75
 - 12 -500 M... 6.50 5/25 H-500 M. 6.50

866's H.D.....\$1.00

866 Trans. (cased).....\$1.50

CARDWELL

	Gap	
MT — 100 GD	.07	\$4.80
XP — 90 KD	.084	4.50
NP — 165 KD	.084	6.60
NG — 110 KD	.171	10.80
NC — 40 XD	.200	7.80
NC — 75 XD	.300	10.20
TL — 50 UD	.294	15.00

MYCALEX INSULATION

RME-69 Complete \$134.90

NATIONAL HRO \$167.70

MAIL ORDERS FILLED
SEND MONEY ORDER

ROANOKE DIVISION

NORTH CAROLINA—SCM, H. S. Carter, W40G—Raleigh: HV has a Super Skyrider and a new crystal-controlled rig. EBA is on the air for Navy Drills. JB is QRL Public Address work and B.C.L. set repairing. BUE is experimenting with low-powered 'phone on 3.9 mc. BRT's power supply burned out. ANU is planning on increasing power. DW has been QRL, but found time to handle some traffic. Mount Holly: CYY leads the State again in traffic total, and seems to be the most outstanding traffic man, alternating on Trunk Line "C" and A.A.R.S. for N. C. Tarboro: DCG has caught the DX fever from CCH; he worked his first German and South American as a result. CCH now has 77 countries and is W.B.E. Lattimore: DGU is rag-chewing on 3.5 mc. Kings Mountain: CEI swapped receivers. DOV is working plenty of VK's. DOQ has his home-made s.s. super going FB. DOZ is very active on 7 mc. Belmont: CXO has gone to the hospital in Sanatorium. N. C., and all the gang that can visit him please do so; he will appreciate it very much. DLY is working plenty on 7 mc. Gastonia: CEN is getting along fine with his 14-mc. k.w. rig. CPV is on 3.9-mc. 'phone. BDU has finished new rig. CXW built a radio analyzer to test automobiles in the garage. CXV is getting FB results with his 6L6. SFOU spent his vacation with CJQ. Bessemer City: DVZ tore down his rig and can't get it back together again. Hi. Wilmington: FT is having FB results on 28-mc. 'phone. BQZ gave up the idea of going on 3.9-mc. 'phone and has decided to stick to 14 mc. BPL is going in for 'phone on 3.9 and 14 mc. EC is back on 28 mc. CPT is on 7 mc. for a QSO when he can sneak home for a few days from traveling on the road. DIE, who recently joined the Navy, has pneumonia. Hurry up and get well, OM. Albermarle: DPB reports plenty of activity on 3.5-mc. c.w. Winston-Salem: DWB is now O.R.S. and says he is going to give someone a race for the "W4NC Trophy." ABT is working on his k.w. rig for 3.5 mc. CLO is working plenty on 7 mc. I want to thank the Greensboro gang for a swell time at the Floating Club Meeting there October 2nd, 73.

Traffic: W4CYY 73 ABT 25 DW 13 AEH 12 DWB 10 NC-BHR 8 OG 7 EG 4 BVD 6 CXO-DGU 2.

VIRGINIA—SCM, Charles M. Waff, Jr., W3UVA—GBK has half his states towards W.A.S. EXI has two new rigs—each with a T-155 in the final. BVA is very QRL. BSB worked two new countries—PZ and VQ3. AJA was active during hurricane. FHF wants to be O.R.S. MQ handled hurricane traffic and expects to join A.E.C. soon. CSY has built a new shack. AIJ is on 3995 kc. with the Virginia 'Phone Net. All interested write AIJ. FKD worked 7 countries on 14-mc. 'phone with 75 watts input. FJ is getting set for his 6th Sweepstakes Contest. CHE has worked 26 countries on 'phone! CQW has a bunch of schedules. AKN was quite active in hurricane. GGI and GGP are new hams in Newport News. CFL has a new QTH. EVT made W.A.C. in three hours, Sept. 24th-25th, working U9ML, ZL2PC, W3EXI, ES5C, FT4AA, and PY2AG. FBI EMM was on 'phone continuously during hurricane with schedules. BCI appreciates QRX. BEK reports five 14-mc. 'phones on in Norfolk. DBV has 211D on 14 mc. with 200 watts input. BIG is helping AIJ with the 'Phone Net. KU talks to his "public" all day from WTAR, and rag-chews all night from KU. Hi. CA says the frost has driven him back on again. FBR is on 3975-ke. 'phone. EMX is still rebuilding. ELJ expects to join Navy soon. GB, OM. DGT is on 1.75-mc. 'phone. FIK has new QTH. DWE is having trouble getting equipment from mfrs.—rush season. BPI is having trouble getting excitation on 28 mc. ADD received W.A.C. certificate. ABY is on 3532 kc. FE is getting out with a 14-mc. indoor antenna. ELA has entered Lynchburg College. WS attended Washington hamfest. GGP is on 7 mc. with crystal rig; he is also doing some 56-mc. work. UVA is back on at last—started out with a bang by working two new countries, OH and YR. GEA is at new QTH with a pair of 801's. ENQ took Class A exam. EXW is back on with new transmitter. FZG is building new rig with 53, '10 and P.P. 801's final. BFW is rebuilding. BZ is on 14 and 28 mc. only. EBD is back at V.P.I.; he has a Class A ticket now. BYQ, ECS, EBD, EDG, 9GGB and ZJEK are at V.P.I.; GIC is their club station call. BW is planning new rig for 28 mc. with T-55 final. FQP worked FT4AE for his 51st country. EAP is rebuilding. FQQ is now in Georgia operating BT4. FGW worked U9MI for his W.A.C.; he needs only Nevada for W.A.S. (You've got company there!) GLV is a new ham in

Leesburg: he expects to have 1-kw. c.w. and 1/4-kw. 'phone on 1.75 mc. soon. FXL keeps schedules with 1/2-watt input and an SRR receiver. FPL is on 28-mc. 'phone with 200 watts input. EXW, FQO, EJS, CGB, UVA, AQB, EVV, FRK, 2HKD, ZIPP and IISM are at the U. of Va.; FDR is their club station call. Don't forget, those who report to the S.C.M. will receive "QRX" each month.

Traffic: W8CFL 157 AKN 59 CQW 47 CHE 39 FJ 38 FKD 18 AIJ-CSY 6 MQ 3 FHF 2 AJA-BSB-BWA-EXI-GBK 1.

WEST VIRGINIA—SCM, Dr. Wm. H. Rihedaffer, W8KKG—The Grafton High School Radio Club voted in 12 new members. Its station, CFD, is on daily. MIS has a nice new panel job. KXV has a new Jr. operator. NTV is working 14 mc. QBS is on 7 mc. with a single '47 crystal oscillator. MIT lost his skywire by lightning. EP is 1.75-mc. 'phone light when home over the week-ends. ONP has a low-power rack and panel job. KWU applies for A.A.R.S. HD is busy with new home. PEY gets out fine with pair of tens in final. KXC schedules 5FRZ, who visited in West Virginia this summer. Charleston Radio Club applies for A.A.R.L. affiliation. PSR was elected Secy-Treas. Tri-State Army-Navy Club. PDW is new Moundsville amateur. KIU is on 28-mc. 'phone and c.w. daily with schedules with K4DDH. DFC is listenin' in on amateur bands. ASI has a new RK-20 oscillator T-200 final; worked K5, NY2, D4, G5 on 14 mc. with 10 watts input. NAU applies for A.A.R.S. FVU is grid-modulating his 50-T's and is working nice DX on 14 mc. CXR is working most of the DX heard in Wheeling. CWY is new W.A.C. AZD doesn't count countries until contact is verified (which is a good idea); he leads the W. Va. gang in countries worked. JRL worked V57FR. KKG just finished new final amplifier with pair of Gammatrons at 4000 volts. JWL has new QTH and 5 acres for skywires. MZD has been 6L6—'04—pair 150T's job.

Traffic: W8LII 14 LXP 6 HWT 11 ANU 20 NAU 1 OFD 3 PSR 21 KXC 8 PHY 4 KIU 12 CMJ 3 AKQ 20 KKG 47 JRL 9.

ATLANTIC DIVISION

EASTERN PENNSYLVANIA—SCM, James M. Bruning, W3EZ—R.M.'s: 3AKB, 3AQN, 3EOP, 3ASW. The question is frequently raised about the number of schedules an O.R.S. is required to keep. Your S.C.M. is more interested in the quality and quantity of traffic handled than in the number of schedules maintained. For those of the traffic gang who find spare time at a premium, we advise taking part in the "Penna. Traffic Band" system. Ask the S.C.M. for details. Remember, this band is open to ALL Traffic stations regardless of your affiliations. 3EJV worked 6NPU with a P.P. crystal oscillator on 3.5 mc. 3GMK has installed 56-mc. equip't for local relaying. 3GDI increased power to 95 watts output. 3BBV has been rearranging his radio room. 3EUP worked HK3JB for his first S.A. contact. 3MG has been having some nice ragchews on 7 mc. 3AMR is operating his own and 3NF's station while George is away at college. 8DIG comments on the strange feeling one gets while working A.A.R.S. on 4610 kc. No QRM! 3AKB had plenty of trouble with her new rig. 3AGK has been busy with radio repairing. 8ASW is now a Lighting Engineer. 3FXZ (Mary) has worked some excellent 7-mc. DX during last few weeks. 3GHP is becoming a real traffic man with his Bryn Mawr College traffic. Hep, he's a Prof! 3EYO is back on the air. 3BRZ built a new overmodulation indicator. 3BUI is back on the air with his old call and a new Junior Op. 3CEQ reports that his brother now has a separate station license with call 3GIQ. 3CZS reports success with 18 watts to a special 6A6 rig on 14 mc. 3EJP is back on 3.5 mc. 3FBJ says the bands are beginning to sound good again. 3EEW recently called Cleveland, Ohio, and was answered by G5FT on 7 mc. 3EZ reports that on the 13th of Aug., Sept. and Oct. the following happened in order: Worked South Africa, worked Australia, was transferred to a better job. By the way, he moved to his present QRA on April 13, 1933. Lafayette College formed a new Radio Club and it includes 3GNU, 2CJT, 2GED, 2HZC and 8ORV. Stations active this month in addition to the above were 3ETM, 3BYS, 3IU, 3EBP, 3EOZ, 8EU, 8EKG and 8UV. Some of the many who attended the 3rd C.A. A.A.R.S. Second Encampment at Fort Howard are 3AKB, 3ADE, 8AVK and YF, 8BEV and YF, 8MRQ, 8UV, 8DIG, 8HLK and 8NOV. 8PPW is interested in DX reports on his 14,302-ke. signals and requests such reports.

Traffic: W3EOP 407 (WLQB 197) EZ 340 AMR 280 ETM 74 BYS 54 EBP 38 FXZ 32 AKB 31 NF 29 AGK 22

EWJ 16 GMK 15 GDI-GHP 12 CEQ 9 ADE 5 FBJ-EOZ 4 AQN 3 CZS 2. W8DIG 81 FLA 65 (WLQG 45) UV 55 EKG 42 MRQ 14 EU 1.

MARYLAND-DELAWARE-DISTRICT OF COLUMBIA—SCM, Edgar L. Hudson, W3BAK—R.M.'s: 3CQS, 3CXL, 3EOU, Chief R.M.: 3BWT, P.A.M.: 3WJ. It is with a great deal of regret that we report the death, on Sept. 18th, of our beloved fellow amateur, Henry Farnham, W3ASO. We shall greatly miss his daily cheery greetings over the air. He passed on after a three months' illness due to a heart attack, at the age of 63. Entering amateur radio as early as 1907, he kept his equipment always up to the minute as the art developed, from spark coil to the latest ultra-modern rig. He was interested in all the phases of amateur radio and his transmitters have been designed for traffic, DX and 'phone. He was successful at all of these. Traffic, however, was his specialty. For a number of years he was actively engaged in trunk line work, had nightly schedules, and assisted in special relays and emergency work. W3ASO was in the center of every activity in (radio amateur) which the Washington amateurs participated. He held an O.R.S. appointment for many years, being one of the veterans of his Section. Besides being a member of the Third Corps Area, A.A.R.S. Net, he was an alternate N.C.S. for WLM and held the call WLMC. He was quite active in affairs of the Washington Radio Club. Despite all his activity, he was never too busy to give a brother ham a hand. Many a ham in his vicinity owe their start in our hobby to Pop Farnham. In addition to his versatility in the amateur field, he was a photographer of note. His photo laboratory and studio was at one time the leading one in Washington, D. C. His other hobbies included gasoline-powered water craft and automobiles. He is survived by his widow and two daughters. The sympathies of hundreds of hams all over the nation were extended to the family in the hour of their bereavement. Let us who remain continue to carry the banner of Ham Radio in as noble a manner as did our old friend "HF" of W3ASO. Operator Stull, a former member of WLM staff, was recently transferred to Langley Field, Virginia, and is being replaced by Richard Bradley (5VZ). CIZ and CQS attended the A.A.R.S. Convention at Fort Howard, Md. EPD was active during the recent hurricane. FQB has just completed W.A.S., but is waiting for 3 cards. GKZ had O.R.S. transferred to this Section from San Diego, Calif. Welcome, OM. GKT operates O.R.S. from Ferris Industrial School near Wilmington, Del. BAK had a fine trip to the West Coast, by auto, and covered 7600 miles without a puncture. FPQ has gone back to college. BWT was off the air on two weeks' vacation. FBQ has Class "A" ticket. EZN is rebuilding. GFF has new 25-watt rig, and made 57 contacts in 2½ days. CDQ visited Bermuda on her vacation, and reports fine time. AOO will be back on the air again in about a month; he has just graduated from the U. of Md. Glad to welcome you back again, Bob. GAD operated portable at Silver Spring, Md., on last Field Day.

Traffic: W8CIZ 426 CXL 313 (WLM 1203) BWT 287 CQS 23 EZN 16 FPQ 10 EPD 4 FQB 3 GKZ 2. (Aug.—Sept., W8FPQ 176 BWT 96 CXL 126 (WLM 1413) CIZ 115 BKZ 42 EHW 6 FBQ 1 EZN 6 EPD 5 FSP 4 GFF 3 GKZ 2.)

SOUTHERN NEW JERSEY—SCM, C. D. Kentner, W3ZX—The South Jersey Spot Net is now functioning smoothly, and indications are that the amount of traffic handled will be even greater than last winter. The Section will lose FOS, who is moving to Phila. FBM is playing with new 6L6 crystal rig. EFM is a busy man during the summer and is just leaving for his vacation. DNU is new alternate for APV in T.L. "B" and will have break-in going soon. DQO is going out after schedules and lots of traffic. EKL is spending most time on 14-mc. c.w. BIR is active on 3.5, 7 and 14 mc. and reports GNM new ham in Trenton. ZI made 34 contacts in last RM Party and had a very FB time. BEI is booking up his old schedules again. CES makes Net occasionally, but is badly tied up with overtime work. GAI works Washington, D. C., on 3.5 mc. with 4 watts, and has built his rig into rack and panel. ZX finds plenty of 'phone activity on 28 mc.

Traffic: W8FTK 263 BYR 37 QL 23 VE 63 BO 38 FBM 16 EFM 128 (WLNJ 65) DNU 45 DQO 4 AEJ 5 EKL 33 ZI 133 BEI 18 ZX 19.

WESTERN PENNSYLVANIA—SCM, Kendall Speer, Jr., W8OFO—R.M.'s: 8GUF, 8KWA, 8MOT. New O.R.S.—IUY. Prospective O.R.S.—DDC, OSI, PIX. All plans and prizes are ready for the W.P.A. QSO Contest. Two O.R.S. Section Nets are going full force in W. Pa. now with four trunk line and one National trunk line connection and two

divisional hookups. OFO works most of his schedules in early mornings. KWA bought an '04A. KUN has his schedules working fine now. MOT was visited by KWA. ADY works every other week. KBM enjoyed the A.A.R.S. Convention. PIW and FZG say the only interesting thing at the C.C.C. is the woods. HI. QAN just returned from the West Indies. Welcome back to the O.R.S., IUY. KNB is WLQM in the A.A.R.S. KOB is building a 1-kw. rig. NDE says INE is now open for season. MIW has a T55 final now. FIP is pushing the W.P.A. Contest. OSI is working hard for O.R.S. CUG was "best man" at CFR's wedding recently. (Congrats, Bob.) CJB is busy with W6's on 7 mc. MWV wants to know what happened to 3610 kcs. LGD got his jaw broken in an auto accident. CHT burnt out an 850. GUY says the Beaver Valley Amateur Radio Club is holding a big hamfest on November 14th at Aliquippa. GBC, ex-RM, has the bug again and is getting a rig on the air. DGL is working some nice DX on 14 and 7 mc. QHS is a newcomer in Sharon. BVP is on 14-mc. 'phone. IYQ drives a coal truck. EZB is putting in two 830's. OAJ has a swell 56-mc. antenna. HLA is club station for the Valley Key and Mike Club in Sharon. EHX moved to Farrell. CBG is back from Texas. OUH worked a couple W6's on 3.5 mc. with 20 watts. OKP, QEH, PDT and PFE, all of Wilkingsburg, are on 1.75-mc. 'phone. NCJ went W.A.S. after working Nevada. MTJ has a T55 final. LBB is on 14-mc. 'phone. NDE, LSH, JZR, KBM, CUG, UK, CKS, CFO, GUB, MIW, EDG and ADY attended the Third Corps A.A.R.S. Convention at Baltimore on October 10th-11th.

Traffic: W8OFO 418 (WLQE 8) KWA 310 KUN 236 MOT 196 ADY 104 KBM 101 PIW/FZG 55 QAN 44 KNB 38 (WLQM 9) PIX 31 IUY-KOB 23 NDE 14 CPM 10 MIW 7 FIP 5 AXD-OSI 6 CUG-CJB-MWV 2 UK 9.

WESTERN NEW YORK—SCM, Charles F. Smith, W8DSS—R.M.'s: 8JTT, 8BJO, 8AQE, P.A.M.: 8CGU. The Western N. Y. Section QSO Party will be held on Sat., Dec. 26th, starting at 6 p.m. E.S.T. and ending at midnight, Sun., Dec. 27th. All stations, 'phone or c.w., in this section are invited to participate whether holding A.R.R.L. appointment or not. Let's see who can make the most contacts. Send your score to the S.C.M. not later than Jan. 15th. CSE, who has been appointed N.C.S. in place of JE, leads the gang this month with a very fine total. FUG did a very creditable job at the ham booth during the Rochester Electrical Show; many fine messages were originated and relayed. BFG asks for reappointment as O.R.S. and O.O. MBI worked four continents and sixteen countries before leaving for Tri-State College with OGH. Cayadutta A.R.A. is considering affiliation with A.R.R.L. These members are building 56-mc. rigs: LGS, NTY, FPC and NWT. BDX is starting up again. NWK worked HB9VE on 7 mc. MQX is back in harness again; he does fine DX work, XEIG on 3.9-mc. 'phone. PFK and JMI are getting interested in A.A.R.S. and O.R.S. respectively. KXA is going in for higher power and more traffic. AQE is hoping to get on the air during the evenings for a change. HTT reports CQW gone on 1.75-mc. 'phone. BJO and JTT are organizing W.N.Y. Net and doing a fine job besides handling lots of traffic. QBB sends his first report; he uses a c.c. rig with 35 watts input. PCU is back on the air after burning out some tubes and is now working nice DX. JQE is having trouble with new rig. BHK expects to be a benedict soon. GWT is looking for reliable long distance schedules. DHU is traveling around Connecticut with transceiver. GWY and BWY are 100 per cent for W.N.Y. Traffic Net. NWZ is increasing his totals every month. OAG is new O.R.S. in Fleischmann's and expects to handle lots of traffic. W.N.Y. Traffic Nets probably will operate from 6:30 to 7 p.m. on a spot frequency of 3634 and 3638 kcs. All traffic-minded men are invited to join up with us to insure quick and reliable relaying and delivery of messages. Traffic stations are badly needed in Ithaca, Elmira, Watertown and Northern New York. FCG took over N.C.S. of the Utica district in place of CSE. Congrats, Guy. 73.

Traffic: W8CSE 407 FUG 241 JTT 212 MQX 78 DSS 59 NWZ 54 BJO 50 FCG 40 AQE 33 OAG 18 QBB-PCU 7 JQE 6 CGU 4 GWT 3 KXA 1.

NEW ENGLAND DIVISION

CONNECTICUT—SCM, Frederick Ells, Jr., W1CTI—The traffic season started Oct. 1st with a big increase in activity. The following stations are given special credit for taking part in the Nutmeg Net: AFB, AFG, AJB, BFS, CTI, CJD, DOW, FNM, GKM, GME, GTX, GVV, HSX, (Continued on page 106)



RADIO FREQUENCY CHOKES

COTO R.F. CHOKES were designed to lead the field in PRICE, QUALITY, and UTILITY.

They continue to be the best "BUY" regardless of price.

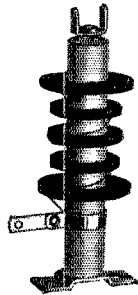

CI-11 (125 ma) NET \$3.36

CI-12 (250 ma) NET \$4.45

CI-20 (.6-8 A.) NET \$7.75
for 160-80-40 M.

CI-21 (.6-8 A.) NET \$7.75
for 80-40-20-10 M.

Available at any leading jobber

RADIO



PRODUCTS

Power
X cut

**O. C. L.
Control Crystals**

High
Output

Unconditionally Guaranteed
7000 KC ± 5 KC \$1.85
3500 or 1750 KC ± 5 KC 1.50

OMAHA CRYSTAL LABORATORIES

Jobbers write

W9JRY

NORTH PLATTE, NEBR.

W9CPM

READ SEND CODE LIKE AN EXPERT!

Learn Quickly at Home, Get Real Speed

It's easy, fascinating, to become a good op with the NEW ALL ELECTRIC MASTER TELEPLEX Code Teacher to help you.

Only instrument ever produced which records your sending in visible dots and dashes — then sends back to you at any speed you desire.

Also sends practice work, recorded by an expert. That is why so many schools teaching code prefer Master Teleplex.

That is why thousands agree this method is surest, quickest — has taught more ops in the past few years than all

other methods. We furnish Complete Course, lend you Master Teleplex, give you personal instruction with a MONEY-BACK GUARANTEE. Low cost. Send today for booklet Q12; no obligation.

THE "HAM" SPECIAL

Standard Teleplex — a highly efficient code teacher using heavy specially prepared waxed paper tape, having two rows of perforations. Write for Free folder QT-12.

We are the originators of this type instrument

TELEPLEX CO. 76 CORTLANDT STREET

NEW YORK, N. Y.

TELEPLEX — "The choice of those who know"

New Amateur Tubes

(Continued from page 96)

The following power outputs are obtainable in different classes of service:

	500	750	1000	1500
				Watts
Class-A (single tube).....	3.5	9.0	13.5	15.5
Class-A (push-pull).....	7.0	20	35	40
Class-B (two tubes) audio.....	150	200	225	250
Class-B radio (single tube).....	18	25	26	28
Class-C r.f. (single tube) .	85	125	165	200

Required driving is power approximately as follows: Class-B audio, 10 watts; Class-B r.f., 5 watts; Class-C r.f., 10-15 watts.

The 154 has a standard four-prong base and a tubular hard glass bulb. Plate and grid terminals are brought out on opposite sides of the bulb, making these connections highly convenient for short leads to grid and plate tank circuits.

RCA-807

The 807 is a glorified 6L6, rearranged to make it especially suitable for transmitting. To this end, the tube is enclosed in a glass bulb, has a ceramic base, and has the plate connection out the top. Some additional shielding has been incorporated in the element structure so that the tube compares with the 802 in grid-plate capacity, although because of its high power sensitivity it may have a tendency to self-oscillate in amplifier circuits at high frequencies (14 mc. and up) or in layouts where the input and output circuits are not carefully isolated. Preliminary ratings and operating data are as follows (all ratings are maximum):

Heater voltage.....	6.3 volts
Heater current.....	0.9 amp.
Interelectrode capacitances:	
Grid-to-plate (with shield).....	0.2 μfd.
Input.....	11.6 μfd.
Output.....	5.6 μfd.
As Class-B R.F. Amplifier:	
Plate voltage.....	400 volts
Screen voltage.....	300 volts
Plate current.....	80 ma.
Plate input.....	32 watts
Plate dissipation.....	21 watts
Screen dissipation.....	2 watts
Plate-modulated R.F. Amplifier:	
Plate voltage.....	325 volts
Screen voltage.....	250 volts
Grid voltage.....	-200 volts
Plate current.....	83 ma.
Grid current.....	5 ma.
Plate input.....	27 watts
Plate dissipation.....	14 watts
Screen dissipation.....	2 watts
Class-C Amplifier or Oscillator (unmodulated):	
Plate voltage.....	400 volts
Screen voltage.....	300 volts
Grid voltage.....	-200 volts
Plate current.....	100 ma.
Grid current.....	5 ma.
Plate input.....	40 watts
Plate dissipation.....	21 watts
Screen dissipation.....	3.5 watts

Typical operating conditions for 807 as an oscillator or keyed amplifier are as follows:

Plate voltage.....	300	400 volts
Screen voltage.....	250	250 volts

80-T TRANSMITTER

1500 TO 30,000 KILOCYCLES

ONLY 3 TUNED CIRCUITS
ANTENNA MATCHING CIRCUIT
EXCITATION CONTROL
PHONE — CW SWITCH
4 FULL SCALE METERS
SEPARATE OSCILLATOR SUPPLY
NEW 6L6 OSCILLATOR
3 TYPES OF KEYING AVAILABLE
NO NEUTRALIZATION
125 WATTS INPUT

Both 60-X and 60-T TRANSMITTERS now operate in 4 bands and include 3 keying methods.

MI-4 MODULATION-MONITOR really indicates voice modulation peaks which Meter Types will not do. Inexpensive and accurate.

WRITE FOR INFORMATION

HARVEY RADIO LABORATORIES, INC.

12 BOYLSTON STREET, BROOKLINE, MASSACHUSETTS

Export: 25 Warren St., N. Y. C. Cable: "Simontrice"

"CORDIAL TO THE BANKROLL"

One of the Terminal customer comments which we liked best was the remark of a "Ham" who said recently, "You folks at Terminal Radio are not only cordial to the customer — you're also cordial to the bankroll." Unusual, perhaps — but it explains why, to many "Hams," "Terminal is the First and Last Stop."

PARTS

Parts that are advertised or described in *QST*. Parts that you have difficulty in getting elsewhere, you will surely find at Terminal Radio.

TRY US FIRST

We have all parts for the Noise Silencer and Crystal Filter circuit as described in October *QST*. Everything in stock for James Millen's Transmitter. *Terminal Has It.*

Write us for your requirements.

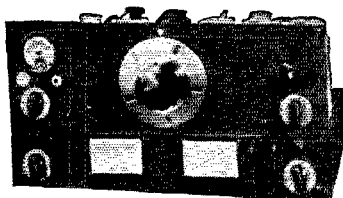

HEADQUARTERS for NATIONAL Sets and parts. Most complete stock in town. Amateur discount 40%

"HAM" RECEIVERS

We have 'em all
"HALLICRAFTERS"

ULTRA SKY RIDER
SUPER SKY RIDER
SKY CHIEF
SKY BUDDY

RME-69

RCA ACR 175

Your old receiver accepted in trade. Place your order now for any receiver to be delivered by XMAS. Be safe.

TERMINAL RADIO CORP.

80 CORTLANDT ST.
BILL FILLER

★ W2AOQ ★

NEW YORK, N. Y.
ADOLPH GROSS

THREE STORES

Hartford, Conn.

203 Ann Street

New Haven, Conn.

86 Meadow Street

Bridgeport, Conn.

195 Cannon Street

Fulfilling the frequent need of the Connecticut amateur for prompt, efficient, satisfactory service on amateur supplies.

NEW and SPECIAL

RCA 866	\$1.75
Taylor T-55	8.00
Amperex HF-100	10.00
39 Unit Rack	8.50
Strong Preswood Rack Panels, Black Crackle, Standard Slotting — 3 unit 54c, 5 unit 87c, 7 unit.	\$1.23
<i>All Sizes Stocked</i>	
EIMAC 50T — only 5 left	\$10.50
Thor 6L6 Inputs	2.21
Thor 6L6 Modu. Outputs 60 w.	5.88
Thor 6L6 P.A. Line V.C. Output	3.53
RCA 6L6 Tubes	1.18
Thor 6L6 Power Tr.	5.30
RCA 807 Tubes	3.90

THORCASED-T6878
600 v. 200 ma.
Fils 7/8-2 1/2-S. \$2.45
Thor Ck. T6877
12 Hy. 250 ma. \$1.95

National NC-100
Hallicrafter
ACR-175
RME-69
Hammarlund

TIME PAYMENTS FOR CONN. HAMS

HATRY & YOUNG

Radio Since 1912

Grid voltage	-50	-50 volts
Peak r.f. grid voltage	80	80 volts
Plate current	95	95 ma.
Screen current	10	9 ma.
Grid current (approx.)	3	2.5 ma.
Driving power (approx.)	0.2	0.2 watts
Power output (approx.)	17.5	25 watts

The 807 has a 5-prong base, with connections corresponding to those of the 27 or 56 with the screen replacing the plate. The tube may be used at maximum ratings at frequencies as high as 60 megacycles.

RAYTHEON RK-39

The Raytheon low-power beam tube carries the designation RK-39. Although resembling the 807 in appearance and basing arrangement, the physical structure is somewhat different so that the two tubes are not identical. Because of the internal construction, the tube is rated for plate voltages as high as 750; the grid-plate capacity is such, however, that the tube must be neutralized when used as a straight amplifier. Ratings and characteristics are as follows:

Heater voltage	6.3 volts
Heater current	0.9 amp.
Max. plate voltage	750 volts
Max. plate current	80 ma.
Max. screen voltage	250 volts
Max. screen current	10 ma.
Max. plate dissipation	20 watts
Max. screen dissipation	3 watts

Interelectrode capacitances:

Grid-plate	1.0 μ fd.
Input	12.0 μ fd.
Output	7.5 μ fd.

Typical operating conditions for various types of service are given below:

Tetrode crystal oscillator:

Plate voltage	500	750 volts
Plate current	60	70 ma.
Screen voltage	250	250 volts
Screen current	6	7 ma.
R.F. crystal current	20	20 ma.
Plate dissipation	14	20 watts
Power output	16	33 watts

Frequency doubler:

Plate voltage	500	750 volts
Plate current	35	45 ma.
Screen voltage	250	250 volts
Screen current	10	7 ma.
Grid voltage (battery)	130	130 volts
Grid current	2	2 ma.
Plate dissipation	7	14 watts
Power output	11	20 watts

Class-C Amplifier:

Plate voltage	500	750 volts
Plate current	60	80 ma.
Screen voltage	200	250 volts
Screen current	10	10 ma.
Grid bias	40	60 volts
Grid current	4	4 ma.
Driving power	0.2	0.5 watts
Plate dissipation	7	20 watts
Power output	23	40 watts

If screen voltage is obtained from a dropping resistor, a minimum value of 50,000 ohms is recommended. When the RK-39 is used as a crystal oscillator the grid-leak resistor should not be more than 10,000 ohms for realization of full output; the use of a 400-ohm cathode resistor also is recommended.

RAYTHEON TUBES

FOR THE "PROFESSIONAL" AMATEUR

YOU started communication all over the world with low power on short waves. None of the commercial broadcasting organizations had such a problem — yet, *there was no such thing* as a transmitter tube designed especially for your requirements until RAYTHEON started building them for you!

RAYTHEON led the way with the *first* transmitting pentode and the *first* zero bias Class B modulator.

The amateurs who use RAYTHEON tubes are among the record breakers and leaders in amateur transmitting.

RAYTHEON AMATEUR TUBES are built of the finest materials in the world — Tantalum plates, Nonex hard glass bulbs, Isolantite bases, etc. And they are *conservatively* rated.

They are built to give the most output per dollar over the *longest possible time!*

TWO BRAND NEW TUBES, just out of the laboratory are:

RK-37 High-Mu Triode	\$8.00	Power Output 60W
RK-38 High-Mu Triode	\$14.50	Power Output 225W

Used and Recommended by Leading Amateurs

The most complete line — all types of glass, octal base, metal and amateur transmitter tubes

SOLD BY ALL PARTS JOBBERS

RAYTHEON PRODUCTION CORPORATION

420 Lexington Ave., New York, N. Y. 445 Lake Shore Dr., Chicago, Ill. 415 Peachtree St., N. E., Atlanta, Ga. 555 Howard St., San Francisco, Cal. 55 Chapel Street, Newton, Massachusetts

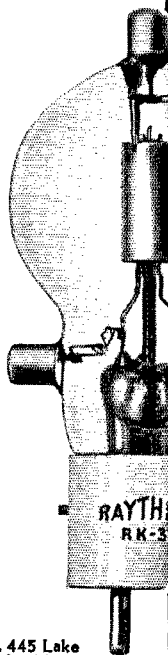

"The Crystal Specialists Since 1925"

PIEZO-ELECTRIC CRYSTALS

Guaranteed Accurate to BETTER than .01%

SCIENTIFIC RADIO SERVICE

UNIVERSITY PARK, HYATTSVILLE, MD.

LEARN RADIO

New Classes Now Forming! Send for 40-page catalog, explains

fully. 300 licensed graduates placed in past 4½ years in broadcasting, shipping, police radio, aviation, etc. We teach all branches. Oldest, largest and best equipped school in New England. Equipped with Western Electric sound and broadcasting equipment and RCA marine transmitter. Course prepares for United States Government telegraph or telephone license.

MASS. RADIO SCHOOL, 18 Boylston Street, BOSTON

Below

Below

Below

Sure It's an Old Song —

ham radio's going down the meter scale — but WICBD gives it a fresh meaning in his

200 METERS AND DOWN

pounded out in a way that'll lift the two-letter callers right out of their wheelchairs!



VISASIG

Full Automatic Siphon Tape Recorder
for Commercial and Amateur Use

Records up to and in excess of 100 words per minute

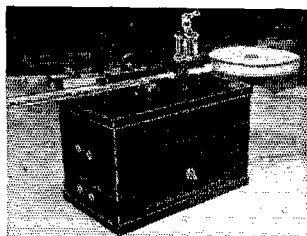

Make a permanent record from your receiver of weather reports, press news, distress signals, amateur broadcasts, speed contests, and your own transmissions! See how your fist improves with practice!

VISASIG — with electrically driven tape puller complete in one unit \$49.00

VISASIG — without tape puller . . . \$35.00

PRICES F.O.B. NEW YORK CITY

UNIVERSAL SIGNAL APPLIANCES

64 West 22nd Street New York City

Visasig Blueprints \$1.00

THE "C.P.I." LINE

INCLUDES

R.F. Switches
 "Locturn" Transmitting Inductors
 Concentric Transmission Line for all powers
 Famous Q-Max R.F. Lacquer
 Neutralizing Condensers
 Vitrolex Ceramic Articles for many radio needs
 Transmission Line Spreaders
 Victron — "The Magic Insulator of Radio"
 "Plug-in" Coils
 Transmitter Housings
 U.H.F. Resonant Line Oscillator Kits
 Q-Max Finishes
 Every jobber should have these products available to the amateur. They're made right, rigged right and priced right.

NEW CATALOG UPON REQUEST

COMMUNICATION PRODUCTS, INC.
 245 Custer Avenue, Jersey City, N. J.

T. R. McELROY

WORLD'S CHAMPION RADIO TELEGRAPHER
 23 Bayside Street, Boston, Mass.

MAC KEY @ \$7.95 a real speed key.
 MAC KEY DELUXE @ \$15.00.
 MAC CORD @ \$1.00 speed key cord.
 MAC CASE @ \$3.95 speed key case.
 MAC OSC @ \$3.95 ac/dc oscillator. Tone control.

If u hv Mac Key wri me fo xmy ipt & dsrb ifn.
 All my stuff emcy gad best pduts obl. 73 Mac.

VALPEY CRYSTALS

Step by Step Precision Made

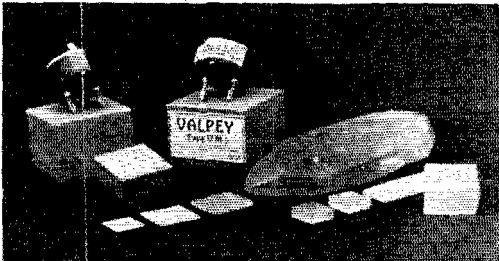

Type VM2 mounted X cut crystal frequency drift less than 15 cycles supplied within 5 Kc of specified frequency in the 1.7, 3.5, 7 mc bands \$3.00, exact. \$5.00
 Type VM2A mounted crystal frequency drift less than 4 cycles supplied within 5 Kc of specified frequency in the 1.7, 3.5, 7 mc bands \$4.50, exact. \$6.50
 Type VC2 unmounted 1 inch square crystal supplied in the 1.7, 3.5, 7 mc bands within 5 Kc of specified frequency. \$2.25
 Type VC2 in the 1.7, 3.5 Kc bands only supplied within 20 Kc of specified frequency. \$1.50

We guarantee your satisfaction or your money will be cheerfully refunded. You may obtain our products by ordering direct or from your dealer.

THE VALPEY CRYSTALS

377 SUMMER STREET

MEDWAY, MASS.

The 808 is a low-capacity high-mu triode in the 50-watt plate-dissipation category, designed for both r.f. and Class-B audio applications. Grid and plate connections are brought out through the bulb, the former at the top and the latter at the side. It has a tantalum plate and a spherical bulb. Tentative characteristics are as follows:

Filament voltage	7.5 volts
Filament current	4 amps.
Amplification factor	47
Interelectrode capacitances:	
Grid-plate	3 μ fd.
Grid-filament	5 μ fd.
Plate-filament	0.2 μ fd.
Max. plate voltage	1500 volts
Max. plate current	150 ma.
Max. plate input	200 watts

Typical operating conditions are as follows:

Class-B audio (two tubes):

Plate voltage	1250	1500 volts
Grid voltage	-15	-25 volts
Peak a.f. grid-to-grid voltage	120	110 volts
Zero-sig. plate current	40	30 ma.
Max.-sig. plate current	230	190 ma.
Load resistance (per tube)	3175	4575 ohms
Max.-sig. driving power	7.8	4.8 watts
Max.-sig. power output	190	185 watts

Class-B r.f. amplifier:

Plate voltage	1250	1500 volts
Grid voltage	-30	-35 volts
Peak r.f. grid voltage	65	60 volts
Plate current	55	45 ma.
Grid current (approx.)	1	1 ma.
Driving power (approx.)	3	2 watts
Power output (approx.)	22	22 watts

Class-C plate-modulated amplifier:

Plate voltage	1000	1250 volts
Grid voltage	-210	-225 volts
Peak r.f. grid voltage	360	360 volts
Plate current	120	100 ma.
Grid current (approx.)	35	32 ma.
Grid resistor	6000	7000 ohms
Driving power (approx.)	11.5	10.5 watts
Power output (approx.)	85	105 watts

Class-C telegraphy:

Plate voltage	1250	1500 volts
Grid voltage	-150	-200 volts
Peak r.f. grid voltage	300	350 volts
Plate current	135	125 ma.
Grid current (approx.)	30	30 ma.
Driving power (approx.)	8	9.5 watts
Power output (approx.)	120	140 watts

The 808 has a four-prong standard base, with filament pins connected as usual. The tube carries full ratings up to 30 Mc. At 60 Mc. plate voltage and plate input should be reduced to 75% of the normal maxima; at 130 Mc., to 50%.

With these new tubes added to the assortment already made available in the past year, the low- and medium-power fellow certainly has no reason to complain of lack of tube types. Rather it is the other way 'round! It is of interest to note that the trend now seems to be away from the graphite plate and back to the bright ones—the latter having the advantage, which we have stressed occasionally, that improper operating conditions are evident immediately by a flare-up of the plate.

—G. G.

HAMS
ARE YOU LOOKING
FOR A RELIABLE
SOURCE OF SUPPLY?

... Then Read This!

There are several thousand Hams who are our regular customers. They come to us for their requirements instead of a dozen other companies whom they might have chosen. And they swear by us . . . for we go out of our way to give them what they want, when they want it and at prices that are always as low as the lowest. We make no pretense of being the "Biggest in the World." We aren't . . . because if we were we couldn't give quite that extra bit of service that is so important to the amateur who wants the kind of service that we are peculiarly geared up to render. We ask you to try us once just to satisfy yourself. YOU be the judge! Remember that we carry all nationally known lines for immediate shipment.

A FEW OF THE LINES WE CARRY

National
 Thorderson
 Cardwell
 Astatic
 Shure Mikes
 Triplett
 Aerovox
 United Transformer
 Electrad
 Cornell Dubilier
 IRC
 RME

RCA
 Hallicrafters
 Hammarlund
 Ohmite
 Bliley
 Weston
 Pyrex
 Taylor Tubes
 Raytheon
 Johnson
 Yaxley

AND MANY OTHERS

SUN RADIO CO.

15 YEARS OF RADIO RELIABILITY

227 Fulton Street, Cor. Greenwich Street
 New York City, N. Y.

Mail Orders Promptly Filled

SICKLES COILS

ALL TYPES OF RF AND IF WINDINGS

Manufactured by

F. W. SICKLES COMPANY

300 Main Street

Springfield, Mass.

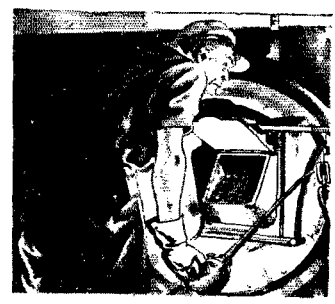

On the skilful check of the minutest details hangs life and death . . . **Protect against Tuberculosis by checking your health.**

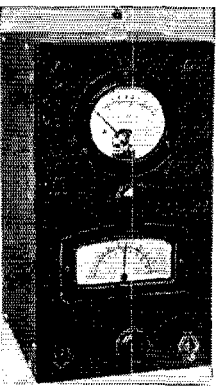

HAYNES RIGCHECKER

Hams all over the world are telling us that these two instruments are the biggest values in radio today. Your station is not complete without one. Circular and instructions for using sent free on request.

BIG RIGCHECKER \$17.90

LITTLE RIGCHECKER \$9.85

Send for FREE circulars on RH-6 Duplex High Frequency Transmitter-Receiver, portable and power transceiver, and other Ham specialties.

RADIO CONSTRUCTORS LABORATORIES
 Dept. Q-12 136 LIBERTY ST., NEW YORK, N. Y.



The National, State and Local Tuberculosis Associations of the United States

(Continued from page 99)

HYF, INP, JIL, JMY, JWG, UE, JXP is expected to join the net soon. INF B.P.L.'s for the first time and leads the Section. Good work, Hal. UE worked 82 stations in "BP," scored 13,120 points. CTI is on the air for Nutmeg Net daily except Sat. & Sun. at 6:30 p.m. AFB was N.C.S. for Nutmeg Net for first three weeks and then turned it over to UE, as Trunk "C" work demanded his attention. Thanks for a swell job, Ray. JMY and JXP sent in their first reports. Glad to have them and hope they will continue. HYF and TD are rebuilding again. BDI attended 13 club meetings and 2 conventions while away on contact trip. BIH is on the air again on 14 mc. BFS has receiver trouble. IIS built transmitter twice, only to find out his crystal was no good. DLX was on the Net until forced to QRT because of work. BNB is getting 35T's to work on 3.5 mc. IGR is on 28 and 14-mc. 'phone and 7-mc. c.w. EAO was reported heard in England on 3.5 mc. during the New England Birthday Party. ITI is active in A.A.R.S. and schedules UE, Gil, CJD, went to sea as radio operator on the S.S. *Atenas*, KDAK, AMZ and ACV visited CBA. C.A.R.C.'s Bulletin will be sent to all amateurs in Conn. free for two issues. All O.R.S. appointees are requested to review the established qualifications for O.R.S. as set forth in "Operating an Amateur Radio Station" or the Handbook. Appointments are made to active, traffic-handling stations in recognition of their ability and interest in traffic work, and may be suspended or revoked for failure to live up to the qualifications referred to above. Lack of interest shown by several Conn. O.R.S. in the Nutmeg Net indicates that several cancellations are in order. Attendance at O.R.S. parties is not sufficient to hold an appointment in good standing. The quarterly parties are a reward for good O.R.S. work and not just for the enjoyment of certificate holders. We don't want to QTA any appointments. Pound brass in the Nutmeg Net or show other appreciable activity in traffic handling and we won't have to!

Traffic: W1INF 396 AJB 246 UE 232 DMP 163 GKM 98 CTI 83 AFB 77 GME 64 GTX 39 JMY 27 INP 10 JXP 4 JUD-HYF 3 BDI-TD 2 DOW-JL 1.

MAINE—SCM, John W. Singleton, W1CDX—BTG is high man this month (B.P.L.) and reports the Army Net going fine. INW is new Maine Route Manager; he received a lot of praise for his fine work with Bowdoin Kents Island Expeditions. GOJ is Maine's Chief R.M. and is lining up the "Maine Message Pushers Net." KEN is going to put in a 211 and rattle the Aussies' eardrums. EFR has applied for O.R.S. IST is new R.M. AQL has changed QTH to 21 Chamberlain St., Brewer. ERB is looking for a few schedules. EEEY has been doing a lot of rebuilding. There are a lot of Maine stations handling traffic who don't report. Won't you chaps please get your report in each month in order to boost your Section and put Maine up with the leaders where she belongs. We need a little more "Section Spirit." Join the Maine Message Pushers Net and watch Maine go places this season. "Be Distinctive," fit yourself and your station to become an O.R.S. and, when you win this recognition, endeavor to keep up among the leaders in this high organization. Let's have a little more competition within our gates and don't let two or three stations grab the traffic honors month after month. Plan to lead the Section yourself next month and keep at it until you do. Come on, Gang.

Traffic: W1BTG 561 INW 116 GOJ 55 CDX 14 KEN 35.

EASTERN MASSACHUSETTS—SCM, Albert N. Giddis, W1ABG—AKS says things are picking up. HKK is new O.R.S. IHI mailed his report from N.H. IWC is new R.M. KH is crystal-controlled on 56 mc. BEF has new 28-mc. rig. ABC is looking for more net stations in the southern part of the Section. ASI has been busy campaigning for Director. JNU is interested in Cairo Survey. HKY deserted e.c. for e.c. IIN starts reporting again. HWZ is having transmitter trouble. IVX applies for O.R.S. JID won 212D in N.C.R. competition. JRH is joining M.N.G. WV needs VK for W.A.C. on 28 mc. IQH is knocking off VK's and K6's with RK23-RK20 rig. QW blew his RK18. A testimonial dinner was held for Dr. C. R. Crosby, retiring pres. of the Framingham Radio Club. The new officers of the club are FCZ, pres.; ICO, vice-pres.; CTR, secy.-treas.; and GMD, activities mgr. The Mystic Valley Radio Club and Parkway Radio Association have started their meetings for the season. You non-A.R.R.L. members can keep your Section on top, so let's have your reports on the 16th of the month. All will be appreciated.

Traffic: W1AKS 482 HWE 360 JCK 122 HKK 116 IHI 108 (WLGS 93) IWC 101 KH 88 BEF 80 FRO 78 ABG 51 ZQ 35 (WLGO 106) ASI 32 RE-JNU 11 HKY-CIK 10 IIN

S HWZ 7 IVX 5 GGB-CRO 4 AKE-JID-JRH 3 EPZ 1 DMF 59 QW 49 (CCIC 30) DDE 41 RH (CX1B 20).

WESTERN MASSACHUSETTS—SCM, William J. Barrett, W1JAH—IZW ran up a nice total. Keep it up, Andy. IOR sets the pace for originations. A little help from the rest of the gang would keep the schedules supplied with traffic. BVR managed to get into three figures, besides sponsoring the N.E. QSO Party. JAH went e.c. to let crystals cool off. IOT is warming up for the season. GUO turned in his best score to date, and is putting tens in final. DUZ is building RK23-803 rig. AJ qualified for O.R.S. Congrats, Ralph. HNE now has 53-RK20 setup. HJR, attending Tri-State College, Ind., is portable on 3.5 mc. Overtime work didn't keep EOB from leading Section in Birthday Party. ISN would like some regular schedules. Any of you fellows having similar trouble, please drop me a line so we can get things really moving. ZB is back on 14-mc. 'phone using his trick s.g. modulation. COI gets out nicely on ten with 6L6-6L6's—now to drive those '52's. BAP is taking a rest from 56 mc. JOT and IIP made the rounds visiting ERF, EUB, FGA, ARH and HNE. BNL moved to Holden, where WTAG is installing new shack for the new kw. rig, using vertical antennae 350' high—I'll take two—HI. JXN is building 3.5-mc. rig for traffic season. What say, fellows, how about some news for this here colyum??

Traffic: W1WZ 408 IOR 247 BVR 114 (WLG 20) JAH 110 IOT 52 GUO 71 DUZ 22 AJ 21 AJD 19 HNE 18 HJR 6 EOB 7 ISN 3 ZB 2 JJR 75.

NEW HAMPSHIRE—SCM, Carl B. Evans, W1BFT—Thanks a lot for all the reports, fellows. Let's have more next time. They may be forwarded via radio through TA, FFL and IP, as the S.C.M. contacts these stations regularly. APK has been appointed P.A.M. in charge of the 'Phone Net of the N.H. Emergency Network. Any stations interested in getting in on the emergency net, please write BFT for details. Present tentative set-up calls for a test drill the first Sunday of each month at 11:00 A.M. It is not necessary for operation with emergency power supply. Your regular station is OK. IVU has finally got the oscillation out of his new super-het. EWF has 1-kw. input on ten, and does he go places! JT has been fracturing crystals. 2FDD was a recent visitor in Concord. JGC is a new ham in Concord active on 7 mc. FFL has the Army Net going in great style; just look at the traffic totals. IP has a batch of schedules now and feels more at home now that traffic is picking up. HI, ADR and CPM are on ten. JSL has a T200 in the final. EAL schedules FFL daily. AUY had a good time in the N.E.B.P.; so did every one who was in on it. ANS is still spending 100% operating time rag-chewing. IDY has several schedules on 1.75-mc. 'phone. ITF is using a 6L6 crystal oscillator. KAW went to the Hudson Division Hamfest at Schenectady and reports an FB time. JJD has a new transmitter in the process of construction. JCA is being bothered by a local's key clicks. OE finally decided a crystal was the easiest way to clear up that note of his. BK is taking some graduate work at N.H.U.

Traffic: W1IP 338 HTO 318 FFL 294 (WLGB 49) BFT 261 IJB 132 GHT 124 FFZ 33 GMM 32 EAL 3 APK 24 IDY 9.

RHODE ISLAND—SCM, Clayton C. Gordon, W1HRC—IEG is still tops in A.A.R.S. in R.I. doing his job as state control. JPY has new 3519 crystal and new 59 osc., also swinging a new bug built by JLM. JNO sends his report in from Boston; he gets home week-ends and works a few on 7 and 14 mc. IAV is working plenty of DX on 14 mc. and has an HRO. HRC went on vacation way up in Vermont; can't meet the winter soon enough here. GTN is writing this report, so if no like don't blame HRC. IQF is now WLGW in A.A.R.S. and Alt. State control in place of QR, who still holds call WLGV. BJA is regular attendant at P.R.A. meetings now. CAB is back on the air after summer lay-off. IPU took two weeks' trip with the Navy. BES' antenna rope took its yearly falling out, and a pole lowering was held; among those present were IZO, CAB, GTN and T. Herman Gerry, the popular Spanish gent, and several others too numerous to mention. On the second Saturday in January the annual Rhode Island QSO party will be held, and that is the time for all you W.A.S. seekers to fill your R.I. hand; it will run from 11 p.m. EST, Sat., to 7 a.m., next morning, so put down the date—Jan. 9th-10th. JXA has signed up with the A.A.R.S. and IRJ with the N.C.R. IZO is Ensign in N.C.R. as well as Net Control in A.A.R.S. FAH is thinking of moving into town from his summer cottage on second beach, Newport. HRZ and JUE are still holding the 56-mc. band well in hand. AFO has portable 56-mc. rig in car, took it on vacation and spent his time, while driving, hamming

with the boys as he passed thru. The boys at AQ are getting in their winter wood and standing by for a cold winter. FUB is working on P.A. system using 6L6's. The P.R.A. held its annual Hallow'een Party, and all the goblins were there. JRY has a new superhet of which he is real proud. Code classes have started at the P.R.A. again on Monday evenings at 7:30 P.M. Anyone interested is welcome to attend.

Traffic: W1IEG 120 (WLGK 240) JFJ 110 IAV 31 GTN 163 IQF 59.

VERMONT—SCM, Alvin H. Battison, W1GNF—R.M.'s: 1FSV, 1EZ. P.A.M.'s: 1AVP, 1DQK. FSV is high traffic man; he has a fine line of schedules. GAZ now has a Go-Devil bug. GAN and IRO are on 3.5- and 14-mc. 'phone. IRO and AAJ attended the Schenectady Hamfest; both won prizes. ATF plans to be on for the Vt. traffic hour. EZ alternates between DX and traffic. AVP reports visits from CND, JKE and 4AZV. GAE is going to use remote control. AXN has parts for his new transmitter. FN is on 14-mc. 'phone. AAK made W.A.C. on 28 mc., VU2AU being the much sought Asian. ATZ is on 1.9-mc. 'phone. ELR needs Asia for his 28-mc. W.A.C.; he reports VK's easy to work. CUN is back in Newport. BJP has been promoted to Superintendent of Distribution of his power company; he needs Asia for 28-mc. W.A.C.; worked MX2G, VQ8AA and three J's on 14 mc.; needs two states for W.A.S. and sends two sheets of O.O. work. DQK is on 7 mc.; his XYL is now licensed as KEP. JZF has new NC100 ordered. AHN reports a visit with EMQ. GVJ attended the State Teachers Convention. BD still has his nose to the grindstone! AOO passed away after a short illness. He was one of the pioneering amateurs and will ever be remembered for his large abilities, yet modest nature, and for his radiant personality. His frequency will ever seem a dead spot on our dial—a tender remembrance. "30" W1AOO.

Traffic: W1FSV 324 GNF 96 EZ 60 GAE 38 ATF 11 AHN 6.

HUDSON DIVISION

EASTERN NEW YORK—SCM, Robert E. Haight, W2LU—EGF changed QTH to 23 Catherine St. NYC is using '03A final, 200 watts on 3.5 mc. BLU is getting out on 14, 7 and 3.5 mc. AZX reports HON OB schedule, 7 to 8:30 A.M. CC had several visits from VK3AL, also VK3HM, 3AL's son-in-law; G5GQ visited also. BJX reports activities of M.H.A.R.C. JWT, A.A.R.S., applies for O.R.S. IKV is on 3940-kc. 'phone: he won '03A at Hudson Division Convention. HUM is in Florida for next six months. HCM tried 'phone, but c.w. looks better. FQG sends 73 to gang and desires to hear from all. HNH is teaching geometry teacher the code. CJS won 211 at Hudson Convention. JRG reports for Mt. Vernon boys. JQX and JCY are on 56 mc. with new 60-watt 6L6 M.O.P.A.'s. VJ is on 3.5- and 7-mc. c.w. with 75-watt job. JRG is on 3.5- and 7-mc. c.w. with 50-watt rig. HKD has new ACR-175 and new 75-watt M.O.P.A. on 56 mc., also new Jr. op. of YL variety. JAM is rebuilding 56-mc. rig for 100 watts. JCY got letter from Wales on 56-mc. sigs heard there. EGI is back on the air on 7 mc. with 60-watt rig. Westchester Amateur Radio Ass'n in membership drive got 30 hams signed up. ILN is off 56 mc. for good because of B.C.L. trouble. MQ is building police u.h.f. rigs in Eastchester; just finished 50-watt job for Greenburg. P.D. BFB is now running 960 watts on 14-mc. 'phone. BNR is back after all-summer layoff. BDB built new superhet. ITK will report for HUM. ISQ made initial report and promises to handle traffic on 3.5 mc. JSL joined A.R.R.L. and desires activity on the air, handling traffic, etc. We are sorry to report that BJA, due to bad health, goes on the inactive list. The boys extend their best wishes for a speedy recovery. JKT is using 6L6G crystal osc.-55 watts input. BJX reports for following: IXK and GXE returned to Harvard and M.I.T. GDF and CWT are hamming around on 56 mc. DOS, the c.w. man, is on 7 and 3.5 mc. DWO reports signals from West Coast audible on 28 mc. HES is on 3.5 mc. while CGT waits for the fire cracker to go off to get him on again. BJX is active daily on 3560 kc. and desires to contact anyone desiring schedule; drop him a card. HVS got the 56-mc. bug. CDM's real he-man transmitter will use 600 watts in final. The M.H.A.R.C. was well represented at the Hudson Div. Con. by CDM, BJX, GWY, HES, HVS, Bob Hubbard, Earl Rhodes and DDW.

Traffic: W2EGF 674 HYC 344 BLU 100 HON 20 CC 12 BJX 8 JWT 6 IKV 4 HUM-HCM 3.

NEW YORK CITY AND LONG ISLAND—SCM, E. L. Baunach, W2AZV—All reporters please note my new QTH:

102 Central Ave., Massapequa, L. I. New O.R.S.: BDN, DQW. KI can be heard on Trunk Line "C" daily on 3665 kc. at 7 P.M. PF is studying for promotion to major in Signal Reserve and can be heard on Monday nights for A.A.R.S. schedules. CHK has new job as studio engineer at WNEV. LG has the urge to go back to sea operating, but at the present time is trying to make crystals oscillate. O. O. GDF finds plenty of harmonics in the commercial bands to keep him busy checking. JFP is studying for a Class "A" ticket. FF wants a QSO with a Delaware station on 3550 kc. ELK sent a message to Hollywood, Calif., via 6WQ, and got an answer in five minutes. HSV handled his first message. CGI reports for the first time after being inactive for five years. JWN wants to get back on 7 mc. after being on 56 mc. all summer. GVX finally made his W.A.C. cert. and reports that the Columbia College Radio Club has a pair of 830B's on 7 and 14 mc. JGR reports for C.C.N.Y. Radio Club, HJ; new ops there are: HGM, HRT, IVK, JCD and KAF. IOP operates CXN, Brooklyn Tech. station, and is looking for O.E.S. appt. HBO reports that the Tu-Boro Radio Club is building 200-watt rig. BGO is rebuilding his complete outfit. APV is working on vertical antenna with reflector rotatable. JCD gets better results with a center-fed antenna than the end-fed Zepp. JAJ's 14-mc. harmonic was heard in Java, so now he is on 14 mc. HKO's rectifiers went west. HLI is going on 1.75-mc. 'phone. EYQ is at his new QTH: 116-58 130th Street, South Ozone Park. ISL blew his only 211D. GUL can't get his doubler to work on 14 mc. JVX's feeders blew down. BMG uses 4-tube Super Gainer. OQ is new net member. JBJ can be heard on 7012 kc. using 6L6 tritret and 10 final, 50-watts input. IHT has 6L6's working on 7145 kc. JGC is building rack and panel job. HWS is working school station JIP, CYX worked 50 VK's on 14-mc. 'phone during month. JBL is limited to one hour a day on the air. JWU is building up new rig. DXO is looking for the L. I. Net. EXR hears plenty of Canadians. IBT is on 56 mc. using TNT P.P. '45's; he leads in traffic. The L. I. Net operates on 3710 kc.; work DBQ for details. HGO is having trouble with 242 P.P. final. Regular operating frequencies: EYS 3512; JHB 3614; HRA 7101; HMJ14, 348. N.C.R. members on 3570 kc.: ADW, FLD, GES, AOV, AJM, HDP, AA, CIT, ENS, BIK, BFA. IOP is anxious to have out-of-town hams visit him at 277 West End Ave., N.Y.C., telephone SU-7-2928.

Traffic: W2IBT 367 BMG 223 JBL 202 DQW 157 KI 135 DBQ 216 (WLNb 96) PF 94 IHT 46 BGO 44 HBO 38 FF 30 CYX 29 DXO 22 GDF 21 AZV 20 EXR 19 HMJ 15 LG-CGI 13 HGO 10 APV 7 HRA 6 ELK-BYS-ADW-FLD-GES 5 AOV 4 AJM 5 HDP-AA-CIT-ENS-BIK-BFA-JBJ 4 HSV 1 HLI-HWS 2.

NORTHERN NEW JERSEY—SCM, Charles J. Hammersen, W2FOP—HZY made the B.P.L. this month. HOZ is new member of the N.N.J. QSP Club. GVZ finished 1-kw. rig for 7 mc., his third high-power rig in operation. ICM is now living in Newark. HNP won 211 at Hudson Division Convention. FOP is member of the A.A.R.S. HXI had CM2BA as a visitor. HBQ is looking up new O.R.S. in Ocean and Monmouth Counties. HCO is back on the air after a stay in the hospital. ECO needs Asia for W.A.C. FFY has revamped osc. in his 14-mc. 'phone to use 6L6. GZG has raised power and is satisfied with his new Class B unit. JDO has changed QTH again. JDY sticks to 7 mc. and soon hopes to get W.A.S. HLX is working on 53 exciter. IMB gave up cascade modulation—result, big improvement in signal. HIA's brother has 7-mc. rig in the same room; their antenna layout would make A.T. and T. jealous. FOI is new secretary of O.T.C.R.A., taking the place of HTX, who is away at college. BTZ has new job, also a new car. HVK is also running around in new car. CAY acquired a new relay rack. CQX believes in matrimony after being stuck to his power supply and not being able to let go; lucky his XYL pulled the 110 line or CQX would appear elsewhere in this issue. GMN, HVK and HNP represented O.T.C.R.A. at the convention; GMN was only one not to win a prize. IGN took a try at 14 mc. and worked five countries in a couple of days. HFT is back on the air for winter traffic work. IDZ is working 14,242 kc. this winter. HFB is working out fine on 1991.5 kc. HNX had FB time at convention, acquiring some good parts from the scrap heap of WGY at Schenectady. We are still looking for some good traffic men to fill out our Section Net. If you are interested, see your S.C.M.

Traffic: W2BCX 436 (WLNb 654) HZY 524 GGE 356 GGW 329 HOZ 218 GZV 216 ICM 178 HNP 114 FOP 109 HXI 108 GAS 63 HQL 58 HBQ 50 BZJ 35 ICJ 30 IQM 27 CJX 24 HCO 5.

Know Your Condensers!



What determines a good condenser?

How does temperature affect a capacitor?

These are the important considerations in buying transmitting condensers. CONTINENTAL Carbon impregnated, non-inductive, high-voltage capacitors have all the desirable characteristics of an oil condenser with the compact size of a paper condenser. The characteristic curves are your guarantee of full value in transmitting condensers. Write for Bulletins 103 and 104-A.



13924 Lorain Avenue, Cleveland, Ohio Toronto, Canada

RME-69 "PATRONIZE THE HAM"
 60-day money-back guarantee! Shipped C.O.D. nothing down! "Give the ham the break." Order your RME-69 direct from Rus Sakers (WBDED), the QSL printer, who has been an active ham over 10 years! Prices: Set complete, with speaker \$134.90. Set complete without speaker \$119. "Write us for free circular today."
 BILEY CRYSTALS: BC3 (40 or 80) \$3.95; LD2 (160-80 or 40) \$4.80; HF2 (20 meters) \$6.50. Holder included in price.
 RUS SAKERS (WBDED)
 53 East 7th St., Holland, Michigan
 QSLst World's finest. Send stamps for samples.

80 PAGES OF ANTENNA DOPE!

The **RADIO ANTENNA HANDBOOK**

Just imagine, an entire book on antennas — 80 pages, profusely illustrated with diagrams, charts and tables that make involved calculations unnecessary. Descriptions of every kind and type of antenna by RADIO'S expert staff. This book should be in every amateur's technical library.

50¢
 75¢
 1.00

50¢
 IN U. S. and CANADA
60¢ ELSEWHERE
 Canadian and British (2/6) special rates acceptable

On sale at all good radio parts dealers or direct from us by mail postpaid.

RADIO, LTD.
 7460 BEVERLY BOULEVARD, LOS ANGELES, CAL.

A.R.R.L. QSL Bureau

FOR the convenience of its members, the League maintains a QSL-card forwarding system which operates through volunteer "District QSL Managers" in each of the nine U. S. and five Canadian districts. In order to secure such foreign cards as may be received for you, send your district manager a standard No. 8 stamped envelope. If you have reason to expect a considerable number of cards, put on an extra stamp so that it has a total of six-cents postage. Your own name and address go in the customary place on the face, and *your station call should be printed prominently in the upper left-hand corner.*

- W1—J. T. Steiger, W1BGY, 35 Call Street, Willimansett, Mass.
- W2—H. W. Yahnel, W2SN, Lake Ave., Helmetta, N. J.
- W3—R. E. Macomber, W3CZE, 418 10th St., N. W., Washington, D. C.
- W4—B. W. Benning, W4CBY, 520 Whiteford Ave., Atlanta, Ga.
- W5—E. H. Treadaway, W5DKR, 2749 Myrtle St., New Orleans, La.
- W6—D. Cason Mast, W6KHV, 423 East E Street, Ontario, Calif.
- W7—Frank E. Pratt, W7DXZ, 5023 So. Ferry St., Tacoma, Wash.
- W8—F. W. Allen, W8GER, 324 Richmond Ave., Dayton, Ohio.
- W9—George Dammann, W9JO, 319 Sherman Ave., Evanston, Ill.
- VE1—J. E. Roue, VE1FB, 84 Spring Garden Rd., Halifax, N. S.
- VE2—W. H. Oke, VE2AH, 5184 Mountain Sights Ave., N. D. G., Montreal, P. Q.
- VE3—Bert Knowles, VE3QB, Lanark, Ont.
- VE4—Dr. J. J. Dobry, VE4DR, Killam, Alberta.
- VE5—E. H. Cooper, VE5EC, 2024 Carnarvon St., Victoria, B. C.
- K4—F. McCown, K4RJ, Family Court 7, San-turce, Puerto Rico.
- K5—John J. Carr, K5AV, 78th Pursuit Squadron, Albrook Field, Canal Zone.
- K6—James F. Pa, K6LBH, 1416D Lunalilo St., Honolulu, T. H.
- K7—Frank P. Barnes, K7DVF, Box 297, Wrangell, Alaska.
- KA—George L. Rickard, KA1GF, P. O. Box 849, Manila, P. I.

Circulation Statement

PUBLISHER'S STATEMENT OF CIRCULATION AS GIVEN TO STANDARD RATE AND DATA SERVICE

This is to certify that the average circulation per issue of QST for the six months' period January 1st to and including June 30, 1936, was as follows:

Copies sold	42,872
Copies distributed free	406
Total	43,278

K. B. Warner, Business Manager
 D. H. Houghton, Circulation Manager

Subscribed to and sworn before me on this 31st day of August, 1936
 Alice V. Scanlan, Notary Public

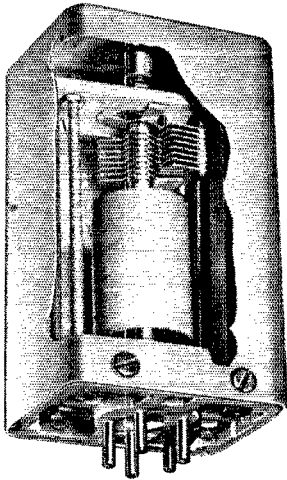

Something New for SHIELDED PLUG-IN COILS

WITH this new plug-in base, it is extremely easy to build high performance gear—whether it be for experimental receivers, bread board layouts, monitors, exciters or what have you.

The low-loss R-39 base, with prongs moulded in to fit standard sockets, has mounting holes for our type UM Air Dielectric Condensers and our R-39 coil forms. The illustration shows the effective assembly that is possible with these units. This PB-10 base fits our Fixed Tuned Exciter Tanks, thus making them available for plug-in mounting. Attachment to the shield can is easily made by four screws.

The generous shield and the low-loss base offers you the best assurance of satisfactory operation of whatever gear you may mount inside.

Plug-in Base and Shield, Type PB-10 (either 5 or 6 prong), Net price, \$.45
 Plug-in Base (only 5 or 6 prong) Type PB-10A, Net Price,24
 Fixed Tuned Exciter Tank, with PB-10 Base, Type FXTB (either 5 or 6 prong), Net price,2.94
 Midget Coil Forms (R-39), Type XR-2 (1" dia. x 1½" long), Net price,21
 Type XR-3 (9/16" dia. x ¾" long), Net price,18
 Ultra Midget Condenser, Type UM, Net prices from, \$.75 to \$1.10

NATIONAL COMPANY, INC.
 MALDEN, MASS.

The New 1937 Bigger-than-ever Handbook

WILL MAKE THE IDEAL
 XMAS PRESENT

Simply send in your order now with name and address of the person or persons to whom it is to be sent, giving the name of the donor. We'll do the rest — see to it that the new **HANDBOOK** reaches destination on or before December 25. A suitable gift card will be sent with each copy. Swell idea, huh?

\$1 POSTPAID
 \$1.25 OUTSIDE CONTINENTAL U. S. A.

Buckram Bound, \$2.50

AMERICAN RADIO RELAY LEAGUE
 West Hartford, Connecticut

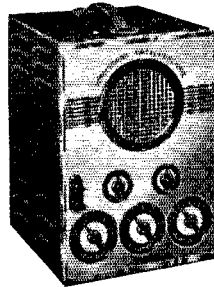

NEW
 NEOBEAM

OSCILLOSCOPE

"Makes Sound Visible"

- SUPER-SENSITIVITY — 1 MICROVOLT
- 4-INCH CALIBRATED SCREEN
- SELF-CONTAINED POWER SUPPLY AND SWEEP SYSTEM
- SIMPLICITY OF OPERATION

Latest development in oscilloscopes — uses new Modulated Neon Beam principle — opens new fields in audio measurement. Checks modulation, locates distortion. Excellent for amplifier, microphone and speaker response. Used in wave form study or as a super-sensitive galvanometer and vacuum tube voltmeter. The unit as illustrated measures 8¾" wide, 10" deep and 13" high. Beautiful etched chrome finish on panel. Durable and fully guaranteed.

Send for full details today
 \$40.00 NET — COMPLETE

SUNDT ENGINEERING CO.

Affiliate of Littelfuse Laboratories

4246 Lincoln Avenue

Chicago, Illinois

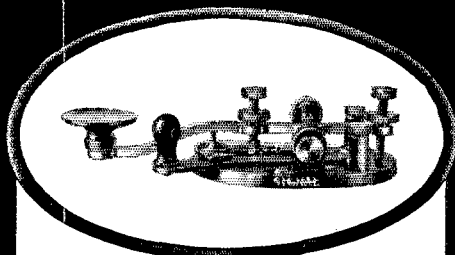

FOR RAPID TRANSMITTING

This telegraph key M-100 is preferred by skilled operators and beginners. The base, equipped with binding posts, is brass with lacquer finish — key lever nickel plated. Furnished with platinum contact points. List price \$3.00.

SIGNAL's line of Wireless Keys, Telegraph Instruments and Wireless Practice Sets is complete. Send for our bulletin.

SIGNAL ELECTRIC MFG. CO.
Menominee, Michigan, U.S.A.

SIGNAL
MANUFACTURERS OF ELECTRICAL PRODUCTS

GULF RADIO SCHOOL

Radiotelegraphy Radiotelephony
Radio Servicing

SECOND PORT } 1007 Carondelet Street
U. S. A. } NEW ORLEANS, LA.



**NEW
HOLDER
DESIGN**
15 SECONDS
TO INSTALL
CRYSTAL

For All Bands
**GREATER
STABILITY**
Plugs in 5 prong
tube socket
Beautiful
Appearance

MODEL AH HOLDER \$1.00

At your dealer or direct

HIPOWER LOW DRIFT CRYSTALS:
within 10 kc. or Choice of stock

AH-10, 1700-3500 Kc. bands \$2.35
AH-10, 7000-7300 " band 3.90

write for new Literature

Hipower "Low Drift" Broadcast and Commercial
Crystals Are Approved by F.C.C.

Hipower Crystal Co., 2035 Charleston St., Chicago

Standard Frequency Transmissions

Date	Schedule	Station	Date	Schedule	Station
Dec. 4	A	W6XX	Jan. 8	B	W9XAN
Dec. 11	B	W6XX		B	W6XX
	B	W9XAN	Jan. 13	C	W9XAN
Dec. 18	B	W9XAN	Jan. 15	B	W9XAN
	A	W6XX		A	W6XX
Dec. 23	BB	W9XAN	Jan. 20	BB	W9XAN
Dec. 25	Holiday		Jan. 22	BB	W6XX
Dec. 26	BX	W6XX		A	W9XAN
Dec. 27	C	W6XX	Jan. 23	BX	W6XX
Jan. 1	Holiday		Jan. 24	C	W6XX
			Jan. 29	A	W6XX

STANDARD FREQUENCY SCHEDULES

Time (p.m.)	Sched. and Freq. (kc.)		Time (p.m.)	Sched. and Freq. (kc.)	
	A	B		BB	C
8:00	3500	7000	4:00	7000	14,000
8:08	3600	7100	4:08	7100	14,100
8:16	3700	7200	4:16	7200	14,200
8:24	3800	7300	4:24	7300	14,300
8:32	3900		4:32		14,400
8:40	4000				

Time (a.m.)	Sched. and Freq. (kc.)
6:00	7000
6:08	7100
6:16	7200
6:24	7300

The time specified in the schedules is local standard time at the transmitting station. W9XAN uses Central Standard Time, and W6XX, Pacific Standard Time.

TRANSMITTING PROCEDURE

The time allotted to each transmission is 8 minutes divided as follows:

- 2 minutes—QST QST QST de (station call letters).
 - 3 minutes—Characteristic letter of station followed by call letters and statement of frequency. The characteristic letter of W9XAN is "O"; and that of W6XX is "M."
 - 1 minute—Statement of frequency in kilocycles and announcement of next frequency.
 - 2 minutes—Time allowed to change to next frequency.
- W9XAN: Elgin Observatory, Elgin National Watch Company, Elgin, Ill., Frank D. Urie in charge.
W6XX: Don Lee Broadcasting System, Los Angeles, Calif., Harold Perry in charge.

Schedules for WWV

EACH Tuesday, Wednesday and Friday (except legal holidays), the National Bureau of Standards station WWV will transmit on three frequencies as follows: noon to 1:00 p.m. E.S.T., 15,000 kc.; 1:15 to 2:15 p.m., 10,000 kc.; 2:30 to 3:30 p.m., 5000 kc. On each Tuesday and Friday the emissions are continuous unmodulated waves (c.w.); and on each Wednesday they are modulated by an audio frequency. The audio frequency is in general 1000 cycles per second.

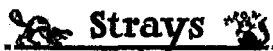

In connection with the voice-controlled relay described in November *QST*, W2AKH writes that some trouble with oscillation of the 885 without voice input was experienced when the 50,000-ohm cathode resistor specified in the article was used. Changing to 100,000 ohms cured it and the unit then worked as described.

W9OKZ reports that there is now a third VS2: Mr. Beebe, VS2AJ. Which certainly proves that VS2's are consistent! (October *QST*, p. 78.)

HARVEY'S POPULAR TWIN KITS

Provide High Performance at Extremely Low Price

TRANSMITTER KIT

HAMS are enthusiastic about their c.w. transmitters built from our official diagram and Model X Twin Kit, using 6L6-G crystal oscillator and 83 rectifier. This rig, link-coupled to antenna, provides 20 watts output with self-contained power supply, on 40, 80 and 160-meter bands. Carefully designed, laboratory checked and air tested, this circuit has met every reasonable demand. The kit also is marked by completeness and quality of parts. RCA tubes, Cornell-Dubilier condensers, UTC choke and transformer in the kit.

WHAT YOU GET: Coil form, wire, directions for winding and spacing secondary and link for 40, 80, 160 meters. Power transformer, 400-0-450 v. a.c., 50-watt primary. B supply choke, 10 henries at 200 ma. 2.5 millihenry r.f. choke. 100 mfd. tuning condenser, Isolantite insulation, 1,000 v. B.D. Three .01 mfd. paper condensers, 600 w.v., 8 mfd. dry electrolytic 400 v. wkg. Voltage divider, 3,000-ohm, 10-watt; 50,000-ohm, 3-watt, 10,000-ohm, 1-watt, 400-ohm, 10-watt. Drilled, punched, finished chassis 7 x 14 x 3 inches. Valpey crystal (specify band) VM2. Four sockets (two for tubes, one for crystal, one for coil), 0-100 etched metal dial plate with pointer knob. Line cord and toggle switch. Two standoff insulators for link output connection. Screws, nuts, bolts, wire. 6L6-G and 83 tubes (one each). Diagram and instructions. Order Model Twin X Kit, shipping weight 10 lbs. **\$15**

The crystal oscillator kit may be built for use as driver of a 100-watt transmitter, and the amplifier kit built as modulator of the r.f. final.

10 METERS NOW HOT; CHIME IN!

GREAT activity now marks the 10-meter band as signals once more pierce great distances. For 10 meters we recommend: Johnson Q Antenna, **\$3.75**
New RCA 807 beam power tube, 25 watts, **3.90**
Taylor T-55, 168 watts, **8.00**
Latest and best high-frequency parts in stock, including National 110 Receiver (1 to 10 meters).

Send for Circular 1236 for a Wide Choice of Quality Parts and Sets, including Sky Riders on time payments with generous trade-in allowance

HARVEY RADIO CO., NEW YORK

103 West 43rd Street, New York, N. Y.
Harvey E. Sampson, President

"LET'S SHAKE HANDS WHEN YOU VISIT NEW YORK"

AMPLIFIER KIT

THE Model A Twin Kit contains parts for building an audio amplifier of 15 watts output at 2 per cent. total harmonic distortion. Primarily a speech amplifier, with its 5Z3 power supply, for modulating a medium-powered voice transmitter, with 100 dB gain, and high impedance input, this circuit may be used also for public address, phonograph pickup, or for supplying audio power amplification for a tuner. Our circuit is a phase inverter balanced against degeneration and phase distortion. A 6J7 input feeds a 6C5 inverter-driver. Output consists of 6L6 push-pull. Volume and tone control.

WHAT YOU GET: UTC Power transformer, 400-0-400 a.c., 50-watt primary. UTC 30-henry, 125 ma. B choke. UTC output transformer, primary 6,000 ohms p. to p.; secondary tapped for 1.5, 3, 5, 8 and 15 ohms for voice coils. Chrome shield. 25 mfd. 35-v., C-D dry electrolytic. Two separate 8 mfd. 400 v. C-D dry electrolytics. Two 1 mfd. C-D 400-v. paper stopping condensers. 1 mfd. C-D 400-v. cone control condenser. 25,000-ohm tone control rheostat. 500,000-ohm potentiometer volume control. 10,000-ohm, 1-watt. Two 100,000-ohm, 1-watt. Three 50,000-ohm, 1-watt. 125-ohm, 10-watt. Punched, drilled and finished chassis, 5 x 15 x 2.5 inches. Five sockets for tubes, one socket for tuner output (tuner plug and connector not supplied); 3-terminal strip; line cord, plug and toggle switch; two knobs; screws, nuts, bolts; RCA tubes, one 6J7, one 6C5, one 5Z3, two 6L6. Diagram and instructions. **\$17.00**
Order Model Twin T Kit (shipping wt. 15 lbs.)

WE STOCK ONLY BEST PRODUCTS!

WE handle only the best lines, including RCA, National, WRC, Hammarlund, UTC, Cornell-Dubilier, RME, Hallcrafters, Eimac, Johnson, Valpey, etc., and have a wide stock of tubes of every famous tube manufacturer in the country. We guarantee reliability, promptness and courtesy, backed by ten years' success in radio.

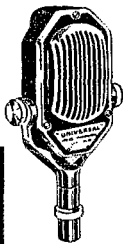

UNIVERSAL VELOCITY AND CARBON MICROPHONES

Universal's latest achievement — Ideal for stage use — Not affected by temperature or humidity — Flat frequency response curve from 40 to 10,000 c.p.s.; Output-63 db; Low impedance or direct to grid types. Compact 2 3/4 x 4 3/4 in. by 1 3/4 in. thick — Weight, less than 18 oz. — Head swings to any desired angle. Beautifully finished in black enamel and artistic chrome plate — ask for new catalog sheet describing models RL, RP, RH and CB — List \$22.50 — Latest model music type sectional stand for above microphones — List \$10.00.

UNIVERSAL MICROPHONE CO., LTD.
424 Warren Lane Inglewood, Calif., U. S. A.

PREFERRED BY ALL TRIMM LEADS

with the most complete headset line in the world. Thousands of operators are using TRIMM phones because they are assured of a reliable source of supply and service.

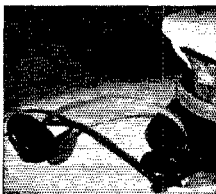

TRIMM RADIO MFG. CO.
1770 W. Basteau Avenue, Chicago
Illinois, U.S.A.

NEW

BIRNBACH

X'mitting sockets

AT LOW PRICES

featuring



- SIDE WIPING CONTACTS
- BRASS, NICKEL PLATED SHELL
- HIGHLY VITRIFIED, LOW ABSORPTION BASE
- ALL BRASS HARDWARE
- LOW PRICES

No. 434, 50 watt. \$1.25 list ea. No. 435, 10 watt. 90c list ea.

SPECIAL LOW PRICES IN LARGE QUANTITIES

Improved Cone Standoff Insulators

Made of STEATITE, the better ceramic. Complete range of heights. Condenser, coils, tube sockets, etc., can be mounted with minimum labor. White glaze.

No.	Heights	List	See your jobber. If he cannot supply you, write direct to Dept.
430	3/8"	10c	
431	1"	15c	Q-12.
431J (Jack Type)	1"	20c	
432	1 1/2"	20c	
432J (Jack Type)	1 1/2"	25c	
433	2 1/2"	25c	
433J (Jack Type)	2 1/2"	50c	



BIRNBACH RADIO CO. INC.
145 HUDSON ST. BIRCO NEW YORK, N. Y.



**Ask the Ham
who owns one!**



**"Speech Range" Model D-104
Crystal Microphone**

The favorite of amateurs all over the world because of its superior quality in the "speech range," its high output level, its ruggedness of construction, absence from background noise and trouble-free dependability. Bronze case heavily chrome plated. List Price \$22.50. Available with handle, handle with hand switch, handle with relay switch or stand — slightly extra. Equipped eight feet of rubber covered cable.

*Under
Constant
Engineering
Improvement*

**GUARANTEED. Licensed Under BRUSH Development
Company Patents**

SEE YOUR JOBBER

ASTATIC MICROPHONE LABORATORY, INC.
YOUNGSTOWN, OHIO, U. S. A.

**A New
TIME PAYMENT PLAN**

No Interest Charges

We now offer you a special five payment plan, which applies to all receivers, transmitters, and parts. A nominal \$3.00 account charge is made to cover credit investigation, etc. No time payment sales outside U. S. A.

EXAMPLES

RME 69 Receiver Complete — *Net Cash, \$134.90; Down Payment, \$29.98; Four Monthly Payments of \$26.98.*

NC-100X Complete, Tubes, Speaker, Cabinet — *Net Cash, \$140.60; Down Payment, \$31.12; Four Monthly Payments of \$28.12.*

2 Type 805 RCA Tubes — *Net Cash, \$36.00; Down Payment, \$10.20; Four Monthly Payments of \$7.20.*

Our regular ten payment plan, with a down payment of only 10%, is available to those who desire longer terms. Finance charges are made on this plan. Parts and accessories are sold for either cash or five payments.

WILLARD WILSON—W3DQ

**DELAWARE
RADIO SALES COMPANY**
Established 1920

405 Delaware Avenue, Wilmington, Del.

A Versatile U.H.F. Transmitter

(Continued from page 86)

amplifier vacuum tubes, they will be excited sufficiently also to draw plate current. The plate meter should be removed from the third amplifier plate jack and inserted in the power amplifier plate jack and the plate tank circuit of the final amplifier should be brought to resonance to prevent damage to the two WE305A tubes. It is advisable at this time to readjust all circuits in the entire unit as previously described. The 60-watt bulb acting as a dummy load for the transmitter should be at full brilliancy with these preliminary adjustments. More accurate adjustments will improve this to some extent.

Throwing the toggle switch in the grid circuit of the final amplifier in either direction measures the grid current of either of the WE305A vacuum tubes in the final amplifier. The tuning coils should be compressed or expanded as necessary to provide equal grid current in either circuit. Once equalized, such readjustment is unnecessary. It is preferable to obtain this condition with neither plate nor screen voltage on the push-pull final amplifier stage, since a non-resonant condition in plate of the final amplifier may bring about unequal grid current. After equal grid currents are established, similar adjustments should be made to the plate tank coils in the final amplifier by checking to see whether the grid currents have been unbalanced. It is not necessary that this procedure be very accurate. Experience has shown that more than a 10% discrepancy seldom occurs. In passing it may be well to mention that the push-pull inductances, both in the grid and plate circuits, are spaced equally distant from the shielding at both ends and the transmitter is inserted in the cabinet with but one side removed to allow access to the coils during adjustment, thus retaining a balanced condition.

The authors wish to express their appreciation for the excellent cooperation offered by the Wilder Manufacturing Company of Brooklyn, New York, and for their aid in solving the mechanical problems and the actual metal work involved.

The Delta Division Convention

BRIGHT and early Saturday morning, September 5th, several members of the Monroe Amateur Radio Club were on hand at the Virginia Hotel to greet the arriving Delta Division amateurs. The ladies were sent off to the theatre at about 1:30 P.M. to enjoy the film "Anthony Adverse," while the rest of the gang gathered on the roof for greetings by the Commissioner of Public Utilities, Hon. W. D. H. Rodriguez, representing the mayor of the city. Informality was the rule of the day, especially after Com. Rodriguez compared the influx of "hams" to the shipping of

(Continued on page 116)

Two Hundred Meters and Down

The Story of Amateur Radio

By **CLINTON B. DESOTO**

THERE'S a new topic of conversation in amateur radio these days. It starts off with the question: "Have you read Clint DeSoto's new book on ham history? 'Two Hundred Meters and Down', you know?"

And from then on almost anything may develop — swapping of reminiscences over the good ol' days — memories of things long past and long forgotten, nostalgic trifles dredged up by this fascinating and absorbing account of amateur radio from its earliest days to its present grand estate.

You owe it to yourself, as an amateur, to learn from this book the fundamental why's and wherefore's of amateur radio. You owe it to yourself, as an individual, to provide yourself with the evenings of thrilling entertainment surging between the attractive gold-lettered deep red covers of "Two Hundred Meters and Down: The Story of Amateur Radio."

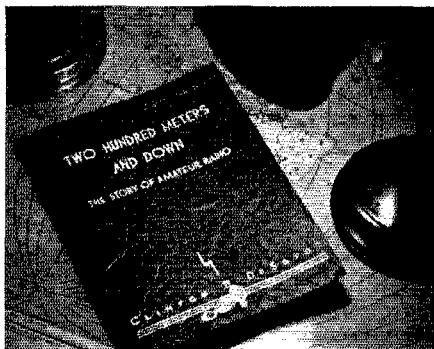

\$1 postpaid

Approximately 200 Pages, 90,000 Words, with Durable Imitation Leather Red Paper Cover

DE LUXE EDITION, bound in blue cloth, \$2.00

AMERICAN RADIO RELAY LEAGUE, West Hartford, Conn., U. S. A.

5000 Watt Western Electric Broadcasting Transmitter FOR SALE

Price very reasonable, either "as is" or modified to meet FCC requirements

LEROY M. E. CLAUSING « » 5509½ Lincoln Avenue, Chicago, Illinois

A NEW *Factory*
POLICY *Prices*

Watch your QUALITY

Triumph Top Operated Top scanned Oscillograph. Protects your transmitter. Keeps you within F.C.C. regulations. Standard U. S. Government Equipment. Write today and save big money. Ship. wt. 33 lbs. F. O. B. Chicago. 25% down. Balance C.O.D.

\$63.60

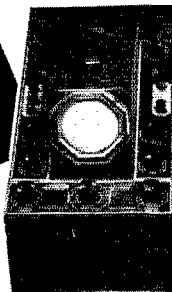

Money Back Guarantee

We stand back of every piece of testing equipment we sell direct. Your money cheerfully refunded on merchandise returned within 10 days in original condition.

TRIUMPH MFG. CO.

4015 W. Lake St.
Chicago, Ill.

Triumph Slashes Prices

New Factory-Direct Plan. No middleman profits—no high interest rates—no long time payments. Order direct from Triumph. Send today for complete details, ACT NOW.

Where to buy it

A directory of suppliers who carry in stock the products of these dependable manufacturers.

ASTATIC
Crystal Microphones and Pickups

ASTATIC MICROPHONE LABORATORY, Inc. YOUNGSTOWN, O.
Pioneer Manufacturers of Quality Crystal Products

NEWARK, N. J. 219 Central Ave.
Wholesale Radio Service Co., Inc.

NEW YORK, N. Y. Harvey's Radio Shop 103 W. 43rd St.

NEW YORK, N. Y. Wholesale Radio Service Co., Inc. 100 Sixth Avenue

PHILADELPHIA, PENN. Eugene G. Wile 10 S. 10th Street

super sky rider
hallicrafters
ultra sky rider

ALBANY, N. Y. Uncle Dave's Radio Shack 356 Broadway

BALTIMORE, MD. Radio Electric Service Company 3 North Howard St.

BOSTON, MASS. Radio Shack 46 Brattle Street

HARTFORD, CONN. Radio Inspection Service Co. 227 Asylum Street

NEWARK, N. J. Wholesale Radio Service Co., Inc. 219 Central Ave.

NEW YORK, N. Y. Gross Radio, Inc. 51 Vesey St.

NEW YORK, N. Y. Harrison Radio Co. 12 West Broadway

NEW YORK, N. Y. Harvey's Radio Shop 103 W. 43rd St.

NEW YORK, N. Y. Wholesale Radio Service Co., Inc. 100 Sixth Ave.

READING, PENN. George D. Barbey Company 404 Walnut St.

SPRINGFIELD, MASS. T. F. Cushing 349 Worthington St.

E.F. JOHNSON COMPANY
MANUFACTURERS OF
TRANSMITTING RADIO EQUIPMENT
WASECA, MINN
U.S.A.

MONTREAL, CANADA 285 Craig Street, West
Canadian Electrical Supply Co., Ltd.

NEWARK, N. J. 219 Central Ave.
Wholesale Radio Service Company

NEW YORK, N. Y. Harrison Radio Company 12 West Broadway

NEW YORK, N. Y. Wholesale Radio Service Company 100 Sixth Avenue

PITTSBURGH, PENN. Cameradio Company 603 Grant Street

READING, PENN. George D. Barbey Company 404 Walnut Street

RCA Amateur Products

ALBANY, N. Y. Uncle Dave's Radio Shack 356 Broadway

BALTIMORE, MD. Radio Electric Service Company 3 North Howard St.

BOSTON, MASS. H. Jappe Company 46 Cornhill

BOSTON, MASS. Radio Shack 46 Brattle Street

CAMDEN, NEW JERSEY Radio Electric Service Company 811 Federal Street

ERIE, PENN. 1011 West 8th Street
J. V. Dumcombe Company

GREENWICH, CONN. 252 Greenwich Ave.
Mead Stationery Company

HARTFORD, CONN. Radio Inspection Service Co. 227 Asylum Street

MONTREAL, CANADA 285 Craig Street, West
Canadian Electrical Supply Co., Ltd.

NEWARK, N. J. Wholesale Radio Service Co. 219 Central Avenue

NEW YORK, N. Y. Bruno-New York, Inc. 460 W. 34th St.

NEW YORK, N. Y. Sanford Samuel Corp. 136 Liberty St.

NEW YORK, N. Y. Wholesale Radio Service Co. 100 Sixth Avenue

NEW YORK, NEW YORK Harrison Radio Company 12 West Broadway

NEW YORK, NEW YORK Grand Central Radio, Inc. 124 E. 44th Street

PHILADELPHIA, PENN. Eugene G. Wile 10 S. 10th Street

PHILADELPHIA, PENN. Raymond Rosen & Company 117 North 7th St.

PHILADELPHIA, PENN. M & H Sporting Goods Company 512 Market Street

PHILADELPHIA, PENN. 3125 N. Broad Street
Radio Electric Service Company

PHILADELPHIA, PENN. N.E. Corner 7th & Arch Streets
Radio Electric Service Company

Where to buy it

A directory of suppliers who carry in stock the products of these dependable manufacturers.

PITTSBURGH, PENN. Cameradio Company 603 Grant Street
READING, PENN. Bright & Company 8th & Elm Streets
ROCHESTER, NEW YORK 244 Clinton Avenue, N.
 Radio Service Shop
SPRINGFIELD, MASS. T. F. Cushing 349 Worthington Street
SPRINGFIELD, MASS. 1540 Main Street
 S. S. Kresge Radio Department
WASHINGTON, D. C. 938 F Street, N. W.
 Sun Radio & Service Supply Co.

NEWARK, NEW JERSEY 219 Central Street
 Wholesale Radio Service Co.
NEW YORK, N. Y. 12 West Broadway
 Harrison Radio Company
NEW YORK, N. Y. 103 W. 43rd St.
 Harvey's Radio Shop
NEW YORK, N. Y. 100 Sixth Avenue
 Wholesale Radio Service Co.

RME
 RECEIVERS -- PRE SELECTORS
 AMATEUR RADIO EQUIPMENT
 RADIO MFG. ENGINEERS, Inc.
 PEORIA ILLINOIS

Use **SHURE**
MICROPHONES
Microphone Headquarters

ALBANY, NEW YORK 356 Broadway
 Fort Orange Radio Distributing Co.
ARGYLE, NEW YORK
 Harper Richards Radio Service
BINGHAMTON, NEW YORK 25-27 Sturges Street
 Radio Testing Station
BUFFALO, NEW YORK 216 E. Genesee Street
 Dymac Radio
HARRISBURG, PENN. 35 South Cameron Street
 Hall's Radio Company
HARTFORD, CONNECTICUT 210 Chapel Street
 Stern Wholesale Parts Company
NEW YORK, NEW YORK 12 West Broadway
 Harrison Radio Company
PITTSBURGH, PENNSYLVANIA 603 Grant Street
 Cameradio
ROCHESTER, NEW YORK 244 Clinton Ave., N.
 Radio Service Shop

ALBANY, N. Y. Uncle Dave's Radio Shack 356 Broadway
BOSTON, MASS. H. Jappe Company 46 Cornhill
BUFFALO, N. Y. 326 Elm St.
 Radio Equipment Corporation
NEWARK, N. J. 219 Central Avenue
 Wholesale Radio Service Company
NEW YORK, N. Y. Harrison Radio Co. 12 West Broadway
NEW YORK, N. Y. 100 Sixth Avenue
 Wholesale Radio Service Company
READING, PENN. 404 Walnut Street
 George D. Barbey Company
SPRINGFIELD, MASS. T. F. Cushing 349 Worthington Street

TRIPLET
INSTRUMENTS

ALBANY, N. Y. 356 Broadway
 Uncle Dave's Radio Shack
BOSTON, MASS. Radio Shack 46 Brattle Street
BOSTON, MASS. Selden Radio Company 28 Brattle St.
MONTREAL, CANADA 285 Craig Street, West
 Canadian Electrical Supply Co., Ltd.
NEWARK, N. J. 219 Central Ave.
 Wholesale Radio Service Company
NEW YORK, N. Y. 100 Sixth Avenue
 Wholesale Radio Service Company
PITTSBURGH, PENN. 603 Grant Street
 Cameradio Company
READING, PENN. 404 Walnut Street
 George D. Barbey Company

RAYTHEON
TRADE MARK
AMATEUR TUBES

ALBANY, NEW YORK 356 Broadway
 Uncle Dave's Radio Shack
BOSTON, MASS. The Radio Shack 46 Brattle Street
BOSTON, MASS. Selden Radio Company 28 Brattle Street
BUFFALO, NEW YORK 326 Elm Street
 Radio Equipment Corp.
CONCORD, NEW HAMPSHIRE 80 N. State Street
 Carl B. Evans

SO NOW YOU'RE A
Licensed Amateur
 AND YOU DON'T NEED THE
LICENSE MANUAL?

●
**HERE'S
 SOMETHING
 TO THINK
 ABOUT . . .**

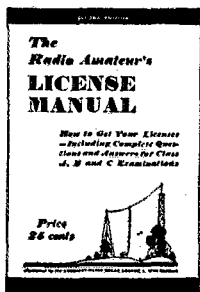

Many amateurs find *The Radio Amateur's License Manual* a useful operating booklet for frequent reference. They keep it on their operating tables. It not only contains the detailed federal regulations governing the operation of an amateur station, but the convenient question-and-answer form provides ready reference to obscure points.

Up to date in every respect. As valuable to the already-licensed as it is to the beginner going after his first ham "ticket."

25 CENTS POSTPAID
 (no stamps, please)

No. 9 in the series entitled
The Radio Amateur's Library

The
**AMERICAN RADIO
 RELAY LEAGUE**
*West Hartford
 Connecticut*

"hams in barrels" to refugees in the city during the 1927 flood. Unfortunately, Senator Noe was out of the city as well as Mr. Williamson, who had been scheduled to address the assembly. Vacation time and sundry other things conspired to deprive us of the majority of the scheduled events and speakers. Nevertheless, the program went off very well. Mr. E. Ray Arledge, Delta Division director, addressed the assembly, giving much valuable and interesting information to the hams.

It was decided to dispense entirely with that part of the program scheduled for 5:00 P.M. on Saturday, and much to our surprise all the boys were on hand on the roof to enjoy the dance recital prepared for the ladies. The entire group of assembled hams melted away shortly after the dance program, with the invitation to reassemble on the roof at 7:00 P.M. for refreshments and dancing, the scheduled barbecue having been postponed until the same time the following day. This particular meeting was the grandest "get-together" of congenial folk I have ever seen. Music was provided and everyone danced, talked, "refreshed themselves," etc., until one of the local hams invited the whole gang out to his home to finish the evening surrounded by an astounding assortment of ham paraphernalia.

Promptly at noon all gathered on the roof again to partake of the banquet—and what I mean, it was some banquet! It was an absolute shame for all the Delta hams not present to miss those delicious thick, tender steaks we had. Naturally, very little was said or done for some time with the exception of seeing that all food in sight vanished as quickly and satisfyingly as possible. Pat Lynch, W5EGK, toastmaster for the occasion, introduced Mr. Arledge who presented a very interesting talk. Then the matter of distribution of prizes got under way. It was halted at about two o'clock to view another dance program presented by the same school. After this several contests were held, as called for in the program, and the remainder of the prizes were distributed by the drawing of numbers.

At 6:30 P.M., Sunday, the delegation met at the southern entrance to the hotel where a bus donated by the city waited to take everyone out to the mayor's country home for the barbecue, the last scheduled event of the convention. The boat ride had been omitted because Senator Noe was absent from the city. Well, you wouldn't have thought it possible for that gang to eat so much barbecue after all that banquet! A few had to leave a little early in order to catch their train home, but there was a good crowd still there when the bus finally started them back toward the hotel. A few of the bravest continued the celebration even after that. Then came the final parting with many regrets for the necessity of departure and expressions of good will and wishes for future meetings.

—Jewel L. Caraway, W5FJW

HAM-ADS

(1) Advertising shall pertain to radio and shall be of nature of interest to radio amateurs or experimenters in their pursuit of the art.

(2) No display of any character will be accepted, nor can any special typographical arrangement, such as all or part capital letters be used which would tend to make one advertisement stand out from the others.

(3) The Ham-Ad rate is 15c per word, except as noted in paragraph (4) below.

(4) Remittance in full must accompany copy. No cash or contract discount or agency commission will be allowed.

(5) Closing date for Ham-Ads is the 25th of the second month preceding publication date.

(6) A special rate of 7c per word will apply to advertising which, in our judgment, is obviously non-commercial in nature and is placed and signed by a member of the American Radio Relay League. Thus, advertising of bona fide surplus equipment owned, used and for sale by an individual or apparatus offered for exchange or advertising inquiring for special equipment. If by a member of the American Radio Relay League takes the 7c rate. An attempt to deal in apparatus in quantity for profit, even if by an individual, is commercial and takes the 15c rate. Provisions of paragraphs (1), (2), (4) and (5) apply to all advertising in this column regardless of which rate may apply.

Having made no investigation of the advertisers in the classified columns, the publishers of *QST* are unable to vouch for their integrity or for the grade or character of the products advertised.

SELL—3 RCA DeForest carbon plate 845's slightly used, \$8 each. 2 Sylvania carbon plate 211's new \$9 each. All guaranteed perfect. Dallas Akers, W2FL, 181 Greenwood Ave., East Orange, N. J.

GOLD Buescher E-flat saxophone—sell \$75, or trade for 200 watt modulation system or communication receiver. J. M. Moran, KTHS, Hot Springs, Ark.

CRYSTALS: Zero cut. Guaranteed to compensate at near zero without oven. 80-160 meters. \$1.85. Forty meters, \$2. Holders, 75¢ postpaid. Fisher Laboratory, 4522 Norwood St., San Diego, Calif.

SWAP or sell \$125. RCA course. Want superhet. W8CWT, Penn Yan, N. Y.

XMITTER and power supply, \$20. W1FWD.

PFHANSTIEHL Super, complete, band spread 10 to 160—cheap. W9ESZ, Bay City, Wis.

CALL plaques, natural wood. To order—\$1.25. Conneaut Sign Co., Box 242, Conneaut, Ohio.

QSL'S—90¢ per 100 and up. Samples for stamp. W2AEY.

VIBROPLEXES bought and exchanged. Rebuilt, \$6. New large base, \$9. Lydeard, 14 Temple, Mattapan, Mass.

SELL 5 meter receiver August, 1934. *QST* with power supply. \$7; Leads silence, one i.f., \$5, b.f.o. for GE K80 or RCA 140, \$3. John Lodge, Upper Montclair, N. J.

ANNOUNCING: Eidson T9 80 and 160 meter crystals—as good as our unbeatable 40's. Dependable, powerful X cut. Close frequency supplied, 40, 80, or 160, \$1.50—fully guaranteed. T9 ceramic plug-in holders, \$1.10 postpaid. C.O.D. orders O.K. Eidson's, Temple, Texas or W2GWS, 88-34 209th St., Queens Village, N. Y.

CRYSTALS: Unconditionally guaranteed, small, X cut, 80-160 meters, within ten kilocycles, \$1.35. Approximately 1", spot frequency, \$2.50. Small X cut, 80 meter semi-finished blanks, including carborundum, while they last, three for \$1.20. Dust proof plug-in holders, 85¢. Wm. Threm, W8FN, 4021 Davis Ave., Cheviot, Ohio.

ACSW3—complete; power supply, tubes; 10, 20, 40, 80, 160 m. bandspread coils; recently factory overhauled. \$30. W8OZH.

SACRIFICE stock new ham apparatus. Bliley, Cardwell, Raytheon, Speedy, Taylor, etc. 200 different items. Stamp for list. W9AGO, Hokah, Minn.

W2ATK selling, meters, Cardwells, rack-mounted Tritet with two 802 \$28. Thordarson 600 volt power supply \$30. Many other excellent buys. Write for list. 248 William, Rahway, N. J.

6L6 Modulation transformers, class AB 60 watts pair \$6.50—P. P. parallel 120 watts \$9.50—High fidelity reversed feedback pair \$7.50—120 watt pair \$13.50—High voltage transformer 1250-0-1250 V. 3A \$7.50—Power supply delivering 1200 V.—2A, 550 V. 1A, 7½ V-3A, 2½ V-6A, 6.3V-3A, filaments CT \$25. A. T. Crystals \$2.25 amateur bands 120 Watt Rack Panel Construction 6L6 Modulator, 2 Channel input mixer, 675 W. to 20,000 W. output \$69.50. We build equipment to order. Transformer manufacturers to specifications. Write for further information. Precision Radio Laboratories, 135 Liberty St., N. Y. C.

SWAP—Zeiss Ideal Camera 9 x 12 cm., Zeiss Tessar F 4.5 lens, leather case, tripod, lens filter and hood, complete developing and printing outfit, enlarger, etc. all practically new. Want factory built 160 meter fone xmitter and accessories. A. Rasmussen, 135-14-241 St., Rosedale, L. I., N. Y.

SKYRIDERS—all types, prepaid. W7BDS, Roundup, Montana.

TELEPLEXES, Omnigraphs, bought, sold, traded. Ryan Radio Co., Monroe City, Mo.

TRADE—Perfect pair WE-212-D's for same 872-A's. W7EMQ.

COMPLETE amateur station for sale. \$65. MW 37 Prof. Comm. revt. 7 tube super new. Victor Rozshart, Chenoa, Ill.

CRYSTALS: Free latest ARRL or RADIO Handbook with mounted crystal. Small molded bakelite plug-in mountings. 160-80-40, ± 0.2%. X \$3.25. Low drift \$4.25. Unconditionally guaranteed. C.O.D. if desired. Premium Crystals, Box 2250, Kansas City, Mo.

SELLING out, send for list—W8KJN.

SELL 500 watt 20-75 Phone \$200. SuperSkyrider \$50. W3ERK, Millville, N. J.

SKY Buddy. Used one month. Guaranteed good as new. Price complete \$24.50. W5DMA, Trent, Texas.

CRYSTALS: X's, 80m—\$1, 40m—\$1.35. AT-V's, 160-80m—\$1.50, 40m—\$1.65. Molded bakelite holders 90¢. Moneyback guarantee. C.O.D.'s accepted. Star Crystal Co., 1324-D Georgia, Kansas City, Kansas.

QSL'S—\$1. hundred. Finest obtainable. Attractive. 2 colors. Quality stocks, inks. Samples (stamp). W8NOS.

MG 110 220 AC to 1500 volts 300 mils DC \$25 or what have you. 14112 Becket, Shakerheights, Ohio.

QSL'S—200 two color, \$1. W8LQM, 1040 Keltan Ave., Columbus, Ohio.

MORE power from your crystal! Is your crystal weak, heating, hard to start? Use kristal Kleer, best quartz, wash known. 35¢; large bottle 50¢. Electro-Chemical Laboratories, 1781 Riverside Drive, N. Y. C.

SALE, speakers, microphones, amplifiers, test equipment, tubes, horns, units, and lots of other surplus supplies that are useful to hams. Write for list—quitting business. XW8AYK.

SELLING all equipment—two stations—write W2APB.

NEW Hilet plate transformers 2½ KVA, 160 lb. \$39. Send for circular. Leitch, Park Drive, West Orange, N. J.

TRANSMITTERS—Ninety watts output, three bands—\$75. Sylvania isolantite 210's—\$1.75 prepaid. Howard Radio, 5526 Lake Street, Chicago. (Austin 1188)

CALL letters on aluminum plate ¼" x 2" x 6½" for car license or transmitters. 75¢, two \$1.25. QSL's swl's cards. Attractive. Samples (stamps). W8ESN, 1827 Cone, Toledo, Ohio.

QSL'S—Special introductory offer. Finest quality. Lowest prices. Radio Headquarters, Ft. Wayne, Indiana.

50 watt Phone transmitter \$40. 30 watt modulator unit \$18. 100 watt modulator unit \$35. Other bargains. 316 N. Main, Blackwell, Okla.

FIFTY cents for a radio magazine! Yes, and worth it. The special annual (January) 200-page number of Radio out in December. Included in subscriptions without extra charge. \$2.50 yearly, U. S. A. and Canada. Radio, 7460 Beverly, Los Angeles. **EVERYWHERE**. Radio now available at all radio parts dealers and most leading newsstands. Get yours today; 30¢ (January, 50¢).

1200 pages for \$2.50; 2400 for \$4. The most worthwhile technical data for your money in a Radio subscription.

OVER \$200 per issue paid outside authors for articles in several recent numbers of Radio. Variety makes Radio still further superior. Complete dope on writing contributions for 3¢ stamp.

DEALERS: Radio, the leading parts-sales-stimulator, is now available from our wholesaler near you. Kable News Co., Mt. Morris, Ill.

CRYSTAL transmitter, complete tubes crystal, power on cadmium plated chassis. \$25. W2CFQ, 24 Westview, White Plains N. Y.

QSL'S, SWL'S, 3 colors. 75¢ a 100. Iapco, 344 W. 39 St., Indianapolis.

NEW receivers—all makes. Will accept your present receiver as part payment. W8ANT.

COILS for FB7's. W8ANT.

WESTON galvanometers. W8ANT.

USED receivers. W8ANT.

NEW 542A. Cheap. W8ANT.

SUPER gainer. \$10. W8ANT.

USED crystal mike. W8ANT.

500 mill R. F. chokes. 25¢. W8ANT.

RCA ACR136. Cheap. W8ANT.

ALL lines of new and used radio equipment, bought, sold, and exchanged. Write to Southern Ohio's only amateur owned amateur business. Jbs. N. Davies, W8ANT, 2767 N. Bend Rd., Station A, Cincinnati, Ohio.

QUARTZ—direct importers from Brazil of best quality pure quartz suitable for making piezo-electric crystals. Diamond Drill Carbon Co., 719 World Bldg., New York City.

RADIO engineering, broadcasting, aviation and police radio, servicing, marine and Morse telegraphy taught thoroughly. All expenses low. Catalog free. Dodge's Institute, Byrd St., Valparaiso, Ind.

NATIONAL—Hammarlund, Patterson used sets, 60% off list. W3DQ, 405 Delaware Ave., Wilmington, Del.

QSL'S, W2SN, Helmetta, N. J.

WRITE us for trade-in price on your old receiver. We buy meters. Walter Ashe Radio Co., St. Louis, Mo.

FOR sale. 3-750 volt, 150 watt generators \$11. each. Also a few other generators and motors. Wilmot Auto Supply Company, 1970 Wilmot Street, Chicago.

QSL cards, two color, cartoons, snappy service. Write for free samples today. WIBEF, 16 Stockbridge Avenue, Lowell, Mass.

TELEGRAPH speed keys in kit form, only \$2.89. A post card brings full information. Electric Specialty Mfg. Co., PO Box 645, Cedar Rapids, Iowa.

KEEP posted. Save money with Radio Data Digest. Stamp brings sample. Kladag, Kent, Ohio.

WANTED: One DeForest Portable Buzzer Radiophone, type O T-5, manufactured by the DeForest Radio Telephone & Telegraph Company during 1920. State condition and price desired. Benjamin Chromy, National Press Building, Washington, D. C.

METER Repair Service—Accurate and expert work. Typical prices. Milliammeters shunted to different range, with new scale; hairsprings repaired and hands straightened; \$1.50-\$2.00. Send your meter in for estimate. Braden & Apple Co. 305 Park Dr., Dayton, O.

RO-1 Cable any length. Prompt shipment. W8DT.

\$350 worth of equipment including high power rack xmitter. All for \$115. W8GWA.

WANT proceedings, I.R.E., Jan., 1930 to Jan., 1936. State price. W5BTX, Fayetteville, Ark.

RCVR—7 tube AC coils, tubes, speaker, pwr supply—\$20. WIHEK.

PAY cash for good 160 fone. W7AUS.

SELL—Complete ten tube receiver and 130 watt phone xmitter, \$290. Standard parts. Write WLEZF, 318 E. Sinto, Spokane, Wash.

SELL or trade 115 KVA, 110 volts d.c. to 110 volts a.c., Janette rotary converter with filter. Excellent condition. Best offer takes. W9WXD, Box 345, Albany, Wis.

PORTABLE enclosed steel racks. Circulars? W6DZL.

TRADE National A. G. S. receiver for Leica or Contax camera or accessories. Meyer Solzman, Route 1, Council Bluffs, Iowa.

350 watt transmitter, phone and C. W. complete, also McMurdo-Silver receiver. Best offer takes it. Write for details. W1GJG.

WANTED—any or all of first eleven QST's. Providence Radio Association, Providence, R. I.

THERMO couple ammeters repaired, \$2.50. W9GIN, 412 Argyle Bldg., Kansas City, Mo.

WILL sell complete Gross CW25 xmt. Photo and information free. W9UPU, Ripon, Wis.

SELL—RCA 852, Keuffel and Esser Log Log Duplex slide rule. Want pair Class B transformers. W1GCG, Box 75, Chatham, Mass.

METERS—Brand new Jewell 3" bake. cased meters. Patt. 88 0-300, 500 microamps, 1 ma., \$3.50. 0-1.5-750 ma., \$3. Patt. 68 RF 0-100 ma., 20 amps. \$5. W2CXY, Hillside, N. J.

WANTED: 5 or 10 meter mobile or portable station. Capt. Carroll, Fort Clayton, C. Z.

QSL'S, free samples. Printer, Corwith, Iowa.

QSL'S. Unbeatable. Samples? (stamp) W8DED, Holland, Mich.

RACKS and panels. W9IHH, Parsons, Kansas.

CRYSTALS: Special: 80M Power X, within 10 kilocycles, \$1.50. V, 10 cycle coefficient, within 5 kilocycles, \$2.25. Either type mounted our HC-10 holder, 95¢ additional. Catalog. Ham Crystals, 1104 Lincoln Place, Brooklyn, N. Y.

QSL'S, 300 one-color cards, \$1. Samples, 2143 Indiana Ave., Columbus, Ohio.

CLASS B transformers—Universal for two or four 46's, 6L6's, 210's, 800's, etc., \$7.75 pair postpaid, 70 watts audio from 46's, 100 watts from 10's. Write for details. W8UD, Douglas, Mich.

RME—697 Look for W8DED'S ad.

CALLBOOKS—new DX calls, new prefixes, thousands of new W and VE calls, in the Winter 1936 Radio Amateur Call Book. Sent postpaid \$1.25, or a whole year (four issues) for \$4. (In foreign countries \$1.35 and \$4.35.) Your call and QRA printed in large type \$1 per year. Radio Amateur Call Book, 610 S. Dearborn, Chicago.

AMATEUR radio licenses, complete training. Resident and correspondence courses. Every graduate a licensed operator. N. Y. Wireless School, 1123 Broadway, N. Y.

SELL—QST'S—Lot 1925-1935 inclusive, or yearly. Thomas Wildman, Mitchellville, Iowa.

TRY your skill. Micrometer, carborundum and a crystal blank—postpaid, \$1. Faberadio, Sandwich, Ill.

SELL my service equipment. RCA oscilloscope, Supreme tube tester, 1200 Triplett, and condenser tester. Stamp for details. Hugh Nix, 1616 Hemphill, Fort Worth, Texas.

FOR sale—2 860's, 1 RCA, 1 DeForest. Guaranteed. Good condition, \$10 each postpaid. R. Ernstein, 2885 Hampshire Rd., Cleveland Hts., Ohio.

QSL Printing Service. Theo. Porcher, Chestnut Hill, Penn.

QSL'S. Finest at lowest prices. Samples. Maleco, 1512 Eastern Parkway, Brooklyn, N. Y.

FOR sale \$24—Hartley transmitter including 550 V power supply—two DeForest 210s—Jewel 0-100 Milliammeter—0-1 Jewell Thermo-coupled R. F. meter. Ex-W8BVC, 11 Cedar St., Warren, Pa.

STATIONERY for amateurs, \$1.25 postpaid brings you 125 note sheets 5 1/2 x 8 1/2, 100 envelopes, each beautifully printed in rich blue ink with your call letters, name and address on white bond paper. West of Mississippi 10¢ additional. Port Stationery Co., Port Chester, N. Y.

QSL'S—samples! Fritz, 203 Mason, Joliet, Ill.

QSL'S, SWL'S and Cardograms, new designs. Stamp for samples. Powell, 3271 Upas Street, San Diego, Calif.

UNUSUAL bargain: Band switching, rack and panel transmitter, nine crystal controlled frequencies, four bands, 350W CW, 250W fone, condenser mike, good quality, commercial appearance. Complete, \$200. W8AEU, Cleveland.

WE OFFER —

Specialized personal service of genuine value that is not available from other jobbers.

Time sales of all receivers and transmitters with terms arranged to suit you and 6% interest charge.

Complete stock of all amateur apparatus at net prices. Export orders given individual attention too.

All Collins, RCA, RME, Harvey transmitters at net prices. Trade in your transmitter. Buy on terms.

TRADE IN YOUR RECEIVER AND TRANSMITTER

All receivers shipped on ten day trial. You need send but \$5.00 with order, balance C.O.D. These receivers in stock:

The new National NC-100s.....	\$118.10
The new National NC-100Xs.....	140.60
National HIROs.....	167.70
RME-69s complete.....	134.90
The new 1937 Breting 14s.....	99.00
RCA ACR-175s.....	119.50
Hammarlund Super Pros.....	223.44
Hallcrafters Sky Buddys.....	29.50
Hallcrafters Sky Chiefs.....	44.50
Hallcrafters 1937 Super Skyriders S-11.....	89.50
Hallcrafters Ultra Skyriders S-10.....	99.50

Every order and inquiry is personally attended to by Robert Henry, W9ARA, an active amateur for eleven years; graduate E.E. from M. I. T. and owner of Henry Radio Shop selling amateur supplies for seven years. You can reach me by letter, telegram, phone call, or visit 24 hours a day, 365 days a year. Write for any information.

HENRY RADIO SHOP

211-215 North Main Street

BUTLER, MISSOURI



A NEW BOOK FUNDAMENTALS OF RADIO

Second Edition, 426 pages 6" x 9", 430 figures. By R. R. Ramsey, Prof. of Physics, Ind. Univ. Revised, enlarged, repaged, reprinted. New cover. Radio theory and practice brought up to date. New subjects, problems and questions on each chapter.

EXPERIMENTAL RADIO—(255 pages, 168 figures, 128 experiments.) The experimenter's manual.

Price, \$2.75. Fundamentals, \$3.50 postpaid.
RAMSEY PUBLISHING CO.
Bloomington Indiana

Your Nearest Dealer Is Your Best Friend

Your nearest dealer is entitled to your patronage. You can trust him. He is equipped with a knowledge and understanding of amateur radio. He is your logical and safe source of advice and counsel on what equipment you should buy. His stock is complete. He can supply your needs without delay. His prices are fair and consistent with the high quality of the goods he carries. He is responsible to you and interested in you.

Patronize the dealer nearest you—You can have confidence in him

ALLENTOWN, PENNSYLVANIA

Radio Electric Service Co.
1024 Hamilton Street
Complete stocks transmitting equipment

PITTSBURGH, PENNSYLVANIA

Cameradio Company
601-3 Grant Street
"Ham" Headquarters for Pennsylvania-Ohio-W. Virginia

BALTIMORE, MARYLAND

Radio Electric Service Co.
3 N. Howard St.
Everything for the amateur

PHILADELPHIA, PENNSYLVANIA

Eugene G. Wile
10 S. Tenth Street

BUFFALO, NEW YORK

Radio Equipment Corp.
326 Elm Street
W8GJ — Ham, service and sound equipment — W8BTS

Complete Stock of Quality Merchandise

MANCHESTER, NEW HAMPSHIRE

Radio Service Lab. of N. H.
1187-1191 Elm Street — Tel. 218-W
Branches — Portland, Me. and Barre, Vt.

PROVIDENCE, RHODE ISLAND

W. H. Edwards Co.
32 Broadway
National — Hamerlund — RCA — and other leaders

MONTREAL, CANADA

Canadian Elec. Supply Co., Ltd.
285 Craig St., W.
Quality parts and equipment for discriminating buyers

PROVIDENCE, RHODE ISLAND

Kraus & Company
89 Broadway
Everything for the amateur and serviceman

NEW YORK, N. Y.

Gross Radio, Inc.
51 Vesey Street
Fair dealings plus fair prices. Anything in radio

ROCHESTER, NEW YORK

Radio Service Shop
244 Clinton Avenue, North
Complete stock amateur-BCL parts. Standard discounts. W8NUC

PHILADELPHIA, PENNSYLVANIA

Consolidated Radio Corp.
612 Arch Street
Ham receivers, Transmitting tubes, Collins transmitters, etc.

SYRACUSE, NEW YORK

Roy C. Stage, W8IGF
Complete stock of standard Ham & BCL parts
Standard Discounts. Free technical service

PHILADELPHIA, PENNSYLVANIA

Radio Electric Service Co., Inc.
N. E. Cor. Seventh & Arch Sts.
All nationally-advertised lines in stock

SPRINGFIELD, MASS.

S. S. Kresge Company
1540 Main Street
Standard discounts on standard lines.
Advisory service: W1JQ, W1FOF

WHEELING, WEST VIRGINIA

Cameradio Company
30 Twelfth Street
Complete stock of amateur Equipment at standard discounts

You Are Protected When You Buy From QST Advertisers

“Advertising for QST is accepted only from firms who, in the publisher’s opinion, are of established integrity and whose products secure the approval of the technical staff of the American Radio Relay League.”

Quoted from QST’s advertising rate card.

Every conceivable need of a radio amateur can be supplied by the advertisers in QST. And you will know the product has the approval of the League’s technical staff.

For Your Convenience QST’S INDEX TO ADVERTISERS IN THIS ISSUE

Aerovox Corporation	92
Aladdin Radio Industries, Inc.	71
Amperex Electronic Products	68
Ashe Radio Company, Walter	94
Asiatic Microphone Laboratory	112
A.R.R.L. Binders	89
Calculators	82
Christmas Offer	87
Emblem	102
Handbook	83, 109
How to Become a Radio Amateur	101
License Manual	116
Map	97
Memorandum	88
Message Blanks	111
Two Hundred Meters and Down	103, 113
Birnback Radio Company	111
Billey Electric Company	91
Bud Radio, Inc.	92
Burgess Battery Company	4
Candler System Company	93
Capitol Radio Engineering Institute	36
Cardwell Manufacturing Corp., Allen D.	95
Centralab	64
Clausing, Leroy M., E.	113
Cohen’s Sons, I. S.	105
Collins Radio Company	Cov. 2
Communication Development Co.	88
Communication Products, Inc.	104
Continental Carbon, Inc.	108
Cornell-Dubilier Corporation	66
Coto-Coil Company	100
Delaware Radio Sales Company	112
Delco-Remy Corporation	81
Eitel-McCullough, Ltd.	77
Electrad, Inc.	84
Electrical Products Co., Inc.	90
Freck Radio & Supply Company	111
General Electric Company	87
General Radio Company	62
General Transformer Company	96
Go-Devil Instrument Company	92
Gross Radio, Inc.	68
Gulf Radio School	110
Hallcrafters, Inc., The	1
Hammarlund Manufacturing Co.	6
Harvey Radio Company	111
Harvey Radio Laboratories, Inc.	101
Hairy & Yarnall	102
Heintz & Kaufman	94
Henry Radio Shop	78, 118
Hinds & Edgarton	2
Hipower Crystal Company	110
Instructograph Company	86
Jefferson Electric Company	76
Kenyon Transformer Company	79
Leeds	121
Massachusetts Radio School	103
McElroy, T. R.	104
McGraw-Hill Book Company	72
M & H Sporting Goods Company	86
Meissner Manufacturing Company	95
National Carbon Company	70
National Company	Cov. 3, 61, 63, 75, 88, 109
Newark Electric Company	85
Ohmite Manufacturing Co.	74
Omaha Crystal Laboratories	100
Ottawa Radio Company	90
Port Arthur College	95
Precision-Piezo Service	96
Radio Constructors Laboratories	105
Radiolab	105
Radio, Ltd.	108
Radio Mfg. Engineers	65
Radio Shack	97
Radio Supply Company	111
Radio Transceiver Laboratories	94
Ramsey Publishing Company	118
Raytheon Production Corporation	103
RCA Institutes, Inc.	96
RCA Manufacturing Company	Cov. 4
Salkers, R.	108
Scientific Radio Service	103
Shure Brothers	93
Sickles Company, F. W.	105
Signal Electric Manufacturing Co.	110
Standard Transformer Corporation	91
Sundt Engineering Company	109
Sun Radio Company	105
Taylor Tubes, Inc.	5
Teleplex Company	100
Terminal Radio Corporation	101
Thornton Electric Mfg. Company	73
Trimn Radio Manufacturing Company	111
Triplett Electrical Instrument Co.	80
Triumph Manufacturing Company	113
Tuberculosis Association of U. S.	105
United Transformer Company	122
Universal Microphone Company	111
Universal Signal Appliance Co.	103
Valpey Crystals	104
Vibroplex Company	90

LEEDS MERCHANDISE ALWAYS LEADS



Type 50-TK Transmitter

Fifty watts output from the final push-pull 6L6 stage. The tube line-up is 59 Tri-tet crystal oscillator, latest type quadrupling circuit, link coupling used, fixed neutralization. Panel, 8 3/4" x chassis 8". Complete in kit form with one set of **\$23.95** coils.....

Type 50-TB Transmitter — Wired by our Laboratory. **\$31.95**. Power supply 500-PB is used with the 50-TB. Additional coils for the 50-TK, **\$3.00** per set.

Combination Type 50-TBC Transmitter — Crystal and holder, 59 and two 6L6 tubes, Sylvania..... **\$37.15**

Type 50-C — as above, complete with 500-PB power supply and 83 tube..... **\$51.00**

LEEDS BAND WAGON SPECIALS

Made on chassis with protecting grill. 32 watt high fidelity push-pull 6L6 amplifier, high and low impedance input — 3% distortion. Output impedance 2, 4, 6, 8, 15 v.c. 200 and 500 w. line..... **\$28.75**

Same 32 watt amplifier with modulation transformer (will modulate 64 watt R.F. load)..... **\$31.75**

Set of 6 matched Sylvania metal tubes, **\$4.49**
1 Wright DeCoster No. 1590 — 12" speaker, **\$7.80**

1 Astatic D-104 microphone..... **\$13.23**
1 Floor stand (adjustable 67")..... **\$3.95**

COMPLETE SOUND SYSTEMS

32 watt amplifier two No. 1590 WDC speakers, Astatic crystal microphone, and 2-20" sound projectors..... **\$68.95**

\$\$\$PECIAL — 11 watt 6L6 amplifier, high and low impedance input..... **\$14.50**

Set of 4 matched Sylvania metal tubes, **\$2.73**
Complete 11 watt unit, tubes, Wright DeCoster No. 990 speaker, Bell projector, crystal microphone..... **\$39.95**

NOISE SILENCER ADAPTERS are a great help on reducing natural static too. LEEDS "QUIET CAN" and "SILENT CAN" also provide freedom from ignition noises and afford an ideal arrangement for push to talk phone and break-in CW.

LEEDS "Quiet Can" for receivers with 2 IF stages; complete with tubes and instruction..... **\$7.05**

LEEDS "Silent Can" illustrated herewith, for receivers with 1 IF stage; complete with tubes and instructions **\$9.95**

RELAY RACKS RACK PANELS BASES AND DEMI BASES

for sizes, complete descriptions and prices, see our advertisement in Nov. issue

We Are Headquarters for the Following

Hammariund — Meisner — Alladin — Triplett — Littelfuse — United Transformer — Cornell-Dubilier.

GENERAL RADIO Variac Transformers

A wonderful line voltage control, that is smaller, more convenient to use and furnishes high current over a narrow voltage range.

Type 70-B — 115 v. at 2 amps, **\$10**

Type 80-B — 115 v. at 7.5 amps, **\$15**

Write for Bulletin 67-Q for complete data

Here are two handy G.R. forms for that multiband transmitter.

Type 677-U — 21 turns, 2 1/2" diameter, resonant on 3.5 mc with 100 mfd. capacity; shipping weight 2 lbs. Price..... **50c**

Type 677-Y — 30 turns 4" diameter, resonant 1.7 mc with 100 mfd. capacity; shipping weight 3 lbs. Price..... **75c**

Also 7-pin base to fit above forms at 70c and a matching base with jacks at 65c.

G.R. Amateur accessories always in stock



AEROVOX

OIL IMPREGNATED CONDENSERS

1 mfd. 1000 v..... **\$1.59**
2 mfd. 1000 v..... **1.97**
4 mfd. 1000 v..... **2.85**
1 mfd. 1500 v..... **1.67**
2 mfd. 1500 v..... **2.30**
1 mfd. 2000 v..... **2.09**
2 mfd. 2000 v..... **2.79**

Electrolytic and tubular condensers in stock

ALL SYLVANIA RECEIVING TUBES at 50% off list price



LEADS THE FIELD

World Wide Service to Amateurs

45 Vesey Street
New York City

Tel. COlandt 7-2612

Circle Address: "RADLEEDS"



Important Announcement

On Our NEW LD-5 Mounted Crystals

These low drift plates, factory sealed in the new LEEDS metal holder are outstanding from the standpoint of stability, accuracy, high output and low cost. Low Drift — 5 cycles per million per degree. Accuracy of calibration — better than .05%. Orders filled plus or minus two kc. of specified frequency. Last but not least, the price of the mounted crystals, anywhere in the 100-80 and 40 meter band is only **\$3.50**

Money back guarantee if you are not completely satisfied.

LEEDS type A.L. metal crystal holder, as illustrated above, fits standard 5-prong socket..... **89c**

Raytheon Transmitting Tubes

RK-10.....	\$3.50	RK-28.....	\$38.50
RK-15.....	4.50	RK-30.....	10.00
RK-16.....	4.50	RK-31.....	10.00
RK-17.....	4.50	RK-32.....	12.00
RK-18.....	10.00	RK-34.....	3.50
RK-19.....	7.50	RK-36.....	14.50
RK-20.....	15.00	RK-100.....	7.00
RK-21.....	5.00	841.....	3.25
RK-22.....	7.50	842.....	3.25
RK-23.....	4.50	866A.....	5.00
RK-24.....	2.25	872A.....	18.50
RK-25.....	4.50		

WRITE FOR FOLDER

TAYLOR Custom Built TRANSMITTING TUBES

T55 — 55 watt plate dissipation..... **\$8.00**
T155 — 155 watt plate dissipation..... **19.50**
T200 — 200 watt plate dissipation..... **21.50**
866 Mercury Vapor Rectifying tube..... **1.65**
T-20 ceramic base, 20 watt plate dissipation, conservatively rated 600 **\$2.45**
V, 100 mc.

All other types in stock

NATIONAL NC 100 and NC 100 X

Sold on time at cash prices in Metropolitan area. No down payment.

Liberal allowance on your old set.

We carry the complete line of NATIONAL.

Thordarson Neon Transformers, 115 v. primary — 1500 volts at 20 mils..... **\$1.45**

Thordarson Cased Transformer, 600 volts each side of C.T. 200 ma 2 1/2 v. 10 amp. C.T. 5 v. 3 amps. 7 1/2 v. 3 amps. C.T. **\$2.45**

Thordarson Choke, 12 H. 250 ma. **\$1.95**

We carry the complete Thordarson line at 40% and 2% from list price.

NEW LOW PRICES ON JOHNSON HANDLE INDICATORS

No. 204 — 1/8" shaft, now..... **58c**
No. 206 — 3/8" shaft, now..... **73c**
No. 210 socket, now..... **58c**
50 watt socket..... **88c**

All other Johnson products, including Type Q antenna system at 40% and 2% off list.

The record is 100% perfect. Thousands of microfarads of LEEDS OIL FILLED CONDENSERS are in use without one case of failure.

1 M F	1000 volt D.C. working.....	\$1.10
2 M F	1000 volt D.C. working.....	1.45
1 M F	1500 volt D.C. working.....	1.45
2 M F	1500 volt D.C. working.....	1.95
1 M F	2000 volt D.C. working.....	1.75
2 M F	2000 volt D.C. working.....	2.45

LEEDS has the most complete line of Antenna Wire found in any shop. Hard and soft drawn wire — enameled copper — tinned copper — tinned wire — any length, at lowest prices.

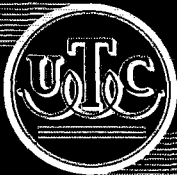

Most Complete Transformer
Line in the World

QUALITY · RELIABILITY

VARIMATCH transformers are used in the UTC 6LC Universal Beam Power Amplifier

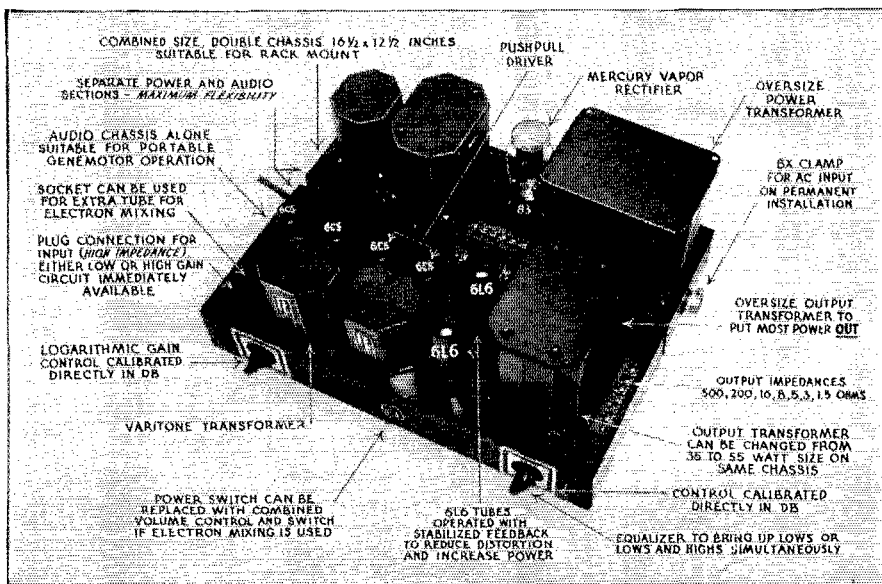

PAK amplifier kits feature: Power output 35 watts self bias, 55 watts fixed bias; gain 118 DB, immediate change-over to 95 DB; separate power supply and audio decks; stabilized feedback; mobile operation with genemotor — 20 watts output; provision for electron mixer or low impedance input if desired.

● **PAK-1** Self bias amplifier kit. 35 watt operation. Output transformer impedances 500, 200, 16, 8, 5, 3, 1.5 ohms. Includes all accessories such as resistors, condensers, sockets, calibration plates, chassis, dust covers, hardware . . . except tubes. All fully mounted. Net to hams . . . \$45.00

● **PAK-1X** Same as PAK-1, but with Varimatch modulation output transformer. Impedances available are 237, 380, 1310, 1750, 2060, 2700, 3270, 4100, 5200, 6900, 7000, 9150, 9470 ohms. Net to hams . . . \$45.00

● **PAK-2** Fixed bias amplifier kit. 55 watts operating condition. Output transformer with impedances of 500, 200, 16, 8, 5, 3, 1.5 ohms. Includes all accessories, such as resistors, condensers, sockets, calibration plates, chassis, dust covers, hardware . . . except tubes. All fully mounted. Net to hams . . . \$48.00

● **PAK-2X** Same as PAK-2, but with Varimatch modulation output transformer. Impedances available are: 237, 380, 1310, 1750, 2060, 2700, 3270, 4100, 5200, 6900, 8200, 11900, 16500 ohms. Net to hams . . . \$48.00

UTC Varipower autotransformers perform 3 functions

(1) **VARIABLE voltage service . . .** for reduced power operation you can obtain any voltage from 0 to 130 Volts in 5 VOLT STEPS.
(2) **LINE VOLTAGE CONTROL . . .** Transmitter equipment is critical in operation. For maximum efficiency and long life of tubes the voltage applied to your equipment should be within 5% of rated value. The UTC VARIPOWER units take care of line voltage variations of 75 to 130 volts in 5 volt steps.

(3) **ADJUSTMENT OF TRANSFORMER VOLTAGES . . .** Thru the use of a UTC VARIPOWER unit you can adjust EACH of your filament and plate transformers to its required line voltage correction so that exact voltage at the tubes is obtained.

VA-1	150 watt output rating. Net to hams	\$3.60
VA-2	250 watt output rating. Net to hams	4.50
VA-3	500 watt output rating. Net to hams	6.00
VA-4	1000 watt output rating. Net to hams	9.00
VA-5	2000 watt output rating. Net to hams	12.00

Typical applications of a transformer of this type are described in August QST 1936, page 29.
See your local UTC distributor for VA-10 data sheet on UTC VARIPOWER units.

Ask your distributor for the new UTC Beam Power Amplifier bulletin. Chapters treated: operation of 6L6 . . . distortion stabilized feedback . . . 6L6's as drivers . . . High Fidelity equalizer circuits . . . fixed and self bias 6L6 circuits . . . circuit for mobile service . . . electron mixing.

UNITED TRANSFORMER CORP.

72 SPRING STREET

NEW YORK, N. Y.

EXPORT DIVISION, 100 VARICK STREET NEW YORK, N. Y. CABLES "ARLAB"

▷ QST ◁

INDEX

TO

VOLUME XX



1936

AMATEUR RADIO STATIONS

CO6OM, Tuinucu, Cuba.....	58, May
W1HRX, Middleton, Mass.....	41, Dec.
N2LA, Larchmont, N. Y.....	57, Feb.
VK4DO, Rockhampton, Queensland, Australia.	59, Oct.
W2BSD, New Rochelle, N. Y.....	56, Feb.
W2IDQ, East Orange, N. J.....	57, Apr.
W3CZO, Carlisle, Pa.....	56, Feb.
W5VU, Dallas, Texas.....	45, July
W6ETX, Los Angeles, Calif.....	59, Oct.
W6GVT, Lompoc, Calif.....	59, May
W6NCT, Santa Barbara, Calif.....	43, Aug.
W7CHT, Payette, Idaho.....	43, Aug.
W7DET, Seattle, Wash.....	57, Apr.
W8ACY, Rochester, N. Y.....	45, July
W8KQQ, Centre Hall, Pa.....	57, Feb.
W9AS, Newton, Iowa.....	59, May
'Phone-C.W. De Luxe: W1CCZ.....	11, Nov.

AMATEUR REGULATIONS AND LEGISLATION

Applying for a Renewal.....	21, Jan.
Blind Transmissions.....	25, Mar.
Bootleggers.....	22, Aug.
Change in Regs.....	27, Nov.
Citations.....	26, May
Code Exams.....	27, Dec.
Code Speed Increased.....	22, Aug.
Code Test.....	27, Sept.
F.C.C. Examinations.....	25, Feb.
F.C.C. Notes.....	25, Mar.
F.C.C. Rules.....	33, Apr.
Fees.....	33, Apr.
Fees?.....	25, Mar.
June Hearings.....	19, July
Monitoring.....	22, Aug.
Music Testing.....	25, Mar.
'Phone Frequencies.....	27, Oct.
'Phones Freqs.....	22, Aug.
Portable Operation.....	21, Jan.
Preparations for Cairo.....	27, Oct.
Requests of F.C.C.....	19, July
The June Hearing.....	21, Aug.

ANTENNAS, TRANSMISSION LINES

A 28-Mc. Rotary Beam (Breuer).....	28, Apr.
A Cheap and Efficient Vertical Antenna for 7- and 14-Mc. Operation (Keay and Pehoushek)	18, Oct.
A New Antenna Relay.....	68, Sept.
A New Type of Unguyed "Sky-Hook" for Amateur Antennas (Cartwright).....	37, July
A Sleet Melting Antenna (Exp. Section).....	30, Jan.
A Three-Feeder Double-Antenna System (Pool)	49, May
An Unorthodox Antenna (Exp. Section).....	32, Mar.
Antenna Coupling to the 56-Mc. Receiver (Exp. Section).....	60, Apr.
Antenna-Rotating Device (Exp. Section).....	39, June
Car Antenna Kinks (Exp. Section).....	47, Aug.
Changing Antenna Directivity (Exp. Section).....	43, July
Kink for Using Single-Wire End-Fed Antennas (Exp. Section).....	39, Aug.
Plain Talk About Rhombic Antennas (Hull and Rodimon).....	28, Nov.
Some Zepp Pointers (Exp. Section).....	39, Aug.
The All-Around Radiation Characteristics of Horizontal Antennas (Grammer).....	19, Nov.
The Pre-Selector Antenna (Cresner).....	44, May
Transmission-Line Loading for Antennas (Keen)	31, Mar.
Tuning the Receiving Antenna (Exp. Section).....	39, June
Variable Antenna Coupling (Exp. Section).....	30, Jan.

ARMY-AMATEUR RADIO SYSTEM

Armistice Day Message—1935.....	10, Feb.
The Army-Amateur Radio System.....	7, May
V.W.O.A. Banquets United by A.A.R.S. (Talley).....	69, Apr.
Weather Reporting Net.....	58, June

BEGINNERS

Beginners Net.....	43, Mar.
Code Practice Volunteers.....	49, Nov.

BOOK REVIEWS

Official Radio Service Handbook (Bernsley)....	86, Nov.
Police Radio Operator's Manual (General Electric Co).....	64, Mar.

CALLS HEARD

60, May.....	60, June.....	58, Oct.....	47, Dec.
28-Mc. Calls Heard.....			83, Jan.

COMMUNICATIONS DEPARTMENT

A.R.R.L. Trunk Lines.....	69, Apr.
Brass Pounders League.....	37, Jan.; 66, Feb.; 41, Mar.; 67, Apr.; 67, May; 46, June; 52, July; 49, Aug.; 47, Sept.; 67, Oct.; 49, Nov.
Cairo Observers' Honor Roll.....	38, Mar.; 68, Apr.; 69, May; 45, June; 51, July; 50, Aug.; 45, Sept.; 63, Oct.; 45, Nov.
College Net.....	47, Sept.
Handling Ham Messages.....	36, Aug.
Los Angeles Emergency Committee.....	122, Apr.
New Members, A.R.R.L. Emergency Corps.....	34, Jan.; 42, Mar.; 45, Sept.
New O.P.S.....	50, Aug.; 47, Nov.
New O.R.S.....	45, June; 50, Aug.; 47, Nov.
Official Broadcasting Stations.....	38, Jan.; 67, Feb.; 42, Mar.; 66, May; 50, July; 48, Aug.; 44, Sept.; 118, Oct.; 47, Nov.
Oklahoma Police Net.....	47, June
Ontario 'Phone Network.....	66, May
Ontario R.M. Net.....	68, May

CONTESTS AND TESTS

1.75-Mc. Tests.....	120, Apr.
1935 Sweepstakes Contest Results (Battley)....	26, July
1936 DX Contest Hits New Highs.....	35, May
1936 DX Contest Results.....	33, Sept.
1936 VK/ZL International DX Contest.....	20, Oct.
All-New England Birthday Party.....	65, Oct.
All Season O.R.S. Contest.....	86, Oct.
Announcing W.A.S.I.—Worked All States Club	33, Jan.
Another 1936 A.R.R.L. Field Day—August 22nd-23rd.....	39, Aug.
A.R.R.L. Copying Bee—Dec. 11th.....	38, Dec.
A.R.R.L.'s Eighth International DX Competition (Handy).....	35, Feb.
Charter Members, W.A.S.....	69, Apr.
Copying Bee Winners.....	47, Nov.
Flash! W9ERU Wins Code Speed Contest.....	39, Oct.
Fourth Annual A.R.R.L. Field Day Contest.....	22, June
July O.R.S. Leaders.....	122, Oct.
M.R.A.C.-A.R.R.L. 56-Mc. International DX Contest.....	27, Jan.
Oakland Radio Club Votes Plaque.....	24, Mar.
Oct. '36 to May '37 O.P.S. Competition.....	63, Oct.
Official Relay Stations Make Records in January Party.....	67, Apr.
O.P.S. Scores High.....	118, Oct.
O.R.S. Trophy for '36-'37 Competition.....	45, June
Results—3500-kc. Transoceanic Tests.....	16, Mar.
Results, A.R.R.L. Copying Bee.....	27, Aug.
Results, June '36 A.R.R.L. "F.D.!".....	47, Oct.
Seventh A.R.R.L. Sweepstakes Contest (Handy)	30, Nov.
The Canada-U.S.A. Contact Contest, 1935 (Saxon and Trainer).....	28, Mar.
The D.A.S.D.'s Jubilee DX-Contest.....	47, Aug.
The 1936 1.75-mc. Transatlantic Tests (Mitchell).....	63, Feb.
The January O.P.S. Tests.....	68, Apr.
VK-ZL 1935 DX Contest Results (Cunningham).....	52, Apr.
VK-ZL 1936 DX Contest—First Scores (B. G.)	46, Dec.
W2HNP Leads in O.P.S. Tests.....	51, July
W3EOP Wins of April O.R.S. Party.....	51, July
W9IU Winner O.R.S. Trophy Cup.....	35, Jan.
W9NY 28-Mc. Contest Winner!.....	19, Jan.

CONVENTIONS AND HAMFESTS

August Hamfests.....	50, Aug.
Connecticut State Convention.....	70, June
Get-Togethers Held.....	48, Sept.
North Dakota State A.R.R.L. Convention.....	90, Oct.

November Hamfests	49, Nov
Rocky Mountain Division Convention	70, Jan.
South Dakota State Convention	92, Oct.
Southwestern Division Convention	66, June
The Atlantic Division Convention	88, Oct.
The Eastern Canada Convention	90, Aug.
The Iowa State Convention	64, Sept.
The Moncton Hamfest	94, Oct.
The New England Division Convention	66, July
Washington Radio Club Hamfest	26, Jan.

EDITORIALS

28 Mc.	9, Mar.
A.R.R.L. Elections	11, Sept.
Amateur Radio vs "Radio Amateurs"	7, Jan.
Arthur A. Hebert	8, July
Charles H. Stewart (Obituary)	7, Apr.
Dr. Eugene C. Woodruff	7, July
Formula Conversations	9, Mar.
George W. Bailey	8, July
Hiram Percy Maxim (Obituary)	7, Apr.
Home Construction	10, June
Manufacturers' Contests	11, Sept.
More on the League and Elections	9, Nov.
On Getting QSO	7, Jan.
'Phone Interference and Harmonics	9, June
'Phone Practices	7, Jan.
Planned Use of Our Bands	9, Oct.
QST Comes of Age	9, Dec.
The Army-Amateur Radio System	7, May
The History of Amateur Radio	10, Oct.
The "Shadow"	9, Feb.
The Ultra-High Frequencies and the June F.C.C. Hearing	7, Aug.
The 1936 Floods	7, May

EMERGENCY AND RELIEF WORK

1.75-Mc. QRR	64, Feb.
Amateurs Carry On (DeSoto)	23, June
Amateurs Help in Florida Hurricane	65, Oct.
Amateur Radio Rises to Greatest Emergency Need of All Time (DeSoto)	9, May
Bravery!	71, May
East Coast Hurricane Work	46, Nov.
Florida 1.75-Mc. 'Phone Emergency Net	48, June
More Re Moose River Mine	52, July
Oakland Casualty Drill	37, Jan.
Paradise Postponed (Robinson)	44, June
Politician Denounces Amateur Operator, "Bans" Amateur Radio in Johnstown	52, May
QRR Work With Lighthouse	52, Jan.
VE2HN/WIEBM Aid Auto Crash Victims	67, Feb.
Winter Brings Emergencies! QRV? (White)	39, Mar.

EXPEDITIONS

American Museum Expedition to New Guinea	43, Mar.
Andes-Amazon Expedition	33, Jan.
Schooner <i>Morrissey</i>	48, July
Schooner <i>Wander Bird</i> — KMUP	48, Aug.
WCFT — Yacht <i>Yankee</i>	49, Nov.
Yacht <i>Kinkajou</i>	54, Jan.

EXPERIMENTER'S SECTION

January, page 29	
110-Volt Transmitter Using 48's	
Break-In Plus Monitored Keying	
Mixing System	
Variable Antenna Coupling	
A Sleet Melting Antenna	
Shorting Link	
Calibrating the E.C.M.O.	
February, page 58	
Grid Leak Modulation	
Oscillator Keying with Grid Leak Bias on Amplifiers	
Revised Transceiver Circuit	
Spotting Frequencies	
Combined Plate and Bias Pack	
Correction, 94, May	
More on the 6A7 Transmitter	
Quick Shift for Amplification or Doubling	
March, page 32	
An Unorthodox Antenna (Beers)	

The 6E5 for Checking Overmodulation	
Adapting the Patterson PR-10 for 10 Meters	
Adapting the QST Three-Tube Transmitter to Ten Meters	
Crystal Oscillator Keying	
Code Practice Set for Eliminating Clicks	
A Monitoring Kink	
April, page 59	
Oscillator-Mixer Coupling with the 6F7	
Simple Filament-Voltage Booster for 6.3-volt Tubes	
Insulating Filter Chokes	
Antenna Coupling to the 56-mc. Receiver	
Break-In and Monitoring System	
Neon-Bulk Oscillator for Tone Modulator	
Simple Monitoring System for Checking Hum or Modulation Quality	
28-Mc. Converter with Tuned R.F. Receivers	
May, page 54	
Suppressor Modulation with Linear Amplification	
More Locked Oscillator Circuits	
Regenerative Doubler	
Improving Selectivity in the Regenerative Receiver	
Combination Time Delay and Bias Supply	
Regenerative Detector Kinks	
June, page 39	
Tuning the Receiving Antenna	
Antenna-Rotating Device	
Parasitics and Interference	
July, page 43	
A Simple and Inexpensive QRP Transmitter	
Changing Antenna Directivity	
Adapting Inductive Neutralization to the Low-Power Transmitter	
August, page 40	
Keying the E.C. or Tri-Tet Oscillator	
Five-Meter Interference to B.C.L.'s	
Improved System of Regeneration Control for the Screen-Grid Detector	
An Effective Regeneration Control	
Relayless Audio Oscillator for Monitoring Keying	
Monitoring Audio Oscillator with Keyer Tubes	
Car Antenna Kinks	
Twenty-Meter Crystals	
Regenerative Receiver Using a 53	
September, page 38	
Transceiver à la "Minute Man"	
R. F. Amplifier for the "Minute Man"	
A Cure for Blanketing	
Kink for Using Single-Wire End-Fed Antennas	
Some Zepp Pointers	
Calibrated Band-Spread and General Coverage With the Same Coil	
Break-In Monitoring	
October, page 54	
The Class C Audio Amplifier Applied to Regenerative Receivers	
A Method for Measuring Frequency Drift	
Automatic Tone Control	
Single Control of Transmitter, Receiver and Monitor	
Measuring Power with Wattmeter	
Calibrating the Receiver for General Coverage	
Switching 53 Sections	
A Handy Alcohol Lamp from the Junk Box	
November, page 39	
Overload Protection	
Suppressor-Grid Keying of Oscillator Tube for Break-In Operation	
Neon-Bulb Noise Reducer	
Home-Made High-Voltage Fuses	
December, page 44	
Cathode Ray Oscilloscope Switching Circuit	
A Voltage Quadrupling Circuit	
A Different Keying Monitor	
Negative Bias from the Plate Power Pack	
FEATURES, FICTION, AND VERSE	
A Few Random Remarks (The Old Man)	26, Feb.
Dixie Jones' Owl Juice	34, April; 35, May; 15, June; 42, July; 35, Aug.; 37, Sept.; 45, Oct.; 18, Nov.
Hello, Old Timer (Sheehan)	34, Jan.
Ingang, B.E.R.U., and All That! (Beers)	31, Feb.
"Move Over!" (Castner)	12, Sept.
Peace on Earth (Williams)	26, Mar.
The Love of Hazel (Coe)	50, Feb.
To a Lady With Red Hair (Flippin)	48, Apr.

Watt a Chirp from Dominica (Murray).....	46, Oct.
When the Cat's Away or The Sourdough's Lament (Gish).....	30, Aug.

FREQUENCY CALIBRATION AND CONTROL

A Method of Measuring Frequency Drift (Exp. Section).....	54, Oct.
Calibrating the E.C.M.O. (Exp. Section).....	31, Jan.
Frequency Checking Service.....	70, May
Schedules for WWV.....	85, Jan.; 88, April; 84, May;
64, June; 64, July; 72, Aug.; 70, Sept.; 96, Oct.; 90, Nov.	
Spotting Frequencies (Exp. Section).....	59, Feb.
Standard Frequency Transmissions.....	85, Jan.; 88, Apr.;
82, May; 64, June; 64, July; 72, Aug.; 70, Sept.;	96, Oct.;
	90, Nov.

HAMDON

40, April	25, July	31, August	40, October
-----------	----------	------------	-------------

I.A.R.U. NEWS

45, Jan.; 61, Feb.; 35, Mar.; 63, Apr.; 62, May; 41, June	
46, July; 44, Aug.; 41, Sept.; 60, Oct.; 43, Nov.; 48, Dec.	
The Amateur Regulations of the World: 1936..	41, Sept.
WAC During 1935.....	62, Feb.

INTERFERENCE

(See also KEYING)

A Cure for Blanketing (Exp. Section).....	39, Sept.
Five-Meter Interference to B.C.L.'s (Exp. Section).....	40, Aug.

KEYING

A Different Keying Monitor (Exp. Section)...	44, Dec.
Break-In and Monitoring System (Exp. Section)	60, Apr.
Break-In Plus Monitored Keying (Exp. Section)	29, Jan.
Code Practice Set for Eliminating Clicks (Exp. Section).....	34, Mar.
Crystal Oscillator Keying (Exp. Section).....	34, Mar.
Keying the E.C. or Tri-tet Oscillator (Exp. Section).....	40, Aug.
Oscillator Keying with Grid Leak Bias on Amplifiers (Exp. Section).....	58, Feb.
Parasitics and Interference (Exp. Section)....	40, June
Suppressor-Grid Keying of Oscillator Tube for Break-In Operation (Exp. Section).....	39, Nov.

METERS AND MEASUREMENTS

A General Purpose V.T. Voltmeter With Ray-Tube Indicator (Griffin).....	19, Aug.
A Laboratory-Type Beat-Frequency Audio Oscillator and R.F. Signal Generator (DeSoto) Part I.....	45, Apr.
Part II.....	41, Oct.
A Method of Measuring Frequency Drift (Exp. Section).....	54, Oct.
Amateur Applications of the "Magic Eye" (Waller) Part I.....	35, Oct.
Part II.....	23, Nov.
Cathode-Ray Monitoring of Received Signals (Ewing).....	35, Apr.
Measuring Power with Wattmeter (Exp. Section).....	57, Oct.
The 6E5 for Checking Overmodulation (Exp. Section).....	33, Mar.

MISCELLANEOUS

A Handy Alcohol Lamp from the Junk Box (Exp. Section).....	57, Oct.
A Loving Tribute and a Challenge.....	8, May
A New "Cold Dry" Crackle Finish (Summer and Emmott).....	19, June
Art-Metal Finish (Millington and Zaun).....	30, Mar.
Election Notices (Directors).....	27, June; 19, July;
	26, Sept.; 26, Oct.
Election Notices (SCM).....	68, Feb.; 70, April;
	48, June; 50, Aug.; 67, Oct.
Election Results (Directors).....	24, Feb.; 26, Sept.
Election Results (SCM).....	68, Feb.; 70, Apr.;
	49, June; 51, Aug.; 67, Oct.

How to Pass the Amateur Exams.....	54, Jan.
How to Read and Use Your QST (Merrill)....	42, Feb.
Mysterious Interference.....	58, Jan.
QSL Bureaus.....	63, May;
	61, Oct.
W.B.E. Rules.....	67, Feb.

MONITORS

A Different Keying Monitor (Exp. Section)...	44, Dec.
A Meter-Type Modulation Monitor (Summerford).....	24, May
Correction.....	40, July
A Monitoring Kink (Exp. Section).....	54, Mar.
A "Neon-Stick" Visual Modulation Monitor (Campbell).....	21, July
Break-In and Monitoring System (Exp. Section)	60, Apr.
Break-In Monitoring (Exp. Section).....	74, Sept.
Monitoring Audio Oscillator with Keyer Tubes (Exp. Section).....	42, Aug.
Neon-Bulb Audio Oscillators (Schnell).....	52, Feb.
Relayless Audio Oscillator for Monitoring Keying (Exp. Section).....	41, Aug.
Simple Monitoring System for Checking Hum or Modulation Quality (Exp. Section).....	61, Apr.

NAVAL COMMUNICATIONS RESERVE

1935 Navy Day Competition.....	46, Feb.
Navy Day Receiving Competition.....	10, Oct.

OBITUARY

Allen H. Babcock.....	25, Jan.
Charles H. Stewart.....	7, Apr.
Hiram Percy Maxim.....	9, Apr.
Silent Keys:	
90, Jan. 122, Feb. 32, Apr. 64, May	
80, July 81, Aug. 52, Sept. 96, Oct.	66, Dec.

OPERATING PRACTICES

Atmosphere! (Crutchfield).....	68, May
Correct Speaking (Thompson).....	46, Sept.
"Fists" I Have Seen (Schnell).....	22, Mar.
Handling Ham Messages.....	36, Aug.
Harmonics! Look into Your Rig, Please.....	67, May
Perfection—Not Speed (Bowers).....	68, May
Re Testing (Dye).....	66, Apr.
R9 Plus! (Bliss).....	10, Nov.

OSCILLOSCOPES

An I.F. Coupling Amplifier for the Cathode Ray Oscilloscope (Wilson).....	51, May
Cathode-Ray Monitoring of Received Signals (Ewing).....	35, Apr.

POWER SUPPLY

An Improved Method of Voltage Control (Blitch).....	29, Aug.
Combination Time Delay and Bias Supply (Exp. Section).....	57, May
Combined Plate and Bias Pack (Exp. Section)...	59, Feb.
High Voltage from 32 Volts D.C. (Tabor).....	21, Mar.
Home-Made High-Voltage Fuses (Exp. Section)	40, Nov.
Insulating Filter Chokes (Exp. Section).....	59, Apr.
New Line Chokes.....	66, Sept.
Overload Protection (Exp. Section).....	39, Nov.
Simple Filament-Voltage Booster for 6.3-volt Tubes (Exp. Section).....	59, Apr.
Single Control of Transmitter, Receiver, and Monitor (Exp. Section).....	56, Oct.

PROPAGATION AND TRANSMISSION EFFECTS

DX by the Calendar (Perrine).....	34, Aug.
Five Meters Again Shoots the Works.....	9, July
High-Frequency Radio Fadeouts Continue (Dellinger).....	37, June
New Cosmic Phenomenon (Dellinger).....	8, Jan.
The Kennelly-Heaviside Layer—Its Relationship to Our Everyday Communication Problems (Kenrick).....	13, Sept.
What's Happened to Ten?.....	8, Aug.

RADIOTELEPHONY

200 Watts C.W., 75 Watts 'Phone (Gow)	16, Feb.
An All-Band 'Phone Transmitter Using Beam Power Tubes (Mathis and Carter)	32, Dec.
A General Utility Mixer and Speech Amplifier (DeSoto)	37, Nov.
A Meter-Type Modulation Monitor (Summerford)	24, May
Correction	40, July
A "Neon-Stick" Visual Modulation Monitor (Campbell)	21, July
A Volume-Compressing Method for 'Phone Transmission (Smith)	28, Sept.
A 50-Watt Audio Amplifier-Modulator With Beam Tube Output (Grammer)	11, June
An Improved Speech Preamplifier (Fraser)	20, Mar.
Automatic 'Phone Break-In	32, Nov.
Cathode-Ray Monitoring of Received Signals (Ewing)	35, Apr.
Class-B "Squirt" Modulation With a Pentode Class-C Stage (Young)	51, Oct.
Considerations in Speech-Amplifier Design (Lund and Howe)	15, Jan.
Grid Leak Modulation (Exp. Section)	58, Feb.
Mixing System (Exp. Section)	30, Jan.
Resistance-Coupled Input for Carbon Microphones (Sather)	38, Aug.
Rebuilding a Condenser Microphone for Ham Use (Coe)	35, Dec.
Suppressor Modulation With Linear Amplification (Exp. Section)	54, May
The 6E5 for Checking Overmodulation (Exp. Section)	33, Mar.
Types of Distortion in 'Phone Transmitters (Tucker)	53, Feb.

RECEIVERS—REGENERATIVE

Pocket Superregen Receivers (Roberts)	22, Jan.
Regenerative Receiver Using a 53 (Exp. Section)	62, Aug.
Simple Regenerative Receiver with Separate Beat Oscillator (Talbert)	15, Feb.
An Effective Regeneration Control (Exp. Section)	41, Aug.
Improving Selectivity in the Regenerative Receiver (Exp. Section)	56, May
Improved System of Regeneration Control for the Screen-Grid Detector (Exp. Section)	41, Aug.
Notes on Audio Power Amplifiers in Regenerative Receivers	39, Apr.
The Class-C Audio Amplifier Applied to Regenerative Receivers (Exp. Section)	54, Oct.

RECEIVERS—SUPERHETERODYNE

A Crystal Filter and Noise-Silencer for the "High-Performance" Super (Grammer)	28, Oct.
Building a Simplified High-Performance Superhet (Grammer)	19, Apr.
A Noise-Silencing I.F. Circuit for Superhet Receivers (Lamb)	11, Feb.
Adding A.V.C. to the Ham Super (Grammer)	35, June
Dual-Diversity 'Phone Reception With Single-Control Tuning (McLaughlin and Lamb)	39, May
Heterotone C.W. Telegraph Reception (Lamb)	16, Nov.
More Developments in the Noise-Silencing I.F. Circuit (Lamb)	16, Apr.
Operating Noise-Silencing Units (Grammer)	11, Mar.
Oscillator-Mixer Coupling with the 6F7 (Exp. Section)	59, Apr.
Oscillator-Mixer Design Considerations for the Amateur-Band Superhet (DeSoto)	31, Sept.
Using the 6L7 To Improve Superhet Performance	48, Feb.

RECEIVING—GENERAL

A Detector Circuit for Reducing Noise Interference in 'Phone Reception (Thompson)	44, Feb.
A Moving Coil Tuning System for the H.F. Receiver (Millen)	30, Dec.
A Resonant Loud-Speaker for C.W. Reception (Seaton)	64, May
An Automatic Tape Recorder for the Radio Amateur (Schnell)	36, Apr.

An I.F. Coupling Amplifier for the Cathode Ray Oscilloscope (Wilson)	51, May
Another Crack at Background Noise in C.W. Reception (Bishop)	39, July
Audio Output Limiters for Improving the Signal-to-Noise Ratio in Reception (Robinson)	27, Feb.
Automatic Tone Control (Exp. Section)	55, Oct.
Calibrated Band-Spread and General Coverage With the Same Coil (Exp. Section)	40, Sept.
Calibrating the Receiver for General Coverage (Exp. Section)	57, Oct.
Circuit Design of a Modern U.H.F. Superheterodyne (Miles)	39, Dec.
Grid Bias Cells	68, Sept.
High-Fidelity Audio at Low Cost (Hull)	34, July
More About the Low-Cost High-Fidelity Audio Amplifier	34, Nov.
Neon-Bulb Noise Reducer (Exp. Section)	40, Nov.

TRANSMITTERS—PORTABLE AND LOW POWER

A Low-Cost Crystal Transmitter (Chambers)	13, Mar.
A Simple and Inexpensive QRP Transmitter (Exp. Section)	43, July
A Simple Two-Band 6L6 Tri-Tet Transmitter (Goodman)	35, Nov.
An Inexpensive Five-Band Low-Power Transmitter (Grammer)	11, Dec.
An Inexpensive Four-Band Transmitter (Chambers)	23, Aug.
Separate Transmitters on Five Bands (Budlong and DeSoto)	27, May

TRANSMITTERS—MEDIUM AND HIGH POWER

100-Watt 56-Mc. Crystal-Control Output With Only Four Stages (Goodman)	16, Oct.
200 Watts C.W., 75 Watts 'Phone (Gow)	16, Feb.
5-Meter Crystal Control With Push-Pull 800 Output (Reinartz)	24, Oct.
56-Mc. Crystal Control With Resonant-Line Coupling (Sanders)	12, Aug.
A High-Performance Three-Stage Transmitter With Improved Tri-Tet Exciter (Goodman)	16, June
A High-Power Three-Stage C.W. Transmitter With Beam-Power Crystal Control (Edmonds)	41, July
A Medium Power Transmitter for 7, 14 and 28-Mc (Grammer)	11, Oct.
A Novel All-Band Transmitter of One Kilowatt Capability (Eitel and McCullough)	31, Oct.
A Simple 14- and 28-Mc. Rig That Has Worked Over 30 Countries (Kohler)	47, May
A Versatile Crystal-Controlled U.H.F. Transmitter (Grosselinger and Prosser)	17, Dec.
A 500-Watt Transmitter With Band-Switching Exciter (Rodimon)	13, July
An All-Band 'Phone Transmitter Using Beam Power Tubes (Mathis and Carter)	32, Dec.
Licking the Crystal Control Problem on the Ultra-High Frequencies (Moody and Kirby)	9, Aug.
Open-Type Transmitter Construction for Small Floor Space (Goodman)	41, Apr.

TRANSMITTING—CRYSTAL CONTROL

Electron-Coupled vs. Crystal Transmitter Control (Mix)	50, Apr.
Some Trick Crystal Circuits (Brown)	19, Sept.
The 6L6 Beam-Power Tube as a High-Output Crystal Oscillator (Edmonds)	20, June
Tuning the Crystal (Hollister)	31, Apr.
Twenty-Meter Crystals (Exp. Section)	42, Aug.

TRANSMITTING—GENERAL

110-Volt Transmitter Using 48's (Exp. Section)	29, Jan.
Adapting Inductive Neutralization to the Low-Power Transmitter (Exp. Section)	44, July
Electron-Coupled vs. Crystal Transmitter Control (Mix)	50, Apr.
Inductive Neutralization of R.F. Amplifiers (Craft and Collins)	22, July

More Locked Oscillator Circuits (Exp. Section)	55, May
More on the 6A7 Transmitter (Exp. Section)	60, Feb.
Quick Shift for Amplification or Doubling (Exp. Section)	60, Feb.
Regenerative Doubler (Exp. Section)	56, May
Revised Transceiver Circuit (Exp. Section)	59, Feb.
Simplifying the Push-Pull-Push Crystal Oscillator (Brown)	10, July
Some Trick Crystal Circuits (Brown)	19, Sept.
Switching 53 Sections (Exp. Section)	57, Oct.
The 6L6 as Amplifier and Doubler	30, Sept.
The 6L6 Beam-Power Tube as a High-Output Crystal Oscillator (Edmonds)	20, June
Transmitting Band-Switching Systems (Grammer)	17, Mar.

TUBES

830-B and 834 Transmitting Tubes Announced	86, Mar.
A New Audio Power Tube	50, May
A 50-Watt Audio Amplifier-Modulator With Beam-Power Tube Output (Grammer)	11, June
Characteristics of the 316A	25, Sept.
Metal Tubes	18, Aug.
Miniature Cathode Ray Tube Announced	37, Dec.
New Amateur Tubes: 154, 807, RK-39, 808	96, Dec.
New Metal Tubes	51, Feb.
New Receiving Tubes	29, Mar.
New Receiving Tubes: 1F4, 1F6, 5W4, 6N7	60, July
New Transmitting Tubes: 804, 805, 836, 35T	64, Apr.
Operating Notes on the 35T	53, May
Operating Notes on the Transmitting-Type Beam Power Tube	28, Dec.
Pentodes as Class-AB Amplifiers	29, Mar.
Picking Out the Receiving Tubes	53, Oct.
The 6E6 Twin Power Amplifier, and the 6G5—New Electron-Ray Tube	28, Aug.
The 6L6 As Amplifier and Doubler	30, Sept.

ULTRA-HIGH FREQUENCIES— APPARATUS

100-Watt 56-Mc. Crystal-Control Output With Only Four Stages (Goodman)	16, Aug.
23-Mc. Converter with Tuned R.F. Receivers (Exp. Section)	62, Apr.
5-Meter Crystal Control With Push-Pull 800 Output (Reinarts)	24, Oct.
56-Mc. Crystal Control With Resonant-Line Coupling (Sanders)	12, Aug.
A 23-Mc. Rotary Beam (Breuer)	23, Apr.
A 5- and 10-Meter Converter (Long)	55, Apr.

A Novel Low-Cost Ultra-High-Frequency Receiver (Williams)	22, May
A Simple 14- and 23-Mc. Rig That Has Worked Over 30 Countries (Kohler)	47, May
A Ten-Meter Converter (Grammer)	39, Feb.
A Versatile U.H.F. Transmitter (Grosselinger and Prosser)	17, Dec.
Adapting the Patterson PR-10 for 10-Meters (Exp. Section)	33, Mar.
Adapting the QST Three-Tube Transmitter to Ten Meters (Exp. Section)	34, Mar.
Antenna Coupling to the 56-Mc. Receiver (Exp. Section)	60, Apr.
An Unconventional Receiver for the Ultra-High Frequencies	21, Feb.
Car Antenna Kinks (Exp. Section)	42, Aug.
Licking the Crystal-Control Problem on the Ultra-High Frequencies (Moody and Kirby)	9, Aug.
Multi-Tube Oscillators for the Ultra-High Frequencies (Zottu)	21, Oct.
Neon-Bulb Oscillator for Tone Modulator (Exp. Section)	61, Apr.
Remote Tuning of U.H.F. Receivers (Rife)	32, Aug.
Revised Transceiver Circuit (Exp. Section)	59, Feb.
R.F. Amplifier for the "Minute Man" (Exp. Section)	38, Sept.
Shorting Link (Exp. Section)	31, Jan.
Spotting Frequencies (Exp. Section)	59, Feb.
Transceiver à la "Minute Man" (Exp. Section)	38, Sept.
Transmitters for Ten Meters (Grammer)	11, Jan.
Working at One Meter and Below (Hull)	22, Sept.

ULTRA-HIGH FREQUENCIES—TESTS

23-Mc.	30, Feb.
28-Mc. Activity at All-Time High	9, Jan.
Amateurs Needed to Aid 56-Mc. Experiments	116, Oct.
British 56-Mc. C.W. Transmissions	28, Aug.
Five Meters Again Shoots the Works	9, July

WHAT THE LEAGUE IS DOING

20, Jan.	24, Feb.	25, Mar.	33, Apr.	26, May	27, June
19, July	21, Aug.	26, Sept.	26, Oct.	27, Nov.	27, Dec.
Minutes of 1936 Board of Directors Meeting	29, June				
'Phone Frequencies	27, Oct.				
The June Hearing	21, Aug.				
The Ultra-High Frequencies and the June F.C.C. Hearing	7, Aug.				

WITH THE AFFILIATED CLUBS

28, Jan.	54, Apr.
----------	----------

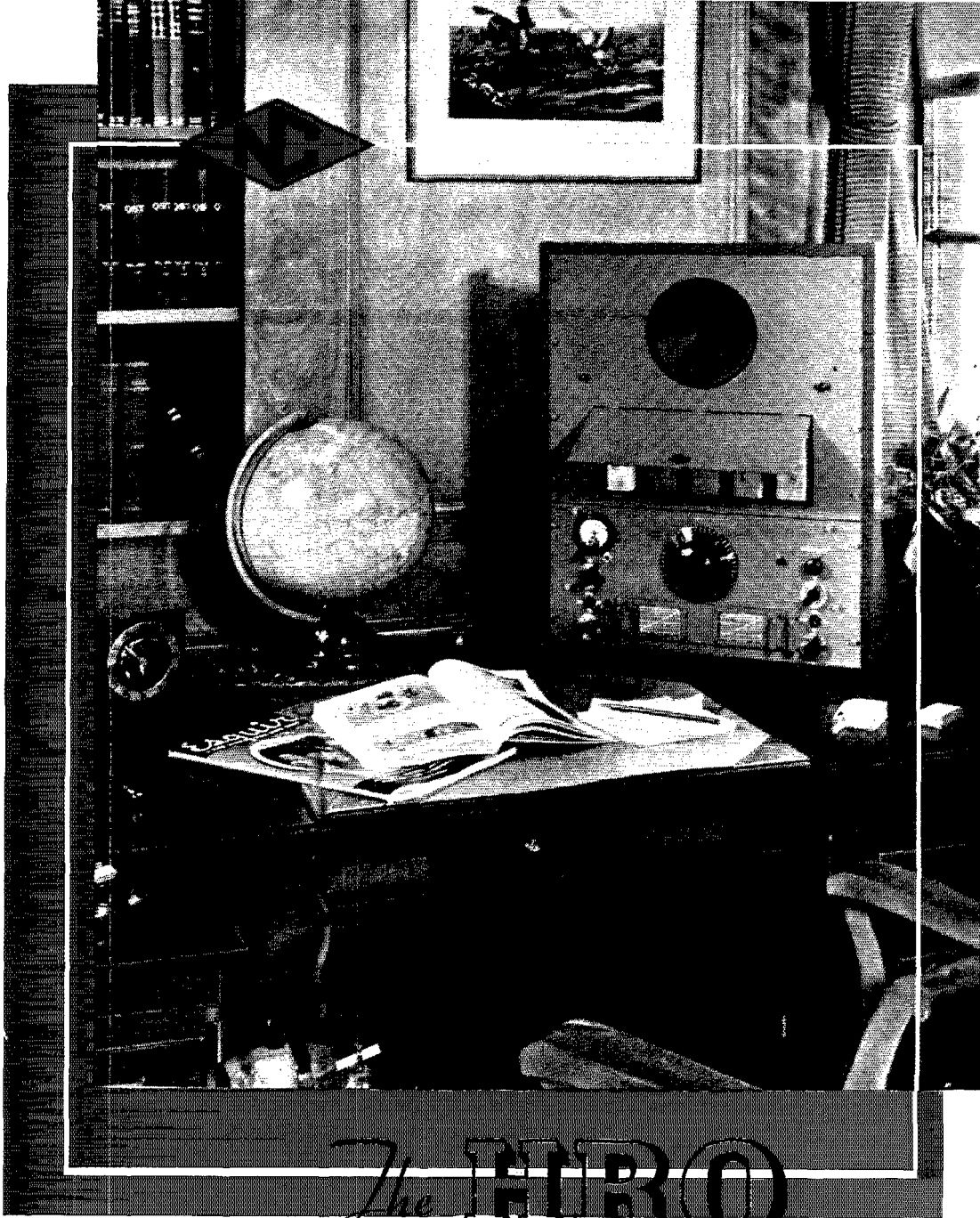

The HRO

IN REPLY to professional demand, a Combination Panel consisting of a spare-coil cabinet, matched speaker and power supply is now offered as an auxiliary to the HRO Receiver. Making a compact well-appointed receiver with its speaker properly segregated to prevent annoying mechanical feed-back. Your choice of finish, either rich grey or black leatherette. Retail prices are: HRO receiver, relay rack type, with coils covering 1.7 to 30 megacycles — \$179.70; Combination Panel type SPC — \$52.50; Table-model Relay Rack type MRR — \$13.50.

NATIONAL COMPANY



NEW RCA-808...

added performance at lower price

This outstanding new transmitting tube provides not one but a host of features never before incorporated in one tube type. Study these features carefully to assure yourself that this is the type to use in your new transmitter.

- 1 TANTALUM PLATE**—Gives high plate dissipation and assures freedom from gas.
- 2 LEADS**—Plate at top, grid at side, provide maximum insulation, maximum convenience of circuit arrangement, and low inter-electrode capacitances.
- 3 BULB STYLE**—Gives maximum heat dissipating area and cooler bulb for equivalent size tube. Large spacing between plate and bulb reduces possibility of gas evolution from bulb.
- 4 ELECTRODE SUPPORTS**—Constructed with minimum of insulating materials.
- 5 LARGE PLATE CAP**—Provides low contact resistance and greater strength.
- 6 HIGH PERVEANCE**—Perveance is a fundamental tube constant inversely proportional to tube impedance. A high-perveance tube is, therefore, a low-impedance tube. A high-perveance tube can be operated at reasonable plate voltages with high plate efficiencies, thus avoiding the necessity for costly high-voltage power supplies.
- 7 HIGH-MU GRID**—Requires less bias—is economical and convenient. Low cut-off voltage means low plate current at zero bias; thus, the tube is protected should excitation fail with grid-leak bias.

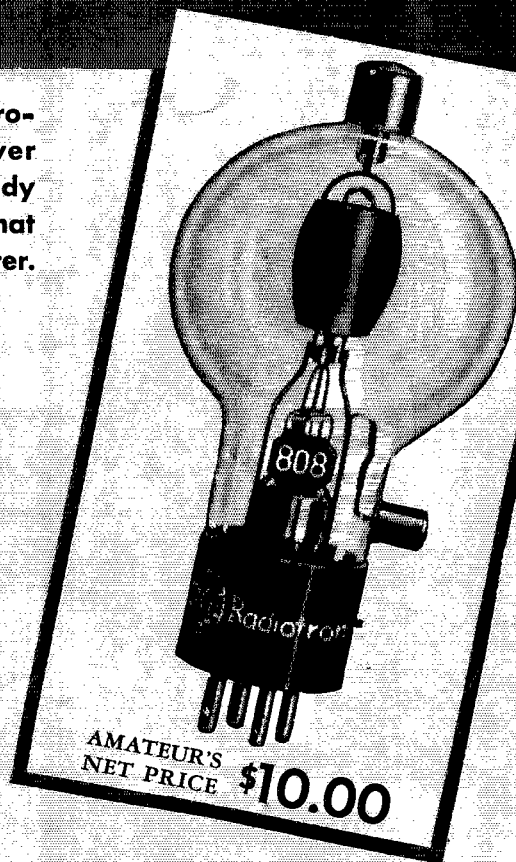

- 8 HEAVY DUTY FILAMENT**—7.5 volt, 4 amp filament provides large reserve emission for heavy-duty operation.
- 9 CONSERVATIVE RATINGS**—Class C telegraph service: 50 watts plate dissipation, 1500 plate volts, 200 watts input power.—RCA's conservative ratings assure long, economical, and satisfactory tube operation.



for Amateur Radios

Address Amateur Radio Section, RCA Manufacturing Co., Inc., Camden, N. J.

A service of the Radio Corporation of America