

QST

November, 1936
25 cents

devoted entirely to

amateur radio

In this issue—
New Data—
on—
Antenna—
Performance

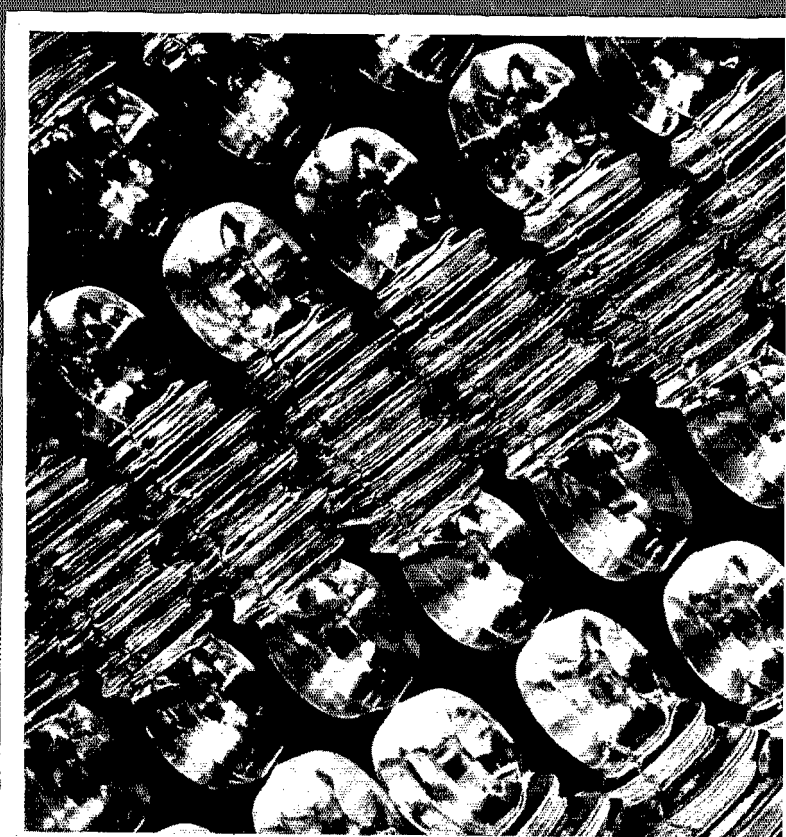

10X—100 Watts
10 mc to 60 mc

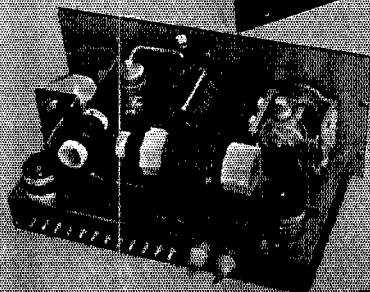
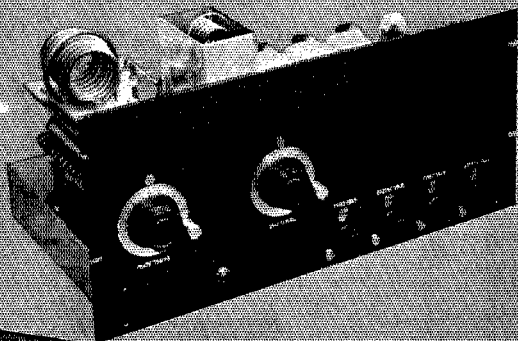

10P—175 Watts
1.5 mc to 10 mc

10M—175 Watts
1.5 mc to 30 mc

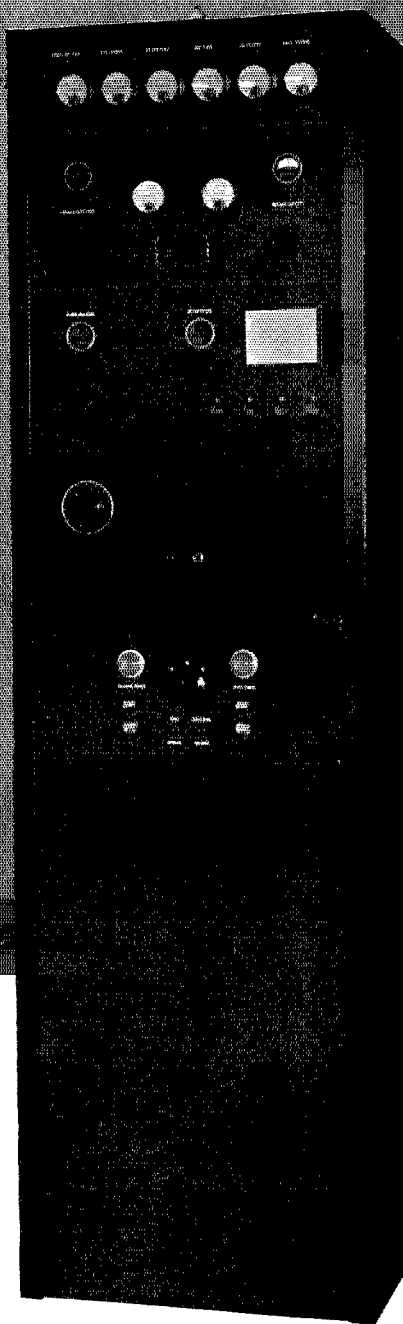
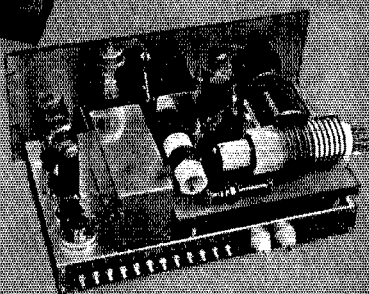

Type 150 Series Transmitters

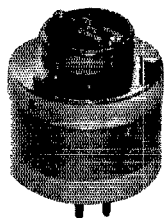

Three new r-f units make it possible to supply a transmitter of the 150 Series for any type of service where an output up to 175 watts is required. As many as four r-f units may be included in one transmitter with automatic telephone dial control if desired for instant frequency shift. 150 Series Transmitters are supplied for airways, police, military, point to point and deluxe amateur service. Technical data sent on request.

TYPE 150C-6C General Purpose Transmitter with 10M R-F Unit, 2R Network, 9K Modulator, 7L Amplifier, 100R Lay Control and 415A-1 Power U

Collins Radio Company

CEDAR RAPIDS
New York
11 West 42nd St.



IOWA, U. S. A.
Mexico City
Edificio "La Nacional"

HAMMARLUND

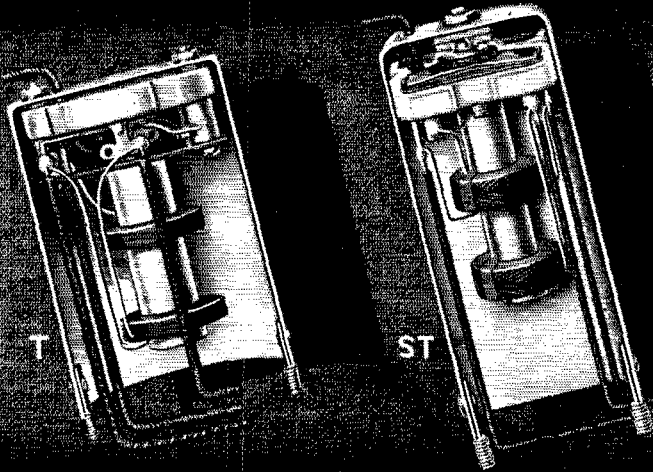

I.F. TRANSFORMERS

.. for Better Radio!

A GROUP of I.F. replacement and experimental transformers by Hammarlund, for broadcast and short waves, for the critical engineer, research student, repairman, and amateur demanding superior results for better radio. Ten types are available in a round can "T" model for 175 and 465 kc., and a square can "ST" model for 175, 262 and 465 kc.

The electrical characteristics of "T" and "ST" are identical, with tuned grid and tuned plate lattice wound coils, impregnated to prevent moisture effects. The tuning condensers are the highest grade mica compression type, mounted on Isolantite bases and adjustable from the top of the shield can. Leads are RMA color coded, and tagged for easy installation. Secondaries are either plain for standard screen grid tubes, or center tapped for tubes requiring split input circuits.

Aluminum shield of "T" model is $2\frac{1}{8}$ " outside diameter by $3\frac{1}{8}$ " high, with threaded

mounting lugs on 2" centers. The "ST" aluminum shield can is $2\frac{3}{4}$ " high by $1\frac{7}{16}$ " square, with threaded mounting studs on $1\frac{5}{16}$ " centers.

Here are truly quality transformers! And they are now available at the new low price of \$1.45 each, list.

Write for the special I.F. transformer bulletin with further details! Just mail the coupon below.

HAMMARLUND MANUFACTURING CO., INC.
424-438 W. 33rd St., New York

Q-11

Check here for new I.F. Transformer bulletin.

Check here for 1936 Hammarlund General Catalog.

Name

Address

.....

HAMMARLUND'S 25TH YEAR



ACCLAIMED

THE FINEST AUDIO TRANSFORMER



AT THE RECENT
CHICAGO A. R. R. L.
CONVENTION

**PURE—CLEAR
AUDIO POWER**

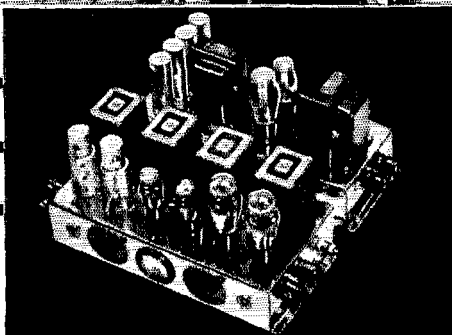

5,000 radio enthusiasts heard Tru-Fidelity live up to every claim we have made for it at the great A.R.R.L. Central District Convention in Chicago. Others tried, THORDARSON has succeeded. Insist on Tru-Fidelity by Thordarson. Enjoy the results gained through the use of transformers built with laboratory perfection in commercial production.

Tru-Fidelity transformers offer every known refinement. High-permeability core; special winding formulae; non-magnetic mounting brackets; perfect symmetry; self-shielding case; sub or above panel leads; single hole reversible rotate mounting.

Send Today for THORDARSON CATALOG 500
Containing curves, diagrams and listings
of all Tru-Fidelity transformers. Just out
bulletins SD-258 and SD-259 describing
Tru-Fidelity uses in power amplifiers. Send
for your copies today or see your parts
distributor.



THORDARSON ELECTRIC MFG. CO.

500 W. HURON ST., CHICAGO, ILL.

Demand "Power by Thordarson"

QST

devoted entirely to

AMATEUR RADIO

PUBLISHED, MONTHLY, AS ITS OFFICIAL ORGAN, BY THE AMERICAN RADIO RELAY LEAGUE, INC., AT WEST HARTFORD, CONN., U. S. A.; OFFICIAL ORGAN OF THE INTERNATIONAL AMATEUR RADIO UNION

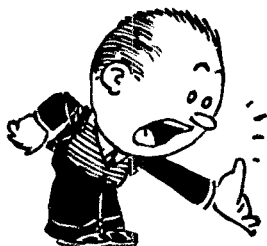

NOVEMBER 1936

Volume XX Number 11



Kenneth B. Warner (Secretary, A.R.R.L.), *Editor-in-Chief and Business Manager*; Ross A. Hull, *Associate Editor*; James J. Lamb, *Technical Editor*; George Grammer, *Assistant Technical Editor*; Clark C. Rodimon, *Managing Editor*; David H. Houghton, *Circulation Manager*; F. Cheyne Beekley, *Advertising Manager*; Ursula M. Chamberlain, *Assistant Advertising Manager*.

*Editorial and
Advertising Offices*

38 La Salle Road
West Hartford, Connecticut

Subscription rate in United States and Possessions and Canada, \$2.50 per year, postpaid; all other countries, \$3.00 per year, postpaid. Single copies, 25 cents. Foreign remittances should be by international postal or express money order or bank draft negotiable in the U. S. and for an equivalent amount in U. S. funds.

Entered as second-class matter May 29, 1919, at the post office at Hartford, Connecticut, under the Act of March 3, 1879. Acceptance for mailing at special rate of postage provided for in section 1103, Act of October 3, 1917, authorized September 9, 1922. Additional entry at Concord, N. H., authorized February 21, 1929, under the Act of February 28, 1925.

Additional second-class entries to cover sectional editions authorized March 20, 1935. Copyright 1936 by the American Radio Relay League, Inc. Title registered at United States Patent Office.

The Contents

Editorials	9
R9 Plus	<i>Alonzo O. Bliss</i> 10
'Phone — C. W. De Luxe	11
Heterotone C. W. Telegraph Reception	<i>James J. Lamb</i> 16
Dixie Jones' Owl Juice	17
The All-Around Radiation Characteristics of Horizontal Antennas	<i>George Grammer</i> 19
Amateur Applications of the "Magic Eye" <i>Part II. L. C. Waller, W2BRO</i>	23
What the League Is Doing	27
Plain Talk About Rhombic Antennas <i>Ross A. Hull and C. C. Rodimon, W1SZ</i>	28
Seventh A.R.R.L. Sweepstakes Contest <i>F. E. Handy, W1BDI</i>	30
Automatic Phone Break-In	32
More About the Low-Cost High-Fidelity Audio Amplifier	34
A Simple Two-Band 6L6 Tri-Tet Transmitter <i>Byron Goodman, W1JPE</i>	35
A General Utility Mixer and Speech Amplifier <i>Clinton B. DeSoto, W1CBD</i>	37
Hints and Kinks	
Overload Protection — Suppressor-Grid Keying of Oscillator Tube for Break-In Operation — Neon-Bulb Noise Reducer — Home-Made High-Voltage Fuses	39
I.A.R.U. News	42
Operating News	44
Correspondence Department	51
Book Reviews	86
Standard Frequency Transmissions	90
Hamads	107
QST's Index of Advertisers	110

A TRANSCRIPT from an AMATEUR'S LOG*

*Based on
one amateur's
actual experi-
ence with the
Ultra Sky Rider.

OK Bill, 100% that trip -- that way nearly all the time now, a big kick out of five last night -- fellows from 25 to 40 miles in there like sore thumbs. Now that I can hear things I find this a darned attractive band. The expander is particularly justified on 5 as the boys do flutter around a bit but it takes care of that. The running motor on the neighbor's car doesn't even bother me, which speaks well for the noise silencer as ignition noises used to paralyze me from 40 down. Did you hear all the 10 meter stations yesterday? Seems all the 6's are on 10 nowadays. More DX there than you can shake a stick at. Now that I can hear them I've got to get the bugs out of my transmitter so that I can get down there myself.

Felt sorry for "Doc" Simpson on 20 around 3 o'clock. ON4VK had the band all sewed up on the Ultra and even the Doc was at the mike SPC couldn't hear him in this country. I believe the Iron Cores are responsible for a lot of this receiver's performance. The Signal to Noise ratio is much better than we've been used to - why, early Saturday morning -- 7:15 to be exact -- I heard four VK fones none less than 4-6 and the average 5-6-7. VK7JV and VK7CO were in especially well.

Either 20 was hot yesterday or this receiver is unusual. English fones were in from 3 o'clock on after the band lengthened out. Got SUL6H, G5NI, G5ML and a flock of others.

Last night, I tried 40 and found a lot of good signals, and could separate them clearly, too. Crystal is certainly the answer on code and voice too. Much pleased with the sensitivity of the Ultra -- ZL's started coming through in great style at 10:30 o'clock.

How am I coming thru? After we get used to operating the Ultra we won't have to worry much about QRM. Even now, after only a week, I can set 'em up all by themselves and keep them that way. Darn shame more of our foreign friends aren't using the Ultra. I'd fell much surer of getting them -- sorry to be so long-winded -- I'd guess my enthusiasm got the better of me - Just a minute until I see if your channel is clear . . . OK, go ahead.

The ULTRA SKY RIDER AN ENTIRELY NEW APPROACH TO ULTRA HIGH FREQUENCY RECEPTION—

3.76 to 53 meters in 4 bands. Built-in Lamb Noise Silencer. 10 All-Metal Tubes. Iron Core Expanding I. F. Transformer. Direct Reading Frequency Calibrated Micro-Vernier dial. Individual Coils for each band, and dozens of other new and exclusive features.



See it at your dealers or
write for complete information.

the hallicrafters inc.

2611 Indiana Avenue, CHICAGO, U. S. A. — Cable Address "LIKEX" N. Y.

the SKY BUDDY

the
hallicrafters
Amazing New
JUNIOR MODEL
Communication
RECEIVER
Now Available
On Time
Payments



\$29⁵⁰

- ★ 5 tubes do the work of 8.
- ★ Combined I.F. and beat frequency oscillator.
- ★ Built-in speaker and power supply.
- ★ Single tuning control.
- ★ Iron core I.F. (high gain and select.)
- ★ Mechanical band-spread.
- ★ 18 to 555 meters in 3 bands.
- ★ Beat frequency oscillator switch.

TIME PAYMENTS

Buy your new Hallicrafters receiver on Hinds & Edgerton's Time Payment Plan — small down payment and easy monthly payments — write at once for details!

LEARN all about the sensational new SKY BUDDY, the genuine Hallicrafters-engineered communication receiver now available at this astonishingly low price. Its performance is amazing. Sensitivity and selectivity better than models at several times its exceptionally low price.

Hinds and Edgerton are in excellent position to render prompt service on any of the outstanding new Hallicrafters Receivers. Because of our location in Chicago we are in almost daily communication with the Hallicrafters factory, and in close touch with the latest developments in this leading line of communication receivers. Write today for the Hinds and Edgerton Free Catalog and details of our favorable Time Payment Terms.

MAIL THIS COUPON

HINDS & EDGARTON

ESTABLISHED 1914

19 South Wells Street Chicago, Illinois

Gentlemen: Please send me complete details of the New 1937 Hallicrafters Line and the Hinds & Edgerton Time Payment Plan.

NAME _____

ADDRESS _____

CITY _____ STATE _____

OPERATED BY W9APY AND W9WK

HERE'S WHY—

—we recommend The NEW 1937 hallicrafters RECEIVERS



The NEW 1937 SUPER SKYRIDER

BECAUSE Hallicrafters Receivers have always represented advanced engineering — because Hallicrafters have always been among the first to incorporate the newest and soundest developments in the short wave field into their receivers — we conscientiously recommend them to our customers as the most modern of communication receivers.

The Hallicrafters were the first to abandon cumbersome plug-in coils.

All-Metal tubes were first used in a communication receiver in the Super Skyrider.

And now — Hallicrafters again demonstrate their progressive leadership by the exclusive use of Iron Core I. F. Transformers, providing finer sensitivity, better selectivity and improved Signal to Noise Ratio.

Always forging ahead — a Hallicrafters Receiver represents real value for any amateur and short wave listener.

The New 1937 11-Tube Super Skyrider is amazing! With greater sensitivity than before, improved 10 meter reception, it represents advanced thought in short wave engineering.

See it today.

- 11 Tubes, 10 of them metal.
- 40 M.C. to 535 K.C. in 5 bands.
- 338 Degrees main tuning dial.
- 14 Watts Undistorted Output
- Direct Calibration Tuning — No Charts or Tables.
- Field Strength Indicator.
- Improved 10 meter performance.
- 465 K.C. Iron Core I. F. for improved selectivity.

TIME PAYMENTS

We have arranged TIME PAYMENTS on all of the New 1937 Hallicrafters Skyriders! There's only a small down payment when you buy — the balance is spread out over the months you are enjoying your New Hallicrafters Skyrider! Don't use obsolete equipment another week! Send us the coupon TODAY — find out how easy it is for you to own the LATEST SKYRIDER!

MAIL THIS COUPON! THE RADIO SHACK

46 BRATTLE STREET, BOSTON, MASS.

Please send me complete technical data on new Hallicrafters Receivers.

NAME..... ADDRESS.....

CITY..... STATE.....

Section Communications Managers of the A.R.R.L. Communications Department

All appointments in the League's field organization are made by the proper S.C.M., elected by members in each Section listed. Mail your S.C.M. (on the 10th of each month) a postal covering your radio activities for the previous 30 days. Tell him your DX, plans for experimenting, results in phone and traffic. He is interested, whether you are an A.R.R.L. member or get your QST at the newsstands; he wants a report from every active ham. If interested and qualified for O.R.S., O.P.S. or other appointments he can tell you about them, too.

Eastern Pennsylvania	W3EZ	ATLANTIC DIVISION James M. Bruning	339 W. Lancaster Ave	Haverford
Maryland-Delaware-District of Columbia	W3BAK	Edgar L. Hudson		Laurel, Delaware
Southern New Jersey	W3ZX	Carroll D. Kentner	1107 Park Ave.	Collingswood
Western New York	W8DSS	Charles Smith	310 E. Walnut St.	Oneta
Western Pennsylvania	W8OFO	Kendall Speer, Jr.		Lowber
		CENTRAL DIVISION		
Illinois	W9KJY	L. John Huntoon	327 Brandon Ave.	Glen Ellyn
Indiana	W9TE	Arthur L. Braun	530 East Morris St.	Indianapolis
Kentucky	W9AUH	G. W. Mossbarger	Box 177	Camp Taylor
Michigan*	W8DPE	Harold C. Bird	R.F.D. 2	Pontiac
Ohio	W8AQ	E. H. Gibbs	300 High St.	Wadsworth
Wisconsin	W9ATO	E. A. Cary	3922 No. 19th Pl.	Milwaukee
		DAKOTA DIVISION		
North Dakota	W9OEL	Hartwell B. Burner		Hope
South Dakota	W9SEB	Andrew J. Kjar	257 Prospect Ave.	Pierre
Northern Minnesota	W9OWU	Leonard Hoistad		Elbow Lake
Southern Minnesota	W9DCM	Webster F. Soules	3549 36th Ave. So.	Minneapolis
		DELTA DIVISION		
Arkansas	WSABI	H. E. Velte	2918 West 15th St.	Little Rock
Louisiana	W5DWV	W. J. Wilkinson, Jr.	1523 Laurel St.	Shreveport
Mississippi	W5CWO	J. H. Weems, Jr.	P. O. Box 244	State College
Tennessee	W4DEP	B. G. Lowrey Smith	2010 Carnes St.	Memphis
		HUDSON DIVISION		
Eastern New York	W2LU	Robert E. Haight	511 South Holmes St.	Scotia
N. Y. C. & Long Island	W2AZV	E. L. Baunach	7823 10th Ave.	Brooklyn
Northern New Jersey	W2FOP	Charles J. Hammersen	92 Claremont Ave.	Verona
		MIDWEST DIVISION		
Iowa	W9LEZ	Phil D. Boardman	325 Kirkwood Blvd.	Davenport
Kansas	W9FLG	O. J. Spetter	305 Western Ave.	Topeka
Missouri	W9CJR	J. Dewey Mills	Box 205	Mount Vernon
Nebraska	W9FAM	Samuel C. Wallace	Green St.	Clarks
		NEW ENGLAND DIVISION		
Connecticut	W1CTI	Frederick Ells, Jr.	19 Merrill Rd.	Norwalk
Maine	W1CDX	John W. Singleton	73 Allen St.	Wilton
Eastern Massachusetts	W1IAB	Albert N. Giddis	128 Crawford St.	Lowell
Western Massachusetts	W1IAH	William J. Barrett	239 Columbia St.	Adams
New Hampshire	W1BFT	Carl E. Evans	80 No. State St.	Concord
Rhode Island	W1HRC	Clayton C. Gordon	206 California Ave.	Providence
Vermont	W1GNF	Alvin H. Battison	1 Central St.	Windsor
		NORTHWESTERN DIVISION		
Alaska	K7PQ	Richard J. Fox	Box 301	Ketchikan
Idaho	W7NH	Nellie H. Hart	Box 6	Twin Falls
Montana	W7CRH	Russell U. Richmond		Somers
Oregon	W7AJV	Eugene E. Lovejoy	5013 N. E. Clackamas	Portland
Washington	W7WV	Robert H. Votaw	Route 1, Box 398	Vancouver
		PACIFIC DIVISION		
Hawaii	K6EQW	Atlas O. Adams	21st Infantry Brigade	Schofield Barracks
Nevada	W6BIC	Edward W. Heim	509 Claremont St.	Reno
Santa Clara Valley	W6PWC	Elbert Amarantes	475 So. 11th St.	San Jose
East Bay	W6FTV	Harold J. Burchfield	2740 106th Ave.	Sakland
San Francisco	W6SG	Alan D. Whitaker, Jr.	79 Elinor Ave.	Mill Valley
Sacramento Valley	W6DVE	Geo. L. Woodington	716 Redwood Ave.	North Sacramento
Philippines*	KA1GR	George L. Rickard	Box 849	Manila
San Joaquin Valley*	W6LPE	Angelo V. Astone	729 Safford	Fresno
		ROANOKE DIVISION		
North Carolina	W4QG	H. S. Carter	115 Crafton St.	Winston-Salem
Virginia	W3UVA	Charles M. Waff, Jr.	P. O. Box 1212	Univ., Charlottesville
West Virginia	W8KKG	Dr. Wm. H. Riheldaffer		Lost Creek
		ROCKY MOUNTAIN DIVISION		
Colorado	W9FA	Glen Glasscock	2164 So. Corona St.	Denver
Utah-Wyoming	W7COH	Townsend J. Rigby		Midwest, Wyoming
		SOUTHEASTERN DIVISION		
Alabama	W4DGS	James F. Thompson	2248 S. Arlington Ave.	Birmingham
Eastern Florida	W4ASR	William C. Shelton	556 Westmoreland Drive	Daytona Beach
Western Florida	W4MS	Edward J. Collins	"Hillcrest", P. O. Box 652	Pensacola
Georgia-So. Carolina-Cuba-Isle-of-Pines-Porto Rico-Virgin Islands	W4CE	Bannie L. Stewart	C.C.C. Co. 4466	York, S. C.
		SOUTHWESTERN DIVISION		
Los Angeles	W6GXM	Don M. Draper	4421 West 63 St.	Los Angeles
Arizona	W6LVG	C. C. Day	"La Posta Quemada"	Vail
San Diego	W6EOP	Harry A. Ambler	4101 Hamilton St.	San Diego
		WEST GULF DIVISION		
Northern Texas	W5BII	Richard M. Cobb	Box 185	Dodd City
Oklahoma	W5CEZ	Carter L. Simpson	2010 So. 4th St.	Ponca City
Southern Texas	W5BDI	Ammon O. Young	4803 E.H. St.	Houston
New Mexico	W5CGJ	Joseph M. Eldodt		Chamita
		MARITIME DIVISION		
Maritime	VE1DQ	A. M. Crowell	69 Dublin St.	Halifax, N. S.
		ONTARIO DIVISION		
Ontario	VE3QK	John Perdue	229 Askin Boulevard	Windsor, Ont.
		QUEBEC DIVISION		
Quebec	VE2EE	Stan Comach	780 Brault Ave.	Verdun, P. Q.
		VANALTA DIVISION		
Alberta	VE4LX	Alfred D. Kettenbach	635 Garfield St.	Winnipeg
British Columbia	VE5EP	D. R. Vaughan-Smith	1221 Burnaby St.	Vancouver
		PRAIRIE DIVISION		
Manitoba	VE4BG	A. J. R. Simpson	71 Thelmo Mansions	Winnipeg
Saskatchewan	VE4EL	Wilfred Skaffe	2040 McTavish St.	Regina

* Officials appointed to act until the membership of the Section choose permanent S.C.M.'s by nomination and election.

The American Radio Relay League



THE AMERICAN RADIO RELAY LEAGUE, INC., is a non-commercial association of radio amateurs, bonded for the promotion of interest in amateur radio communication and experimentation, for the relaying of messages by radio, for the advancement of the radio art and of the public welfare, for the representation of the radio amateur in legislative matters, and for the maintenance of fraternalism and a high standard of conduct.

It is an incorporated association without capital stock, chartered under the laws of Connecticut. Its affairs are governed by a Board of Directors, elected every two years by the general membership. The officers are elected or appointed by the Directors. The League is non-commercial and no one commercially engaged in the manufacture, sale or rental of radio apparatus is eligible to membership on its board.

"Of, by and for the amateur," it numbers within its ranks practically every worth-while amateur in the nation and has a history of glorious achievement as the standard-bearer in amateur affairs.

Inquiries regarding membership are solicited. A bona fide interest in amateur radio is the only essential qualification; ownership of a transmitting station and knowledge of the code are not prerequisite. Correspondence should be addressed to the Secretary.

HIRAM PERCY MAXIM, FOUNDER

OFFICERS

President.....EUGENE C. WOODRUFF, W8CMP
State College, Pa.

Vice-President.....GEORGE W. BAILEY, W1KH
Weston, Mass.

Secretary.....KENNETH B. WARNER, W1EH
West Hartford, Connecticut

Treasurer.....ARTHUR A. HEBERT, W1ES
West Hartford, Connecticut

Communications Mgr....F. EDWARD HANDY, W1BDI
West Hartford, Connecticut

General Counsel.....PAUL M. SEGAL
1010 Shoreham Building, Washington, D. C.

Address all general correspondence to the executive headquarters at West Hartford, Connecticut

DIRECTORS

President
EUGENE C. WOODRUFF.....W8CMP
234 W. Fairmount Ave., State College, Pa.

Vice-President
GEORGE W. BAILEY.....W1KH
74 Webster Road, Weston, Mass.

Canadian General Manager
ALEX REID.....VE2BE
169 Logan Ave., St. Lambert, P. Q.

Atlantic Division
WALTER BRADLEY MARTIN.....W3QV
Box 612, Roslyn, Pa.

Central Division
EDWARD A. ROBERTS.....W8HC
2699 Endicott Rd., Shaker Heights, Cleveland

Dakota Division
CARL L. JABS.....W9BVH
1822 James St., St. Paul, Minn.

Delta Division
E. RAY ARLEDGE.....W5SI
P. O. Box 286, Pine Bluff, Ark.

Hudson Division
KENNETH T. HILL.....W2AHC
115 Willow St., Douglaston, L. I., N. Y.

Midwest Division
FLOYD E. NORWINE, JR.....W9EFC
120 South Fourth St., St. Louis, Mo.

New England Division
PERCY C. NOBLE.....W1BVR
37 Broad St., Westfield, Mass.

Northwestern Division
RALPH J. GIBBONS.....W7KV
c/o United Air Lines, Pendleton, Ore.

Pacific Division
S. G. CULVER.....W6AN
2962 Russell St., Berkeley, Calif.

Roanoke Division
H. L. CAVENESS.....W4DW
State College Station, Raleigh, N. C.

Rocky Mountain Division
RUSSELL J. ANDREWS.....W9AAB
1867 So. Lafayette St., Denver, Colo.

Southeastern Division
BENNETT R. ADAMS, JR.....W4APU
1512 Grove Place, Homewood, Ala.

Southwestern Division
CHARLES E. BLALACK.....W6GG
443 Main St., El Centro, Calif.

West Gulf Division
WAYLAND M. GROVES.....W5NW
c/o Humble Pipe Line Co., Neches, Texas



THE EDITOR'S MILL

IF THERE'S anything that makes an editor happy it's to discover that somebody reads his editorials. Having kept careful count down the years, we know that there are four people who read ours. When, last month, we heard from all four of our readers, and from one new one to boot, we knew that we had rung the bell. Only trouble is that we seem to have left some things unsaid in our September column that disturb all five of our readers.

It's about the duties of directors and our remark that there is no such thing as a division instructing a director to a point where he cannot use any personal judgment. We were talking about the solicitation of nominations, urging the selection of capable candidates, and we pointed out that our League needed men of mature minds who could face realities, think objectively, be able to form wise conclusions when they saw the whole nationwide picture of our problems. Our correspondents now rise to inquire what about the provision in our constitution that the directors must keep themselves informed on the needs and desires of the members of their divisions in order that they may intelligently represent them at board meetings; weren't we overlooking that when we said a director couldn't be instructed?

No, we weren't, but we ought to have said so. Let us now assert that we regard that provision as one of the wisest and most important ones in our constitution. It happens that it fell our lot, back in 1922 and 1923, to make the first draft of the present League constitution. We originated that thought and are ourselves the author of the language which provides that directors must keep themselves informed on the needs and desires of their members, that they may faithfully and intelligently represent them in the board. That principle is therefore fully as precious to us as to anybody else. For years and years we have emphasized in *QST* the twin principles of our democracy: that our elections provide opportunity for members to put the government of their League in the hands of men of their own choosing, and that those men are bound to keep themselves informed on their members' needs and desires. Lately we have had the feeling that perhaps we have overemphasized these thoughts, since we perceive some indications that members think that it doesn't make much difference who their director is, since all he has to do is to report their opinions. The other side of the picture also deserved some thought, we concluded — those phases of a director's duties that do require him to exercise personal judgment under many circumstances. We suggested some of those desirable attributes in this column in September. If we were not right in what we there said, if personal popularity can offset infantile thinking, and so on, then we do not need mature minds and directors may be mere messenger-boys, parrot-like repeating preconceived opinions. No one, we trust, will agree to that proposition.

At this stage of the discussion it should be apparent that in a society with as relatively simple a structure of government as our A.R.R.L., the board of directors has a dual status, actually discharging the functions of both the upper and lower houses of a parliamentary government. The directors are the representatives of the membership, obliged to know their needs and wishes, and at the same time they are responsible for the sound and sane direction of our affairs. These very circumstances have been the subject of much discussion and planning in our board meetings. They are what have caused the creation in most of our divisions of quite elaborate organizations of assistants to the directors for the maintenance of close contact with members: for the joint objectives of knowing at all times the members' needs and desires and supplying data on what the League is doing for its members.

This machinery is at its best when the problem is to ascertain the wishes of organized amateur radio concerning some projected request to the F.C.C. for a change in our regulations, or some similar matter. In such cases it is potentially capable of working to practical perfection. However, there is another angle to the matter that led us to believe that we should emphasize in *QST* the need for

selecting men who possess native intelligence and judgment. Our society is a corporation, governed by corporation law, and our constitution grants to the directors the power and authority conferred by statute upon a board. Moreover, the statutes impose upon directors certain responsibilities that are personal to them and that they cannot escape nor delegate. They must take actions that they consider are for the best interests of their society, else they are guilty of misfeasance and for certain acts could be punished personally at law. During the many years that we have been in attendance at meetings of the A.R.R.L. Board we have seen several instances where an idea would take hold in a particular division and the director would consider himself "instructed" when he came to a board meeting. But when he got there and compared his ideas with those of other directors, and all the legal and similar angles were disclosed to view, it would become apparent that the action that director had first contemplated would be very harmful indeed to the interests of amateur radio generally and to those of the League. A director is responsible for doing intelligent directing, directing that advances the interests of his association, and it is impossible legally to put him in a position where he is obliged to take an action which he knows definitely is harmful to the interests of his society. There is where intelligence and judgment come in. Under those circumstances, we said, directors must be more than messenger-boys.

We emphatically do not believe that directors should ever put their purely personal and private preferences ahead of those of their members. We have never seen that done by any director of our League and we trust it will never occur in A.R.R.L. It is an integral part of our scheme of things that the directors must keep themselves informed on what their members want, and it is to be expected that they will always act in accordance therewith except in the rare instances where it becomes evident, upon deeper examination in the meetings, that such action would be against the best interests of amateur radio.

This discussion comes at a fitting time. In the first week of November ballots will go out to members in half the divisions for the selection of directors to act for two years. The need exists to choose wisely the men into whose hands the government of our society will be put.

K. B. W.

R9 Plus!

Advocating a More Accurate Method of Reporting Received Signal-Strength

By Alonzo O. Bliss, W3KP-W4ES*

HOW often have you made some adjustment to the transmitter or spent hours of hard labor putting up a new antenna, only to have the first station worked come back with that well-worn, flattering but meaningless report "Ur sigs R₉ plus hr OM!" How much more it would mean if he had said "Sa OM ur sigs Sunday were R₅ & nw R₇ to 7 & ½ wt abt it OM? K." You would immediately know that the change you made boosted your signals about 50 per cent, which would be the equivalent of increasing the power two times, a worthwhile gain.

How often have you pumped a 400-watt CQ and received an "R₉ plus" report—only to hear Harry, with 60 watts on the other side of town, get the same report from the same station? Harry is tickled pink to know that he is putting out just as good a signal as you are, while you wonder how he gets such good reports with so little power.

There are several cures for this condition. It is

* 455 N.E. 28th St., Miami, Fla.

only up to us to decide which method is most suitable.

One method would be to measure the received signal strength in microvolts-per-meter. This is an absolute method and I am sure we will all agree that it is the most accurate method, but it requires a little more than just a receiver and few of us would want to bother with it. Those that do have the equipment could easily say "Ur sigs 200 MV/M hr OM," but what would that mean to anyone except an engineer?

There is another way, and to my mind, a very simple and sufficiently accurate one. This is how it is done:

1. Use an indicating meter with a range such that a few of the stronger amateur signals will run the meter off scale.

2. Divide the scale into nine parts between the no-signal point and the maximum end of the scale.

3. Put a suitable adjustable shunt across the meter and tune over the band. Be sure that the

(Continued on page 54)

'Phone-C.W. De Luxe

A Description of the Station and New Transmitters at W1CCZ

TO OLD-TIMERS, mention of 1CCZ inevitably brings to mind the establishing of a record that was a record back in the old 200-meter days—working all districts in one night! That was in 1922, but in the intervening years this station has kept in the forefront of amateur progress and accomplishment. A good deal of the equipment which at various times has been used at W1CCZ has been described in *QST*, because experimental and constructional work has accounted for a large share of the activity. And amateurs of some eight years' standing will remember that it was at W1CCZ that the 28-mc. beam antenna work was carried out as part of the A.R.R.L. Technical Development Program in 1928, when signals were put into New Zealand on 10 meters for the first time from the eastern part of the United States.

W1CCZ is located on the summer estate of Edward C. Crossett, at Wianno, Cape Cod, Massachusetts. A beautiful location, only a step from the Atlantic, matched by a collection of equipment which does full justice to the possibilities of the setting.

Originally located in Mr. Crossett's residence, provision was made for installing the station in a

special room over the garage when, some years ago, plans were made for enlarging the latter. Concealed power and control wiring, the system being designed by Paul S. Hendricks, was installed at that time. There are five large tables in the room, one for the operating position and the other four for holding the transmitting equipment. Each of the transmitting tables is connected with the power supplies and with the operating table through ten control circuits. No wiring is visible in the room except the antenna lead-ins. Adjoining the transmitting room is a stock room and shop. With the exception of the Western Electric speech amplifier, all the transmitting equipment has been built at the station.

Coincident with the completion of its fifteenth year of existence, W1CCZ has during the past summer undergone a rather extensive rebuilding. There are now four complete transmitters, one each for 3.5, 7, 14, and 28 megacycles, all newly completed and installed during the summer. Their design and construction is the work of Martin A. Brown, W6ABF, who has also done a considerable share of the operating this year. Though few amateurs are in a position to have layouts as elaborate and complete as this, yet

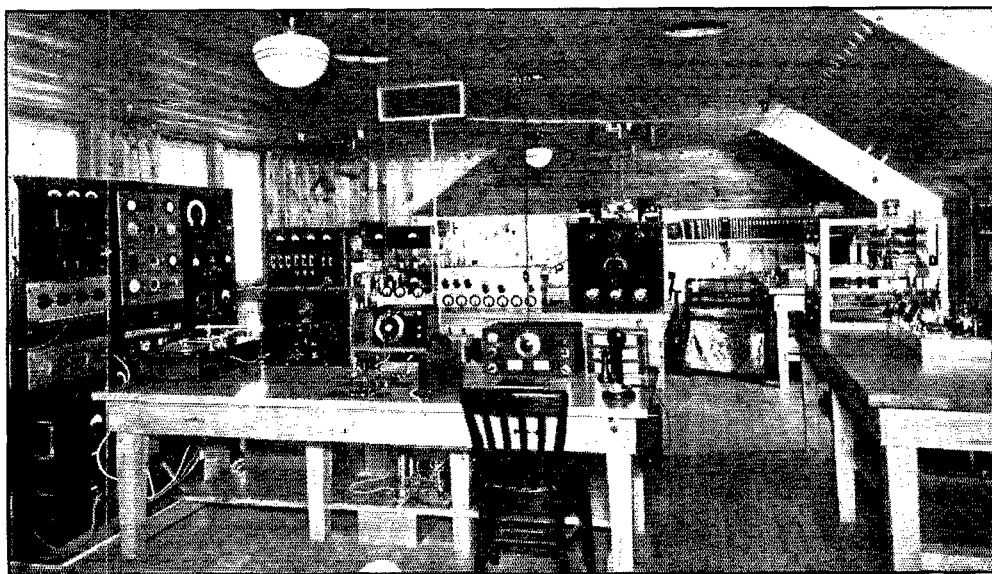

W1CCZ, WIANNO, CAPE COD, MASSACHUSETTS

For many years a familiar call over most of the world, W1CCZ is a veritable amateur's paradise. A large and comfortable operating room, separate high-power 'phone and c.w. transmitters, each with its own antenna, for each band from 28 to 3.5 mc.; all the monitoring and measuring equipment an amateur could need. And to top it off, a location right at the edge of the ocean. Could any ham ask for more? The loudspeakers are behind the holes cut out in the ceiling.

there is much of interest and value to be gleaned from a perusal of the diagrams and photographs of the individual transmitters herewith presented.

EXCITER UNITS

Since the final amplifier for each of the four transmitters is rated at a kilowatt input, the various exciter units were designed to provide something more than adequate excitation for either c.w. or 'phone operation. Hence each exciter is in

An interesting feature of all the exciter units is that the same tuning-condenser capacities and coil socket wiring are used for corresponding stages, hence the plug-in coils are interchangeable in all exciters. The convenience of this arrangement, especially when something is to be tried at short notice, will be appreciated.

All exciters are constructed on metal chassis of suitable dimensions. Meters are mounted on porcelain feed-throughs at the front of each chassis. The chassis are readily adaptable to rack mounting, since meters and controls can easily be put on a panel. Power-supply connections are brought out to terminal strips at the back.

THE 3.5-MC. TRANSMITTER

The exciter for the 3.5-mc. transmitter consists of a 42 pentode oscillator, 802 buffer, and RK-28 driver. This unit, together with the final amplifier, is shown in one of the photographs. The final amplifier, mounted in a square wooden frame with bakelite control panels, uses a single W.E. 251-A tube, normally operated at a kilowatt input. Both 'phone and c.w. are used on this rig.

THE 3.5-MC. TRANSMITTER

The exciter unit, at the right, uses a 42 oscillator, 802 buffer, and RK-28 driver. The final stage, at the left in the wooden frame, has a single 251-A which operates with a kilowatt input.

itself a complete transmitter capable of developing a few hundred watts of r.f. power. The same general plan has been followed in all of them, the differences being largely in the number of low-power doubler stages incorporated. Although a separate exciter is used for each band, two of these units can readily be put on any of four bands, one of them on three, and the last—that for the 7-mc. transmitter—on two. In each case the output tube is an RK-28, except in the exciter for the 14-mc. transmitter, where two RK-28's are used in push-pull.

THE 7-MC. TRANSMITTER

The 40-meter c.w. transmitter has three stages altogether. The exciter is a two-tube unit having a 2A5 crystal oscillator on 3.5 mc., and an RK-28 doubling to 7 mc. The output of the RK-28 is link-coupled to a pair of 150T's in push-pull. Normal input to the final is 800 watts.

The push-pull amplifier is also mounted on metal. Another photograph shows the two units comprising the 7-mc. transmitter.

THE 14-MC. TRANSMITTER

For a time, this rig served for both 20 and 10 meters, which accounts for the more elaborate

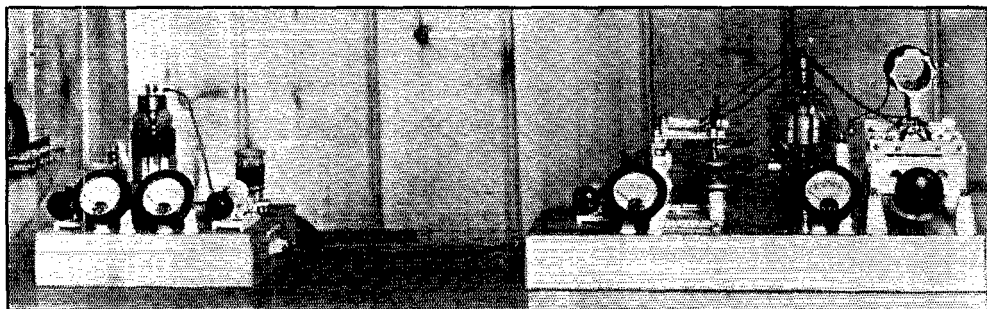

THE 7-MC. C.W. TRANSMITTER

Exciter at the left, amplifier at right. In the exciter, a 2A5 crystal oscillator drives an RK-28. A pair of 150T's in push-pull, link-coupled to the driver, constitutes the final.

exciter arrangement. Since the completion of a separate 10-meter transmitter, however, it has been used exclusively for 14-mc. work.

The exciter consists of a 6A6 crystal-oscillator and doubler, 802 buffer-doubler (these two tubes bring the frequency from 3.5 mc. to 14 mc.), an RK-28 buffer on 14 mc., followed by two RK-28's in push-pull. The chief reason for using an RK-28 for driving the final two is to simplify the power-supply requirements; with the present arrangement the last three tubes all operate at 2000 volts, while if a smaller driver tube (such as an RK-20) had been used it would have been necessary to furnish 1000 volts for this stage. A smaller tube would give plenty of drive, of course. This exciter is a completely shielded job, built in a cabinet made of heavy sheet aluminum. It is shown in a separate photograph. In itself it makes an excellent all-band transmitter.

The 14-mc. final amplifier has two 251-A tubes in push-pull. These are mounted in a wooden frame similar to that for the final of the 3.5-mc. transmitter. The amplifier occupies the right-hand end of the table immediately in front of the operating table. This amplifier normally operates at 900 to 1000 watts input on either 'phone or c.w. Needless to say, the tube plates show no color at a kilowatt input!

THE 28-MC. TRANSMITTER

The 10-meter transmitter probably will be of particular interest to readers in view of the increase in activity on this band. A view of the complete rig is given in one of the photographs, while Figs. 1 and 2 give the circuit diagrams of the exciter and amplifier, respectively. These diagrams are typical of all the transmitters.

In the exciter unit, the first tube is a 6A6 crystal oscillator-doubler, starting out on 7 mc. As the photographs show, it is at the right-hand end of the chassis. The second section of the 6A6 is capacity-coupled to an 802 doubler to 10 meters.

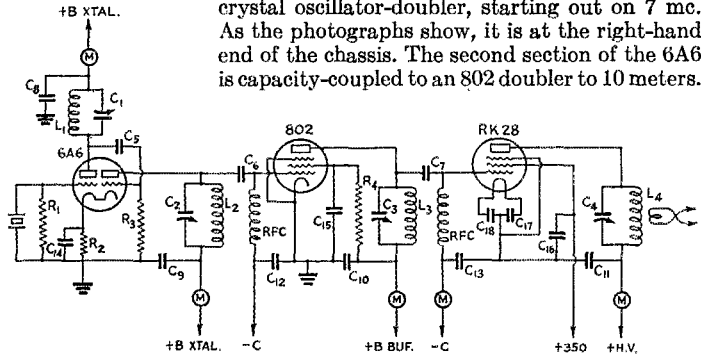
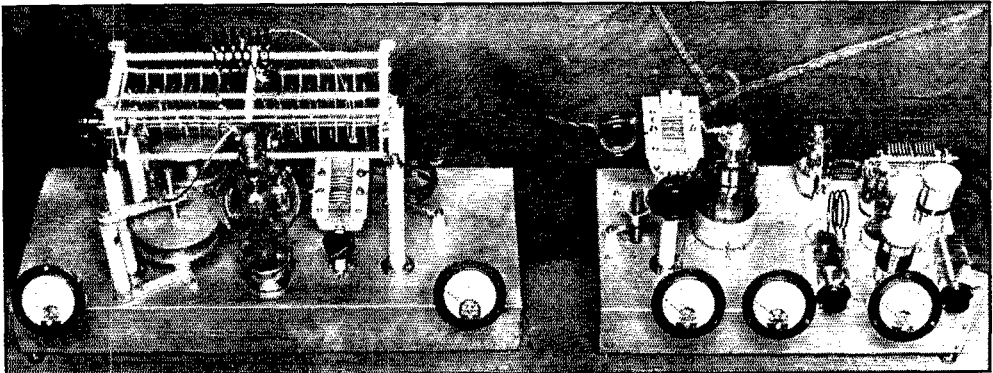

FIG. 1—CIRCUIT DIAGRAM OF THE 10-METER EXCITER

- C_1, C_2, C_3 —70- μ fd. midjet transmitting condensers (Hammarlund MCD-35-MX with stators in parallel).
 C_4 —70- μ fd. transmitting condenser (Cardwell NP-35-GD with stators in parallel).
 C_5 —0.0005- μ fd. mica.
 C_6, C_7 —0.002- μ fd. mica.
 C_8, C_9, C_{10} —0.01- μ fd.
 C_{11} —0.002- μ fd. mica, 5000-volt.
 C_{12} — C_{15} , inc.—0.01- μ fd. mica.
 C_{16} —0.002- μ fd. mica.
 C_{17}, C_{18} —0.01- μ fd. mica.
 R_1 —50,000 ohms, 1-watt.
 R_2 —400 ohms, 10-watt.
 R_3 —50,000 ohms, 2-watt.
 R_4 —50,000 ohms, 25-watt.
RFC—Solenoid-wound short-wave chokes (Ohmite).
M—Plate and grid milliammeters.
 L_1 —7-mc. oscillator coil; 40 turns No. 14 enamelled wire,
close-wound on 1 1/2-inch diameter receiving form.
 L_2 —14-mc. plate coil; 5 turns same as L_1
 L_3 —3 turns No. 10, diameter 2 inches, spaced turns.
 L_4 —4 turns No. 10 same as L_3 .

It is of interest to note here that considerably greater output, plus the possibility of using a higher L-C ratio, was obtained when the air-wound coil shown in the photograph was substi-



THE TEN-METER TRANSMITTER IS IN THE SAME GENERAL STYLE AS THE OTHER RIGS

The final amplifier, at the left, uses a pair of 150T's. The exciter consists of a 6A6 oscillator-doubler, 802 doubler to 28 mc., and an RK-28 driver.

tuted for one wound on a bakelite form, which was the original arrangement. The coil is soldered directly on the condenser terminal lugs. The

the tank. Both c.w. and 'phone are used on 10. The 150T's have 500 volts of fixed bias on the grids, so that it is evident there is plenty of excitation available from the RK-28.

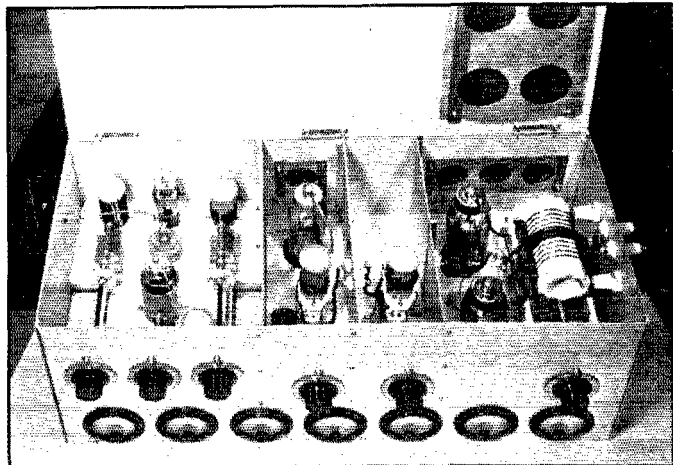

THE EXCITER FOR THE 20-METER SET

This rig in itself is a fairly high-power all-band transmitter, although actually used only on 14 mc. A 6A6 oscillator-doubler drives an 802, followed by an RK-28, then two RK-28's in push-pull. All coils are plug-in.

RK-28 is mounted through a hole in the chassis to provide the desirable shielding between grid and plate, since the tube is used as a straight amplifier. To get a short plate lead, the output tank circuit is mounted on tall stand-off insulators. The tube runs cold at an input of 250 to 300 watts on 28 mc.

In the final push-pull stage, considerable thought was given to the problem of getting short leads from the tank circuits to the tubes, the construction shown finally being adopted. The grid tuning condenser is mounted on short stand-offs directly alongside the grid caps of the 150T's. The plate condenser is elevated to bring the stator connections level with the tube plate caps; no regular stand-offs of sufficient length were available for this purpose, so each post consists of two shorter insulators held together by headless machine screws. It was found better to leave the plate tank circuit ungrounded. The coils are air-wound and mounted directly on the condensers. No filament by-pass condensers are used, a direct connection being made from one side of the filament to ground, instead.

This amplifier is ordinarily loaded to an input of about 600 watts, the chief reason for not going higher being the fact that the plate voltage is only 1800. Since this same voltage is used on the final and driver stages of all transmitters (with big tubes like the 251-A there is no necessity for going higher) it is convenient to use the same on the 10-meter set so that the power supply need not be changed when going from one band to another. At 600 watts there is plenty of fire left in

The antenna coupling arrangement used with the 10-meter transmitter is probably new to most amateurs. It is a linear pi-section filter, of a type used in some of the new Collins transmitters. Fig. 3 gives the details. The inductances consist of two quarter-inch copper tubes, spaced two inches apart, 5½ feet long. The tuning condensers, each 100 μ fd., are slid along the tubing until points are found where they control the coupling as in the normal filter. At W1CCZ the input condenser is 4½ inches from the plate tank, and the distance between the input and output condensers is 3½ feet. This system offers possibilities to those who have had difficulty in getting regular coils to work in the filter at 28 mc.

SPEECH EQUIPMENT

Most of the speech equipment is on the two nearer racks to the left of the operating table. The output of the Western Electric condenser microphone feeds into a W.E. 8C amplifier and power

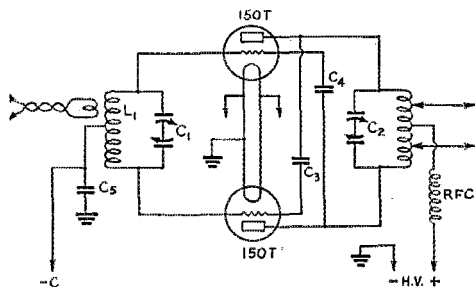

FIG. 2—THE PUSH-PULL 28-MC. FINAL CIRCUIT DIAGRAM

- C₁—Split-stator transmitting condenser, 35 μ fd. per section (Cardwell NP-35-GD).
- C₂—Split-stator transmitting condenser, 40 μ fd. per section (National TMA-40-DC).
- C₃, C₄—Neutralizing condensers (National NC-150).
- C₅—0.002- μ fd. mica.
- L₁—6 turns No. 10, diameter 2 inches, turns spaced 3/16 inch.
- L₂—7 turns No. 10, diameter 2 inches, spaced to make coil length 3 inches.
- RFC—Solenoid-wound choke (Ohmite).

supply which occupies the nearest rack. Some alterations have been made to this amplifier, and a four-channel mixing panel has been added. The

output of the 8C amplifier drives a pair of 2A3's, Class-A, in the next rack, and these in turn feed into a pair of 845's, also Class-A. The 845's constitute the driver for the Class-B modulator, which uses a pair of 849's.

The modulator and its power supply are built up in two wooden frames similar to those used for the final stages of the 3.5- and 14-mc. transmitters. They can be identified at the rear left in the photographs of the station. The power supply is three phase using 866 rectifiers.

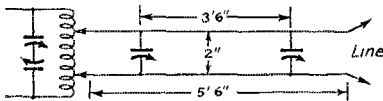

FIG. 3—LINEAR PI-SECTION FILTER USED TO COUPLE THE 10-METER AMPLIFIER TO A 600-OHM LINE

The "inductances" are quarter-inch copper tubing.

The same modulator is of course used for all transmitters.

POWER SUPPLY

The main power supplies for the station are built on a rack which does not appear in the photographs. Two high-voltage supplies can be used. The first is a three-phase, full-wave affair using six 872 rectifiers; this supply furnishes plate power for the final stages of all transmitters. Voltages from 1800 to 5400 are available, although 1800 is generally used because of the ease with which the 251-A's will handle a kilowatt input at this voltage. The second unit is a single-phase, full-wave rectifier using a pair of 872's. Voltages from 700 to 2000 can be obtained from this supply; it is used for the lower-power stages.

Plate power is connected to all transmitters whenever the control switch is closed. To shift from one band to another, it is only necessary to light the filaments of the tubes in the desired transmitter, since each transmitter has its own antenna.

ANTENNA SYSTEM

As the photograph of part of the antenna system shows, the station is surrounded by tall pine trees, so that it is not an easy matter to erect elaborate antennas. Various special types have been tried, but practically as good results have been secured from the simple structures in use at the present time.

Four masts hold all the antennas. Two of them are 75 feet high, spaced about 140 feet apart. A 75-meter Zepp for the 3.5-mc. set is strung between them. A third mast is about 55 feet high, and the fourth somewhat lower. The masts are arranged so that it is possible to run the antennas either north and south or east and west. For 23

mc., a Johnson Q running north and south is used. Two Q's, one north-south, the other east-west, are used for 14 mc., the feeders being switched inside the station at the transmitter to choose the direction. An east-west doublet is used on 7 mc.

AUXILIARY EQUIPMENT

The third relay rack holds a number of items of measuring equipment usually found only in laboratories and broadcasting stations. At the top is an RCA beat-frequency oscillator. Immediately below it is a General Radio transmission-monitoring assembly, consisting of a 400-cycle oscillator panel, modulation monitoring panel with overmodulation indicator, and a distortion and noise metering panel. On the operating table is a G.R. oscilloscope, a G.R. frequency meter, and a Universal Recorder, the latter being used for making air checks. Other measuring equipment includes G.R. precision inductance, capacity and resistance bridges.

The station is connected with the house by a number of lines through which the transmitter can be turned on and off and speech input fed in. There is also a telephone line from the station to the house. Although there is no complete remote-control system, the station can be operated from



PART OF WICCC's ANTENNA SYSTEM

Four wooden masts, two of them 75 feet high, the others about 50 feet, support the five antennas.

several rooms in the house (where separate receivers are installed) once the filaments of the desired transmitter are turned on. Receivers include a Hammarlund Super-Pro, an RME-69, and an HRO, the latter being used in the station proper.

Recent years have found most of WICCC's operating activities carried on with radiotelephony, principally in the 14- and 28-mc. bands, although—as might be expected with such easy band-switching—the other two bands are by no means neglected.

Heterotone C. W. Telegraph Reception

An Improvement Giving M.C.W. Advantages to Pure D.C. Signals

By James J. Lamb*

IN ALL the years since we have had c.w. signals to receive there has been little fundamental change in our method of reception. True enough, the receivers have been improved. Selectivity has been increased, so that we can now do a pretty good job of picking out the signal we want; stability has been furthered, both at the transmitting end and in the receiver, so that we

modulation was not beyond the pale of government regulations; not that all such "characteristic tone" was altogether euphonious or particularly creditable to the owner of the transmitting station. But, nevertheless, something in the output made these old-time signals easier to copy, made the other fellow's fist sound more professional and lessened the fatigue of long hours of traffic handling.

In heterodyne reception of pure d.c. telegraph signals there is a monotony, an exasperating tiresomeness, about that piercing beat-note that makes old time operators wish for the good old days and makes those who haven't had modulated m.c.w. or i.c.w. experience wish they could do something besides change the beat-note just another single tone that drills a hole in the hearing system. This fatigue and monotony from listening to a pure d.c. beat-note isn't all imagination, either. It's quite real and demonstrable by authentic scientific proof. We learned that back in 1929 and tried to do something about it.

At that time, K. B. Warner (who is always starting us out on some technical chase to correct things that ought to be corrected in this game of ours) aroused us with some practical ham interpretations of a few physiological and psychological gleanings from Dr. Harvey Fletcher's classic text, *Speech and Hearing*.

In sum and substance, it appears that our hearing apparatus is not so simple. In addition to the binaural and other peculiar characteristics which have been given greater popular publicity in more recent times, it seems that we also possess disability to withstand overloading on a single-frequency tone. Furthermore, the sensation of loudness is not only a function of the total energy in what excites our hearing system, but is also a function of the frequency make-up of the excitation. Our hearing mechanism, while more or less frequency selective, is non-linear and has what might be called saturation limits. In other words, different sensitive elements in the pick-up system respond to different frequencies, but each can transmit only a limited amount of sensation to the head-top central station. Each aural frequency-communication line can handle only so much; and after a while it gets tired. Consequently, when we listen to a single-frequency c.w. beat-note we find that the monotone signal not only becomes a bore, but also becomes apparently weaker and weaker, even though the receiver output may stay constant. We once had the experience of listening to

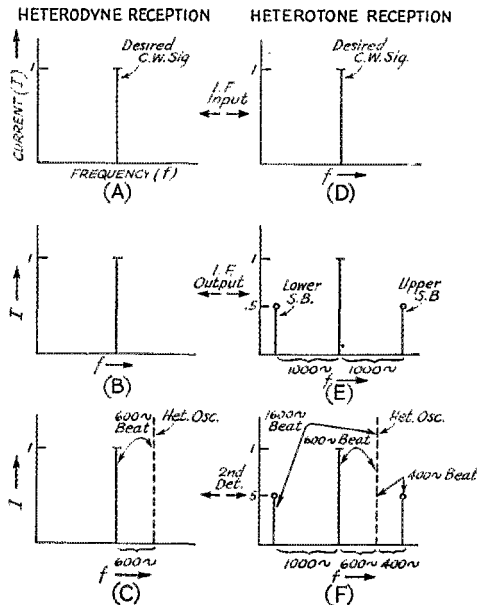

FIG. 1—CONTRASTING THE FREQUENCY COMBINATIONS OBTAINED IN SIMPLE HETERODYNE RECEPTION (LEFT) AND IN HETEROTONE RECEPTION (RIGHT). THE COMPLEX HETEROTONE OUTPUT NOT ONLY MAKES THE SIGNAL SOUND MORE PLEASING BUT ALSO INCREASES THE LOUDNESS

can better hold the desired signal throughout a QSO; but we still stick to heterodyne reception.

Even with our most modern single-signal superhets we continue to use no more than a local beat oscillator to make c.w. telegraph signals intelligible. In fact, by their very high selectivity these receivers have robbed us of something. They take out of less than originally perfect d.c. signals some, or even all, of the "tone" that we used to have in the old days when a little incidental

*Technical Editor.

a 1000-cycle tone for a protracted period of hours—and of seeming to hear nothing but 1000 cycles for two days afterward but of being unable to distinguish when a 1000-cycle tone was sent our way. A “hole” had been drilled at 1000 cycles. That particular section in our aural frequency spectrum had temporarily worn out. It was an extreme case, of course; but to a lesser degree the same thing happens in much shorter periods of operation, as every experienced operator will testify. How many have had “ringing ears” after a DX contest?

Well, to get back to what we tried to do about it in 1929:

In those days, the standard receiver was a regenerative autodyne. R. B. Bourne, then IANA and still WIANA, was in it, too. Our idea was to frequency-modulate the oscillating autodyne detector and thereby “spray” a range of audio frequencies over the hearing system. Thus, we visualized, more than a single group of elements would be excited—and both the monotony and the fatigue would be eliminated. Unfortunately, the result didn’t fulfill the premise. In the first place, the regenerative detector insisted on picking up the audio-frequency of the tone-generator, which was driving the frequency-vibrating tuning-condenser element, whether there was a radio signal coming in or not; and the signal didn’t seem to be helped thereby. So we dropped it.

Still later, in 1931, we had another idea. At that time we were working with the various efforts which finally produced a single-signal receiver. In the National MB 30 tuned r.f. broadcast receiver, which was used as an i.f. amplifier following the crystal filter, there was no beat oscillator for c.w. reception. Rather than hook up a heterodyne oscillator, we tried a General Radio 1000-cycle tuning fork oscillator as an audio-frequency modulator for one of the intermediate stages. The audio-frequency tone was applied to the screen-grid of an i.f. stage. It worked, but the resulting a.f. output on c.w. signals was nothing to arouse excitement. Later, we tried the same idea on an ultra-high frequency phone superhet of Ross Hull’s. The idea there was to make possible reception of “unmodulated” c.w. telegraph signals from 56-mc. transmitters which were so unstable with frequency modulation as to preclude possibility of conventional beatnote reception. That worked fairly well, too; but Ross didn’t think the receiver was good enough for presentation. He went on to the super-infragenerator—and double-sideband amplitude modulation as an alternative to heterodyne single-sideband modulation in superhet receivers again went on the shelf.

In both these instances, it will be noted, the idea was tried in receivers which were without beat-note oscillators. Had we tried it then on a more or less conventional superhet with a c.w.

beat oscillator we’d have had heterotone reception earlier. For that’s all heterotone reception is: The application of audio-frequency modulation in an i.f. stage of a good superhet, preferably behind a s.s. crystal filter, with proper c.w. oscillator injection in the second detector. It’s called heterotone reception just to distinguish it from tone modulation (m.c.w.) and from simple heterodyne reception. It’s literally both.

A graphical contrast between simple heterodyne reception and heterotone reception is shown

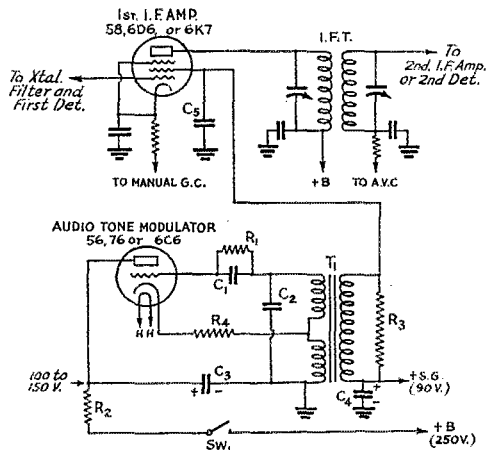

FIG. 2—CIRCUIT OF A TRANSFORMER-TYPE AUDIO OSCILLATOR FOR HETEROTONE MODULATION

- T₁—Push-pull input type audio transformer.
- C₁—0.002- μ fd. fixed condenser (paper).
- C₂—500- μ fd. primary tuning condenser (various sizes should be tried until tone is between 500 and 1000 c.p.s.).
- C₃—1- to 4- μ fd. plate by-pass condenser (paper or electrolytic).
- C₄—1- to 4- μ fd. screen-supply by-pass (may be unnecessary).
- C₅—0.002- μ fd. screen-grid r.f. by-pass.
- R₁—100,000-ohm grid leak.
- R₂—100,000-ohm plate-voltage dropping and filtering resistor.
- R₃—Audio load resistor (100,000-ohm or smaller).
- R₄—20,000-ohm or smaller cathode resistor.
- SW₁—Single-pole toggle switch (audio “On-Off”).

by the charts of Fig. 1. In heterodyne reception, as suggested by A, B and C, the character of the signal is unchanged until simultaneous rectification with the c.w. oscillator current in the second detector occurs. With heterotone reception, however, the signal acquires a pair of sidebands in the i.f. amplifier and arrives at the second detector as a complex wave. Whereas heterodyne detection of the unmodulated signal results in a beat note of practically single frequency, as shown in C, the modulated signal combines with the local oscillator current in the second detector to give audio-frequency output having a complex combination of frequencies, as indicated in F. With the heterodyne oscillator frequency different from the carrier and sideband frequencies of

the modulated signal, there are at least three principal beat-note components in addition to the double-sideband component resulting from i.f. modulation.

The most striking effect of this change in the character of the signal is the apparent increase in loudness. This is partly the result of actually greater electrical output, of course, since the signal power arriving at the second detector is increased by the sidebands resulting from the i.f. modulation. With 100 per cent modulation by a single-frequency (sinusoidal) tone the side-band power increases the detector input 50 percent. Measurements demonstrate that the receiver audio-frequency output is increased by approximately this amount when tone modulation is applied in addition to the heterodyne. This would be expected to give no great increase in loudness sensation, however, on a strict energy basis. It is the change in the character of the sound, rather than a simple energy increase, which accounts for the jump of several times in loudness which becomes apparent when listening comparison is made between simple heterodyne reception and heterotone reception of the same pure d.c. signal. The explanation is that more of the sensitive elements in the hearing mechanism are excited by the complex sound than by the merely pure heterodyne beat note.

An infinite variety of frequency combinations can be obtained simply by varying the tuning of the heterodyne oscillator, leaving the i.f. modulation frequency fixed. Even relatively small changes in the beat oscillator frequency make apparently great changes in the character of the complex sound. Likewise, a small difference between two signal frequencies gives much greater

difference in the apparent pitch and character of the sounds than a simple variation in carrier beat-note would produce. This appears to be associated with change in the "harmony" relationship of the component frequencies of the complex sound. For instance, in the case of the

(Continued on page 76)



DIXIE JONES' OWL JUICE

THIS is the doggonedest world I ever saw. It looks like everthing in it has sumpn to pester it. Even lions and taggers, witch ain't skeered of nothin' or nobody, has some kinda creepers a crawlin' over 'em and a bitin' 'em when the day's work is o'er and they've garnered a gnu and et it and have crawled into a veldt beneath a kopje beside a babbling safari and are tryin' to catch a few winks of shut-eye. There ain't nobody or nothin' barred from troubles. Flies has spiders, and spiders has dirtdobbers, and dirtdobbers has jaybirds, and jaybirds has sparrerhawks, and sparrerhawks has farmer boys with muzzle loaders, and the latter has their paw and maw who beat on 'em off and on, and their paw and maw has flies, and so it goes. What the Army Amateur Radio System has is work, school and wimmen. A ham can sponge off of his old man all of his life so far and do nothing but ham and git along fine, but let him join the AARS and keep a few skeds and then the first thing you know you miss him and look around for him and there he is away up in Indiana or some dang place outsidea my territory a workin' in a saw mill and you hafto charge him off. Or maybe he's goin' to school at home. If he is he ain't learnin' nothin' as he hams half of the night and gits his lessons by sorta skimmin' at 'em before breakfast, and if he passes any exams it's by the cuff method, but just let this guy join the AARS and brother he ain't got time to do nothin' but study. A hundred percent in 'rithmetic and spellin' and all that stuff is the least he could make and not be plumb mortified. So he goes around with a book in his hand mumbly tootums two is four and tootums three is six and he might as well be a BCL, or even a sheep-herder, for all the good he does you. Or take, for instance, one of these here hams that hams ever night and wimmen ain't nothin' to him but a animated bundle of rags and a hank of hair and he don't pay 'em no mind, but right away after he joins the AARS he finds a squaw that shivvers his timbers and he puts in all of his spare time which is all of it hangin' around her shack and you couldn't raise him even if you had a California kilowatt. It ain't right.

—W4IR of the "Dixie Squinch Owl"

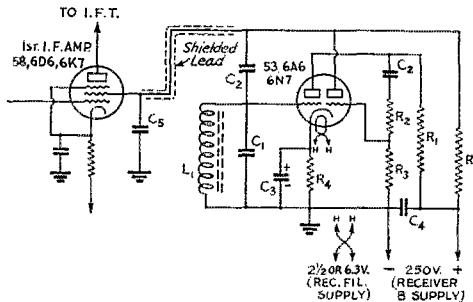

FIG. 3—DOUBLE-TRIODE RESISTANCE-CAPACITANCE FEED-BACK AUDIO OSCILLATOR CIRCUIT
L₁—125-millihenry r.f. choke (Bud "Magicores" No. 1287 or 1298).

C₁—0.25- μ fd. paper condenser (vary to give desired tone).

C₂—0.1- μ fd. paper condensers.

C₃—10- μ fd. electrolytic cathode by-pass.

C₄—1- to 4- μ fd. 400-volt paper or electrolytic plate by-pass (may be omitted).

C₅—Usual i.f. screen-grid by-pass, 0.01- to 0.1- μ fd.

R₁—50,000-ohm $\frac{1}{2}$ -watt plate resistors.

R₂, R₃—Total 500,000 ohms, approximately 250,000 ohms each (adjust for best oscillation).

R₄—750-ohm 1-watt cathode resistor.

A single-pole on-off toggle switch may be connected in the plus-B lead.

The All-Around Radiation Characteristics of Horizontal Antennas

Utilizing Directive Properties To Increase Transmission Effectiveness

By George Grammer*

THE big unknown in the equation "Transmitter times X equals Results" is the antenna. The constant taking down and putting up of antennas emphasizes the point. Sadly, most of these changes are aimless; blind gropings inspired by the eternal hope that something new will "get out" better. We think they need not be.

Simple antennas have certain properties which can be utilized to advantage provided we know what we want to do. It is impossible to predict exactly what any given type of antenna will do when hung in a particular location, unfortunately. However, theoretical analysis is possible when certain assumptions are made; although these assumptions are never realized in practice, experience with several types of antennas in different locations over the past year indicates that the antenna performance checks quite closely, qualitatively, with the behavior predicted by theory. This article concerns itself only with simple horizontal antennas, the kind the majority of amateurs use either through choice or necessity.

ANTENNA DIRECTIVITY

No amateur who does any reading at all can have avoided being exposed to the plane diagrams purporting to show the directive properties of antennas of various lengths. A set of them

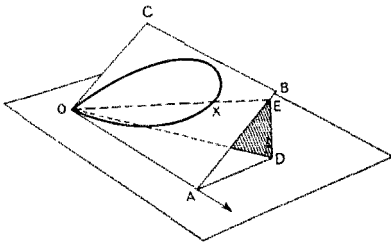

FIG. 1—ILLUSTRATING THE METHOD OF EVALUATING FIELD STRENGTH AT A GIVEN ANGLE ABOVE THE HORIZONTAL

illuminates the antenna chapter in the *Handbook*. Providing they are not taken too literally, such diagrams can be of value but (as is also pointed out in the *Handbook*) they merely represent a cross-section of a figure which is really a solid, symmetrical about the antenna wire. An easy way

* Assistant Technical Editor.

to get a mental picture of the actual free-space directive pattern of any particular type of antenna is to copy the plane diagram on a piece of cardboard, cut it out and mount on a length of stiff wire which represents the antenna axis. If

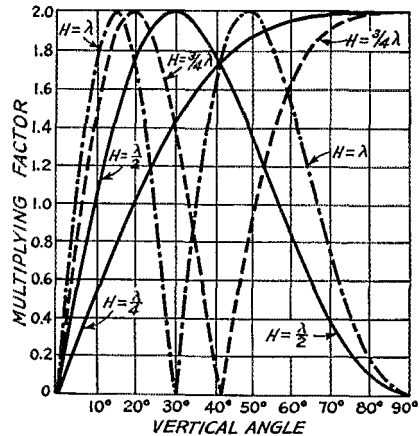

FIG. 2—EFFECT OF GROUND ON RADIATION AT VERTICAL ANGLES FOR FOUR ANTENNA HEIGHTS

the wire is then twirled rapidly in the fingers a "motion picture" of the solid directive diagram readily can be seen.

However, even this is of no great value except to form a mental image which will be of help in understanding what follows. No antenna works in free space. Amateur antennas, in particular, always hug the ground and the surrounding houses and flora pretty closely. Of these surroundings, the ground is the only item common to all locations, and is the only one that can be taken into account in a discussion of this kind. It should be realized, however, that the proximity of tin roofs, house wiring, downspouting, and similar obstructions in the field of the antenna can have a marked effect on its performance.

RADIATION IN THE VERTICAL PLANE

With the solid directive pattern firmly in mind, let us suppose that the antenna is placed horizontally over the earth. Neglecting for the moment the effect of the ground, this immediately cuts off the lower half of the pattern, since we are

concerned only with radiation in space. Now if we cut the solid pattern by a plane passing through the axis of the antenna at any random angle with respect to earth, the outline of the pattern on the plane will be the same plane diagram which we have already said must be handled with care. The idea is represented in Fig. 1, in which the large horizontal plane represents the earth and the line OA the line of the antenna wire. $OABC$ is the cutting plane just mentioned, and on it is drawn the plane diagram, in this case representing one quadrant of a full-wave antenna diagram.

(Only one quadrant need be considered, since the patterns are always symmetrical, and what happens in one quadrant also happens in the other three.) As the plane $OABC$ is rotated about the antenna as an axis, the plane diagram will describe the solid directive pattern.

Most amateurs realize that energy radiated upwards from the earth is effective for long-distance communication. Suppose we wish to know the relative field strength at a distant point caused by radiation at some upward angle with respect to the earth's surface. Let us say that a straight line

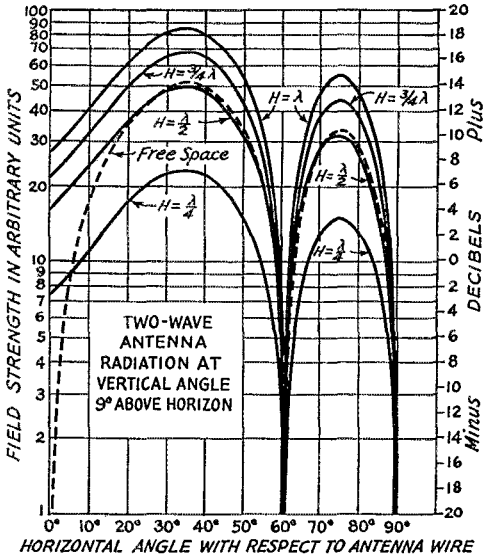
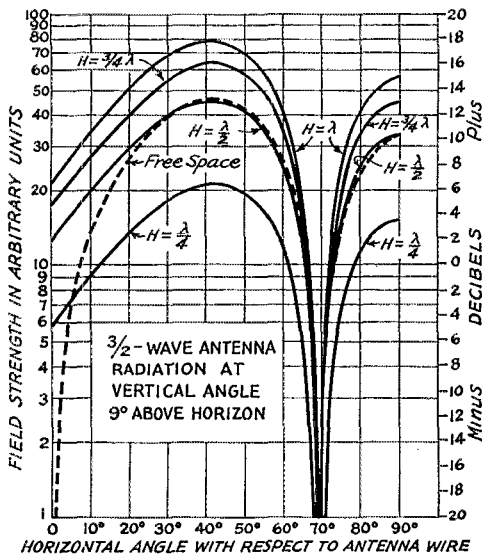
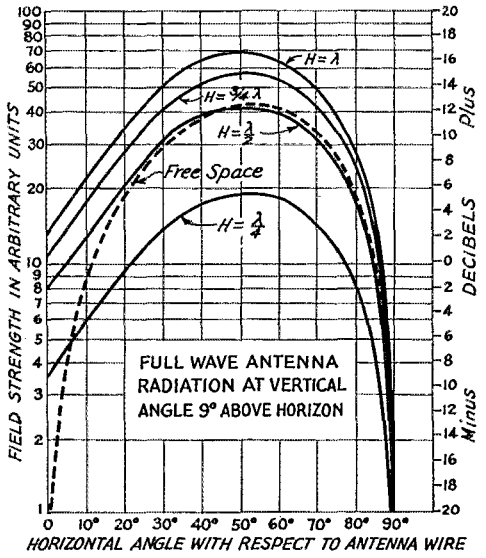
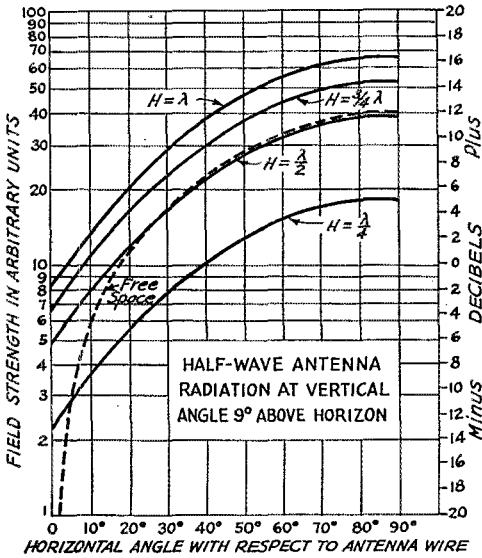

FIGS. 3-6, INC.—DIRECTIVITY CHARTS FOR FOUR SIMPLE ANTENNAS FOR RADIATION AT A VERTICAL ANGLE OF 9 DEGREES

from the distant point makes an angle DOA , Fig. 1, with the line of the antenna. Along the line DO we erect a vertical plane and on it draw a line, EO , so that the angle EOD represents the upward angle of radiation in which we are interested. If then the plane $OABC$ is rotated so that it passes through the line EO , the point X , where the line EO intersects the plane diagram, gives the desired value of relative field strength, this being expressed as the length of a radial line running from O to the outline of the diagram. If the vertical angle, EOD , is kept constant while the horizontal

angle, AOD , is changed through 90 degrees, a series of points can be obtained from which a directive diagram for the vertical angle EOD can be plotted. It is important to note that the diagram so obtained coincides with the plane diagram *only when the vertical angle is zero*—an impossible case, since purely horizontal radiation is negligible at high frequencies. At horizontal angles close in to the line of the antenna, the relative field strength will depend upon the particular vertical angle considered, and *if the right vertical angle is chosen the maximum radiation will*

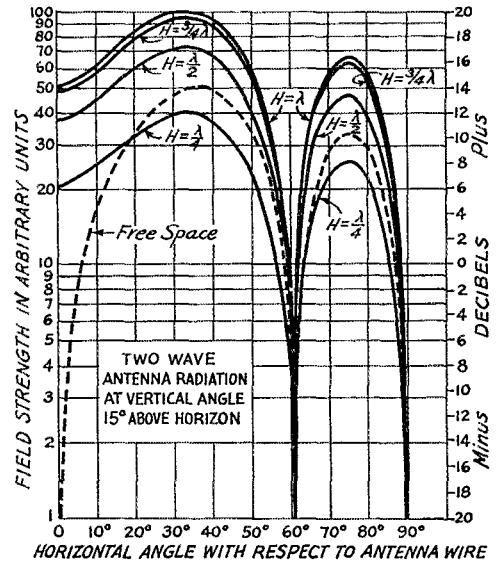
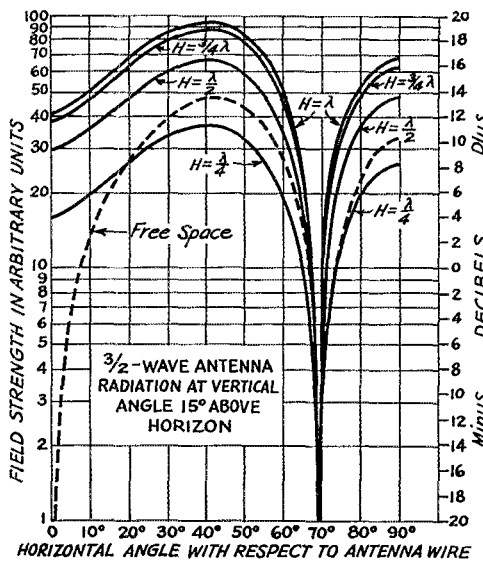
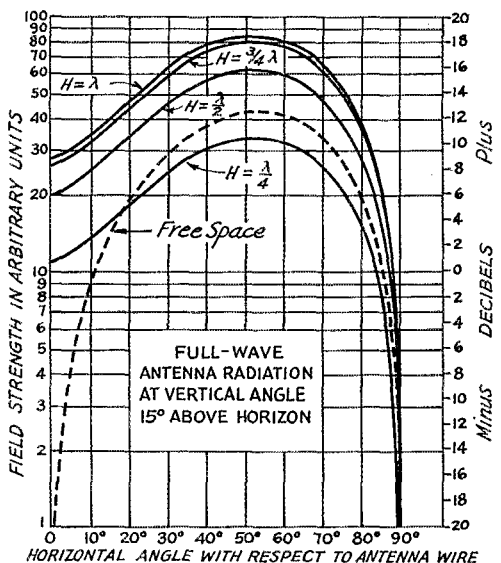
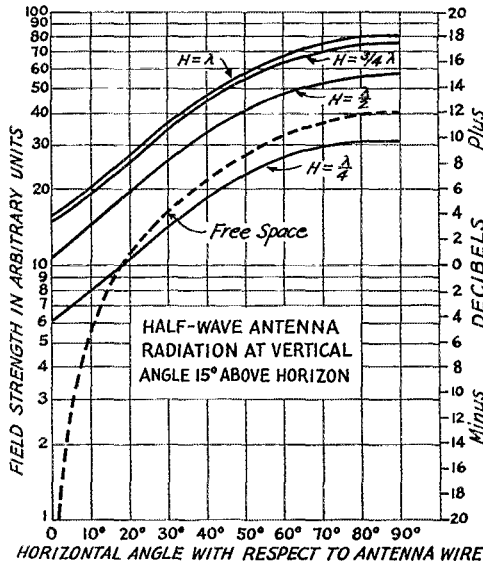

FIGS. 7-10, INC.—DIRECTIVITY CHARTS FOR RADIATION AT 15 DEGREES

be along the line of the antenna. This is not hard to visualize, because if we imagine the plane $OABC$ to be vertical and the line DO to coincide with AO , obviously the maximum relative field strength will be obtained when the angle DOE is made such that OE cuts the plane diagram at its maximum point. Contrast this with the misleading impression given by the unadorned plane diagrams, which would indicate that the radiation is always zero along the axis of the antenna.

GROUND EFFECTS

In making antenna calculations it is customary to assume that the ground acts as though it were a perfect conductor. Despite the known fact that the ground does no such thing at high frequencies, it appears from a number of published papers that, for horizontal antennas at least, the agreement between observed results and theoretical predictions made on this basis is very close. The calculations culminating in the curves to be given

(Continued on page 41)

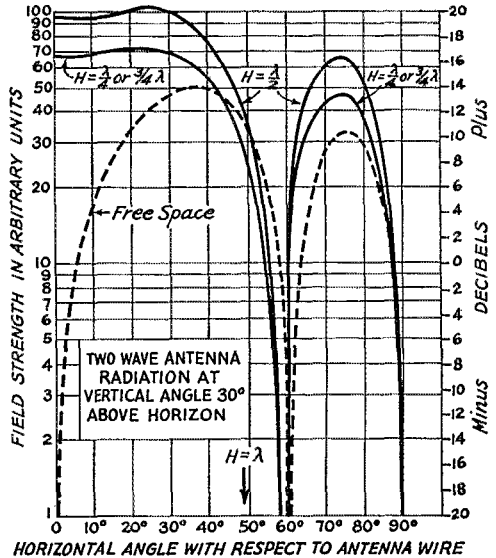
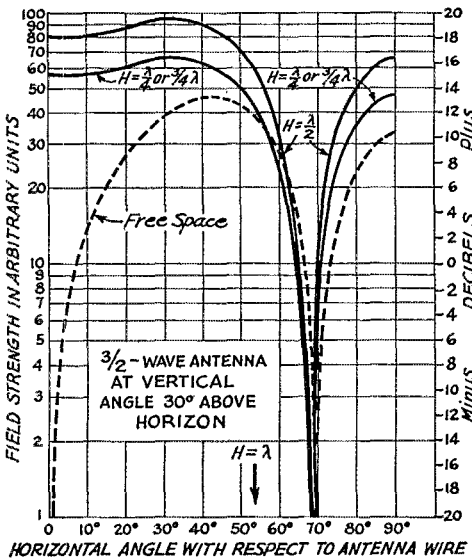
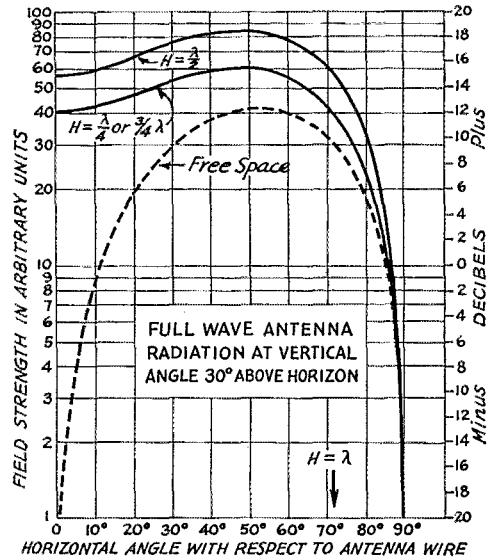
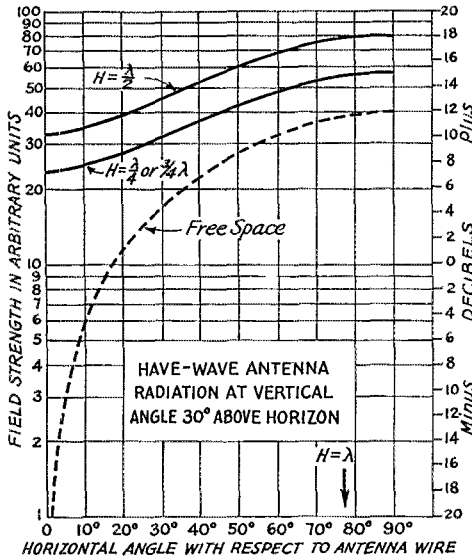

FIGS. 11-14, INC.—DIRECTIVITY CHARTS FOR RADIATION AT 30 DEGREES

Amateur Applications of the "Magic Eye"

Using the 6E5 in Transmitter Adjustments, as a Modulation Meter, and as a Visual Tuning Indicator In Two Parts—Part II*

By L. C. Waller,** W2BRO

THE use of the 6E5 as a "balance" indicator in a simple vacuum-tube voltmeter circuit was described in the October issue of *QST*, in Part I of this article. Many practical applications were discussed, and it was shown that such an instrument probably ranks next to a cathode-ray oscilloscope as regards its usefulness in the amateur station.

Before further applications are taken up, it seems worthwhile to describe again, very briefly, the manner in which either d.c. or *peak* a.c. voltages are measured with the v.t. voltmeter. The following procedure refers to Fig. 4 in Part I.

- (1) Test prods *A* and *B* are shorted together.
- (2) Slide-back potentiometer R_7 is moved to the plus end of its range, so that d.c. voltmeter *V* reads zero.
- (3) The "zero-set" potentiometer (R_5) is

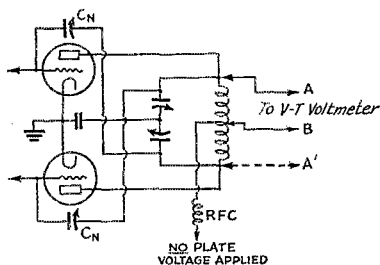

FIG. 8—THE V.T. VOLTMETER AS A NEUTRALIZING METER

adjusted so that the pattern on the fluorescent screen of the 6E5 is closed to a dark, narrow line. This is the "zero" position of the pattern.

(4) The d.c. or a.c. voltage to be measured is applied across test prods *A* and *B* (plus voltage to *A* in the case of d.c.). The application of this voltage causes the 6E5 pattern to "flip" open, either partly or all the way, depending on the value of the unknown voltage.

(5) Slide-back control R_7 is now slowly moved toward its $-B$ end until the pattern on the 6E5 again closes to its hair-line or "zero" position. At this point the voltmeter *V* will read the value (d.c. or *peak* a.c.) of the applied voltage. The por-

tion of the voltage across R_7 , read by *V*, has been adjusted *just to cancel* the unknown voltage across *AB*. While this procedure may sound a little complex, it can actually be followed in far less time than it takes to tell.

TRANSMITTER ADJUSTMENTS

The v.t. voltmeter has a number of valuable applications in the adjustment of transmitters. It may be used as an ultra-sensitive neutralizing indicator, as shown in Fig. 8. The test prods are placed across the plate tank coil (the plate voltage being *off*, of course) so that the r.f. voltage getting through from the driver stage can be measured. The actual value of the voltage is not of interest, as long as the neutralizing condensers can be adjusted so that the r.f. across the amplifier tank circuit is at a *minimum*. Perfect neutralization usually will not be obtained, in partially shielded or unshielded stages, but at least the point of best possible neutralization can be determined for a given case. Prod *B* does not have a high impedance to ground at radio frequencies, while prod *A* has appreciable impedance. For this reason, *B* is placed at the center of the plate coil, in a push-pull circuit, and prod *A* is placed at first one end and then the other. Minimum r.f. voltage is sought for each half of the coil. In single-ended stages, *B* is put at the ground or low-r.f. end of the coil, and *A* at the plate or "hot" end.

When one is experimenting with the constants of a TNT oscillator (such as portable 5-meter rig) or of a crystal oscillator stage, in an effort to determine the conditions for maximum r.f. out-

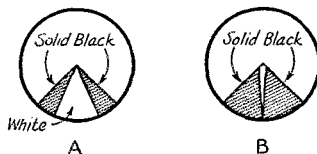

FIG. 9—THE V.T. VOLTMETER AS A NEGATIVE-PEAK OVERMODULATION INDICATOR

put, the v.t. voltmeter can readily be used, with the aid of a small pick-up coil, as an r.f. output meter. The pick-up coil is coupled at a suitable *fixed* distance from the plate tank of the r.f. stage, and the r.f. voltage across it measured as changes are made in the circuit.

* Part I, October, 1936, *QST*.

** RCA Radiotron Division, RCA Manufacturing Co., Harrison, N.J.

FIELD-STRENGTH MEASUREMENTS

Although the writer has not tried the following idea, it seems that the v.t. voltmeter is sensitive enough to be used as a r.f. field strength indicator, if a power supply for it can be found some distance from the transmitting antenna (a battery supply is feasible, because the v.t. voltmeter can be modified to work from a 200-volt source, where r.f. voltages of the order of 1 to 10 volts are to be measured). A short, portable, receiving aerial, or rod, can be connected to a tuned circuit, with or without a ground, whichever proves best, and the r.f. voltage developed across the tuned circuit measured. It seems probable that such a set-up could be used at a considerable distance from the transmitting antenna and still develop a volt or two for indicating purposes, as transmitter or antenna changes are made. The stronger the radiation, the more r.f. voltage the v.t. voltmeter will show.

MODULATION METER

As a modulation meter, the v.t. voltmeter will measure the percentage of modulation with good accuracy, provided modulation is symmetrical and the carrier is not subject to too much shift on modulation. A small pick-up coil (untuned) is loosely coupled at a suitable fixed distance from the plate tank coil, and the unmodulated carrier voltage measured. A steady a.f. signal is then applied to the modulator until the measured r.f. voltage is just twice its unmodulated value; this point corresponds quite closely to 100 percent modulation, as regards the *positive* modulation peaks. It does not take care of *negative* modulation peaks, lop-sided a.f. waves, or of excessive carrier shift. If the pick-up coil is coupled so that the unmodulated r.f. voltage is, say, 100 volts, then a reading of 180 volts under modulation would indicate a modulation percentage of 80. R_7 is the only control that need be adjusted on the v.t. voltmeter, assuming that the "zero" point was correctly set at the beginning. If desired, the instrument can be placed at the receiving position, more or less permanently, and connected to the transmitter by means of ordinary twisted lamp cord, with a pick-up coil at each end.

As an *overmodulation* indicator, potentiometer R_7 is adjusted just to cancel the unmodulated carrier voltage, picked up as described above, and the voltmeter (V) reading noted. R_7 is then set so that V reads about 95 percent higher. This over-biases the 6E5 and over-closes the pattern. Then, under modulation, when the eye begins to "kick" open slightly, the positive carrier peaks are just beginning to exceed the 95% modulation point. The only catch with this arrangement is that, like all positive peak indicators, the v.t. voltmeter does not tell the operator what his *negative* modulation

peaks are doing. It is the negative peaks which cause the most trouble, when they reach the carrier cut-off point, because of the resultant flattened modulation envelope with its plentiful high-frequency harmonics.

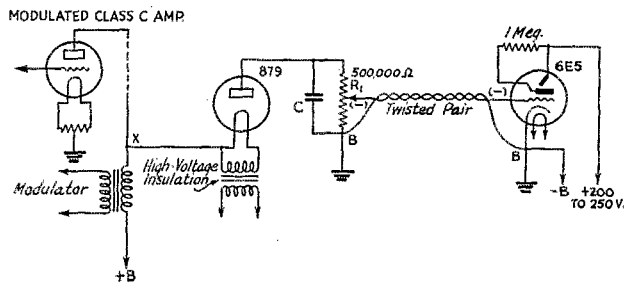

FIG. 10—ANOTHER APPLICATION OF THE 6E5 IN A NEGATIVE-PEAK OVERMODULATION INDICATOR

C—0.05 to 0.5 μ fd. Use value to give desired time lag. Larger values give slower action of 6E5 pattern.

Another arrangement of the v.t. voltmeter is possible, however, so that the negative modulation peaks can be indicated. In this case, a few minor changes in the v.t. voltmeter circuit of Fig. 4 (Part I) are necessary. Condensers C_1 and C_4 should be disconnected (one terminal is adequate), and C_2 should be changed to 100 μ fd. The pattern of the 6E5 is then adjusted to its zero setting, or preferably to a slightly over-closed position, with the r.f. pick-up coil connected but with the carrier off. The carrier is next turned on, unmodulated, this causing the "eye" to open fully. Then, as modulation is applied and the percentage increased, the pattern will have two slightly-fluorescent triangular sectors, of lighter hue than the rest of the screen. The border lines of the normal shadow sector will still be plainly visible. When the two lightly shaded triangles approach each other, at the center of the screen, the *negative* modulation peaks of the carrier are approaching the cut-off, or zero r.f. point. This is true because the pattern was originally adjusted to the zero line under the condition of no carrier. The lightly-shaded triangular screen sectors have less brilliance than the rest of the pattern because they receive excitation only on the negative a.f. peaks. This effect can better be understood by reference to Fig. 9. Fig. 9-A shows that the negative modulation peaks are not reaching carrier cut-off, while in Fig. 9-B the pattern shows overmodulation. The bright line where the two triangular sectors merge (Fig. 9-B) is the indication of this condition.

A SIMPLE NEGATIVE-PEAK OVERMODULATION INDICATOR

Another application of the 6E5, entirely different from that of the v.t. voltmeter, is shown in Fig. 10. Here the 6E5 is used in conjunction

with a half-wave vacuum-tube rectifier. The circuit is almost self-explanatory. When the a.c. modulating voltage at point "x" swings positive, the 879 does not pass current because its filament is plus with respect to its plate. When the a.c. voltage swings negative at point "x", the 879 still fails to pass current until the negative a.f. peak

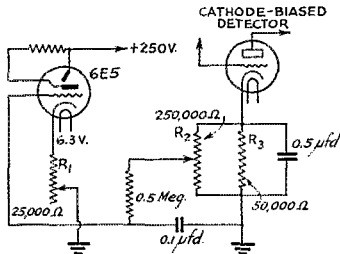

FIG. 11—THE 6E5 ALSO CAN BE USED AS A VISUAL TUNING INDICATOR IN SETS NOT HAVING A.V.C. OR A DIODE DETECTOR

The "eye" works "backwards" in this case.

exceeds the d.c. plate voltage of the Class-C amplifier. When this occurs, the instantaneous voltage at point "x" is negative with respect to ground, the 879 passes current through the load resistor R_1 , and the voltage drop thus produced across R_1 biases the grid of the 6E5 negatively. The pattern, therefore, "kicks" shut whenever the negative a.f. peaks are great enough to cause carrier cut-off. As long as the pattern remains open, there can be no overmodulation on negative a.f. peaks, and no carrier cut-off. Inasmuch as a negative peak modulating voltage of 1007 volts (assuming that the Class-C tube is operating with a 1000-volt supply) is adequate to cause complete closure of the 6E5 pattern, it is apparent that this device is exceedingly sensitive to the slightest overmodulation. The sensitivity can be controlled by means of potentiometer R_1 , which applies as great a portion of the excess modulating voltage to the 6E5 grid as may be desired. For example, an overmodulation of 14 volts will cause complete closure of the "eye," even if R_1 is set in the middle of its range.

The size of condenser C controls the speed with which the pattern reopens after an excessive modulation peak has passed. That is, although the pattern will shut quickly, it can be made to reopen slowly, to assist in the observation. This

type of overmodulation indicator is much to be preferred to the positive-peak indicating type, for reasons already mentioned.

This arrangement is not an original one, inasmuch as a similar circuit using a d.c. milliammeter in series with the diode resistor has been published before. The idea of using the 6E5 in place of the d.c. meter, as an indicating medium, was suggested by W8HLM.

USE OF THE 6E5 IN NON-A.V.C. RECEIVERS

The normal application of the versatile 6E5 as a visual tuning indicator in receivers may be of interest to some amateurs. As is well known, the 6E5 is ordinarily used in receivers employing automatic volume control with a diode detector. The control voltage for the 6E5 grid is ordinarily obtained from a suitable point in the a.v.c. or diode detector circuit. It is not so well known, however, that the "magic eye" can also be used in a receiver having neither a.v.c. nor a diode detector. The alternative arrangement is suitable for t.r.f. or superheterodyne receivers using a cathode-resistor-biased detector, as shown in Fig. 11.

With reference to this circuit, potentiometer R_2 is set at the end next to the detector cathode. This places a positive voltage (equal to the detector's no-signal bias) on the 6E5 grid and opens the pattern. Cathode resistor R_1 is next set just to close the pattern to a narrow, dark line, this being accomplished when the bias across R_1 exceeds the bias across R_3 by about 7 volts. Now, if an r.f. signal is tuned in, the plate current of the detector rises slightly, the voltage drop across R_3 increases, and the "eye" will open slightly. At the point of resonance, where the receiver is accurately tuned,

the pattern will have opened to a maximum. Detuning the set causes it to close again. Thus, the 6E5 acts as a visual tuning indicator, but operates exactly backwards with respect to its normal movement in an a.v.c. receiver, where the control voltage is negative instead of positive. This backward operation, however, is not objectionable—the bigger the shadow, the better the tuning.

If a strong signal develops so much voltage across R_3 that the pattern opens fully, and ceases to give an accurate indication, it is advisable to move the arm of R_2 towards the ground end. R_1 must also be readjusted, in this case, with no signal applied, so that the pattern will again be at its zero or closed position under no-signal

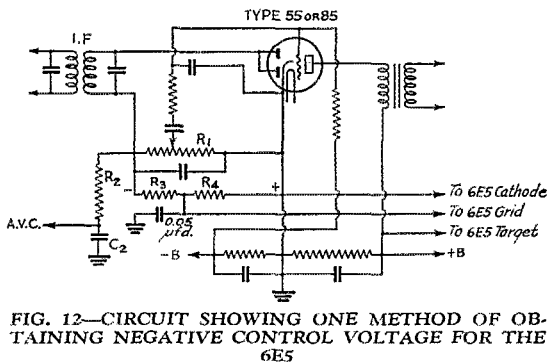

FIG. 12—CIRCUIT SHOWING ONE METHOD OF OBTAINING NEGATIVE CONTROL VOLTAGE FOR THE 6E5

A high-resistance bleeder (R_3 , R_4) is connected across the diode load resistor R_1 .

conditions. There are undoubtedly many receivers, amateur and otherwise, which can easily be equipped with this type of visual tuning circuit; no extra plate-voltage supply is needed for the 6E5, the power supply of the receiver being quite suitable.

In most cases, the 6E5 is used in receivers having a.v.c. and a diode detector. Fig. 12 shows a typical diode-detector and a.v.c. circuit. The d.c. control voltage developed across R_1 (the diode load resistor) may, on a very strong signal, be too large for optimum operation of the 6E5, because only 7 or 8 volts of bias are required to close the pattern completely. If the receiver has considerable r.f. or i.f. gain, and if it is tuned to a very strong signal, the control voltage will almost invariably exceed -8 volts. Thus, the pattern will over-close and will not accurately indicate the correct tuning. To avoid this condition, it is advisable to connect a high-resistance bleeder (R_3, R_4) across R_1 and then tap in the grid lead from the 6E5 at a suitable voltage point.

The resistors R_3 and R_4 should have, in most cases, a total resistance of about 4 to 6 megohms, so that they will not cause undue loading of R_1 . In addition, R_3 and R_4 should be so proportioned that on the strongest signal the effective control voltage across R_4 will just close, but not overclose, the pattern. This means, of course, that the "eye" may close only a little on weak signals.

In certain receivers where a special i.f. stage and a separate diode are used for the a.v.c. system, the 6E5 can be operated from the detector diode with better results. The reason is that the range of carrier voltage applied to the second detector diode is greatly reduced by the action of the a.v.c. system. Such sets have a fairly "flat" a.v.c. characteristic.

Regardless of the manner in which the 6E5 is used as a visual tuning indicator, it can also be utilized as an "S" meter, or carrier strength indicator, at the same time. That is, with the r.f. gain control at any fixed position, any variation in strength between different carriers will be indicated quantitatively by the amount of pattern movement. For c.w. telegraph indications, the transmitting operator should hold his key down for a short interval. The pattern will also show either positive or negative carrier shift of a 'phone carrier under modulation.

RESISTANCE AND CAPACITANCE MEASUREMENTS

In addition to the uses of the v.t. voltmeter which have been described, it also has a number of other applications. Among these are measurement of unknown resistance and capacitance. The circuit arrangements for these measurements are given in Fig. 13. In both cases it is necessary to have a resistor of known calibration for R_k . In making resistance measurements, the corresponding input terminals of the voltmeter are first connected to A and B and R_7 is adjusted until the

eye just closes. The voltage then read is E_x . Prod A is then transferred to A' and E_k is simi-

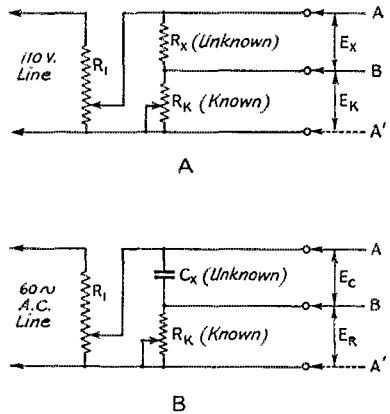

FIG. 13—CIRCUIT ARRANGEMENTS FOR RESISTANCE MEASUREMENT (A) AND CAPACITANCE MEASUREMENT (B) USING THE V.T. VOLTMETER

R_1 —1000-ohm 25-watt adjustable resistor across power line, tap set at 10 volts or so.

R_k —Calibrated adjustable resistor or known fixed resistors. For convenience in resistance measurements its value may range from 10 times to 1/10 the estimated value of the unknown resistance. For direct-reading capacitance measurements, as described in the text, the resistance range may be from a few hundred ohms for capacitances of several microfarads to 10 megohms and higher for capacitances below 0.0002 μ fd. (less than 200 μ fd.) This method is for a.c. condensers only (mica, paper, and similar types). It should not be used with electrolytic condensers.

larly measured, with R_k left at the same setting. Then,

$$\frac{R_x}{R_k} = \frac{E_x}{E_k}$$

and

$$R_x = \frac{E_x}{E_k} R_k.$$

If R_k is adjusted until $E_x = E_k$, then $R_x = R_k$.

Resistance values are all in ohms and voltage values in volts, of course.

To measure unknown capacitance, the circuit of Fig. 13-B is used. The a.c. voltage E_c across the condenser and the voltage E_r across the known resistor are measured with the voltmeter.

Then

$$\frac{X_c}{R_k} = \frac{E_c}{E_r}$$

where X_c is the reactance of the condenser in ohms and R_k is the resistance of the calibrated resistor.

$$X_c = \frac{R_k E_c}{E_r} = \frac{1,000,000}{2\pi f C \mu\text{fd.}}$$

(Continued on page 33)

What the League Is Doing

League Activities, Washington Notes, Board Actions—For Your Information

Changes in Regs

In the last paragraph of F.C.C. Rule 30a, there is a list of ten cities, commencing with Albuquerque, where the Class A amateur examination has been available twice a year but never the Class B. The League having pointed out that the Class B examination could be given at the same time without additional expense or inconvenience to the government, the Commission so modified its rule on September 22nd, but without changing in any way the regions in which an applicant may still be eligible for Class C. The modified rule reads as follows:

(a) Examining cities—Examinations for all classes of radio operator licenses will be given frequently at Washington, D. C., and the District offices of the Commission in accordance with announced schedules.

(1) Such examinations will be held quarterly at:

Cincinnati, O.	Pittsburgh, Pa.
Cleveland, O.	St. Louis, Mo.
Columbus, O.	San Antonio, Tex.
Des Moines, Ia.	Schenectady, N. Y.
Nashville, Tenn.	Winston-Salem, N. C.
Oklahoma City, Okla.	

(2) Examinations will be held not more than twice annually at:

Albuquerque, N. M.	Jacksonville, Fla.
Billings, Mont.	Little Rock, Ark.
Bismarck, N. Dak.	Phoenix, Ariz.
Boise, Idaho	Salt Lake City, Utah
Butte, Mont.	Spokane, Wash.

Understand that at the cities listed in Rule 30a (2), the Class B examination is now available on examination days as well as the Class A examination, but one is not obliged to appear for personal examination simply because one lives within 125 miles of one of the cities named in this paragraph.

In Rule 404, the paragraph about Class C, the second sentence was amended to read as follows:

“ . . . Applicants for Class C privileges must reside more than 125 miles airline from the nearest office of the Commission and the nearest point named in Rule 30-a (1), or in a camp,” etc. (Remainder unchanged.)

On the same date a change was made in Rule 384a to change the bands of frequencies on which the “N” prefix may be used, under proper authorization, to read: “. . . 1715–2000 kilocycles, 3500–4000 kilocycles, 56,000–60,000 kilocycles and 400,000–401,000 kilocycles.”

New A.R.R.L. Publications

Our editorial staff has been intensely occupied for many weeks past with the building of apparatus and the writing of material for the new 1937 edition of *The Radio Amateur's Handbook*. A great many new pieces

of apparatus, particularly, of course, transmitters and receivers, have been constructed and tested and are described in the new edition. The book is now ready and is announced elsewhere in this issue. It is even bigger than the last previous edition, handsomer, and we hope will be found even more helpful to readers.

We amateurs have long needed a map especially designed to meet our particular problems and bringing conveniently to our view the particular sorts of geographical data which we need in our work. No such map has existed, so for the past year and a half A.R.R.L. headquarters has been at work on its design. To our specifications, Rand-McNally, the well-known map makers, have laid out a map making use of a modified azimuthal equidistant projection which make it possible to bring on to one sheet of paper a large assembly of useful geographical data for the amateur. Distances from the United States may be scaled with satisfactory accuracy and approximate determinations of bearing made. Hams, of course, know countries more in terms of their prefixes than their geographical names, and the A.R.R.L. map will enable the ready spotting of a country in terms of its prefix. WAC zones and time divisions will be shown with complete accuracy, the I.A.R.U. standard list of recognized countries, etc. The job is handsomely done in seven colors on fine paper. A great effort has been made to bring into it the peculiar qualities that working amateurs require in a map. We trust that it fills the answer to that long-felt need. Its availability is announced elsewhere in this issue.

Staff Notes

Miss Ursula M. Chamberlain, since 1925 the assistant advertising manager of A.R.R.L. publications, has gone and left us—for the particular purpose of becoming Mrs. Maurice C. Huerstel. Moreover, she will hereafter have to live in Bridgeport,



which is an awful comedown. UMC has been an essential part of our Advertising Department for over eleven years. Whereas our members have known her only through their patronage of the Ham-Ad department, over which she presided, hers has been a familiar name in radio

(Continued on page 56)

Plain Talk About Rhombic Antennas

The Story of Some Experiences with Haywire Diamonds

By Ross A. Hull,* and C. C. Rodimon,** WISZ

FOUR years ago, shortly after Bruce announced the development of the rhombic antenna, we put up an experimental antenna of this type with the idea of working Asia. As we see it now, everything was wrong with the project except the antenna itself. We had picked the wrong time and the wrong place. Asia simply wasn't willing. There were no signals. As a result of that experience our interest in the general subject of directive antennas fell off to a mere nothing—and stayed there.

Then, in 1934 we stuck up a directive array for the 60-mc. band and found, much to our astonishment, that nice fat signals could be had with it from stations a hundred miles away at times when the signals were actually inaudible on a normal half-wave antenna. This experience gave

since, we have had a pronounced leaning toward directive antennas. We have used them whenever circumstances permitted and we have looked longingly at every tree, roof, and chimney within a half mile, mulling over all the possibilities.

One big problem with any array is to decide in what direction to shoot it. This difficulty was solved recently upon hearing that Brother A. G. Hull in Sydney, Australia, had grabbed off a license and was on the air. The other big problem, to which we have never found a ready solution, is to decide just how big an array is needed to give worth-while gain. It is one thing, we have discovered, to wade through the many technical treatments of directive antennas, visualizing a great stretch of flat, swampy ground with the various wires strung up in the blue over it. Gains can be

computed so readily then, and it is not at all difficult to think in terms of the R point gain per hundred feet of wire. It is a horse of a different color to stand out on the only available piece of ground—sloping, bumpy, chuck full of trees, smeared with buildings, poles, wires and miscellaneous junk—and then to wonder what might happen to this textbook antenna under those circumstances.

Anyway, we got out the compass and a measuring tape and made a crude plan showing all the chimneys and trees of the surrounding territory. On this we superimposed models of all the antennas we could think of. Study of the layout of the many trees around the place revealed chiefly that the

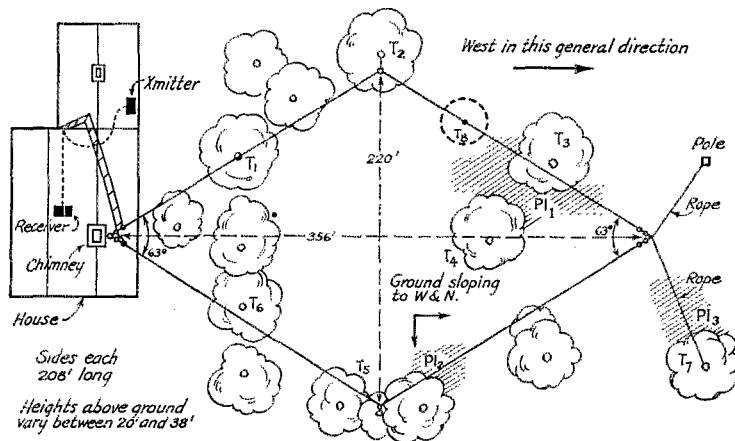

FIG. 1—THE LAYOUT AT WJPE SHOWING THE NEW $3\frac{1}{4}$ -WAVE RHOMBIC ANTENNA

The original rhombic antenna discussed in the text was suspended between the chimney and cherry tree T4. Its dimensions were exactly those used for the WISZ rig shown in Fig. 2. The antenna shown does not actually have the clean lines and symmetrical shape indicated. The wire wanners irregularly through T1, T2, T3, T5, and T6. Also, the height varies between 20 and 35 feet. The shaded areas PI1, 2 and 3 are dense patches of poison ivy—shown in practice to be important factors in antenna construction and adjustment. The rope between the 40-foot pole and T7 allows small changes in the setting of the antenna. T8 is the stump of a 40-foot tree which the authors removed by throwing a rope over it, then swaying it at its resonant frequency.

The antenna works.

us a big jolt because the apparent gain was out of all proportion to normal expectations. We became heavy beam-backers overnight. Ever

had very little knowledge of directive antennas and still less consideration for the possible needs of future radio amateurs. The outcome, anyway, was a decision to string up a rhombic antenna of such dimensions that the transplanting of a few

* Associate Editor.
** Managing Editor.

maps would be unnecessary. The presence of several choice 50-foot trees in the wrong places dictated that the wire would have to be threaded through two of them and wrapped around another but, we thought, that very circumstance would at least permit us to discover what does happen when such departures from the ideal are made.

We shall skip now a hectic day of scrambling over slate roofs; climbing trees; threading wires through branches; getting smeared in poison ivy; unscrambling wires and ropes tangled in tree tops. These matters were important enough at the time but, like most experiences of the kind, faded into insignificance once the whole procedure was shown to be justified. And this particular procedure was justified. The antenna, from the very word go, functioned in a manner which we should have believed quite impossible.

The gadget we ended up with had the general shape of a diamond with sides 144 feet (approx-

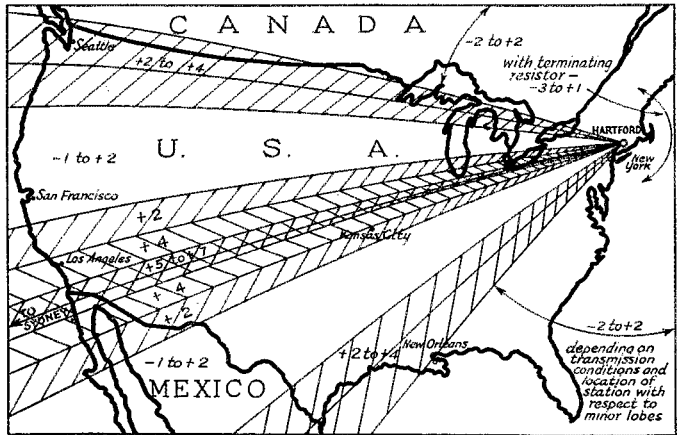

FIG. 3—A SKETCH DIAGRAM PRESENTING A VERY APPROXIMATE SUGGESTION OF THE RECEPTION PERFORMANCE OF THE HAYWIRE DIAMOND

The losses and gains indicated are R points measured on the a.v.c. meter of an HRO receiver. The comparison antenna was a conventional half-wave affair with a 75-ohm transmission line. The figures given are averages of several hundred measurements made over a period of two weeks. Though this diagram represents the performance of the antenna shown in Fig. 1 it differs only in minor respects from that obtained with the WISZ antenna.

mately $2\frac{1}{4}$ wavelengths) long. The wire was about 30 feet above ground most of the way with a couple of excursions down to about 20 feet. The far end, strung up in the cherry tree T4 of Fig. 1, was terminated with several pieces of

"Ohmspun" (a non-inductive resistance element manufactured by the States Company, in Hartford) totalling 700 ohms (d.c.). An ordinary 6-inch feeder with 14-gauge wire was attached to the station end of the antenna and draped over the ridge, down the wall and through the window and a couple of doors to the transmitter. A double-pole double-throw relay served to switch the antenna to feeders running into another room where the receiver and operating controls are located.

First tests were made in reception—the diamond being thrown on to the receiver with a double-pole double-throw switch in place of one of the various normal receiving antennas previously used. Gains or losses were measured with the "S" meter on an HRO and all references made to R's are, therefore, in terms of divisions on the "S" meter dial. Stray pickup from the wrong an-

(Continued on page 74)

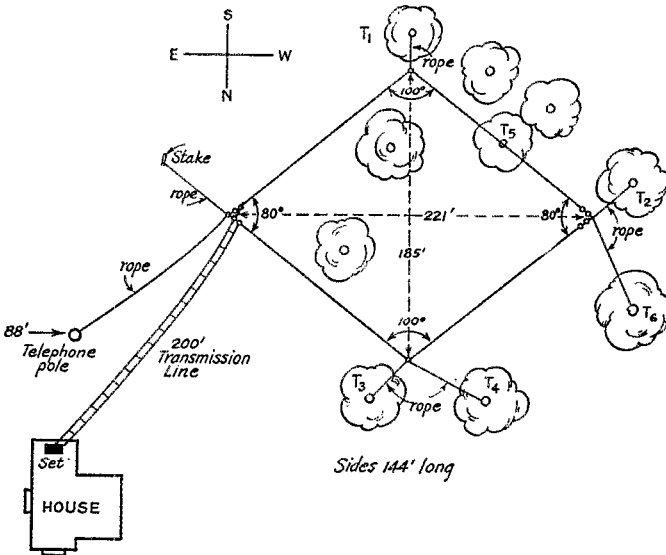

FIG. 2—A BIRD'S-EYE VIEW OF THE WISZ DIAMOND

The clear spaces on this diagram indicate dense underbrush, brambles and a forest of second-growth trees. The antenna itself is 40 feet high at the station end and approximately 60 feet at the other points of suspension. The location of the trees used for support allows slight changes in the direction of the antenna but any change is, of course, a half-day's job. The antenna is ordinarily operated without any terminating resistor. The comparison antenna consists of two phased vertical half-waves mounted on the telephone pole.

Seventh A.R.R.L. Sweepstakes Contest

40 hours of fun! Nov. 14th—15th, 21st—22nd. 'Phone or C.W. Any Ham Band(s)

Two week-ends of opportunity to WAS in National All-Section ' QSO Party W, VE, K, KA, CM, VO Hams Invited to Vie for Certificates

Awards: To the C.W. Leader . . . to the 'Phone Leader. In each Section . . . in each Club. Gavel Trophy to Winning Club!

Develops snappy accurate operators. Tests Stations. Proves Operating Supremacy in each Section!

By F. E. Handy*

THE "SS"! Again we present one of the outstanding annual operating events of the year. Any licensed ham can enter. 'Phone hams will compete with other 'phone hams. Telegraphing operators will work and compete with other telegraphing operators. A certificate award is provided in each Section within each group. Many will also complete their QSL-card record and achieve "WAS" honors through this year's SS.

Whether you wish to "work all states" or all A.R.R.L. Sections, which is even tougher, this is the prime chance of the year to progress toward that objective. The basic idea of the contest is to see how many stations *can* be worked in such a brief time. The points derived from this will be multiplied by the number of *different* A.R.R.L.

have boiled all the essential contest information down into the form of a standard preamble. Exchanges will give necessary data for the record sent to Hq., provide for exchanging signal reports, and show approximate progress of competitors at the same time. New hams may also add to their knowledge of the way preambles to A.R.R.L. messages are sent and acknowledged, and fills requested, accuracy of 'phone communication assured, etc., if they take part and follow the standard practices set forth for these things in the new edition of the Radio Amateur's Handbook. Some emergencies of late years have found many amateurs unfamiliar with good operating practices resulting in delays, garbles, and inability to write or take a message in standard form. We

EXPLAINING CONTEST EXCHANGES						
<i>Send Like Std. Msg. Preamble</i>	<i>NR</i>	<i>Call</i>	<i>CK</i>	<i>Place</i>	<i>Time</i>	<i>Date</i>
In the "SS" Exchanges	Number contest info. sent consecutively, 1, 2, 3 etc., a new nr. for each station worked	Send your own call	CK is RST report ³ of station worked	Your city and section ³	Send time of transmitting this "NR"	Send date of QSO
Purpose	The QSO-nr tells how you are doing; aids Hq. checking	Identification	All stations exchange complete reports	The A.R.R.L. Section is vital contest data	Time and Date must check in both logs and fall within the contest period to prove each point claimed	

Sections² worked with at least a complete one-way exchange (and QSL) in the contest. Message swaps are *not* required in proof of QSO this year. **No thinking up texts to worry about. Instead we**

* Communications Manager, A.R.R.L.

¹ Including Cuba, Porto Rico, Hawaii, Alaska, P. I., etc. Amateurs in Newfoundland are included in the Maritime Section of the A.R.R.L. field organization.

² See the complete list of Sections in the A.R.R.L. organization page 7 of this issue of QST.

hope that the "SS" will help both new and old timers to improve and perfect operating tech-

³ Send the letters CK and just the three numeral report which is understood to be by the RST system. In 'phone exchanges only two numerals need be used in the report, the first always "readability," the second "strength."

Instead of just the state (which is the same as the Section in many cases), identify your A.R.R.L. Section as, for example, Salem, Eastern Mass.; Prov., R. I.; Buffalo, W. N. Y.; Omaha, Neb.; Oakland, E. Bay, etc.

nique at the same time all have an enjoyable time and roll up new station records.

All contest exchanges can be logged directly on the sheet that you send Hq. for a report. The paper work will be completed as you go along with nothing to do but total and summarize points and send it in. Mimeographed contest forms will be sent gratis to anyone who sends a radiogram or drops a card for the same. Use of our sheets is not required nor is advance entry necessary. The purpose is to help participants keep a uniform log. It is necessary that the arrangement or form shown with this announcement be followed. Draw your own columns on your own paper if you like . . . or ask us for the prepared sheet.

Many wanted the "SS" to skip the Thanksgiving holiday. The majority liked our idea of a shorter contest. After considerable discussion it was decided to make the "SS" a two-installment contest with the operating program in two week ends with a time limit. We hope you like it this way.

The contest will take place within two consecutive 33-hour week ends. Choose any hours between the start on a Saturday evening, and the finish at the end of a Sunday night (early Monday morning). You can work more than 20 hours

THE CONTEST PERIOD		
Time	Starts	Ends
A. S. T.	Nov. 14 & 21, 7:00 P.M.	Nov. 16 & 23, 4:01 A.M.
E. S. T.	Nov. 14 & 21, 6:00 P.M.	Nov. 16 & 23, 3:01 A.M.
C. S. T.	Nov. 14 & 21, 5:00 P.M.	Nov. 16 & 23, 2:01 A.M.
M. S. T.	Nov. 14 & 21, 4:00 P.M.	Nov. 16 & 23, 1:01 A.M.
P. S. T.	Nov. 14 & 21, 3:00 P.M.	Nov. 16 & 23, 12:01 A.M.

on one of the two week ends, but in no case will any entry of more than 40 hours' total operating in the two contest periods be accepted. Use any amateur frequency bands you choose. This timing plan permits the average ham to plan for his

(Continued on page 90)

STATION W/VE . . . SUMMARY OF EXCHANGES 7TH A.R.R.L. ALL-SECTION SWEEPSTAKES															
Freq. Band (mc.)	Time On cr Off Air	NR	SENT (1 point)			Time	Date (Nov.)	RECEIVED (1 point)				Time	Date (Nov.)	Number of each Different New Section as WK'd	Points
			Stn.	CK-RST	Place			NR	Stn.	CK-RST	Place				
3.5	On 6:10 P.M.	1	W1INF	579	W. Hartford, Conn.	6:15 P.M.	14	3	W1GME	589	Middlebury, Conn.	6:18 P.M.	14	1	2
		2	"	439	W. Hartford, Conn.	6:25 P.M.	14	7	W1BHM	479	New Haven, Conn.	6:30 P.M.	14	..	2
"	"	3	"	587	W. Hartford, Conn.	6:40 P.M.	14	2	W3BKZ	389	Chey Chase, M. D., D.C.	6:45 P.M.	14	2	2
7	"	4	"	498	W. Hartford, Conn.	10:18 P.M.	14	3	W8BEN	569	Rochester, W. N. Y.	10:24 P.M.	14	3	2
"	"	5	"	578	W. Hartford, Conn.	1:25 A.M.	14	7	W9TSV	589	Chicago, Ill.	1:15 A.M.	14	4	2
"	Off 3:00 A.M. 8 hours 50 min. On 1:00 P.M.	6	"	549	W. Hartford, Conn.	2:50 A.M.	14	15	W9VKF	479	Minneapolis, So. Minn.	2:55 A.M.	15	5	2
14	"	"	"	"	"	"	"	14	W5WG	339	Ruston, La.	1:05 P.M.	21	6	1
"	"	7	W1INF	479	W. Hartford, Conn.	2:15 P.M.	21	17	W5BDI	459	Houston, So. Tex.	2:20 P.M.	21	7	2
7	"	8	"	588	W. Hartford, Conn.	3:00 P.M.	21	11	W1EWD	589	New Britain, Conn.	2:55 P.M.	21	..	2
"	"	9	"	578	W. Hartford, Conn.	4:06 P.M.	21	"	"	"	"	"	"	"	1
"	"	10	(W5WG)* W1INF	347	W. Hartford, Conn.	4:30 P.M.	21	16	W6MVK	439	Modesto, S. J. V.	4:31 P.M.	21	8	2
"	Off 5:20 P.M.	11	"	479	W. Hartford, Conn.	5:10 P.M.	21	9	W9IPT	579	Wheaton, Ill.	5:15 P.M.	21	..	2

4 h. 20 m.
3.5, 13 h. 10 m.
7 and
14 mc.
used.

85 watts Input Power

. . . Different Stations Worked 8 Sec. 22 pts.

Number and name of operators having a share in above work

Claimed score: 22 points X 8 Sections = 176 X 1.5 (85 watts input) = 264

I hereby state that in this contest I have not operated my transmitter outside any of the frequency bands specified on my station license, and also that the score and points set forth in the above summary are correct and true.

Signature

My Tube Line up:

Address

Automatic 'Phone Break-In

Another Crack at Improving Radiotelephone Technique and Lessening QRM

OFTEN we have wished we really had an automatic gadget to make 'phone transmissions more like contacts and less like monologues. This wish generally makes itself especially pronounced after some station has reeled off question after question for ten minutes and blithely stands by taking it for granted that each question is on paper before you and an answer at

Besides being extremely simple to construct, requiring few parts and containing controls for lengthening the hold-in period, it works without a hitch. W3FVF constructed the experimental model pictured, in a couple of hours, after the idea struck him of using the 885 as a control tube. In the past it was the control circuit that had presented the difficulties.

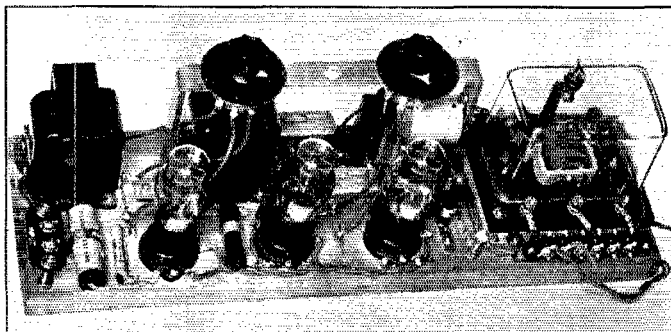

THE EXPERIMENTAL MODEL CONSTRUCTED BY W3FVF

This breadboard layout gives a very good account of itself. For a permanent installation shielding would be good insurance.

hand to rattle back. During the past few years seasonal attempts have been made at reviving the "push to talk" method of 'phone contacts. That arrangement still has its merits but the urge to "push" mechanically is lacking. So it would appear that the only logical solution to the problem is to have it done automatically. The system has tremendous advantages, mainly in that each QSO is absolutely 100%—or one knows it immediately and corrects the situation by a QSY or a stand-by until the channel is clear. The receiving station can notify you of conditions any moment you hesitate.

This has all been hashed over for years, but nothing very much has been done about it. On a recent trip to Baltimore we were re-introduced to the idea by Phil Stout, W3FVF. Perhaps it is only logical that he would be the one to follow up the subject for it was he, then at W4AAD, who described automatic 'phone break-in years ago.

The 1936 model at W3FVF certainly works like a charm and possesses the newest features.

With the latest ideas fresh in mind we came back to West Hartford and made up a model completely shielded and used it for a test at W1SZ. The shielding was deemed necessary to keep down r.f. feedback as well as isolating the gaseous 885 from audio circuits of transmitter and receiver. It performed right off the jump and with a few minor adjustments was set for service.

The diagram and photos will help explain the circuit layout. A few words regarding the manner of operation are now in order. With the proper

voltages applied to the tubes the sensitive relay in the plate circuit of the amplifier will close, as the tube is working without bias and drawing about 15 ma. The instant that audio voltage appears at the input of the buffer stage the 885 control tube

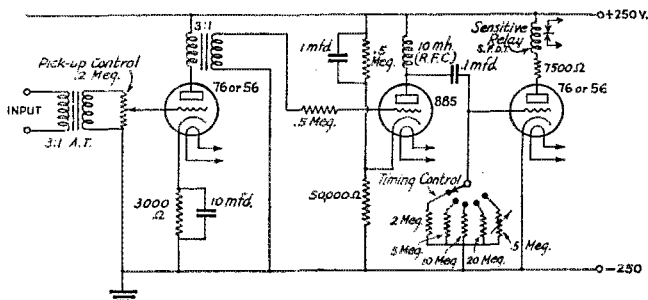

CIRCUIT OF THE ELECTRONIC RELAY

The components specified are not critical in value for the most part. The 20 meg resistor gives about a 15 second lag and the 2 meg resistor gives practically none. The relay used is a Dunco type CXB51.

starts to work—this blocks the power tube resulting in the relay opening. When the 885 breaks down there is a potential at its plate circuit which charges the coupling condenser to the grid of the power tube. After audio voltage ceases to be applied, this charge leaks off gradually, its rate

depending on the amount of resistance present in the timing control. It is only necessary to have a volt of audio at the input terminals to actuate the 885. This audio voltage may be taken from one of the first tubes in the speech amplifier. Should there be considerably more voltage than that actually needed to actuate the input circuit the excess may be reduced by the gain control in the grid circuit of the first 56.

The sensitive relay in the plate circuit of the power tube must have a back contact, that is, a single-pole double-throw relay opening on less than 12 ma. is called for. For most satisfactory operation one should use this relay to stop and start the oscillator in the transmitter, leaving no r.f. running when the relay is in a receiving position. In this way the moment the relay is closed (normal position) one will be listening. No precautions need be taken in ordinary cases to quiet the receiver when one is transmitting as the transmitter will block the receiver and only a weak hum will be heard in the 'phones. However, should this be annoying a complete job of disabling the receiver may be done by shunting a large condenser across the receiver output and ground via the relay.

This will work out very nicely if the oscillator is stopped and started by opening and closing its grid return circuit. In this case the relay arm will be grounded and the front contact (normal position) will have no connection to it. The back contact will go to the transmitter oscillator at the point the r.f. return has been broken, for this provides the ground return path. One side of a 1- μ fd. condenser is connected to the back contact and the other side of the condenser will go to the "hot" side of the headphones. This will effectively ground the receiver output while transmitting. The moment the relay opens the receiver will be in the normal position for reception and the transmitter will be off the air. It is quite obvious that buffer and final amplifier stages will have to have some form of fixed bias for excitation will be off when receiving and plate voltage will be on all the time. The audio equipment will be on all the time but in an idling position. The moment the microphone is actuated the audio will be excited, but the r.f. will be on the air so no damage will result because of no r.f. load. However, it can be seen that with Class-B modulation it will be necessary to have fool-proof operation of the oscillator.

We can hear someone saying that this whole idea is n.g. because it can't be used in connection with a speaker. He must wear headphones. Such is a true but perhaps fortunate fact. It is still possible to do a much better job of receiving especially through heavy interference by the use of headphones in preference to loudspeakers.

When this unit is placed in operation one can-

not really appreciate its merits until a station similarly equipped or one able to work duplex is worked. It has advantages over the duplex-operated station in that a channel is not being used continually but just during periods of actual conversation. There will be those who are annoyed at the continual stopping and starting of the carrier, but this is a very weak criticism of an excellent advancement in present-day radiophone technique in our restricted territories. There will be times when one will not want to use it for break-in operation. In this case it is merely a flip

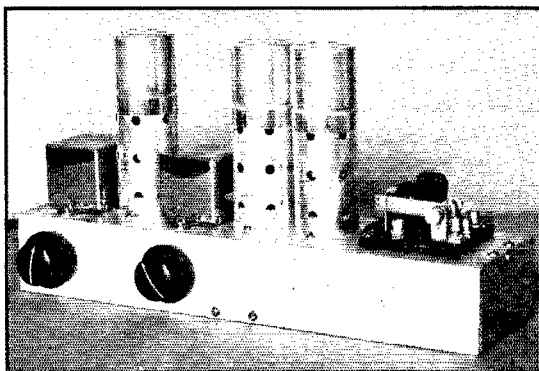

SHIELDED MODEL BUILT FOR USE AT WISZ
Shielded transformers with leads brought through the aluminum base keep all wiring underneath. This model uses a Ward Leonard relay.

of the switch controlling the timing resistances and throwing in the largest resistance which will hold in for 15 or 20 seconds after speech is no longer put through the audio channels.

—C. C. R.

Amateur Applications of the "Magic Eye"

(Continued from page 26)

From this,

$$C_{\mu fd.} = \frac{1,000,000 E_r}{2\pi f R_k E_c}$$

$C_{\mu fd.}$ being the capacity of C_x in μ fd.

Where the frequency, f , is 60 cycles per second,

$$C_{\mu fd.} = 2650 \frac{E_r}{R_k E_c}$$

If R_k is adjusted until $E_c = E_r$, then $R_k = X_c$ and

$$C_{\mu fd.} = \frac{2650}{R_k}$$

Hence, R_k can be calibrated directly in terms of $C_{\mu fd.}$ (capacitance of C_x in microfarads).

In conclusion, the writer wishes to acknowledge the assistance given by Mr. P. A. Richards, also of the RCA Radiotron Division, in the development of the v.t. voltmeter and for suggesting many of its numerous practical applications.

More About the Low-Cost High-Fidelity Audio Amplifier

Coupling the Single-Tube Phase Inverter to Diode Detectors—Performance Data and Construction Precautions

THE simple high-fidelity audio system using a single triode tube in a phase inverting circuit to feed a pair of 6L6's in push-pull, as described by A. G. Hull,¹ has attracted considerable interest as revealed by the inquiries for further information which have been received. Many of these have concerned methods of coupling the amplifier input circuit to unbalanced sources, particularly to detector output circuits. Others have described difficulties which were not experienced in our work with the amplifier but which might result with a different type of construction in which the assembly is mounted on a metal foundation. The following helpful information on these particular points, given in an RCA Application Note² on a similar type of amplifier, accordingly should be of interest.

The circuit of the phase inverter is shown in Fig. 1. The secondary of the i.f. transformer feeds the diode D_1 of a 6H6 to supply audio voltage; the primary of the transformer feeds the diode D_2 to supply a.v.c. voltage. The audio voltage that appears across R_2 is fed to the grid of a 6F5 through coupling condenser C_2 . The output of the 6F5 appears across resistors R_5 and R_6 . Because the potentials of points e and f are equal in magnitude and opposite in polarity with respect to ground, the output tubes operate in push-pull.

In order that the a.c. voltages across R_5 and R_6 will be equal in magnitude and 180 degrees out of phase, the capacitance across R_5 must be equal to that across R_6 . This requirement places restrictions on the assembly and the physical size of the components. Condenser C_2 should be physically small and should be mounted as far from large grounded objects as space permits. R_1 , R_2 , R_3 , C_1 and C_2 should be mounted close to the sockets of the 6H6 and the output tubes and to the volume control R_4 ; it may be necessary to extend the shaft of the volume control in order that it be placed in the most desirable location. The lead to the cap of the 6F5 should not be shielded.

¹ A. G. Hull, "High-Fidelity Audio at Low Cost," *QST*, July, 1936.

² Application Note No. 63, RCA Radiotron Division, RCA Mfr. Co., Inc. (July 30, 1936.)

R_1 and R_3 are filter resistors. They serve to minimize the r.f. voltage that can appear across the volume control and to reduce the effects of capacitance from point a or b to ground. If point c or d should have a large capacitance to ground, the magnitude and phase of the signal voltage across R_6 will be changed. A shift in magnitude or phase of the voltage across R_6 is manifested by a

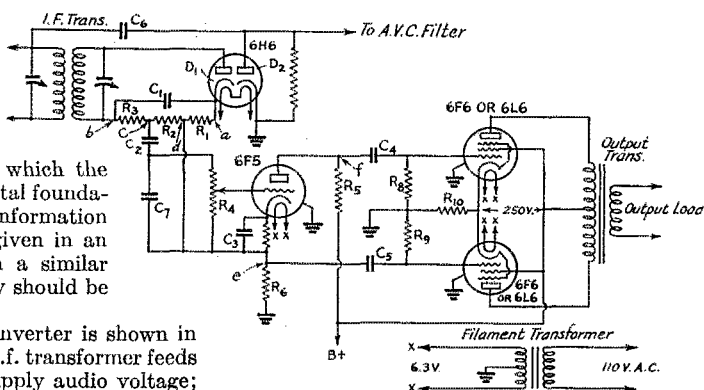

FIG. 1—THE AMPLIFIER CIRCUIT WITH SINGLE-TUBE PHASE INVERTER FED FROM A DIODE DETECTOR CIRCUIT

- | | |
|------------------------|--|
| R_1 —0.05 megohm. | R_{10} —200 ohms for 6F6's, 125 ohms for 6L6's. |
| R_2 —0.1 megohm. | C_1 —100 μ fd. |
| R_3 —0.05 megohm. | C_2 —0.1 μ fd. |
| R_4 —0.5–0.9 megohm. | C_3 —4–8 μ fd. |
| R_5 —0.1 megohm. | C_4 —0.1 μ fd. |
| R_6 —0.1 megohm. | C_5 —0.1 μ fd. |
| R_7 —2600 ohms. | C_6 —100 μ fd. |
| R_8 —0.5 megohm. | C_7 —100 to 500 μ fd. (r.f. bypass condenser). |
| R_9 —0.5 megohm. | |

decrease in power output, especially at high audio frequencies.

In order to determine the effects of stray capacitances on the operation of the phase inverter, a detector-amplifier was constructed as shown in the figure. Those components whose capacitances to ground might adversely affect performance were mounted at least one-half inch from the chassis. A cathode-ray oscilloscope was connected to the grids of the output tube in order to determine the magnitude of each grid voltage and the phase angle between them. A modulated r.f. signal was applied to the i.f. transformer.

The voltages at the grids of the output tubes

(Continued on page 96)

A Simple Two-Band 6L6 Tri-Tet Transmitter

An Effective Set for Portable and Emergency Work

By Byron Goodman,* W1JPE

IN THESE days of inexpensive crystals and tubes, there is really no reason for the beginner or amateur of limited means to deprive himself of the advantages of a crystal-controlled transmitter. Crystal oscillators automatically set themselves on a frequency within the band, and most certainly require less critical adjustment than a self-excited, or even electron-coupled, oscillator. A self-excited transmitter requires some auxiliary equipment for checking frequency, troublesome at any time, but especially so if the transmitter is to be used for portable work. The transmitter to be described is inexpensive, easy to build and, last but by no means least, makes a good portable transmitter for emergency work or for that trip you're going to take.

Portable transmitters have never been a problem of tube line-up, but more a problem of getting the most out of the necessarily-limited power supply. Crystal oscillators using one or two 47's or 42's have been the closest approach to a compromise between power available and desired power output; but with the introduction of the beam-power type tube, a still further improvement has been made available. An effective crystal oscillator at low plate voltages, the 6L6 is readily adaptable to use in a low-powered transmitter for portable work.

Another requirement of a portable transmitter is that it be as simple as possible, with a minimum of coils and extra gear. Using a 3.5-mc. crystal, the 6L6 transmitter requires no extra coils for two-band (3.5- and 7-mc.) operation, and is effective with plate voltages from 250 to 400, delivering from 7 to 20 watts output in this plate voltage range. A 133-foot wire is the only antenna required for operation on the two bands.

The transmitter was designed primarily for

*Assistant Secretary, A.R.R.L.

portable use, and consequently is fitted in a plywood box built to withstand the knocks incurred in transportation. It might be mounted even more simply if home use was the only requirement to be met. The base consists of a $9\frac{1}{2}$ by $4\frac{1}{2}$ -inch piece of tempered Masonite, finished in black crackle lacquer, upon which the circuit essentials are mounted. The $7/16$ -inch square wooden strips used in the corners of the box are notched so that the Masonite base may be slid into the box, which measures $9\frac{1}{2}$ inches wide by $7\frac{1}{2}$ inches high by $4\frac{1}{2}$ inches deep, inside dimensions.

The variable condenser on the left side of the

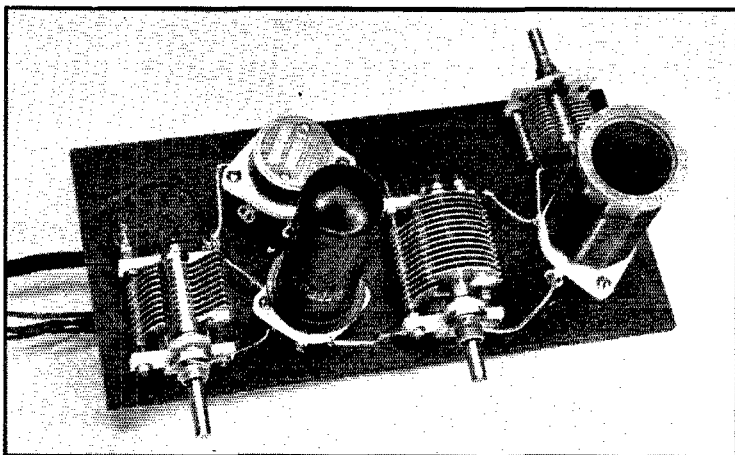

A SIMPLE TWO-BAND TRANSMITTER USING A 6L6

This outfit is built for either use at the home station or as a portable. With a 3.5-mc. crystal having a frequency between 3500 and 3650 kc., it can be used for both 3.5 and 7-mc. work.

The cathode tuning condenser, C₁, is at the left on the front edge; the condenser at the right is C₂, the plate tuning condenser. The cathode coil is cemented flat on the base just behind C₁.

base is for cathode tuning in Tri-Tet operation with second-harmonic output. One plate is bent so that, with the condenser full in, the cathode coil is shorted for fundamental operation. Directly behind the cathode tuning condenser is the cathode coil, fastened to the base by Duco cement. The cathode winding is simple to make; a strip of paper is wrapped around any $1\frac{1}{2}$ -inch diameter bottle or circular form, and eleven turns No. 30 d.c.c. wire are scramble-wound on the paper. The paper is used so that the coil can be easily removed, and is not retained to support the finished coil. The paper and coil are then slid off

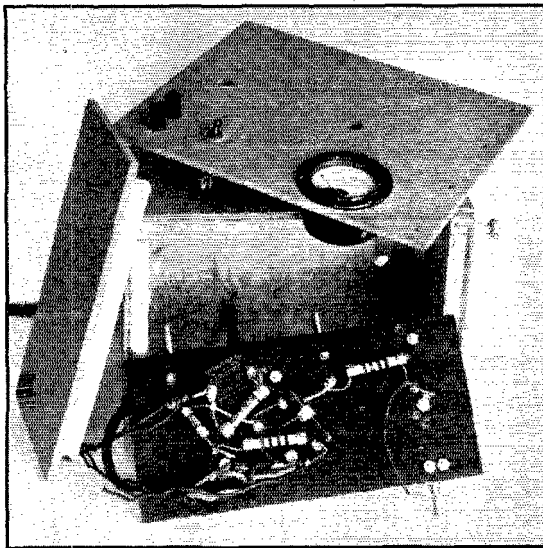

A BOTTOM VIEW OF THE 6L6 OSCILLATOR, SHOWING THE PLYWOOD CABINET AND FRONT PANEL

The wires to the plate milliammeter, on-off switch for the plate supply, and key terminals have been disconnected to show the construction. Bypass condensers and resistors are placed in convenient locations; no layout precautions are necessary aside from getting short bypass connections.

the form, the paper is dropped while the coil is tied together at several places by short lengths of wire, and the coil is "doped" with Duco cement. After the cement has hardened, the wire used to tie the coil is removed, resulting in a simple a winding as one could ask for.

The condenser on the right is for plate tank tuning, and is large enough so that two bands can be tuned with the one coil. The plate coil is mounted alongside, and the antenna coupling condenser is mounted at the back.

Underneath the base, the fixed condensers and resistors are mounted as convenient, being placed so that their leads will be as short as possible. A five-wire cable is used to make connection to the power supply. Four wires are all that are necessary unless a battery-driven generator is to be used for the high-voltage supply, in which case the fifth wire connects to the switch (on the panel of the transmitter) which turns the generator on and off. If it is intended to use only battery or a.c. filament and plate power supply, the switch can be omitted and a four-wire cable used. It is well, however, to have provision for the switch and extra lead, in anticipation of the time when the transmitter will be called upon for emergency work with generator plate supply. The meter on the front of the panel reads plate current only, and is especially useful in tuning up the transmitter. The two binding posts connect to the key.

Tuning of the transmitter is simplicity itself. After all wiring has been checked, the power sup-

ply is connected and a half minute or so allowed for the heater of the 6L6 to warm up. With the cathode condenser shorted by turning it full in, the key is closed. The meter will probably shoot off-scale. Advancing the plate tuning condenser towards the maximum capacity end, the plate current should start to dip, until with the condenser nearly all of the way in the plate current should read 10 ma. or so. A neon bulb should light up brilliantly if touched to the stator plates of the tuning condenser. The cathode condenser can now be opened nearly all of the way out. The neon bulb should still glow, although less brightly. Now rotate the plate tank condenser until it is nearly all open, and another point should be found where the plate current suddenly dips, and the neon bulb glows brightly. This is the second harmonic or 7-mc. output setting. The cathode condenser can now be retuned for maximum output. If output cannot be obtained on the two bands, the plate coil turns will have to be varied until the two bands fall within the range of the plate tuning condensers.

Once the plate coil has been checked, the transmitter is ready for operation.

With the antenna connected to its terminal post, the series coupling condenser is advanced

(Continued on page 98)

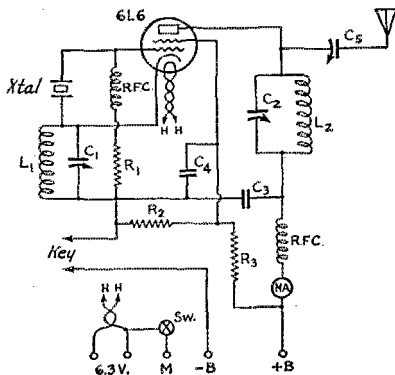

CIRCUIT DIAGRAM OF THE 6L6 CRYSTAL OSCILLATOR TRANSMITTER

L₁—11 turns of No. 30 d.c.c. wire, scramble-wound and cemented with Duco Cement; diameter 1 1/2 inches.
L₂—24 turns of No. 18 enamelled wire, wound on 1 1/2-inch bakelite form. Turns spaced to occupy a winding length of 1 1/2 inches.

C₁—100-μfd. midget condenser (National ST-100).

C₂—140-μfd. midget condenser (National ST-140).

C₃—0.02-μfd. mica condenser (Sangamo).

C₄—0.005-μfd. mica condenser (Sangamo).

R₁—250,000 ohms, 1/2 watt (IRC).

R₂—50,000 ohms, 2 watt (IRC).

R₃—3000 ohms, 10 watt wire-wound (IRC).

RFC—High-frequency r.f. choke (National 100).

With plate voltages of 250 or less, R₂ and R₃ are not needed, the screen voltage return being connected directly to the positive terminal of the plate supply.

A General Utility Mixer and Speech Amplifier

Three Input Circuits With Automatic Over-All Level Control Provide Flexibility

By Clinton B. DeSoto,* W1CDB

THAT the design, adjustment and operation of speech equipment is the most complex part of amateur transmitting there can be little doubt. In the r.f. end, so long as plenty of power is provided all along the line, it matters little just what sort of power it may be. But in the

power ratio of perhaps 20,000 to 1—a tremendous range.

Probably the most critical point in this range is the region between the millivolts from the microphone and the volts applied to the driver-modulator system proper—in other words, the

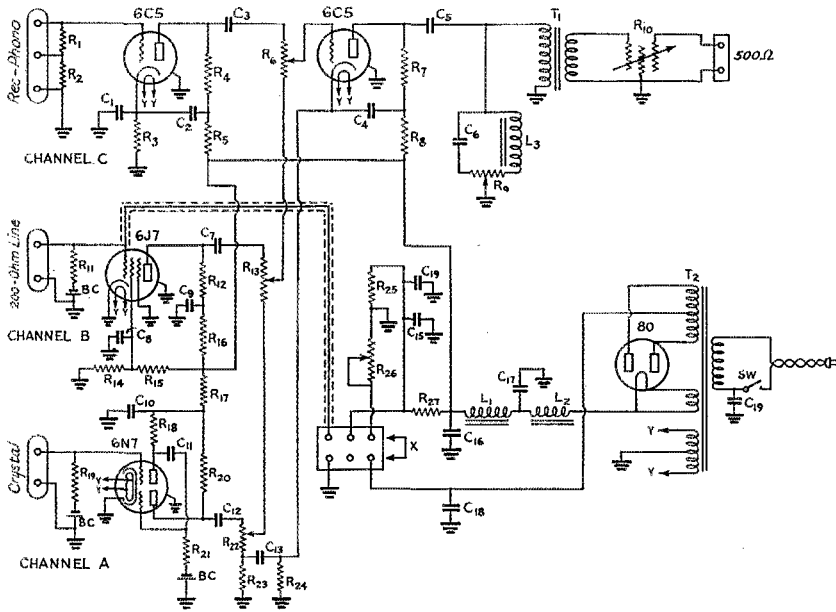

FIG. 1—SPEECH AMPLIFIER CIRCUIT DIAGRAM

- C₁, C₁₃—5- μ d. 25-volt electrolytic tubular condensers.
- C₂, C₄, C₈, C₉, C₁₀—4- μ d. 300-volt electrolytic condensers.
- C₃, C₇, C₁₂, C₁₄, C₁₉—0.1- μ d. 400-volt tubular paper by-pass condensers.
- C₆—0.25- μ d. 400-volt tubular paper condenser.
- C₁₁—0.01- μ d. 400-volt tubular paper condenser.
- C₁₅, C₁₆, C₁₇—16- μ d. 450-volt can-type electrolytic condensers.
- C₁₈—50- μ d. 25-volt tubular electrolytic condenser.
- R₁—8000-ohm $\frac{1}{2}$ -watt fixed resistor.
- R₂—2000-ohm $\frac{1}{2}$ -watt fixed resistor.
- R₃, R₄—2500-ohm $\frac{1}{2}$ -watt fixed resistors.
- R₄, R₇, R₁₄, R₁₆, R₁₇, R₂₅—50,000-ohm $\frac{1}{2}$ -watt fixed resistors.

- R₅, R₈—10,000-ohm $\frac{1}{2}$ -watt fixed resistors.
- R₆, R₁₃, R₂₂—0.5-megohm shielded potentiometers.
- R₉—0.2-megohm potentiometer.
- R₁₀—500-ohm T-pad (Electrad Type TR500).
- R₁₁—200-ohm $\frac{1}{2}$ -watt fixed resistor.
- R₁₂, R₁₅, R₁₈, R₂₀—0.25-megohm $\frac{1}{2}$ -watt fixed resistors.
- R₁₉—5-megohm 1-watt fixed resistor.
- R₂₁—1-megohm $\frac{1}{2}$ -watt fixed resistor.
- R₂₃—3000-ohm 25-watt fixed resistor.
- R₂₄—250-ohm 25-watt potentiometer (Ohmite 0154).
- R₂₇—1000-ohm 10-watt fixed resistor.
- T₁—Tube-to-line transformer (Thorndarson T-6226).
- T₂—300- ω , 60-ma. power transformer, with 5- ω , 2-a. and 6.3- ω , 1.2-a. windings (Thorndarson T-7021).
- L₁, L₂—12-henry 60-ma. filter chokes (Thorndarson T-4402).
- L₃—20-henry 50-ma. filter choke (Kenyon KC-200).

audio system everything must be right—from the microphone to the modulation transformer. And in the kilowatt 'phone that represents a

speech amplifier. It is here that distortion, of both the frequency and harmonic type, is often encountered and is most difficult of isolation and analysis. With proper speech amplifier design it is possible to detour many of the worst headaches of 'phone operation.

Perhaps the normal way to design a speech amplifier is to start with the modulator tube

* Assistant Secretary, A.R.R.L.
 1 O. J. Sather, "Resistance-Coupled Input for Carbon Microphones," *QST*, p. 38, August, 1936. Note: The cut labels for Figs. 1 and 3 have been transposed in this article. Reference is to the circuit of Fig. 1, label of Fig. 3.

grids and work back to the microphone, providing enough gain in the fewest possible stages to make the modulation indicator "talk up" nicely. This method is all right for a fixed design where nothing is ever to be changed, but if the urge to try that new microphone won as a door prize at the Big Bend convention becomes overpowering, one is frequently out of luck. Then, too, there may be the desire to put through a little five-meter relay, or even a trifle of music transmission from phonograph records; in all of which cases the average ham speech amplifier is usually just a clumsy makeshift. How much better to provide several input circuits of varying over-all gain, with an adequate mixer circuit, in the beginning. The initial cost may be a little greater—not a whole lot—but the utility and satisfaction will be measurably increased.

Looking at it from the other end of the system, too, it would be much simpler if, when changing

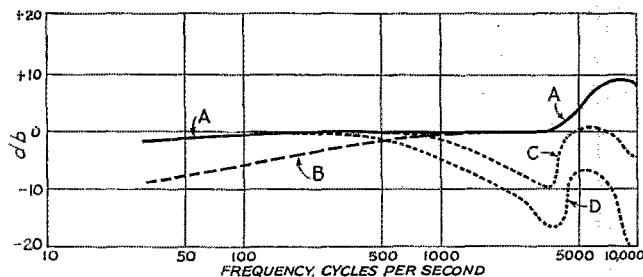

FIG. 2—FREQUENCY CHARACTERISTIC OF THE GENERAL UTILITY SPEECH AMPLIFIER

Curve A (solid line) shows the normal characteristic, control at center, with a high-frequency rise to compensate for microphone and modulator deficiencies.

Curve B (dashed line) results with the control turned all the way to the right, with a 20-henry (rated) choke.

Curve C (dotted line) results with tone control to left, C_6 having a value of 0.006 μ fd.

Curve D (dotted line) is under the same conditions with C_6 having 0.01- μ fd. capacity.

Actual LC values can be chosen for specific applications. The above were selected as the best under average conditions. See text for explanation of response curves.

the modulator system itself or the Class-C input, the same old speech amplifier could be used without change. Yes, there are justifications enough for a speech amplifier unit of general utility suitable for all purposes. Now let us see what the requirements for such an affair might be.

BASIC REQUIREMENTS

Rule No. 1 in designing an audio amplifier is to decide on the output voltage required. The introduction of the 6L6 type of tube greatly simplifies this decision. Since a pair of these tubes will drive almost any modulator system extant, it simply becomes a question of supplying enough stuff to meet their needs. In Class-A or -AB operation, to provide power adequate to drive 200- or 250-watt modulator systems, a pair of 6L6's require a peak grid-voltage swing of from 30 to 40 volts. For higher power operation more grid

swing is required, but then grid current is drawn and an intermediate push-pull amplifier capable of supplying power with good regulation is necessary anyway.

For all practical purposes, then, it can be assumed that 40 volts peak capacity is adequate. This will serve the needs of most other tube combinations, as well; for instance, the common arrangement of a pair of 56's pushing a pair of 45's or 2A3's driving 800's or 203A's (or equivalents) is handled with a great deal of reserve. In the same manner, Class-AB 845's can be handled with an intermediate push-pull triode driving stage.

The starting value of the design is set, therefore, at approximately 40 volts. A 6C5, resistance-coupled, is capable of providing this output with ease, with a gain of approximately 14. Thus the output tube is chosen, for metal-tube operation; in the glass tube series a 56 or 76 would, of course, be substituted, although the stage gain would be lower.

The next step is to decide on the input levels which will most probably be used. Microphone input is the major consideration. So popular in amateur 'phone stations is the crystal microphone that it has become almost standard. The 1937 edition of the A.R.R.L. Handbook gives an output level of 0.005 volt as representative for design purposes with the types of crystal microphones used by amateurs. An over-all gain of 400, in conjunction with the 6C5, will give a basic sensitivity of around 0.005 volt, which is adequate. This gain can be realized by the use of a 6N7 twin triode as a two-stage resistance-coupled amplifier.

This stage—the crystal microphone stage—is indicated as Channel A in Fig. 1. The circuit arrangement is quite orthodox, with the exception of the use of Mallory bias cells and grounded cathode. These cells are the solution to the problem of internal couplings which set up the regeneration so disturbing in many cascaded dual-triode amplifiers of this type. At full gain this amplifier is entirely stable. The bias cells also reduce hum level by eliminating any a.c. impedance in the cathode circuit. Direct interconnecting leads between all component parts eliminate the need for shielding beyond the shielded input cable.

Proceeding to Channel B, in the existing amplifier this is intended primarily for use with a condenser microphone. The power supply connections for the head amplifier will be described in conjunction with the power supply. Output from

(Continued on page 30)

HINTS and KINKS for the Experimenter



Overload Protection

FIG. 1 is the diagram of a kink used at W4BZX for a simple, cheap, and quite effective method of overload protection.

The heart of the circuit is relay Ry_2 , which is one of the type originally used with d.c. receivers to turn off the A battery trickle charger and turn on the B battery eliminator automatically when

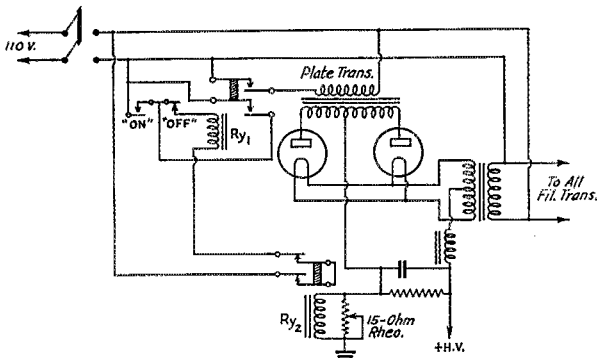

FIG. 1—OVERLOAD PROTECTION WITH PUSH-BUTTON CONTROL

The overload relay, Ry_2 , is a unit taken from an old "AB" eliminator.

the filament circuit in the set was closed, the relay coil being of rather low resistance and connected in series with the filament circuit. The relay is revamped by connecting as shown in the diagram and using only the contacts normally closed. Since the relay will operate on 300 milliamperes, a rheostat of 15 ohms is shunted across the coil to adjust for the desired operating current.

Operation is something like this: The transmitter filaments are lighted by closing the master switch, while relay Ry_1 serves to turn on the high voltage. It is controlled by the "On" and "Off" push buttons, which are located on the operating table and connected to the transmitter by a three-wire cable. The double-pole relay Ry_1 , with a 110-volt a.c. coil, has one of its contacts in the primary circuit of the high voltage transformer, while the other contact serves to lock the relay closed once the momentary-contact "On" push button has been depressed. The high voltage is normally turned off by pressing the "off" button, which is of the closed circuit type, and which, when pressed, breaks the holding circuit of relay Ry_1 .

When an overload occurs, relay Ry_2 operates, instantaneously breaking the holding circuit of relay Ry_1 , and allowing the contacts of Ry_1 to open. To apply the high voltage again, it is only necessary to press the start button, since Ry_2 is normally closed and immediately resets itself when the overload is removed; thus the necessity of having to get up from the operating position to reset the relay on the transmitter (if separated from operating position) is avoided.

The overload protection has really been worth the small trouble it took to install it, particularly so when troubled by "are-overs." The system may be of value to others needing an inexpensive and effective method of overload protection.

—R. D. Lambert, Jr., W4BZX

Suppressor-Grid Keying of Oscillator Tube for Break-In Operation

NO DOUBT one of the simplest ways to achieve break-in operation with a multi-stage transmitter is to key the cathode circuit of the crystal oscillator and bias the following stages to cut-off. Many stations use this system and,

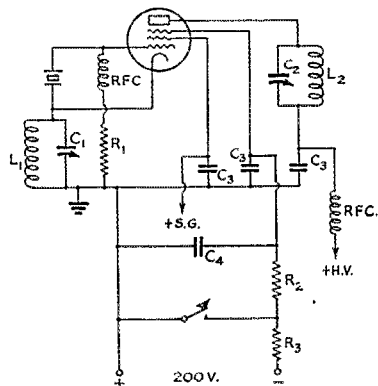

FIG. 2—SUPPRESSOR KEYING OF A TRI-TET OSCILLATOR

C_1 —150-250 μ fd. variable. C_4 —see text.
 C_2 —50-100 μ fd. variable. R_1 —50,000 ohms.
 C_3 —1,005 μ fd. R_2 —see text.
 R_3 —Bleeder resistor, 30,000-50,000 ohms, 2-watt.
 L_1, L_2 —Suitable to tune to desired frequency.

while it does permit break-in operation, it often gives a somewhat chirpy note that isn't much of an improvement over a self-excited oscillator. Even if it doesn't chirp, the thumps and clicks are often difficult to eliminate.

One method of keying that will allow break-in

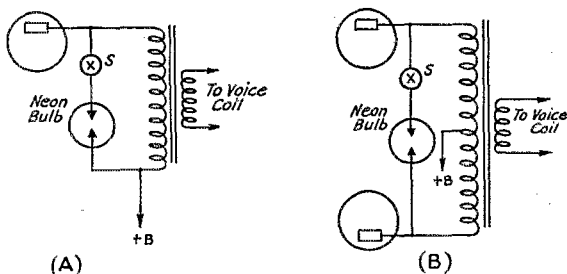

FIG. 3--NEON BULB CIRCUIT FOR REDUCING ELECTRICAL NOISE

operation right up to the frequency of the crystal is that shown in Fig. 2. A Tri-tet oscillator is used, with suppressor-grid keying as outlined previously.¹ Using a blocking voltage of 200 volts or so (which may be obtained from an old receiver power pack, or your present bias supply), perfect cut-off of output is obtained. There is the advantage that, since the crystal is running all of the time, there is no chirp with keying. The receiver will pick up the radiation from the cathode circuit of the oscillator, but ordinarily this will be no stronger than an S8 or S9 signal, when the transmitter is in the same room as the receiver. By shielding the oscillator this signal will be greatly reduced.

R_2 and C_4 constitute a lag circuit that eliminates any thumps. The resistor and condenser can have practically any value, so long as their product (ohms times microfarads) is around 5000. It is not wise to have the value of resistance too high, especially if the suppressor-grid has a positive voltage impressed on it when the key is down, as shown in the article referred to; 5000 or 10,000 ohms is about right.

This circuit has been tried using an RK25 and also an 89. Both gave clean keying with the output circuit tuned to either the crystal or to the second harmonic.

—W1JPE, ex-W6CAL

Neon-Bulb Noise Reducer

A SIMPLE noise reducer that I have found to be very effective in reducing automobile QRM, some QRN, and any noise that is composed

¹ Grammer, A Medium Powered Transmitter for 7, 14, and 28 mc. QST, October, 1936, page 17.

of short pulses that are louder than the signal, is shown in Fig. 3. It consists of a neon bulb, three-watt size or larger, connected in parallel with the primary of the receiver output transformer. Phone stations that were completely covered with automobile QRM without the bulb have been read 100% with it in the circuit. A switch may be put in series with the bulb if desired, but it is not necessary. Smaller bulbs than three watts have not been found satisfactory.

The resistance in the base must be removed, which can be done by unsoldering the wires at the tip and side, and heating the base with a soldering iron until the cement softens so that the base can be taken off. The action of the bulb is such that its resistance is practically infinite until the e.m.f. across it reaches approximately 90 volts. It then discharges, the resistance reducing to practically zero for as long as the current flows. The volume control must be turned up until the signal barely causes the bulb to flash. Any voltage higher than this will then be dissipated in the bulb instead of the speaker. Further advance will only cause distortion.

—W. W. Burnell, W5CZM

Home-Made High-Voltage Fuses

MR. HILL's description of an inexpensive home-made fuse, which appeared in the Experimenters' Section of the June 1935 issue of QST, suggests that the high-voltage fuses used at W7EZL may be of interest. Fuses for use on 5000 volts or more, as well as those for low voltage, may readily be made and calibrated for currents as low as a hundred mils.

Get a sheet of tinfoil from a paper condenser or from the wrapping of a photographic film. The thinner the foil, the better for low current fuses. Some of the foil used in paper condensers is bonded to the paper; this is unsuitable. If the foil has any wax on it, this should be removed with a solvent such as benzol or gasoline. Lay the sheet of tinfoil on a plate of glass and carefully rub out the wrinkles. With a steel scale or straight edge and a razor blade or other sharp knife cut strips a few hundredths of an inch in width. The proper angle at which to hold the razor blade may be found by trial; with a little practice very narrow strips may be cut. One of these strips is then inserted in a quarter inch glass tube and the ends of the strip bent over, as in Fig. 4-A. For a 5000-volt fuse a tube about 4 inches long will suffice. The strip of foil should be about an inch longer than the glass tube.

To complete the fuse, take two end caps from a



FIG. 4

grid leak and attach them as follows: Heat the caps until the low temperature alloy is melted and push the glass tube and its strip into the molten metal as at B. In case no such caps are at hand, they may be made from brass tubing or cast from solder. The low-melting alloy is the same as that used for mounting detector crystals. It is obvious that such fuses may be refilled an indefinite number of times.

The calibration of the fuse is carried out by connecting it in series with an ammeter or milliammeter of suitable scale, a sensitive rheostat, and a battery. As the current is increased, the fuse is watched carefully for any sign of heating. There will always be some narrowest point, and this will heat up first. When a faint red glow is seen, the instrument is read, and this reading is taken as the rating of the fuse. If the rheostat is further reduced in resistance, the current stays at almost this value until the fuse blows. The reason is that the resistance of the fuse increases with temperature so that the voltage drop across the fuse increases slightly thus preventing the current from rising.

All fuses of this type, consisting of a simple wire without de-ionizing devices, are properly used only on alternating current or on unfiltered rectified d.c., such as in the plate circuits of 866's and other high voltage rectifiers. There is a possibility of a continuous arc forming when the fuse is used in a pure d.c. circuit of over 250 volts, as for example, on the output side of a filter, because of lack of quenching of the ions formed when the fuse blows.

A de-ionizing agent such as silicic acid may be put in the tube around the fuse wire if the fuse is to be used on d.c. The writer has never tried out this scheme because there has been no occasion to use fuses on d.c., but the fuses made as described in the preceding paragraphs have given excellent results at W7EZZ and represent a considerable saving when much experimental work is being done.

—E. A. Yunker, W7EZZ

Radiation Characteristics of Horizontal Antennas

(Continued from page 22)

later were based on the assumption of a perfectly-conducting ground. There is no reason to believe that these curves should not be perfectly valid for comparative purposes when the comparisons are made at the same location. However, do not interpret them as meaning that because a particular antenna gets you an R7 report from Siam in one location it will do equally well at another location a couple of miles distant. Our argument is that, given two similar antennas of the same orientation at different locations, the relative effectiveness in different compass directions should be the same.

Energy radiated downward from the antenna strikes the ground and is reflected back into space. If there are no ground losses, all the energy striking the ground is reflected and, depending upon the antenna height, will at certain vertical angles give complete reinforcement of the original space radiation. At other angles complete cancellation will take place. The effect of a perfectly-conducting ground is thus simply to cause the field strength to be increased or decreased at certain vertical angles. Without losses, the maximum increase possible is 100%; in other words, a multiplying factor of 2. The curves of Fig. 2 show the effect of the ground for four different antenna heights expressed in terms of wavelength. It will be seen that as the antenna height is increased the maximum reinforcement comes at progressively lower vertical angles.

We have already stressed the point that the shape of the directive diagram will depend upon the particular vertical angle considered. A little imagination applied to Fig. 1 will show that widely differing diagrams can be obtained simply by choosing high or low vertical angles. It now becomes necessary to include the effect of the ground for, although the *shape* of the diagram is unaffected by ground reflections, the *relative amplitude* can be very largely affected. And in order to obtain significant information, it is necessary to determine which vertical angles are most useful for communication purposes.

THE ALL-IMPORTANT ANGLE OF RADIATION

For long-distance transmission, the most favorable vertical angle is probably the lowest—that is, nearly horizontal radiation is most effective. The reason for this is that the waves leaving the antenna at the lower angles make fewer skips in reaching their destination. The greater the number of reflections between ionosphere and earth, the greater the energy loss because a considerable amount of energy is dissipated in the ground at each "bounce."

Aside from this consideration, the angle of radiation is important from another standpoint. The higher the frequency, the smaller the bending of the waves in the ionosphere, hence waves radiated at high angles may not be bent sufficiently to return to earth. Waves travelling through the ionosphere and out into space are not useful for communication and represent a waste of power. This effect is important at 14 and 28 mc., much less so at 7 mc., and practically negligible at 3.5 mc. As Dr. Kenrick demonstrated in his article in September *QST*,¹ waves radiated directly upwards are returned to earth under nearly all conditions at frequencies up to the 7-mc. region. On 7 mc. and lower, therefore, high-angle radiation is quite effective, although possibly not as

(Continued on page 56)

¹ G. W. Kenrick, "The Kennelly-Heaviside Layer," *QST*, September, 1936.

● I. A. R. U. NEWS ●

Devoted to the interests and activities of the

INTERNATIONAL AMATEUR RADIO UNION

Headquarters Society: THE AMERICAN RADIO RELAY LEAGUE, West Hartford, Conn.

MEMBER SOCIETIES

American Radio Relay League
Associazione Radiotecnica Italiana
Canadian Section A.R.R.L.
Československý Amatérský Vysílač
Deutscher Amateur Sende-und-Empfangs
Dienst
Experimenterende Danske Radioamatører
Irish Radio Transmitters Society
日本アマチュア無線聯盟
Liga Colombiana de Radio Aficionados

Liga Mexicana de Radio Experimentadores
Nederlandse Vereniging voor Internationaal Radioamateurisme
Niederländisch-Indische Vereniging voor
Internationaal Radioamateurisme
New Zealand Association of Radio Transmitters
Norsk Radio Relé Liga
Oesterreichischer Versuchssenderverband
Polski Związek Krotkofalowcow
Radio Club Venezolano

Radio Society of Great Britain
Rede dos Emissores Portugueses
Reseau Belge
Reseau des Emetteurs Français
South African Radio Relay League
Suomen Radioamatööriilitto r.y.
Sveriges Sändareamatörer
Unión de Radioemisores Españoles
Union Schwyz Kurzwellen Amateure
Wireless Institute of Australia

Conducted by Byron H. Goodman

Armistice:

The *Reseau des Emetteurs Francais* invites the radio amateurs of the world to commemorate with them the anniversary of Armistice Day, November 11, 1918. In previous years, it will be recalled, a "silent minute" ceremony was observed. At precisely 1100 GT, every station on the air in France and a number in foreign countries allowed their transmitters to run with full carrier power, unkeyed and unmodulated, for one minute. This impressive observation of the minute of silence traditionally spent in homage for the heroes of the Great War is again to be carried out this year. The R.E.F. requests every amateur to stop transmitting at exactly 1100 GT (0600 EST), holding the key down but not sending code or speaking into the microphone. From thousands of other amateur stations the same ceremony will be observed and from their antennas the "silent carriers" will be transmitted, indicating the silent presence of the amateurs at their posts.

Amateurs in all countries are asked to cooperate with their French comrades in making this gesture, and in uniting with them in thought.—*Jean Lory, F8DS.*

Portugal:

We have just received word from the R.E.P. that all amateur transmitters in Portugal are, until further notice, strictly prohibited from operating by a decree issued by the authorities. Listening is still permitted, but transmitting is absolutely banned unless official authorization is given. There is a possibility that some of the amateur stations will be called upon to aid their government.

Authentic information on conditions in Spain is solicited.

D.A.S.D.:

The headquarters office had the pleasure of a visit from Willi Saunat, D4DGF, and Erwin Hausmann recently. Messrs. Saunat and Hausmann, officials of the German broadcasting system, presented a very favorable picture of amateur activities in Germany.

From another source, D4BUF via W8HD, we hear that the DJDC contest was a big success, with scores running up into the 400,000 mark! One of the top stations contacted more than 70 countries during the event, which is DX no matter how you look at it.

India:

From B. M. Tanna, VU2LK, we learn of radio in India. Until recently, licenses were granted to all who applied for them, with no technical examination or code-speed test. Consequently, amateur conditions in India had not been good, what with the improperly adjusted transmitters and slow speed capabilities of some of the stations. However, several of the more advanced amateurs suggested more stringent regulations, with the result that there is now a code test of 16 words per minute, in conjunction with an examination covering radio theory and law and operating procedure. The new regulations should prove a boon to the VU gang, and should do much to raise the standard of amateur radio in India. Our congratulations to those responsible for bringing about the improved condition.

'Phone WAC:

Remember when a 'phone WAC was one of those things, like a 28-mc. WAC, that you dis-

cussed but never dreamed of owning? Well, the improved conditions on the higher frequencies, coupled with the greatly increased interest in radiotelephony, have made it possible for many of the more advanced stations to obtain the award. Latest additions to the list are Bill Nightingale, G5NI; Ray Ohrbom, VK3OC; John Steventon, W6CLS; H. H. Gosling, HI7G; W. H. Heathcote, ZT6X; A. G. Lapworth, G6DL; F. M. Gray, VK5SU; Juan Lobo y Lobo, XE2N; Charles DeRose, W1CND; M. Koninckx, ON4VK; Henry Harris, W6LLQ; Millard Walker, W5AHK; Frank Speir, KA1AN; and George Sinclair, W6GAL. Sinclair, whose "California kilowatt" consists of push-pull 10's with 120 watts input, made his WAC two months after going on 'phone. He admits, however, that a "V" beam for Europe helped some.

VU7FY started something when he claimed that he and K4SA had the first "all 'phone" 'phone WAC. W5CCB and W6GAL both step forward to vigorously protest his claim, and we presume there are others. So that's settled.

Now that WAC on 'phone is becoming more common, we are having special certificates made up, instead of the former type which merely had the radiotelephony endorsement added. Any one who has a certificate of the old type is welcome to exchange it for one of the new ones.

QSL Bureau:

The address of the Bureau for India should be changed to read: B. M. Tanna, Satya Sadan, Santa Cruz, India. Otherwise the Bureaus as listed last month in this column are believed correct.

WAC:

Several months ago we listed the WAC's as issued to the nine districts of the United States. We now list the other certificates as issued, and leave you to draw your own conclusions. These are as of January 1, 1936:

CE	8	ON4C	1
CM	3	OZ	15
GN8	1	PA	49
CR7	2	PK	7
CR9	1	PY	15
CT	18	SM	17
CT2	2	SP	15
CT3	1	ST	1
CX	12	SU	4 1 'phone
D	68	TI	1
EA	37 1 'phone	VK	90 1 'phone
EI	4	VK7	3
ES	1	VO	1
F	42 1 'phone	VP5	2
FB8	1	VP9	1
G	181 3 'phone	VQ2	2
GI	6 1 'phone	VQ3	1
HAF	13	YQ4	5
HB	14 1 'phone	VS2	1
HC	1	VS3	1
I	5	VS5	1
J	44 1 'phone	VS6	3
KA	11	VS7	3

K4	4	VU	9
K5	2	XE	6
K6	10	XU	19
LA	9	YI	2
LU	7	YL	2
LY	2	YM	1
MX	1	YT	5
OE	15	ZC6	1
OK	37	ZD2	1
OM	3	ZE1	6
ON	56 6 'phone	ZL	53
		ZS	70 2 'phone

And don't forget, those G's use low power!

General:

On Sept. 20th VK3OC worked WAC between 4:40 and 6:10 p.m., just one and one-half hours by



WELL-KNOWN SOUTH AFRICAN AMATEURS ZS1D, ZS6A, AND ZUIT (EXTREME RIGHT), WITH FRIEND

Van of ZUIT seems to be the first African contact of many a hopeful DX man—his card shows up regularly in WAC applications.

the clock John Butcher, G5XG, is studying atmospherics and fading, and would appreciate the cooperation of W 'phone stations. Look on 14,120 kc. at around 2300 BST G. C. Cawood, VS4CS, straightens us out on some prefixes. VS4 is British North Borneo, VS5 is Sarawak, and PK5 is Dutch Borneo From G6NJ we learn that the annual convention of the R.S.G.B. had 181 present at the banquet, a goodly gathering ZL3DJ brings welcome news. If you want a ZL 'phone contact, you will have to get on 28 mc., that being the only DX band on which ZL's are permitted to use 'phone. And it isn't such a rusty band at that, if 3DJ's need of only a European 'phone QSO to have a 28-mc. WAC on both 'phone and c.w. means anything. His contacts with ZS1H and ZT6Y were the first ZL-ZS 'phone contacts If you want a 28-mc. K6 QSO, don't call K6MVB on c.w. He has no b.f.o. on his super. But hc's easy to raise on 'phone, what with that beam pouring in a rocking signal all over the country And don't close down on ten meters too early. W1EWF worked ZL1DV at 8:30 p.m. on that band.



OPERATING NEWS



Conducted by the Communications Department

F. E. Handy, Communications Manager

E. L. Battey, Asst. Communications Manager

ALL MEMBERS of the A.R.R.L. Board's Cairo Committee were present at Chicago at the Central Division Convention in early September. They examined the measures taken by the League in requesting additional low frequency bands for the amateur service including the presentation of our case at the F.C.C. hearings in June, and the subsequent requests of the United States Cairo Preparatory Committee with further written argument which was rejected together with the minority report of the broadcasters, the only other service asking for anything in the low frequency ranges. Our A.R.R.L. Cairo committee members hear it said that to back any one service in requesting an upset of existing low frequency allocation is considered by our government prejudicial to the whole U.S.A. position and unwise for us as well as others.

The League's Cairo committee members received a report on the status of the operating surveys in progress in the 4-mc. and 8-mc. regions to determine commercial occupancy and which information has already played an important part in the League's case for amateur radio. The committee appreciates such amateur volunteer cooperation as it has received in this effort and believes that a sufficient volume of data is now available for Cairo needs and uses in this part of the spectrum. Thanks are extended to all amateurs who have helped.

At this time the members of the A.R.R.L. committee are in agreement that further 4- and 8-mc. surveying may be abandoned, in order that those amateurs who can do so may undertake necessary surveys and studies elsewhere. Not intending to overlook any bets, our Cairo committee now inaugurates a study of the region 21,000-21,900 kcs., which is a third harmonic of our present 7-mc. allocation. It is felt desirable to build up here likewise, specific information and evidence of the extent and character of commercial occupancy to equip our representatives at international conferences with data to use if, as, and when openings occur. As in the other regions it is proposed to find out what stations registered are not using their frequency, and also which stations cannot be heard internationally. The familiar Cairo survey forms used for the past year in other frequency ranges will be extended to this new use by changing the headings. Work in the 21-mc. range will supplant work in the 4 and 8

mc. regions and count for the Cairo survey plaque.

If you can help, brother amateur, ask for our survey forms which will be sent promptly, direct from Headquarters. Any receiver with a beat oscillator that will cover the 21-21.9-mc. range can be used. A card will bring details—or send a radiogram.

Cairo observers buttons are still available for new observers sending in survey logs. Also see the announcement in March *QST* (page 24) concerning the Oakland Radio Club's silver plaque. All work in the survey reported up to March 1, 1937, will count for you toward the plaque award.

— . . . —
The A.R.R.L. SWEEPSTAKES, for many years one of the outstanding operating events of the fall season for W/VE hams is again announced in detail in this issue. It is a thoroughly democratic activity in which any and all amateurs can enter at will just by use of the snappy call, CQ SS. If you have time only for a passing interest in the contest, which will be held two successive week ends this year, a CQ SS will still bring you ample in the way of new QSOs and contacts that may extend to every part of the country and put you a long way on the road to "working all states," one of the most signal achievements.

An educational aspect in the contest this year is the exchange of data in the form of message preambles, which should familiarize new hams with the right way to send such data and the proper way to take down a message, and start neophytes on the road to cultivating superior operating ability and qualifications. Also the information in preambles is all the very essential information needed in carrying on through the contest. Special blank contest forms are available to anyone on request, but such are not required and you can rule your own from information presented elsewhere in this issue. Let us have all your suggestions and comments on the new SS arrangements which have been based on your comments of last year. "See you in the SS."

—F. E. H.

— . . . —
Too late for official consideration, W9RQR, Carter Lake, Iowa, sends his 1935 Sweepstakes report: 115 QSO's in 43 Sections; final score 15,735; all work on 7 mc. with 75 watts input.

The article by Mr. W. H. Barlow, W9UEU, wins C.D. article contest prize this month. Each month we print the most interesting and valuable article received marked "for the C.D. contest." Contributions may be on any phase of amateur operating or communication activity (DX, phone, traffic, rag-chewing, clubs, fraternalism, etc.) which adds constructively to amateur organization work. Prize winners may select a 1936 *Handbook*, six logs, six message files, six pads blanks, or equivalent credit toward other A.R.R.L. supplies. Send your contribution today!

—F. E. H.

What is Radio Operating?

By W. H. Barlow, * W9UEU

A GREAT many beautiful pictures have been painted on the wonderful futures in store in commercial Radio Operating, the positions available, and the opportunities for travel, but little has been said regarding preparation for such positions. There are opportunities in this field, but they are gained *only through training and conscientious effort.*

Anyone who has ordinary mechanical ability should be able to handle the placing of transmitting equipment into operation, but that is far from being all of the operator's responsibilities. Perhaps the most difficult side of the question is keeping the equipment in good operating condition, care and maintenance. One should have good technical operating knowledge, and a good knowledge of radio fundamentals and principles as well as of the practical side. Operating necessitates a knowledge of all working circuits of the equipment used, their most common troubles, and the quickest and most effective ways of making a repair. Speed is essential, which means that one of the qualifications must be alertness.

A good knowledge of the United States regulations regarding the handling of Radio Communications requires diligent study. Without this knowledge, an operator would be treading on dangerous ground, as the penalties which may be imposed are severe, and in some instances involve the suspension of an operator's license.

In connection with operating aboard ship, additional studies relative to the general geography of the world, the cable count, together with land line tariff, are necessary, as well as the ability to manipulate a Morse hand key in the sending of dots and dashes intelligibly, and the ability to handle a small amount of secretarial procedure in the way of abstracting messages and accounts as well as cash received for paid radiograms.

"Would you advise me to study Radio Operating?" is a question often asked. This depends on the individual, and his desire to follow the art to the extent that he will not stop at becoming an operator but go on to something that requires a great deal more knowledge than mere operating, and use the operating vocation as a stepping stone to higher responsibilities. Too many students today perhaps fail to aim high enough in their ideals and ambitions along this line of work, and get into a rut which is in many cases detrimental, not only to themselves but also to the profession. A continual movement to higher standards and to more responsible positions is necessary. As the older executives leave the field, the younger men must be prepared to replace them.

Most of our outstanding engineers today are those who have spent a great deal of their time, and in some cases money, in experimenting with various types of circuits, raising the standards of efficiency. Most of these men have at some time during their radio career performed the duties of an operator on board a ship, at a coastal station, and in some cases in the Navy. A great many have been and still are radio amateurs.

The amount of education naturally plays an important
*500 South Paulina St., Chicago, Ill.

part in probable success in the operating profession. However, a fellow with a high school education or its equivalent can make a success in radio operating provided he will broaden his viewpoint from the study angle, and keep abreast of new developments. This can be done by continued study, and the careful scanning of current radio engineering magazines. Text books cannot be relied upon entirely inasmuch as they are printed only every few years, while the progress of the radio art continues from day to day. The choice of magazines can best be decided upon through the recommendation of a reliable radio engineer.

A student should realize that if he obtains only a limited amount of knowledge from the theoretical and practical standpoint, he cannot expect to step into a station and take charge. But if he receives a thorough technical and practical training with full size commercial transmitting equipment, he will be in a position to handle ordinary operating positions.

The fact that a person holds an operator's license, does not necessarily mean he is a good operator. It merely means he has passed the required examination for such work and can legally operate. Just what success he has will be determined from his general operating qualifications which might be summarized as mechanical ability, technical ability, safety-consciousness, initiative, good personality, punctuality, personal appearance, and willingness to take orders from his superiors.

The art of depending on one's own ability to operate and maintain equipment should be practised as much as possible. There will be times when you are the sole operator, where minutes mean dollars to the owner of the station. You will be called upon to trace a trouble quickly and make a repair. Then comes the real test as to whether you are merely a license holder or an operator. This side of the picture is one that should be considered during the training period. Confidence and self reliance in any particular line of operating is essential for success.

Hard and fast rules applied to the operation of transmitting equipment should not be taken too literally. Deviation from these is often essential because of the effects on radio emissions produced by atmospheric conditions, geographical locations, and to some extent the type of circuit involved. Here again we find the necessity for good judgment from the technical and practical standpoint.

I hope the foregoing will serve to guide some who might be anticipating the radio art as a profession.

OBSERVERS' HONOR ROLL

Cairo Commercial Occupancy Survey For September 1936

6000-8000 kcs.		
W8NQ	W4ACC	W9EPK
F8OM	W2CSH	F8EQ
FR194H	W2HAY	W6JLR
W9CHE	W80OW	W9WKO
W. R. Faries	F8NC	
4000-1500 kcs.		
W9EPK	W1HSK	W6JLR

Some time ago Waldo E. Good, a patient (TB) at Koch Hospital in Missouri, wrote A.R.R.L. headquarters that he was interested in getting started in amateur radio but, due to financial difficulties and physical handicaps, was unable to get the necessary equipment. The situation was referred to the Missouri S.C.M., W9CJR. He brought the matter to the attention of the Midwest Division Director, W9EFC, who, in turn, presented the case to his local club, the O.B.P. After investigation the case was found to be a worthy one and O.B.P. Chapter Number 1 in St. Louis gave Mr. Good a new SW3 receiver, complete with 7-mc. coils and power supply and a pair of headphones.

East Coast Hurricane Work

AMATEUR Radio's preparedness and utility in emergencies was demonstrated to a high degree before and during the hurricane which hit the eastern shores of the United States on September 17th and 18th. From the moment that storm warnings were issued along the coasts of the Carolinas, Virginia, Maryland and New Jersey amateur radio operators in all the endangered territory manned their stations and took steps to assure the continuance of communication in the event of disruption of regular channels. Although little need of actual emergency communication developed, amateur radio links were set up and maintained until the crisis was past—amateur radio was ready! Every amateur should realize that amateur radio is the emergency communication resource of the nation and take steps to prepare his station for service, if and when needed.

The Virginia A.A.R.S. Net was active throughout the entire storm period. W3AKN/WLQD and W3DVO of Newport News collected batteries and other emergency power equipment on the 17th in preparation for possible failures in regular supply. W3AKN's heavy activities started at 7 P.M. that evening when contact was established with W3BJX, Winchester, Va. Hourly contacts were scheduled between W3AKN and W3BJX. Between 7:30 and 10:30 P.M., W3AKN worked the following Virginia A.A.R.S.: W3FBA, Richmond; W3ENJ, Norfolk; W3FJ, who arrived in Norfolk from Richmond with a National Guard unit at 8 P.M. He was headed for Virginia Beach, the center of the storm area. W3ENJ, with W3DQB at the key, was located in the National Guard Armory at Norfolk. W3FBA, operated by W3CFL, was located in the 111th Field Artillery Armory, Richmond. Continuous contact was maintained with these stations for routing communications into and out of the storm areas. Several important messages were handled during this time, one being to General Waller, who had established headquarters at the Monticello Hotel, Norfolk, on orders from Governor Peery, and was directing National Guard emergency work from there. Contact with Washington was established from W3AKN with W3EUG and W3BWT. Various U.P. dispatches were handled via W3EUG. With W3FJ set up at Virginia Beach, all-night communication was held between that station and W3ENJ. W3FJ also maintained contact with the Richmond Armory, where his home station was also operating under the W3FJ. Official traffic was handled for the Corps Area Commander, Governor of Virginia and the Adjutant General. W3AMB assisted in the maintenance and operation of W3FJ portable at Virginia Beach. Before signing off for the night of the 17th, W3AKN established contact with A.A.R.S. 3d Corps Area HQ's station W3SN and reported conditions.

Power lines failed in Norfolk during the night and W3ENJ switched to emergency power for contacts with W3FJ. Due to difficulty in reception of signals, W3AKN acted as intermediate station starting about 8:30 on the morning of the 18th. W3EUG was again worked by W3AKN during the 18th and news dispatched each hour. Contact between W3CXL and W3AKN was made at 11:45 A.M., and effort was made to get information on conditions at Forts Monroe and Story. At 1:15 P.M. a message via W3ENJ to Governor Peery from General Waller, advising that conditions were definitely improving, was relayed W3ENJ-W3AKN-W3FBA, with the help of W3BJX. From 2:30 to 5:45 P.M. communication was held steadily by W3AKN with Norfolk, Virginia Beach, Richmond and Washington. By 6 P.M. all danger seemed past and the wind was dropping steadily in velocity, so communications let up. This work so far reported was all on 3.5-mc. c.w. W3BZE operated at W3FJ, Norfolk.

A report from W3EMM, Norfolk, via the Virginia S.C.M. W3UVA, gives the following information: W3KU operated portable at WTAR transmitter plant with W3GDX and W3KU as operators; they had an emergency power supply; operation was on 3.5-mc. 'phone and c.w. and some traffic was handled. W3AEY was on 3.5-mc. c.w. with several operators; they also had battery rig in case of power failure; traffic was handled. W3CEY operated portable in Portsmouth at Va. Elec. & Power Co. sub-station; traffic was handled for the Army and National Guard. W3CHE had his 3.9-mc. 'phone set up in the V.E.P. building in Norfolk; W3GCH was operator there also; traffic was cleared, several

stations worked. Broadcast station WGH had a battery set in the studios (installed by W3DVO) as stand-by in case of emergency. W3ANT, Ft. Monroe, was on handling Army traffic. W3FFY, Portsmouth, was on 3.9-mc. 'phone. W3BEK, Norfolk, was also on 3.9-mc. 'phone. W3GFV, Virginia Beach, was standing by with battery-powered rig. W3MQ, the R. I., was active. W3AUG was also standing by. W3EMM was on 3.5-mc. 'phone and c.w. working local stations and several surrounding points: W4DW, W3CQS, W3FCU, W3BVG, W2KBL, W2HSO, and held 15-hour schedule with W3DCG, Washington, all on 3.9-mc. 'phone. W3BWT, Washington, worked with the Virginia A.A.R.S. Net, and with W4DW, Raleigh, N. C., maintaining regular watches on the frequencies of the Virginia Net, W4DW and the A.A.R.S. special 3497.5-kc. frequency. W3BWT also worked W3CQS with whom a permanent emergency arrangement is held. The North Carolina S.C.M. (W4OG) reports but little QRR work in his state since the storm hit but lightly there.

In Maryland/Delaware W3CQS (Salisbury, Md.), as Acting S.C.M., correlated and directed activities in that area. Upon receiving word that the storm was expected to hit his vicinity he telephoned all the amateurs possible, and sent telegrams to those without phone service, lining them up for emergency work. Definite schedules were made with W3AED at Ocean City, Md., which point would doubtless be hardest hit. W3CQS maintained schedules with W3AED throughout the night of the 17th until midnight, signing off then to resume at 6:00 A.M. on the 18th. The schedules were continued, but there was no sign of the storm arriving before 6:00 P.M., so schedules were dropped until that time, unless something came up beforehand. The storm hit Salisbury about 11:00 A.M. and attempt was made to raise W3AED. W3AED's main power went off at noon and telephone service to Salisbury was out except for one circuit, which had calls waiting for eight hours. W3AED managed to get on with an emergency rig, although both of his masts went down in the wind. W3CQS held schedules all day the 18th with W3SN, Baltimore, Md., until power went off in Salisbury. With regular power gone, W3CQS attempted contacts with his low-power emergency rig operated from a gas-driven generator. W3CQS worked the following during the storm period: W3CRO, W3SN, W3BWT, W3AED, W3EMM, W3AWM, W3ZK, W3EUV. Other amateurs on the job included W3WJ, who assisted at W3AED; W3EUV, Cambridge, Md.; W3EUK, Rehoboth Beach, Del.; W3EPD, Snow Hill, Md. W3VJ, Salisbury, Md., was in charge of the local Naval Reserve Unit and kept steady watch at W3GAE until dismissed by NDK, Norfolk; he was assisted by W3DJU.

The U.S. Naval Communication Reserve in the Naval Districts affected was mobilized for emergency communication duty. Scores of N.C.R. members were on the job keeping their circuits open. One circuit was in operation from Cape May to Point Pleasant along the Atlantic coast. W3QV, A.R.R.L. Atlantic Division Director, personally handled this circuit from 2:00 P.M. until midnight on the 18th; his dinner was served on his operating table so that he would not have to miss a single minute. About 26 stations reported into the circuit and arrangements were also made with several A.A.R.S. stations to give hourly reports. Information was obtained for newspapers and broadcasting stations.

W2CXN, station of the Brooklyn Technical High School, was on the air starting at 8:18 A.M., the 18th, to render whatever aid possible. W2IOP and W2HNS were the operators. Weather reports were collected from the storm area and routine emergency traffic handled. At 11:45 A.M. a QST was copied from W3FZ, Washington, that Army officials in Washington were anxious to establish contact with Norfolk, Va. W2CXN worked W3EFY, Norfolk, and passed the information along, advising of W3FZ' frequency—7152 kc. W3ERA, who was then worked by W2CXN, relayed W3EFY's frequency to W3FZ. W3EFY and W3FZ succeeded in making contact.

Something new in the line of records: VE2JK worked eight YL's in one day: VE2DA, W9TSV, W9UOH, VE2KZ, W1FTJ, W3FXZ, W1FRO and SP1YL.

New O.P.S., Welcome!

THE field organization welcomes 30 new Official 'Phone Station appointees, all received into the ranks since the last roster appeared in *QST*. Quarterly station tests for July, October, January and April are announced for Official 'Phone Stations in the bulletins issued to the A.R.R.L. 'phone organization of O.P.S. in these months. Attention is also called to October *QST* (page 63) wherein a 1936-'37 season O.P.S. Competition is announced. The St. Louis and Kansas City O.B.P. Chapters are offering a beautiful cup trophy (here pictured) to the leading participant and three bronze medallion watch charm awards will also be made to the winners. All operators of good 'phone stations are invited to line up now for O.P.S. and prepare to try for the splendid O.B.P. Trophy. New men joining O.P.S. ranks up to March 1st are welcome to take part. See the rules in October *QST* and get in touch with your S.C.M. today about O.P.S. appointment. Application forms will be sent you on request as well as a sample O.P.S. bulletin from headquarters.

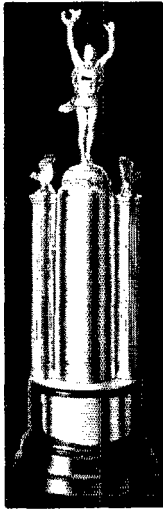

Additions to the O.P.S. group:

W1COI	W2IKV	W6KEK	W8GMI	W9ELL
W1EFC	W3CZS	W6KKL	W8JFC	W9LAW
W2AZX	W3EOP	W6LBK	W8KJV	W9IQZ
W2BJP	W4BM	W6LPE	W8LVW	W9SEA
W2DSB	W4DDB	W6OCH	W8NYY	VE2AB
W2HFB	W4DGU	W6ZI	W8QAN	VE2HT
W2HON	W6EXH	W8FIP	W9AEN	VE3KR

O.R.S. Appointed

FIFTY-SEVEN Official Relay Station appointees have been added to the roster since the last official listings were printed in *QST*. Refer to page 66, October *QST*, for details on the All-Season O.R.S. Contest and the attractive trophy cup offered to the leading participant by the Winston-Salem Amateur Radio Club (W4NC). Bronze medallion watch charm awards will also be made to the leaders. All interested and qualified hams are invited to drop a card to their S.C.M. (address in each issue of *QST*) or direct to A.R.R.L. Hq. for details on O.R.S. appointment, and application blank for same. Take steps now to be eligible for the several activities and plans, competitions, etc., for the coming season. Sample O.R.S. bulletin will also be sent on request.

The new O.R.S. appointees:

W1AFB	W2HON	W3KU	W8CFB	W8PSR
W1HWZ	W2INF	W4CXO	W8CSE	W8QAN
W1IQF	W2IOW	W4DVB	W8DHU	W9AIO
W1JHK	W2ITX	W6JVG	W8FCG	W9FOQ
W1JJL	W2JBL	W6KEK	W8HMH	W9IQZ
W1JPJ	W2JGC	W6KUT	W8HTT	W9KUI
W2AZX	W2JHB	W6LBK	W8LZK	W9MNN
W2BJP	W2LG	W6LOS	W8KXA	W9TKX
W2BLL	W3ETM	W6MHZ	W8KXC	KA1HR
W2GAS	W3FPQ	W6OF	W8LGD-LZT	VE2LC
W2HLI	W3GDI	W7EFR	W8NGC	VE3AGM
	W3GKT		W8OAG	

O.B.S.

The following is a supplement to the list of A.R.R.L. Official Broadcasting Stations in October *QST* (page 122): W3BBV, W4CE, W6AM, W6ITH, W7EYC, W9AUH, W9DUD, CM2WW/CO2WW, VE3KR, VE3NX.

Join the Emergency Corps

A.R.R.L.'S Emergency Corps now has a membership of 374. The A.E.C. is open to all amateurs and every amateur is urged to register in one of the two groups, (1) Emergency Powered Stations, or (2) the Supporting Division. For membership in the first group it is necessary to possess equipment suitable for operation in an emergency when regular power facilities are disrupted. Auxiliary power must be on hand or must be obtainable from a reliable source upon a few minutes' notice. Membership in the Supporting Division is open to all amateurs who will pledge themselves to assist in the event of failure of regular communication facilities as long as normal power is available; these members do not have to have auxiliary power, although all members are urged to join the Emergency Powered group at the earliest opportunity.

To join the A.E.C. simply send a postal to the Communications Department, A.R.R.L. (or write for application blank), listing what equipment you have. Applicants for Emergency-Powered membership should list fully all emergency apparatus, especially auxiliary power facilities. An Emergency Manual now in the course of preparation will contain definite suggestions and rules relative to emergency work; this will be furnished free to all A.E.C. members. Seventy-seven amateurs have signed up in the Corps within the past two months. Send your application NOW!

New A.E.C. Members

Emergency-Powered: W1AMH W1AVP W1BJU W1DNT W1HKK W1JAH W1JEQ W1JHM W1JYJ W1JN W1JUZ W2JYR W2JSL W2JVP W2JKJ W3BBV W3EBC W3ELV W3GAO W4AAR W4BQR W4CAT W4DUA W4RO W5CPV W5EPC W5EYE W5FSS W6CLS W6GCM W6IIF W6JLR W6NXO W6OPD W7DBE W7DIS W7ETG W7EVW W7FWY W8BRC W8ELU W8FNN W8FSK W8JSU W8JZN W8LY W8OQU W8PBQ W8QGW W9EBK W9EJD W9LJP W9PBV W9UUC W9UWQ W9VGN W9VWP W9WTT W9YHD VE4CQ. Time Union Short-wave Club, W2EON (Albany, N. Y.); Helix Amateur Radio Club, W6MGJ, La Mesa, Calif.; Saskatoon Amateur Radio Club, VE4AA, Saskatoon, Sask.

Supporting Division: W1TTF W1JOT W1JYE W2DBQ W2GCC W4ECN W5DAQ W5FDI W7FWB W8LAU W8OAG W8PIX W8PQQ W9WDC.

Copying Bee Winners

AS REPORTED in August *QST* (page 27), six operators tied for first place in the A.R.R.L. 1935 Copying Bee. In view of this an elimination contest was announced for these operators for the evening of August 14th. A new text was prepared and transmitted from W1INF and W2AYN. Three of the original leaders did not enter the elimination test, namely W2DHI; YN1AA; and D. R. Wingate of Leonia, N. J. Those participating were K4KD; K4RJ; and W8BKM. K4KD and K4RJ tied for first place, each making but five errors (apparently due to bad QRM), or a score of 90%. Duplicate awards of the silver loving cup trophy in the 1935 Copying Bee go to these operators! Congratulations, OM's.

The text as transmitted from W1INF and W2AYN: DISCERNIBLE 12VNTH QUADRUPLER ERRATIC NUETRALIZING MULTIPLICITY RST5H5 SKOVVEIEN TETEATETE MBGACYNINLE QUEQUEU TSETSE YTTERBIUM AXMIIF4V BIZARRE INITEATE ZEENO ENTENTE JUEJUTSU TIENTSIN FINDESIECLE ICHTHYOPHAGOUSMOBULATION ONOMATOPOEIA 6F4TH501 DROHOBYCZ LAUTSAAARI YTTRIA PEPWEERMINT METEOROGRAP5S INDIVIDUALIAY PYJAMA ANTEATER TENNESSEI 73MS3H SCHEHERAZADE MISSTRESSSHIP MISIISPWEI ZACATECAS LIGNIN BUBBHAL MILILLHENRI MNEMONIC YWAINEZ CINNIC NNUUJ TOMTHUMD GEOPHYICAL AFFIXED HEREUNTO AE. Speed of transmission was approximately 22.5 w.p.m. Special mention is due W4AUE, an un-official participant in the elimination test, who made but two errors for a rating of 96%. Very FB!

DX Notes

28-mc. has definitely opened up again with reports of good DX coming in from all sides. In preparing for what experts say will be "the best DX season ever," don't overlook 28 mc. There is plenty of room on that band and, when conditions are right, it makes 14-mc. enthusiasts sit up and take notice. Recent 28-mc. reports include a long list of Europeans worked by W3ZJ; Europeans worked by W1ICA and HP, LU, K6 and ZS1H heard; VK4AP worked by W9NY at 4:30 p.m., CST, Sept. 12th, and same date LU's, XE's, VE5's, W6 and W7 and VP5GM heard; also at W9NY, ZS1H and ZE1JJ heard Sept. 13th, and PY5QD heard Sept. 16th, 5:30-6:00 p.m.; W9JZJ is hearing quite a bit of DX on "ten" including VP, XE, G, K6, K5, OA and numerous W4's; heard by W9SPB during September are K5, LU, VK4, VP5, ZE1, XE, D4, OH, ON4, ZS—most of these were worked. Don't pass up 28 mc.!

PA0JMW reports via W9EEZ that he worked 175 W's during the DJDC contest and made a total of 100,404 points. . . . VE3AU has been snagging some good ones: FB8AD (14,280 kc.), T9, Sept. 6th, 7:50 a.m. EST; ZS5Z (14,260), Sept. 6th, 8:50 a.m., T9 and 'phone. ZS5Z reported VE3AU his first VE contact and a contact that made him W.B.E. on 'phone; he asks the W 'phones to look for him in the mornings; PK1JR was worked by VE3AU, Sept. 8th, 8 a.m., 14,330 kc., T9, VQ8AA on Sept. 24th, 8 a.m. (low freq. end 14 mc.), and VQ8AF, Sept. 27th, 6:45 a.m., T9 but wobbly, about 14,070. . . . Some of the real DX 'phones being logged on the U.S. east coast: PK1QU 14,070; PK1MX 14,110; KA1ME 14,135; KA1BH 14,120; ZE1JR 14,270; SU1KG 14,290. . . . W2CYS worked HS4T, Sept. 20th, 5:20 p.m., EST, about 14,430 kc., 500-cycle note; QTH given as Care of Radio HSJ, Bangkok, Siam. . . . W8BBN reports contact with YR5CP, Roumania, about 14,290 kc., Sept. 3rd, 11:35 p.m., EST. . . . W1GNE worked MX1AI on Sept. 17th, 6:20 p.m., EST, about 14,370 kc., chirpy d.c. note; has anyone else worked this one, and any dope on QTH? . . .

W6CUH reports: "Rang up about 92,000 points in the DJDC contest. Worked 105 Europeans in 20 countries for 195 QSO's during the five week-ends; 33 different D's were worked in 16 of the German districts. Central and Eastern Europe are good in the evenings from 0300 to 0600. Mornings find dozens of South Americans rolling through from 1400 to 1630. Europe is also in there around 1600 and peaking again around 2200 GT. Rather new ones worked recently during the evenings include ES2C 14,270 T9, LA2B 14,260 T9, LA3C 14,420 T8, LA5P 14,340 T7, 11ZZ 14,430 T7, U5AT 14,280 T9, YR5AR 14,090 T9, LA6A 14,320 T9, OK3XF 14,290 T6, YR5AT 14,280 T7, U5KS 14,120 T9, SP1CS 14,090 T9, 11LD 14,430 T8, U9MI 14,410 T8, U9AL 14,340 T9, U3DQ 14,260 T6." . . .

W2IQP worked VS2AG (QTH given as Kuala, Kangsar, Perak, F.M.S.) one morning about 10:00 a.m.; frequency-high end of 14 mc. He also worked ZZZZ, 6:55 p.m., Sept. 12th. . . . false? W2IQP reports reception of IITKM, about 14,384, T9X; SU1CH, SU1RO and SU1AC, high-frequency end of 14 mc. . . . October 1st marked the day when WIWV QSO'd his 600th G. 199 have been worked this year (up to that date) and 40 during September. 222 of the 600 have been worked at least twice, and one, G2OL, with whom schedule is kept, 135 times. Practically all QSO's were on 14 mc., a very few on 28 and 7 mc., and two on 3.5 mc. QSL percentage is very high—to October 1st, 473 QSL's had been received from the 600. . . . A group of well-known DX men ganged up at the Chicago Convention: W1FH, W1FNO, W2AIW, W4DEZ, W8CRA, W8BSF, W8PT and W8DWV. . . . W8BKP worked J8CA, August 30th, at 8:10 a.m., and claims it is his 151st country; he lists some frequencies: ZC6CN 14,440; U9MF, U9AC 14,410; VQ4SNB 14,235; FO8AA 14,340; VS7JW 14,300; VS7RF 14,350; PK1PK 14,320; PK1BX 14,305. . . . VK2IG is after W.A.S. He is particularly anxious to QSO North and South Dakota; hams in those states, watch for VK2IG on 14 mc. . . . W9PIL worked 11KG on 14-mc. 'phone, Sept. 1st, 11:05 p.m.; frequency about 14,500. . . . W6JMR writes, "One fellow on 14 mc. who deserves commendation is ZT6Q, who steals the show as far as South

Africans are concerned; he could be logged practically every night right through the summer, S9 on several occasions and never below S5. He describes his rig as crystal-controlled with four 48's push-pull-parallel final, 32 watts input! DX has been exceptionally good here on 14 mc. with Europeans coming through in droves—and louder than ever. OH3OI is putting in a very consistent signal out here; he is using an RK20 final with about 100 watts input."

DX 'Phone Notes (West Coast), by W6LLQ: Some amateurs have been satisfied with the practice of "flagging down" a c.w. DX contact by the use of c.w. and then shifting to 'phone to complete the desired QSO. This year the 14-mc. band has opened to such an extent that a good consistent two-way 'phone contact can be quite easily established with every continent with a little perseverance and patience. This spring the West Coast 'phone men had plenty of opportunity to get their Europeans as G6LK, G5NI and ON4VK came in regularly night after night on 'phone. All during this summer the elusive Asian contact was available in VS6AQ in Hong Kong and VS2AK in Kaula Lumpur, Malaya—the former being on early Sunday mornings on 14,300 kc. and the latter operating practically every morning between 6 and 8 a.m. P.S.T. on 14,125 kc. The real DX, however, has opened up in the form of regular S6 to S8 reception of ZS1B, Cape Town, South Africa, on 14,110 kc.; ZS2X, Port Elizabeth, South Africa; on 14,100 kc.; and the most remarkable S8 signal of ZE1JR, Salisbury, Southern Rhodesia, on 14,255 kc. These rather rare signals come in at their peak between 7 and 8 a.m. P.S.T., particularly on Saturday and Sunday mornings.

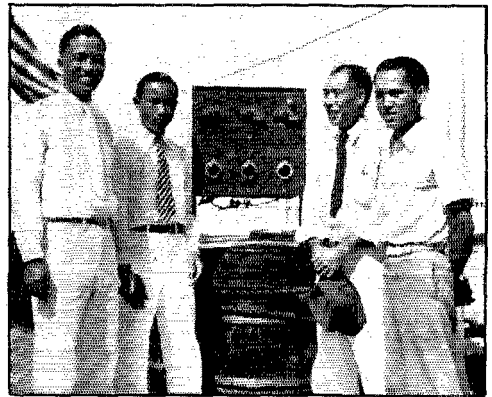

THE RADIO CREW OF THE 1936 JARVIS ISLAND, SOUTH SEA EXPEDITION

Left to right: K6GNW, chief operator of the expedition's station on Jarvis Island; Ah Kin Leong (licensed ham, but no call), member of the expedition; K6GAS, who maintains regular schedules with the expedition from his station in Honolulu; K6INF, assistant operator at K6GAS. The transmitter shown is the 150-watt ham set used at Jarvis Island. The call K6GNW will be used in the 7- and 14-mc. bands; 7114 kc. will be the principal frequency, doubling to 14,228 kc. on 14 mc. The expedition is under the auspices of the Departments of Interior and Commerce (Airways Division). A Navy frequency and call will be announced later. K6GAS uses 14,224 kc. for his schedules. Watch for K6GNW and please report all reception and contacts to A.R.R.L.

Additional DX Awards

The North Carolina 1936 DX Contest winner, undecided when the report was printed in September QST, is W4AH with 31,185 points. Additions to the list of club winners: W2DC, Schenectady Amateur Radio Association; W3FKK, The Tri-County Radio Association, Inc., of Plainfield, N. J.; W8CBI, Dayton (Ohio) Amateur Radio Association; W9BEZ, Wichita (Kansas) Amateur Radio Club; VE2EE, Montreal Amateur Radio Club.

Wanted—Stations to Send Code Practice

The A.R.R.L.'s program of code practice on the 1715-ke. band is being revised for the 1936-37 season. Many new stations are needed to carry on this work. With the increase of the code speed requirement to 13 w.p.m. beginners will find the code practice program of even greater assistance than in the past. Any amateur working in the 1715-ke. band wishing to volunteer regular schedules of code practice is invited to drop a card to A.R.R.L. Headquarters. Please state the days and hours you would like to send code lessons, and list your exact frequency. Stations engaged in the work last season are requested to send in their new schedules. The schedules of all Code Practice Stations will be printed in QST. Helpful hints on sending code practice are furnished to all volunteers. What say, OM, will you help the newcomers master the code?

Code Practice Volunteers

W6HUX, Los Angeles; W8MFV, Vandalia, Ohio; and W9YEO, Milwaukee, Wis., are the first '36-'37 season volunteers in the A.R.R.L. 1715-ke. Code Practice Program. Their schedules of transmission are: W6HUX, 1960 kc., Mondays and Fridays except holidays, etc., 7:30 to 8:30 p.m., PST; announcements by voice. W8MFV, 1936 kc., Monday to Friday, inc., 6:30 to 7:30 p.m. EST; 500 watts on 150T's. W9YEO, 1936 kc., Mondays, 6:30 to 7:15 p.m. CST; Kleinschmidt perforator, Boehme transmitting head. It is expected that W1DAV, Hartford, Conn., will conduct code lessons in the 1715-ke. band daily at 11:00 p.m. W6IXZ, San Francisco, is also arranging a schedule. Schedules of additional volunteers will be announced as received. W1HXE, Lawrence, Mass., sends code practice on 56.2 mc. daily from 7:00 to 7:30 p.m. EST. W4DNA, St. Petersburg, Fla., announces a schedule of code practice on 7208 kc.: Mondays, Wednesdays and Fridays, 6:30 to 7:30 p.m., EST; 15-minute periods at increasing speeds from 3 to 20 w.p.m.

November Hamfests

November 14th: The Finger Lakes Transmitting Society will hold its Ninth Annual Banquet and Hamfest at the Osborne Hotel, Auburn, N. Y., Saturday, November 14th. Registration at 5:00 p.m., banquet promptly at 6:30 p.m.; plenty of good food, entertainment, speakers, contests; special session for N.C.R. members; prizes; a good time assured for all with the well-known hospitality of the F.L.T.S.; price is \$1.50, including everything; all amateurs are invited—as is the custom in F.L.T.S. "blow-outs," the affair will be strictly stag. Send reservations to W. E. Thompson, W8BDV, 39 Mattie Street, Auburn, N. Y.

November 21st: The Arrowhead Radio Amateurs Club of Duluth (Minn.) and vicinity announce a Hamfest for November 21st at the Hotel Arrowhead, Duluth. Registration \$1.25 per person. Well-planned entertainment, banquet and plenty of prizes are promised all who attend. Those amateurs coming from out of the city will find lodging at homes of various local amateurs. Visits to amateur stations will be made on Sunday, the 22d. Every amateur is welcome. If further details are desired, write Roger Krause, W9SIW, 222 West 7 Street, Duluth, Minn.

WCFT—Yacht Yankee

Alan R. Eurich, W8IGQ, sails November 1st from Gloucester, Mass., as radio operator on the ex-pilot schooner of the Dutch government service, now the private yacht *Yankee*, owned by the skipper, Irving Johnson. The equipment on board consists of an M.O.P.A. using an 801 driving four 801's in P.P.P. with an output of 75 watts on the high frequencies. The receiver is expected to be a Sargent model 12, all-wave t.r.f. Power is obtained from the ship's supply, a 50-volt bank of batteries, through a 500-volt dynamotor. WCFT will operate on the following frequencies: 4140, 5520, 6210, 8280, 11,040, 12,420, 16,560 kcs. For working hams in the 7-mc. band 6210 and 8280 will be used, and for work with 14-mc. hams operation will be on 12,420 and 16,560. At present the only scheduled contacts are at 2100 and 0300 GT. After all schedules a CQ will be called and an indication given of the ham band on which to reply.

The *Yankee* will sail to many desirable (from the ham standpoint) DX points, such as Galapagos Is., Easter Is., Pitcairn Is., Tuamotu group, Society Is., Cook Is., Tonga Is., Samoa, Fiji Is., New Hebrides, Solomon Is., Papua, Bali, Singapore, French Guiana. Anyone interested in the latest dope on progress of WCFT may obtain same from G6NJ, K5AA or W8PH. These stations are keeping a constant schedule for the duration of the trip, a year and a half. All cards for WCFT should be sent care of W8IGQ, 4138 Oak Knoll Drive, Youngstown, Ohio. All amateurs, please watch for the yacht *Yankee*, WCFT, and report contacts and reception to A.R.R.L., West Hartford, Conn.

BRASS POUNDERS' LEAGUE

(August 16th-September 15th)

Call	Orig.	Del.	Rel.	Extra Del. Credit	Total
W9VWB	31	8	813	2	854
W5FDR	124	146	386	94	750
W7DUE	10	34	562	34	640
W5CEZ	58	33	402	11	504

MORE-THAN-ONE OPERATOR STATIONS

Call	Orig.	Del.	Rel.	Extra Del. Credit	Total
KALHR	443	314	412	—	1169

These stations "make" the B.P.L. with totals of 500 or over. Many "rate" extra credit for one hundred or more deliveries. The following one-operator stations make the B.P.L. for delivering 100 or more messages; the number of deliveries is as follows: Deliveries count: WIINW, 247 W6TFV, 141 W7APS, 120 KATAN, 104

A.A.R.S. STATIONS

Call	Orig.	Del.	Rel.	Extra Del. Credit	Total
WLML (W3AMR)	11	58	593	52	714

MORE-THAN-ONE OPERATOR STATIONS

Call	Orig.	Del.	Rel.	Extra Del. Credit	Total
WLJ (W5OW)	153	558	490	—	1201

A total of 500 or more, or just 100 or more deliveries will put you in line for a place in the B.P.L.

STATION ACTIVITIES

CANADA MARITIME DIVISION

MARITIME—SCM, A. M. Crowell, VE1DQ—GL, Route Mgr. Bill Horne has the Maritime Net reorganized and ready for the fall work; he is now scheduling VE2DG, and the Trunk Line is working rapidly as far as Ottawa. HH is Net man for P.E.I. GU is going to apply for O.R.S. EC keeps Dartmouth on the map when not QRL the R.C.A.F. HJ is thinking of sending in application for O.R.S. EA is using flea power—single 30 crystal oscillator. CW hits all bands with single 6L6. BZ sports new FB7 preselector; he is working 3.5 and 7 mc. EY has been QRL service work. HX has been busy building new receiver. GB is using 'phone on 3.9 mc. GE spends most of his time on 14 mc. AP works both 3.9- and 14-mc. 'phone. FR sticks to low power. CO is dividing time between 14 and 28 mc. IV is QRL college. EQ is getting out FB with a 250 final. GK is still after bug—Hi! JM/VE3ALK is in Hamilton for the winter months; had his first QSO in the 3rd district—on 56 mc.—and with the R.I. IZ worked his first VK. JF, BV and CB are busy with service work. HK is making the new 35T do its stuff. KB is a newcomer. FV is using a pair of 46's final and has an FB homebuilt super—9 tubes. EX has new YL 2nd op. DU, Bathurst Mines, N.B., has rebuilt the rig to use P.P. '03A's in the final, driven by another '03A. ET has left on his last trip this season—southern cruise—op on R.M.S. *Lady Nelson*. BH, Canso, has been working 'em right and left on 14-mc. 'phone; incidentally this is our most "eastern" station on the mainland. The H.A.R.C. had a booth equipped with full ham station in operation at the N.S. Provincial Exhibition; the station operated duplex 14-mc. 'phone for the instruction and interest of visitors and prospective hams; several late-type ham supers were available for comparison by visiting hams.

Traffic: VE1GL 22 HH 18 GU 10 EC 6 HJ 8 IB 3

ONTARIO DIVISION

ONTARIO—SCM, Jon Perdue, VE3QK—R.M.'s: 3MB, 3SG, 3GT, 3GG, 3TM, 3WX, 3QK. P.A.M.'s: 3NX. Welcome AGM to O.R.S. ranks. NC was visited by YW and CI, and met NX and AEV while visiting VE9CNE. WK is looking for more schedules after carrying one with VE2BU all summer. IR reports after 3-year layoff in which interim he signed at VE5MR, CKMO and SVHP!!! Welcome, ole-timer! AZ busts out and reports. JI hauled off and got himself a YF. Congrats from the gang to Mr. and Mrs. Walker. XY is getting DX cards from S.A. while inoperative. KM rolled up FB score in O.P.S. contest. SG has Klix trouble and is open for suggestions. DU is forced to give up R.M. duties, and are we gonna miss him? Gosh, Dave! QB was visited by LC and DA and has at last gone crystal control. JZ is QSYing to Toronto. HV and MA visited QB. TM resumed T.L. "M" duties. MB saw a lot of the gang at Ottawa Club picnic and is new R.M. in Ontario. UO has QSYed to Cardinal and aspires to O.R.S. post. The Ottawa Club president, 3PL, is still looking for dinosaur bones out west. SR, RK and BY will soon leave for college. DA has been bagging plenty of DX on 14 mc. all summer with his RK-20—George is now a proud Daddy. AFR works DX on 14 mc. with new RK23 tri-tet. VN is looking thru rose-colored glasses at a pair of 50T's. AGG is crowded for time, but has a couple of likely-looking 6L6's around. AGL is the "mystery man" of the Northern Nights Oooohhh! AGM had visit from W8JOO. OD is moving into the Kirkland Lake fold. ABW resumed T.L. "I" duties. VZ schedules ABW nightly and is polishing up his "Mr. X-er." HV will be O.R.S. by this reading. GG is strangely silent. AE wants another All-VE3 contest. AU is doing some more FB DX work on 14 mc. AEM sits and admires his VE3-Contest Trophy and is rarin' to get at traffic again. NX has new 50T and is getting OFN working again. KR is now in Windsor and new O.P.S. RO is considering 50T's and Sewickley, Pa. Swell note from ZU covering Lakehead activities. LY, RA, DX, GB are all on O.F.B. service. FW and GS are on 14-mc. 'phone. AKP is Fort William's newest. AKC, Windsor's. BU is waiting for commercial ticket. 9AL works Mrs. Russell daily at 3AL at Stoney Lake, and in FB style. WX has new rig about finished. Guess that's all for now—and from me, all for an indefinite time. It's hard lines for yours truly to say 73 to such a swell gang—but business pressure and a new QTH totally unsuitable for continuance of my S.C.M. duties combine to wring a swan song for 3QK. Let me, before leaving, shake the hand of "a great team," a Section second to none in A.R.R.L. organized ham radio—so, with a gulp and a tear, fellows, it's "Till We Meet Again"—Gee! But you were reg'lar guys—Tnx, CUL and 73.—Jon.

Traffic: VE3WK 85 AEM 65 AU 36 ABW 34 AZ 21 QB 19 AE 8 SG 6 IR 4.

QUEBEC DIVISION

QUEBEC—SCM, Stan Comach, VE4EE—The fall is upon us; the shades of night fall faster, the old gang are forsaking the great outdoors and polishing up their keys. The position of R.M. has been filled by the "maestro" DG, and schedules are being arranged to box the compass; anyone interested in traffic is asked to get in touch with the R.M. DR is "Alternate" on Trunk Line "I." EC has rebuilt his final to accommodate higher power and is using a single wire-fed antenna in place of the old Zepp. LC is a very competent operator. JK is new W.A.C.; Tommy worked a Japanese for the Asian; congrats. BU assisted in clearing Toronto Exhibition traffic. AP, not satisfied with his rig on 14 mc., is thinking of rebuilding. LJ has at last got his 6L6 exciter unit perking. CR has acquired a new receiver. BB has been negotiating for a new receiver. DA is quite active on the 3.5-mc. 'phone band. CS is making a relay rack job. LV is getting out nicely with the new rig. LC wore out two pairs of pants getting up an antenna for the Field Day tests. HH is enjoying himself on the traffic lanes. ER is keeping active schedule with HH5PA. It is with regrets that we learn that HK is contemplating selling out, lock, stock and barrel. ID is purchasing a new receiver. FQ is interested in 56 mc. After hearing the Super-Gainer at 1Y, IJ went right back to the shack and started tearing his old receiver to pieces. DD is now working in Montreal. HT, AC and AB are

still keeping the Tri-Colour Network moving. IT puts a very FB signal into this location on 3.5-mc. 'phone. FO is considering remote control à la VOII. JI is building a Super-het with all the trimmings. EW is selling out to modernize his station. FK is putting his 'phone across the pond in good shape. LM has a nice signal on 3.5 mc.; how about being the first YL on 14 mc.? JJ is thinking of purchasing an ACR-175. BE, GA and BG have been scheduling VPPNA. GO was one of the Montreal representatives at the Ottawa picnic. BO has been modernizing his receiving equipment. IO used Payette's whole stock of stand-off insulators on the new transmitter; the actual count is fifty-four. Hi. KY is getting more than his share of DX. AX has been heard working the Aussies consistently. LP has purchased a 6L6. We are pleased to hear IR with us again; Corey has almost completely recovered from his accident. The Montreal Radio Club is in session again, meetings every third Thursday. Abner-Kingman 28, Y.M.C.A.

Traffic: VE2HH 20 BU 65 DC 21 EC 10 LC 99 DR 20 JK 16.

VANALTA DIVISION

ALBERTA—SCM, Alfred D. Kettenbach, VE4LX—Our new R.M. is GE, replacing BZ, who will be QRL this season. EO is now using remote control. JP visited GM and LX. RY visited EA. AA is QRL with railroad. HM attended the Vancouver hamfest. BW and GM buried the hatchet for three days. GD is still fishing. OF reports FB times hunting ducks this fall. OJ is back on 3.9-mc. 'phone. CY is a finished photographer. LA is getting out FB. SW's XYL is making speedy recovery. SN wants cannon lillies. JJ cured his motor boat. OD and DV keep Calgary active evenings. HQ is QRL touring the Province. ZD sounds FB. LQ will grid modulate 1.75-mc. 'phone rig on low power. WX is new traffic hound. Congrats to GE on W.A.C. HM is rebuilding exciter. GM is QRL fixing up the shack to keep out the wintry blasts.

Traffic: VE4LX 31 EO 10 GE 8 QK 7 WX 2.

PRAIRIE DIVISION

MANITOBA—SCM, A.J.R. Simpson, VE4BG—VG reports some traffic and has schedules working with MH, Biggar, Sask. Trunk Line activities will this season be looked after by GC, who is an old-timer at this job, AG having decided to take a rest this coming winter after a very FB job on the Winnipeg end for the last two seasons. AE is moving to a new QTH and has sold his copper pipe vertical. BQ is back in Winnipeg to stay after putting in a few seasons up North operating for the Airways. DU is moving to a new QTH in the west end of Winnipeg. EK keeps busy on 14-mc. 'phone band and finds the RK-20's do their stuff. GC has a 50T, which we hear is intended for some 56-mc. work. GL has acquired an XYL and, after a California trip, is heard once again on 14-mc. 'phone. GQ's 14-mc. 'phone sigs are very FB. IC purchased a car. IP finds the 14-mc. 'phone best. IS is heard consistently on 14-mc. c.w. KX is moving to a new QTH. LH has a new super. LL is puzzling over an antenna arrangement at new QTH. MW is building an all-wave receiver. MY has been rebuilding his transmitter into a cabinet job. NI is having good luck working DX with his 14-mc. 'phone. NM shows what can be done with low-power 'phone and c.w. NT has Class B modulated his RK-20's. OK devotes all his time to 56 mc. QA is now running an FB 14-mc. 'phone. QC went on a two weeks fishing and hunting trip in the wilds of western Ontario. QF finds his new antenna FB for DX. QV's 14-mc. 'phone is FB and he is putting up a new vertical. RO is moving to a new location and will have a 90-foot trestle tower for his antenna. TO keeps on 14 mc. with his c.w. rig. UX is going to give 56 mc. a rest and get back on 14 mc. VI is about ready to go with his T250 final. ZK is still acquiring equipment for his new rig. AAH keeps busy on 7 mc. KF just needs five more states for his W.A.S. ABE schedules ZT at Norway House. AEL is new on the air with an 802 final. AAW has a new antenna. AE is building a new modulator. TV up at The Pas sends his regards to the gang and would like to hear from you fellows; he is putting in a new rig with an RK-23 and RK-20. At The Pas we have XT with a 6L6 osc., RK-23 buffer and final. LO has a new rig with an RK-23 final. LI

(Continued on page 84)

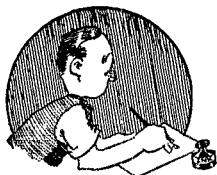

CORRESPONDENCE

The Publishers of QST assume no responsibility for statements made herein by correspondents

Coping with the B.C.L. QRM Problem

2202 Wellington St., Greenville, Texas
Editor, QST:

Looks like the 160-meter 'phones are in for a general calling down, from the F.C.C. on down through the ranks of well-meaning hams. . . .

I believe the larger part of the complaints against the 160-meter 'phones are due as much to the design of the majority of b.c. receivers as to any shortcomings in the 'phone transmitters. The fact that a great many of the b.c. superhets built in the past several years use an i.f. around 450 kc., with the oscillator frequency 450 kc. or so higher than the signal frequency, makes it a matter of simple arithmetic to see that a strong image signal from stations operating between 1800 and 2000 kc. may be expected to show up on the receiver between approximately 900 and 1100 kc., right in the middle of the broadcast band. Naturally the enraged b.c.l. sets up a howl, and it is almost impossible to explain the mysterious ways of the superhet circuit in such a way as to convince him you are not operating in the b.c. band. You come in right on top of his favorite station, therefore you *must* be operating there.

Since it is the nature of the 160-meter band to produce strong signals for a matter of several miles around the transmitter, even when it is one of low power, this "primary" image signal is very strong in all receivers of this design in the vicinity. It is worse, of course, when the receiver employs no pre-selection; but it can be bad enough on those with pre-selection where a fairly large antenna is used or the transmitter has considerable power. In fact, signals from my 30-watt set have been reported from neighboring towns as far as fifteen miles away as coming in "right in the middle of the broadcast band," strong enough to interfere with b.c. reception; and I have been called down by well-meaning fellow hams on this account. I checked this carefully by means of an "old-fashioned" three-stage *tuned r.f.* b.c. receiver (which has been giving me good service for some six or eight years), operating with a 50-foot antenna directly under my transmitting antenna and the gain well up beyond normal b.c. signal requirements, and could find no faint trace of any signal from my transmitter anywhere in the b.c. band except with the gain wide open on the 1500-kc. end. . . . This test convinced me my transmitter was by no means at fault, and there was no actual radiation in the b.c. band.

Of course, the small "cigar-box" midget receivers with one stage of tuned r.f. and non-regenerative detector are quite hopeless against any kind of signal from local transmitters, regardless of frequency. They simply have not enough selectivity to be effective against strong signals, and reception is generally smeared all across the dial when a local station is on, b.c. or amateur. But with the superhet of usual design, a 160-meter 'phone signal will usually show up only as an image signal on one spot on the dial. I don't see just what can be done about it, short of operating on some other band! It is hardly fair to ask an amateur to buy wave-traps for half the receivers in town; and their effectiveness is doubtful, anyway, I think, in this case, as enough 160-meter signal would get into the receiver through the power line to produce a husky image.

I have cut down complaints considerably by choosing an operating frequency that places the image in between our two loudest nearby b.c. stations: WFAA on 800 kc. and KRLD on 1040. Since very few people are likely to be listening to the weaker and more distant stations between those two in the daytime, and I seldom use my transmitter on 160 during the first part of the night, I have kept comparative peace in the neighborhood. Most b.c.l.'s are likely to listen to their local stations, I believe, and perhaps this choice of frequency to avoid interference with the more popular stations in one's vicinity would be helpful. Figuring the b.c. receiver frequency at 450 kc. you can subtract 900 kc. from your operating frequency to see where the image will be on receivers of this type; if it is near one of the b.c. stations popular in your vicinity, perhaps you had better change your frequency. You certainly can't change the i.f. in the receivers!

Now all this is by way of pointing out that a large amount of QRM from 160-meter 'phones is not the fault of the transmitters at all, but is due to the inherent design of possibly the majority of b.c. receivers now in use. I am unable to suggest any remedy except the half-way measure of using a frequency that will not interfere with the reception of the b.c. stations most popular in your town, as mentioned above. Mr. Lydon's suggestion of limiting 160-meter operation to Class A licensees will not help this situation, since QRM from this cause will persist no matter how carefully the transmitter is handled. Of course I am heartily in accord with him in urging that proper operation be insisted on; but speaking for those

transmitters in our part of the country, there are very few that are improperly operated. The majority of the 160-meter 'phones do have good clean signals, in my opinion.

... Of course we should cooperate gladly to avoid b.c.l. QRM; but it looks to me like there is need for a deeper inquiry into the matter before blaming the transmitting amateurs with all the trouble.

—C. F. Butcher, W5AL

On Class A for One Sixty

Montevallo, Ala.

Editor, QST:

After reading the resolution of W8KSY for 160-meter 'phone QRM, I wish to put in my say so. . . I'll admit that the QRM caused by 160-meter 'phone to b.c.l.'s is most serious and surely warrants attention. If we would all do what Mr. Handy said I think most of our troubles would be over. Fellows, the thing we need is to create good will with the b.c.l.'s, and run tests to see if we are causing them QRM by operation in that band. If we are, act at once.

But taking the 160-meter 'phone band from the Class B and C hams would be an injustice and should be done as a last resort. Let us hope the F.C.C. doesn't have to go that far. In the first place, I've heard some rotten sigs coming from Class A. Don't get me wrong; I'm not trying to knock them because all that I know are certainly fine men. I'm just trying to show that a Class A ticket doesn't make one immune from bad sigs. As a rule, I don't expect the new ham would start into 'phone immediately. So he would have some experience, at least.

Another thing. Why does W8KSY give the merits of the 160-meter band and try to entice the Class A to it? He says if it were given to them entirely, they wouldn't have to contend with QRM from new ops. Class A has the privilege of working that band so if it is so desirable, they can surely work it right now.

In my opinion, this is the drawback. He tries to smooth things over by telling how good five and ten meters are. Five is OK for the gang in large cities, but what about the ones in the country? There probably wouldn't be a five-meter station for many miles and the only time that band would be any good would be when conditions were unusual. . . . Even if he managed to work both these bands, he could not have those ragchews with the fellows in the states close by or the other side of his state. These men would be the ones he might be able to meet personally and therefore he would enjoy working them more than others. We all need the privilege of having a 'phone band for medium and short distances, also one that is reliable. One sixty is just the thing and should be open to everyone. I hope we can keep it that way. . . .

—Clay Griffin, W4DXI

188 Linden Boulevard, Brooklyn, N. Y.

Editor, QST:

... I agree with Mr. Lydon that transferring 'phone operation by Class B operators from 160 meters to the 5, 10 and other ultra-high frequency bands will greatly reduce the present interference to broadcast listeners. In view of the recent comments by the F.C.C. in this connection, namely, that 69.59 per cent of radiophone interference cases were due to operation in the 1800-2000-kc. band, it is evident that immediate steps should be taken by the League to attempt to eliminate this source of bad public relationship.

From my own experience, almost any 'phone operation on the 160-meter band will cause QRM to adjacent b.c.l.'s, especially in congested areas, unless low power and less than 100 per cent modulation is used. By low power, I mean not more than 50 to 60 watts input to the final stage. By reducing the percentage of modulation this type of interference can be greatly reduced to the neighbors. In fact, from my own observations, it seems that lowering the modulation percentage from 100 per cent to 80 per cent reduced the QRM more than 80 per cent and in many cases eliminated it entirely in adjacent broadcast receivers. Although, these tests were made on the 3900-4000-kc. 'phone band, the

results are applicable as well to the 160-meter 'phone band. . . .

—David Talley, W2PF-WLNA

393 North Main St., Wellsville, N. Y.

Editor, QST:

... The idea of having 160-meter 'phone restricted to Class A operators! Aren't we fellows satisfied with what we have? I think one fellow amateur should cooperate with another. After all, what is loyalty?

W8KSY says in the text of his letter that the 160-meter 'phone band isn't being used right—that all beginners should use 5 and 10 meters until they get enough sense into them and learn how to handle a mike, 'phone etiquette, etc.

Well, let me tell you something. I've listened in on the 20-, 75- and 160-meter 'phone fellows and . . . 75 per cent of the 'abuse, overmodulation, frequency modulation, wobbly signals, and drinking parties heard on the air using vulgar language . . . were from OT's and Class A ops.

It seems to me that some of the OT's with Class A privileges think that after receiving this cherished license they no longer need to respect the regs. If they don't wake up soon, it's going to be too bad.

I have a list here from observers throughout the country with the call letters of such stations as the above, and again I say that 75 per cent are fellows who have been in the game for years and years.

If you will pay a visit to the new hams you will find them using the best of equipment, custom built receivers, etc., and not breadboard jobs as thousands of the OT's will be found using.

So, what say, fellows? Let's not say that the F.C.C. should have to allot all the 'phone bands to Class A, but keep what we have, quit "squabbling" amongst ourselves, and for Heaven's sakes cooperate with each other! . . .

—George J. Pasquale, W8OQU

4911 Farnam St., Omaha, Neb.

Editor, QST:

I heartily agree with all the proposals made by Mr. Robert C. Lydon, W8KSY. I have had his same experiences, and if a ham cannot pass a Class A examination after a year of operating on ten and five he should not be allowed on 'phone at all.

—Thomas P. Leary, W9VTP

10 or 10.7 for C.W.?

North Wales, Pa.

Editor, QST:

... The following incident has happened many, many times last year and already has shown up again last week:

Sunday afternoon on ten: A c.w. man working a c.w. man around 28,250 kc.: "Sorry OM but a high power 'phone carrier just drowned you out, didn't get much of your last transmission. . . ." Now, I am not against 'phone operation. If a chap wishes to get laryngitis shouting "one, two, three, test" that's his business. By a matter of fortune or misfortune the 'phone men are assigned the territory 28-29 mc. But why in thunder must the c.w. man stick to that portion, too, when he has from 29 to 30 mc. for c.w. only, where he can romp around without any interference except from his own "soul brothers"?

Just because the first fellow on ten located at 28,200 kc., must we stay there for years to come? I have as yet to hear an "amateur" signal at 29 mc. The receivers tune down there, crystals or their harmonics will fall down there, and the signals will get out from down there. . . .

Wonder if you could start a campaign amongst the old ten-meter men to get all c.w. men to move down to our rightful territory, 29 to 30 mc., and have a good 1936 winter season. A little fine grinding compound or even good old Pepsodent Toothpaste has enough abrasive in it to grind down the crystal. What say, XE1AY, W6QG, W6BPD, and the 1936 crew? Do we use the band or have it knocked off from the ham allocations?

—John J. Michales, W3FAR

(Continued on page 54)

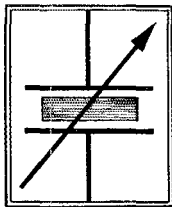

THOSE of our friends whose scientific inclinations have led them to study solar activities, cyclic changes and other phenomena assure us that the conditions for DX in the ten meter band will be even better this Fall than last. Consequently, it seems to be a good time for those of us interested in this band to rebuild our rigs and get ready in advance for an active season.

In our advertisement on the inside back cover of this issue is illustrated our own new ten meter rig. This design was worked out with care, and we think it deserves a better description than we have given it on the cover. The illustration shows the layout pretty well, but does not explain the reasons. A pair of Raytheon RK-36 high-plate-efficiency triodes are used in the output. These tubes are rated at 400 watts output; but considering the ability of these tubes to take punishment, the actual output is more likely to be limited by the operator's conscience than by the rating. They combine high output at ten meters with low price and economy of power supply.

The RK-36's each require 15 watts of driving power. This could be supplied very conveniently by an RK-20, since it is itself easy to drive, requires no neutralizing, and has ample output. However, it was not chosen, for the reason that it is rather expensive. Also it requires a 1000 volt power supply, and for economy it was desirable to use a single power supply. Low tube cost indicated the use of a triode, and after looking over the list of available tubes, the Eimac 35T was chosen. Happily this tube has a μ of 30, making it easy to drive. It operates nicely from a 2000 volt power supply, being of "hard" construction. Its compact size made it fit into the layout well. Compared to other suitable triodes, its inter-electrode capacity is low, making possible the use of the small NC-800 neutralizing condenser.

Although many amateurs favor a tri-tet oscillator, we have always been partial to a triode crystal oscillator with triode doublers (RCA 53's). This system and its advantages have been described so often that details are scarcely necessary here. We have done one unusual thing in this rig, however. Half of one 53 is the oscillator, half of the second 53 is the first doubler. Then back to the first 53 for the second doubler, and then to the second 53 for the third doubler. The reason for this criss-cross connection is that it makes a much better chassis layout, with short leads and easy wiring.

Other details of the rig need but little comment, even though they combine to give up-to-the-minute performance. The variable frequency crystal (affectionately known as the "rubber crystal") provides easy adjustment of the frequency within the band. The new National fixed-tuned exciter tanks with plug-in base are used in the oscillator and doubler, making it easy to shift frequency to 56 MC.

Much as we would like to claim all the credit for the design, we must confess that we owe more than a little to Herb Becker, whose rig suggested many of the features of the design. To 6QD, our thanks. We have added so many ideas of our own, however, that we can call it "our rig" without embarrassment.

JAMES MILLEN



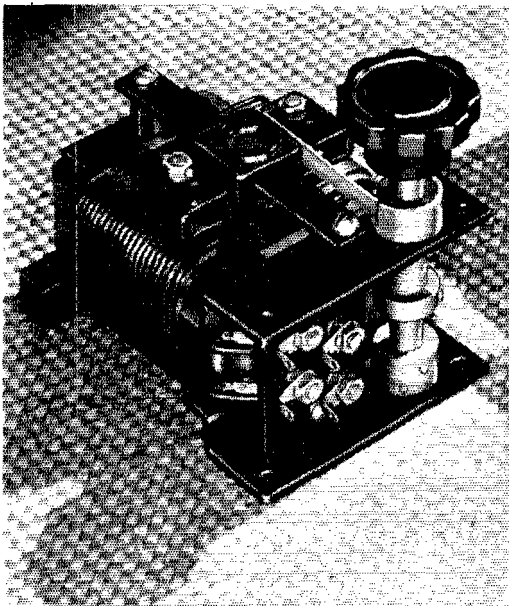

A NEW LINE-VOLTAGE CONTROL

- Maintains Line at 115 Volts
- Less Expensive
- Smaller
- More Convenient to Use

THE Type 70 and Type 80 Variac Transformers are new designs of our continuously adjustable transformers. Wound on a rectangular transformer-type core with a double slider making contact with the top layer of wire on each leg of the core, the new Variac Transformers furnish high-current control over a narrow voltage range.

Two models are especially suited to amateur and experimental use for maintaining the line voltage constant.

Type 70-B supplies a constant output of 115 volts at 2 amperes maximum, when used on line voltages fluctuating between 100 and 125 volts, 50-60 cycles.

Type 80-B supplies a constant output of 115 volts at 7.5 amperes maximum when used on a line fluctuating between 90 and 130 volts, 50-60 cycles.

Type 70-B..\$10.00 Type 80-B..\$15.00

Write for the new VARIAC BULLETIN No. 67-Q for complete data on a large number of models

GENERAL RADIO COMPANY
30 State Street Cambridge, Mass.

Point of View

Editor, *QST*:

Shenandoah, Pa.

I was very much pleased with my August and September issues of *QST*, especially the September issue. I read Mr. Thompson's article on correct speaking, and the thousands of h.c.l. listeners tuning in on the short-wave band may think the amateurs are a very ignorant bunch of fellows.

I read through the September and August issues and liked both issues. When I was reading through them I was thinking what a wonderful hobby amateur radio is. It lets you talk to thousands of amateurs all over the world. Could you tell me how to get listener's cards (QSL's)? I would appreciate it very much.

—Donald Sorber

R9 Plus

(Continued from page 10)

receiver is properly trimmed and adjusted, and that you are using the antenna you intend to employ for reception on that band. If you find a station that puts the meter off scale (R_9 plus) reduce the shunt resistance until the signal is brought to the R_9 position. This setting of the shunt should be checked by tuning across the band from time to time when the receiver is in use, and the shunt readjusted whenever a signal is found that will run the meter off scale. After a few days the proper setting will be found where a good signal (R_9) will run the meter to the end of the scale, but not beyond that point. Of course, if the receiving antenna is changed or the receiver allowed to get out of adjustment, the shunt will have to be re-adjusted, unless the antenna and receiver are placed in their usual condition.

This seems like an ideal system to me, as it compensates for the variation in the sensitivity of different makes of receivers, types and location of receiving antennas, etc., gives you an accurate idea how any signal at that point compares with other signals on the air and assures a fair comparison between signals before and after any change that may be made.

Undoubtedly some flaws can be found in this system, but if we wait for the ideal we may have a long wait, and certainly there is need for immediate improvement in the method now used, i.e., reporting a signal " R_9 plus" if it has enough "sock" to give good audio output from the receiver. Correspondence on this subject is invited, as it may lead to a better method, but meanwhile, let's do the best we can.

Most modern amateur receivers have signal-strength meters already installed, and most of them can stand the "shunt correction" method outlined above. This can be proven by a look over the band, where you will hear "Ur sigs R_{12} on this recvr" or "Ur sigs R_9 plus with meter hard off scale" or "Ur sig knocks needle against pin OM." The resistance used here with this particular layout is about 20 ohms, and when you consider that this is placed across a 1-ma. meter to keep the signals on the scale, it will give you some idea of how far off the usual report may be.

The meter, when used with this method, can be placed in any suitable position, using either the "series" or "bridge" circuit, and after a few days of operation I am sure that almost any operator will ask himself "How did I get along without it?" Let's give it a try!

Taylor

HEAVY



DUTY

Tubes

MORE WATTS PER DOLLAR

in
Audio-FREQUENCY TUBES
as well as
in R.F.

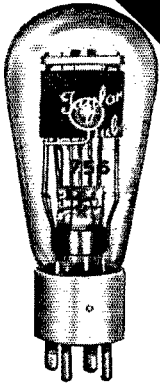

756

100 WATTS
AUDIO OUTPUT
(Per Pair)
in Class "B"

\$4.95 Each

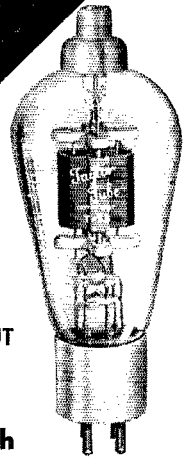

T-55

250 WATTS
AUDIO OUTPUT
(Per Pair)
in Class "B"

\$8.00 Each

Class "B" Audio Characteristics Push Pull Operation

Filament, volts	7.5
Filament Current, amps	2
D.C. Plate Voltage, volts	850
Mutual Conductance, uMhos	1600
Amplification Factor	25
Grid. Voltage, appr. volts	30
Load Resistance (Plt. to Plt.), ohms	6750
Av. D.C. Plate Current (2 tubes), mils	225
Static Plate Current (per tube), mils	10
Power Output (2 tubes), watts	100

Thordarson, Jefferson, United and other leading transformer manufacturers have new Class "B" units available for these Taylor Tubes

Class "B" Audio Characteristics Push Pull Operation

Filament Voltage	7.5
Filament Current, amps	2.0
Mutual Conductance, uMhos	2200
Amp. Factor	20
AT 1000 VOLTS	
Grid. Voltage, appr.	45
Load Resistance (Plt. to Plt.), ohms	10,000
Av. D.C. Plate Current (2 tubes), mils	300
Static Plate Current (per tube), mils, appr.	20
Power Output (2 Tubes)	175 watts
AT 1250 VOLTS	
Grid. Voltage, appr.	67.5
Load Resistance (Plt. to Plt.), ohms	12,000
Av. D.C. Plate Current (2 tubes), mils	250
Static Plate Current (per tube), mils, appr.	20
Power Output (2 Tubes)	250 watts

822

500 WATTS
AUDIO OUTPUT
(Per Pair)
in Class "B"

\$18.50 Each

Class "B" Audio Characteristics Push Pull Operation

Filament, volts	10
Filament Current, amps	4
Mutual Conductance, uMhos	5400
Amplification Factor	27
D.C. Plate Voltage, volts	2000
Grid. Voltage, appr. volts	-90
Load Resistance (Plt. to Plt.), ohms	9000
Av. D.C. Plate Current (2 tubes), mils	450
Static Plate Current (per tube), mils	25
Power Output, (2 Tubes), watts	500

BUY TAYLOR TUBES AND SPEND THE SAVINGS ON OTHER PARTS!

All Leading Radio Parts Distributors Recommend Taylor Tubes

Get your copy of the New Taylor Tubes Combined Catalog and Handbook No. RM from your favorite Distributor or write to us **FREE**

TAYLOR TUBES, INC., 2341-Q Wabansia Ave., CHICAGO, ILLINOIS

Say You Saw It in *QST* — It Identifies You and Helps *QST*

BROWN DEVILS

AS EVEN AS A PICKET FENCE

Don't risk the loss of valuable operating hours searching for a damaged resistor. "Hot spots" develop and resistor failure results when the winding is uneven and crowded together in places. BROWN DEVILS are dependable because the specially developed OHMITE Vitreous Enamel holds each turn of wire firmly in place — during the firing process and in the finished unit. This exclusive feature enables BROWN DEVILS to be wound closer, and thus permit the use of a larger wire for a given resistance value — making these units both electrically and mechanically superior in every way. Made in 10 and 20 watt sizes and all practical resistance values. Ask your dealer or write for Catalog 14 — FREE!

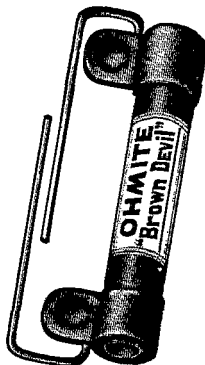

OHMITE

MANUFACTURING COMPANY

4831 Flournoy Street

Chicago, Illinois



HANDBOOK
PAGES
[518-519]
CATALOG
SECTION

OHMITE AMATEUR HANDBOOK

Revised enlarged second edition contains 24 pages of useful data and information on bandswitching, power supplies, modulators, filament control, etc. From your dealer, or sent 10c postpaid.

What the League Is Doing

(Continued from page 27)

advertising circles. We are sorry to lose her, wish her every happiness.

She is succeeded on our staff by Mr. Charles Brunelle, Cornell '36, recently of New York City. Not yet a ham, he is certainly being exposed.

Radiation Characteristics

(Continued from page 41)

desirable as low-angle radiation for long distances.

At 14 mc., however, the picture is different. Investigation has shown that radiation at angles exceeding 35 degrees is seldom returned to earth under normal conditions.² Radiation at all angles from the horizontal up to 30 degrees or slightly higher is useful, the higher angles being particularly effective when the critical frequencies are highest. Normally, however, lower angles are more dependable on this band; as an average, after a search through the available literature for data, we have selected 15 degrees as representing the center of the optimum region.

The radiation angle is still more critical on the 28-mc. band, although we do not know enough about the behavior of "ten" to say what constitutes "normal" conditions—if indeed there is any real normalcy. The same source² places the limit of useful radiation at 9 degrees above the horizontal for reflection from the upper layer, although of course there are many instances of transmission at higher angles than this. It is probable that under present conditions, when we are approaching a sunspot maximum, higher-angle radiation is useful on 28 mc., although the lower angles remain more desirable.

The charts given in this article are of value particularly in gauging the long-distance characteristics of the antenna at 14 and 28 mc. Since high radiation angles are not considered, the patterns are much sharper than the actual directive characteristic of the antenna at 7 and 3.5 mc. Indeed, for these two bands it is reasonable enough to assume that the antenna is practically non-directional except for the 90 degree null points which appear with antennas an even number of half waves in length. Unless otherwise specified, the discussion is assumed to be confined to 20- and 10-meter DX transmission.

The charts have been prepared for four different antenna lengths, four different heights, and for the three radiation angles previously mentioned. It must be kept in mind that these particular angles have no great significance in themselves, but since definite figures must be chosen for purposes of analysis, 9, 15 and 30 degrees have been selected each as representing, so far as can be determined from the available data, typical radiation patterns for optimum 28-mc. transmission, op-

² T. L. Eckersley, "Multiple Signals in Short-Wave Transmission," *Proc. I.R.E.*, January, 1930.

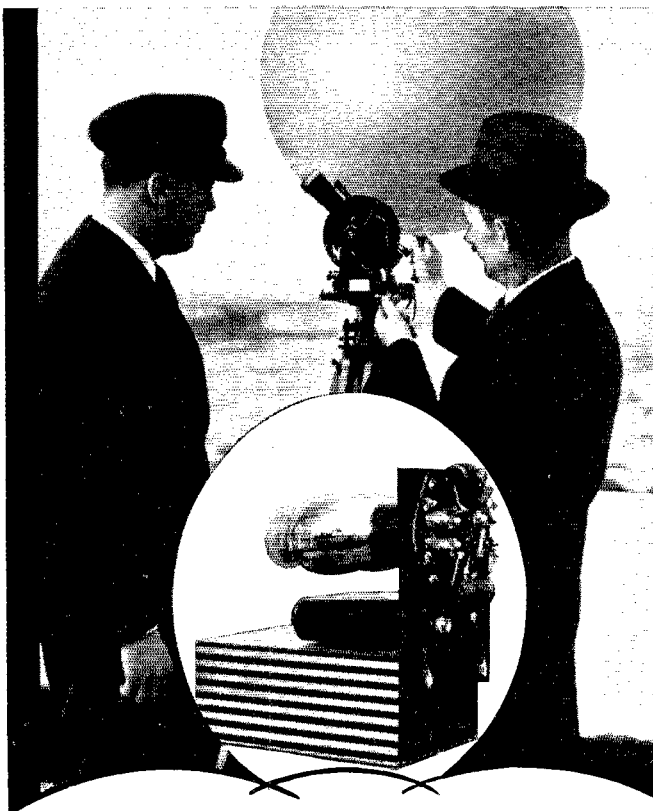

Man Traces the Winds with the Help of **BURGESS PORTABLE POWER**

"— they appear to give the service we require, and as the weight is so favorable we will continue to use them —" So writes Arthur E. Bent of the Harvard University Blue Hill Meteorological Observatory. Here Burgess Batteries are used in balloon transmitters adjusted to five meter wave length. In this remarkable research work, scientists have been able to follow ascents to over 60,000 foot altitudes.

All Burgess Batteries are designed and built to provide reliable portable power. In your radio or experimental work you can command the same consistently dependable battery performance and economy required by the country's leading scientists. Ask for Burgess.

BURGESS BATTERY COMPANY
Freeport, Illinois



BURGESS



SO NOW YOU'RE A
Licensed Amateur
 AND YOU DON'T NEED THE
LICENSE MANUAL?

HERE'S
 SOMETHING
 TO THINK
 ABOUT...

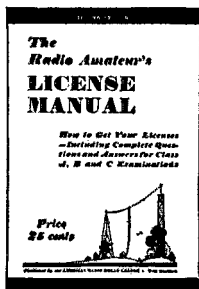

Many amateurs find *The Radio Amateur's License Manual* a useful operating booklet for frequent reference. They keep it on their operating tables. It not only contains the detailed federal regulations governing the operation of an amateur station, but the convenient question-and-answer form provides ready reference to obscure points.

Up to date in every respect. As valuable to the already-licensed as it is to the beginner going after his first ham "ticket."

25 CENTS POSTPAID
 (no stamps, please)

No. 9 in the series entitled
The Radio Amateur's Library

The
**AMERICAN RADIO
 RELAY LEAGUE**

West Hartford
 Connecticut

tinum 14-mc. transmission, and the limit of useful 14-mc. radiation, respectively.

A word about the antennas themselves: A half-wave antenna is a half-wave antenna, regardless of the method of feeding it. Feed systems have nothing to do with this discussion—nor with the results secured from the antenna—providing the feeders do not radiate and providing the power is delivered efficiently to the antenna itself. Therefore, the half-wave charts apply equally well to a Zepp, Q, single-wire feed, doublet, or what you will.

A full-wave antenna is one in which the currents in two halves are in phase opposition. The Zepp is an example. An antenna of the same length fed in the center by the usual method is not a full-wave antenna but two half-waves in phase, and its pattern is entirely different from that of the full-wave antenna. The same applies to a two-wavelength antenna; it cannot be divided into two parts and fed in the center. A 3/2-wave antenna, however, can be fed in the center because the desired phase relationships are not disturbed by this method. Any feeding method which makes the phases of the currents in the various half-wave sections differ from the relations holding in a single, continuous wire of the same length will change the patterns considerably. With antennas a full-wave or more in length end-fed, either directly or through Zepp feeders, is the simplest method of obtaining the desired result.

ANTENNA PERFORMANCE CHARTS

The performance charts are given in Figs. 3-14, inclusive. These have been grouped according to the angle of radiation considered rather than by types of antennas, since this method gives a direct comparison between the several types.

(Continued on page 68)

BRUSH
Headphones

● Meet every headphone requirement. They bring in weak signals strong and clear and will handle excessive volume without overloading. Response 60 to 10,000 cycles. No magnets to cause diaphragm chatter. Specially designed cases minimize breakage. Light in weight. Only 6 oz., complete with headband and cords. A quality product at a low price. Details, Data Sheet No. 10. Copies on request. Send for one.

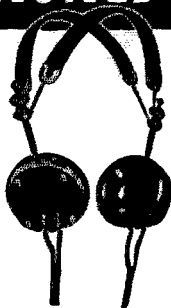

The **BRUSH** DEVELOPMENT COMPANY
 310 E 49th St. PIERCE ELECTRIC CLEVELAND, O.
 MICROPHONES • MIKE STANDS • TWEETERS • HEAD PHONES • LOUD SPEAKERS

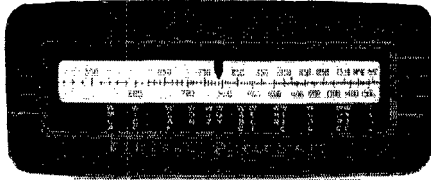

At Last... A RADIO THAT REVOLUTIONIZES
TUNING AUTOMATICALLY ASSURES PERFECT TONE

If you should unknowingly tune-in a station the slightest bit off-tune — and nine out of ten people do — instantly, the new G-E Focused Tone Radio corrects your error and shifts itself into hair-line tuning for perfect reception. Immediately, the new G-E COLORAMA DIAL changes from red to green to tell you "your station is perfectly tuned." The call letters flash on to announce the local station tuned in. This G-E "custom-tailored" PERSONALIZER scale puts an end to hunting up the kilo-



HOW GENERAL ELECTRIC FOCUSED TONE RADIO AUTOMATICALLY AND INSTANTLY SHIFTS ITSELF INTO HAIR-LINE TUNING

cycle numbers of your favorite stations. It's done like magic and just as silently too, for the G-E SILENT TUNING CONTROL silences all noise as you switch from one program to another. G-E Focused Tone combines all the revolutionary new features described above, plus these new General Electric Radio inventions and developments—G-E METAL TUBES, G-E SENTRY BOX, G-E STABILIZED DYNAMIC SPEAKER, G-E SLIDING-RULE TUNING SCALE and G-E "V-doublet" ALL-WAVE ANTENNA SYSTEM.



GENERAL ELECTRIC
AUTOMATICALLY

RADIO GIVES IT TO YOU
VISIBLY . . . INSTANTLY

The new G-E Focused Tone Radio brings you every radio service on the air . . Standard Broadcasts; Foreign Reception; Police Calls; Amateurs; Aviation; Ultra Short-

wave; Experimental Broadcasts. General Electric Radio comes in 31 handsome models, priced from \$22.50 to \$750.00 (Eastern list) - Slightly higher in West and South.

For Metal Tube Renewals, Specify G-E

GENERAL  ELECTRIC

Focused Tone Radio

APPLIANCE AND MERCHANDISE DEPARTMENT,
GENERAL ELECTRIC CO., BRIDGEPORT, CONN.

YOU'LL ALWAYS BE GLAD YOU BOUGHT A G-E

Say You Saw It in QST — It Identifies You and Helps QST

"LEEDS LEADS" in the amateur March of Time

Transmitters developed by Leeds' engineering department. Available to the amateur in kit form or completely built, rack panel construction. The finest of parts used (no surplus equipment) National, Dubilier, Birnbach, Hammarlund, Cardwell, IRC are some of the manufacturers whose parts are used.

LEEDS for Amplifier and Modulation Equipment

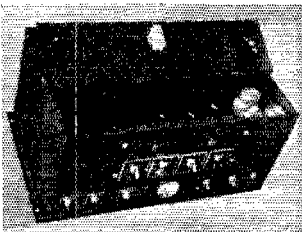

60 watt modulator or amplifier. High fidelity two channel mixer, high and low impedance, etc. Reverse feed-back and fixed bias circuit. 60 watt modulator to modulate 120 watt R.F. load at 675, 2000, 3700, 5000, 8000, 20000 ohms.

Modulator-60 — complete kit. . . . \$59.75

60 watt sound amplifier to voice coil or line — 2, 4, 6, 8, 15, 200 and 500 ohm.

Amplifier-60 — complete kit. . . . \$56.75

With following tubes: 4-6C5, 2-6L6, 2-83V, 1-82 Sylvania (List \$12.80). Net with kit. . . . \$6.00

Wiring and testing either unit. . . . \$8.95

For relay rack mounting, add. . . . \$5.00

Basic essential kit includes LEEDS special 16-gauge chassis and cabinet, 19 x 11 x 10", power transformer, four chokes, two high fidelity transformers in castings, one output transformer with reversed feed-back winding.

Modulator-60-B — basic kit. . . . \$45.00

Amplifier-60-B — basic kit. . . . \$42.50

Modulator 120-MK — 120 watt amplifier, modulator, high fidelity, two channel mixer, high and low impedance. Reversed feed-back, and fixed bias circuit. 120 watt modulator to modulate 240 watt R.F. load at 675, 2000, 5000, 8000, 20000 ohms.

Modulator unit contains power equipment, bias supply, filament supply, 4 modulator tubes, output transformer, input driver transformer, and input push-pull for pre-amplifier. Tube line-up is 2-6B6 triode push-pull drivers, feeding 4-6L6's in push-pull parallel, power supply 3-83V's, and 1-82. Dimensions of unit 10 1/4" panel, chassis 17 x 13 x 3".

Modulator 120-MK — complete kit. . . . \$59.95

120 watt sound amplifier to voice coil or line, 2, 4, 6, 8, 15, 200 and 500 ohm output. In kit form, Type 120-SK. . . . \$59.95

Either type amplifier or modulator, completely built and tested. . . . \$69.95

Type 120-MB or 120-SB (sound) completely built and tested with matched set of Sylvania metal tubes, (list of tubes \$16.40). Net. . . . \$77.39

Pre-amplifier — broadcast quality output to feed into above units. Contains 6F5 and 6C5 tubes, two channel mixer, high and low input impedance, dimensions of unit, panel 5 1/4", chassis 17 x 4 x 2". Shielded input and output plugs used. Type 2-PK in kit form. . . . \$13.95

Completely built and tested, Type 2-PB. . . . \$17.95

Sylvania 6C5 and 6F5 for above. . . . \$4.88

Combination Type 120-MB or 120-SB and pre-amplifier Type 2-PB complete with 12 matched tubes (List \$18.60), completely built and tested. . . . \$95.00

LEEDS Velocity Microphone when purchased with modulator or amplifier equipment. . . . \$13.50

Any of the above units with 2" Triplett bakelite case milliammeter. . . . \$2.94

LEEDS BAND WAGON SPECIALS

Made on chassis with protecting grill. 32 watt high fidelity push-pull 6L6 amplifier, high and low impedance input — 2% distortion. Output impedance 2, 4, 6, 8, 15 v.c. 200 and 500 w. line. . . . \$28.75

Same 32 watt amplifier with modulation transformer (will modulate 64 watt R.F. load) \$31.75

Set of 6 matched Sylvania metal tubes, . . . \$4.49

1 Wright DeCoster No. 1590 — 12" speaker. . . . \$7.80

1 Astatic D-104 microphone. . . . \$13.23

1 Floor stand (adjustable 67") \$3.95

COMPLETE SOUND SYSTEMS

32 watt amplifier, two No. 1590 WDC speakers, Astatic crystal microphone, and 2-20" sound projectors. . . . \$68.95

\$\$\$SPECIAL — 11 watt 6L6 amplifier, high and low impedance input. . . . \$14.50

Set of 4 matched Sylvania metal tubes, . . . \$2.73

Complete 11 watt unit, tubes, Wright DeCoster No. 990 speaker, Bell projector, crystal microphone. . . . \$39.95

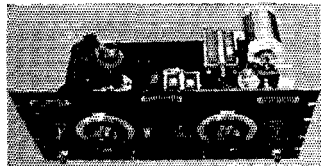

Top 25-TSK Transmitter

Most type 25 to date low power unit, can be used as an exciter unit for higher power transmitters, or as a complete 25 watt transmitter in itself. Contains 59 Tri-tet crystal, electron controlled circuit with complete band switching facilities, the 59 plate circuit feeds into an RK-23 in the final stage which also contains band switching; the circuit switching is designed to control coils, crystal, E. C. tap, and also short circuit the coils not in use. Crystal control, or electron control, by merely flipping the switch. Three crystals can be plugged into this unit, providing complete crystal control from 1500 Kc. to 28 mc. in the amateur spectrum. Electron control can also be utilized to cover the same range. Provisions for suppressor modulation of the RK-23 are provided.

Type 25-TSB Transmitter — Available completely built. \$37.50. Power supply Type 650-PB at \$17.95 is used with the above.

Combination 25-TSBC — Complete with 59, RK-23, and one crystal. . . . \$45.00

Type 25-C — Includes 25-TSBC with tubes and crystal, and Type 650-PB power supply with 83 tube. . . . \$63.40

Power Supply 1250-PBK — Complete in kit form, supplying the following outputs: 1250 V — 200 ma., 600 V — 100 ma., 2.5 V — 3 amps., 6.3 V — 3 amps., 7.5 V — 3 amps., three 5 V windings for four 83 tubes in bridge rectifier circuit. 650-PBK in kit form. . . . \$29.95

Completely built and tested Type 650-PB, \$35.95. With four 83 tubes Sylvania, \$1.60 additional.

Power Supply Type 650-PK — 650 V — 200 ma., 2.5 V — 10 amp., 7.5 V — 3 amps., 6.3 V — 4 amps. Kit form with chassis only. . . . \$13.95

Type 650-PB — completely built and tested. . . . \$17.95

Power Supply 500-PK — Delivers 500 V — 250 ma., 2.5 V — 3 amps., 6.3 V — 3 amps., in kit form with chassis only. . . . \$11.95

Completely built and tested by our Laboratory, Type 500-PB. . . . \$14.50

83 rectifier tube for above power supplies, Sylvania. . . . \$4.40

Rack Panels for 650-PB, 500-PB, \$1.00 additional.

Model X-100 — Adjustable overload relay, can be easily set to open 110 v. input, when plate currents exceed any value from 150 to 500 ma. List \$12. Net. . . . \$8.72

Type 1 Midjet Relay — Operates on 1 dry cell. One contact arm "makes and breaks"; the other closes the circuit when the relay is operated. Special. . . . 29c

Type 2 Relay — Operates between 10 and 150 ma. — DC — single contact arm with "make and break" contact. 350 ohm resistance. Only. . . . \$2.00

Type 3 Relay — 3000 ohm resistance, operates on 1.5 ma DC single contact arm with "make and break" contact is supplied. Ideal for photo electric work. Special. . . . \$3.00

New Junior VIBROPLEX in stock; this new bug key must be seen to be appreciated. Price. . . . \$10.00

Q Max No. 3 R.F. Laquer, 1/4 pint can 25c; pint can \$1.75.

Q Max air drying crystalline black, 1/4 pint can 25c; 1/2 pt. 75c; pt. \$1.25.

Q Max black, air drying, prices as above.

Victron "G" — highest grade insulation known to science today.

Thick 6" x 12" 6" x 6" 1" x 12"

3/16" \$3.60 \$2.00 \$7.75

1/4" 2.50 1.35 .45

1/16" 1.40 .75 .25

Condenser Insulation Strips

3/8" x 3/16" x 12" \$3.35

1/2" x 1/4" x 12" \$6.00

All other Communication Products in stock

Guardian Transmitting Relays

Keying Relay Type K-100 — Works from 5 to 16 v. AC or DC list \$5.50. Net. . . . \$3.24

Model B-100 — Break in relay d.p.d.t. 110 v. AC. List \$7.50. Net. . . . \$4.41

Overload Relays — 250 or 500 mil. List \$7.50. Net. . . . \$4.41



Type 50-TK Transmitter

Fifty watts output from the final push-pull 6L6 stage. The tube line-up is 59 Tri-tet crystal oscillator, latest type quadrupling circuit, link coupling used, fixed neutralization. Panel, 8 3/4", chassis 8". Complete in kit form with one set of. . . . \$23.95

Type 50-TB Transmitter — Wired by our Laboratory. \$31.95. Power supply 500-PB is used with the 50-TB. Additional coils for the 50-TK, \$3.00 per set.

Combination Type 50-TB Transmitter — Crystal and holder, 59 and two 6L6 tubes, Sylvania. . . . \$37.15

Type 50-C — as above, complete with 500-PB power supply and 83 tube. . . . \$51.00

★ LEEDS Leads the Fall Radio Parade ★

BASES and DEMI-BASES



By LEEDS for use with rack panels are now available in a greatly increased variety at lower prices. Crystalline finished units of 20 gauge steel; each base is finished with a bottom cover plate, so that apparatus underneath the chassis may be kept free from dust and at the same time electro statically and electrically shielded.

8 1/2 x 8 x 2	\$.65	10 x 17 x 2	\$1.10
8 1/2 x 10 x 2	.70	10 x 17 x 3	1.30
8 x 17 x 2	.95	12 x 17 x 2	1.30
8 x 17 x 3	1.15	12 x 17 x 3	1.40
4 x 17 x 2		\$.70	

RELAY RACKS

Our Relay Racks are built to stand up under the heavy loads of modern transmitter construction. Uprights are made of 3/16" stock, 1 1/2" wide. Welded angle supports, cross braces and sturdy cross bars insure extreme rigidity. LEEDS Racks unlike some units on the market, are drilled for panel mounting according to Bureau of Standards specifications.

Table Rack Type RAD 3 3/4" panel space high, 20 3/4" wide, 12" deep, with a complete set of drilled and tapped panel mounting holes. **\$5.75**

Shipping weight 30 lbs.

Type RBD rack 6 1/4" panel space high, 20 3/4" wide, 12" deep, with a complete set of panel mounting holes **\$7.45**

Shipping weight 50 lbs.

Brackets—4" high, 5 3/4" deep, 1/2" bend for mounting, pair 25c; 7 1/2" high, 9 1/2" deep, 1/2" bend for mounting, pair 35c

Wet Process 1" Diameter Glazed Porcelain Insulators

7".....25c	12".....35c	20".....50c
Egg-type strain insul, 10 for.....35c		

The record is 100% perfect. Thousands of microfarads of Leeds oil filled Condensers are in use without one case of failure.

1 M F	1000 volt D.C. working	\$1.10
2 M F	1000 volt D.C. working	1.45
1 M F	1500 volt D.C. working	1.45
2 M F	1500 volt D.C. working	1.95
1 M F	2000 volt D.C. working	1.75
2 M F	2000 volt D.C. working	2.45



AEROVOX

Oil Impregnated Condensers

1 mfd.	1000 v.....	\$1.59
2 mfd.	1000 v.....	1.97
4 mfd.	1000 v.....	2.85
1 mfd.	1500 v.....	1.67
2 mfd.	1500 v.....	2.30
1 mfd.	2000 v.....	2.09
2 mfd.	2000 v.....	2.79

Electrolytic and tubular condensers in stock

LEEDS has the most complete line of Antenna Wire found in any shop. Hard and soft drawn wire — enameled copper — tinned copper — tinned wire — any length, at lowest prices.

Rack Panels

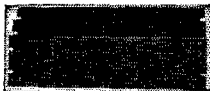

By LEEDS are furnished with black shrivell finish in the standard 19" length, 1/2" thick. Mounting slots are spaced according to Bureau of Standards specifications, insuring freedom from all trouble in mounting or interchanging panels.

Steel	Price	Width	Aluminum	Price
PS-1	\$.52	1 3/4"	PA-1	\$.74
PS-2	.57	3 1/4"	PA-2	1.03
PS-3	.68	5 1/4"	PA-3	1.30
PS-4	.71	7 "	PA-4	1.55
PS-5	.95	8 3/4"	PA-5	1.90
PS-6	1.15	10 1/4"	PA-6	2.45
PS-7	1.30	12 1/4"	PA-7	2.90
PS-8	1.50	14 "	PA-8	3.35
PS-9	1.70	15 3/4"	PA-9	3.70
PS-10	1.90	17 1/4"	PA-10	3.95
PS-11	2.05	19 1/4"	PA-11	4.45
PS-12	2.30	21 "	PA-12	5.20

Brass panel mounting screws 1/4" long 10/24 thread, 15c per dozen.

Masonite Crystalline finish panels, sizes as above, prices slightly lower.

NOISE SILENCER ADAPTERS are a great help on reducing natural static too. LEEDS "QUIET CAN" and "SILENT CAN" also provide freedom from ignition noise and afford an ideal arrangement for push to talk phone and break-in CW.

LEEDS "Quiet Can" for receivers with 2 IF stages; complete with tubes and instruction. **\$7.95**

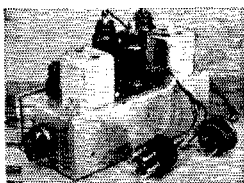

LEEDS "Silent Can" illustrated herewith, for receivers with 1 IF stage; complete with tubes and instructions.

\$9.95

We are Headquarters for the Following

Hammarlund—Mejsner—Alladin—Triplett—Littelfuse—United Transformer—Cornell—Dubilier.

ALL SYLVANIA RECEIVING TUBES at 50% off list price.



LEADS THE FIELD

World Wide Service to Amateurs

45 Vesey Street
New York City

Tel. COlandt 7-2612

Cable Address: "RADLEEDS"

Important Announcement On Our NEW LD-5 Mounted Crystals



These low drift plates, factory sealed in the new LEEDS metal holder are outstanding from the standpoint of stability, accuracy, high output and low cost. Low Drift — 5 cycles per million per degree. Accuracy of calibration — better than .05%.

Orders filled plus or minus two kc. of specified frequency. Last but not least, the price of the mounted crystals, anywhere in the 100-80 and 40 meter bands is only **\$3.50**

Money back guarantee if you are not completely satisfied.

LEEDS type A.L. metal crystal holder, as illustrated above, fits standard 5-prong socket.....89c

Raytheon Transmitting Tubes

RK-10	\$3.50	RK-28	\$38.50
RK-15	4.50	RK-30	10.00
RK-16	4.50	RK-31	10.00
RK-17	4.50	RK-32	12.00
RK-18	10.00	RK-34	3.50
RK-19	7.50	RK-36	14.50
RK-20	15.00	RK-100	7.00
RK-21	5.00	841	3.25
RK-22	7.50	842	3.25
RK-23	4.50	866A	5.00
RK-24	2.25	872A	18.50
RK-25	4.50		

WRITE FOR FOLDER

TAYLOR Custom Built TRANSMITTING TUBES

T55 — 55 watt plate dissipation	\$8.00
T155 — 155 watt plate dissipation	19.50
T200 — 200 watt plate dissipation	21.50
866 Mercury Vapor Rectifying tube, 1.65	
T-20 — ceramic base, 20 watt plate dissipation. Conservatively rated 600 v, 100 mc.	2.45

All other types in stock

NATIONAL NC 100 and NC 100 X

Sold on time at cash prices in Metropolitan area. No down payment.

Liberal allowance on your old set.

We carry the complete NATIONAL line.

Thordarson Neon Transformers, 115 v. primary — 1500 volts at 20 mls. \$1.45

Thordarson Cased Transformer, 600 volts each side of C.T. 200 ma 2 1/2 v. 10 amps. C.T. 5 v. 3 amps. 7 1/2 v. 3 amps. C.T. 2.45

Thordarson Choke, 12 H. 250 ma. . \$1.95

We carry the complete Thordarson line at 40% and 2% from list price.

GENERAL RADIO

Amateur accessories are always in stock.

Here are two handy forms for that multiband xmitter.

Type 677-U — 21 turns, 2 1/4" diameter, resonant on 3.5 mc with 100 mfd. capacity; shipping weight 2 lbs. Price.....50c

Type 677-Y — 30 turns 4" diameter, resonant 1.7 mc with 100 mfd. capacity; shipping weight 3 lbs. Price.....75c

Also 7-pin base to fit above forms at 70c and a matching base with jacks at 65c.

New Low Prices on Johnson Handle Indicators

No. 204 — 1/4" shaft, now	58c
No. 206 — 1/4" shaft, now	73c
No. 210 socket, now	58c
50 watt socket	88c

All other Johnson products, including Type Q antenna system at 40% and 2% off list.

THE ULTIMATE IN SUPER-SENSITIVITY

1. *NO CURRENT DRAW *plus*
2. **SELF-CALIBRATION

MODEL
1250



**DEALER
PRICE
\$33.34**

Vacuum Tube
Voltmeter

*Means Accuracy cannot be affected by the current draw of the instrument itself. No current draw and permanent accuracy of Triplet Vacuum Tube Voltmeter is assured by the self-calibrating bridge circuit used.

**The most important advancement in circuit design for precision electrical measurements recent years.

Laboratories and engineers will immediately use and appreciate the significance of this remarkable instrument. Indispensable also in the servicing field for measuring electrical impulses either A.C. or D.C. of low magnitude such as the carrier wave of signal circuits, and particularly for television work.

The self-calibrating feature is automatic with the tube bridge circuit developed by Triplet Engineers (Pat. Pending). The initial operation of adjusting the bridge at the Zero level insures exact calibration independent of tube emission values or when replacing tubes.

Model 1250 has Triplet Precision Twin instrument and is complete with all necessary accessories including 1-84, 1-6C6, 1-76. Readings in peak A.C. and D.C. voltages. Ranges are 2.5, 10 and 50 volts. Other ranges to order. Case is metal with black wrinkle finish. Panels are silver and black.

THIS IS A TRIPLET MASTER UNIT
See your jobber — write for more information



THE TRIPLET ELECTRICAL INSTRUMENT CO.
2511 Harmon Drive, Bluffton, Ohio

Without obligation please send me complete information on TRIPLET VACUUM TUBE VOLT-METER.

I am also interested in

Name

Address

City.....State.....

(Continued from page 58)

The ordinate at the left represents an arbitrary scale of field strength, while the ordinate at the right is in decibels to give a better idea of the actual change in signal strength under various conditions. Zero level is arbitrarily placed at half scale; this has no significance, and zero db is not to be taken to mean a signal too weak to be useful. As a rough guide, the comparison may be made in "R" points by assuming three to six db per "R". The free-space characteristic in a plane passing through the antenna wire is shown in dotted lines for comparison.

The method of drawing these charts may make them look unfamiliar compared with the usual polar diagrams, but with the system adopted it is possible to show a great deal more in the same space, and show it more accurately. Only 90 of the 360 degrees of compass direction are given since, as already explained, the antenna characteristic is symmetrical. For example, the field strength at a horizontal angle of 45 degrees may be—assuming that the antenna runs north and south—either northeast, southeast, northwest, or southwest. Zero horizontal angle is along the line of the antenna and 90 degrees is at right angles to the wire.

A number of interesting points develop from inspection of these charts. Foremost, it is evident that a half-wave antenna is the only one which has no real null, or direction of zero radiation. The field strength does, however, drop off along the line of the antenna as compared with the value at right angles, the extent of dropping off depending upon the vertical angle considered. At 9 degrees the difference is about 18 db between maximum and minimum, at 15 degrees about 14 db and at 30 degrees only about 8 db. At 14 mc., assuming all other factors to be the same, the difference in the strength of signal put into distant stations broadside to and off the end of the antenna should not be more than two or three R

Why 100,000 Operators

New
GENUINE
MARTIN

Prefer the
VIBROPLEX
SEMI
AUTOMATIC KEY

JUNIOR

Weight 2 3/4 lbs.

ONLY \$10

Smaller and more compact. Large contact points. Black japanned base. A low priced key with world famous vibroplex quality.

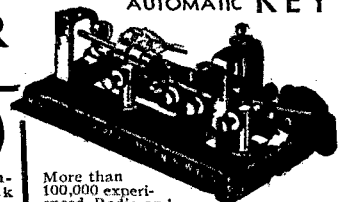

More than 100,000 experienced Radio and Morse operators prefer the Vibroplex key because its semi-automatic style produces a higher quality signal... a more uniform style of sending... 50% easier manipulation and a degree of sending proficiency seldom attained by users of the regulation telegraph key. So if you want the best, be sure to insist on the Genuine Martin Vibroplex key. Accept no substitute. Order yours TO-DAY! Money order or registered mail. Other models \$17 and \$19.

FREE
Catalog

THE VIBROPLEX CO., INC.

832 Broadway New York, N. Y.

The
Martin
Vibroplex

RME - 69

RELAY RACK MODEL,
combining all component parts
in one compact cabinet . . . re-
ceiver, speaker, cords. Satin
aluminum or crinkle black finish
optional.

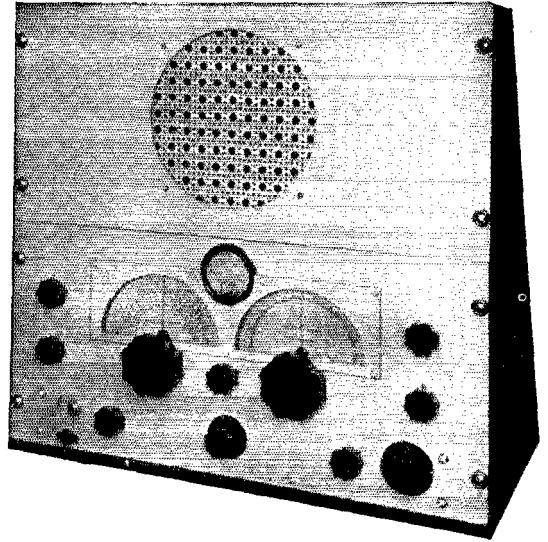

INDIVIDUALIZED

WRITE FOR BULLETIN
NO. 69 and PRICES

The 1937 RME-69 Single Signal Super-receiver, represents the very last word in radio engineering achievement. Outstanding both in appearance and performance, it is truly a precision instrument. Being the product of an engineering laboratory, RME-69 may be ordered equipped with certain accessories for your own special requirements . . . an advantage not obtainable in mass-production instruments. Our Bulletin will tell you what special adapta-

tions may be provided for your individual station layout. And remember . . . *you* must be satisfied.

RME - 69

RADIO MFG. ENGINEERS INC.

306 First Avenue, Peoria, Illinois

Say You Saw It in *QST* — It Identifies You and Helps *QST*

Now—a high-powered—



New!

The Library now comprises a revised selection of books culled from latest McGraw-Hill publications in the radio field.

**RADIO
ENGINEERING
LIBRARY**

— especially selected by radio specialists of McGraw-Hill publications

— to give most complete, dependable coverage of facts needed by all whose fields are grounded on radio fundamentals

— available at a special price and terms

These books cover circuit phenomena, tube theory, networks, measurements, and other subjects— give specialized treatment of all fields of practical design and application. They are books of recognized position in the literature — books you will refer to and be referred to often. If you are a researcher or experimenter — if your interest in radio is deep-set and based on a real desire to go further in this field — you want these books for the help they give in hundreds of problems throughout the whole field of radio engineering.

5 volumes, 3064 pages, 2000 illustrations

1. Glasgow's RADIO ENGINEERING
2. Terman's MEASUREMENTS IN RADIO ENGINEERING
3. Chaffee's THEORY OF THERMIONIC VACUUM TUBES
4. Hund's PHENOMENA IN HIGH-FREQUENCY SYSTEMS
5. Henney's RADIO ENGINEERING HANDBOOK

Special Low Price and Easy Terms

Bought singly, the five volumes comprising this library would cost you \$25.00. Under this offer you save \$1.50 and, in addition, have the privilege of paying in easy installments beginning with \$2.50, 10 days after receipt of the books, and \$3.00 monthly thereafter. Already these books are recognized as standard works that you are bound to require sooner or later. Take advantage of these convenient terms to add them to your library now.

SEND THIS ON-APPROVAL COUPON

McGraw-Hill Book Co., Inc.
330 W. 42nd St., New York, N. Y.

Send me Radio Engineering Library, 5 vols., for 10 days' examination on approval. In 10 days I will send \$2.50, plus few cents postage, and \$3.00 monthly till \$23.50 is paid, or return books postpaid. (We pay postage on orders accompanied by remittance of first installment.)

Name

Address

City and State

Position

Company *QST-11-36*
(Books sent on approval in U. S. and Canada only.)

points. Probably a somewhat greater difference is to be expected at 28 mc.

Antennas two or more half-waves long always show distinct nulls at the angles under consideration. If the wire is an even number of half-waves long, one null always is directly at right-angles to the wire. In the case of a wire an odd number of half-waves long, there is always a maximum point at 90 degrees to the wire. As the antenna length is increased, additional null points appear, always to the number of one less than the number of half-waves in the antenna. As the charts show, the nulls are always "sharp"; that is, only a comparatively small number of degrees in the horizontal plane can be considered to be blotted out. The effective width of the null depends upon a number of factors; for example, if the location and transmitter power are such that consistently R8 reports are received in the direction of maximum radiation, the null obviously will be narrower than if the same antenna is used with lower power and a poorer location so that average reports in the maximum direction are only R5. The stronger signal can stand more "knocking down" before getting lost in noise and QRM.

The third point is that there is a slight increase in field strength in the direction of maximum radiation as the antenna length is increased, assuming the same height in all cases. For example, the full-wave antenna is about 1 db better than the half-wave, the $\frac{3}{2}$ -wave about $1\frac{1}{2}$ db better, and the 2-wave antenna about 2 db better. The difference is not as marked as might be expected from previously published data² because these charts are calculated on the basis of the same power in all antennas, while the data in the reference are based on unit current in the antennas.

² Potter and Goodman, "More on the Practical Operation of Transmitting Antennas," *QST*, April, 1935.

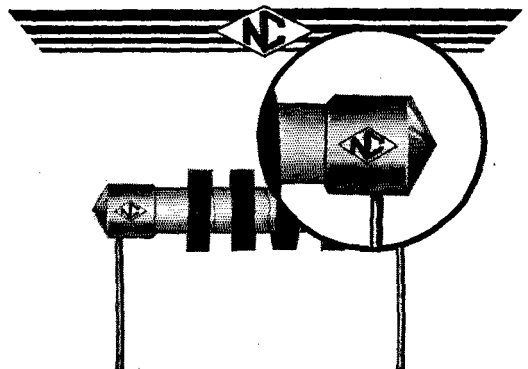

Ever-increasing popularity and consequent production of the National type R-100 Choke has enabled us to immediately reduce the retail price to **\$.36 each**.

Presenting the RCA-807

The RCA-807, a new transmitting tube incorporating the up-to-date beam-power features of the receiving type RCA-6L6, is designed particularly for r-f transmitting applications. To meet the strenuous requirements of r-f power service, the RCA-807 has been provided with: ceramic base, top cap connection for high insulation and low interelectrode capacitances, and improved shielding to minimize the need for neutralization.

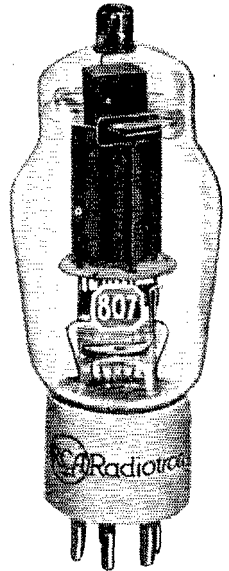

THE TRANSMITTING BEAM POWER TUBE
YOU HAVE BEEN WAITING FOR—
\$3.90 NET



HEATER RATINGS

Voltage 6.3 volts
Current 0.9 amps.

CLASS C TELEGRAPH RATINGS

Plate Voltage . . 400 volts max.
Plate Current . . 100 ma. max.
Plate Dissipation . 21 watts max.

Use the RCA-807 to obtain the best possible performance in r-f applications suggested for the 6L6. It is available at your RCA Transmitting Tube Distributor. For further data see him or write us.



for Amateur Radio

Amateur Radio Section, RCA Manufacturing Co., Inc., Camden, N. J.

A service of the Radio Corporation of America

RH-6 DUPLEX TRANSMITTER-RECEIVER FOR THE HIGH FREQUENCIES

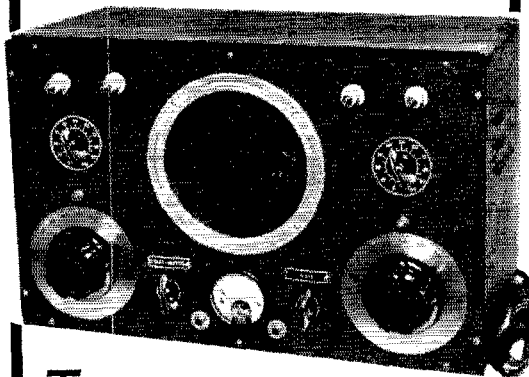

This Rig is RIGHT

You won't want to CHANGE a THING on it

- 6E6 (or RK-34) tube in unusually stable and efficient T.P.T.G. circuit.
- 6L6 fixed bias, beam power modulation.
- A really F. B. receiver, worth the price of the whole job, using the new 6J5G super-regen-detector; a stage of R. F. which does work, and two stage audio with 6L6 output to dynamic speaker.
- 150 mil. plate supply with double filter in same cabinet.
- 150 mil. meter which switches to either oscillator or modulator circuit.
- 15 to 25 watt input with 5 to 10 watt output depending on frequency and antenna used. (More with RK-34.)
- Coils supplied for 1 1/2 to 10 meters on receiver — 5 meters on transmitter (may be shifted to 2 1/2 if desired).

See the RH-6 at your dealers or write us for complete literature on it

RH-6 Duplex complete in hinged-top cabinet, size, 18" x 10" x 8" (Less tubes) only..... **\$35.75**

Kit of six specially picked Sylvania tubes 1-6L6, 1-6E6, 2-6J5G, 1-6D6, 1-5Z3..... **\$5.10**

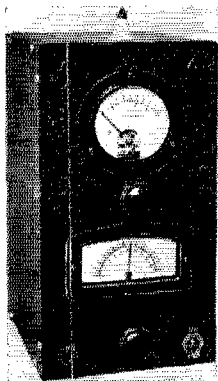

HAYNES RIGCHECKER

Hams all over the world are telling us that these two instruments are the biggest values in radio today. Your station is not complete without one. Circular and instructions for using sent free on request.

BIG
RIGCHECKER **\$17.90**
LITTLE
RIGCHECKER **\$9.85**

RADIO CONSTRUCTORS LABORATORIES
Dept. Q-4 136 LIBERTY ST., NEW YORK, N. Y.

HEIGHT

Because the action of any particular piece of ground is unpredictable, the improvements indicated on the charts as resulting from increasing the height are to be regarded with caution. The curves represent an ideal case which cannot be realized in practice. For example, the maximum multiplying factor of 2 cannot be obtained simply because some of the energy in the wave striking the earth is consumed in ground losses; therefore all of it cannot be reflected as the theory assumes. The extent of the loss will depend upon the characteristics of the soil; probably it is higher over rocky, sandy soil than over naturally moist soil. Likewise, the actual height in any case is open to question, since it may be necessary to go considerably below the surface before reflection occurs.

Nevertheless, the curves are more or less in accordance with what we have learned from actual experience. For optimum results at 14 mc., a height of about 3/4-wavelength, or about 50 feet, is indicated; the improvement resulting from increasing the height above this figure is slight. As Fig. 2 shows, the value of height as a means of increasing signal strength depends upon the angle of radiation considered. At the lower angles, the relative field strength (as indicated by the multiplying factor) goes up rapidly as the height is increased; at 15 degrees, for example, the field strength should be in the ratio of 2.0 to 0.78 for an antenna a wavelength high as compared with one a quarter-wave high. If we take 50 degrees as representing the average of the most useful angles at 7 and 3.5 mc., however, it is obvious that a height of one-quarter wavelength is practically as effective as a height of a full wavelength. All of which means that everything "breaks" in our favor, because a height of a half-wave is something anybody can get at 14 mc., but is something only a very few can have at 3.5 mc.

It is of interest to note that in the theoretical case there is no radiation at an angle of 30 degrees above the horizon when the antenna is a wavelength high, because the multiplying factor is zero. There is therefore no curve for this condition on the 30-degree charts.

TILTING

Strictly speaking, the charts will apply only to antennas horizontally erected over level ground. If the antenna is higher at one end than the other, the directivity patterns will be altered. The general effect of such tilting is to lower the angle of radiation in the directions toward which the antenna slopes, and to raise it in the other directions. This in turn means a broadening out of the directivity pattern along the line of the slope, and a pulling in in the direction away from the slope. In such case, of course, the patterns are no longer symmetrical in all quadrants. A slight tilt will have relatively little effect with any of the antennas considered except at very low angles, although somewhat better transmission may be expected in the direction of the slope than in the opposite direction.

(Continued on page 68)

A. C. RELAYS

Made by

Allen-Bradley

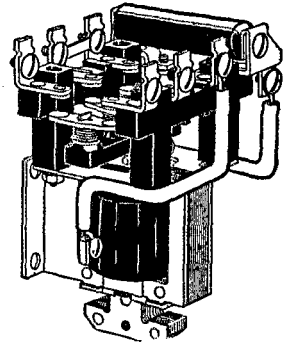
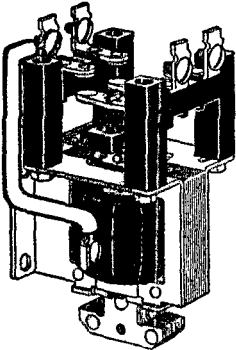

These A. C. solenoid relays are ideal for remote control of transmitters, for control of crystal ovens, and for any general remote control application except for keying. THESE RELAYS WILL NOT OPERATE IN KEYING SERVICE. Silver-to-silver double-break contacts are used throughout.

The maximum contact rating is 10 amp. at 220 v. or 3 amp. at 550 v. The relay coils are wound for 115 volts 60 cycle alternating current. Relays for other voltages can be supplied on special order. Use coupon below.

Type No.	Poles	Nor- mally	Action	Circuit Diagram	Price		Type No.	Poles	Nor- mally	Action	Circuit Diagram	Price	
					Open	In Cab.						Open	In Cab.
A107	1	Open	SP ST		\$3.50	\$4.50	A177	1	Closed	SP ST		\$7.50	\$8.50
A117	1	Closed	SP ST		4.50	5.50	A207	2	Open	DP ST		4.00	5.00
A127	1	Open and Closed	SP DT		5.00	6.00	A217	2	Closed	DP ST		6.00	7.00
A137	1	Open	SP ST		4.00	5.00	A227	2	Open and Closed	DP DT		7.00	8.00
A147	1	Closed	SP ST		5.00	6.00	A237	2	Open	DP ST		4.50	5.50
A157	1	Open and Closed	SP DT		5.50	6.50	A247	2	Closed	DP ST		6.50	7.50
A167	1	Open	SP ST		6.50	7.50						Radiostat —A stepless graphite compression rheostat for primary of 550 watt filament or plate supply transformer. Range 4 to 150 ohms. Price \$6.50	

ORDER BLANK—MAIL WITH REMITTANCE TO

Allen-Bradley Co., 108 W. Greenfield Ave., Milwaukee, Wis.

Enclosed find money order for \$..... for which please send me, shipping charges prepaid, the following items:

..... for..... Volts..... Cycles

Name.....

Address.....

Power...

at Ultra-High and A.F.

300 Watts Class B Audio (Push Pull)
200 Watt Antenna Power at 5 Meters

with the NEW

AMPEREX HF100

\$10

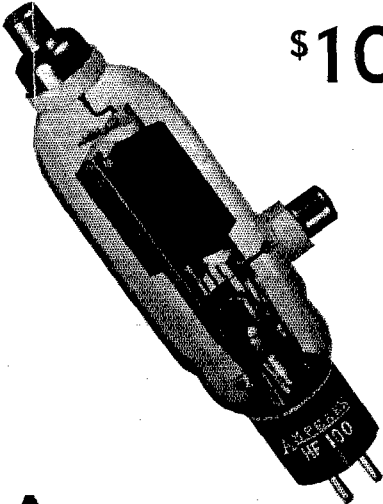

AMPEREX engineers, in designing this HF100, have presented the ham with a remarkable tube that can truly be classed as "all-purpose." For, even though it has produced amazing results in the ultra high frequency field, its range of operation extends into various stages of audio, delivering power outputs which can only be obtained from tubes selling for twice its cost. Its efficiency and versatility makes it the ideal tube for amateur and experimenter.

This HF 100 joins the other Amperex ultra high frequency tubes (HF 200 and HF 300) in that it also possesses the highest ratio of transconductance to interelectrode capacitance yet attained by any tube manufacturer.

CHARACTERISTICS

Filament:	Voltage 10 Volts Current 2 Amps.
Amplification Factor	23
Grid to Plate Transconductance @ 100 ma.	4200
Direct Interelectrode Capacitance:	
Grid to Plate	4.5 μf
Grid to Filament	3.5 μf
Plate to Filament	1.4 μf

Write to our Engineering Department for complete data

AMPEREX

ELECTRONIC PRODUCTS, Inc.
79 WASHINGTON STREET - BROOKLYN, N. Y.

Assuming that the antenna is situated in a fairly clear space, the charts should work out with quite good accuracy insofar as relative results in the horizontal plane are concerned, because the relation between the directions of maximum and minimum radiation are practically unaffected by the ground. However, the particular vertical angle at which a signal is transmitted or received is always indeterminate, so it is but reasonable to expect that the same antenna will show different results from day to day, especially off the ends and near the nulls. As the charts show, it is in these regions that the angle of radiation has the greatest influence on the performance.

Although over a region of a few degrees around the null point the radiation may be negligible, this does not necessarily mean that it is impossible to work stations in this exact direction. It has been found that waves travelling between two points often show minor variations in direction, amounting to as much as five degrees in some cases, so that on occasion the actual null may be masked by this "wandering." In any case, assuming a transmitter of moderate power, the region in which the signal strength is negligible is very small.

Knowledge of what any particular type of antenna can be expected to do in the horizontal plane is the power to get the most effective performance from the antenna. We are bound to point out, however, that there is absolutely no use in guessing at directions. Most amateurs have only the foggiest of notions of the great circle routes to various points on the globe from their particular locations, and when given the actual direction usually are dumbfounded to find that it is not in the least what they expected from looking at the conventional Mercator projection. If you live near Washington or San Francisco, maps which show actual great circle directions to any point are available; if not, the only recourse is to a globe. A "great circle" cut out of cardboard or made of heavy wire, plus a protractor for measuring angles, will give the required information on directions; north, of course, is the direct line between your location and the North Pole. Equally important is getting a true north line for basing the antenna position. This can be done by using a good compass and making the necessary correction for magnetic deviation, or by getting a sight on the North Star. While extreme accuracy is not required, it is surprising how much difference a few degrees along the horizontal may make, especially over a large distance.

The most obvious thing to do is to place the line of maximum radiation in the most desired direction. For DX work, however, this may not always be the most desirable way to do it, because the null points may fall in a direction where we may also want to work. With antennas longer than a half wave, there are always two directions in which the antenna can be run to give a maximum point in the most desired direction; the nulls, however, will fall differently. It is probably

(Continued on page 78)

New

Special Values

INCLUDING SPECIAL BARGAINS OFFERED AT SENSATIONAL LOW PRICES!

Just out... *National NC-100*
... the "Perfected" Super-Het!
Amazingly selective, high sensitivity, low noise level. A wonderful performer. Full coverage, individual built-in plug-in coils, shifted by knob on front panel. 540 to 30,000 KC coverage in 5 ranges. 12 tubes, one stage RF, two IF, P.P. Pentode 10 w. audio output. Full AVC circuit. Built-in power supply. Single and double antenna connections. Latest type crystal filter. "Electric Eye" tuning indicator. Large, latest type *Dynamic Speaker* in cabinet to match.



ONLY \$140.60

(Prices and Terms on NC-100 and Other Sets Listed Below)

	Cash Price	Down Payment	6 Months Payments	9 Months Payments	12 Months Payments
NATIONAL NC-100 complete with tubes and speaker.	\$118.10	\$23.10	\$16.90	\$11.37	\$8.59
NATIONAL NCX-100 complete with tubes, crystal and speaker to match.	\$140.60	\$25.60	\$20.26	\$13.64	\$10.36
NATIONAL HRO JR. with tubes, one set of coils, 10 to 20 meters.	\$99.00	\$24.00	\$13.52	\$9.09	\$6.87
NATIONAL HRO less power supply and speaker.	\$167.70	\$37.70	\$22.78	\$15.35	\$11.69
NATIONAL HRO with power supply.	\$183.00	\$43.60	\$24.46	\$16.51	\$12.57
RGA-AGR-175 complete receiver, speaker separate.	\$119.50	\$24.50	\$16.90	\$11.37	\$8.59
RME-69 complete with tubes, crystal, speaker housed in baffled cabinet.	\$134.90	\$29.90	\$18.58	\$12.50	\$9.47
HAMMARLUND SUPER PRO, complete with tubes, crystal and speaker.	\$241.00	\$51.00	\$32.92	\$22.29	\$16.98

We will have new receivers, as released by manufacturers, on our deferred payment account.

Full details of any set listed, mailed immediately upon request.

RATES AS LOW AS
6%
ON TIME
PAYMENTS!

Oil Filled, Oil Impregnated

FILTER CONDENSERS

All well known makes. Guaranteed at rated voltage. A "lucky" purchase of a 10,000 lot enables us to offer a few remaining items at these low prices. Hurry, before they're all gone!

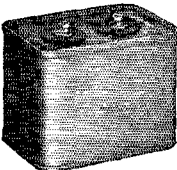

Cap.	Voltage	Size	Weight	Price
1 mfd.	2000 V. DC	5 x 3 1/4 x 1	1 1/2 lbs.	\$1.25
2 mfd.	2000 V. DC	5 1/4 x 3 1/4 x 2 1/4	3 lbs.	1.50
8 mfd.	2000 V. DC	5 1/4 x 3 1/4 x 4	4 lbs.	2.75
9 mfd.	3000 V. DC	5 1/4 x 3 1/4 x 11	9 lbs.	7.25
(including 2 1/2 bakelite stands)				
4.4 mfd.	1500 V. DC	3 x 3 1/4 x 1 1/4	1 1/4 lbs.	1.75
5 mfd.	1500 V. DC	3 1/4 x 3 1/4 x 1 1/4	1 1/4 lbs.	1.90
5.2 mfd.	1500 V. DC	5 x 3 1/4 x 2 1/4	2 1/2 lbs.	2.00
10 mfd.	1500 V. DC	5 x 3 1/4 x 3	2 3/4 lbs.	2.75

Use the 10 mfd. for perfect filtering in class B modulation Power Supply.

Newark Paper Filter Condensers

1 mfd. 1000 V. DC. 49¢
1 mfd. 1500 V. DC. 59¢
Standoff insulators and mounting feet.

Thordarson No. T6877 Heavy Duty Choke. 15 henries at 250 MA. \$1.95

High Voltage Transformer. 1000-750-500-0-500-750-1000-300 MA. 3 1/4 x 4 1/4 x 5 1/2. \$5.95

NEW RAYTHEON TUBES

RK-35.....\$8.00 RK-36.....\$14.50

EIMAC

35T.....\$8.00
50T.....\$13.50
150T.....\$24.50

BLILEY CRYSTALS

BC3.....\$3.95
LD2.....\$4.80
HF2.....\$6.50

Thordarson No. T6878 Plate and Filament Transformer, 600-0-600 V. at 200 MA. 2 1/4 V. at 10 amp., 5 V. at 3 amp., 7 1/2 V. at 3 amp. \$2.45

2 1/2 V. 10 amp. Filament Transformer—2500 V. insulation for 866's.....\$9.95

A Year to Pay THE NEWARK WAY!

EVERY ITEM GUARANTEED BY NEWARK!

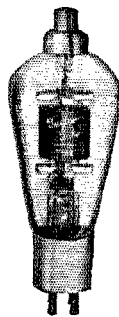

TAYLOR TUBES

866.....	\$1.65
756.....	4.95
203B.....	7.50
203A.....	12.50
814.....	18.50
832.....	18.50
T200.....	21.50

High Frequency Tubes

T55.....	\$8.00
T155.....	19.50

Write for Free Complete Taylor Catalog

FREE
JUST OUT! BIG NEW CATALOG!

Big Bargains in Parts, Equipment and Supplies for Hams, Servicemen and Dealers. Lowest wholesale prices. Write quick!



ORDER DIRECT FROM THIS AD — NOW

Receivers listed in this ad are best values anywhere. Order today on EASY TERMS. Send your down payment with order. Set will be shipped immediately upon approval of your credit. Entire transaction in 1 week. No red tape. Full details of any item, with complete NEW CATALOG FREE upon request.

NEWARK ELECTRIC COMPANY

226 W. MADISON ST. Dept. Q CHICAGO, ILL.

THE NEW 1937

RADIO A

HAND

Ready

EDITION OF THE
MATEUR'S
BOOK

Nov. 1

\$1 POSTPAID
\$1.25 OUTSIDE OF
CONTINENTAL U.S.A.

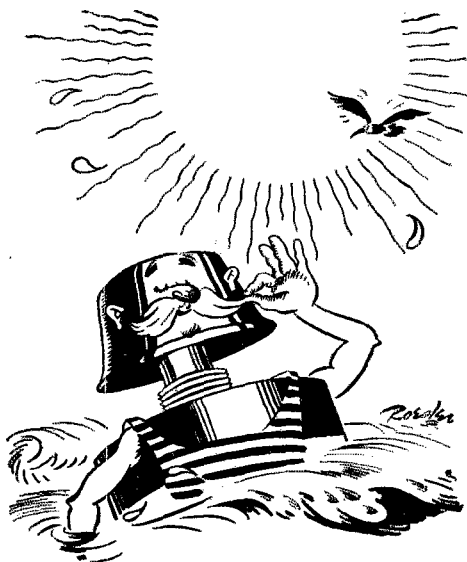

OL' MAN CENTRALAB 'TAKES IT' EITHER WAY

blistering heat, or excessive humidity . . . it's all the same to a CENTRALAB CONTROL . . . Millions of these controls are "standing up" under unbelievably severe conditions . . . so the next time a control goes "haywire" change to CENTRALAB . . . and play safe.

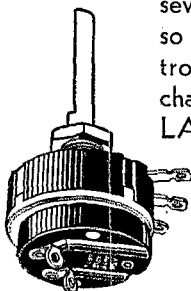

Every Radio Service Man
Should be a member of the
Society of Radio Service Men

Centralab

Milwaukee, Wisconsin

British Centralab, Ltd.
Canterbury Rd., Kilburn
London N.W.6, England

Centralab
68-70 Rue Amelot
Paris, France

**VOLUME CONTROLS
FIXED RESISTORS**

(Continued from page 68)

fair enough to grade the antenna performance in steps of four db from the maximum value given on the charts; practically identical results will be secured over the whole region within four db of the maximum. The next 4 db would be the second-best region, the next 4 third best, and so on. For example, taking the full-wave antenna at 15 degrees, the "best" region would be included in the horizontal angles between 25 and 75 degrees; "second best" between 10 and 25 degrees and between 75 and 82 degrees, etc. An alternative method would be to place the nulls where they would do the least harm, letting the best directions fall where they may. An interesting and profitable evening can be spent with a globe and the chart of the antenna or antennas of most interest.

It is apparent that the signal strength in a given direction may be varied either by changing the length of the antenna or by altering its direction. In most locations it will be possible to do one or the other. In case neither is possible, the charts will at least enable one to determine what should be expected in the matter of optimum directions for working.

It should be emphasized again that these charts are not intended to offer a method for getting anything except *comparative* results. Knowing what the antenna itself can do in various directions may be the means of improving results, but it cannot possibly make a poor location into a good one, or overcome natural factors which prevent one station from "getting out" and make another one outstanding. Neither is there any attempt to show that there is one "best" antenna; the best one for your location is the one that covers best the territory you want to reach. There is no magic in any one of them except insofar as one type may fit a given set of conditions better than another. We suspect that, aside from the perennial feed question, the prejudices many amateurs have for or against one type of antenna are the result of accident, favorable or unfavorable, in choosing a length and direction.

Heterotone C.W. Reception

(Continued from page 18)

combination diagrammed in Fig. 1-F, the desired signal gives evenly-related principal heterodyne beat components of 400, 600 and 1600 cycles, in addition to the 1000-cycle double-sideband component. Sum and difference components also result from intermodulation of these principals, probably in major steps of 200 cycles. Now suppose an interfering signal of, say, 1300 cycles higher frequency than the desired signal also comes through the i.f. amplifier. In simple heterodyne reception, it would beat with the c.w. oscillator to give a note of 700 cycles, only 100

(Continued on page 76)



● *Mr. C. B. McMurphy in charge of the Radio development work of the Piedmont Police Department, Piedmont, California, who has pioneered and developed one of the finest police two-way communication systems in America today, holding the EIMAC 50T, finally retired after giving such an excellent account of itself.*

This **EIMAC** 50T was finally retired after 12,500 hours of grueling 24 hour a day service in a 9 meter police transmitter (W6XBF).

Just another example of the stamina and unusually long life built into each and every **EIMAC** tube.

PLAY SAFE - BUY EIMAC

At Leading Dealers Everywhere

EITEL-McCULLOUGH, INC.

San Bruno, California, U. S. A.

A New Name TO SOME OUT OF TOWNERS BUT AN Old House

ESTABLISHED 10 YEARS



Of Course We Carry

EIMAC	TAYLOR
R C A	R M E
RAYTHEON	AMPEREX
U. T. C.	I. R. C.

HAMMARLUND

And a Host of Other Foremost Lines

HARVEY TWIN "15" KITS

A Transmitter Kit with Xtal Tubes, Drilled Chassis, Transformer Wire Screws, etc. Uses 6L6 R.F. Output — 15 Watts.

Complete **\$15.00**

A 15-watt audio amplifier — Uses 6C5 to pr. of 6L6's, with Tubes, xformers, Drilled Chassis, Wire Screws, etc.

Complete **\$15.00**

PLATE XFORMERS Manufactured by U. T. C.

<i>Tapped Primary</i>	<i>Tapped Secondary</i>	
500 v d.c., 350 m.a.		\$4.49
800-1000 v d.c., 400 m.a.		\$8.49
1250-1500 v d.c., 400 m.a.		\$12.95

TOBE MICRANOL CONDENSERS

2 mfd. 2000 v. working **\$2.50**
1 mfd. 2000 v. working **\$1.70**

Crackle Finish Cabinet

Ideal for pre-selector or monitor. Has hinged top, side louvers. Chassis, 8³/₄" high, 10¹/₄" deep, 6" wide.

Only, **\$1.49**

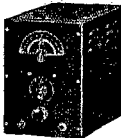

14" NEON STICKS.....\$1.75

HARVEY RADIO CO. NEW YORK

103 WEST 43rd Street, N. Y. C.
W21JL — W2VL

Plain Talk About Rhombic Antennas

(Continued from page 29)

tenna at the wrong time was reduced by coupling the diamond to a tuned circuit and thence to a low impedance line (the arrangement is described later) and by using a 75-ohm line from the comparison antenna. The change-over switch was therefore in a low impedance circuit in both cases.

The use of "S" meter points to express gain or loss is doubtless far from ideal but we found it preferable to the conventional business of estimating signal levels by ear or, on the other hand to actual measurement of the field around the antenna—a process made quite impractical by the existence of dense woods in almost all directions.

To get back to earth, we found immediately that signals on the line of the beam were given such a lift that, while they were painfully weak on the comparison antenna, they were extremely strong on the diamond. That, of course, is the sort of sweeping statement that we are unable to avoid. It is the sort of statement with which antenna engineers might have little patience. From the ham operating standpoint, though, it states the case. The performance of the antenna on interfering signals was similarly striking. Frequently it would be possible to hear sixth-district stations on the beam with nothing more than faint heterodyne QRM. Switching to the half-wave comparison antenna would produce, on precisely the same frequency, a fourth-district station of similar strength and with similarly inconsequential interference. The 20-meter signals from W1JPE were bumped, along the line of the beam, anything from 2 to 6 R points (estimated by the various listeners). The VK's (20-meter 'phone) over the period of a week's testing, reported us variously as the "loudest first-district station," as "loud as the strongest W's from any district" and "three or four R points stronger than W1SZ."

The latter line of talk led W1SZ to throw up a similar antenna — not that it was all throwing. The location at W1SZ is even more thoroughly smeared with trees and underbrush than that at W1JPE. This circumstance, together with the fact that W1SZ decided to use copper-clad steel wire, led to many complications. A two-day struggle with the project leaves us with one firm recommendation—that if copper-clad steel wire must be strung above dense underbrush, it should be dropped into position from a blimp or other convenient type of skyhook. Threading the wire through the brush with the idea of pulling it up into position afterward is, quite definitely, the wrong idea.

To get back to cases, the W1SZ antenna also worked like a charm, bumping his signal along the line of the beam to such an extent that he now became a point or more stronger than W1JPE. The comparison antenna used at W1SZ is a pair of vertical half-waves in phase strung alongside an 85-foot telephone pole. It is an excellent antenna in the ordinary sense of the word but the

(Continued on page 100)



"SPRINGFIELD POLICE CARS stand by"

When the Springfield, Massachusetts, Police Department announcer communicates with the radio-equipped cars of his department he expects attention from all "cruisers" on duty. To keep all cars in service the maximum amount of time and to assure an ample supply of current for all electrical requirements, the Springfield police cars are equipped with Delco-Remy Special Service Generators and Delco-Remy Current and Voltage Regulators. Amateurs, too, find that these Delco-Remy High-Output Generators provide ample current for two-way radio service and experimental work in their own cars. Any Branch or Electrical Service Station of United Motors Service will analyze your problem and determine the right Delco-Remy equipment for your use.

DELCO-REMY CORPORATION • ANDERSON, INDIANA



This is part of the fleet of ten new police cars recently purchased by the Springfield, Mass., Police Department. All have been equipped with Delco-Remy Model 934-F Generators and Model 5881 Current and Voltage Regulators.



United Motors Service is the official distributor of Delco-Remy products, including all service parts for Delco-Remy starting, lighting, and ignition systems.

Delco-Remy

Say You Saw It in *QST* — It Identifies You and Helps *QST*

(Continued from page 72)

Coto

LO-LOSS INDUCTORS

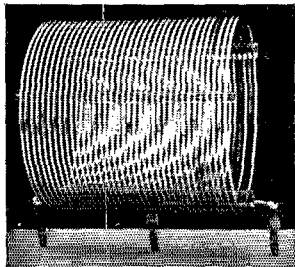

for
TANK
BUFFER
ANTENNA

The Modern Way to an R9 Signal!

ASK TO SEE THEM AT
YOUR DEALER OR WRITE
FOR DESCRIPTIVE BULLETIN

COTO-COIL CO., INC.
PROVIDENCE, R. I.

cycles different from the beat with the desired signal. However, with heterotone modulation a combination of additional sideband beats would give the signal an entirely different characteristic pitch and quality. The oddly-related principal components of 300, 700, 1000, 1300 and 2000 cycles would make it so. Thus aural selectivity is aided.

All the foregoing applies equally to signals transmitted with tone modulation compared with pure d.c. signals. However, the full advantages of heterotone reception of pure d.c. signals cannot be obtained with heterodyne reception of m.c.w. signals. In the first place, high selectivity in the receiver peels off the tone modulation. In the second place, it takes modulation power ranging up to 50 percent of the carrier power to do the job properly at the transmitter, while only a fraction of a watt of audio power is required in the receiver. In the third place, fading effects inevitable in transmission continually alter the character of the received m.c.w. signal and impair its quality, whereas such effects are absent with tone modulation applied in the receiver. Finally, it's illegal for us to use anything but A1 (pure d.c.) transmission on our bands below 14,400 kc., anyway. But that is no hardship, when we can do the job better in the receiver than at the transmitter.

A few practical circuit suggestions should be in order before this article ends, even though the actual application is so simple that it's hardly necessary to say much about it. While almost any kind of audio oscillator might be used, a simple vacuum-tube type is most generally adaptable. Two circuits which have been used are shown in Figs. 2 and 3. That of Fig. 2 uses a standard push-pull input transformer secondary winding in a Hartley arrangement, the primary winding serving to couple the audio modulation into the screen-grid circuit of the first i.f. stage, immediately following the crystal filter in the single-signal receiver. The particular circuit values given may require variation to suit transformers of different characteristics. It is particularly important that the grid condenser and leak, and the cathode resistor, be of such values as to prevent "blocking" oscillation of extremely peaked wave-form. This type of oscillation will set up radio-frequency "hash" and cause interference. The arrangement of Fig. 3, adapted from the circuit given by L. C. Waller in October, *QST*, is less expensive to set up, since it employs a standard r.f. choke as the tuned circuit inductance. This oscillator has a very good wave-form. It is not so adaptable in coupling into the screen-grid circuit as the circuit of Fig. 2, and the former may be preferable where it is inadvisable to disturb the screen-grid supply circuit (as in the National HRO receiver).

The heterotone modulator should be isolated as much as possible from the receiver's audio-frequency circuits, to prevent leakage of continuous tone into the output circuit. Even more important, *r.f. output of the receiver's c.w. beat oscillator must not get into the i.f. circuits through*

CALL-LETTER PLATES!



FREE
with Purchase of
\$5.00 or Over NET

Removable characters mounted on heavy metal plate, highly finished in black enamel on rich orange background. Size 12" x 3".

Display your Call Letters on your car, front porch, or over your transmitter. Available for all United States Districts, Canada and Foreign Countries.

FOR A LIMITED TIME ONLY we are offering one of these handsome plates made up of **Your Own Call-Letters Free** with a purchase of \$5.00 or over at net of amateur parts or equipment.

We are headquarters for standard makes of amateur parts and equipment. Send us your order for any make of part or equipment desired. Fastest service on hard to get parts. Fully guaranteed.

TERMS: Cash with order in net U. S. A. funds. Give your Call-Letters when ordering. Your plate will be included in shipment.

Radio Parts & Equipment Co.

244 Clinton Avenue, North, Rochester, New York, U. S. A.

Two Hundred Meters and Down

The Story of Amateur Radio

By CLINTON B. DESOTO

For many years you have heard amateurs say, "When the history of amateur radio is written . . ." Now the history of amateur radio *has* been written, a detailed and yet concise presentation in full book length of all the elements that have served to develop the most unique institution of its kind in the history of the world.

A book of history, but not a history-book, "Two Hundred Meters and Down: The Story of Amateur Radio" tells in spirited, dramatic fashion the entire chain of significant events in the development of the art, from the work of Thales in 600 B.C. to the March floods and the Lamb noise silencer. The chapter headings indicate the scope and the subject matter:

<i>Introduction</i> THE RADIO AMATEUR	
<i>Part I — PIONEERS</i>	
CHAPTER	CHAPTER
<i>One</i> THE DAWN OF THE ART	<i>Thirteen</i> TRANSOCEANICS
<i>Two</i> THE NEW HOBBY	<i>Fourteen</i> THE DEVELOPMENT OF THE SHORT WAVES
<i>Three</i> AMATEUR COMMUNICATION	<i>Fifteen</i> THE INTERNATIONAL AMATEUR RADIO UNION
<i>Four</i> THE COMING OF THE LAW	<i>Sixteen</i> STABILIZATION
<i>Five</i> ADJUSTMENT AND DEVELOPMENT	<i>Seventeen</i> READJUSTMENT
<i>Six</i> THE AMERICAN RADIO RELAY LEAGUE	<i>Eighteen</i> THE REGULATION OF AMATEUR RADIO
<i>Seven</i> GROWTH AND EXPANSION	<i>Nineteen</i> EXPEDITIONS
<i>Eight</i> WAR!	<i>Twenty</i> EMERGENCIES
<i>Part II — DEVELOPMENT AND RECOGNITION</i>	
<i>Nine</i> BACK ON THE AIR	<i>Conclusion</i> WHITHER AMATEUR RADIO?
<i>Ten</i> SPARK VS. C.W.	
<i>Eleven</i> THE BROADCAST BOOM	
<i>Twelve</i> RECORDS AND ACCOMPLISHMENT	

MOST OF TODAY'S AMATEURS HAVE NO MORE THAN FRAGMENTARY KNOWLEDGE OF THE BEGINNINGS OF THEIR ART. THIS BOOK IS AN INVALUABLE RECORD THAT EVERY AMATEUR OUGHT TO OWN, TO LEARN THEREBY THE FASCINATING TALE OF OUR EARLIER DAYS

The future of amateur radio — what will that be? Television — what place does it hold in the amateur picture? The 'phone-c.w. war — its genesis, an evaluation of the arguments, its probable outcome — a frank, impartial, dispassionate, courageous treatment. The story of the international radiotelegraph conventions, where the destiny of amateur radio is decided — facts never before disclosed. The legislative record of amateur radio. Trends in technical development. Social trends and implications. Virtues and faults — lessons learned and lessons to be learned — a complete, informative, instructive, entertaining picture of the art of amateur radio as a whole.

NOW READY \$1 POSTPAID

Approximately 200 Pages, 90,000 Words, with Durable Imitation Leather Red Paper Cover
De Luxe Edition bound in blue cloth \$2.00

AMERICAN RADIO RELAY LEAGUE, WEST HARTFORD, CONN., U.S.A.

NEW X BIRNBACH mitting sockets AT LOW PRICES

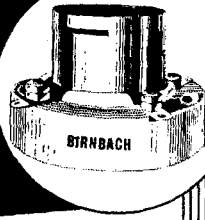

featuring

- Side wiping contacts
- Brass, nickel plated shell
- Highly vitrified low absorption base
- All brass hardware
- Low prices

No. 434—50 watts,
\$1.25 List each.
No. 435—10 watts,
90c List each.

Special Low Prices in Large Quantities

IMPROVED CONE STANDOFF INSULATORS

Made of STEATITE, the better ceramic. Complete range of heights. Condenser, coils, tube sockets, etc., can be mounted with minimum labor. Specify brown or white glaze.

No.	Heights	List
430	3/8"	10c
431	1"	15c
431J	1"	20c
432	1 1/8"	20c
432J	1 1/8"	25c
433	2 3/4"	25c
433J	2 3/4"	50c

See your jobber. If he cannot supply you, write direct to Dept. Q-11



BIRNBACH RADIO

145 HUDSON STREET • NEW YORK, N. Y.

THEY CHOOSE "ULTRA" on PERFORMANCE!

SHURE



Crystal Microphones

Expert Sound Engineers, seeking the utmost in crystal microphone performance, are consistently choosing Shure "Ultra" Wide-Range. They know that "Ultra" gives them 8 Exclusive Performance-Insuring Features — features that are translated into thrilling life-like reproduction... beautiful modern styling... dependable 24-hour trouble-proof service... at low cost.

Compare Shure "Ultra" against them all. Let Ultra performance prove how right you are to choose Shure "Ultra" Wide-Range as the best microphone buy!

FREE! Microphone Applications and Specifications Chart. Just ask for Chart 227Q.

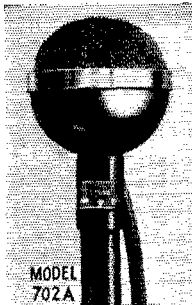

Available in Spherical, Swivel, and "Grille-Type" Models.
List Price, \$25

See your Jobber or write for Bulletin 140Q today!

Licensed under patents of the Brush Development Company. Shure Patents pending.

SHURE MICROPHONES

SHURE BROTHERS • MICROPHONE HEADQUARTERS
215 WEST HURON STREET • CHICAGO, U. S. A.

the first i.f. stage. If it does, it will come through to the second detector as a continuous modulated signal. It must be remembered that any signal in the first i.f. stage will be modulated by the audio oscillator, whether the signal originates outside the receiver or in it. The c.w. oscillator circuit should be thoroughly shielded and isolated from everything but the second detector, into which (and into which only) it is supposed to feed. Also, the beat oscillator should operate at plate voltage as low as it may be run for good heterodyne action on weak signals. This also gives the best signal-to-hiss ratio, by the way, since it provides less carrier voltage for the set noise to beat with. Application of the heterotone modulator will certainly show up stray beat oscillator input to the i.f. circuits.

In addition to trying out the heterotone reception on receivers here, several visiting amateurs were interested in trying it in their own superhets. Among these is W2ZC, who reports as follows:

"I immediately went to work on my arrival back at W2ZC and installed a 56 audio oscillator to modulate the screen grid of the first i.f. stage in my Comet Pro. It gives a new impetus to code and my big modulators are now idle; and the two Eimac 150T modulators are merely keying the final stage. The idea has certainly lent a great deal more pleasure to the amateur frequencies."

Briefs

Capt. Frederic B. Westervelt, W3CZO, Carlisle Barracks, Carlisle, Pa., gave a talk on amateur radio before the Carlisle Rotary Club on August 6th.

When Tupelo, Miss. was struck by a tornado on April 9th, the local newspaper called W4ABY (Memphis, Tenn.) with the request that he attempt to establish communication with the stricken city. Unable to find any station on the air at Tupelo, W4ABY and W4LI rigged up a portable outfit for 3.5- and 7-mc. c.w., power being a type 53 with about 6 watts input in a T.P.T.G. circuit. W4ABY, together with a reporter and a driver for the truck which transported them, took this rig to Tupelo, having arranged schedules with W4ARZ of Memphis, and his own station, W4ABY. The portable was set up at the Armory. Contact was made with W4ARZ and a dispatch sent from the Adjutant General, asking for hospitalization for the injured. Contact was also made with W4ABY, which was manned by W4DRL, W4BCA and W4DIX. Naval Reserve station NDD was manned by N4CQX.

An unusual bit of QRR work was performed by W5DRQ and W5CQO on July 26th. They were at White Rock Lake (Dallas, Texas) with two 56-mc. equipped cars, parked on opposite sides of the lake. W5CQO saw a sailboat turn over; wind and waves were high. He told W5DRQ about it and DRQ promptly sent a motor boat to the rescue from the other side, saving the lives of the two occupants of the boat.

A good opportunity for amateur operators to gain experience exists at Fort Knox, Kentucky, in the mechanized force of the U. S. Army. The 68th F. A., the 1st Cav., and the 13th Cav. operate many radiophone and c.w. sets in armored cars, and need trained operators. Good ratings may be attained by good operators. Applicants for enlistment should write to Capt. M. P. Chadwick, W9YHQ-ex-K6KTF, Radio Officer, 68th F. A., Ft. Knox, Ky., and should enclose references from two business or professional men in their community, and if under 21 years of age, their parents' consent.

W8OSL has worked Mars on 66 mc!! (Now for the let-down: It was Mars, Pennsylvania!)

A.R.R.L. presents its

AMATEUR RADIO *Map* OF THE WORLD



On a sheet of heavy map paper 30 x 40 inches Rand, McNally, world's premier map-makers, have — to A.R.R.L. specifications — imprinted in six colors and black every single bit of map information useful to the radio amateur.

The special modified equidistant azimuthal projection permits great circle distance measurements in miles or kilometers accurate to better than 2%. Local time in all parts of the world is shown, as well as Greenwich corrections. The official I.A.R.U. WAC continental sub-divisions are given. Principal cities of the world are shown, including, in the U. S., all district inspection offices and examining points.

Perhaps most useful of all is — for the first time — a standard list of countries of the world, arranged on a basis of geographical and political divisions — clearly shown by color breakdown and the detailed reference index. There are 230 countries shown, 180 prefixes (the prefixes in large open red lettering that you can't miss). More than that, all known national districts and other sub-divisions are shown.

Entirely new in conception and design, large enough to be *useful*, complete in every detail — here is the map radio amateurs have been waiting for these many years. Make a place for it on your wall now — it'll be the most *interesting* object in the shack.

Price \$1.25, postpaid

American Radio Relay League, West Hartford, Connecticut

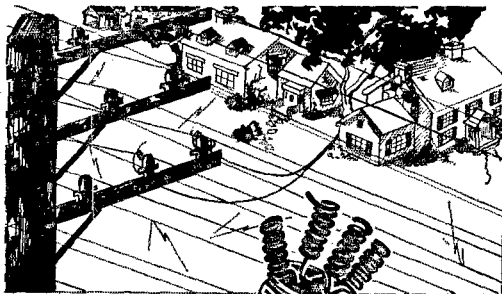

Block a-c line

QRM!

Your neighbor's vacuum cleaner is no help when you're listening for an Aussie

To block line noise from your neighbor's appliances, **CONTINENTAL Carbon**, manufacturers of low-power factor transmitting condensers and insulated resistors, offers a power line Filtercon, 10 amps. capacity, which is very effective in keeping out of your shack r-f QRM from the power line. Filtercon F 1005DH contains two chokes and two capacitors for use on 110 to 220 v lines. List price, only \$5 00. Ask your jobber for Filtercon data, Bulletin 104-A

CONTINENTAL CARBON Inc.

13924 Lorain Ave., Cleveland, Ohio

Toronto, Canada

A General Utility Mixer and Speech Amplifier

(Continued from page 38)

the condenser head amplifier is through a 200-ohm shielded line to the resistance input circuit. This circuit can be used for any other 200-ohm line, the jumper marked "X" being inserted at the proper point to complete the power supply circuit. With the 6J7 input stage contributing a gain of approximately 100, the basic sensitivity of this channel is in the neighborhood of 0.03 volt, which is adequate for most condenser microphones with head amplifiers, as well as for carbon microphones. If a double-button carbon microphone is to be used, the circuit shown in August *QST*¹ can be substituted. Incidentally, the "hot" leads in the 200-ohm input circuit are all shielded to reduce hum pick-up, since they are rather long. Here, too, a Mallory bias cell eliminates hum and regeneration problems and simplifies wiring.

Channel C is a low-gain stage designed for use from receiver output circuits for relay work, and from high-impedance phonograph pick-ups. Low-impedance pick-ups can be tied in on the 200-ohm "B" circuit, of course. The input circuit provides resistances of 2000 and 10,000 ohms, which will meet practically all the requirements that can possibly be imposed. The over-all gain is approximately 150, giving a basic sensitivity of about 0.3 volt. Any pick-up or receiver first a.f. stage will provide more than this value; up to about a 4-volt signal can be handled with reasonable distortion. Again, the input lead is shielded.

MIXER AND FREQUENCY CHARACTERISTIC

By this time the somewhat unusual output circuit linking the three input stages will doubtless have attracted attention. This circuit is designed to accomplish series mixing of the three possible sources, with individual control over the level from each source, and at the same time to maintain automatically a more or less constant over-all output level. This is accomplished by the displacement of a proportion of the output of any initial circuit when any other gain control is advanced, and the transfer of the displaced proportion of the input load to the additional channel. In this way overmodulation due to the additive superposition of two inputs is avoided; unless compensating adjustment is made, the level of each single input is reduced so that, under most conditions, the total output voltage swing is not increased.

Decoupling in the output 6C5 cathode circuit eliminates any tendency toward regeneration and holds the low-frequency transmission up. The same is true of the parallel resistance-fed output circuit, which couples into a tube-to-line transformer. In order to facilitate operation of the gain and mixer controls, this speech amplifier is intended to be placed directly on the operating table, with a 500-ohm line running to the modulator unit in the transmitter proper. A T-pad in the line serves as a master gain control.

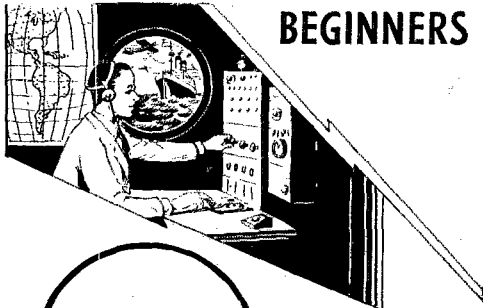

BEGINNERS

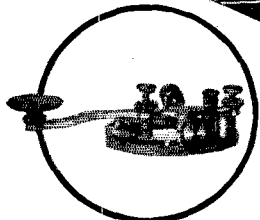

YOU'LL LIKE THIS SIGNAL WIRELESS KEY

Every beginner who has used this Signal ¼ K.W. key approves it for its desirability and inexpensiveness. It is well made, with polished key lever and lacquered parts. Contact points are platinum. List price \$2.80. Signal's line of Wireless Keys, Telegraph Instruments and Wireless Practice Sets is complete. Send for our bulletin.

SIGNAL ELECTRIC MFG. CO.
Menominee, Michigan U. S. A.



STATION OPERATING SUPPLIES

For full enjoyment of your operating activities this coming season, you will want these new forms designed to meet your needs

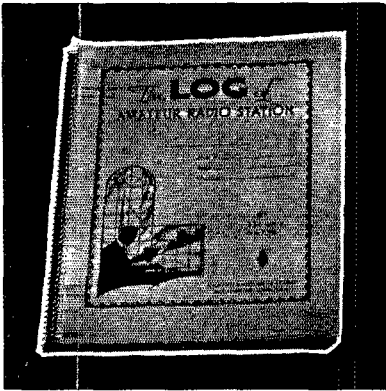

SPIRAL BOUND LOG BOOK

The most interesting feature of the new LOG BOOK is the incorporation of spiral binding. This permits the book to be folded back flat at any page, requiring only half the amount of space on the operating table and making it easy to write on. The log-sheet has been redesigned by the Communications Department so that there is space provided for recording the number of messages handled and QSL's sent and received. General log information (prefixes, etc.) has been brought up-to-date. The LOG BOOK price has been reduced and is now 35c per book, 3 books for \$1.00, postpaid.

OFFICIAL RADIOGRAM PADS

The radiogram blank is now an entirely new form, designed by the Communications Department to comply with the new order of transmission. All blocks for fill-in are properly spaced for use in typewriter. It has a strikingly new heading that you will like. Radiogram blanks, $8\frac{1}{2} \times 7\frac{1}{4}$, lithographed in green ink, and padded 100 blanks to the pad, are now priced at 25c per pad, postpaid.

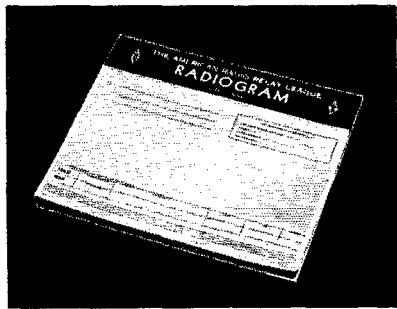

and MESSAGE DELIVERY CARDS

Radiogram delivery cards embody the same design as the radiogram blank and are avail-

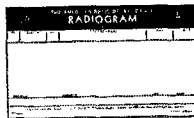

able in two forms — on stamped government postcard, 2c each; unstamped, 1c each.

AMERICAN RADIO RELAY LEAGUE, INC.
WEST HARTFORD, CONNECTICUT

"Ask the Ham Who Owns One"

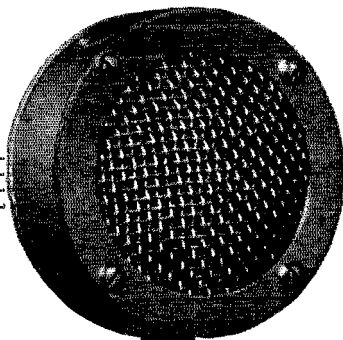

"SPEECH
RANGE"
MODEL D-104

BIMORPH
CRYSTAL
MICROPHONE

Amateurs have proved, in every corner of the globe under every transmitting condition, that the Astatic D-104 is the most effective microphone made for clear, clean, strong output in the speech range. Ruggedly built and economically priced. See your Jobber or Write.

Licensed under Brush
Development Company Patents
ASTATIC MICROPHONE LABORATORY, INC.
YOUNGSTOWN, O., U. S. A.



The next point of interest is the over-all frequency characteristic. Theoretically, of course, the ideal frequency characteristic of an audio amplifier would be one that was perfectly flat over the entire audible range. In practice, however, this does not always hold true. In particular, it is frequently desirable to compensate in one circuit for deficiencies in others. In amateur speech equipment the use of microphones which drop off at the higher frequencies is common; this, too, is a characteristic of some common modulator transformer combinations. While these higher frequencies are not vitally essential to the transmission of intelligible speech, they do add to the naturalness of reproduction. Too, most ham receivers cut side-bands necessarily, further reducing the high-note response. All in all, some rise in the high-frequency characteristic seems tolerable in the speech amplifier of the amateur transmitter.

Reference to Fig. 2 will show that this amplifier provides approximately 8 db rise from 7000 to 10,000 cycles, starting at 36,000. Although not extreme, this rise will serve to compensate for the average high-note deficiencies of microphone and modulator. Even if an over-all rise remains, it should not be objectionable. The low frequency range is flat within 1 db down to about 80 cycles, and within 2 db to 30 cycles.

Modification of this frequency characteristic is possible by means of $C_6-L_3-R_9$ in Fig. 1. Rotation of the control all the way to the right provides approximately 6 db drop at 30 cycles, as shown by the dashed line. Turning it to the left provides curves as shown by the dotted lines. It will be seen that the high-frequency resonance characteristic provides an oddly-distorted curve at maximum high-note attenuation. Ordinarily such a condition would be objectionable, but in this case it seems to make the quality rather more pleasing than otherwise because it serves to attenuate somewhat the customary 3500 cycle peak, at the same time preserving the sibilants and other phenomena of good high-note response. For most voice transmission, the control will be either in the neutral position or advanced to the right (low-note attenuation).

POWER SUPPLY AND CONSTRUCTION

The power supply circuit is entirely conventional, except insofar as the provision for operating a condenser microphone head amplifier is concerned. Such amplifiers usually require 6 volts at 60 ma. for filament supply, and 6 or 7 ma. at 180 volts for plate supply. Through a heavy-duty bleeder arrangement these requirements are satisfied, and it is merely necessary to plug the condenser mike into the six-connection socket provided. Referring to Fig. 1, the filaments are connected in series with the negative high voltage and the load adjusted to exactly 60 ma. Since the speech amplifier circuits proper draw only a few milliamperes, the balance of the drain is provided in R_{25} , R_{26} and R_{27} . R_{27} reduces the 250-volt supply to 180 volts, while R_{26} is the adjusting device to enable setting the filament drop to precisely 6 volts.

Something New!



Oil-impregnated oil-filled transmitting condensers in neat, compact, convenient form. Rectangular drawn-metal cans. Dependable. Long-lived. Mass produced for new low prices.

In 600, 1000, 1500 and 2500 v. ratings.

★

1, 2 and 4 mfd. capacities; 1 and 2 mfd. for 2500 v.

★

High-tension pillar terminals. Mounting lugs.

★

Seepage-proof. Cool operation. And tough!

★

Write for new catalog just issued.
More pages. More items.
Lower prices and best values.

AEROVOX
CORPORATION

73 Washington St. Brooklyn, N. Y.

Also round-can type if you prefer.

1000, 1500 and 2000 v. ratings. 1, 2 and 4 mfd.

High-tension terminals. Mounting rings. Seepage-proof.

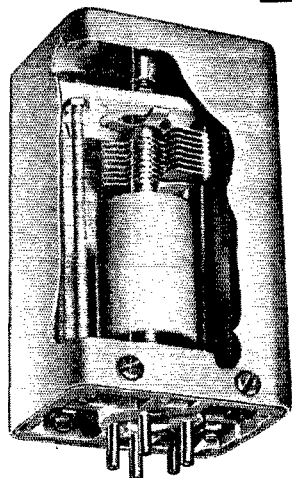

Plug-in Base and Shield, Type PB-10 (either 5 or 6 prong). Net price, \$.45
 Plug-in Base (less shield). Net price..... .24
 Fixed Tuned Exciter Tank, with PB-10 Base.
 Type FXTB (either 5 or 6 prong). Net price.....2.94
 Midget Coil Forms (R-39).
 Type XR-2 (1" dia. x 1 1/4" long). Net price..... .21
 Type XR-3 (5/16" dia. x 3/4" long). Net price..... .18
 Ultra Midget Condenser, Type UM. Net prices from..\$.75 to \$1.10

Something New for SHIELDED PLUG-IN COILS

WITH this new plug-in base, it is extremely easy to build high performance gear — whether it be for experimental receivers, bread board layouts, monitors, exciters or what have you.

The low-loss R-39 base, with prongs moulded in to fit standard sockets, has mounting holes for our type UM Air Dielectric Condensers and our R-39 coil forms. The illustration shows the effective assembly that is possible with these units. This PB-10 base fits our Fixed Tuned Exciter Tanks, thus making them available for plug-in mounting. Attachment to the shield can is easily made by four screws.

The transmitter in the advertisement on the inside back cover of this issue shows a handy application of this base with our FXT units.

NATIONAL COMPANY, INC.
MALDEN, MASS.



TED R. McELROY, Official Champion of the World, Class A. Speed 69 wpm.

CANDLER SYSTEM taught at HARVARD and Massachusetts Institute of Technology in their course "The Art of Radio Communication," conducted by our famous student, Champion McElroy.

MARCH OF THE CHAMPIONS!

Get Your Code Training and Technique Where They Got Theirs!
 Twenty-fifth Anniversary of
 THE CANDLER SYSTEM

This famous SYSTEM is backed by a Quarter Century of Success in training Amateurs and Commercial Operators who could be satisfied only with the best!

You Can Learn Code RIGHT, from the Beginning or obtain your commercial license and qualify for a good job by taking CANDLER TRAINING in your own home, as McElroy, Jean Hudson and many others have done and are doing. It is surprisingly easy and inexpensive.



JEAN HUDSON, W3BAK Official Champion of the World in Class E.

Jean obtained her ham license at the age of 8, and two months after she began Candler SCIENTIFIC CODE and Touch Typewriting Courses, could copy 30 wpm on her "mill." At the age of 9 she won official championship in Class E, against rigid competition.



FREE—1936 Book of FACTS

Contains McElroy's own story, "How I Learned to Read Code, and What Candler Training Has Meant to Me," also little Jean's story and other valuable information. Whether you want to learn code or increase your speed, this book will help you. A card will bring it. No obligation.

CANDLER SYSTEM CO.

Dept. Q-11

ASHEVILLE, NORTH CAROLINA

STATION ACTIVITIES

(Continued from page 50)

has moved from The Pas to Saskatoon to a better position. YR is changing over to an RK-23 and RK-20 final. CZ gets on occasionally. ABO, a new ham at The Pas, is building an RK-23 and RK-20 rig. Your S.C.M. is moving to 635 Garfield St., Winnipeg, so please send all communications to this address. Thanks.

Traffic: VE4VG 9 AAW 6.

SASKATCHEWAN—SCM, Wilfred Skaife, VE4EL—QZ reports 28 mc. opening up again with So. Americans coming through S9. MB worked his 22nd country to finally break the jinx. TI is to be heard on 3.5-mc. 'phone, grid modulating his 211D. FD was visiting in Brandon and met some of the gang. TW's brother, W8PXR, was visiting Saskatoon for two weeks and met the gang. PQ schedules his cousin, VE3AHK, at Windsor, on 14 mc. AEF is new Saskatoon ham at R.C.M.P. BF snagged FT4 for his first African and completed W.A.C. Congrats, Gus. The S.A.R.C. Bulletin "T9X" has resumed publication after vacation layoff. CM has trouble with his 14-mc. 'phone which persists in oscillating at both ends. EL hopes to finish his rebuilding in a couple of weeks. AT visited some of the gang in Regina. OO visited EL. LU is in Regina for the winter. NE moved his rig to Beinfait. OC is now in Stoughton. ES is getting out well on 14-mc. 'phone.

Traffic: VE4QZ 17 PQ 1.

ATLANTIC DIVISION

EASTERN PENNA. MEN, ATTENTION: TRAFFIC/EMERGENCY BAND ORGANIZED!

The Eastern Penna. Traffic and Emergency Band—3640 to 3665 kc.—is now in operation. Route Managers and S.C.M. patrol this band each week night from 6-7 P.M. E.S.T. to take your outgoing traffic; and from 8-9 P.M. to distribute traffic they have received from the National Trunk Lines, etc. From 7-8 P.M. the master station is connected to various Trunk Lines.

1. TO SEND TRAFFIC (6-7 P.M.): Get in the band with crystal or e.c. control and call "PARM PARM de . . ." (Penna. Route Manager). The PARM on duty will answer and take your message.

2. TO RECEIVE TRAFFIC (8-9 P.M.): Listen for the PARM to call "CQ PATB" (CQ Penna. Traffic Band). Call him and ask QRU? He will give you anything he has for your location. If "clear" his brief "NIL" and your "R TU" can add a professional touch to the system.

3. EMERGENCY WORK: Call "QRR" within OUR BAND. A Section Official (RM, Chief RM or SCM) will be standing by ready to help in all emergencies. He will use his high power signal to clear the band for your low power emergency rig.

4. HOW TO HELP: Only send good traffic over this system. Get on the air between 8-9 P.M. as often as possible to help our Master Station clear his hook. When rag chewing please QSY out of the "Penna. Traffic Band" between 8 and 9 P.M.

5. QUESTIONS OR SUGGESTIONS: Give them to SCM W3EZ.

Remember the Official Calls "PA RM and PA TB." Let's go, Gang!

EASTERN PENNSYLVANIA—SCM, James M. Bruning, W3EZ—R.M.'s: 3AKB, 3AQN, 3EOP, SASW. P.A.M.'s: 3EOZ, 3BGD worked Utah at last and received W.A.S. certificate on his 21st birthday! 3EOZ held schedules for a week with W1OXD. 8FLA blew filter on his first A.A.R.S. drill of the season. 3BBV applied for O.O., O.B.S. and O.P.S. ratings. 3ETM is D.N.C.S. of Penna. Net 1. 3EPJ had his 3.5-mc. Zepp broken by falling tree. 8DIG is back to work. 8ASW has new job at new QTH and is working portable at present. 8PAF and 8PCL are new A.A.R.S. 8EKG and 8UV handled much traffic while at Nat. Guard Camp. 8DXC is interested in becoming O.R.S. 3EWJ plans further rebuilding. 3AMR has gone to the Univ. of Michi-

gan. 3CZS has built an experimental 18-watt 6A6 transmitter to keep company with his 175-watt O.P.S. 3AQN is putting out a nice signal. 3CEQJ is saving pennies for a commercial-built set. 8NNC wants schedule with Elmira, N. Y. 3MG built an 804 rig with 3.5-, 7-, 14-mc. band switching for use of 3FKZ. 3GMK likes traffic work and wants more of it. 3EUP has new 14-mc. rig with tantrums. 8EU is rebuilding again from stem to stern. 8MRQ has been acting L.N.C.-A.A.R.S. 3FBJ has very good results with e.c. osc. 3EZ added chromium-plated strips to his new transmitter to reward it for nice performance. 3BRZ sends an interesting list of 14- and 28-mc. contacts worked on c.w. and 'phone; we suggest you 28-mc. fans get in touch with Denny and see how it's done.

Traffic: W8AMR/NF 177 (WLML 714) ETM 48 AGK 17 GMK-EWJ 7 FBJ-EOZ 2 CEQ 1. W8EKG 271 UV 31 DIG 15 NNC 12 FLA 6 MRQ 3.

SOUTHERN NEW JERSEY—SCM, C. D. Kentner, W3ZX—The South Jersey Radio Association completed a very successful Field Day on August 16th. Winners were ZX, EWF and BWI in the hidden station hunt. FTK plans on resuming schedules. FBM is back on 3.5 mc. for the winter. BIR is active on 3.5-mc. c.w. and 56-mc. 'phone. EUY, who is working crystal control on 56 mc., sends the following dope on the 56-mc. gang: EET is about to blossom out on 120 mc.; BJZ is worrying about top-sided modulation; 9EY is operating portable from CJJ; CUD is going to 240 mc.; VX has new tower. FOS has been very QRL job. DNU claims prize run of bad luck: his Jr. op broke his arm, his little girl taken with ruptured appendix, burned out one power transformer and lightning got another. FXM tried 56 mc. but was too isolated for QSO; he works west coast regularly on 7 mc. and is working for W.A.S. BO started activity in A.A.R.S. EKL is at new QRA: 19 Villa Ave., Pitman. ZI sent long O.O. report, and announces his transfer to Obs. Squad, 44th Div., with headquarters at Newark Airport. ZX has a new pair of 805 modulators and new break-in system for 3.5 mc. and finds 28 mc. again very hot. CES plans net and traffic activity for the winter.

Traffic: W8FTK 72 BIR 4 BEI 2 AEJ 7 BO 12 ZI 24.

WESTERN PENNSYLVANIA—SCM, Kendall Speer, Jr., W8OFO—R.M.'s: 8GUF, 8KWA, 8MOT. Reports have doubled this month over last month. Thanks, fellows. Let's triple next month. Fall activities include the O.R.S. nets and the QSO contest. New O.R.S.—LGD (LZT), QAN, New O.P.S.—FIP, QAN, Prospective O.R.S.—OSL KWA is high man this month. Nice work, Wik. FZG has been transferred from LWK to PIW. GJM and CKO operated the S.H.B.P. & M. exhibit at the Allegheny County Fair. LGD, op at LZT, has left the C.C.C. for a job at home. JSU worked a G with only P.F. crystal. MOT is busy with A.A.R.S., N.C.R. and Trunk Line "L." QAN has added another rack (3.5 mc. with 803 final). CMP completed an extensive trip in the West, visiting Chicago, Walla Walla and Dallas. KBM is busy as War Games Advisor for the A.A.R.S. 3rd C.A. OFO received heard cards (3.5 mc.) from Germany, England, France and Czechoslovakia. AXD is busy reorganizing a Novelty Company in Smethport. MTK works 7 mc. OXI, ASE and 3DYT are rebuilding the old College Physics station 8CB. LIG schedules a Canadian YL (VE3EE). UK moved to Carnegie. DGL bought a new 14-mc. 'phone. EQZ is working 28-mc. 'phone. MYM was visited by 9UVV. OKP is experimenting with 1-meter 'phone. The Warren gang turned out for the J.A.R.A. Hamfest. The Warren Radio Club starts its season off with a dinner. EFA has moved again. YA has opened for another season. OZR has a 13-tube super. QEM announces a new club in Wilkensburg, "Ham Hollow Radio Club," with PFB, PJH, QEH and QFB as members. GUY would like to swap for an Asian QSL. Hi. MIW is adding a pair of tens final. When NDE is not QRL with the Boys Club of St. Marys, he is trying to get a 7- and 14-mc. rig perking. OJS has built a low-power rig especially for the QSO contest. MHE is now located at Brackenridge. FIP is the QSO contest "Drummer Upper." EDG is going for 616's in a big way. Six and a half feet of flood water and an antenna struck by lightning don't keep ASE off the air. JSS is going to M.I.T. to become an E.E. HUL is a movie op at Franklin. DNV works 3.9-mc. 'phone when not at Tri-State U. ITF is busy on 7 mc. The Amateurs Transmitters Association of Western Pennsylvania will hold a "Winter Hamfest" in Pittsburgh, Pa., sometime in January or February. More details later. Nominal charge.

Traffic: W8PIW (FZG) 93 CKO 74 LGD 63 JSU 47 GJM 29 KUN 16 QAN 15 CMP 10 KBM-OF0 9 AXD 8 MTK 7 OSI 2 LIG 1 KWA 329 MOT 17.

WESTERN PENNSYLVANIA SECTION QSO CONTEST

Dates: Contest begins 6:00 p.m. EST, November 2nd, and ends 10:00 p.m. EST, November 8th. Operating hours: Weekdays except Saturday—6:00 p.m. to 10:00 p.m.; Saturday and Sunday: 2:00 p.m. to 10:00 p.m. EST.

Qualifications: Only operators of stations located in the Western Pennsylvania Section of the Atlantic Division (this shall include the boundary counties Potter, Clinton, Centre, Mifflin, Huntingdon and Franklin) who send in copies of their logs with final scores shall be eligible for prizes.

Object: To contact and get acquainted with as many other Western Pennsylvania stations as possible during the contest. Contacts outside the Section do not count in the scoring.

Call procedure: The following call procedure shall be used by all stations taking part in the contest: CQ WPA de W8—.

Completion of contact: A contact shall be considered complete when the two operators have "chewed the rag" for at least ten minutes.

Scoring: One point shall be allowed for each contact with a different Western Pennsylvania Station. Each station can only be worked once. Note.—It is not necessary that the station you work turn in a score. All that is required is that the station be in the Western Pennsylvania Section.

Power: Power used will have no effect on the scoring.

Frequency: Any or all frequencies may be used.

Either or both c.w. and 'phone can be used.

Log sheets: Copies of the log sheets, listing the stations worked, the date, the time contacted, time contact completed (at least ten minutes), and the location of the station worked, shall reach the SCM (Kendall Speer, Jr., W8OFO, Lowber, Pa.) not later than midnight, November 21st.

Prizes: There will be plenty of prizes to make things interesting. Besides prizes for high scoring, there will be a prize or two drawn from a hat for those who fail to win in the scoring. Even if you only contact one station you have a chance of winning a prize.

DON'T FAIL TO TAKE PART AND SUBMIT A LOG.

WESTERN NEW YORK—SCM, C. F. Smith, W8DSS—Ye Olde S.C.M. leads the gang this month and his total is about on a par with his usual golf score. CSE always has a nice traffic total. FUG and PBO are thinking about applying for O.R.S. NWZ wants W.N.Y. QSO Party. CKC, ex-S.C.M., reports he is on 3.9-mc. 'phone with 1 kw. CGU has been appointed Phone Activities Manager for W.N.Y. JTT, our star traffic man, is going to resume schedules at once. Watch W.N.Y. traffic scores soar now. DHU is still traveling around, but finds time to handle a bit of traffic. GWT reports AKC, DX and himself on 14 mc. looking for long haul traffic; he has worked 28 countries with 40 watts input. CPJ worked Belgium with low-power 14-mc. 'phone. OFU reports QGL new ham in Batavia. HTT joined N.C.R., was rated RM2C. LUQ received certificate for winning DX Contest in W.N.Y.; he uses 500 watts on 14-mc. c.w. and 15 watts on 3.9-mc. 'phone! AQE is now using sky-buddy receiver. OAG has asked for O.R.S.; he is now a member of A.E.C. FB, PFK sent this FB report on Kenmore and Buffalo gang: NWH is still on the fence for choice of transmitter. NYO wants Class A so he can get on 14-mc. 'phone. OWE is back on 1.75-mc. 'phone with a nice rig. MFB uses a bamboo pole for a vertical antenna on 14 mc., and needs only Asia for W.A.C. OMD needs the fourth and fifth to have worked all districts. MQX has a new bug. KXA is new O.R.S. in Chapin. FCG is very active in A.A.R.S. and is new O.R.S. in Johnson City. QIL is on 56 mc. with an RK-10 and says he heard three-way QSO on that band between RV in Buffalo, HQZ and POL in Lewiston and VE3AEO in Toronto. BJO is getting ready for big season in A.A.R.S. and A.R.R.L. AXW is coming back on the air after two years with 50 watts crystal on 14, 7 and 3.5 mc. OAP turned in first report; he works 14 mc. with 5 watts input. OXI has been very busy opening new restaurant. BHK has his rig ready to perk. "Hal" chief opr. at Hqtrs., was a recent overnight guest at the shack of the S.C.M. The hamfest held at Binghamton was a great success with over two hundred Central New York and Northern Penna. hams present. CP divides his time between c.w. and 'phone. If you read

this column you must be interested in O.R.S. or O.P.S. How about your application, OM? 73.

Traffic: W8DSS 97 CSE 64 FUG 39 NWZ 21 CKK 14 CGU 14 JTT 20 DHU 5 GWT-CPJ 4.

HUDSON DIVISION

EASTERN NEW YORK—SCM, Robert E. Haight: W2LU—EGF is going strong on T.L. "L." IU is tuned up for fall traffic. HYC is using '47-'10-'10 final 200 watts input. UL schedules K4BU and VE1JD. HUM is on 3720 kc.; he will be Florida-bound in Nov. JWT on 3550 kc. applies for O.R.S. QY was active on c.w. in Field Day, making 7 QSO's using 6L6 on 3.5 mc. CJS worked two G's, two F's and one VK. GUW visited Hudson Convention. HUM reports HUB tuned up for 'phone. BDB has new homemade superhet. ITK is Class A. HUM is building 6L6 osc. to drive two tens. IUR schedules the west on 7 mc. QY reports BCR and JIG of Newburgh joined N.C.R. JAX met 3PG at Lake George. HNH desires to hear from hams in Kingston. BLU got heard card from U.S.S.R. GTW is going to R.C.A. FQG is doing nicely at State Hospital, Raybrook; he would appreciate hearing from the boys. IKV and XYL report attending Chicago Hamfest; they visited Collins factory, also visited 8PNF, VE2HE, 8KXH, General Radio (Cambridge, Mass.) and Harvard Tercentenary. JWK is active on 1.75 mc.; he reports the onion farm visitors IKS, JNI, JRR, DBY and BLU. IXK returns to Harvard for 1937. GFD, ex-Kingston, now at Poughkeepsie is back on 56 mc. CVT built very near 56-mc. receiver and transmitter using metal tubes. DWO has his 132-ft. antenna fastened to tallest building in city. DOS, HES and HVS are mostly on 3.5 mc. BJX is on daily A.M. schedule on 3560 kc. handling traffic and rag-chewing. CDM is working DX on 14 and 7 mc. GXE returns to M.I.T. FXC enjoyed N.C.R. cruise on *Wyoming*, sailing to Halifax, N.S. ACB is at new QTH on Lenox Road, Schenectady.

Traffic: W2EGF 252 LU 144 HYC 181 UL 8 HUM-JWT 6 QY 4 CJS 1 BJX 199.

NEW YORK CITY AND LONG ISLAND—SCM, Edward L. Baunach, W2AZV—LG is now O.R.S. IXZ and KAT sent their first reports. DBQ has the A.A.R.S.—Section net operating daily on 3710 kc.; all those wishing to be on should get in touch with him. IBT is on every day from 6:30 A.M. to 8:30 A.M. on 3598 kc. and is open for schedules. HGO operates on 7096 kc. with 510 watts input and is looking for schedules. DXO can be heard in the Section net. AYJ won club certificate in last DX contest. HBO worked all districts but the sixth on the night of Sept. 7th on 3720 kc. HUI moved to Woodhaven. ECL contacted W1OXDA on 14 mc. HLI is arranging a schedule with the U.S.S. *Gilbert* of the U.S. Coast and Geodetic Survey. APV is trying out new antennae and reflectors. The Stork brought EAR a Jr. op. on August 31st; he counts that as one delivered. EVA is building new rig for the winter. IHE joined the N.C.R. HGM is using M.O.P.A. on 56 mc. GNZ is using '45's in push-pull modulated by a 53 on 56 mc. EPZ constructed an amplifier using 6L6's in push-pull and says they are FB. BMG and HFM spent a whole evening looking for FIJ on 3710 kc. while he was calling them on 3720 kc. The new officers of the Erasmus H.S. are HPG, president; KAT, vice-president; J.J.N, secretary; the school station, ANU, has a new transmitter and receiver and operates on 1980 kc. JFP will operate portable from Stoney Brook prep school after September 28th on 3.5-mc. c.w. KI will resume trunk line schedules. DBR operates the Harbor mail boat, WTDS. JGC is having trouble with crystals. J.J.Y. is on 7 mc. with ten in final. IOP worked VS2AG; that makes him W.A.C. BGO is back on the job after a very busy summer. JBL's vacation is over and he has to cut time on the air. HVS worked his first VK. EXR had happy days on his vacation. IHT is having tough time getting 6L6's to perk in final. EYS had good time with N.Y.N.G. AZY is back on 3570 and 3922 kc. GDF is back checking bad signals. AHC is out for some regular schedules. JHB is building new 100-watt rig. GJC blew his bottle and crystal.

Traffic: W2BMG 288 JBL 131 IBT 107 DBQ 89 PF-IHT 59 BDR 57 FF-AZV 31 ECL 27 DXO-EXR 9 HBO-HGO 8 BGO 6 JGC-GDF 5 IOP 4 LG-AHC 3 APV-HLI 2 HWS 1 JHB 27.

NORTHERN NEW JERSEY—SCM, Charles J. Hammersen, W2FOP—RZY joined the A.A.R.S. HOZ is a member of the early morning traffic net. HNP has new HRO. GAS had 3PTK as visitor. HXI has 53 c.c.-'10 amp. working FB on 3.5 mc. with about 60 watts input. GVC is back

(Continued on page 88)

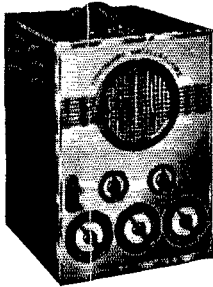

Neobeam Oscilloscope

**MAKES
SOUND
VISIBLE**

- ★ Super-sensitivity — 1 Microvolt
- ★ 4 inch Calibrated Screen
- ★ Self-contained POWER SUPPLY and SWEEP SYSTEM

LAATEST development in OSCILLOSCOPES. Opens new fields in audio measurements. Has extreme simplicity of operation. Best and least expensive instrument for wave form study. Also used as an ultra-sensitive galvanometer and vacuum tube voltmeter. Weighs only 25 lbs. Measures 8 3/4" x 10" x 13". Chrome finish on panel. Fully guaranteed. Write for full details or send order today.

**ONLY
\$4000
Complete**

SUNDT ENGINEERING CO.

(Affiliate Littelfuse Laboratories)

4246 Lincoln Ave.

Chicago, Ill.

VALPEY CRYSTALS

Step by Step Precision Made

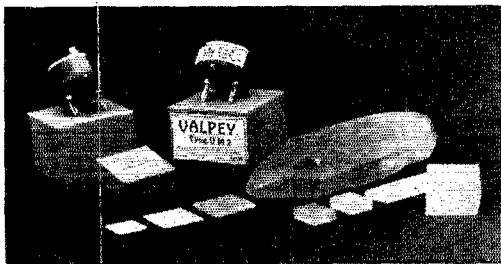

Type VM2 mounted X cut crystal frequency drift less than 15 cycles supplied within 5 Kc of specified frequency in the 1.7, 3.5, 7 mc bands \$3.00, exact..... \$5.00
 Type VM2A mounted crystal frequency drift less than 4 cycles supplied within 5 Kc of specified frequency in the 1.7, 3.5, 7 mc bands \$4.50, exact..... \$6.50
 Type VC2 unmounted 1 inch square crystal supplied in the 1.7, 3.5, 7 mc bands within 5 Kc of specified frequency..... \$2.25
 Type VC2 in the 1.7, 3.5 Kc bands only supplied within 20 Kc of specified frequency..... \$1.50
We guarantee your satisfaction or your money will be cheerfully refunded. You may obtain our products by ordering direct or from your dealer.

THE VALPEY CRYSTALS

377 SUMMER STREET

MEDWAY, MASS.

SICKLES COILS

ALL TYPES OF RF AND IF WINDINGS

Manufactured by

F. W. SICKLES COMPANY

300 Main Street

Springfield, Mass.

When the condenser plug is not in place there is no d.c. connection from the negative high voltage side except through C_{13} . In consequence, a jumper, "X," must be inserted when the condenser mike is not plugged in. Failure to do this may result in injuring C_{13} .

The entire assembly is mounted on a standard chassis base, supplied with a cane-perforated dust cover. The transformers and chokes are oriented for least hum pick-up, at the same time avoiding the necessity for small angles of difference in placement. Hum level with maximum gain in the 6N7 channel is approximately 40 db down. With all gain controls near mid-setting the hum level is somewhat higher, due to "floating" input circuits offering a greater impedance for hum voltages. This effect, unfortunately, cannot readily be entirely avoided. It is doubtful if the basic hum level could be further lowered appreciably without resorting to special precautions and power supply on a separate chassis. Such residual hum as is present is probably largely due to the type of output transformer; a balanced "high-fidelity" type would, of course, be preferable—and also much more expensive. For ordinary uses, however, no departure need be made from the fundamental objective of the general design—the achievement of a maximum of performance with a minimum of complication and expense.

BOOK REVIEW

Official Radio Service Handbook, by J. T. Bernsley.

1008 pages, including index, with numerous illustrations. Published by Gernsback Publications, Inc., New York City. Price, \$4.00.

This volume is probably the most comprehensive up-to-date compendium of service information (not circuit diagrams) at present available. There are detailed chapters on circuit fundamentals, intricate tuning circuits and aligning data, volume control, tone control, a.v.c. and resonance indicator circuits, receiver a.f. amplifier systems, receiver power supplies, loud speakers, pickups and electric phonograph equipment, analysis of commercial receiving circuits, fundamentals of meter and test equipment, commercial types of test equipment, the cathode-ray oscillograph and supplementary equipment, practical applications of the cathode-ray oscillograph, how to build essential servicing and test instruments, hints on localizing trouble, short cuts with test equipment, hints on receiver repairs, unusual servicing experiences, all-wave high-fidelity receiver data, auto radio installation and service, specialized installation and servicing, noise interference elimination, modernizing and improving receivers, receiver conversion work, improving knowledge and technique, uplifting the profession, and, in the final 455 pages, an elaborate operating notes section giving a wide variety of such useful information as field coil resistances, i.f.'s, etc., for all types of sets.

The treatment is essentially complete and accurate. It treats all servicing angles up to the autumn, 1936, models of receivers. The book is profusely illustrated. There is, however, no attempt to diagram all types of receivers. The principal structural defect is remarkably poor proof-reading.

The Radio Service Handbook can be summarized as an authentic and competent serviceman's compendium, as well as an effective course in practical work on radio receivers which many amateurs can study with profit and a highly suggestive manual of general radio testing and simple laboratory technique.

C. B. D.

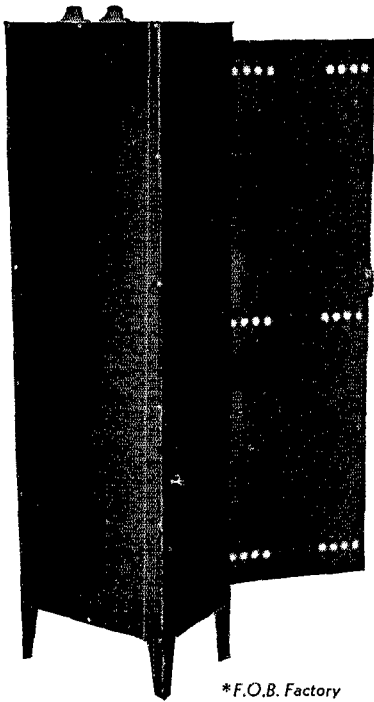

*F.O.B. Factory

TRANSMITTER HOUSINGS

... THAT HIT THE SPOT ●

Now you may have a complete housing for your transmitter — panel, shelves, sub-shelves — all assembled and ready for your rig! Provided with hinged door and latch, these housings are finished in Q-Max Telephone Black. Continuous 3/16" Tempered Masonite panel, backed up by thin steel panel, is finished in Q-Max Crystalite Black, is easy to drill and excellent in appearance. Does not warp. Sub-shelves are black finished 3/8" ply-wood approximately 11" x 16" with rubber feet. These slide on fixed shelves in the housing making assembly of apparatus easy and in full view.

These housings provide practically complete shielding, keep your rig clean and free from dust and give protection against contact with high voltage leads. We believe these housings better fill the needs of the amateur than rack and panel construction. And notice how easy they are on your pocketbook!

PRICES

- CP-49 — 66" high, 18" wide, 12" deep with 6 shelves.....\$22.50* Net
- CP-49A — 44" high, 18" wide, 12" deep with 4 shelves.....\$15.50* Net
- CP-49B — 34" high, 18" wide, 12" deep with 3 shelves.....\$12.50* Net

If your dealer can't supply you, we will ship direct. No crating charge

Send for our new catalogue of amateur radio devices

COMMUNICATION PRODUCTS, INC.

245 Custer Avenue, Jersey City, N. J.

HAMS HERE'S A PRIZE CONTEST FOR YOU!

If you have a good idea on a Ham item that is not made by any manufacturer, tell us about it. If your idea sounds good and we manufacture it you will be awarded a cash prize of twenty-five times the price the product will sell for. Submit as many ideas as you can think of — and remember — we award the cash prizes promptly.

GORDON SPECIALTIES COMPANY
440 South Dearborn Street, Chicago, Illinois



PLUG-IN COIL FORMS

For every purpose where plug-in inductances are required in S.W. Receivers and Transmitters. Made of Special High Grade Low Loss Bakelite in natural brown color, and in the following three sizes. Ribbed for air space windings.

- 2 3/4 inch diameter — 3 1/4 inch winding space.
- No. 734 — 4 Prong — List.....\$.60
- No. 735 — 5 Prong — List.....\$.65
- No. 736 — 6 Prong — List.....\$.70
- 1 1/2 inch diameter — 2 1/4 inch winding space.
- No. 123 — 4 Prong — List.....\$.30
- No. 126 — 5 Prong — List.....\$.30
- No. 310 — 6 Prong — List.....\$.35
- 1 1/4 inch diameter — 2 1/4 inch winding space.
- No. 594 — 4 Prong — List.....\$.20
- No. 595 — 5 Prong — List.....\$.25
- No. 596 — 6 Prong — List.....\$.25

40% Discount to Radio Dealers and Amateurs
New 1937 Catalog Available — Write Today for Same

BUD RADIO, INC.

1937 E. 55th Street

CLEVELAND, OHIO

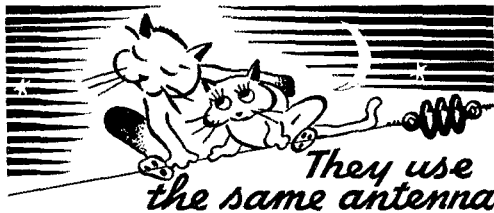

They use the same antenna

WARD LEONARD RADIO FREQUENCY RELAY

automatically changes over from receiving to sending antenna. Most convenient where directional and doublet antennae are used. Send for circular 507B. It tells about this relay and other items of interest to the amateur.

WARD LEONARD RADIO SPECIALTIES

WARD LEONARD ELECTRIC COMPANY

41 South St., Mount Vernon, N. Y.
Please send FREE Bulletin 507B.

Name.....

Street.....

City and State.....

Call Signal..... Q

(Continued from page 85)

on the air after an FB vacation. HQL went to Camp Dix for short military maneuvers. CIZ coached his cousin, KAZ, so he would have an outlet for his N.Y.C. traffic. HRN got an FB mark in his Communication Sergeant exam for the National Guard. GGW finally got his '03A perking again. IQM worked portable in the third and eighth dists. during the summer. BZJ had plenty of operating on S.S. Yarnall during N.C.R. cruise. HFT is building new rig with T55 amp. JKU worked portable in most of the southern states during his vacation. HMV is still killing the ether on 14 mc. GBZ is back from T.H. where he operated K6DV for two years. AGH is moving to a new unknown QTH. JMX moved to Roselle from Bayonne. HTX is going to Cornell. HVK is the proud possessor of a 14-mc. Johnson Q antenna. FFY has new QTH and is on 14-mc. 'phone. HFB is very active on 1.7-mc. 'phone. GZG is working on new Class B unit. IBZ has WE-252A on 4-mc. 'phone. IMB plans all chassis type transmitter. HLX spends his time shifting from 1.7 to 4 mc. DAC helped out at N.J. State Glider meet. JDY is having success on 7 mc. KAV hopes to increase power. JIO worked fine DX on 1.7-mc. 'phone using '45 in final, 6 watts input. JOU is still having trouble with his 56-mc. 'phone. IIA sticks to brass pounding with his pair of tens. 3LT is coming back on the air. 2FPO bought plate transformer to give 2000 volts—it gave 3500. FBG has pair of 35T's on 28-mc. and other bands. AHN has FB home built super. Plainfield Radiophone Assn. meets this year each Friday at the Local Y.M.C.A.: FFY, pres.; GYY, vice-pres.; GZG, treas.; IBZ, secy. The N.N.J. Section net is now in full swing. Contacts are needed in Bergen, Hudson and Passaic counties. If you are interested in traffic and want to get in the net, get in touch with your S.C.M. An A.R.R.L. membership or O.R.S. appointment is not necessary to become part of it. A genuine interest is all that is asked.

Traffic: W2BCX 297 (WLNK 342) HZY 240 GGE 170 HOZ 138 HNP 71 GAS 64 FOP 49 GMN 41 HXJ 28 GVZ 24 HQL 19 CIZ 14 HRN 6 GGW 4 IQM 5 ICJ 4 BZJ 2.

NEW ENGLAND DIVISION

CONNECTICUT—SCM, Frederick Ellis, Jr., W1CTI—UE kept INF's schedules part of the month. Hal at INF had a week's vacation. GKM will be 100% traffic station this fall. AFG reports IED worked CP1AA on 'phone. JOR sends first report. The Connecticut Association of Radio Clubs was officially organized at a meeting at the Bristol Radio Club, Sept. 11th. A constitution and by-laws were adopted and a committee appointed to investigate ways and means of publishing a monthly bulletin. Officers elected were: pres., EFV; vice-pres., EER; secy., JHM; treas., FZA; directors, APA, FLQ and DBG. The C.A.R.C. is anxious to have all active Connecticut radio clubs join the Association. Inquiries should be addressed to Secy, Ben Lydick, 109 Carleton St., Hamden. Traffic is picking up. We expect a much better report next month. Don't disappoint us.

Traffic: W1UE 117 INF 73 GKM 13 AFG 10 HYF-JOR 8 DOW 4 GC-HTS 2 CTI 1 EAO 4.

MAINE—SCM, John W. Singleton, W1CDX—INW is in line for R.M. appointment; he did very fine work with Bowdoin Kents Island expedition. BTG runs second place and is aiming at the top of the traffic pile. ICB has returned to N. Y. C. but will be back in Maine next June. GOJ has been appointed Chief R.M. in charge of Maine "Message Pushers Net." DHE has worked all continents in 10 hours 3 minutes and he would like to know if this is a record for Maine. How about it, you DX men? DUJ in Warren and DHH in Hallowell were preceded in their QSO's with VS6 by both BPX of Brewer and IQZ of Orono. BPX worked VS6 a year and a half ago and IQZ QSO'd VS6 early last winter. AKR of Brewer worked 15 countries on 3.5 mc. IQZ made over 60,000 points in last DX contest but didn't send in his log so lost first place to DHE.

Traffic: W1INW 325 BTG 113 CDX-ICB 4 GOJ 2.

EASTERN MASSACHUSETTS—SCM, Albert N. Giddis, W1ABG—AKS is reorganizing 56-mc. A.A.R.S. Net. HWE is practicing up on the "bug" key. KH says 28 mc. is opening up again. HKK worked his 41st country; he applied for O.R.S. JSK says push-pull final pushes no power into the antenna, but pulls plenty from the power pack! JCK reports FAR rebuilding. QW is having outfit re-vamped by DYC. HKY cured chirp in transmitter. JNU is getting out FB on 1.75-mc. 'phone. HHR has complete station in box one foot square! HCH led Section in

last O.R.S. Party. HWZ is back in O.R.S. ranks again. EVJ is headed for So. America. JXO is on 3.5 mc. with '10's. WV made his first So. American contact on 28 mc. IID worked LU7AZ for his first foreign 'phone-c.w. contact. JTI is new O.O. JNV is at new QTH in Dorchester. IZZ is running air compressor on state projects. HOB and IXL did fine work operating GEX/1 at Marine Corps Convention, BEF, AKE and LJ installed receivers for Lowell Police Dept. QW and DYC toured New England and Eastern New York with 56-mc. portable rig. HMM is conducting code classes for the Brockton Amateur Radio Club. This club is a live-wire one with over one hundred members; the officers are: JPM, pres.; HMM, vice-pres.; IZB, 2nd vice-pres.; JBP, treas.; and HNY, secy. The M.V.A.R.C. elected BEF, pres.; JNU, vice-pres.; HXE, treas.; and JED, secy. This club is anxious to hear from other clubs in the Section relative to an inter-club competition. The S.C.M. should like to hear from stations in or about New Bedford, Taunton, Brockton, Fall River or on the Cape, whether A.R.R.L. members or not, that might be interested in becoming part of the Section's new traffic network. Other Sections have already indicated a desire to take our measure this year, so don't fail to report your activities to the S.C.M., no matter how unimportant they may seem. Many thanks.

Traffic: W1AKS 177 HWE 155 KH 92 GEX/1 89 IWC 45 HKK 35 JSK 29 JCK 27 ABG-QW 15 HKY 12 RE 9 FRO 5 BEF-JNU 4 HHR 2.

WESTERN MASSACHUSETTS—SCM, William J. Barrett, W1JAH—Director BVR appointed New England S.C.M.'s as asst. directors. IJR is working hard on Police Net. Any hams interested in this project, please get in touch with IJR. JAH made the R.C.C. and also Emergency Corps. AJ applied for O.R.S. FB, OM, HJR is going to college in Indiana—Good luck, OB, congrats on Class A. ISN visited 2IPB on vacation. GUO now has break-in keying. JMH is working 7-mc. DX with '45 TNT. BAP is sticking to 56-mc. mobile. COI is working DX on 14-mc. 'phone; 6L6 exciter still in the works. The Communications Dept. lineup as found on taking over S.C.M. job is as follows: R.M.: A.JD, JAH; A.A.R.S.: IJR; N.C.R.: DDK; P.A.M.: GZL; O.B.S.: BKQ, BVR, BSW, GZL; O.O.: ZB; O.R.S.: A.JD, APJ, ARH, ASY, AWW, BKQ, BNL, BJS, BVR, BWY, COI, DDE, EOB, GUO, IJR, IOR, IOT, ISN, JAH, ZB; O.P.S.: ASY, BAP, COI, DUZ, GZL, HJR. Appointments not on this list have been cancelled for failure to report. Making a good showing for our Section calls for the cooperation of each operator, whether or not you hold appointment. Just a card each month on the 16th, giving the traffic handled, if any, and any news you believe interesting to the rest of the boys, will do the trick. A.A.R.S. and N.C.R. traffic may be reported either direct to S.C.M. or to your R.M. We need reliable traffic stations in Worcester and Franklin counties. If interested, drop me a line to arrange for test for O.R.S. Let's go, gang, and show the rest of the Sections what we are made of. 73.

Traffic: W1BYR 61 (WLG 147) IJR 52 (WLG 5) IOR 48 JAH 41 AJ 29 HJR 13 ISN 9 AJD 8 GUO 5.

NEW HAMPSHIRE—SCM, Carl B. Evans, W1BFT—I want to thank the fellows in this Section for their support in the recent election. I will try to perform the duties of this position to the best of my ability. Any and all suggestions will be gladly received. JT has a new Jr. op; congrats, OM. EAW called CQ on his horn and raised a cop; the cop demanded to see his license! The M.V.A.R.A. held a hot dog and corn roast at Broad Cove, Contoocook River, Sept. 14th; a good time was enjoyed by all. JJD is working part time for BFT now. JCA is thinking that he will need a new receiver if he is going to work any DX this fall. HUD has tried a 53 crystal oscillator and claims there is nothing like it. IVU has been working DX on 14-mc. 'phone. FAB has just returned from New York City. AVL is now working for Swift & Co. IOC has a home-built super-gainer and claims it is very FB. After a summer on 56 mc., IP is back on 3.5 mc. lining up traffic schedules. Ask IJB how to build a good super-het; he knows all the answers. KAW, our new N.H. YL operator, is very active on 4 and 7 mc. OE has finally left 56 for 3.5 mc. HOU has at last got his 860 to take a half kw. input and has worked a lot of VK's on 14 mc. HPX is at the University of N.H. JBA has gone to Florida for the winter. GKE has forsaken ham radio for shooting dump rats. APK was honored by a visit from HB9R and HB9Q. AVJ has a new HRO receiver. ESB has had an RK-28 for several months and hasn't got around to

even light the filament! HOV is still having trouble with filter condensers. JKH is building a new transmitter and will be on 3557 kc. by the time this is in print. DUK has moved to a new location. AUW would like to have all N.H. 'phone stations join in with the N.E.D.R.A. every Sunday at 9:00 A.M. CEA has joined the A.A.R.S. GTY blew a filter condenser. IDY had a nice visit from 2DSH. AXW has given up the thought of going on 'phone. The first test drill of the N.H. Emergency Net was held Sept. 20th; total contacts included 17 stations in 10 towns and cities; if any of the gang is interested, get in touch with the S.C.M. GMM has been reappointed O.R.S. APK has been appointed P.A.M. in charge of 'phone emergency net operations.

Traffic: W1FPL 62 (WLGW 29) IP 27 LJB 22 IDY 8 CEA 6 BFT 6 GTY 5.

RHODE ISLAND—SCM, Clayton C. Gordon, WIHRC—JJP has rebuilt entirely in iron rack and has new Hall-crafter "Sky-Buddy." It is a real pleasure to see QR sending in traffic reports again (former S.C.M.) and also to get a request for O.R.S. application from another former S.C.M. (AFO). GTN got rid of key-clicks in 59 by keying the screen grid. ILO lost 16 miles of filter and went on 7 mc. BVI has new job. ISG and JNO are attending Eastern Radio Institute. IQF is new O.R.S. GTS has new job with Phone Co. JXA tried putting high polish on one of those "blasted surface" crystal holders with very excellent results. HRC has ordered 3660-ke. crystal for the N.E. Div. Director's net, and, by the time this reaches you, you will be able to hear your Asst. Directors rag-chewing A.R.R.L. business on this spot frequency at 6:30 p.m. on Friday nights. CBX lost an "ole fran" when he stuck 5-year-old crystal in in 6L6 circuit and blew her up. JEZ is off 56 mc. brushing up on code to go on 7 mc. IZO has Class "A." CAB is back on the air at another new QTE. BFV is getting Army radio experience with Nat'l Guard. DAH has been enjoying vacation with FAH. JXL won a 6L6 in a rag-chewers contest. DDY made his own B.C.L. coils for Skyryder, and they worked. Fellows handling traffic should note they are entitled to an extra credit of 1 for each message delivered to a third party; to get credit for them, however, they have to show on the report card; we are no mind readers. The Providence Radio Association is planning another of its Annual DX-QSO contests for early winter or late fall—exact date to be announced next month—this will be a wonderful opportunity for W.A.S. aspirants to hook Rhode Island stations; it will be a Saturday all-night affair, as usual.

Traffic: W1JJP 108 IEG 86 (WLGK 41) QR 37 (WLGW 8).

VERMONT—SCM, Alvin H. Battison, W1GNF—R.M.'s: 1FSV, 1EZ. P.A.M.'s: 1AVP, 1DQK, FFS (BCK-DAQ also operating) is high traffic man. AXN has moved back from camp and has two new 50-foot poles up. ELR and AAK both have 500 watts on 28 mc.; AAK is now using 50T's in his final. IIV is forming a 1.75-mc. 'phone net. EMQ attends M.I.T. ATZ rebuilt to '47-RK-23-35T-'52 in a six-foot relay rack. GAE is now operating on 3.9-mc 'phone. ATF reports the good fist of JMO. FSW is still in Philadelphia. Playful AVP has an electric chair arranged for his visitors. IRO is operating 14 mc. with 450 watt 'phone. GAN and IRO are sharing GAN's shack. EZ has his 14-mc. beam aimed over the North Pole. JHK is having receiver troubles. BD is preparing for A.A.R.S. season. IDW has 250 watt 14-mc. rig well started. BD and BVJ return to their teaching positions. ILX has returned to the fold. BJP is experimenting with 6L6 osc. Vermont amateurs will observe a General Traffic Hour starting Oct. 1st at 6:00 p.m. E.S.T.; FSV will act as control station for stations unacquainted with the proper routes.

Traffic: W1FPS 57 FSV 36 JHK 20 GNF 17 EZ 7 GAE 6 ATF 3.

ROANOKE DIVISION

NORTH CAROLINA—SCM, H. S. Carter, W4OG—Badin: Two new hams in Badin, EIT using a pair of '46's in final, and EIU using a pair of '10's in final on 7 mc. Mount Holly: CYY led the State in traffic this month; he has good schedules, and is on Trunk Line "C." (Shoot him your traffic.) Latimore: DGU is 100 percent traffic. Warren Plains: BHR has been using his 25-watt emergency rig for the last two months and gets out well. Belmont: CXO has finished his new rig. Kings Mountain: DOQ is increasing power. DOV is getting along fine, but is planning to rebuild. DOZ has a new receiver. CEI is QRL building an all-band

'phone for 4CE. Gastonia: BDU is rebuilding rack and panel transmitter. CEN is working plenty of DX. CDQ can't decide which band to light on. CXV has moved. CXW is QRL fixing autos. CPV is going to try 3.9-mc. 'phone. Oxford: ECH is working plenty of DX on 7 mc. Wilmington: FT is coming along fine with the 1-kw. 'phone rig. EC is returning to the air with increased power, and is experimenting with a Johnson Q. BPL has a new receiver. BQZ is experimenting with 6L6's. BRK is trying to get some of the "bugs" out of his 802. CPT reports, this time from Hot Springs, Ark.; he spent two weeks vacation at home for a change, and made up for lost time with his rig; he is experimenting with 56 mc. with CVQ at Fort Bragg. Winston-Salem: DWB has applied for O.R.S. CXF, CYA, CJU, DCQ and IF have left for N.C. State College at Raleigh. ABT is back on with the A.A.R.S. DCQ and BOH had a nice trip visiting the hams up North. CYA and OG attended the Central Division Convention at Chicago, also visited the Great Lakes Exposition and 8QBT in Cleveland. With the 'Phones: DCG completed new rack and panel job to operate on 14, 7 and 3.5 mc.; he is trying for W.A.S. BIP has applied for O.P.S. appointment and promises to be on regularly this winter. 73.

Traffic: W4CYY 38 CXC 29 BHR 19 ECH 18 DCS 14 ABT 9 BRT 8 OG-BVD-DCQ 6 EG 4.

VIRGINIA—SCM, Charles M. Waff, Jr., W3UVA—CSY has a new shack. DJC cancelled schedules during summer. FQY received Class A ticket. BWA scheduled ENJ while in National Guard Camp. AKN is putting on an 861. EZL works Baltimore on 56 mc. from Alexandria. WS reports QRL with Division Convention plans for 1937 in Richmond. BZ is using an 800 in the final on 28 mc. AIJ plans big things for the 3.9-mc. 'phone net this winter. Write him if interested. DDD is building three-stage five-band transmitter. EAP has 860 e.c. osc. and '52 final on 14 and 7 mc. FFC is building a new rig with a '10 final. FE has QRM from hay fever. FFD will be back on 3.5 mc. soon. BGS is putting up a new zepp antenna. DWE will be on c.w. and 'phone. FIK expects to have his new 'phone rig on in October. 1BMP/3 will be on soon; he is in Coast Guard. EKV schedules 1HYC. FGW worked SUIRO and ONSAH for first African contacts. FZS was off last month due to cross-country flight with Army to west coast. CA has finished his exciter unit. GBC worked three Cubans. EMA is on with a 211 with 200 watts input. EHL is working in ham store in Richmond. DQB resigned as O.R.S. and R.M. for Norfolk Section. ELJ is building a new 14-mc. rig. UVA is back home again and will be on soon. 4AKH/3 is operating on S.S. Fairfax. BSB enjoys "QRX." FQO is in school at Univ. of Va. BZE operated at FJ during hurricane; he is freshman at Univ. of Richmond. 1ISM is at Univ. of Va. So are 2HKD, 2IPP, 3AQK, EXW, and UVA. BIW reports 28 mc. wide open again; he worked G, ON, PA, F, VE, and W7 on 28 mc. week-end of Sept. 20th-21st. ADD, AHQ, AKN, BEK, BJX, BYA, CSI, EMM, EZR, FQO, FTC, GCH, UVA, WS and ZA attended Roanoke Division Convention at Clarksburg, Va. Next meeting of Virginia Floating Radio Club is in Norfolk, Oct. 31st-Nov. 1st; a big time assured. All reporters will receive "QRX" monthly; let's hear of your activity!

Traffic: W3BWA 78 DJC 9 CSY 8 AHQ 4 EKV-FFC-FQY-GBC 1.

WEST VIRGINIA—SCM, Dr. Wm. H. Riheldaffer, W8KKG—PHY, PSR and KXC are new O.R.S. DSJ worked XE1CM on 28 mc. MOP has new RME-89. CMJ is finally on with crystal control. ANU schedules 9TFH. PSR attended Ohio River Festival. QFN is new Huntington Amateur. PZT has a pair of 814's in his new final. FQB reports that he is working portable 1BFB. Mrs. MCR is recovering from recent illness. LXF is on 3574 kc. AKQ won PR-16 at Roanoke Division Convention. MCL is back on trunk line. ELO finished new rack and panel job. KXC schedules 5EHQ. PUA is on with new beam tube rig all bands. NLE left for University of Alabama. KKG received verification of Asian 'phone contact. BOW, CXR, MOP, MOL and BDD are on 3.9-mc. 'phone regularly. JRL is running 1 kw. on 14 mc. driving final with three 6L6's. AZD has 97 countries. CWY is new West Virginia W.A.C., as is FVU. LII has new R.C.A. receiver. PZP traded a mike for three '42A's. BOK is building high-power crystal transmitters. OJI is putting in an '01A.

Traffic: W8ANU 5 PSR 8 LXF 7 OBA 3 KXC 6 LII 5 MCL 19 ELJ 2 KKG 92 OK 24 HWT 32 AKQ-PZP 4 CZ 2 MCR 7.

LIKE BEARS AFTER HONEY

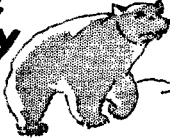

Not unexpected, but nevertheless quite gratifying, was the response to the Type 9 series of Moulded Mica Transmitting Capacitors. It has proven itself to be one of the most popular of the many capacitor series that C-D has engineered for the "dot-dash" fraternity.

No "Ham" has ever been more careful of the components built into his "rig" than we, at C-D, in the manufacture of the Type 9 condensers. Unending laboratory research and supervision, careful production control and inspection has made possible the assembly of this unit, so extensively used by the U. S. Government departments, manufacturers of aircraft, marine and submarine transmitters and others where utmost dependability and unflinching continuity of operation is imperative.

For assured and dependable DX—use C-D Type 9. Your favorite jobber can supply you. Catalog No. 133A illustrating and listing this series in complete detail, on request.

MANUFACTURERS OF FINEST CONDENSERS FOR
MORE THAN TWENTY-SIX YEARS

MICA • DYKANOL • PAPER
Wet and Dry Electrolytic

CORNELL DUBILIER

1013 HAMILTON BLVD.

SO. PLAINFIELD, N. J.

M & H Specials for the Thrifty Ham

Raytheon 6L6G Glass Beam Tubes **\$1.18**

Thordarson Modulation Xformers for 6L6 & 35T **\$5.88**

Thordarson Ham Specials T6878 600V 200MA 7½ - 2½ - 5V **\$2.45**

T6877 Choke 12 Henry 250MA **\$1.95**

Oil-filled Condensers

2MF — 1000V.....98¢ 2MF — 1500V.....\$1.98

2MF — 2000V.....\$2.45 1MF — 3000V.....\$4.98

Kenyon Specials

1000V 200MA.....\$3.95

2½V 10AMP 3000V Ins......99¢

Hoyt R. F. Meters

1½ - 3 - 5 Amp.....\$3.67

Taylor T55.....\$8.00

Write for the New 1937 Radio Catalog

M & H Sporting Goods Co.

512 MARKET ST.

PHILADELPHIA

1709 Atlantic Ave.

Atlantic City

T. R. McELROY

WORLD'S CHAMPION RADIO TELEGRAPHER

23 Bayside Street, Boston, Mass.

MAC KEY @ \$7.95 a real speed key.

MAC KEY DELUXE @ \$15.00.

MAC CORD @ \$1.00 speed key cord.

MAC CASE @ \$3.95 speed key case

MAC OSC @ \$3.95 ac/dc oscillator Tone control.

If u hv Mac Key vrrl me fo xmy ipt & drsb ifn.

All my stuff emcy gad best pdnts obl. 73 Mac.

Standard Frequency Transmissions

Date	Schedule	Station	Date	Schedule	Station
Nov. 1	C	W6XX	Nov. 29	C	W6XX
Nov. 6	A	W6XX	Dec. 4	A	W6XX
Nov. 13	B	W9XAN	Dec. 11	B	W9XAN
	B	W6XX		B	W6XX
Nov. 18	C	W9XAN	Dec. 16	C	W9XAN
Nov. 20	B	W9XAN	Dec. 18	B	W9XAN
	A	W6XX		A	W6XX
Nov. 25	BB	W9XAN	Dec. 23	BB	W9XAN
Nov. 27	BB	W6XX	Dec. 26	BX	W6XX
	A	W9XAN	Dec. 27	C	W6XX
Nov. 28	BX	W6XX			

STANDARD FREQUENCY SCHEDULES

Time (p.m.)	Sched. and Freq. (kc.)		Time (p.m.)	Sched. and Freq. (kc.)	
	A	B		BB	C
8:00	3500	7000	4:00	7000	14,000
8:08	3600	7100	4:08	7100	14,100
8:16	3700	7200	4:16	7200	14,200
8:24	3800	7300	4:24	7300	14,300
8:32	3900		4:32		14,400
8:40	4000				

Time (a.m.)	Sched. and Freq. (kc.)
6:00	7000
6:08	7100
6:16	7200
6:24	7300

The time specified in the schedules is local standard time at the transmitting station. W9XAN uses Central Standard Time, and W6XX, Pacific Standard Time.

TRANSMITTING PROCEDURE

The time allotted to each transmission is 8 minutes divided as follows:

2 minutes—QST QST QST de (station call letters).

3 minutes—Characteristic letter of station followed by call letters and statement of frequency. The characteristic letter of W9XAN is "O"; and that of W6XX is "M."

1 minute—Statement of frequency in kilocycles and announcement of next frequency.

2 minutes—Time allowed to change to next frequency.

W9XAN: Elgin Observatory, Elgin National Watch Company, Elgin, Ill., Frank D. Urie in charge.

W6XX: Don Lee Broadcasting System, Los Angeles, Calif., Harold Perry in charge.

Schedules for WWV

EACH Tuesday, Wednesday and Friday (except legal holidays), the National Bureau of Standards station WWV will transmit on three frequencies as follows: noon to 1:00 p.m. E.S.T., 15,000 kc.; 1:15 to 2:15 p.m., 10,000 kc.; 2:30 to 3:30 p.m., 5000 kc. On each Tuesday and Friday the emissions are continuous unmodulated waves (c.w.); and on each Wednesday they are modulated by an audio frequency. The audio frequency is in general 1000 cycles per second.

Seventh Sweepstakes Contest

(Continued from page 31)

time for meals, for 8 hours' daily sleep, etc. Cross examination of logs makes it possible to check the operating time submitted of course.

Most effective choice of and use of the available operating hours, intelligent choice of the different amateur bands, and a high degree of operating proficiency will take one a long way toward success. Single-signal selectivity and high sensitivity will win and bring in the stations at distant points calling you. But the best equip-

ACE HIGH

with
Amateurs

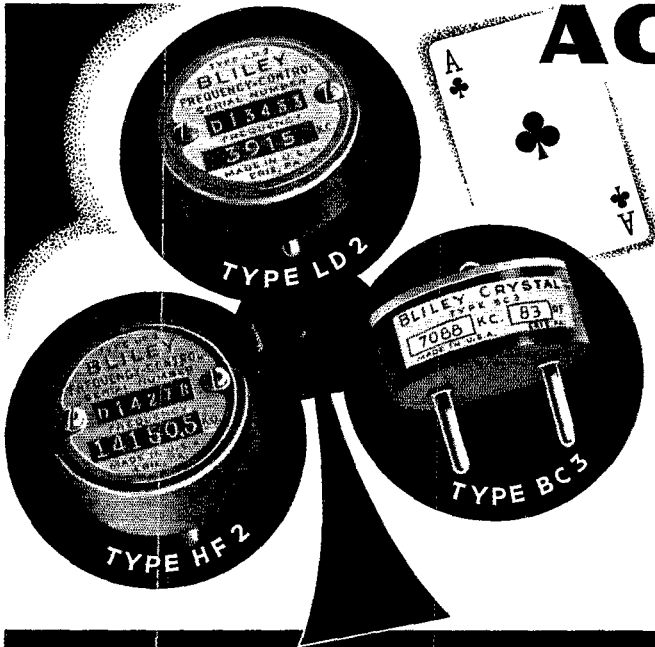

It's not by chance that thousands of amateurs all over the world use Bliley Crystal Units for dependable, accurate frequency control.

Operating experience has shown that these units are always thoroughly reliable, instantly snap into oscillation, key readily and give excellent power output.

Whether you choose the LD2 low-drift crystal unit, the HF2 unit for twenty meters, or the economically priced BC3 X-cut mounted crystal for your transmitter, you will make a grand slam in frequency control.

See your dealer about these popular crystal units and ask for your copy of the Bliley 1937 Technical Catalog. Bliley Electric Co., Erie, Pa.

BLILEY CRYSTAL UNITS

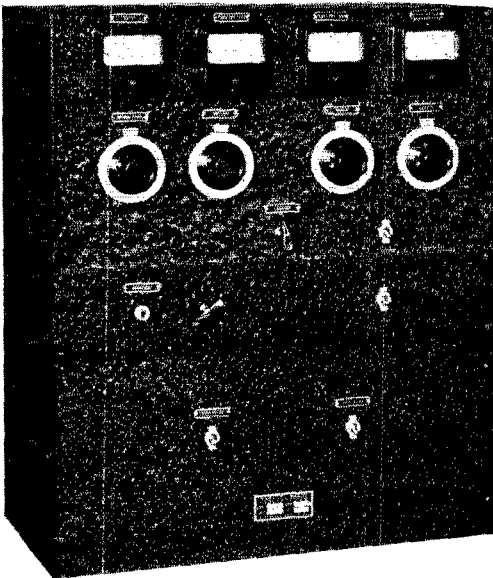

80-T TRANSMITTER

1500 TO 30,000 KILOCYCLES

- ONLY 3 TUNED CIRCUITS
- ANTENNA MATCHING CIRCUIT
- EXCITATION CONTROL
- PHONE — CW SWITCH
- 4 FULL SCALE METERS
- SEPARATE OSCILLATOR SUPPLY
- NEW 6L6 OSCILLATOR
- 3 TYPES OF KEYING AVAILABLE
- NO NEUTRALIZATION
- 125 WATTS INPUT

80-T TRANSMITTER

Less tubes and accessories

\$135.00 WRITE FOR
FULL DETAILS

HARVEY RADIO LABORATORIES, INC.

12 BOYLSTON STREET, BROOKLINE, MASSACHUSETTS

Export: 25 Warren St., N. Y. C. Cable: "Simontrice"

THREE STORES

Hartford, Conn.
203 Ann Street

New Haven, Conn.
86 Meadow Street

Bridgeport, Conn.
195 Cannon Street

Fulfilling the frequent need of the Connecticut amateur for prompt, efficient, satisfactory service on amateur supplies.

NEW and SPECIAL

RCA 866.....	\$1.75
Amperex HF 100.....	10.00
Taylor T-55.....	8.00
Taylor 866.....	1.65
Thor. 1200 v. CT 200 ma. pow. tr. 2.5 and 7.5 v. Fils. ...	2.45
Thor. 12 hy. 250 ma. ck.....	1.95
Thor. 6L6 tr., 60W. Modulation	5.88
Thor. 6L6 input tr.....	2.21
RCA 6L6 tubes.....	1.18
50 watt sockets.....	.75
39 unit rack (6 feet).....	8.50
Aerovox 2 mf. 2000 v. oil....	2.80
Aerovox 2 " 1000 v. ".....	1.97
Aerovox 2 " 1500 v. ".....	2.30

Rugged prest-wood, crackle, rack panels. Cost less, serve well, easy to drill, cut. 7 unit only \$1.25, 3 unit 54c, etc. Ready cut meter panels.

National NC 100, Hallcrafters, RME 69, ACR-175, Hammarlund

TIME PAYMENTS FOR CONN. HAMS

HATBY & YOUNG

Radio Since 1912

ment is only as useful as the man behind the key or mike can make it.

THE GENERAL CALL

"CQ SS CQ SS CQ SS de W . . . W . . . W . . ." is used by stations looking for contacts in the Sweepstakes. During the most active hours a single snappy CQ SS will bring results! The chance is one to test station performance, to work new states and Sections, to improve operating efficiency and ability, and meet old and new friends, all in the true ham spirit.

PROOF OF QSO

At least a *one* way complete six part exchange must be completed and acknowledged between two stations as "proof of QSO" ⁴ before points or Sections can be claimed.

Logs will be checked against each other to insure fairness and accuracy in making awards. It is not essential that each station worked be taking part in the contest to make your points count. Any operator who needs information can be referred to this announcement. First, ask the operator to take your preamble and come through with like information in preamble form.

POWER FACTOR

If the power input to the final stage (plate current times plate voltage— $E \times I$) is:

- (a) Up to and including 100 watts—multiply score by 1.5.
- (b) Over 100 watts—multiply score by 1.

Operating in both low- and high-power classes at different times is still permitted, but scoring rules do not permit Sections worked on high power to be used in the low-power classification. Points of some kind are credited for every QSO with a *bona fide* exchange, whether the station worked is a leading "SS" man or a ham outside the contest. If one breaks his power class, however, the Total Score is the sum of scores separately computed for each power class and added together.

Scoring system in brief:

All contacts:

One point for each QSO when "receipt" is completed for an exchange one way.

Two points for each QSO when the required information is exchanged both ways.

For final score:

Multiply totaled points by the number of different A.R.R.L. Sections ² worked, that is, the number in which at least one *bona fide* S.S. point or exchange has been made.

Multiply this ⁶ by 1.5 if you used 100 watts or less for transmitter input.

ADDITIONAL RULES

1. Information required in contest exchanges (six parts) must be sent in the order indicated, that of the new A.R.R.L. message preamble. Incomplete exchanges or haphazard (wrong) order of sending will be considered as justifying

NEW!

SECOND EDITION

- The new STANCOR book of transmitter circuits and ideas is soon to come off the press. Get your order in early.
- REMEMBER — STANCOR transformers are designed by Amateurs especially for Amateur use.
- STANCOR transformers are built and GUARANTEED by one of the oldest and largest transformer manufacturers in the world. Your jobber carries them in stock.



Your Jobber
Recommends



MAIL THIS COUPON

STANDARD TRANSFORMER CORP.
852 BLACKHAWK STREET, CHICAGO, ILLINOIS

* I am enclosing 25c for Transmitter Manual

NAME _____ CALL _____

ADDRESS _____

CITY _____ STATE _____

NEW! NEW! AMPEREX HF 100

170 Watts Output at 1500 V. **\$10**
NET

SUN RADIO CO.

15 YEARS OF RADIO RELIABILITY
227 Fulton Street, New York City, N. Y.

NEW! NEW! RAYTHEON RK 35

60 Watts Output at 1000 V. **\$8**
NET

BLILEY CRYSTALS

HF2 \$6.50 LD2 \$4.80 BG3 \$3.95
ALL FREQUENCIES IN STOCK

R.C.A. TRANSCEIVER **\$19.95**

CARDWELL SPLIT STATOR
MIDGET CONDENSERS **39c** ea.
All capacities

De Forest 50's and 81's... **79c**

R.F. CHOKES — Low Resistance
200 MA. **88c**
500 MA. **88c**
1000 MA. **88c**

JOHNSON 50-WATT SOCKETS. **88c**

TAYLOR TUBES

T55 \$8 T155 \$19.50 866 \$1.65
Other types in stock

NEON TUNING WAND **\$1**

OIL IMPREGNATED XMITTING CONDENSERS

MFD.	Volts	Price
1	1000	\$1.10
2	1000	1.50
1	1500	1.45
2	1500	2.00
1	2000	1.75
2	2000	2.45

Raytheon RK36... **\$14.50**

National NC100 Receivers in stock

NC100X LATEST NATIONAL RECEIVER

Having very fine features such as — Built-in Power Supply, Band Switching, Crystal Filter and many other features. This is an outstanding Receiver and one of its kind.

Complete with Tubes, Speaker and Cabinet
YOUR OLD RECEIVER TAKEN IN TRADE

You may now buy any HALLICRAFTER RECEIVER ON TIME PAYMENTS

Write to us regarding plan and literature

HAMMARLUND SUPER PRO IN STOCK

RCA AGR 175... **\$119.50 complete**

NATIONAL HRO AND HRO, JR. IN STOCK

JOHNSON "Q" ANTENNA SYSTEMS

5M	\$3.82	20M	\$ 5.82
10M	3.67	40M	10.29

We carry a complete stock of Test Meters, Oscilloscopes, Oscillators, Analyzers, Tube Checkers.

THORDARSON XMITTING KITS IN STOCK COMPLETE NATIONAL LINE IN STOCK

40% DISCOUNT OFF LIST PRICES

TRADE IN YOUR OLD RECEIVER FOR THE LATEST MODELS

All mail orders promptly filled

THORDARSON'S SPECIAL TRANSFORMER. 600 volt output at 200 MA. with various filament taps. Cased... **\$2.45 Net**

Choke — 250 MA. at 12 Henrys... **\$1.95 Net**

Raytheon 6L6 Glass... **\$1.32**

Brush Crystal Phones... **\$5.40**

THORDARSON

CLASS B INPUT AND OUTPUT For 6L6's. Secondary is tapped for 2500, 5000, 7500 ohms and will deliver 60 watts of audio.

Input \$2.21 Output **\$5.88**
R.C.A. 6L6 tubes... **\$1.18 ea.**

We have in stock... Shure, Turner, Astatic, Amperite, Brush, all types of mikes, stands. Prices on Request

GUARDIAN & DUNCO RELAYS IN STOCK

MACKEYS... **\$7.95**

BUD CRYSTAL HOLDERS... **98c**

SUN XMITTING TUBES

801	\$ 2.95	203A	\$ 8.45
841A	2.95	211	8.45
830B	7.50	804	10.00
838	12.45	805	12.75
866	.98	304R	7.45
866A	1.45	830	6.00

NOW!

GTC HI-LO Power Transformers — with three tremendous new advantages!

HI OR LO Power Snap of a Switch

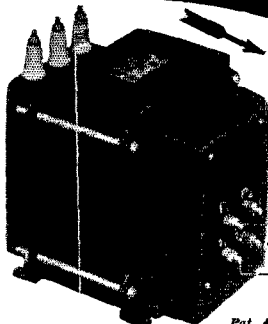

1. Now you can conveniently, safely reduce the power in tubes while tuning. Panel-controlled!
2. You eliminate waste of power. You tune with low power — then snap — and the soup's on!
3. Switch is in the 110 volt lead when you use GTC transformers — not in the high voltage lead, which is susceptible to arcs.

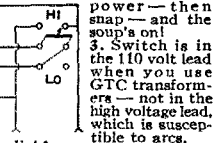

SENSATIONAL NEW BOOK YOU NEED

"Progressive" Transmitter Guide, published by the Amateur Press, 1800 W. Harrison St. Chicago, now includes 32 page Supplement on "Progressive II" with 14 illustrations, 8 circuits, and 8 working drawings, 25c net postpaid. (15c for Supplement only). Bulletin form 35 free for the asking.

GENERAL TRANSFORMER CORP.

518 S. Throop Street

Chicago, Illinois



NEW HOLDER DESIGN
15 SECONDS TO INSTALL CRYSTAL

For All Bands

GREATER STABILITY

Plugs in 5 prong tube socket

Beautiful Appearance

MODEL AH HOLDER \$1.00

At your dealer or direct

HIPOWER LOW DRIFT CRYSTALS:
within 10 kc. or Choice of stock

AH-10, 1700-3500 Kc. bands \$2.35

AH-10, 7000-7300 " band 3.90

write for new Literature

Hipower "Low Drift" Broadcast and Commercial Crystals Are Approved by F.C.C.

Hipower Crystal Co., 2035 Charleston St., Chicago

GULF RADIO SCHOOL

Radiotelegraphy

Radiotelephony

Radio Servicing

SECOND PORT } 1007 Carondelet Street
U. S. A. } NEW ORLEANS, LA.

disqualification, depending on the sufficiency of evidence reported.

2. Entries should be (a) in the low-power class, or (b) high-power class, or submitted as the sum of separately computed work at one station falling in each class. Sections worked on high power do not count in the multiplier for low-power-score and vice versa. Logs must show the power used for each QSO or for groups of QSOs.

3. Reports must show operating time for each period spent on the air in the "SS," and the total of such operating time.

4. Logs must be marked for "Phone" or "C.W." entry, grouping all work by either method together as one score.

5. All work must fall within the period of the contest.

6. Decisions of the award committee of C.D. staff members shall be accepted as final.

7. Reports must be received at A.R.R.L. Hdq. from all stations except those in Alaska, Hawaii, and P. I. on or before noon, Dec. 26, 1936, to be considered for certificate awards. From outlying points, reports must similarly be received on or before Jan. 20, 1937.

CLUB PARTICIPATION

Additional certificate awards (besides the 'phone and telegraph Section awards) will be made through each club where *three or more* individual club members, or new hams invited and reported by such a club, in addition to sending a contest report *have their club secretary* write Hq. listing their individual calls and scores, and the total of such scores. If there are both club 'phone and c.w. entries, A.R.R.L. will provide two certificate awards for the club to give its leading members. Besides this, the sum of the scores of all club participants ('phone and c.w.) will be added by the secretary, *to count for the club!*

A genuine gavel, with engraved sterling silver band, is offered as an award to that club whose officers or activities manager submits the greatest collective score or total number of "SS" reports

⁴ There is no point in working the same station more than once in the contest period if two points have been earned by exchanging messages. If but one point is made the first time, you can add a point by working this station again and handling a message in the opposite direction. Underline all such entries in your "list," identify them by showing parenthetically the call of the correspondent station, and leave right or left report columns blank so that all pairs of exchanges completed in *one* contact are side by side.

⁵ The highest individually-attained score of any *one* of the operators of amateur stations having more than one operator is the official score for such a station. The summary of score must show *all* stations worked by *all* operators however, circling the entries of stations and/or Sections that cannot count in the official total. Awards will be based on the official total and will be made to the individual operator accredited with this total. To show the possible scores that can be built up by several operators at one station, such scores (all Sections listed by all points listed) may be shown parenthetically after the "official" score that counts toward a possible award.

⁶ If the power was changed between (a) or (b) during the contest, separate scores must be kept for each power class, and the two added together for the total.

⁷ All hams are requested to submit lists, even if they only show a small score, on a postal. By doing this they help support claims made in logs from other stations, and *also* they receive full credit in QST.

Built for POWER

Johnson Transmitting Condensers

STRENGTH to stand up in high-power circuits . . . to stay "in-tune" amid shock and vibration . . . is built into every JOHNSON condenser. Years of experience in manufacturing broadcast and commercial condensers enabled us to attain this "huskiness" compactly, economically, BETTER in Johnson Type "D" and the new Type "C" units for amateur transmitters. Yet, on the average, they cost no more than you pay for inferior condensers!

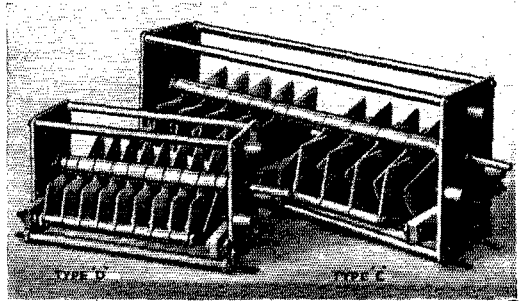

Note These Exclusive Features!

- Heaviest plates, edges rounded. ● MYCALEX and ALSIMAG 196 insulation. ● Few, long insulation paths.
- Large laminated rotor brush-terminals front and rear.
- Adjustable bi-metallic cone bearings front and rear.
- Heavy tie rods for rigidity, insulated to eliminate "short circuit loops." ● Large diameter shaft and spacers. ● Shafts extended both front and rear, for gearing or rear drive.
- Higher capacities and wider spacings.

See your Jobber or write for new free Johnson Catalog 961. Gives complete data on "C" and "D" Condensers, "Hi-Q" Inductors, Type "O" Antenna Systems, Stand-Off Insulators, and other Johnson products.

		NEW TYPE "C" CONDENSERS			
	Single-Section	Cat. No.	Plate Spacing	Capacity Max. μf^*	List Price
	Single-Section	500C70	.175"	500	\$21.00
		350C90	.250"	350	20.60
		50C110	.350"	50	9.00
		100C110		100	11.80
		250C110		250	20.80
		50C130	.500"	50	9.90
	100C130	100		14.10	
	Dual-Sec.	200CD90	.250"	200	\$25.30
		50CD110	.350"	50	13.70
		100CD110	.500"	100	19.30
		50CD130		50	15.55

* Ratings are Per Section.

E. F. JOHNSON COMPANY

MANUFACTURERS OF *Radio Transmitting Equipment*

● WASECA · MINNESOTA · U.S.A

EXPORT OFFICE
25 Warren St., New York

Cable Address:
"SIMONTRICE"

RAYTHEON TUBES

FOR THE "PROFESSIONAL" AMATEUR

YOU started communication all over the world with low power on short waves. None of the commercial broadcasting organizations had such a problem — yet, there was no such thing as a transmitter tube designed especially for your requirements until RAYTHEON started building them for you!

RAYTHEON led the way with the first transmitting pentode and the first zero bias Class B modulator.

The amateurs who use RAYTHEON tubes are among the record breakers and leaders in amateur transmitting.

RAYTHEON AMATEUR TUBES are built of the finest materials in the world — Tantalum plates, Nonex[®] hard glass bulbs, Isolantite bases, etc. And they are conservatively rated.

They are built to give the most output per dollar over the longest possible time!

TWO BRAND NEW TUBES, just out of the laboratory are:

- | | | |
|--------------------------------|---------|-------------------|
| RK-37 High-Mu Triode | \$8.00 | Power Output 60W |
| RK-38 High-Mu Triode | \$14.50 | Power Output 225W |

Used and Recommended by Leading Amateurs

SOLD BY ALL PARTS JOBBERS

RAYTHEON PRODUCTION CORPORATION

420 Lexington Ave., New York, N. Y. 445 Lake Shore Dr., Chicago, Ill. 415 Peachtree St., N. E., Atlanta, Ga. 555 Howard St., San Francisco, Cal. 55 Chapel Street, Newton, Massachusetts

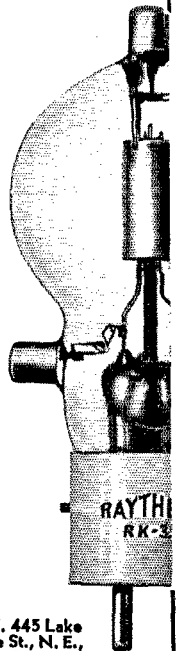

VISASIG

Full Automatic Siphon Tape Recorder
for Commercial and Amateur Use

Records
up to and
in excess
of 100
words per
minute

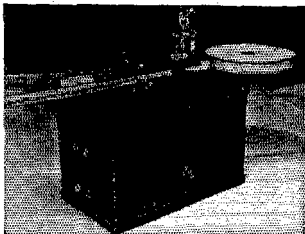

Make a permanent record from your receiver of weather reports, press news, distress signals, amateur broadcasts, speed contests, and your own transmissions! See how your fist improves with practice!

VISASIG — with electrically driven tape puller complete in one unit. . . . \$49.00

VISASIG — without tape puller. . . \$35.00

PRICES F.O.B. NEW YORK CITY

UNIVERSAL SIGNAL APPLIANCES

64 West 22nd Street New York City

Visasig Blueprints \$1.00

when he adds figures reported by individual members. The individual club fellows must send in full reports either direct or through the secretary to substantiate the club's claim on the gavel award! A chance to win honors for your club and a useful trophy for the club's presiding officer to use at meetings!

IN GENERAL

The only competition each operator must consider comes from operators in his immediate Section. Awards are for the operator running up the best communication record for each Section (as indicated by the score). In this manner, operators in each territory are placed on a basis of equality as to DX conditions and operating opportunity. Those who take part may report improper sequence in sending preambles used as contest exchanges. Fullest operating enjoyment is assured. See page 26 of July *QST* for full details on the last SS or ask any amateur who took part last year!

REPORTING RESULTS

Report ⁷ to A.R.R.L., West Hartford, Conn., as soon as the contest is over. Use the log form shown in the example. List all operators ⁸ whose work at your station is responsible for any part of the score.

All active ham operators are invited to take part and report. You will work a new bunch of stations, make new records for your station, get QSL cards (be sure to send one for each QSO), have a lot of fun, meet new friends, and perhaps rate an A.R.R.L. award at the conclusion. Any new hams will get good operating experience, working with a "swell" bunch of operators and friendly fellow hams. The chances have been made as equal as they can be made for all. Do your best operating and send A.R.R.L. the results for *QST* mention.

MAIL YOUR REPORT IMMEDIATELY AT THE END OF THE CONTEST TO AVOID DELAY AND INSURE THAT YOUR RESULTS ARE CREDITED AND KNOWN THROUGH *QST*.

PRECISION CRYSTALS



Crystal Holder

Highest quality crystals one-inch square, carefully ground for frequency stability and maximum output. Be sure of your transmitter frequency — use PRECISION CRYSTALS.

'X' cut PRECISION Crystals carefully ground for maximum power supplied within 0.1% of your specified frequency and calibrated to within 0.03% are priced as follows: 1750, 3500 and 7000 kc. bands —

\$3.00 each. Add \$1.00 to above price if plugin, dustproof holder is desired. (Holder as illustrated to fit G.R. jacks or round holder to plug into a tube socket can be furnished) G.R. jacks to plug illustrated holder into — \$1.50 pair.

Low frequency drift crystals (Type LTC) having a drift of less than 5 cycles per million per degree C. are supplied at the following prices: 1750 and 3500 kc. bands — \$3.50 each; 7000 kc. band — \$4.00 each. Holder \$1.00.

'AT' cut crystals for commercial use quoted on at your request. When ordering our product you are assured of the finest obtainable. Now in our sixth year of business.

PRECISION PIEZO SERVICE

427 Asia Street

Baton Rouge, La.

Low-Cost High Fidelity Amplifier

(Continued from page 34)

were very nearly equal in magnitude and 180 degrees out of phase at 400 cycles. This relationship was indicated on the cathode-ray tube by a single-line trace, which was inclined 45 degrees. At 7000 cycles, the output was 6 db lower than the output at 400 cycles. The trace on the cathode-ray tube was then a narrow ellipse; the slope of the major axis of this ellipse was slightly different from the slope of the single-line trace observed at 400 cycles. This difference indicated that a relative shift in magnitude and phase of one voltage had taken place. Below 100 cycles, the trace was also a narrow ellipse; the slope of the major axis of the ellipse was nearly the same as that of the straight-line trace observed at 400 cycles. The length of the major axis of the ellipse was slightly less than the length of the straight-line trace. These differences indicated that the phase of one voltage had shifted slightly and that the magnitudes of both voltages were reduced by the same amount. The output was down less than 1 db at 100 cycles compared to the output at 400 cycles. It should be noted, however, that the selectivity of the i.f. transformer affected the frequency characteristic of the phase-inverter circuit.

With the volume control set at the maximum-output position, about 20 μ fd. of capacitance, in addition to the stray capacitances that were inherent in the system, could be connected from

RADIO COURSES

RADIO OPERATING: Prepare for Gov't License Exam. ●
RADIO SERVICING: Including Short Wave ● AMATEUR
CODE ● New Course in ELECTRONICS.

Day and Evening classes — Booklet upon Request

NEW YORK YMCA SCHOOLS

4 West 63rd Street, New York City

A New Arrival IN THE GAMMATRON FAMILY

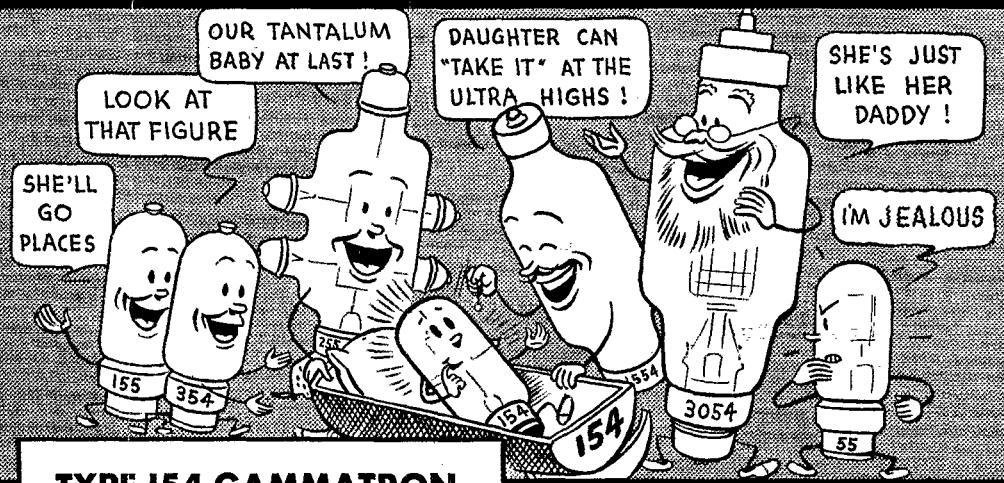

TYPE 154 GAMMATRON
\$12.50 AT YOUR DEALER

¼ kilowatt a pair at 1000 VOLTS and 5 meters

HEINTZ AND KAUFMAN
LTD
SOUTH SAN FRANCISCO CALIFORNIA U. S. A.

YOUR FIRST AND LAST STOP!

Hundreds of "Hams" have already "discovered" Terminal! Established but a few months, its hospitable atmosphere has become a by-word among the dot and dash lads and YL's. Here at Terminal Radio there are no cold business transactions! Into every sale is injected the warmth of understanding. The cheery "Hello" and the regretful "So long" are sincere.

BLILEY

All types in stock

- VF1-80 meter band. Variable frequency unit.\$8.00
- HF2-20 meter crystal. ..\$6.50
- LD2-Low drift unit. 40-80-160 meter bands.\$4.80
- BC3-X-cut crystal unit. 40-80 meter bands.\$3.95

WE HAVE THEM ALL AT TERMINAL RADIO LIBERAL ALLOWANCE

Trade in your old Receiver for one of these New Models

National	Hallicrafter
NC 100	Ultra Sky Rider
HRO	Super Sky Rider
HRO-Jr.	Sky Buddy

RME
RME-69

All Receivers on Demonstration
THE DB-20 BY RME—Complete with tubes. . \$39.95

RACKS

Panels, Cabinets. Our supply is considered the largest in town — get our catalogue listing hundreds of different items. Write or call for it.

TERMINAL RADIO CORP.

80 CORTLANDT STREET
BILL FILLER

W2AOQ

NEW YORK
ADOLPH GROSS

• UNITED •



MERCURY RECTIFIERS

WE CLAIM they are better
WE EXPLAIN why they are better
WE PROVE they are better

NEW FOUR-PAGE BULLETIN MAILED UPON REQUEST

UNITED ELECTRONICS COMPANY

42 SPRING ST., NEWARK, N. J.

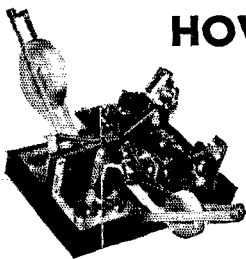

HOW TO LEARN CODE

TELEPLEX has taught Code to more operators in past few years than other methods. YOU can learn Code—or step up your w.p.m. amazingly—this surer way. No experience needed. Beginners, amateurs, experienced ops get ahead faster with Teleplex. You actually HEAR dots-dashes any speed you want. Sends you practice messages and SENDS BACK your own key work in visible dots and dashes.

For quicker license find out about this better way. We furnish you complete course, lend all equipment including the new All Electric Master Teleplex, give personal service on MONEY-BACK GUARANTEE. Low cost, easy terms. Without obligation write for booklet Q. 11.

“HAM” SPECIAL STANDARD TELEPLEX

A highly efficient code teacher using heavy specially prepared waxed paper tape, having two rows of perforations. Write for Free Folder Q.T. 11. We are the originators of this type instrument.

**TELEPLEX CO. 72-76 CORTLANDT STREET
NEW YORK CITY**

MASTER TELEPLEX—“The Choice of Those Who Know”

Power X cut	O. C. L. Control Crystals	High Output
Unconditionally Guaranteed		
7000 KC ± 5 KC	•••••	\$1.85
3500 or 1750 KC ± KC	•••••	1.50
OMAHA CRYSTAL LABORATORIES		
1817 West 3d	Jobbers Write	North Platte, Nebr.

point *b* to ground before the output at 6000 cycles dropped 2 db below the normal 6000-cycle output. With normal plate-to-plate load, rated power output could be obtained at 400 cycles. The voltage applied to the grid of the 6F5 is $R_2 / (R_1 + R_2 + R_3) \times E_a$, where E_a is the total audio voltage developed by the diode. For the values specified in the figure, $R_2 / (R_1 + R_2 + R_3) = 0.5$. Thus, although only 50 per cent of the available audio voltage is used, the high gain of the 6F5 permits the output tubes to be driven to full output.

Simple Two-Band 6L6 Tri-Tet Transmitter

(Continued from page 36)

toward maximum setting until the proper plate current is drawn. This will be around 45 ma. for a 250-volt supply, advancing to 90 or 100 ma. for a 400-volt supply. A neon bulb held on the antenna post will help in tuning for maximum output. Slight readjustment of the plate tuning condenser may be necessary if the antenna differs much from the proper length of 133 feet. Keying should be checked in the monitor or receiver, since it usually will be found that the keying will be better if the plate tuning capacity is decreased slightly from that setting that gives maximum output for 3.5-mc. operation. If there is any tendency for the crystal to miss keying, back off the plate condenser. This only holds true for fundamental (3.5-mc.) operation; working on the harmonic (7-mc.), the plate circuit should be tuned for maximum output.

If you intend to use the same crystal for both 3.5- and 7-mc. operation, remember that the crystal should not have a frequency higher than 3650 kc. Otherwise, the second harmonic will fall outside of the 7-mc. band. Any 80-meter band crystal may be used for 3.5-mc. work only.

The resistors R_2 and R_3 shown in the diagram are to be used when 300- or 400-volt supply is available. However, if the transmitter is run from a 250-volt pack, more output will be obtained by cutting the resistors out of the circuit, returning the screen-grid connection directly to the positive plate supply lead. A little experimenting with these voltage divider resistors will repay you by giving maximum output at the voltage you have available. A series resistor for dropping the screen-grid voltage would be more economical of high-voltage power, but better keying results with the divider arrangement.

This transmitter was operated in the June A.R.R.L. Field Day, from a location in the hills 30 miles from Hartford, and it performed remarkably well. A 133-foot wire was fastened to the top of a 40-foot tree (no, we didn't climb it; a rock and cord did the trick), the other end being run to the antenna post of the transmitter—and we were ready to go, with 15 watts available on either 3.5 or 7 mc. by a twist of the knobs. Activity was curtailed by the coming of dusk, but enough contacts were established, with encouraging reports, to demonstrate the effectiveness of this simple transmitter.

Old Friends That Wear Well

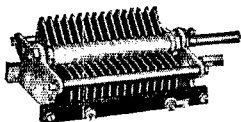

Cardwell MIDWAY
Transmitting
Type MT-150-GS
\$3.30 net to Hams
For 3000 V. Tanks

Here are just a few of the hundred and one types of Cardwell transmitting and receiving condensers you will find specified in constructional articles and in use in amateur and commercial radio equipment everywhere.

MIDWAY
Double Stator
MR-150-BD
\$2.88 net
1000 V. Buffer

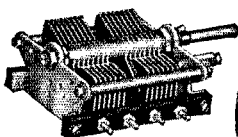

Where space is at a premium these small, featherweight units fill the bill. The price is right too, with no sacrifice in quality. Ask for our latest sheet, listing in convenient tabular form 100 condensers for every purpose and power including one K. W. phones.

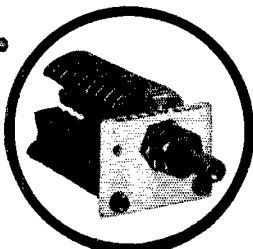

TRIMAIR Transmitting
Type ZT-30-AS
\$1.11 net
30-4 MMF. 3000 V.
Neutralizer

H.F. Tank Unit
Type NP-35-GD
\$3.60 net
4200 V. — Isolantite
Insulation

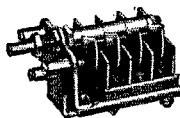

H.F. Neutralizer
Type NA-14-NS
\$3.00 net
For 805's, etc.

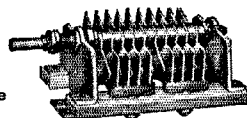

THE ALLEN D. CARDWELL MFG. CORPORATION

83 PROSPECT STREET, BROOKLYN, N. Y.

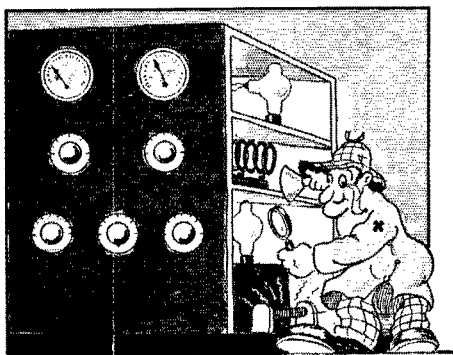

Our new transmitting manual contains complete up-to-date transmitter circuits ranging in size from five watts to one kilowatt. The new triple winding plate transformer is utilized to full advantage in many of these circuits. This not only provides better regulation but considerably lowers the cost. Ten pages are entirely devoted to full page "Ken-O-Grafs" which cover most of the calculations used in radio in a modern and painless method. This book is no subterfuge for a catalog. To receive your copy send 25 cents in coin or stamps.

Chief Engineer — Amateur Section

KENYON TRANSFORMER CO. INC., 840 BARRY ST., NEW YORK, N. Y.

Is Your XMTR ★ HÆMOPHILIAC?

★ A transmitter utilizing bleeders dissipating wasteful and costly wattage in order to obtain correct operating potentials thereby reducing efficiency and impairing load regulation.

BEFORE modernizing your present equipment or buying a new plate transformer why not get the dope on our new exclusive triple winding plate transformer and compare it on merit alone with others. This new exclusive triple winding plate transformer provides the utmost in flexibility. Over 30 different voltages are available ranging from 400 to 3000 volts. Regardless of revolutionary overnight changes in radio, this unit will never become obsolete. Applicable to over ten different rectifier circuits. The most versatile transformer ever manufactured.

LOW IN PRICE YET BUILT TO STAND THE GAFF

KENYON manufactures, in addition, a complete line of quality audio products that defy competition both as to quality and price.

Ask your local dealer for a free copy of the first issue of the new 16-page monthly magazine "THE KENYON ENGINEERING NEWS."

Plain Talk About Rhombic Antennas

(Continued from page 74)

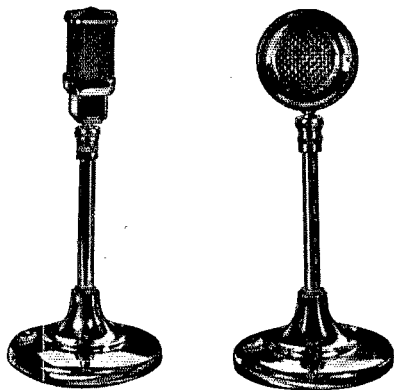

38TI

24TI

A true non-directional, or semi-directional microphone — both Hi-Level. Either microphone on a chrome desk stand as shown.

List — \$25.00

Write for your KoLor Bulletin

THE TURNER COMPANY
CEDAR RAPIDS, IOWA

Licensed under patents of the Brush Development Company

new diamond ran rings around it in just as striking a fashion as did the diamond at W1JPE. The vertical antenna was, of course, preferable for work to Europe, South America, Canada, and some portions of the United States but, surprisingly enough, the diamond gave quite good general coverage in spite of the great gain along the direction of its main lobe. Using this antenna without a terminating resistor W1SZ has been able to maintain contact with VK3MR and other VK stations for 19 hours out of the 24—a performance, from this part of the world, which we have long considered an impossibility.

The point about all this rigmarole is that after reading all the idealistic technical material and after hearing vague rumors of results obtained by other amateurs we have at last had intimate experience with the rhombic antenna in ham dress. And since the experience embraces two installations under widely different conditions (both of them being similarly successful) we feel justified in trying to express our enthusiasm. Without any doubt, there are hundreds of hams with the space to put up a small diamond and the desire to pump a particularly heavy signal into some one corner of the world. Most of them would hesitate to do anything about it because they are faced, as we were, with the impossibility of discovering from any of the published material whether or not the thing would be worth while. The textbooks say that a rhombic antenna with sides $3\frac{1}{4}$ wavelengths long will have a power gain of 25 over a half-wave antenna at the same height. But this leaves many questions unanswered. Over what angle, for instance, is this gain likely to be noticeable; what happens to it if the location is covered with trees; and what if the wires are actually tangled in the branches, and if the height of the wire is less than a half wave and variable along the length of the antenna—what then? What happens if the ground is irregular or sloping? And what happens to the performance if the terminating resistor is left off?

Answers to these questions, based on our own experience, go about like this: Over an angle of approximately 5 degrees the apparent power gain over a half-wave antenna in reception, particularly on DX signals, is likely to be very much more than the theoretical value—this probably resulting in cases where the vertical directivity of the antenna places the main lobe at the angle of arrival of the incoming signal. The height of the antenna above ground will influence the vertical directivity and the slight superiority of the W1SZ antenna over that at W1JPE leads us to suspect that the additional height at W1SZ has given him a lower angle of radiation in the vertical plane and, hence, a better performance on DX signals. The irregular ground and the irregular height at W1JPE has doubtless destroyed the clean form of the ideal main lobe, the effect appearing chiefly to be a slightly broader characteristic in both the horizontal and vertical planes.

WE HAVE IT!

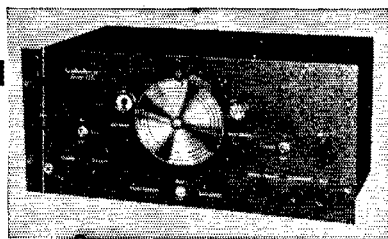

The **NEW** hallicrafters
1937 SUPER SKYRIDER

NOW AVAILABLE ON TIME PAYMENTS

ONE of the World's most advanced short wave receivers — incorporating the latest engineering developments — embodying every new convenience to take the grief out of short wave reception — we recommend it enthusiastically to every amateur and short wave listener. And now you can operate the finest of communications receivers as you pay for it on easy terms. **GENEROUS TRADE-IN ALLOWANCES ON ACCEPTABLE RECEIVERS.** See the Hallicrafters 1937 Line today or write us for full particulars.

WALTER ASHE
RADIO COMPANY
11th and Pine Streets, St. Louis, Mo.

Progress from the Dark Ages*

We can remember when instruments as presented here, could not be bought for a King's Ransom. Truly, mechanical ingenuity — the amazing progress from the engineering outlook has opened the door, and permitted the light to shine in with real economy.

MODEL CRA — CATHODE RAY OSCILLOGRAPH



● Complete facilities for circuit study. High Input Sensitivity. Wide range sweep 20,000 cycles per second. Complete with 900 Cathode Ray Tube **\$84.50**
 OTHER C-B INSTRUMENTS
 Model O. C. R.F. Signal Generator..... **\$33.95**
 Model O.M.A. Frequency Modulated R.F. Generator **\$57.75**

PRECISION INSTRUMENTS
 MODEL 79A — BEAT NOTE AUDIO OSC.

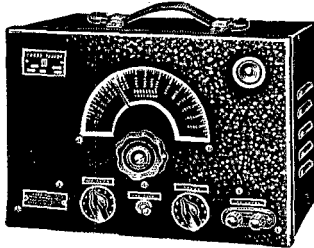

● Continuously variable from 0-15000 cycles. Output 27 volts at 5000 ohms or 150 milliwatts. Electric Eye zero beat indicator. Distortion Content less than 3%..... **\$53.75**

COMPLETE STOCK CATALOGUE ON REQUEST
 MAIL ORDERS FILLED

MODEL 99 R.F. SIGNAL GENERATOR

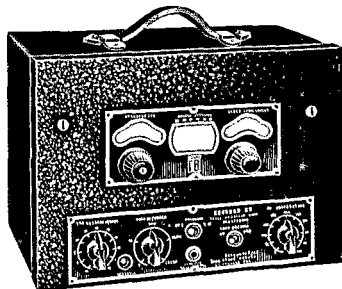

● Output calibrated directly in microvolts. Variable % of Modulation. 100Kc to 60 MC on Fundamentals. Direct reading Frequency Calibration. Frequency 1/4 to 1% accurate. Net Price..... **\$43.90**

OTHER C-B INSTRUMENTS
 Model 88 — Vacuum-Tube and Peak Voltmeter..... **\$42.50**
 Model 95 — Super Unimeter..... **\$53.75**

The Reason: Yes, the reason for the excellent service here is first our ever present desire to do the job right. Second — to carry an inventory which to us represents what tools represent to a mechanic. Glance over the lines stocked — RCA — UTC — BRUSH — PIONEER — G.E. — TOBE — AEROVOX — TAYLOR — EIMAC — H-K. — AMPEREX — BURGESS — CENTRALAB — OHMITE — WESTON — TRIPLETT — and these are but a few. You name it and we have it at distinct savings. MAIL ORDERS FILLED — SEND M.O.

INTERNATIONAL PLATE TRANSFORMERS

We recommend these companion transformers as representing real value — quality has not been sacrificed — rather the volume increased greatly to make possible these low prices. Fully cased in black crystal finish steel.

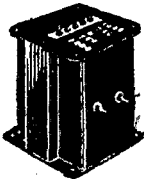

Model 2000-300 mills 750-1000 each side..... **\$5.95**
 Model 3000-300 mills 750-1000-1500 each side..... **\$8.95**

International Chokes FULLY CASED

Swinging	Smoothing	
5/25-200 mill		\$2.50
5/25-300 mill		3.75
5/25-500 mill		6.50
12H-200 mill		2.50
12H-300 mill		3.75
12H-500 mill		6.50
Cased 2.5A-12A-866 Tube.....		\$1.50

TRIPLETT METERS

3" Bakelite Case	2" Bakelite Case
0-5 to 300M. \$3.75	0-5 to 1000M. \$2.92
0-15 ACV. 3.75	0-15 VAC. 2.92
0-150 ACV. 4.55	0-150 VAC. 3.75

Sweeping the Country!
 TAYLOR TUBES

T-55.....	\$8.00	T-155.....	\$19.50
T-56.....	4.95	T-814.....	18.50
T-203B.....	7.50	T-200.....	21.50
T-822.....	18.50	HD-203A.....	17.50
T-845.....	12.50	HD-866.....	1.65

SEND FOR CATALOGUE

INTERNATIONAL RELAY RACK

Standard six-foot steel rack drilled to 1 1/4-1/2". Screws furnished..... **\$13.50**

NEVER OBSOLETE
 UTC Varimatch Units

from **\$4.80 to \$42.00**

It will pay to investigate

We carry a complete line of

UTC

IMMEDIATE SERVICE
 MAIL ORDERS FILLED — SEND M.O.

STILL LEADING!

PYRANOL
 2 MFD. 2000-VOLT
 FILTER CONDENSERS

Guaranteed 2 Years Unconditionally

Not one has blown in service over the last 18 months and we KNOW that many are being used consistently on voltages 200% in excess of their rating. Don't take our word for it. Ask the ham that owns some.



\$2.90

We are pleased to present the entire BRUSH line of sound cell crystal microphones and phones at 40% discount. Send for literature.

The MAC-KEY..... **\$7.95**

ALL THE LATEST
 HALLICRAFTERS

Time payments if desired

46 BRATTLE STREET

THE RADIO SHACK

BOSTON, MASS.

DON'T BE FOOLED!

By Low Prices and Surplus Parts

TYPE TR-6A6 DUPLEX TRANSMITTER-RECEIVER
Contains the Following:

- Cardwell or Bud Isolantite air condensers
- Crowe illuminated dials and drives
- Cabinet and Escutcheons second to none
- C.T.S. controls for volume and regeneration
- Eby sockets, outlets and jacks
- Erie new ceramic shell resistors
- F.M.C. mica condensers rated 1000 v.
- Jensen five inch dynamic speaker
- Ohmite Brown Devil 10 watt resistors
- R.T. Labs. famous 6E6 unity coupled oscillator
- Solar and Aerovox condensers rated twice applied voltage
- U.T.C. famous class B audio. Output 10 watts

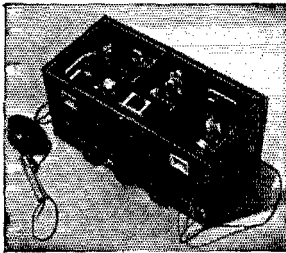

TR-6A6 FIXED or MOBILE
Complete 56-60 or 30-41 Mc. Station

COULD YOU SELECT BETTER COMPONENTS?

A BARGAIN at \$39.75 net F.O.B.

RADIO TRANSCEIVER LABORATORIES.

8627 115th St., Richmond Hill, N. Y.

LEARN RADIO

New Classes Now Forming! Send for 40-page catalog, explains

fully. 300 licensed graduates placed in past 4½ years in broadcasting, shipping, police radio, aviation, etc. We teach all branches. Oldest, largest and best equipped school in New England. Equipped with Western Electric sound and broadcasting equipment and RCA marine transmitter. Course prepares for United States Government telegraph or telephone license.

MASS. RADIO SCHOOL, 18 Boylston Street, BOSTON

"The Crystal Specialists Since 1925"

PIEZO-ELECTRIC CRYSTALS

Guaranteed Accurate to BETTER than .01%

SCIENTIFIC RADIO SERVICE

UNIVERSITY PARK, HYATTSVILLE, MD.

LEARN CODE RIGHT — the Practical, Easy Way —

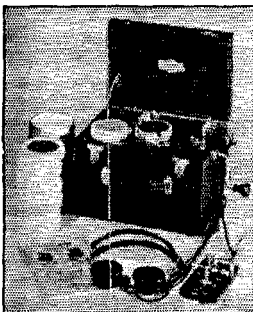

Instructograph

Radio amateur code exams now require 30% more speed. And experts agree: "It pays to learn from a perfect teacher — Instructograph." It's easy to become a real operator when you can practice Radio or Morse at your convenience — at any speed you want. Comes in two models — Senior or Junior Economy. You may buy or rent, at low cost. Just send post-card for complete details now to —

INSTRUCTOGRAPH CO.

Dept. Q-11

912 Lakeside Place Chicago, Illinois

Representatives for Canada
Radio College of Canada, Ltd.
888 Bay Street, Toronto

Trees, buildings and miscellaneous wires in the field of the antenna probably have a similar effect on the performance of the antenna, but the influence is very hard to detect. Not so long ago we should even have chopped down the family's pet trees to avoid contact between the antenna and branches or leaves. To-day we are of the impression that the matter is of precious little consequence—in the case of very long-wire antennas, at any rate.

Then there is the matter of the terminating resistor. Should facilities be available it would be possible to adjust the terminating resistor precisely and thus virtually eliminate unwanted signals from the rear of the antenna. And it would be possible, doubtless, to improve the radiation in the forward direction by establishing and matching the characteristic impedance of the system. With our particular antennas, access to the terminating resistor is had only after a half-day's work untangling ropes and wires from the trees. A program of cut-and-try adjustment with field intensity measuring equipment is, therefore, quite impractical. We have been left with the alternatives of connecting in a 700-ohm resistor, hoping for the best, or dropping the resistor out. The chief observation is that any terminating resistor, (accidentally we have tried 300, 500 and 800 ohms) simplifies feeding the antenna since, under those circumstances the system will take plenty of power without tuning the feeder. Elimination of the termination resistor makes it necessary to tune the feeders but the performance in the forward direction is quite similar. The terminating resistor, even if incorrectly adjusted, gives a drop of several R points to signals arriving from the rear of the antenna. The reduction in noise coming from the rear is also noticeable.

Our most recent experience with this type of antenna has been in the erection of a larger system (3¼ wavelengths on a side) at W1JPE in the attempt to blot out the W1SZ signal in Australia. The new antenna, though larger, is considerably more irregular in its various dimensions than the first version and probably because of that its performance is not quite what we had expected. The main lobe and the two first secondary lobes give us a performance in reception similar to that shown in Fig. 3. This chart, indeed, is the result of several hundred readings taken on the HRO "S" Meter while comparing the 3¼ wavelength diamond against a half-wave comparison antenna. It differs from the characteristic had with the 2¼ wavelength antenna only in the distribution of the minor lobes. It represents, in short, just about what one might expect from a very haywire diamond between 200 and 300 feet from tip to tip.

And so, after all these very general statements, we reach the point where we can suggest with all the emphasis we can command that any ham who has a hankering to pump big signals in one or two particular directions, and who has any chance at all to borrow or rent the space, is doing the wise

(Continued on page 106)

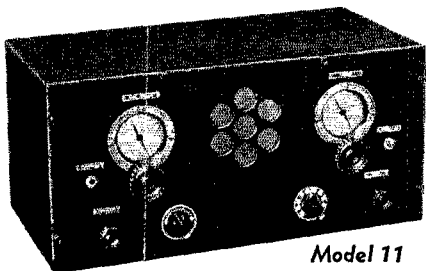

Model 11

Long wave models cover to 3750 and to 20,000 meters with high efficiency throughout. No short wave losses caused by the addition of the long wave bands. All-wave band spread, coil switching, built-in power supply, Jensen dynamic speaker, R.C.A. tubes, fully calibrated dial, phone jack, break-in switch, R.F. Gain and regeneration controls, and antenna trimmer. Everything an experienced operator can possibly want. **IMMEDIATE DELIVERY** on A.C., D.C. or battery models for any tuning range.

New Sargent Ham Super — Ready Nov. 1st.

MODEL 21. Amateur tuning range, 9.5-550 meters, regenerative input, metal tubes, iron core I.F.s, tuning indicator, band spread. **Medium price range.** Deliveries scheduled for November 1st. *Write for details.*

96 "CLEAR CHANNELS" on 40 Meter Band

Not "clear channels" in the BCL sense — that would be impossible on any amateur band. The test was conducted at 10 p.m. Saturday night, the peak time for local QRM. Starting at one end of the band, tuning continuously across it, 96 separate stations from all districts could be copied solid through the QRM. This is an average of 3.14 K.C. total coverage per station — 1.57 K.C. to each side of the center of the carrier. With this selectivity and with the extreme sensitivity and quietness of a well-designed tuned r.f. circuit, is it any wonder that Model 11 out-ranges larger receivers on weak C.W. signals?

160 METER BAND PERFORMANCE. On this popular phone band, Model 11 is a real performer. Good tone, high sensitivity, and selective enough to get through, when "getting through" is at all possible. A pleasing receiver to operate — the longer you use it the better you will like it.

Model 11 Net Prices for 110 V. 60 cycles operation

- Model 11-UA, UNIVERSAL tuning range, 9.5 to 20,000 meters **\$75.00**
 - Model 11-MA, MARINE tuning range, 9.5 to 3,750 meters **\$54.00**
 - Model 11-AA, AMATEUR tuning range, 9.5 to 550 meters **\$46.00**
- Prices include power supply, speaker and R.C.A. tubes
Model 11 is available in all A.C., D.C. and battery voltages
Immediate Delivery *Write for full description*

E. M. Sargent Co., 212 9th St., Oakland, Calif.

A NEW Factory Prices

Watch your **QUALITY**

Triumph Top Operated Top scanned Oscillograph. Protects your transmitter. Keeps you within F.C.C. regulations. Standard U. S. Government Equipment. Write today and save big money. Ship. wt. 33 lbs. F. O. B. Chicago. 25% down. Balance C.O.D.

\$63.60

Money Back Guarantee

We stand back of every piece of testing equipment we sell direct. Your money cheerfully refunded on merchandise returned within 10 days in original condition.

Triumph Slashes Prices

New Factory-Direct Plan. No middleman profits—no high interest rates—no long time payments. Order direct from Triumph. Send today for complete details. **ACT NOW.**

TRIUMPH MFG. CO.

4015 W. Lake St.
Chicago, Ill.

Radio Operator's Course

Complete in
Telegraphy—
Telephony

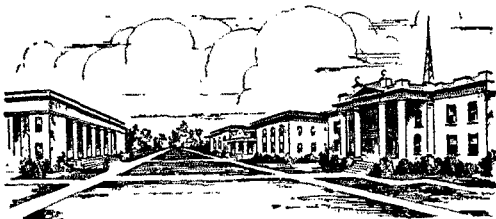

Practical
Experience
Studio—
Transmitter—
Announcing

P. A. C. is an endowed, educational institution — not privately owned, not operated for profit, college rank maintained. Course consists of maximum knowledge necessary to secure Commercial Telegraph Second-class, and Radio-telephone First-class government licenses. Course includes Wireless Code, Radiophone, Announcing, Microphone-Studio Technique, Service, Police, and Aeronautical Radio. We are authorized to teach RCA texts. At the completion of course you receive practical studio technique experience in our commercial broadcast studios located in the administration building, and experience as an operator on K P A C (500-Watt Commercial transmitter located on the campus, owned and operated by the college), and inter-departmental marine communication experience.

If interested, write for Bulletin R

PORT ARTHUR COLLEGE ■ **PORT ARTHUR (World-known port) TEXAS**

Where to buy it

A directory of suppliers who carry in stock the products of these dependable manufacturers.

ASTATIC
Crystal Microphones and Pickups

ASTATIC MICROPHONE LABORATORY, Inc. YOUNGSTOWN, O.
Pioneers Manufacturers of Quality Crystal Products

NEWARK, N. J. 219 Central Ave.
Wholesale Radio Service Co., Inc.

NEW YORK, N. Y. Harvey's Radio Shop 103 W. 43rd St.

NEW YORK, N. Y. 100 Sixth Ave.
Wholesale Radio Service Co., Inc.

PHILADELPHIA, PENN. Eugene G. Wile 10 S. 10th Street

super sky rider
hallicrafters
ultra sky rider

ALBANY, N. Y. Uncle Dave's Radio Shack 356 Broadway

BALTIMORE, MD. Radio Electric Service Company 3 North Howard St.

BOSTON, MASS. Radio Shack 46 Brattle Street

HARTFORD, CONN. 227 Asylum Street
Radio Inspection Service Co.

NEWARK, N. J. 219 Central Ave.
Wholesale Radio Service Co., Inc.

NEW YORK, N. Y. 51 Vesey St.
Gross Radio, Inc.

NEW YORK, N. Y. 12 West Broadway
Harrison Radio Co.

NEW YORK, N. Y. 103 W. 43rd St.
Harvey's Radio Shop

NEW YORK, N. Y. 100 Sixth Ave.
Wholesale Radio Service Co., Inc.

READING, PENN. George D. Barbey Company 404 Walnut St.

SPRINGFIELD, MASS. T. F. Cushing 349 Worthington St.

E.F. JOHNSON COMPANY
MANUFACTURERS OF
TRANSMITTING RADIO EQUIPMENT
STATE
WASECA, MINN
U.S.A.

BUFFALO, NEW YORK 216 E. Genesee St.
Dymac Radio

MONTREAL, CANADA 285 Craig Street, West
Canadian Electrical Supply Co., Ltd.

NEWARK, N. J. 219 Central Ave.
Wholesale Radio Service Company

NEW YORK, N. Y. 12 West Broadway
Harrison Radio Company

NEW YORK, N. Y. 100 Sixth Avenue
Wholesale Radio Service Company

PITTSBURGH, PENN. 603 Grant Street
Cameradio Company

READING, PENN. 404 Walnut Street
George D. Barbey Company

RAYTHEON
THREE P-311A
AMATEUR TUBES

ALBANY, NEW YORK 356 Broadway
Uncle Dave's Radio Shack

BOSTON, MASS. The Radio Shack 46 Brattle Street

BOSTON, MASS. Selden Radio Company 28 Brattle Street

BUFFALO, NEW YORK 326 Elm Street
Radio Equipment Corp.

CONCORD, NEW HAMPSHIRE 80 N. State Street
Carl B. Evans

NEWARK, NEW JERSEY 219 Central Street
Wholesale Radio Service Co.

NEW YORK, N. Y. 12 West Broadway
Harrison Radio Company

NEW YORK, N. Y. 103 W. 43rd St.
Harvey's Radio Shop

NEW YORK, N. Y. 100 Sixth Avenue
Wholesale Radio Service Co.

RCA de Forest
RADIO TUBES
RCA Radiotron Division of RCA Manufacturing Co., Inc.

ALBANY, N. Y. Uncle Dave's Radio Shack 356 Broadway

BALTIMORE, MD. 3 North Howard St.
Radio Electric Service Company

BOSTON, MASS. H. Jappe Company 46 Cornhill

BOSTON, MASS. Radio Shack 46 Brattle Street

BUFFALO, NEW YORK 216 E. Genesee St.
Dymac Radio

Where to buy it

A directory of suppliers who carry in stock the products of these dependable manufacturers.

NEWARK, N. J. 219 Central Avenue
Wholesale Radio Service Co.

NEW YORK, N. Y. 460 W. 34th St.
Bruno-New York, Inc.

NEW YORK, N. Y. 136 Liberty St.
Sanford Samuel Corp.

NEW YORK, N. Y. 100 Sixth Avenue
Wholesale Radio Service Co.

NEW YORK, NEW YORK 12 West Broadway
Harrison Radio Company

PHILADELPHIA, PENN. 10 S. 10th Street
Eugene G. Wile

PHILADELPHIA, PENN. 117 North 7th St.
Raymond Rosen & Company

PHILADELPHIA, PENN. 512 Market Street
M & H Sporting Goods Company

PITTSBURGH, PENN. 603 Grant Street
Cameradio Company

READING, PENN. Bright & Company 8th & Elm Streets

SPRINGFIELD, MASS. T. F. Cushing 349 Worthington Street

WASHINGTON, D. C. 938 F Street, N. W.
Sun Radio & Service Supply Co.

PHILADELPHIA, PENN. 3145 N. Broad Street
Radio Electric Service Company

PHILADELPHIA, PENN. N. E. Cor. 7th & Arch Streets
Radio Electric Service Company

PHILADELPHIA, PENN. 512 Market Street
M & H Sporting Goods Co.

PITTSBURGH, PENN. 603 Grant Street
Cameradio Company



**AMATEUR
RADIO
EQUIPMENT**

RCA Victor Division of RCA Manufacturing Co., Inc.

ALBANY, N. Y. Uncle Dave's Radio Shack 356 Broadway

BOSTON, MASS. H. Jappe Company 46 Cornhill

BOSTON, MASS. Radio Shack 46 Brattle Street

BUFFALO, NEW YORK 216 E. Genesee St.
Dymac Radio

CAMDEN, N. J. 811 Federal Street
Radio Electric Service Company

ERIE, PENN. J. V. Duncombe Company 1011 West 8th S.

GREENWICH, CONN. 252 Greenwich Ave.
Mead Stationery Company

HARTFORD, CONN. 927 Asylum Street
Radio Inspection Service Co.

MONTREAL, CANADA 285 Craig Street, West
Canadian Electrical Supply Co., Ltd.

NEWARK, N. J. 219 Central Avenue
Wholesale Radio Service Company

NEW YORK, N. Y. Bruno-New York, Inc. 460 W. 34th St.

NEW YORK, N. Y. Harrison Radio Co. 12 West Broadway

NEW YORK, N. Y. 136 Liberty Street
Sanford Samuel Corporation

NEW YORK, NEW YORK 124 E. 44th Street
Grand Central Radio, Inc.

NEW YORK, N. Y. 100 Sixth Avenue
Wholesale Radio Service Company



Use **SHURE**
MICROPHONES
Microphone Headquarters

ALBANY, N. Y. Uncle Dave's Radio Shack 356 Broadway

BOSTON, MASS. H. Jappe Company 46 Cornhill

BUFFALO, N. Y. 326 Elm St.
Radio Equipment Corporation

NEWARK, N. J. 219 Central Avenue
Wholesale Radio Service Company

NEW YORK, N. Y. Harrison Radio Co. 12 West Broadway

NEW YORK, N. Y. 100 Sixth Avenue
Wholesale Radio Service Company

READING, PENN. 404 Walnut Street
George D. Barbey Company

SPRINGFIELD, MASS. T. F. Cushing 349 Worthington Street



TRIPLET
INSTRUMENTS

ALBANY, N. Y. Uncle Dave's Radio Shack 356 Broadway

BOSTON, MASS. Radio Shack 46 Brattle Street

BOSTON, MASS. Selden Radio Company 28 Brattle St.

BUFFALO, NEW YORK 216 E. Genesee St.
Dymac Radio

MONTREAL, CANADA 285 Craig Street, West
Canadian Electrical Supply Co., Ltd.

NEWARK, N. J. 219 Central Ave.
Wholesale Radio Service Company

NEW YORK, N. Y. 100 Sixth Avenue
Wholesale Radio Service Company

PITTSBURGH, PENN. 603 Grant Street
Cameradio Company

READING, PENN. 404 Walnut Street
George D. Barbey Company

MR. E. H. RIETZKE



PRESIDENT OF CREI

RADIO Can Offer You More Than "Just A Living". . .

No man should be satisfied to "just get along" . . . especially when employed in such a prospering industry as Radio. Radio wants and needs men with adequate MODERN training to cope with the new improvements constantly introduced.

WRITE TODAY
FOR FREE
48-PAGE
BOOKLET

Start Training at Home PRACTICAL RADIO ENGINEERING

Written for the professional Radio-man, these courses are practical and available on easy terms that all can afford.

CAPITOL RADIO ENGINEERING INSTITUTE

Dept. Q-11

WASHINGTON, D. C.
14th and Park Road

NEW YORK CITY
29 Broadway



COME IN or WRITE
for Complete Information on the
NEW 1937 SUPER SKYRIDER
America's Leading Short Wave Receiver

It's a full year ahead of its field. With eleven all-metal tubes, greater sensitivity than before, improved 10 meter performance, Iron Core I. F. System, finer tone reception, this splendid receiver is the leader of communication receivers today. Stop in to see it or write today!

ALL NEW HALLICRAFTERS RECEIVERS
NOW AVAILABLE ON TIME PAYMENTS

RADIO ACCESSORIES CO.

2566 Farnam Street Omaha, Nebraska



NO MORE CRYSTAL
TROUBLES FOR ME!

I HAVE A
BC3

Price
\$3.95

**BLILEY BC3
CRYSTAL UNITS**
40-80 METER BANDS

AT
INTEGRAL
SPECIFIED
Kc. \$4.95

(Continued from page 108)

thing if he cancels his order for two half kilowatt bottles and puts up a diamond instead. Don't mind the trees and the underbrush; don't mind the buildings and the clothes line—just string the thing up and shoot. Remember though, that it is quite ridiculous to use such an antenna for transmission while using a piece of wire around the picture rail for receiving. It is utterly impossible to exploit the possibilities of the antenna without a change-over switch or relay which will permit using the antenna for reception. The method of coupling the antenna to the receiver is also important. We suggest setting up a tuned circuit consisting of a 35- μ fd. midget variable condenser and an 8-turn coil of bare wire one inch in diameter, coupling this with a 2-turn link to the terminals of the receiver. The feeders from the antenna should then be clipped across about the middle four turns of the coil. A somewhat similar arrangement, shown in Fig. 4, is suggested for the transmitter.

Possibly the most important feature of all is that the rhombic antenna operates effectively over a very wide frequency range. It is the one type of directive antenna that functions without

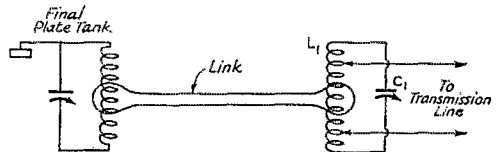

FIG. 4—THE ANTENNA COUPLING CIRCUIT
USED AT WIJPE

L_1 and C_1 are similar in size and rating to the coil and condenser used in the plate circuit of the final amplifier. The coupling of the two-turn link and the setting of the taps on L_1 are varied until the desired load is obtained.

the need of any adjustment or change on, say, the 40-, 20-, and 10-meter bands. Further, as the frequency is increased the vertical angle of radiation is decreased. Result—a hot performance on three bands. In practice the WIJPE antenna is an absolute whizz on 28 mc., even giving greater gains than those had on 14 mc. Time and again we have had thoroughly satisfactory 'phone contacts with stations along the line of the beam at times when the signals simply did not exist on the normal antenna.

It is all rather hard to believe.

Briefs

Transmissions of general interest to Newfoundland amateurs are made from VO1C on 3600-kc. c.w. at 7:00 p.m. each Monday and from VO1J on 3973.5-kc. 'phone at 7:00 p.m. each Tuesday. These are supplementary to the Newfoundland Amateur Radio Association's quarterly publication, "VO News."

During a year's illness of his father, W8CBF, Columbus, Ohio, used amateur radio to maintain communication with members of the family living in Los Angeles. The following amateurs provided splendid service in handling W8CBF's messages: W6GK, W6KFZ, W6CPG, W6KVM, W6GNV, W6IQU, W6BPD, W6JBO, W6MFG, W4ABS and Paul Meijers.

HAM-ADS

(1) Advertising shall pertain to radio and shall be of nature of interest to radio amateurs or experimenters in their pursuit of the art.

(2) No display of any character will be accepted, nor can any special typographical arrangement, such as all or part capital letters be used which would tend to make one advertisement stand out from the others.

(3) The Ham-Ad rate is 15¢ per word, except as noted in paragraph (6) below.

(4) Remittance in full must accompany copy. No cash or contract discount or agency commission will be allowed.

(5) Closing date for Ham-Ads is the 25th of the second month preceding publication date.

(6) A special rate of 7¢ per word will apply to advertising which, in our judgment, is obviously non-commercial in nature and is placed and signed by a member of the American Radio Relay League. Thus, advertising of bona fide surplus equipment owned, used and for sale by an individual or apparatus offered for exchange or advertising inquiring for special equipment, if by a member of the American Radio Relay League takes the 7¢ rate. An attempt to deal in apparatus in quantity for profit, even if by an individual, is commercial and takes the 15¢ rate. Provisions of paragraphs (1), (2), (4) and (5) apply to all advertising in this column regardless of which rate may apply.

Having made no investigation of the advertisers in the classified columns, the publishers of QST are unable to vouch for their integrity or for the grade or character of the products advertised.

RADIO engineering, broadcasting, aviation and police radio, servicing, marine and Morse telegraphy taught thoroughly. All expenses low. Catalog free. Dodge's Institute, Byrd St., Valparaiso, Ind.

NATIONAL—Hammarlund, Patterson used sets, 60% off list. W3DQ, 405 Delaware Ave., Wilmington, Del.

CLASS B transformers—universal for two or four 46s, 210s, 800s. RK18s, etc., \$7.75 pair postpaid. 70 watts audio for 46s, 100 watts from 10s. Write for details. W8UD, Douglas, Mich.

QSL's, W2SN, Helmetta, N. J.

WRITE us for trade-in price on your old receiver. We buy meters. Walter Ashe Radio Co., St. Louis, Mo.

TELEGRAPH speed keys in kit form, only \$2.89. A post card brings full information. Electric Specialty Mfg. Co., PO Box 645, Cedar Rapids, Iowa.

WANTED "QST" December 1916, and membership edition copies (with section reports) of June 1925, and April and October 1930. Must have both covers. Sumner B. Young, "Maplewoods", Wayzata, Minn.

CRYSTALS: guaranteed, 80-160, Y \$1.; X or A \$1.50. Blanks-X and Y 50c. "A" 75c. Postpaid anywhere. Roy Scherman, W9FHS, 4433 North Kilbourne, Chicago.

QSL cards, two color, cartoons, snappy service. Write for free samples today. W1BEF, 16 Stockbridge Avenue, Lowell, Mass.

SPECIAL bargain! Limited supply of used six volt automobile motor generators input 6 volts at 2 amps. output 135 volts d.c. at 40 to 60 MA. Just right for use on five meter portable rigs. All in A-1 condition. Net \$3. f.o.b. Walter Ashe Radio Co., St. Louis, Mo.

QSL's—See these samples first. Frits—203 Mason—Joliet, Ill.

QSL's! Everything printed! Samples? (stamp) W8DED, Holland, Mich.

CANADIANS: For sale, Skyriders battery model 27/350 dynamo, 9 tube battery BC receiver. Parts for Xmitter 47-46-pr 46's final, power pack, write, description, price. VE4WF, Weyburn, Sask.

WANTED: Used RME9D or 69. Advise best price. W9HOL, 1153 Lincoln, Decatur, Ill.

CRYSTALS—1" square 80-160 approximate frequency X-cut \$1.45. Constant frequency \$2. -cut \$1.20. Mounted unit socket plug-in type X-cut 40-80 \$2.50. Constant frequency \$3. Guaranteed. Dealers write for terms. Wolverine Crystal Service, Calumet, Mich.

QSL's—Free samples. Printer, Corwith, Iowa.

TRANSMITTER—400 watts. Fone-cw. 40 & 20. Class B. Good quality. Two racks. Complete key, mike, etc. \$300 cash. National oscilloscope complete \$30. W8IKE.

WANTED: 1 or 1/2 kw. Thordarson spark transformer in good condition. B. H. Moran, 6 Grant Street, Natick, Mass.

BEST offer takes QST's December 1926 to March 1936. Gilbert Countryman, Kane, Pa.

COMPACT cabinets illustrated page 83 July QST. Chassis punched five tubes. Leather handle. Size 12 1/2 x 15 x 5". Price, \$3.60. Radio Transceiver Labs., Richmond Hill, N. Y.

QSL's—SWL's—Superlative quality. Samples. (stamps) W8ESN, 1827 Cone, Toledo, Ohio.

VISUAL neon-stick modulation monitor. Mounted, with instructions \$2. W8ESN.

NAT. SW45—4 sets, coils, tubes, power supply, \$20. Noise silencer with tubes for receivers with two IF stages, \$5. W2HBO.

BEAUTIFY, pep up the transmitter, mounted on one of these new, all-welded relay racks. Standard or pressed-steel, chassis, panels. Heavy duty hi-power equipment. Rectifier Engineering Service, 4837 Rockwood Road, Cleveland, Ohio.

NO. 10 Enamel air wound coils, 2 3/4" diameter, 2¢ per turn. W8JWC.

MICHIGAN hams! Let W8DED demonstrate RME-69's.

WANTED: One DeForest Portable Buzzer Radiophone, type O T-5, manufactured by the DeForest Radio Telephone & Telegraph Company during 1920. State condition and price desired. Benjamin Chromy, National Press Building, Washington, D. C.

NEW Skyriders time payments, W7BDS, Roundup, Mont.

QSL's, 300 one-color cards \$1. Samples. 2143 Indiana Avenue, Columbus, Ohio.

CLEANING house. Two complete small transmitters, five meter transceiver, miscellaneous accumulated junk useful to someone. Stamp for list. W6QF, North Hollywood, Calif.

WANT to buy low power Collins, Marine or similar transmitter. Reasonable for cash. W6QF.

NEW Gross Eagle, RCA tubes. \$12. W9PNG.

SELL—Trade complete station. 100 watt RK18 transmitter, TRF receiver. Want miniature camera. W3EPV.

TRANSFORMERS—1200 watt 1200-2200-3200 each side \$24. F. Greben, W9CES, 2012 S. Peoria St., Chicago, Ill.

QSL's. Finest at lowest prices. Samples. Malero, 1512 Eastern Parkway, Brooklyn, New York.

MEDIUM power xmitter for sale to highest offer. Fone—C. W. all bands. W2GVX.

1000 W transformers, 1100-2200-4400 volts each side center on 110-60 cycles. Some double power same voltage. Dawson, 5740 Woodrow, Detroit, Michigan.

TO highest bidder unused RCA 800, 845, 865, W. E. 211E, 205D. Permanent magnet velocity microphone \$2.95. Photo cells cheap. 5 meter 2 tube receiver \$3.20. W6LSH.

CRYSTALS: Zero cut. Guaranteed to compensate at near zero without oven. 80-160 meters \$1.85. Forty meters \$2. Holders 75¢ postpaid. Fisher Lab., 4522 Norwood Street, San Diego, Calif.

QUICK service on QSL cards. Send for samples. Radio Printers, Lewiston, Minn.

QSL Printing Service. Samples. Theodore Porcher, Chestnut Hill, Penna.

HALLICRAFTER Skyriders—1935 & 1936 models. Very special prices. Also RME & HRO. Leica Camera. Will trade. Need binoculars, cameras, SW radios. Wells-Smith Radio Corp. 26 N. Wells, Chicago.

CRYSTALS: When in need of a good crystal order from Bill Thram, W8FN, 4021 Davis Ave. Cheviot, Ohio. No dealers. Direct to you. Unconditionally guaranteed. 160-80 meter, X cut, within ten kilocycles, less than 1", \$1.35. Exact frequency, 1" square, \$2.50. Plugin holders, 85¢.

SELL, Thordarson type, 3-stage speech amplifier and 210 modulator, T6425 output \$12; slightly used 204-A \$9; 1500-750-0-750-1500 volt, 280ma transformer, \$4; States Co. phantom load, \$7.50. Harold Henry, Clarion, Iowa.

ARTISTIC QSL's, T. Vachovetz, Elmsford, N. Y.

GENERAL Electric Dynamotors 24 750 volt 200 mills \$25. Operate on lower battery delivering 30 v per input volt. 500 cycle 500 watts with excitors \$10. slightly used \$6. Henry Kienzie, 215 Hart Blvd., Staten Island, N. Y.

CRYSTALS: Special: 80M Power X, within 10 kilocycles, \$1.50. V, 10 cycle coefficient, within 5 kilocycles, \$2.25. Either type mounted our HC-10 Holder, \$95 additional. Catalog. Ham Crystals, 1104 Lincoln Place, Brooklyn, N. Y.

GROSS CW25, power supply, xtal holder, four sets coils. SW3 supply, eight coils. Make offer. W2HWN.

FOR sale—Receiving equipment, hand carved cabinet, your own terms. S. Blaskey, 108 Treacy Ave., Newark, N. J.

CALLBOOKS—new DX calls, new prefixes, thousands of new W and VE calls, in the fall 1936 Radio Amateur Call Book. Sent postpaid \$1.25, or a whole year (four issues) for \$4. (In foreign countries \$1.35 and \$4.35.) Your call and QRA printed in large type, \$1 per year. Radio Amateur Call Book, 610 S. Dearborn, Chicago.

SELL—4—204A—\$20 each, graphite plate; 3—360—\$10 each; 2—352—\$8 each. All above tubes are RCA manufacture and never used. Cash or money order, no swaps, please. W2ECI.

CANADIANS: VE2HK complete station for sale. 500W fone, Comet Pro, etc. Particulars on request.

SW5 Coils, \$1.50 set. W3FYW.

QST'S—books, radio apparatus, for sale or trade for photographic equipment. List. W. Cox, 745 California, Columbus, Ind. **MAGNETS**—small, powerful, make excellent ribbon microphones. \$1 per pair. J. L. McFarland, 507 South Washington, Royal Oak, Mich.

TRADE in your old receiver or buy your new one from **W9DOQ** all makes and everything in radio. Palmer's Trading, Route 1, Duluth, Minn.

UNUSUAL bargain: Band switching, rack and panel transmitter, nine crystal controlled frequencies, four bands, 350W CW, 250W fone, condenser mike, good quality, commercial appearance. Complete, \$2. **W8AEU**, Cleveland.

SELL QST file, first issue Dec. 1915 to Dec. 1931. W. L. Otto, 1520 18th Ave., Rock Island, Ill.

SPEAR Transformers: Heavy construction. Guaranteed; 1000-750, 200ma, \$5.30; 300ma, \$6; 1575-1350-850, 300ma, \$7.50; 500ma, \$11; 2000-1500, 350ma, \$10.50; 500ma, \$15. Voltages are each side. 500ma Chokes, 10H, \$4.80; 5H, \$3.50. **Spear Manufacturing Co.**, Bowling Green, Ohio.

IMAGINE. Your or your station photo on QSL's, \$1.75, 100. Cut furnished free. Samples. Foto QSL, 628 Briar Place, Chicago.

FOR Sale—03-A xmitter complete or parts. **W1FKQ**, 36 Lincoln St., New Haven, Conn.

WANTED—ten meter coils for **AGSX-W3APJ**.

QSL'S—Samples, prices on request. Stamp. **W2AEY**, 338 Elmora, Elizabeth, N. J.

175 copies **QST**. 1920 thru 1935—\$15. Jewell 0-10 Thermo-Ammeter—\$4.50. Weston Thermo Galvanometer—\$5. **W9AFU**, 1848 Taylor Ave., Racine, Wis.

SELL—100 watt c.w. and 'phone transmitter. Complete. \$90. **W8OCN**.

REBUILT Vibroplexes, \$6. Bought, exchanged. New large base bugs. \$9. **Lydeard**, 14 Temple Street, Mattapan, Mass.

CRYSTALS: Latest Call Book free with each mounted crystal. Molded bakelite plug-in mounting. 160-80-40, ± 0.2%, X—\$3.25. Low Drift \$4.25. Unconditionally guaranteed. C.O.D. if desired. Premium Crystals, Box 2250, Kansas City, Mo.

TELEPLEXES, Instructographs, Omnigraphs. Bought, sold, traded. **Ryan Radio Co.**, Monroe City, Mo.

QSL'S—200 two colors \$1. **W8LQM**, 942 Linwood Avenue, Columbus, Ohio.

EIDSON "T9" dependable X cut 40 meter crystals: high activity—ground to resist fracture. Very close frequency supplied \$1.50 postpaid. Fully guaranteed. Eidson 40 meter ceramic plug-in holders \$1.10 postpaid. C.O.D. orders OK. **Eidson's**, Temple, Tex.

QSL'S—Special introductory offer. Radio Headquarters, Ft. Wayne, Indiana.

QSL'S—\$1. hundred. Finest obtainable. Attractive. 2 colors, quality stocks, inks. Samples. (stamp) **W8NOS**.

TRANSFORMERS, new, guaranteed, Hilet, 2 1/2 kw, 150 lb., \$35. Write for details. **Leitch Park Drive**, West Orange, N. J.

EIDSON'S 40 meter crystals usually within 5-ke, \$1.50. Efficient ceramic holder, \$1.10 postpaid. **W2GWS**, 8834 209th Street, Queens Village, N. Y.

TIME payments. **W8ANT**.

USED receivers. **W8ANT**.

USED tank condensers. **W8ANT**.

USED filter condensers. **W8ANT**.

USED transformers. **W8ANT**.

NEW 868A's—\$1.85. **W8ANT**.

New Breting, **Hallcrafters**, National, **RME** and **Sargent** receivers. Trade in your old set. **W8ANT**.

ALL lines of new and used equipment. Cash or time payments. Parts bought, sold, and exchanged. Write to **Southern Ohio's** only amateur owned amateur business. **Jos. N. Davies**, **W8ANT**, 2767 North Bend Road, Mt. Airy, Station A, Cincinnati, Ohio.

QSL'S, samples; **Lapco**, 344 W. 39th St., Indianapolis.

EO-1 Cable designed by **Graham Write**. **W8DT**.

TRANSMITTERS constructed. Superior workmanship. Give full particulars. Sell 25-watter complete, \$20. **Sylvania**, Isolanite based, T-210's, \$1.75 prepaid. **Howard Radio**, 5526 Lake Street, Chicago.

CRYSTALS—Unmounted 1.7, 3.5, 7 megacycle amateur band crystals. Your approximate frequency, X cut \$1.50; low drift cut, \$2.50. Holders, \$1. Calibration accuracy 99.99%. Postage prepaid. **Southwest Piezo Service**, Box 792, Abilene, Texas.

BEST cash offer takes **RCA ACR 175** complete. **W6CAW**.

CRYSTALS: X's 80—\$1, 40—\$1.35; AT's 160-80—\$1.50, V's 40—\$1.60. Guaranteed perfect. Holders, 90c. c.o.d.'s accepted. **Star Crystal Co.**, 1324 Georgia, Kansas City, Kansas.

RCA \$200 Type 4A1 Condenser Microphone, used, \$25. Special stand, \$5 desk type; \$7.50, floor type. \$30, 20 step, G. R. H-pad, 200 ohms, \$7.95. Used telegraph keys, 75¢. Unused, cut wires, **Dongan transformer**, cased, 550 v, 175 ma. half wave, 7 1/2 v. fil., 75¢ each. Two for \$1.25 make full wave. **Hatry & Young**, Hartford.

RADIO ENGINEERING



RCA Institutes offer an intensive course of high standard embracing all phases of Radio. Practical training with modern equipment at New York and Chicago schools. Also specialized courses and Home Study Courses under "No obligation" plan.

Illustrated Catalog on request

RCA INSTITUTES, INC. Dept. ST-36

75 Varick St., New York 1154 Merchandise Mart, Chicago
Recognized Standard in Radio Instruction Since 1909

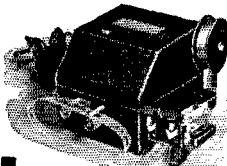

Let the New
Improved Automatic
ROBOT
RADIO KEY
do your calling.

Repeats calls or messages indefinitely, automatically, by motor-driven endless paper tape. Length of tape unlimited. Greater speed and flexibility; sends from 2 to 70 words per minute. Positive roller contacts. Practically noiseless. Induction-type motor. New, improved perforating device, easier to use; spacing of characters always uniform. Complete unit, with four rolls of tape and full instructions. No additional equipment needed.

Price
\$12.50

Postpaid
in U. S. A.
Patent
Pending

FULLY GUARANTEED

Gardiner-Levering Co. Haddon Heights
New Jersey, U. S. A.

I WILL SHOW YOU

that it is to your advantage to buy from me. Your inquiry about any amateur apparatus will prove that to you.

I give you specialized service of genuine value that is not available from other jobbers.

I take in trade used apparatus. I sell on time with only 6% interest charges.

I stock all amateur lines at lowest prices. Export orders given individual attention.

No apparatus shipped prepaid.

I ship all receivers on ten-day trial. You need send but \$5.00 with order, balance C.O.D. These receivers in stock:

RME-69s.....	\$118.80
The new 1937 Breting 14s.....	99.00
Breting 12s.....	93.00
RCA ACR-175s.....	119.50
Hammarlund Super Pros.....	223.44
Hallcrafters Sky Buddys.....	29.50
Hallcrafters Sky Chiefs.....	44.50
Hallcrafters 1937 Supr. Skyriders.....	89.50
Hallcrafters Ultra Skyriders.....	99.50

TRADE IN YOUR RECEIVER OR TRANSMITTER

I am jobber for all Collins, RCA, RME, Marine, Harvey transmitters. Trade in your transmitter. Buy on terms.

Collins 32G, 45A, 30FXC, 600A, others.

Harvey 60-X, 60-T, 200-R, UHX-35, others.

RME CT-100, SR9, 5T5, others.

RCA ACT-40 transmitters..... \$235.00

RCA ACT-200 transmitters..... 475.00

HENRY RADIO SHOP

211-215 North Main Street

BUTLER, MISSOURI

Your Nearest Dealer Is Your Best Friend

Your nearest dealer is entitled to your patronage. You can trust him. He is equipped with a knowledge and understanding of amateur radio. He is your logical and safe source of advice and counsel on what equipment you should buy. His stock is complete. He can supply your needs without delay. His prices are fair and consistent with the high quality of the goods he carries. He is responsible to you and interested in you.

Patronize the dealer nearest you—You can have confidence in him

ALLENTOWN, PENNSYLVANIA

Radio Electric Service Co.
1024 Hamilton Street
Complete stocks transmitting equipment

PITTSBURGH, PENNSYLVANIA

Cameradio Company
601-3 Grant Street
"Ham" Headquarters for Pennsylvania-Ohio-W. Virginia

BALTIMORE, MARYLAND

Radio Electric Service Co.
3 N. Howard St.
Everything for the amateur

PHILADELPHIA, PENNSYLVANIA

Eugene G. Wile
10 S. Tenth Street
Complete Stock of Quality Merchandise

BUFFALO, NEW YORK

Dymac Radio
216 E. Genesee Street
Cl. 2080. National, RCA, Eimac, etc. Standard discounts.

PROVIDENCE, RHODE ISLAND

W. H. Edwards Co.
32 Broadway
National—Hammarlund—RCA—and other leaders

BUFFALO, NEW YORK

Radio Equipment Corp.
326 Elm Street
W8GJ—Ham, service and sound equipment—W8BTS

PROVIDENCE, RHODE ISLAND

Kraus & Company
89 Broadway
Everything for the amateur and serviceman

MANCHESTER, NEW HAMPSHIRE

Radio Service Lab. of N. H.
1187-1191 Elm Street—Tel. 218-W
Branches—Portland, Me. and Barre, Vt.

ROCHESTER, NEW YORK

Radio Service Shop
244 Clinton Avenue, North
Complete stock amateur-BCL parts. Standard discounts. W8NUC

MONTREAL, CANADA

Canadian Elec. Supply Co., Ltd.
285 Craig St., W.
Quality parts and equipment for discriminating buyers

SYRACUSE, NEW YORK

Roy C. Stage, W8IGF
Complete stock of standard Ham & BCL parts
Standard Discounts. Free technical service

NEW YORK, N. Y.

Gross Radio, Inc.
51 Vesey Street
Fair dealings plus fair prices. Anything in radio

SPRINGFIELD, MASS.

S. S. Kresge Company
1540 Main Street
Standard discounts on standard lines.
Advisory service: W1JQ, W1FOF

PHILADELPHIA, PENNSYLVANIA

Consolidated Radio Corp.
612 Arch Street
Ham receivers, Transmitting tubes, Collins transmitters, etc.

PHILADELPHIA, PENNSYLVANIA

Radio Electric Service Co., Inc.
N. E. Cor. Seventh & Arch Sts.
All nationally-advertised lines in stock

WHEELING, WEST VIRGINIA

Cameradio Company
30 Twelfth Street
Complete stock of amateur Equipment at standard discounts

You Are Protected When You Buy From QST Advertisers

“Advertising for QST is accepted only from firms who, in the publisher’s opinion, are of established integrity and whose products secure the approval of the technical staff of the American Radio Relay League.”

Quoted from QST’s advertising rate card.

Every conceivable need of a radio amateur can be supplied by the advertisers in QST. And you will know the product has the approval of the League’s technical staff.

For Your Convenience QST’S INDEX TO ADVERTISERS IN THIS ISSUE

Aerovox Corporation.....	82
Allen-Bradley Company.....	67
Amperex Electronic Products.....	68
Ashe Radio Company, Walter.....	100
Astatic Microphone Laboratory.....	82
A.R.R.L. Binder.....	92
Calculators.....	101
Emblem.....	93
Handbook.....	70, 71
How To Become a Radio Amateur.....	97
License Manual.....	95
Map.....	79
Supplies.....	81
Two Hundred Meters and Down.....	77
Birnbach Radio Company.....	78
Bliley Electric Company.....	91, 106
Brush Development Company.....	58
Bud Radio, Inc.....	87
Burgess Battery Company.....	57
Candler System Company.....	83
Capitol Radio Engineering Institute.....	106
Cardwell Manufacturing Corp., Allen D.....	90
Centralab.....	72
Cohen's Sons, I. S.....	97
Collins Radio Company.....	Cov. 2
Communication Products, Inc.....	87
Continental Carbon, Inc.....	80
Cornell-Dubilier Corporation.....	90
Coto-Coil Company.....	76
Delco-Remy Corporation.....	75
Eitel-McCullough, Ltd.....	73
Freck Radio & Supply Company.....	93
Gardiner Levering Company.....	108
General Electric Company.....	89
General Radio Company.....	54
General Transformer Company.....	94
Gordon Specialties Company.....	87
Gross Radio, Inc.....	111
Gulf Radio School.....	94
Hallcrafters, Inc.....	4
Hammarlund Manufacturing Company.....	74
Harvey Radio Company.....	91
Harvey Radio Laboratories.....	92
Hatry & Young.....	97
Heintz & Kaufman.....	108
Henry Radio Shop.....	64
Hinds & Edgerton.....	94
Hipower Crystal Company.....	102
Instructograph Company.....	95
Johnson Company, E. F.....	99
Kenyon Transformer Company.....	60, 61
Leeds.....	102
Massachusetts Radio School.....	90
McElroy, T. R.....	64
McGrav-Hill Book Company.....	90
M & H Sporting Goods Company.....	53, 64, 83, Cov. 3
National Company.....	69
Newark Electric Company.....	96
New York V. M. C. A. School.....	56
Ohmite Manufacturing Company.....	98
Omaha Crystal Laboratories.....	103
Port Arthur College.....	102
Precision-Piezo Service.....	106
Radio Accessories Company.....	66
Radio Constructors Laboratories.....	63
Radio Mtg. Engineers.....	76
Radio Service Shop.....	6, 101
Radio Shack.....	101
Radio Specialties Company.....	93
Radio Supply Company.....	102
Radio Transceiver Laboratories.....	95
Raytheon Production Corporation.....	108
RCA Institutes, Inc.....	65, Cov. 4
RCA Mtg. Company.....	103
Sargent Company, E. M.....	102
Scientific Radio Service.....	78
Shurtz Brothers.....	86
Sickles Company, F. W.....	80
Signal Electric Manufacturing Co.....	93
Standard Transformer Corporation.....	86
Sundt Engineering Company.....	93
Sun Radio Company.....	55
Taylor Tubes, Inc.....	98
Teleplex Company.....	97
Terminal Radio Corporation.....	2
Thordarson Electric Manufacturing Co.....	62
Triplet Electrical Instrument Company.....	103
Triumph Manufacturing Company.....	100
Turner Company.....	98
United Electronics.....	112
United Transformer Company.....	96
Universal Signal Appliance Co.....	86
Valpey Crystals.....	62
Vibroplex Company.....	87
Ward Leonard Electric Company.....	

New! L60 Beam Power (60 Watt) Modulator

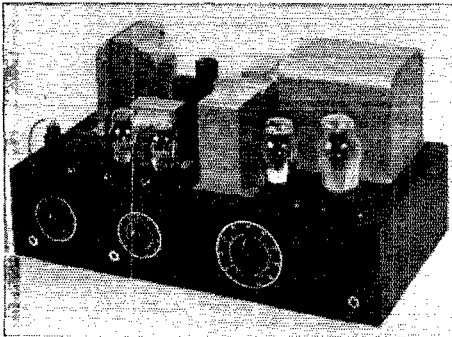

- 4 stages (1-6J7, 2-6C5, 2-76, 2-6L6, 1-45, 1-83)
- Push Pull second stage and driver for high fidelity
- Two channel, high and low gain high impedance inputs
- Built-in modulation transformer
- Fixed bias

This beam powered 60 watt modulator will 100% plate modulate transmitters with up to 120 watts input. The built-in modulation transformer will match R.F. loads of 5000, 8000, and 10,000 ohms. On special order we can supply this unit with output impedances of 4, 8, 15, 500 ohms for general public address work.

A two channel input permits full output with mixing from a crystal, ribbon or carbon mike. The tone control provided is used to attenuate voice or music frequencies to suit the requirements of best modulation. Chassis size: 19" x 11" x 4 1/4". Weight 50 lbs. Built-in extra heavy duty power supply.

Completely wired and tested in our lab., less tubes **\$42.50**
 Matched set of Sylvania tubes..... **\$5.50**

GROSS C C TRANSMITTER—OUTPUT 25-30 WATTS

The "CW-25" transmitter kit due to its low cost makes it possible for any one to own a modern crystal controlled station. A schematic hook-up and parts layout sheet as well as tuning instructions are furnished, thus enabling the most inexperienced operator to wire and put the set on the air, for real results. The "CW-25" is supplied with a shrivel finished sturdy metal chassis under which all parts are mounted, making the wiring and components dust-proof. A plug-in crystal holder is furnished with the kit. Only one milliammeter is required for tuning the transmitter and each stage is provided with a jack for this purpose. The "CW-25" uses one 47 as crystal oscillator, one 46 as buffer or doubler and two 46's in the amplifier stage, set of three coils supplied with kit for 20, 40, 80 or 160 band. Additional coils 75c each.

Complete kit, less tubes and crystal..... **\$14.95**

P-25 POWER SUPPLY — for CW-25 transmitter with matching chassis — **\$11**
 450 volts at 200 MA, choke input — complete kit, less tubes.....

30Watt Modulator

Tubes used, 2-6J7, 3-6O5, 2-6L6, 1-5Z3. Will 100% plate modulate transmitters up to 60 watts input. Completely wired and tested, less tubes... **\$29.50**
 Kit of Sylvania Tubes..... 5.50

CW-60 (Uses New Eimac 35T)

Crystal Control Transmitter

OUTPUT: 60-100 WATTS
 COMPLETE KIT, LESS TUBES AND CRYSTAL

\$20.95

POWER OUTPUT DEPENDS ON PLATE VOLTAGE USED

TUBE LINEUP: 47 crystal oscillator — 53 Buffer and Eimac 35T in output stage.
 POWER SUPPLY REQUIREMENTS: Filament voltages 2 1/2 volts at 4 amps. — 5 volts at 4 amps.
 PLATE VOLTAGES: 400 Volts at 100 MA and 500 to 1250 volts at 100 MA.
 COILS: One set of three coils are furnished with kit for operation on any one amateur band. Coils for 1.7; 3.5; 7; 14 MC may be purchased separately at \$2.75 per set.
 SIZE: Overall dimensions of the unit are Height 4 1/4 inches, width 11 inches, length 19 inches.
 P-60 DUAL POWER SUPPLY KIT for CW-60 Transmitter — with matching chassis **\$25.95**.

NEW! Single 6B5 (6 Watt Peak Output) Amplifier

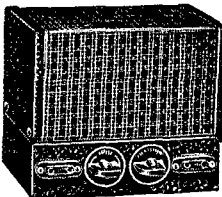

- 3 high gain stages
- Crystal mike input
- Fully fused
- Gain and tone controls
- 5 watt undistorted output
- Tubes used 6J7-6C5-6B5-5Z4

A versatile and high quality amplifier combining all the desirable features yet at a very reasonable price, is now offered for your use. High gain, sufficient for full output from a low level crystal mike with noiseless high fidelity output. Tube lineup: 1-6J7 high gain input stage, 1-6C5 driver, 1-6B5 power output amplifier, 1-5Z4 rectifier, Fully fused for your protection.

Complete kit of parts, less tubes..... **\$8.50**
 Wired and tested in our lab., less tubes... **10.95**
 Matched set of tubes **3.50**

NEW! Push Pull 6B5 (20 Watt Peak Output) Amplifier

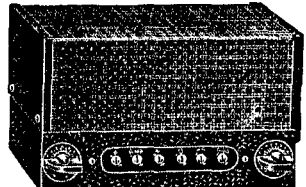

- 3 high gain stages (last two in push pull)
- Crystal or Ribbon mike input
- Fully fused
- Gain and tone controls
- Universal output (4-8-15-500 ohms)
- 15 w. undistorted output

As a modulator for a low powered transmitter, or for general P.A. work this amplifier is unexcelled in its adaptability. May also be used as a driver for high powered modulators. A clean gain of 126 D.B. permits full undistorted high fidelity from either a ribbon or crystal mike. Tube lineup: 1-6J7 input stage, 2-6J7 p.p. driver stage output p.p. 2-6B5 with phase inversion, tubes 1-80 rectifier

Complete kit of parts less tubes **\$16.95**
 Wired and tested in our lab., less tubes..... **20.70**
 Matched set of tubes..... **5.10**

Complete kit of parts less coils, tubes, cab.... **\$7.59**
 2-5-10 meter coils (set of 3)..... **.95**
 9 1/2 to 15 meter coil..... **.39**
 15-200 meter coils (set of 4)..... **.95**
 200-310 meter coil..... **.39**
 310-550 meter coil..... **.39**
 550-1050 meter coil..... **.60**
 1000-2000 meter coil..... **.60**
 Metal cabinet..... **1.50**
 Kit of three tubes. **2.40**
 Wired and tested in our lab., add. **2.00**

NEW! "THE STANDBY" (2 TO 2000 METERS) 3-TUBE A.C. AND D.C. RECEIVER

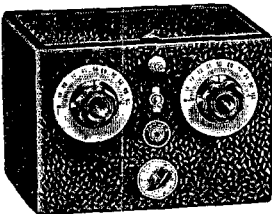

This excellent 2 to 2000 meter receiver is offered with full realization of the present-day need of the amateur for a dependable "standby" receiver which will cover practically all of the radio bands in use today. Super regeneration, which is the most efficient form of detection at these frequencies, is used from 2 to 15 meters. By throwing a toggle switch, straight regeneration and higher wavelengths up to 2000 meters may be had. Throughout the entire tuning range, there are no skips or dead spots. Loud speaker volume is available from practically every station received.

- 1000 to 1 tuning ratio
- Super regeneration below 15 meters
- Instant change over from straight to super regeneration
- Power supply incorporated
- Individual antenna tuning for high and low wave ranges
- 1-76 super regenerative detector, 1-6J7 regenerative detector, 1-12A7 audio amp. and rectifier

WRITE IN FOR FREE NEW CATALOG ON HAM AND P.A. EQUIPMENT

20% DEPOSIT WITH ALL C. O. D. ORDERS

REMIT BY M. O. INCLUDE POSTAGE

Cable Address: GROSSINC

GROSS RADIO, INC., 51 VESEY STREET, NEW YORK CITY



*Most Complete Transformer
Line in the World*

QUALITY · RELIABILITY

UTC Linear Standard Audio Transformers are

Precise measurements of high quality audio transformers in the net price range of \$8 to \$25 show:

LINE TO GRID TRANSFORMER	UTC LS 10 (\$9 net)	Best competitive unit found (\$25 net)	Poorest characteristics of any high fidelity units
Measured deviation between 30 and 1000 cycles	1.0 DB	1.5 DB	13 DB
Measured deviation between 1000 and 10,000 cycles	4 DB	1.2 DB	3 DB
Measured deviation between 1000 and 15,000 cycles	.9 DB	2.8 DB	7 DB
Measured deviation between 1000 and 20,000 cycles	1.2 DB	2.5 DB	17 DB
DB rise at resonance (Approx. measure of phase shift)	0 DB	2.8 DB	2.8 DB
Hum at maximum position	1 DB	4 DB	42 DB
Hum at minimum position	0 DB	2 DB	10 DB

Critical organizations, that check claims, buy UTC Linear Standard audios

*best
by test*

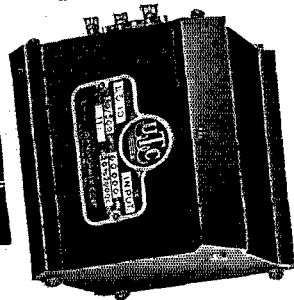

• UTC Leads . . . others follow

FREQUENCY RANGE

Claims for wide frequency response are common today. UTC is the only organization that **GUARANTEES** its frequency response and it specifies the widest range of all: 30 to 20,000 CYCLES \pm 1 DB.

PHASE SHIFT

Low distributed capacity is of paramount importance in audio components. The exclusive UTC winding method costs more but assures lowest possible capacity . . . makes 20,000 cycle response possible . . . and assures negligible phase shift.

HUM PICKUP

Most manufacturers have already adopted some form of humbucking coil structure and cast ferrous case. Both of these developments were pioneered by the UTC engineering staff. But UTC's hum balanced coil structure is designed for **POSITIVE SELF BALANCE** and the UTC cast alloy has **FIVE TIMES THE PERMEABILITY OF ORDINARY CAST IRON**.

TRI-ALLOY MAGNETIC FILTER

In addition to their normal shielding, UTC low level input transformers now incorporate **TRI-ALLOY MAGNETIC FILTERING**, a new method of shielding which reduces hum pickup tremendously. This **MAGNETIC FILTER** was developed after a thorough analysis of hum reduction methods. Rotation in one plane was found of practically no value. Orientation in two planes, while much better, makes necessary unusual and unworkmanlike mounting and loses most of its effect if the field plane is altered or if stray flux from surrounding equipment is encountered (frequent in remote pickup equipment). The **MAGNETIC FILTER** makes possible a transformer which in its worst pickup position has a hum level far lower than any other transformer in its best position. The nearest available transformer on the market under \$25 shows 17 DB greater hum than the UTC LS-10. This UTC advancement in shielding is the greatest forward step in ten years.

UNITED TRANSFORMER CORP.

72 SPRING STREET

NEW YORK, N. Y.

EXPORT DIVISION: 100 VARICK STREET NEW YORK, N. Y. CABLES "ARLAB"

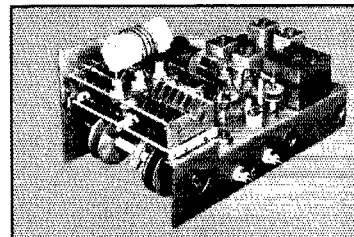
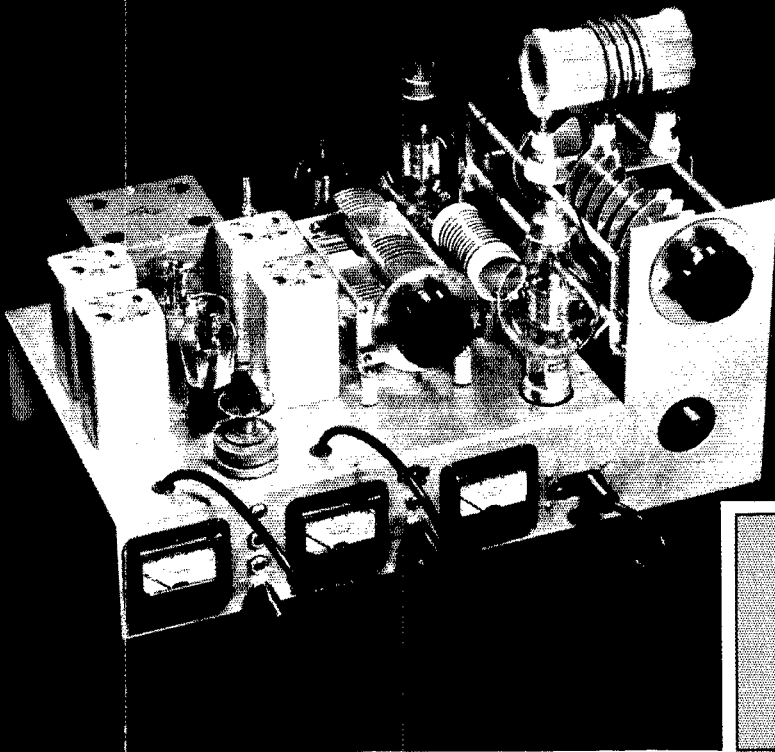

WHEN BUILDING or remodeling your transmitter, remember there is no substitute for National Radio Products, either in quality or price. Genuine National parts will insure better performance of the old rig and peak operating efficiency of the new.

An example of the well-balanced compact design that may be achieved with National transmitter parts is shown above. A highly efficient multi-band transmitter built around the recent RK-36s. Further details of this application of National Products is on Page 53 of this issue, and a complete description of all parts may be found in our new catalog, available at your nearest dealer or by mail direct from us.

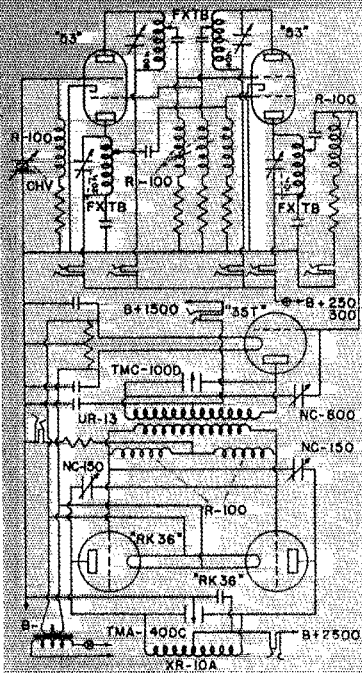

NATIONAL COMPANY

Another RCA "Ultra-Hi" Achievement

The RCA-956 Super-Control R-F Pentode, a new addition to the Acorn Family

The RCA-956 marks another advance in the art of ultra-high frequency communication. The super-control feature (remote cut-off characteristic) provides an easy means for controlling the gain in r-f stages and permits a reduction in cross modulation.

The 956 with its companion tubes, the 954 and 955, provides a complete family of Acorn receiving types for the ultra-high frequencies.

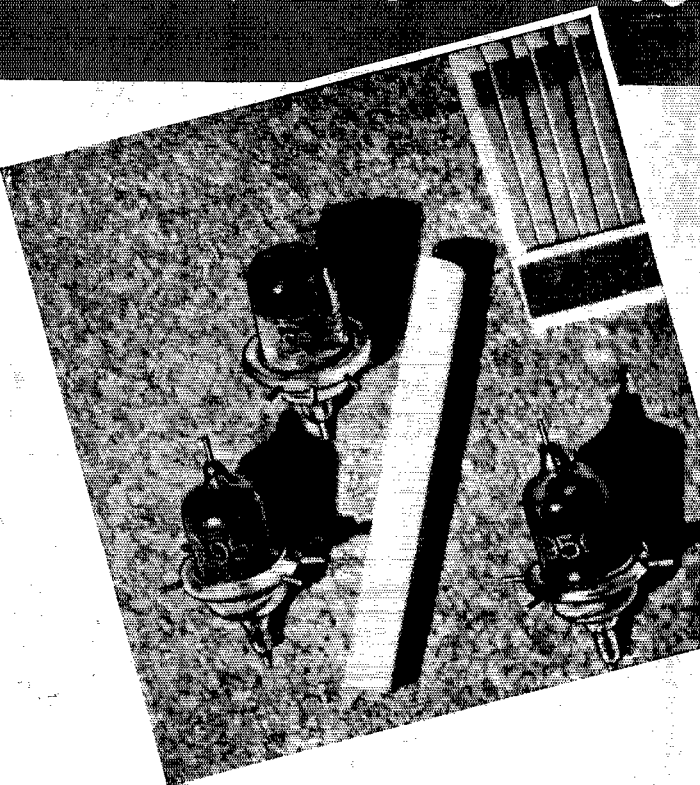

AMATEUR'S NET PRICES



- RCA-954 - - - \$5.80
- RCA-955 - - - 3.75
- RCA-956 - - - 5.80

The RCA-956 is available for immediate delivery. For technical data, see your supplier or write to us.

Listen to "The Magic Key" every Sunday, 2 to 3 p. m., E.S.T., on NBC Blue Network

IMPORTANT NEWS

Prices reduced on three popular RCA rectifier types

TYPE	OLD PRICE	NEW PRICE		
RCA-866	\$ 2.25	\$ 1.75		RCA 866
RCA-872	16.50	14.00		RCA 872
RCA-872-A	18.50	16.50		RCA 872

Increased volume has made possible these substantial reductions. Take advantage of these new low prices on these three famous RCA rectifier types. High-voltage power supply costs are now materially lower. Your supplier can take care of your requirements immediately.



for Amateur Radio

Address Amateur Radio Section, RCA Manufacturing Co., Inc., Camden, N. J.

A service of the Radio Corporation of America