

# QST

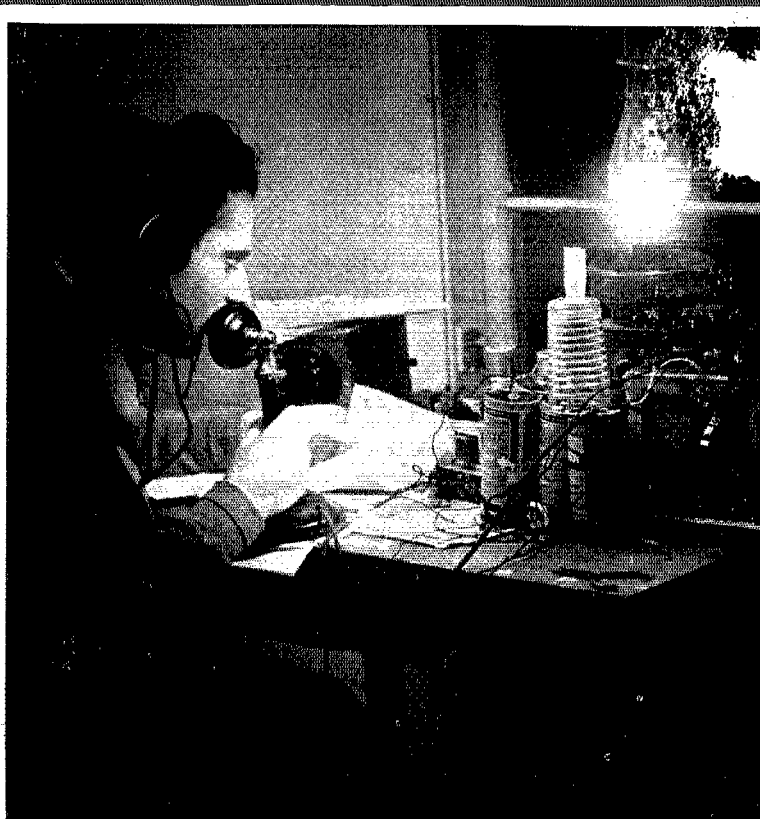

devoted entirely to

# amateur radio



may  
1936  
25 cents



*The 45A* IN BARCELONA

**EA3DY** Sr. Enrique Cortes, EA3DY, sends his compliments on the performance of his Collins 45A transmitter and multiband antenna. Between the first and the fifteenth of February Sr. Cortes worked 30 dx stations on 40 meter phone including stations in France, Belgium, England, Portugal, Switzerland, Canary Islands, Argentina, Cuba, Africa, Egypt, Santa Domingo, Mallorca, Mexico, Azores, Rumania and Brazil. Reports received on the signals of the 45A transmitter ranged from r/6 to r/9, most of the stations reporting r/8 and r/9. Congratulations, Sr. Cortes, and welcome to the family of Collins users.

**30FXC** The high output of the Type 30FXC Transmitter is of importance, but equally worthwhile are the many refinements which contribute to convenience of operation and increased utility. For example, the 30FXC's system of shifting frequencies is the fastest and easiest arrangement yet devised which gives full efficiency at each frequency. The antenna network is continuously adjustable over the entire frequency range of the transmitter—a complete complement of meters and power controls is provided. In short, the 30FXC has every feature which experience has shown to be desirable in a general purpose high frequency transmitter.

MANUFACTURERS OF BROADCAST TRANSMITTERS AND SPEECH INPUT EQUIPMENT

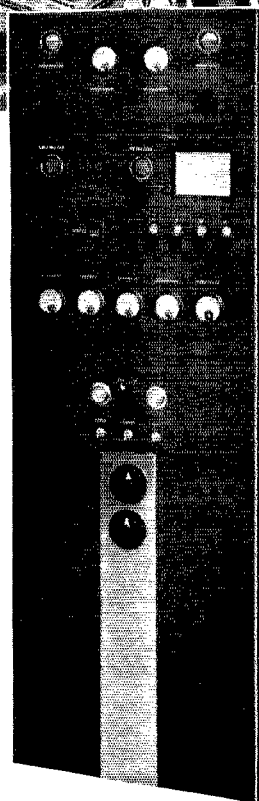

# Collins Radio Company

CEDAR RAPIDS  IOWA, U. S. A.  
 New York Mexico City  
 11 West 42nd St. Edificio "La Nacional"



COURTESY NBC

with **BURGESS PORTABLE POWER**  
*the World Hears a Whisper  
 in the Heavens*

In spite of bitter, stratospheric cold, the daring pilots of the U. S.-National Geographic stratosphere balloon kept in constant communication with the earth throughout their record-breaking flight.

At the same time, over San Francisco on the world-famous China Clipper flew Captain Musick and Burke Miller (shown above). They easily communicated with the balloon high above the Dakotas. The conversations were then rebroadcast to the public by NBC over a nationwide network.



Constant, dependable portable power, furnished by Burgess Batteries, supplied the short-wave equipment in the flying boat as well as in the balloon gondola. Here, again, the advanced construction and patented "Chrome" preservative of Burgess Batteries proved the wisdom of their exclusive use on

these famous scientific expeditions. Do as the scientists do—use Burgess Batteries in all your experimental work.

Burgess Battery Company  
 Freeport Illinois

**BURGESS**

Say You Saw It in QST — It Identifies You and Helps QST

# • MARINE TRANSMITTERS •

MARINE 18A

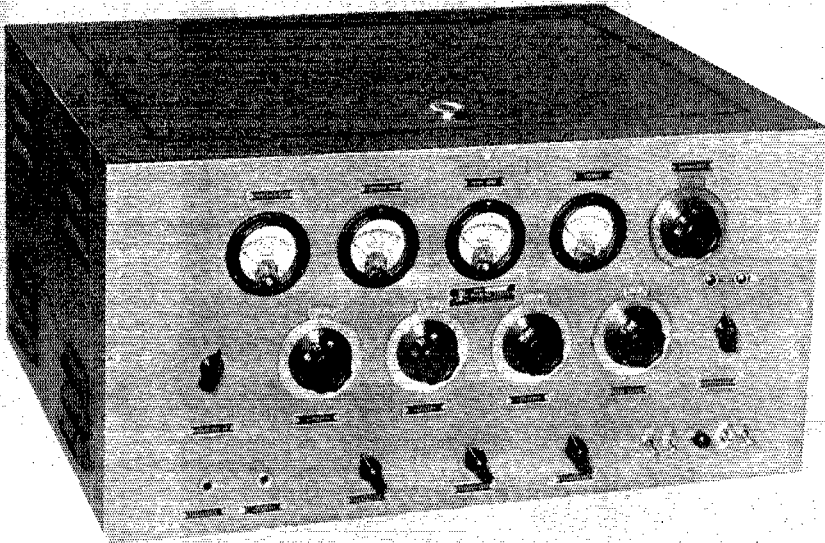

## MARINE 18 A

50 watts phone, 125 watts C.W.  
A low power transmitter designed for low original and low operating cost.

● Frequency range: 30,000 to 1,500 Kcs. ● Four R.F. stages. ● Break-in keying system. ● Size: 24" wide x 12" high x 19" deep.

## MARINE 22 BP

20 watts phone and C.W.  
A reliable portable transmitter incorporating many of the features found in the high power Marine transmitters. Frequency range: 30,000 to 1,500 Kcs. Light and compact, this unit ideally suited for home or field work.

MARINE 22BP

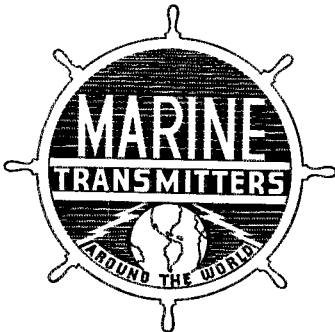
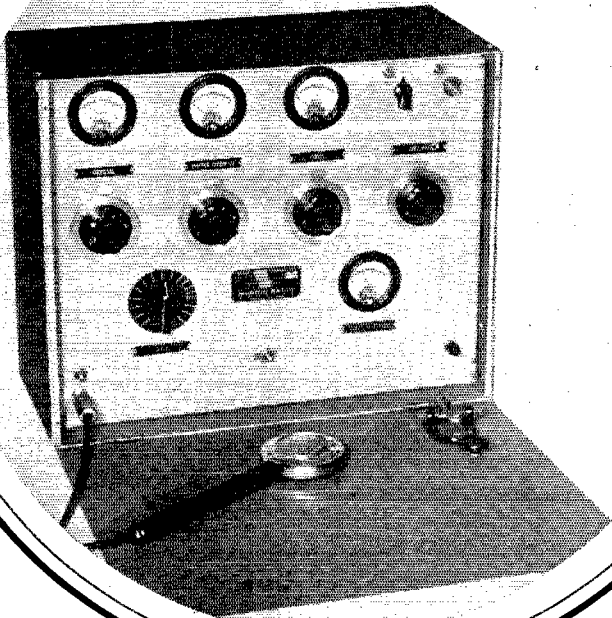

Write for the complete details and photographic illustrations on these and other models for all purposes

## MARINE RADIO COMPANY

**REMOVAL NOTICE:** The universal acceptance of "MARINE" Transmitters has necessitated our moving to larger quarters. New centralized location after May 1st will be 60 LISPENARD STREET, New York, N. Y. (One block south of Canal just west of Broadway).

# QST

devoted entirely to

# AMATEUR RADIO

PUBLISHED, MONTHLY, AS ITS OFFICIAL ORGAN, BY THE AMERICAN RADIO RELAY LEAGUE, INC., AT WEST HARTFORD, CONN., U. S. A.; OFFICIAL ORGAN OF THE INTERNATIONAL AMATEUR RADIO UNION

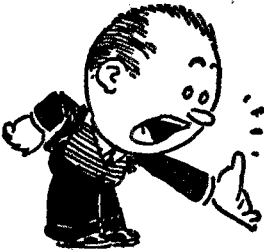

MAY  
1936

Volume XX  
Number 5



Kenneth B. Warner (Secretary, A.R.R.L.), *Editor-in-Chief and Business Manager*; Ross A. Hull, *Associate Editor*; James J. Lamb, *Technical Editor*; George Grammer, *Assistant Technical Editor*; Clark C. Rodimon, *Managing Editor*; David H. Houghton, *Circulation Manager*; F. Cheyney Beekley, *Advertising Manager*; Ursula M. Chamberlain, *Assistant Advertising Manager*.

*Editorial and Advertising Offices*

38 La Salle Road  
West Hartford, Connecticut

Subscription rate in United States and Possessions and Canada, \$2.50 per year, postpaid; all other countries, \$3.00 per year, postpaid. Single copies, 25 cents. Foreign remittances should be by international postal or express money order or bank draft negotiable in the U. S. and for an equivalent amount in U. S. funds.

Entered as second-class matter May 29, 1919, at the post office at Hartford, Connecticut, under the Act of March 3, 1879. Acceptance for mailing at special rate of postage provided for in section 1103, Act of October 3, 1917, authorized September 9, 1922. Additional entry at Concord, N. H., authorized February 21, 1929, under the Act of February 28, 1925.

Additional second-class entries to cover sectional editions authorized March 20, 1935. Copyright 1936 by the American Radio Relay League, Inc. Title registered at United States Patent Office.

## The Contents

Editorials . . . . .	7
A Loving Tribute and a Challenge . . . . .	8
Amateur Radio Rises to Greatest Emergency Need of All Time . . . . . <i>Clinton B. DeSoto</i>	9
A Novel Low-Cost U.H.F. Receiver, <i>R. O. Williams, W8FUQ</i>	22
A Meter-Type Modulation Monitor . . . . . <i>D. C. Summerford, W9AYH</i>	24
What the League Is Doing . . . . .	26
Separate Transmitters on Five Bands . . . . . <i>A. L. Budlong, W1JFN and Clinton B. DeSoto, W1CBD</i>	27
Dixie Jones' Owl Juice . . . . .	34
1936 DX Contest Hits New Highs . . . . .	35
The Dual Diversity Receiver . . . . . <i>J. L. A. McLaughlin and James J. Lamb</i>	39
The Pre-Selector Antenna . . . . . <i>Isaiab Creaser, W1BSJ</i>	44
A Simple 14- and 28-Mc. Rig That Has Worked Over 30 Countries . . . . . <i>E. E. Kohler, W7BQX</i>	47
A Three-Feeder Double-Antenna System . . . . . <i>John A. Pool, W3ZZ</i>	49
A New Audio Power Tube . . . . .	50
An I.F. Coupling Amplifier for the Cathode Ray Oscilloscope . . . . . <i>Willard S. Wilson, W3DQ</i>	51
Politician Denounces Amateur Operator . . . . .	52
Putting the 35T to Work . . . . .	53
Hints and Kinks	
Suppressor Modulation with Linear Amplification — More Locked Oscillator Circuits — Regenerative Doubler — Improving Selectivity in the Regenerative Receiver — Combination Time Delay and Bias Supply — Regenerative Detector Kinks . . . . .	54
Amateur Radio Stations . . . . . <i>CO6OM, W9AS, W6GVT</i>	58
Calls Heard . . . . .	60
I.A.R.U. News . . . . .	62
A Resonant Loud-Speaker for C.W. Reception, <i>S. L. Seaton</i>	64
Atlantic Division Convention . . . . .	64
Operating News . . . . .	65
Correspondence Department . . . . .	73
Standard Frequency Transmissions . . . . .	82
A.R.R.L. QSL Bureau . . . . .	96
Kentucky State Convention . . . . .	106
South Carolina State Convention . . . . .	110
Hamads . . . . .	123
QST's Index of Advertisers . . . . .	126

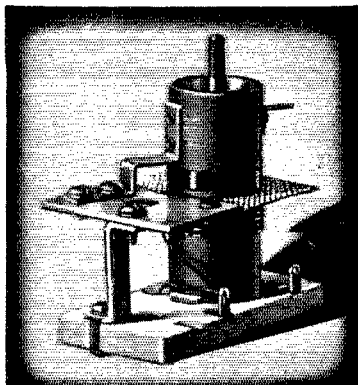

SCREENED INPUT COIL

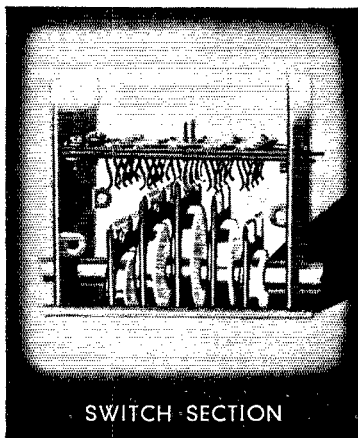

SWITCH SECTION

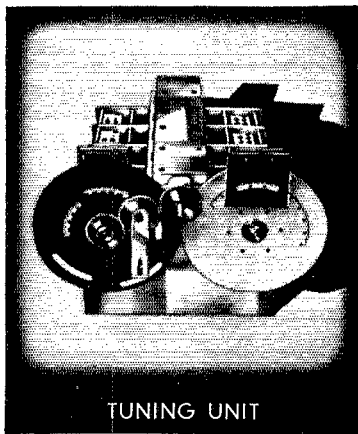

TUNING UNIT

# Advanced..

## AMATEUR-PROFESSIONAL RECEIVER

*Precision—Performance in Every Detail!*

THE "Super-Pro," the new Hammarlund amateur-professional receiver incorporates a multitude of distinctive developments which provide that exacting efficiency you have always wanted! One of these new features is the screened input coil which has an electrostatic or Faraday shield between the primary and secondary. This makes the receiver suitable for correct connection to a balanced transmission line without interposing any additional transformer. Still another exclusive development is the silver-plated, five-band changing switch, a radical departure from switches commonly used for this purpose. As the switch is turned a new contact is made before the old one is broken. This avoids open plate and grid cir-

cuits and eliminates sparking at the contacts. The contacts are absolutely positive.

Another "Super-Pro" feature is a 12-gang band spread condenser. Four sections of this condenser are used on the 10 to 20 megacycle band; four other sections on the 5 to 10 mc. band and the remaining four are for the 2½ to 5 mc. band. This permits correct proportion of band spreading in each of the three high frequency bands.

The tuning dial and the band spread dial each have a 12 to 1 ratio. They are absolutely free from backlash. Other unusual features of the "Super-Pro" are:—continuously variable selectivity; four air-tuned I.F. transformers; separate power supply unit, and separate grid bias supply.

Mail  
Coupon  
For  
Full  
Details

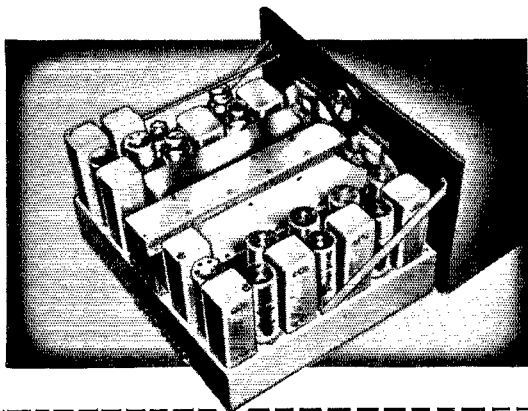

# The Hammarlund "Super-Pro"

HAMMARLUND MANUFACTURING CO., INC. Q-5  
424-438 W. 33rd St., New York

- Check here for complete data on the new Hammarlund "Super-Pro."
- Check here for 1936 Hammarlund General Catalog.

Name.....

Address.....

## Section Communications Managers of the A.R.R.L. Communications Department

All appointments in the League's field organization are made by the proper S.C.M., elected by members in each Section listed. Mail your S.C.M. (on the 16th of each month) a postal covering your radio activities for the previous 30 days. Tell him your DX, plans for experimenting, results in phone and traffic. He is interested, whether you are an A.R.R.L. member or get your QST at the newsstands; he wants a report from every active ham. If interested and qualified for O.R.S., O.P.S. or other appointments he can tell you about them, too.

Eastern Pennsylvania	W3EZ	<b>ATLANTIC DIVISION</b> James M. Bruning	339 W. Lancaster Ave.	Haverford
Maryland-Delaware-District of Columbia	W3BAK	Edgar L. Hudson	1107 Park Ave.	Laurel, Delaware
Southern New Jersey	W3ZX	Carroll D. Keutner	310 E. Walnut St.	Collingswood
Western New York	W8DSS	Charles Smith	261 N. Balph Ave.	Oneida
Western Pennsylvania	W8CUG	C. H. Grossarth		Bellevue
		<b>CENTRAL DIVISION</b>		
Illinois	W9WR	Fred J. Hinds	6618 West 34th St.	Berwyn
Indiana	W9TE	Arthur L. Braun	530 East Morris St.	Indianapolis
Kentucky	W9AUH	G. W. Mossbarger	Box 177	Camp Taylor
Michigan	W8DYH	Kenneth P. Conroy	18030 Waltham Ave.	Detroit
Ohio	W8CJO	Robert P. Irvine	5508 Northcliffe Ave.	Cleveland
Wisconsin	W9ATO	E. A. Cary	3922 No. 19th Pl.	Milwaukee
		<b>DAKOTA DIVISION</b>		
North Dakota	W9OEL	Hartwell B. Burner		Hope
South Dakota*	W9CFU	Walter E. Beeler	231 S. E. Iowa St.	Huron
Northern Minnesota	W9OWU	Leonard Hofstad		Elbow Lake
Southern Minnesota	W9DEI	Francis C. Kramer	W. Bluff St.	St. Charles
		<b>DELTA DIVISION</b>		
Arkansas	W5ABI	H. E. Velte	2918 West 15th St.	Little Rock
Louisiana	W5DWW	W. J. Wilkinson, Jr.	1523 Laurel St.	Shreveport
Mississippi	W5CWO	J. H. Weems, Jr.	P. O. Box 244	State College
Tennessee	W4BBT	Merrill B. Parker, Jr.	1912 Oak St.	Chattanooga
		<b>HUDSON DIVISION</b>		
Eastern New York	W2LU	Robert E. Haight	511 South Holmes St.	Scotia
N. Y., C. & Long Island	W2AZV	E. L. Baumach	7823 10th Ave.	Brooklyn
Northern New Jersey	W2FOP	Charles J. Hammersen	92 Claremont Ave.	Verona
		<b>MIDWEST DIVISION</b>		
Iowa	W9LEZ	Phil D. Boardman	325 Kirkwood Blvd.	Uvanport
Kansas	W9FLG	O. J. Spreter	305 Western Ave.	Topeka
Missouri	W9CJR	J. Dewey Mills	Box 205	Mount Vernon
Nebraska	W9FAM	Samuel C. Wallace	Green St.	Clarks
		<b>NEW ENGLAND DIVISION</b>		
Connecticut	W1CTI	Frederick Ellis, Jr.	19 Merrill Rd.	Norwalk
Maine	W1CDX	John W. Singleton	73 Allen St.	Wilton
Eastern Massachusetts	W1ABG	Albert N. Giddis	128 Crawford St.	Lowell
Western Massachusetts	W1BVR	Percy C. Noble	37 Broad St.	Westfield
New Hampshire	W1AVJ	Robert Byron	12 Humphrey St.	Concord
Rhode Island	W1HRC	Clayton C. Gordon	206 California Ave.	Providence
Vermont	W1BJP	Forrest D. Drew	947 E. Main St.	Newport
		<b>NORTHWESTERN DIVISION</b>		
Alaska	K7PQ	Richard J. Fox	Box 301	Ketchikan
Idaho	W7NH	Nellie H. Hart	Box 0	Twin Falls
Montana	W7CRH	Russell U. Richmond		Somers
Oregon	W7AMF	Frank L. Black	1502 McPherson St.	North Bend
Washington	W7WY	Robert H. Votaw	Route 1, Box 398	Vancouver
		<b>PACIFIC DIVISION</b>		
Hawaii	K6EWO	Atlas O. Adams	21st Infantry Brigade	Schofield Barracks
Nevada	W6BIC	Edward W. Heim	716 West Sixth St.	Reno
Santa Clara Valley	W6BMW	Charles J. Camp	318 Hawthorne Ave.	Palo Alto
East Bay	W6JTV	Harold J. Burchfield	2940 106th Ave.	Oakland
San Francisco	W6SG	Alan D. Whittaker, Jr.	79 Elinor Ave.	Mill Valley
Sacramento Valley	W6DVE	Geo. L. Woodington	716 Redwood Ave.	North Sacramento
Philippines*	KA1GR	George L. Ricard	Box 849	Manila
San Joaquin Valley	W6CRF	Vernon C. Edgar	732 Blackstone Ave.	Fresno
		<b>ROANOKE DIVISION</b>		
North Carolina	W4OG	H. S. Carter	115 Crafton St.	Winston-Salem
Virginia	W3UVA	Charles M. Waff, Jr.	P. O. Box 1212	Univ., Charlottesville
West Virginia	W8KKG	Dr. Wm. H. Riheldaffer		Lost Creek
		<b>ROCKY MOUNTAIN DIVISION</b>		
Colorado	W9FA	Glen Glasscock	2160 South Josephine St.	Denver
Utah-Wyoming	W6GQC	Arty W. Clark	260 So. 9th West	Salt Lake City, Utah
		<b>SOUTHEASTERN DIVISION</b>		
Alabama	W4DGS	James F. Thompson	2248 S. Arlington Ave.	Birmingham
Eastern Florida	W4BCZ	Philip A. McMasters	731 Arlington Ave.	St. Petersburg
Western Florida	W4MS	Edward J. Collins	1517 East Brainard St.	Pensacola
Georgia-So. Carolina-Cuba- Isle-of-Pines-Porto Rico- Virgin Islands	W4CE	Bannie L. Stewart	C. C. C. Co. 4466	York, S. C.
		<b>SOUTHWESTERN DIVISION</b>		
Los Angeles	W6BPU	Howell C. Brown	120 N. El Molino Ave.	Pasadena
Arizona	W6LVG	C. C. Day	"La Posta Quemada"	Vail
San Diego	W6EOP	Harry A. Ambler	4101 Hamilton St.	San Diego
		<b>WEST GULF DIVISION</b>		
Northern Texas	W5BH	Richard M. Cobb	Box 185	Dodd City
Oklahoma	W5CEZ	Carter L. Simpson	2010 So. 4th St.	Ponca City
Southern Texas	W5BDI	Ammon O. Young	4803 Eli St.	Houston
New Mexico	W5CGJ	Joseph M. Eldodt		Chamita
		<b>MARITIME DIVISION</b>		
Maritime	VE1DQ	A. M. Crowell	69 Dublin St.	Halifax, N. S.
		<b>ONTARIO DIVISION</b>		
Ontario	VE3QK	John Perdue	229 Askin Boulevard	Windsor, Ont
		<b>QUEBEC DIVISION</b>		
Quebec	VE2EE	Stan Comach	780 Brault Ave.	Verdun, P. Q.
		<b>VANALTA DIVISION</b>		
Alberta	VE4LX	Alfred D. KettenLach		Rockyford
British Columbia	VE5EP	D. R. Vaughan-Smith	1221 Burnaby St.	Vancouver
		<b>PRAIRIE DIVISION</b>		
Manitoba	VE4BG	A. J. R. Simpson	71 Thelmo Mansions	Winnipeg
Saskatchewan	VE4EL	Wilfred Skalfe	2040 McTavish St.	Regina

\* Officials appointed to act until the membership of the Section choose permanent S.C.M.'s by nomination and election.

# The American Radio Relay League



## DIRECTORS

*President*

*Vice-President*

*Canadian General Manager*

ALEX REID.....VE2BE  
169 Logan Ave., St. Lambert, P. Q.

*Atlantic Division*

EUGENE C. WOODRUFF.....W8CMP  
234 W. Fairmount Ave., State College, Pa.

*Central Division*

EDWARD A. ROBERTS.....W8HC  
2699 Endicott Rd., Shaker Heights, Cleveland

*Dakota Division*

CARL L. JABS.....W9BVH  
1822 James St., St. Paul, Minn.

*Delta Division*

E. RAY ARLEDGE.....W5SI  
P. O. Box 286, Pine Bluff, Ark.

*Hudson Division*

KENNETH T. HILL.....W2AHC  
115 Willow St., Douglaston, L. I., N. Y.

*Midwest Division*

FLOYD E. NORWINE, JR.....W9EFC  
120 South Fourth St., St. Louis, Mo.

*New England Division*

G. W. BAILEY.....W1KH  
74 Webster Road, Weston, Mass.

*Northwestern Division*

RALPH J. GIBBONS.....W7KV  
c/o United Air Lines, Pendleton, Ore.

*Pacific Division*

S. G. CULVER.....W6AN  
2962 Russell St., Berkeley, Calif.

*Roanoke Division*

H. L. CAVENESS.....W4DW  
State College Station, Raleigh, N. C.

*Rocky Mountain Division*

RUSSELL J. ANDREWS.....W9AAB  
1867 So. Lafayette St., Denver, Colo.

*Southeastern Division*

BENNETT R. ADAMS, JR.....W4APU  
1512 Grove Place, Homewood, Ala.

*Southwestern Division*

CHARLES E. BLALACK.....W6GG  
143 Main St., El Centro, Calif.

*West Gulf Division*

WAYLAND M. GROVES.....W5NW  
c/o Humble Pipe Line Co., Neches, Texas

THE AMERICAN RADIO RELAY LEAGUE, INC., is a non-commercial association of radio amateurs, bonded for the promotion of interest in amateur radio communication and experimentation, for the relaying of messages by radio, for the advancement of the radio art and of the public welfare, for the representation of the radio amateur in legislative matters, and for the maintenance of fraternalism and a high standard of conduct.

It is an incorporated association without capital stock, chartered under the laws of Connecticut. Its affairs are governed by a Board of Directors, elected every two years by the general membership. The officers are elected or appointed by the Directors. The League is non-commercial and no one commercially engaged in the manufacture, sale or rental of radio apparatus is eligible to membership on its board.

"Of, by and for the amateur," it numbers within its ranks practically every worth-while amateur in the nation and has a history of glorious achievement as the standard-bearer in amateur affairs.

Inquiries regarding membership are solicited. A bona fide interest in amateur radio is the only essential qualification; ownership of a transmitting station and knowledge of the code are not prerequisite. Correspondence should be addressed to the Secretary.

HIRAM PERCY MAXIM, FOUNDER

## OFFICERS

*President*.....

*Vice-President*.....

*Secretary*.....KENNETH B. WARNER, W1EH  
West Hartford, Connecticut

*Treasurer*.....ARTHUR A. HEBERT, W1ES  
West Hartford, Connecticut

*Communications Mgr.*...F. EDWARD HANDY, W1BDI  
West Hartford, Connecticut

*General Counsel*.....PAUL M. SEGAL, W3EEA  
1010 Shoreham Building, Washington, D. C.

Address all general correspondence to the executive headquarters at West Hartford, Connecticut





# THE EDITOR'S MILL

**A**MATEUR radio needs a poet laureate. What we wouldn't give right now for the ability to fling the English language in a proper manner to write the epic of the radio amateur's heroic performance in the Great Flood of 1936!

Amateur radio has always clearly perceived that its greatest field of public service lay in the supplying of communication in emergencies. Fourteen of our states have just been visited by the most appalling disaster of recorded history. It is estimated that half a million people are homeless, that the property damage approaches a billion dollars. In these late desperate days amateur radio came through gloriously, performed a service in saving lives and alleviating misery and conserving property that never can be estimated in dollar value. Handicapped somewhat by the fact that our mother city of Hartford has been a major sufferer, we present in this issue an account of the amateur's accomplishment. Obviously it is incomplete. But it will be sufficient to show, as it has never so clearly been visible before, how vastly in the public interest is the policy of our nation of assigning bands of radio frequencies to amateurs. They came through when nobody else could come through, their inventive ingenuity enabled them to overcome unbelievable obstacles, and their devotion to duty has been unparalleled. Proud we have been this past month that we have had a place in the great institution of amateur radio!

Every emergency has found radio amateurs ready and responding. But the Great Flood was so extensive in scope that it seems to us considerably more fitting to consider the job here done as one performed by amateur radio collectively rather than by individual radio amateurs. There was scarcely an amateur station east of the Mississippi River that was not actively concerned in the work, even if only to the extent of standing by to reduce interference. Some of these amateurs became leaders, automatically and spontaneously. Some already had their places in organized systems such as A.A.R.S. and N.C.R. Some of them fell into networks, some stood by for traffic for their cities, some took relief shifts at other stations, some helped to keep the channels clear by warning interfering stations. Many did not transmitting at all but stayed on watch, hour after hour, waiting for an opportunity to serve. And they who only watched and

waited also served. Especially was this true on the 4-mc. 'phone band, where only a few stations out of hundreds did not actively cooperate. All classes of amateur stations did their part: telegraph stations and 'phone stations, in traffic bands, 'phone bands and ultra-high-frequency bands. Unprecedented in the nation's history, an emergency that could not be guarded against because it was never within the realm of the probable, the great flood found amateur radio ready and willing to give the full measure of its devotion to the cause of humanity. How proud our Old Chief would have been if he could have stayed to see the amateur radio he so greatly loved coming through as he always said it would in a major disaster! *QST* salutes the individual amateurs who have written radio history.

**W**HILE every agency capable of helping did its bit in this emergency, we pause here to sing particular praise to the Army-Amateur Radio System. This organization provides the real and officially-recognized amateur radio link between the scenes of distress and the official relief agencies. Although it operates under War Department supervision it is not at all a military organization. It is the amateur's prime medium for giving his collaboration to relief communication, since the Army has the peace-time duty of rushing to the assistance of the civil population when it is visited by disaster. The fundamental relief organization in the United States is the National Red Cross, and the A.A.R.S. is particularly geared and organized to serve it as its communications system. When there is an emergency, Red Cross moves in first, with supplies and facilities to carry on for a few days, then to be backed up by the resources of the Army. It is of first importance, then, that amateur radio lend its aid to this system specifically organized for disaster-relief communication.

The A.A.R.S. needs more members. Not every amateur can qualify, as reasonable standards must be maintained. Interesting drills are provided to train the members and keep them in the pink of condition for troubles that may come rolling over the horizon at any moment. Amateurs who are interested in the work and who would like to join it are invited to write to their Corps Area Signal Officer. If you don't know where to write him, contact any other A.A.R.S. amateur in

your vicinity and learn the address. Or write to the Liaison Agent, the Army-Amateur Radio System, at the Office of the Chief Signal Officer, Munitions Building, Washington. The A.A.R.S. is a cooperative, a blending of the forces of the Signal Corps and of the American Radio Relay League under a plan of operation formally ratified years ago both by the Secretary of War and by the Board of Directors of A.R.R.L. It is therefore the official medium of participation by A.R.R.L. members in large-scale emergency projects where Red Cross and federal aid may be necessary. The events of recent weeks emphasize anew the desirability of our support. The system is not as extensive as it might be; it can be strengthened by additional members. Let those who are interested in helping offer their services!

EVERY once in a while we permit ourselves the luxury of a bit of practical ham talk on this page. There are two items we would like to mention this month.

*One.* Break-in ought to be used a great deal more than it is. Modern receivers deserve separate antennas. It doesn't take much tinkering of a transmitter to prevent its exciter stages from blocking the receiver: separating the two, shielding the transmitter, keying the crystal, etc. Break-in conserves time and adds operating pleasure. If a receiving operator misses so much as a single word in a message, he breaks and gets his fill then and there, without a subsequent long harangue about it. With perfect simplicity it permits "working around" the activities of an interfering station. It is particularly a blessing in making calls: one calls and says "bk" or "bk me,"

and thereby calls only so long as necessary to raise the desired station, while at the same time one is enabled to keep on calling as long as the other fellow has not yet replied. The days of the change-over switch are gone. Let's have more break-in.

*Two.* The 60-megacycle band needs some cleaning up. In populous areas and notably in New York and Boston, the use of the band has reached the place where "selfish signals" are as intolerable in the common good as in the lower bands. While we still think there is a place for inexpensive transceivers and similar simple modulated-oscillator transmitters in regions where there is yet no appreciable use of this band, we do think that their employment in such congested regions is now out of order. They take up too big a portion of the band. Except in emergencies their employment must be regarded as in very bad taste, as in wholesale disregard of the rights of others. The transmitters used ought to have high-Q circuits—say copper-tubing grid circuits—or be M.O.P.A. rigs. We know how to build such apparatus now just as easily as the type that offends. The simple super-regenerative receiver is justly popular in this band because of its great effectiveness, but it also badly offends because of its strong radiation. Users of these receivers would confer a great favor upon other occupants of the band if they would cut down their plate voltages to values just sufficient for satisfactory reception—it would greatly reduce interference. What do you say, men; don't we agree that these are bad practices and can't we have a little coöperation in reducing them, for our mutual benefit?

K. B. W.

## A Loving Tribute and a Challenge

A. R.R.L. members have doubtless noticed in many publications the splendid tributes paid to the memory of our beloved president, Hiram Percy Maxim. One of the finest of these, we think, was the one appearing under the above title in the *Bulletin* of the Hartford Engineers Club, whose founder and first president Mr. Maxim also was. Because we have so much in common with the other engineering fields, the thoughts of this tribute fit equally in the radio world in which H. P. M. had so prominent a part, and we reprint the article here, that our members may read it:

"It is the sad duty of the editor to mark, in this issue of the bulletin, the passing of our first president, Hiram Percy Maxim, but it is also an inspiration to be accorded the privilege of expressing, so far as words can, the debt which we, and the rest of the world, owe to him.

"His death touches the heart of every member of the Club and leaves a sense of loss which amounts almost to desolation. Almost, but not

quite, for with it comes the knowledge that men like Hiram Percy Maxim never die. And this is exactly as he would have wished it—that we should honor his memory with a high heart.

"Few men have met life's challenge with as high a courage as his and there is nothing which would mean more to him than the thought that his passing would leave burning thousands of torches which had been lighted at his. Above all else his was a gallant spirit.

"Every member of the Club has known and loved him and we all have a part in him. This occasion should not pass without an expression, in the spirit of brotherhood, to the younger members of the Club, from those older members who have had the privilege of friendship and communion with him during the nearly twenty years in which he has given generously of his time and spirit to the growth of comradeship and common effort in the engineering and scientific life of Hartford. It is hard to find words in which to properly express this message. Mr. Maxim certainly possessed that spark which we call genius, but he had much

(Continued on page 90)

# Amateur Radio Rises to Greatest Emergency Need of All Time

Fourteen States Flooded, Twenty Large Cities Isolated,  
Four Hundred Radio Amateurs Serve

By Clinton B. DeSoto,\* W1CDB

*Acts of nature do not observe publication schedules. The aftermath of the Great Flood was at its apex when we realized that we would have to act at once if QST this month were to carry the story of amateur radio's greatest public service. Communication facilities still sadly impaired, mail service awry, participants still exhausted, we could not wait for voluntary reports. We saw we had to go and get the story. Our own staff was nearly exhausted after the Hartford emergency but publication schedules do not wait. So Clinton B. DeSoto of our staff was given the assignment and went after the story. He and Ross Hull made a hazardous automobile trip the whole length of the Connecticut and White River Valleys, interviewing every amateur they could, getting from them the story of the others who served, taking pictures. Then a trip by air to Pittsburgh and so to devastated Johnstown and other affected cities, 1,500 miles in seven states, notebook in hand. Meanwhile some reports had arrived at headquarters. A feverish few days of writing back home and here is the story. Read it, be proud you're an amateur, and show the story where it will do good!—EDITOR.*

**T**HE world did not end during the fourth week in March, but there were people who thought it would.

Even so, the second greatest deluge in history (if you credit your *Genesis*) took 171 lives, prematurely began a dozen others, left a half million persons homeless, wreaked property damage estimated at more than a half billion dollars.

Fourteen states were flooded, over a score of large cities seriously affected. More than a dozen cities in nine states were almost completely isolated—normal communications facilities wiped out.

Amateur radio, true to tradition and training, stepped into the breach, bridged the gap, restored communications links.

There will be no reader of these words who is not already aware of the essential details. They have been the subject of thousands of feet of newspaper copy, millions of words of radio commentary. But all this spot news, fascinating and impressive though it may have been, fades into insignificance beside one not-yet-thoroughly-recognized fact, to wit:

*There has never been a disaster of such magnitude, involving such enormous property damage, in which there was such a proportionately small loss of human life.*

A half million homeless—only 171 persons dead.

Why?

The answer seems generally agreed:

*Effective communications facilities enabled prompt warning of authorities, immediate evacuation of threatened areas, undelayed provision of relief and rescue aids.*

Who supplied the great bulk of this communication?

Not the wire services, although they did their best with crippled facilities. Not the radio broadcasting stations, although they performed heroic and invaluable service in their proper spheres. Not the military communications systems, except as they utilized amateur reserve elements, for almost without exception these proved non-utilitarian.

*It was amateur radio that did the job—no one else.*

From Maine to Washington, at the first warning of danger, they went to work. It was the greatest single contribution of public service performed by amateurs since the World War. It was the most dramatic and spectacular public demonstration of amateur radio's utility and worth thus far afforded. It was a proving of our powers, a testing of our weaknesses, an exploiting of our values, a charting of our future paths.

The story of that work is an epic of heroic and useful accomplishment.

WATER—WATER—WATER

From the peaks of the broad beam of mountain ranges that cleave northeastern United States last March coursed streams of spring waters, augmented by hard rains throughout New England, New York, New Jersey and Pennsylvania, rising to a swift, high tide. New England rivers and lakes bulged

\* Assistant Secretary.

with the input from steady rains, melting snow, thawing river ice-cakes. Northeast from the Gulf, over Texas, to the Appalachians, moved a huge low-pressure area. Seven climatic extremes added in positive potential to produce the greatest waterflow in the history of eastern United States; example: 40° Fahrenheit was the temperature difference between New York State and New England one night. Rampant rivers roared roisterously southward. Into Pennsylvania swept the deluge, swiftly eclipsing in death, damage and disaster its northern parallels, soon to be overtaken in turn by their mounting cataclysmic force. Down to the wind-swept Atlantic on the one hand, through the Ohio to the winter-hungry Mississippi on the other, swept turbulent streams metamorphosing into turgid, muddy, havoc-dealing inland seas. . . .

**Conemaugh and Allegheny Rivers and Tributaries**

It started raining in Johnstown in the middle of the night.

By Tuesday noon, 36 hours later, the swollen Conemaugh River and Stony Creek were ready to burst their banks. Two hours later the streets of downtown Johnstown, a steel and coal city of 66,000 population, began filling with water—water that had already flooded most of the rocky 10-mile Conemaugh River gorge at whose neck Johnstown waited. The folk who happened to be

downtown then stayed there for another 24 hours, marooned. The water kept rising until it reached a depth of 14 feet in the city.

At 4 p.m. on Tuesday, the 17th, telephone and telegraph services and the broadcasting station went out of commission. More than that, power was off in most sections of the city. The town was then well-flooded. Immediately, Johnstown's seven amateurs, none of whom lived in the area actually inundated, went to work. Gerald D. Coleman, W8FRC, and Robert K. Dixon, N8DYY, both Naval Reservists and close neighbors in Moxham, a suburb, decided that there was need for both 3.5-mc. 'phone and c.w. outlets. Coleman, having the more powerful 'phone rig, took that assignment; Dixon guarded 3610 kc. in the N.C.R. net.

At 5:05 p.m. the first message calling for relief—"worst flood in history . . . we need everything"—went from N8DYY via Pittsburgh to Washington. That was the start. From then on traffic and news moved in a swift stream from these and the other Johnstown stations—for and to the Red Cross, Coast Guard, National Guard, telephone and telegraph companies, and individuals. N8DYY alone handled 800 Western Union messages.

The other stations active were Francis M. Duffy, W8FAK, who operated principally at Summerhill, 10 miles away, Dr. Clarke Olney, N8LNZ, Rexford M. Ackley, W8IZS, and Milton

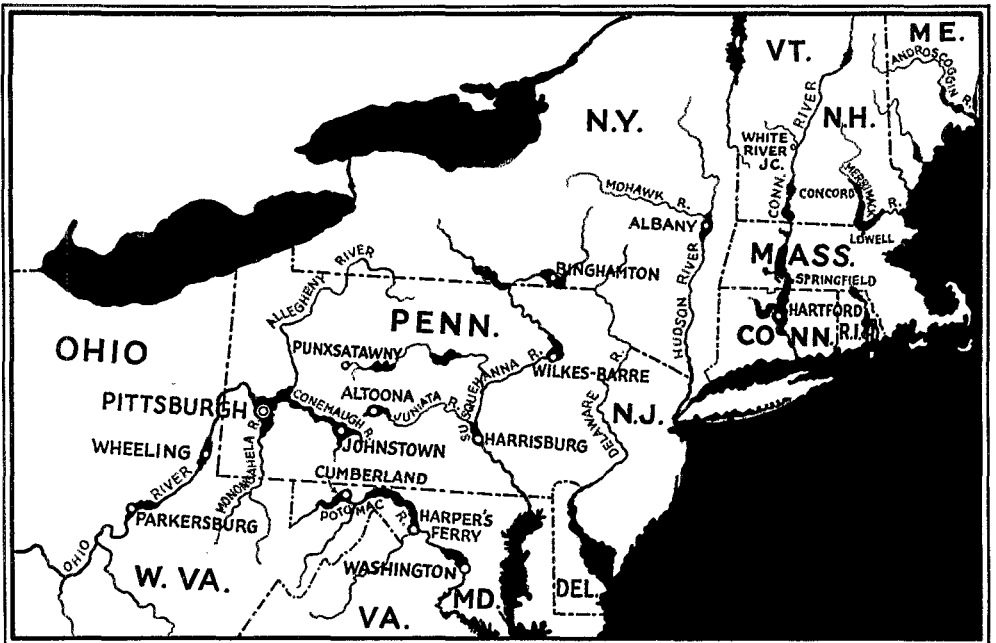

**THE FLOODED EASTERN STATES**

Shaded portions indicate the principal inundated areas. Both the Atlantic Ocean and the Mississippi River got their share of the flood waters that coursed through every one of the northeastern states in the greatest flood of modern history.

E. Hanson, W8KRF, assisted by H. M. Nickel, W8EMH. Wm. C. Bossler, W8GYB, served as relief operator at N8DYY when that station was taken over by the National Guard on Friday.

W8FAK performed a varied tour of duty, handling traffic for the National Guard for more than a week, taking messages accumulated by the local Johnstown broadcasting station, WJAC, and handling other personal traffic. Message totals at this station passed the 2000 mark, we are told. The people of Johnstown owe a great debt to W8FAK for the communications service supplied.

Power being off at W8LNZ Tuesday afternoon, at the request of the Associated Gas and Electric Systems the station was moved to the Memorial Hospital and set up. Antenna facilities were poor, however, and, with power back, the station was reinstalled at Olney's home in Westmont, handling Red Cross and other traffic relative to blankets, cots, medicines, road and railroad conditions, "requisitions" for doctors, nurses and supplies. Despite the fact that power was available only intermittently, before the week was out 300 private messages had been handled in addition to the Red Cross traffic.

W8LZS served as an important National Guard outlet, as well. Originally, the guardsmen, acting on their military authority, had attempted to commandeer several amateur stations. This attempt was resisted. However, the volunteer service of Johnstown amateur stations, freely given and 100 per cent. effective, was both an answer to such tactics and a completely effective substitute for a military signal corps station.

W8FRC attracted national attention in the operation of his 75-meter 'phone station, first as a result of his broadcasts on flood conditions, and later because of the charges made against him by Mayor Shields of Johnstown. This latter incident is a story in itself; it is recounted elsewhere in this issue. On Friday, after the difficulty with the Mayor in which Coleman was ordered to close his station, he went on c.w. on 3610 kc., the Naval Reserve channel, and held down that post until the end of the emergency, N8DYY on that day having been taken over by the National Guard.

Operating in the 4-mc. 'phone band practically continuously throughout the emergency period, handling a good deal of emergency traffic, W8KRF was the first Johnstown amateur to transmit news of the mayor's "ban" on amateur radio and of W8FRC's predicament. W8KRF is



FLOODED AREA NEAR JOHNSTOWN, PA.  
Scenes such as the above were common in the flooded areas.

the originator of the "flood patrol," including W2IXY, W8PAN, W8LHU, W8GBH, W3BR, W8KQY, W3GAN and W8NVI.

The same rains that fell on Johnstown for more than 70 hours deluged the hills near Punxsutawney, 55 miles to the north of Johnstown and 80 miles northeast of Pittsburgh. The flood at Punxsutawney and neighboring points progressed almost simultaneously with the Johnstown inundation, therefore, although the levels remained much lower. The rivers in this region also flow into the Allegheny. Punxsutawney, it will be seen by a glance at the map, is located in a strategic position with respect to the entire lower flood area.

Local flood conditions did not, however, inspire the first amateur work in Punxsutawney. It was at 4:30 p.m. on Tuesday that Dr. Joseph A. Vancheri, W8BWH, worked W8FRC in Johnstown and exchanged flood reports. Although W8BWH was situated on a hill well away from water danger, some of the streets downtown even then had 4 to 6 inches of water in them. By early evening most of the business section of town was inundated. Through the course of the evening it became obvious that an emergency of considerable proportions existed and would shortly become worse; in consequence, before midnight an emergency 75-meter 'phone net had been formed. In the basic net were Harry S. Myers, W8BRC, Van, Pa.; Grant E. Makinson, W8DBC, Saxonburg, Pa.; W8BHN, Erie, Pa.; W8LXV, Cleveland, Ohio; W8AOM, Buffalo, N. Y.; W8IXP, Butler, Pa.; and Joshua G. Swartz, W3WX, Harrisburg, Pa. Many other stations cooperated in keeping various channels free of interference, particularly the 3910 kc. channel of W8FRC and the 3975 kc. channel of W8BWH.

During the succeeding days an impressive performance record was piled up by this network. Through W3WX in the State Capitol, Governor Earle was placed as near to the affected areas and *vice versa* as his telephone, and by means of

amateur radio he personally directed the broader aspects of the relief and reconstruction work, calling a special session of his cabinet and directing the sending of State Police, National Guard troops and supplies to the flooded regions. W3WX handled more messages, it is understood, than any other station in the net; the exact number is not known. W8BRC was next with approximately 1000 messages—all handled on 75-meter 'phone, although at times messages were received simultaneously on 'phone and c.w. At times messages were taken from W8FAK in lots of 60 and 90 without pause. But the outstanding station in



#### W8BWH IN ACTION!

*With a kilowatt to a pair of '04As, Class-B modulated by another pair of '04As, Dr. Joseph A. Vancheri brought aid to refugees in Johnstown and vicinity, dramatized the flood for b.c.l.'s.*

this net was W8BWH, whose strategic location, operating ability, and knowledge of the topography and probable needs of the region made him the ideal operator to act as a central clearing point, which he automatically and spontaneously became. W8BWH operated continuously for an initial 39-hour stretch, then for another 20 hours after 2 hours' rest; he put in a total of 95 hours of emergency work without relief. W8BWH it was, too, who was twice rebroadcast on the N.B.C. chain, on special programs, transmitting word pictures of flood conditions and citing amateur emergency work.

Another station in Punxsutawney which performed excellent work was W8NAW, operated in the downtown section of the city with emergency equipment on 80-meter c.w. by James F. White. This station handled a quantity of personal and official emergency traffic, not only for Punxsutawney but for the surrounding region. Through WSOFO and WLM, Red Cross aid was secured for 1500 families homeless in the city.

From Johnstown to Pittsburgh is a distance of perhaps 60 miles, air line. The flood waters of the Conemaugh River, however, must have travelled at least 100 miles to arrive at the City of Steel for they had first to join the Allegheny, 25 miles northeast of Pittsburgh, before descending on the city. Thus it was that, where Johnstown had been flooded by the end of Tuesday after-

noon, Market Street in the Smoky City was dry the next morning at 8 a.m. as workers went to work.

But by 10 o'clock it was hip deep in swollen water. The waters of the Conemaugh, once arrived, were augmented by the coffee-colored waters of the Allegheny and the Monongahela. Ordinarily these rivers criss-cross placidly below Pittsburgh's downtown business section to form the famed Golden Triangle. Now the scene was chaos. It was soon to be worse than that. Before midnight of the second day flood waters had risen to the unbelievable height of 48 feet—14 feet higher than the record flood of 1907. In the Golden Triangle a swimmer could not touch bottom. Mid-afternoon, word flashed to A.R.R.L. Headquarters via a news service that Pittsburgh—queen of the steel industry, city of 700,000 inhabitants—was without power, without communication . . . cut off from the outside world.

It was unbelievable—to us.

But to the amateurs of the Pittsburgh area it was real enough. In characteristic fashion they renounced failure, buildled on the ruins of unpreparedness, and sought their duty.

The Naval Reserve circuit, under Ensign Burton B. Williams, W8ZD-W8ZAE, Section Commander, was already in operation. In fact, it had been going since 5 p.m. Tuesday. Louis Schlesinger, W8LBO, had relayed the first message from Johnstown to the Red Cross at about that time, using the tactical call CX4G; also a message requesting the Coast Guard to send a cutter and crew, as well as men and equipment.

When the emergency reached a crucial stage, W8ZAE-NDC issued a plea which was broadcast over KDKA requesting all local N.C.R. operators to come to the station and asking Naval Reserve stations outside the area to stand by to be of assistance.

The Pennsylvania N.C.R. circuit included Pittsburgh, Johnstown, Altoona, Harrisburg, Philadelphia, Wheeling and Cleveland. Over 5000 messages were handled between Pittsburgh, Johnstown and Altoona. Other thousands went into and out of Harrisburg. This circuit provided communications for the National Guard, Coast Guard, Bureau of Lighthouses, Red Cross, Department of Health and Department of Public Safety of the City of Pittsburgh, Naval Reserve, and also handled a few important private messages. Col. Dunlop, commanding the National Guard, which had no communications of its own available, found this service particularly valuable. Some difficulty was experienced in clearing the 3610-kc. channel but, once clear, W3QV, W3FI and W3SB kept it so.

As the water rose, Arthur W. Pryor, W8GRY, and Mike Bernacki, W8IUY, were flooded out, losing their homes and most of their possessions. But Harry C. Yingling, W8GUF, and C. H. Grossarth, W8CUG, were able to stay on

throughout the emergency period. All of these stations are in Pittsburgh or vicinity.

The West Penn Power Co., faced with the job of restoring power to the inundated areas and with no wire services available, relied on an amateur net organized by one of their engineers, John McKinley, W8OB. This network linked the local office in Pittsburgh for the Keystone Division with Ridgeway, Mt. George, Kane and State College. A.A.R.S. and C.C.C. stations tied in on the net, which had an external loop to Washington and Johnstown through W3SN and W3OK over which Western Union and other traffic was handled. W8BRJ, the father-and-son station of Rue T. and Charles Beatty, was on 24 hours a day with the aid of C.C.C. ops. Wm. A. Stichel, W8JLS, operating portable, T. D. Eckhardt, W8OX, also using batteries, and Reece M. Armstrong, W8LBL, were in the net. This system had one detail of organization worthy of comment: at every point a duplicate stand-by station was on duty, ready to step in in case of failure of the regular station. Vitally important work was accomplished by the net.

All stations in Pittsburgh and vicinity used batteries or generators for power supply, for all power went off at 3:50 p.m. Wednesday. Fred Stiening, W8FIP, was no exception. Helping him with equipment and operating were George V. List, Jr., W8NTA, and John M. Clarke, W8LED, who had the satisfaction of picking up a message for himself from Massachusetts on a relay schedule. H. E. Schurman, W8DJE (battery-powered), and Henry Wickheiser, W8KWA, were on every day and did good work.

H. W. Irving, chief operator at KDKA, was on constantly during the emergency on 75-meter 'phone, using KDKA's power on W8DBC. It was he who effected re-broadcasts of W8FRC and who set up a ham 'phone network feeding information to KDKA. Harry Mills, W8BHY, operated portable during the flood. Starting Friday, John B. Dearing, W8NTP, was on 75-meter 'phone handling personal traffic. A. C. Capell, W8KSC, was on 'phone until power went off, Wednesday afternoon, as was Robert E. Hartshorn, W8MIR. A large group of hams, mostly students at Carnegie Tech, collected at the Carnegie Tech Radio Club

station, W8NKI, on with a 3-kw. motor-generator. This station was instrumental in securing serum for Williamsport, and handled traffic for the Butler Police, Bell System, Red Cross and National Guard, as well as KDKA-secured personal traffic. It also gave news dispatches to N.B.C., C.B.S. and Hearst Radio. The station was operated by Alexander C. Speyer, Jr., W8DML (chief operator), Oswald G. Lutz, W8JFN, Thomas J. Patterson, W5CEN, Charles Affelder, W8HLM (who also operated his own 75-meter 'phone when power was on, securing river and harbor information for city and state officials), and Philip Morrison, W8FIS.

Sgt. W. L. Montgomery, W8GUO, operated on behalf of the National Guard at the Pittsburgh Armory, along with W8ZAE-NDC (who, by the way, used the tactical call CX4B); both used the Armory's 110 d.c. supply. Samuel R. Leisifer, W8MTY, a city fireman, although not operating his amateur station during the flood, deserves a word of tribute for his 6 days of *continuous* duty, fighting fires and doing rescue work.

#### Susquehanna River and Tributaries

In Buffalo snow fell—heavy, deep snow, laden with moisture. Among the southern tier of New York State a heavy sleet storm weighted and snapped telegraph wires—voiding communications facilities in many sections from March 18th to 21st. On the 19th came rain and rapid thaw, flushing the sleet and melting snow down hillsides into already-swollen watersheds. The Cohocton

River, feeding into the Susquehanna, rose. . . . Remorselessly, the flood pattern of other areas repeated itself.

So, too, did the amateur emergency pattern repeat itself. Chronology in the following reports is not too clearly known, but the events are self-sufficient.

When wire lines failed on the 18th, the only knowledge of train operation and flood conditions that the division office of the Erie R.R. at Buffalo could obtain relative to its Rochester branch in

the Cohocton Valley was furnished by W. K. Hamilton, W8BHK, at Bath, to Howard H. Clark, W8BSU, assistant division engineer of the road. Eight successful contacts were established and much traffic handled despite two power

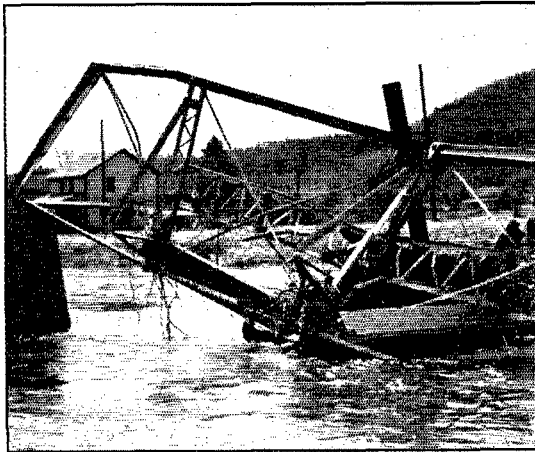

CRUMPLED ALMOST BEYOND RECOGNITION: A BRIDGE ACROSS ONE OF THE SMALLER TRIBUTARIES OF THE CONNECTICUT RIVER

failures at Bath. C. F. Smith, W8DSS, of Oneida, also aided by W8BHK, obtained information concerning flood conditions in Hornell, N. Y., which was completely cut off, for Governor Lehman. C. T. Young, W8CVB, and other Binghanton amateurs handled a quantity of flood traffic as their city was swamped by the Chenango and Susquehanna Rivers.

At Avon, N. Y., John N. Easterbrook, W8KDB, and James Green, W8MYW, combined their emergency equipment at W8KDB's QRA and handled communications for the local power company, directing equipment disposition and repair crews, as well as personal messages. Most of this traffic was routed through W8BLO and W8KYR. In Ithaca, when wires

went down Wednesday, John B. Herson, W8KXR, took over the disrupted AP link for the *Ithaca Journal*, for which he works as linotype operator. He also functioned on behalf of the State Police, the New York Telephone Company, the New York State Electric & Gas Corporation, and others. Leslie H. Connolly, W8NEI, was also on in Ithaca at intervals, on 4-mc. 'phone.

What was sleet in New York State was swirling, flooding muddy water by the time it had crossed the state line and flowed down to Townanda and Wilkes-Barre. Through this region telephone and telegraph service remained essentially intact, as it happened, and no reports of outstanding amateur communications work have been received. Some 50 miles to the west, however, the West Branch of the Susquehanna was compensating for the oversight.

Overflowing almost at its headwaters, the West Branch first inundated the town of Westport. There W8LYB went on the air, operated by Stuart B. Over at C.C.C. Camp S-78. Hourly schedules were maintained with W8INE and a quantity of traffic was handled, including the securing of relief aid. An urgent Red Cross call for lime from Kane was relayed through this circuit and a reply received in 5 minutes' time. This station also secured the first food, clothing and medical aid for Renovo, a few miles down the stream, when a plea was put through to Walter

Stiles, W8DPY, of Coudersport. The local Red Cross chapter of that city loaded the needed supplies on a C.C.C. truck and W8DPY (a thoroughly-prepared A.R.R.L. Emergency Corps member) loaded on his emergency equipment,

too—National a.c. SW3 receiver, revamped Collins 4-A transmitter, and gasoline-driven 5-kw. 100-volt generator!—and they set out for Renovo. Arriving after many mishaps, the rig was put into operation and served for 130 hours, until telephone and telegraph communication was restored. More than 1000 messages were handled, and much work was done for the National Guard. Two relief operators from W8YA, State College, assisted. Schedules were kept with W8KKM, Coudersport, W8YA, and W8INE,

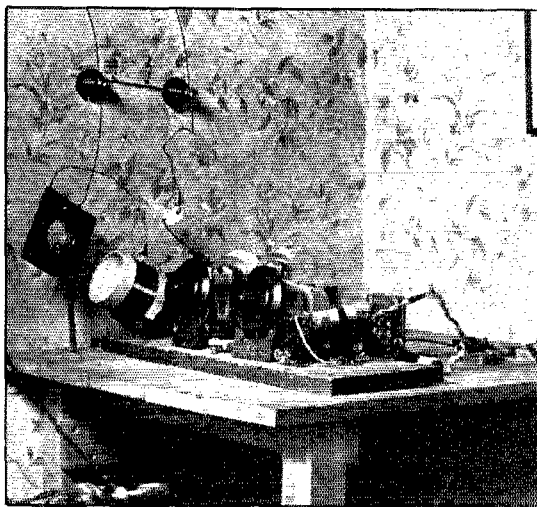

AN EMERGENCY TRANSMITTER BUILT BY A NON-HAM FROM INSTRUCTIONS RECEIVED OVER THE 'PHONE

The rig built by W1AD's assistant.

the Boys' Club of St. Mary's. W8NPQ, W8CTD, W8AVK and W8YX also took traffic.

Piling to the highest crest in its history—35 feet 8 inches, or 2 feet higher than in 1889—the river swept on towards Williamsport. The raging waters inundated two-thirds of that city and from early Wednesday through Friday it was without wire communication. Practically all of Williamsport's amateur radio crew found a post of duty early in the emergency, either manning their own emergency stations or operating equipment set up at the local broadcasting station, WRAC, and operated in conjunction with it. The particular heroes of the flood in that region were Elmer Bond, W8MAH, and Alan Glaes, W8AVK, both of whom blazed along at top speed for periods of 20 and 30 hours continuously, pushing out a steady stream of traffic on 80-meter c.w. at speeds of 30 to 35 w.p.m. Most of this traffic went via W8BQ, W3EEY, and, later, W3CXL. For the first 36 hours practically no personal messages could be handled, due to the pressure of traffic from the Red Cross, State Police, Coast Guard, Bell Telephone, Pennsylvania Power & Light, food agencies, and other official bodies.

Other notable performers in the Williamsport region were Fred Hassenplug, W8MEH, C. W. Knoebel, W8IVO, both of whom handled a great deal of traffic, William Szendry, W8LMY (who



operated a 20-meter 'phone link with W9CJH and W9JB who then re-routed traffic through the east and to the west), and the operators manning the various rigs in conjunction with WRAK: Harold W. Reitze, W8HHO (supervising operator for the Amateur Radio Communications Headquarters set up in Studio B), Gordon Phipps, W8AFT, Howard Miller, W8IKG, Reed Hann, W8GWH, Melvin Gundrum, W8KRJ, Tony Stanzone, W8CDT, Harold Swartz, W8BLL, George Hodges, W8MEG, R. G. Petts, W8ART, Dan Leibensperger, W8PIK, Edward Crow, W9IMK, Clinton B. Dawes, W8NNC, George Feehrer, W8MPA, and Eugene Fegley, W8MPB.

Down the river another 35 miles, at Lewisburg, the city was completely isolated both as concerned communication and transportation. The only link was an amateur station operated at Bucknell University by the licensed amateurs at the school, who used their own calls under portable regulations when working. The call most used was W2COF, Joseph J. Bosze, Jr., although W. M. Drozdziak, W8LEY, was a close second. With a thousand students in the school, and with Northeastern Penitentiary near by, traffic totals were high.

#### *Merrimack River and Tributaries*

The spring ice break-up on the Merrimack River occurred on March 14th. Conditions seemed to indicate that a flood stage was probable. On March 18th, after a three-day downpour, waters rose to a serious level. Away up north, near Plymouth, N. H., at the junction of a small tributary, the Montreal Express was reported marooned by a bridge washout.

At 8:30 p.m. on Wednesday, the 18th, the governor's office called C. B. Evans, W1BFT, in Concord, telling him that a dangerous flood emergency was impending and requesting that as many amateur stations as possible be lined up for communications purposes. Some telephone lines were already down and more were expected to go. This was the start of what became known as the "Governor Bridges Network," consisting of W1BFT, W1FEK, W1AVG, W1AUU, W1CCM, W1GEY, W1AXB, W1EMQ, W1AVP, W1CGF and W1FYR, organized to provide information concerning road and flood conditions and relief needs, with stations located at every strategic point in the flood zone.

Robert V. Byron, W1AVJ, was at W1BFT's at the time. He promptly went home and went on the air. Basil Cutting, W1APK, was called away from a supper at the church and went to work at Pembroke. DX scores forgotten, the network proceeded to shape itself up. Louis E. Jacob, W1IP, in Manchester, was contacted. He in turn got in touch with Walter E. Lessard, W1FFL, and they proceeded to line up the A.A.R.S. stations. Daniel T. Wilkins, W1BII, also of Manchester, who retained telephone

service, provided a radio and land-line link with unaffected parts of the state.

At W1BFT a watch of approximately 20 hours daily was maintained from Wednesday night through Sunday night. Thursday afternoon power went off, and the transmitter of J. P. Moran, Jr., W1JJD, was pressed into service as an emergency battery-powered rig with 500 volts of "B" battery, aided by W1AVJ, Charles V. May, W1JCA, and several SWL's. Friday night W1AVJ and W1BFT took a receiver down to the governor's office, keeping watch on such stations as W1TA, W1APK, W1FFL and W1ANS, who transmitted reports blind which were turned over to the staff in the office. On Saturday at 4:00 p.m. power came back. Normal schedules were resumed and traffic was handled for the governor's and adjutant general's offices, the mayor of Nashua, the National Guard, the highway department, etc. About 400 words of press went to AP via W1FRO.

Meanwhile the Merrimack flowed relentlessly onward. Down at Pembroke W1APK, together with Albert Belrose, W1IJB, operated on both 'phone and c.w. with emergency battery equipment in the 3.5-mc. band. The first job was gathering road and flood reports for the Governor's office. Thursday morning contact was made with WFEA, the local b.c. stations, and news reports



EARL WHIDDON AND N. E. BLACKIE, W1EXB, AT THE STATE POLICE BARRACKS NEAR NORTHAMPTON, MASS.

supplied them on schedule. That day 'phone skeds were kept with W1AVG, Henniker; W1AUU, Meredith; W1GEY, Nashua; W1FYR, Plymouth; W1AXP, W1HJI and W1CME, Manchester; and W1BST, Laconia. At night, on c.w., skeds were kept with W1TA, Nashua; W1JDF, Lyme; W1BFT, Concord; W1FFL, Manchester; and Roland H. Bouchard, W1BLV, Woonsocket, R. I., which was also flooded. The

latter station took all UP news, numbering 43 dispatches, each of which was double-checked for accuracy.

When power went out that afternoon the situation was serious. There was no telephone, no telegraph, and roads and railroads were impassable. The network embracing the principal New Hampshire cities—W1BFT, W1FFL, W1TA and W1BLV—functioned perfectly on batteries, however, and cleared all traffic, sometimes at the rate of four messages a minute. This included Red Cross and Western Union traffic.

W1IP's real work started Thursday evening. Much traffic was pushed out on schedule with the following stations: W1CME, W1FFL, W1CMB, W1BII, W1TA, W1BFT, W1AVJ, W1IOC, W1ABG, W1AJD, W1FSV, W1UE, W1BDI and W1BLV. On Friday night press came in from Boston via W1FRO for more than two hours, for the local *Union-Leader*, whose wires were out. This amounted to about a thousand words. When the station closed down its emergency watch Sunday it had handled messages for all the official agencies mentioned, including the Public Service Co., and numerous personal messages.

R. U. Nadeau, W1ICS, on the west side of the river, and Jules C. Deschenes, W1GDE, on the east side, linked the two shores on behalf of the



ED. TILTON, W1HDQ, AND MRS. TILTON CARRIED THROUGH A BACK-BREAKING PROGRAM OF EMERGENCY WORK IN SPRINGFIELD, MASS.

telephone company when the McGregor bridge carrying cables went out. The city of Manchester, it may be said, was not only isolated but was cut into sections, with the washing away or closing of all bridges on the Merrimack and Piscataquog Rivers. Other stations in Manchester who did excellent work were Jesse Wouters,

W1FFZ; Maurice H. Deschenes, W1JBM; Wilbur G. Remick, W1HJM; Erwin S. Davis, W1CME; M. A. Chapman, W1CMB, and, in particular, Miss May L. Smith, W1BDN, who not only operated her own station but allowed W1CME and W1KX to use it.

Supplementing the 80-meter network was a group of 5-meter stations, including Everett E. Pillsbury, W1EAK, who was at the Armory on the east side; Joseph Peeters, W1GPN, and F. E. Dery, W1HQS, at the Legion Post; and Benjamin D. Marcy, W1EFE, and Louis E. Robitaille, W1CMR, at the Main St. Church, where most of the refugees were assembled. W1HJM toured around with Scout outfits. In Derry, also, Elwyn Nutt, W1ADR, relayed traffic on 56 mc. to Walter A. Pillsbury, W1EAL, who then put it out on 80 meters.

W1FFL was on for 5 consecutive nights, standing 12-hour watches. He was largely instrumental in lining up all stations to report to a central station on the A.A.R.S. frequency of 3735 kc., which was a highly effective procedure from the standpoint of coordinating activity and reducing QRM.

When power went out in Nashua Thursday afternoon, Raymond Gallagher, W1TA, and Raymond A. Rogers, W1GHT, rigged an emergency station at a filling station which generated its own power, located, luckily, right in the center of the city. The first temporary antenna failed to work satisfactorily, and it was not until another antenna with a matched impedance line was erected Friday morning that successful communication was achieved—or, for that matter, needed. From that time on the identical order of official traffic that had been passing through the rest of the New Hampshire network poured through W1TA. Additional operators at the station were William Barry, W1HTO; Roy Snow, W1AFD; and Charles Berube, W1HQE.

Before and after the power lapse in Nashua Lawrence Barker, W1GEY, handled traffic on 75-meter 'phone, assisted by Robert Slavin, W1FGC. At the same time Charles Hardy, W1BCT, opened up on the 160-meter band.

In Lowell, where the mills were flooded to the roofs, the only amateur station known to be operating in the 80-meter band was W1BEF, operated by E. E. Taylor. On 5 meters, C. F. Hutchinson, W1DBE, in Lowell, and P. W. Muller, W1HXE, in Lawrence, provided a link between these flooded cities and the wire circuits through W1CGU, W1DMS and W1NF. W1AKS and W1ME also handled flood traffic on 5 meters, transferring news and messages from the inundated mill cities to the Boston area.

#### *Connecticut River and Tributaries*

In 1927 the "Great New England Flood" peaked in northern New England, wrecked and ruined Vermont, and, mollified, let lower Massa-

achusetts and Connecticut off relatively easily. In 1936 the "Great Flood," tamed by fairly-successful flood control projects, did less damage in Vermont, spread itself all over Massachusetts and upper Connecticut, defied Hartford's million-dollar dike and blithely swamped the entire Connecticut Valley as far down as Middletown.

It was not immediately that New Englanders, although already flood-minded due to the high waters in Maine, the burst New Hartford dam and flooded Farmington River in Connecticut, and the disquieting news from New York and Pennsylvania, realized that the friendly old Connecticut, too, was planning a rampage. About the middle of Wednesday afternoon Alfonso Izzo, W1EMQ, in White River Junction, Vt., who had been on chewing the rag, received reports that the White River was rising to dangerous heights, and that the Connecticut was coming up as well.

In a short time a QRR network was organizing among a group of 75-meter 'phone stations, including W1EMQ, W1AHN, W1FCE, W1AVP, assisted by W1GN, W1AXE, W1AD, W1FPS, W1AZV, W1MX, W1PD, W1CCM, W1CLL, W1AVY and W1ET. This network handled a considerable quantity of traffic, mostly personal. W1EMQ provided an outlet for Earl Hutchins, Red Cross director, and for the Metropolitan Life Insurance Co. office. Also on in White River Junction, on c.w., was Clifford J. Fleury, W1ELR. Nelson M. Fowler, W1DQK, North Troy, had an interesting link with W1BD, he operating on 160-meter 'phone with W1BD on 80-meter c.w. This proved a highly efficient method for pushing traffic. W1BD, in Barre, provided an outgoing and coordinating link for much Vermont flood traffic.

Wednesday evening, W1BDX was requested by the governor of Vermont to secure information concerning flood conditions, particularly concerning road conditions for the State Highway Department. A c.w. network made up of A.A.R.S. stations tied in with the afore-mentioned 'phone net and regular bulletins were received. Other stations mentioned in connection with this upper New England emergency work are W1CGV ('phone), W1CBW, W1DAQ, W1AVZ, W1FPS, W1ERJ, W1GGT, W1AXN (the latter two stations formed a link), W1BNS, and W1FSV.

Down below, in Bellows Falls, which was entirely cut off for days except for one telephone line north, Charles S. Doe, W1AD, and his wife and a young assistant operated continuously from Wednesday through Monday, handling messages on 4-mc. 'phone for the power company to Boston and a quantity of personal traffic. Their regular station was across the river and could not be reached, so an emergency set was rigged. Most of the traffic went through W1AVP and W1AVG.

At Brattleboro, where some of the tensest scenes of the entire flood emergency occurred

during the struggle to save the great power dam at that place—and, incidentally, most of the cities below—amateur radio unfortunately did not play a part—a great opportunity regrettably muffed.



HARTFORD'S KEY FIVE-METER STATION LOCATED HIGH IN THE TRAVELER'S BUILDING

Emile Clavez, W1BUE is at the mike with Ed. Sanders of W1XT behind him. Fred Edwards, W1DJC is at the left.

At Shelburne Falls, Mass., Leland F. Wheeler, W1DIZ, operating portable, did a spectacular job, maintaining contact with Turner's Falls for the State Police. It was he who transmitted the message which resulted in the incredible two-hour evacuation of the lower valley, including the entire village of Hatfield—people, cows, pigs, chickens—in which place the river rose to a point where only eaves were showing.

W1JTK, operated at the State Police Barracks on the Greenfield Road out of Northampton in conjunction with the State Police radio system by Lieut. Martin W. Joyce, Bob Pierce, Earl Whiddon, N. E. Blackie, W1EXB, and A. E. Richardson, handled a great deal of official traffic for the National Guard and State Police. During three power failures juice was supplied by mobile generating plants from the Boston area. Harry J. Murphy, W1CPG, handled all the press communications out of the Northampton region, all wires being out; reporters ate and slept at his home for two days. Charles N. DeRose, his own station, W1CND, swept down the river at a loss of \$3000, cooperated with W1JTK. Charlie had just purchased a new oscilloscope, had hooked it up and was about to try it out, when he thought he'd take a look at the flood. When he came back, it and everything else had gone down the river. He hasn't found it yet. . . .

"The Holyoke Dam has burst!" Twenty times if once that rumor came hustling down the Con-

necticut Valley to strike terror in the hearts of people in Springfield, Hartford, and all between. One of amateur radio's most trying jobs in that section was checking and exploding these reports. But the dam did not burst. However, the Holyoke Water Power Co., its owners, found communication between the two ends, and between Holyoke and Hadley, imperilled, so amateur 5-meter links were solicited of the Holyoke Amateur Radio Club. The Club set up a station under its own call, W1JJO, at the power company's offices, and James W. King, W1EVZ, possessor of the only battery equipment in town, travelled 25 miles to get to South Hadley, normally a 1½-mile drive—passing through 4 feet of water on the way. There he lived in his car for three days, practically without food and sleep. Communication between the two ends was established, the only link with the outside possessed by South Hadley. A total of 1537 power company messages were handled, directing much dangerous and important work. A number of other official and personal messages were handled as well. Lincoln B. Smith, W1IEI, was in charge of W1JJO. Club members working in shifts operated both stations.

Edward Petrin, W1AJD, kept in touch with Turner's Falls on 3500 kc., telephone lines being out. Schedules were kept with W1HNP of Greenfield, as well, this station also functioning on behalf of the Greenfield Gas Co. with the assistance of W1EKP and W1IHH. A third 5-meter rig was set up in the power station in Holyoke, operated by J. J. Bradford, W1BPT, assisted by Walter Hardman, W1IMF, standing by in the event Holyoke telephone service failed. W1GQT, the station of Mrs. W1EVZ, was on 80 meters, although most of the time was spent on 5-meter listening watch. F. L. Horner, W1GZL, although right in the inundated region, was on the air steadily on all useful amateur bands, 160 meters and 5 meters being the chief standbys.

The link across the Holyoke Dam was of great service to the people in the region. Doctors on opposite sides of the river, for instance, "traded" patients when the river could no longer be crossed, exchanging diagnostic and remedial instructions. Food, medicine and supplies were secured. The link functioned for three days and nights.

At Springfield, Mass., the Connecticut is augmented by the Westfield River, the confluence being just above the business section of the city. The product of the merger represented inundation of a large part of the city. Twenty thousand of Springfield's 150,000 citizens were forced out of their homes by the rising water. But most of Springfield's amateurs stayed on the job.

In Westfield, a suburb of Springfield, S.C.M. Percy V. Noble, W1BVR, functioned from Wednesday, the 18th, at 4:30 p.m., for more than a week, maintaining numerous schedules. Three types of messages were handled, i.e., official (from the National Guard to the Army Base in Boston), utilities (on behalf of the gas and electric companies) and personal. Aided by John E. Vermeiren, N1DUZ, as relief operator, W1BVR became the main communications standby for the city of Westfield during the time of most danger.

At 7:45 p.m. Lieut. Meader of the Boston Navy Yard issued instructions to Malcolm H. Robertson, W1BPN, to establish contact with Section Commander Green, N1ASU, on 3638 kc. and stand by for emergency traffic. This was done through W1ZB, operated by Carl J. Madsen. W1ZB, by the way, had to throw the DX Tests overboard (as happened at so many stations) when local citizens called him up asking that he transmit messages which had been

refused by Western Union because of delivery uncertainties. This station thereupon became part of a network including N1APP, N1EVZ, N1NS and N1DIF. A number of emergency messages calling for supplies were handled over this network. The next day the local broadcasting stations issued a call for N.C.R. men to report at police headquarters in Springfield for guard and communications work. On the 20th, three members of the Unit, Harmon, Beard and Madsen, installed Westinghouse u.h.f. police equipment on a Coast Guard boat and at the police station, thus providing direct communication with any part of the flooded zone. N.C.R. men not needed to operate these units went out in boats and aided in rescue work. Later, the equipment in the cutter was transferred to a police cruiser. On March 28th the unit was discharged from duty with fulsome praise from the chief of police. The opera-



**RED CROSS HEADQUARTERS HAD FIVE-METER CONTACT WITH OTHER RELIEF AGENCIES THROUGH W1DFT LOCATED IN THE RED CROSS BUILDING**

*I. E. Riebenburgh, W1DFT is at the right. Harry Dubofsky, W1IJP, wears the phones.*

tors who served, with Ensign Walter Kozacko, W1NS, in charge, were: B. J. Carpenter, W1DMZ; H. L. Converse, W1IOL; E. W. Dunscombe, W1ESG; H. J. Gourley, W1APP; L. E. King, W1DCF; C. H. Leete, W1GBZ; V. W. Paunoff, W1EOB; J. Pilaian, W1IDB; P. E. Potter, W1CFC; M. H. Robertson, W1BPN; F. L. Sherman, W1CEU; J. E. Vermerien, W1DUZ; M. D. Clifford; H. P. Shumsky; and M. L. Varney. N1NS, N1APP and N1BPN handled the communications activity in the 3.5-mc. amateur band.

W1BWY, the Springfield Radio Association station, operated by Isaiah Creaser, W1BSJ, John Burdett, and W1JSP, went on the air at 3 p.m. on the 18th on behalf of the Springfield Red Cross. Broadcasts and warnings concerning road conditions were sent out for the Springfield Safety Council, reports on conditions secured for WBZ, and personal messages handled for WMAS. W1BSJ also operated a 5-meter link on behalf of the Springfield papers, to keep them in touch with their reporters in Greenfield, Holyoke and Turners Falls.

Fred E. Gould, W1BAP, although flooded out of his home, operated his mobile station on Provin Mt., scheduling W1BVR, Westfield, W1MY, Thompsonville and W1HDQ, Springfield. Lionel R. Mabb, W1FMM aided as relief operator. He also operated a station of his own on the mountain later. During an interim, W1BAP operated at W1BEC. W1BAP served in organizing Springfield activity.

Up in the Walnut St. Fire Station in Springfield Walter E. Rossmeisl operated W1BEC, with the aid of W1ACJ. This station and W1JTF at the State Police Barracks formed a valuable link for the National Guard and State and municipal police. Indeed, Major Bailot, Northampton, and Captain Waring, Springfield, came to these stations and conferred with each other a total of five times, once for 35 minutes, in lieu of telephone and teletype communication.

W1AWW, owned by T. F. Cushing, spent two days on 80 meters for the National Guard, two days on 5 meters for the Red Cross (linking Springfield and West Springfield), and also installed a 5-meter rig at the West Springfield Town Hall for the National Guard.

A number of 75-meter 'phone stations were on in Springfield, and did excellent work. At W1BPZ, owned by Fred L. Pinney, approximately 1800 messages were handled, of which perhaps 600 were Red Cross, police, press, etc. Three operators were on duty continuously for 98 hours at this station. Sherman A. Story, W1HPZ, was instrumental in securing quantities of needed supplies from Boston. Stanley Laughlin, W1BPG, and W1BZP also distinguished themselves on this band, being fortunate in that they were reliably supplied with power. Louis A. Richmond, W1AVK, handled Northampton

police traffic at the Western Massachusetts Amateur Radio Association club rooms at the Springfield Airport.

Other stations who were on in the Springfield area include Henry B. Sprague, Jr., W1CHR, operating portable; Arthur R. Boeder, W1CQR; and S. C. Howes, W1ARE. Louis Appleton, W1ISN, stood by in case the station was needed by the telegraph company; no call coming, the operator applied himself to other relief work.

When the Connecticut started its relentless upward climb at Hartford, amateur radio in that vicinity was more or less prepared. Two days before, the Farmington River, tributary of the Connecticut which meanders through northwestern Connecticut above Hartford, had started climbing its banks, swollen by rain and jammed melting ice. The rise was climaxed by the bursting of the large Greenwood Dam at New Hartford, 30 miles northwest of Hartford, inundating that city and several villages and the farming community just below, leaving hundreds homeless. Immediately an emergency radio link was planned at A.R.R.L. headquarters. The crisis quickly passed, however, and telephone service was restored without great delay. Meanwhile, the Pennsylvania disaster was taking toll and amateurs were rising to the need. At W1MK and W1INF and also at W1BDI emergency watches were maintained, both for the purpose of handling flood traffic when required and to secure press information. Up until the time when local Hartford emergency needs became more urgent, 126 press bulletins were issued to the news services from League headquarters. From then until the succeeding Tuesday, amateur radio in Hartford was given over wholeheartedly and exclusively to emergency work.

So many amateurs were operating at so many stations in the Hartford area, and such good work was done by all, that in fairness to everyone it is impossible to do more than list the participants and suggest the major lines of activity.

The communications system that more or less automatically developed itself through the day on Friday, shaped and modified and adapted by the travail of experience, was divided into four sections, with an auxiliary coordinating office at A.R.R.L. Headquarters in West Hartford:

1. The external 3500-kc. group embraced stations in the outlying regions of metropolitan Hartford where in most instances power was still available. Stations in this group were W1UE, Newington, operated by E. L. Battey, W1UE, and Harold A. Bubb, W1MK-W1JTD; W1TS, Plainville, operated by Don Mix, W1TS, and A. A. Hebert, W1ES; W1BEQ, Stephen Lozrim, Manchester; W1CMP, Claude H. Leroux, New Britain (75-meter 'phone); W1DTJ, David L. Goldberg, Collinsville (75-meter 'phone); W1ERU, Conrad C. Rothammer, W1ERU, Elmwood; W1AFB, Ray C. Lowery, Hartford,

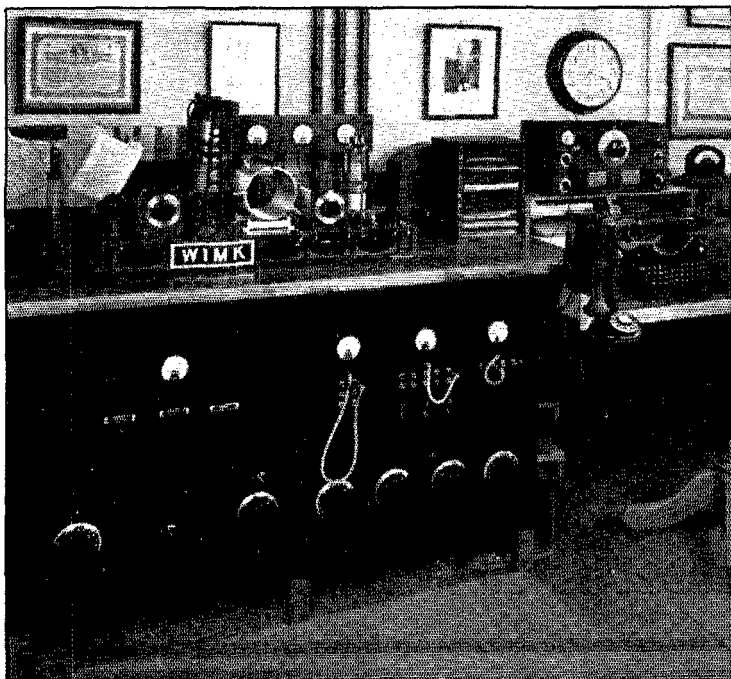

Carleton Burt, W1GZX, and J. B. Griswold, W1JLG—with battery power, transmitted to W1UE and W1TS. At the State Armory in downtown Hartford and at W1INF in West Hartford mobile National Guard equipment was operated as a local link on behalf of the National Guard and the Adjutant General's office. W1INQ was operated on battery power in East Hartford by V. H. McBride, W1INQ, E. G. Warner, W1INP, and H. R. Fisk, W1DR. In a sense this network supplemented the 5-meter networks, although the type of traffic involved was such as to make the medium-frequency c.w. superior to u.h.f. 'phone.

3. The local Hartford

and Charles C. Spencer, W1HJW, Hartford (the latter stations being on intermittently, when special but unreliable power facilities permitted). W1HDF, Elmwood, was operated on 160-meter 'phone for a time, as an auxiliary to the local 5-meter network. W1SZ, W1ES and W1BAW (operated by W1JPE) were going at intervals when power was on.

2. The internal 3500-kc. network functioned with battery- and hand-generator-powered equipment to move traffic from downtown Hartford and West Hartford to stations in the external network and to telephone circuits via the Headquarters office. W1BDI—operated by F. E. Handy, Hal Bubb, H. W. McIntosh, W1DMP, A. A. Hebert, C. C. Rodimon, W1SZ,

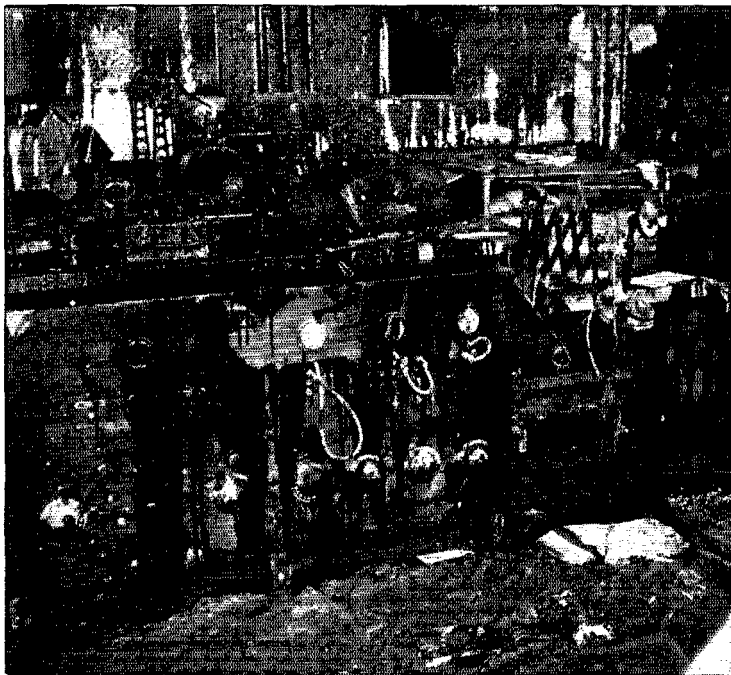

**WIMK, BEFORE AND AFTER!**

*The A.R.R.L. HQ's station was completely inundated by the flood waters. As though a thick coating of silt over the shack and everything in it were not enough, several tanks of heavy road or fuel oil broke and got into the shack. When the waters receded the well known WIMK, familiar to all as shown in the top picture, turned into the sad sight which you may be able to recognize in the lower photo!*

5-meter network was one of the biggest and most effectively-functioning machines ever created amongst amateur radio operators as a result of spontaneous emergency organization. A large

number of stations and operators located at strategic points covered West Hartford, East Hartford and suburban areas almost with the effectiveness of the land telephone system. W1BUE, later W1XT, high in the famous Traveler's Tower in downtown Hartford, was the central clearing station, manned by Emile Clavez, W1BUE; Ed Sanders, W1XT; Pat Clancy, W1BAH; Sam Moses, W1ASD; Fred Edwards, W1DJC; I. Jeter, W1IVJ; L. Kramer, W1HOP; Ed Kiley, W1DSV; Oakes

Spalding, W1FTR; A. E. Bent, W1JPK; H. D. Taylor, W1XHC, and Joe Vincent. Working into this station and amongst themselves were Al Bisbee, W1FZA; A. E. Chase, W1JN (who operated portable in a car atop wind-swept Trinity Hill for 60 hours continuously), aided by Dr. R. E. Woodward, W1EAO, and others; W1IVJ, Lindsay H. Jeter; Charles C. Spencer, W1HJW, who acted as a mobile delivery unit to the downtown region; Raymond S. Terwilliger, W1DLJ, Newington; David Haymond, W1IYE; Oakes Spalding, W1FTR, on Coast Guard Cutter 404; Carl Pierce, W1HDF, aided by Lester Webb, W1HBD and Wolcott Smith, this station acting as control for several mobile units; W1JPE, located on Selden Hill, West Hartford, operated by Byron Goodman, W1JPE, A. L. Budlong, W1JFN; K. B. Warner, W1EH; George Grammer, W1DF; Vernon Chambers, W1JEQ; Ross A. Hull and Wolcott M. Smith; and W1DFT, located at Red Cross headquarters in Hartford, operated by I. E. Rivenburgh, W1DFT, W1HJW, W1IVJ, W1HOP and H. Dubofsky, W1JJP. Truman G. Smith, W1HQQ, operated mobile at the State Armory and other points.

In East Hartford W1XO, operating under adverse conditions at a privately-owned power plant, was installed and handled by J. Clayton Randall, W1XO-W1HPI; Richard K. Blackburn, W1JVS (both of WTIC); and Frank Alford, this station cleared Ernest A. Reed, W1DVO, at Rentschler Airport in East Hartford and Wm. L.

Butler, W1JGO, in Glastonbury. In New Britain, Theodore J. Zuk, W1GUL, served as a southern outlet and relay point.

4. The 5-meter network operated on behalf of the Connecticut Valley Power Exchange was basically instrumental in the early restoration of power to the Hartford area, for it provided the various power companies concerned with what was to all intents and purposes the equivalent of a flexible land telephone circuit that was completely reliable even when the most dangerous and critical orders were being transmitted. Coördinated and managed by John L. Reinartz, W1QP, of Manchester, who had power via the Cheney Mills plant, this network, also

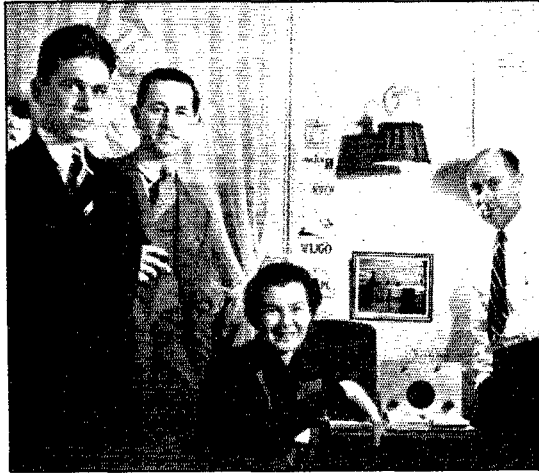

AN IMPORTANT LINK IN THE FIVE-METER NET EXTENDING NORTH FROM HARTFORD: W1MY

Donald Comstock, W1MY is at the right with daughter Ellen in the center. E. H. Fenn, W1DJG, is at the left with Al. Lawrence, W1IFS, beside him.

the result of a process of evolution, started actively functioning at 4 p.m., Friday. In its most extended form it constituted a relay chain from New Haven to Shelburne Falls, Mass., but the basic network consisted of Alton L. Bisbee, W1FZA, operating at the 410 Sheldon St. building of the Hartford Electric Light Co.; W1XT, Traveler's Tower; W1QP, Manchester, manned by Lieut. and Mrs. Reinartz, Harold Ballard, W1CSC, Charles W. Hollister, W1EDL, Stephen L. Lozsim, W1BEQ, Frank Wilson, W1GPD, Russell Hazen, Austin Weiman, and Janette Reimer; W1MY, Thompsonville, operated by Donald C. S. Comstock, Ellen Comstock; and W1HDQ, Springfield, Mass., operated by Edward T. Tilton, who acted as a terminal point a great deal of the time. However, W1BEC in Springfield, W1DVH in Holyoke, W1BVG in Easthampton, and W1DEI of Amherst College, operating portable at Shelburne Falls, participated in the net at times. To the south, Alred M. Winchell, W1AIY, on Walcott Hill near Waterbury, coördinated W. H. Smith, W1AUK, New Haven; Ernest L. Markham, W1GYT, South Meriden; James E. Ford, W1FLQ, Middletown; H. L. French, W1JLK, Portland; and Carroll E. Drysdale, W1BWL, Plainville.

These 5-meter networks functioned for a period of about 6 days, exactly 144 hours in the case of the Connecticut Valley Power Exchange Net. Both networks handled a total of 7500 messages

(Continued on page 118)

# A Novel Low-Cost Ultra-High-Frequency Receiver

## A Super-Regenerative Circuit Using the Pentagrid Converter Tube in a New Rôle

By R. O. Williams,\* W8FUQ

**T**HE receiver to be described was developed after a long search for the ideal detector for frequencies in the vicinity of 60 megacycles.

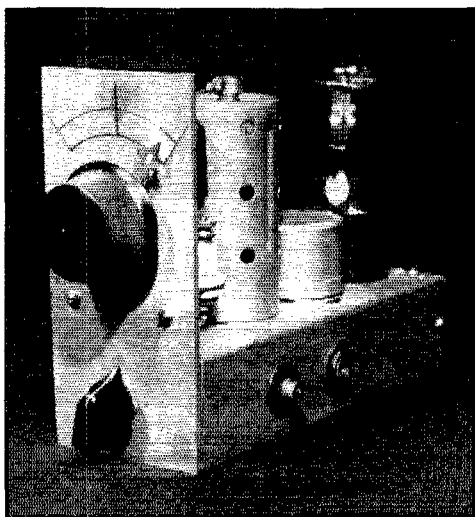

THE NEW ULTRA-HIGH-FREQUENCY RECEIVER

*The quench frequency unit in the small shield can be made with the cap of a normal tube shield.*

Of course, a receiver for these frequencies must employ super-regeneration if the greatest efficiency is to be had with a minimum number of tubes and the smallest possible batteries. Self-quenching detectors were out from the standpoint of radiated interference; standard two-tube systems employing separate quench oscillators were bulky and usually failed to give the smooth action and perfect control desired.

Going through the tube manual from cover to cover we were unable to find any new clues until we read with care the dope on the pentagrid converter tubes. The book says, ". . . a multi-electrode tube designed to perform simultaneously

\* Engineer, Radio Project, Michigan Dept. of Conservation, 239 Gunson St., East Lansing, Michigan.

the functions of . . . mixer and oscillator. . . ." Why not use it on 5 meters; oscillator section on the quench frequency and pentode section as high-frequency detector? It looked like a grand idea. We tried it and it worked. It out-performed all other detectors we had tried. In its most sensitive condition the radiation was substantially absent. It had a splendid smoothness of control and, above all, it was simple and cheap to construct (after we got the bugs out of it!).

We tried various tubes including the 6A7, 1C6, 1A6, and found the 1C6 to be the best of all, though the 1A6 will work and can be used where low battery drain is important.

Last year we tried this detector working straight from the antenna and also with tuned r.f. ahead of it. In all cases it gave a better performance than commercial models we had purchased for trial and other home-made models we had devised. Using this detector in one of our fire towers, we had two-way communication with the Department airplane flying at 3000 feet over level ground for a distance of over 100 miles using non-directional antennas in both tower and plane. This detector will be used in all of our

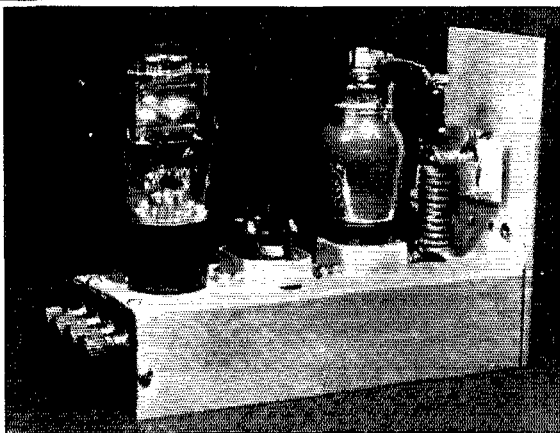

A SIDE VIEW OF THE RECEIVER

*The shield over the quench frequency unit has been removed.*

models from the simplest (employing a 1A6 detector and 30 audio) to the sets using two stages of 954 t.r.f. ahead.



Now for the theory of operation and the extermination of the "bugs". It is easy to see how the triode section of these tubes can be made to oscillate on the quench frequency, but the trick was to make the section composed of grids 3, 4, and 5 oscillate at the high frequency. Using grid No. 4 as signal grid with grid-leak-condenser combination and the input circuit between it and ground, we tried tapping the filament up a turn or so for regeneration without success. We also tried feedback through separate coils with no luck. Finally we discovered that, with the filaments and one side of the input circuit grounded, the circuit oscillated merrily—apparently without feedback! What a simple circuit this made! No expensive dielectrics and no fussing with tricky coil combinations.

After much pondering we arrived at the following possible explanation of the action. Instead of tapping a real cathode "up" on a coil we had the same condition in the tube itself, using capacitive reactances and the electron stream as the coupling

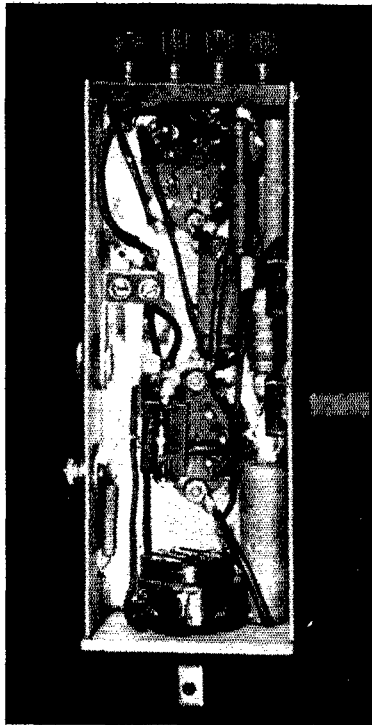

THIS VIEW UNDERNEATH THE CHASSIS SHOWS HOW SIMPLE THE ASSEMBLY ACTUALLY IS

0.001 condenser. This detector may be used with any audio system. The set shown was built up to test out the circuit and uses a Type 33 pentode audio giving fair loudspeaker volume on the average signal, with a reasonably good antenna.

As may be seen, the mechanical layout is simple, requiring only the tube, socket, quench coil unit and 5-meter tuning coil and condenser. This arrangement makes it possible to mount the condenser on the metal front panel and do away with insulation and by-passing in the circuit. Also mounting of parts can be done without additional insulation since the u.h.f. section is composed of only the coil and condenser and connection to the grid cap. All the rest of the connections are either d.c. or low frequency and require little care in arrangement.

The 6A7 tube was found to work well on 6-volt supplies but the increased effectiveness of the 1C6 led us to use it

(Continued on page 84)

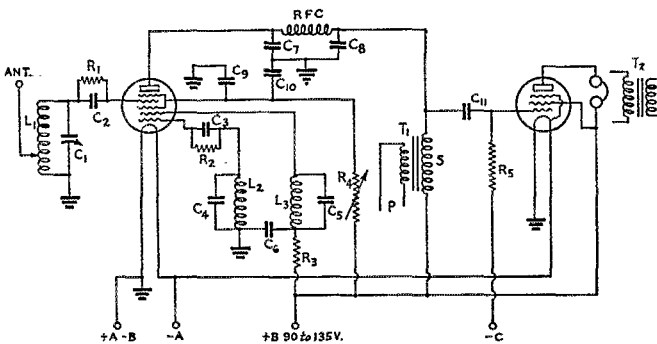

FIG. 1—THE RECEIVER CIRCUIT

- L1—8 turns of No. 14 wire 1/2 inch diameter for 56-mc. band.
- L2, L3—Large coils from I.C.A. 5-meter quench coils.
- C1—15  $\mu$ fd. Cardwell Trim-Air.
- C2—100  $\mu$ fd. mica.
- C3, C7, C8—250  $\mu$ fd. mica.
- C4, C5—0.001  $\mu$ fd. mica.
- R3—20,000 ohm, 1 watt.
- R4—500,000 ohm Centralab 70-203 variable resistor.
- R5—500,000 ohm, 1/2 watt.
- T1—Audio or mike transformer.
- T2—Modulation trans. 7000 to 5000 ohms.
- Note—T1 is mike and T2 is modulation transformer when this portion of the circuit is used as modulator for a transmitter.
- C6, C10—0.1  $\mu$ fd., tubular.
- C9, C11—0.006  $\mu$ fd. mica.
- R1—4 meg., 1/2 watt.
- R2—100,000 ohm, 1/2 watt.

# A Meter-Type Modulation Monitor

## Indicating Carrier Shift and Modulation Percentage

By D. C. Summerford,\* W9AYH

**M**OST anyone who has operated a 'phone station has often wondered what his percentage of modulation is and how much distortion is present, and if so, whether or not it is in the audio or radio frequency end of the transmitter. Very few operators are sure of these things. This assumption is borne out by the great number of questions on the air of, "How is my

46's on a Western Electric 276-A with 200 to 250 watts input under actual checks with a cathode ray oscilloscope and with the modulation monitor. One can readily see that with an input of 100 to 150 watts, the transmitter would probably be greatly overmodulated. This increases the interference of the station in the form of interchannel cross-talk or monkey chatter without increasing the range of the transmitter. On the other hand, if the transmitter is undermodulated, the efficiency drops off rapidly. The following table shows the power required to give the same coverage with modulation of less than 100% as compared with a 100-watt transmitter modulated 100%.

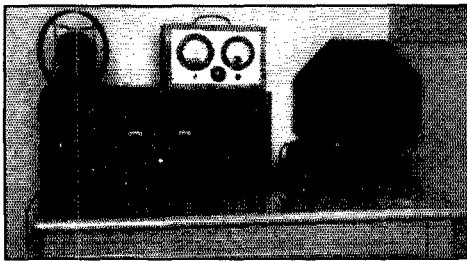

COMPLETED MONITOR ATOP THE RECEIVER

Power	% Modulation
100 watts	100
400 "	75
900 "	50
1600 "	25
Infinite	0

modulation and quality." The Federal Communications Commission has a ruling that the transmitter shall not be modulated in excess of its modulation capability. Of course, the top limit is 100%. Without some means of checking the transmitter one may get a pink ticket for overmodulation.

R.f. ammeters are wholly unreliable for checking the percentage of modulation. On speech, we may get about 5% increase in antenna current for 100% modulation but that figure varies with different voices, speed of talking and damping of the meter. A pick-up loop with a light bulb is equally unreliable. So is the "kick" of the Class-B plate meter unless it has been previously checked against some standard and frequently rechecked. A modulation monitor or cathode ray oscilloscope is the acceptable means of checking modulation.

A large percentage of the 'phone men are using Class-B modulation. Usually Class-B lineups are underrated so far as modulation capability is concerned. For instance, it is possible to modulate 250 watts input fully with 4 46's in Class-B push-pull parallel with 600 volts on the plates. Usually, these tubes are rated at about 70 watts of audio. Here at W9AYH, I am doing a good job with the

\*WHAS, *The Courier-Journal*, Louisville, Ky.

Grid modulation is being used quite a bit on the higher frequencies. Those that have used this method know that a transmitter of this type is

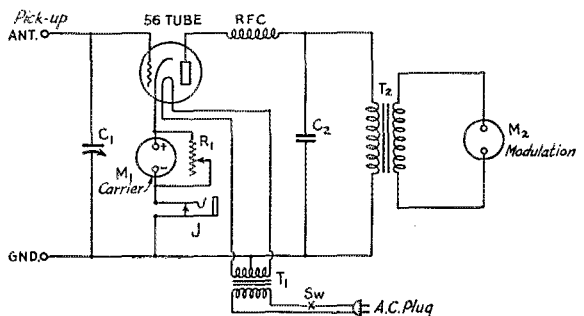

FIG. 1—CIRCUIT OF THE MONITOR

- C<sub>1</sub>—100- $\mu$ fd. midget.
- C<sub>2</sub>—0.002 mica.
- M<sub>1</sub>—0.1 ma., Weston or Triplett, 3-inch.
- M<sub>2</sub>—Weston or Triplett db Meter, 3-inch.
- R<sub>1</sub>—30-ohm.
- J—Closed-circuit jack.
- T<sub>1</sub>—2½ v. fil. trans.
- T<sub>2</sub>—5000-5000 ohm transformer.
- SW—S.p.s.t. toggle switch.

very hard to adjust for good quality and the proper percentage of modulation. Some method of checking the carrier should be used by all means by those attempting grid modulation.

Realizing the importance of proper modulation, the Federal Communications Commission have in

Rule 139 required that after November 1, 1936, all broadcast stations have in use a modulation monitor approved by them. The rule says that the percentage of modulation must be at all times maintained above 85% on peaks at frequent intervals. The audio harmonic distortion at 85%

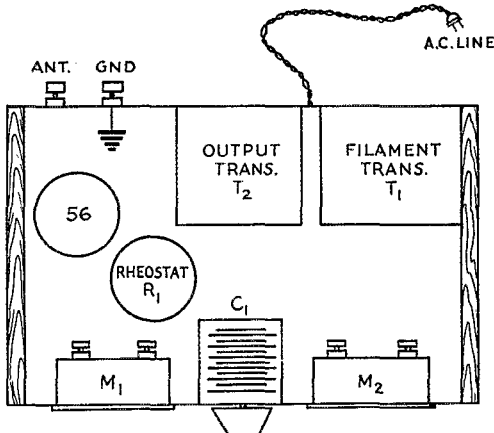

FIG. 2—LAYOUT PLAN OF THE MONITOR  
The modulation monitor at the operating position for convenient continuous check on the signal.

modulation must be less than 10%. The specifications are essentially as follows:

1. A d.c. meter for setting the average rectified carrier at a specific value and to indicate changes in carrier intensity during modulation.

2. A peak modulation light.

3. A peak indicator with a meter having the characteristics below shall be used in a circuit such that peaks of modulation between 40 and 90 milliseconds are indicated to 90% of full value. The meter shall be accurate to  $\pm 2\%$  and read the positive and negative peaks and may read full wave peaks.

4. The audio frequency characteristic of the meter shall be flat to within plus or minus  $\frac{1}{2}$  db from 30 to 10,000 cycles per second. Of course, it must cover all broadcast frequencies. (You will note cathode ray oscilloscopes are not of the approved type.)

The General Radio Company in cooperation with the engineers of the Columbia Broadcasting System have developed such a monitor (GR No. 731-A) that meets the requirements of the F.C.C. WHAS, Louisville, Kentucky, has had one of these monitors in operation for almost a year and it has proven to be reliable. Most people are surprised at the small variation of the antenna ammeter when the transmitter is modulated 100% on talking programs.

A modulation monitor similar in operation to the General Radio monitor without its refinements has been designed and built, and is described in this article. In the picture, the carrier

meter is on the left and the peak modulation meter is on the right. The listening jack is on the lower left and the shunt condenser in the lower center. The a.c. switch is on the lower right.

The carrier meter has two functions. First, it is used to indicate the reference carrier lever at which the monitor is to operate; and second, it shows carrier shift during modulation which is an indication of inequalities in the positive and negative peaks. This meter, as shown in the diagram, is connected in the cathode of the 56 tube through the listening jack to ground. This tube is a linear diode rectifier and gives an instantaneous output voltage proportional to the carrier envelope. This output voltage is fed through a low-pass filter consisting of an r.f. choke, by-pass condenser and an audio output transformer. The modulation indicator meter is across the output winding of this transformer, and since a meter of this type has an impedance of about 5000 ohms, very little load is put on the rectifier. This meter reads the average of both sides of the wave or full-wave peaks. In this particular model no attempt was made to put on a reversing circuit to measure the individual sides, but if there is no kick in the carrier meter during modulation there should be no necessity for it, and if one gets a kick on the carrier meter showing carrier shift, the trouble should be corrected anyway. Since the modulation meter reads in db instead of percentage of modulation, below is given a conversion table:

db	% Modulation
*1.8	120
*0.9	110
0.0	100
-0.9	90
-1.8	80
-3.0	70
-4.0	63
-5.0	56
-6.0	50
-7.9	40
-11.0	30
-14.0	20
-20.0	10

\* Overmodulation.

#### CONSTRUCTION AND CALIBRATION

The monitor is built in a wooden box 6 by 9 $\frac{1}{2}$  by 5 $\frac{1}{2}$  inches made of hardwood with adequate holes for ventilation. It is fully shielded with sheet copper tacked inside the box and bonded. A metal box may be used if available. The antenna and ground terminals are brought out at the rear, as is also the a.c. cord. The panel is made of  $\frac{1}{16}$ -inch aluminum, 5 by 8 $\frac{1}{4}$  inches. All parts are arranged as in the sketch, but are not very critical as to placement.

A word might be in order about some of the parts. The peak modulation indicator may be any fast acting copper oxide rectifier type meter. Both Triplett and Weston make suitable meters

(Continued on page 84)

# What the League Is Doing

League Activities, Washington Notes, Board Actions—For Your Information

**Citations** The F.C.C. calls the attention of amateur licensees to a change of procedure in replying to notices of violation: "Rule 105.23 of the Practice and Procedure of the Federal Communications Commission, which supersedes Rule 24 of the Rules and Regulations of the Federal Radio Commission, requires the licensee of a station to forward within three days after receipt of a notice of violation, a reply to the Commission at Washington, D. C., with a copy to the office originating the complaint when that office is other than the Commission at Washington. This procedure will afford the inspector citing the station for violation an opportunity to review the licensee's reply and present to the Commission for consideration, along with the reply, any facts and observations which are pertinent to the proper handling of the case."

**URSI-IRE** Ross A. Hull, our associate editor, will deliver a paper on further observations of ultra-high-frequency signals over long indirect paths, at the joint meeting of the American Section of the International Scientific Radio Union and the Institute of Radio Engineers, on May 1st, at the building of the National Academy of Sciences in Washington. U.R.S.I., organized under the International Research Council, has for its object the promotion of knowledge and the study of phenomena connected with radio waves. The joint spring meetings of its American section with the I.R.E. have become the favored place of presentation for papers on the truly scientific aspects of radio. Many valuable papers will be presented this year which will interest scientists and close technical students. Further information may be had from Mr. S. S. Kirby, Technical Secretary, c/o National Bureau of Standards at Washington.

**Meeting** The Board of Directors of A.R.R.L. will meet in Hartford on May 8th for their regular annual meeting. An unusually full program awaits the Board this year, and there doubtless will be many interesting announcements to make when the sessions are over. A new president and a new vice-president are to be elected this year, to succeed the late Messrs. Maxim and Stewart. Special telegraphic broadcasts of the results will be sent after the meeting from W1NF on 3828 kc. and from W1BDI on 7066 kc. For quickest possible dope on the meeting, listen for these stations.

**Conferences** United States preliminary preparation for the fourth meeting of the C.C.I.R., to be held at Bucharest in May of next year, approaches a conclusion. Representatives of the League have participated in this work, and A.R.R.L. headquarters is also centralizing amateur studies of some of the questions which will be submitted in the name of I.A.R.U. Meanwhile the United States announces the beginning of the preparatory work for Cairo, with committees holding their first meetings in Washington on May 5th, at which our Cairo Committee will be represented. Before commencing the preparatory study on frequency allocations, however, F.C.C. intends to hold extended informal public hearings, some time in the month of June. The hearings will deal with allocation matters for the entire radio spectrum, and all interests who desire to use part of the spectrum will be expected to appear and present their cases. These hearings will be most interesting and important. They constitute a preliminary to the actual determination of U.S.A. recommendations on frequency matters to the Cairo Conference. A.R.R.L., of course, will be represented.

**Flood** Any account of what the League was doing in the month of March would be large with the account of flood relief. That, however, is the subject of special articles in this issue. The flood loomed large in all our lives last month. The entire male portion of the headquarters staff worked on emergency communication matters exclusively for a period of about a week. Though W1MK was flooded, the League offices in West Hartford were far from the flooded area, but we lost nearly a week of office time and correspondence has suffered delays. By the time this issue appears we should be caught up, but we hope our members will understand if our performance in recent weeks has not been quite up to par. April *QST* was produced by the normal date, but transportation facilities throughout the East were so embarrassed that all second-class mail has suffered delay in delivery. This issue we trust will reach our readers on time.

## Strays

Tell the 160-meter boys that I worked more DX on 160 meters in 1923 using the faithful 202 than I've worked during the past year on 7 mc. with a 203-A!

—W5JP

# Separate Transmitters on Five Bands

## A Practical Method of Realizing Rapid All-Band Switching

By A. L. Budlong,\* WIJFN, and Clinton B. DeSoto,\*\* WICBD

**I**T ALL started when we set out to build a new rig at WIJFN. Simultaneously, we let ourselves get to thinking about that dream of every ham: a bank of separate transmitters to hop from one band to another with the flip of a switch. After all, plug-in-coil transmitters are all right, and band-switching rigs are still better, but the *ultra* of the *plus* is separate transmitters for each band. That, gents, is the tops.

### CIRCUIT LINE-UPS

Well, it didn't take us long to decide that to meet the two requirements that had been set up—simplicity and economy—meant a minimum of tube stages and parts. Crystal control was indicated by so many considerations that there's no need to run over them here, but a single c.c. stage wasn't capable of delivering even the moderate output that was wanted... unless a tube like the RK-20 were used; but this introduced further complications: more expensive 1000-volt power supply, and separate power-supply for the very high-frequency rigs, where a different lineup would be needed anyhow.

So a crystal oscillator—pentode type, of course, using a cheap and readily available receiving tube—and a one-tube output stage capable of pushing out 30 or 40 or 50 watts, became the indicated line-up. A 2A5 was chosen over a 47 for the oscillator position simply because it was a heater-type tube. For the output stage, the good old 10 was selected, the reasons being its proven ability to "take it," in contrast to the 400-volt receiving types.

\* Assistant Secretary.

\*\* Assistant Secretary.

In so far as possible, the basic design was to be standardized so that it could be used effectively on all bands. In practice, it turned out that the simple oscillator-amplifier arrangement worked swell on 80, 40 and 20, but that on 10 meters the oscillator, when operated as a Tri-tet with 20-meter crystal, did not have enough soup to push the amplifier so a doubler stage was squeezed in. On 5 meters, of course, where modulation was to be provided, an entirely different line-up would be needed. But that's out of order here, let's take up these things as they happened.

### RACK-PANEL CONSTRUCTION

The first thing, naturally, was the wooden rack on which the transmitters are mounted. It was decided to build this in relay rack style for a variety of reasons, space economy and accessibility being the most important. The construction and appearance of the rack are clearly shown in the photographs and Fig. 1. On the theory that maximum economy in physical effort should be practiced at all times, the rack was made of white pine, although a harder wood might be preferable. Even so, it is as solid as a rock; the transmitters would be supported no more firmly on a heavy steel rack. The upright members and cross pieces are of 2" x 3" stock; the base is made of flat boards and lengths of 2" x 3" fashioned on a band saw, as pictured. Long wood screws are used in assembling at all points of particular strain; heavy nails suffice when "cross-wise" stresses alone are encountered. When completed, the rack was finished with two coats of flat black (telephone black) Duco; Bud thought a shiny finish would be better, so we slapped on a third coat of glossy Duco, and that's the way it is

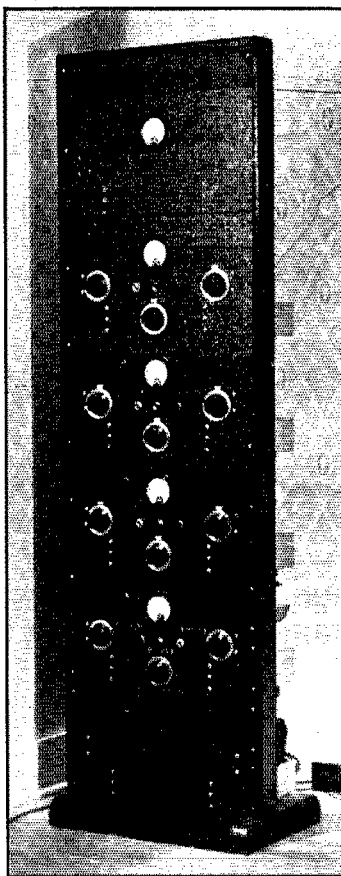

CLICK—THAT'S THE POWER SWITCH—CLICK—THAT'S THE ANTENNA SWITCH—AND A COMPLETE TRANSMITTER IS AVAILABLE ON EITHER 80, 40, 20 OR 10 METERS

the rack was finished with two coats of flat black (telephone black) Duco; Bud thought a shiny finish would be better, so we slapped on a third coat of glossy Duco, and that's the way it is

today. The black frame, the crackle-finish black steel panels, and the aluminum-finished Atlas chassis pans look very nice indeed. The chassis bases, by the way, are  $10 \times 16 \times 3$  inches of heavy steel, rigidly fastened to the panels with brackets and a total of ten  $3/16$ -inch machine bolts.

#### POWER SUPPLY

The rack all finished, let's start at the bottom of the transmitter assembly and work up. The first panel is that of the power supply. This supply is so constructed as to provide full plate power to any one transmitter at any time, and filament power to all transmitters at all times. The reason for the latter requirement is, of course, to enable instantaneous switching from one transmitter to another during operating periods without necessity for waiting for tubes to warm up. Filament power is derived from two transformers, one taking care of the 2A5's and 83, the other supplying the 10's; plate power comes from a 525-volt 150-ma. supply using an 83 rectifier with a swinging-choke-input filter system. Dual 8- $\mu$ fd. 475-volt electrolytic condensers are wired in series to provide 4  $\mu$ fd. each of 950-volt-rating filter capacity. One 83 rectifier tube has given up the ghost in service to date but no other component shows so much as a sign of strain.

On the panel of the power supply there appears a red pilot jewel, which glows when the filament switch is turned on. Beside it is the knob controlling a 2-section 5-point rotary switch, heavily insulated, one section of which transfers the positive plate voltage connection to any one of the transmitters, while the other section switches the green pilot lights that appear on each transmitter panel. Boy, it is a thrill to run that switch around and see the pilot

jewels glow in sequence while the millimeters kick spasmodically upward in controlled order!

In the lower left-hand corner of the power supply diagram are shown two switches and the key terminals. These are actually contained in a small remote control box, consisting of a dual tumbler-switch plate mounted on a small wooden box, which is placed next to the receiver. A 10-foot 5-wire cable connects to the power unit proper. This portable control panel is just another of the little gadgets that make operation of the entire transmitter assembly simple, trouble-free and convenient to a degree.

#### THE TRANSMITTERS

So much for the power supply. Next up from the bottom of the rack is the 80-meter rig. On it are three dials, three insulated jacks, the pilot jewel, and a milliammeter and plug. In order, left to right, the dials and jacks apply to: oscillator plate circuit, amplifier grid circuit, amplifier plate circuit. The two plate circuits are built above the chassis, with coils at right angles, while the amplifier grid circuit is shielded from both by being placed underneath. Feed-thru insulators and link coils effect energy transfer between oscillator and amplifier. This arrangement provides adequate isolation of the circuits and simplifies the neutralization problem.

In most respects the circuit and layout are entirely orthodox. A link circuit having a somewhat higher impedance than is ordinarily encountered is used, this is done because it is readily demonstrated that such a circuit effects a more efficient energy transfer and yet does not have an objectionable reactive effect or cause noticeably-interlocking tuning adjustments. Oscillator loading is varied simply by moving the above-chassis link coil. The method of antenna coupling is unique in its simplicity, in these days of  $\pi$ -section networks, L-section networks, and so on, *ad infinitum*; its whys and wherefores are considered in the antenna discussion, a bit later on. The simplicity of this antenna connection alone, it seems, should provide an effective argument on behalf of the radiating system used as an element of this transmitting system.

The 40-meter transmitter is practically identical, the constructional layout and diagram being just the same. The only changes are increases in the values of the grid resistors, making the job of the oscillator, with its somewhat more fragile 40-meter crystal, a trifle easier. Too, a little auxiliary feedback capacity is added between the grid and plate of the 2A5 oscillator tube. One of the reasons for using a pentode crystal oscillator, is that the internal shielding is so good that feedback voltage is reduced. In the 2A5 this shielding is particularly good, and the feedback is reduced so much that a rather inactive 40- or 20-meter crystal will refuse to oscillate at all. Two 3- or 4-inch lengths of varnished-covered insulated

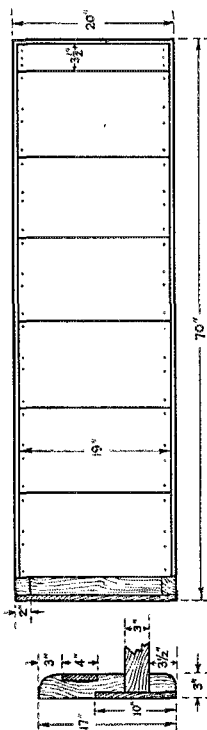

FIG. 1—DIMENSIONS OF THE WOODEN RELAY RACK

To a rectangle 20 by approximately 69 inches, made of 2 x 3-inch sugar pine, is attached a base including a 10 x 20-inch board, extension feet fashioned from additional short lengths of 2 x 3, and an auxiliary cross-piece of 4-in board. Angle brackets at strategic points brace the structure and hold it together. The result is rigid and stable, fully capable of supporting several hundred pounds of power supply and transmitter units.

other section switches the green pilot lights that appear on each transmitter panel. Boy, it is a thrill to run that switch around and see the pilot

wire, soldered to the grid and plate terminals respectively on the tube socket and then twisted together, will readily eliminate this difficulty. The exact capacity should preferably be adjusted to permit free oscillation, and excess wire then clipped off.

This same stunt is used in the 20-meter set, and the grid resistances again increased. Outside of these details this set also closely follows the basic design.

At 10 meters, however, the situation is not so much the same. Ten-meter oscillating crystals are not readily obtainable, and in consequence doubling must be resorted to between oscillator and amplifier. The original idea was to use a Tri-tet oscillator in this set, probably with an RK-23, doubling in the plate circuit to drive the 10. It was no go. There simply wasn't enough stuff at the grid of the 10 to make it operate according to the book. An additional doubler stage was necessary, if the 40-watt input level were to be maintained.

The problem that then presented itself was to incorporate this doubler stage economically and with as little disturbance of the basic mechanical and electrical layout as possible. Returning to the 2A5 as the crystal oscillator tube and impressing another 2A5 into the job of doubling got us a good part of the way; using untuned grid circuits throughout finished it up. The panel of the 10-meter set looks exactly like that of the others; the only change is that the center dial and meter jack are associated with the doubler plate rather than the amplifier grid. Similarly, on the chassis proper the only important change is the addition of the doubler tube and socket, a couple of untuned grid coils, and an odd small part or two.

The 5-meter panel is still blank. It will be filled in due course, but the rig will be quite different from the standardized design followed on the lower frequencies, probably using 53's throughout as m.o., p.a., modulator, driver and speech amplifier, with series (controlled-carrier) modulation. But that is definitely a story by itself.

#### ADJUSTMENT

The adjustment of these transmitters is as thoroughly satisfactory a part of their operation as is their appearance and the pleasant reflections on comparative cost. Everything is quite straightforward. First of all, a dummy plug, consisting simply of a short length of 1/4-inch Bakelite shafting fitted with a knob, is inserted in the amplifier plate jack to cut off the amplifier plate voltage. The milliammeter is plugged into the oscillator plate jack. The link coil above the chassis is bent several inches back from the oscillator coil. Filaments having been allowed to heat for 30 or 40 seconds, the plate switch on the control panel is turned on. The oscillator tuning dial is then rotated until the point of resonance is found.

Next, the key is depressed, and the link coil moved close to the oscillator plate inductance, watching the plate current meanwhile to observe the point at which the circuit becomes loaded up to normal plate current. The milliammeter is then switched to the amplifier grid circuit, said circuit being tuned to resonance. A grid current of 10 or 15 ma. should show. If there is less, the oscillator is retuned and/or the link coil readjusted, the coupling being set just below the point where the crystal will refuse to start up immediately when the plate voltage is switched on and off. The proper oscillator tuning adjustment, by the way, is not the point of minimum (unloaded) plate current dip, but that point on the slope of the curve which produces most r.f. voltage, as indicated by maximum glow in a neon bulb.

In the 10-meter rig an intermediate tuning process is involved. The oscillator adjustment closely follows the procedure just outlined, enough excitation being secured to cause the plate current of the unloaded 2A5 doubler (i.e., with the amplifier grid coil uncoupled) to change in a ratio of about 4 to 1 when tuned through resonance. The untuned grid coil of the 10 stage is inductively coupled to the plate coil of the 2A5; this coupling is adjusted

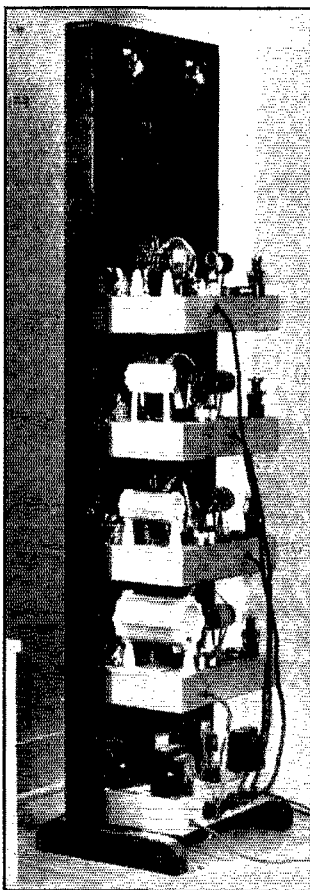

GOING UPWARD WITH FREQUENCY, THE POWER SUPPLY UNIT APPEARS AT THE BOTTOM AND UNIFORMLY-DESIGNED TRANSMITTERS FOR FOUR AMATEUR BANDS (56 MC. TO BE INCLUDED LATER) FOLLOW ABOVE

*Each transmitter is completely independent except for its power plug and antenna connection. Changing bands is a matter of seconds, and tuning is known to be optimum at all times.*

to a point where the 2A5 doubler plate current is about 30 ma. The rest of the tuning routine is common to all the transmitters.

Neutralization comes next. A neon bulb may be used as an r.f. indicator, although a galvanometer with a few turns of wire for coupling is better. Whatever the method, there should be a good

millimeter in the amplifier plate jack, the final tank circuit is tuned to resonance. On 80 meters the ratio between off-resonance and on-resonance plate current is easily 10 to 1, indicating a high order of performance. On the higher frequency bands this ratio is reduced, of course, but the efficiency still remains good. With the plate circuit

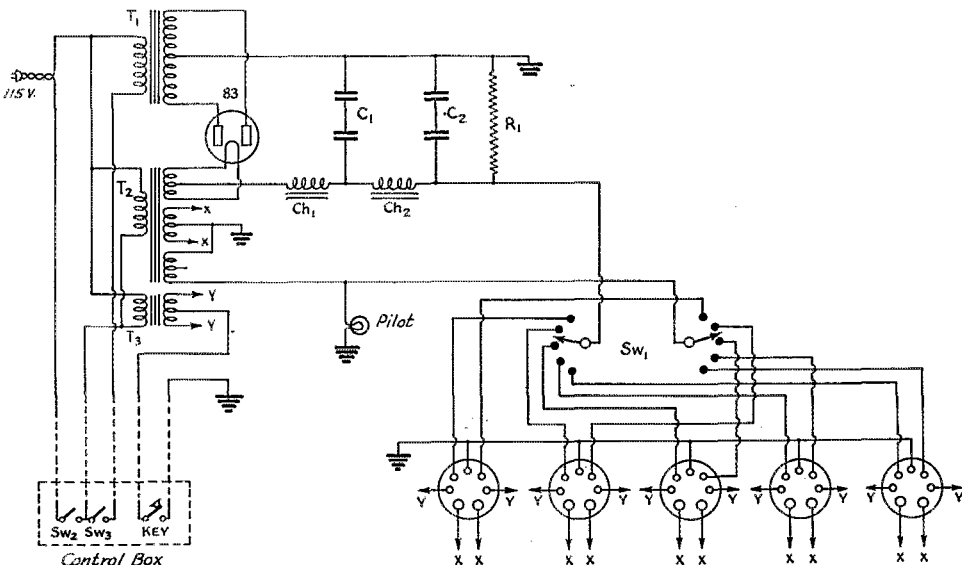

FIG. 2—POWER SUPPLY CIRCUIT

Each transmitter plugs into one of the rows of sockets along the back of the chassis, drawing filament power at all times when the main switch is on and plate and pilot-lamp power when the rotary switch is in the proper position.

- T<sub>1</sub>—Plate transformer, 525-volt 150-ma. (Thordarson T-6280).
- T<sub>2</sub>—Filament transformer for 83, 2A5's and pilot lamps, 5-volt 3-amp., 2.5-volt 14-amp., 2.5-volt 3.5-amp. (Thordarson T-6094).
- T<sub>3</sub>—Filament transformer for 10's,

- 7.5-volt 6.5-amp. (Thordarson T-6435).
- Ch<sub>1</sub>—Input swinging choke, 10 henries (Thordarson T-6405).
- Ch<sub>2</sub>—Filter choke, 20 henries (Thordarson T-6409).
- C<sub>1</sub>, C<sub>2</sub>—Dual 8- $\mu$ fd. 475-volt electrolytic condensers, with

- separate leads, wired in series (Sprague CL-88).
- R<sub>1</sub>—50,000-ohm 20-watt fixed resistor.
- SW<sub>1</sub>—Two-section 5-point rotary switch.
- SW<sub>2</sub>, SW<sub>3</sub>—Dual tumbler switches (see text).

indication of r.f. on the amplifier plate coil when the condenser is rotated through resonance. When this point is reached, the neutralizing condenser is turned until the r.f. disappears. The plate circuit condenser is then readjusted, whereupon the r.f. will probably reappear. This process of adjustment and readjustment is continued until practically no trace of r.f. can be found in the amplifier plate circuit.

Almost perfect neutralization can be achieved on all bands as long as the antenna is not connected. Connection of the transmission line will introduce some unbalance, however, and it is probable that zero r.f. indication will be unattainable on the higher frequency transmitters under operating conditions. If the maximum degree of neutralization is achieved, however, there will be no impairment in performance, regeneration helps, rather than hinders, usually—if it is limited to reasonable doses.

With the dummy plug removed, and the

tuned precisely to resonance, the plate voltage is turned off and the antenna transmission line clipped on a few turns in from the plate end of the amplifier coil. The plate voltage is then switched on again. The plate current will be considerably higher. If it is higher than is desired for normal operation, the antenna should be clipped a turn or two nearer the center tap, if it is less, the clip should be moved out to the plate end.

Exactly what the desired input is to be will vary in different cases, of course. An average of about 40 watts input is used in these transmitters; this means a plate current of about 75 ma. An input of 60 watts would represent average practice on 80 meters, this would constitute a plate current of somewhat more than 100 ma. On 10 meters, more than 40 watts input to the final cannot be taken without overloading the power supply; although, as a matter of fact, there is probably no reason why this couldn't be done! Alternatively, it would take an additional 40 watts to produce any



audible change in signal strength, according to theory, so what's the use?

Design . . . construction . . . adjustment. There's not a whole lot more to be said about the transmitters proper—except possibly on that important topic of cost. At the outset we decided that economy was an essential factor. At the same time, we insisted that high quality parts be used,

#### THE ANTENNA

While Clint was busy on the transmitters themselves, we were pondering over the antenna problem. Obviously, four rigs that could be switched quickly would be no advantage at all if we didn't have an antenna system that could be switched every bit as promptly. We had to have

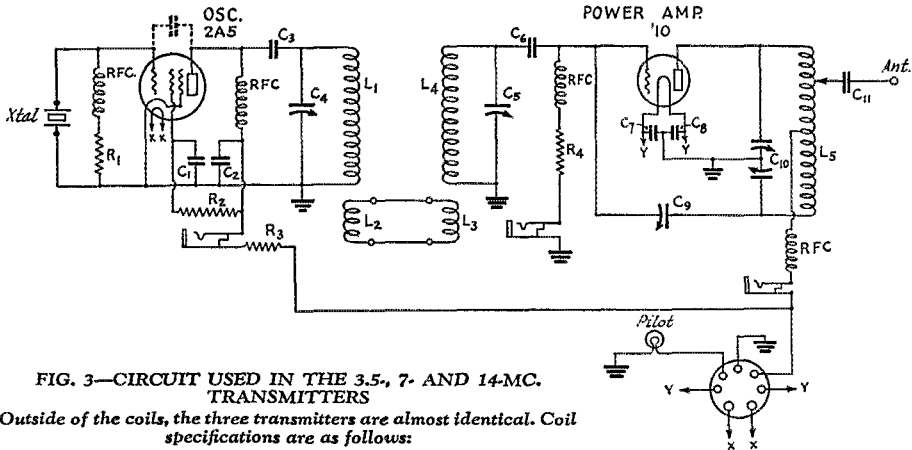

FIG. 3—CIRCUIT USED IN THE 3.5-, 7- AND 14-MC. TRANSMITTERS

Outside of the coils, the three transmitters are almost identical. Coil specifications are as follows:

- L<sub>1</sub>, L<sub>4</sub>—80 meters: 24 turns No. 14 d.c.c. close-wound on 2-inch diameter bakelite tube.
- 40 meters: 14 turns No. 14 d.c.c. close-wound on 2-inch diameter bakelite tube.
- 20 meters: 7 turns No. 14 d.c.c. spaced diameter of wire on 2-inch diameter bakelite tube.
- L<sub>2</sub>, L<sub>3</sub>—80 meters: 4 turns No. 14 d.c.c. 1½-inch diameter.
- 40 meters: 3 turns No. 14 d.c.c. 1½-inch diameter.
- 20 meters: 3 turns No. 14 d.c.c. 1½-inch diameter.
- L<sub>5</sub>—80 meters: 28 turns No. 14 tinned 4-inch diameter, 5 inches

- long (National XR-12A coil form wound full).
- 40 meters: 22 turns No. 14 tinned 2½-inch diameter, 4 inches long (National XR-10A coil form wound full).
- 20 meters: 9 turns No. 14 tinned 2½-inch diameter, 3 inches long (General Radio 677-U form, double-spaced winding).
- C<sub>1</sub>, C<sub>2</sub>—.005-μfd. mica fixed condensers.
- C<sub>3</sub>—.001-μfd. mica fixed condenser.
- C<sub>4</sub>, C<sub>6</sub>—100-μfd. variable condensers (National TMS-100).
- C<sub>7</sub>, C<sub>8</sub>—100-μfd. fixed mica condenser.

- C<sub>7</sub>, C<sub>8</sub>—.002-μfd. fixed mica condensers.
- C<sub>9</sub>—18-μfd. neutralizing condenser (National STN).
- C<sub>10</sub>—50μfd. split-stator condenser (National TMSA-50).
- C<sub>11</sub>—.005-μfd. 2500-volt mica fixed condenser.
- R<sub>1</sub>—10,000-ohm 2-watt fixed resistor on 80, 25,000-ohm on 40, 50,000 ohm on 20.
- R<sub>2</sub>—50,000-ohm 2-watt fixed resistor.
- R<sub>3</sub>—2500-ohm 10-watt fixed resistor.
- R<sub>4</sub>—5000-ohm 10-watt fixed resistor on 80, 7500-ohm on 40, 10,000-ohm on 20.
- RFC—2.5-μh. r.f. chokes (National R-100).

of adequate rating, to guarantee permanent, trouble-free performance and present an appearance of which we could be proud. Well, these requirements have been met; and the bill? At ham prices, complete with tubes, crystals, meters, etc., the parts in each of the transmitters cost under \$35 (plus about \$3 more for the 10-meter rig). The power supply ran to about \$30. We don't know, yet, just how much the 5-meter job will be. But, taken step by step, that wasn't so bad, was it? And step by step is the ideal way to take it, we have found. It means the fun of building a new piece of gear, of getting it working, of putting it on the air, of getting that first "Ur sigs 599 hr in Oscaloosa" and "FB, OM," four or five times, instead of just once. That feature, alone, would go a long way toward justifying the basic idea. . . .

Here's Bud again; he wants to tell you how the antenna problem was licked.

one antenna (with the exception of a separate one for "5") because we didn't have space for more. It had to be immediately switchable without any fussing or tuning or changing of coils because it would defeat the whole program otherwise. Besides, we are constitutionally lazy and prefer convenience to the last mile of DX.

Cutting across lots we arrived at two possibilities for such multi-band operations: first, the simple single wire, end-fed (pages 273-274 of the latest *Handbook*) and second, the single-wire-fed Hertz (page 277, *Handbook*). Both were workable. It must be borne in mind, though, that the end-fed single wire starts radiating right from the transmitter and is therefore best suited to those locations where the antenna is going to be fairly well in the clear beginning immediately outside the shack window. Unfortunately, this happy state did not apply to our eventual location; we were confronted with a location in thick woods

and couldn't get up much enthusiasm over the prospect of our 40 watts arguing with a heavy stand of second-growth pine and spruce on its way out. The nearest clear space was several hundred feet away. The single-wire-fed Hertz (also known as the "Windom" antenna) was clearly indicated.

hmmmm; looks from the diagram like what we want is a wire 134 feet, 6 inches long for the antenna, with the feeder soldered on 18 feet, 9 inches from the center, or 48 feet, 6 inches from one end (the last dope arrived at by halving the antenna length and subtracting 18 feet, 9 inches

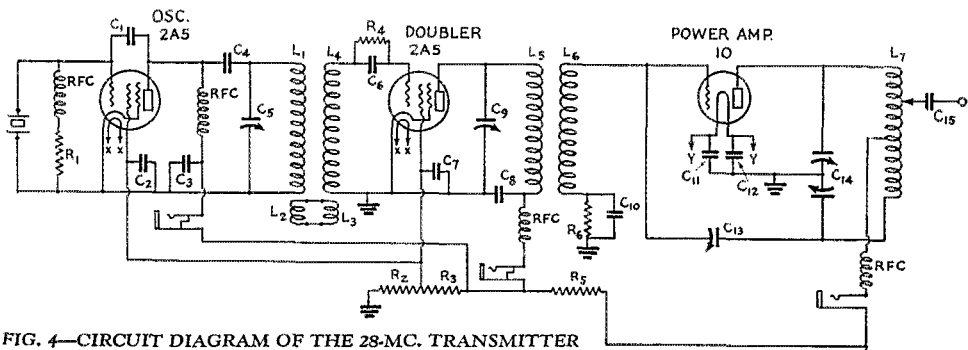
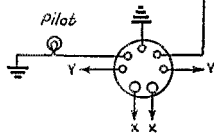

FIG. 4—CIRCUIT DIAGRAM OF THE 23-MC. TRANSMITTER

- L1—9 turns No. 10 enamel 1¼-inch diameter, 2 inches long.
- L2—2 turns No. 14 d.c.c. 1½-inch diameter.
- L3—2 turns No. 20 push-back 1-inch diameter.
- L4—24 turns No. 18 d.s.c. 1-inch diameter, close-wound, self-supporting.
- L5—8 turns No. 14 tinned 7/8-inch diameter, 2¼ inches long.
- L6—9 turns No. 18 d.s.c. ¾-inch diameter, close-wound, self-supporting.
- L7—6 turns No. 14 tinned 1½-inch diameter, 2½ inches long.
- C1—(See text).

- C2, C3, C7, C8, C10, C11, C12—.002 µfd. fixed mica condensers.
- C4—.001-µfd. fixed mica condenser.
- C5, C9—100µfd. variable condensers (National TMS-100).
- C6—100µfd. fixed mica condenser.
- C13—18-µfd. neutralizing condenser (National STN).
- C14—50-µfd. split-stator variable condenser (National TMSA-50).
- C15—.002-µfd. 2500-volt fixed mica condenser.
- R1, R4—50,000-ohm 2-watt fixed resistors.
- R2—20,000-ohm 10-watt fixed resistor.

- R3, R5—10,000-ohm 10-watt fixed resistors.
- R6—1000-ohm 10-watt fixed resistor.
- RFC—2.5-µh r.f. chokes (National R-100).



With such an arrangement an 80-meter half-wave job would also be workable on 40, 20 and 10, would require but one feeder wire (which could be any length at all) and could be switched instantly from one rig to the other if we pre-adjusted the antenna clips on each tank coil and then switched as shown in Fig. 5.

Now, it has always been our feeling that this single-wire-feed system has been much neglected. Plenty of people grant that it *sounds* good—operation on all bands, no feeder tuning, no critical feeder length, etc.—but claim it is tricky to put into operation, needs to be hand-pruned in each individual case and never works out according to the *Handbook* diagrams.

Well, thought we, we'll look into this *Handbook* business. We will be "dumb," simply follow directions from the *Handbook*, and see what happens. So we here describe the whole process, just as we went through with it.

We decided on a 3525-kc. half-wave job on the basis that it is good dope to cut an antenna for the lowest frequency you are likely to use, and also because an antenna at this frequency would seem to have the best chance of lining up properly for harmonic operation all down the line. Now, where's the *Handbook*? . . . page 277 . . .

from the result). Now out to the yard, where we carefully cut the antenna to that length, exactly, and soldered on the feeder at the calculated point, also exactly. When we say "exactly" we mean *exactly*; we measured everything twice, down to the quarter-inch. *Handbook* says the feeder must run off at a right angle from the sky-wire for at least a third of the length of the antenna; we laid out our supports so it would.

After hitching on some insulators we hoisted the whole works into the air, turned our backs on it and walked away. It has never been touched since! In fact, when we thought it might be a good idea to lower it, the other day, and re-measure it because of possible stretch, we found the halyard-pulley combination at the top of the mast was a solid block of ice, so whether it has stretched or not the rig will have to do the best it can until Spring.

Did it work? It did! Right from the start, all bands (as we added transmitters), virtually any frequency in any of the bands. It hasn't shown any signs of temperament and we haven't changed, altered or fussed with it in any way. We led the feeder into the house by the simple process of running it under the window-sill, and soldered it to the antenna switch. The coupling of each

transmitter was altered by moving the antenna clip until the "final" drew the desired plate current, after which we locked up the set and threw away the key. Only a few turns of coupling are needed when operating at the fundamental frequency or the correct harmonic frequency (whatever that may be, by the time end-effects, proximity of trees, etc., are dragged in, we don't know and care less). A bit more coupling is required when operating farther from the fundamental. All that means is you move the antenna clip out toward the end of the tank coil until the plate mills come up to the right figure. But our 3525-kc. antenna hugs 3855 kc. to its bosom and gives it every bit as nice treatment, so far as we can see; when it comes to harmonic operation, it doesn't seem to matter what frequency we select. She takes 'em all in, and hands 'em out without favor.

For the benefit of our purist readers, if any, we may as well admit that if we started in to dissect this antenna, scientifically, we'd probably find lots of things we could "improve" one way or another. We refuse to get excited over the possibility, though. What if we *have* found out that there are some directions, on this or that band, that we can't seem to work into? While we might be able to do something about it by an exhaustive investigation which would show we should re-orient the works, or cut down this tree, or lop off that blade of grass, or shift the garbage can 6 feet, 3 inches to the right, we—personally—prefer simply to forget about working stations in those particular "bad" directions and let it go at that; there are plenty of other stations to be worked. Sometimes, when we are grabbing off some particular DX station from a one-kilowatt outfit, we are smitten by the thought that perhaps the feeder really isn't working according to theory, and instead is full of standing waves. To tell the truth, we've never tested it for standing waves, and probably wouldn't do anything about it even if we found they existed. The look of horror that spreads over the faces of certain of our friends when they find we consistently use the 3525-kc. antenna for 3855-kc. work doesn't detract a mite from the enjoyment that we may be getting at that particular moment from a solid hour of QSO, "single," with somebody 1200 miles away. In other words, we can't seem to get

steamed up over the awful possibility that we aren't doing everything we could, or shouldn't be doing some of the things we are. We wanted a quick-change, all-band, foolproof antenna, and we have it. And in this day of an increasing tendency toward multi-band operation, we suspect there are going to be more and more like this as time goes on! Incidentally, this transmitter was able to get in its "licks" with flood traffic.

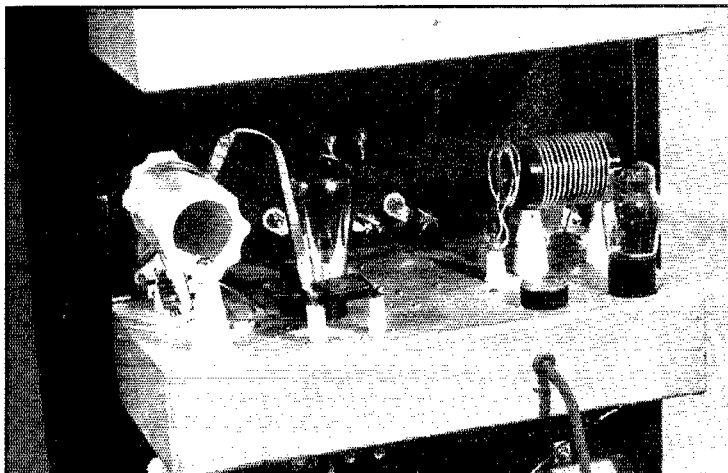

#### THE 40-METER TRANSMITTER TYPIFIES THE REST

*The amplifier plate circuit is at the left, the oscillator at the right. The amplifier grid circuit is under the chassis. In the foreground can be seen the antenna coupling condenser and clip lead.*

#### RESULTS

It has always been our opinion that it is bad business to talk about results. What a given set has done in one location is no indication of what it will do in another. Even under similar conditions, a difference in operating hours, calling habits, etc. will alter the results, sometimes radically.

However, since this layout represents all the investment we're going to be able to afford in radio gear for some time to come it is fair enough to ask ourselves if we are satisfied with the result, or if we wish, instead, that we'd put all our money in a higher-powered rig with coil-changing arrangements.

We don't have to think twice on that score: we're tickled pink with the outfit! All the thrills of operation that we anticipated have been realized, many times over. It was fun to start out with the 80-meter job, and then look forward to adding the others, one by one. The instant band-switching is a pure and unadulterated joy. We do a little work on 80 in the early evening, and then find QRM is getting tough. *Click!* (that's the power switch); *click!* (that's the antenna)—and we're on 40. Not a makeshift affair, either, but a

transmitter whose sole job is handling 40-meter transmissions. We have a sked on 20 in the morning, but it doesn't worry us; we operate on 40 right up to bunk-time and don't get up in the a.m. until just in time to give the tubes a proper warm-up. *Click-click*—and there we are. The sked over, we wonder how "ten" is and give a listen on the receiver. *Hotcha!* Sigs are coming through! In five seconds we're right in the ol' swimming hole with the rest of them.

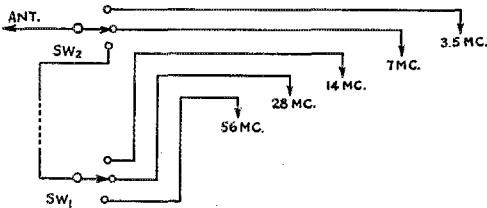

FIG. 5—ANTENNA CHANGE-OVER SYSTEM

With one antenna, or even two, and five transmitters, some change-over system is essential. Use of the single-wire transmission line makes the job easy. Two Ohmite inductance switches mounted on the 3¼-inch panel at the top of the transmitter rack do the trick. At present, one antenna is used on four bands, as shown, 56 mc. not being currently in use. With a separate antenna for 5 and 10 meters, as is eventually contemplated, it will be connected to the rotor of SW<sub>1</sub>, the dotted jumper removed, and the 14-mc. rig connected to SW<sub>2</sub>. The only precaution to be observed is to eliminate all possible bends and make the necessary ones curving, keep the transmission line as straight as possible, and use heavy conductor running several inches away from the chassis bases. Simple, isn't it?

Oh, yes, the results. Well, the 80-meter rig calmly knocked off 26 states in its first six weeks of operation and to date, by actual count (no cheating, either!), has hooked 42.8 per cent of the stations called, as well as dragging replies to 49.01 per cent of its CQ's. The 40-meter rig, with considerably less time on the air, shows 31.7 per cent of the stations called as having been worked, with replies to 40 per cent of the CQ's sent. These percentages don't have to give much in the way of odds to anybody's 250 or 500 or 1000 watts! The 10- and 20-meter rigs are too new to yield percentages accurately indicative of their potentialities, but the first returns point toward thoroughly satisfactory and comparable performance.

The invariable rejoinder to our ill-concealed pride in the results we obtain is "Aw, nuts! It's just that you have a good location!"

We don't deny the probability. But just the same, it is going to be a long, long time before we show any interest in higher power. If ever, in fact! In the meantime, we're having more solid fun than we have ever had from any rig since our first one, and that was away back in 1911.

### Strays

For years scientists have been endeavoring to isolate the "circular mil." Don Holaday, W9DOY, tracked down one of the elusive creatures not

long ago and sent it to Hq. It is round, bright, shiny and has a hole through the center. On both sides appear the numeral "1" and the words, "Consumer's tax check Oklahoma."

January *QST* editorial neglected to say that Harner Selvidge, W9BOE, was assisted by W1JFO and W2BWF in searching for the "Shadow."

#### ERRATA

In the Armistice Day report, February *QST*, the photograph was of W3OK—not W8OK.

The signal recordings in March *QST* were authentic—so much so that W1IYL points out that it was his signal, not W1YL who was being traced.

The 4th district winner in the VK-ZL contest was W4AJX. This was incorrectly given in April *QST*.

W8XWJ is owned and operated by the *Detroit News*, contrary to our report of this high-frequency station in last *QST*.

And, to top it off, W6AM's mast is only 171 feet high!

The photograph of the Clair Foster trophy was taken by Mr. Clyde Sunderland, W6CBF of the Oakland Radio Club.



## DIXIE JONES' OWL JUICE

THERE'S a time of life that everybody gits at if they live long enough when they either git mushy and go around feedin' sugar lumps to strange horses and pattin' hounds on the head, and beamin' at younguns, or else they're mean old scrooges that ain't got no patience with nothing no more and don't care who knows it. In other words, their goat is tied loose and everybody gets it. What makes me mad enough to bust is to send a hamgram to some egg, going slow around the corners and mashing out the letters with great care, and then have him crank up and say: "Sorry, om, QRM on you." Do I cuss? The idea of anybody making more QRM than me is very obnoxious. I am not one to be QRMmed with impunity. The spirit of the Crusaders dwells within me. Conquer or Die, says us. Better to live for a day with a killy input than for years with a mere 210. W4IR has rebuilt, with a nice fat \$300 bottle shoveling it through the hole in the window pane. Let high school youths, the scrooges of the future, fiddle with their puny power when papa sleeps. The Bird of Time has far to fly for them. They can wait.

—W4IR of the "Dixie Squinch Owl"

# 1936 DX Contest Hits New Highs

## DX Station Has Leading Score for First Time in History of Tests

**Y**ES, OM's, the Battle of Brass, the Duel of Dials, the Grand Clash of CQ's, the event of the ham radio year sometimes referred to as the annual A.R.R.L. International Relay Competition is over. We shouldn't be at all surprised if radio services all over the world felt the effects because Old Man Ether was most certainly torn wide open from end to end from the second the gong rang at 0001 GT, March 14th, until the last contacts were squeezed under the line at 2359 GT, March 22nd. Nothing left to do now but sit back and view the wreckage through the smoke and manufacture the alibis. The weather, the family, the ham next door with the gargley Hartley, the location, antenna, power, receiver and what not are now coming in for their share of the blame. "If I coulda, I woulda" will be the best known phrase for the next several weeks.

In looking over accounts of previous DX contests in *QST* we find that we have used up our stock of superlatives and exclamation points.

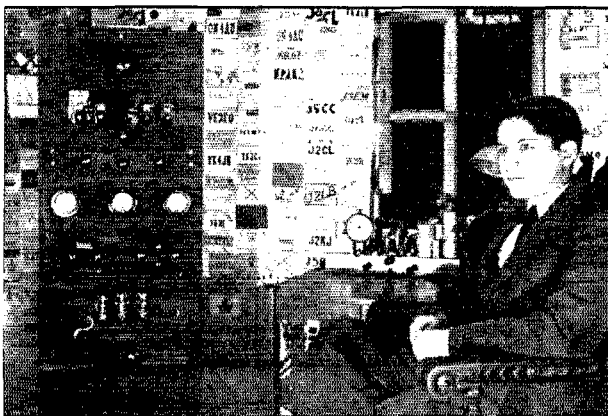
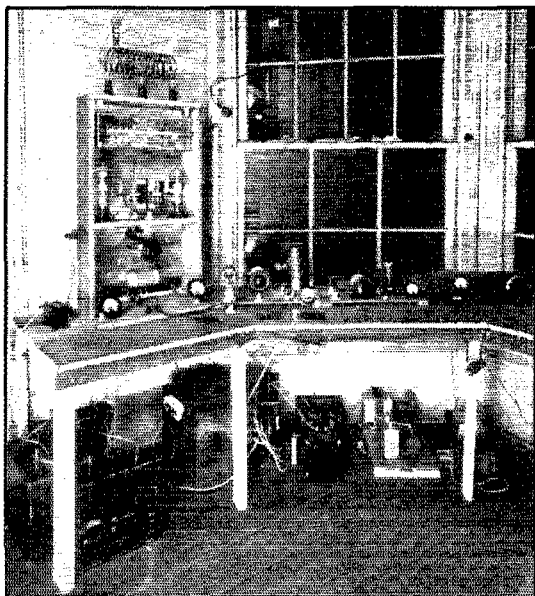

**XE2N WITH 189,000 POINTS**

Most of us wondered during the contest what was behind the 24-hour sock of XE2N, the station of Juan Lobo y Lobo in Monterrey, Mexico. The tube line-up is rather unusual. A 59 Tri-tet oscillator is followed by four 46s in push-pull parallel on all bands except the 28-mc. band where a 2A5 doubler is connected between the oscillator and the push-pull parallel stage which is operated as a straight amplifier at all frequencies with 150 watts input. The receiver is an early model Comet Pro. The antenna is semi-horizontal Hertz with single-wire feeder.

However, early reports already indicate that all previous records will be ground to dust by the time complete returns are available. Even though the contest started on Friday the 13th in most places, almost every report boasts of more contacts, more countries, higher scores and more fun than ever before. (A few, we notice, didn't start until after midnight of the 13th. Hi.) The number of WAC's made and remade if laid end to end would reach from here to VS6 and the 2TBOC, 3BTOC, and 4BTOC stacked up would fall only four miles short of the moon. And, Ws and VEs take notice, it seems to be almost certain that at least one DX station has slipped inside our guard and knocked our highest scores for a goal!

At the moment XE2N, Monterrey, Mexico, has a score well ahead of all others. His log looks like the call book! In making a total of 1370 contacts with W and VE

### **W4DHZ**

W4DHZ, the high scorer of U.S.A. the station of Dave Evans, Atlanta, Georgia. A 59 Tri-tet oscillator is followed by a 10 doubler, 10 buffer, 852 buffer-doubler and push-pull HK354s in the 1 kw. final. On 3.5-mc. the antenna is coupled to the driver and the final omitted. A 268-foot wire is used for transmitting on all bands except the 28-mc. band. A vertical Q is used on this band.



#### WHERE W4DZH KNOCKED 'EM OFF!

Main receiver used was an ACR-175 with an auxiliary tuned r.f. job as a standby. The world globe doesn't show in this photo but take our word that Dave covered it!

stations he has piled up the amazing total of 189,081 points. XE2N averaged over 15 contacts per hour for the entire 90 hours of the contest. He worked 26 stations in 8 of the 14 call areas on 7 mc., 915 stations in 13 call areas on 14 mc. and 176 stations in 12 call areas on 28 mc.!

Unofficial reports place W4DZH of Atlanta, Georgia, at the top of the W-VE list with a total of over 91,000 points. No large scores have been reported from Canada at the time of this writing.

DX conditions in most parts of the world were at a peak during most of the 9 days. It was not unusual to hear several continents coming in simultaneously on two or more bands and doubtless many were transmitting on one band and listening on another in an attempt to keep up with the mad pace. A check of reports filed thus far show that W/VE stations were in contact with at least 90 different foreign countries. Good use was made of five bands. WIBB made two transatlantic contacts on 1.7 mc. Hundreds of 3.5-mc. contacts with Europe and Africa are reported. J2LO worked 3 W6s and a W7 on this band. At certain times of each day 7 mc. and 14 mc. were on about even terms across both oceans. 28 mc. was popular especially over both week-ends although conditions were at their best only over the first week-end. W3BIW worked 25 countries with 50 contacts for a score of 3550 points on 28 mc. only. Contrast this with the lone contacts made on this band last year by ON4AU and XE1AY with W9TJ.

As usual, reports from the fellows with the low and medium scores reflected more actual enjoyment than those with top scores evidently because they weren't worrying so much about their final score but were content to get the fullest enjoyment from the unusual opportunity to work DX. All of the new rules introduced this year for the purpose of increasing the interesting angles of

DX work were heartily endorsed. Those in favor of the three station quota feature outnumbered those commenting against it in the ratio of 5 to 1. The approval of the band multiplier and code number system was practically unanimous.

The combination of signal report with the serial number certainly speeded up contacts. The multiplying factor for multi-band operation had the desired effect of spreading the operation of both local and DX stations over several bands, increasing the interesting angles of the contest and materially reducing QRM. Many were pleasantly surprised at the effectiveness of the 7- and 3.5-mc. bands and plenty of DX was to be found in both bands every night of the contest. The opportunity for multi-band contacts with the same station was also enthusiastically appreciated. The quota system of three stations per band per country for W/VE participants was also popular. Improvements in conditions brought about by the quota system included, reduced QRM especially during the latter part of the contest, helped especially those operating with lower power, those located inland and those operating inside the edges of the bands by reducing QRM and requiring more careful listening for contacts on the part of foreign operators, helped these in the same way by requiring more careful listening on the part of W/VE stations, introduced element of satisfaction in completing a

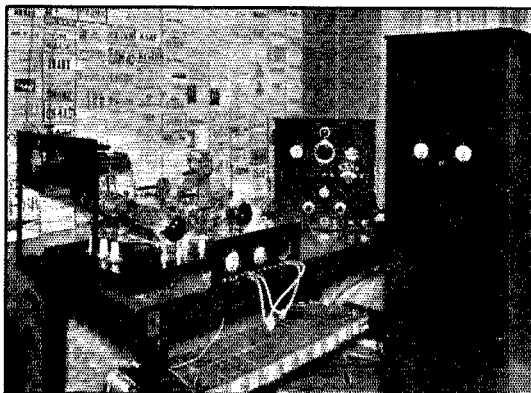

#### W9IJ

W9IJ is the station of LeRoy Moffett of Downers Grove, Chicago, Ill. The transmitter is designed for complete band-switching throughout. The basic exciter unit is similar to that described by Herb Hollister in QST and the Handbook with 6A6 tubes. An 802 follows which drives an 803 which, in turn, drives the final amplifier of three 852s in parallel. While the final may be operated either as an output doubler or straight amplifier at 28 mc., it is usually used as a doubler because of simplified band-switching. The input is 500 watts at 28 mc. and 1 kw. on other bands. Two antennas are used for transmitting. One is a 66-foot center-fed antenna 60 feet high running 30 degrees west of north. The two halves operate in phase at 14 mc. This antenna is used chiefly for Europe, North Africa and Australia. The other is a 133-foot slanting wire 55 feet high at one end and 20 feet high at the other. This one is used for South America and Japan.



**W2BYB—ABOVE AND AT RIGHT**

W2BYB, owned and operated by Dr. George A. Mack, Jr., an old timer of Chappaqua, N. Y. Besides power supplies, the transmitter unit includes a 53 oscillator-doubler, another 53 as doubler-doubler, an RK20 buffer, an 852 driver and push-pull 852 final amplifier. Input 700 watts on all bands from 1.75 to 28 mc. The receiver is an RME 69. An 80 meter Zepp is used on all bands except 28 mc. A vertical half-wave is used for this band. Doc says, "The day after the contest ended, I started rebuilding for the 1937 contest."

quota, and increased competitive angle by introducing necessity for judgment in selection of most productive hours of operation.

Not even revolutions could keep hams from showing up for the contest. W and VE stations were pleasantly surprised to hear the PY's tuning up a day or so before the contest. They had been closed down by the government several months previous because of political troubles. Our old friend PY1AW was missing, however. It was feared for a time that recent troubles in Tokyo might prevent the J's from participating, but they were right there on the job to gladden the pumping hearts of those on the East Coast especially. Italy with strict regulations against ham transmitters had several good representatives. IITKM appears on almost every W/VE report. Latvia, Yugoslavia and Roumania, other countries in which ham radio is not appreciated, were heard on several bands which gave many stations a chance to add these normally rare countries to their DX lists. We hope that these under-cover stations will be permitted to operate openly when the next DX contest rolls around.

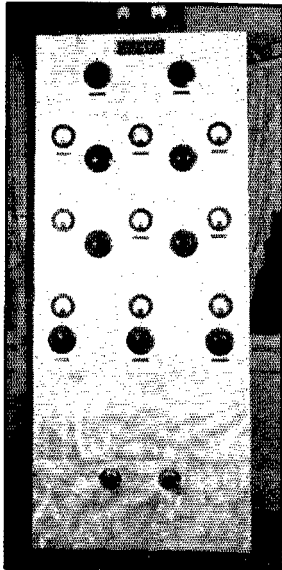

Those remembering last year's contest found a vacant hole near the low frequency edges of the 14- and 7-mc. bands used by the memorable CT2BK in the last contest. He was sorely missed this year. A few were lucky enough to add the Azores via CT2BJ who worked a few one evening although not actively participating in the contest. A few lucky ones also hooked PZ1AA in Surinam, South America, before he discovered there was a contest on and took to cover. Many thrilled at the opportunity offered by a contact with the southern tip of South America, our old friend of many contests CE7AA. FASBG and FT4AF seemed to be the only representatives of their respective countries Algeria and Tunisia. FT4AF apparently confined his operation to the 7-mc. band but FASBG kept the W/VEs chasing after him with fine signals on four bands. EASAF and EASAO, the pair of Canaries from Africa both put wallop signals into all parts of U. S. and Canada on several bands. Probably more

stations report EA4AO more consistently than any other. His signal strength over the eastern half of the country at least seemed to be R9 regardless of the band he chose to use. For the first time in any DX contest operators on both

**WIDZE—BELOW**

Mellen Gulesian of Mattapan, Mass., operating his station WIDZE ran up one of the highest scores in New England. The transmitter is a two-deck breadboard affair with four stages. Single 2A3s are used in the oscillator and two doubler stages which drive the final amplifier of four 10's in push-pull-parallel. A four-hundred-volt unit supplies voltage for all stages except the final amplifier which is provided with eight hundred volts from another. All transformers used in the transmitter are homemade. Input to the final runs about 150 watts. The two tube receiver has only a tuned r-f. stage and regenerative detector with no audio amplification. The antenna is a 14-mc. fundamental semi-vertical fed by a single-wire feeder. Within the last two years, WIDZE has made WAC over sixty times and has worked 105 countries.



Atlantic and Pacific coasts had really good opportunities to work across opposite oceans. Practically all of the active European countries were heard and contacted frequently by stations on the West Coast. The Easterners were kept on edge every morning on the 14-mc. band by the swell signals put over by a half dozen VS6s, eight or ten Js, three or four XUs, a couple KAs and PK's and even one or two MX's. J8CA in Korea was one of the most sought-after Asians. Signals from these countries were good on the East Coast for only an hour or two so that competition in this part of the country was at its peak between 8 and 9 A.M. On the other hand, European signals were reported on the West Coast on both 7 and 14 mc. and signals could be heard on one band or the other over a period of about 15 hours per day. During the evening one or two U9s in Siberia came through to the East Coast and several W/VEs were fortunate enough to land VQ3FAR in Tanganyika and VR2FF in Fiji, the latter on the 7-mc. band. Alaska was well represented this year, K7PQ probably being responsible for many large light bills next month. During the middle of each evening,

the South Americans CX1CG, CX2AK, HJ3AJH, OA4J, a half-dozen or more LUs with nice signals and the raspy K5s held the spotlight for most of the U. S. and Canada. The West Indian stations including FM8D in Martinique (frequently mistakably reported as Algeria), the VPIs in British Honduras, the VP2s in Antigua, VP5s in Jamaica and Central Americans were most active. Only one contact with VP3 in British Guiana and YS, Salvador have been reported thus far. One contact is also noticed for ZEILA on 3.5 mc. by WHIOV. Those contacting FM, VQ8, CP, J8, VP9, VP7, FB, VR2, TF, VP6, VQ3, OX, HP, VP3, CR7, VS3, CN8, ZD8, ZP, FT, FA, LY, OM, OA, ZB, PZ, CT2 or YS may consider themselves lucky because these countries were in all probability represented by but one station.

Sufficient time has not elapsed to allow us to present a comprehensive picture of the foreign side of the contest. However, J2LO is reported to have run up the

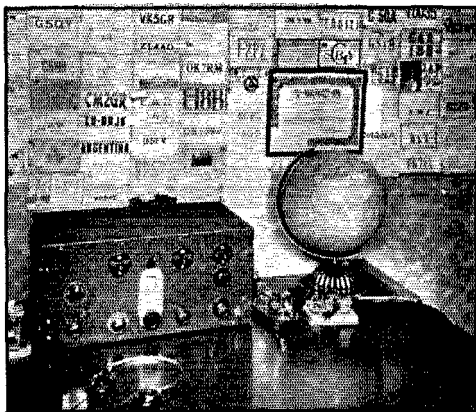

#### RECEIVING POSITION AT W9LJ

Mr. Moffett ex-5ZAV is perhaps best known to QST readers as the author of the article on one of the early homemade crystal filter superheterodyne receivers, which appeared in our May 1934 anniversary number. The same receiver with slight modifications is still in use.

highest score for Japan with a total of about 11,500 points. His contacts include trans-Pacific QSO's on four bands. K7PQ reports via radio 520 contacts on four bands for a total of 50,000 points. F8KJ is reported to be holding the high F score with 30,000 points. The best score received so far from Germany is that of D4BIU of 43,800 points. He made 514 contacts on four bands. K4KD did some nice work on four bands running up a score of 72,000 points. HJ3AJH has a total of 51,156 points after working 569 stations on two bands. He worked all W/VE call areas on both 14 and 28 mc. OA4J made 642 contacts on 3 bands. 228 of these were made on the 28-mc. band. His score hits 66,000 points, which may be high for South America. NY2AB made 524 contacts on three bands for a total of 50,304 points. Other foreign scores received include: XE1AA 32,700; EI4G 246; ON4HM 12,300; U3QE 15,000; K4DDH 40,000; OZ7Z 1700; G2PL 25,500; PAQAZ 25,700; EA4AV 26,000; GI5QX 15,300; LY1J 6215; CM2AD 48,500; CM2AI 16,200; K6EO 11,484.

Although a few W/VE

(Continued on page 98)

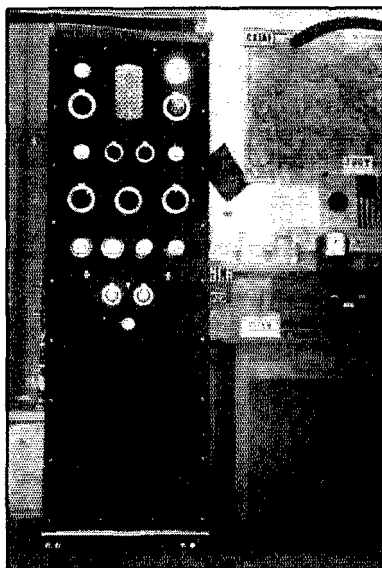

#### W6CXW

The call of Henry and Sam Sasaki at Long Beach, California, W6CXW has been well known throughout the world for many years. The latest transmitter shown in the photograph is a complete unit of the rack-and-panel type. The only external connections necessary are those for the 110-volt input, key and antenna. This main transmitter is used for 14- and 7-mc. work. The tube line-up consists of 47 crystal oscillator, 801 buffer, 50T second buffer, 354 buffer-doubler and a pair of 150Ts in the push-pull final amplifier stage. Crystals are temperature controlled and the input on both bands is 1 kw. A second transmitter consisting of 53 oscillator, 2A3 doubler, RK20 doubler and parallel 852 doubler-final is used for 28-mc. work. Receiver, Hammarlund Comet Pro.



# Dual-Diversity 'Phone Reception With Single-Control Tuning

An Advanced Type Receiver Minimizing Fading Effects and Further Improving Signal-Noise Ratio

By J. L. A. McLaughlin and James J. Lamb\*

*Back in 1931, just five years ago, the two authors of this article began their collaboration in experimenting with diversity reception. The result of this work was the birth of an idea for something which had not been done before—a dual diversity receiver with single-control tuning. In the intervening time, Jim McLaughlin has taken an extended trip around the world, by way of the South Sea Islands, while Jim Lamb has been engaged by such matters as S.S. receiver, Tri-tet oscillator, noise-silencer developments and the like. It was not until the spring of 1935 that the two Jims again got together and compared notes on what they had mullied over in the way of diversity receiver improvements in the interim. Coincidentally with this meeting, Dr. James M. B. Hard, well known operator of Mexican amateur station X1G, volunteered to sponsor construction of the receiver embodying the design ideas of the two collaborators—as the result of which the advanced "Dual-Diversity" model illustrated in this article has been built by Jim McLaughlin and delivered to Dr. Hard this spring. While this particular receiver, considered the most advanced type yet built for private use, is almost spectacularly elaborate and beyond the means of most all of us, it embodies principles which are fully adaptable to relatively simple, less expensive designs and which undoubtedly will find their way into our everyday receiving technique in the near future, as shown in this article.—EDITOR.*

**I**NTERFERENCE from undesired radio signals, interference from atmospheric and other kinds of noise, and fading—QRM, QRN and QSB—are the unholy trio which receiver design has had to battle ever since there first was such a thing as radio reception. Attacks have been aimed at each singly, and at two or all three in combination. Within the receiver proper, our principal weapon against signal interference has been increased circuit selectivity—which has also worked to aid in overcoming noise. A further weapon against noise has been found in limiting and silencing circuits, which also are helpful in overcoming fading. So far as the receiver itself is concerned, however, automatic gain or volume control systems have been the principal means of reducing the effects of fading in 'phone reception, which is

more disastrously damaged by fading than is c.w.

\* Technical Editor.



THE ADVANCED DUAL-DIVERSITY RECEIVER WITH SINGLE-CONTROL TUNING BUILT BY J. L. A. MCLAUGHLIN FOR DR. JAMES M. B. HARD X1G, BASED ON THE DESIGN DESCRIBED IN THIS ARTICLE

Beside the rack carrying the main receiver unit and power supplies are the speaker cabinet and separate audio amplifier.

telegraphy. But in many respects, conventional a.v.c. systems prove to be disappointing because with the kind of fading experienced on high frequencies, the effective noise is aggravated, becoming worse than it might be without a.v.c. After all, the typical a.v.c. system only operates to keep the r.f. input to the receiver's detector from becoming excessive. This it does by automatically reducing the gain of the r.f. and i.f. amplifier stages as the signal input level rises. When the signal fades down, however, the operation goes into reverse, and the amplification of the receiver increases as the signal becomes weaker. This would be perfectly satisfactory if fading signals did not have the persistent habit of diving down into the noise level, with the consequence that the receiver periodically finds itself with mostly noise to amplify, and this at the very times when the gain is highest. To make the situation still worse, the kind of

fading most likely with high-frequency 'phone signals is not simply a uniform drop in amplitude of all the sideband and carrier components simul-

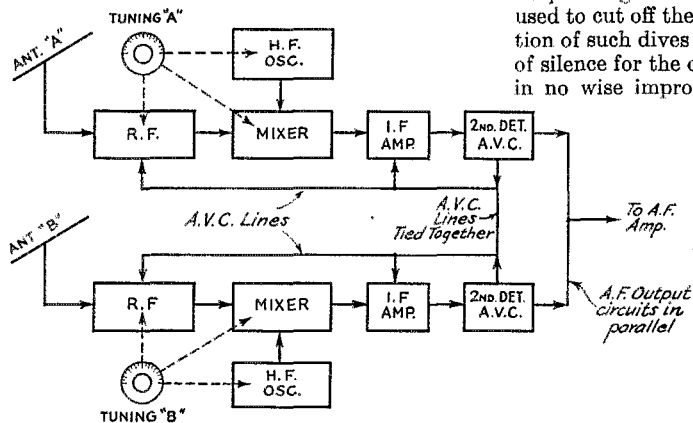

FIG. 1—BLOCK DIAGRAM OF THE EXPERIMENTAL DIVERSITY RECEIVER WHICH WAS USED IN 1931

taneously. More usually the fading is of a selective nature. The carrier upon which the a.v.c. system depends for its action apparently disappears and leaves the highly amplified sidebands

to beat with each other in detection, accounting for the raucous "catarrhal" sound effects which accompany the bursts of noise in the intervals of deep fading. While a "squelch" system might be used to cut off the receiver's output for the duration of such dives of the signal, substituting gaps of silence for the disagreeable sounds, this would in no wise improve the intelligibility. What is needed is a method of maintaining useful intelligible output for as much of the time as possible; some system that not only minimizes the disagreeable effects but also fills in their place with what we want to hear.

The lead to a method of solution lies in the happy fact that a signal does not fade identically in the two antenna locations at the same instant, even when the two antennas are spaced only a relatively small distance apart, or when they are near to each other and in different planes of polarization. In other words, there is considerable diversification in the fading of a radio signal, not only as regards space but also as regards polarization. Diversity reception is the method which takes advantage of this vulnerable spot in fading's armor.

#### DIVERSITY PRINCIPLES

The principles of diversity reception have been known for at least ten years and have been applied practically in commercial 'phone and c.w. services for the past six years or so. The basic principles were outlined by C. W. Rice in August, 1927, *QST*,<sup>1</sup> and commercial space-diversity receiving systems were described by RCA Communications engineers in April 1931 *Proceedings of the I.R.E.*<sup>2</sup> The basic idea is to pick up the signal waves on two or more different antenna systems and then combine the signals in a common receiver circuit. While it might seem possible to accomplish the result by coupling the several antennas to a single receiver in such fashion that the signal amplitudes are added at r.f., this simple method is impracticable. An input coupling arrangement for several antennas might be phased to give addition of the r.f. amplitudes under constant signal phase conditions; but constant r.f. phase conditions just do not exist. If they did, there would be no justification for diversity reception because there would be no appreciable diversification in the behavior of the waves at the different antennas. Variation in phase condi-

<sup>1</sup> C. W. Rice, "Short-Wave Radio Transmission And Its Practical Uses," Part II, *QST*, August, 1927.

<sup>2</sup> H. H. Beverage and H. O. Peterson, "Diversity Receiving System For Radiotelegraphy"; H. O. Peterson, H. H. Beverage and J. B. Moore, "Diversity Telephone Receiving System," both in *Proc. I.R.E.*, April, 1931.

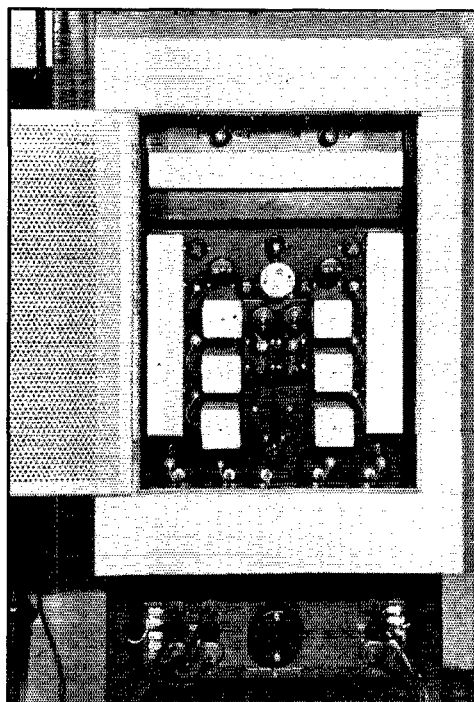

REAR VIEW OF THE RECEIVER ASSEMBLY, SHOWING THE COMPACT VERTICAL CONSTRUCTION

tions is inevitable in the phenomenon of fading. The combining operation must take place in some part of the receiver circuit where unpredictable radio-frequency phase differences are no longer of consequence. The wrong phase conditions exist just as much in the intermediate-frequency section of a superhet as they do in the earlier circuits, being unchanged in the heterodyning process in

sor grids of the respective amplifiers. Phase differences would then be inconsequential, just as if the c.w. signal had been modulated at the transmitter, and the detector outputs could be combined at audio frequency. As was mentioned earlier, fading is not so damaging to intelligibility in aural c.w. telegraph reception, as compared to its effects on 'phone, so that diversity reception may

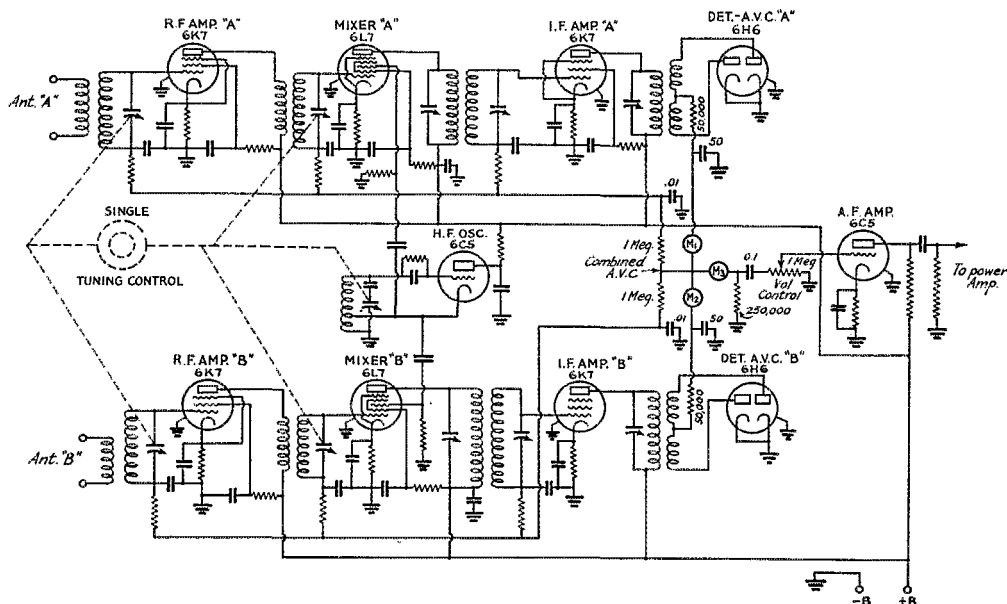

FIG. 2—SCHEMATIC DIAGRAM OF A SIMPLIFIED DUAL-DIVERSITY RECEIVER WITH SINGLE-CONTROL TUNING

The single oscillator feeding both mixer stages takes care of automatic synchronization. Circuit values other than those noted correspond with those given for equivalent components in Fig. 3.

the first detector. It is only in the output of the final detector, where we have the rectified envelope of the signal to work with, that the combining operation becomes practicable.

This applies only to modulated signal reception, however, and not to heterodyne c.w. reception. The audio-frequency beat-note outputs of two separate final detectors will vary with each other in phase just as the i.f. outputs of the first detectors vary. For diversity reception of c.w. signals, therefore, some other method than simple combining of the audio-frequency beat-note outputs of the second detectors must be used. The method in commercial practice is to combine the d.c. components in the detector output circuits and use the resultant d.c. voltage to operate a tone-keying circuit. An alternative method which we have considered is to modulate the received c.w. wave in a corresponding i.f. or r.f. stage of each receiver with an audio-frequency signal. One modulation source would be used for the several receivers. This might be a small "hummer" or vacuum-tube oscillator modulating the suppres-

not be so advantageous for amateur code communication as it unquestionably is for 'phone.

The second important feature in the diversity receiving system is the automatic gain control. This must operate so that, in effect, the receiver having the greater signal input will be principally responsible for the gain of the whole set. Otherwise, the bursts of noise and distortion which occur in deep fades with a single receiver will still be present in the combined output of the diversity set. With a two-receiver (dual-diversity) combination, the practical method of accomplishing this unified gain control consists in connecting the d.c. load circuits of the separate a.v.c. rectifiers or detectors in parallel; or, in other words, in providing a common load resistor for the separate detectors which furnish the a.v.c. voltage to all the gain-controlled stages in the set. The gain of the separate receiver channels is then maintained equal at all times, gain-control voltage being the sum of the d.c. voltages contributed by the respective detectors. The receiver channel having the greater signal input

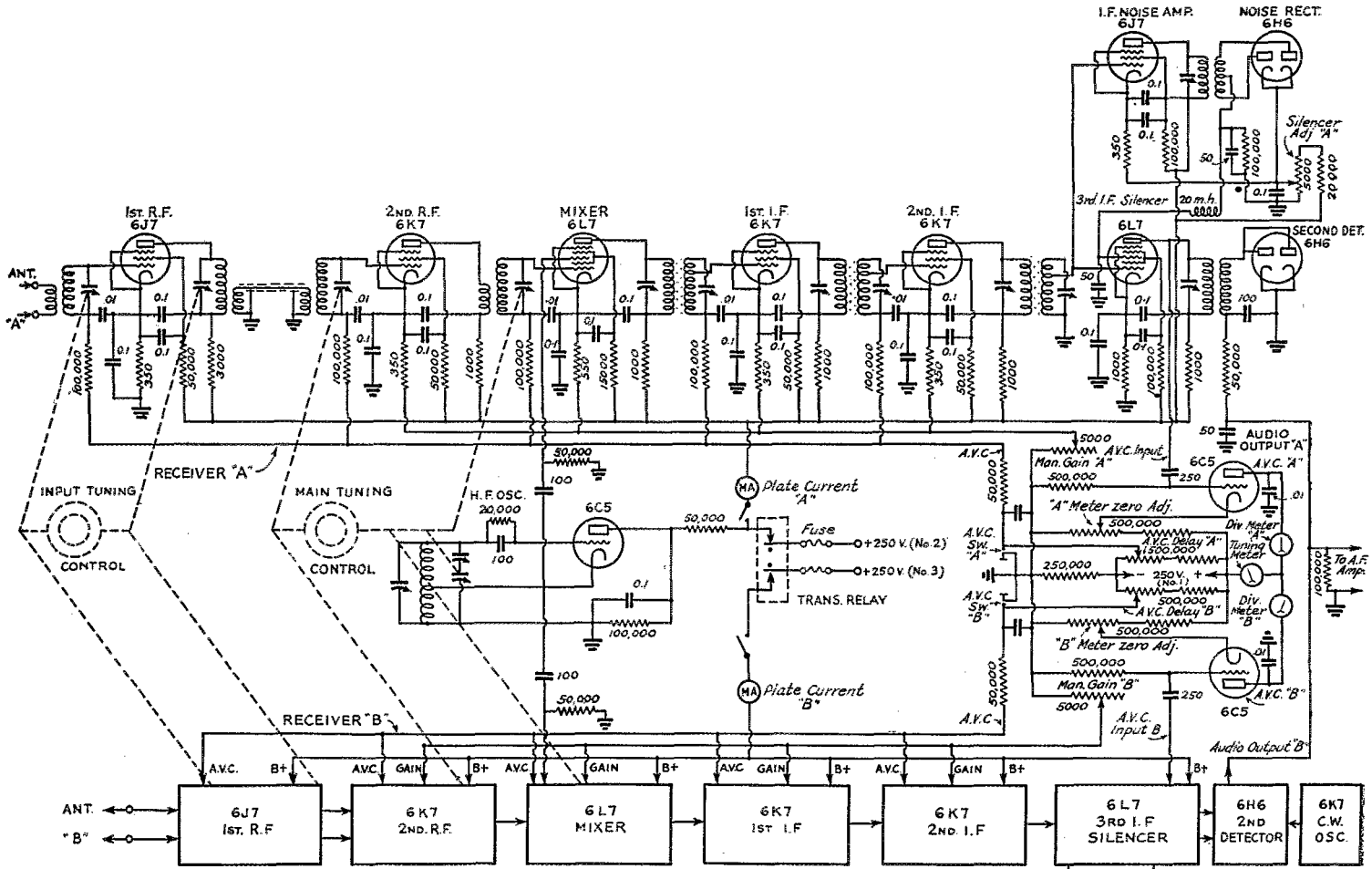

FIG. 3—DIAGRAM OF THE DUAL-DIVERSITY RECEIVER ILLUSTRATED IN THE PHOTOGRAPHS  
 The circuit of the stages shown in block form is the same as the schematic shown for receiver "A". Decimal capacitance values are  $\mu\text{fd.}$ , whole number values are  $\mu\mu\text{fd.}$  Resistance values are ohms.

automatically sets the gain for the whole receiver, and prevents the undesirable bursts of noise and distortion which might otherwise be contributed by the "idle" receiver.

The block diagram of Fig. 1 indicates the arrangement of a dual-diversity superhet combination incorporating combined second-detector audio output and common a.v.c., each receiver being separately tuned. In our 1931 experiments, a set-up of this type was employed, following the commercial design described in the second I.R.E. paper previously cited. Two short-wave converters were used with two identical tuned radio-frequency broadcast receiver chassis as i.f. amplifiers and second detectors, the latter being of the plate detection type arranged to furnish a.v.c. as described in Nov. 1933 *QST*.<sup>3</sup> This experimental arrangement clearly demonstrated the large improvement in high-frequency 'phone reception which the diversity method would give, but was not considered practicable for general use. With the two i.f. amplifiers of identically the same frequency, it was necessary also to tune the two oscillators to identically the same frequency, or to tune one of them i.f. above the signal frequency and the other i.f. below the signal frequency. Attempting to put both on the same frequency was unsatisfactory because there was interaction between the two circuits which would require extraordinary shielding for its elimination, while maintaining even approximate synchronization of the two oscillators was altogether too difficult. Tuning one above and one below the first-detector frequency strained the tuning range. The expedient method of using slightly different intermediate frequencies, with each oscillator tuned i.f. above the signal frequency, was found more feasible.

But this still left the tuning complicated and too time-consuming for practical amateur operation. (Just tune in a signal on the crowded 4-mc. band some busy evening on one receiver, and then try to tune a second receiver to the same signal—and find out how much time it takes. And as for simultaneously tuning both across the band looking for the answer to a CQ——!)

#### SINGLE-CONTROL TUNING

The logical answer to this problem was, it became apparent, automatic synchronization of the oscillator voltage fed to the separate first detectors; that is, one oscillator for both receivers. Several oscillator circuits were designed for this purpose, necessarily including buffer features to prevent undesirable coupling between the two first detectors, but they were too complicated for their time.

With later advances in superhet technique and with more adaptable types of tubes developed, this idea has now become practicable and has

<sup>3</sup> J. J. Lamb, "Automatic Gain Control For The Superhet," *QST*, Nov., 1933.

permitted the realization of a dual-diversity receiver with tuning just as simple in operation as that of a conventional receiver. The circuit is even simpler than for two separate superhet sections of comparable line-up, since only one oscillator circuit is required for the whole set, as shown by the schematic diagram of Fig. 2, which illustrates the essential elements of a simplified single-con-

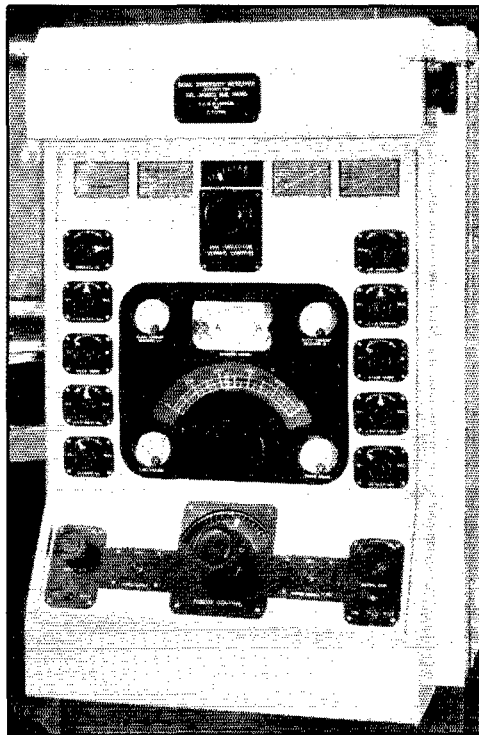

FRONT VIEW OF THE MAIN RECEIVER SECTION

trol dual-diversity circuit. It is at once evident that a receiver of this type need not be unduly complicated. The circuit values other than those noted on this diagram would be according to standard practice, and might be taken as for corresponding circuit elements in the diagram of the X1G receiver which is given in Fig. 3. Full single-control tuning would not be necessary, of course. The oscillator might be ganged with the r.f. and detector tuning of one receiver, and the r.f. and detector tuning of the other receiver ganged with a second control. This would not involve synchronization problems as with two separate oscillators. Good shielding should be used between the two receiver sections, or inter-coupling between the respective circuits will handicap diversity action.

#### THE ADVANCED X1G DUAL-DIVERSITY SET

The special dual-diversity receiver shown in

(Continued on page 102)

# The Pre-Selector Antenna

A New Use for the Resonance Wave Coil in Amateur Reception

By Isaiah Creaser,\* WIBSJ

**B**ACK in the year 1902 the writer put up his first antenna for the sole purpose of receiving signals from the high-power Marconi station in England. Said antenna was 600 feet long, had 12 inches of Electro-se insulators at each end, the wire being seven-strand phosphor bronze which cost as much as a modern receiver of the present day. In contrast to that day, it is amazing now in 1936 to listen to the world of amateurs chewing the rag with nothing more for a receiving antenna than the gadget which is the subject of this article sitting along side the receiver and standing up only a few feet from the operating table.

The basic principles of antenna operation have not changed since 1902, and were the same then as in 1887, the day of Hertz. Voltage is induced in

a conductor either by moving said conductor through a stationary electric field, or by a stationary conductor intercepting a moving electric field. The latter is what applies in the case of the receiving antenna. Ordinarily we try to get the antenna high and in the clear, to intercept the moving field of the transmitted radio signal under the most favorable conditions possible. If we could do so, we should also like to adjust the antenna particularly for the frequency of

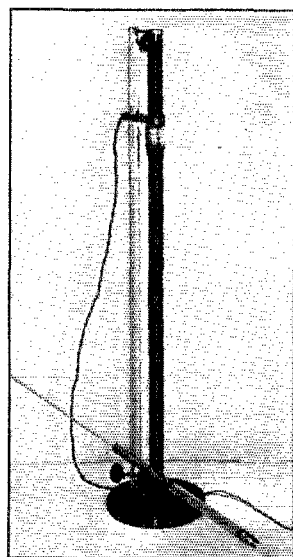

THE PRE-SELECTOR ANTENNA WITH THE ALUMINUM ROD EXTENSION REMOVED FROM WITHIN THE WAVE COIL

each radio signal we attempt to receive, because we are well aware that the voltage developed on the antenna will be greatest when the antenna is resonant and the maximum receiver input will be obtained when the antenna is tapped at a point where most efficient transfer of energy to the

\*76 Cortland St., Springfield, Mass.

receiver is obtained by impedance matching. When we think of the almost infinitesimal voltages which are induced in our receiving antennas by the passing radio waves, we may well wonder that even more signals are not lost in the QRM.

The modern receiver is the outgrowth of much development, and many present types will pick up some signals with a few inches of wire for an

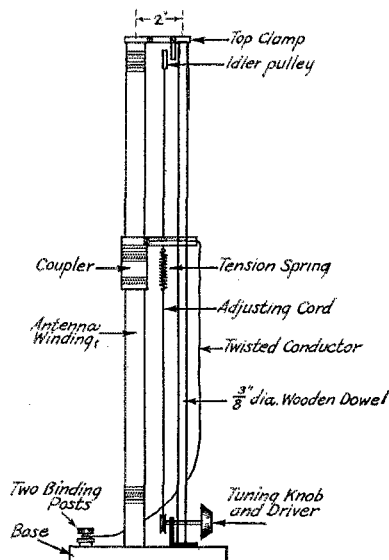

FIG. 1—SKETCH SHOWING THE COMPLETE ASSEMBLY

The over-all height is 34 inches, the main winding form being 33 inches long.

antenna. But the attempt is seldom made to tune that few inches of wire, or to tune the full-size outdoor antenna for that matter. The so-called all-wave doublet antenna systems are designed to be approximately resonant at several frequency bands, and some include tuning circuits at the receiver end of the transmission system, but none provide close tuning of the antenna itself along with adjustment of the coupling point for different frequencies. Even the usual method of tuning at the input to the receiver, pre-selection with a condenser-coil combination, introduces considerable complication where a wide range of frequency bands is to be covered, separate coils for each band being necessary with switching or plug-in operations for more or less rapid shifting.

WAVE-COIL PRÉ-SELECTION

While a tuned circuit having lumped capacitance and inductance will resonate at only one frequency, one having distributed capacitance and inductance will resonate not only at its fundamental frequency, but also at higher frequencies which are approximately the harmonics of this fundamental. This occurs in the case of an antenna, which is a circuit with the conductor strung out in a straight line, and also in the case of the resonance wave coil, which is a circuit with the conductor wound so that the diameter of the coil is small in proportion to its length. Such a circuit has standing wave properties, like an antenna. With both ends "free" (no ground connection) the two ends are the points of maximum voltage when the coil is excited at about its natural or fundamental frequency, this frequency being approximately that corresponding to the wavelength the wire would have if strung out as a half-wave antenna. With harmonic excitation, more voltage antinodes appear in addition to those at the ends. Now if we couple our receiver to the wave coil at one of these points of maximum voltage, as by sliding a small pick-up coil to the proper position, there is a sharply defined response peak to the signal of this particular frequency; or, in other words, the resonance wave

coil provides effective pre-selection whether it is excited at frequencies near its fundamental or at harmonic frequencies.

Because of its resonance properties and the impedance-matching adjustment which is provided, the wave coil arrangement is an effective antenna system on its own, without the aid of a wire extension. In an unshielded location, like a building of non-metallic construction, it may be superior to the usual non-resonant piece of wire ordinarily used for a receiving antenna. The gain from the resonance effect of the wave coil can more than make up for its smaller dimensions in picking up signals. This feature makes it handy for

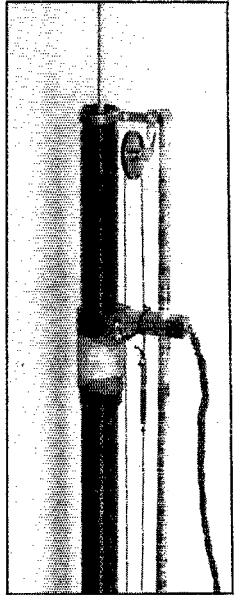

CLOSEUP VIEW SHOWING THE COUPLING COIL AND ITS DRIVING MECHANISM

portable use and for temporary set-ups, as well as for regular operation in many locations. When used with loose coupling to an antenna extension, the wave coil is an effective all-band pre-selector.

THE ANTENNA ASSEMBLY

Now for the construction of the condensed skywire and pre-selector. The photographs and detail drawings are almost self-explanatory, so that little additional dope is necessary. The form for the wave-coil winding may be either a 33-inch long and 1-inch diameter length of well-seasoned wood dowel or piece of bakelite tubing. If wood is used, the surface should be first finished with fine sandpaper and the piece then heated to drive out possible moisture. When thoroughly heated, the dowel should be given a coat of good-grade quick-drying "dope" such as clear Duco. Of course if bakelite tubing is used, this operation will not be necessary.

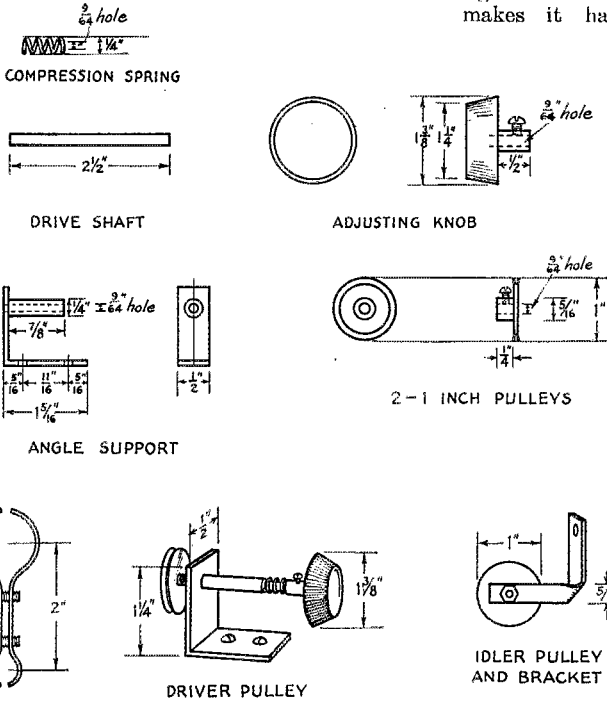

FIG. 2—DETAILS OF THE HARDWARE COMPONENTS

Next comes winding on the No. 20 enameled wire, of which about a pound will be needed. A temporary winding rigging is a big help, because there are about 870 turns close-wound on the 30-inch winding length. Fasten both ends, as there are no terminal connections to this coil. When finished, the coil can be given a coat of

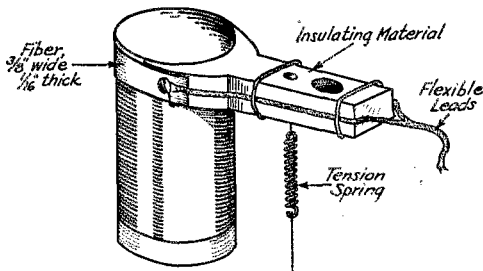

FIG. 3—SHOWING HOW THE COUPLING COIL SUPPORT IS MADE UP

low-loss dope. But be sure it is of the kind which will not dissolve or otherwise affect the enamel insulation of the wire.

The secondary or coupling coil which slides over the main coil is wound on a piece of tubing having an *inside* diameter of  $1\frac{1}{2}$  inches, outside diameter  $1\frac{1}{4}$  inches ( $\frac{1}{16}$ -inch wall). This piece is  $2\frac{3}{4}$  inches long and the winding of 50 turns of No. 22 d.c.c. wire occupies approximately  $1\frac{5}{8}$  inches of length. The winding is started about  $\frac{1}{2}$  inch from one end of the tube and the ends are secured by interwinding strips of cotton tape looped over to hold the end turns. This is important, because the clearance is too small to allow the conventional method of poking the end turns through holes in the form.

The slider support or guide is a  $\frac{3}{8}$ -inch diameter wooden dowel, sandpapered, given a coat of lacquer and finally rubbed down with wax to give a smooth sliding surface. The details of the coil support are shown in Fig. 3. The base is a piece of well-seasoned hardwood 7 inches in diameter and 1-inch thick. Details of this, as well as of the string-drive mechanism, are shown in the figures. The two pulleys are from a Meccano or Erector set, secured by proper persuasion of the kid brother, and are just right for the fish-line cord which is used.

The coupling coil of the pre-selector antenna is intended for connection to a receiver equipped with a doublet input circuit. If the receiver has only an antenna and a ground post, connect a doublet antenna coupling transformer at the receiver input, or disconnect the grounded side of the antenna coil within the receiver and bring out another connecting lead. Most ham type receivers nowadays are arranged for the doublet connection, but many all-wave type b.c. sets are not. If the pre-selector unit is used with an ex-

ternal antenna, this may be loosely coupled by looping the antenna lead-in wire around the top end of the wave coil, or the antenna may be connected to an extension rod arranged to slide inside the wave coil. Such an extension rod is shown in one of the photographs. It consists of a piece of aluminum rod approximately the same length as the wave coil (33 inches) and has a spring brass fitting at the lower end which fits rather snugly inside the bakelite form on which the wave coil is wound. This fitting gives capacitive input coupling to the winding, and its adjustment along the inside of the coil allows a sort of impedance matching of the antenna extension to the coil, which is a further helpful improvement. The rod may be used without an external antenna connected, of course, to increase pick-up over that obtained with the coil.

The tuning procedure of the unit is the same whether or not an antenna extension is used. A "best" region of adjustment of the coupling coil along the wave coil will be found for each band. On the higher frequencies (14 mc., for instance), several points will be found at which the same signals will peak strongly. The optimum adjustment shows up most readily on a receiver equipped with a tuning indicator. The sharpness with which signals peak is quite surprising, even over a range of a few kilocycles, so that effective additional selectivity for separating signals within a band is provided as well as pre-selection for suppressing images. Even with selective superhet receivers, a small final adjustment of the coupling coil knob frequently assists in separating signals on nearly adjacent frequencies.

No directional effects have been noticed with the unit used as a complete antenna. Although better results are generally obtainable with some height above ground, sixth-district ham signals have been logged in Springfield, Mass., with the rig set up in a basement amateur station. The system also has been used as a transmitting antenna, but the results obtained so far are not sufficiently complete to show how it can be best utilized. It appears to have possibilities in this application, however.

In thirty-four years in the ham game, the writer has witnessed the march of progress from "wireless" to "radio," and believes that the quest for novelty has frequently blinded experimenters to the modern possibilities of many old but basically sound ideas. In the present case no claim is made to having discovered the last word in a new type of antenna system, but it is considered that practical modern use has been found for an almost forgotten principle.

## Strays

D4ARR is looking for a 3.5-mc. contact with South America to give him WAC on four bands—28, 14, 7 and 3.5 mc.



# A Simple 14- and 28-Mc. Rig That Has Worked Over 30 Countries

By E. E. Kohler,\* W7BQX

IT IS seldom a fellow will read an article on the construction of a piece of radio equipment and copy it detail for detail. Where some of us want to work on one or two bands, others will want to work them all. The same goes for power output, 'phone and c.w., and so on. With these thoughts foremost in mind the writer believes the transmitter at W7BQX will be of interest to the amateur fraternity. There is nothing radical or extraordinary in its design or operation, its main features being compactness and thorough shielding.

Though the writer believes 50 watts or so of antenna power is enough for all practical purposes on 14 mc. and higher frequencies, this rig can readily be made to put out 100 watts or more by adding another amplifier tube. Or if a fellow likes 'phone, a modulator can easily be built into this set without any crowding whatsoever. The frequency coverage is limited only by the number of crystals and coils available.

This same Tri-tet oscillator and pentode amplifier tube lineup was first tried last August. It was built up bread-board fashion and mounted in a wooden frame with  $\frac{1}{4}$ -inch Prestwood panel and sides. While this layout worked very satisfactorily on 14 mc. and lower frequencies, when it was decided to get in on some of the fun down on "ten" it was practically impossible to get the amplifier to operate without going into oscillation on the slightest provocation. After much thumbing through past issues of *QST* and looking at the pile of junk hidden behind the panel, it was concluded that the only way out was a new mechanical design. The result is the rig herein described.

A glance at the circuit diagram in Fig. 1 will show it to be conventional in every respect. The 59 oscillator is used as a Tri-tet on 28 mc. and as a straight pentode on 14 mc. and the lower frequencies. The amplifier uses shunt plate feed because a small single-spaced receiving condenser was the only one on hand when the rig was built. Link coupling is used between stages, and the amplifier grid coil is self-resonant for the reason outlined by George Grammer on page 11 of the January issue of *QST*. This method is nearly as simple to adjust on these higher frequencies as when tuned with a condenser, as slight adjustment of the turns spacing has quite an effect on the resonant frequency. Keying is done in the negative lead to the crystal stage and works out very nicely, even with 20-meter crystals.

\* 120 East 7th St., Port Angeles, Washington.

The whole rig is built on a standard cadmium plated steel chassis measuring 10 by 17 by 3 inches, with room enough left over for a modulator for the suppressor grid or for another RK-20, as mentioned previously. A National type HRO cabinet is used as an overall shield and dust cover,

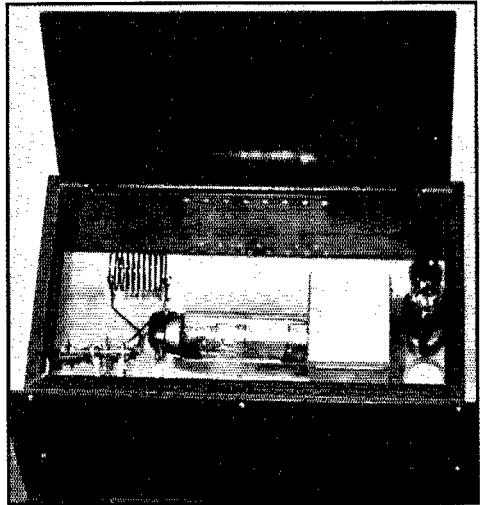

TRANSMITTER BUILT IN RECEIVER CABINET

and to give the job a finished touch. The panel is the standard crackle finished aluminum, measuring  $7\frac{3}{4}$  by 19 by  $\frac{1}{8}$  inches and is slotted for the rack mounting.

## THE OSCILLATOR

The exciter occupies three inches on the right side of the chassis. From back to front on top are: the crystal, cathode condenser knob, 59 tube, plate condenser knob, and the plate coil. Holes are drilled in front of the plate coil for another Type UM condenser to tune the amplifier grid. However, for these high frequencies it is not necessary.

The cathode coil is mounted under the chassis, the ends being soldered directly to the tuning condenser terminals. A fixed mica condenser is shunted across this coil, together with the Type UM variable unit, to lower the  $L/C$  ratio of the circuit. A lower value of  $C$  caused considerable frequency drift and the keying wasn't as clean as desired. With the specified values, drift is barely

perceptible with the key closed indefinitely, and the crystal responds to the bug perfectly. The cathode circuit is tuned about half-way between 14 and 28 mc. when output is on "ten." One of the rotor plates of  $C_1$  is bent to short out the coil

necessary to raise the lid of the cabinet to make tuning adjustments.

If a tube such as the 802 or RK-23 is available, it would be well to use it in place of the 59, especially if two RK-20s are used in the amplifier on 28 mc. On 14 mc. this exciter will put over 25 mils on the amplifier grid with the amplifier plate load disconnected. On 28 mc. about 9 mils is the limit, but this is plenty to drive the RK-20.

#### THE AMPLIFIER

The aluminum can to the left of the 59 is used as a mounting for the RK-20. In this can are also the by-pass condensers for the filaments, screen, and suppressor, and also the screen r.f. choke. A small can built up as described by Gow (August 1935 *QST*, page 18) is used to further shield the base of the RK-20 and also as a mounting for the socket. If it is desired to include another RK-20, the shield can should be made the same depth as the chassis and the grid coil mounted between the tubes.

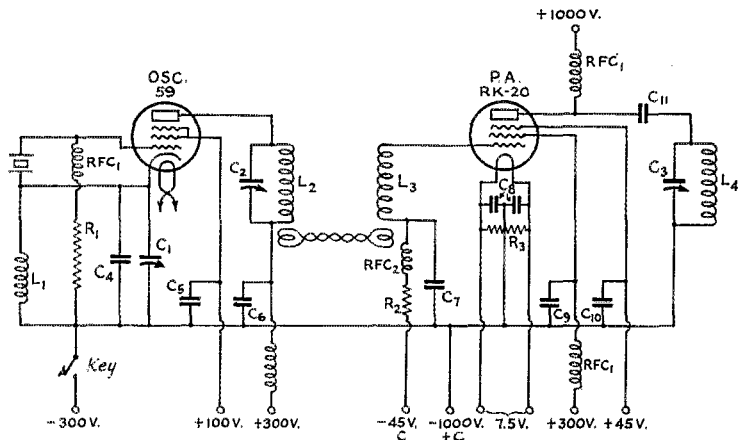

FIG. 1—CIRCUIT OF THE 14-28 TRANSMITTER

- $L_1$ —5 turns No. 14 spaced 1/16-inch for operation on 28 mc. with a 20-meter crystal (10 turns for 7-mc. crystal).
- $L_2$ —13 turns No. 18 spaced to occupy winding length of 1 7/8 inches for operation on 14 mc. (wound on Hammarlund type SWF form).
- 5 turns No. 18 spaced to occupy winding length of 1 inch for 28-mc. (Some adjustment necessary.)
- $L_3$ —14 turns spaced to occupy 1 1/4 inches on Hammarlund SWF form for 14 mc.
- 9 turns No. 18 spaced to occupy 1 inch for 28 mc. (Adjustment necessary on these coils.)
- $L_4$ —9 turns No. 12 spaced to winding length of 1 3/4 inches for 14 mc.

- 6 turns No. 12 spaced to winding length of 1 1/4 inches for 28 mc. Inside diameter of both coils air wound is 1 3/4 inches.
- $C_1$ —100- $\mu$ fd. (National Type UM).
- $C_2$ —14- $\mu$ fd. (National Type UM).
- $C_3$ —20- $\mu$ fd. (Hammarlund Type MC 120-S).
- $C_4$ —100- $\mu$ fd. fixed mica (Sangamo).
- $C_5, C_6, C_7, C_8, C_9, C_{10}$ —0.002- $\mu$ fd. (Sangamo).
- $C_{11}$ —0.002- $\mu$ fd. 5000-volt (Sangamo).
- $R_1$ —50,000-ohm 2-watt.
- $R_2$ —15,000-ohm 2-watt.
- $R_3$ —75-ohm center-tapped.
- $RFC_1$ —Receiving type r.f. choke (National Type 100).
- $RFC_2$ —Transmitting type r.f. choke (Hammarlund Type CH-X).

when set at maximum capacity, for operation on 14 mc.

The oscillator has its own common ground point, insulated from the chassis. It is located between the screen and plate by-pass condensers and is connected to the common ground return of the amplifier by an insulated lead. All leads are as short and direct as possible, to help reduce stray r.f. which seems to want to follow every path but the right one in the vicinity of 28 mc.

The tuning condensers used in the exciter are accessible from the top of the set, but the plate coils are wound so that no adjustments are necessary when changing bands. In this case they don't have to be in a more convenient location, although if this rig were used to drive a high-power amplifier it would be best to mount them on the side of the chassis. Then it would be un-

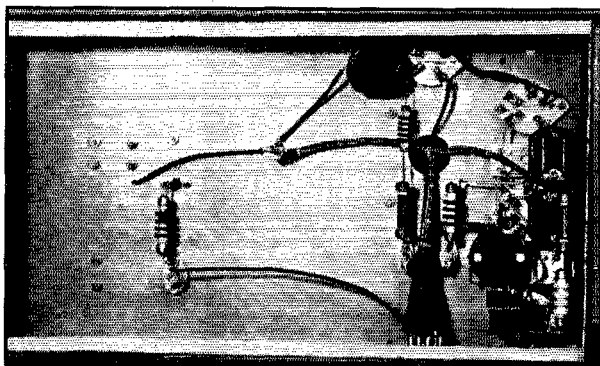

WIRING UNDERNEATH THE SUB-BASE

The amplifier grid coil is just in front of the shield can and is located so that its leads are exactly like the plate coil leads. The grid coils

(Continued on page 86)

# A Three-Feeder Double-Antenna System

By John A. Pool,\* W3ZZ

THE knowledge of propagation of electrical impulses into space, thence to the human senses in one form or another, has come to be a highly specialized, polarized, phased, evolved and what-not science which the amateur hardly dares to delve into. If he did, I am very much afraid that he would be discouraged and would not accomplish his present day results. It is the solemn and nude fact that under dire necessity, he is compelled to use such materials his pocket book allows, such conditions that nature provides, and work under complex influences that every home or ranch exhibits. For instance, certain sanctions are clamped on: holes in walls, attics, wire in back yards, climbing roofs, poles, electric light bills. Even so, the boys do get their

about them yet. Anyway, it is my theory that if you hear a nice sweet p.d.c. in your own monitor, then you can put it somewhere, regardless of your power, if your antenna is directed correctly. We know that a single-wire half-wave antenna radiates best at right angles to its axis, as shown in Fig. 1-A, if it is in free space. It never is, but we'll get to that later. In Fig. 1-B the "best" direction is east and west. Now, supposing we put up two half-wave radiators at 90° from each other, not connected but fed separately as in Fig. 1-C. This looks good from a northeast-southwest direction. Then let's put the two together with

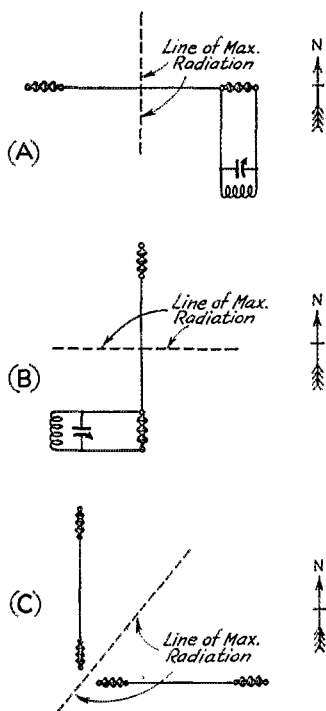

FIG. 1—DEVELOPMENT OF THE DOUBLE-ANTENNA SYSTEM

signals out, usually better in one direction than in any other—and that brings us right to the reason for writing this article.

Being a plain nut when it comes to antennas, I have every reason to believe very little is known

\*205 Springfield Ave., Merchantville, N. J.

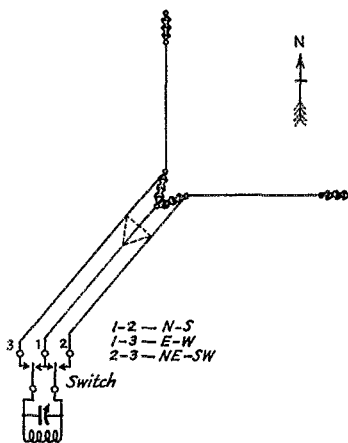

FIG. 2—THE DOUBLE ANTENNA WITH ITS THREE FEEDERS

The switch permits selecting either antenna or using both at once for different directional effects.

one common feeder and another for each antenna, making three feeders in all, rigging a switch to select either radiator alone or both together, as shown in Fig. 2. This means we can select either a north-south, east-west or northwest-southeast directed antenna.

I constructed an antenna like this and am more than pleased with the results. The switch was made with five stand-off insulators and two pieces of copper tubing, as sketched in Fig. 3. Three insulators are spaced five inches apart, with the two that support the two blades of the switch between them. The mechanical construction is only important in so far as the feeders should be kept apart to prevent the inactive wire from increasing the capacity between the other two. The three feeders should be exactly the same length, and should be spaced to form an equilateral triangle so that all three are equidis-

tant. This is important, because it will be necessary to retune when switching from one antenna to another if the system is not perfectly balanced.

If an impedance-matching filter system is used for tuning, the feeders can be less critically cut in length (so long as they are equal), and the differ-

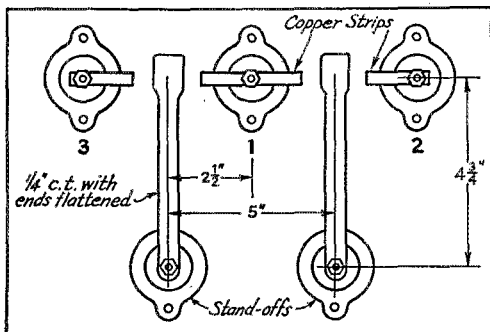

FIG. 3—FEEDER SWITCH CONSTRUCTION

ence made up in the filter. One thing might be said, however, about the filter system. If the feeders are of such a length as to bring a current loop at the first condenser, adjusting this condenser often accomplishes little or nothing and is probably the reason why a number of amateurs have condemned the otherwise popular "pi" system. If you run into this condition, adjust the loading coils until the second condenser, when set at resonance, causes the proper plate current to flow in the final stage.

As mentioned before, the action and influence of surrounding objects affects the antenna appreciably. For this reason the feeders should be tuned without the antennas connected, but pulled up in their final positions. Reduced voltage should be used during this testing. Note the dial reading of the antenna tuning condenser at resonance and attach one antenna. If a readjustment of the condenser is necessary with the antenna connected, the antenna is too long or too short. If the capacity has to be increased, the antenna is too short, and vice-versa. The best way is to make the wire a little too long in the first place; then prune until the length is right. Now attach the other antenna and with the switch in this position, proceed as before. After both aeri-als have been adjusted you are ready to load your final and CQ.

Something should be said about what to expect. With either antenna connected singly, the other is almost ineffective. However, there do seem to be some reflecting properties because my signal strength, judging by reports from those contacted, seems to have increased in all directions. With the switch in the 3-2 position there may be an increase in plate current, the reason possibly being that the inactive feeder is acting

as a shield, or perhaps because of a reduction in impedance as a result of feeding two antennas instead of one. As to results, in every contact an increase of at least one "R" point was noted.

As a further suggestion, current fed systems could be tried, crossing at the center. However, I am inclined to believe that the feeder and one antenna right in the center of radiation might cause complications. For ultra-high-frequencies, reflectors might be added fore and aft of the system. Combined horizontal and vertical polarization can be used for a switch from high- to low-angle radiation or both.

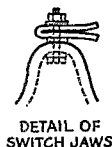

The three-feeder double antenna system has more than proved effective in the seven-megacycle band, and I should like to hear of results from others who try it in this or any other band.

## A New Audio Power Tube

AS THIS issue of *QST* goes to press data on a new type of audio output tube, to be known as the 6L6, has just been released by RCA Radiotron. Not just another triode or pentode, this new all-metal tube is of distinctly different design. It has four elements, cathode, control grid, screen grid and plate, so arranged that the electrons reach the plate in "beams" of high density. As a result of the new design a new order of efficiency is reached in audio amplifiers of the Class-A and -AB type, together with much lower high-order harmonic distortion. At the same time unusually high power sensitivity is secured.

Some idea of the capabilities of the 6L6 can be gained from the fact that a pair of the tubes, operating with 400 volts on the plate, can deliver an audio output of as much as 34 watts with a total distortion of only 2% (practically all third harmonic), without working into the grid current region. For this output a peak grid-to-grid voltage of only 50 volts is required; it can be supplied by any purely voltage amplifier, since no power is drawn from the exciting source. If grid current is drawn, the same pair of tubes can deliver 60 watts of audio power at the same plate voltage and same total distortion (providing the distortion introduced by the driver is negligible). Driving power required is 350 milliwatts. This would certainly seem to be the ideal modulator, from both fidelity and economy standpoints, for a transmitter running an input of around 100 watts.

Complete dope on operating the tubes and on their special features in our next issue.

### Brief

Friday, the 13th, holds no superstitions for W9TY; it was on that day in December, 1935, that he worked his 48th state!

# An I.F. Coupling Amplifier for the Cathode Ray Oscilloscope

By Willard S. Wilson,\* W3DQ

**T**HE r.f. ammeter in the feeder of your 'phone transmitter may show a rise of only 10%, but assurance that there is no over-modulation or accurate checking of the percentage of modulation, especially when using speech,

is extremely difficult by this method of observation. The cathode ray oscilloscope properly coupled to the modulated or output r.f. stage of your 'phone transmitter will accurately present a true picture of modulation as it is.

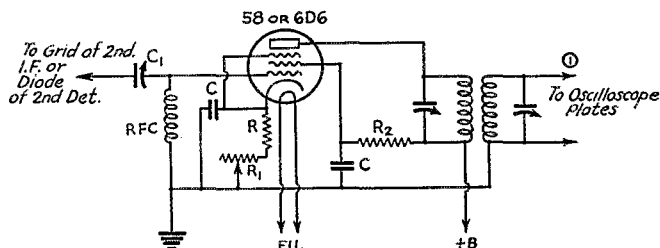

FIG. 1—CIRCUIT OF THE OSCILLOSCOPE COUPLING I.F. AMPLIFIER

C—0.01- $\mu$ fd.  
 C<sub>1</sub>—5- to 50- $\mu$ fd.  
 R—300-ohm.  
 R<sub>1</sub>—7500-ohm potentiometer.  
 R<sub>2</sub>—50,000-ohm 1-watt.  
 RFC—Approx. 20 (2-meg. resistor may be used instead).

is extremely difficult by this method of observation. The cathode ray oscilloscope properly coupled to the modulated or output r.f. stage of your 'phone transmitter will accurately present a true picture of modulation as it is.

However, a majority of amateurs operating 'phone are not yet equipped with the cathode ray method of modulation indication. Those of us who have 'scopes can help the situation by using them on our receivers<sup>1</sup> as well as on the transmitter. When the use of an oscilloscope on the receiver is mentioned during a QSO, the usual question is, "How is my modulation?" If the station being received is clear, quite free from heterodyne interference and fading, it is quite easy to give the inquirer a true and satisfactory reply. Most amateurs acknowledge the report with gratitude and appreciate the information given. Many have been agreeably surprised to learn that they were modulating 100% on peaks, when they thought their modulators were not capable of accomplishing the task.

The photograph shows the coupling amplifier used between the i.f. output of the receiver and the oscilloscope. This amplifier is excited through a small capacity (5- to 50- $\mu$ fd. padder condenser) connected to the diode of the second detector or grid of the final i.f. tube. It is impor-

tant to re-align the i.f. stage exciting the coupling unit because the small additional load necessitates a slight adjustment. The capacity of the padding condenser C<sub>1</sub> should be no greater than sufficient to excite the coupling unit. Too much capacity is of no advantage and tends to unbalance the circuit.

The i.f. transformer in the coupling unit should be tuned to the i.f. of the receiver. The following is a list of some of the popular receivers and the intermediate frequencies used:

- National FB7—495 kc.
- National HRO—456 kc.
- Patterson PR-10—467.5 kc.
- RME9D—465 kc.
- RCA ACR-136—460 kc.
- Hammarlund Comet Pro—465 kc.
- Hammarlund Super Pro—465 kc.
- Breting 12—432 kc.
- Super Skyrider—465 kc.

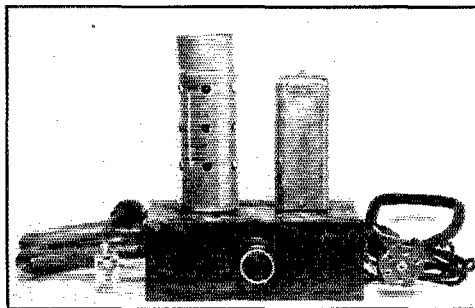

COMPLETED COUPLING AMPLIFIER

The method of operating the coupling unit is as follows: With the receiver in normal operation and the oscilloscope controls properly adjusted to linear sweep of usual voice frequencies, the signal received will produce the familiar pattern on the cathode ray tube. The width (unmodulated) of the received carrier for correct operation should be about one inch, and can be regulated by potentiometer R<sub>1</sub>, or the r.f. gain control on the receiver. Switching off the a.v.c. on the receiver will greatly enlarge the image except on very weak signals, making it necessary to reduce the r.f. gain of the receiver or increase the bias at R<sub>1</sub>. A fading signal will cause the carrier width to vary according to the surging swing of the fade.

\* 405 Delaware Ave., Wilmington, Del.

<sup>1</sup> See, "Cathode-Ray Monitoring of Received Signals," by E. C. Ewing, April 1936 *QST*.—Editor.

Too strong a signal input to the coupling unit causes non-linear amplification and gives an erroneous indication of the modulated carrier. After a few minutes of operation the user will

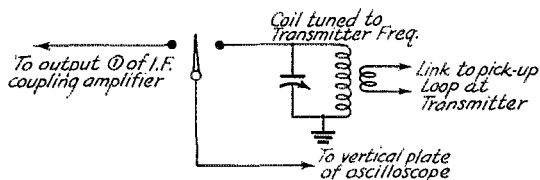

FIG. 2—ARRANGEMENT TO SWITCH THE OSCILLOSCOPE TO TRANSMITTER OR RECEIVER

familiarize himself with the unit and obtain very interesting and satisfactory results. In order to use the oscilloscope with both transmitter and receiver, a switching arrangement may be used as shown in Fig. 2.

## Politician Denounces Amateur Operator, "Bans" Amateur Radio in Johnstown

WHEN a man bites a dog, that's news. It's the unusual that makes news. It was definitely news, therefore, when during the flood emergency of last March one lone public official and one lone newspaper denounced amateur radio instead of praising it as all others were doing.

The official was a gentleman by the name of Daniel Shields, Mayor of the City of Johnstown, Pa. It is the city of Johnstown which, as will be seen by reference to the general flood story in this issue, owes such a great debt to the radio amateurs who first provided it with relief aid when there was no other means to transmit the city's plea, and then later served its citizens directly by transmitting thousands of their personal messages.

Shields' attack on amateur radio, although couched in general terms, was directed specifically against Gerald D. Coleman, W8FRC, of Johnstown, who operated his transmitter in the 75-meter 'phone band during the early days of the emergency. Coleman, the mayor charged, maliciously broadcast false reports concerning the bursting of the Quemahoning Dam above the city and the resulting inundation, thereby causing a panic amongst the Johnstown citizenry in which several old people died. Along with Robert K. Dixon, W8DYY, Coleman was brought to the mayor's office by uniformed policemen, given a summary hearing but no opportunity for explanation, and ordered to stay off the air pending shaping of actual charges. A "ban" was placed on all amateur operation in Johnstown; but it was not, of course, observed by any station. An investigation by the district attorney's office en-

sued. The mayor found time to take a day and a half off from his pressing duties in rehabilitating the devastated city of Johnstown to go to Washington and ask the F.C.C. to revoke Coleman's licenses. This was on Thursday. Asked to submit his charges in writing, he failed to do so, for reasons that will be apparent later in this account. The local newspapers, under common management, gave wide circulation to all these incidents, at the same time refusing to present Coleman's side of the case.

Mayor Shields undoubtedly realized that he had struck on the best angle available in all the catastrophe to attract the attention of the press and a nice chunk of free personal publicity. He probably didn't expect the type of attention he got, however—for prominent amateurs and newspaper columnists and radio commentators throughout the east blasted into the mayor as a result of this indefensible performance and didn't pull any punches. Boake Carter, Walter Winchell, Si Steinhilber in the *Pittsburgh Press*, Elmore Bacon in the *Cleveland News*—these are just a few of those who took the mayor apart in no uncertain terms. At first, the mayor apparently had no consciousness of just what he was running into. When W8KRF attempted to deliver a message of protest from A.R.R.L. he "was very abusive and threatened me with arrest. He then threatened to send someone out here to put me in jail if I went on the air Sunday night." This hard-boiled public servant soon softened, however.

The A.R.R.L. was, of course, on the job. Assistant Secretary Clinton B. DeSoto went into the Pittsburgh and Johnstown territory and conducted a thorough investigation into the circumstances, establishing three positive conclusions: 1. *Coleman did not start a panic in Johnstown.* The panic had begun before he was on the air making his announcement. He simply reported an occurrence already in progress and its presumptive cause. In doing so he was actuated by supposedly "official" reports from municipal authorities. These statements are derived from credible local testimony. 2. *Coleman could not have started a panic in Johnstown.* For the public to have known of his broadcasts general radio reception facilities would of necessity had to have been available. There was no power in Johnstown, therefore no reception facilities. People in outlying areas, although with power and capable of hearing the broadcast, could not have acquainted Johnstown people with its details because there was no telephone service available. 3. *Coleman's transmissions were not of such a nature as to have caused a panic,* had either of the above sets of circumstances not prevailed. He reported information which he had received, from sources which were apparently regarded as authentic by many other Johnstown people, plainly

(Continued on page 92)

# Operating Notes on the 35T

AS PART of the process of obtaining the further information on the operation of the 35Ts promised in April *QST*, a complete transmitter using a pair of the tubes had been planned for this month. The flood washed up those plans, along with a lot of other things. However, we did get together an experimental breadboard amplifier for the purpose of finding out how the tubes performed at 14 and 28 mc., naturally a subject of particular interest with this type of tube. The photograph shows the rig, which incidentally is entirely conventional so far as circuit details go.

The chief reason for showing it is to give some idea of the appearance and size of the tubes themselves.

The elevated mounting of the plate tuning condenser permits having short plate leads, since the plate terminal is out the top of the tube, and likewise provides a little room for mounting the neutralizing condensers on the base. A word about the latter: The data we had on the tubes listed their grid-plate capacity as 2  $\mu\text{fd.}$ , about the lowest of any transmitting triode. In an attempt to neutralize them ordinary midget condensers were cut down plate by plate until it became obvious that the job couldn't be done that way. Finally two small strips of aluminum, mounted on stand-off insulators, did the trick. We recommend, therefore, that when you try neutralizing 35Ts start from nothing and work up—it will be a faster process. The amplifier neutralized perfectly once the proper order of condenser capacity was obtained.

For driving purposes, the amplifier grid coil was link-coupled to an RK-25, working as a straight amplifier on 14 mc. and as a doubler on 28 mc. With a 2500-ohm grid leak for the 35Ts, the grid current was adjusted to 45 milliamperes on both bands under load conditions, giving a bias of about 100 volts, following the manufacturer's recommended grid current values of 18 to 22 milliamperes per tube. Because of the high amplification factor, relatively little bias is required for Class-C operation, 100 volts bias being sufficient with 1500 on the plate.

Under the above conditions, the tubes could be run on both 14 and 28 mc. at maximum ratings without exceeding the plate dissipation limits. The plates run a cherry red color at full dissipation, contrary to the usual "cold" ratings on most small transmitting tubes. As the photographs show, the plate lead is a short length of heavy wire projecting through the top of the tube, connection being made by means of a Fahnestock clip. Because of the small size of the tube the heat just above the bulb is considerable, while the plate lead itself conducts off a fair proportion

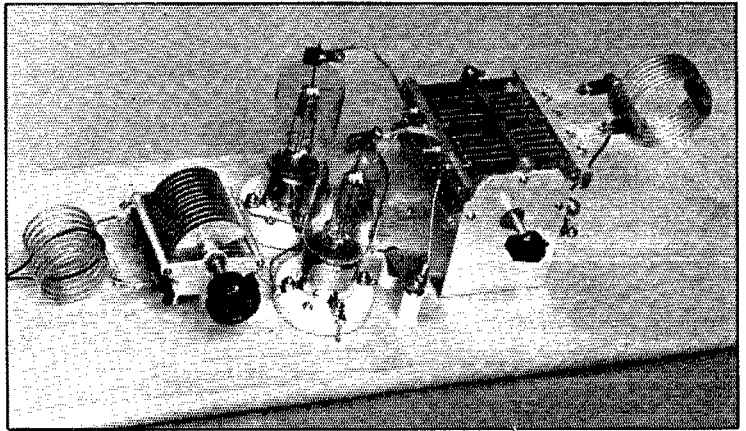

THE BREADBOARD EXPERIMENTAL AMPLIFIER IN WHICH THE 35Ts WERE TESTED

*Some idea of the compactness of the tubes can be gained by comparing them with the Cardwell Midway condenser at the left and the standard-frame condenser at the right. The bulb is smaller than that of a Type 10 tube. Note the neutralizing condenser in the foreground.*

of the heat generated in operation. It has been found advisable, therefore, to bolt the flexible plate lead from the tuned circuit to the clip rather than to solder it—the solder is likely to melt.

Assuming that for plate modulation the tubes would be operated at 1000 volts and 200 ma. for the pair, a further test was run at 28 mc. to determine whether, with the excitation described above, linear modulation could be obtained. For this purpose the input plate voltage was varied through the range from zero to 2000 volts, by means of Variac primary control on the plate transformer. At 2000 volts the plate current was 400 ma., showing linearity to the maximum conditions. Naturally with 800 watts input the tube plates lighted up like the proverbial Christmas tree, but no bad effects resulted from momentary operation under such drastic overload conditions. Similar performance also was obtained on

*(Continued on page 88)*

# HINTS and KINKS for the Experimenter



## Suppressor Modulation With Linear Amplification

AS A means for getting on 'phone with a minimum of equipment, Charles Lober, W8ICO, has found the arrangement shown in Fig. 1 to be highly effective. The transmitter is a typical 100-watt (nominal) c.w. layout using a 47 crystal oscillator, RK23 buffer, and heavy-duty 203-A final. Ordinarily in such a rig the final would be modulated either with Class-B audio or by the grid-bias system. In this case, however, the pentode driver tube is suppressor-modulated, the final stage being used as a Class-B linear amplifier.

antenna ammeter, the variable resistor  $R_5$  is swung to make the suppressor negative (a potentiometer should be used to give smooth adjustment of grid voltage). Set the bias so that the antenna current drops 50%.

"Some minor adjustments of excitation may have to be made, hence the variable condenser  $C_5$ . If antenna current does not show normal modulation increase, this probably will mean the buffer isn't being modulated heavily enough so excitation should be increased. This in turn will require more negative voltage to be used to cut down antenna current; making the buffer easier to modulate.

"The modulator used here is a double-button

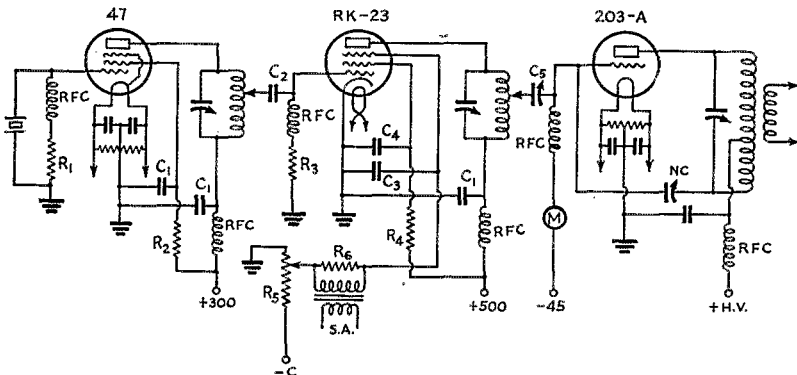

FIG. 1—THREE-STAGE 'PHONE TRANSMITTER WITH SUPPRESSOR MODULATION AND LINEAR AMPLIFICATION

$C_1$ —0.004 $\mu$ d.	$C_4$ —0.001 $\mu$ d.	$R_2$ —50,000 ohms.	$R_5$ —50,000 ohms, variable.
$C_2$ —250 $\mu$ d.	$C_5$ —350- $\mu$ d. variable.	$R_3$ —2000 ohms.	$R_6$ —Load resistor for modulator.
$C_3$ —0.002 $\mu$ d.	$R_1$ —7000 ohms.	$R_4$ —20,000 ohms, 10 watts.	

The carrier output is about equivalent to that obtainable with grid-bias modulation of the final, but with less rigorous biasing and audio power requirements.

In connection with adjusting the set for 'phone, W8ICO writes:

"The transmitter is tuned up in the ordinary manner. Grid current will be much lower for the final than with the usual Class-C amplifier. Input should be adjusted so as to be about 30% more than the rated tube dissipation. The higher the tube plate dissipation, the greater the input that can be used.

"Then negative suppressor voltage, which may be obtained from a "B" eliminator or bias batteries, is applied. Then, while watching the

microphone with a 24 speech amplifier and a 56 modulator.

"A carrier of approximately 55–60 watts can be realized with 1250 volts at 190 ma. on the plate of the final."

In the adjustment of such a system the aim should be to attain normal operating plate currents and biases simultaneously on both modulated stage and linear amplifier. The operating data furnished with the tubes should be consulted. An alternative method of adjustment is as follows: Disconnect the final from the pentode driver, apply rated plate and suppressor voltages for suppressor modulation, and couple a dummy antenna to the pentode tank circuit, adjusting the coupling until the tube draws the specified



plate current. A modulation test will show whether or not this stage is working properly. When satisfactory operation is secured, apply plate voltage and rated bias for Class-B r.f. amplification to the final stage, couple on the driver, and adjust the interstage coupling to make the pentode draw the proper plate current. Then adjust antenna coupling to obtain rated plate current

circuit to bring the plate current back to its normal value. A non-inductive resistor is preferable; it need be rated at only five watts or so and should have a value in the vicinity of a few hundred ohms. The loading can be adjusted by varying the number of tank turns across which the resistor is connected. The additional loading not only provides a means for reaching the proper operating conditions on both modulated stage and amplifier, but also improves the operation of the circuit as a whole by improving the r.f. regulation in the grid circuit.

It is advisable to connect a by-pass condenser (1  $\mu$ fd. or more) between the movable arm of  $R_5$  and ground to shunt out the potentiometer resistance for audio in the suppressor circuit.

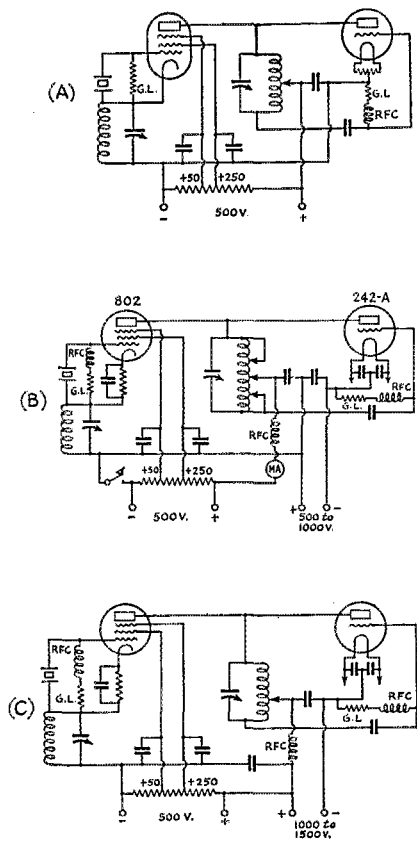

FIG. 2—TRI-TET-CONTROLLED LOCKED OSCILLATOR CIRCUITS

Three variations of one fundamental arrangement. In each circuit the plate circuit of the Tri-tet oscillator and tank of the locked Hartley oscillator are common.

(for Class-B conditions) on the final stage. If the excitation is correct, the antenna current will show an upward kick of five to ten percent with modulation and the final stage plate current will be steady. Should the plate current kick downward when modulating, the excitation must be reduced to the point where there is no change in plate current or, at most, a very slight upward kick. As excitation is reduced, the antenna coupling must be adjusted to keep the final plate current at the same value. Should the driver plate current drop when these changes are made, some resistance should be connected across its tank

### More Locked Oscillator Circuits

FIG. 2 shows several versions of a different type of locked oscillator circuit, originated by Carl C. Drumeller, ex-W9EHC. A novel feature of these circuits is the use of a common tank circuit for the crystal oscillator and locked stage. The crystal oscillator is a Tri-tet, using a pentode of the 802 type; the amplifier or locked oscillator may be any type of triode, depending upon the plate voltage to be used. The tube used by W9EHC was a 242-A, with plate voltages up to 1750. Needless to say, a considerable amount of power can be taken from the tube under these conditions.

Although the circuits of Fig. 2 show the locked oscillator as a Hartley, all of the other familiar oscillator circuits have been tried and found to work satisfactorily. The Hartley has the advantage of requiring fewer parts than most, however, and the excitation is readily adjustable. W9EHC writes: "Results have been uniformly satisfactory. We put as high as 1750 or 2000 volts on the 242-A and it still locked perfectly under load on both the fundamental and second harmonic. When we tried to load the circuit on the fourth harmonic it did not lock any too well, however. The circuit shown at B seems to be the best. With over 200 watts into the 242-A, it locks as steady as a rock on both eighty and forty meters.

"Tuning is simple. One cuts the filament voltage on the 242-A and tunes up the 802 Tri-tet in the conventional manner, then one cuts the 802 filament voltage, turns on the 242-A, and juggles the filament tap on the Hartley for best output exactly as if he were using a self-excited rig. With filament and plate voltage on both tubes, the rig can be tuned by the plate current dips as with any Tri-tet.

"In circuit C we used a separate power supply for each tube (this was the best system, disregarding power supply cost and keying difficulties) and the whole rig could be tuned up, after the

Hartley tap had been set, by the 802's plate meter. The rig acted exactly like a Tri-tet except that the output was very much greater.

"It is important to use very low  $C$  in the plate tank so that the Hartley will be unstable and

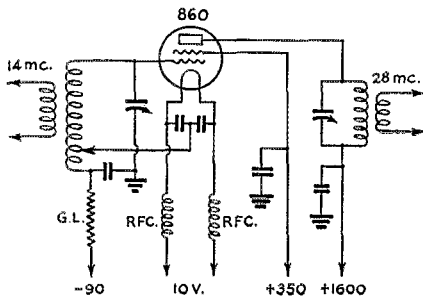

FIG. 3—A REGENERATIVE DOUBLER CIRCUIT FOR USE WITH SCREEN-GRID TUBES

Used by W9CJJ with an 860 for 28-mc. output, this circuit is readily adaptable to other bands and other types of tubes, especially those having indirectly-heated cathodes.

pull into lock readily. The Hartley is always exactly in tune with the Tri-tet, since both plate circuits are common."

At this distance the only disadvantage to the circuit that we can see is that the full r.f. tank voltage from the high-power oscillator appears at the plate of the low-power crystal oscillator tube. No bad effects have resulted from this in W9EHC's experiments with the circuit, however.

## Regenerative Doubler

THE cathode regeneration circuit for increasing the output of a 28-mc. doubler shown in Fig. 3 has been used with considerable success by J. P. Veach, W9CJJ. Its resemblance to the electron-coupled oscillator, the harmonic-generating properties of which are well known, will be remarked. Although an 860, the particular tube to which the circuit is applied in W9CJJ's transmitter, is indicated, any transmitting tetrode or pentode can be used. With types having indirectly-heated cathodes the filament chokes will not be needed, thus simplifying the circuit. For filament-type tubes, the chokes may consist of about 15 turns of No. 14 wire on a two- or three-inch form, close wound, with one coil on top of the other. The inductance should not be particularly critical (see Romander, "The Inverted Ultraudion Amplifier," September 1933 *QST*). At lower frequencies more turns should be used. The cathode tap on the grid coil should be set so that the tube will not quite self-oscillate.

W9CJJ uses the same circuit in the 28-mc. and 56-mc. doubler stages in a low-power crystal-controlled transmitter on five meters, and writes that he has obtained enough 2.5-meter output from an 89 in the same circuit to excite a 6D6 for suppressor modulation on 120 mc.

## Improving Selectivity in the Regenerative Receiver

IN THE February issue of *QST* I see the great interest in noise and QRM reducing circuits. Allow me to tell you of my receiver used in the 1935 DX contest.

The second a.f. of the simple 1V2 receiver (see Fig. 4) may be an old tube working as a limiter by adjusting its plate voltage. Now all signals and QRM have practically the same QRM. That alone helps, but the following peak tube improves it still more. In its plate is the headphone, and a variable mica condenser,  $C_1$ , feeds back to the plate of the limiter tube. Therefore a coupling transformer is used and connected so that it feeds back. Two condensers,  $C_2$  and  $C_3$ , are switched across the transformer secondary to tune to about 1000 and 100 cycles. The switch also places an additional capacity  $C_4$  in parallel to  $C_1$  for 100 cycles, as a greater value on this frequency is necessary. Once the feedback condenser  $C_1$  is adjusted to a point just before oscillation it need not again be touched. The trans-

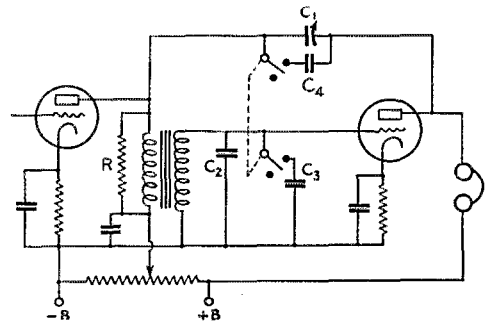

FIG. 4—VOLUME LIMITER AND REGENERATIVE AUDIO AMPLIFIER FOR REDUCING NOISE AND INCREASING SELECTIVITY IN C.W. RECEPTION

The values of the condensers marked must be determined by experiment. The values of the "tone" condensers,  $C_2$  and  $C_3$ , will depend upon the constants of the audio transformer used; values in the usual range of mica condensers—.0001 to .002  $\mu$ f.—should give a satisfactory result with most transformers. The feedback condensers,  $C_1$  and  $C_4$ , likewise must be adjusted experimentally to give satisfactory regeneration with the tube and plate voltage employed.

former primary has across it a resistor of about 10,000 ohms as a constant load to prevent changing the feed-back condenser at various limiter tube settings.

If you want to simplify the circuit and prevent connecting the large feedback condenser for 100 cycles, use the larger capacity in parallel to the transformer secondary alone for the low peak frequency. Don't use too great plate voltage on the peak tube or your ear drum gets hot at adjusting the feedback condenser!

Last but not least a separate h.f. oscillator is

important for such strong QRM signals as would block the detector. Now, for example, an R9 interference and a wanted R4 signal are first limited until both are the same strength, and after passing the peak stage the interference can be R3 to R5 and the signal R9. Often the difference between wanted signal and interfering signal is only 100 cycles or less; then use the low pitched peak and the signals are still readable until both sigs have the same frequency, where there is no help of course. The same goes for auto and static QRM where either the 1000- or 100-cycle peak may be found best.

—Hans. H. Plisch, OK2AK

The above text, plus the diagram, were transmitted from OK2AK to W2DFN on 14 mc.—ED.

## Combination Time Delay and Bias Supply

THE circuit of Fig. 5 works very nicely as a time delay relay for mercury vapor rectifier tubes, and in addition serves as a transformerless "C" bias supply and automatic cut-off of high voltage in case of any failure in this supply.

To obtain the time delay feature, advantage is taken of the heater type of filament of the 25Z5 which was designed to operate as a voltage doubler directly off the 110-volt line. Two tubes are used in parallel to stand the drain through the low-resistance bleeder used to stabilize the "C" voltage, and to operate the heavy-duty relay that was at hand. Care should be taken to hook the plate and cathode connections at the tube sockets in the exact order shown in the diagram.

A time delay of 17 seconds was obtained with the particular 25Z5s used. This will probably vary somewhat with the make of tubes.

Practically any d.c. relay that has contacts heavy enough to handle the current drawn by the plate transformers can be used. Telegraph relays or sounders might be fitted with heavy contacts or automobile generator cutouts revamped. To obtain good regulation as a C bias supply, 75 to 150 ma. bleeder load should be used. The particular relay at hand and value of bleeder resistor will have to be adjusted to secure this. If the relay has a resistance of several thousand ohms it can be used directly across the output of the

filter; if of low resistance and operating on 75 to 150 ma. can be used as shown in the diagram. If it takes less than 75 ma. it can be shunted by a variable resistor, the latter being varied to give proper relay current, and the combination tied

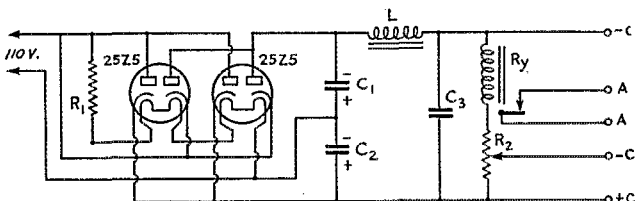

FIG. 6—REVISED BLEEDER CIRCUIT FOR THE QST TWO-TUBE RECEIVER FOR IMPROVING CONTROL OF REGENERATION

The circuit at A is as given in the original diagram, resistors  $R_2$  and  $R_3$  having the values specified in June, 1934 QST and the current Handbook. Circuit B, with its heavier bleeder load, gives less critical control of regeneration.  $R_2$  is the same as in A (50,000-ohm potentiometer),  $R_1$  is a 3000-ohm, 10-watt resistor, and  $R_3$  a 10,000-ohm, 10-watt resistor.

in series with the bleeder resistor.

In the unit constructed the relay required 140 ma. and the winding had a d.c. resistance of 150 ohms. With a bleeder resistor of 850 ohms in series the load current was 140 ma., with the voltage 140. A voltage of 165 could be secured at this load if  $C_1$  and  $C_2$  were increased to 16  $\mu$ fd. each.

Many hours of life should be added to the tubes protected with this arrangement. A cut in the line voltage immediately opens the high voltage; a several-second cut will allow the filaments of the 25Z5s to cool slightly and there will be a delay before the high voltage is automatically reapplied.

There is one precaution to be observed: If the high voltage negatives are tied to direct ground it will be impossible to use this unit as a "C" supply, since it is necessary to connect the C positive to B negative. One side of the a.c. line is grounded and that shorts out  $C_1$  and  $C_2$ . In this case the device would still be useful as a

time delay relay, and one 25Z5 might prove sufficient to operate the relay.

—Paul S. LeVan, W3MG

## Regenerative Detector Kinks

FOR smoother control of regeneration in the two-tube receiver described in June, 1934 QST, and in the Handbook (it applies equally

(Continued on page 98)



# Amateur Radio STATIONS

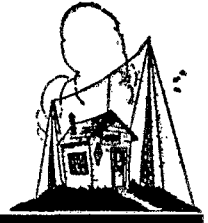

## CO6OM, Tuinucu, Cuba

**TUINUCU** is a familiar name to practically any ham who listens on the 20-meter band, not only in North America but in most other continents as well. For that matter, not only hams know it—Tuinucu and its cuckoo were equally well known to BCL's in the early broadcasting days, when 6KW was DX on the broadcast band.

All of which is by way of saying that Frank H. Jones has been closely associated with both amateur and commercial radio for a good many years. We'll let him tell that part of the story himself: "In the pre-war days around 1911 I had two 1-kw. spark sets, one here at the Tuinucu Sugar Company mill and the other at the Washington Sugar Company mill at Hatney, Cuba, about 75 miles away. Did we communicate between the

two stations? Mostly we did not. The sparks made lots of noise and the antennas were sights to behold, covering most all outdoors and then some. Down here in those days with waves somewhere around 200 meters the QRN was worse and more powerful than 20-kw. signals. . . . Got to monkeying with the new vacuum tubes around 1920 and made a receiver that picked up KDKA's preliminary broadcasting. Decided to make a transmitter and received several 50-watt bottles from the States. Every other one used to come broken or with the filaments in pieces. Finally got 50 watts going in 1921 on 'phone and did some broadcasting on 332 meters under the call 6KW. Later ran the power all the way up to 4000 watts at times, using a power amplifier with a whole flock of 204s (15¾ amps per filament). Stoves would be a better name.

"Built a 250-watt 20-meter 'phone which was described in *QST* around 1928, and worked a few fellows, but there was practically nobody on the air then. What a contrast now!"

Besides the activity with 6KW (later CMHC), Frank built CMJK in Camaguey in 1931. This station is still operating. Amateur operation was resumed in 1934, when a pair of 800's was put on the air, modulated by a pair of 845's Class A. In October of last year the station was rebuilt for higher power, a panel view of the present transmitter being shown in the accompanying photograph.

The transmitter is located about forty feet from the receiving and operating position, in a small room of its own. The rack at the left contains the Class-B modulator, using a pair of 203-A's, all controls, meters, and the power supply for the modulator. The r.f. section is in the right-hand rack. This consists of a 59 Tri-tet oscillator, using a 7-mc. crystal and doubling to 14 mc., link-coupled to an RK20 driver which in turn is link-coupled to a pair of 150-Ts in the final. The final occupies the upper section of the rack, with a pi-section antenna coupler on top. Below the exciter section is the old push-pull 800 amplifier, now used with grids in push-pull and plates in parallel for doubling to ten meters. A simple switching arrangement changes the RK20 to excite the 800s for ten-meter operation. As a temporary expedient the 800s are used as output tubes on

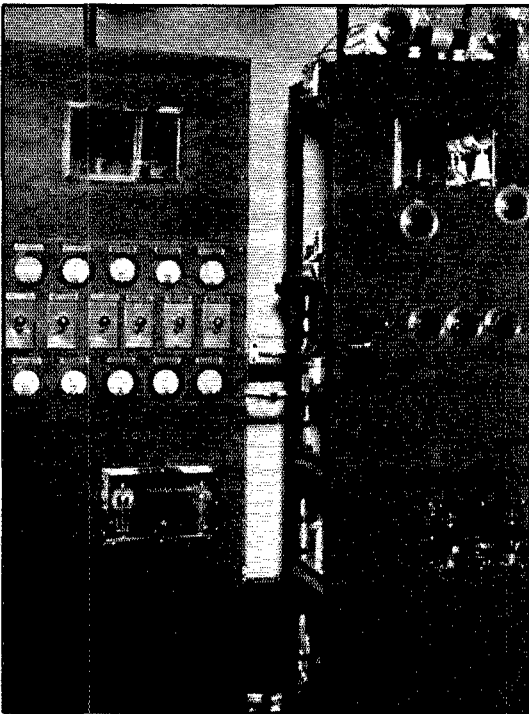

CO6OM

ten, although eventually they will be used as an exciter for the 150-Ts on that frequency. Speech equipment includes a Collins 7C amplifier and various types of crystal microphones.

CO6OM works chiefly with friends in the eastern part of the U. S., and for this purpose uses a horizontal rhombic antenna one wavelength high and four wavelengths long on each leg, directed at New York. This antenna is located about 950 feet from the transmitter, and is fed through a 600-ohm line. Besides putting an exceptionally strong signal into the East, the secondary lobe of this antenna also brings in R9 reports from England. A 3/2-wave antenna, 95 feet high, fed at the center with a quarter-wave Johnson Q section and a 600-ohm line, also is used at times. This antenna is particularly effective toward Hawaii and Australia.

Excellent reports have been received from all continents, although Asia and Africa remain to be contacted. No particular effort has been made to work all continents. One thing that distinguishes the operation of CO6OM is that CQ's are very rarely called—and then only when the station is being demonstrated to non-radio visitors or perhaps when a quick report is wanted on changes in adjustment or apparatus.

### W9AS, Newton, Iowa

THE photograph of W9AS shows one feature which most hams have neglected when they get to the stage of making pictures of their stations—there's plenty of room left on the racks for future expansion. We think the idea is a good one, since it takes remarkable self-control to keep from making changes and improvements in a set after it's in its "final" form. W9AS, owned by John P. Mathews of Newton, Iowa, has become very well known on the 20-meter 'phone band during the course of the last year.

The r.f. section of the transmitter consists of a

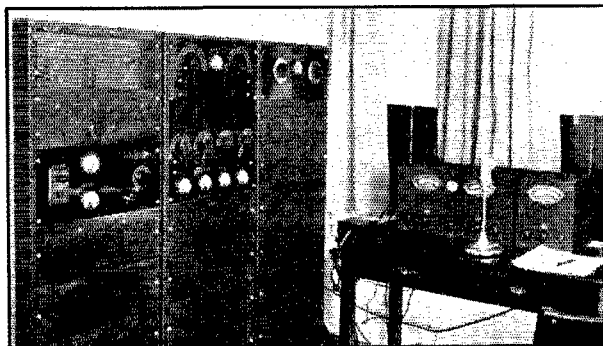

47 crystal oscillator on 7 mc., 46 doubler to 14 mc., 10 buffer, a second buffer using a pair of 10s in push-pull, and a final stage with a 203-A.

Provision has been made for adding a second 203-A to the final—it may, in fact, be in the transmitter by the time this photo appears in *QST*. The single tube is usually run at 220 watts input. Each stage has its own power supply.

Audio equipment starts out with a Turner multicell crystal mike, working into a 57-56 pre-amplifier. The speech amplifier consists of a 56 followed by a second 56, then a pair of 50s as



drivers for the Class-B modulator, a pair of 203-Bs. The third rack contains the pi-section antenna filter and blank panels for experimental layouts. The antenna is a 20-meter Johnson "Q."

A Patterson PR-10 with a two-stage pre-selector is used for receiving.

Present work of W9AS is confined to 20-meter 'phone and c.w. John is also a member of the old-timers' brigade, having started out with a Bulldog coil in spark days, later followed by a 1-kw. outfit working with 9ERH. The calls 9LK and 9DZW have been held in the interim, along with a couple of commercial tickets and some ship operating.

### W6GVT, Lompoc, Calif.

AFTER being off the air since pre-war spark days H. G. Martin of Lompoc, Calif., broke into the c.w. game in 1932 with the call W6GVT. His first c.w. rig was a 201-A TNT and a regenerative receiver using 201-As. Since then several transmitters and receivers have been built "for practice" before going commercial (in equipment). This accompanying photo shows the station as it is today. It consists of a Collins 4-A transmitter mounted in a Hallcrafters cabinet to match the receiver (not a bad idea, this), working into a single-wire end-fed antenna; a 1936 Hallcrafters Super-Skyrider, and an a.c.-operated monitor, the latter sitting on top of the receiver. Control switches

on the left operate the whole station; with one switch the receiver is disconnected from the

(Continued on page 96)



# CALLS HEARD

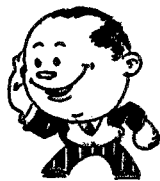

**EA4AO, J. M. de Cordova, Apartado 745, Madrid**

(28-mc. band during January, 1936)

Worked—d4gwf d4arr sm7uc spleb ym4aa lulep lu9ax ve2ee ve3kf ve3wa wibux wlogy wldhe wldze wlelr wlewd wlewf wlfh wlfjn wlhwp wlirb wliqz w2acy w2aer w2aff w2afu w2aog w2aiw w2ber w2bhm w2dtb w2dyk w2dza w2fba w2mb w2sz w3air w3bve w3bvn w3bsy w3dbx w3emm w3epz w3evt w3cgu w3far w3fed w3pe w4bbr w4ca w4dek w4ef w5afx w5ql w6dob w6hjt w6kij w6tj w7avv w7ean w7flu w8aat w8biq w8byn w8ded w8dsu w8dyk w8ebs w8fyc w8hgw w8ixm w8ixs w8ktw w8lea w8mah w8nmh w8pk w8abe w9aeh w9bmx w9bqm w9bbb w9bpu w9ces w9cog w9cvu w9cyt w9dnc w9dec w9dei w9dww w9ffq w9flh w9fur w9ghn w9gbj w9gmv w9hag w9hfk w9huv w9ico w9isu w9iun w9iwx w9kje w9lf w9mcd w9mkz w9min w9nfm w9jgs w9pte w9spb w9we

Heard—l1aak wlaep wlaf wlaqd wlaur wlbgy wlcser wldf wldqd wlduk wlelr wlhov wllz wlnw wlpa wlra wlwv wlsb wlze w2awf w2ajd w2ouz w2dby w2ddv w2dfn w2evi w2fwk w2hfm w3ebe w3edp w3enx w3fdo w3jm w4ah w4afc w5bdb w5wg w6dtb w6bxx w7amx w8agu w8ann w8cra w8evi w8jll w8jrq w8jv w8kwi w8kyy w8min w8mok w8mwl w9arn w9bht w9dgh w9fqc w9gil w9gub w9grv w9jie w9llx w9mv w9pne w9ro w9ruk w9rpk w9tat w9usl d4csa d4mkn fa8hg g6lk g6wy iilit la4k oh5ng oh7nc on4my sm6wi u9av ve2ac ve2kx ve3aq ve3mj ve3my vp5pz zslh

\*Phones—wlogy w2aog w2ber w2mb w3air w3far w8dsu w9cvn w9mcd ym4aa

**W9KPD, Wm. F. Frankart, 741 Michaels Ave., Fort Wayne, Ind.**

(28-mc. band)

g6qb g6zv g6lk g6nt g6bv f8oz f8wb f8wk f8ct pa0xd ea4ao ea2if on4my ok1bc spleb oa4b vp5ac vp5pz em2fa vo4y k5ac co6om veids velds ve4dq ve4uy ve4um ve4vg ve4ku ve4ig ve5be ve5ke x1cm x1ay x1ac x2c x2n

**A. Sigurdsson, Lindargata 3, Reykjavik, Iceland**

(14-mc. 'phones)

ok2ko sulrk ea3er laic co6om g5ml g5pt g6ad g6go w1cnd w2bsd w9dcu w9cd

**W5ADZ, Aboard S.S. Pueblo, Between N. Y. C. and Texas**

(7-mc. band)

j2ll j2ma j2lj j2cc j2cl j2do j3dp j3cr j4cf j5cc j8ca

**OK2MA, Ant. Machan, Slezska Ostrava 1381, Czechoslovakia**

(28-mc. band)

wlafu wlafr wlduk wldxl wleht wlelr wlewd wlfsn wlhv wlfqz wlnw wlvw w2aog w2avz w2ber w2cpa w2ouz (fone qso) w2hfs w2sz w3biv w3bay w3bwb w3enx w4auu w4bbr w4mr w4qn w5af w5irc w8mok w9bok cn8mq eplac ea3an ea4ao g6lk suljk ve2ee

**G6WY, H. A. M. Whyte, 9, The Mead, Beckingham, Kent, England**

(28-mc. band)

eplac d4arr ei8b lulep lu9ax wlaf wlaef wlafo wlaep wlavv wlahi wlaur wlavj wlibx wlibj wlcmx wlcser wlcwv wldze wldf wlduk wldqd wlewd wlebr wlelr

wlfpw wlhwp wliqz wlhdv wlirb wllz wlme wlss w1ze w1zl w2aog w2aiw w2aol w2acy w2amm w2afu w2bhm w2ber w2bqk w2cpa w2ouz w2cay w2dtb w2dza w2dfn w2dlo w2dyk w2evi w2fwk w2fdl w2far w2gik w2hfm w2hij w2tp w3ajd w3air w3bph w3bwb w3biv w3bvn w3cyk w3cgu w3chh w3dbx w3dqp w3enx w3edp w3evt w3ebk w3far w3hc w3pc w3si w4auu w4ajy w4bbp w4dek w4ft w4mr w5afx w5bfs w5dvw w5ehm w5ql w5wg w6cal w7amx w8agu w8azg w8biq w8dyk w8drj w8ebs w8hci w8ixm w8kkq w8mah w8mwl w9abe w9abp w9ark w9arn w9cvt w9drn w9flh w9gfd w9ghn w9jie w9kje w9lbb w9mkz w9nbn w9ny w9rh velea ve2ee ve2jb ve3er ve3td vo4y vk2lz vk3bd vk3bq vk3yp vk4ap vk4q vk4ei vk4bb vk5hg vk6sa oklaw ok1bc on4au oh7nd oh7nf vu2bl zslh zt6k

**W9DBC, Joe Tomczyk, 312 14th Ave. N. E., Minneapolis, Minn.**

(28-mc. band)

em2fa d4arr d4gwf ea4ao f8ct f8oz g2hg g2mv g2yl g5by g5fv g5la g5qy g5vu g6lk g8kr g8vy g8zm hj3ajh ie8b inj k7ua lu9ax ok1bc oa4b pa0xr pct velaq ve1bq velco ve1dz velea ve5be ve5fu ve5hc ve5iq ve5ke ve5qa vo4y vk3yp vp5pz xelay xelcm xe2c ym4aa ea2a

**G6YL, Miss B. Dunn, Felton, Northumberland, England**

(28-mc. band)

wlaep wlaf wiakd wlavv wlayx wlbxe wlcfd wlcmx wlcser wldf wldgv wldze wlelr wlewd wlfh wlgvh wlhdy wlihtz wlihz wllz (phone) wlwv w1zb w1zw w2aoo w2arb w2ary w2ayj w2bbr w2ber (phone) w2byp w2bpd w2cpa w2cvj w2dfl w2dng w2dtb w2dvw w2dza w2emv w2if w2fhi w2fwk (phone) w2gjb w2gik w2gos w2hij w2jn w2mb w2sz w2tp w3air (phone) w3ajv w3biv w3bph w3byf w3chh w3dth w3dlb w3zab w3chg w3dbx w3enx w3epz w3evt w3far w3fed w3si w4agp w4agy w4ajy w4auu w4bbp w4cyu w4ef w4mr w5afx w5ahj w5ddb w6cal w6flw w8agu w8ans w8biq w8cra (phone) w8cww w8cte w8cxc w8dod w8dsu w8egv w8iil w8iwg w8ixm w8jls w8kip w8ktv w8lea w8lvr w8man w8mmh w8mwl (phone) w8pko w9abe w9agm w9aj w9arn w9bmm w9bht (phone) w9bpu w9ef w9fur w9gbj w9ghn w9huv w9jgs w9jbn w9kpd w9lf w9lq w9mcd w9min w9ny w9spb cx1cg cn8mq f44af suljt suiro sulsg ve2ca ve2ee ve2gh ve2jb ve3du ve3lu ve3mj ve3sv ve3wa vk2no vk3bd vk3bq vk3km vk3yp vk4ei vk6sa vp5pz lulep lu9ax lu9bv zeljn zelju zslh zs2j zu5b zt6k zu6a zu6p

**J2HZ, M. Oshima, 19 nihon-enoki, Kanagawa, Yokohama, Japan**

(7-mc. band)

wlcnq w1ch w1mm w2abc w2bcy w2buj w2dyv w2ejb w2fvx w2gc w2gwe w2hfn w2hyy w2ml w3bhw w3kb w3cpw w3dot w3fey w3hrd w3icp w3le w3onr w3omf w9ffr w9jvw w9sgm k7dvi k7ua ve2cc ve4le vedro lu8al lu8ad lu8c lu8ez lu8br lu8dj lu7ef lu8en splbb splcc splde em2wd f8lu g2hg g2qy g6cl g6vp oa4b ok1bc ok1jj ok1kw ok2op ok3va on4fx on4ws oh3np oh5ng pa0alo pa0iv ea3dp ea3ef ea3eg ea3xg ea5bo ea7au d4dsc d4jxk d4qft d4srx hc1cf cx1bg zslal zult zsaal sulsg su5nk

(14-mc. band)

w1cnu w1cxm w1zz w8bbw w8enf w9pjn x2c ok2ms ok2op ok3no ok2rm f8xl iilit la1h la3i la5b ve2cl splbc cx1cg cx2ak oa4j zu6a g2pn g5fj g6nj lu2ag



# I. A. R. U. NEWS

Devoted to the interests and activities of the

## INTERNATIONAL AMATEUR RADIO UNION

Headquarters Society: THE AMERICAN RADIO RELAY LEAGUE, West Hartford, Conn.

### MEMBER SOCIETIES

American Radio Relay League  
Associazione Radiotecnica Italiana  
Canadian Section, A. R. U.  
Ceskoslovenski Amatér Vysilací  
Deutscher Amateur Sende-und-Empfangs  
Dienst  
Experimenterende Danske Radioamatører  
Irish Radio Transmitters Society  
日本アマチュア無線聯盟  
Liga Colombiana de Radio Aficionados

Liga Mexicana de Radio Experimentadores  
Nederlandische Vereniging voor Internationaal Radioamateurisme  
Nederlandsch-Indische Vereniging voor  
Internationaal Radioamateurisme  
New Zealand Association of Radio Transmitters  
Norsk Radio Relæ Liga  
Oesterreichischer Versuchssenderverband  
Polski Związek Krotkofalowców

Radio Society of Great Britain  
Rede dos Emissores Portugueses  
Reseau Belge  
Reseau des Emetteurs Français  
South African Radio Relay League  
Suomen Radioamatöörlitto r.y.  
Sveriges Sandareamatörer  
Unión de Radioemisores Españoles  
Union Schweiz Kurzwellen Amateure  
Wireless Institute of Australia

Conducted by Clinton B. DeSoto

### Apology:

While Clint DeSoto, the maestro of this column, is busy leaping from house-top to house-top getting the true story of the Johnstown and Pittsburgh floods, this column will be conducted by Byron Goodman, who herewith tenders his apologies and prepares his not-so-broad shoulders for the expected criticism.

### Acknowledgment:

I.A.R.U. headquarters gratefully acknowledges the many expressions of sympathy sent us by the member-societies on the passing of our beloved founder and president, Hiram Percy Maxim, and our vice-president, Charles H. Stewart.

### R. S. G. B. Cruise:

Many of us envied Yardley Beers, W3AWH, his trip with the British gang recounted in the February issue under "BERU, INGANG, and All That!" Max B. Buckwell, G5UK, writes to say that another cruise to the continent is planned during the August Bank Holiday, July 31st to August 4th. The itinerary is London-Harwich-Amsterdam-Antwerp-Zeebrugge-Harwich-London, and the cost of the cruise will be roughly \$25, inclusive of travel, meals, and accommodation. Any foreign amateur in England at the time should avail himself of the opportunity to participate in this delightful affair.

### WA(8)C:

Latest applicant to the Worked Eight Continents Club (including Arctica and Antartica) is Everett Kick, W7EK, of Everett, Washington. Don Mix of WNP finally broke down and sent a card, completing W7EK's collection.

### W.B.E.:

Jack Clarricoats, G6CL, and secretary of the R.S.G.B., reminds us that the W.B.E. award (Worked British Empire) is made only to financial members of the R.S.G.B. The rules were published in February *QST* and, to settle a hazy point, it is unnecessary for claimants to show evidence of working British Empire stations in both North and South America. A VE card is all that is required from the American continent.

### Danish Notes:

H. Tscherning Petersen, OZ7Z, writes that 28-mc. interest is increasing in Denmark. Recently OZ2M worked four continents in four days with an input of only 20 watts, with an R6 on 'phone from a W5 the best report.

The annual convention will take place in Kalundborg on May 31st and June 1st. Any foreign amateur in Denmark at the time is cordially invited to attend. A postcard in advance to EDR, Box 79, Copenhagen, would be appreciated.

### General:

First Roumanian WAC goes to Anatol Poruznik, YR5AP . . . 5AP says that amateurs in his country are greatly handicapped by the inability to obtain good equipment . . . Judging by some of the notes heard during the DX contest, many W hams are up against the same problem! . . . From D. Martin, VU2BL, who recently moved to England, comes the report that VU2LJ is active Sundays on 28 mc., and reports hearing W6 at 0800 GT . . . A rare one to look for on 28 mc. is VS8AA, J. A. Faithful of Radio House, Bahrein Island, Persian Gulf. He has heard W2HFS at



1540 GT . . . When going after the faraway places, don't overlook the 3.5-mc. band . . . On March 14th W9BQJ worked ZEILA on about 3560 kc. This at 0615 GT . . . A sixteen-year-old "young squirt," W3DMQ to be exact, hasn't been doing so badly. An 8-hour-and-40-minute WAC knocks 2 hours and 3 minutes off the 3rd District record formerly held by W3CHG. He also casually mentions that he made WAC in six consecutive contacts during the DX tests, and worked WAC in one day three times in one week! . . . What Central American 'phone station, and well known at that, recently applied for a 'phone WAC and included three forged cards? . . . WIAB reports PK1MK coming through at 0100 GT, a rather unusual time. Look for a chirpy T9 about 14.3 mc. . . . Frank Speir, KA1AN, recently received his WAC, the first for any KA on 14 mc.

#### Netherlands:

In spite of all other announcements on this subject, we wish to draw the attention of amateurs and especially of all QSL Bureaus to the fact that the only QSL address for the Netherlands (PAØ) is still N.V.I.R., Post-box 400, Rotterdam. The N.V.I.R. is the only Netherland I.A.R.U. section.

#### QSL:

Here is the latest revised list of QSL Bureaus of the world. It is to these addresses that cards intended for the countries indicated are to be sent. Direct mailing in quantity to QSL Bureaus is the fastest and least expensive method of handling for individual amateurs. Corrections, additions or deletions to or from this list will be welcomed. Another complete revised list will appear in the September issue.

Algeria: See France.

Argentina: Radio Club del Argentina, Rividevia 2170, Buenos Aires.

Australia: W.I.A. Federal QSL Bureau, George W. Luxon, VK5RX, 8 Brook St., Mitcham, South Australia.

Austria: O.V.S.V., Willy Blaschek, Bahngasse 29, Klosterneuberg.

Azores: See Portugal.

Belgium: Reseau Belge, 312 Rue Royale, Brussels.

Brazil: L.A.B.R.E., Caixa Postal 26, Sao Paulo.

British West Indies: Ian C. Morgan, "Southlands," Warwick East, Bermuda.

Canada: A.R.R.L., West Hartford, Conn., U.S.A.

Ceylon: A. M. Rahim, "Rillington," Wellawatte, Colombo.

Chile: Luis M. Desmaris, Casilla 761, Santiago de Chile.

China: I.A.R.A.C., Box 685, Shanghai.

Colombia: L.C.R.A., Apartado 330, Bogota.

Cuba: Pedro Madiedo, calle Santa Rosa, Buen Retiro, Marianao, Habana.

Czechoslovakia: C.A.V., Post Box 69, Praha I.

Denmark: E.D.R., Post Box 79, Copenhagen K.

Dominican Republic: Dr. Enrique de Marchena, Apartado Postal 912, Santo Domingo.

Egypt: F. H. Pettitt, Catholic Club, Mustapha Barracks, Alexandria.

England: R.S.G.B., 53 Victoria St., London S.W. 1.

Estonia: V. Suigusaar, Hobe t. r, Pernau.

Finland: S.R.A.L., Pohjola, Box 42, Helsinki.

France: R.E.F., 6 square de la Dordogne, Paris 17°.

Germany: D.A.S.D., Schweinfurthstr. 78, Berlin-Dahlem.

Guam: Foster D. Brunton, 62 Santa Cruz St., Agana.

Haiti: J. D. Poindexter, Pan-American Airways, Port-au-Prince.



LU9BV, ARGENTINA

Low power has not kept Colin H. Grattan of Buenos Aires from becoming one of Argentina's best known stations, especially on the 28-mc. band. WAC on 7 and 14 mc., only a contact with Oceania is needed for WAC on 10.

Hong Kong: H.A.R.T.S., Box 651.

Hungary: National Union of Hungarian Short-Wave Amateurs, VIII, Matyas-ter 6, Budapest.

India: B. M. Tanna, Ismail College, Jogeshwari, Bombay



VP7NC, INGLIS LOWE, BOX 531, NASSAU BAHAMAS

"Note the sloppy fist," comments George Montgomery, W8IKE, who took the picture.

Iraq: L. A. C. Lewis, No. 1A.C.C., R.A.F., Hinaidi, Baghdad.

Irish Free State: H. Riley, 58 Belmont Ave., Donnybrook, Dublin. (Cards for Northern Ireland go to R.S.G.B., England.)

(Continued on page 80)

# A Resonant Loud-Speaker for C.W. Reception

By S. L. Seaton\*

FROM childhood days of tin-whistles it is known that open and closed pipes produce musical sounds when the contained air-column is excited. The pitch produced is largely dependent upon pipe-length and whether the pipe is open or closed. A pipe of determined length will resonate at its fundamental and higher *harmonic* frequencies but will not respond to random frequencies. This latter characteristic of acoustical selectivity has been utilized to facilitate c.w. telegraph-reception in the presence of atmospherics and interference.

A small dynamic speaker is housed in a box to the front of which is attached a tube having a length giving fundamental resonance at 350 cycles. To avoid cavity-resonance, it is filled with some such dead material as raw wool. The

gratifying results. Signals that are absolutely uncopyable through background and interference without the pipe are quite readable as soon as the pipe is placed in operation.

Acknowledgment is gratefully made to Dr. J. A. Fleming, Director and to Mr. W. C. Parkinson, Observer-In-Charge, for encouragement in making this study.

## Atlantic Division Convention

June 19th-20th at Wilmington, Del.

ONE of the most elaborate programs ever presented at an A.R.R.L. divisional convention is now in preparation for the Atlantic Division Convention to be held at the Hotel du Pont, Wilmington, Del., June 19th and 20th. The convention is being sponsored by the Delaware Amateur Radio Club.

There will not be an idle moment in the program now being prepared by the general convention committee. Entertainment will be provided by nationally known radio and stage stars. It will be the first Atlantic Division Convention to be held in the eastern part of the division in four years and the Delaware Amateur Radio Club is expending every effort to make the convention a long remembered affair.

More than \$2,000 worth of prizes will be awarded with a special prize, a Comet Super Pro, for those registering by June 15.

Convention tickets are \$5.00. A 10 per cent discount will be given on all tickets secured by June 15.

Registration may be made by writing Willard S. Wilson, W3DQ, 405 Delaware Ave., or Charles E. Kane, W3DNI, 1206 Elm St., Wilmington, Del.

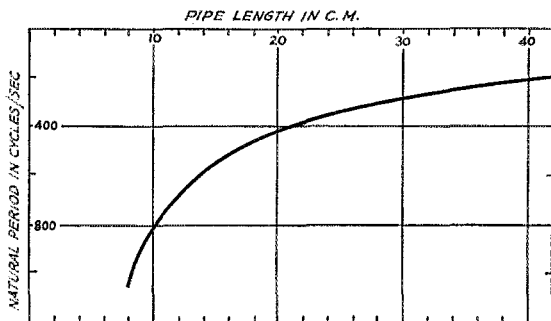

FIG. 1

supporting ring of the speaker is placed against the pipe end giving a closed-pipe situation. Since individuals differ as to the most pleasing tone for copying, Fig. 1 has been prepared giving pipe-lengths for the ordinary range of audio-frequencies.

The pipe material and thickness are unimportant, wood or heavy cardboard being perfectly satisfactory. A pipe diameter of two to four inches is suitable for ordinary frequencies.

In operation, a pipe-length is selected and the pipe fitted to the speaker in such a way that the speaker-diaphragm closes the pipe. A pure signal is tuned in and the heterodyne varied until resonance is noted. If a crystal filter is used in the receiver the beat-frequency oscillator should be adjusted so that crystal-resonance and beat-frequency coincide with the pipe resonant-frequency. Such an adjustment is in use at VK6MO with

\* Department of Terrestrial Magnetism, Carnegie Institution of Washington, Watheroo Magnetic Observatory, Watheroo, W. A.

## Silent Keys

It is with deep regret that we record the passing of these amateurs:

John C. Gillies, W3BRU, Philadelphia, Pa.  
James F. Hancock, W4BIX, Bessemer, Ala.  
E. D. Reynolds, W6LRW, Woodland, Calif.  
Kenneth F. Schumaker, W6DQS, Hollywood, Calif.



# OPERATING NEWS



Conducted by the Communications Department

F. E. Handy, Communications Manager

E. L. Battey, Asst. Communications Manager

**E**MERGENCY WORK takes on increasing importance in amateur radio. The public has come to appreciate through demonstration of successful operation in many instances, our high emergency communication value. It is important that respect for our institution, amateur radio, be maintained high by continually showing all the useful things that our communication work accomplishes. Emergency work puts across in a striking way that which we most need to have the public appreciate about our ability and willingness to serve. All amateurs can point with pride to the fine job that was done in widely separated areas during the unprecedented floods that ushered in the spring. No individual single-handed can claim the glory; no amateur group is alone responsible; *all* amateurs in all groups did all they could, contributing equipment, volunteering service where operators were needed for relief watches, standing by to reduce interference when that seemed the most helpful thing to do. It was another time when complete coöperation and coördination of individual hams with communicating ability "did a good A.R.R.L. job," which adds mightily to the good record of amateur radio which is now history.

Many practical lessons were taught through the emergency situation, and it is the purpose of these paragraphs to put some of them down for what they are worth, the history being recorded elsewhere. Too many operators outside emergency flood zones (with no power) failed to appreciate adequately the problems of battery and low-power stations trying to clear traffic and establish contacts to important state, corps area, regional, and national headquarters. Too many operators having picked up an inquiry message to move into a flood area worked themselves up to the point of sending a "QRR" or "CQ flood Area" on full power, when some listening would have been more constructive. Be it known—that QRR IS THE OFFICIAL A.R.R.L. LAND S.O.S., A DISTRESS CALL FOR EMERGENCY USE ONLY, TO BE USED ONLY BY A STATION DEFINITELY ASKING ASSISTANCE!

There were, of course, stations busy with the DX tests that had to be called upon to take on emergency responsibilities. One DXer failed to appreciate the situation to such an extent that he actually worked a battery-power emergency

station, desperately looking for a reliable outlet, and instead of offering help inquired about results and wished him "good DX." In another case a telephone call over some hundreds of miles was necessary to clear 'phone channels of a persistent operator proceeding "in lighter vein" without caring whether emergency interests were served or not. Selfish personal viewpoints must be controlled and subjugated to the general good in emergencies.

After the load of seriously important emergency traffic was dispatched, many stations did a splendid job of delivering inquiries relating to personal safety, securing replies in a number of instances. Certain operators were heard to decry such messages as unimportant and "too much work." We do wish that the hams who query the value would receive some of the 'phone calls from highly grateful patrons of our service who assured their out-of-town people of safety during the trying times. These hams might symbolize the situation better by imagining their own close relatives at a distance and in unknown dangers. There are perhaps a dozen such messages to our ham credit for *each* message from an official and, even if the order of merit may not rate as heavily, the sum total of public appreciation nevertheless reaches an amazing total for this class of work. Remember, no one ever files a message, unless with the idea that it will mean something to him or the far-away addressee. All such contribute substantially at any time, emergency or not, to the sum total of public good will and appreciation of amateur radio.

In any time of public excitement it becomes increasingly necessary for communication people to check and double check the source of reports for accuracy and authenticity. Messages should be signed and come from reliable and authoritative sources. Hearsay and rumors must be carefully labelled as such, or better not transmitted at all until *confirmed*. Many of the broadcasting stations were labelled prominently in the press as guilty of exaggerations and false reports after the recent emergencies. An easy flow of language coupled with an active imagination on the part of announcers probably accounts for this. At any rate, it is better not to be hasty, but to aim to be *right*. If possible, link your emergency station direct with the military or civil authorities so

that messages will all be derived from competent sources.

Operating ability is a prime necessity, and is only developed by proper study and practise at times before emergencies develop. This is equally true whether key or mike is used to clear traffic. Of course, supplementing radio stations good men are always needed for telephone and messenger service, but operators who can take stuff without garbles and work at efficient speeds are at a premium, and all too scarce. One must "keep his head when all about are losing theirs." Skill, judgment, and training meet the supreme test when communications emergencies develop. If there are not an adequate number of operators with "savvy," the communication load is doubly heavy for the other good operators in the community. Amateur radio was fortunate in this widespread emergency in having good men in so many communities to shoulder the burden.

A.R.R.L. Emergency Corps stations were prepared and on the job, the following stations taking on useful communication jobs in communities where power was gone:

W1APK	W2BGO	W8BSU
W1BAP	W3AQN	W8DIG
W1BDI	W3BWT	W8DPY
W1BVR	W3CQS	W8HHO
W1GOJ	W3CXL	W8NAW
W1DUZ	W3QV	W8OFO

Preparedness is the all-inclusive term that covers all the lessons. Those who were ready played a vital part, and their efforts were supplemented by those fortunate enough to have power and operating facilities and a will to help clear channels and clear traffic for those in hard-hit localities. The A.E.C. stations and operators were prepared.

To be prepared requires that the equipment be at hand and the operator know what he will do when the power goes, and indeed that arrangements have been perfected beforehand. The A.R.R.L. Emergency Corps is being extended and expanded, the goal "An emergency station in every community." New plans are being laid . . . but we can't go into that yet. Join the A.E.C. today; make yourself a good operator; be ready for the emergency of tomorrow!

—F. E. H.

## DX Notes

About a year ago W9POV, Marinette, Wisconsin, worked OZ7ZL; he thought it was Denmark but his last batch of cards via the QSL Manager included one from OZ7ZL, who gave his QTH as Greenland. W5ASG made contact recently with VHE, whose QTH is c/o Naval Depot, Adelaide, S.A., Australia. This is a government station but the operators, four VK5 hams, have been given permission to work amateurs. They are anxious to work as many W's as possible. G5QY needs contacts with North Dakota, South Dakota, Nebraska, Wyoming, Nevada and New Mexico to complete his WAS; he would appreciate a call from hams in these states.

W1AWX, Hyde Park, Mass., reports a contact with VK3JA on 3.5 mc. at 5:00 a.m. EST, February 16th, using

25 watts input to a pair of '46's. W3ZX needs only Asia to complete WAC on 'phone; he has worked all others on two-way 'phone, and all were raised by calling on 'phone—he worked PK1MX at 8:05 a.m. March 4th and believes it to be the first PK-W two-way 'phone QSO. PK1MX is on 14,100 kcs. from 1200 to 1400 GT. W9FYY and W9DNP, Denver, Colo., have combined rigs and gone in for DX in a big way; on March 30th DNP worked all continents in an hour and fifty-eight minutes. Stations included OH5NR, ZU6P, ZS1AL, VK3KC, T12RC, VK2QC, ZL2QM, J2LL, CM7AB, VS7TC, F3AD and OA4L; all 14 mc. WIDZE claims contacts with 98 countries using nothing bigger than '10's in the final!

VK 'phones were rolling in exceptionally well on 14 mc. on the morning of March 29th. At 3:20 a.m. EST VE3WV worked VK4BB, who later got VK3KX in on the QSO; then VE3WV got VE4AW in and for two hours there followed a 100% solid four-way DX 'phone QSO. This was all on moderate power, too—the VK's were both using less than 50 watts input, VE3WV 75 and VE4AW 115 watts. VU3DV, O. M. Carleson, Andaman Islands, Bay of Bengal, India, has been making some of the lads happy on 28 mc.; among those to work him in early March were WIDZE and W3AIU. W1HJI says that YL4O (on 7 mc.) is operated by YL2AB on some ship; he has worked him several times. W9TJ ran a daily schedule with VQ8AB, Mauritius, on 14 mc. for 21 consecutive days without a miss! W9TJ WAC'ed in one hour and thirty minutes on 14 mc., March 30th; stations were U9ML, VQ8AB, CE1AU, U3QE, VK2BK, VE1EP. This may be a record for W9. VQ8AB operates in the vicinity of 14,025 kcs., T5 tone. U9ML operates on approximately 14,080 kcs., T9.

"You hear 'em, we work 'em" is the slogan of the 210 DX Club. The presidency of the club is now held by W8OSL (ex-8DVS) with a total of 95 countries. He makes the fifth president in the club's six months of existence, starting with W6GAL, followed by W4AKH, W8DVS, W8DWV. The membership of the club now totals 19 and includes W1AQT, W1WV, W3BVN, W4AKH, W5ADZ, W6GAL, W6EJT, W8ACY, W8APD, W8BOF, W8BSF, W8DWV, W8HGA, W8GQB, W8KVX, W8OSL, W8SPB, G2LB, XE2N. The leading "presidential prospects" are W8DWV with 92 countries, W8BSF 83, W6GAL 82, W1WV 80, all using tens or equivalent bottles. Requirements for 210 Club membership in the various continents are as follows: Europe—contacts must have been made with 85 countries; No. Africa 70, So. Africa 50, Oceania 55, Asia 60, No. America 50, So. America 60, Central America 60. Other requirements, which are the same for all continents: WAC, 150 watts or less, tubes of the 210 power rating or those of less. Inquiries may be addressed to W8GQB.

## Ontario 'Phone Network

The Ontario 'Phone Net (OFN) was formed March 1st under the leadership of VE3NX in Wingham, Ontario. Fifteen participants were present at the initial gathering on various frequencies between 3850-3900 kcs. Officers were elected and the group decided to operate twice weekly, Sundays at noon and Wednesdays at 7:30 p.m. on 3853 kcs. Nineteen were present at the first official drill on March 3th. Procedure was formulated and the OFN became an efficiently organized and working unit of which Ontario may well be proud. Plans have already been discussed with the Quebec Section (VE2) for the formation of a net on 3852 kcs., and it is hoped that the Maritime and Prairie Divisions will follow suit so that enough momentum may be gathered for the formation of a trans-Canada 'Phone Net to operate on a spot frequency, net style. Major credit for the Ontario movement goes to VE3NX and VE3FP, who are serving as President and Secretary, respectively, of the OFN.

—VE3QK, Ontario SCM

## O.B.S.

The following is a supplement to the list of A.R.R.L. Official Broadcasting Stations in November QST (page 60): W1JB, W1JSK, W2GQX, W3AQN, W3BGD, W6EQM, W6LNH, W7AAT, W8BDG, W8BZY, W8OFO, W9KEF, W9SDQ, VE3PL, VE4HM.

## Harmonics! Look into your rig, please

Members interested in short wave broadcasting, operators using frequencies assigned the press, and Cairo observers all comment on the interference difficulties caused by "too prominent harmonics" radiated from ham band transmitters. One writer says, "Not an evening passes that I am not seriously interfered with in my reception of foreign short wave broadcasting by these harmonic components. . . . This occurs principally between 5500 and 6500 kcs. and between 7500 and 8000 kcs. I have reported this in several instances to the proper district radio supervisors who invariably lend cooperation, and suggest this be brought to the attention of all members."

It is important that this trouble be corrected at the source. All amateurs are required by the F.C.C. to have transmitters as free from spurious radiations and harmonics as the state of the art permits. The good old absorption type wavemeter tuned to the 2nd, 3rd, etc. up to the 7th harmonic will often show surprising things! Both 1715-2000 kc. band stations and 3500-4000 kc. band stations, and c.w. as well as 'phone operators should look to equipment and make any simple adjustments necessary to modify and correct the conditions that may be discovered.

Improperly high bias, too high plate voltages, over-modulation, and other maladjustments may create strong signals at harmonic frequencies and in addition too close coupling to the radiating circuits, or use of trick systems of impedance matching (and mismatching), may lead to the radiation of such components. Let's each look into our adjustments today and do what is necessary to make the rig work *right!*

## Briefs

On February 23rd the Federal Building at Sitka, Alaska, burned to the ground. WXC, the U. S. Signal Corps radio station, was completely destroyed and the town was absolutely cut off from the rest of the world. Larry Burrow, K7EKE, who is also an operator at WXC, had no transmitter on the air, but he and another WXC operator built up a rig using push-pull '45's. Contact was made with VE5DX at Prince Rupert, B. C., who took rush traffic. With communication established through the Signal Corps station at Ketchikan, Alaska, the improvised ham transmitter continued to do its stuff for four days, while a complete medium frequency Signal Corps station was being rushed to Sitka by the U. S. Coast Guard.

The marriage of two well-known Pacific Coast amateurs was solemnized in Cleveland, Ohio, Saturday, March 28th. Miss Mildred D. Burdick, W7FKS, is now Mrs. J. Raleigh Wildman. The OM is known as W7UJ, former Oregon Route Manager and member of Trunk Line "E," and active A.A.R.S. They are now permanently located in Ohio.

While W9TLQ (327 lbs.) still seems to be in the lead as the "heaviest ham," W9ESL, Valley Falls, Kansas, makes a healthy bid. He tips the scales at 295 pounds!

Did you know that those new beer cans make good shields for 802's and exciter coils? W2HHG says the cans are well built and plenty easy to saw—and in addition to the shield you get twelve ounces of excellent beer!

When W2AQN called CQ on 56 mc. at W2HJ (City College Radio Club) one night at 1:00 A.M., he didn't expect anything unusual to occur. However, W9ADU happened to be sitting in his car at the moment in the lower part of New York City. He had parked and turned on his 56-mc. receiver to see what was doing. It naturally looked suspicious to the uninitiated, and two of New York's minions of the law decided that this bird was contemplating some crime and was listening to police calls. W9ADU pleaded that it was nothing but an amateur transceiver he had in the car, but "Prove it" was the reply. It was at this crucial moment that W2HJ's CQ was heard. A W9ADU-W2HJ QSO resulted and the police were satisfied. After that, W2HJ guided portable-mobile W9ADU through New York's streets until ADU finally parked right in front of HJ!

## BRASS POUNDERS' LEAGUE

(February 16th-March 15th)

Call	Orig.	Del.	Rel.	Total
W8JTT	39	87	1630	1756
W1IHI	70	94	1154	1318
KAIDS	236	201	874	1311
W3FTK	74	53	1100	1227
W6DNH	247	270	678	1195
W1AKS	112	75	890	1077
W1FFL	66	96	876	1038
W1IP	8	45	888	941
W1MK	256	227	456	939
W9FAM	29	33	820	882
W1LSP	15	41	822	878
W8LCX	47	67	762	876
W1DCW	22	—	851	873
W8BWT	108	105	651	864
W8GUF	19	19	14	827
W1LJB	64	42	682	788
W1ICS	347	37	380	784
W5CEZ	105	101	538	744
W2RGP	28	24	670	722
W9ESA	32	114	556	702
W8ICM	19	19	663	701
W1ZQ	5	16	666	687
W2EZY	53	47	544	644
W9SGP	36	41	558	635
W1IJE	100	30	500	630
W8JQE	83	197	336	616
W9HUO	340	4	252	596
W3CIZ	39	62	477	578
W9MZD	21	15	526	562
W8FLG	30	25	500	555
W1IJR*	201	50	300	551
W9RJJ	43	31	463	537
W2HBQ	161	50	320	531
W2HYC	98	22	408	528
W8UW	17	16	498	526
W2GGE	47	83	381	511
W8HCS	21	80	410	511
W8LMD	14	31	466	511
W8MOT	18	6	481	505

### MORE-THAN-ONE-OPERATOR STATIONS

Call	Orig.	Del.	Rel.	Total
W9BNT	139	934	608	1681
KA1HR	482	319	620	1421
W4BBV	57	28	768	853
W1OR	46	78	394	518
W8CXL	37	37	443	517

These stations "make" the B.P.L. with totals of 500 or over. Many "rate" extra credit for one hundred or more deliveries. The following one-operator stations make the B.P.L. for *delivering 100 or more messages*; the number of deliveries is as follows; Deliveries count!

W6GHD, 325	KAILG, 152	W2IBT, 105
W8CXR, 281	W8MNL, 150	W6FGS, 103
K7BND, 165	W8BPU, 125	W9KJY, 102
W7DUE, 153	W1FQ, 117	W1HWL, 102
	VE5ABW, 116	

### A.A.R.S. STATIONS

Call	Orig.	Del.	Rel.	Total
WLQB (W3EOP)	26	19	482	527
WLMJ (W6KGO)	61	104	348	513

### MORE-THAN-ONE-OPERATOR STATIONS

Call	Orig.	Del.	Rel.	Total
WLM (W3CXL)	170	207	1672	2049
WLM1 (W6GXM)	96	239	633	973

A total of 500 or more, or just 100 or more *deliveries* will put you in line for a place in the B.P.L.  
\* January-February.

## Re W.A.S.

It has come to our attention that many licensed hams in the District of Columbia have been bemoaning the fact that stations in the States will not QSL to them, since the D. of C. is not a state and cards and letters from there could not count "in the mad rush" for W.A.S. Many D. of C. amateurs claimed it difficult to get out-of-town stations to answer them at all (!) according to letters received on this situation.

In the future, all stations will be permitted to count for "Maryland" either a confirmation from the District of Columbia or one from Maryland itself. This is logical and fair since the District is located on the Maryland shore of the Potomac River.

The articles by Mr. Crutchfield, W3EUV, and Mr. Bowers, W5EAY, win C.D. article contest prizes this month. Each month we print the most interesting and valuable article received marked "for the C.D. contest." Contributions may be on any phase of amateur operating or communication activity (DX, phone, traffic, rag-chewing, clubs, fraternalism, etc.) which adds constructively to amateur organization work. Prize winners may select a 1936 *Handbook*, six logs, six message files, six pad blanks, or equivalent credit toward other A.R.R.L. supplies. Send your contribution today!

—F. H. H.

## Atmosphere!

By James A. Crutchfield, Jr., W3EUV\*

**F**EW hams realize the effect of station appearance on the general pleasure they receive in operating. There is nothing more conducive to an enjoyable and clean-cut QSO than a neat, businesslike transmitter and receiver in an attractively furnished room; and conversely, more than one amateur who has lost interest in the game could trace the cause to sloppiness in keeping up his station.

Naturally, all of us cannot have expensive rack-mounted transmitters that bristle with meters and gadgets, located in a luxurious suite. But anyone can turn a corner of his room, an attic, or a cellar into something that resembles a den rather than a haystack in a windstorm; and with *QST* and the *Handbook* as guides, he can turn out a rig with a smart appearance as easily as one with the proverbial haywiring—what's more, it will perk better!

My own station used to be a perfect illustration of how an unpleasant location can ruin one's interest in the game. I was forced for lack of room into the cellar, together with the furnace, the fire-wood, and all the unwanted furniture. The situation was not helped any by my own deplorable lack of neatness in construction, and I began to drift away from ham radio rather rapidly. Then, chiefly because of the invaluable aid of W3EQZ, things began to happen. Walls were neatly decorated with maps, pictures, and QSL cards; a few comfortable chairs and a new table took care of physical needs; more important still, the rig was rebuilt rack and panel style—with no haywire. The station proper was moved to one end of the cellar, away from the workshop, woodpile, and furnace.

The result was a revelation to me. The old transmitter didn't grind out any more watts, nor did the receiver pull in any more DX; but quality, quantity and interest in operating increased unbelievably. It is a real pleasure to slip down to a comfortable little room on a rainy day, hit the switches with some assurance that the fuses will hold, and click off a few QSO's. Amateur radio means something again; it is again a hobby instead of a source of irritation and disappointment—all because a fellow-ham helped me make the appearance of my rig more attractive and provide the proper operating "atmosphere."

Take a look at your station, OM. If it isn't the kind you are proud to show visitors, turn to for a few days and make it so. You'll be well repaid by the difference it makes in the pleasure and benefit you get from radio.

\* 2705 33rd Place, N. W., Washington, D. C.

## Perfection—Not Speed

By S. E. Bowers, W5EAY\*

**G**OOD operating practice" is an expression that covers a multitude of virtues, many of which the young ham cannot be expected to know "right off the reel," but there is one fundamental that every one, from the proud possessor of the latest ticket issued by the F.C.C. to the old-timer who learned his code in the spark coil days, should know and practice.

It is the first principle in amateur radio, yet it is surprising how many believe that a mediocre ability is sufficient to get

\* Aitalfa Plantation, RFD 1, Boyce, La.

by. This basis of ham radio is nothing more nor less than being able to make those simple little dots and dashes and make them so they may be understood. If any one believes that all hams know how to send, all they have to do to become convinced of their error is to listen in on a ham band and then tune over among the commercials.

For a ham's own benefit he should have a good fist. Every day, hundreds of CQ's are heard but unanswered simply because the listening operators do not care to take the trouble to translate something that sounds like a baby beating on a board with a stick. Good sending on a pair of '40's will get more DX than will a poor fist on a KW rig. Good sending, with the use of abbreviations, speeds up contacts and makes room for some one else. Abbreviations are legitimate and should be used, but when used, the letters that are made must be made correctly, or the man on the receiving end will throw his send-recv switch and start calling CQ for another contact.

There is no trick about good sending, and a bum fist is generally a sign of pure carelessness rather than lack of possible ability. Here are a few rules that may help: have ample room on the table for the arm, it is better to have too much than too little. Hold the key firmly between the thumb and first and second fingers. For slow or reasonably slow sending, adjust the space between the key points to the width of a thin dime, and then really make dots, dashes and spaces—and don't forget the spacing. Quite a few hams fail to realize that proper spacing is as necessary as correctly made dots and dashes. For an illustration, take any three-letter call, mix up the spacing and see how many different calls you can arrange. Add to improperly proportioned dots and dashes a good measure of bum spacing, and it is no wonder that a lot of hams wear out an arm before getting an answer to a call.

As for speed, an old and recognized rule is to send no faster than you can receive. Be snappy, but not too snappy. When sending slowly, make your letters correctly and let the slowness come in the spacing between the letters and words—do not make long dots and longer dashes. And the next time you call CQ, don't make "NNQ." If you must test on the air, say "test" not "nst," and, although it is not relative to the subject, when testing, don't hold the key down forever for the pleasure of busting up somebody's pleasant QSO.

Remember, it is better to send good, readable code at 10 words per minute than to stumble along at high speeds with characters that disgrace the art and yourself both! If the code you send is sent well, you need not worry about speed—your ability will be respected by all operators!

## BRIEFS

In retiring as Montana Section Communications Manager, O. W. Viers, W7AAT, leaves behind a service record of nine years, 110 months! This is the longest term of any SCM. When C. S. Hoffman, Jr., W8HD, resigned as West Virginia SCM he had held the office for four successive two-year terms.

## Ontario R.M. Net

The Ontario Route Manager's Net, organized on January 27th, operates on 3762 kcs. Mondays and Thursdays at 7:30 p.m. The object of its organization was primarily to afford the S.C.M. constant contact with the various localities within his Section. The members of this group, besides moving traffic during network drills, exchange many timely suggestions which all go towards maintaining an active and efficiently working field organization within the Section. The net includes VE3WX, VE3QK, VE3TM, VE3DU, VE3GT, VE3SG, VE3PL, VE3GG.

"Many have condemned long-winded CQ's, in which we all agree. Another bad practice is 'duplex.' If our bands were four times as wide as now, 'duplex' phone operation would cause QRM that would be 'just too bad!' But with the present bands—!!! Duplex is getting to be on the march lately.

A march which I feel would be disastrous should it be universally practiced. The push-to-talk system would give almost the same advantage and would lessen instead of increase the QRM. So I say, "Down with duplex and up with the push-to-talk system!"

—C. E. Chilson, W1COS.

### W1INF (for W1MK)

Due to W1MK salvage operations that station is off the air. As soon as possible the Official Broadcast and other schedules will be picked up on the same 80-meter band frequencies and at usual times, from W1INF, using the automatic transmitter salvaged from W1MK.

The present members of the Phillips Academy Radio Club, W1SW, would like information about the club in years gone by. They would like to hear from old members, those at the Academy prior to 1930, as to when the club was first organized, where meetings were held, what sort of equipment was used, operating records, etc. Photographs of any of the old outfits would be particularly appreciated. Any former members of the Club are asked to write to George G. Symes, Jr., W1EFM, Day Hall No. 2, Phillips Academy, Andover, Mass. After June 1st letters should be addressed to the South Street Inn, Pittsfield, Mass.

After emergencies make sure that amateur radio gets credit for the work you do. Don't feel any compulsion to be "modest" about this. It's not a matter of personal glory-seeking; it's a matter of vital importance to the entire institution of amateur radio that the art gets full credit for all the work done by its membership. We depend for our existence on our public service activity; when you contribute such service, and when you see that it is adequately publicized, you are doing your bit toward guaranteeing the continued existence of amateur radio.

### Hams Afloat

K4KD and K4RJ extend to all hams running into Porto Rico (San Juan) as commercial ship operators an invitation to look them up. K4KD can be located at the Pan-American Airport, Isla Grande, San Juan, phone Santurce 1884, or at his home, 1194 Blue Santurce. K4RJ can be located at RCAC San Juan, Ochoa Building, phone San Juan 1960, or at his home, phone Santurce 879 Green. When W5ASD came in on the S.S. *Fairland* he was shown around the local stations by RJ and KD; he met K4UG and K4AOP on this trip.

W4CMN is keeping the spark rig buzzing on WKCA the S.S. *Carolyn*. W1JFV is sailing as Seaman on the S.S. *C. J. Barkdull*. W8FOO, Radioman in the Coast Guard, is now aboard the U.S.S. *Yeaton* with mailing address at Gulfport, Miss. Operator on the S.S. *Malacca*, KERT, is W9LNX. From W6GTM comes word that W6HQM is Sparks on WOPF, the *Cabrillo*, largest Tuna boat in the world, running from San Diego to the fishing banks Galapagos Islands. W8DYM, ex-W4AJL, is Radio Officer on the S.S. *Winston-Salem*. W1BZO is back of the gear on KMOU, the S.S. *Edward Pierce*. W7DAV is on the U. S. Army Transport *Meigs*, signing WUAC. W7CPK is operator on KFEW, S.S. *North King* of the Pacific American Steamship Lines. W7AF is engineer on a cannery tender at Squaw Harbor, Alaska, and maintains K7AIF when tied up there in the evenings; he has maintained a bi-weekly schedule from K7 with W7AJ for over four years during summer months. W7AF's sister operates W7AF while he is north, and W7AJ QSP's traffic between them.

VE5LQ is operator aboard the British Columbia Police

## OBSERVERS' HONOR ROLL

### Cairo Commercial Occupancy Survey For March 1936

6000-8000 kcs.

W2HMK	W9GY	W1IKC	W7EYB
W8NQ	W9LHV	W1BQ	W7FCG
W1ILL	W9SXL	W2GTA	W7FFD
W4DNA	W9UIZ	W3DRO	W7FGH
W1ABG	Jas. C. Hayes	W3DXC	W8BFF
W7DYH	W10A-3	W3QOE	W8KWA
Walter R. Paries	W2CSH	W4BUC	W8LVH
W1BGJ	W2LXQ	W5DWV	W8MMF
W7DXF	W4CYV	W6AF	W9DIB
W9EPK	W7FDZ	W7BDD	W9RLR
W3EQP	W9RQR	W7BPM	VE3AGI
W7AAN-DRF	VE8SQ	W7BVM	VE3TH
W9LEB	VOIC	W7CWN	VE3WK
W9TAY	W1AMH	W7DTK	VE3ZE
W9GMT	W1ICW	W7ENQ	

4000-4500 kcs.

W1AFO	W1IPU	W1IKC	W2JFZ
W1AXS	W1JCN	W1ZO	W3CGU
W3EQP	W2DPA	W1JAC	W3EBC
W8NQ	W2HLK	W2AUQ-	W4DXI
		W8MZN	
W1CAB	W1BGJ	W2IMB	
W1GTS	W1ICW	W2LXQ	

Director Carl L. Jabs has appointed Mr. Oliver S. Keay, 169 Seymour Ave., S.W., Minneapolis, Minn. to be in charge of Cairo survey work for Minnesota. He has also appointed Mr. Scott Davison, Miller, S.D. to be in charge of surveying operations in South Dakota. All clubs in those states are asked to communicate with Mr. Keay or Mr. Davison for forms and information. Blanks for individuals are also available on request. Work in each state will be coordinated by the individual in charge.

Patrol boat PML No. 3, with call sign VGZK. During the past year he has signed VGPM, GSYX, VGWS, VGWQ, VGFD, VGCL, VGDS, VGPK, CZH and CZF, the latter two being Police central stations. On these various assignments VE5LQ has operated everything from a 3-watt battery 'phone-c.w. rig to a 500-watt c.w.-i.c.w. rig, and from a 1/2-kw. spark to a 5-kw. spark set. W6BLZ found W6JQB swinging his hammock next to him at the Naval Training Station, San Diego. On a conquest for more hams they found W6LJS, W7BMM and W6LEL, all in the same barracks. W8QH, old-time ship operator, lists the various berths he has held and invites other old-timers who may remember him to drop him a line: KFCN, WJT, WED, TAY, WVOI, KOBV, KSOU, WECW, WADQ, KDMQ, KIJT; at present he is at WMO, Police, Highland Park, Mich. W1CPH is operator on the *W. C. Teagle*, WSCB, running from New York to Venezuela. The outfit is a pair of '01A's with 500-cycle juice. The *Teagle* is quite well known in Maritime circles, holding the World Championship Life Boat Crew Trophy. W1CPIH's past berths have been WECJ, WRCZ, WBDA, WBDW, KGOX, KJSJ, KDWZ, KDGQ.

W9SBH is operating on the S.S. *Nevada*. W4ART is on the S.S. *Colorado*. W4CV is aboard the Woods Hole Oceanographic Institution's Research Vessel *Atlantis*, WCFB. W9IFD is now signing WQBV on the M.V. *Australia*. W9RVU is on the U.S.S. *Altair* at San Diego, Calif. W6HRX is operator with the tuna fleet plying out of San Diego.

## BRIEFS

### Michigan 1.75-mc. Network

W8LZV, Detroit, is organizing a network of Michigan stations to further cooperation between 'phone and c.w. operators, to maintain a high standard of operating on the 1.75-mc. band, to organize a statewide group of stations for emergency purposes, to facilitate delivery of local traffic and to encourage the exchange of traffic between 'phone and c.w. stations. A weekly meeting will be held on the air called the All-Michigan Round Table. Any operator interested in

joining the network is invited to get in touch with W8LZV. Kurt R. Schmeisser, 13117 La Salle Blvd., Detroit, stating regular operating frequency, number of bands used, whether Class "A" ticket is held, what operating times are available and what day and time is most suitable for the Round Table.

W1KH says the new "Noise-Silencing Circuit" has solved the oil-burner troubles on his early morning schedules with the Grenfell Mission, Newfoundland. He adds, "You might say that noise is 'taking it on the I.am(b)!'"

The Los Angeles territory has been divided into three "areas," each consisting of five local districts. Each district is supplied with a transmitter and manned by sufficient amateur operators to handle the necessary work. W6IHK, R.M., advises that the Committee has furnished each of fifteen district chiefs with genmotors and AT crystals for spot-frequency operation. The emergency sets consist of one Type 41 crystal-controlled oscillator, and a receiver composed of a Type 6C6 detector and 76 audio.

New recruits are needed by the Los Angeles Amateur Radio Emergency Committee. Any amateurs who wish to obtain valuable training in emergency and traffic drills are invited to communicate with the Secretary, W6ETX, 639 N. Lafayette Place, Los Angeles, Calif.

W3ZI says W8OYK has nothing on him when it comes to "number of different calls held." In his 24 years of radio he has held 3NG (1915), 3CS (1919), 3ZI (1921), 3AEC, 3XAN, W3ZZB, W3ZZH, W3ZZL, W3AOV, W8GHY, W3CMH, a total of eleven. W8BTM has held the following calls: 8AYW, 8BTM, 8ILV, 8ICK, 8MI, 8CRF, 9FPT, 6GEC. 8MI and 8CRF were held between 1919 and 1923.

W5FKQ received the surprise of his life recently when, after answering CM2AF's CQ, the CM came back to W6FKQ. It was one of those "once in a lifetime" things!

The latest "network" to come to our attention is the "Dark Brown Network," an organization of 56-mc. hams in Columbus, Ohio. The members of this group operate all on the same frequency and, by means of quick-change automatic, hand, or foot-operated switches, each operator can listen in on the round-table discussions without having to retune each time a different station has the "floor." Members of the Network include W8EQV, president; W8IJ, president of the Columbus Amateur Radio Assn.; W8LEN, secretary of the C.A.R.A.; W8NPW, W8ABO, W8DCS, W8DUC, W8BYR, W8OHB and W8BYV, secretary. The official meeting time is 8:30 p.m., Tuesday. Meetings usually last an hour or more, followed by another hour of informal discussions. The network would like to arrange tests with stations outside Columbus. Communications concerning such tests should be addressed to the president, W8EQV, or the secretary, W8BYV, Jay N. Edmondson, 1280 Broadview Ave., Columbus, Ohio.

Something new in emergency work comes to light in Indiana. During a regular A.A.R.S. drill period in Hammond, W9ODH called his NCS, W9TGC, and reported that his wife had just been held up in front of their home. Having no telephone W9ODH asked W9TGC to call the police. But—W9TGC had no 'phone either, so using regular emergency procedure TGC raised a third A.A.R.S., W9CB, who called the central police station. The police radio system went to work and in very short order squad cars were arriving at W9ODH's shack in a most abundant fashion! . . . six in all . . . and this was just eleven minutes after he had first called W9TGC.

VE3ED, the Central Technical School station, Toronto, Ontario, wishes to thank all hams who helped with QSO's and QSP's during the annual school exhibition March 7th. Transmitters were operated on 28-, 14- and 3.9-mc. 'phone and 7- and 3.5-mc. c.w. Operators were VE3CN, VE3FB,

VE3AIB and VE3IZ. A 28-mc. portable was installed in an aeroplane and was successful in contacting outside stations; a duplex QSO demonstration between the plane and the 3.9-mc. 'phone was also given. The 150-watt 14-mc. 'phone was successful in handling six messages direct to British Columbia. To top off the day a well attended hamfest was held by the school.

### VE3 3.5-mc. QSO Contest

VE3AEM was winner of the SCM's cup in the recent VE3 3.5-mc. QSO Contest with a score of 3885. Scores ran as follows: VE3QB 2409, 3ADF 2040, 3AE 1044, 3AHL 1008, 3GT 954, 3ACS 801, 3DU 504, 3ADD 434, 3SG 420, 3SS 364, 3WX 346, 3QK 336, 3AET 162 and 3ZE, who received the special Sur-prize, 112.

In the "larder department" of amateur radio we find W8OIX, Duck; W8DW, Quail; W1FW, Ham; W1FTY, Salmon; W8MPX, Bacon; W2BYT, Beans; W3AYE, Rolls; W8HKY, Weiner; W6EAB, Rice; W8CCR, Cheese; W6ECX, Pickles; W8JPT, Punch; and W1AL, Lamb!

W6AM reports that he worked all states from 9ZT in 1922-23 on 200-meter c.w. While not substantiated by confirmations, this claim follows W2EQS' challenge (page 69, April QST) that he will be the first to receive WAS certificate for 160 meter c.w. work.

W2TO, operator on a Dollar Line boat, travels around China and Japan taking motion pictures of hams and their stations; these he shows to fellows in the U. S. they have worked. Likewise, pictures of U. S. hams are reeled off for the benefit of Asiatic hams.

W2FBU reports free code practice classes being held daily Monday to Friday, 2:00 to 4:00 p.m. and 8:00 to 10:00 p.m., at 132 West 138th Street, N.Y.C.

### Frequency Checking Service

W2DBQ, operating "Ham Crystals," Piezo-Electric Specialists, 1104 Lincoln Place, Brooklyn, N. Y., offers a free frequency checking service to radio amateurs. To take advantage of this service it is only necessary to heed the following instructions carefully. Due to limited facilities correspondence concerning the service cannot be entered into.

(1) The service is available only to amateurs in the 7- and 3.5-mc. bands, including 3.9-mc. radiophone. (2) Checks will be made only at these times: Tuesdays—10 A.M. to noon, 3:00 to 5:00 p.m.; Wednesdays—2:00 to 4:00 p.m., 8:00 to 10:00 p.m.; Thursdays—10:00 A.M. to noon, 9:00 to 11:00 p.m.; Fridays—1:00 to 3:00 p.m., 7:00 to 9:00 p.m. All times are EST, holidays are excepted. (3) When requesting a frequency check use this procedure: (a) Send self-addressed, stamped envelope. (b) Be sure to mention your call letters. (c) State day and times of preceding schedule you can be on the air. Mention the whole two-hour period and W2DBQ will notify you *exactly* what time to be on. (d) State your approximate frequency. (e) Make note of the room temperature when transmitting for check. (f) Be sure you will be within the receiving range of W2DBQ at the time you choose. A fairly strong signal is required for an accurate check. (g) At the time W2DBQ designates, it will be necessary to transmit for five minutes, sending as follows: V V V de W2— W2— W2— V V V, etc. At the end of five minutes, hold down the key for one minute. In the case of 'phone stations they will say, "Testing for Frequency Check" and then leave carrier unmodulated for one minute. Be certain to have the exact time. Check your clock with an accurate standard. (4) On 3.5 mc. calibrations will be guaranteed to be within 170 cycles. On 7 mc., within 340 cycles.

The Revolver Team of the First National Bank & Trust Company of New Haven, Conn., is desirous of arranging a radio match with other teams. W1GC will handle the radio arrangements at the New Haven end. Anyone interested



should communicate with Fred Brill, W1GC, 35 Howard Street, West Haven, Conn.

-----  
The business of spelling out all numbers in messages for accuracy can go a lot too far. An example came to our attention the other day where it resulted in inaccuracy, a message from W9BB being received signed E. Russell W EIGHT MAN instead of E. Russell Wightman!!

-----  
W9NWE of Chicago doesn't agree with W2EYG, N.Y.C., that EYG's is the most "ham-crowded" locality in the world, with 14 hams all within key-click distance. W9NWE reports W9JNF NOV OBS GSB PAK LVM WAF VRX SRI LC SZW FXT GJC UTJ TMQ MHY LLR JYZ MEL MXL IWK RMA STG BON and VY—25 calls—all within key-click radius!! The next time you have local QRM think of W9NWE!

### Bravery!

On February 7th W3CQS, Ed Thompson, was one of a party of volunteers who attempted to take 2000 pounds of food, medicines and an amateur radio set to Smith and Tangier Islands in Chesapeake Bay, which were isolated by ice. The two thousand or so inhabitants were in danger of a food shortage and needed medical supplies. The party, consisting of four Maryland State policemen, two Coast Guardsmen and nine civilians including W3CQS, left Salisbury, Md., in a blinding snow storm, pushing their supplies and radio set over the ice on two sleds. Most of the party soon became exhausted and nearly frozen. Three of the men including Thompson fell through one of the many treacherous spots of thin ice. All three managed to return to firm ice, but the wetting resulted in one man, a Sergeant of State Police, freezing to death on the ice and Thompson being carried back to shore unconscious, his clothes frozen stiff. Thompson subsequently recovered after hospital treatment. W3CQS, a member of the Army Amateur Radio System and holder of the special call WLQW, received from the Chief Signal Officer of the Army a letter of commendation on the extreme courage displayed in this dangerous expedition.

-----  
A duplex radiophone contact between W4OA, Mobile, Ala. (3990 kc.) and HJ3ABD, Bogota, Colombia (6050 kc.), made it possible for William Alford of Mobile to talk with his two brothers in Bogota for the first time in 22 years. Contact was established at 11:00 p.m., January 23rd, through a prearranged schedule established with the aid of TI2AV and other Costa Rican stations. A highly successful conversation was maintained for two hours and forty-five minutes.

-----  
A novel method of mounting QSL cards on the shack wall is to use lengths of dressmaker's bias tape, stretched along the wall and held in place with thumb tacks spaced approximately three and one-half inches apart. The cards are inserted cornerwise, all at the same angle. This results in a neat and attractive display with the added advantage that individual cards may be slipped out at any time for closer inspection. The tape comes in various widths and colors and can be purchased at any five-and-ten-cent store.

—VE4JV

## STATION ACTIVITIES

### CANADA

#### MARITIME DIVISION

MARITIME—SCM, A. M. Crowell, VE1DQ—Nova Scotia: VE1GL, in addition to his R.M. duties and schedules, has landed his tenth country on 3.5 mc. HH schedules ER daily, GS Sunday, and O.B.S. twice weekly. GU reports direct via Maritime Net. IV is still on 3.5 mc. HX is working 3.5 and 7 mc. FW landed IIRA on 7 mc. and G5VQ on 14 mc. EY works DX on 7 and 14 mc. BZ left for Antigua and other points south for his health—on three months' trip.

Bon voyage. OM. AA works the W6 district consistently on 14 mc. FT is putting in some work on new portable receiver. GB is on 3.5 mc. mostly. GE is still hitting 14 mc. AP, the new R.L. Summerside, is chasing QRM. CO gets swell reports on his 28- and 14-mc. sigs. FR says he's lowest power ham in Maritimes. AC has a new super. AF is on 3.8-mc. 'phone. CW is new Summerside ham on 3.5 mc. JG, also Summerside, works at the local B.C. station—CHGS. BE is active on 3.5 mc. CV is on 7 mc. mostly. DO is putting 100 watts into '10's on 3.5-mc. 'phone. HJ burnt up his r.f. unit. BC is going again on 3.5-mc. 'phone. EF with the cooperation of the F. C. Manning Co. has been assisting local 'phones improve quality and check modulation percentage. AW is not quite satisfied with his rack and panel rig. A1 is active on 3.5-mc. 'phone. EA is adding RK20. FE is using double doubler for receiving. GD has new rack and panel job on 3.8-mc. 'phone. GH and GC are quite active on 56 mc. EX built new Collins Net. HV puts a nice sig into 4th and 9th W's with his 1.75-mc. 'phone. BT built up one of the neon oscilloscopes. CV is using a 59 suppressor grid mod. CA burnt out all the tubes in his transmitter. New Brunswick: GI has pair of ten's in the final. CX schedules GP on 3.9 mc. IK is amused over the DX reports of the Moncton gang. JJ is building a 56-mc. transceiver. DC is building new 56 and 28-mc. rig. DI worked his first W4 and W9. GS is working on 56 mc. DL is rebuilding to parallel '45's in final. EV worked ON2MV on 7 mc. with a '45. CF was recent visitor to DC and spoke at the club meeting. Newfoundland News (by VO1W): VO1A is coming on 14-mc. 'phone. VO1C is still doing Cairo Survey work. VO1F is active with '59 e.c. osc. VO1G is active on 3.5 mc. with '52 osc., 1000 volts on plate. VO1H is active on 14- and 3.9-mc. 'phone. VO1I has 53 in osc. VO1L is pleased over the fact that he was heard in England on 3.5 mc. in the B.E.R.U. tests. VO1N is active on 28 mc. VO1P has 53 crystal, RK20, pair of 50-watters final. VO1U is active with '45 osc. VO1V sends code practice every Monday and Thursday from 6:30-6:45 p.m. AST on 3519 kc. VO1X is active on 14 mc. VO4Y is active on 3.9-mc. 'phone. VO3O is new ham on 3.5 mc. VO3EM is active on 7 and 3.5 mc. VO2Z schedules VE1GL for traffic. Slight mistake in March QST—VO4Y was not first VO to work 28 mc. outside Nfld. VO1N (ex-VO3MC), under call VO3MC, worked couple of W's and G's on 28 mc. about 5 years ago. All the gang is getting portables underway for the summer, especially VO1I and VO1H. The N.A.R.A. holds regular monthly meetings first Monday every month at the QRA of VO1H. The local publication of the N.A.R.A. is to be mimeographed now.

Traffic: VE1GL 128 ER 190 HH 24 GU 8 IV 6 HX-FW 2 EY 3, VO1W6.

### ONTARIO DIVISION

ONTARIO—SCM, John Perdue, VE3QK—R.M.'s: 3WX, 3QK, 3DU, 3TM, 3GT, 3SG, 3PL, 3GG. P.A.M.: 3NX. 9AL is still waiting for bids on moving his new rig into proper diggin's. ABW again hit the B.P.L. IB is searching the spectrum for Asia. TJ has his new rig perking after many weeks. PM is trying 14-mc. 'phone with the rig late of VE9CNE. FK and AHW are active on 3.85-mc. 'phone; the latter hops between Montreal and Toronto and signs VE2DX while residing in the former. KF and ER choose 28-mc. 'phone. Memo to XX, AFW, AAG and MR: "Why don't you form a VE3 'phone net on 160!" 9EW puts a healthy 'phone signal most anywhere on 3.85 mc. and boasts two FB ops, Jim and Mrs. Jim. AE keeps FB schedules on 7 mc. WB acquired W.A.C. and W.B.E. after a QSO with VU2BG with a pair of '10's. XU tells about the Central Tech Exposition at which ED represented our ancient pastime . . . meaning Hamming. TH reminds us that March 16th marked the passing of Cliff Bond, VE3JD, just a year ago . . . his kind friendliness will long be remembered. KM and the gang are building an 89x-802 rig in a case with the laurels of the coming Field Day in sight. FP is heard from Fruitland as Sec'y of the OFN. QH is thumbing-down all supers. NH uses an RK20 on 28 mc. AFA has given the nod to 'phone. DO hopes his second attempt at super-building is better'n first one. ADF and QU are ether-busting with great success. VZ is dreaming of unlimited 'phone. QE is growing antenna sticks. AEM is getting DX bug and the

"barber's swing"—scallions! DU has been visiting the YL's in Victoria Hospital with an R9 case of inflewendways. AEV is the Forest City's Medical Ham, GC has a fine 'phone signal on 3.85 mc. and works into the O.F.N. with AEV . . . speaking of Medics, NC in Little Britain is a doctor-upper with the 'phone gang on 3.85, and he gave a nice paper to the High School Literary Society on Ham Radio. NQ arrived from Toronto, and is making us all like him. ADN is on the verge of completion as a 'phone. EC will be on 3.5 mc. each Sunday a.m. Welcome back, Rick! ABT cannot seem to tear himself away from the flickering squawks . . . in the projection room. AHL is no longer found in the "Sounds-Of-The-Night" column; he's crystal now. MY is DXing with a brand-new pair of '10's on all bands. AHK on 28 mc. needs Asia for W.A.C. AIL and AHN are heard on 7 mc. OC just completed a derrick to lift a new power house to the shack on the second story. GP has degraded to 14 mc. ZV worked K5. AFJ is hands-across-the-table with a YL. The Frontier Radio Club visited Detroit's Motor City Radio Club. QB brags of a "Heard" card from Germany on 7 mc. with a 201B in the final!!! SV and AET work Europe with a single 59! SN is heard from Galt with 3.85-mc. 'phone. PC is soldiering at Camp Borden. WV chucks 3.85 for 14-mc. 'phone. ZR needs ice-packs; the YL's have him in their power. ZA and VP are heard in the O.F.N. every week. RB promised application for O.R.S., and now we find him on 3.85-mc. 'phone. VT, CI, ACN, HX and JU all favour 'phone and are very active on 3.85 mc. ACS is changing to 59x-59-841 to replace the old '10's. QI is using a '03 in Orillia. XO and VG are QRL Toronto. QM, we are glad to hear, has recup-ed from an operation and can now brag with ACS about his incision. The Cardinal gang include UO, XS, LB, AER and an active radio club with their own a.c. code practice rig, a portable transmitter, a 56-mc. squirter and a host of enthusiasm. MB sends his nineteenth consecutive report stating that he received the scare of his life when an a.c. line got friendly with old man ground and blew his 82. The usual FB letter and blanket report on Kirkland Lake doings came from AGM. AGG is "El Ropo-ing" on his recent blessed event. FB, VN wants to know how come filter condensers blow every time he throws a new exciter unit together. RI is recovering from serious accident. AFR and AGL are active on 7 mc. AA and ADP are official pinch-hitters for GG when he is marooned by ice and Brass Hat trouble. Newmarket boasts of YS on 7 and 3.5 mc. with 2A5-46-RK23. Aside to all VE3's: "Why not let's try and give the Fone Gang on 3.85 mc. a break—the area between 3750 and 3850 offers about the clearest space in the 3.5 mc. band for group operation, and, in order to relieve congestion in the Canadian Fone Band and at the same time strive for centralization of VE3's in the 100 kc. between 3750 and 3850, why not make an honest endeavour to convince your cronies that the sooner we all gather around that vicinity the more quickly we will be able to find a VE3 QSO when we want one." Aren't you interested enough in this suggestion to drop me a note on it?

. . . I didn't originate the idea, nor do I know who sent the anonymous suggestion. However, whoever, and wherever it sprang from deserves an orchid, and the fact that I don't even know them is a double reason for the posey. 73.

Traffic: VE3ABW 447 GG 208 QK 153 AEM 140 WX 139 WK 118 TM 06 IR 81 VZ 77 MB 73 ED 62 PL 48 DU 45 SG 27 CP 10 AE 9 AU 6 WB 4 TH 3 ACS-AHL-EM 2 NX-RO 1. VE9AL 18.

#### QUEBEC DIVISION

QUEBEC—SCM, Stan Comach, VE2EE—Active in the DX contest: GO, AX, BU, DR, EW, JK, CR, CA and EE. CR and AX both hooked that elusive VS. Congrats. The S.C.M. snagged a VU for W.B.E. HM is with us again. Welcome back. AP has been digging out the old fishing rods. Doug Jarvis, x2AG, went North to join LQ, CU and GZ. LM is changing QRA. BE had trouble with speech equipment. CA, HG, BU, EW, HP and EE are on 28 mc. JY is contemplating that band. JQ has a beautiful harmonic on 28 mc. GO gets out well with new transmitter. DR has fully recovered from illness. EK was recent visitor in Montreal. IJ purchased an RK-23. IY is still handling traffic on low power. LV has received his super-gainer. LJ was so taken with it that he has started building one. 3PP is attending

McGill. LN has had trouble with his transmitter. JK is using a new rig. IN is busy studying. FK built himself a super-het. HH is looking for traffic schedules. BT is building an elaborate rack with receiver, freq. meter, etc., 26 tubes in all. DM is coaching a newcomer. DU strung a new skywire. AM is talking of plate modulation. xVE2CH wants to be remembered to all the gang. CO is building new receiver. JA is an old call but a newcomer on the air. BO has been under the weather, but is recovering. LU has been heard on 14 mc. FF is selling his receiver. LX is handling traffic at Maniwaki. This will be Convention issue. Many local hams have volunteered to billet out-of-town visitors, especially those from across the line. Anyone desiring accommodation kindly get in touch with the S.C.M. or the M.A.R. Club Secy. Come, See, and let Montreal conquer. In recent severe snow and sleet storm lines of communication between St. Johns, Que. and Montreal were entirely out of commission. Contact was maintained on 1.75 mc. by VE2HE in Iberville (across the river for St. Johns) and HV, IR, KW and JJ in Montreal.

Traffic: VE2DR 206 DG 195 JK 79 EC 68 BB 69 LX 14 HH 9.

#### VANALTA DIVISION

ALBERTA—SCM, Alfred D. Kettenbach, VE4LX—AW is on with an '03A. LX moved back to Rockyford for the summer. LE is going to high power. BZ is going East for a visit. EO and AF are going to hold down the trunk line during his absence. GM is new O.P.S. and O.B.S. QK is organizing a Provincial Traffic Net to facilitate delivery and collection of traffic in conjunction with the trunk line. HM is new O.R.S. and O.O. PH and UY are going strong on 28 mc. EZ returned to Edmonton from Vegreville. ZP has returned to Edmonton.

Traffic: VE4LX 88 BZ 40 QK 21.

#### PRAIRIE DIVISION

MANITOWA—SCM, A. J. Simpson, VE4BG—Your S.C.M. is back on the job and thanks Cliff Ferguson, R.M., for the very FB report of last month. TJ claims DX honors with 45 countries to his credit. RO with his dual rigs works Europe daily. DU is heard on 14 mc. Plenty of DX is heard calling BQ. FT is on again. GC is on with his '52. GL is on high-power Class B 'phone. KU shows us how to work out with low power. DY is considering tube changes. GQ is busy making the annual inspection of the local gang for the R.I. IP puts out a nice signal with his 'phone. KX has his RK20 modulated. LH is going to build a super. LL has given up his 'phone rig. NI divides time between 14 and 28 mc. NM is putting out a strong signal on 14 mc. MW is having difficulty maintaining eastern schedules. AG devotes his time exclusively to the trunk line. MY keeps schedules on 3.5 mc. QF made a few changes in his transmitter. QC is trying to find the right combination in his locked amplifier. VI will soon be on with a T250 final. ZK is trying to master a bug key after getting a glass arm.

Traffic: VE4AG 241 MK 29 VG 26.

SASKATCHEWAN—SCM, Wilfred Skafte, VE4EL—VQ reports rig working FB since rebuilding. JV worked FA8BG on 28 mc. IG worked four new countries on 28 mc. KA finds a new ham band around "12 meters." HI. ZC worked his first DX, an XE on 14 mc. OM worked F8 and his first VE1. LV is hunting DX on 14 mc. JU wants to trade rig for good Jews Harp. EP is active on 7 mc. FW reports RK-20 FB. RE lost antenna in windstorm. Mrs. IG worked VK on 28 mc. Congratulations. KM sold his '03A. UQ has now kept 5G1 schedule for six months. XM tried 28-mc. 'phone without much success. UK rebuilt for 28 mc. BD rebuilt transmitter. HP is experimenting on 56 mc. SK intends to go on 7-mc. and 1.75-mc. 'phone. DI gets good DX from rebuilt 14-mc. 'phone rig. LJ has new t.r.f. receiver. UZ has trouble on 14 mc. OC has good results on 28 mc. YC gets nice reports from 1.75-mc. 'phone rig with grid modulation. UL appreciates the very nice cooperation he is receiving from hams reported off-band, with bad notes, etc.

Traffic: VE4CM 105 DI 49 SK 30 EL 9 UL-EJ 2.

(Continued on page 10A)

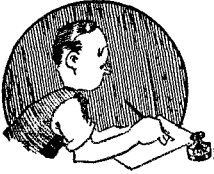

# CORRESPONDENCE

The Publishers of *QST* assume no responsibility for statements made herein by correspondents

## In Reply to "An Open Letter"

3510 Porter St., N.W., Washington, D. C.

Editor, *QST*:

I was inspired by VE3GG's plea in the January *QST*. My QSL is all made out to apply, and will be mailed as soon as the receiver's construction is completed.

It might be conjectured that VE3GG was excited when he mailed the letter. Certainly, much as I agree with the part of his letter printed in the January *QST*, the part printed in the March issue contains much that is unfair and untrue. I refer to that part concerning the younger hams. I was thirteen years old a year ago when I got my license, and so must be within this group. In my acquaintance with hams, of whom a considerable number have been of high-school age, I have found none of the type referred to, except a few who were over 21 years of age. Age is a criterion of neither operating ability nor willingness to cooperate; therefore it would be unfair to impose the limitations which he proposes. Furthermore, the most worthwhile things in life are ostensibly free for the asking though put at a premium, which is of a far different type from that which VE3GG suggests. It is not so easy to rule out "irresponsible kids" by discriminating against those under a certain age; they occur in all age groups. The way is rather by education.

—Julian S. Lorenz, W3FEW

Converse, Ind.

Editor, *QST*:

We have been reading Mike Caveney's recent letters, and started to write him in regard to them. However, we decided to change the idea and send it to you for publication instead, even though it is still addressed to him.

Dear Mike:

Have been reading your recent articles with interest and believe that they deserve an answer.

First, to the gang who are going to rear up on their hind feet and yell to high Heaven that you should hang at sunrise—and believe you me, old-timer, there are going to be plenty of the boys who feel that way about your last article. Fellows, we have known Mike for the last 15 years, and don't make any mistake—he is one swell Englishman. We know him and his son, who is also an amateur, as a darn good guy—so you can take our word for it and dismiss that angle of the case.

Now, let's consider. Mike, you live in a country where in your own words the snow was two feet above a counterpoise ten feet off the ground, where to break log jams a sack of dynamite is exploded every two minutes for a couple of days and yet there is work and solitude. So you have given a lot of thought to a situation which gripes all of us.

Much of what you say is right and the remainder we can for practical purposes skip—yet, much of what you recommend is highly unsound and unfair.

First, you propose to place the fate of all amateurs in the hands of the A.R.R.L. This is a position which you cannot support even if the opposition granted to the A.R.R.L. the wisdom of Solomon. I could spend an hour telling you why this is not only unfair to the amateur but to the A.R.R.L. as well, so it just won't do.

Secondly, Mike, the gang on this side of the line left England a long time ago with the idea that every one should have a free and equal chance. Maybe they don't get it, but we try not to legislate it away from them. You cannot set a limit to the number of amateurs without violating one of our constitutional rights.

Third, after you have granted a person a privilege it is highly unfair to come along and take it away from him because you made a mistake in the original set-up that issued the privilege. This paragraph of yours practically holds a club over the head of the amateur saying in effect that if he doesn't help the Cairo Survey he will lose his license. May I still point out that the great majority of us don't drive worth two whoops. It won't do, old top.

Your suggestion number four puts an age limit on mentality. The examination should test that mentality and not the passing of years. Once again I think you are wrong.

We won't argue with number five except for the part which says cancel his license forever for a frequency violation, and here again in principle you are going against all accepted standards. This idea ruins a reasonable paragraph.

Article six in effect says that every operator must become better and better qualified as time goes on. Now, Mike, he isn't getting paid for doing this and maybe he is well pleased to be an average operator and work average operators during what may be a very limited time on the air. This amateur radio is only a hobby and if any of the gang don't like it, they can always go into

jig-saw puzzles or what have you. Sure we want to have the best conditions possible but we have no right to set an unreasonable standard. Once again in this paragraph you are delegating power to the A.R.R.L. or its members and here again we rise to point out that the A.R.R.L. is not a governing body and that furthermore there is a large element of amateurs who do not approve of the A.R.R.L. and they have every right to be heard.

Article seven is slightly squiffy in its set-up, Mike. The two infractions might be ten years apart and you would still cancel the license. Furthermore, one observer only is set up and here again you have handed it to the A.R.R.L. to control the situation. In just one year's time after such a set-up went into effect there wouldn't be any A.R.R.L., so maybe it isn't such a bad idea after all. Hi!

Article eight doesn't state any reason for existing, so I am forced to conclude that there really is no reason for it. Suppose you are going to make them get their sleep whether they want it or not—maybe you are giving the girl friend a break.

There are many things that could be said in favor of the new or young amateur, but that we are skipping.

There is much about which you complain which needs to be complained about, but I cannot approve the remedy.

—Fowler E. Macy, W9MM

P. O. Box 425, Tampa, Fla.

Editor, *QST*:

The past few months have ushered in to the Correspondence Department of *QST* many letters offering suggestions as to how ham radio could be improved. These suggestions for the most part have been of a constructive nature and for the benefit of all amateurs in general. Those writing to *QST* have made, I believe, an honest endeavor to improve amateur radio. March *QST* holds a lengthy letter from VE3GG offering his suggestions and his opinion of what should be done in conjunction with the Cairo Survey to better ham radio. I am sure that the majority of hams appreciate Mr. Caveney's contribution to a good cause, *but*—I am also quite sure that there is one thing on which many hams heartily disagree; that is found in paragraph three of Mr. Caveney's list of modifications. Quote: "Cancel all licenses held by persons under 18 years of age or any license held by a person with less than two years' activity on the air, with promise of renewal if the Cairo Survey is successful in obtaining more frequencies for amateur use."

That is preposterous. It is hard to comprehend such a statement from a fellow ham. Mr. Caveney, did there ever occur to you the happiness that would be blotted out of many fellows' lives if such an issue were passed? It is a very easy statement to make when one has been so fortunate as to have a ham ticket for more than two years and is older than 18, isn't it? Surely, just cancel the spirit, the moral, the goal of hundreds of young fellows under 18 who enjoy operating their rigs as much as you do, Mr. Caveney. Quite right, my dear sir, many of we fellows under 18 years are "punks," "lids," fellows who know little of the deeper technicalities of radio engineering. There are ranks of operators who putter along at 7 or 8 w.p.m. with a wobbly signal on some of those "precious frequencies," but let us look at the other side of this. VE3GG, how many times have you seated yourself at your bug and spurted along about 25 or 30 w.p.m. with some fellow and not known just exactly how old he was? Of course you don't know. Well, listen, believe it or not, there are many, many hams 18 years or under who demonstrate a higher rank of amateur operating procedure than many of the veteran operators of today. How many high-class 'phone men can sit down and burn the fellow up at the other end when on c.w.? I don't mean to say anything of an offensive nature to the 'phone men because we all need those fellows in many ways. We appreciate and respect their way of handling a QSO, their knowledge of the more intricate divisions of radio, their willingness to do more than their bit for many worthy causes sponsored by the A.R.R.L. But please keep in mind, though, that there are many hundreds of hams over 18 years, who have been licensed for a period longer than two years *but* who . . . slow up considerably on the c.w. slinging.

Just to offer a bit of defense on my own part I might say

that numerous times I have been forced to slow up in order to accommodate some two-letter fellow and many other slow-speed fellows who have been licensed for more than two years. These fellows, moreover, were for the most part over 18 years of age. Let's think that statement over just once more, VE3GG, and then decide if we will again lay it on the counter as an example of our feeling of fellowship to our brother hams. It's not a matter of age, OM. Let's base our discriminations on the efficiency of an operator. If an operator is a beginner and sends 10 w.p.m. or less, let him be put in the much-talked-of "separate band for beginners." All I ask is, if and when any licenses are cancelled that the fellows holding those tickets be given a chance to reinstate themselves. Those fellows who come on the air sending 7 and 8 w.p.m., cluttering up the band with improperly handled transmissions, not using the Q signals, are on the ham bands for purely one reason; the exam was too easy. We consider it a privilege to use ham bands and as such we should undergo rigid enough qualifications to make that term properly called "A Privilege." Instead of asking, let us demand that ham operators be *efficient operators*. Liberal knowledge of the Continental Code to the extent of being able to copy 15 w.p.m. instead of 10 w.p.m. should be required. If we desire new frequency allocations we should be able to fill those new allocations with efficient operators. We may be just amateurs, fellows, but the time has arrived when we must raise our standard of operating and our requirements for becoming an amateur. As someone has previously stated in *QST*, "Every station should be required to operate break-in." The above few lines are stated so as to comply with a statement in *QST* that there shall be no criticism unless it is followed up with constructive suggestions. . . .

—Ralph C. Charbeneau, W8OLJ

-----

805 Carson Ave., La Junta, Colo.

Editor, *QST*:

. . . My reaction is that VE3GG is either crazy or he has passed out of the amateur game and this applies to those who agree with him.

—M. O. Davis, W9CDE

-----

**Erron's Note.**—Several types of letters were received in answer to VE3GG's proposals in the March issue. Examples of each are reproduced above and just below.

Other letters of disapproval were received from Robert W. Schoening, W9TKX; Julian D. Hirsch (New Rochelle, N. Y.); Smith "Buck" Woodson, W4DKO; Bruce T. McCoun, W2HWS-W2JIP; Max M. Bolton, W9RWS; Leroy Kimble, W5FPV; Samuel J. Hyman, W9VRX; Lloyd N. Green (Juneau, Alaska); Leo C. Levitt, W6IBZ; Kenneth Klippel, W9SQO; Ivan Eby, W6MHF; "The Lid" (North-east Harbor, Maine); and Dave Rupp, W3FKJ.

With reference to the higher code speed requirement, A.R.R.L. Communications Manager Handy submitted such a proposal to the A.R.R.L. Board in his 1935 annual report.

2310 Margaret St., Philadelphia, Pa.

Editor, *QST*:

Boy, *did* VE3GG hit the nail on the head! Of course, in the fanatical heat of loyalty he has become too much of an extremist, but he sure has the right idea.

This population business has had me thinking for a long time. There is no question that ham radio at the present time, if not overcrowded, is certainly full to capacity. Now when I first got on the air it was OK to know ten per—just—and no theory, but today this situation is intolerable. I know it will seem selfish, but I feel that some limitation of licensing is now in order. After all, I'll bet I could teach my kid sister in a month more than enough to pass the Class B exam; it is just this situation which has permitted an ever-increasing number of lids to infest our bands—and I don't mean to imply that lids and beginners are synonymous.

It is a cinch that our ham population will continue to increase in a geometrical rather than an arithmetical progression. Naturally, this state cannot continue indefinitely, and limitation is the only way out. Some of the wise heads will counter with that old answer to all problems, technical

(Continued on page 78)

# On the new "One-Ten" Receiver

AS WE write this page, the first One-Ten Receivers are being shipped from our factory; when you read this page, our dealers will have them in stock. Following our custom in the past with other new receivers, we are going to comment on some of its more interesting features. But before starting on the technical aspects of the One-Ten, we have two explanations to make.

First, our original cost estimate on the One-Ten was much too optimistic, for the receiver has proved to be a far more complicated piece of apparatus than we expected. We could, of course, have met our original figure by cutting corners, but we feel we have a reputation to maintain, and when it is a question of either raising price or lowering performance, the price goes up. However, to protect those of our customers who ordered One-Ten Receivers from our dealers before the price raise went into effect, we have decided to fill old orders at the old price, on the understanding that the dealer passes the saving on to the customer.

Our second explanation is about the intended purpose of the One-Ten. It is primarily an experimental job, intended to fill the need for an efficient receiver to cover the ultra-high frequency spectrum. It is not as good as the HRO or FB-7 on ten meters. It does not have the rugged simplicity

of the SW-3. But *does* operate (and darn well!) at one meter, and it opens up an enormous and practically unused frequency spectrum. The One-Ten was built for those pioneering amateurs who are leading the march to Ultra-High Frequencies. There is lots of room up there.

Some months ago, we described and showed pictures of the One-Ten in our General Catalogue. That data was taken from our first experimental model, which we fondly hoped would be our production model also. The actual production model is illustrated on this page. We have forgiven it the many headaches it caused us, for we have finally persuaded it to perform as a National Receiver should.

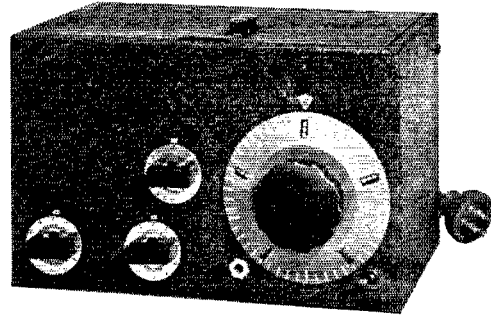

unusual from a mechanical point of view. Its unusual design springs from the fact that leads *must* be short and stray capacities held at a minimum. Consequently, all parts had to be placed for high electrical efficiency, without the slightest regard to manufacturing convenience. As the pictures show, the two acorn tubes, the two plug-in coils and the two sections of the ganged tuning condenser, are grouped together in optimum relationship. But what the pictures do not show is the endless attention to detail that was necessary to make the receiver work the way we wanted it to. For whether the designer likes it or not, at these frequencies, every piece of hook-up wire is a capacitance, an inductance and an antenna, and it also usually has ideas of its own regarding what frequency the set should operate at. For example, some of our early production sets had a certain ground connection made through a bolt and nut on the chassis. The laboratory model had a screw tapped into the chassis, and no nut. The production sets did not operate; changing the ground fixed them.

Another thing — usually when one gets a set operating properly on the highest-frequency range, the battle is practically over. Designing the other coils is pretty much of a routine matter. In the One-Ten, this was by no means done. We had the set operating very nicely on one meter but it was no good on ten. We fixed it on ten, and it no longer worked on one. And so on, back and forth; meantime, we struggled with other and equally pernicious problems, such as keeping the detector oscillating and the RF stage not oscillating.

A few years from now our present problems may seem amusing. Already we know much about high-frequency design that we did not know before. But in the meantime, we do not think that building a one-to-ten meter receiver is a job to be tackled lightly. And while we shall be very glad to sell you a stripped tuning unit, as illustrated at the top of the page, please do not ask us to explain by mail how to make it work. But if you desire a copy of our booklet describing the receiver, our dealers will be glad to give you one.

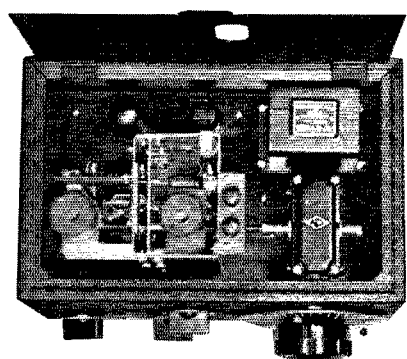
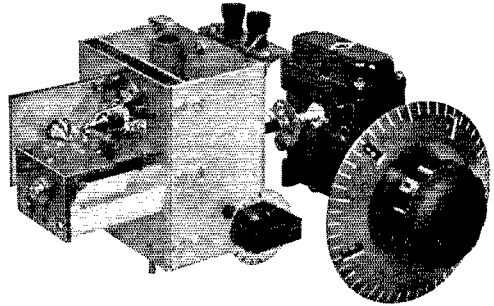

JAMES MILLEN



# DECIBEL METERS

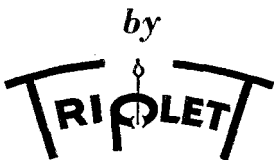

Precision Without Extravagance

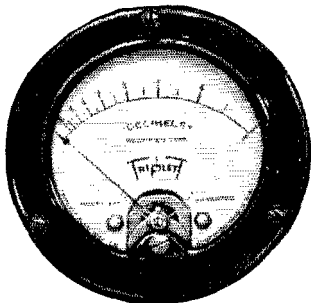

MODEL 321

The standard range reads up 6 and down 10 decibels, 0 decibels at 1.73 volts, 500 ohm line, 6 milliwatts. Furnished either standard or highly damped. Other ranges to order only. Meter supplied in moulded case.

## DECIBEL KITS

Triplet Kits are available to increase range of Power Level Indicators. Readings advance in steps of 4 decibels up to 22 decibels.

**No. 150 Decibel Meter Kit — Non Constant Impedance.**

Includes Triplet 3" meter, 2 deck selector switch, 9 wire wound multipliers with Bakelite mounting board, hook-up wire, blueprints and instructions. Dealer Net Complete. . . . . **\$21.67**

**No. 200 Decibel Meter Kit — Constant Impedance.** Similar to No. 150 but with Triplet 3" Constant Impedance Decibel Meter.

Has four studs allowing movement to be shunted without altering impedance over 50 ohms.

Dealer Net Complete. . . . . **\$23.50**

The above kits are also supplied with Triplet 2" Decibel Meters at \$1.00 net each less than above prices. Kits are easy to assemble — all parts are marked to correspond with blueprints.

Write for Catalogue

**TRIPL'ETT ELECTRICAL INSTRUMENT CO.**  
255 Harmon Drive, Bluffton, Ohio

Without obligation please send me

- More information on Decibel Kits and Meters
- Your New 1936 Catalogue

Name \_\_\_\_\_

Address \_\_\_\_\_

City \_\_\_\_\_ State \_\_\_\_\_

## Correspondence Department

(Continued from page 74)

progress, but how many of us, now or ever, can afford single-sniggles?

My suggestion is this: make the A, B, and C exams stiffer; since we obviously can't accommodate all newcomers, let's take the cream of the crop! For the B and C exam a real theory exam coupled with a code speed requirement of fifteen per would not be, by any means, too radical an innovation. . . .

—Louis Seltzer, W3COG

3363 So. 18th St., Milwaukee, Wis.

Editor, QST:

Kindly place my call on record as one heartily approving the program set forth in Mr. Caveney's open letter which appeared in the March issue of QST. I am in favor of more restrictions and higher requirements for amateur licensing; it is the only practical way of raising the standards of our ranks.

—C. C. Richelieu, W9ARE

120 N. Mills St., Madison, Wis.

Editor, QST:

. . . With reference to Mike Caveney's article in March QST, let it be known that I am in favor of, and will support changes 1 to 4 inclusive. A further suggestion is to place the issuance of amateur licenses under the control of the League, thus giving the League a chance to limit the amateur ranks as its directors and other members deem necessary.

I oppose the suggestion by Duane Magill, W9DQD, that one-half of the 80-meter band be given up in favor of widening the higher frequency bands. I think that this band is one of those which should be widened because of its general-purpose utility.

—Howard R. Olds, W9UMQ

Stop 4, Lake Ave., Elyria, Ohio

Editor, QST:

. . . While I cannot, due to circumstances, agree with all the limitations VE3GG would apply to amateurs (two years holding of license would throw me out), I agree with him in spirit and want to be the kind of ham he would call a credit to the fraternity. . . .

—Corliss I. Miller, W8NZC

**Editor's Note.**—Amateurs speaking of the "increase in amateur population" should remember that F.C.C. figures show 46,390 licensed amateur stations as of June 30, 1934, 45,561 as of June 30, 1935, and a current estimate of approximately 44,000. Of course, figures on licensed operators —unfortunately not available—would be more useful.

Qualified approval of VE3GG's proposals is expressed also by Charles A. Pine, W9CWW, and E. B. Gladding, W1GTW-W1GTX.

## Guam Prefix

446 Shepherd Ave., Brooklyn, N. Y.

Editor, QST:

. . . For eight years—since OM1TB became the first station in Guam—stations in Guam have carried the prefix OM, and have become known throughout the world by that call until during the latter part of last year, when the Federal Communications Commission ordered all unlicensed stations closed. Mine was one of those stations. We shut down for two months while the K6 call was applied for.

Guam is 1,800 miles from Hawaii, and only 310 from the Philippines, yet a K6 prefix is assigned to this island.

If we go on the air and call K6 using the K6 prefix we receive no replies. They have no way of telling that we are thousands of miles from them.

If we go on and call W6 using the K6 prefix we sometimes receive an answer, but very seldom, as it is nothing exceptional to work Hawaii from the west coast.

There are at one time never more than three or four active amateurs in Guam due to transfers, so we lack the numbers to ask for a special prefix for the island. We organized a club at one time, hoping to be recognized by the A.R.R.L. and then to ask through you for a change. However, several members had to leave before that could be done.

# A.C. RELAYS

Made by

## Allen-Bradley

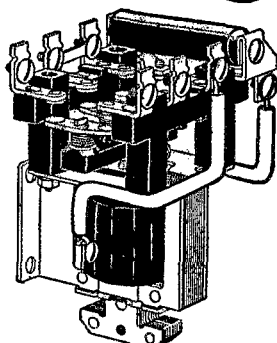
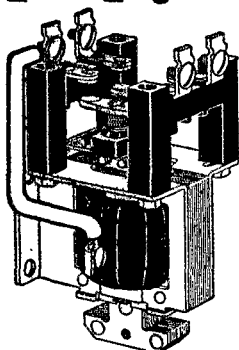

These A. C. solenoid relays are ideal for remote control of transmitters, for control of crystal ovens, and for any general remote control application except for keying. THESE RELAYS WILL NOT OPERATE IN KEYING SERVICE. Silver-to-silver double-break contacts are used throughout.

The maximum contact rating is 10 amp. at 220 v. or 3 amp. at 550 v. The relay coils are wound for 115 volts 60 cycle alternating current. Relays for other voltages can be supplied on special order. Use coupon below.

Type No.	Poles	Nor- mally	Action	Circuit Diagram	Price		Type No.	Poles	Nor- mally	Action	Circuit Diagram	Price	
					Open	In Cab.						Open	In Cab.
A107	1	Open	SP ST		\$3.50	\$4.50	A177	1	Closed	SP ST		\$7.50	\$8.50
A117	1	Closed	SP ST		4.50	5.50	A207	2	Open	DP ST		4.00	5.00
A127	1	Open and Closed	SP DT		5.00	6.00	A217	2	Closed	DP ST		6.00	7.00
A137	1	Open	SP ST		4.00	5.00	A227	2	Open and Closed	DP DT		7.00	8.00
A147	1	Closed	SP ST		5.00	6.00	A237	2	Open	DP ST		4.50	5.50
A157	1	Open and Closed	SP DT		5.50	6.50	A247	2	Closed	DP ST		6.50	7.50
A167	1	Open	SP ST		6.50	7.50	<p><b>Radiostat</b>—A stepless graphite compression rheostat for primary of 550 watt filament or plate supply transformer. Range 4 to 150 ohms. <b>Price \$6.50</b></p>						

### ORDER BLANK—MAIL WITH REMITTANCE TO

Allen-Bradley Co., 108 W. Greenfield Ave., Milwaukee, Wis.

Enclosed find money order for \$..... for which please send me, shipping charges prepaid, the following items:

..... for..... Volts..... Cycles

Name.....

Address.....

# THESE SPLENDID BOOKS FREE!



**THINK OF IT!** 2 books full of invaluable information, to be had for just the mailing costs! One with 20 complete transmitter designs including 12 tested transmitter RF section designs and 8 modulator and speech amplifier designs. Circuits, complete parts specifications, inductances, etc. all included. Outputs ranging from a little fellow all the way up to the big ones comparable to the best broadcasters.

Ten complete designs for public address amplifiers in the other book. It includes one for every purpose, from 3 Watts to 30 Watts output, tried and tested designs that you can build, with complete parts lists for each.

These books should be in every amateur's technical library. Just 22 cents in stamps, to cover postage, brings them both to you, or get them from any Standard Distributor. Send for your copies today.

## STANDARD TRANSFORMER CORPORATION

856 Blackhawk Street, Chicago, Illinois

### MAIL THIS COUPON!

STANDARD TRANSFORMER CORPORATION

Dept. A, 856 Blackhawk St., Chicago, Ill.

I am enclosing 12c for Transmitter Manual

I am enclosing 10c for Amplifier Manual

Name.....Address.....

City.....State.....

Changing the prefix from K6 to KB, KG, or any of those combinations similar to KA should not require much work. Amateur radio in Guam means more than in the States. It is for us the only way of sending word to people in the States quickly and without expense. The traffic stations are put to a great disadvantage in having to use the K6 prefix.

As I am leaving Guam in March for Shanghai, China, I will not be here to take advantage of the change if any, but I hope that this letter will help toward effecting such a change. . . .

—Feliz Ferranto, OMITB-K6NDH-WVQG

## For Ham Television

295 E. Plant St., Winter Garden, Fla.

Editor, *QST*:

While all of the words are goin' 'round and 'round I'd like to drop a few here or there and see what effect it would have on the gang as a whole.

To-day, while glancing through my copy of the F.C.C. rules and regs I noted with some interest Rule 378, which is: "The following bands of frequencies are allocated for use by amateur stations for television, facsimile, and picture transmission: 1,715 to 2,000 kc. and 56,000 to 60,000 kc."

It seems strange to me that few if any amateurs have ever tried their luck at television. I have come to the conclusion that most of us are afraid to delve into that field of radio. Knowing that it has many possibilities for those who do attempt it I feel sure that in the near future many hams will be seeing each other over the air.

And I hope that before long I will have some kind of equipment to broadcast a small picture. I already have begun to purchase parts for a television transmitter. And so far I have spent no more than I ordinarily would have for stuff that I really don't need.

Hams with transmitters working in the 1,715- to 2,000-kc. band and using 'phone will have very little to buy.

At least it would be fun as well as educational to try a hand at this work. Too, with several hundred hams working on television, who knows something might turn up to eliminate all doubt as to the actuality of television. What say, gang? And, oh yes! Space in *QST* for this work would be more than helpful to those who are interested.

—C. C. Wilson, Jr., W4AT

## A 20-Megacycle Band?

Box 6, Ruxton, Md

Editor, *QST*:

There is a current drive on to get more frequencies (4-4.5 mc. and between 6 and 8 mc.) at the approaching Cairo Convention. The former looks no good and the latter impossible to get.

Come on, all you 20-meter 'phone men, 20-meter c.w. men, 10-meter men and 40-meter DX men, and talk it up for a band around 15 meters. It would help DX lots and lots; and the consequent lightning of QRM on the present bands would help the 'phone and traffic gangs.

How about a 15-meter band? Everybody gains; nobody loses.

—L. W. Ballard, W3BVN

## One of the Three Recent Cases

R.F.D. 3, Box 215, Orlando, Fla.

Editor, *QST*:

It gives me great pleasure to announce to you that through your generosity in permitting the New York Chapter of the American Red Cross to transcribe the *Handbook* into Revised Braille, I am the proud possessor of a Class C license. This makes my second license, but it is through the *Handbook* that I was able to obtain this one. Since the reading of the *Handbook*, I have made many friends among the local hams. This fact alone is a great source of satisfaction; but to hold a license with the privilege of operating a transmitter is something still better.

I just received a letter from another blind man in New York City who took the exam about seven weeks ago, and he is another reader of your wonderful book



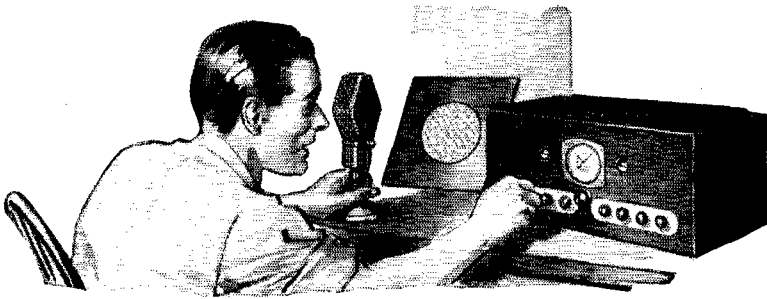

## "YOU'RE PUTTING A 250-MICROVOLT SIGNAL IN HERE"

**T**HAT'S the kind of accurate "S" report you can give when you have the ACR-175, RCA's new Amateur Communication Receiver. The sensitivity control of this remarkable instrument is calibrated logarithmically in microvolts of signal input to the receiver, the value being read when the 6E5 ("Magic Eye" tuning indicator) just begins to show a deflection. This new method gives you a measurement in terms of absolute value, and marks a new high in amateur operation. It is an RCA origination, of course . . . that is but one of

the mighty fine features of this new receiver, every one designed for practical operation. There's a stand-by switch that removes plate voltage, illuminates green pilot light, but leaves heaters on for instant operation. Also an ultra-selective crystal filter, of course. And iron-core i-f transformers give unusually high gain. Sensationally smooth vernier knob, and wide band-spread. Many other improvements of tremendous value in actual use. See the ACR-175 at your supplier, or write Amateur Radio Section for full details.

ACR-175, an 11-tube Amateur Communication Receiver by RCA tunes 5 to 600 meters without skips, has separate dynamic speaker, all controls on front panel, many other outstanding features. \$119.50, amateur's net price f.o.b. Camden, N. J.

Calibrated  
Sensitivity  
Control

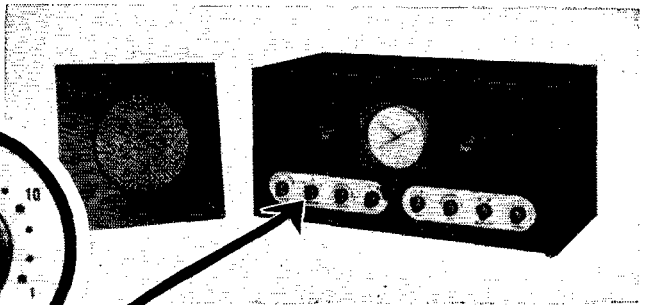
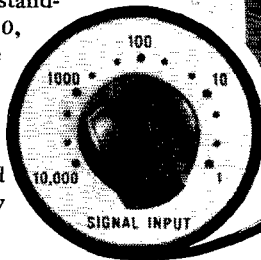

AMATEUR RADIO SECTION

# RCA MANUFACTURING CO., INC.

CAMDEN, N. J. A SERVICE OF RADIO CORPORATION OF AMERICA

# EASY TO DRIVE

## AMATEUR NET PRICE

RK-10	\$3.50
RK-18	10.00
RK-19	7.50
RK-20	15.00
RK-21	5.00
RK-22	7.50
RK-23	4.50
RK-24	3.25
RK-25	4.50
RK-28	38.50
RK-30	10.00
RK-31	10.00
RK-32	12.00
RK-34	3.50
841	3.25
842	3.25
866A	4.00
872A	18.50

Raytheon tubes for the amateur have characteristics suited to amateur requirements. There is a modern type in each of the three principal power classifications for R. F. use.

Ask your dealer or write to the nearest Raytheon Office

**RAYTHEON PRODUCTION CORP.**

30 EAST 42nd STREET, NEW YORK, N. Y.

55 Chapel St.    443 Lake Shore Dr.    535 Howard St.  
Newton, Mass.    Chicago, Ill.    San Francisco, Cal.

RK-28=

# RAYTHEON

AMATEUR RADIO TUBES

At a later date, when I get on the air, I hope to be able to become one of the members of the A.R.R.L.

I thank you again for the good you have done the blind of this country in granting permission for the transcribing into Revised Braille of the *Radio Amateur's Handbook*.

—Henry Lehmann

## Third Harmonics, Too

Atlanta, Mo.

Editor, *QST*:

In the last few issues of *QST* I have noticed a great number of letters about harmonics. Most of these were about 'phone, but I find that the c.w. men are also guilty.

A few weeks ago a local received a ticket for a harmonic on 10,772 kc. This turned out to be the third harmonic of his 80-meter c.w. crystal. While testing with him I heard several other guys coming through on about that frequency, and all of them were good healthy sigs, too. The average was around R7 and some were louder.

I think the boys would do well to check their third harmonic frequency as well as the second. In fact I have heard more third harmonics than any other and they cause a lot more QRM on the commercials than the much talked about second harmonics. . . .

—Lewis C. Hanna, W9SGP

## Bankruptcy Racket

208 Union Ave., Framingham, Mass.

Editor, *QST*:

I enclose herewith a letter which I recently received from the Radio Co. I also enclose a short editorial from the *Boston Traveler* which seemed to fit the case.

I sent a small order to the above concern last month. The order was partly filled and after several letters of inquiry regarding the balance of goods due I received the enclosed letter.

My only excuse for ever patronizing such a concern, is that they happened to have listed two articles which I could not obtain from any Boston supply house. Needless to say, I shall go without in the future rather than trade with these "gyp" concerns. They should be shouted down, and, while my loss was practically nothing, I feel that the matter might be given a little publicity for the sake of any of the boys living in the rural sections, who might be lured into sending in a good sized order with a worthwhile cash deposit.

I am not complaining at all because I was a "sucker," but would like to see some mention of the matter appear in *QST*, or this letter if you wish. I feel quite sure that if we would all stick to *QST* advertisers or local concerns of whom we have first-hand knowledge everybody would be happy.

—Dr. Carlton R. Crosby, W1DDM

**Editor's Note.**—The letter which was enclosed on the letter-head of a catalog-distributing mail-order corporation, was the customary statement of a "general assignment for the benefit of creditors," a request for the filing of proof of claim, and the signature of the assignee. The editorial referred to excoriates bankruptcy schemes and concludes: "One great step toward diminishing the bankruptcy racketeers' loot is for every good citizen to make purchases only from our reputable business establishments of standing and good repute."

## I.A.R.U. News

(Continued from page 63)

Italy: c/o A.R.R.L., West Hartford, Ct.  
 Jamaica: Cyril M. Lyons, 2-B North St., Kingston.  
 Japan: J.A.R.L., P. O. Box 377, Tokyo.  
 Java: Th. F. Leyzers (vis), Van Heutz Boulevard 2, Batavia, Centrum.  
 Yugoslavia: Stephen Liebermann, Meduluceva 9, Zagreb.  
 Kenya: Radio Society of East Africa, Box 380, Nairobi.  
 Latvia: A. Karlin, 2 Lenca dz. 8, Riga.  
 Lithuania: L.R.M., Post Box 100, Kaunas.  
 Luxembourg: J. Wolff, 67 Avenue du Bois.  
 Madeira: See Portugal.  
 Malaya: J. MacIntosh, c/o Posts and Telegraphs Dept., Penang, Straits Settlements.

# PYRANOL

## 2MFD-2000 Volt CONDENSERS



Guaranteed TWO YEARS—  
UNCONDITIONALLY. No  
restrictions as to use. Before  
you buy insist  
on this broad **\$2.90**  
guarantee.

### TRIPLETT METERS

3 1/4" bakelite case 0-5 to 500M... \$3.75  
0-15 a.c. volts... 3.75  
0-150 a.c. volts... 4.55

# THE RADIO SHACK

## 46 BRATTLE STREET BOSTON

### INTERNATIONAL CHOKES

*Smoothing — Swinging — Cased*

12H — 200 Mill..... \$2.50    5/25H... \$2.50  
12H — 300 Mill..... 3.75    5/25H... 3.75  
12H — 500 Mill..... 6.50    5/25H... 6.50  
866's H.D..... \$1.00

2.5V-10A. Trans. for 66's..... \$1.25  
10 Volt — 6.5A Fil-Trans.-Cased..... \$2.10

Thordarson T6878 Transformer  
600-0-600-2.5V-10A-5V-3A-7.5V-3A  
200 Mill..... \$2.75

### International Relay Racks **\$13.50**

Another Outstanding Value

This rack is standard construction, according to  
WE. specification. See January *QST* for details.

RAYTHEON ISOLANTITE BASE  
210.....H.F..... \$1.95

# INTERNATIONAL PLATE TRANSFORMERS

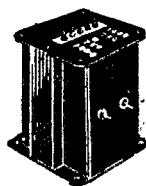

Model 2000 — 1000 and  
750 volts each side of C.T. **\$5.95**

Model 3000 — 1500, 1000 and  
750 volts each side of  
C.T. **\$8.95**

Model 2000 — Overall size  
7 1/4" x 5 1/8" x 5 1/2"

Model 3000 — Overall size  
7 1/4" x 5 1/8" x 5 3/4"

BILEY L.D. MTD.  
CRYSTALS..... \$4.80  
BILEY 20 M CRYSTALS..... \$7.50

# ONLY THE SUPER-SKYRIDER

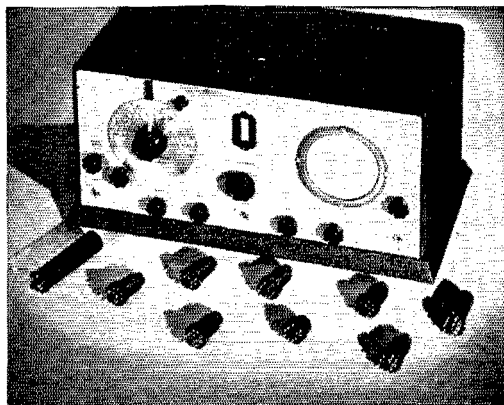

### GIVES YOU ALL THESE FEATURES!

- Complete Coverage of the Short-wave Radio Spectrum.
- Efficient 10-Meter Band
- 9 Metal Tubes
- Iron Core I.F. System
- Controlled Crystal Filter Circuit
- Modern Band Changing System
- Built-in Power Pack and Speaker
- Continuous Band Spread

Johnson 5M Q. ant..... \$3.90  
Johnson 50 watt socket..... 1.05  
Alladin iron core I.F..... 1.80  
Valpey 160-80M xtals..... 1.50  
International xtal holders..... .79  
Raytheon 250 tubes..... .75  
RCA210..... 1.20  
Raytheon 210..... 1.20  
RS 203A Graphite..... 9.00  
RS 800 Graphite..... 5.95  
RS 801 Graphite..... 2.95

Raytheon RK20..... \$15.00  
Raytheon RK23..... 4.50  
Eimac 50 T..... 13.50  
Eimac 150T..... 24.50  
H-K 354..... 24.50  
  
Used tubes  
WE276A..... \$8.00  
RCA852..... 8.00  
RCA860..... 9.00  
RCA204A..... 20.00

Baldwin Type C Phones..... \$2.50  
Cardwell M.T. 100 GD..... 4.80  
Star 35X d.s. condenser..... .60  
Readrite mill meters..... .60  
Dunco keying relay..... 2.00  
Neon Oscilloscope Tattlelite..... 2.00  
Ohmite Band Switch..... 1.80  
Ohmite 200 watt resistors  
0-10,000 ohms..... 1.80  
10,000-100,000..... 2.10

**Mail Orders Filled — Send Money Order**

# Yes, the New MAC KEY IS HERE

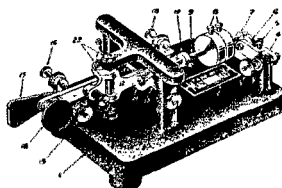

QSD diddledahbumdidit

NO! Its perfect Morse with a genuine

**MAC KEY @ \$7.95**

And the finest code practice oscillator we have  
ever seen. AC/DC plus tone control

**MAC OSCILLATOR @ \$3.95**

A few carefully hand built navy specification

**De Luxe MAC KEYS @ \$15.00**

*and worth it!*

# Newark's

## SETS on PAYMENT PLAN at New Lower Rates

The receivers listed below are the best money can buy. Our time payment plan, at the new low rates, makes it easy to own one. COMPARE our rates with others. THE EASY WAY: Send in your down payment with your order. Set will be shipped as soon as credit is OK'd. Entire Transaction: One week. TRY US. Write for complete catalogue.

Cash Price	Down Payment	6 Months Payments	10 Months Payments
<b>NATIONAL HRO JR.</b> —with tubes — 1 set of coils, 10 to 20 meters (2 amateur bands)			
\$99.00	\$24.00	\$13.52	\$8.20
<b>NATIONAL HRO JR.</b> —complete with tubes — power supply — 2 pair of coils			
\$124.80	\$29.80	\$16.90	\$10.25
<b>NATIONAL HRO</b> —less power supply and speaker			
\$167.70	\$37.70	\$22.78	\$13.89
<b>NATIONAL HRO</b> —with power supply			
\$183.60	\$43.60	\$24.46	\$14.93
<b>NEW SUPER SKYRIDER</b> —with crystal—Model SX9			
\$89.50	\$19.50	\$12.68	\$7.69
<b>RCA—ACR—136</b>			
\$69.50	\$19.50	\$9.32	\$5.65
<b>RME69</b> —complete with crystal—tubes—speaker housed in baffle			
\$134.90	\$29.90	\$18.58	\$11.28
<b>HAMMARLUND SUPER PRO</b> —Complete with tubes and speaker			
\$223.44	\$43.44	\$31.23	\$19.11
<b>HAMMARLUND SUPER PRO</b> —Complete with crystal, tubes and speaker			
\$241.00	\$51.00	\$32.92	\$20.16
<b>PATTERSON PR-16</b> —Complete with crystal, tubes and speaker			
\$101.70	\$26.70	\$13.52	\$8.20
<b>NEW ACR-175</b> —complete as advertised			
\$119.50	\$24.50	\$16.90	\$10.25

Full Details of Any Set Listed, Mailed Immediately upon Request

### WELL KNOWN OIL FILLED, OIL IMPREGNATED FILTER CONDENSERS

Our Special OIL IMPREGNATED-OIL FILLED CONDENSERS are guaranteed at rated voltages. All ratings are DC working voltage. These are well-known condensers. We have a few left of each capacity. Send in your orders at once.

Cap.	Voltage	Size	Weight	Price
1 mfd.	2000 V. DC	5 x 3 3/4 x 1	1 1/4 Lbs.....	\$1.25
2 mfd.	2000 V. DC	5 1/2 x 3 3/4 x 2 1/2	3 Lbs.....	1.50
4 mfd.	2000 V. DC	2 1/2 x 2 1/2 x 5	3 Lbs.....	2.25
8 mfd.	2000 V. DC	5 1/2 x 3 3/4 x 4	4 Lbs.....	2.75
9 mfd.	3000 V. DC	5 1/2 x 3 3/4 x 1 1/2	9 Lbs.....	7.25
(including 2 1/2" bakelite standoffs)				
4.4 mfd.	1500 V. DC	5 x 3 3/4 x 1 3/4	1 1/4 Lbs.....	1.75
5 mfd.	1500 V. DC	3 3/4 x 3 3/4 x 1 1/2	1 1/4 Lbs.....	1.90
5.2 mfd.	1500 V. DC	5 x 3 3/4 x 2 1/2	2 1/4 Lbs.....	2.00
10 mfd.	1500 V. DC	5 x 3 3/4 x 3	2 3/4 Lbs.....	2.75
20 mfd.	1500 V. DC	5 x 3 3/4 x 3 3/4	3 3/4 Lbs.....	3.50

Use the 10 and 20 mfd. for perfect filtering in class B modulation Power supply

Newark Paper Filter Condensers	Thordarson No. T6878 Plate and Filament Transformer, 600-0-600 V. at 200 MA. 2 1/2 V. at 10 amp., 5 V. at 3 amp. 7 1/2 V. at 3 amp.....	2 1/2 V. 10 amp. Filament Transformer — 2000 V. insulation for 866's.....
1 mfd. 1000 V. DC... \$56		\$2.45
1 mfd. 1500 V. DC... 66		\$1.95

**HIGH VOLTAGE TRANSFORMER.** 1000-750-500-0-500-750-1000-300 MA. 3 3/4 x 4 3/4 x 5 1/2.....\$5.95

WRITE FOR OUR COMPLETE CATALOGUE!

## NEWARK ELECTRIC CO.

FASTER SERVICE—BETTER BARGAINS

226 W. MADISON ST. DEPT. Q CHICAGO, ILL.

Mexico: L.M.R.E., Apartado Postal 907, Mexico D.F.  
 Morocco: A.A.E.M., BP 50, Casablanca.  
 Netherlands: N.V.I.R., Post Box 400, Rotterdam.  
 Netherlands East Indies: N.I.V.I.R.A., J. M. van Heusden, Jr., Burg. Coopsweg 28, Bandoeng.  
 New Zealand: N.Z.A.R.T., P. O. Box 517, Dunedin.  
 Norway: N.R.R.L., P. O. Box 2253, Oslo.  
 Palestine: See Egypt.  
 Peru: Radio Club Peruano, Apartado 538, Lima.  
 Philippine Islands: George L. Rickard, P. O. Box 849, Manila.  
 Poland: P.Z.K., Bielowskiego 6, Lwow.  
 Puerto Rico: Francis M. McCown, Family Court No. 7, Santurce.  
 Portugal: R.E.P., Rua Primerio de Dezembro 33-3, Lisbon.  
 Roumania: Dr. Alex Savopol, Radio Club Craiova, Rosetti 6, Craiova; or Lieut. ing. F. Dinescu, Ecole Polytechnique, Bucharest.  
 Salvador: J. Frederico Mejia, 7a Calle Poniente 76, San Salvador City.  
 South Africa: S.A.R.R.L., P. O. Box 7028, Johannesburg.  
 Spain: U.R.E., Apartado 262, Madrid.  
 Sudan: Frank H. Pettitt, Catholic Club, Mustapha Barracks, Alexandria, Egypt.  
 Sweden: S.S.A., Stockholm 8.  
 Switzerland: U.S.K.A., Neu Allschwil near Basle.  
 Tunis: See France.  
 Uruguay: U.S.W.C.G., Box 37, Montevideo.  
 U.S.S.R.: C.S.K.W. QSL Bureau, I Samotechny per., 17, Moscow.

## Standard Frequency Transmissions

Date	Schedule	Station	Date	Schedule	Station
May 1	B	W9XAN	June 3	C	W9XAN
	B	W6XK	June 5	B	W9XAN
May 6	C	W9XAN		A	W6XK
May 8	B	W9XAN	June 10	BB	W9XAN
	A	W6XK	June 12	BB	W6XK
May 13	BB	W9XAN		A	W9XAN
May 15	BB	W6XK	June 13	BX	W6XK
	A	W9XAN	June 14	C	W6XK
May 16	BX	W6XK	June 19	A	W6XK
May 17	C	W6XK	June 26	B	W9XAN
May 22	A	W6XK		B	W6XK
May 29	B	W9XAN		B	W6XK
	B	W6XK			

### STANDARD FREQUENCY SCHEDULES

Time (p.m.)	Sched. and Freq. (kc.)		Time (p.m.)	Sched. and Freq. (kc.)	
	A	B		BB	C
8:00	3500	7000	4:00	7000	14,000
8:08	3600	7100	4:08	7100	14,100
8:16	3700	7200	4:16	7200	14,200
8:24	3800	7300	4:24	7300	14,300
8:32	3900		4:32		14,400
8:40	4000				

Time (a.m.)	Sched. & Freq. (kc.)
6:00	7000
6:08	7100
6:16	7200
6:24	7300

The time specified in the schedules is local standard time at the transmitting station. W9XAN uses Central Standard Time, and W6XK, Pacific Standard Time.

### TRANSMITTING PROCEDURE

The time allotted to each transmission is 8 minutes divided as follows:

- 2 minutes—QST QST QST de (station call letters).
  - 3 minutes—Characteristic letter of station followed by call letters and statement of frequency. The characteristic letter of W9XAN is "O"; and that of W6XK is "M."
  - 1 minute—Statement of frequency in kilocycles and announcement of next frequency.
  - 2 minutes—Time allowed to change to next frequency.
- W9XAN: Elgin Observatory, Elgin National Watch Company, Elgin, Ill., Frank D. Urie in charge.

# RME

ANNOUNCE THE

## CT-100

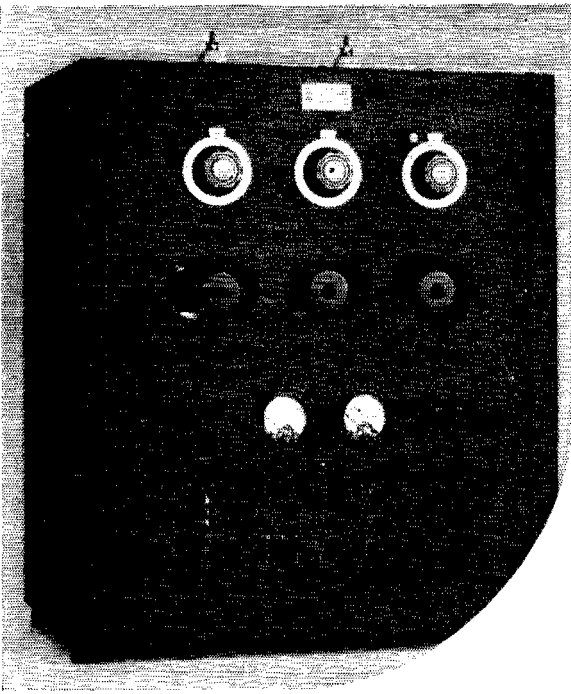

- A CW Transmitter covering all bands
- With plug-in coils from the front
- Rated 100 watts input
- Designed with great care
- Excellent for portable operation
- Weighs only 105 lbs.
- Just the transmitter for summer DX on ten meters
- Component units identical to those in 3R9 transmitter
- Low in price

COMPLETE INFORMATION ON REQUEST—See an RME dealer for a demonstration

*Two models of Noise Silencers have been developed by RME for general amateur use.*

MODEL LS-1 has been specifically designed to fit into the present RME-69. By removing the 1st and 2nd IF tubes (6D6s) and fitting this unit into position the receiver is equipped with the noise reduction circuit. The combination switch and control device may be mounted in some convenient position.

*Amateur Net \$11.40 with tubes*

MODEL LS-2 is contained in a separate cabinet and carries its own power line connection for filaments. It will operate effectively with any of the RME receivers now on the market and may also be conveniently adapted to other receivers.

*Amateur Net \$15.36 with tubes*

The RME-69 S S S Receiver was announced only recently (November 1st, 1935). No material changes in this comparatively new receiver are contemplated for the coming year.

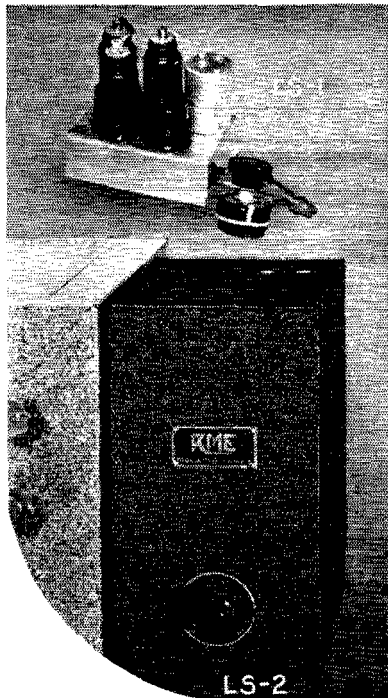

**RADIO MFG. ENGINEERS, INC.** 306 FIRST AVENUE  
PEORIA, ILLINOIS

# EVEREADY

TRADE MARK

## RADIO BATTERIES for PORTABLES

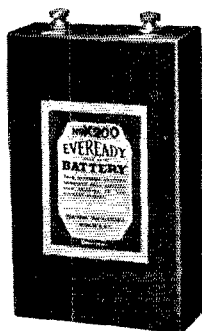

No. X-200  
3 volt "A" Battery  
5½" x 3½" x 1½"  
Wt. 1½ lbs.  
List Price \$ .82

No. X-201  
45 volt "B" Battery  
4" x 3¾" x 2¼"  
Wt. 1½ lbs.  
List Price \$ 1.50



Larger than our "midget" types and therefore last longer, but still very portable. 3 volts "A" and 90 volts "B" weigh only 3 lb. 14 oz.

BATTERY HEADQUARTERS

**NATIONAL CARBON CO., INC.**

GENERAL OFFICES: NEW YORK, N. Y.

BRANCHES: CHICAGO, SAN FRANCISCO

UNIT OF UNION CARBIDE



AND CARBON CORPORATION

W6XK: Don Lee Broadcasting System, Los Angeles, Calif., Harold Perry in charge.

### Schedules for WWV

EACH Tuesday, Wednesday and Friday (except legal holidays), the National Bureau of Standards station WWV will transmit on three frequencies as follows: noon to 1:00 p.m. E.S.T., 15,000 kc.; 1:15 to 2:15 p.m., 10,000 kc.; 2:30 to 3:30 p.m., 5000 kc. On each Tuesday and Friday the emissions are continuous unmodulated waves (c.w.); and on each Wednesday they are modulated by an audio frequency. The audio frequency is in general 1000 cycles per second.

### Low-Cost U.H.F. Receiver

(Continued from page 25)

even in our automobile units. In these cases we provided voltage dropping resistor for the filaments.

It is my belief that this type of detector makes a simpler, more efficient, non-radiating receiver than anything heretofore devised using a single tube. It should find its way into many transmitter-receiver combinations where low cost, simple construction and freedom from radiation are important factors.

### Meter-Type Modulation Monitor

(Continued from page 25)

for this purpose. They should have very little over-swing. There are three types, a slow speed, a medium speed and a fast acting meter. The latter should be used. The one in this monitor was made from a Weston galvanometer Type 301 (No. KS 2665) and a Taurex rectifier unit installed in the meter case, the wiring of the meter being rearranged so that the input to the copper oxide unit goes to the meter terminals. The output transformers should be of good quality so that the audio frequency response of the meter will be good. A transformer designed to work between a triode tube and a magnetic speaker will be satisfactory. The filament transformer should be large enough not to get hot. If it does, the smoke from the impregnating material may gum up the meter works. Of course, the filaments may get power from the receiver power unit.

The adjustment and calibration of the monitor is one of the most important items. This may be done by taking the monitor to a broadcast or amateur 'phone station equipped with a modulation monitor or cathode ray oscilloscope. Plug the monitor into the a.c. line and turn it on. Attach an antenna of sufficient length to cause at least ½ scale deflection on the carrier meter with the shunt condenser  $C_1$  all the way in. Note the amount of swing on the modulation meter. It will be less than 0 db for 100% modulation as read on the station monitor. Gradually decrease the resistance  $R_1$  and at the same time turn the shunt condenser  $C_1$  out, keeping the carrier meter at ½ scale. Continue this adjustment until the modulation meter kicks 0 db when the station monitor shows 100% modulation. Lock  $R_1$  at that setting, as that value should remain fixed. Now check the monitor against the station monitor on voice

# IT'S HERE Hallicrafters ULTRA SKYRIDER

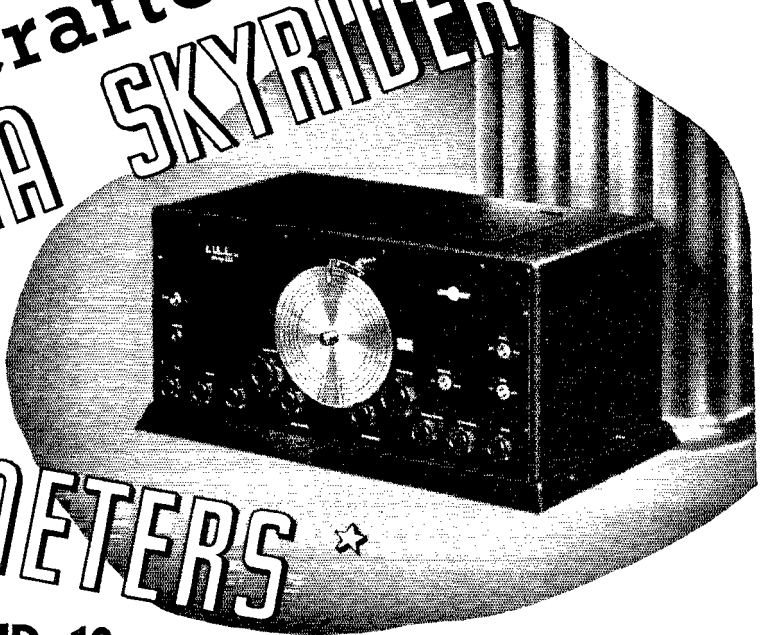

## 5-10 METERS ★

\*ACTUALLY 3.9 TO 46 METERS

### "THE 5 AND 10 METER JOB YOU'VE BEEN WAITING FOR"

**A**FTER months of work and experiment, the Hallicrafter engineers are finally satisfied. The Ultra Sky Rider is complete — an entirely new approach to ultra high frequency reception. It's a sensitive Superheterodyne, with the new Noise Silencer to reduce the man-made noises so annoying at high frequencies. This new device, described in QST will ensure practically noise-free reception.

The Ultra Sky Rider fulfills the amateur's dream for 5-10 meter reception — it tunes up to 46 meters with the same high efficiency. In spite of its advantages, it's extremely moderate in price.

The Ultra Sky Rider is the finest Hallicrafter product to date with more exclusive features than we can list here — you've got to see it and operate it for full appreciation of its efficiency.

See the new Ultra Sky Rider at your jobbers, or write for full particulars now.

#### HALLICRAFTERS MILEAGE MARATHON

All the entries have been checked and as this is being written the judges are determining the winners of this remarkable contest. The totals piled up by some enterprising amateurs are amazing. The winners will be notified immediately upon receipt of judges' final decision.

### FEATURES!

- Fractional Micro-Volt Sensitivity.
- 3.6 to 46 meters tuning on 4 bands.
- Noise Silencer, first time used on any commercial receiver, cuts out 60% of the noise prevalent on ultra high frequency bands.
- No Plug-In Coils.
- Individual Coils for each band.
- 10 All-Metal Tubes.
- Generous Isolantite and Steatite Insulation.
- Continuous Electro-Mechanical Band Spread.
- Iron Core Expanding I.F. Transformer.
- Built-in Power Pack.
- Frequency Calibrated Micro-Vernier 4-Band Dial.
- Antenna Compensator.
- Moderate Price.

# the hallicrafters

3001 Z Southport Avenue, Chicago, Ill.

Cable Address: LIKEX New York City

Say You Saw It in QST — It Identifies You and Helps QST

**Now—a high-powered—**

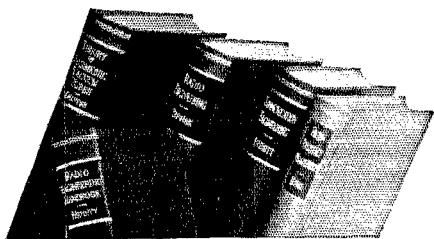

## RADIO ENGINEERING LIBRARY

- especially selected by radio specialists of McGraw-Hill publications
- to give most complete, dependable coverage of facts needed by all whose fields are grounded on radio fundamentals
- available at a special price and terms

These books cover circuit phenomena, tube theory, networks, measurements, and other subjects — give specialized treatment of all fields of practical design and application. They are books of recognized position in the literature — books you will refer to and be referred to often. If you are a researcher or experimenter — if your interest in radio is deep-set and based on a real desire to go further in this field — you want these books for the help they give in hundreds of problems throughout the whole field of radio engineering.

5 volumes, 2981 pages, 2000 illustrations

1. Everitt's COMMUNICATION ENGINEERING
2. Terman's RADIO ENGINEERING
3. Chaffee's THEORY OF THERMIONIC VACUUM TUBES
4. Hund's HIGH-FREQUENCY MEASUREMENTS
5. Henney's RADIO ENGINEERING HANDBOOK

### Special Low Price and Easy Terms

Bought singly, the five volumes comprising this library would cost you \$26.00. Under this offer you save \$2.50 and, in addition, have the privilege of paying in easy installments beginning with \$2.50, 10 days after receipt of the books, and \$3.00 monthly thereafter. Already these books are recognized as standard works that you are bound to require sooner or later. Take advantage of these convenient terms to add them to your library now.

#### SEND THIS ON-APPROVAL COUPON

McGraw-Hill Book Co., Inc.  
330 W. 42nd St., New York, N. Y.

Send me Radio Engineering Library 5 vols., for 10 days' examination on approval. In 10 days I will send \$2.50, plus few cents postage, and \$3.00 monthly till \$23.50 is paid, or return books postpaid. (We pay postage on orders accompanied by remittance of first installment.)

Name.....

Address.....

City and State.....

Position.....

Company.....QST-5-36

(Books sent on approval in U. S. and Canada only.)

modulation so as to simulate as nearly as possible the type of modulation of amateur stations. If it does not show 0 db on 100% modulation on voice, adjust  $R_1$  and  $C_1$  until it does. The monitor is now calibrated and can be used on any transmitter regardless of the frequency without loss of accuracy provided the carrier meter reads up to the calibrated value.

Tubes may be replaced without upsetting the calibration provided that the meter shunt is not changed. If that is done the monitor must be recalibrated.

With the monitor in operation there should be no indication of carrier shift on the carrier meter when the modulation meter shows 100%. If there is any, it indicates improper operation of the transmitter. The signal from the transmitter may be heard on 'phones plugged into the listening jack and is an exact picture of what is going on the air. However, the 'phones should be out of the circuit when calibrating and checking percentage of modulation.

The cost of this monitor should be less than \$20. This is low when you consider the satisfaction of knowing that you are always in the limits of modulation and getting the best results from your transmitter.

## A Simple 14- and 28-Mc. Rig That Has Worked Over 30 Countries

(Continued from page 48)

are adjusted by spacing the turns a little more than is figured necessary. With the set in operation, a few of the top turns are pushed down until maximum grid current is reached.

The common ground return of the amplifier is located mid-way between the grid and plate coils. It is made by running a small machine screw through the chassis, fitted with several soldering lugs to accommodate the various return leads. It is felt this has as important a part in getting the amplifier to operate stably as has good shielding. The plate end of the RK-20 is supported by a small stand-off insulator which has a copper bolt running through it from the fuse clip plate connection to the r.f. choke below. Needless to say, this makes a very sturdy mount for the tube as well as a good solid connection to the plate.

In this particular layout there are no controls on the panel, as the rig is mounted on a shelf in the cabinet mentioned earlier in the article. This cabinet has all the necessary switches and meters on its panel so it was decided not to put any controls on the r.f. unit's panel until the rig is mounted in a permanent rack. The plate condenser of the RK-20 has a knob extended to the left side of the cabinet by means of an insulated shaft. This makes the tank control readily accessible for any slight adjustments without raising the lid of the cabinet, and also allows the plate to be tuned "on the nose." With the lid raised and the tank tuned from inside the set, the plate



**MORE** AND MORE FOREIGN AMATEURS USE GROSS  
RELIABLE SERVICE. *We ship to all parts of the globe*

**New! Hallicrafter Sky-Buddy**  
5 Tubes Superheterodyne, Built-  
in Power Supply, and Speaker **\$29.50**

Another HALLICRAFTERS innovation — real Junior model communication receiver at a breathtaking low price! Equipped with five late type tubes the SKY-BUDDY is a superheterodyne of remarkable performance capabilities. The long list of features conveys some measure of its excellence.

**TUNING—IRON CORE I.F.**

Tuning from 18 to 555 meters in three bands, its single iron core IF stage and improved mechanical band spread system make it a receiver difficult to beat in sensitivity and selectivity even when compared with the higher priced communication sets. Bands tuned are 16 to 5.5 MC; 3.6 to 1.66 MC; 1640 to 550 KC.

**HALLICRAFTERS  
ULTRA SKYRIDER**

**5-10 METERS\***

\*ACTUALLY 3.9 TO 46 METERS

With the new **LAMB NOISE SILENCER**. A ten-tube Superheterodyne of remarkable sensitivity and many features. Moderately Priced.

**CW-60 (Uses New 35T)**

**Crystal Control Transmitter**

**OUTPUT: 60-100 WATTS**

*Complete Kit, Less Tubes and Crystal*

**\$20.95**

Power output depends on plate voltage used!

**TUBE LINEUP:** 47 crystal oscillator — 53 Buffer and Eimac 35T in output stage.

**POWER SUPPLY REQUIREMENTS:** Filament voltages 2½ volts at 4 amps. — 5 volts at 4 amps.

**PLATE VOLTAGES:** 400 Volts at 100 MA and 500 to 1250 volts at 100 MA.

**COILS:** One set of three coils are furnished with kit for operation on any one amateur band. Coils for 1.7; 3.5; 7; 14 MC may be purchased separately at \$2.75 per set.

**SIZE:** Overall dimensions of the unit are Height 4½ inches, width 11 inches, length 19 inches.

**P-60 DUAL POWER SUPPLY KIT..... \$25.95**

for CW-60 Transmitter — with matching chassis

*Descriptive Bulletin on Request*

*Just the Tube for 10 Meters*

**EIMAC 35T**

**38-112 WATTS OUTPUT**

High frequency oscillator, r.f. amplifier, doubler, and Class "B" modulator.

Class "C" output up to 112 watts. Class "B" output (2 tubes) 150 watts. Tantalum grid and plate (no "getter"). No internal insulators.

**CHARACTERISTICS:**

Filament voltage.....	5 volts
Filament current.....	4 amperes
Amplification factor.....	30
Maximum plate current.....	100 milliamperes
Plate voltage.....	200-1500 volts
Plate dissipation.....	35 watts
Grid-plate capacity.....	2 mmfd.
Base.....	Standard UX-4 prong
Height — Overall.....	5½ inches
Maximum diameter.....	1¾ inches

**Price \$8.00**

**20-10-5 METER BANDS**

**Simplified with Bliley HF-2**

**20 Meter Crystals**

Between 14.0 and 15.0 MC.....	\$7.50
BC2 Crystal Holders.....	1.00
BC3-40-80 M Mounted Crystals.....	3.95
LD2-40-80-160 M Mounted Crystals.....	4.80

**LARGEST BLILEY STOCK IN NEW YORK**

**OUTSTANDING ! !**

**Gross Crystal Holder**

**WHITE CERAMIC** commercial type crystal holder — priced at less than ordinary holders. Adjustable pressure, dust proof, no tools required to open. Takes crystal to 1¼" square. Plugs standard ¼" spacing. Most efficient job yet..... **\$1.00**

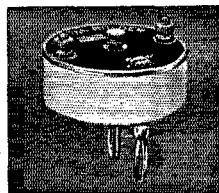

**KEYING RELAY**

will operate on one dry cell. Can be used as Single Pole Single Throw or Single Pole Double Throw. Sturdy construction, has ⅜" diameter Solid Silver Contacts. Compares favorably with expensive types. Special..... **59c**

20% DEPOSIT WITH ALL C. O. D. ORDERS

REMIT BY M. O. INCLUDE POSTAGE

Cable Address: GROSSINC

**GROSS RADIO, INC., 51 VESEY STREET, NEW YORK CITY**

# HIGH POWER

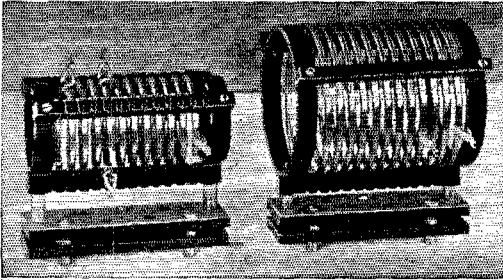

THESE two inductors cover all of the amateur bands to 10 meters, and have current carrying capacity for the highest power transmitter. Plug-in . . . wound with heavily plated copper tubing . . . mounted in rigid supporting frames . . . glazed porcelain insulation . . . outside of supporting ribs notched for additional coils . . . supplied with copper clips formed to fit the tubing . . . three JUMBO-type G-R plugs supplied with each coil.

## SPECIFICATIONS

	Type 679-A	Type 679-B
Turns.....	12	7 and 4
Number of sections.....	1	2
Inductance.....	10 $\mu$ h	2 and 1.5 $\mu$ h
Clips supplied..	3	4
Outside diameter of coil.....	5 $\frac{3}{4}$ inches	3 $\frac{1}{4}$ inches
Length, over all..	7 $\frac{1}{4}$ inches	7 $\frac{1}{4}$ inches
Height, over all	8 $\frac{1}{2}$ inches	6 $\frac{3}{4}$ inches
Depth, over all..	6 $\frac{1}{2}$ inches	4 $\frac{1}{2}$ inches
Price.....	\$7.50	\$6.50

Type 680-J Jack Base for use with the Type 679 Inductors, with three JUMBO Jacks, mounting holes, and holes for four additional jacks; Price: \$1.25.

*Order direct from this advertisement, sending remittance with order, and we ship prepaid anywhere in the United States*

## General Radio Company

30 State Street Cambridge, Mass.

current increases about 5 mils when the lid is lowered.

The plate coils are wound to be self-supporting of No. 12 enameled wire. These are used because of their low loss and ease of construction. They are first wound on a form 1 $\frac{3}{4}$  inches in diameter, and when taken off, the springiness of the wire makes them 1 $\frac{3}{4}$  inch inside diameter. Their small size makes them quite rigid.

The antenna used on both 14 and 28 mc. is an 80-meter single-wire fed Hertz, connected to the tank coil through a 0.002- $\mu$ fd. condenser. The power supplies are conventional. Two are used, one for the oscillator and another delivering 1000 volts to the plate of the amplifier, 300 to the screen and 45 to the suppressor.

## OPERATION

As was expected, the shielding and short direct leads eliminate all tendency toward self-oscillation in the amplifier at 28 mc. As it takes less than a minute to change bands, it is quite flexible in operation. There seems to be a slight regenerative effect in the amplifier on both 14 and 28 mc., but it doesn't cause any sign of self-oscillation, so it is a desirable condition. With the rig tuned to resonance (with the plate load disconnected) the grid current of the amplifier is 5 mils while the plate current is about 15 mils on 14 mc. With the plate loaded to draw 100 mils, the grid current rises to around 6 or 7 mils. When a pi-type antenna coupler was tried, the grid current dropped to about 3 mils. This was probably caused by the better impedance match between the plate circuit and the antenna, causing the regenerative effect to be canceled out. The minimum plate current on 28 mc. with no load is 32 ma.

The shielding does not reduce the output, as might be expected. In fact, it increases the output by keeping the r.f. where it belongs, instead of in the power leads and house wiring.

For c.w. there is seldom a time when more power is needed on these frequencies. Since this rig has been in operation some 30 countries have been worked; and from the reports given by these fellows, the signals compare favorably with signals from much higher-powered stations.

## Operating Notes on the 35T

*(Continued from page 53)*

14 mc., the efficiency being slightly better, although the difference was small. Evidently excitation power of the order of 10 to 15 watts is ample for driving the tubes as Class-C modulated amplifiers at 200 watts input for the pair at 28 mc.

## CLASS-B MODULATION

As Class-B modulators, a pair of 35T's can deliver about 140 watts of substantially undistorted output under maximum conditions. The following typical sets of operating conditions have been taken from the Class-B performance curves:

**RADIO SERVICE MEN  
GET FREE COPY**

**GENERAL  ELECTRIC  
SERVICE NOTES**

**1930 - 1935**

**HOW TO GET THIS BOOK  
FREE**

THIS OFFER EXPIRES MAY 30, 1936

Simply return **CARTON LABELS FROM 10 G-E "V-DOUBLET ANTENNA KITS**, to your G-E Radio Distributor and this new book of practical information will be yours. Better act **NOW!** Every radio service man can use a copy of General Electric Radio Service Notes for 1930 to 1935.

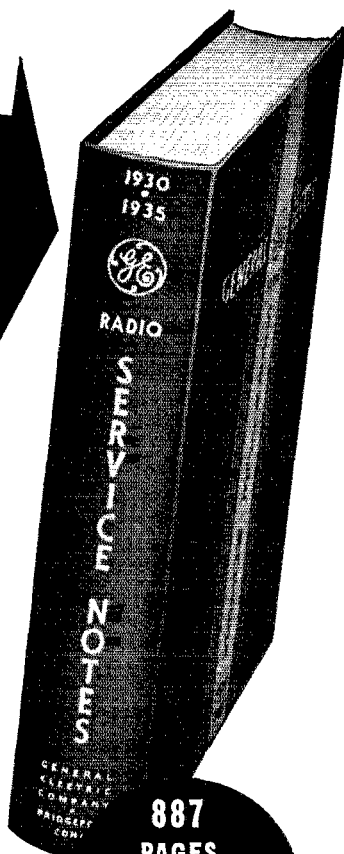

**887  
PAGES  
OF VALUABLE  
INFORMATION  
REGULAR PRICE  
\$2.00**

**THE GENERAL ELECTRIC "V-DOUBLET" ALL-WAVE ANTENNA OFFERS REAL OPPORTUNITIES FOR ALERT SERVICE MEN**

If you make a survey of your neighborhood, you'll find hundreds of radio owners who need a G-E "V-Doublet" All-wave Antenna. Service men can make good profits selling and installing this noise-reducing antenna system. The "V-doublet" gives excellent sensitivity on all short-wave frequencies . . . takes full advantage of the directional effects . . . reduces "man-made" static . . . equally effective for standard broadcasts . . . and is easy to install.

*Your nearest G-E Radio Distributor will gladly give you complete information.*

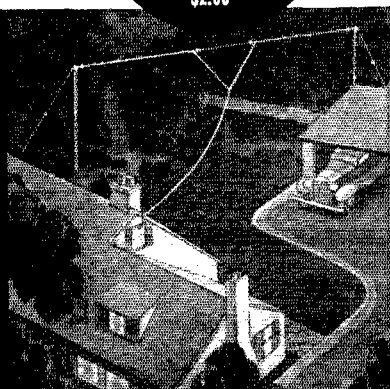

**GENERAL  ELECTRIC**

**The Original Metal-tube Radio**

APPLIANCE AND MERCHANDISE DEPARTMENT, GENERAL ELECTRIC COMPANY, BRIDGEPORT, CONN.

# “QRR—FLOOD WATERS CUT OFF ALL WIRE LINES!”



**HATS OFF TO THE RADIO AMATEURS** IN THE FLOOD AREAS! General Electric voices the nation's indebtedness to these "hams" and is proud to congratulate them for their invaluable service during the recent flood disasters.

For days, in many localities, amateur radio was the sole means of communication. No one can estimate the value of the sleepless hours—the untiring vigilance—that these "hams" spent at their sets. They warned communities of impending dangers, called for assistance for stricken towns, sent out pleas for food, medicine, and supplies, transmitted communications for relief organizations, assisted railroads and the power and telephone companies in restoring service to isolated regions, furnished news dispatches to the anxious world, and performed untold other services.

Though often the homes and families of these operators were endangered, and in many cases the very houses in which they worked were threatened with destruction—still they stuck to their posts. It required courage and experience to meet the test of such an emergency. Many an operator who was being pushed to the limit was grateful that he could count on the dependability of the G-E equipment in his set. General Electric Company, Schenectady, N. Y.



96-261

## GENERAL ELECTRIC

Plate voltage.....	1500	1250	1000	750	500	volts
Max.-sig. plate current (two tubes).....	140	158	188	200	200	ma.
Load resistance (per tube).....	5900	4300	2750	1750	1000	ohms
Power output (2 tubes)	140	125	120	90	50	watts
Driving power (2 tubes)	4.5	5.5	7.5	8.5	6.5	watts

The power output is limited by the permissible maximum plate current at low plate voltages, and by the safe plate dissipation at high plate voltages. The 1000-volt rating is of particular interest in that a pair of 35T's operating in Class-B at this voltage have ample output for plate-modulating another pair of the tubes also operating at the same plate voltage. This combination should give a fully-modulated 150-watt carrier with nothing being "pushed." A plate supply delivering 1000 volts at 300 ma. would be ample for both modulator and Class-C amplifier because of the nature of the speech wave-form. Because of the high amplification factor, the tubes can be operated at zero bias for Class-B audio at 500 volts on the plates. At higher voltages enough bias should be used to bring the static plate current down to a value which keeps the plate dissipation below the rated figure. Bias values ranging proportionally from 10 volts at 750 plate to 50 volts at 1500 plate should be satisfactory.

Incidentally, the driver used in the r.f. tests described above consisted of only two tubes, both RK25's. With a 500-volt plate supply, these two tubes provide more than ample excitation for the pair of 35T's on 28 megacycles, working from an 80-meter crystal. Measured output is better than 15 watts; more with 600 on the second RK25. To be described in June *QST*.

—B. G. + G. G.

### A Loving Tribute and a Challenge

(Continued from page 8)

more. He understood his fellow men and he loved them. Understanding—kindly, tolerant, helpful understanding—perhaps that expresses his high qualities as well as any words could.

"To this he added a boundless interest and energy. Always inquiring, reading, conversing, studying, working—he touched many fields of engineering and science and what he touched he vitalized.

"Through his leadership of the Hartford Section of the American Society of Mechanical Engineers, the Hartford Engineers Club, the American Radio Relay League, and other organizations, he influenced the lives of thousands of men.

"On the shoulders of you who are now the younger members—within a few years—will rest the responsibility of carrying on the fine tradition which our beloved first president, Hiram Percy Maxim, helped us to create. You have had the privilege of lighting your torches at his—carry them on undimmed—that others may be lighted from yours and the eternal light of knowledge and love burn ever brighter."

The

# CINAUDAGRAPH

Magic Magnet\*

**SPEAKER**

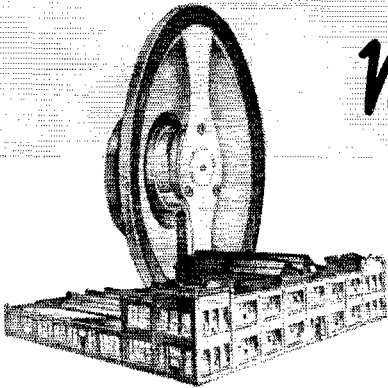

## REVOLUTIONIZES CONVENTIONAL SPEAKER CONCEPTS

\*"Nipermag," the MAGIC MAGNET used exclusively in Cinaudagraph Speakers, should not be confused with other permanent magnet alloys now available in American Speakers. It is an exclusive Cinaudagraph product.

Cinaudagraph engineers visualized a MAGIC MAGNET SPEAKER. They experimented; tested; and produced a fidelity of tone and a frequency range which are unique in speaker design. Hearing the new Magic Magnet Speaker is a far better advertisement than we could write.

Built under one roof, in one of the largest, most modern speaker plants in the world, all parts required in the assembly of the MAGIC MAGNET SPEAKER are completely manufactured by Cinaudagraph.

In every detail of its design — its construction — its materials — the MAGIC MAGNET SPEAKER is new!

### ● *IT'S NEW* in Cone Construction

A polyfibrous material developed, manufactured and introduced for the first time in speakers by the Cinaudagraph Corporation, presents a varying density of structure. This polyfibrous cone structure "shades" from one fibrous composition to another as the periphery of the cone is approached. This permits the oscillations of the voice coil to be transmitted with uncanny fidelity.

### ● *IT'S NEW* in Magnetic Material

"Nipermag" — a permanent magnet alloy presented for the first time in American speakers by Cinaudagraph engineers, has been and is being used extensively with great success in Europe. The use of "Nipermag" makes possible real humless reception.

### ● *IT'S NEW* in Voice Coil Construction

Because of its non-elastic, extremely dense nature . . . quartz silicate was used in the construction of the voice coil core.

### ● *IT'S NEW* in Spider Construction

A centering device, an exclusive Cinaudagraph development, consisting of an interlaced net, gives continuous attachment at a distance from the voice coil and at a point where maximum radial rigidity will be obtained without impairing the tonal quality of the cone.

### ● *IT'S NEW* in Baffle Construction

The Magic Magnet Speaker is designed to operate within a box or cabinet, which gives the effect of an infinite baffle. This baffle absorbs rear radiation, and allows only the true undistorted tones to emanate from the front of the speaker.

*Write today and get the technical data on many other interesting engineering developments incorporated in the construction of the Cinaudagraph MAGIC MAGNET SPEAKER.*

**CINAUDAGRAPH CORPORATION**

Speaker Division, "Ham" Dept.

STAMFORD, CONN., U. S. A.



## The New 1936 CENTRALAB Volume Control Guide

is off the press . . . more listings . . . way ahead . . . and up to the minute including 1935 data never before shown. All listings "checked and double checked" and will be found extremely accurate.

Keep abreast with this new Guide . . . and keep abreast with CENTRALAB Volume Controls and Fixed Resistors for ALL replacement jobs. Get a FREE copy from your jobber.

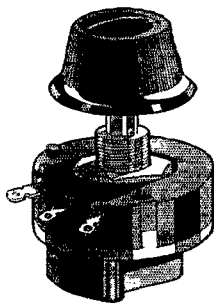

Every Radio Service Man should be a member of the Institute of Radio Service Men

**NEW! Up-to-the-minute**

# Centralab

MILWAUKEE, WISC.

**RADIOHMS ■ SUPPRESSORS  
FIXED RESISTORS**

## Politician Denounces Amateur Operator

(Continued from page 58)

labelling it as a rumor which had reached his ears, reporting without hysteria, yet with fear, that he was in danger, being plainly manifest on the part of both himself and his family and neighbors. These facts are verified by unimpeachable witnesses and by a transcription of the entire broadcast which was fortuitously made by an N.B.C. engineer at the time.

On the afternoon of Saturday, the 28th, DeSoto called on Mayor Shields and informed him in detail not only concerning this investigation but concerning amateur work in general throughout the flood area. As a result of this conference, the mayor announced that the case was being filed—the charges (one of involuntary manslaughter was under advisement by the district attorney's office) were being dropped.

That still, however, didn't restore the prestige of Johnstown's amateurs and amateur radio in general in the mind of the public throughout that section, which had been poisoned by the distorted and unfair newspaper accounts. So W1CBD and W8FRC next went to the office of the *Johnstown Democrat*, where a detailed two-column story covering the amateur's side of the case was left. This was duly published, and resulted in a pronounced reversal of opinion. In fact, Dixon, W8DYY, wrote afterward: "The sentiment of the public is gradually changing to one of admiration instead of hate and amateur radio again receives the credit due."

The fight still isn't over. The mayor hasn't yet eaten his words. The *Democrat* is still fishing for "evidence" that some amateurs broadcast a false report, although they've given up the panic angle. A.R.R.L., N.B.C., Westinghouse, and dozens of infuriated Pennsylvania amateurs are on the job, however, and the matter is going to be cleared up, definitely, before it is allowed to die.

## Experimenters' Section

(Continued from page 57)

well, incidentally, to the t.r.f. receivers in the *Handbook*), William A. Golden, W6EMJ, writes:

"The performance of the two-tube regenerative receiver can be improved noticeably by certain changes in the wiring of the voltage divider and regenerative control circuits.

"In the original circuit a 50,000-ohm potentiometer, used to control regeneration, is connected in series with a 25,000-ohm resistor across the high-voltage source (Fig. 6-A). This causes an unnecessarily large voltage drop across the potentiometer, especially when a power supply delivering more than 200 volts is used, and makes the control very critical and difficult to operate. If the potentiometer used is inclined to be noisy, this circuit only tends to aggravate the condition.

In Fig. 6-B is shown an arrangement which provides a very smooth and much quieter means of controlling regeneration and which spreads

# A.R.R.L.

The American Radio Relay League, Inc., founded in 1914, is the national non-commercial association of radio amateurs who have banded for the promotion of interest in amateur radio communication and experimentation.

AMATEUR RADIO OF TODAY IS THE RESULT OF THE EFFORTS OF THE A.R.R.L.

## For More Than Twenty Years

the A.R.R.L. has been the organized body of amateur radio, its representative in this country and abroad, its champion against attack by foreign government and American commercial, its leader in technical progress.

## Had It Not Been for the League

- amateur radio would never have reopened after the World War
- the swarming influx of broadcasters in 1922 and 1923 would have killed it off by legislation
- recent international conferences would have virtually wiped amateur radio from the face of the earth

# QST

*The oldest radio magazine*

First published in December 1915 — now, as then, devoted to amateur radio

## QST

### SCOOPS THE FIELD

Developments of real consequence in amateur radio appear *first* in QST . . . most new developments appear in QST *exclusively* . . .

## QST

*was the first to publish information on:*

- super-regeneration — July, 1922
- crystal control for amateurs — July, 1924
- the single-control neutrodyne — Aug., 1924
- 5-meter experimental work — Oct., 1924
- the single-control superheterodyne — Nov., 1924
- the skip distance theory — April, 1925
- link coupling — May, 1925
- the Zepp antenna — June, 1925
- the single-wire-fed antenna — July, 1925
- tuned r.f. amplifiers using screen-grid tubes — Dec., 1927
- high-C oscillator circuits — Aug., 1928
- satisfactory ham superhets — March, 1929
- 100 per cent modulation — April, 1929
- the Class B r.f. amplifier — April, 1929
- the dynatron frequency meters — Oct., 1930
- the matched-impedance doublet — Dec., 1930
- the first stable 5-meter oscillators — July, 1931
- super-regenerative 5-meter receivers — July, 1931
- Class B modulation — Nov., 1931
- electron-coupled oscillators — Jan., 1932
- electron-coupled oscillators in superhets — April, 1932
- The Single-Signal superheterodyne — Aug., 1932
- high-efficiency Class-C amplifiers — Sept., 1932
- m.o.p.a. 5-meter transmitters — May, 1933
- the Tri-tet circuit — June, 1933
- Pi-section antenna coupler — Feb., 1934
- suppressor-grid modulation — March, 1934
- the Type 53 exciter circuit — Oct., 1934
- u.h.f. directive antenna arrays — Oct., 1934
- successful DX 224-mc. communication — Nov., 1934
- controlled-carrier modulation — Jan., 1935
- resonant-line u.h.f. oscillators — Feb., 1935
- temp.-gradient u.h.f. propagation theory — June, 1935
- super-infra-generator receiver — Nov., 1935
- successful noise-silencing circuits — Feb., 1936

Always in QST — owned and controlled by A.R.R.L. members — you find what's both new and worth while in amateur radio.

### AMERICAN RADIO RELAY LEAGUE

West Hartford, Connecticut, U. S. A.

Date.....

Gentlemen:

I hereby apply for membership in the American Radio Relay League, and enclose \$2.50 (\$3.00 outside of the United States and its Possessions, and Canada) in payment of one year's dues, \$1.25 of which is for a subscription to QST for the same period. Please begin my subscription with the ..... issue. Mail my Certificate of Membership and send QST to the following name and address.

Name .....

Street or box address .....

City and State .....

Please write your name and address plainly



# AMPEREX HF200

A superior tube for every purpose, particularly for ultra-high frequency operation . . .

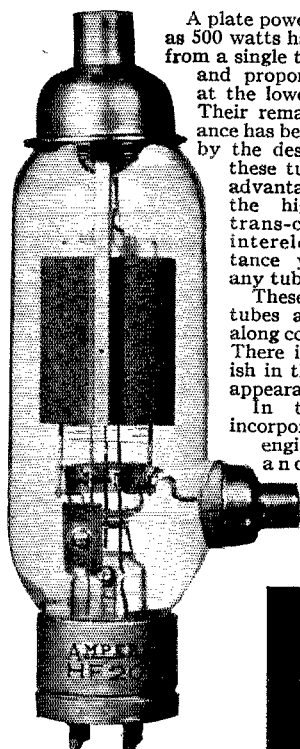

A plate power output as high as 500 watts has been obtained from a single tube at 5 meters, and proportionate outputs at the lower wave lengths. Their remarkable performance has been made possible by the design which gives these tubes the distinct advantage of possessing the highest ratio of trans-conductance to interelectrode capacitance yet attained in any tube.

These new Amperex tubes are proportioned along conventional lines. There is nothing freakish in their structure or appearance.

In their design is incorporated the latest engineering practice and knowledge of ultra-high frequency operation.

**\$24.50**

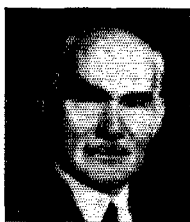

**Lee DeForest Says:**

"... we have had nothing but most satisfactory results, and frankly have found Amperex tubes superior for our work to those of other manufacturers which we have tried.

"We are highly pleased with the results obtained. We feel that manufacturers of radio transmitters are fortunate to have available oscillator tubes possessing this degree of reliability."

**WRITE** for catalog listing complete line of Amperex transmitting tubes

# AMPEREX

Electronic Products, Inc.

77 Washington Street, Brooklyn, N. Y.

the range of the control out considerably, eliminating any tendency of the detector to jump into or out of oscillation at a very slight turn of the knob. This circuit also has less detuning effect on the set than the original one.

Two 10-watt resistors, one of 10,000 ohms and the other of 3000 ohms, connected in series, are used as a voltage divider and the regeneration control is placed in parallel with the one of 3000 ohms. This gives sufficient voltage drop across the potentiometer to bring the detector into oscillation over the entire frequency range covered by the receiver, using coils wound according to specifications given in the original article.

"The above resistor values are not recommended when batteries are used to supply plate voltage because the excessive current through the low-resistance voltage divider will shorten their life considerably. These low values are used to reduce the detuning effect of the regeneration control when an a.c. power supply is used. However, resistors of 60,000 ohms and 18,000 ohms could be used in a battery powered set with the same beneficial results."

In connection with blocking of a regenerative detector when strong local signals are received, W6LHA suggests the use of a low-resistance grid leak. This practice has resulted in a distinct improvement in the performance of his t.r.f. set in this respect. He writes: "The effective selectivity has been greatly improved over that ordinarily obtainable by the usual manual adjustment of the r.f. gain control by using a 100- $\mu$ fd. mica grid condenser and a 300,000-ohm grid leak in place of the larger values commonly used. This permits advancing the gain control for weak DX signals and still reduces detector blocking to practically nothing on strong local QRM. There is no noticeable decrease in detector sensitivity with the lower value of grid leak. I had known for a number of years that reducing the grid leak value would reduce detector blocking on loud signals, but W6WC introduced me to the idea of using quarter-meg. values to eliminate blocking completely, where I had previously been using 1- and 1.5-megohm values and getting only partial reduction—being afraid to go lower because no one else did, and considered it good practice."

## Correction

**T**HROUGH oversight we neglected to show a grounded center-tap connection in the combined power and bias pack described by W9JHY in the Experimenters' Section in February *QST*. The center-tap of the high-voltage winding must be connected to ground or else no current can flow. The circuit is not that of a bridge rectifier, which it resembles in the diagram, but two separate center-tap rectifiers.

W3AJF has called our attention to an error in the milliammeter-switching diagram, Fig. 3-B, page 42, December *QST*. As diagrammed, the meter is short-circuited when the switch is thrown to the "plate" position. The common connection



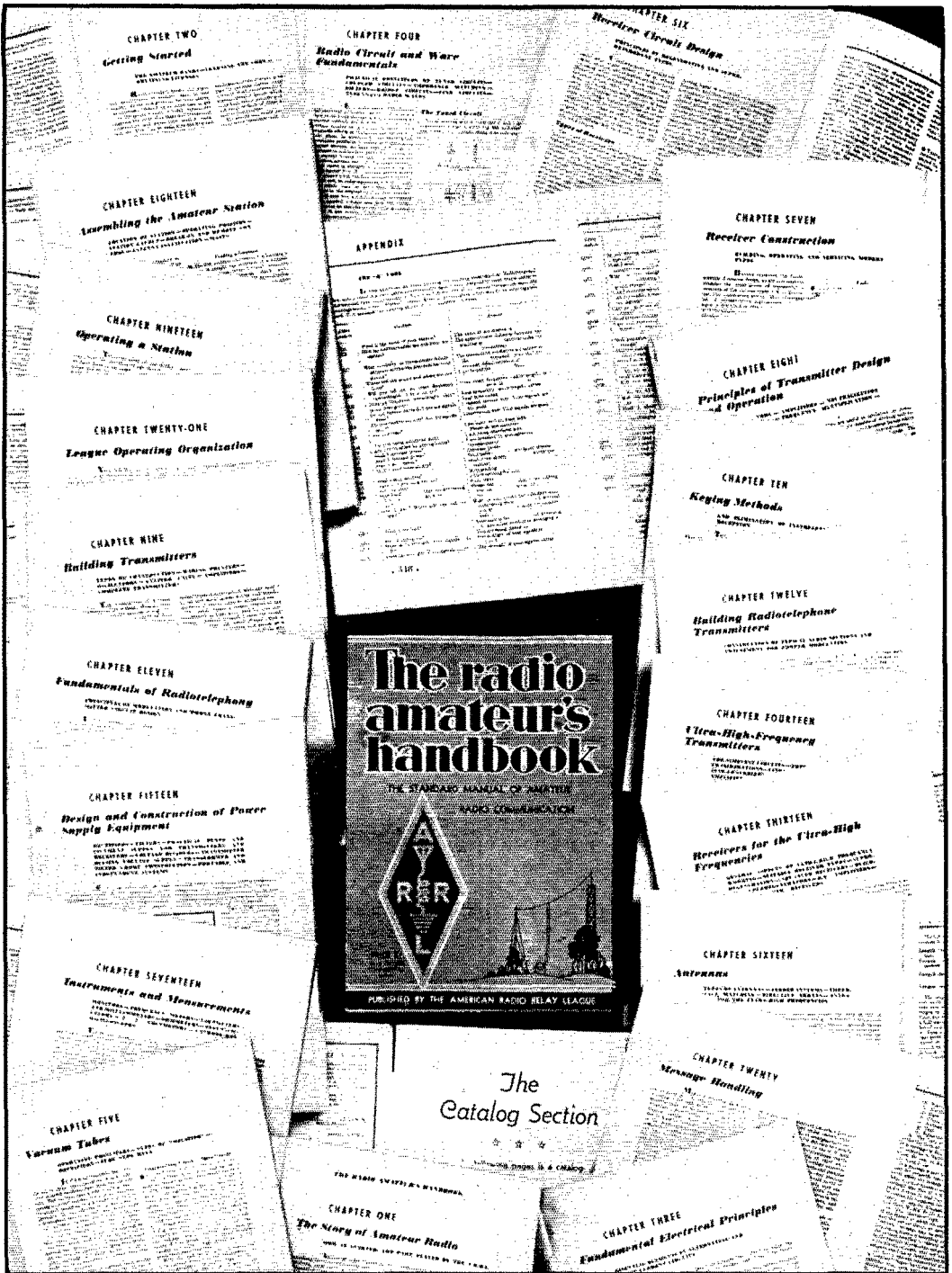

\$1.00 Postpaid in Continental U. S. A.

\$1.15 postpaid elsewhere

Buckram Bound, \$2.50

**American Radio Relay League, West Hartford, Conn.**

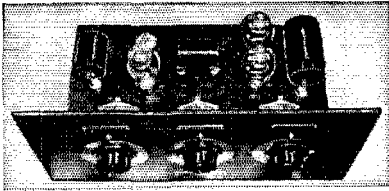

## RATTLE THE AUSSIE'S FONES WITH THE MB50

This modern, flexible, inexpensive crystal-controlled Transmitter Kit uses a 59 "Tritet" Oscillator, driving a pair of 802's to 50 watts output. No neutralization is required. Coils are available for operation on all bands from 100 to 10 meters.

The MB50 Kit uses the highest quality parts representing such names as National, Hammarlund, Sangamo, Vaxley and others equally well-known. The complete kit includes all component parts, a drilled, crackle-finished chassis and panel, metal-etched dials and one set of coils. Complete with instructions. . . . **\$19.90**

## M. & H. Heavy Duty Power Supply Kit

This Power-supply Kit, consistent with our policy to use only the best of parts is made of Thordarson Transformers and Chokes, and oil-filled 1000-volt filter condensers. Voltages are available up to 600 volts at 200 milli dc. Filament voltages of 7.5; 6.3; and 2.5 are supplied. The use of an 83 or 523 rectifier is optional. The base is punched and crackled ready for assembly. This pack may be considered a companion unit to the MB50 transmitter. Complete with instructions for assembly. Price. . . . . **\$10.75**

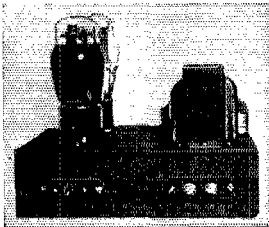

**Loud-Speaker Reception on Your SW3**

The M. & H. Combination Power Pack and Audio Amplifier supplies power and amplification for receivers similar to the National SW3, making it possible for them to deliver loud-speaker volume.

Socket and terminal connections enable one to attach this unit in a few moments. Overall dimensions are 6 1/4 x 7 1/4 inches. Tubes used are an 80 Rectifier and a 2A5 Amplifier. Completely wired, less tubes. **\$9.95** price. . . . . Tubes 93c

**M & H Sporting Goods Co.**

512 MARKET ST.

1709 Atlantic Ave.

PHILADELPHIA

Atlantic City

I'm going to change to a BC3.

You'll never regret it They are FB

**BLILEY BC3** \$3.95

**CRYSTAL UNITS** and up

**THOUSANDS ARE IN USE**

between ground, -B, and the positive meter terminal should go to the upper center switch post, and the filament center-tap should be returned to the upper right switch post, leaving the shunt connected between the two as already indicated. This connects the meter across the shunt when the switch is thrown to "plate."

W6GVT, Lompoc, Calif.

(Continued from page 59)

'phones, the monitor is connected and the power to the plates of the transmitter final turned on.

Answering a query from W9KEH in a recent O.R.S. Bulletin, W6GVT is another southpaw O.R.S. and is a member of the A.A.R.S.

## A.R.R.L. QSL Bureau

FOR the convenience of its members, the League maintains a QSL-card forwarding system which operates through volunteer "District QSL Managers" in each of the nine U. S. and five Canadian districts. In order to secure such foreign cards as may be received for you, send your district manager a standard No. 8 stamped envelope. If you have reason to expect a considerable number of cards, put on an extra stamp so that it has a total of six-cents postage. Your own name and address go in the customary place on the face, and your station call should be printed prominently in the upper left-hand corner.

- W1—J. T. Steiger, W1BGY, 35 Call Street, Willimansett, Mass.
- W2—H. W. Yahnel, W2SN, Lake Ave., Helmetta, N. J.
- W3—R. E. Macomber, W3CZE, 418 10th St., N. W., Washington, D. C.
- W4—B. W. Benning, W4CBY, 520 Whiteford Ave., Atlanta, Ga.
- W5—E. H. Treadaway, W5DKR, 2749 Myrtle St., New Orleans, La.
- W6—D. Cason Mast, W6KHV, 423 East E Street, Ontario, Calif.
- W7—L. Q. Kelly, W7BPC, 4919 So. Prospect St., Tacoma, Wash.
- W8—F. W. Allen, W8GER, 324 Richmond Ave., Dayton, Ohio.
- W9—George Dammann, W9JO, 319 Sherman Ave., Evanston, Ill.
- VE1—J. E. Roue, VE1FB, 84 Spring Garden Rd., Halifax, N. S.
- VE2—W. H. Oke, VE2AH, 5184 Mountain Sights Ave., N. D. G., Montreal, P. Q.
- VE3—Bert Knowles, VE3QB, Lanark, Ont.
- VE4—Dr. J. J. Dobry, VE4DR, Killam, Alberta.
- VE5—E. H. Cooper, VE5EC, 2024 Carnarvon St., Victoria, B. C.
- K4—F. McCown, K4RJ, Family Court 7, San-turce, Puerto Rico.
- K7—Frank P. Barnes, K7DVF, Box 297, Wrangell, Alaska.
- KA—George L. Rickard, KA1GF, P. O. Box 849, Manila, P. I.



# Oil-Filled!

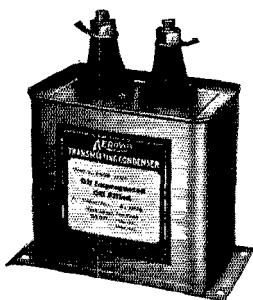

AEROVOX transmitting condensers are oil-filled and so labelled. ● That means an oil-impregnated section placed in hermetically-sealed seepage-proof metal can filled with oil. ● Thus section is constantly bathed and permeated with oil for constant, cool, safe operation over longest service life.

In round and rectangular cans.

High-tension pillar insulator terminals.

Hermetically-sealed. Seepage-proof joints and terminals.

Conservatively rated. Honestly labelled.

New low prices.

You'll save money in the long run by insisting on AEROVOX oil-filled (note exact term) condensers.

**DATA** Latest catalog covers advantages of oil-filling. Send for copy, and sample of Research Worker.



73 Washington St. Brooklyn, N. Y.

## Multi-Purpose Model for Amateurs

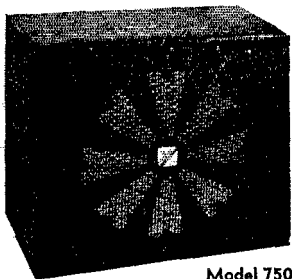

Model 750

The demand for a high quality, high efficiency separate speaker for "Hams," Amateurs, Experimenters and Engineers resulted in the design of the above Wright-DeCoster Multi-Purpose Model.

**MODEL 750**—Cabinet complete with 6" Hyflux Magnetic Speaker. Standard impedances, 7000 ohms or 10,000 ohms center tapped. List price..... **\$7.50**

**MODEL 880**—Cabinet complete with 6" Electro Dynamic Speaker with Universal Transformer to match all output tubes. List price... **\$8.80**

**MODEL 1050**—Cabinet complete with 6" No-Koil Reproducer with Universal Transformer to match all output tubes. List price..... **\$10.50**

Write for description of other models and general catalog. Buy through Wright-DeCoster distributors. They are always anxious to cooperate.

### WRIGHT-DECOSTER, INC.

2259 University Ave. St. Paul, Minn.

Export Dept. — M. Simons & Son Co., New York  
Cable Address: "Simontrice"

Canadian Office, Wright-DeCoster, Inc., Guelph, Ont.

## DX Contest Highlights

(Continued from page 38)

stragglers still insisted on the condemned practice of calling CQ DX, a marked improvement over last year was noted. On the other hand, nearly all reporters complain of poor quality signals from many W/VE stations as well as from foreign stations. Entirely too much out-of-band operation also was reported and we fear that many good scores may have to be eliminated on this count. One CM2 had four or five signals of equal strength evenly spaced throughout each band in which he operated. A U3 crept through more than half of the 14-mc. band on an ordinary CQ. One K5 was frequently mistaken for static or a car motor idling in the vicinity of the receiver. And there was the VK2 who called CQ and signed VU2 and who after contacting would correct it to VK2 much to the disappointment of many W/VE's. Compared with the number taking part, however, these types were very much in the minority. Many W/VE reporters expressed their great disappointment in the failure of most DX stations to use the QLM, QHM, etc. signals.

Proof that after eight years enthusiasm for the contest of contests is still on the increase may be found in the remarks attached to many logs. "Had to walk four miles each way to the station whenever I wanted to get on the air."—W9WFV, exW4CA. "The standard of operating from practically all the stations I worked was very high and the large majority of them had very fine crystal-controlled signals. I would like to say thanks to all my old W/VE friends and many new ones who gave me points in the contest."—GI5QX. "Biggest disappointment was missing new WAC record by mere inattention. Was so busy chasing Europeans one evening that not until too late did I notice that I had QSO'd D, ZE, LU and J in some 35 minutes leaving the two easiest continents for a WAC in record time."—W6CUH. "Europeans heard at all hours excepting 11 p.m. to 6 a.m."—W6AWT. "I thought that all spark stations were off the air but I found that there are quite a few still buzzing away in certain sections of this country and Canada."—W9HHQ.

"WAC'd four times, once in 2 hours and 25 minutes."—W8KKG. "I move that the contest be made an all-year affair."—W9DHN. "Due to strong March gale which sprang up in these parts the last day of the contest, I had to be content with my antenna on the roof. It seemed to work about as well."—W9DFY. (Also W2CGJ.) "Didn't go on 80 until March 18th and, to my surprise, DX was fine there."—W4AH. "Looking forward to winning the next contest, so be ready to put W4AUU on the certificate."—W4AUU. "WAC'd five times."—W8LEA. "Why not make it a semi-annual contest?"—W4CBZ. "On Friday evening I decided as I wasn't able to work south very well that I should have a southern antenna. So with the help of W3EOI and W3OR took a two-section 36-foot ladder and raised it in the field and put three guy ropes to hold it. The ladder mast stayed up through a very severe wind storm Sunday morning."—W3EVV.

# COMPLEX PROBLEMS

This Problem Quickly and Easily Solved with Type A Calculator

**PROBLEM: HOW MANY TURNS ON A 1/2" DIAMETER FORM 1/2" LONG MUST I USE WITH A 25 μMFD CONDENSER TO TUNE TO 4000 KC.?**

$$L = \frac{10^8}{(2\pi f)^2 C} \text{ MICROHENRYS}$$

$f = 4 \times 10^6$   
 $C = 25 \times 10^{-6}$

$$L = \frac{10^8}{(2\pi \times 4 \times 10^6)^2 (25 \times 10^{-6})}$$

$$= \frac{10^6}{15776} = 63.4 \text{ MICROHENRYS}$$

$$N = \sqrt{\frac{3A + 4B}{0.2A^2} \times L}$$

$A = 1.5$   
 $B = 0.5$   
 $L = 63.4$

$$N = \sqrt{\frac{(3 \times 1.5) + (4 \times 0.5)}{(0.2 \times 1.5)^2} \times 63.4}$$

$$= \sqrt{\frac{3.75 + 2.0}{0.225} \times 63.4}$$

$$= \sqrt{36 \times 63.4} = \sqrt{2282.4} = 47.7$$

**= 35 TURNS ANS.**

## MADE EASY WITH

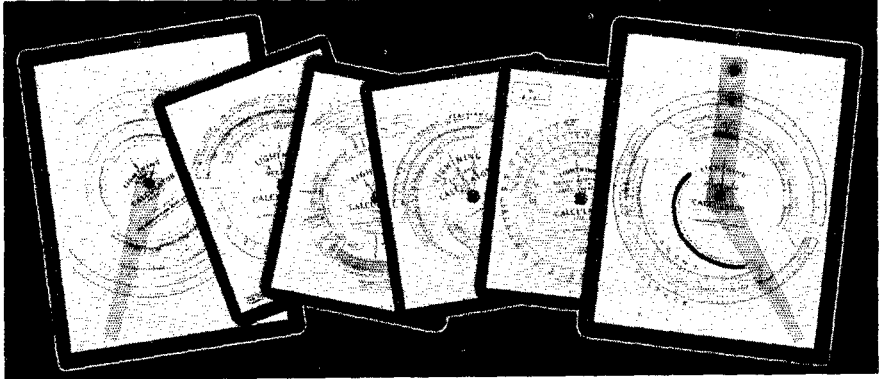

## LIGHTNING CALCULATORS

Six Types Solve ALL Problems

**TYPE A**—For problems involving frequency, inductance and capacity, in design of radio frequency circuits. Direct reading answers for size of coils and condensers for any range between 400 kc. and 150 mc. Price, \$1, postpaid.

**TYPE C**—More information on electrical conductors than you could find in a book full of tables. Price, 50c, postpaid.

**TYPE E**—Direct reading total resistance of resistors connected in parallel, and total capacity of condensers connected in series. Price, 50c, postpaid.

**TYPE B**—Gives direct reading answers to calculations involving current, resistance, voltage and power with scale for resistance of copper wire and scale for calculating decibel gain or loss. Price, \$1, postpaid.

**TYPE D**—Gives decibel gain or loss when input and output voltages, currents or power are known. Price, 50c, postpaid.

**TYPE F**—Permits measurement of resistance, from 1 ohm to 1 megohm by use of a voltmeter. Makes an ohm-meter of your voltmeter. Price, 50c, postpaid.

AMERICAN RADIO RELAY LEAGUE, INC., West Hartford, Conn.

Say You Saw It in QST — It Identifies You and Helps QST

# 32%

## OF THE APPLICANTS FOR AMATEUR LICENSE PRIVILEGES FAIL THE EXAMINATION

### Why?

Inadequate technical background? Perhaps.

Lack of practical operating experience? Very likely.

Code incompetency? Yes.

Insufficient background of general information? Unquestionably.

A major step toward making certain that *you* will not fail is thorough study of

## THE RADIO AMATEUR'S LICENSE MANUAL

*Includes:*

Corrected text of the amateur regulations up to date.

Corrected answers to typical examination questions relating to regulations, where the same are changed by the amendments to regulations.

Corrections in the text concerning permissible 'phone bands and portable privileges, under new regulations.

Additions to the text about licensing, to incorporate the existing arrangements in Alaska, Puerto Rico and Hawaii, the right to have code tests administered by government radiotelegraph operators; and a similar paragraph extending to cripples the right to have their material dictated or typewritten.

Several notable changes in the way of improved answers to questions in the Class-A 'phone examination, bringing them in line with the modern engineering concept of modulation.

Several other improved answers to questions appearing in the Class-B-C examinations.

UP TO DATE IN EVERY RESPECT. VALUABLE ALIKE  
TO THE BEGINNER AND THE ALREADY-LICENSED

**25 CENTS POSTPAID . . .** (No stamps, please)

[[ No. 9 in the series entitled ]]  
[[ The Radio Amateur's Library ]]

## THE AMERICAN RADIO RELAY LEAGUE

WEST HARTFORD, CONNECTICUT

"WAC'd three times."—W8LUQ. "Made WAC twice."—W1EZ. "Had a flock of equipment ordered especially for the contest but none of it arrived."—W8DED. "Made WAC 6 times."—W9PGS. "Made WAC in 3 hours, 57 minutes."—W9OQP. "Biggest thrill of the contest for me was working VS6AQ, KA1LB and J2KJ in 18 minutes on 3 calls in succession right through the Sunday morning QRM on 14 mc."—W8DGP. "Heard all continents in three minutes on 10."—W9CNE. "With blood-shot eyes, frazzled nerves, aching jaws (from yawning too much), a glass arm and the seat of my trousers badly worn but still with a smile in my heart, I take great pleasure in submitting the results of my efforts in your Eighth International Competition. In spite of all the casualties, I enjoyed every minute of it. During the contest the only time I ever encountered the YF was at meal time, and even some of those were taken on-the-fly. She is a good sport—and having been through several of these competitions with me, she enjoyed watching the results as much as I did in bringing them about. I would like to extend my sincerest thanks to each and every operator who was contacted for the splendid way in which they cooperated to make possible many short, clear and fast QSO's. Among other things I had the pleasure of renewing radio acquaintances that had almost slipped into oblivion, this being one of the many things which your competition makes possible. All licensing areas worked although it took three bands to do it."—NY2AB.

Most of the fellows in the northeastern part of the country have a real alibi. The serious floods which swept this portion of the country took many of them off the air after only a day or two of operation. Too much credit cannot be given to those who voluntarily quit the contest for which they had been planning a full year to lend their assistance in establishing communication with isolated areas.

In closing we should not fail to offer three cheers and condolences to that valiant army of YL's and YF's who had to endure nine full days of broken dates, irregular, late and lonely meals and alternately grouchy and insanely elated menfolk.

Some of the higher scores reported thus far include:

W1RY 22,000; W1CMX 41,500; W1DZE 61,191; W1ZI 56,000; W1FH 61,236; W1SZ 53,000; W1TS 48,000; W1BFT 23,000; W1EWD 40,000; W1BUX 34,800; W2OA 24,000; W2BJM 22,500; W2DC 51,700; W2UK 78,000; W2BYP 70,000; W2AIW 57,000; W3IMM 50,000; W3JM 20,000; W3SI 75,800; W3DMQ 46,000; W3EYS 43,000; W4AUU 15,000; W4AH 31,000; W4COE 10,000; W4AAQ 17,700; W4AJX 33,000; W5ASG 13,000; W5FI 10,000; W6AWT 22,500; W6CUH 35,000; W6FQY 36,000; W6GRL 58,000; W6CXW 50,000; W6GRX 39,000; W7DL 13,300; W7AVV 11,700; W8LEA 36,000; W8ZY 32,000; W8CRA 20,000; W8IXS 11,000; W8AAT 16,000; W8KKG 23,000; W9TJ 15,000; W9JFB 18,000;

# Build Your Own ALL-STAR TRANSMITTER

At right—Bottom view of 40-watt R. F. unit

## FOR 10 METERS!

THE All-Star Transmitter is designed so that either the 40 or 400-watt R. F. unit can be operated at full rated input on any amateur frequency up to 30 megacycles without any changes in wiring.

Data on 10-meter operation, as well as complete details on the All-Star Transmitter, are available at your Parts Distributor.

See your jobber or write  
**ALL-STAR HEADQUARTERS**  
 222 W. Adams St., Chicago

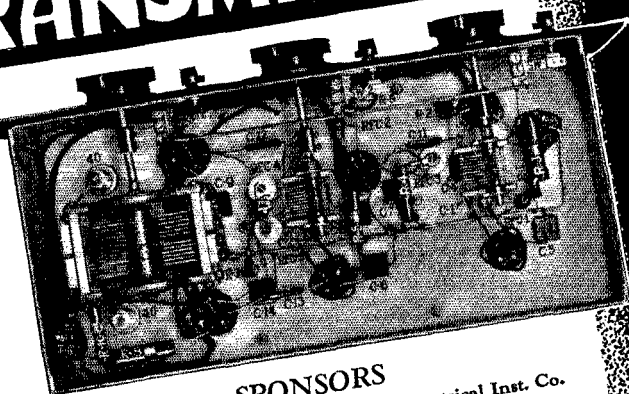

### SPONSORS

- Thordarson Electric Mfg. Co.
- Hammarlund Mfg. Co.
- Cornell-Dubilier Corp.
- Triplett Electrical Inst. Co.
- Ohmite Mfg. Co.
- E. F. Johnson Co.
- Crowe Name Plate Co.

## LEARN RADIO

New Classes Now Forming! Send for 40-page catalog, explains fully, 300 licensed graduates placed in past 4½ years in broadcasting, shipping, police radio, aviation, etc. We teach all branches. Oldest, largest and best equipped school in New England. Equipped with Western Electric sound and broadcasting equipment and RCA marine transmitter. Course prepares for United States Government telegraph or telephone license.  
**MASS. RADIO SCHOOL, 18 Boylston Street, BOSTON**

## BRUSH

### Headphones

Meet every headphone requirement. They bring in weak signals strong and clear and will handle excessive volume without overloading. Response 60 to 10,000 cycles. No magnets to cause diaphragm chatter. Specially designed cases minimize breakage. Light in weight. Only 6 oz., complete with headband and cords. A quality product at a low price. Details, Data Sheet No. 10. Copies on request. Send for one.

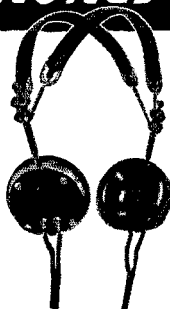

The **BRUSH** DEVELOPMENT COMPANY  
 1888 E. 40th St. CLEVELAND, O.  
 MICROPHONES • MIKE STANDS • TWEETERS • HEAD PHONES • LOUD SPEAKERS

## New Compact Condensers especially suited for mobile ultra-high frequency transmitters

CONTINENTAL Type "H" condensers are non-inductive and wax impregnated. Tested at twice rated voltage. Impervious to moisture and extreme temperature changes. Both price and quality are right! Available from your CONTINENTAL Carbon jobber.

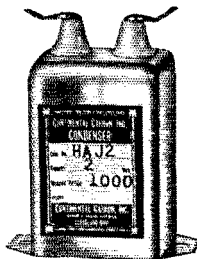

Code	D-C Working		Dimensions in Inches	List Price	Your Net Price
	Cap.	Volt.			
HAI1	1	1000	3 x 2 x 2	\$1.75	\$1.05
HAI2	2	1000	3 x 2 x 2	2.50	1.50
HAI4	4	1000	5 x 2 x 2	4.50	2.70
HAE1	1	1500	3 x 2 x 2	2.25	1.35
HAE2	2	1500	5 x 2 x 2	3.25	1.95
HAE4	4	1500	5 x 3¼ x 2-1/16	5.00	3.00
HBJ1	1	2000	5 x 3 x 1¾	2.90	1.74
HBJ2	2	2000	5 x 3¼ x 2-1/16	4.00	2.40
HBJ4	4	2000	5 x 4-5/16 x 2-15/16	6.00	3.60

Write for FREE Engineering Bulletins 103 and 104

## CONTINENTAL CARBON Inc.

13924 Lorain Avenue, Cleveland, Ohio

# GTC AMATEUR PLATE TRANSFORMERS are DUO-PRIMARY

## HIGH OR LOW POWER AT THE SNAP OF A SWITCH

● Off resonant currents get plenty high. Don't damage expensive tubes or equipment when tuning with high power. Use GENERAL TRANSFORMERS with fingertip control—all switching done in the primary—at low power—safely, economically, practically.

Tune with safe Lo Power—Snap, and the "soup's on!" Snap to Lo for those local QSO's! Snap and you're set for DX!

Switching power with G T C's does not affect efficiency of the unit, whereas tremendous power would be wasted if resistors were used for Hi-Lo Power.

All controls on the front of the panel—you don't reach behind and run the risk of tangling with high voltage. Changing power by switching high voltage terminals is dangerous—3,000 volts is no toy.

Fingertip switching with GENERAL'S is the safe answer—it eliminates those cold sweat visions of tubes going up in smoke.

GENERAL TRANSFORMER CORPORATION  
518 S. Throop Street Chicago, Illinois

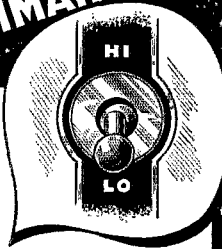

W9TB 50,000; W9IJ 50,000; W9PGS 12,800;  
VE5EO 7400; VE2AX 21,000.

—D. H. M.

## Dual-Diversity 'Phone Reception With Single-Control Tuning

(Continued from page 45)

the photographs is an elaborated version of the simple circuit, including in each section an additional antenna coupling stage, three i.f. stages with iron-core transformers, a noise silencer and an amplified a.v.c. system of the type used in the earlier development experiments.<sup>3</sup>

No attempt will be made to describe this model in detail, but its major features will be outlined. A new type of moving-coil system is used for band changing, separately shielded coil units being shifted by a chain mechanism. The frequency coverage is 1.7 to 30 mc. in four overlapping ranges. As indicated in the diagram, r.f., first detector and oscillator circuits are tuned by a five-gang condenser, while the tuned-grid tuned-plate antenna coupling stage is tuned by a separate four-gang condenser, the five-gang unit being at the bottom of the main panel and the four-gang unit at the top. As shown in the rear view, the antenna-coupling r.f. stages are at the top with the other five high-frequency circuits at the bottom. A concentric transmission line feeds from the top unit to the bottom. The i.f. circuits progress up the vertical assembly to the silencer, second-detector and a.v.c. circuits. The separate audio amplifier is a modified Collins Type 7C equipped with bass and treble tone controls. Three separate power supplies are mounted in the lower part of the rack, one for the r.f. and i.f. section of each receiver and one for the a.v.c. tubes. One filament supply is used for the miniature lamps which illuminate the recessed meter and dial scales. The speaker in its separate cabinet is a high-fidelity Jensen with a "tweeter" unit.

The various controls lined up vertically along the sides of the main panel are mostly "set and forget," including adjustments for a.v.c. delay, diversity meter sensitivity and zero setting, and silencer threshold, two for each purpose. The control at the upper left is for selecting either receiver "A" or "B," or both in diversity combination, while that at the upper right controls the c.w. beat oscillator which is used on receiver "B." The large scale in the center, above the main tuning control on the console panel, is an auxiliary tuning indicator having two pointers, one connected by cord drive to the main tuning shaft and the other to the input-stage tuning control. This feature is a convenience for estimating band-tuning position and for rapid alignment of the input and main tuning adjustments.

The lower-left meter indicates line voltage, the upper two (right and left) show plate current of the respective receivers, while that at the lower right indicates the combined plate current of the two a.v.c. tubes and is used as the tuning meter. The twin meters of the rectangular unit

(Continued on page 108)

## NOW . . . CONTROL AT THE MICROPHONE

● Now for the first time you can control the volume of a crystal microphone at the microphone . . . without in any way affecting the quality of reproduction! Ideal for soloists, speakers, announcers . . . for any application where control at the microphone is desirable.



A special capacity attenuator developed by Shure Engineers now makes possible volume adjustments which are entirely free from "tone-control" effects. Operation is "smooth" and noiseless over the total volume range of approximately 25 db. An independent ON-OFF switch allows the microphone to be turned on or off without disturbing the volume adjustment. The unit mounts on any Shure Stand (3/8"-27 thread).

Ask your Jobber for complete information, or write for Data Sheet.

**SHURE MICROPHONES**  
SHURE BROTHERS • MICROPHONE HEADQUARTERS  
215 WEST HURON STREET • CHICAGO, U. S. A.



# TRY SPRAGUES ...

*and note the difference*

## DON'T MISS THIS!

Hot off the press comes the new 1936 Sprague Catalog brimful of new condensers, new ideas, new service helps, new low prices on transmitting condensers, etc. Write for yours today! Save time by making duplicate replacements the Sprague Way! Get the new dope on Interference Elimination! See the complete new line of 450 volt condensers—the finest ever! Learn about the Sprague Short Wave High Frequency Oil Impregnated Condensers—and countless other features you can't afford to miss!

Remember: No need to check surges when you use Sprague's. You know they're right.

**SPRAGUE PRODUCTS CO.**  
North Adams, Massachusetts

# SPRAGUE 600 LINE CONDENSERS

AMERICA'S FINEST LINE OF QUALITY UNITS

## RADIO ENGINEERING

RCA Institutes offers an intensive course of high standard embracing all phases of Radio. Practical training with modern equipment at New York and Chicago schools. Also specialized courses and Home Study Courses under "No obligation" plan.

Illustrated Catalog on request

**RCA INSTITUTES, INC.** Dept. ST-36

75 Varick St., New York 1154 Merchandise Mart, Chicago  
Recognized Standard in Radio Instruction Since 1909

## ECONOMY CODE MACHINE—\$12

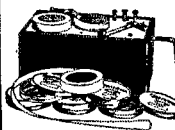

Learn code easily, at your convenience—and economically. Famous Instructograph principle. Complete with choice of 5 tapes, and Book of Instructions. Delivered postpaid anywhere in U. S. A. Send postcard for full details.

Instructograph Co., Dept. Q-53  
912 Lakeside Place Chicago, Ill.

## There's More than Efficiency in TRIMM FEATHERWEIGHTS

We at Trimm take a personal pride in the products we manufacture—this assures you of the finest headset that can be made.

Available from all of the discriminating jobbers

**TRIMM RADIO MANUFACTURING CO.**  
1770 W. Berneau Ave., Chicago, Ill.

## VALPEY CRYSTALS STEP BY STEP PRECISION MADE

Type VM2. Mounted crystal within 5 Kc of specified frequency 1.7, 3.5, 7 Mc Bands .....\$3.00  
Type VC2. Unmounted x cut within 5 Kc 1.7, 3.5, 7 Mc Bands .....\$2.25  
Type VC2 in 1.7, 3.5 Bands only. Plus or minus 20 Kc.....\$1.50  
Type VM2A. AT cut mounted. Drift less than 4 cycles per Mc per degree C 1.7, 3.5, 7 Mc Bands.....\$4.50  
Type VC2A AT cut unmounted drift less than 4 cycles 1.7, 3.5, 7, Mc Bands.....\$3.50

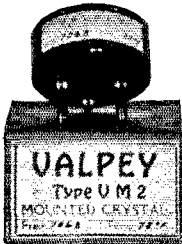

Crystals for All Requirements. At Your Dealer's or Order Direct.

**The Valpey Crystals**

377 Summer Street, Medway, Mass.

## BUD IMPROVED MIDGET CONDENSERS

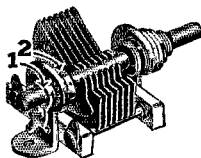

Note These Improved Features!

1. New Positive Wiping Contact on rotor shaft with adjusting screw, eliminates mechanical noise on high frequencies.
2. Close Fitting Bearings hold rotor calibration and smoothness of operation.
3. Insulated with ISOLANTITE. Soldered brass plate assemblies, and heavy aluminum end plates make a precision built, ruggedly constructed condenser.
4. Shaft extends 3/16" beyond rear bearing for ganging several units with flexible couplings.

Dual units and multiple space units in various capacities illustrated and described in our new catalog. Free upon request!

40% DISCOUNT TO AMATEURS

**BUD RADIO, INC.** 1937 E. 55th Street  
Cleveland, Ohio

## STATION ACTIVITIES

(Continued from page 72)

### HUDSON DIVISION

**EASTERN NEW YORK—SCM**, Robert E. Haight, W2LU—EGF is doing FB work on T.L. and A.A.R.S. HYC has fine line-up of schedules. LU reports Unit 1, N.C.R., received uniforms. FQG broke R.M. NITE QSO record for E.N.Y. FWC leaves E.N.Y. in June. GTW spent a week-end at EGF. BLU reports local hams active on flood communication work. BLL is QRL at R.P.I. ATM took for himself a wife. Our best wishes to both. HCP is on 3785 kcs. HCM signed N.C.R. application. CJS reports 14 mc. bum, 7 and 3.5 mc. FB, GUV puts in nice signal at LU's. GUV reports GXL on 14-mc. 'phone, 100 watts. LH is building a modulator for 1.75-mc. 'phone. IJG deserted C.W. for 1.75-mc. 'phone-125 watts. ITK reports for HUM who is still in Florida. JFE is trying out Zepp. IUR is rebuilding. HUK is on 1.75-mc. 'phone. HDB is FB C.W. man. HUB is FB on 3-way QSO's. SZ is now on 14-mc. 'phone. CBN works 3.5-mc. DX, G5-K4-NY2-VO1. UL is rebuilding to real panel relay rack job. CJP has been active on 7 mc. handling flood traffic. DEL is back on 3530 kc. with FB signal. BJA kept his head above the flood waters. GPB did flood work. 80QCG is active in A.A.R.S. 2GGP reported via FQG.

Traffic: W2EGF 722 HYC 528 LU 391 FQG 233 FWC 69 GTW 47 BLU 20 BLL 10 ATM 9 HCP 7 HCM 3 CJS 1 BJA 11 GPB 39 GGP 62 80QCG 111.

**NEW YORK CITY & LONG ISLAND—SCM**, E. L. Baumach, W2AZV—New O.R.S. EXR, FLD, HGO. INF is out for O.R.S. JKB is operating on 56 mc. HWS is out for Class A ticket. FMT, an elevator boy, was striking against IBA, a superintendent of the same apartment in recent N.Y.C. elevator strike. ESO will be operating at Georgia Tech, until late May. HRT wants a schedule for Saturday mornings on 3772 kc. BNJ is installing Naval Reserve unit headquarters station at 3109 Broadway, N.Y.C. HBO is looking for more stations for the B.Q. A.A.R.S. Net. PF is operating from SC. HNJ is building a low-power 1.75-mc. 'phone job. GZS reports a new Bayville station, JND on 7 mc. IHT operates the Progressive Beginners' Net on 3569 kc. on Sundays at 9 a.m. AGC requests all stations hearing his call on any other band than 56 mc., please report it to him as he operates exclusively on that band and is receiving numerous cards for 3.5-mc. operation. MY has ½-kw. 'phone on 3952 kcs. IKI worked his first foreigner, EA8AL, on Friday the 13th. CYX got his Class A ticket. DOG and his YF are practicing for the tennis season. BSR did not compete in DX contest for first time in many years. UK QSO'd Java on 14-mc. 'phone. CSY is putting a husky 'phone sign on the air with a pair of RK-28's. EAR's new rig has 59 e.c., RK25, P.P. '10's into P.P. 50T's, input 700 watts. CCD will exhibit a specialized collection of U. S. stamps known as the Farley issue at the International Philatelic Exposition to be held at Grand Central Palace in May. HXT put up a better antenna. IBT is still out for schedules. EYQ and FHB are working 56-mc. mobile. JBL says that IHT thinks the writer of his math book must have been a ham, because most of the answers seem to come out "DX," "BCL," "FB," etc. IKV is looking for members for the new Hudson Division 'Phone Association. IAW received a card from EA3CY, who heard his 1.75-mc. 'phone sigs. ECL needs Asia for W.A.C. FF, HMJ and HJ were in the DX contest. HNH worked all his DX before the contest. IOP had a.c. installed at his d.o. QRA and is now putting 400 watts in a pair of 242A's on 7 mc. AZV handled considerable flood traffic on both 'phone and C.W. BVT moved back to Brooklyn.†

Traffic: W2KI 231 EYQ 165 IBT 144 HJ 62 INF 55 PF 49 AZV 48 CYX 28 HXT 27 BNJ 22 HGO 18 BYL 14 COD-FF 11 ADW 10 HKO 9 FIP 8 ECL 8 JW 8 EYS-EAR-AA-CIT 7 HXT-BMM 6 EYD-HGO-IPB-GWK 5 ALZ-IAW-FLD-IOP 4 AGC 3 IKV-HMJ 1(WLN 133) W2SC 210.

### NORTHERN NEW JERSEY SECTION QSO PARTY

**Date:** The contest begins at 6 p.m., Friday, May 8th, and ends at midnight, Sunday, May 10th, E.S.T.

**Qualifications:** Only operators of stations located in the Northern New Jersey Section of the Hudson Division, consisting of the counties of Bergen, Essex, Hudson, Middlesex, Monmouth, Passaic, Ocean, and Union, who send in copies of their logs with final scores are eligible for prizes.

**Object:** To contact and get acquainted with as many other Northern New Jersey stations as possible during the

contest; contacts outside of the section do not count in the scoring.

**Call Procedure:** The following call procedure shall be used by all stations taking part in the contest: CQ NNJ de W2—.

**Completion of Contact:** A contact shall be considered completed when the two operators have exchanged the dates of their birthdays; for example: June 19th, October 11th, etc. The year of birth need not be given.

**Scoring:** Five points shall be allowed for each completed contact with a different NNJ station. Each additional station heard but not worked may be counted one point. Two points may be counted for an incomplete contact, that is, one in which two birthday dates are not exchanged. The total score shall then be multiplied by the number of different towns (townships, boroughs, etc.) worked. **NOTE:**—It is not necessary that the station you work turn in a score. All that is required is that the station be in the Northern New Jersey Section.

**Power:** The power used shall have no effect on the scoring. **Frequency:** Any frequency may be used. Either C.W. or 'phone may be used.

**Log Sheets:** Copies of the log sheets, listing the stations worked or heard, the dates and times worked or heard, the locations, and the birthday dates of the operators shall be forwarded to the S.C.M. within two weeks after the conclusion of the contest. The birthday date of the operator making the report shall also be stated.

**Prizes:** There will be plenty of prizes to make things interesting, so don't fail to be on hand if you are in N.N.J. Section.

**NORTHERN NEW JERSEY—SCM**, Charles J. Hammersen, W2FOP—HZY made B.P.L. for first time. HBQ worked Switzerland twice on 3.5 mc. during DX contest. GGW made changes in his rig which greatly improved his note and sock. GAS is now a member of the N.N.J. QSP Club. ICM is back on 3.5 mc. after rebuilding rig. GVZ had six DX QSP's in last month. HNP is QRP 20 watts due to 50-watter going west. BSC of the Stevens Radio Club is now in the A.A.R.S. CGG schedules IIGA for the benefit of ICA's cousin who lives in Livingston. HCO is new O.R.S. appointee. GMN did fine job on QSO contest arrangements. HOZ has all his feeders indoors. HFT installed code practice set in his rig to eliminate key clicks. ICJ took Class A exam. HTX is now using 50-watter in final. GQX is QRL school. BZJ is looking for schedules. Ex2ED is back on the air with 21UV as a call. HRN has worked 9 countries on 7 mc. with 30 watts input. After six years CFW has crystal control. HTW is back from Panama. BZJ, HBQ, HTW and GAS from Jersey Shore Club are now members of N.N.J. QSP Club. FRF has moved to Pa. for R.R. job. JES is now on 1.75-mc. 'phone. CAY has 300 watts on all bands from 1.75 to 28 mc. CQX is using remote control to keep from waking the Jr. op. BPY is going strong on 28 mc. BTZ wants "O.O." appointment. HMV is knocking over plenty DX on 7 mc. with 30 watts. GIZ has new receiver. FOI is back on the air after several years' absence. IBR is about to increase power. IDZ finished 14-watt transceiver for his car. IKD is working on 56 mc. IYT is looking for new receiver. FFY has a real commercial looking job. GZG has been appointed N.C.S. of A.A.R.S. 'phone net. IWU is getting gray hairs from B.C.L. QRM. IBZ is back on 1.75 mc. at new QRA. HLX ground crystal to triple to 14-mc. 'phone. DAC has 285-watt alternator installed in his car. JDY returned from Nebraska. HME makes a living servicing police equipment. GYY has 211E on 56 mc. FLB has YLitis. AHN is in Texas on business. IMB is using '46 as Class B Linear. 3COP burned a hole through the glass of a '52. 3DKL is using mobile transceiver on 56 mc. 3FBG is working on new superhet. 3FPO is back on 'phone after a try at c.w. 2JJE is working on rig using RK23 Tri-tet. It is the earnest hope of your S.C.M. to work up a good 'phone unit in the N.N.J. Section which will help in the better use of our 'phone bands and aid in the elimination of overmodulation, etc. How about getting on the wagon and applying for your O.P.S. appointment? Let's hear from you if you are interested in the appointment.

Traffic: W2HZY 644 HBQ 531 GGE 511 GGW 480 GAS 456 ICM 273 GVZ 236 HNP 118 BSC 78 CGG 57 HCO 50 IAMZ BTZ 40 2HOZ 33 GMN 36 HFT 28 FOP 27 ICJ 17 HTX 16 GQX 15 CJX 14 IAP 13 BZJ 13 IUV 7 ECO-CIZ 5 HRN 3.

### ROANOKE DIVISION

**NORTH CAROLINA—SCM**, H. S. Carter, W4OG—Mount Holly: CYY is now O.R.S. Raleigh: DW gave up working the DX contest when the first K7 he ever heard

came back to OG when he called him. EG used a k.w. on 14 mc. during the DX contest. BRT leads the state in traffic this month. Congratulations, OM, Greensboro: AEL says the DX contest showed up the bugs in his rig. MR quit 28 mc. for 7 mc., stayed there two hours, and was back on 28 mc. working up a storm. Wilmington: CPT is sticking to his New Year's resolution to report every month. BPL is getting out well with low power on 14 mc. NY is QRL building a new home. FT is tickled pink with his new HRO. EC is planning a portable on his boat to report how the fish are biting. VW is QRL selling B.C.L. receivers. Warrenton: BHR has been on the A.A.R.S. regularly. Lattimore: DGU is using an '03A with 145 watts input to the final. Graham: AEH is installing a pair of '10's in P.P. final. CYE is on 1.75-mc. 'phone. CLH is QRL work. COC is in college. CYN is going on 7 mc. with a 211D. DCU is building a new Class B modulator. CJP is on 3.9-mc. 'phone most of the time. Chapel Hill: CXM is using an RK-20. Bessemer City: DVZ is running 200 watts input to a 242A. Winston-Salem: BYA spent most of time experimenting. DGV went in for DX. DWB has worked all districts on 3.5 mc. CXF, DCQ and IF were in from school for the spring holidays. ABT, CYA, RA, AHF and OG entered the club competition on the DX contest. CFR is on the air after building on his rig for exactly one year. CKJ is active on 3.5 mc. IY is planning a comeback. With the 'phones: QI is installing plug-in coils in his rig for quick band changing. DKF is on 1.75 mc. DOR is building a small rig. AI is on 14 mc. DIS handled several death messages for Charlotte. BX is having receiver troubles. ALD is the most active 'phone in Charlotte. CZU is rebuilding for 'phone and C.W. The Charlotte Club's new location is Room 318, Piedmont Fire Insurance Bldg. DKB is having trouble with his Tri-tet, also his modulator. AEN is pleased with his new crystal mike. BQE has his 1.75-mc. rig about ready to go. AH is on 28 mc. DSY will use a pair of 150-T's in the final on 28 mc. CLB worked a W7 which made all districts on 'phone with 50 watts input; he also visited BTI, ADN, DCC and CVG during the month. WBT asked CLB to assist in rebroadcasting a typical 'phone QSO, which he did to the best of his ability. The Charlotte Club as well as A.R.R.L. got some good publicity out of the stunt. CJP says 3.9-mc. 'phone is a ham's paradise on Sunday afternoon, if he is interested in YL's.

Traffic: W4BRT 125 DW 103 NC 17 CJP 11 AEL 7 AEH 6 CXM-AI-QI-BYA 4 DWB 3 OG 2 ABT 15.

VIRGINIA—SCM, Charles M. Waff, Jr., W3UVA—COO had the flu. ELC spends 75% of his time with N.C.R. FBL has plenty of good junk to trade. ELN schedules CUV and K4AAN. BXN is rebuilding with rack and panel. AKN has flock of freqs. he can use. AAJ is rag chewing. EWX is using 59 and RK20. EZL wants to work more Va. stations. ELF is putting in an 803. FE is still portable in Hampton. WM wants a receiver. MQ has new 40-ft. mast. ZU returns to the air on low-power 'phone. CLV is experimenting with low-power 'phone. AIJ is getting new receiver soon. RL can't find traffic on 7 mc. FIK is rebuilding with P.P. '03A's final modulated by 211's Class B. EQQ will be on 'phone soon. DWE found bugs (not live ones) in his rig. FBW and ELB will take Class A exam soon. CYM has new 7-mc. crystal. AVR will be on 28-mc. 'phone soon. FGW has 44 states confirmed for W.A.S. ENQ is working for W.A.S. FKD needs but 4 states for W.A.S. BTR doesn't like Tri-tet osc. UVA worked 13 new countries and W.A.C. in DX test. EXW worked 7 new countries and BSB two new ones. EDG was in college. EBK let BZE use his rig in tests.

Traffic: W3AKN 110 ELN 46 FBL 23 CSY 15 CLV 14 CAK-UVA 10 FHF 8 ZU 5 MQ-WM 4 EDG 3 ENQ-ELC-BSB 1.

WEST VIRGINIA—SCM, Dr. Wm. H. Riheldaffer, W8KKG—The West Virginia A.A.R.S. Net handled a load of emergency flood traffic. BOK handled emergency traffic to PA. MZD and PAJ are working nice DX. JRL worked VQ8 and VS6. KWI received card from VU2CQ and worked VS6 and VU7FY. MOL is in hospital. HD schedules 5ZM. LSK and JCB are in private W.A.S. contest. TI is working for G.E. in Erie, Pa. KWU worked KPQR off S.A. PME is Bethany College Radio Club station. ANU schedules AKQ and NLP. NFO made W.A.S. BJB, LCN and CYV are on 56 mc. in Wheeling. KSJ is on C.W. with a pair of 150T's. 3ZD visited HD. BDD is working 14 mc. DUO is in Huntington. NMD finally got his meter for R.D. participation. MCR is getting a PR16.

Traffic: W8KYJ-AKQ 13 GOQ 10 HWT 13 ANU 9 LXF 13 ELO 29 LII 16 HD 34 (WLHF 16) OK 95 (WLHB 141)

NMD 44 KSJ 15 EIK 16 MCR 46 MCL 13 CFB 31 BOK 61 JRL 20 KKG 48 (WLHP 37) (WLHQ 44).

## NEW ENGLAND DIVISION

CONNECTICUT—SCM, Frederick Ellis, Jr., W1CTI—As this is being written Connecticut is experiencing the most disastrous flood in its history. Reports from many stations have not been received due to pressure of QRR work. MK B.P.L.'s with large total. Hal has his personal call JTD on the air at home. FIO schedules 9ESA, Denver, on 7 mc. IKE has practically recovered from his illness. FB, GKM resumed schedules. AFG is in N.C.R. 6LWP-1 handles traffic for the fellows at Gunnery School, Washington. JBQ says DX good on 14 mc. GTX is used almost entirely for Navy work on 3510 kc. EWD worked XUSAL, CTW is on 14382 kc. HTS schedules VE2HH. Anyone interested in the Army Amateur Radio System should get in touch with HJW. BDI had an emergency rig on the air during the flood.

Traffic: W1MK 939 (WLMK 15) FIO 161 GME 147 JHK 113 AMG 73 BDI 51 IKE 32 JTD-GDK 14 AFG 13 JBQ-GVV-6LWP-1 6 BNB-BTX-DW 4 EWD 1 DLX 3.

MAINE—SCM, John W. Singleton, W1CDX—OR uses 3.9-mc. 'phone some and continues to work England on 1.75 mc. c.w. GOJ is installing oscillator keying and automatic bias. INW is buying a Comet Pro. FAP can route traffic all over the section and guarantee delivery. AQW is working on 14, 7 and 3.5 mc. IKC visited S.C.M. and intends to beat him to W.A.S. JFF is new ham in Northeast Harbor. JRS is new ham in So. Portland. CDX is operating on four bands. VF has new emergency equipment ready to go. FJP lost his '03A and is now using a pair tens. IDN wants dope on 28 mc. receivers. EBY is getting on 56 mc. with new rig. There were many Maine amateurs busy day and night handling flood traffic. Those who were in the flood area all did fine jobs in keeping a signal on the air.

Traffic: W1OR 518 HSS 289 GOJ 273 INW 183 FAP 158 HSE 48 AQW 21 IKC 3 JFF 2 JRS 1 CDX 62.

EASTERN MASSACHUSETTS—SCM, Albert N. Giddis, W1ABG—BEF was forced off the air by flood waters. ABG is still trying to catch up on sleep! HXE was the busiest and most important station in the Merrimack Valley during the flood. IWC is clicking FB. FRO reports by radio. CRO is getting out well on 56 mc. JL has to get up at 4 a.m. on his new job! RE is still grinding 'em out. FCR is looking for traffic on 3.5 mc. KH is still "hot-footing" it around. HCH is having good luck on 28 mc. IYT brought his report in person. QW is doing a good job as N.C.R. Liaison R.M. JDK was elected President of the M.V.A.R.C. ISM did quite a bit of DX-ing. JSK is a new ham going places! BR is still keeping schedules with his brother at NY2AE. GMD deplures "dead hooks," next time give it to an O.R.S.! BMW sends a long list of off-frequency stations. EVE comes back to the fold after two years away. JRH is building '59-RK20 rig. JCK blew his plate meter. GEX put a couple of RK23's in his buffer stage. IGN is busy making candy and rebuilding. ASI has his hands full with Convention business. M.V.A.R.C. elected JDK pres., ACM vice-pres., FCR secy., HXE treas., IQH publicity mgr., IQI activities mgr. Harvard Radio Club is on the air with call JOO. Its officers are BND exec. chairman, EVE station mgr., 2IXK treas., Glen Morris, secy. COX is going to increase power on 56 mc. JTP is new station in Lawrence. JKY is building new rig. BB worked Algeria on 1.75 mc. JOO is going in strong for DX. DBE is working everything but Mars on 28 mc. Was the outstanding Lowell station during the flood. IHI is "tops" this month. AKS is rebuilding 3.5 mc. rig. DCW was appointed O.R.S. ZQ was appointed Asst. Radio Aide, First C.A. IUQ joined A.A.R.S.

Traffic: W1BEF 379 ABG 311 HXE 296 EVJ 236 DDE 232 IWC 209 FRO 141 LJ 130 CRO 129 JL 114 RE 110 FCR 84 KH 64 HCH 57 IYT 44 QW 37 (CCIC 42) AKE 37 JDK 35 HKY 33 ISM 31 JSK 30 BR 27 CIK 3 IWF-GGB-HRE 6 JID 5 EPZ 4 GMD-IQH 3 BMW 2 EVE 1. Following A.A.R.S. Stations reported: IHI 1318 (WLG 137) AKS 1077 DCW 873 (WLGJ 245) ZQ 687 (WLG 160) ILD 425 HWE 345 IUQ 53 IAO 434 BCK 431 CLN 340 GBW 213 AAR 148 INA-JMJ 116 CGL 63 FXE 51 AAU 32 EAU 15.

WESTERN MASSACHUSETTS—SCM, Percy C. Noble, W1BVR—IJR made the B.P.L. FB, Ed. BVG came through with a good total. BVR now has a 56-mc. transceiver. JAH is running fine schedules. AJD is keeping

(Continued on page 108)

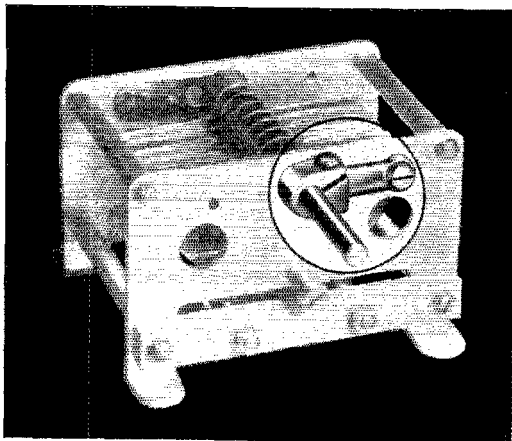

## ROTOR LOCK

This simple device clamps the rotor rigidly, making adjustments proof to vibration and unauthorized tampering. It will fit any National condenser having a 1/4" shaft, and may be fitted to many condensers of other manufacture. Net Price to Amateurs. . . . \$5.1

**NATIONAL COMPANY, INC.**  
MALDEN, MASS.

## OHMITE — for PERFORMANCE!

- Vitreous enameled RHEOSTATS
- Vitreous enameled FIXED RESISTORS
- "DIVIDOHM" Semi-variable Resistors
- Band-change SWITCHES
- High Frequency CHOKES

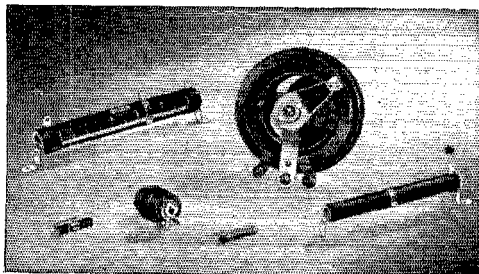

**HANDBOOK**  
PAGES  
**458-459**  
CATALOG  
SECTION



● Get your copy of the 1936 OHMITE HANDBOOK. Whole new sections on BAND-SWITCHING and modulators from 4 to 100 watts. Charts and diagrams that eliminate difficult calculations. Used by thousands of amateurs. From your dealer or send 10c to:

**OHMITE**  
MANUFACTURING CO.

4831 Flournoy Street Chicago, Ill.

indicate the plate currents of these two tubes separately, serving as the diversity indicator by showing the signal variation between the two separate receiver circuits. Their action is fascinating to watch, giving a striking picture of the wide and ever-unlike variation of the signal input to the two receiver sections. The effectiveness of the diversity action is shown by the fact that even though they may swing wildly, the tuning meter reading the combined a.v.c. current hardly ever shows more than barely noticeable change.

Although greatly improved reception is obtained with the dual-diversity receiver when the two antennas are no more than two separate wires run off in different directions from the same building, or when one is run out horizontal and the other is vertical, better results are to be expected with the two antennas more widely separated, a spacing of 8 or 10 wavelengths being considered about optimum. This would mean separation (of two similar horizontal antennas) of 500 feet or so for the 14-mc. band, and would require more ground space than ordinarily available. A good transmission-line system should be used between each antenna and its receiver in any case, of course. But the diversity performance with lesser antenna separation is still so much of an improvement over the best single receiver performance that lack of outdoor space should not be allowed to discourage the prospective user.

This method of reception unquestionably has such practical advantages that the dual-diversity type receiver, with the simplified single-control tuning described in this article, may well be expected to become standard for high-frequency 'phone and program reception in the near future.

## Kentucky State Convention

(Central Division)

Fort Knox, Ky., May 23rd-24th

WHEN army men get in back of anything it is sure to move, so this should apply at this first Kentucky State Convention. It is being sponsored jointly by the Amateur Radio Transmitting Society of Louisville and the 1st Cavalry Brigade (Mecz.) with Capt. B. V. Morse, Brigade Signal Officer, in charge of the convention activities. All events of the convention will be held at Fort Knox. The visitors will be quartered in barracks and eat in an army mess, to keep the expenses as low as possible. Exceptions are made for those who wish to bring their wives, in which case they may be quartered and messed in the central mess of the Post. The cost per visitor will be \$2.50, which will include charges for mess, quarters, and registration fee for the entire period. Think it over, fellows, and ask yourselves if any other convention has been able to give so much for so little cost. Military equipment, including radio, ve-

(Continued on page 110)

**How to  
Become**

# A RADIO AMATEUR

Published by the AMERICAN RADIO RELAY  
LEAGUE, INC. • West Hartford, Connecticut



Price 25 Cents

« « « «

**Price 25¢ postpaid**  
(no stamps, please)

## AMERICAN RADIO RELAY LEAGUE WEST HARTFORD, CONNECTICUT

Universally recognized as the standard  
elementary guide for the prospective amateur

the 1936 EDITION of

# HOW TO BECOME A RADIO AMATEUR

features equipment which, although simple in construction, conforms in every detail to 1936 practices. The apparatus is of a thoroughly practical type capable of giving long and satisfactory service — while at the same time it can be built at a minimum of expense. The design is such that a high degree of flexibility is secured, making the various units fit into the more elaborate station layouts which inevitably result as the amateur progresses. Complete operating instructions and references to sources of detailed information on licensing procedure are given, as well as a highly absorbing narrative account of just what amateur radio is and does.

"Quicker  
than a  
short circuit"

## LITTELFUSE

INSTRUMENT LITTELFUSES, for meters, 1/200 amp. up. HI-VOLT. LITTELFUSES for transmitters, etc. 1,000, 5,000 and 10,000 volt ranges, 1/16 amp. up. Neon Voltage Fuses and Indicators (Tattletales), 100, 250, 500, 1,000 and 2,000 volt ratings. Fuses for Aircraft, Auto, Radio and Fuse Mountings, etc. You will want to know about all these products — get new free catalog — write

LITTELFUSE LABS., 4246 Lincoln Ave., Chicago, Ill.

"The Crystal Specialists Since 1925"

## PIEZO-ELECTRIC CRYSTALS

Guaranteed Accurate to BETTER than .01%

## SCIENTIFIC RADIO SERVICE

UNIVERSITY PARK, HYATTSVILLE, MD.

**Utah**

TRANSFORMERS  
and CHOKES

Send for complete Reference Guide of Better Transformers and Chokes for all Receiver and Transmitter Purposes.



UTAH RADIO PRODUCTS CO.  
Orleans St., Chicago

MAC KEY @ \$7.95, finest speed key built; MAC OSC @ \$3.95, ac/dc oscillator. Tone control; MAC CORD \$1.00, navy spfn speed key cord; MAC MARINE receiver 550-850 meters. r u intd? Few deluxe MAC KEYS @ \$15.00 fm me di. Wri me. T. R. McELROY, 23 Bayside St., Boston, Mass. If u hv Mac Key wri me for xmy ipt & dsrb ifn.

## THE PERFECT CODE TEACHER! NEW MASTER TELEPLEX

For beginners, experienced operators, and schoolroom. The sure easy way to learn code and to step up your speed. This amazing new instrument will record your own sending on double row perforated paper and repeat it back to you at any speed you desire. 10,000 words can be recorded on one tape.

**NO BATTERIES  
NO WINDING  
ALL ELECTRIC**

It is the same in principle and in operation for this service is equal to the Wheatstone Perforator and Transmitter, which cost over \$1,000.

**BUY IT OR RENT IT**

Send for Folder Q-5, which tells you how to get the use of this instrument without buying it. No obligation. We furnish complete course and personal instruction with a money-back guarantee. Low cost, easy terms. Write today for information.

## TELEPLEX CO.

72 Cortlandt St.

New York City

The New Master Teleplex "The Choice of Those Who Know"

Say You Saw It in QST — It Identifies You and Helps QST

(Continued from page 105)

3732.5 kc. hot. IOT is rebuilding with 842A final. GZL is having whale of a time on 28 mc. IIP is getting real interested in traffic. BNL is operating mostly on 14 mc. JOT is leading IIP by 50 miles in their private DX contest. ISN is in P.B.N. net, AJ is waiting for the bonus. BAP is building portable receiver and crystal transmitter for 3.5 mc. JGY is now chief op. at BKQ. DIE is working at WTAG. COI is progressing on his new rig. EOB reports lots of activity at Conn. Valley Radio Club, 1LAU. Flood reports will be included in general write-up elsewhere in this issue. We know that all of you were on the job and were a credit to amateur radio and the League. FB, boys!

Traffic: W1IJR 630 BV 219 (WLGE 141) BVR 189 (WLG 213) JAH 117 AJD 68 IOT 36 GZL 27 IIP 14 BNL 12 JOT 8 ISN 5 ARH 4 (Jan.-Feb. W1IJR 551).

NEW HAMPSHIRE—SCM, Robert Byron, W1AVJ—HJI's high power transformer went west. ILK reports the purchase of a new commercial rig. IDY is making fine contacts on 28 mc. AUY was busy with traffic. FFL and IP are still the same traffic hounds. IJB is also pushing out plenty of traffic. ICS runs neck and neck with IJB in traffic total. HPX, IMB and JEH at Glencliff report the "seed" that CCM sowed there is still growing; they expect to have two more operators soon. FFZ and GHT are busy in A.A.R.S. JSL is new ham in Derry. ADR is back on 56 mc. with M.O.P.A. EAL is DXing on 14 mc. and in A.A.R.S. work on 3.5 mc. APK is still pounding the key. GOC is busy in the north country. AEF is going strong. DUK is heard calling all way stations between here and Mars. Another fine letter from EPE with good story about IP. AXW gave a talk before local Rotary Club. HOU is after DX on 14 mc. and finally made his W.A.C. AVG has a kilowatt going on 'phone. AVL is now working for Swift & Co. As this is being written we have just passed through the greatest disaster that New Hampshire and New England has ever had. The hams of this State are to be congratulated on their exceptionally fine work.

Traffic: W1EFF, 1038 (WLGB 68) IP 941 IJB 788 ICS 784 EPE 137 FFZ 127 BFT 97 GHT 48 EAL 25 AVJ 23 GMM 16 ILK 14 APK 8 GOC 3.

VERMONT—SCM, Forrest Drew, W1BJP—Reports will be in next month on the flood activities of several Vt. stations. This disaster shows us more and more the desirability of having emergency transmitting and receiving equipment on hand so as to be independent of a.c. power supply. Let us all try to equip ourselves so as to be able to render service in such cases. BJP was in the DX contest with CUN at the key. DQK is on 28 mc. as well as 1.75 mc. AXN sends a nice traffic total. GAE is handling traffic with EVJ, FSV, GAZ and GUO. ATF is active in the A.A.R.S. and has been entertaining his two grandsons. FSV and HOW are new O.R.S. GNF is working DX on 14 mc. ERS and EHB are on again. AHN is on 3.9 mc. 'phone. IQG has work now. We are glad to hear the good old fist of IT again. AOO is on 14 mc. AVP sends us a photo of the new rig and it sure is commercial looking. BNS is top traffic man as usual and will soon have a new rig installed at the St. Johnsbury Airport. CBW is working nice DX on 7 mc. TJ is watching the YL's at Daytona Beach at present but we expect him to be homesick for Vt. before long. Thanks, fellows, for the prompt reports this month; they are much appreciated.

Traffic: W1BNS 148 AVP 5 AOO 32 IT 43 GNF 4 FSV 61 ATF 45 GAE 26 AXN 54 (WLG 37) DQK 2 BJP 29.

RHODE ISLAND—SCM, Clayton C. Gordon, W1HRC—IAV was reported heard in England on 3.5 mc. 9SCY, quartered with IAV, is on 14- and 3.9-mc. 'phone. BJA has no more schedules since BEF's outfit took the water-cure during the recent unpleasantness. IPU is now in U.S.N.R. JSD is new ham in Peacedale. IEH has been visiting in Schenectady and says 2HYQ and 2HYS, together with the Union Radio Club, gave him a royal time. HJ works all he hears on 14-mc. c.w. & 'phone, getting R7 on 'phone from Australia, and getting plenty of SWL cards from Europe while on 7 mc. JNO and BLS are on 14 and 7 mc. JPJ is handling A.A.R.S. traffic. HPE is only one reporting this month as on 28 mc. BLS, BVI and JIK are still on 56 mc. IWZ is on 7 mc. with P.P. '45's. GTN noted improper use of QRR during the flood work. It is our understanding that QRR is only to be used by a station in the distress area. GTN offers good suggestion to the effect that owners of sound trucks having gasoline-powered 110 a.c. generators delivering about 500 watts be asked to list their equipment and 'phone number with the local Red Cross to be made available as a source of power for emergency transmitting

stations in the event of Electric Light power in future emergencies.

Traffic: W1IEG 398 (WLGK 132) GTN 62 IZO 94 IAV 41 BJA 24 ISR 23 IPU 22 INB 1.

#### ATLANTIC DIVISION

EASTERN PENNSYLVANIA—SCM, James M. Bruning, W3EZ—P.A.M.: 3EOZ. R.M.'s: 3AKB, 3AQN, 3EOP, 8ASW. Congratulations to all who took part in the flood emergency. It is requested that all who have not yet done so make a complete report of your work and forward it to either the S.C.M. or direct to Hartford so that the records of amateur work in the emergency will be complete. Information at hand indicates that especially good work was done by 3AKB, 3CRO, 3EEY, 3EOP, 3EOZ, 3EZ, 3OK, 3QV, 3WX, 8ASW, 8AVK, SDIG, 8EU, 3FLA, 3MAH, 8MEH and 8NNC. B.P.L. this month: WLQB (3EOP). 3BGD worked 4 new countries in two days. 3BRZ continues fine DX work on 14 and 28 mc. 3BZP has run his transmitter daily for over 8 months without retuning. 3DXC is back on the air with 90-watt rig. 3EEW gets excellent results with pair of ten's in final. 3EPJ worked his first ZL. 3EUP worked his first K4. 3EYO worked D4, PA, K5 and FT. 3EZ is building a new transmitter to replace "old faithful." 3FKJ worked Australia with one '10. 3FWB made his debut Friday, March 13th. 3MG has installed "push to talk" system. 8MRQ worked west coast on 3.5 mc. using 30 watts input. 8NNC was chased from house by flood waters. 8ITS is new O.P.S. 3AQN and 3BGD are new O.B.S. 8NNC is new O.R.S. 3EFH, 8MRQ and 8OML will soon be O.R.S.

Traffic: W3BZP 477 EZ 438 EOP 334 (WLQB 527) EPB 256 AKB 146 BVS 141 ECA 99 EYO 76 AQN 72 EHF 54 FKJ 41 EPJ 17 EUP 9 EWJ 7 ADE 3 BGD 2. W8FLA 187 (WLQG 17) ASW 94 DIG 82 DMA 34 MRQ 33 NNC 27 OML 20 EU 12.

MARYLAND-DELAWARE-DISTRICT OF COLUMBIA—SCM, E. L. Hudson, W3BAK—R.M.'s: 3CQS, 3CXL, 3EOU. Chief R.M.: 3BWT. P.A.M.: 3WJ. On March 7th, the Chief Signal Officer appointed Lt. Loren G. Windom, WLH/W3ZG, Chief Radio Aide for A.A.R.S. Lt. Windom's appointment will be for a period of one year. He succeeds Mr. Roy C. Corderman, WLMD/W3ZD, who has served successfully in that capacity the past year. ASO was in communication with Johnstown and Pittsburgh stations during the recent flood, and handled plenty of emergency traffic. CDG worked several new countries in the DX contest. EPD got up early one morning recently to work DX and found a nigger in his wood-pile—stealing wood. HI. CWE still reports from a college in Michigan. EDS sent report, but no traffic handled. Boys, we appreciate these reports. All reports are welcome, traffic or not.

Traffic: W3BWT 864 CIZ 578 CXL 517 (WLM 2049) ASO 193 BKZ 91 CQS 49 EZN-BAK 35 FFF 33 CDG 22 EPD 15 WJ 14 WZ 12.

SOUTHERN NEW JERSEY—SCM, Carroll D. Kentner, W3ZX—APV, FBM, EKL and FTK report by radio via the Net. APV reports ARW and DNU have changed QRA's. FBM is applying his spare moments toward making a 56-mc. transceiver function. EKL took a slice of the international DX. FTK made the B.P.L. for the third month in a row, and can give one day service to west coast and Hawaii. FFE is working for W.A.S. BPT has joined A.A.R.S. and installed a 211 in final stage. DQV worked K6 on 7 mc. with 45 watts. FOS reports that his call is being bootlegged; he requests that anyone hearing FOS on any other frequency than 3782 kc. inform him right away. ZI got into England during the Trans-Oceanic 3.5-mc. tests. EWF is going to town with a 50T and 350 watts. DNU sends in his remarks of approval on the new Jersey Net. BIR is new O.P.S. NF promises early participation in the Net. EEQ is new O.R.S. in Trenton. ZX had busy week with DX contest, SCM report, and in getting the Net operating. The first session of the new Jersey Net took place March 17th, and indications are that the new procedure is going to be FB. The net meets Tues., Thurs., and Sat. at 7:15 p.m. on 3700 kc. EFM was active in flood QRR work.

Traffic: W8APV 318 FBM 36 EKL 74 FTK 1227 AEJ 8 FFE 20 DQV 4 FOS 115 VE 79 DQO 2 ZI 143 BEI 5 EWF 8 NF 60 (WLML 256) EEQ 30 FCB 2 BO 96 ZX 20 EFM 142 (WLNJ 57).

WESTERN NEW YORK—SCM, Charles Smith, W8DSS—C.R.M.: 3JTT. JTT is way out in front this month with a grand total. Nice work, Roger. JQE also makes the

B.P.L. DSS rigged a peep-peep horn to his bug and now contacts hams passing by the shack. CSE sent in a nice total. BJO cancels any schedule that does not produce traffic. GWY finds time to do "O.O." work. GWT vacates 3.5 mc. on account of local QRM. LWD is keeping some schedules. LVZ has plenty of line QRM. BHK sells ice-boxes. CPJ is still the only O.P.S. reporting traffic. OXI reports regularly on the gang in Saratoga Springs. Messrs. Budlong and Goodman attended a special meeting of the Jamestown Club which was well attended by many out-of-town hams. PJR and PMZ are new stations in Jamestown. AWN is on again. GPS got Class A license and was QSO the S.C.M. recently, using both 'phone and C.W. DES and PCI are rebuilding. CXI moved to Wellsville, not Buffalo. PCM and FKA are working nice DX. LUJ is trying 3.5-mc. C.W. MKA, MJU, and LGV are new Class A holders in Ilion. KMC is operating N3GZ (NDA) on 3705 kcs. at Norfolk and keeping regular schedules with his home thru SJTP. M.V.B.P., Utica Club, will elect officers at the club house soon which will have been newly decorated. BAI made W.A.C. Congrats. O.A.R.T.A., Oneida Club, is sponsoring a Field Day at Panther Lake in July. Plan now to be there with all your friends. CGU was heard in New Zealand on 1.75-mc. 'phone. FB, Anthony. Don't forget to send your entries in the slogan contest to the S.C.M., as announced in the last issue. The contest closes June 30th. The S.C.M. uses approximately 3650 and 3520 kcs. Give him a buzz any night. 73.

Traffic: W8JTT 1756 JQE 616 DSS 389 MQX 322 CSE 265 BJO 220 MBI 161 KJW 133 GWT 105 GWT 49 BHK 45 LVZ 43 LWD 36 OXI 16 CPJ 13 LGV 6.

WESTERN PENNSYLVANIA—SCM, C. H. Grossarth, WSCUG—EFA says the gang enjoyed the Pgh. Banquet. OFO has been working some good DX on 7 mc. MOT wants a Route Manager's appointment. CMP says the alphabet now includes ECCCP oscillator! IOH is still pounding away. UK is handling GUB's schedules. KBM has a nice total. DGL is spending most of his time doing Cairo Survey and O.O. work. KUN is working hard for that O.R.S. appointment. HBG has two rigs going for all band work. ADY has a new ACR-136 receiver. CUG managed to squeeze in a little flood traffic. OIZ has a new antenna which works FB. LBA wants to get his W.A.S. UR is rebuilding the rig. RG wants to sell his entire transmitter. OUK says he wants to get a W.A.S. GZI is being operated by OKS, MSS, NFS and himself. PFZ is a new ham. PAQ blew out an 83. By the time this sees print the flood waters which have been causing so much death and destruction throughout our section, Western Pennsylvania, will have receded and another page will have been written in amateur radio history. I know that the gang has done a bang up job and I want to congratulate those who have helped to lessen the suffering of those in stricken areas. My hat is off to you, fellows.

Traffic: W8EFA 152 YA 90 (WLMA 192) OFO 221 MOT 505 CMP 68 KOB-169 AXD 19 IOH 11 UK 193 KBM 107 DGL 7 KUN 236 HBG 78 ADY 338 CUG 253 GUF 827.

OHIO—SCM, Robert P. Irvine, W8CIO—UW leads the state in traffic. MQO will have new rig soon. RN says between new car and traffic, not much time left for DX contest. WE is increasing power. LZK blew '52. LUS reported by radio. HMH is QRL DX contest. LCY is trying to line up some new O.R.S. DVL needs Asia for W.A.C. BYM is looking for Nevada for W.A.S. OXK is new O.P.S. EEQ is rebuilding to higher power. HWC and FFK are new O.R.S. AQ got R8 report from ZL on 14 mc. using indoor zepp antenna. MQC's XYL is going to take Class "B." DIH is QRL work and says, "No rest for the wicked." GSO dropped schedules on account of work. JGJ is on with new power transformer. ANU is QRL college at Bethany, W. Va.; he is chief operator and trustee of College Radio Club station with call 8PME. KLP says 28-mc. reception very good. JOU is QRL college at Cleveland. LAU likes 3.5-mc. best. NGZ is on 1.75-mc. 'phone. OKN is new reporter from Norwich. PJV and PJZ are new hams in Bedford. BUM is on 14 mc. with '04A. PIH, new ham in Mansfield, is working out well with 230 TNT with 120 volts plate supply. NXN worked OM2RX for his first DX using only 25 watts. EME is active again. AVB is A.A.R.S. OXU (YL) has worked all districts except W7 on 1.75-mc. 'phone and has not called a CQ since getting her ticket in November. ANE has new PR-16. DN has new Breting. ORF has Gross CB-25 transmitter on 3.5-mc. C.W. We extend our congratulations and very best wishes to Lt. Loren G. Windom, W8ZG/W8ZG—WLH, on his appointment as Chief Radio Aide, A.A.R.S.,

for the coming year. 'Phone News by 8DXB; KVD is experimenting with television. JJZ spent a month in Florida. JFC has a knock-out 3-tube receiver on 28 mc. KNF moved to shack again. HFR operated portable in Norfolk, Va., for a week. JTI announces his candidacy for S.C.M. EDR handles traffic and chews rag on 14 mc. KBX is on 28-mc. 'phone and C.W. OXK makes fine addition to Ohio O.P.S. ICF reports famous visitors, KVJ, IGO, HFR. IAI, on morning of Feb. 20th, worked all districts in just two hours on 1.75 mc. EMV is treading easy on 14 mc. DXB is experimenting with voice-controlled carrier. OGK and APC handled flood bulletins for the Cleveland Press. Those who volunteered to do flood duty were: AXV, KVJ, KNF, LXV, IWL, QQ, ICF and DXB. We congratulate BRC, FRC, DBC, BWH, EA and 3WX for their fine work.

Traffic: W8UW 526 (WLHI 41) HCS 511 MQO 397 ISK 330 RN 257 CIO 204 (WLHC 114) HMH 176 LCY 135 DVL 125 LUS 120 LZK 110 WE 106 NAL 67 BYM 43 LZE 32 OXK 31 FFK 33 EEQ 20 ITR 18 HWC 17 AQ 16 KIM 15 MHH 14 MQC 8 KEV 6 LY-MMF 4.

WISCONSIN—SCM, E. A. Cary, W9ATO—SES leads the state in traffic. JAW reports by radio via State Net. HSK wants dope on Milwaukee party. ONI tried shorting crystal for keying and works FB. OXP is picking up traffic from high school; he resumed activity on Trunk Line "A." WFW was elected to board of directors of Kilocyte Club. RSR is getting ready for hobby show. OTL says frozen dots and dashes have thawed out now. AKT says short month and exams knocked traffic total down. ZSL wants more stations in State Net. TJJ won boxing title in high school, 145-pound class. TXR has pair of RK18's on 3830 kc. ATO is on when time permits. UUX will report basketball game in Sparta. SPV is having trouble with woodpeckers pecking at his antenna mast. RQM, LFK and RH went strong in DX contest. TFS is working hard at new O.O. job. SJF is QRL school. Mary Meyer, the aspiring YL, has bought NKP's rig and hopes to have a license to run it soon. ROU and URM are "The Love Doctors of 160" in Madison. SST and ROU got two bushels of junk from some X would-be ham. RNX has a sound proof "studio" lined with insulite. RSA is back on 7 mc. after 4 months of rebuilding. BGV's new RME69 is working FB. ADK of Lowell has '52 in final. GTJ is having speech amplifier trouble. JVV is working out well on 28 mc. OQY got Wis. O.P.S. Nr. 1. WET is a new ham in Beaver Dam. VEC is working FB DX on 7 mc. EQP worked England 3 minutes after DX contest opened. UGN had spring fever. SPH is on 14 mc. SYZ exhibited his 56-mc. portable at Kilocyte Club. KQB is having antenna troubles. PXT is using crystal now. WKY is new ham in Green Bay. BOP spends most of his time listening to S.W. R.C.L.'s. PFA is rebuilding his r.f. again. SPV and FAA visited FDI at Elroy. FDI is on 14-mc. 'phone. PFQ dropped top shelf of his rig on the '03A. AUV is working for Western Electric in Milwaukee. WIR will be rebuilt and on the air soon. IQW intends joining the Royal Order of the Benedict! Madison gang on 1.75 mc. are SWF, ROU, TDN, IHB, EEQ, URM, WFO, BAS, FVX and JLM. HSK of La Crosse signs "W9HSK/WLTD OO ORS RM BACH SNCS AARS KK VA." An all-round ham! Clubs: Thanks for the new club reports, fellows. The Milwaukee Radio Amateurs Club will hold its annual QSO party May 16th. La Crosse Radio Amateurs Club will hold its annual round-up Sunday, May 24th. Wausau club is planning to enter the Field Day contest. The Four Lakes Radio Club of Madison sends another issue of *F.L.A.C. News*. They are having a "DX heard and worked" contest. The Kilocyte Club of Milwaukee sponsored an all-band QSO party March 28th. The last meeting of The Rock River Radio Club was held at the home of 9GTJ in Beaver Dam. The officers of the club are: BGV, pres.; NNT, vice-pres.; and OQY, sec'y. The Northern Wireless Assn. of Superior sends a copy of its new paper, *Strays*. They are planning a hamfest this summer. OZQ got up his antenna again after a windstorm blew it down. EIO tried flea power 1.75-mc. 'phone. WJD is new ham in Wausau. VBC has new PR16. FEO is on 1.75-mc. 'phone and 3.5-mc. C.W. IED's Jr. op is quarantined. He is keeping CFT's rig warm in the meantime. RQM worked his final African. CFT built a new crystal rig. KVJ is QRL school. PRM is building portable transmitter and receiver for Field Day. LWX is building 200-watt job for 14 and 28 mc. The regular meeting of the Wausau club was held at the home of LWX.

Traffic: W9SES 103 JAW 83 HSK 76 (WLTD 31) ONI 48 OXP 46 WFW 43 RSR 33 OTL 28 AKT 16 SZL 11 (U.S.N.R. 7) TGJ 10 TXR-ATO 4 UUX-SPV-RQM 1.

## Grating-g Scraping-g-g little SCREECHES



MODEL 38

Do they set YOUR  
teeth on edge?

Turner offers crystal mi-  
crophones with the  
**ACOUSTA-PHRAGM**

Irritating *metallic quali-  
ties* inherent in *metallic  
diaphragms* are obsolete  
as the croaks of extinct  
"dodo" birds.

Give the pleasing, individualizing elements in  
your voice a chance. HUMAN ears will respond  
to the treat.

For information ask your dealer, or write

**THE TURNER COMPANY**  
CEDAR RAPIDS, IOWA

Licensed under patents of the Brush Development Company

hicular and armament, will be on display. There  
are some 60 transmitters, ranging from 7½ to 800  
watts, used tactically at the Post. Tell Capt.  
B. V. Morse, 1st. Cav. (Mech.) Signal Officer,  
Fort Knox, Kentucky, you will be there.

## South Carolina State Convention

(Southeastern Division)

May 10th at Columbia, S. C.

WITH last year's hamfest experience as a  
criterion the Palmetto Amateur Radio Club  
will hold the first South Carolina State Con-  
vention at the University of South Carolina, on May  
10th. The convention will be replete with all the  
customary trimmings, including the banquet,  
talks, demonstrations, prizes, contests and  
recreation. All attending can be assured of a very  
enjoyable time and will consider their money well  
spent. The admission fee has been set tentatively  
at \$1.00. For further information drop a note to  
Herbert B. Sholar, Sec'y, 2820 Wilmot Ave.,  
Columbia, S. C.

## Strays

From Columbia we learn that, apparently, the  
one ham in the country who did not hear the  
March of Time broadcast featuring amateur  
radio's part in the flood emergency was the man  
who made the hero of the sequence, as it was  
telephoned from A.R.R.L. headquarters to the  
March of Time editors. W8BWH, whose early  
transmissions were dramatized on the broadcast,  
was still busy handling relief traffic on the 75-  
meter 'phone band.

-----  
On May 16th

At Stamford, Conn.: The Sixth Annual Dinner  
of the Connecticut Brasspounders' Association  
will take place at 7:30 p.m., May 16th, in the  
auditorium of the Stamford Gas & Electric Com-  
pany, 429 Atlantic Street. A turkey dinner will be  
served. Speakers prominent in amateur radio  
circles will address the gathering. G. W. Bailey,  
W1KH, New England Division Director, is  
expected to be present. Don Meserve, W1FL,  
first president of C.B.A. and present president  
of the Eastern Massachusetts Amateur Radio  
Association, will act as toastmaster. A 56-mc.  
station will be in operation. There will be the  
usual prizes. Reservations must be made not  
later than May 12th with G. Wilkins Whitney,  
P. O. Box 426, Stamford, Conn. Tickets \$1.50.

-----  
At Milwaukee, Wis.: The Milwaukee Radio  
Amateurs' Club, Inc., will hold its Thirteenth  
Annual QSO Party at 6:30 p.m., May 16th, in the  
Elizabethan Room of the Milwaukee Athletic  
Club, N. E. Corner Mason and Broadway. E. A.  
Roberts, W8HC, Central Division Director, will  
be present. The program will include dinner, re-  
freshments, prizes, entertainment and a revival of  
the "Loyal Order of the Derby." Reservations  
(\$2.00) may be made with Herbert L. Baker,  
W9GSP, 3922 N. 24 Place, Milwaukee.

## Coto PRESENTS!!

a new vogue in tuning controls

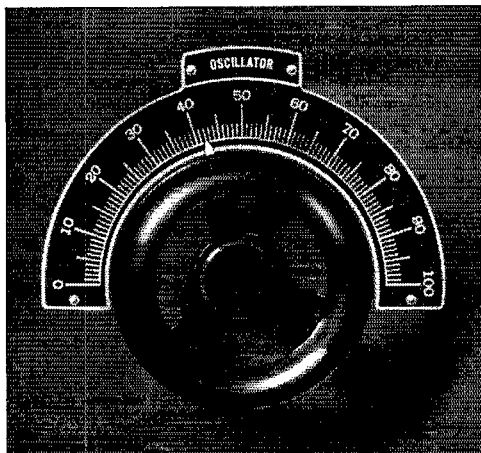

A Molded Bakelite Control Wheel, 3¼" in diameter. Available  
separately or complete with pointer, scale and choice of inter-  
changeable name plates. Standard for ¼" shafts. Other sizes  
up to ½" to order.

CI-40 Control Wheel, complete.....Net Price \$1.80  
CI-41 Bakelite Wheel only.....Net Price 1.20

**COTO-COIL CO., Inc., PROV., R. I.**

New York Office: 2 Broadway

West Coast Office: 4214 Country Club Drive, Long Beach, Calif.



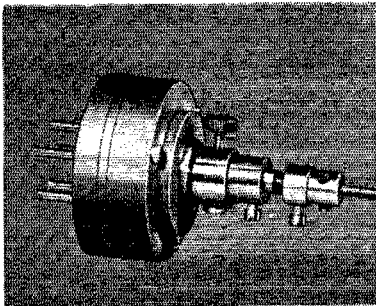

# TUNING THE CRYSTAL

A new device providing crystal control at an easily-adjusted fixed-frequency.

Net Price (less Crystal)—\$5.70  
With Hollister Crystal—\$19.50

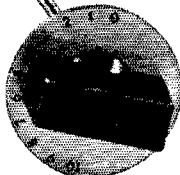

National presents a new adjustable-gap crystal holder with front-of-panel control of frequency. It is designed particularly for use with special Hollister A-cut crystals, and when properly installed will provide a frequency range of 6 kc. at 3500 kc. nominal frequency. Frequency spread is proportionately greater when operating on harmonics, as for example 24 kc. in the 20 meter band. Crystals specially selected for this service should be used, as some A-cut crystals are wholly unsuitable for variable frequency use. Holders are sold either without the crystal, or with a genuine Hollister 80 meter crystal for doubling into the 20 meter band. Crystals for other bands will be available later.

## FEATURES:

- Frequency change of one part in 600.
- Low loss R39 Housing, totally inclosed.
- Plug-in mounting.
- Flexible shaft drive for convenient panel control.
- Locking device for fixed-frequency operation.

**NATIONAL COMPANY, INC., MALDEN, MASS.**

## Meet

**BILL NIGHTINGALE (G5NI)**

(proprietor Radiomart and Raymart Mfg. Co.)

Birmingham, England

who is again visiting New York, arriving June 3, and is eager to contact manufacturers of amateur equipment, etc., who WISH TO DEVELOP BRITISH MARKET. Clean merchandise and sales policy essential and closeout goods entertained subject to the same proviso. Address letters to Box Z, c/o QST.

## ● DUPLEX TRANSMITTER-RECEIVER

A complete 5-meter station employing 7 tubes . . . including our new 6E6 PUSH-PULL oscillator.

● TYPE TR-6A6-  
F.O.B. factory **\$3975**

● SPECIAL EQUIPMENT FOR ALL REQUIREMENTS  
RADIO TRANSCIVER LABORATORIES  
General Offices and Plant **Richmond Hill, N. Y.**

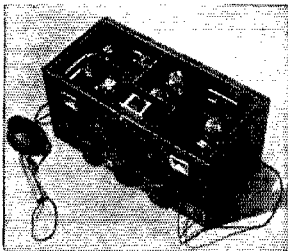

Instrument with tapes prepared by expert and complete course of lessons; all for \$11.95

**"HAM" SPECIAL** Standard Teleplex  
A highly efficient code teacher using heavy specially prepared waxed paper tape, having two rows of perforations. Write for Free folder Q.I. DEALERS — Correspondence invited with dealers for protected territories.

We are the originators of this type instrument  
**TELEPLEX CO.**  
72 Cortlandt St., New York City

## PRECISION CRYSTALS



Crystal Holder

Highest quality crystals one-inch square, carefully ground for frequency stability and maximum output. Be sure of your transmitter frequency — use PRECISION CRYSTALS.

'X' cut PRECISION Crystals carefully ground for maximum power supplied within 0.1% of your specified frequency and calibrated to within 0.03% are priced as follows: 1750, 3500 and 7000 kc. bands —

\$3.00 each. Add \$1.00 to above price if plugin, dustproof holder is desired. (Holder as illustrated to fit G.R. jacks or round holder to plug into a tube socket can be furnished) G.R. jacks to plug illustrated holder into — \$1.50 pair.

Low frequency drift crystals (Type LTC) having a drift of less than 5 cycles per million per degree C. are supplied at the following prices: 1750 and 3500 kc. bands — \$3.50 each; 7000 kc. band — \$4.00 each. Holder \$1.00.

'AT' cut crystals for commercial use quoted on at your request. When ordering our product you are assured of the finest obtainable. Now in our sixth year of business.

**PRECISION PIEZO SERVICE**

427 Asia Street

Baton Rouge, La.

# EIMAC

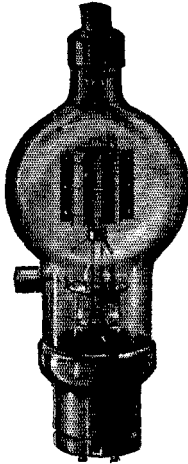

EIMAC 150T

THERE  
ARE NO TUBES  
"JUST AS GOOD"  
EIMAC TUBES  
for performance ruggedness and quality  
are unsurpassed

*There is a superior  
EIMAC Tube in each  
power group*

35T — 50T — 150T  
300T — 500T

AT LEADING DEALERS EVERYWHERE

**EITEL-McCULLOUGH, INC.**  
SAN BRUNO, CALIFORNIA  
U. S. A.

## Iowa State Convention

(Midwest Division)

Place: Iowa City, Iowa.

Date: May 15th-16th.

Headquarters: American Legion Building.

Auspices: Iowa City Amateur Radio Club.

## Amateur Radio Rises to Greatest Emergency Need of All Time

(Continued from page 21)

of all types, with W1XT recording 1000, W1XO 500, W1JN 400, W1FZA 400, W1JPE 400, and so on.

The A.R.R.L. Headquarters office occupied a peculiarly interesting position in this emergency work. Through the local exchange we retained telephone service, but practically all of the official agencies, located in downtown Hartford, were substantially cut off from communication and inaccessible, excepting for a few especially-patched "emergency" lines that were intermittent and greatly overloaded. Realizing that the League "could relay messages," the telephone operators began switching urgent calls to us, whereupon we took the messages and placed them on one or the other of the local networks. This dependency grew until before long the League's telephone number 4-7114 (which applied to both incoming trunks; a special outgoing trunk was maintained for dispatching purposes) was on every long distance telephone operator's switchboard in the east and became, in fact, the telephone number for "Hartford, Connecticut." An unbelievable number of DX and local telephone calls were received, all properly routed and delivered; all this, of course, in addition to acting as a clearing house and coordinating center for the local and outgoing radio networks.

### Other Regions

In a number of other areas throughout the east flood waters wreaked a less or a greater amount of destruction. In these regions amateur radio, too, performed to a greater or less degree. Such reports as have been received are here presented:

All this flood emergency actually began up in Maine, where they experienced emergency conditions due to high waters hours and days ahead of the rest of the country. A comprehensive review of amateur work in that state is very difficult because the emergency work was in no sense cohesive, not confined to well-defined valleys and streams as elsewhere but simply the result of high water, primarily caused by ice jams, on many rivers and in a number of non-contiguous spots. However, a few performances that stand out have been reported: In Rumford, Maine, on the Androscoggin River, isolated for several days, Ray E. Longway, W1IST, was for more than three days the only contact with the outside

## With ASTATIC at the ARCTIC

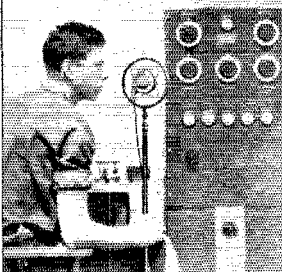

THE  
D-104

## Known the World Over

● Wherever ruggedness, durability and speech range quality are necessary, the D-104 is the choice of expert and veteran amateurs. The recent flood disasters proved how many D-104's were in use over the U. S. And from all points of the globe, like this Arctic Expedition, come reports of D-104's fine performance under all conditions. A GRAFOIL CRYSTAL Microphone that cannot be excelled for steady, long use by the amateur who wants both performance and economy.

Ask Your Jobber for Details  
Astatic Crystal Microphone  
Laboratory, Inc.  
Youngstown, Ohio, U. S. A.  
Pioneer Manufacturers of Quality  
Crystal Devices

At their base in the Bay of Fundy, the Bowdoin Arctic Ornithological Expedition are using an Astatic D-104. The above photograph shows George R. Cadman, Chief Operator, at the controls of the short-wave transmitter.

● The D-104 is licensed under Brush Development Company Patents. Fully guaranteed.

● LIST PRICE  
\$22.50

**Ask the HAM who OWNS ONE!**

## The Brace of Cans for Break-in CW and Push-to-Talk Phone

You have a new thrill in operating practice awaiting you if you have not seen a noise silencer in action alongside a transmitter. First off, hash from high voltage rectifiers is eliminated. Best of all, tune the receiver wide open to the transmitter frequency. Key as fast as you want. Instead of diaphragm bending thumps — just quiet, with that weak signal coming through unaffected with the key up. For phone, just install a push button control on the crystal oscillator. With the speaker on, turn on the transmitter. Instead of an ear-splitting acoustic howl due to feed-back, you get dead silence. Release the button and there's the other fellow back before you know it.

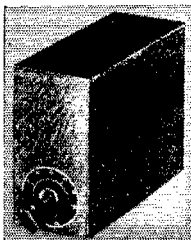

**LEEDS "QUIET CAN"** noise silencer is a 3-tube unit that can be applied to every communications receiver on the market that has two IF stages and many all wave receivers as well. Wired and tested, with RCA tubes and complete instructions the "Quiet Can" sells at . . . **\$8.55**

**LEEDS "SILENT CAN"** noise silencer is a 4-tube unit for use with receivers employing one IF stage employing a circuit development by our engineering staff that minimizes feed back trouble. Wired and tested with RCA tubes and complete instructions. . . . **\$10.95**

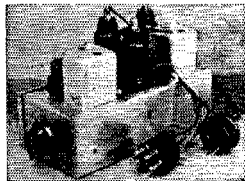

LEEDS "CANS" are unconditionally guaranteed. The shipping weight is five pounds. When ordering specify name of receiver, model number and IF frequency.

If your nearest dealer cannot supply you, order direct from  
**GORDON RADIO & ELECTRIC CO.**  
713 Third Avenue, Seattle, Washington

or

**LEEDS RADIO CO.**

**45 VESEY STREET  
NEW YORK CITY**

## QST YEARLY BINDERS



**T**HOSE who take pride in the appearance of their lay-out and wish to keep their reference file of *QST*'s in a presentable manner, appreciate the *QST* binder. It is stiff-covered, finished in beautiful and practical maroon fabricoid. Cleverly designed to take each issue as received and hold it firmly without mutilation, it permits removal of any desired issue without disturbing the rest of the file. It accommodates 12 copies of *QST* and the yearly index. Opens flat at any page of any issue.

With each Binder is furnished a sheet of gold and black gummed labels for years 1919 through 1938. The proper one can be cut from the sheet and pasted in the space provided for it on the back of the binder.

A file of several years of *QST*, kept in order in binders, is a most valuable reference library for any Radio Amateur.

Price **\$1.50** postpaid

Available only in United States and possessions

**THE AMERICAN RADIO RELAY LEAGUE**  
WEST HARTFORD, CONNECTICUT

# EBY

## Specializes in Quality

**Binding Posts**  
**Tip Jacks Male Plugs**  
**Female Plugs**  
**Low-Loss Sockets**  
**A-C Switches**  
**Tap Switches**  
**Terminal Strips**  
**Short Wave Switches**  
**Moulded Sockets**  
**Electric Eyes**

Write for Latest Bulletin

**HUGH H. EBY Inc.**  
 2066 Hunting Park Ave.  
 PHILADELPHIA, PENNA.



This circuit calls for  
 Aladdin Polyiron  
 core transformers!

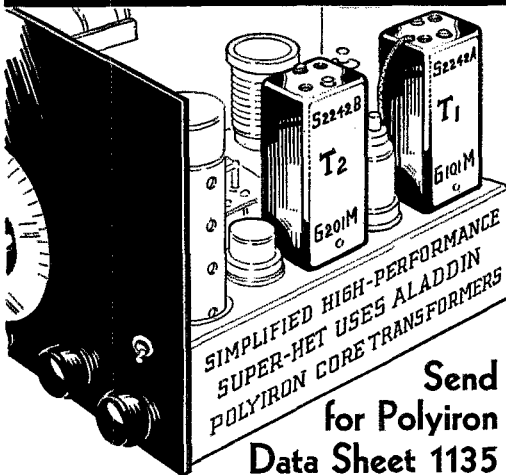

**SIMPLIFIED HIGH-PERFORMANCE  
 SUPER-HET USES ALADDIN  
 POLYIRON CORE TRANSFORMERS**

Send  
 for Polyiron  
 Data Sheet 1135

### Aladdin Radio Industries, Inc.

Licencees of Johnson Laboratories, Inc.  
 466-q West Superior St., Chicago, Ill.

These devices are manufactured under one or more of the following U. S. Letters Patents:  
 1887380, 1940228, 1978568, 1978599, 1978600, 1982689, 1982690, 1991453,  
 2002500, 2005203, 2018626, 2028534, 2032580, 2032914. Other patents pending.

except for one unreliable telephone line. W1IST was jammed with traffic from the National Guard and other sources, and handicapped by the necessity for battery operation part of the time. Another route for some traffic was via W1BOR in Rangeley, who was able to make deliveries in Rumford. Other Maine stations doing excellent work were W1VV, W1GOJ, and W1CFO.

During the flood crisis of last March the old Potomac, boundary between the states of Maryland and Virginia, rose until it was 2 miles wide in places, sweeping down on the valley towns at the rate of 20 miles per hour, 7 feet 8 inches above the old record of 1889. Cumberland was flooded, Hancock, Williamsport (near Hagerstown), Harper's Ferry . . . all the way down to Washington itself the water rose to dangerous heights. It was Thursday when conditions became serious. J. G. O'Connell, W3DAL, a commercial representative for the Potomac Light & Power Co., recognized the danger and got on the air with an emergency transmitter rig at the main office of the power company in Martinsburg, Va., 20 miles southwest of Hagerstown. The first contact between the two cities was made at 2:55 p.m. that day, the 19th, and the station was operated throughout the afternoon. Meanwhile, it became apparent that communication would urgently be needed at Berkeley Springs, half way up the river to Cumberland, so the station was dismantled and again set up at that point by 10:40 that evening. Not until wire communication was restored at 5:00 p.m., Saturday, was the station off the air. The other end of the circuit was manned by Marlin H. Thurmond, W3CTD, also of the power company, in Hagerstown, aided by Elliott L. Roof, W3BQB. Through this circuit a quantity of important two-way messages were handled for the power company and others. In Washington, which was so seriously threatened that government records were moved from the city, W3BWT manned his emergency-power-equipped station in readiness, as did other amateurs.

In the northwestern corner of Massachusetts the Hoosic River, contrarily, flows northwestward into Vermont and then over into New York State. Near its headwaters lies Adams, and a few miles to the north, North Adams. On Wednesday E. L. Roberts, W1GUO of Adams, came on the air reporting, among other things, that two bridges had been washed away. Wm. J. Barrett, W1JAH, of the same city, was also on, standing by with emergency self-powered equipment, filling in for W1GUO on the Army net and keeping emergency channels clear. Up in North Adams, Edward J. Fitzpatrick, W1IJR, over a period of 75 hours handled the routine budget of emergency traffic, official and personal, not only for the National Guard but for newspapers and airports as well. Wm. M. Allison, W1FFK, was also on the job in North Adams but was handicapped by the fact that he could work only on 20 and 40 meters —bands universally found to be almost worthless for emergency work.

(Continued on page 118)

# Where to buy it

A directory of suppliers who carry in stock the products of these dependable manufacturers.

**ASTATIC**  
Crystal Microphones and Pickups  
ASTATIC MICROPHONE LABORATORY, Inc. YOUNGSTOWN, O.  
Pioneer Manufacturers of Quality Crystal Products

JAMAICA, L. I., N. Y. 92-26 Merrick Rd.  
Federated Purchaser, Inc.  
NEWARK, N. J. Federated Purchaser, Inc. 230 Central Ave.  
NEWARK, N. J. 219 Central Ave.  
Wholesale Radio Service Co., Inc.  
NEW YORK, N. Y. 25 Park Place  
Federated Purchaser, Inc.  
NEW YORK, N. Y. 103 W. 43rd St.  
Harvey's Radio Shop  
NEW YORK, N. Y. 100 Sixth Ave.  
Wholesale Radio Service Co., Inc.  
NEW YORK, N. Y. (BRONX) 542 East Fordham Rd.  
Wholesale Radio Service Co., Inc.  
PHILADELPHIA, PENN. 10 S. 10th Street  
Eugene G. Wile  
PITTSBURGH, PENN. 343 Blvd. of the Allies  
Federated Purchaser, Inc.

**BURGESS BATTERY COMPANY**  
"Chrome" protected  
**RADIO BATTERIES**  
Look for the Black and White Stripes  
FREEPORT, ILLINOIS

ALBANY, N. Y. Uncle Dave's Radio Shack 356 Broadway  
BALTIMORE, MD. Radio Electric Service Co. 303 W. Baltimore St.  
BOSTON, MASS. Radio Shack 46 Brattle Street  
HARTFORD, CONN. 210 Chapel Street  
Stern & Company, Inc.  
JAMAICA, L. I., N. Y. 92-26 Merrick Rd.  
Federated Purchaser, Inc.  
MANCHESTER, N. H. 1008 Elm Street  
Radio Service Lab. of N. H.  
MONTREAL, CANADA 285 Craig Street, West  
Canadian Electrical Supply Co., Ltd.  
NEWARK, N. J. 219 Central Ave.  
Wholesale Radio Service Company  
NEWARK, N. J. 230 Central Avenue  
Federated Purchaser, Inc.  
NEW HAVEN, CONN. 86 Meadow St.  
Hatry & Young  
NEW YORK, N. Y. 25 Park Place  
Federated Purchaser, Inc.  
NEW YORK, N. Y. 12 West Broadway  
Harrison Radio Company  
NEW YORK, N. Y. (BRONX) 542 E. Fordham Rd.  
Wholesale Radio Service Company  
NEW YORK, N. Y. 100 Sixth Avenue  
Wholesale Radio Service Company  
PITTSBURGH, PENN. 343 Blvd. of the Allies  
Federated Purchaser, Inc.  
SPRINGFIELD, MASS. 349 Worthington St.  
T. F. Cushing

super skyrider  
hallicrafters  
ultra skyrider

ALBANY, N. Y. Uncle Dave's Radio Shack 356 Broadway  
BALTIMORE, MD. Radio Electric Service Company 303 W. Baltimore Street  
BOSTON, MASS. Radio Shack 46 Brattle Street  
HARTFORD, CONN. 227 Asylum Street  
Radio Inspection Service Co.  
MANCHESTER, N. H. 1008 Elm Street  
Radio Service Lab. of N. H.  
NEWARK, N. J. 219 Central Ave.  
Wholesale Radio Service Co., Inc.  
NEW HAVEN, CONN. 86 Meadow Street  
Hatry & Young  
NEW YORK, N. Y. 51 Vesey St.  
Gross Radio, Inc.  
NEW YORK, N. Y. 12 West Broadway  
Harrison Radio Co.  
NEW YORK, N. Y. 103 W. 43rd St.  
Harvey's Radio Shop  
NEW YORK, N. Y. (BRONX) 542 East Fordham Rd.  
Wholesale Radio Service Co., Inc.  
NEW YORK, N. Y. 100 Sixth Ave.  
Wholesale Radio Service Co., Inc.  
PITTSBURGH, PENN. Tydings Company 620 Grant St.  
READING, PENN. 404 Walnut St.  
George D. Barbey Company  
RICHMOND HILL, NEW YORK 124-11 101st Ave.  
Marine Radio Company  
SPRINGFIELD, MASS. T. F. Cushing 349 Worthington St.

**E. F. JOHNSON COMPANY**  
MANUFACTURERS OF  
**RADIO**  
TRANSMITTING EQUIPMENT  
WASECA, MINN.  
U.S.A.

JAMAICA, L. I., N. Y. 92-26 Merrick Rd.  
Federated Purchaser, Inc.  
MONTREAL, CANADA 285 Craig Street, West  
Canadian Electrical Supply Co., Ltd.  
NEWARK, N. J. 230 Central Avenue  
Federated Purchaser, Inc.  
NEWARK, N. J. 219 Central Ave.  
Wholesale Radio Service Company  
NEW YORK, N. Y. 25 Park Place  
Federated Purchaser, Inc.  
NEW YORK, N. Y. 12 West Broadway  
Harrison Radio Company  
NEW YORK, N. Y. (BRONX) 542 E. Fordham Rd.  
Wholesale Radio Service Company  
NEW YORK, N. Y. 100 Sixth Avenue  
Wholesale Radio Service Company  
PITTSBURGH, PENN. 603 Grant Street  
Cameradio Company  
PITTSBURGH, PENN. 343 Blvd. of the Allies  
Federated Purchaser, Inc.  
READING, PENN. 404 Walnut Street  
George D. Barbey Company

# Where to buy it

A directory of suppliers who carry in stock the products of these dependable manufacturers.



- ALBANY, NEW YORK** 356 Broadway  
Uncle Dave's Radio Shack
- BOSTON, MASS.** 588 Commonwealth Ave.  
Littlefield-Greene Corporation
- BOSTON, MASS.** The Radio Shack 46 Brattle Street
- BOSTON, MASS.** Selden Radio Company 28 Brattle Street
- BUFFALO, NEW YORK** 326 Elm Street  
Radio Equipment Corp.
- CONCORD, NEW HAMPSHIRE** 80 N. State Street  
Carl B. Evans
- JAMAICA, L. I., N. Y.** 92-26 Merrick Rd.  
Federated Purchaser, Inc.
- NEWARK, NEW JERSEY** 230 Central Avenue  
Federated Purchaser, Inc.
- NEWARK, NEW JERSEY** 219 Central Street  
Wholesale Radio Service Co.
- NEW YORK, N. Y.** 25 Park Place  
Federated Purchaser, Inc.
- NEW YORK, N. Y.** 12 West Broadway  
Harrison Radio Company
- NEW YORK, N. Y.** 103 W. 43rd St.  
Harvey's Radio Shop
- NEW YORK, N. Y.** 100 Sixth Avenue  
Wholesale Radio Service Co.
- PITTSBURGH, PENN.** 343 Blvd. of the Allies  
Federated Purchaser, Inc.



- ALBANY, N. Y.** 31 Hudson Avenue  
Havens Electric Company, Inc.
- ALBANY, N. Y.** Uncle Dave's Radio Shack 356 Broadway
- BALTIMORE, MD.** 303 W. Baltimore St.  
Radio Electric Service Company
- BOSTON, MASS.** H. Jappe Company 46 Cornhill
- BOSTON, MASS.** Radio Shack 46 Brattle Street
- HARTFORD, CONN.** 203 Ann Street  
Hatry & Young
- JAMAICA, L. I., N. Y.** 92-26 Merrick Rd.  
Federated Purchaser, Inc.

- NEWARK, NEW JERSEY** 230 Central Avenue  
Federated Purchaser, Inc.
- NEWARK, N. J.** 219 Central Avenue  
Wholesale Radio Service Co.
- NEW HAVEN, CONN.** 86 Meadow Street  
Hatry & Young
- NEW YORK, N. Y.** 460 W. 34th St.  
Bruno-New York, Inc.
- NEW YORK, N. Y.** 25 Park Place  
Federated Purchaser, Inc.
- NEW YORK, N. Y.** 16 West 22nd Street  
Royal-Eastern Electrical Supply Co.
- NEW YORK, N. Y.** 136 Liberty St.  
Sanford Samuel Corp.
- NEW YORK, N. Y. (BRONX)** 542 E. Fordham Rd.  
Wholesale Radio Service Co.
- NEW YORK, N. Y.** 100 Sixth Avenue  
Wholesale Radio Service Co.
- NEW YORK, NEW YORK** 12 West Broadway  
Harrison Radio Company
- PHILADELPHIA, PENN.** 10 S. 10th Street  
Eugene G. Wile
- PHILADELPHIA, PENN.** 117 North 7th St.  
Raymond Rosen & Company
- PHILADELPHIA, PENN.** 512 Market Street  
M & H Sporting Goods Company
- PITTSBURGH, PENN.** 343 Blvd. of the Allies  
Federated Purchaser, Inc.
- PITTSBURGH, PENN.** 603 Grant Street  
Cameradio Company
- READING, PENN.** Bright & Company 8th & Elm Streets
- SPRINGFIELD, MASS.** T. F. Cushing 349 Worthington Street
- WASHINGTON, D. C.** 938 F Street, N. W.  
Sun Radio & Service Supply Co.



- ALBANY, N. Y.** Uncle Dave's Radio Shack 356 Broadway
- BOSTON, MASS.** H. Jappe Company 46 Cornhill
- BOSTON, MASS.** Radio Shack 46 Brattle Street
- CAMDEN, N. J.** 811 Federal Street  
Radio Electric Service Company
- ERIE, PENN.** J. V. Duncombe Company 1011 West 8th St.
- GREENWICH, CONN.** 252 Greenwich Ave.  
Mead Stationery Company
- HARTFORD, CONN.** Hatry & Young 203 Ann Street
- HARTFORD, CONN.** 227 Asylum Street  
Radio Inspection Service Co.

# Where to buy it

A directory of suppliers who carry in stock the products of these dependable manufacturers.

**MONTREAL, CANADA** 285 Craig Street, West  
Canadian Electrical Supply Co., Ltd.

**NEWARK, N. J.** 219 Central Avenue  
Wholesale Radio Service Company

**NEW HAVEN, CONN.** Hatry & Young 86 Meadow Street

**NEW YORK, N. Y.** Bruno-New York, Inc. 460 W. 34th St.

**NEW YORK, N. Y.** Harrison Radio Co. 12 West Broadway

**NEW YORK, N. Y.** Sanford Samuel Corporation 136 Liberty Street

**NEW YORK, NEW YORK** Grand Central Radio, Inc. 124 E. 44th Street

**NEW YORK, N. Y. (BRONX)** Wholesale Radio Service Co. 542 E. Fordham Rd.

**NEW YORK, N. Y.** Wholesale Radio Service Company 100 Sixth Avenue

**PHILADELPHIA, PENN.** Radio Electric Service Company 3145 N. Broad Street

**PHILADELPHIA, PENN.** N. E. Cor. 7th & Arch Streets  
Radio Electric Service Company

**PHILADELPHIA, PENN.** M & H Sporting Goods Co. 512 Market Street

**PITTSBURGH, PENN.** Cameradio Company 603 Grant Street

**RICHMOND HILL, N. Y.** Marine Radio Company 124-11 101st Ave.

**NEW YORK, N. Y.** Sun Radio Company 227 Fulton Street

**NEW YORK, N. Y.** Federated Purchaser, Inc. 25 Park Place

**PITTSBURGH, PENN.** Federated Purchaser, Inc. 343 Blvd. of the Allies

**PITTSBURGH, PENN.** Tydings Company 620 Grant Street

**READING, PENN.** George D. Barbey Company 404 Walnut Street

**SPRINGFIELD, MASS.** T. F. Cushing 349 Worthington Street

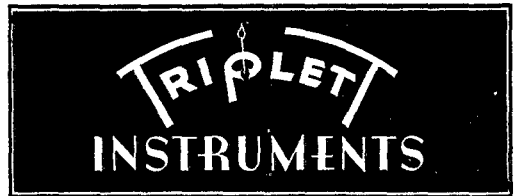

**ALBANY, N. Y.** Uncle Dave's Radio Shack 356 Broadway

**BOSTON, MASS.** Radio Shack 46 Brattle Street

**BOSTON, MASS.** Selden Radio Company 28 Brattle St.

**HARTFORD, CONN.** Hatry & Young 203 Ann Street

**JAMAICA, L. I., N. Y.** Federated Purchaser, Inc. 92-26 Merrick Rd.

**MONTREAL, CANADA** 285 Craig Street, West  
Canadian Electrical Supply Co., Ltd.

**NEWARK, NEW JERSEY** Federated Purchaser, Inc. 230 Central Avenue

**NEWARK, N. J.** Wholesale Radio Service Company 219 Central Ave.

**NEW HAVEN, CONN.** Hatry & Young 86 Meadow Street

**NEW YORK, N. Y.** Federated Purchaser, Inc. 25 Park Place

**NEW YORK, N. Y.** Wholesale Radio Service Company 542 E. Fordham Rd.

**NEW YORK, N. Y.** Wholesale Radio Service Company 100 Sixth Avenue

**PITTSBURGH, PENN.** Cameradio Company 603 Grant Street

**PITTSBURGH, PENN.** Tydings Company 620 Grant St.

**PITTSBURGH, PENN.** Federated Purchaser, Inc. 343 Blvd. of the Allies

**READING, PENN.** George D. Barbey Company 404 Walnut Street

Use **SHURE**  
**MICROPHONES**  
*Microphone Headquarters*

**ALBANY, N. Y.** Uncle Dave's Radio Shack 356 Broadway

**BOSTON, MASS.** H. Jappe Company 46 Cornhill

**BUFFALO, N. Y.** Radio Equipment Corporation 326 Elm St.

**JAMAICA, L. I., N. Y.** Federated Purchaser, Inc. 92-26 Merrick Rd.

**NEWARK, NEW JERSEY** Federated Purchaser, Inc. 230 Central Avenue

**NEWARK, N. J.** Wholesale Radio Service Company 219 Central Avenue

**NEW YORK, N. Y.** Harrison Radio Co. 12 West Broadway

**NEW YORK, N. Y.** Wholesale Radio Service Company 542 E. Fordham Rd.

**NEW YORK, N. Y.** Wholesale Radio Service Company 100 Sixth Avenue

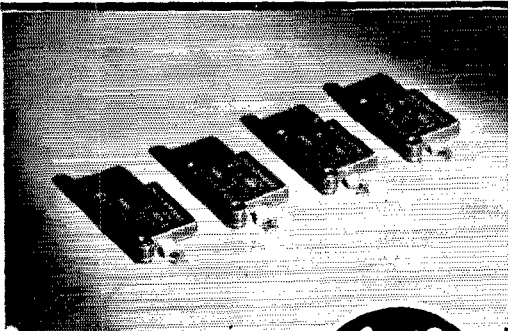

# Demand **CORNELL-DUBILIER** Type 4

Hermetically sealed in a special bakelite composition, these moulded mica capacitors are ideally suited for transmitting condensers in power amplifiers and low power transmitters. Available in a complete capacity range up to and including 5000 volts. Stocked by all C-D distributors

**CORNELL-DUBILIER**  
CORPORATION  
4373 BRONX BOULEVARD -  
NEW YORK



## Resistance Maintained

The Ward Leonard policy of conservative Watt Rating is a protection to you. Ward Leonard Resistors stand up. No burn-

outs of the resistors themselves or any other parts that take the load when resistors fail. Why jeopardize your equipment when you can get Ward Leonard Resistors? Send for the new Bulletin 507 on resistors and Bulletin 507B on relays.

-----  
**WARD LEONARD ELECTRIC CO.**

41 South Street, Mount Vernon, N. Y.

Please send me Service News Bulletin 507 and 507B.

Name.....  
Address.....  
City.....State.....  
Call Signal.....Q

Allentown, in Pennsylvania, lies on the Lehigh River. On its way to the Delaware this stream broadened out last March until it reached a width of very nearly 1 mile, inundated steel company yards and washed out a residential section of the city. Dr. A. D. Baer was on the air with his well-known 75-meter 'phone, W3EEY, handling a quantity of traffic to Harrisburg and being re-broadcast over KYW, Philadelphia, on the W3CRO-m.c.'ed program. He was assisted by D. E. Wilbur, W3FJU.

As these lines are written, the flood situation along the Ohio and Mississippi remains acute. Scattered reports have been received on the Ohio work, but in view of the fact that the story is at best incomplete and since there will be much more to tell in another month, no attempt will be made to recount amateur emergency work west of Pittsburgh at the present time.

"THEY ALSO SERVE"

Insofar as possible, the names and calls of every amateur known to have participated in emergency communications work in the flooded areas has been included in the foregoing account. Undoubtedly there have been omissions; time was short, written reports were relatively scanty, and it was possible to personally interview but a small fraction of the active group. However, such omissions, it is hoped, will be rectified in future issues of QST.

Other than the stations actually in the inundated zones, a large number of amateur stations in less crucial locations performed nobly in the relaying and delivery of relief traffic, some of them staying on watch for days on end, with crews of relief operators, pushing through hundreds of messages—effectively providing the "other end" which is an absolute necessity in any communications circuit. From the reports and the interviews with flood stations, a tentative "honor roll" of these cooperating amateurs has been constructed. This list is presented herewith. An asterisk after a call means that reports indicate that the station did outstanding work and is especially worthy of praise. The letter "p" after a call means that the station is understood to have operated on 75-meter 'phone. Neither the list nor the ratings are presented as either complete or accurate; they are simply the net result of the reports at hand. Apology is here and now made to any station underrated or overlooked, and rectification of the error is promised. The roll:

- W1AHN, W1ANS\*, W1AVGp\*, W1AXP, W1BD\*, W1BJF, W1BKQ (operated by W1JQY), W1BLU\*, W1BNL, W1BPH, W1CCM, W1CHG, W1CHR, W1DA, W1DCW, W1DDK, W1DJU (operated by W1BFG), W1DUH, W1ECK, W1ET\*, W1FYR, W1GME\*, W1GZL, W1HNE, W1HOO, W1HUV, W1HWZ\* (operated by W1FL, W1AAO, W1IIQ, W1HE, and W1PH), W1HXL, W1ICP, W1IDG\*, W1IGN, W1IOR, W1IOT, W1IYY, W1IZW, W1JBU, W1JDF\*, W1JNA, W1KH\*, W1LC, W1MX, W1NS, W1ZJ, W1ZQ\*, W2ALP, W2AUp\*, W2AUG, W2AWJp, W2BDE, W2BGO\*,



*More pep* at 28 Mc.

**Because**  
 Bliley HF-2 Crystal Units are tailor made for the 20 meter band, they oscillate readily and deliver more power for a given tube set-up when multiplying down to 10 and 5 meters. Join the popular swing to 28 Mc. operation. You'll be right there with a Bliley HF-2. Supplied within 0.2% of desired frequency or choice from your dealer's stock for \$7.50

**BLILEY ELECTRIC CO.**  
 ERIE, PA.

# BLILEY HF-2 CRYSTAL UNIT

## BIRNBACH "STEATITE" INSULATORS

A transmitting antenna insulator of exceptional tensile strength — 1500 lbs. Glazed overall, high insulation value. No sharp edges in grooves or holes. For all power up to 1 KW. Priced only

470 — 6"..... \$ .50 (list)	471 — 12"..... \$ .70 (list)
-----------------------------	------------------------------

**PORCELAIN SPREADERS**

462 — 2"..... \$ .12 (list)
464 — 4"..... \$ .15 (list)
469 — 7"..... \$ .20 (list)

Write Dept. Q5 for Antenna Information

**BIRNBACH RADIO CO., Inc.**  
 145 HUDSON STREET • NEW YORK CITY

## NEW A CR-175 AMATEUR RECEIVER

This new Super uses 1 glass and 10 metal tubes and is supplied in a handsome metal cabinet, with separate 8" dynamic speaker. It covers 5 to 600 meters, continuous and has greater band-spread. Other features include — Preselection, Band Switch, Iron Core I.F.'s, Crystal and Built-in-power.

**NET PRICE \$119.50 COMPLETE**

# ▶ CAMERADIO ◀

601-3 GRANT ST. PITTSBURGH, PA.      30 TWELFTH ST. WHEELING, W. VA.

Established 1919

*Radio Operator's Course*

*Complete in Telegraphy—Telephony*

*Practical Experience*

*Studio—Transmitter—Announcing*

P. A. C. is an endowed, educational institution — not privately owned, not operated for profit, college rank maintained. Course consists of maximum knowledge necessary to secure Commercial Telegraph Second-class, and Radio-telephone First-class government licenses. Course includes Wireless Code, Radiophone, Announcing, Microphone-Studio Technique, Service, Police, and Aeronautical Radio. We are authorized to teach RCA texts. At the completion of course you receive practical studio technique experience in our commercial broadcast studios located in the administration building, and experience as an operator on K P A C (500-Watt Commercial transmitter located on the campus, owned and operated by the college), and inter-departmental marine communication experience. If interested, write for Bulletin R.

**PORT ARTHUR COLLEGE**      Port Arthur (World-known port) Texas

## LEARN CODE

Quickly and Easily at Home As 9 Year Old Champion Jean Hudson Did with Candler Scientific Code Course

Increase your Code Speed and Technique as Champion McElroy did with High-Speed Telegraphing and "Mill" Courses.

CANDLER SYSTEM teaches you quickly to read code by sound as easily as you read print by sight, to copy behind at high speeds without strain or confusion — to qualify for that com'l ticket!



CHAMPION JEAN, W3BAK. Two months after beginning Candler training, Jean could copy 30 wpm on her "mill" easily.

### FREE—1936 BOOK of FACTS

If you're "stuck," want to learn code RIGHT, or to increase your speed and technique for that com'l ticket, this book will help you. Send for it. No obligation.

**CANDLER SYSTEM CO.**

Dept. Q-5

Asheville, N. C.

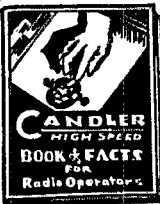

W2BKM, W2CGG\*, W2CGO, W2CGYp, W2CMTp, W2CTC, W2EGN, W2ERYp, W2ETY, W2EYEp, W2EZ, W2FZN, W2GNI, W2GWO, W2HEL, W2HFSp, W2HWS, W2HYpP, W2IHW, W2JILp, W2JP, W2KRp\*, W2KY, W2MWP, W2SJ, W2VOp\*, W3ADE, W3ADM\*, W3AEQp, W3AEXp, W3AIP, W3AKB\*, W3AKX, W3AQN\*, W3AXRp\*, W3BEG, W3BJX (using 2 watts power from batteries), W3BPT, W3BV, W3BWT\*, W3CIZ, W3CQS, W3CROp\* (assisted by W8EOL), W3CTD, W3CXL\*, W3ECN, W3EKL, W3EOP, W3EOZp\*, W3ESU (operated by W8HSC), W3ESY\*, W3EWJ, W3EYp, W3FI, W3FED, W3FIG, W3FTK, W3FWR, W3FVp\*, W3FWR, W3IH, W3OK\*, W3QV (assisted by W3KF, W3EHZ, and W3AOX), W3SB, W3SN, W3UA\*, W3UR, W3WJ, W8AOMp\* (plus XYL), W8AVK, W8BEV, W8BHK, W8BHNp\*, W8BQ\*, W8BWL, W8BWp, W8CEp, W8DCYp, W8DIG, W8DLG, W8EFA, W8FIP, W8FUW, W8GMZ, W8GPS, W8GPX, W8GUB, W8IIP (operated by W8LSQ), W8ILK, W8IVO, W8IXPp\*, W8JE, W8JTT, W8JWZ, W8KUN, W8LXVp\*, W8MOT, W8NDG, W8NJO, W8NPK, W8NPQ, W8OFO (operated by W8MIW), W8OFX, W8OGKp (assisted by W8ODI; this station delivered a flock of messages with the aid of the Cleveland Detective Bureau!), W8OJCp, N8RQ\*, W8URp\*, W8VD, W8YX, VE2DS, VE2JN, and, in particular, WLM, who, as the official Red Cross radio link with the country handled the official traffic not only of the local Pennsylvania emergency but of the entire flooded area.

Up to now we have spoken of the stations who actively participated in the emergency work, and whose work is thus properly recognized and duly recorded. There is another group, however, equally deserving of commendation—and letters from active stations in all sections call attention to their merit. These are the stations who stood by, silent—keeping the amateur channels free of deadly QRM—at the same time ready and waiting should traffic be headed their way, the need for their own facilities arise. It is far harder to be silent than to join the babble when everyone else in creation is having a big time "saving the world." Said W1JTK: "The boys who get the blue ribbon are the boys who stood by." Said "Mother K" of "The Haywire Net": "I feel the boys who remained silent . . . deserve just as much credit as those who handled the traffic." And dozens of other amateurs, from Maine to West Virginia, echo that feeling.

"They also serve who only sit and wait." Our thanks and our plaudits to "the boys who stood by."

#### SUMMARY

There is little space available for reminiscence and back-patting. Yet a brief word of review of the actual performance and accomplishments will not be amiss.

The Army and Navy networks came through in great style, of course, as always. Their type of

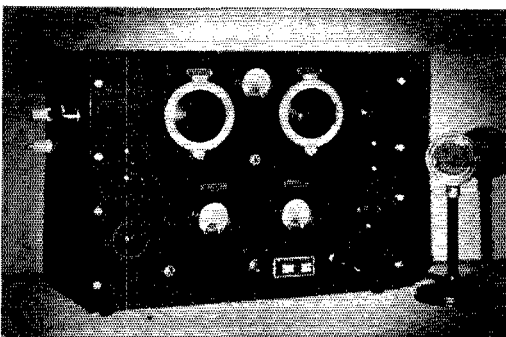

## 50-S TRANSMITTER

**BATTERY OPERATED**

designed for

- EMERGENCY USE
- FIELD COMMUNICATION
- BOAT SERVICES
- PORTABLE — MOBILE

Write for Full Details

**HARVEY RADIO LABORATORIES, INC.**

12 Boylston Street

Brookline, Mass.

# A Few of the Hundreds of LEEDS BARGAINS

If you don't see it listed, write us and get our low net prices

Western Electric 3:1 uncased audio transformers.....49c  
 Western Electric cased condensers 500 v. working 1 mfd...10c. 2 mfd.....15c  
 Premier Midget Magnetic Speakers 3".....90c. 5".....\$1.00. 6".....\$1.20  
 LEEDS all brass key with 1/8" contacts 95c, with navy knob.....\$1.15

## ANTENNA WIRE — COIL WIRE

Soft drawn tinned copper.  
 Soft drawn enameled copper.  
 Hard drawn tinned wire, per hundred feet.  
 No. 14...40c; No. 12...55c; No. 10...85c

LEEDS carries a complete line of General Radio Amateur accessories and laboratory apparatus.

Bulletin No. 936 mailed on request.  
**GENERAL RADIO** coil forms type 677-U price 50c; type 677-Y price 75c. G.R. amateur accessories always in stock.  
 G. R. dials, with fluted knobs 4" — \$1.50; 3 1/4" — \$1.25; 2 1/4" — \$1.00.

G. R. .0005 variable condensers, like new.....75c

**THORDARSON TRANSFORMER** special, 1200 volts CT 200 ma. 5 v. 3 amp. 7 1/2 v. 3 amp. 2 1/2 v. 10 amp. a quality cased job.....\$2.45

Thordarson 12 henry 250 ma choke, 1.95  
 Thordarson cased class B transformers input and output.  
 For 40's. Per pair.....\$6.17  
 For 210. Per pair.....8.23  
 For 203-A. Per pair.....17.64

New RCA transmitting tubes in stock  
 RCA 804...\$15.00 RCA 805...\$18.00

LEEDS cased oil impregnated filter condensers.

\$1.10...1 mfd. 1000 v. 2 mfd.....\$1.45  
 1.45...1 mfd. 1500 v. 2 mfd.....1.95  
 1.75...1 mfd. 2000 v. 2 mfd.....2.45

**NEON BULBS** 1/4 watt — 1/2 watt — 1 watt.....29c  
 2 watt neon or argon bulbs.....45c

LEEDS offers outstanding values in quality transmitting TUBES, backed by our name and guarantee.

\*203-A.....\$8.45 \*830-B.....\$7.25  
 †210-HF.....1.75 \*838.....11.75  
 866.....1.50 †841.....2.95  
 304-A-UHF 9.45 \*852.....11.50  
 †801.....2.95 866-A.....1.95

\*Graphite Anode Tubes

†Isolatite Base

Tubes Shipped by Express Only



**LEADS THE FIELD**

World Wide Service to Amateurs

45 Vesey Street  
 New York City

Tel. COlumbus 7-2612

Cable Address: "RADLEEDS"

**New Communications Products**  
 High Q Vectron lockturn transmitting inductors in stock. Tune with 50 mfd.  
 160 meters...\$2.50 80 meters...\$2.50  
 40 meters...1.25 20 meters... .75

Johnson side wiping contact, 50 watt sockets.....\$1.03

New Aerovox dual midget electrolytic condensers, 450 v. working.

4-4 mfd, 70c. 4-8 mfd, 79c. 8-8 mfd, 88c.

New Alladin air tuned IF transformers in stock.....\$3.25

All Star transmitting kits in stock.

**MEISSNER FERROCART** iron core transformers. These units will increase selectivity, double the gain, increase signal, lower set noise.

175-262-370-456 kc. each.....\$1.18

Meissner IF transformers; mica tuned, all ranges as above; each.....75c

Meissner R.F. choke coils, shielded and unshielded; 2.5 mh to 80 mh.

Meissner Junior trimmer, ceramic base; 10 mmf to 475 mmf working range.

Bulletin and price list mailed on request.

TRIMM 2000 ohm phones.....\$1.80

4000 ohm.....2.25

TRIMM featherweight.....5.88

FROST 2000 ohm.....1.45

FROST 3000 ohm.....1.65

DX 20,000 ohm imp.....2.65

WESTERN ELECTRIC type P-11....3.95

## RECORDER TAPES

Recorder Tapes to enable you to make your own records. 50 ft. 1/2" tape 20c, 8 for \$1.00—on wooden spools, same as used by professional recorders.

Wholesale Prices to the Home-Set Constructors, Experimenters

Headquarters for parts—since 1928

**BLAN THE RADIO MAN, Inc.**  
 177 Greenwch St., New York, N. Y.  
 NO CATALOGUE — BUT LOWEST PRICES

## GULF RADIO SCHOOL

Radiotelegraphy Radiotelephony  
 Radio Servicing

SECOND PORT } 1007 Carondelet Street  
 U. S. A. } NEW ORLEANS, LA.



AH cut — HIPOWER — crystals

### LOW DRIFT—DEPENDABLE—ACTIVE

Why pay more, you cannot buy as good for less

Type	Frequency	Choice of Stock
AH10	1700-3500 Kc. Bands	\$2.35
AH10	7000-7300 Kc. Bands	\$3.90

Hipower crystals are sold by your dealer, or order direct

Write for literature

Zero temp. coef. crystals for

Broadcast and Commercial use

**HIPOWER CRYSTAL CO.**  
 9035-49 W. Charleston Street CHICAGO, ILLINOIS



## CODE TEACHER

It's easy to learn the code with the Instructograph. Book of Instructions shows you how to study to best advantage. You can rent Instructograph on very attractive terms and rental may be applied on purchase price. A postcard will bring you full details.

**INSTRUCTOGRAPH COMPANY, Dept. Q-5**  
 912 Lakeside Place Chicago, Ill.

Representatives for Canada Toronto  
 Radio College of Canada, Ltd., 863 Bay St.

## IMMEDIATE DELIVERY

Trade in Your Receiver  
 or Transmitter

The new Hallicrafters Skybuddy.....	\$29.50
The new ACR-175a.....	119.50
PR-16s complete prepaid.....	95.70
National HRO Jrs.....	99.00
RME-69a.....	118.80
National HROs.....	167.70
Bretting 12s complete prepaid.....	93.00
Super Sevens.....	49.50
Super Skyriders complete.....	79.50
ACR-136s complete.....	69.50
Silver 5Ds complete prepaid.....	109.80
Super Pros complete.....	223.44

Collins, RCA, RME Marine transmitters

All Star and Radio-Silver kits

**FLASH — W9ARA** can supply rotary beam antennas for 20, 10, 5 meters

Consider these reasons why it is genuinely to your benefit to deal with W9ARA. I sell amateur apparatus exclusively and am jobber for every line. Besides guaranteeing to sell to you at lowest prices and to see that you are 100% satisfied with everything you buy from me, I take in trade your used apparatus and furnish technical help free. I sell on time payments. Write to W9ARA about any apparatus.

## HENRY RADIO SHOP

211-215 North Main Street Butler, Missouri

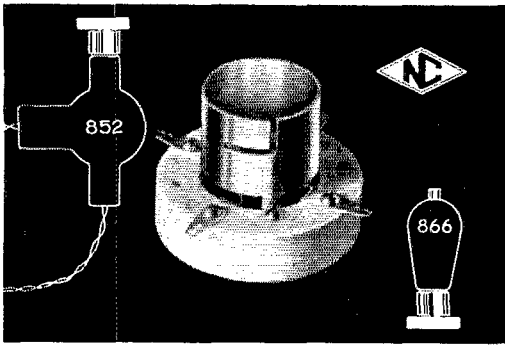

## "210" SOCKET

A bayonet-lock for positive support of upside-down 852's, etc. A low-loss ceramic base with long leakage paths. Positive, side-wipe, high current contacts. Low price. Such is the new Type XM-10 socket, companion to the XM-50 fifty-wattter.

Net price \$ 75

**NATIONAL COMPANY, INC.**  
**MALDEN, MASS.**

organization is especially effective when situations of this type arise. 'Phone operation both on 4 and 56 mc. showed up wonderfully well, and displayed a unique and indispensable utility in two departments: (1) flashing spot news flashes, getting reports and relief information through, and dramatizing amateur activity for the benefit of the general public, the press, and the professional broadcasters; and (2) in providing local links in lieu of land telephone circuits, especially in conjunction with the rehabilitation work of such public utilities as power and gas companies, telephone companies, etc. The group which had its first baptism by fire in this current cataclysm, and which showed up very well indeed, is the recently-organized A.R.R.L. Emergency Corps. The importance of the basic principles of this Corps and the success of their adaptation by its members was thoroughly demonstrated. *Preparedness* is the essential qualification for success in emergency work—preparedness both as regards knowledge of operating technique and the maintenance of self-powered equipment—and this is the keynote of the Emergency Corps. The membership card of the Corps was generally recognized by authorities, and in more than one instance it served to gain admission to critical areas when no other official pass, including police and Red Cross passes, was recognized. It is only natural that the roster of this group will swell rapidly as a result of the impetus gained by lessons learned and prestige gained during the flood. Volunteers are solicited; conditions for membership are reported elsewhere in this issue.

Amateur radio gained considerably in public stature as a result of the flood emergency work. An enormous amount of favorable publicity was received. Practically every newspaper in the flood zones and most of the big eastern dailies carried from one to a dozen detailed stories on amateur performance. The broadcasting networks and individual stations not only utilized amateur facilities largely in gathering news and for similar purposes but dramatized amateur activities and gave pleasingly adequate credit. News reel men made a good many feet of "ham" film. Already arrangements are being made by the A.R.R.L. for publication of more considered tales of amateur accomplishments in national magazines, as a result of interest excited by the current work. If every word that has been and will be written and said about amateur radio in this flood crisis were laid end to end, there'd be plenty for three presidential campaigns—and then some!

When things have quieted down a bit and there is time for sober reflection, unquestionably there will be many things to say about lessons learned during the current disaster. But that can wait—it will have to wait. There's no more room in this story, except to say:

An opportunity came, and it was seized. Merit was displayed, and it is being rewarded. Amateur radio has re-emphasized its status as an absolutely indispensable facility of modern civilization, and we are now provided renewed certainty that that status will be preserved.



MR. E. H. RIETZKE PRES. OF CREI

### A JOB ... or a FUTURE — which for YOU?

We want men who want a future. Radio wants men with ABILITY and is willing to PAY for it . . . if you have the TECHNICAL TRAINING necessary for advancement. Prepare yourself for big opportunities by applying yourself to CREI training. It's helped others and can help you — let us tell you how.

**New 48 Page CATALOG**  
 Just off the Press  
 Illustrates and fully describes all courses. Write for your free copy.

**RADIO ENGINEERING**  
 Three Home study courses  
 . . . Night and Day Residence Schools.  
 Complete details in New Catalogue.

## CAPITOL RADIO ENGINEERING INSTITUTE

14th and Park Road Dept. Q-5  
 WASHINGTON, D. C.



# HAM-ADS

(1) Advertising shall pertain to radio and shall be of nature of interest to radio amateurs or experimenters in their pursuit of the art.

(2) No display of any character will be accepted, nor can any special typographical arrangement, such as all or part capital letters be used which would tend to make one advertisement stand out from the others.

(3) The Ham-Ad rate is 15¢ per word, except as noted in paragraph (6) below.

(4) Remittance in full must accompany copy. No cash or contract discount or agency commission will be allowed.

(5) Closing date for Ham-Ads is the 25th of the second month preceding publication date.

(6) A special rate of 7¢ per word will apply to advertising which, in our judgment, is obviously non-commercial in nature and is placed and signed by a member of the American Radio Relay League. Thus, advertising of bona fide surplus equipment owned, used and for sale by an individual or apparatus offered for exchange or advertising inquiring for special equipment, if by a member of the American Radio Relay League takes the 7¢ rate. An attempt to deal in apparatus in quantity for profit, even if by an individual, is commercial and takes the 15¢ rate. Provisions of paragraphs (1), (2), (4) and (5) apply to all advertising in this column regardless of which rate may apply.

Having made no investigation of the advertisers in the classified columns, the publishers of *QST* are unable to vouch for their integrity or for the grade or character of the products advertised.

**QUARTZ**—direct importers from Brazil of best quality pure quartz suitable for making piezo-electric crystals. Diamond Drill Carbon Co., 719 World Bldg., New York City.

**RADIO** engineering, broadcasting, aviation and police radio, servicing, marine and Morse telegraphy taught thoroughly. All expenses low. Catalog free. Dodge's Institute, Byrd St., Valparaiso, Ind.

**NATIONAL**—Hammarlund, Patterson used sets, 60% off list. W3DQ, 405 Delaware Ave., Wilmington, Del.

**CLASS B** transformers—Universal for two or four 46s, 210s, 800s, RK18s, etc., \$7.75 pair postpaid. 70 watts audio from 46s, 100 watts from 10s. Write for details. W8UD, Douglas, Mich.

**RECEIVERS**—new and used, sold and traded in. Hammarlunds, Nationals, RME69, Skyrider. Schwarz Radio Service, 15 Lawrence Ave., Dumont, N. J.

**FOR** sale. Six 750 volt, 150 watt generators, \$11. each. Also a few other generators and motors. Wilmot Auto Supply Company, 1970 Wilmot St., Chicago.

**1000W** General Electric transformers, 1100-2200-4400 each side center on 110. Sold hams eight years. \$13.50. Dawson, 5740 Woodrow, Detroit.

**CALLBOOKS**—new DX calls, new prefixes, thousands of new W and VE calls, in the spring 1936 Radio Amateur Call Book. Sent postpaid \$1.25, or a whole year (four issues) for \$4. (In foreign countries \$1.35 and \$4.35.) Your call and QRA printed in large type, \$1. per year. Radio Amateur Call Book, 610 S. Dearborn, Chicago.

**INTRODUCTORY** offer. One order to an individual. Send \$1. and call letters for 100 two color modern QSL cards (not filled with advertising—send for sample) and six F.M.C. porcelain case mica low loss transmitting and receiving condensers. Any capacity up to .006 mfd. 5% capacity tolerance 2,000 volt test. Actually a \$7.50 value for \$1. Capacity color chart included. Filtermatic Mfg. Co., Tacony, Phila., Pa.

**MOST** complete line of relay racks, panels, chassis, Hi-power transformers, reactors. Rectifier Engineering Service, 4837 Rockwood Road, Cleveland, Ohio.

**QLS'S**, W2SN, Helmetta, N. J.

**TRANSMITTERS**: special apparatus, to order, Superior workmanship. Howard Radio, 154 Pine Avenue, Chicago.

**SUPER**-signal, the wonder dx crystal. Information on request. W1BD.

**SELL**—QSTs, June 1919 to June 1922 inclusive. W1EKP.

**QSLs**. Free samples. Printer, Corwith, Iowa.

**QST** eleven years complete 1925-1935. Regulation QST binders twelve additional copies prior 1925 best cash offer takes all twelve volumes. Radio, Box 881, Lawton, Oklahoma.

**QSLs!** Unsurpassed! Samples? (stamp), W8DED, Holland, Mich.

**CRYSTALS!** (Biley); RME-69s! Anything o.o.d. Nothing down!

**XTAL** SS super, pre-rf, power supply, coils four bands, speaker, phones. Make offer. W2CZP.

**CASH** for FB7A. W9TNO.

**TRADE** supreme 85 tester and stock of tubes for good receiver. Rod King, Girard, Pa.

**USED** receivers—RME9D's, Comet Pros, National, Skyriders. Satisfaction guaranteed. Mims Radio Company, Texarkana, Ark.

**HC** crystals supplied with individually written year guarantee. "Y" cuts, 80M-160M, four cycle coefficient. \$3.25. Ten cycle, \$2.25. Machined Formica holders, \$1. Inexpensive mounted crystals. Catalog, Ham Crystals, 1104 Lincoln Place, Brooklyn, N. Y.

**WANTED** Jewell 579 Test Panel. C. Steeves, Travers, Alta.

**RACON** six foot trumpets, units, field exciter, 60% off list. W1HIO, Edgell Road, Framingham.

**WANTED**: used Collins fone transmitter 100 watts or less. State all details. W8PNE.

**QSLs**, 300 one color cards \$1. Samples. 2143 Indiana Ave., Columbus, Ohio.

**QSLs**. Best quality. Free samples. Maleco, 1512 Eastern Parkway, Brooklyn, New York.

**SELL** Peak preselector with tubes \$15. W2EYE.

**CRYSTALS**—new zero coefficient "Y" cuts. 160-80 meters, your approximate frequency \$1.85—AT \$1.50—X \$1.25. Exact specified frequency \$2.70—\$2.35—\$1.95. Calibration accuracy 99.99%. Holders \$1. Blanks. Southwest Piezo Service, Box 792, Abilene, Texas.

**CRYSTALS**: Zero cut. Guaranteed to compensate at near zero without oven control. Your approximate frequency, 80 or 160 meters \$1.85. Ordinary zero cuts \$1.35 postpaid. Blanks 65¢. Plug-in holders 75¢, dozen \$6. Crystal quartz, will cut twelve crystals, \$1. Fisher Laboratory, 4522 Norwood Street, San Diego, California.

**WILL** pay cash for good used cartooning or illustrating course. What have you? Hoag, RD 2, Utica, N. Y.

**SELL** six tube superhet, complete \$22. W2IYF.

**THOSE** powerful "T-9" 40 meter crystals as low as \$1.50—see March Ham-ads. Written guarantee, calibration card and instructions with every crystal. "Eldson's"—Temple, Texas.

**"HAMS**: save money on BCL and Xmitting parts. Write for list. Have lot of material to dispose of. Archie Brunner, 89 Lehigh Ave., Newark, N. J.

**QSL's** distinctly different! Samples. W9LHG, 203 Mason Ave., Joliet, Illinois.

**BUY** sell or swap, rigs or whatnot. W4DND, Winterville, Ga.

**QUARTZ**. Faberadio, Sandwich, Illinois.

**CRYSTALS**. Faberadio.

**FOLDER** free. Faberadio.

**SKYRIDERS** in stock. Save express. W7BDS, Roundup, Mont.

**9 TUBE** superhet complete, \$35. W7BDS.

**SALE** Victor, Webster amplifiers; Gross Eagle, Skyrider receivers. Want larger receiver, test equipment. Glenn Watt, Chanute, Kans.

**SALE**: FBXA with National Pre-selector and Lamb Silencer attached. 8897 supply, 17 coils. Wonderful combination. Excellent condition. \$70. Ballantine, 1809 Cheltenham Avenue, Philadelphia.

**WANTED**—old Spark equipment, mica transmitting condensers, quenched gaps, etc. W5KD.

**TELEPLEXES**, Omnigraphs, Vibroplexes, meters, receivers. Bought, sold, exchanged. Ryan Radio Co., Hannibal, Mo.

**CRYSTALS**, guaranteed oscillators. Approximately one inch square. 80-160 meter bands only. Within 5 kc. Y cut \$1. X cut \$1.50. Postpaid. Herbert Addington, 2252 North LeClaire Avenue, Chicago.

**CRYSTALS**. See April QST Ham-Ads for prices and dope on crystals. William Threm, W8FN, 4021 Davis Ave., Cheviot, Ohio.

**REBUILT** Vibroplexes \$6. New large base bugs \$9. Lydeard, 28 Circuit, Roxbury, Mass.

**QSL's**. Samples. W8LQM.

**ARTISTIC** QSL's. T. Vachovetz, Elmsford, N. Y.

**QSL's** that are different. Radio Headquarters, Ft. Wayne, Indiana.

**CRYSTALS**—40 meter band X cut \$1.85. Guaranteed satisfaction or money back. 80-160 bands \$1.50. Omaha Xtal Labs., 501 World Herald Bldg., Omaha, Nebr.

**LATHE**—metal turning. Six inch swing. Compound rest. Power feed. Weight 35 lbs. Factory price, \$10.95. W6ELA, 105½ E. Ave., 38, Los Angeles.

**NEW** Eimac 35T's \$8. W8ANT.

**USED** receivers. W8ANT.

NEW RCA 42A's \$12.50. W8ANT.

NATIONAL products. W8ANT.

USED transmitting tubes. W8ANT.

NEW and used transmitting and receiving equipment for sale by Southern Ohio's only amateur owned amateur business. Joe. N. Davies, W8ANT, Box 602-R.R.9, North Bend Rd., Mt. Airy, Cincinnati, Ohio.

QSL's. Free samples, W8DDS, 2156 West 80th Street, Cleveland.

THICK-cut 20 meter xtals, \$5.50. W9TJW.

TRADE—new Leica "G" F2, any series Graflex, Contax movie camera. Want commercial made amateur transmitter, receiver. WHRC.

QSL's! Best of 'em all! \$1. per hundred, postpaid. Color variety in stock and ink. Free samples. W2FJE, 145 Lafayette Avenue, Brooklyn, N. Y.

W9OJC selling complete 20M fone 211 final 830Ba modulator 7 meters all high grade parts. Bob Payne, c/o J. L. Thomson Mfg. Co., 17 N. Sheldon, Chicago, Ill.

TRANSMITTER wanted;—Collins built phone, 30FXB preferred. Give details. W9GLE, Mason City, Iowa.

CRYSTALS—"Summer sale"—160 & 80 approx. freq. Y—\$1. X—\$1.25 Lo Drift \$2. 40—\$1.75 blanks X—Y 50¢ Lo Drift 70¢. Socket holders 90¢. Guaranteed. Wolverine Crystal Service, Calumet, Mich.

SELL—Hammarlund xtal Pro 5 to 550 meters. Tubes, console, dynamic speaker. Used ten months. W8DQY, Galion, Ohio.

CRYSTALS: 1" Sq. X cut 80-160 meters \$1.40, 40 meters \$2.50. Within 3 Kc. of desired freq. Guaranteed the very best. The Ransom Lab., North Syracuse, N. Y.

QSLs on quality stock. Samples. 5-Meter Print, Escanaba, Mich.

D.C. Generators—2000 volts, .96 amperes or 1600 volts, 1.2 amperes. Bargain. Aaron Machinery Co., 176 Lafayette Street, N. Y. C.

SELL or trade: Comet Pro, \$40. RME9D like new, \$70. Complete rack and panel phone and CW transmitter, \$75. WE251A 1000 watt high frequency tubes, \$50. WE276As, \$6.95. W9ARA, Butler, Mo.

SELL: new \$149.50 silver masterpiece IZA for \$95. W9ARA, Mo.

# FREE RELAY CIRCUIT DIAGRAMS—

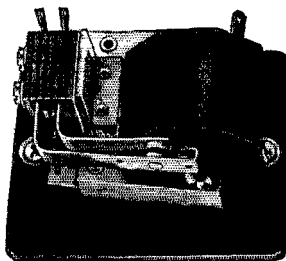

Model K-100 Keying Relay

with  
**"GUARDIAN"**  
IMPROVED  
RELAYS  
POSITIVELY  
PROTECT  
YOUR TRANSMITTER

Model K-100 Keying Relay by GUARDIAN—small—quiet—FAST—Well-Engineered Keying Relay for Amateur transmitting. Pure Silver Contacts on Phosphor-Bronze Springs operate in extra high voltage circuits at HIGHEST WPM rate. Current drain so LOW—never disturbs voltage of circuit.  
Net price..... **\$3.30**

B-100 Break-in Relay. Net **\$4.50** L-500 Overload Relay. Net **\$4.50 (500 ma)**

L-250 Overload Relay. Net **\$4.50 (250 ma)**

X-100 Adjustable Overload Relay (150 to 500 ma) Net **\$7.20** T-100 Time Delay Relay. Net **\$9.00**

Every Progressive Jobber Has Guardian's Complete Relay Line—Mail Coupon for FREE CIRCUIT DIAGRAMS and Bulletin TODAY!

- Guardian Electric Mfg. Co.
- 1621 W. Walnut St., Chicago, Ill.
- Gentlemen: Please send Free Bulletin and Circuit Diagrams for application of GUARDIAN Relays without obligation to me.
- NAME .....
- ADDRESS .....

## The Superiority of Our **DYNAMIC MICROPHONE**

Over Other Types Is  
Mainly in Its Sensitivity

No high gain preamplification required. No background noise. No Power Supply. New low prices and improved performance should be of interest to all amateurs who wish to improve the quality of their stations.

**PRICE \$29.00**

U. S. PATENTS PENDING

Send for Our NEW  
Bulletin 3012

**RADIO RECEPTOR CO., INC.**

110 Seventh Ave., New York City

# DON'T BE FOOLED!

Be sure to get a copy of my latest price list on all Receivers and Transmitters before you buy. You will find my terms more liberal and interest charges lower.

**Flash! The New RCA-ACR175 RECEIVER**

ONLY \$13.15 DOWN—Immediate Delivery  
Balance in Nine Monthly Payments of Same Amount

Attractive Terms and Prompt Delivery on National—Hammarlund—RME 69—Tobe—Skyrider—RCA—Harvey, etc., etc.

**HAM-VETS ATTENTION! I Have a Special Proposition for You—SPECIAL Prices on New 1936 Auto Radios**

**WILLARD S. WILSON . . . W3DQ**

DELAWARE RADIO SALES COMPANY  
465 Delaware Avenue Wilmington, Delaware

"Radio Service Since 1912"

Member ARRL—VWOA—American Legion

## NEW EDITION

# How to Become A RADIO AMATEUR

See page 107

# Get Yours Now!

New  
**GENUINE MARTIN JUNIOR**  
Weight 2 3/4 lbs.

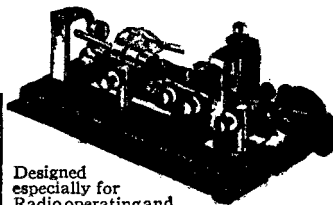

ONLY  
with **\$10**  
ALL  
STANDARD  
IMPROVEMENTS

Designed especially for Radio operating and incorporates mechanical features and improvements found only in the Genuine

Vibroplex Bug . . . Provides greater precision in adjustment—clearer, stronger signals and easier manipulation . . . Quickly establishes the user as a GOOD, RAPID sender with less than half the effort of ordinary key sending. . . May be operated as slow as five words per minute or at a high rate of speed, limited only by the ability of the user to control it. . . Easy to learn. . . Easy to use. . . Easy to own at this low price. . . Over 100,000 Vibroplexes in use. . . Other models in Black or Colors, \$17; Nickel-plated, \$19. Remit by money order or registered mail.

**THE VIBROPLEX CO., Inc.**

832 Broadway, New York, N. Y.

Write  
for  
FREE  
CATALOG

# Your Nearest Dealer Is Your Best Friend

Your nearest dealer is entitled to your patronage. You can trust him. He is equipped with a knowledge and understanding of amateur radio. He is your logical and safe source of advice and counsel on what equipment you should buy. His stock is complete. He can supply your needs without delay. His prices are fair and consistent with the high quality of the goods he carries. He is responsible to you and interested in you.

Patronize the dealer nearest you — You can have confidence in him

## ALLENTOWN, PENNSYLVANIA

Radio Electric Service Co.  
1024 Hamilton Street  
Complete stocks transmitting equipment

## BALTIMORE, MARYLAND

Radio Electric Service Co.  
303 W. Baltimore Street  
Everything for the amateur

## BIRMINGHAM, ENGLAND

Radio Mart  
19 John Bright Street  
Drop in and meet Bill Nightingale—G5NI

## BUFFALO, NEW YORK

Dymac Radio  
216 E. Genesee St. — Tel. CI. 2080  
Complete Stock Amateur Parts — Standard Discounts — W8AWK

## BUFFALO, NEW YORK

Radio Equipment Corp.  
326 Elm Street  
W8GJ — Ham, service and sound equipment — W8BTS

## MANCHESTER, NEW HAMPSHIRE

Radio Service Lab. of N. H.  
1008 Elm Street — Tel. 218-W  
Branches — Portland, Me. and Barre, Vt.

## MONTREAL, CANADA

Canadian Elec. Supply Co., Ltd.  
285 Craig St., W.  
Quality parts and equipment for discriminating buyers

## PHILADELPHIA, PENNSYLVANIA

Consolidated Radio Corp.  
612 Arch Street  
Ham receivers, Transmitting tubes, Collins transmitters, etc.

## PHILADELPHIA, PENNSYLVANIA

Radio Electric Service Co., Inc.  
N. E. Cor. Seventh & Arch Sts.  
All nationally-advertised lines in stock

## PITTSBURGH, PENNSYLVANIA

Cameradio Company  
601-3 Grant Street  
"Ham" Headquarters for Pennsylvania-Ohio-W. Virginia

## PHILADELPHIA, PENNSYLVANIA

Eugene G. Wile  
10 S. Tenth Street  
Complete Stock of Quality Merchandise

## PROVIDENCE, RHODE ISLAND

W. H. Edwards Co.  
32 Broadway  
National — Hammarlund — RCA — and other leaders

## PROVIDENCE, RHODE ISLAND

Kraus & Company  
89 Broadway  
Everything for the amateur and serviceman

## ROCHESTER, NEW YORK

Radio Service Shop  
244 Clinton Avenue, North  
Complete stock amateur-BCL parts. Standard discounts. W8NUC

## SYRACUSE, NEW YORK

Roy C. Stage, W8IGF  
Complete stock of standard Ham & BCL parts  
Standard Discounts. Free technical service

## SPRINGFIELD, MASS.

S. S. Kresge Company  
1540 Main Street  
Standard discounts on standard lines.  
Advisory service: W1JQ, W1FOF

## WASHINGTON, D. C.

George's Radio Co.  
816 F Street, N.W.  
Washington's largest distributor of radio parts

## WHEELING, WEST VIRGINIA

Cameradio Company  
30 Twelfth Street  
Complete stock of amateur Equipment at standard discounts

# You Are Protected When You Buy From QST Advertisers

“Advertising for QST is accepted only from firms who, in the publisher’s opinion, are of established integrity and whose products secure the approval of the technical staff of the American Radio Relay League.”

Quoted from QST’s advertising rate card.

Every conceivable need of a radio amateur can be supplied by the advertisers in QST. And you will know the product has the approval of the League’s technical staff.

For Your Convenience

## QST'S INDEX TO ADVERTISERS IN THIS ISSUE

Aerovox Corporation	98
Aladdin Radio Industries, Inc.	114
Allen-Bradley Company	77
All Star Headquarters	101
Amperex Electronic Products	94
Astatic Microphone Company	112
A.R.R.L., Application Blank	93
Binders	113
Calculators	99
Handbook	95, 115
How to Become a Radio Amateur	107
License Manual	100
Supplies	97
Birnbach Radio Company, Inc.	119
Blan, The Radio Man, Inc.	121
Bliley Electric Company	96, 119
Brush Development Company	101
Bud Radio, Inc.	103
Burgess Battery Company	1
Cameradio Company	119
Candler System Company	120
Capitol Radio Engineering Institute	122
Cardwell Mfg. Corp., Allen D.	127
Central Radio Laboratories	92
Cinaudagraph Company	91
Collins Radio Company	Cov. 2
Continental Carbon Company	101
Cornell-Dubilier Corporation	118
Coto-Coil Company	110
Delaware Radio Sales Company	124
Eby, Inc., Hugh H.	114
Eitel-McCullough, Inc.	112
Freck Radio & Supply Company	115
General Electric Company	89, 90
General Radio Company	88
General Transformer Company	102
Gross Radio, Inc.	87
Guardian Electric Mfg. Co.	124
Gulf Radio School	121
Hallcrafters, Inc., The	85
Hammarlund Mfg. Company	4
Harvey Radio Laboratories	120
Henry Radio Shop	121
Hipower Crystal Company	121
Instructograph Company	103, 121
Leeds	113, 121
Littelfuse Laboratories	107
M & H Sporting Goods Co.	96
Marine Radio Company	2
Massachusetts Radio School	101
McElroy, T. R.	107
McGraw-Hill Book Company	86
National Carbon Company	84
National Company	75, 106, 111, 122, Cov. 3
Newark Electric Company	82
Nightingale, Bill	111
Ohmite Mfg. Company	106
Port Arthur College	119
Precision Piezo Service	111
Radio Laboratories	113
Radio Mfg. Engineers	83
Radio Receptor Corporation	124
Radio Shack	81
Radio Specialties, Inc.	100
Radio Supply Company	115
Radio Transceiver Laboratories	111
RCA Institutes, Inc.	103
RCA Manufacturing Company	79, Cov. 4
Raytheon Production Corp.	30
Scientific Radio Service	107
Shure Brothers Company	102
Sprague Products Company	103
Standard Transformer Corp.	78
Teleplex Company	107, 111
Trimm Radio Mfg. Company	103
Triplett Electrical Instrument Corp.	76
Turner Company	110
United Transformer Company	128
Utah Radio Products	107
Valpey Crystals	103
Vibroplex Company	124
Ward Leonard Electric Company	118
Wright-DeCoster, Inc.	98



# NO FINER CONDENSER

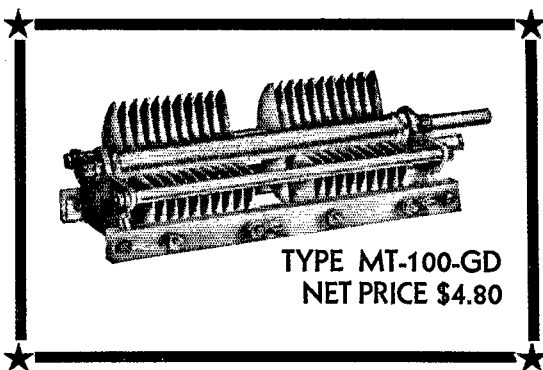

TYPE MT-100-GD  
NET PRICE \$4.80

# than a Cardwell MIDWAY

*Month after month, year after year, the sale of Cardwell Midway Condensers proves the need for the MIDWAY Series. Every Cardwell condenser patent and years of mechanical experience and engineering skill combine to produce one of the finest condensers offered to the American Amateur. The quality is the highest. The price is well within the Amateur's budget.*

Type	Max. Cap.	Min. Cap.	Number of Plates	Depth Behind Panel	Net Price to Amateur
MR-105-BS.....	105	10	11	2 $\frac{9}{16}$ "	\$1.60
MR-260-BS.....	260	13	25	3 $\frac{9}{16}$ "	1.70
MT-50-GS.....	50	11	11	2 $\frac{9}{16}$ "	2.10
MT-100-GS.....	100	15	21	3 $\frac{9}{16}$ "	2.65
<b>DOUBLE CONDENSERS</b>					
MR-100-BD.....	100*	10*	11	3 $\frac{9}{16}$ "	2.75
MR-260-BD.....	260*	13*	25	4 $\frac{1}{2}$ "	3.00
MT-35-GD.....	35*	9*	7	3 $\frac{9}{16}$ "	3.30
MT-50-GD.....	50*	11*	11	3 $\frac{9}{16}$ "	3.50

\*Capacity of each section.

## THE ALLEN D. CARDWELL MFG. CORP.

83 Prospect Street, Brooklyn, N. Y.

# YOU can win this Transmitter Phone - CW Kit, fully mounted, ready-to-wire

The 50-watt input variactor controlled carrier kit shown will be given FREE to the amateur who suggests a name that will best describe this series of kits. Contest closes July 1st, 1936. Judges are L. M. Cockaday and Frank Jones, two nationally known radio editors. Mail suggested names direct to UTC.

While priced within the reach of every amateur, these variactor controlled carrier kits represent the finest in transmitter design. The conservatively rated components come from the finest manufacturers in radio: UTC, Cardwell, Cornell Dubilier, Hammarlund, Isolantite, Aerovox, IRC, Triplett, Yaxley, Johnson, Electrad, etc. . . . Tubes by RCA. These units are furnished completely mounted in rack panel construction, with etched metal overlay plates.

## 50 CW RF UNIT

Consists of Crystal-controlled pentode oscillator, pentode buffer-doubler, push pull final amplifier and choke input mercury vapor rectifier system having a regulation better than 5%, readings on 5 circuits instantaneously through one meter. Used by itself this unit is a highly efficient 50-watt input CW transmitter. 50 CW RF unit completely mounted ready to wire with one set of coils (specify band desired) including dust cover, less tubes and crystal. Tubes required: 2-2A5's, 2-46's, 1-83. Net to hams . . . . . \$68.40

Extra set of coils (either for 20, 40, 80 or 160 meters). Net to hams . . . . . \$4.80

## 30 AF MODULATOR ASSEMBLY

Consists of a high gain speech amplifier and Class B modulating stage. It has an output of 30 watts, and when used to modulate the RF amplifier at 100% modulation the distortion level is less than 5%. This amplifier is designed for use with high level crystal microphones and will operate with any of the carbon type. 30 AF Modulator assembly completely mounted, ready to wire, including dust cover but less tubes. Tubes required: 2-57's, 3-46's, 1-83. Net to hams . . . . . \$39.60

## 50 CC VARIATOR CARRIER CONTROL

Has a separate power supply for 50-watt input class C stage and Variactor units for carrier control. Instantaneous switchover provided from carrier control to constant carrier. When used with 500-watt class B Linear stage DX coverage is increased, efficiency of the Linear stage is easily doubled. Reduces interference between stations tremendously. 50 CC Variactor Carrier Control unit completely mounted, ready to wire, with dust cover, less tube. Tube required: 1-83. Net to hams . . . . . \$33.60

Full Scale Working Print Brochure covering all constructional plans for the 50-watt, 500-watt and 750-watt input units may be purchased from your distributor or direct for 25c. Free with purchase of each sectional unit.

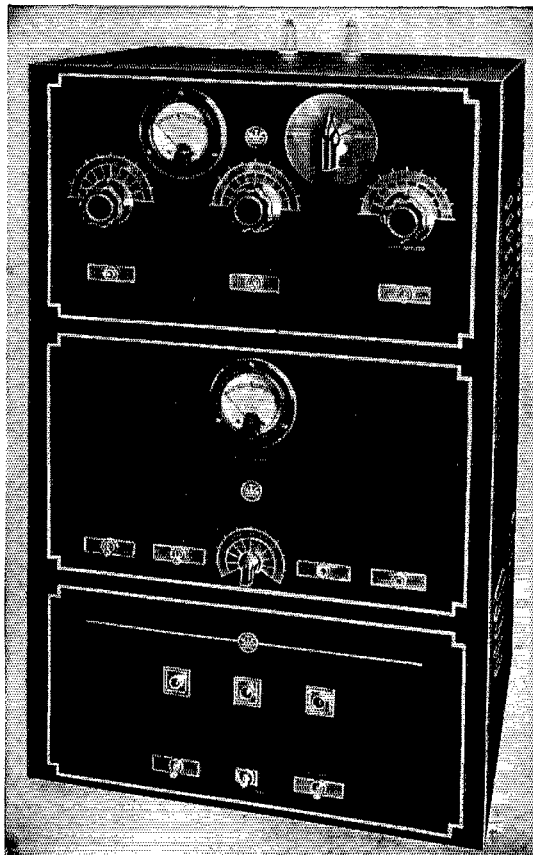

SEND  
**25¢**  
for...

## THE NEW UTC CIRCULAR SLIDE RULE

The most useful instrument a radio engineer could have. Here are some of the electrical and mathematical problems to which it gives direct answers: Multiplication . . . Division . . . Proportion . . . Reciprocals . . . Squares . . . Square Roots . . . Voltage Drop in Resistors . . . Wattage in a Resistor for Given Voltage or Current . . . Impedance of an Inductance at Any Frequency . . . Impedance of a Condenser at Any Frequency . . . Resonance Calculations . . . Effective Capacity of Condensers in Series . . . Effective Resistance of Resistors in Parallel . . . Calculation of Bias Resistors . . . Power Level Conversion to DB . . . Voltage or Current Ratio Conversion to DB Gain . . . Sound and Light Calculations . . . Circumference and Area of Circles . . . Stroboscope for Checking 33-1/3 or 78 RPM Turn-tables. Due

to its 16 inch effective length, the accuracy of this rule is greater than many of the standard rules selling at 30 times its price.

## NEW TRANSMITTER BULLETIN

Covering circuits and laboratory built transmitters from 5 watts to 1,000 watts output.

## ALL LABORATORY CIRCUITS

As they are released over a period of one year covering new amplifiers and variactor controlled carrier RF transmitters.

## NEW 48 PAGE TECHNICAL BULLETIN

which includes data and circuits on amplifiers from 1/2 watt to 1,000 watts output, chapters on audio transformer design, application of power transformers and filters, also charts on decibel conversion in terms of watts and conversion of power or voltage ratios to DB, reactance data, filter ripple calculations, etc. . . .

# UNITED TRANSFORMER CORP.

76 SPRING STREET

NEW YORK, N. Y.

EXPORT DIVISION - 15 LAIGHT STREET, NEW YORK, N. Y.

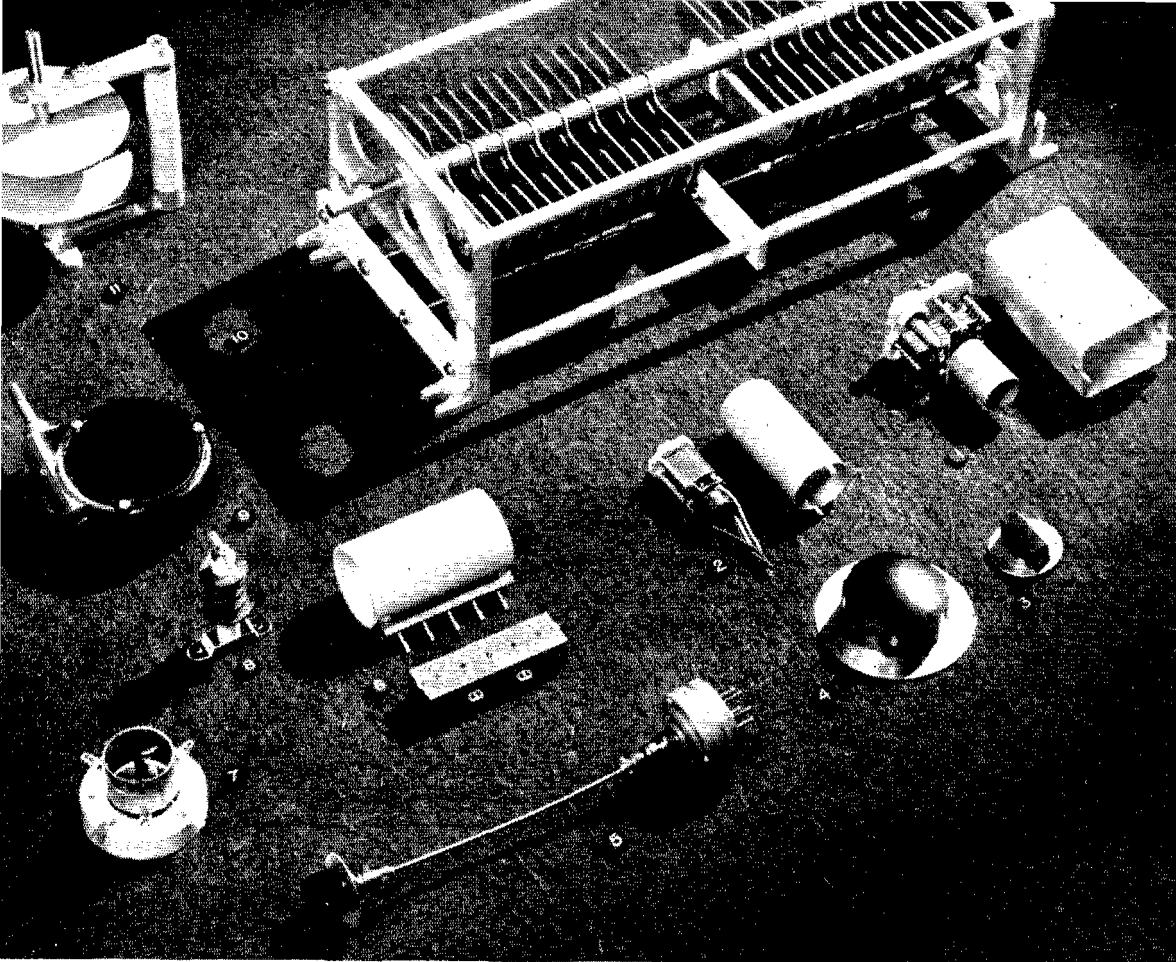

## NEW PARTS

**M**ANY new National products have been developed since our general catalog was published last Fall, and these are illustrated above. Most of these products have been described in detail in other advertisements, and further details may be obtained from our dealers. The products illustrated are tabulated below; other new devices will be released at an early date.

- |   |   |
|---|---|
| 1. Fixed Tuned Exciter Tank, Type FXT                                 | 7. "210" Socket, Type XM-10   |
| 2. Duo-diode I F Transformer, Type IFD                                | 8. Transmitting Choke, Type R-154U                                      |
| 3. Small Dial 10-0, Type HRK  | 9. Worm Drive Unit, Type PWL  |
| 4. Plain Dial, Type O, 0-100  | 10. Transmitting Condenser, Type TML                                    |
| 5. Variable-Air Gap, Adjustable Frequency<br>Crystal Holder, Type CHV | 11. Neutralizing Condenser, Type NC-150 (for:<br>852, 150T, 300T, etc.) |
| 6. Buffer Coil Form and Socket, Type XR-13                            |   |

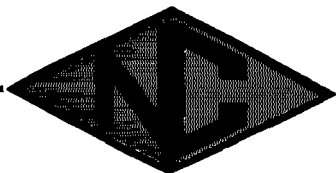

*These favorites give you*

# HIGH OUTPUT at LOW COST

WHEN considering tubes, remember the favorites you see here. They will be found giving reliable service wherever there is amateur radio. Each type

is conservatively rated, and all provide high output at low cost. To get more watts and more watt hours on the air per dollar, use RCA transmitting tubes.

RCA-866 is a half-wave mercury-vapor rectifier. Two tubes in a single-phase full-wave rectifier with choke-input filter will supply 0.5 ampere at better than 2000 d. c. volts. **\$2.25**

RCA-834 is a new type triode for ultra-high frequencies. Can be operated at full input up to 100 megacycles; at reduced input up to 350 megacycles. Maximum plate dissipation, 30 watts. **\$12.50**

RCA-203-A triode gives high output at relatively low plate voltages. As a plate-modulated Class C amplifier at 1000 volts will easily deliver a 100-watt carrier. Also good as oscillator and Class B modulator. **\$15**

RCA-800 triode may be used at full ratings up to 60 megacycles. Grid and plate leads at top. An x-f amplifier, oscillator, or Class B modulator. Maximum plate dissipation, 35 watts. **\$10**



RCA-838 is a high- $\mu$  triode. Maximum plate dissipation, 100 watts. For use as zero-bias Class B modulator, Class B r-f amplifier, or Class C r-f amplifier. **\$16**

RCA-841 high- $\mu$  triode, used as r-f amplifier, oscillator, frequency multiplier, or x-f voltage multiplier. Two will modulate 56 watts Class B. Maximum plate dissipation, 15 watts. **\$3.25**

RCA-801 is another triode for frequencies as high as 60 megacycles. It is useful as oscillator, r-f and x-f amplifier, and Class B modulator. Output in Class C telegraph service is better than 25 watts. **\$4.50**

RCA-802, an x-f power amplifier pentode with heater cathode. Used as crystal oscillator, frequency multiplier, and suppressor or grid-modulated amplifier. Output in Class C telegraph service, 16 watts. **\$3.90**

AMATEUR RADIO SECTION

# RCA MANUFACTURING CO., INC

CAMDEN, N. J. • A SERVICE OF RADIO CORPORATION OF AMERICA