

QST

August, 1935
25 cents

devoted entirely to

amateur radio

More
economical
Phone
operation

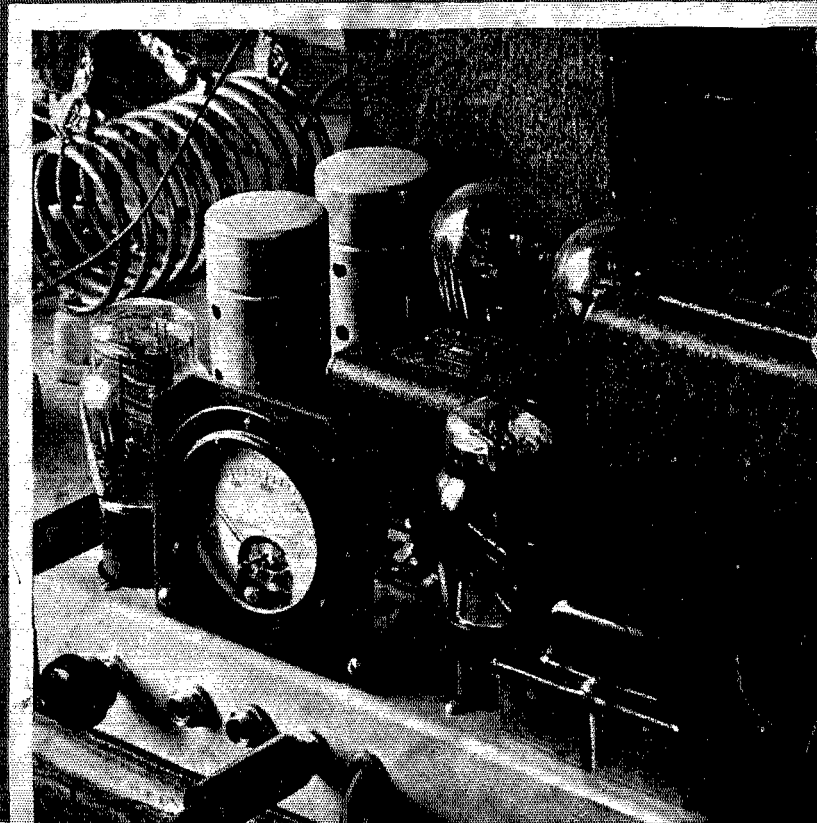

THIS

Transmitter Has a Story to Tell

DELIVERING STERLING PERFORMANCE

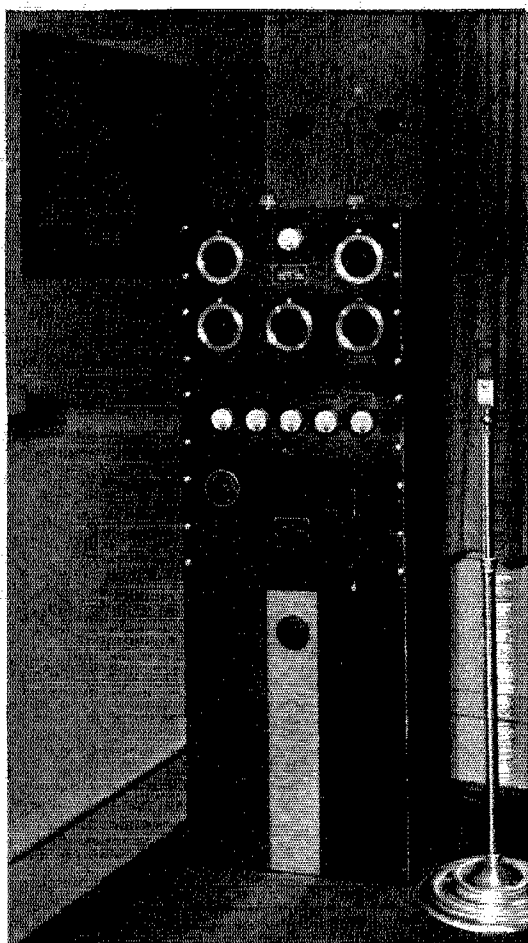

TO HUNDREDS OF AMATEURS THE WORLD OVER

30FXB



In the year and a half since the first **30FXB** was tested in the **Collins** laboratory **more** amateurs have purchased this transmitter than any other model or make. This fact is of considerable interest to amateur radio.

First, it definitely proves that an increasing class of amateurs have come to prefer factory built transmitters as well as receivers. Many members of this class are men of outstanding technical ability who have built equipment experimentally but who have sensed the modern trend toward apparatus designed and built in a **specialized** laboratory and plant.

★ The remarkable sales of the **30FXB** also prove that this transmitter with a power of 100 watts on both telephone and telegraph is just the right size for most amateurs. The power is sufficient to get real performance—the kind of performance amateurs dream about.

It is natural that the **30FXB** is a **Collins** product. There is a lot of experience and hard-headed engineering wrapped up in its sparkling black cabinet. When you buy **your** transmitter it will be worth your while to go to the leader

Collins Radio Company

CEDAR RAPIDS
New York Office



IOWA, U. S. A.
11 West 42nd St.

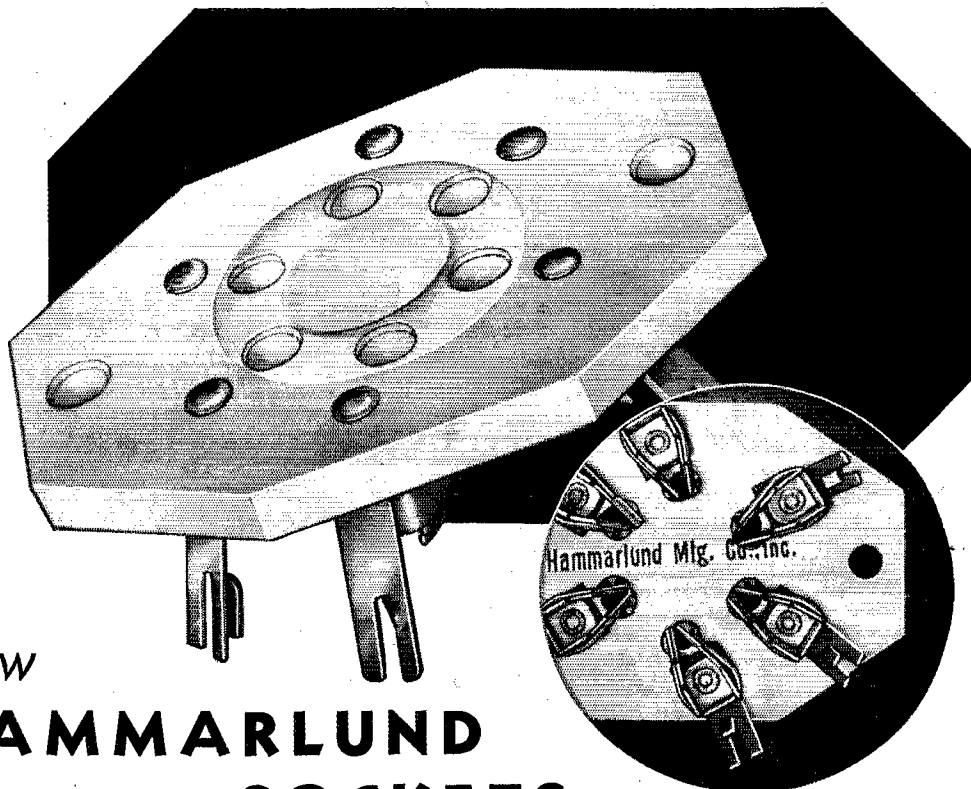

New
HAMMARLUND
 High-Frequency **SOCKETS**

HAMMARLUND originated the low loss, wafer-type Isolantite socket, and it has never been excelled for high-frequency work.

Although economically priced, the Hammarlund Socket has distinctive features which assure the noiseless peak efficiency so necessary in short and ultra short-wave reception.

Only Grade "B-100," the lowest loss and strongest of all Isolantite material is used. This is glazed on the top and sides, and "Ceresin" treated underneath to prevent moisture absorption.

Long leakage paths between new-type, positive side-gripping spring contacts. Due to a unique square-inset

anchorage, Hammarlund Socket contacts *cannot twist, loosen or shift position*, as ordinary sockets often do with changes in temperature and humidity. The new circular Guide-Groove makes insertion easier. For 4, 5, 6 or 7 prongs, 60c each list.

The new Hammarlund "ACORN" Socket for .5 to 5-meter work is a real low-loss achievement.

Extruded Isolantite base with alignment plug. Top, sides and plug, highly glazed. Silver-plated, double-grip spring clips, eyeletted and lipped to base to prevent shifting. 1 7/8" diameter. \$1.50 each list.



New "ACORN"
**ULTRA HIGH
 FREQUENCY
 SOCKET**

*Mail Coupon for Complete Catalog
 of Quality Radio Equipment*

Canadian Office:
 41 West Avenue North,
 Hamilton, Ontario



HAMMARLUND MANUFACTURING CO.
 424-438 W. 33rd St., New York

Check here for New General Catalog. Check here, and attach 70c, for New 32-page Short-Wave Manual.

Name

Address

.....Q-8

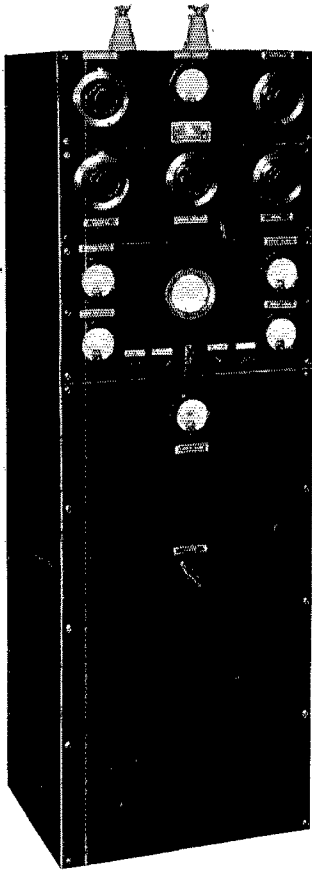

A New F.C.C. Ruling Says:

"Means shall be employed to insure that the transmitter is not modulated in excess of its modulation capability."

The **MARINE 140-B**

WITH BUILT-IN

CATHODE RAY OSCILLOSCOPE

and many other "Exclusive" MARINE Features

MEETS THE F.C.C. REQUIREMENTS

CLASS B UNIT

By means of the CATHODE RAY Oscilloscope an accurate check on the percentage of modulation is kept, thereby maintaining 100% modulation at all times.

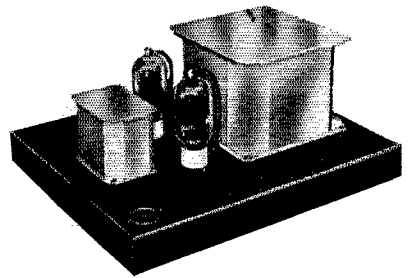

The Class B stage consists of the input and output transformers and the 830-B tubes. This unit has an exceptional frequency response. Note particularly the size of these transformers.

Technical Data



POWER OUTPUT — Conservative rating, 100 watts.

FREQUENCY RANGE — Standard — 15,000 Kc. to 1500 Kc.

CATHODE RAY OSCILLOSCOPE — At a glance, over or under modulation or distortion can be detected. Used as a percentage of modulation indicator, it is possible to maintain 100% modulation. Either trapezoidal or envelope figures can be had.

PERMANENT NEUTRALIZATION — The transmitter is permanently neutralized at the plant before leaving. Changing from one band to another or using different antennas will have absolutely no effect on the neutralization.

HIGH FIDELITY AUDIO CHANNEL — The speech amplifier has a frequency response of 30 to 10,000 cycles, + or - 1 1/2 D.B., with a gain of 125 D.B. which makes it ideally suited for use with a Crystal microphone.

GENERAL OFFICES AND PLANT
124-11 - - 101st Avenue
RICHMOND HILL, N. Y.
Telephone: Cleveland 3-2400

BIAS SUPPLIES — Absolutely no batteries of any kind required.

ANTENNA IMPEDANCE MATCHING NETWORK — Capable of efficiently matching and transferring energy from the final stage to the antenna.

AUTO TRANSFORMER — Tapped in 5 volt steps from 90 to 130 volts so that the transmitter can be used with full efficiency on any line voltage.

CABINET — The MARINE 140-B transmitter is housed in a steel broadcast station type cabinet rack with detachable hinged rear door and is finished in a baked wrinkled enamel. The Bakelite panel finish is optional. Gloss, satin or wrinkled may be had.

GUARANTEE

One year unconditional Guarantee

DESCRIPTIVE LITERATURE — Send stamp for descriptive folder with detailed information and photographs. You will be astounded at what we are offering at such an extremely moderate price.

SECOND POWER SUPPLY

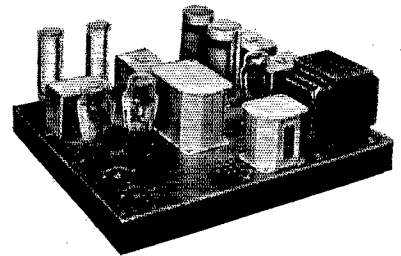

The second power supply consists of a power transformer, swinging choke, smoothing choke, and filter condensers which delivers 400 volts at 225 milliamperes. This chassis also contains the Bias Supply for the 203A and 830-B's with their associated rectifier tubes, chokes, and filter condensers, and in addition, the filament and sweep transformer for the Cathode Ray Oscilloscope.

The Main Power Supply and the High Fidelity Audio Channel were illustrated in July QST.

MARINE RADIO

C O M P A N Y

EXPORT DEPARTMENT
15 LAIGHT STREET
NEW YORK, N. Y.
Cable Address: "Arlab"

Say You Saw It in QST — It Identifies You and Helps QST

QST

Published monthly, as its official organ, by the American Radio Relay League, Inc., at West Hartford, Conn., U. S. A.; Official Organ of the International Amateur Radio Union

devoted entirely to

AMATEUR RADIO

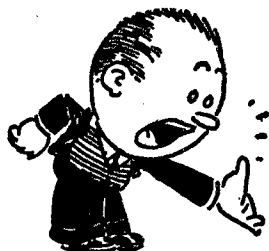

Editorials	7
West Gulf Division Convention	8
Central Division Convention	8
Greater Economy in Class-B Modulator Design for Speech <i>George Grammer</i>	9
An All-Purpose S.S. Superhet with Turret-Type Automatic Coil Changing <i>Charles Fisher, W3FX</i>	13
Five-Meter Signals Do the Impossible	17
Four Bands with Two Tubes <i>Frank Gow, W1AF</i>	18
Ten-Meter Activity Increasing	20
Iron-Core I.F. Transformers <i>Alfred Crossley</i>	22
Adjusting the 'Phone Transmitter for Best Modulation Performance <i>W. C. Lent</i>	24
What the League Is Doing	27
Louisiana State Convention	29
Northwestern Division Convention	29
Rocky Mountain Division Convention	29
The 803 — High-Power Pentode	30
Pacific Division Convention	31
Missouri State Convention	31
A.R.R.L. QSL Bureau	31
Simple Methods of Checking Modulation to Comply with the New Regulations <i>James J. Lamb</i>	32
Hamdom	35
The Application of Iron-Core I.F. Transformers to Amateur-Band Superhet Design <i>H. M. Detrick and Irley Morrison, W9KGM</i>	36
With the Affiliated Clubs	38
South Dakota State Convention	39
About Ham Message Handling	40
Calls Heard	42
Experimenters' Section	
ADJUSTABLE-LENGTH ANTENNA — ANTENNA FILTER VARIANT — KEYING SYSTEM — GUYING ANTENNA MASTS — IDENTIFYING THE FREQ-METER SIGNAL ON A SUPER — A SIMPLE REMOTE-CONTROL SYSTEM	44
I.A.R.U. News	47
Operating Notes	49
Correspondence Department	63
Standard Frequency Transmissions	86
WWV Schedules	90
Hamads	91
QST's Index of Advertisers	94

AUGUST
1935

VOLUME XIX
NUMBER 8

Kenneth B. Warner (Secretary, A.R.R.L.), Editor-in-Chief and Business Manager; Ross A. Hull, Associate Editor; James J. Lamb, Technical Editor; George Grammer, Assistant Technical Editor; Clark C. Rodimon, Managing Editor; David H. Houghton, Circulation Manager; F. Cheyney Beekley, Advertising Manager; Ursula M. Chamberlain, Assistant Advertising Manager.

Editorial and Advertising Offices
38 La Salle Road, West Hartford, Conn.

Subscription rate in United States and Possessions and Canada, \$2.50 per year, postpaid; all other countries, \$3.00 per year, postpaid. Single copies, 25 cents. Foreign remittances should be by international postal or express money order or bank draft negotiable in the U. S. and for an equivalent amount in U. S. funds.

Entered as second-class matter May 29, 1919, at the post office at Hartford, Connecticut, under the Act of March 3, 1879. Acceptance for mailing at special rate of postage provided for in section 1103, Act of October 3, 1917, authorized September 9, 1922. Additional entry at Concord, N. H., authorized February 21, 1929, under the Act of February 28, 1925.

Additional second-class entries to cover sectional editions authorized March 20, 1935

Copyright 1935 by the American Radio Relay League, Inc.
Title registered at United States Patent Office.

THE Amateur's BOOKSHELF

A balanced selection of good technical books, additional to the A.R.R.L. publications, should be on every amateur's bookshelf. We have arranged, for the convenience of our readers, to handle through the QST Book Department those works which we believe to be most useful. Make your selection from the following, add to it from time to time and acquire the habit of study for improvement. Prices quoted include postage. Please remit with order.

RADIO THEORY AND ENGINEERING

APPLIED ACOUSTICS, by H. F. Olson and F. Massa. Covers theoretical and experimental aspects of electro-acoustical systems, including microphones and speakers. Requires knowledge of elementary physics and electric circuit theory. 430 pp., 228 illustrations. \$4.50

THE PHYSICS OF ELECTRON TUBES, by L. R. Koller. Written especially for engineers and students, this book presents the fundamental physical phenomena involved in the design and operation of electron tubes, emphasizing what goes on within the tube itself. 205 pp., 71 illustrations. \$3.00

SHORT WAVE WIRELESS COMMUNICATION, by A. W. Ladner and C. R. Stoner. Not a "how-to-make-it" book, but a text satisfying the needs of practical engineers and advanced amateurs by its thorough treatment of principles and practices in short-wave transmission and reception. The chapters on modulation, aerials and feeders are especially good. 348 pp., 201 illustrations. \$3.50

COMMUNICATION ENGINEERING, by W. L. Everitt. A general text for both first year and advanced courses. 367 pp., 335 illustrations. \$5.00

RADIO ENGINEERING, by F. E. Terman. A comprehensive treatment covering all phases of radio communication. A good all around book for students and engineers. 688 pp., 418 illustrations. \$5.00

MANUAL OF RADIO TELEGRAPHY AND TELEPHONY, by Commander (now Admiral) S. S. Robinson, U.S.N.

Published by the Naval Institute. Covers both the theoretical and practical fields. 791 pp., 6 $\frac{1}{4}$ x 9 \$4.00

ELEMENTS OF RADIO COMMUNICATION, by Prof. J. H. Morecroft. This is the 2nd edition of this book by the author of the "Principles" listed elsewhere. It is about half the size of the larger work, and the subject is treated in more elementary fashion. Simple algebra is sufficient. An excellent book for the "first-year" student. 279 pp., 170 illustrations. \$3.00

PRINCIPLES OF RADIO COMMUNICATION, by Prof. J. H. Morecroft. An elaborate general textbook, and one of the recognized standards on theory for the engineering student. A working knowledge of mathematics is desirable for the reader who expects to get the greatest benefit from this work. 1001 pp., 5 $\frac{1}{4}$ x 9 \$7.50

PRINCIPLES OF RADIO, by Keith Henney. This book is chock-full of meat for the experimenter. The subjects treated range from the fundamentals of electricity to the modern concepts of modulation and detection. 477 pp., 306 illustrations. \$3.50

THEORY OF THERMIONIC VACUUM TUBES, by E. L. Chaffee. Based on Dr. Chaffee's research and study at Harvard University, this book offers much new material and many new presentations, especially in connection with regeneration. Recommended particularly for advanced study. 652 pp., 360 illustrations. \$6.00

RADIO EXPERIMENTS AND MEASUREMENTS

RADIO FREQUENCY ELECTRICAL MEASUREMENTS, by H. A. Brown. A thoroughly practical book for the experienced amateur, the experimenter or engineer who has knowledge of the elementary principles of radio communication and of alternating currents. \$4.00

HIGH-FREQUENCY MEASUREMENTS, by August Hund. A thorough, modern book, especially useful in advanced laboratory work. Includes a chapter on piezo-electric determinations. 491 pp., 373 illustrations. \$5.00

EXPERIMENTAL RADIO ENGINEERING, by Prof. J. H. Morecroft. An excellent laboratory text directed specifically to

emphasizing the principles involved in the operation of radio apparatus and intended as a companion to the same author's "Principles." Following an introductory chapter on instruments and accessories, 51 choice experiments are outlined. 345 pp., 250 illustrations. \$3.50

EXPERIMENTAL RADIO, by Prof. R. R. Ramsey. Revised Edition. A splendid book for the experimenter. This is a laboratory manual, describing 128 excellent experiments designed to bring out the principles of radio theory, instruments and measurements. 150 illustrations, 229 pp., 5 $\frac{1}{4}$ x 7 \$2.75

COMMERCIAL EQUIPMENT AND OPERATING

RADIO THEORY AND OPERATING, by Mary Texanna Loomis. Although giving a moderate amount of theory, it is essentially a practical handbook for commercial and broadcast operators, and as such ranks among the foremost publications of this sort. Used as a textbook by many radio schools. A good book for any amateur. 1000 pp., 800 illustrations. \$2.00

THE RADIO MANUAL, by George E. Sterling. Another excellent practical handbook, especially valuable to the commercial and broadcast operator, and covering the principles, methods and apparatus of all phases of radio activity. Over 900 pp. \$6.00

RADIO TELEGRAPHY AND TELEPHONY, by Duncan and Drew. Still another work along the lines of a general reference handbook. In size it is approximately the same as the two listed just previously, and the subject matter generally follows along the same lines. A good book in this class. 950 pp., 468 illustrations. \$7.50

RADIO TRAFFIC MANUAL AND OPERATING REGULATIONS, by Duncan and Drew. A book for students, amateurs or radio operators who contemplate entering the commercial field; it will enable you to learn quickly and easily all the government and commercial traffic rules and operating regulations. 181 pp. \$2.00

PRACTICAL RADIO TELEGRAPHY, by Nilson and Hornung. Written particularly for the student training for a commercial license, and covering theory and apparatus. A practical handbook. 380 pp., 223 illustrations. \$3.00

RADIO OPERATING QUESTIONS AND ANSWERS, by Nilson and Hornung. A companion volume to "Practical Radio Telegraphy" by the same authors. The latest Revised Edition is very complete, covering Commercial and Broadcasting, Amateur, Aeronautical and Police Radio, Beacons, Airways, Meteorology, and Teletype Operating. 389 pp., 5 $\frac{1}{4}$ x 8 \$2.50

MISCELLANEOUS

SPEECH AND HEARING, by Harvey Fletcher. The standard text on the subject. 331 pp., 154 illustrations. \$5.50

THE RADIO AMATEUR CALL BOOK. Lists all U. S. and foreign amateur radio stations, s.w. commercials and broadcasters. \$1.25 (Foreign \$1.35)

BELOW TEN METERS, by James Millen and R. S. Kruse. Ultra-high-frequency oscillators, radiating systems, receivers, theories, measurements, television reception, etc. Abundant photographs and diagrams. 64 pp. \$5.50

ELECTRICITY, WHAT IT IS AND HOW IT ACTS, by A. W. Kramer. Modern treatment with the electron as its basis. It deals only with accepted theories, presenting them simply and straightforwardly so that those not mathematically

mindcd can understand them. Two volumes, 592 pp., 242 illustrations. \$4.00

RADIO DATA CHARTS, by R. T. Beatty. A series of graphic charts for solving, without the use of mathematics, most of the problems involved in receiver design. 82 pp., 8 $\frac{1}{4}$ x 11. \$1.50

SERVICE RECEIVERS BY MEANS OF RESISTANCE MEASUREMENTS, by J. F. Rider. 203 pp., 94 illustrations. An excellent book for the service man and amateur constructor. \$1.00

WHO'S WHO IN AMATEUR RADIO. Gives photos, personal and station data on over 3000 amateurs. Also includes comprehensive list of radio clubs, s.w. commercials, etc. 172 pp., 140 photos \$5.50

American Radio Relay League, Inc., WEST HARTFORD, CONN.

Section Communications Managers of the A.R.R.L. Communications Department

All appointments in the League's field organization are made by the proper S.C.M., elected by members in each Section listed. Mail your S.C.M. (on the 10th of each month) a postal covering your radio activities for the previous 30 days. Tell him your DX, plans for experimenting, results in 'phone and traffic. He is interested, whether you are an A.R.R.L. member or get your QST at the newsstands; he wants a report from every active ham. If interested and qualified for O.R.S., O.P.S. or other appointments he can tell you about them, too.

Eastern Pennsylvania Maryland-Delaware-District of Columbia Southern New Jersey Western New York Western Pennsylvania	W3GS W3BAK W3ZYX W8DSP W8CUG	ATLANTIC DIVISION Jack Wagenseller Edgar L. Hudson Carroll D. Kentner Don Farrell C. H. Grossarth	26 Meadowbrook Ave. 1107 Park Ave. 213 Hickock Ave. R. F. D. 3, Eicher Rd.	Llanerch, Upper Darby Laurel, Delaware Collingswood Syracuse Emsworth, Bellevue, Pa.
Illinois Indiana Kentucky Michigan Ohio Wisconsin	W9WR W9TE W9AUH W8DYH W8CIO W9FSS	CENTRAL DIVISION Fred J. Hinds Arthur L. Braun G. W. Mossbarger Kenneth F. Conroy Robert P. Irvine Harold H. Kurth	6618 West 34th St. 5211 Brookville Rd. Box 177 7538 E. Robinwood Ave. 5508 Northcliffe Ave. 631 State St.	Berwyn Indianapolis Camp Taylor Detroit Cleveland Madison
North Dakota South Dakota Northern Minnesota* Southern Minnesota	W9OEL W9PFI W9JIE W9DEI	DAKOTA DIVISION Hartwell B. Burner Mike G. Strahan R. C. Harshberger Francis C. Kramer	601 S. Grange Ave. 1200 Fauquier St. W. Bluff St.	Hope Sioux Falls St. Paul, Minnesota St. Charles
Arkansas Louisiana Mississippi Tennessee	W5ABI W5DWW W5CWO W4BBT	DELTA DIVISION H. E. Velte W. J. Wilkinson, Jr. J. H. Weems, Jr. Merrill B. Parker, Jr.	2918 West 15th St. 1624 Allen Ave. P. O. Box 244 1912 Oak St.	Little Rock Shreveport State College Chattanooga
Eastern New York N. Y. C. & Long Island Northern New Jersey	W2LU W2AZV W2FOP	HUDSON DIVISION Robert E. Haight E. L. Baunach Charles J. Hammersen	1080 Helderberg Ave. 7823 10th Ave. 92 Claremont Ave.	Schenectady Brooklyn Verona
Iowa Kansas Missouri Nebraska	W0LEZ W9FLG W9EYG-JPT W9FAM	MIDWEST DIVISION Phil D. Boardman O. J. Spector C. R. Cannady Samuel C. Wallace	325 Kirkwood Blvd. 305 Western Ave. Broadway at Ninth Green St.	Davenport Topeka Monett Clarke
Connecticut Maine Eastern Massachusetts Western Massachusetts New Hampshire Rhode Island Vermont	W1CTI W1CDX W1AST W1BVR W1AVJ W1HRC W1ATF	NEW ENGLAND DIVISION Frederick Ellis, Jr. John W. Singleton Joseph A. Mullen Percy C. Noble Robert Byron Clayton C. Gordon Harry Page	19 Merrill Rd. 73 Allen St. 218 Jamaica way 37 Broad St. 12 Humphrey St. 206 California Ave. R. 1	Norwalk Alto Jamaica Plain Westfield Concord Providence Hinesburg
Alaska Idaho Montana Oregon Washington	K7PQ W7NH W7AAT W7AMP W7AYO	NORTHWESTERN DIVISION Richard J. Fox Nellie H. Hart O. W. Viers Frank L. Black Stanley J. Belliveau	Box 301 Box 6 Box 265 1502 McPherson St. Route 7, Box 387	Ketchikan Twin Falls Red Lodge North Bend Yakima
Hawaii Nevada Los Angeles Santa Clara Valley East Bay San Francisco Sacramento Valley Arizona Philippines San Diego San Joaquin Valley*	K6EWQ W6BIC W6BPU W6BMW W6JTV W6SG W6DVE W6BVF-W6QC KAIXA W6EOP W6CRF	PACIFIC DIVISION Atlas O. Adams Edward W. Helm Howell C. Brown Charles J. Camp Harold J. Burchfield Alan D. Whitaker, Jr. Geo. L. Woodington Ernest Mendoza Newton E. Thompson Harry A. Ambler Vernon C. Edgar	21st Infantry Brigade 716 West Sixth St. 120 N. El Molino Ave. 318 Hawthorne Ave. 2940 106th Ave. 78 Elinor Ave. 716 Redwood Ave. 1434 East Madison St. P. O. Box 849 4101 Hamilton St. Henrietta Substation, Box 195	Schofield Barracks Reno Pasadena Palo Alto Oakland Mill Valley North Sacramento Phoenix Manila, P. I. San Diego Lemoore
North Carolina Virginia West Virginia	W4OG W3BRY W8KKG	ROANOKE DIVISION H. S. Carter Neil E. Henry Dr. Wm. H. Rithehdaffer	115 Crafton St. 1017 Knight St.	Winston-Salem Lynchburg Lost Creek
Colorado Utah-Wyoming	W9FA W6GQC	ROCKY MOUNTAIN DIVISION Glen Glasscock Arty W. Clark	1171 Detroit St. 260 So. 9th West	Denver Salt Lake City, Utah
Alabama Eastern Florida Western Florida Georgia-So. Carolina-Cuba- Isle-of-Pines-Porto Rico- Virgin Islands	W4KP W4BCZ W4MS W4CE	SOUTHEASTERN DIVISION L. D. Elwell Philip A. McMasters Edward J. Collins Bannie L. Stewart	1066 Waverly St. 731 Arlington Ave. 1517 East Brainard St. SC-P53, C.C.C. Camp Lawrence	Tarrant St. Petersburg Pensacola Effingham, S. C.
Northern Texas Oklahoma Southern Texas New Mexico	W5BII W5CEZ W5ADZ W5CGJ	WEST GULF DIVISION Richard M. Cobb Carter L. Simpson Bradfield A. Beard Joseph M. Eldord	Box 185 2010 So. 4th St. 2030 Quenby Road	Dodd City Ponca City Houston Chamita
Maritime	VE1DQ	MARITIME DIVISION A. M. Crowell	69 Dublin St.	Halifax, N. S.
Ontario	VE3GT	ONTARIO DIVISION S. B. Trainer, Jr.	4 Shorncliffe Ave.	Toronto
Quebec	VE2EE	QUEBEC DIVISION Stan Comach	780 Brault Ave.	Verdun, P. Q.
Alberta British Columbia	VE4GD VE5AC	VANALTA DIVISION J. Smalley, Jr. R. K. Town	611 1st Ave., N. W. 1754 Graveley St.	Calgary Vancouver
Manitoba Saskatchewan	VE4BG VE4EL	PRAIRIE DIVISION A. J. R. Simpson Wilfred Skafie	71 Thelmo Mansions 2040 McTavish St.	Winnipeg Regina

* Officials appointed to act until the membership of the Section choose permanent S.C.M.'s by nomination and election.

The American Radio Relay League



• **T**HE AMERICAN RADIO RELAY LEAGUE, INC., is a non-commercial association of radio amateurs, bonded for the promotion of interest in amateur radio communication and experimentation, for the relaying of messages by radio, for the advancement of the radio art and of the public welfare, for the representation of the radio amateur in legislative matters, and for the maintenance of fraternalism and a high standard of conduct.

It is an incorporated association without capital stock, chartered under the laws of Connecticut. Its affairs are governed by a Board of Directors, elected every two years by the general membership. The officers are elected or appointed by the Directors. The League is non-commercial and no one commercially engaged in the manufacture, sale or rental of radio apparatus is eligible to membership on its board.

"Of, by and for the amateur," it numbers within its ranks practically every worth-while amateur in the nation and has a history of glorious achievement as the standard-bearer in amateur affairs.

Inquiries regarding membership are solicited. A bona fide interest in amateur radio is the only essential qualification; ownership of a transmitting station and knowledge of the code are not prerequisite. Correspondence should be addressed to the Secretary.

DIRECTORS

- President*
HIRAM PERCY MAXIM W1AW
Box 216, Hartford, Conn.
- Vice-President*
CHARLES H. STEWART W3ZS
St. David's, Pa.
- Canadian General Manager*
ALEX REID VE2BE
169 Logan Ave., St. Lambert, P. Q.
- Atlantic Division*
EUGENE C. WOODRUFF W8CMP
234 W. Fairmount Ave., State College, Pa.
- Central Division*
EDWARD A. ROBERTS W8HC
2699 Endicott Rd., Shaker Heights, Cleveland
- Dakota Division*
CARL L. JABS W9BVH
1822 James St., St. Paul, Minn.
- Delta Division*
M. M. HILL W5EB
P. O. Box 14, Natchitoches, La.
- Hudson Division*
KENNETH T. HILL W2AHC
115 Willow St., Douglaston, L. I., N. Y.
- Midwest Division*
H. W. KERR W9DZW-W9GP
Little Sioux, Iowa
- New England Division*
G. W. BAILEY W1KH
74 Webster Road, Weston, Mass.
- Northwestern Division*
RALPH J. GIBBONS W7KV
3933 N. E. 76th Ave., Portland, Ore.
- Pacific Division*
S. G. CULVER W6AN
2962 Russel St., Berkeley, Calif.
- Roanoke Division*
H. L. CAVENESS W4DW
State College Station, Raleigh, N. C.
- Rocky Mountain Division*
RUSSELL J. ANDREWS W9AAB
1867 So. Lafayette St., Denver, Colo.
- Southeastern Division*
BENNETT R. ADAMS, JR. W4APU
1512 Grove Place, Homewood, Ala.
- West Gulf Division*
WAYLAND M. GROVES W5NW
c/o Humble Pipe Line Co., Neches, Texas

OFFICERS

- President* HIRAM PERCY MAXIM, W1AW
Hartford, Connecticut
- Vice-President* CHARLES H. STEWART, W3ZS
St. David's, Pennsylvania
- Secretary* KENNETH B. WARNER, W1EH
West Hartford, Connecticut
- Treasurer* ARTHUR A. HEBERT, W1ES
West Hartford, Connecticut
- Communications Mgr.* ... F. EDWARD HANDY, W1BDI
West Hartford, Connecticut
- General Counsel* PAUL M. SEGAL, W3EEA
1010 Shoreham Building, Washington, D. C.

Address all general correspondence to the executive headquarters at West Hartford, Connecticut



THE EDITOR'S MILL

THE changes in amateur regulations concerning the 10-meter band, which were inaugurated by the Federal Communications Commission on June 18th at the request of the A.R.R.L. Board of Directors, give a significant indication of the constant progress of amateur radio and at the same time open up some alluring new operating possibilities. Elsewhere in this issue the textual changes are reported. The regulations for this band now share some of the characteristics of the regulations for the lower frequencies and some of those for the higher frequencies. This is by no means an inconsistency since, as we all know, the performance of the band itself partakes of that of the bands on either side of it.

The first step in the better use of the possibilities of this band was to recognize that it is no longer a region where experimental work goes unrewarded but is actually useful for communication and presently occupied, deserving of the same treatment as our other bands. To this end there has now been applied to it the same regulation that applies to all the lower frequencies, requiring the use of adequately-filtered direct-current power supply. So much has occupancy of this band grown that it no longer can be regarded as reasonable to use raw a.c. supply there; for reception we use in general the same apparatus that we do for the 14-mc. band, and therefore only pure c.w. telegraphy (A-1) and 'phone (A-3) are in order.

With the band thus "cleaned up" it was regarded possible to extend to it the portable-mobile authorization which we already possess for the higher frequencies. An immensely attractive feature of this new authorization is the possibility of working real DX with portable-mobile apparatus. Admittedly this band is irregular in its performance and frequently is good only for local communication, but every reader of *QST* knows that in recent months excellent long-distance work, with Australia, New Zealand, etc., has been performed by many amateurs. In the past our mobile privilege has been confined to five meters and below, but now any amateur may put a ten-meter rig in his car and have a good prospect of working the Antipodes while driving along, wherever he may be. That, of course, is its interesting angle—the possibility of real DX from a mobile installation. Sport for this summer, OM's:

An important part of the story is the expansion of the 'phone allocation to embrace the entire low-frequency half of the band—28,000 to 29,000 kc. This allocation is by no means to be sneezed at—it is valuable. Right now as we write, and for some weeks back, this band has been performing in the fashion that we have long regarded as customary for 14 mc., transcontinental and foreign DX being possible with low power. We know now that our experience with high frequencies has gone through only half of a complete solar cycle; if improvement continues as it has recently, the 'phone allocation in this band will become precisely the place to carry on the DX 'phone communication for which the twenty-meter band has been famous, so famous as to result in its congestion.

When all these items are viewed together it may be seen that the June changes expand our opportunities for interesting accomplishments and open new fields to conquer.

BUT actually the most important change in our regulations is the new language for Rule 381, which we believe every amateur should study carefully. The old language of this rule contained the general requirement that our signals must be as stable and free from harmonics as permitted by the art but then went on to employ some language about ten years old specifically prohibiting certain apparatus arrangements, in a fashion which violates the general intention of amateur regulation to-day—which is to judge a signal purely by its effects, not by the means of generating it. The art has progressed much since that early day. We amateurs are no longer content with a situation which tolerates a "selfish" signal provided only that it does not interfere with other services. As we sit in our stations we ourselves want to experience as little interference from *other amateur signals* as possible. The new regulation takes account of modern thought, and it applies to all classes of station, c.w. and 'phone alike. It defines the various types of excess radiations and says that hereafter all signals on the 30-mc. band and below must be of such quality that they do not cause interference on modern receiving sets outside the frequencies that that particular signal ought to occupy. In other words, the day is gone when a careless amateur may have any chance to believe that he is entitled to

interrupt the communications of thousands of others provided only he does not interfere with broadcast listeners or some other service; he must now have a clean signal, free of spurious radiations, confining itself to the "band of emission" normal for his kind of transmitter. There is no longer any apparatus specification on how he attains that effect. We consider that definite progress is represented by this recognition of the right not to be interfered with by "selfish signals."

The most serious and distracting form of interference to 'phone operation, as every 'phone amateur well knows, is the overmodulation evil. It is so unnecessary, too. Every amateur must be aware that it is detracting more from the enjoyment of 'phone operation than any other factor, much more than sheer congestion of occupancy. For many months some specific prohibition of it has been wanted. Now we have it, in the regulation which damns spurious modulation products in the same rule that asserts that no signal may occupy space beyond that normal for its type of emission. The text also recognizes the modern concept of "modulation capability," as discussed by Technical Editor Lamb on page 21 of our June issue, wherein it is pointed out that these spurious modulation products may arise long before 100% modulation is attained, for example being created by some limitation in the speech amplifier. The regulation states that no 'phone transmitter shall so exceed its modulation capability that these interfering radiations occur, and in no case shall use more than 100% modulation.

To attain this end it is necessary that some means be provided and *be employed* to determine when the transmitter is being modulated in excess of its capability. Any 'phone man will have to admit that he has worked many fellows who say

frankly that they don't know, even qualitatively, how much modulation they are employing. The new regulation does not mean that every 'phone amateur must forthwith hie himself out and purchase an oscilloscope at a fancy price. That, of course, would be a most useful gimmick and many of the better 'phone stations have long employed them. But the regulation requires only that some scheme must be installed and used to know when the modulation has become excessive and is therefore creating an unnecessary broadness of signal. There are many simple means of ascertaining this condition, largely by the use of meters, as has been detailed in innumerable *QST* articles and in the *Handbook*. *QST* is presenting a detailed article dealing with this subject which will show that it is easy to comply with the regulation. By far the overwhelming majority of interference in the 'phone bands is caused not by numbers but by careless and sometimes deliberate overmodulation. When overmodulation is eliminated the signals will contract to the band of frequencies indicated by theory and which their owners probably believe they occupy, the effective width of the 'phone allocations will be at least tripled, and everybody will work much farther and much more satisfactorily. It is not an unreasonable regulation to require that a piece of apparatus easily capable of ruining the enjoyment of many fellows be equipped with simple means to comply with a requirement which itself is obviously necessary. In this new regulation the 'phone stations have an opportunity to put their house in order and immensely increase the effectiveness of their work and the pleasure which they derive from it. Hurray, then, for the death of overmodulation! Let us bury it quickly!

K. B. W.

West Gulf Division Convention

Corpus Christi, Texas, August 16th and 17th

FOR the first time since conventions have been held in the West Gulf Division this year's convention will be held in the summer, and will be under the joint auspices of the Corpus Christi and 'Tip o' Texas Radio Clubs. The Hotel Nueces, Corpus Christi, has been made the headquarters for the convention, and the dates August 16th and 17th.

A program far exceeding any other convention has been worked out in detail, especially entertainment. Committees have labored consistently with that one thing in mind—"a whale of a good time throughout the entire two days." A big dance complete with floor shows galore, boat ride in the Gulf for the ladies, and prizes for everybody.

Registration \$3.50 for the hams and \$1.50 for the ladies.

A RME-9D Receiver will be given as a pre-registration prize,—so send in your registration in advance to C. W. Glasson, Convention Secretary, P.O. Box 1574, Corpus Christi, Tex.

Central Division Convention

August 30th and 31st, Hotel Statler, Cleveland, Ohio

THE Amateur Radio Society of Northern Ohio extends a cordial invitation to all amateurs to attend the official divisional convention to be held at the Hotel Statler, Cleveland, Ohio, August 30th and 31st.

A program replete with interesting features has been prepared, and of interest will be the National Air Races during the convention.

Write to Irving J. Cassidy, 1728 Rosedale Ave., East Cleveland, Ohio.

Greater Economy in Class-B Modulator Design for Speech

A Speech-Amplifier-Modulator Unit for the General Purpose Transmitter

By George Grammer*

IN PLANNING Class-B modulation systems to work with plate-modulated Class-C amplifiers, we have become accustomed to thinking in terms of the type of audio wave-form which most readily lends itself to calculation—the simple sine wave of a single pure tone. Analysis of amplitude modulation on this basis leads to the familiar conclusion that the audio power required to modulate completely the output of a Class-C amplifier must equal half the plate input to the modulated amplifier. In determining the capabilities of tubes as Class-B audio amplifiers, too, the sine wave customarily is used for calculation of power output and plate dissipation.

As a basis for the design of a modulation system for a broadcast transmitter, the sine-wave method leads to results approximating the actual conditions encountered in music transmission. Amateur transmitters, which have in general been laid out along the same lines, are however intended for the transmission of speech only. The wave-form of speech bears little resemblance to the sine form, and practical measurements have shown that speech wave-forms having the same *peak* amplitude as a sine wave will contain considerably less energy than the latter. It has been demonstrated that from a power standpoint speech can be considered to be equivalent to two pure tones of equal amplitude and random frequency, each having a peak amplitude half that of a single sine wave with which the speech is to be compared, i.e., a sine wave having a peak amplitude equal to that of the speech wave-form.¹ Consideration of the two tones against the single tone under the conditions specified shows that the average power in the circuit with the two tones is only half that with the single tone. Although all speech obviously cannot be exactly equivalent to the two tones, nevertheless the assumption is sufficiently justified in practice to enable us to say that *for voice modulation the average audio power required is only half that needed for single tone modulation.*

Two inferences of some importance can be drawn from this statement. The first is that our present Class-B modulators have approximately twice as much power capability as is needed. Much of the overmodulation now prevalent in the 'phone bands results from the attempt on

the part of the operator to make the Class-B modulator plate current rise to the rated value with speech. When this is done, extensive overmodulation invariably results—the audio power being supplied is about twice what it should be. Checks against the oscilloscope on a considerable number of transmitters have shown that complete modulation takes place when the plate meter reads only about half the rated value based on sine-wave input.

The second inference, the one with which this article is concerned, is that since less power is needed than has been thought in the past, it ought to be possible to use smaller Class-B

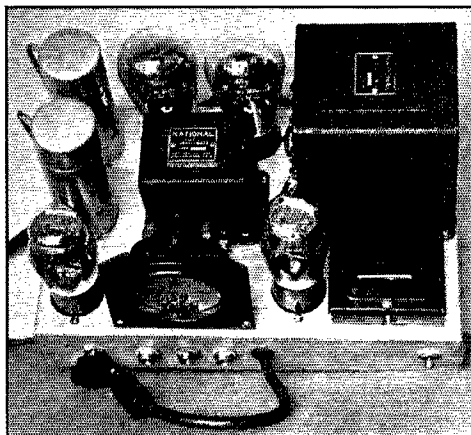

THE UNIT CONTAINS A CRYSTAL-MICROPHONE SPEECH AMPLIFIER, DRIVER AND CLASS-B MODULATOR, AS WELL AS A POWER SUPPLY FOR THE LOW-POWER STAGES

While the 46's in the Class-B stage normally would be considered to have an audio output in the vicinity of 20 watts, for speech work they can readily be made to modulate a Class-C input of 80 watts, as explained in the text.

modulators for a given job. On a power basis alone there would seem to be no room for argument on this premise; however, modulation of a transmitter is not the same thing as lighting a lamp. In addition to power, there is also distortion to be considered. When investigating the capabilities of Class-B modulator tubes it is necessary to take into account faithfulness of reproduction as well as such factors as filament emission

* Assistant Technical Editor.

¹ Technical Topics, QST June, 1935.

and allowable plate dissipation, on which power output figures are based. The requirement of faithful reproduction profoundly influences the design of the modulator on the half-power basis.

Modulation is essentially a process involving variation of *amplitudes*. Regardless of the average power contained in the sidebands, for complete

put; it merely so happens that the *average* power with speech is only about half the *average* power in a sine-wave. Taking an actual case to illustrate the point, assume that a Class-C plate input of 100 watts is to be modulated. With pure-tone modulation the audio power required is 100/2, or 50 watts. This is the average power in a

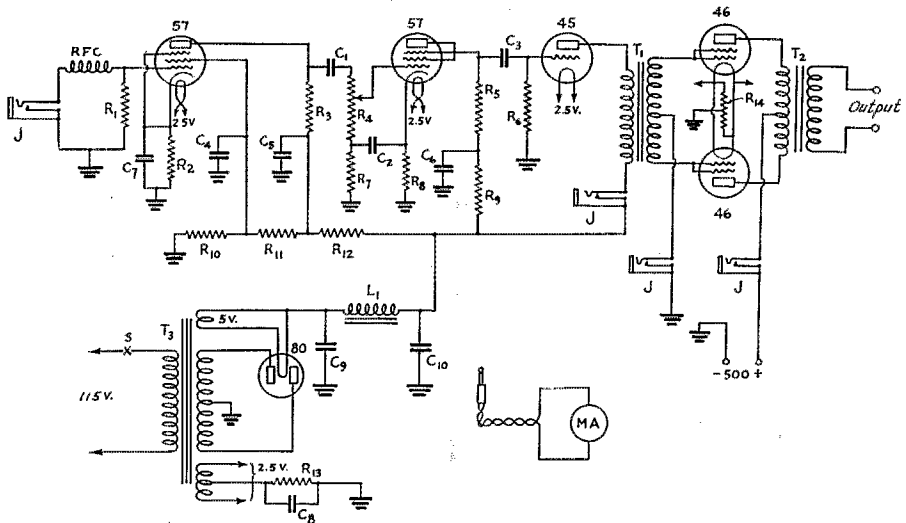

FIG. 1—CIRCUIT DIAGRAM OF THE SPEECH AMPLIFIER AND CLASS-B MODULATOR

The power supply furnishes plate and filament power for the first three tubes only; the Class-B stage must be supplied from a separate source. If a power transformer having an additional 2.5-volt winding is used, filaments of the 46's may be heated from the second winding.

- R₁—5 megohms, ½ watt.
- R₂—3500 ohms, ½ watt.
- R₃—250,000 ohms, ½ watt.
- R₄—500,000-ohm volume control.
- R₅—50,000 ohms, 1 watt.
- R₆—0.5 megohm, ½ watt.
- R₇—0.1 megohm, ½ watt.
- R₈—22250 ohms, 1 watt.
- R₉—10,000 ohms, 1 watt.
- R₁₀—50,000 ohms, ½ watt.
- R₁₁—250,000 ohms, ½ watt.
- R₁₂—50,000 ohms, ½ watt.
- R₁₃—1500 ohms, 2 watt.
- R₁₄—20-ohm center-tap resistor
- C₁—0.1 μfd., 400-volt.

- C₂—0.1 μfd.
- C₃—0.1 μfd., 400-volt.
- C₄, C₅, C₆—2-μfd. electrolytic, 400-volt.
- C₇, C₈—10-μfd. electrolytic, 25-volt.
- C₉, C₁₀—8-μfd., electrolytic, 400-volt.
- T₁, T₂—Class-B input and output transformers; (National Type BI and BO respectively). The input transformer should have a turns ratio, total primary to one-half secondary, of 2:1. Output transformer

- turns ratio should be between 1.05:1 and 1.3:1, total primary to total secondary.
- T₃—Midget power transformer, 275 volts each side center-tap with 5-volt and 2.5-volt windings. (Thordarson type T-5002.)
- L—22-henry, 35-ma. filter choke (Thordarson type T-1892).
- J—Single closed-circuit jacks.
- MA—0-200 d.c. milliammeter.
- RFC—Short-wave choke (National type 100).

modulation it is necessary that the carrier amplitude be doubled on the modulation up-peak and reduced to zero on the down-peak. On the up-peak, therefore, the instantaneous peak power is still four times the carrier power, although the wave-form may be such that the *average* power is only half that with pure-tone modulation. In other words, then, the modulator must still be capable of delivering the same *peak* power regardless of wave-form.

To satisfy this requirement and at the same time work within permissible distortion limits, the modulator must be *capable* of supplying pure-tone audio power to the extent of half the carrier input power. Even though this power capability is never used with speech input, the amplitude requirements are such that the modulator must work over the same range as with sine-wave in-

modulating wave of sine shape which on its up-peak will increase the carrier power to four times normal. With voice modulation the same peak must be reached without distortion, requiring an amplitude capability equal to that of a 50-watt sine-wave modulator. But during the cycle in which the peak is reached, the *average* audio output of the modulator will only be in the neighborhood of 25 watts. It should be evident that a modulator having a sine-wave output of 25 watts will not give the same peak power as the 50-watt modulator, and therefore cannot be used to modulate a Class-C amplifier input of 100 watts. Considerable distortion would result from an attempt to do so, since the modulator grids would have to be driven over a greater range than that for which the modulator is designed.

The question then becomes one of determining

what, if anything, can be saved in modulator design, knowing that although the average power required is but half that with single-tone input, the peak requirements are exactly the same. The opportunity for economy in design lies in the fact that somewhat less tube capacity is required with voice modulation than with tone, since in the Class-B modulator the input varies with the output, and, assuming a given safe plate dissipation, there is at least a possibility that a pair of tubes can be made to modulate twice the Class-C input previously considered possible. This follows from the experimentally determined fact that the average power input with voice modulation is only about half the input with tone modulation, for the same degree of modulation on a given carrier. Since the two-tone equivalent of speech represents half the power of the equal-amplitude single tone, the evidence justifies the assumption that the efficiency in both cases is approximately the same; that is, the plate dissipation would be no greater with 25 watts of speech output than with 25 watts of single-tone output. Hence a pair of tubes capable of 25 watts of single-tone output can be used to modulate with speech 100 watts of Class-C amplifier input, provided the operating conditions can be arranged so that the necessary peak amplitude can be obtained without distortion. Briefly, this condition can be satisfied only when the operating conditions are such that, disregarding plate dissipation, the pair of tubes *could* supply 50 watts of undistorted single-tone modulation if it were necessary to do so.

It can readily be appreciated that such a saving applies only to Class-B modulators, where the plate input, and hence dissipation, is a function of the modulating signal. In Class-A systems nothing can be done, since the power ratings have to be based on the no-signal condition, during which the plate must dissipate the entire d.c. input. It is also doubtful whether much could be gained in Class-AB amplifiers unless worked well toward the Class-B end.

MODULATOR DESIGN

Because of the variable and complex nature of speech wave form, none of this discussion is readily demonstrable by mathematical analysis. An infinite number of results can be obtained, depending upon the particular wave form chosen as a starting point. It is necessary, therefore, to depend upon experimental results for confirmation of the assumptions made. It was for this purpose that the modulator unit shown in the

photographs was built. As mentioned previously, checks on a number of transmitters had demonstrated that the average plate input to the Class-B stage with speech was only about half that with tone modulation; it remained to find whether the thing could be worked backwards; to use, for

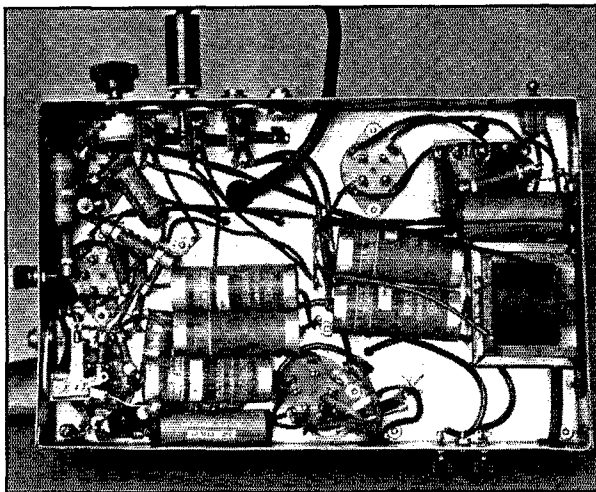

UNDER THE MODULATOR UNIT CHASSIS

The binding post on the left wall of the chassis is the ground post; below it is the microphone jack. The binding posts at the bottom right are the output terminals from the secondary of the modulation transformer. The filter choke is on the right wall. The top (front) wall contains the gain control, jacks for reading driver plate current, Class-B amplifier grid and plate currents, and the on-off switch for the power supply.

example, a pair of tubes normally rated at 25 watts audio output to modulate a Class-C input of 100 watts.

The actual figures used were not these, but were very close to them. The modulator was built to be used with the general purpose transmitter described in January *QST*,² using a pair of 801 tubes at normal input—600 volts at 140 ma. for the pair, or 84 watts. Ordinarily this would have called for a modulator having an output of 42 watts. On the speech basis, however, a pair of tubes which could handle something over 20 watts might do the work. Since a pair of Type 46 tubes carries better than a 20-watt rating at normal voltages, it was decided to base the design on these tubes.

The first step in the process was to find, from the published characteristics, whether a set of operating conditions could be worked out to give a pure tone output of 42 watts without exceeding permissible distortion limits, permissible peak current ratings, and without exceeding twice the safe plate dissipation of the pair of tubes. The first two are definite limits, while the third assumes that with speech the plate input and

²"A General Purpose 50-Watt Transmitter," *QST* January, 1935

plate dissipation will be but half the maximum sine-wave value, so that in practical operation the safe plate rating is not overstepped. A little study of the tube characteristics showed that the conditions could not be met at normal plate voltage—400 volts—but that when the plate voltage was raised to 500 the necessary power could be obtained without particular difficulty. Without going into details, we shall simply state that at 500 volts the theoretical power required (42 watts) could be obtained by using per-tube load resistances varying between about 1200 and 1900 ohms, the latter giving best plate efficiency and the former slightly less distortion and requiring somewhat less driving power. The peak current ratings were not exceeded between these load limits. Calculation showed that with voice input the average plate current at 100% modulation should be in the vicinity of 70 to 80 ma., depending on the load resistance chosen. The driving power required was within the capabilities of a single Type 45 tube. It is evident that the only way in which the tube ratings were exceeded was in the plate voltage increase from 400 to 500 volts, which, having the manufacturers' usual conservatism in mind, we did not consider very serious.

A modulator and speech-amplifier unit designed for working from a crystal microphone was accordingly laid out. Suffice to say that its performance has borne out the assumptions on which its design is based. Using a Class-B output coupling transformer of suitable impedance ratio (total-primary to total-secondary between 1.1:1 and 1.65:1 is satisfactory), the oscilloscope showed that the carrier was completely modulated when, with typical voices, the Class-B plate meter kicked in the region of 80 ma. Steady-state measurements are difficult to make when voice input is used, but the results have been consistent enough to permit us to say that with this particular set-up a maximum Class-B plate current of that order represents 100% modulation.

It should be pointed out that the conclusions apply only to the particular tubes considered. Whether the same result could be achieved with other modulator tubes depends upon the characteristics and ratings of those tubes. Each type would have to be analyzed individually. In general, however, doubling up on the carrier input for a given modulator will require an increase in the modulator plate voltage, an increase in driving power, and perhaps also a change in the output transformer ratio. The same general method of investigation should be used.

MODULATOR UNIT CONSTRUCTION

The complete modulation system of course consists of a microphone and speech amplifier in addition to the Class-B modulator and its associated driver. The amount of speech amplification required will be determined by the grid require-

ments of the driver stage and the output of the microphone. In this case the driver stage requires a peak grid swing of 50 volts; the speech amplifier has been designed to produce this voltage from the output of the diaphragm-type crystal microphones now so widely used in amateur transmitters. While the output of these microphones varies somewhat from make to make it can be taken as being in the vicinity of 0.05 to 0.1 volt across several megohms at the grid of the first tube with normal voice intensity and "close talking". Under these conditions a speech amplifier voltage gain of approximately 1000 (60 db) is required. The speech amplifier in the unit pictured here, a diagram of which appears in Fig. 1, uses a 57 pentode first stage having a rated gain of 100, and a 57 triode-connected second stage having a gain of about 14, giving a total gain of approximately 1400.

It should be pointed out here that the selection of the speech amplifier tubes and circuits was based on talking close to the microphone. Full modulation of the transmitter can be obtained by speaking in a normal tone of voice with the lips within a few inches of the microphone, but it cannot be done from across the room or from a distance of a foot or two. The gain is limited intentionally, since it is our experience that close talking is desirable for amateur 'phone work, especially with crystal microphones, because the ratio of voice to extraneous noises is highest under these conditions, and because room reflections, with their damaging effect on naturalness, are less pronounced. Those who prefer to sit back in comfort with the microphone some distance away will require more amplification. Probably this had best take the form of a separate head amplifier using a triode giving a gain of ten or so, working into a tube-to-line transformer which can be matched by a line-to-tube transformer at the modulator unit input. A suitable type of preamplifier has been described in *QST*.³

The chassis upon which the unit is constructed is a stock item, available at most radio stores, measuring 7 by 11 by 2 inches. The first 57 in the speech amplifier is at the rear left corner; midway on the left-hand edge is the second 57, with the 45 at the front left. The Class-B input transformer is behind the meter panel, with the 46 tubes directly behind. The Class-B output transformer occupies the rear right corner. The small power transformer for the speech and driver tubes is at the front; beside it is the 80 rectifier.

Before the chassis was laid out, some tests were conducted to determine whether serious hum pickup would result from mounting the power transformer so near the audio transformers, and it was found that with the transformers in the respective positions shown the hum in-

(Continued on page 72)

³ DeSoto, "A Transportable 10-watt Public Address System," *QST* December, 1934.

An All-Purpose S.S. Superhet With Turret-Type Automatic Coil Changing

Combining the Efficiency of Plug-in Coils and the Convenience of Switching

By Charles Fisher,* W3FX

In Two Parts—Part I

IN THESE days of reasonably priced manufactured receivers, many hams may consider a home-made set not worth the effort required in its construction. In the introduction to the article by W9ERU on page 44 of May *QST*, this point was touched upon and the writer heartily agrees with W9ERU that home construction decidedly is worth while.

It seems to be the general opinion that a receiver using plug-in coils is more efficient than a receiver of the same type using a multiple switch for band changing. Bearing this in mind, the writer has constructed a superhet in which the coils are really plugged in simply by turning a knob, the coils being all mounted in a specially constructed "turret" assembly and the desired band selected by turning the entire coil assembly with one knob. The principal advantages of this system over conventional coil switching are: Facility of adjustment of individual coils; and higher efficiency resulting from short leads.

While the coil switching assembly is the novel part of the receiver, it also incorporates nearly every other worthwhile feature of modern superhet construction, including a variable-selectivity regenerative i.f. stage giving single-signal reception. Another interesting feature is the method used for band spreading and full coverage tuning. Two separate three-gang condensers are used, one of about 350- μ fd. per section tuning the entire coils for full coverage, and the other of 80 μ fd. per section (three Hammarlund midgets ganged together) tuning tapped portions of the coils for band spreading. This enables the band-spread dial to be calibrated directly in kilocycles for each amateur band. With the main tuning dial set at zero (highest frequency) the band-spread dial just covers an amateur band. This is accomplished by winding the coils so that the highest frequency of each range is about 10 kc. higher than the limit of that particular amateur band. Then the full-coverage dial is calibrated in megacycles with the band-spread dial set at zero. The receiver covers everything from 550 kc. to 30 mc. This is accomplished in five ranges. While this produces considerable overlapping, five ranges are used in order to have

a range starting just higher than each of the 28-, 14-, 7-, and 3.5-mc. bands. The 1.7-mc. band is covered on the range which starts at 3.5 mc. If the regular broadcast range is not desired the fifth range can be made to start just higher than the 1.7-mc. band. However, the full coverage dial provides fairly easy tuning on the 1.7-mc. band.

The receiver has been in use for about four months and has proved more than satisfactory. It certainly is a pleasure to operate after working with the old three-tube plug-in coil receiver. Its

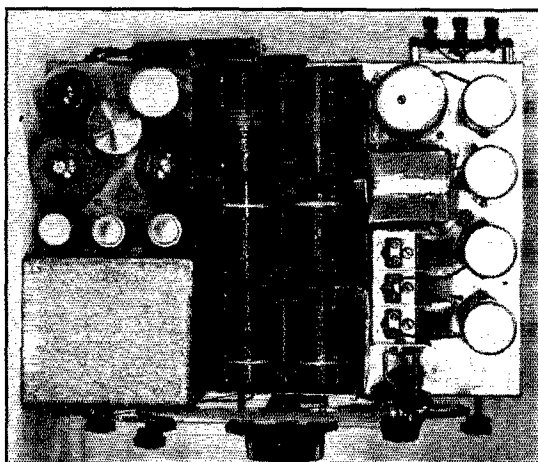

TOP VIEW OF CHASSIS WITH THE COVER OF THE COIL BOXES REMOVED

construction requires considerable mechanical work and should not be attempted with the expectation of finishing the job in a few days.

THE LAYOUT

The base for the writer's receiver is not home-made. It was originally a tuned r.f. receiver, and was chosen because the tube layout was just what was wanted. It is made of steel with welded ends and measures 15½ by 11 by 3 inches deep. It is doubtful if an aluminum subpanel would do for this receiver as it should be very rigid. The coil assembly exerts considerable downward pressure on the base and an aluminum base would probably bend. Large steel bases are obtainable from

* 447 Chestnut Street, Pottstown, Pa.

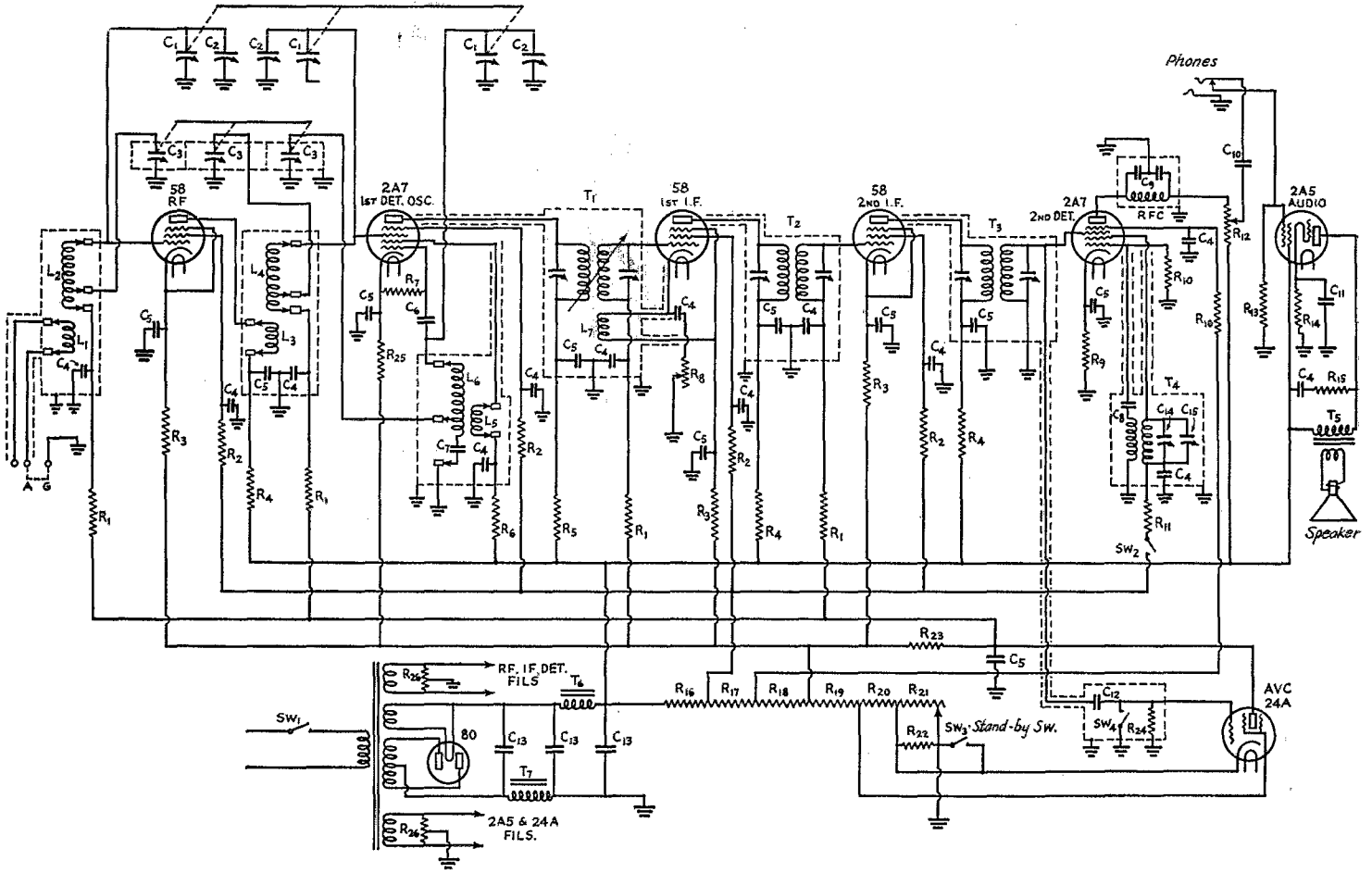

FIG. 1—CIRCUIT OF THE TURRET-TUNED RECEIVER

- L_1, L_2 —etc.—See coil table
 C_1 —3-gang variable, 350- μ f.d. per section
 C_2 —Trimmers on C_1
 C_3 —50- μ f.d. Hammanlund midgets
 C_4 —0.05- μ f.d. paper
 C_5 —0.1- μ f.d. paper
 C_6 —250- μ f.d. mica
 C_7 —Tracking condenser (See coil table and text)
 C_8 —500- μ f.d. mica
 C_9 —0.001- μ f.d. mica
 C_{10} —0.03- μ f.d. mica
 C_{11} —8- μ f.d. dry electrolytic
 C_{12} —1½ inches copper braid over lead (See text)
 C_{13} —8- μ f.d. electrolytic
 C_{14} —75- μ f.d. trimmer condenser
 C_{15} —2-plate midget variable
 C_{16} —100,000-ohm 0.5-watt
 C_{17} —Tracking condenser (See coil table and text)
 C_{18} —500-ohm 0.5-watt
 R_1 —20,000-ohm 1-watt
 R_2 —200,000-ohm 0.5-watt
 R_3 —500-ohm 0.5-watt
 R_4 —2000-ohm 0.5-watt
 R_5, R_6 —500-ohm 0.5-watt
 R_7 —10,000-ohm 0.5-watt
 R_8 —2000-ohm carbon type, 1. h. taper preferred
 R_9 —20,000-ohm 0.5-watt
 R_{10} —40,000-ohm 0.5-watt
 R_{11} —200,000-ohm volume control
 R_{12} —About 150 ohms (See text)
 R_{13} —250,000-ohm 0.5-watt
 R_{14} —500-ohm 1-watt
 R_{15} —5000-ohm or 20,000-ohm potentiometer
 R_{16} —8000-ohm 2-watt
 R_{17} —5000-ohm 0.5-watt
 R_{18} —10,000-ohm 1-watt
 R_{19} —1000-ohm 2-watt
 R_{20} —500-ohm 2-watt
 R_{21} —500-ohm volume control
 R_{22} —About 150 ohms (See text)
 R_{23} —250,000-ohm 0.5-watt
 R_{24} —1-megohm
 R_{25} —300-ohm 0.5-watt
 R_{26} —Center tap resistors
 T_1 and T_2 —See text
 T_3 and T_4 —5004c, 1, 1 transformers
 T_5 —Output transformer
 T_6 —19-ohm 80-ma. filter choke
 T_7 —100-ohm speaker field
 SW_1 —S.p.s.t. on back of R_{21}
 SW_2 —Rotary snap switches
 SW_3 —S.p.s.t. snap switch
 RFC —85 millihenry r. f. choke

any mail order house and punches are now on the market for punching socket holes. A panel is not provided as the set was designed to fit into a cabinet with an opening cut in the front large enough for the dial to show through.

Figs. 2 and 3 show the location of the various parts. The third i.f. transformer is mounted beneath the base and is supported from the rear wall by two angle brackets. The beat oscillator assembly is also mounted beneath the base to permit r.f. wiring to pass beneath them. The power transformer used was originally on the chassis. It is contained in a large can and holes were drilled in the front of the can for the beat oscillator switch bracket and pulleys.

The power filter choke is mounted underneath on the screws which hold down the power transformer and the output transformer is mounted on the Jensen "Gold Stripe" speaker. The 2000-ohm regeneration (selectivity) control is mounted beneath the first i.f. socket by means of a bracket fastened to the end wall, a bakelite rod extending through the control through the front panel. The a.v.c. switch, mounted beneath the a.v.c. tube, is housed in a small copper box and its shaft is also extended by a bakelite rod.

The three ganged midget condensers for band-spread tuning are mounted on a strip of bakelite ¼ inch by ¾ inch

by 7½ inches. They are held with countersunk screws from beneath the bakelite. A copper box is made just large enough to hold the assembly and just deep enough so it will be flush with the bottom of the chassis. The condenser assembly is then placed inside the copper box and three 10-32 screws go through the bakelite strip, through the copper box, pass through ¾-inch bushings, and screw into holes in the base

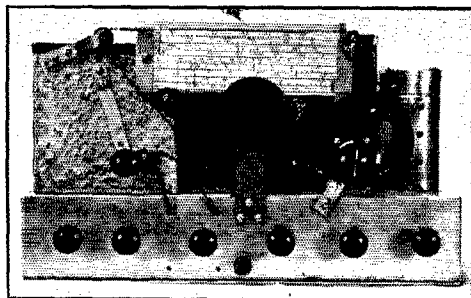

FRONT VIEW OF THE TURRET-TUNED RECEIVER CHASSIS

which have been tapped for 10-32 screws. The bushings are used to space the assembly far enough from the base to allow space for the screen and cathode by-pass condensers between the copper box and the base. This condenser assembly should not be mounted until all the r.f. and i.f. wiring has been completed. The midget condensers are driven by a spring-type gear now generally available for the purpose. A baffle plate is also placed between adjacent condensers and held in place with a couple dabs of solder. The condensers are ganged together with flexible couplings.

The three box shields for the coil assembly are

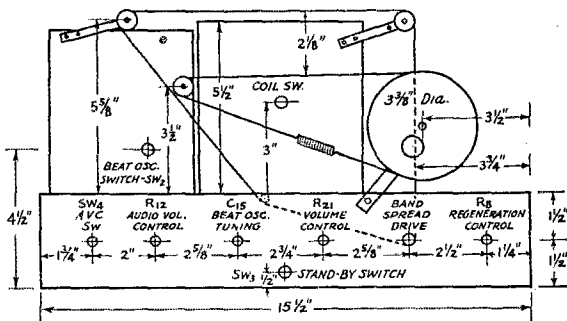

FIG. 2—FRONT LAYOUT-SKETCH

made of soft sheet copper. There are actually three separate boxes and not one large box with partitions in it. Each has a bottom soldered fast. Each of the boxes must be at least 5 inches long inside by 3¾ inches wide by 5½ inches high, and can be shaped quite easily by bending the copper

over blocks of wood fastened in a vise. The bottoms are made like lids, except that they fit inside the box walls. The seams are all soldered thoroughly. This can be done with a small iron if the boxes are first placed on a stove and heated until

r.f. tube, the power transformer being placed at the rear left hand corner of the chassis, and the oscillator coils exchanging places with the r.f. coils. Such an arrangement would do away with the shielded antenna leads passing to the front of the set.

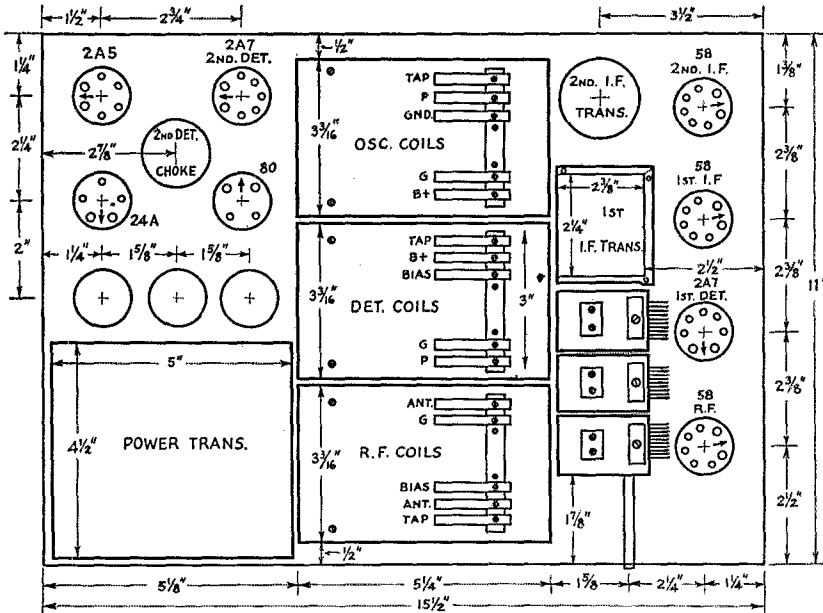

FIG. 3—BASE LAYOUT

The home-made dial arrangement used is rather tricky. A bakelite disc having a groove around its edge is fastened to the fan-type dial of the main tuning gang. A length of drum dial cable is fastened to the disc and carried around the pulley supported on the power transformer can. A piece of enameled wire soldered to the cable, serves as a

they are too hot to handle with the bare hands. Unless they are pre-heated, however, they can never be soldered with a small iron. One lid covers all three boxes. A half-inch hole is made in the front and back of each box for the brass shaft to pass through. The supports for this shaft, which is a one-foot length of 1/4-inch brass rod, can be strips of bakelite or steel fastened to the front and rear walls of the chassis, 1/4-inch holes being drilled in each support at the proper height. The shaft should turn freely.

pointer and travels about five inches on the main tuning scale. A 5/8-inch diameter bushing is placed over the band-spread tuning shaft and another cable wound around it in the manner in which cables are wound on drum dials. This cable is then carried over the upper pulleys. Its pointer travels about seven inches on the band-spread tuning scale.

It is believed that by using a base several inches longer, a better layout could be worked out. The first and second i.f. coils could be moved to the right of the i.f. tubes. Then, by raising the variable 350- μ fd. condenser about two inches above the base, the midget condensers could be mounted on top of the base beneath the large condenser. The large condenser could also be moved farther back, thereby shortening the lead to the oscillator coil. The r.f. and first detector leads should be kept of equal length, however. The mixer tube should be placed as near the oscillator coil as possible, in order to keep the oscillator plate lead short while still keeping the control-grid lead short. The entire layout could also be reversed; that is, the second i.f. tube becoming the

Individual dials could be used but a different layout would have to be arranged. If the chassis were long enough, the midget condensers might be mounted on the left side of the coil boxes, although this would require slightly longer leads. Such details depend upon each individual's taste.

Full constructional details of the tuning system and remaining receiver circuits will continue in the September issue.

— EDITOR

Stays

If the dust storms in the Middle West continue, it won't be long before most of the antennas are grounded—or floating, according to latest reports.

—W9KCR

Five-Meter Signals Do the Impossible

Signals Swapped Over 900-Mile Path; W1CBJ Contacts W8CYE

FOR many years we have had the idea that five-meter signals occasionally traveled long distances and returned to the earth, notwithstanding the suggestion on the part of theorists that this would be quite impossible. Amateur work during the last month has provided undeniable evidence establishing that all sorts of weird and wonderful things can and do happen in the ionosphere. Conditions have been quite extraordinary for some time on the 14- and 28-mc. bands but we have been told so often that five-meter signals could never be bent back to the earth after once reaching the ionosphere that it was not anticipated that the abnormal conditions could ever make themselves felt on 56 mc. It is the same old story over again—the story of ham radio breaking up old “truths” and doing the impossible.

Our first intimation that something was haywire resulted from the receipt of a card from W2DEE saying that his signals and those of W2HG and W3LD had been heard by William West, Jr., at Kalamazoo, Mich. The report was a little hard to take at the time, but W2DEE has, since then, collected full confirmation of the performance. Further confirmation arrived soon after in the form of a report from W9AEA at Indianapolis detailing confirmed reception of W2HG and W3JL on the same day (May 26th). On this same day and on May 29th, W9AEA heard W1HVW; W2BED; W1AKS; W2FBP; W2FWK; but confirmation has not been received from the various stations.

By this time it was perfectly obvious that 56-mc. signals were actually breaking through to the middle of the country. The periods of reception usually were quite brief—the signals climbing rapidly to R6 and R8, fading quite violently and eventually disappearing entirely.

The next terrific jolt was a letter from W1CBJ at Derry, N. H., telling of a two-way contact between his station and W8CYE at Dayton, Ohio. This contact has been fully verified and so far takes the palm for two-way working. It seems to us to be a clean-cut world's record. The contact was established on June 22 at 2:25 p.m., E. S. T., signals fading from R1 to R7. The contact lasted for about fifteen minutes and both ends of it were followed by W8TQ, also in Dayton. W1CBJ was using a pair of 45's in the oscillator; W8CYE used a pair of 800's with 55 watts input. On this same day at about 3:00 o'clock in the afternoon, VE3JW heard a whole group of first- and second-district stations. Because they were all signing rapidly it was not possible to copy the calls accurately, but there is

no question that the reception was authentic. On the following day at 9:15 a.m., W1HDQ at Springfield, Mass., heard W8LMP with a signal that varied from R2 to R8. Apparently the same condition was prevailing.

In addition to those already mentioned, reports have been received from W9RLA and W9CVO. W9RLA states that his signals have been heard by W3DWA in Philadelphia and that the following calls were logged during the first three weeks of June: W1HUZ; W1BQK; W1OQ; W1BPP; W3ARE; W1ICJ; W1ISO. These calls were all copied after hearing them signed quickly and probably are considerably in error. W9CVO and Fritz Frank report the following stations: W1XG; W2AMJ; W2HG; W2KG; W2HHW. These calls, similarly, have not been confirmed.

W2HG is the only station reported from more than one point. His signals, as it happens, have been heard at two locations in Chicago and at Kalamazoo and Indianapolis. Strangely, all the DX work has been done with stations around and not far from Chicago. It is interesting to speculate as to whether this is the result of curious conditions over restricted area or whether it is merely the result of more vigorous ultra-high frequency activity in the Chicago area. In any case, it gives us plenty to think about and, we hope, is only a beginning. Most of the reception appears to have taken place during the middle of the day. More activity at this time of the day, a greater use of i.c.w. and a more thorough signing of calls will undoubtedly give us a new picture of five-meter working.

It is very important, we think, to differentiate between this sort of five-meter DX and that made possible by atmospheric conditions in the lower atmosphere. We believe that there is no doubt that the East Coast-Chicago work is made possible by a bending of the waves in the ionosphere in much the same way as 10- or 20-meter waves are bent. This is the more conventional “sky-wave” transmission. The other brand of transmission involves a bending of the waves in the lower atmosphere. This “air-wave” working is probably an entirely different species.

Turn in those reports, gang. We are going places!

—R. A. H.

Strays

W8LLH: “Sa, om, I am an xyl and not an om.”
W9BHK: “R R R What was that about your xtal, om?”

—Overheard by W9EPT

Four Bands With Two Tubes

An Ultra-Simple C.W. 'Phone Transmitter With RK-20 Output

By Frank Gow * WIAF

CONCERNING the transmitter now to be described in these pages of *QST*, I may say without reservation that I would not swap it for any other rig that has collected dust in my shack in the past 17 years—and in that time a wide variety of so-called ether-busters has been

tubes and stages reduce operating complications to a minimum; thus band-changing becomes relatively simple. Provision for using the oscillator electron-couple for output on 7 and 14 mc. also is built into the set, so that frequency changes within a band can be made quickly and easily.

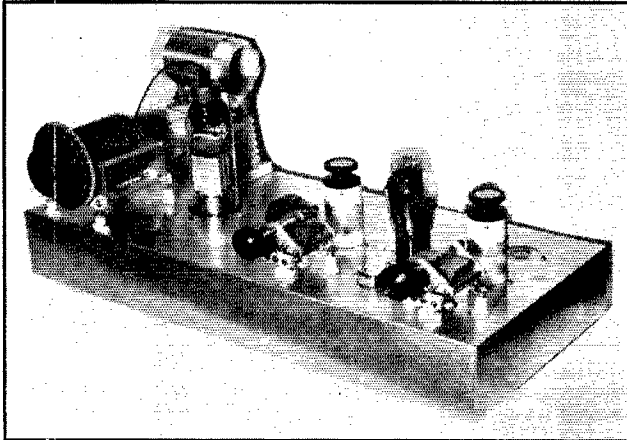

SIMPLE—BUT IT'S THE COMPLETE R.F. END OF A THREE-BAND TRANSMITTER RATED AT 100 WATTS C.W. AND 20 WATTS ON 'PHONE

A 59, pentode or Tri-tet, drives an RK-20 amplifier, using 3.5- and 7-mc. crystals. No buffer stages are needed.

used, from spark-coils through 1-kw. sync-rotaries, 852's and 204-A's. Yet there is nothing unusual in its circuit or construction. However, it represents performance, utter simplicity and economy to no small degree.

Without using any more space for ballyhoo, on getting down to cases we find that the transmitter consists of but two tubes—a 59 pentode-Tri-tet oscillator, and an RK-20 amplifier. With 3.5- and 7-mc. crystals, it can work in any of three bands, and can be used for either c.w. or 'phone, giving about 100 watts output on the former and better than 20 watts carrier (suppressor-grid modulation) on the latter, using the 1300-volt plate supply available at WIAF. The small number of

CONSTRUCTION

For appearance, permanence and ease of wiring, one of the popularly priced cadmium-plated steel chassis was selected for a foundation. Its dimensions, 23 by 10 by 3 inches, allow ample room and a reasonable space between oscillator and amplifier to eliminate the necessity for inter-stage shielding. The machine screw holes were drilled with regular twist drills and the larger holes for sockets, etc., were knocked out with a small cold chisel and worked round with a half-round file.

All sockets are Isolantite wafer type. Three 4-prong sockets are required, for the e.c. cathode coil, Tri-tet cathode coil and plate coil, respectively. One 7-prong socket, for the 59, and one

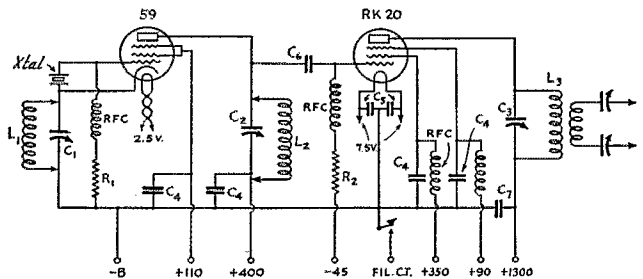

FIG. 1—CIRCUIT DIAGRAM OF THE TWO-STAGE PENTODE TRANSMITTER

- C₁—250- μ fd. cathode tuning condenser (National TMS-250)
- C₂—100- μ fd. oscillator plate condenser (National TMS-100)
- C₃—150- μ fd. amplifier plate condenser (National TMS-150)
- C₄—.002- μ fd. mica condenser, receiving type (Sangamo)
- C₅—.004- μ fd. mica condenser, receiving type (Sangamo)
- C₆—100- μ fd. mica condenser, receiving type (Sangamo)
- C₇—.002- μ fd. mica condenser, 5000-volt (Sangamo)
- R₁—50,000 ohms, 2-watt rating (I. R. C.)
- R₂—15,000 ohms, 2-watt rating (I. R. C.)
- RFC—S.w. chokes (National Type 100)

See separate table for coil data.

Antenna tuning equipment will depend upon the type of antenna system used. With series tuning of Zepp feeders, tuning condensers of 250- μ fd. each will be satisfactory.

*3 Water Street Court, Medford, Mass.

5-prong, for the crystal mounting, also are needed. The amplifier uses another 5-prong socket, making six in all. The oscillator coils are wound on Hammarlund Isolantite coil forms, the amplifier coils on General Radio forms.

The variable condensers (National) are mounted with a combination of tinymite stand-offs and feed-throughs of the same height. In the case of the oscillator tuning condensers, the forward ends are supported by stand-offs, the rear by the small feed-throughs. The rotor connections are made to these feed-throughs. Because none of the condensers are worked at ground potential, feed-through insulators are mounted adjacent to the rear condenser feed-through supports to carry the stator connections through the chassis. The amplifier tank condenser is supported on three legs by stand-offs and the fourth leg by a feed-through. The amplifier coil forms are provided with small G.R. plugs and the large stand-off insulators supporting the tank coil are fitted with G.R. jacks to facilitate coil changing.

Thorough shielding of the RK-20 is realized by the use of the metal chassis. At the same time, the tube may be mounted vertically, saving space and providing an easy form of mechanical mounting. A hole large enough to give $\frac{1}{8}$ inch clearance was cut through the chassis and the RK-20 set down into it until the tube's internal shield (the cylin-

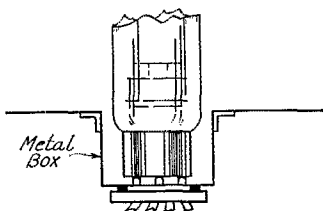

FIG. 3—THE SHIELD-BOX MOUNTING FOR THE RK-20

This is a cross-section; the box actually has four sides and a bottom, with the tube socket mounted on the latter.

drical plate near the bottom of the envelope) was flush with the top of the chassis. This provided a simple buffer shield between the input and output elements of the RK-20. With the tube inserted in this position, the distance from the chassis to the tube's base, or the top of its socket, was measured carefully. With this dimension and the diameter of the hole cut in the chassis in mind, a

sheet metal box, open at one end, was constructed. The 5-prong socket was mounted opposite this open end. This assembly was then made fast to the under side of the chassis by means of small angle brackets. Fig. 3 gives the general idea. A nicer appearing job may be had by providing a lip around the open side of this "box" when it is first cut and fashioned.

The sheet metal box effectively shields the internal base connections of the RK-20 from possible stray r.f. and offers a very convenient socket mounting. This shielding may or may not be necessary but since we must have a socket mounting anyway, we might just as well take advantage of the shielding properties.

OPERATION

Because of the low excitation requirements of the RK-20 a single 59 in Tri-tet or pentode connection will supply ample driving power. For the same reason, further simplifying tuning, capacitive coupling between oscillator and amplifier is used. The circuit of the oscillator will be found to be identical with that used in the widely-known universal Tri-tet exciter unit, with provisions for e.c. control and one plate of the cathode tuning condenser bent slightly to permit short circuiting of the cathode coil at full scale, for pentode operation. The amplifier is the conventional series-fed type.

On 3.5 mc. and 7 mc. the oscillator is operated as a straight pentode, the cathode coil being shorted by the tuning condenser. Two crystals are needed for operation on three bands, 3.5, 7 and 14 mc. On 14 mc. the oscillator is operated Tri-tet, doubling in the plate circuit of the 59. Two crystals, 3.5 and 7 mc., and four coils will furnish oscillator frequencies crystal controlled on 3.5, 7 and 14 mc. and e.c. on 7 and 14 mc. Two coils are used in the amplifier; one exclusively on 14 mc. the other for 3.5 and 7 mc. A small copper clip, with its jaws slightly extended, shorts out 4 turns of the 3.5 mc. tank coil very handily and permits very low C operation of the tank at 7 mc. Without the clip, approximately 85 $\mu\text{fd.}$ tunes the combination to 3.5 mc. It is but a matter of seconds to shift bands with this line-up. 'Phone or c.w. operation is accomplished merely by flipping a double throw double pole switch (connected to reverse polarity) in the suppressor grid circuit, thereby applying positive or negative

(Continued on page 82)

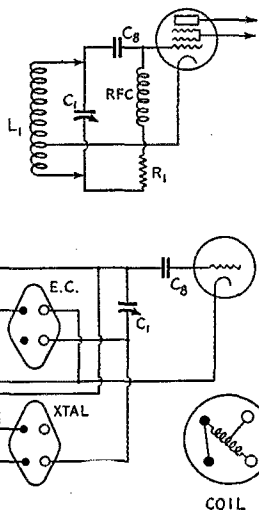

FIG. 2—ALTERNATIVE OSCILLATOR GRID CIRCUIT CONNECTIONS FOR SELF-CONTROLLED OPERATION

Shifting the cathode coil to an appropriate socket and plugging in either a crystal or grid condenser gives a choice of either crystal or electron-coupled operation. The grid condenser, C_2 , is a 250- $\mu\text{fd.}$ receiving-type mica condenser.

Ten-Meter Activity Increasing

South Americans On—Chance for Ten-Meter WAC

ONCE our report of revival of international work on 28 mc. in the May issue, the ranks of ten-meter experimenters have been considerably augmented. Good conditions nowadays find plenty of stations on, with many chances for satisfactory QSO's. After a period of rather poor conditions in May, June came back with the band open for periods ranging from an hour or two to practically all day nearly every day of the month. Most evenings have found considerable activity, and signals often come through up until midnight and later.

Except for a few South American stations which have been coming through consistently, DX work has tapered off somewhat, although as this is being written indications are that conditions are rapidly approaching the point where inter-continent work is going to be resumed. Only one W-VK contact has been reported in recent weeks. W4MR and VK2EP hooked up on the evening of June 15th for a solid hour's QSO with good signals at both ends. VK2EP has heard W4MR on several occasions, reporting him the loudest East-Coast station on the band.

South America finally got into the picture, and this one "hold-out" continent has at last been worked from the U.S. OA4J and W5AOT did the trick, making contact at 4:25 p.m., E.S.T., on June 9th. Thus fell one of the few remaining DX record possibilities. Within an hour this QSO had been duplicated by W5JV and LU1EP, making the first U. S.-Argentina contact on ten. LU1EP made a field day of it on June 9th, working W5JV, W6VQ, X1AY, and ON4AU in succession. The LU1EP-ON4AU QSO is, we believe, the first South-America-Europe ten-meter contact. Since the fateful June 9th, LU1EP has worked quite a number of U. S. stations, including, in addition to the above, W4AGP, W1AVV, W2CPA, W1ELR, and W1DF. Probably some other contacts so far unreported also have been made. W4AGP has been most consistent at LU1EP, having worked him at least a half dozen times on several week-ends, occasionally with 'phone at W4AGP. W1AVV also has worked LU1EP a number of times. In addition to the stations worked, LU1EP also has heard W2AER, W5AFV, W4MR, W8CCW, D4BWF, PA0QQ, W9NY, W9EKU, W2ALW, W5CUA, W5EPP, W9FVI, W2TP ('phone), W1DZE, LU3DD, LU9BV, LU8BAJ, ON4SD, F8OZ, F8EF, F8VS, G6RH, G5LS, D4BWF, D4KPJ. Quite an imposing list! LU1EP has been heard in England and we understand has worked one English station. We also understand that

X1AY has worked a G, although no details are available.

OA4J and LU1EP are on every week-end. Best times to hear them would seem to be about four to five p.m., at least on the east coast. Probably a bit later would be better in the western time zones. OA4J has heard LU1EP, W3DLB, and W5EME, in addition to working W5AOT.

European stations are active on ten, although signals have not been getting across the Atlantic very well. The only U.S.-Europe contact reported is that between W1AVV and EI8B, which took place on June 16th at 4 p.m., E.S.T. EI8B, incidentally, also has QSO'd LU1EP. He is on 28 mc. all day Saturday and Sunday and from 1800 to 2000 GT weekdays, as is also EI5F. Besides working a considerable number of European and northern Africa stations, ON4AU has heard J2CL and has been heard by VK3EG. FASBG (ex-FM8BG) has heard W2CPA, W8CQO and W1DFB on ten, bringing Africa into the picture. F8IH, who has been heard by W4AGP, undoubtedly also has heard American stations. LU8BAJ and LU9BV have been heard by a number of U. S. amateurs, although so far no one has reported working them.

One of the most consistently active ten-meter stations is X1AY, who has been putting good strong signals into this country for several months. We believe the following list of calls heard at X1AY will be of interest. It shows, for one thing, how the number of U. S. ten-meter stations has grown from the handful who were on in late March. Here they are: W1AV, W1AVV, W1CUN, W1DF, W1LZ, W1SZ, W2AER, W2ALW, W2BHZ, W2CIN, W2CJJ, W2DBH, W2FEC, W2FHU, W2FVT, W2GIZ, W2GJB, W2GKR, W2GLJ, W2GOX, W2GVM, W2GWE, W2HNO, W2TP, W2UK, W3AOJ, W3AQI, W3BBB, W3BNK, W3BWD, W3DBX, W3DHP, W3DLB, W3EIS, W3EVT, W4AGP, W4AH, W4AJX, W4AJY, W4APF, W4AWY, W4BBR, W4BDV, W4BKS, W4CON, W4CYV, W4ET, W4MR, W4SV, W4TZ, W4ZH, W5BDT, W5WG, W6AC, W6AET, W6AHZ, W6AND, W6AVT, W6AWA, W6BLZ, W6BNU, W6CAL, W6CD, W6CEM, W6CFX, W6CIS, W6CLH, W6CUQ, W6DGW, W6DIO, W6DJZ, W6DLN, W6DLY, W6DOK, W6DVI, W6EAK, W6ECM, W6EEK, W6EGM, W6ERT, W6EXQ, W6FMY, W6FQV, W6FWN, W6GAJ, W6GFI, W6GOY, W6GRX, W6IDF, W6IRD, W6ITY, W6IVU, W6JJS, W6JJU, W6JMI, W6JNR, W6JPW, W6JRI, W6KBY, W6KGD, W6KGU, W6KIP, W6KRI, W6KVV, W6KZL, W6LBW, W6LDQ, W6LSC, W6RH, W6VB, W6VQ, W6XX, W6ZQ, W7BBY,

W7BD, W7CGR, W8AZD, W8BFD, W8BTI, W8BZD, W8CGP, W8CRA, W8CTE, W8CZU, W8DJJ, W8DVS, W8DVX, W8DYK, W8ESV, W8FDA, W8HBO, W8HET, W8HGW, W8IXS, W8JJW, W8KOL, W8KRV, W8LBH, W8LEC, W8LIJ, W8LIR, W9APE, W9BQM, W9CDM, W9CES, W9COG, W9DEK, W9FDP, W9FFQ, W9FVI, W9GCG, W9GFZ, W9IWE, W9KPD, W9NY, W9RH, K5AF, LU1EP, LU9BV,

efficiency. The tubes, which are half-inch copper tubing, are about eight feet long with a slider for adjustment. Spacing between the tubes is one-half inch. Regarding the tubing, W4AGP writes that he obtained it second-hand from a refrigerator repair house, paying only seventy-five cents for over a hundred feet!

The power supply is built around an old RCA-Victor power transformer, nominally rated at 350

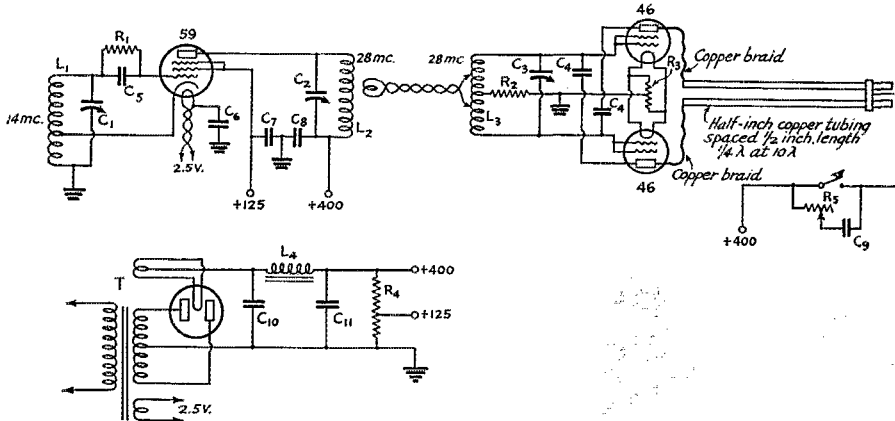

FIG. 1—THE M.O.P.A.—LINEAR TANK CIRCUIT TRANSMITTER USED BY W4AGP

- C₁—250- μ fd. variable.
- C₂, C₃—Midget condensers, 50- μ fd. size.
- C₄—Neutralizing condensers, home-made from aluminum plates mounted on stand-off insulators (capacity about 5-10 μ fd.)
- C₅—100 μ fd.
- C₆, C₇—,002 μ fd.
- C₈—,001 μ fd.
- C₁₀, C₁₁—Double 8- μ fd. electrolytic.
- R₁—50,000 ohms.

- R₂—1000 ohms.
- R₃—20 ohms center-tapped.
- R₄—Voltage divider; about 20,000 ohms total resistance, tapped to give 125 volts for oscillator screen.
- C₉, R₅—Key-thump filter. A 1- μ fd. condenser and 1000-ohm variable resistor are suggested.
- L₁—4 turns, tapped 1 1/2 turns from ground end, coil diameter 1 1/4 inches.
- L₂—8 turns, coil diameter 1 1/4 inches.
- L₃—6 turns, coil diameter 1 1/4 inches.

VE3CF, VE3DB, VE3LU, VK2EP, VK2LZ, VK3YP, ZL2GQ, ZL3AJ.

A SIMPLE TEN-METER TRANSMITTER

The low-power 28-mc. transmitter used by W4AGP will be of interest to fellows who want to get on ten with a minimum of equipment and without disturbing their regular transmitters. This little rig, which consists of a 59 electron-coupled oscillator and a push-pull 46 amplifier, alternates in service at W4AGP with a higher-power crystal-controlled transmitter. It has been used for a good deal of the work with LU1EP.

The circuit diagram of the set is shown in Fig. 1. The oscillator grid tank circuit is high-C, tuned to 14 mc., with the plate very low-C on 28 mc. Since the coils undoubtedly will have to be pruned for best results, only approximate specifications are given. The oscillator plate tank is adjusted so that it hits ten with C₂ just about at minimum. The link is coupled through one turn at L₂ and tapped a half turn each side of the center on L₃. The quarter-wave high-Q plate tank circuit in the amplifier is used to get good plate

each side of center-tap. The output voltage is about 450 at no load, dropping to 400 with the set in operation. The oscillator takes 25 to 30 ma., the amplifier 35 ma. with the antenna disconnected, rising to 75 ma. with the antenna coupled. Condenser C₆ is very important; its use makes the difference between a pure d.c. note and a.c. No r.f. chokes have been found to be necessary. The quarter-wave tank circuit is easy to couple to, the feeders simply being tapped on at a point which takes the power out of the tank. W4AGP has used several types of antennas with the set, a 7-mc. Zepp being in service most of the time.

Not an expensive rig, but it gets out!

SHORTER-DISTANCE WORK

A great deal of work over distances of the order of 500 to 1200 miles has been carried out during June. Almost nightly communication has been maintained between the East, South and Middle West during this period. Although 5's have come through but rarely here in New England, they have been worked regularly by Southern and

(Continued on page 34)

Iron-Core I.F. Transformers

By Alfred Crossley*

IF IT were practicable to build large enough air-core inductances for i.f. transformers in our superhets, we would find as the size was increased—with proper form factor and materials employed on the winding form and with due consideration given to the proper type of wire—that it would be possible to obtain a very efficient inductance. But this efficient inductance, being unusual in size, would become very inefficient when placed in a normal shielding container and associated with the regular amplifying system for which it was intended, because of the eddy current losses in the container. When we consider using i.f. transformers having these large size air-core inductances, with the attendant mechanical difficulties, cost of construction, and the unusual special requirements, it may be said that the practical application of such a unit is extremely limited. It was on this account that search was made for better inductances of smaller size.

In this search much work has been done toward the development of inductances employing powdered iron cores. By using such cores it is possible to obtain a given inductance value in a very small space due to the fact that actual permeabilities ranging from two to four times that obtained with air-core units have been realized. Hence, the iron core permits us to obtain an increase in inductance of from two to four times that obtained with air-core inductances of identical size. In other words, it is possible to reduce the number of turns and by inserting an iron core still obtain the desired inductance. The reduction in turns represents a saving in copper losses and, since the iron losses are made low, we can obtain an inductance which is approximately twice as efficient as the air-core type, particularly when we place said inductances in a small shielding container.

Considerable work has been done on the development of powdered iron, and it has been found for certain frequencies that a definite iron grain or particle size produces best performance. These iron particles are insulated from one another in order to obtain minimum eddy current loss in the iron and a binder is employed to produce a mechanically strong moulded unit on which can be wound the desired coil. American practice employs iron particles, insulation and a phenol binder. The combination is placed in a press and moulded to the desired size or form, which produces a product that closely resembles in appearance a polished steel pellet. Recent samples of powdered iron obtained from Europe indicate a different method of manufacture, wherein the powdered iron is sprayed on a sheet

of paper having shellac or some other adhesive, and this paper is rolled or pressed into the desired form so that it resembles a laminated product having paper layers.

The American cores, manufactured under the trade name of "Polyiron," at present are made in two sizes, one $\frac{3}{8}$ inch in diameter and $\frac{1}{2}$ inch long, and the other $\frac{1}{2}$ inch in diameter and $\frac{1}{2}$ inch long, each unit having a center hole for mounting purposes. This center hole also functions in making the return magnetic flux flow closer to the coil winding and produces a more economical design, inasmuch as this form gives a 10% reduction in the magnetic field with a 30% reduction in iron content. From a coupling standpoint the hollow core, confining the field close to the winding, permits closer spacing between the primary and secondary of the transformer.

The coil is insulated from the iron core with a paper sleeve, and wound centrally on this core. For best performance, this coil winding is of the universal or lattice type. Spacing of wire turns and wire size is, of course, a function of the frequency used. For example, in the 456-kc. transformer a close type of winding is employed having 7 strands of No. 41 Litz wire. The winding width is approximately $\frac{1}{2}$ inch and the $\frac{3}{8}$ inch type iron core is employed. It is necessary to remove moisture from the coil winding and then flash-dip the coil in wax in order to maintain the efficiency of the unit constant under varying atmospheric conditions.

Coil units having inductance of 1.65 millihenry made in this manner show a Q value equivalent to 180 at 456 kc. when the proper grade of powdered iron core is employed. A single air-core inductance of comparable design has a Q of 80, while large multiple-section air core units have been produced with a Q equivalent to 125. The Q values previously referred to are those obtained when the unit was measured in air having no shielding container surrounding it. It is, of course, understood that the smaller the diameter of the shielding container, the greater will be the reduction in Q or efficiency of the inductance, and in this particular instance, the compact size of the iron-core inductance shows further superiority because the shielding container has less effect in reducing its efficiency. For example, in the present design of a 456-kc. iron-core transformer, a shielding container but $1\frac{1}{2}$ inch in diameter and having an overall length of $3\frac{1}{2}$ inches is employed. This container represents about as small a size as is used in the midget type receivers.

TRANSFORMER COUPLING

In connection with the design of iron-core in-

* Consulting Engineer, 154 East Erie St., Chicago, Ill.

intermediate frequency transformers, the question of coupling is very important. Because of the high Q or efficiency of these units, the coupling required for maximum output is much less than that required with air-core units. This condition can be readily understood by examining the following formula for maximum output or critical coupling in transformers:

$$\omega M = \sqrt{R_s R_p}$$

where M is mutual inductance between primary and secondary

R_s is the radio frequency resistance of secondary

R_p is the radio frequency resistance of primary

ω is 2π times applied frequency.

Now if we consider R_s and R_p as unity for an air-core transformer, we would have a mutual inductance product equivalent to unity value; but if we substitute iron-core units having one-half the resistance, we will note that the product will be $\frac{1}{2} M$, which indicates that the coupling will have to be reduced to $\frac{1}{2}$ to obtain the critical value.

To obtain this reduced degree of coupling, it was found necessary to use a new form of coupling, as shown in the illustration. The coils are placed at a short distance from each other but at right angles. One coil is fixed in position, while the other coil can be moved along the horizontal bakelite spindle, thus obtaining any desired degree of coupling up to approximately 5 per cent. In practice, optimum coupling is obtained in the 456-kc. transformer when the movable coil is approximately $\frac{1}{16}$ inch from the center position. This gives a coupling of slightly less than 1 per cent, the value representing the total wherein 0.23 per cent is electrostatic and 0.72 per cent is electromagnetic. The design is such that all leads are secured in definite positions and care is taken to reduce capacitive coupling between tuning condensers to a minimum. Early experiments with these high- Q iron-core circuits definitely indicated the ease with which a small electrostatic coupling could easily produce overcoupling and experimenters are cautioned to reduce this type of coupling to an absolute minimum in order to obtain consistent results.

For amateur-band superhets we use, of course, the higher-frequency type of transformer in order to obtain better image frequency ratio. To give an idea of the relative performance of air-core and iron-core transformers, we shall cite figures showing results obtained when a Type 78 tube is employed in a single amplifier stage at 456 kc., the inductance of both primary and secondary of the respective transformers being 1.5 millihenries in the shielding container. These particular units were housed in $1\frac{1}{2}$ -inch diameter cans having a length of $3\frac{1}{2}$ inches. With an air-core unit of the better type, a gain of 173 is possible with a volt-

age ratio of 4.6 at 20-kc. bandwidth; while with the iron-core transformer, the gain is 278 with a voltage ratio of 10 at the same bandwidth.

If a Type 6D6 or a 58 tube is substituted for the 78, an increase of 10% in gain and selectivity will be obtained with the iron-core unit, while an increase of 8% is possible with the air-core transformer. The greater improvement with the iron-core unit in this tube combination results from better matching of impedance of the 6D6 and 58 tubes with the iron-core primary which has an impedance at 456 kc. of approximately 600,000 ohms as against 300,000 ohms for the air-core unit.

If a pentagrid converter (6A7 or 2A7) is employed to work into the iron-core and air-core

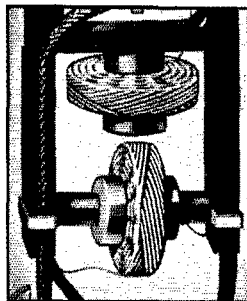

FIG. 1—ARRANGEMENT USED IN IRON-CORE I.F. TRANSFORMERS TO PERMIT ADJUSTMENT AND TO MINIMIZE CAPACITIVE COUPLING

transformers, somewhat different results will be obtained. The single air-core unit will produce a gain of 54.6 with a voltage ratio of 7.13 at 20-kc. bandwidth, while with the iron-core transformer the gain is 86 with a voltage ratio of 18 at the same bandwidth. In this latter case the iron-core transformer is working at a disadvantage because the plate circuit impedance of the 6A7 is but one-half that of the transformer primary.

The air-core unit referred to in these comparisons was the best available type employing single-coil windings, as used in the better type commercial receivers. Other air-core transformers examined by the writer had less gain and selectivity, the selectivity of some transformers being $\frac{1}{4}$ of that of the air-core unit referred to in these comparative data.

When we consider the increased gain per stage obtainable with iron-core transformers, and also that a succeeding stage produces a result equivalent to the square of the performance of a single unit, from a gain standpoint alone it is evident that when two iron-core units are substituted for the usual air-core types the gain will be more than doubled. The selectivity will, of course, be proportionately increased because of the increased efficiency with the iron-core tuning system.

If extreme selectivity is desired, and this most

(Continued on page 80)

Adjusting the 'Phone Transmitter for Best Modulation Performance

By W. C. Lent*

THE transmission of intelligence by radio, whether that intelligence be in the form of an entertainment program or a definite message, depends upon some form of modulation of a so-called carrier wave. By modulation is meant the process by which the instantaneous character of the carrier is made to change in accord with the variations of the intelligence to be transmitted. The character of the modulated wave may be completely described for a particular instant if the phase, frequency and amplitude at that instant are known. Up to the present time, experience has indicated that the most suitable form of modulation is achieved by varying the instantaneous wave amplitude in response to the variations of the signal energy to be transmitted. Experience has likewise indicated that it is desirable to maintain carrier frequency and phase as nearly constant as possible during the modulation cycle.

OUTLINING THE FUNDAMENTALS

Amplitude modulation of a constant carrier-wave by speech results in the production of side-bands of varying width and amplitude. The side-band frequencies are symmetrically displaced from the carrier frequency on both sides by frequency intervals equal to the modulation frequencies at a particular instant. The side-band amplitude is determined solely by the degree of modulation, the proper maximum limit being reached when the total side-band amplitude is equal to the carrier amplitude, which condition represents 100% modulation.

Since the intelligence-bearing portion of the modulated wave is not the carrier but the side-bands, it follows that the greater the side-band amplitude the greater is the useful portion of the wave. For a wave completely modulated (that is, 100%), two-thirds of the total wave energy is concentrated in the carrier with the remaining one-third in the side-bands when the modulating signal is a single pure tone. The side-band power varies, between this one-third maximum and zero, directly as the square of the modulation degree.

If the side-band power is calculated it is found that the following relations hold:¹

* General Communications Laboratories, Ridgefield, N. J.

¹ These power relations hold strictly only with a sinusoidal (pure-tone) modulating signal. For speech modulation the side-band power values are approximately halved, as outlined in "Technical Topics," June QST, and discussed elsewhere in this issue.—EDITOR.

% Modulation	% Total Power in Carrier	% Total Power in Side-Bands
0	100	0.0
25	97	3.0
50	89	11.0
75	78	22.0
100	66.6	33.3

Hence, in a wave modulated 25% by a single tone, only 3% of the total power is useful power. For 50% modulation the useful power is increased to 11% of the total with single-tone modulation. A 100% modulated wave delivers 11 times as much signal energy as one modulated 25%. With sinusoidal modulation applied to a 100-watt carrier, we find that for:

A Modulation Percentage of	The Side-Band Power Is
0%	0.00 watts
25%	3.12 watts
50%	12.50 watts
75%	28.10 watts
100%	50.00 watts

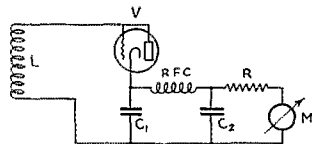

FIG. 1—CIRCUIT OF THE SIMPLE DIODE-TYPE CARRIER-SHIFT INDICATOR WHICH CONSTITUTES "MEANS TO INSURE THAT THE TRANSMITTER IS NOT MODULATED IN EXCESS OF ITS MODULATION CAPABILITY," IN ACCORDANCE WITH THE NEW REGULATIONS

Typical circuit values are as follows:

L—Coupling coil to suit frequency. It may be tuned by a midget condenser and coupled to the transmitter by a link.

C₁, C₂—0.001- μ f. fixed condensers.

R—10,000-ohm non-inductive resistor. Higher resistance improves linearity but reduces current through meter.

M—0-1 d.c. milliammeter.

V—Type 56 or similar triode with grid and plate tied together.

Certain conclusions can be drawn and set down as general rules. They are:

(1) Doubling the modulation degree (up to 100% maximum) for a given carrier power increases the signal level 100% without increasing the nuisance range of the station.

(2) Doubling the carrier power while holding

the modulation degree constant results in only a 41.4% increase in signal level and an equal increase in the nuisance (heterodyne) field intensity.

(3) To obtain a signal level increase equivalent to that obtained by doubling the modulation degree with the carrier power constant, requires a carrier increase to a value 4 times the original power while holding the modulation degree constant. In other words, doubling the modulation degree (up to the maximum permissible limit of 100%) pays the same dividend in signal level as a 4-to-1 carrier power increase.

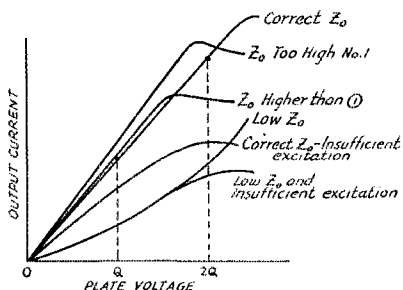

FIG. 2—ILLUSTRATING THE MANNER IN WHICH EXCITATION AND LOAD IMPEDANCE AFFECT THE LINEARITY OF THE CLASS-C MODULATING STAGE

The following formulas are given to enable the station operator to calculate the percentage gain in signal strength to be expected for increases in carrier power or modulation degree, or both. They are:

$$S_m = 100 \frac{M}{M_o} - 100 \text{ for change in mod. degree.}$$

$$S_c = 100 \sqrt{\frac{P}{P_o}} - 100 \text{ for change in carrier.}$$

$$S_{c+m} = 100 \frac{M}{M_o} \sqrt{\frac{P}{P_o}} - 100 \text{ for changes in both.}$$

where:

S_m = Signal level change due to change in modulation.

S_c = Signal level change due to change in carrier.

S_{c+m} = Signal level change due to changes in both.

M = Proposed modulation degree in percent.

M_o = Present modulation degree in percent.

P = Proposed carrier power.

P_o = Present carrier power.

As an example of application, take the following proposition:

Suppose speech power is available to modulate a 10-watt carrier completely. Suppose also that a 50-watt carrier is proposed in the hope of greatly increased signal but with speech power available for only 50% modulation. Going to the formulas

it is found that the 50-watt carrier modulated 50% will deliver only 11.7% more signal level than the 10-watt carrier modulated 100%. This corresponds to an increase in signal level of only 0.96 db—which is hardly perceptible. Economy of operation, therefore, definitely would favor the lower carrier power.

This general information may be summarized as follows, keeping in mind that 100% modulation is the maximum limit:

(1) In general, increased signal level may be most economically obtained by increasing modulation degree rather than carrier power.

(2) Signal level is directly proportional to the modulation degree.

(3) Side-band power, the only signal-producing power in the wave, varies directly as the square of the modulation degree.

(4) Signal level varies directly as the square-root of the carrier power for a given modulation degree.

(5) The heterodyne nuisance range is not affected by changes in modulation degree but does vary as a function of the square-root of the carrier power. Therefore, the higher the carrier power the greater will be the nuisance range.

ADJUSTMENT FOR PROPER MODULATION

What probably concerns all of us most is how to get the best results from the equipment as it now stands. If plate modulation is to be undis-

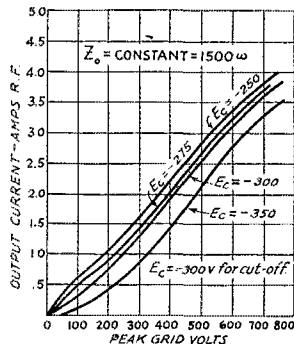

FIG. 3—ILLUSTRATING THE EFFECT OF BIAS ON THE LINEARITY OF THE CLASS-B R.F. STAGE

torted, the r.f. amplifier's plate circuit must behave as a pure resistance; that is, the ratio of plate voltage to r.f. output current must remain constant for plate voltages from zero to twice the operating value. This condition can only be met when the grid is driven to saturation; that is, when sufficient excitation is applied so that any addition fails to result in increased output power. Given grid saturation, the output impedance must be adjusted by varying the coupling to the load (antenna) until the linear relation between plate voltage and current is obtained at the same

time that the power input and effective modulating resistance called for by the design are established. Furthermore, this relation can never be obtained with the Class-C r.f. amplifier unless grid bias is secured automatically by means of a grid resistor. Fixed C-battery bias does not give the necessary change at low instantaneous plate voltages where the peak grid voltage almost equals the minimum plate voltage.

Assuming all these conditions to be fulfilled, the output may be tested for linearity by means of a very simple device which should have a place in every 'phone station. This instrument is essentially a linear rectifier or detector of the type diagrammed in Fig. 1.

If modulation is symmetrical, which it must be for distortionless transmission, the positive peaks of the modulation envelope will have the same amplitude as the negative peaks for corresponding modulation cycles. That is, the envelope amplitude will vary equally on both sides of the unmodulated carrier amplitude value. It follows that the average r.f. amplitude during modulation will be equal to the unmodulated carrier amplitude. This fact provides a very convenient and certain method for checking linearity by means of a carrier-shift indicator.

The linear rectifier is coupled to the stage under test and a convenient deflection obtained on M with the carrier unmodulated. If modulation is applied no change in the rectifier output will appear unless the modulation characteristic of the modulating amplifier is non-linear and the modulation capability is exceeded. This change in deflection, if it occurs, is known as carrier-shift. By carrier-shift is meant the shift in the average envelope amplitude during the modulation cycle. It is not to be confused with frequency shift, which has nothing to do with the processes under discussion. A positive shift indicates that the time-average of the positive half cycle is greater than that of the negative half cycle, and conversely.

In the interpretation of results the following points, in conjunction with Fig. 2, will be found helpful when testing Class-C amplifiers. Class-B amplifiers will be discussed later.

(1) A negative shift usually indicates insufficient grid excitation or too high an output impedance, or both. If it is known from previous test that grid saturation exists for the plate voltage in use, then negative shift definitely indicates a load impedance in excess of the proper value for linearity.

(2) A positive shift usually denotes too low an output impedance, or overmodulation which causes the negative peaks to cross the zero axis for an appreciable portion of the modulation cycle.

Now let us say just a word about adjusting output impedance to the proper value. In practice, most radio-frequency amplifiers work into a

tuned circuit adjusted for resonance at the working frequency. When resonance exists the load presented to the tube is a pure resistance having a numerical value equal to

$$Z_o = \frac{X^2 P}{R_c}$$

where:

Z_o = the output impedance.

X_P = the reactance included between plate and filament in the case of single-ended amplifiers or from plate to plate in balanced systems.

R_c = the total closed circuit resistance at the working frequency, which includes both the inherent resistance of the circuit and the resistance coupled in by the load.

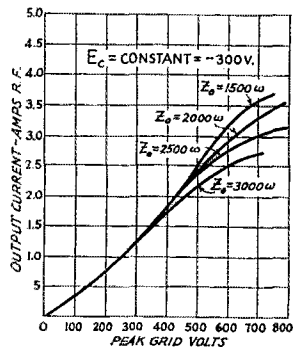

FIG. 4—SHOWING HOW LOAD IMPEDANCE AFFECTS THE LINEARITY OF THE CLASS-B R.F. STAGE

Increasing the reactance, that is, the number of turns, increases the output impedance; and vice-versa. Increasing the coupling to the load reduces the effective output impedance; and the converse of this also is true. A fault in some transmitters designed for 'phone operation is that high- C output circuits are used, in which case, to obtain resonance, the inductances are so small as to make it impossible to adjust the output impedance properly.²

If the foregoing procedure has been rigorously followed, the modulating amplifier should be able to do its job properly. The actual modulation degree can be checked with a cathode-ray oscilloscope or, approximately, with the usual current-squared galvanometer, provided a linear rectifier is also used with the latter to insure that no carrier shift is present. A current-squared instru-

(Continued on page 70)

² Too high plate load impedance is also not uncommon, especially in high-power transmitters where inadequate tank capacitance is provided. As has been shown by H. A. Robinson ("Operating Characteristics of R. F. Power Amplifiers," *QST*, April 1934), there is an optimum $L-C$ ratio, considering excitation requirements, efficiency, and harmonic output. This generally suitable optimum ratio requires tank capacitances of approximately 200 $\mu\text{fd.}$ at 3.5 mc., 100 $\mu\text{fd.}$ at 7 mc., 50 $\mu\text{fd.}$ at 14 mc., the tank capacitance being inversely proportional to frequency.—EDITOR.

What the League Is Doing

League Activities, Washington Notes, Board Actions—For Your Information

New Regulations

At the request of the A.R.R.L. Board of Directors the F.C.C. on June 18th doubled the width of the ten-meter 'phone allocation, extended the requirement of adequately-filtered direct-current power supply to that whole band, and opened the band to portable-mobile operation under the same regulations as apply to the higher frequencies. The actual changes made in the wording of the regulations were as follows:

(1) In Rule 376 the words "23,000 to 23,500 kilocycles" were changed to read "23,000 to 29,000 kilocycles," so as to open the low-frequency half of this band to 'phone.

(2) In Rule 382 the stipulated frequency was changed from "14,400 kilocycles" to read "30,000 kilocycles", so as to require the use of adequately-filtered direct-current power supply on all frequencies below 30,000 kilocycles.

(3) In several places in Rules 368 and 387 the stipulated frequency "56,000 kilocycles" was changed to read "28,000 kilocycles," so as to extend portable-mobile operation to the band 28,000-30,000 kc. under precisely the same regulations as have applied in the past to frequencies above 56,000 kc.

The Commission also gave us for the first time a rule specifically prohibiting overmodulation and strengthening the requirement that all amateur signals of whatever type comply with good engineering practice, to reduce interference to other amateur stations. This was accomplished by adopting new language for their Rule 381, as follows:

"Spurious radiations from an amateur transmitter operating on a frequency below 30,000 kilocycles shall be reduced or eliminated in accordance with good engineering practice and shall not be of sufficient intensity to cause interference on receiving sets of modern design which are tuned outside the frequency band of emission normally required for the type of emission employed. In the case of A-3 emission, the transmitter shall not be modulated in excess of its modulation capability to the extent that interfering spurious radiations occur, and in no case shall the emitted carrier be amplitude-modulated in excess of 100 per cent. Means shall be employed to insure that the transmitter is not modulated in excess of its modulation capability. A spurious radiation is any radiation from a transmitter which is outside the frequency band of emission normal for the type of transmission employed, including any component whose frequency is an integral multiple or sub-multiple of the carrier frequency (harmonics and sub-harmonics), spurious modulation products, key clicks and other transient effects, and parasitic oscillations."

The six field monitoring stations of the F.C.C. are now equipped with oscilloscopes, one of the

uses of which will be to check up on overmodulation by 'phone amateurs.

Cairo Committee

The A.R.R.L. Cairo Committee held its first meeting in Syracuse, N. Y., on June 20th on the eve of the Atlantic Division convention. The committee sends us the following report of its first day's meeting for the information of members:

"The Cairo Committee held its initial formal meeting at the Hotel Syracuse this morning. Directors Woodruff, Bailey and Roberts were all present, with Director Hill of the Hudson Division sitting in as advisory spectator. Irving Cassidy, of Cleveland, Ohio, acted as secretary of the committee. He will very likely be retained in that capacity for the rest of the meeting and perhaps for subsequent meetings. The sessions of the Cairo Committee will continue to-morrow morning, at which time it is hoped definite arrangements will be made for initiating the Cairo campaign. Matters discussed to-day were as follows:

"(1) Representation of the I.A.R.U. by the A.R.R.L. at the coming C.C.I.R. conference at Bucharest was considered by the committee and endorsed most heartily. The personnel of such representation will be decided a little later.

"(2) The personnel of League representation at Washington for the preliminary conferences that have the formulating of the U. S. proposals for Cairo was taken under advisement. Ten individuals have been suggested as sources of information in the selection of said personnel. These individuals will be approached as soon as possible.

"(3) It was decided that there should be published in *QST*, in an early number, a list of the officially registered allocations in the bands in special question, namely, from 7300 kc. to 7500 kc., and possibly from 4000 kc. to 4500 kc.; said listing to include calls, locations and frequencies; and said listing not to be in type of small size, even if the listing should displace apparently important matter. Also appended to the listing should be mention of the great number of mobile and other special stations assigned to these bands. The objects of this listing are to call attention to the real density of occupancy of these ranges, as well as to furnish data for the desired activity surveys soon to be initiated.

"Further consideration of the Cairo matters was postponed for subsequent meetings."

The Cairo Committee has drawn up plans for an occupancy survey, and requests all interested amateurs to volunteer their services as observers. Suitable blanks and necessary information will

be provided by the Communications Department. The first survey will be of the region 6000-8000 kc. See the announcement on page 59 of July *QST*.

C.C.I.R. The A.R.R.L. Board has decided to offer to represent the I.A.R.U. at the fourth meeting of the C.C.I.R. in Bucharest in 1937 if the other member-societies of the Union will make small contributions to the expense. On any prorated basis A.R.R.L. will be standing the lion's share, since we have by far the largest membership list and cover about two-thirds of the world's amateurs. The Bucharest meeting will be particularly important as a prelude to Cairo.

Unfair Criticism We quote the following words of wisdom and information from Director Caveness' monthly bulletin, "The Tarheel Ham":

"Remember that if the Board's actions do not meet your approval, that in itself does not justify you in pulling out from the League and starting a wave of adverse criticism of the League and its policies. Your director is your spokesman, and if things don't go the way you like them to go, hop him about it. But remember that as an individual you are just *one* of the many thousands of amateurs in the United States and that the vast majority may not desire the same things that you want. And another thing! Hi! Be sure you have the right dope before you begin criticism of your League and its policies or of the actions of your director. For instance, one powerful 20-meter 'phone station in the midwest, immediately after the Board meeting, was on the air about 12 hours every day for several days railing against the failure of the Board to extend the 'phone bands. According to his story, told and retold, when the matter was voted on at the Board, the vote was *tied* and Warner cast the vote against the 'phones. That's an example of infamous and inexcusable ignorance. Any League member should know that Warner does not have a vote in League matters. And besides, Mr. Warner, in his annual report, recommended that the 'phone bands be widened, especially the 20-meter band! So, be sure to get the correct dope, and then let's have your criticism, suggestions, judgments, or what have you. That's what makes the League a thriving organization!"

Commission on the Job Those who think that the F.C.C. doesn't trouble itself much about regulating amateur radio—that pink slips are just an incident, that unlicensed operation can be got away with without danger of discovery—had better think again. The Commission takes disciplinary action in from 6 to 10 cases weekly. Just to see what was going on, we tabulated the actions taken by the

Commission in amateur matters during the two-weeks period from May 28th to June 11th. Action was taken in 17 cases. Eight individuals were "barred from examination for radio operator privileges for a period of six months from date, because he unlawfully operated an unlicensed amateur station without a valid operator's license." Seven licensed amateurs had their operator's licenses suspended for a period of six months because the holder operated an unlicensed amateur station. In one case an order was entered cancelling an operator's license because the licensee obtained his ticket by fraudulent means, indicating on his application that he was a citizen of the United States when in fact he was an alien. Another amateur was barred from examination for radio operator privileges for a period of one year, because he unlawfully obtained an amateur operator's license by fraudulent means; in addition to this, his existing operator's license was suspended for two years and his station license was revoked, all for the same offense.

These are all typical cases, in average quantity and in about the usual proportions. Falsification of license applications is regularly—and almost inevitably—uncovered. In the course of a year several hundred unlicensed operators are penalized; the percentage is surprisingly high. These suspensions mean something, too. Once a name is on the Commission's files for violation, its possessor is under regular surveillance, and the penalty for violation is a fine of up to \$10,000 and/or a prison term of up to two years.

"Ham" We reproduce as pertinent to-day an editorial which appeared in *QST* in December, 1931:

Approximately every so often an anguished member writes in to ask us how we can dare to apply the term *ham* to radio amateurs. Not because it is undignified, for we're not much on false dignity in amateur radio, particularly within our own family, but because, says our correspondent, everybody knows that a *ham* means a punk, a lid, a poor performer, a person not fully familiar with his vegetables. Why throw asparagus upon ourselves, our inquirers ask.

Now we arise to remark that if we felt for one moment that that was a correct interpretation of the meaning of *ham*, it would be a thoroughly hated word at the very top of our Index Expurgatorius. We'd have a town ordinance in West Hartford prohibiting its utterance and we'd pay a bounty to *QST*'s proof-readers to run down the despised term. But as a matter of fact we're quite convinced that the appellation is an honorable one, one over which we need have no qualms whatever.

Somebody's dictionary suggests that *ham* is derived from *hamfatter*, which was a word used in a popular refrain of many years ago. Just what the significance was is not now clear. Then there are

many people who believe that the word comes from the theatrical field, being derived from "Hamlet"—because the *ham actor* was forever strutting the boards and reciting from "Hamlet". For ourselves, we find a much more convincing account in an article on the etymology of the language of sports, by William Henry Nugent, appearing in *The American Mercury* several years ago. Mr. Nugent establishes that the United States learned its first lessons in sports journalism and sports slang from the British Isles, where early writers invented a special style and vocabulary that are still in use. *Ham*, says he, "began as an abbreviation of *amateur* to *am*, which the cockney foot-racers and pugilists of the 70's pronounced *h'am*."

The moment one glimpses that *ham* is derived directly from *amateur*, much is apparent that before escaped recognition. One has only to consider, for instance, the way the word *amateur* is abused. Webster says that an amateur is "one who is attached to or cultivates a particular pursuit, study, or science from taste, without pursuing it professionally"; there is no implication of lack of skill. Yet how often have we heard people say, speaking of many things besides radio, "Pooh, he's only an amateur!" They are wrong, dear friends, as sure as you're born, and they've merely displayed the depths of their ignorance. We accept no such connotation with respect to *amateur*; neither do we with respect to *ham*, and for the identic reason.

The word came to us in amateur radio from the wire telegraphing fraternity, where a beginning operator was known as a *ham operator*. That our wire brethren, in professional scorn, employed it to mean a poor operator does not make that application correct; the misuse is, in fact, blood brother to the even more common distortion of *amateur*. If we borrowed the term from them we took it in its proper sense, and emphatically left behind any stigma of the opprobrious. There is, we repeat, nothing in the derivation of either *amateur* or *ham* to imply a lack of skill, but rather the contrary.

Hams we are, then, and proud of it!

Louisiana State Convention (Delta Division)

Hotel Jung, New Orleans, La., August 24th and 25th

THE New Orleans Radio Club is sponsoring its first state convention, and the Hotel Jung at 1500 Canal St., New Orleans, will be the center of the greatest amateur gathering ever held in this city.

A cordial invitation is extended to all radio amateurs to attend and of interest are the registration figures: \$2.00 for the hams and \$1.50 for the ladies.

Further information may be obtained from E. H. Treadaway, Secretary, 1720 Poydras St., New Orleans, La.

Northwestern Division Convention

Spokane, Wash., August 24th and 25th

WHEN a committee starts working on convention plans nearly a year before the date, you may be assured that it means business, and anyone who has seen the program prepared under Chairman Miller knows that it will be an outstanding affair.

Featured at the convention will be the various contests on which every amateur should inform himself if he hopes to get the most out of the convention program. To date they are:

The Rothrock Memorial Key (for the most outstanding station)

The S.R.O.C. Trophy (for the highest traffic total)

The Equipment Competition

The Code Speed Contests (for sending and receiving and for both amateurs and "commercial" amateurs)

The QSL Card Contest

Many prominent speakers will be present, and one of these will be Clinton B. DeSoto of A.R.R.L. Headquarters.

Circulars giving more details have been mailed to all amateurs, but further information may be obtained by writing W. L. Miller, Chairman, 604 East 18th St., Spokane, Wash.

Rocky Mountain Division Convention

August 31st and September 1st, Greeley, Colo.

THE Elks Club has been chosen as the meeting place for the convention activities being sponsored by the Greeley Radio Amateurs who extend a cordial invitation to all interested in amateur radio to attend.

There will be a big picnic at Island Grove Park on Sunday and many interesting meetings all through the convention. A.R.R.L. Headquarters is sending Clinton B. DeSoto, who will have some gadgets with him. He is the one who handles International Amateur Radio Union matters, and will be able to enlighten those present on many questions.

The attendance fee is \$2.00, ladies \$1.50 if not drawing on prizes.

D. L. Clark, the Secretary, Box 508, Greeley, Colo., is prepared to furnish further information on request.



One of the San Francisco five-meter boys is trying his best to suppressor-grid modulate a 45 in a Hartley circuit!

—W6LON

The 803—High-Power Pentode

AMATEURS are getting the breaks in the matter of transmitting tubes these days. On the heels of the announcement of the RK-28, described in our last issue, comes the release of a new RCA-deForest type—the 803, a 2000-volt pentode transmitting tube having a plate dissipation rating of 125 watts and an output rating of approximately 200 watts. It is a graphite-plate tube in a dome-top envelope about half again as large as the familiar 203-A blank, has the plate connection brought out the top, and is equipped with the new giant five-prong base.

Tentative characteristics and ratings on the tube are as follows:

Filament voltage	10 volts
Filament current	3.25 amps.
Mutual conductance (at 55 ma. plate current)	4000 microhms
Interelectrode capacities:	
Grid-plate (with external shielding)	0.15 μ fd. max.
Input	15.5 μ fd.
Output	28.5 μ fd.

CLASS-B TELEPHONY

As a Class-B r.f. amplifier, the 803 carries the following maximum ratings:

Plate voltage	2000 volts d.c.
Screen voltage	600 volts d.c.
Suppressor voltage	60 volts d.c.
Plate current	90 ma.
Plate dissipation	125 watts
Screen dissipation	20 watts

Typical operating conditions for this service are as follows:

Plate voltage	2000 volts
Screen voltage	600 volts
Suppressor voltage	40 volts
Grid voltage	-40 volts
Peak r.f. grid voltage	55 volts
Plate current	80 ma.
Screen current	15 ma.
Grid current	3 ma.
Driving power (approx.)	1.5 watts
Carrier output (approx.)	53 watts

At 1500 and 1250 volts plate, the operating conditions are the same as above except that the carrier outputs are 40 and 33 watts respectively. Carrier power figures are based on 100% modulation capability.

SUPPRESSOR MODULATION

Maximum ratings for suppressor modulation are the same as for Class-B telephony with the exception of the screen dissipation, which is raised to 30 watts. Typical operating conditions for suppressor modulation are as follows:

Plate voltage	2000 volts
Screen voltage	500 volts
Suppressor voltage	-135 volts

Grid voltage	-50 volts
Peak r.f. grid voltage (approx.)	120 volts
Peak a.f. suppressor voltage	175 volts
D.c. plate current	80 ma.
Screen current	55 ma.
Grid current	15 ma.
Screen resistor	27,000 ohms
Driving power (approx.)	1.6 watts
Carrier output power (approx.)	53 watts

At lower plate voltages the power output varies in the same way as with Class-B telephony.

GRID-BIAS MODULATION

Maximum ratings for grid-bias modulation correspond with those for Class-B telephony. Typical operating conditions are listed below:

Plate voltage	2000 volts
Screen voltage	600 volts
Suppressor voltage	40 volts
Grid voltage	-80 volts
Peak a.f. grid voltage	50 volts
Peak r.f. grid voltage	110 volts
Plate current	80 ma.
Screen current	15 ma.
Grid current	4 ma.
Driving power (approx.)	2 watts
Carrier power output (approx.)	53 watts

The output power varies with plate voltage about as with Class-B telephony.

C. W. TELEGRAPHY

As a Class-C telegraph amplifier the maximum ratings are as follows:

Plate voltage	2000 volts
Screen voltage	600 volts
Suppressor voltage	60 volts
Plate current	175 ma.
Grid current	50 ma.
Plate dissipation	125 watts
Screen dissipation	30 watts

Typical operating conditions for c.w. work are as follows:

Plate voltage	2000 volts
Screen voltage	500 volts
Suppressor voltage	40 volts
Grid voltage	-30 volts
Peak r.f. grid voltage (app.)	150 volts
Plate current	160 ma.
Screen current	42 ma.
Grid current	16 ma.
Screen resistor	36,000 ohms
Driving power (approx.)	1.6 watts
Power output (approx.)	210 watts

The 803 is, as the tables indicate, economical of driving power to a highly satisfactory degree. It has been tried out in the experimental set-up described in July *QST* under conditions identical with those used in testing the RK-28. The performance of the two tubes, with due allowances for the slight differences in ratings, is almost identical.

GENERAL CONSIDERATIONS

The rated plate dissipation of the tube

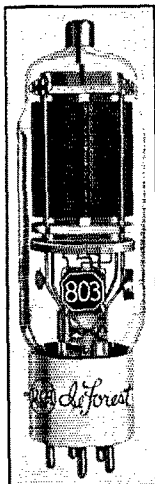

should not be exceeded. Rated plate dissipation will cause the graphite plate to show a barely perceptible red color when the power is cut off with the tube operating in the dark. It should show no color whatsoever in a normally-lighted room.

For tube protection, screen voltage preferably should be obtained from a series resistor or voltage divider from the plate supply. Separate screen supply can be used, but provision should be made for ensuring that the screen voltage cannot be applied when plate voltage is removed. Application of screen voltage alone is likely to damage the screen. The screen should not be allowed to attain a temperature corresponding to more than a barely perceptible red color.

It is important that adequate shielding between input and output circuits be used to prevent self-oscillation. A shield around the lower part of the tube enclosing the circular plate at the bottom will aid in reducing feedback. Suppressor and screen grids should be adequately by-passed to ensure their operation at ground potential.

The 803 may be operated at maximum ratings up to 20 megacycles. Plate voltage and input power should be reduced at frequencies higher than 20 mc.

Suitable grid-leak values are between 2000 and 4000 ohms.

—G. G.

Pacific Division Convention

August 31st, September 1st and 2nd, Los Angeles, Calif.

THE Federation of Radio Clubs of the Southwest sponsoring this year's convention announces one of the fullest programs ever attempted, with side trips to movie and recording studios, well-known technical speakers, and honest-to-goodness entertainment topping the bill. The Hotel Biltmore is the place for all meetings. An innovation is planned in holding the banquet on Sunday night, making it possible for those living at great distances to have ample time to return home, but the convention will not end on Sunday, as Monday has a full program outlined for those able to stay.

The customary fee of \$3.00 will be in effect. Further information will be furnished by C. M. Feay, 10428 Orange Ave., Southgate, Calif.

Missouri State Convention

September 7th and 8th, Hotel Connor, Joplin, Mo.

HURRAH, gang! We were able to plan our convention to coincide with A.R.R.L. Headquarters' traveling plan which makes it pos-

sible for Clinton B. DeSoto, who will be covering the conventions in the north circle, to be with us.

The Ozark Amateur Radio Association is most pleased to extend to all amateurs in the state of Missouri and surrounding states a cordial invitation to be with us for two days of jollification, and our theme is to be "20th Century Amateur Radio." Convention Fee \$2.00—extra YL's 50 cents each. J. R. Marcum, Convention Manager, 1715 Picher, Joplin, Mo., would like to hear from you.

A.R.R.L. QSL Bureau

FOR the convenience of its members, the League maintains a QSL-card forwarding system which operates through volunteer "District QSL Managers" in each of the nine U. S. and five Canadian districts. In order to secure such foreign cards as may be received for you, send your district manager a standard No. 8 stamped envelope. If you have reason to expect a considerable number of cards, put on an extra stamp so that it has a total of six-cents postage. Your own name and address go in the customary place on the face, and *your station call should be printed prominently in the upper-left-hand corner*. When you receive cards, you should immediately furnish your QSL manager with another such envelope to replace the used one. List of managers follows:

W1—Allen W. Jones, W1NW, 1626 Commonwealth Ave., Boston, Mass.

W2—H. W. Yahnel, W2SN, Lake Ave., Helmetta, N. J.

W3—R. E. Macomber, W3CZE, 418 10th St., N. W., Washington, D. C.

W4—B. W. Benning, W4CBY, 520 Whiteford Ave., Atlanta, Ga.

W5—E. H. Treadaway, W5DKR, 2749 Myrtle St., New Orleans, La.

W6—C. E. Spitz, W6FZQ, Box 1804, Phoenix, Ariz.

W7—L. Q. Kelly, W7BPC, 4919 So. Prospect St., Tacoma, Wash.

W8—F. W. Allen, W8GER, 324 Richmond Ave., Dayton, Ohio

W9—George Dammann, W9JO, 319 Sherman Ave., Evanston, Ill.

VE1—J. E. Roue, VE1FB, 84 Spring Garden Rd., Halifax, N. S.

VE2—W. H. Oke, VE2AH, 5184 Mountain Sights Ave., N. D. G., Montreal, P. Q.

VE3—Bert Knowles, VE3QB, Lanark, Ont.

VE4—Dr. J. J. Dobry, VE4DR, Killam, Alberta.

VE5—E. H. Cooper, VE5EC, 2024 Carnarvon St., Victoria, B. C.

K4—F. McCown, K4RJ, Family Court 7, San-turce, Puerto Rico.

Simple Methods of Checking Modulation to Comply With the New Regulations

By James J. Lamb*

MEANS shall be employed to insure that the transmitter is not modulated in excess of its modulation capability"—from the new F.C.C. Rule 381 concerning spurious radiations. But "means" does not necessarily mean expensive special modulation-measuring equipment; and "modulation capability" is not restricted solely to the one figure of 100%. Modulation capability of a particular transmitter is defined as, "the maximum percentage modulation that is possible without objectionable distortion," according to the 1933 I.R.E. Standardization Report. The top limit is, of course, 100%.

Actually, the "means shall be employed" clause is intended to require a bare minimum in ordinary transmitter equipment, not necessarily special new equipment additional to what a passable amateur 'phone should have. It does not require means of measuring the actual percentage of modulation. The principal reason for putting this clause in the regulation, incidentally, was that not a few amateur transmitters have been operating without any "means" at all of checking operation—some even without a plate milliammeter. It certainly was not put in for the purpose of compelling amateurs to buy expensive equipment additional to what a normal 'phone outfit has.

CARRIER SHIFT METHODS

Since modulation in excess of the modulation capability of a constant-carrier type transmitter generally will be accompanied by what is commonly known as "carrier shift," or a deviation in average amplitude from the unmodulated amplitude, any instrument capable of showing up this effect will suffice. As has been pointed out repeatedly in *QST*, and is also emphasized in the 'phone chapter of the A.R.R.L. *Handbook*, the average value of a modulated r.f. stage's plate current is generally proportional to the average amplitude of the modulated wave. Since the average amplitude of the modulated wave is constant and is equal to the unmodulated carrier amplitude, so long as the modulation is symmetrical and the d.c. supply voltage is constant (as should be the case in a transmitter operating within its modulation capability), the average plate current also will be constant. Actual checks against simultaneous cathode-ray indications teach us, however, that some overshooting of the transmitter's modulation capability is likely to occur before the r.f. stage's plate milliammeter reading begins

* Technical Editor.

to show noticeable evidence of carrier shift with speech modulation. This is particularly so with plate modulation of Class-C r.f. amplifiers using either Class-A or Class-B modulators. On the other hand, the plate meter of a grid-bias modulated or Class-B linear r.f. stage seems to be considerably more sensitive in showing carrier shift. The rule is, then, that the audio gain should be set safely below the point at which variation in the modulated stage's plate milliammeter reading indicates carrier shift and overmodulation on normal speech. A little intelligent experimenting, combined with common sense judgment and continuous vigilance, make this a proper "means to insure."

The simplest separate means is a visual modulation monitor consisting of a "linear" rectifier (detector) circuit using, say, a diode with a high-resistance load or a triode with high-resistance cathode bias, and containing a d.c. milliammeter (0-1 ma.). Here again the average current, as indicated by the d.c. milliammeter, should remain constant so long as the modulation capability of the transmitter is not exceeded. Such a simple and positive shift indicator is described in further detail in W. C. Lent's article elsewhere in this issue.

OTHER METHODS

Of course more elaborate means, such as the cathode ray oscilloscope and peak v.t. voltmeter (modulometer), will more than suffice. Also, volume level indicators in audio circuits can be used *provided* the volume level indications are on an actual speech basis and are checked against carrier-shift or cathode-ray measurements often enough to insure that the audio indication really shows proper modulation level. (See notes regarding speech modulation level indications in "Technical Topics," June *QST*, and George Grammer's article elsewhere in this issue.) It is especially important with Class-B modulators that grid or plate d.c. indications be used on a speech basis and not on the single-tone basis of the tube manufacturer's rating.

Unless the transmitter's performance has been checked by oscillograph and carrier-shift methods, thermocouple ammeter or current-squared galvanometer r.f. indications are not to be trusted. The basic reason for this is that these instruments show r.m.s. current values of the modulated wave or indicate *average* radiated power—which may or may not be useful in revealing

whether or not the modulation is proper. It must be remembered always that modulation limitations are in terms of *maximum amplitude*, and that the relationship between amplitude and r.m.s. values is determined by wave form. Not only is speech far from simple in wave form (as was outlined in June *QST*), but also the wave form of the modulating signal may be drastically distorted in the transmitter. Although the half-power value for normal speech modulation, as compared to the single-tone value, works out in practice with such r.m.s. instruments, they are unable to reveal improper modulation with any certainty. Further, the permissible range of variation in readings of such meters with speech modulation is proportionately so small—and the sluggishness of the instruments so great—that they must be considered as less desirable “means to insure.”

Reverse-current rectifier indicators in plate modulation systems, such as that described by W8AWG on page 49 of March 1933 *QST* and in *Hints and Kinks*, will show 100% *negative* modulation peaks—but tell nothing about what's happening on the positive peaks. Therefore, they are not completely satisfactory for showing whether the modulation capability of the transmitter is being exceeded, since the positive peaks may be flattening before 100% negative modulation is reached. However, this method is generally sufficient, especially when a carrier-shift indication is employed in conjunction.

SPEECH AMPLIFIER DISTORTION

It is of no less importance that spurious radiations can originate in the audio circuits prior to the modulator, as the result of overloading and amplitude distortion in the speech amplifier. Parasitic oscillation both at audible and super-audible frequencies also can occur, the latter causing spurious sidebands sticking out disastrously on either side of the carrier. It has been found that a common cause of such oscillation is excessive screen voltage on a screen-grid audio amplifier tube. Since unsymmetrical modulation usually results from the even-harmonic distortion produced by such abnormalities, generally they, too, cause the effect of carrier shift. Their elimination is really a problem of design, however, and they should be cleaned up by testing of the audio circuits before the transmitter is put on the air at all. A good check is obtained by metering the plate current to the successive stages operating Class-A. The respective plate current values should be constant. Oscillation will show up usually as a jump in plate current at a critical point as the gain control is advanced toward maximum. If oscillation occurs with a resistance-coupled screen-grid amplifier in the line-up, immediately suspect its screen voltage of being too high—and lower it.

CHECKING CONTROLLED-CARRIER 'PHONES

Controlled-carrier 'phone, using one of the systems intending to vary the carrier level in proportion to the modulation level, introduces special problems in checking for proper speech modulation during actual operation. The ordinary carrier-shift methods are unsuited, of course, because the carrier is intentionally being shifted continually. Cathode-ray checking is also limited to indicating “bumping” of the negative peeks, since the rapidly changing picture can hardly be analyzed by visual inspection. The reverse current indicator for negative modulation peaks can be used to as good advantage here.

Direct checking for spurious radiations by examining the frequency spectrum of the transmitted wave, by means of a selective receiver, is a conclusive method. Such a check need not be made continually, of course, but can be made periodically while a speech-level indicating meter in the transmitter is calibrated for the maximum limit. Equally applicable to constant-carrier and controlled-carrier transmission, we have found this method of checking a controlled-carrier 'phone to be quite effective, a receiver of the Single-Signal type, incorporating a crystal filter, being used.

With a dummy antenna connected to the transmitter's output (as it always should be for testing not involving communication), the transmitter is given preliminary adjustment as required by its particular design. (See W2HLM's article on controlled-carrier 'phone in January 1935 *QST*.) With a receiver that is properly shielded, a transmitter of usual power can be monitored in the same room. We have done so with a 100-watt outfit, for instance, using a standard type s.s. receiver. If the pick-up is excessive, so as to overload the receiver's input circuit, the receiver can be placed in another room or the monitoring can be done at a neighboring ham station. The test procedure is as follows:

With the receiver adjusted for maximum selectivity and the carrier tuned in “on the nose,” the beat oscillator is switched on and set to zero beat. A.v.c. should be switched “off” and manual r.f. gain set at a suitable level to accommodate the carrier strength. Then, while the transmitter is speech modulated by a talking assistant, the receiver tuning is varied back and forth slowly, through the signal spectrum. As this is done, bursts of sound produced by beating between the heterodyne oscillator and the sideband components of the speech (picked out by the selective filter) will be heard. Their intensity should decrease rapidly either side of the carrier tuning setting, their difference from the carrier frequency being indicated by pitch of the steady beatnote between the carrier and local oscillator. *If no spurious modulation products are present, the speech sidebands should become practically inaudi-*

H A M D O M



TO transpose both words and implication, "wine, women and song" in the case of J. B. Wathen III, W9BAZ, becomes "rye, redheads and radio." As vice-president in charge of sales promotion of the American Medicinal Spirits Co., he disposes of the output of America's largest whiskey distillery—one of the fifth generation of Wathens who have been in the whiskey business since 1788. His interest in amateur radio began in the eighth grade at school, some fifteen years ago. He has been continuously on the air since that time, with appointments ranging through O.R.S., R.M., S.C.M., and Army-Amateur N.C.S.; in 1934 he was elected Alternate Director of the Central Division, and has since been appointed Assistant Director. A charter member of Trunk Line "J," his is the only station of the original group still on that line; his activity in the (Louisville) Amateur Radio Transmitting Society is also outstanding.



HAMS visiting Halifax, Nova Scotia, identify the shack of A. M. Crowell, VE1DQ, by the giant moosehead mounted over the door. Inside is the 200-watt transmitter used on 3.5-mc. c.w. and 'phone for rag-chewing and friendly contacts. His favorite band, however, is 14 mc.—quite appropriate for an old-time DX man. VE1DQ holds ROTAB certificate No. 2, dated Jan. 3, 1924. His biggest thrill (except for the first transatlantic QSO) was working ZC6FF, thus landing WAC and WBE at one stroke. The biggest thrill on 'phone was an hour's solid QSO with ZS1H, Capetown, last year. He first worked Europe on 14-mc. 'phone, Nov. 11, 1926; still needs Asia and Oceania for that 'phone WAC. His profession is chief projectionist (talkie op to you). Art Crowell has an ideal philosophy; he takes radio very lightly and considers it a hobby in the purest sense of the word. Having already gone through the mill with traffic, schedules and the like, he now finds time only for rag-chewing and DX.



HE never saw a spark set, but he's King of the O.R.S. The 1 kw. from W9AUH has thundered to victory in more O.R.S. parties (he's a Sweepstakes winner, too) than any other station, but there still remains the ambition of working all sections in some contest. G. W. Mossbarger, 41, white, handsome, muddy blonde, blue eyes, has radio for vocation and avocation, for he is vice-president and general manager of the Universal Radio Supply Co. During the War he



was material engineer for the Goodrich Company, and later a superintendent of public works. He entered ham radio in 1926 via 160-meter 'phone; has since been WAC several times; and his 3.5-mc. signal is reported all over the world. His other hobbies are boxing, football, baseball, racing, tennis, golf, domestic and foreign 7-11, soccer, hamfests, and the N.C.R. — in which, as Chief Radioman, he cruises each summer.

WHEN not on some Oregon stream or bay fishing for the famous Oregon salmon or in the shack of W7WL pounding brass, Frank L. Bernhardt of North Bend, Oregon, has been helping Uncle Sam with his postal service for the past twelve years. Prior to that he taught vocational work in high school for ten years and became interested in radio through necessity; his pupils always insisted on asking his advice in radio matters. Although he worked his first "wireless" in 1909, he did not become licensed until 1926. An early Extra First Class licensee, he now is Class A, O.R.S., O.O., W.A.C., sometime R.M. and S.C.M., and charter member and ex-president of the Coos Bay Amateur Radio Club. A member of the Kiwanis Club, W7WL is interested in civic affairs as well as radio. He is married and has two children, one a junior op of 9.



The Application of Iron-Core I.F. Transformers to Amateur-Band Superhet Design

A Single-Stage I.F. Amplifier of Good Gain and Selectivity

By Harold M. Detrick and Irley Morrison,* W9KGM

RADIO engineers have long been familiar with the fact that increasing the permeability of a transformer core, providing the losses in the core are low, will greatly increase the efficiency of the coil; for, because of the higher permeability, less wire is required for any given inductance, thereby lowering the r.f. resistance and also the distributed capacity. This results in a much higher- Q coil. The Q of a coil is, of course, the measure of its sharpness of resonance or selectivity, Q being equal to $2\pi fL/R$.

Since the losses at radio frequencies increase with frequency, the problem has been to make a coil with sufficiently high permeability but with a minimum of loss. To do this, a core has been de-

else, the non-magnetic type of coupling being more compact. Both of these types are very sensitive to stray capacity effects, certain positions of the leads, trimmers, etc., producing an over-coupled condition. Therefore, considerable care has been taken to reduce this to an absolute minimum by the use of spacers and the proper placement of leads.

Essentially, the iron cores of to-day are composed of minute particles of iron suitably oxidized and held together with a binder material having a very low dielectric loss. The reason for the increase in the Q or figure of merit of a coil wound on this powdered iron core lies in the fact that while air has a permeability of one, the permeability of iron is many times

greater. Consequently, fewer turns of wire are used for a given inductance when wound on this iron core—resulting in less r.f. resistance and lower distributed capacity. This iron material is so treated that variations in temperature and humidity have no effect upon its performance. The fine division of the iron breaks up its magnetic structure and reduces eddy current losses, which would make ordinary iron unusable at radio frequencies.

With the use of this new iron core it is possible to design coils having a Q approximately twice

that of air-core coils and, since the resonance voltage is equal to Q times the applied voltage (QE), the voltage gain of iron-core units is also approximately double that of air-core coils.

Since most amateurs are primarily interested in the actual application of any development to their own particular field, an intermediate frequency amplifier circuit is shown from the first detector through to the second detector, and the gain and selectivity curves with iron-core i.f. transformers are compared with those of a similar

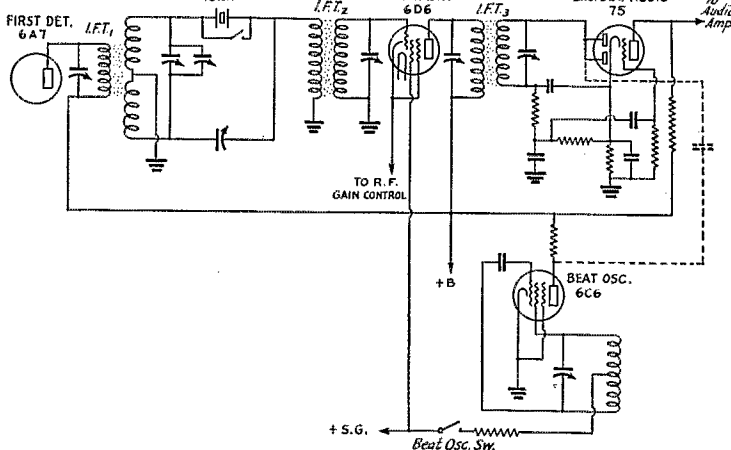

FIG. 1—SCHEMATIC ARRANGEMENT OF THE SINGLE-STAGE I.F. AMPLIFIER USING IRON-CORE TRANSFORMERS

veloped using powdered iron, moulded with bakelite, having approximately 90% iron content. The coil is wound directly on the core and an optimum coil-form size has been developed which compromises between distributed capacity and core dimensions.

Various types of coupling have been developed both of the magnetic and non-magnetic type. Which is the better is more a personal preference in overall size and compactness than anything

* Both of The Hallicrafters, Inc., 3001 Southport Ave., Chicago, Ill.

receiver equipped with good air-core i.f. units. Both of these intermediate amplifiers are equipped with a crystal filter, although their in-

develop i.f. amplifier sensitivity of better than 5 microvolts (for 50-milliwatt audio output). Of course this i.f. sensitivity is hardly required for the

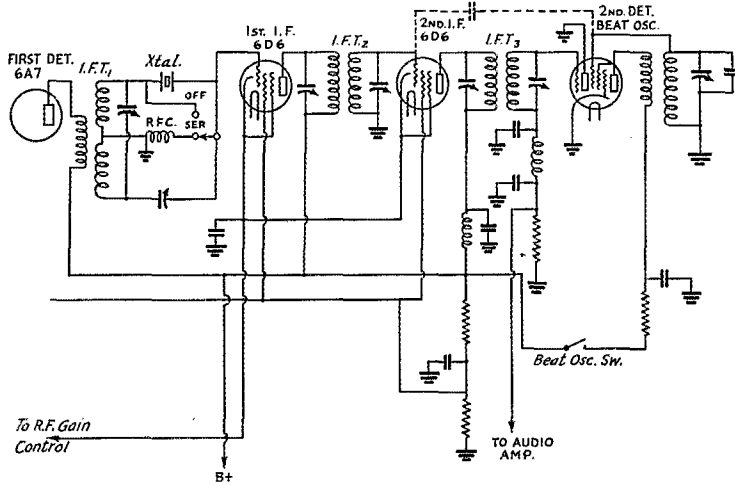

FIG. 2.—THE TWO-STAGE I.F. AMPLIFIER CIRCUIT USING AIR-CORE COILS

put circuits differ somewhat in detail. As will be noted, the circuit with iron-core transformers (Fig. 1) provides transformer coupled output from the filter circuit, in contrast with the simple choke coupling shown in Fig. 2. As has been shown previously in *QST*,¹ the correct design of the i.f. crystal filter circuit has considerable bearing on the sensitivity and selectivity of the receiver, since even with the crystal shorted only one-half of the voltage developed across the "split" secondary of the first i.f. transformer is utilized, making it necessary to increase the gain at the filter output by providing a step-up to the grid of the first i.f. amplifier tube. In fairness to the air-core circuit of Fig. 2, it should be pointed out that this improvement, shown in the circuit of Fig. 1, gives the i.f. amplifier using iron-core transformers some advantage in addition to iron-core coupling.

As can be seen from the schematic in Fig. 1, the i.f. amplifier described here using iron-core (Ferrocart) i.f. units has only one stage of amplification, while the circuit shown in Fig. 2 has two stages using air-core intermediate frequency transformers. Now, your thought will be, "is it possible to get sensitivity from a single stage equal to that developed in two stages?" Actually, a comparison of the overall sensitivity of the two units shows the one-stage iron-core unit to have the advantage. This is partly due to some audio gain developed in the 75 detector, as well as to the improvement previously mentioned. By using a Type 75 or 85 detector, it is possible with one stage of i.f., using iron-core transformers, to

amateur receiver using an efficient pre-selector stage, as is necessary for good image ratio, but this makes it possible to reduce the gain of the i.f. amplifier and thereby increase the overall signal-to-noise ratio considerably. This is a worthwhile advantage in itself, permitting development of a receiver which has effective overall sensitivity of 1 microvolt—which is useful signal sensitivity rather than sensitivity based on output containing a lot of noise.

The selectivity comparison of the two 465-kc. amplifiers, shown by the curves of Fig. 3,

can be tabulated as follows:

Times Input At Resonance	Band Width	
	Air	Iron
10	13 kc.	7 kc.
100	21 "	14 "
1000	31 "	24 "
10,000	62 "	44 "

(Continued on page 89)

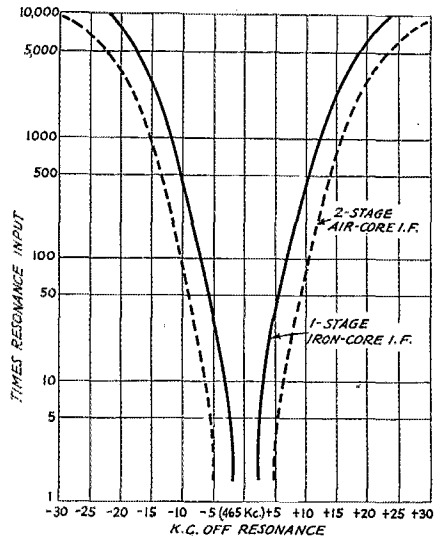

FIG. 3—SELECTIVITY CURVES FOR THE TWO I.F. AMPLIFIERS, WITH THE CRYSTAL SHORTED OUT, SHOWING THE IMPROVEMENT ACCOMPLISHED IN THE SINGLE-STAGE ARRANGEMENT WITH THE MORE EFFICIENT CRYSTAL FILTER CIRCUIT AND IRON-CORE TRANSFORMERS

¹ "Developments in Crystal Filters for S.S. Superhets," *QST*, Nov., 1933.

With the Affiliated Clubs

SUMMER is showing results—sunburn, and more of it! And, with amateur radio, many activities have been discontinued. Numerous clubs have adjourned meetings until fall. The old ham spirit, however, goes on apace, perpetuated by hamfests, conventions and other get-togethers where we meet our brothers face-to-face.

AUGUST HAMFESTS

The South Hills Brass Pounders and Modulators of Pittsburgh will hold their annual Hamfest at Clattys Driving Range, Bower Hill Road, Mt. Lebanon, Pittsburgh, Pa., Sunday, August 4th. They invite you!

The Fox River Radio League's eighth annual Hamfest will be held August 4th at Exposition Park, Aurora, Illinois. The program consists of contests, demonstrations, speeches, prizes and a feed. Tickets, \$1.00 each.

A JOINT MEETING

June 1st was a gala day for the amateurs of Georgia, Tennessee and Alabama who gathered in



CANADIAN AMATEURS ENJOYING A HAMFEST AT REGINA, SASKATCHEWAN, UNDER THE AUSPICES OF THE REGINA DISTRICT RADIO ASSOCIATION, MAY 24TH

Rome, Georgia, for the annual joint meeting of the Atlanta Radio Club, Chattanooga Amateur Radio Club and Rome Radio Club. Although a cooperative event, the actual management of the affair was in the hands of the Rome club. W4UC, president, was ably assisted by W4VO, W4BAZ, W4DAY, W4BZW, W4DBW, W4JL and others in preparing a splendid program.

One hundred twenty-seven amateurs enjoyed "the whole show"—speeches, old fashioned

barbecue dinner, prizes, and all. One of the main features was watching "Fats" Benning, W4CBY (weight 240 pounds), stow away the eats! Among the well-known hams present were W4APU, Southeastern Division Director; W4KP, Alabama S.C.M.; W4BBV, Georgia Assistant S.C.M.; W4BBT, Tennessee S.C.M.; W4CBY, president Atlanta Radio Club; W4PL, president Chattanooga Amateur Radio Club, and W4LU.

ATTENTION BULLETIN EDITORS

L. G. Morris, VE2CO, editor of the *Skywire*, official publication of the Montreal Amateur Radio Club, would like to exchange copies with editors of other club bulletins and newssheets. Address him at 4542 Old Orchard Avenue, Montreal.

SASKATCHEWAN AMATEURS MEET

The largest crowd of amateurs ever gathered together in meeting in Saskatchewan met in Regina on May 24th. One hundred twelve enthusiastic hams came from every part of the province to enjoy the hamfest under the auspices of the Regina District Radio Association. A complete station was in operation at the Champlain Hotel, hamfest headquarters. The afternoon was spent in viewing movies, 56-mc. demonstrations, and general rag-chewing. The banquet in the evening was the big event, and its associated features included a demonstration of photo-electric cells by VE4OT, speeches by well known VE4's including the Saskatchewan S.C.M., VE4EL, entertainment in the form of card and sleight-of-hand tricks, liars' contest, and the prize drawing. Fully satisfied with the good time they had had, the fellows went their respective ways with a common thought in mind—next year!

S.R.A. FIFTEENTH BIRTHDAY PARTY

The Springfield (Mass.) Radio Association celebrated its fifteenth anniversary on June 1st with about fifty members and guests, including representatives from the Connecticut Valley Radio Club and the Western Massachusetts Amateur Radio Association. The program included a talk by Clinton B. DeSoto of A.R.R.L. headquarters on "The Necessity for Organization" in amateur radio, several reels of motion pictures, card flourishes by Doug Jamison, an amusing skit by Carl Reid parodying lectures by African explorers, liars' and cracker-eating contests—all concluded by the serving of refreshments.

VISIT THE CLUBS

At A.R.R.L. headquarters there are recorded the addresses of the several hundred amateur radio clubs affiliated with the League, their places and times of meetings. Clubs are splendid places to get acquainted with other amateurs and to participate in interesting discussions on amateur radio. Why not drop in at your local club and "meet the gang"? Address the Communications Manager (enclosing 3¢ stamp, please) for data on affiliated clubs in your vicinity.

MISCELLANY

At the annual banquet of the Modesto (Calif.) Amateur Radio Club officers were elected as follows; W6ADB, president; W6FNO, vice-pres.; W6FFU, secretary-treasurer (relected). . . . The Associated Radio Amateurs of Southern New England (Providence, R. I.) held a transmitter hunt and clam bake Sunday, June 30th. W1AOP was the best detective, winning the hunt. W1EJ won the clam eating contest. Base-

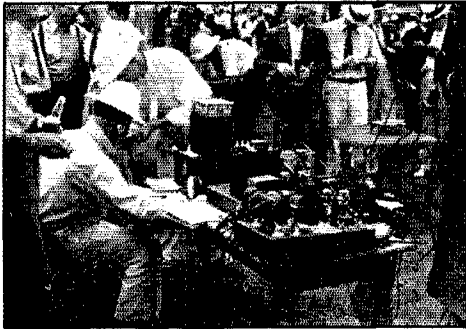

W9JP, INDIANAPOLIS RADIO CLUB'S STATION AT THE INDIANAPOLIS SPEEDWAY

ball, volley ball, quoits, swimming, all were part of the day's activities. . . . This is the kind of club activity to hold the interest of members during the summer. . . . *The Bug*, a well prepared paper, is published by the Finger Lakes Transmitting Society (Auburn, N. Y.). . . . An auction sale was the main feature of the May 17th meeting of the Wireless Association of Ontario (Toronto). Keith Russell, VE9AL, acted as auctioneer and did a professional job of it. The meeting was a complete success, and the association plans to open its fall sessions with another auction. . . . Auctions offer something new for most clubs in the way of activities. The members can bring in apparatus for which they have no further use and put it up for auction. A slight commission for selling can be charged by the club and added to the club treasury. . . . The British Columbia Amateur Radio Association will have charge of an amateur radio booth at the Vancouver Exhibition. . . . —E. L. B.

The Application of Iron-Core I.F. Transformers to Amateur Band Superhet Design

(Continued from page 37)

It can easily be seen the results obtained are more than gratifying. The sensitivity of this particular air-core unit is about 25 microvolts from the grid of the 6A7 at 465 kc., while that of the iron-core unit is 15 microvolts—an improvement of 40%. Moreover, the noise ratio of the air-core to the iron-core unit, at this frequency, is approximately 2 to 1—still favoring the iron.

It can be seen by the curve that not only is the skirt action of the iron-core type better, but also the nose of the curve is considerably sharper. While the latter feature of course would be detrimental from a fidelity standpoint in broadcast program reception, in most cases the amateur is only interested in voice frequencies. Hence this is really an advantage rather than a disadvantage, for it has a tendency to reduce the atmospheric as well as other interference received. It should be mentioned again that some of this increase in selectivity, as compared to the air-core unit, is due to the better crystal-filter circuit design, which in one case has only one tuned circuit and in the other three.

Using two stages with iron-core coupling it is possible to make a 465-kc. i.f. unit which has a band-width of only about 16 kc. at 10,000 times resonance input. It seems unbelievable, but in using two stages it is something of a problem to hold the gain of each stage sufficiently low to stabilize the receiver. More work will undoubtedly be done along this line in the near future; for what amateur would not like to have a receiver with selectivity such that a band-width of approximately 10 kc. was realized at 10,000 times resonance input?

Strays

W3LI and W3EWU, close friends attending a hamfest at Wilmington recently, ran across W2LI and W2EWU, also close friends. While chewing the rag, it developed that W2LI and W2EWU operate 'phone principally while W3LI and W3EWU are c.w. men!

South Dakota State Convention (Dakota Division)

PLACE: Pierre, South Dakota.
DATE: August 31st-Sept. 1st.

Further information from Roy A. Gull,
President, Pierre Amateur Radio Club,
Box 224, Pierre, S. D.

About Ham Message Handling

Announcing a Change in A.R.R.L. Checking Practice

MESSAGE handling as a form of amateur activity has never required any boosting—for just as the ultimate aim of amateur radio on all frequency bands is *communication*, so is the relaying of word by radiogram a “natural” when one has something to say to a party beyond immediate reach. Not all of us hams perhaps appreciate the utility that results from using amateur message service in our ham correspondence. No ham, not even a new member of the brotherhood, can help but feel the satisfaction of having really accomplished something tangible in exchanging a message (recorded communication) with another amateur. Of course not all beginners develop the advanced operating technique of the finished message handler, but it is within the reach of all who will try. The knack of handling a key is explained elsewhere, so here we shall attempt merely a discussion of some basic points in handling messages, at the same time the new checking practice is covered.

A message is nothing more or less than the concise expression of thoughts that are conveyed in more detail and personality when exchanged in the form of rag-chewing between operators or in the personal contacts of everyday life. Such transmission of intelligence is the basis for organization of commercial enterprises valued at many millions of dollars. In fact, amateur radio is about the only means by which an individual can convey thought over distances beyond the range of the spoken voice without paying toll to some such service!

In spite of occasional complaints of delay or non-delivery of ham messages, amateur traffic handling is effective and highly developed, *if one knows how to use it*. Don't expect that you can get on the air with the message you have written and give it to the first station that comes along and expect miracles to happen. You fellows who get your fun principally from DX, rag-chewing, and building equipment should appreciate that you must place the occasional message *you* start and wish to have reach its destination, not in the hands of others like yourselves, but in the hands of one of the many operators who specializes in keeping schedules and handling messages, one who gets his fun mainly out of this branch of our hobby, who knows the best current routes and is in a position to use them. Reference to the “station activities” of the latest *QST* to identify the calls gleaned from listening as those of men actually handling and reporting traffic regularly will enable anyone to start a message on its way intelligently by giving it to a station that will properly and reliably direct it on its way with

minimum delay. Now for some hints on preparing your messages, whether personal station-to-station traffic or that for a third party.

IN STARTING MESSAGES

Request full and complete address. The importance of a complete address cannot be over-estimated. Senders should be encouraged to give as full and specific an address as possible in all cases. This avoids delays and prevents undelivered messages. Misspelled words should be changed with the consent of the sender and punctuation marks where necessary should be spelled out. All words should be sent in full (no abbreviations except in service messages). The place from and the station or office call logically go together.

Almost every member knows A.R.R.L. message form, and the *order of transmission*, city of origin, station of origin, number, date, check, address, text, and signature.

The inclusion of all component parts of a message is possibly more important than the exact form, since these parts make it possible to trace a message back and ascertain important facts about its handling. A standard form is useful because it enables one to know just what is coming next, and makes accuracy possible with speed. Whatever is worth doing at all is worth doing right. That is where we come to the subject of the message check, optional in amateur radio but more widely used in recent years. The purpose of a check on any message is to help insure its accuracy and completeness.

LAND-LINE CHECK ADOPTED—EFFECTIVE AT ONCE

The League's Board of Directors at the recent meeting felt the time opportune to simplify the official A.R.R.L. practice to a land-line or “text only” count. This makes our count comparable to that used by wire services and in other land work and encourages more amateurs to put a “check” on messages filed for transmission by amateur radio, even though our check remains “optional” as in the past. The policy in checking messages by cable count was adopted by the Board several years ago at a time when many ham operators were going into marine operating work (a field now overcrowded) where the address, text, and signature are all counted.

Reduced to its essentials, A.R.R.L. message checking is henceforth simply the count of words in the text or body of the message. Those words in the address, signature, and preamble, in general are *not* to be counted. When in a few exceptions to the rule, such words are counted they are known as *extra* words and are so designated in the check.

COUNTING WORDS IN MESSAGES: The check includes count of (1) All words, figures and letters in the body, and (2) the following *extra* words:

(a) Signatures except the first, when there are more than one (a title with signature does not count extra, but an *address* following a signature does).

(b) Words "report delivery," or "rush" in the check.

(c) Alternative names and/or street addresses, and such extras as "personal" or "attention" "-----"

Examples: "Mother, Father, James and Henry" is a family signature, no names counted extra. "John Brown, Second Lieutenant," or "Richard Johnson, Secretary Albany Auto Club" are each one signature with no words counted as extra. An official title or connection is part of one signature, not extra. "Technical Department, Lamb, *Grammer and Mix*" as a signature would count three extra words, those italicized after the first name counting as extras. The check of a message with ten word text and three such extras in the signature would be "CK 13 3 extra."

At the request of sender the word "report back delivery," asking for a service showing success or failure in delivering at the terminal station, may be inserted after the check (or "rush" or "get answer" similarly), such words counting as extras in the group or check designation as just covered by example. "Phone" or "Don't Phone," or other sender's instructions in the address, are not counted as extra words. In transmitting street addresses where the words east, west, north or south are part of the address, spell out the words in full. Suffixes "th," "nd," "st," etc. should not be transmitted. Example: Transmit "19 W 9th St" as "19 West 9 St." "F St NE" should be sent, "F St Northeast." When figures and a decimal point are to be transmitted, add the words "CNT DOT" in the check.

Dictionary words in most languages count as one word irrespective of length of the word. Figures, decimal points, fraction bars, etc., count as one word *each*. It is recommended that where feasible words be substituted for figures to reduce the possibility of error in transmission. Detailed examples of word counting are about as difficult in one system of count as another.

Count as words dictionary words taken from English, German, French, Spanish, Latin, Italian, Dutch and Portuguese languages; initial letters,

surnames of persons, names of countries, cities and territorial subdivisions. Abbreviations as a rule should be used only in service messages.

Complete spelling of words is one way to avoid error. Contractions such as "don't" should be changed to "do not." Examples:

Emergency (English dictionary)	1 word
Nous arriverons dimanche (French dictionary)	3 words
DeWitt (surname)	1 word
E.L.B.D. (initials)	4 words
U. S. (country)	1 word
President Hoover (steamship)	1 word
Prince Wm. Sound	3 words
M. S. City of Belgrade (motor ship)	2 words
Exceptions:	
A.M., P.M.	1 word
F.O.B. (or fob)	1 word
O.K.	1 word
Per cent (or percent)	1 word



Figures, punctuation marks, bar of division,

decimal points count each separately as one word. It is best practise to spell out all such when desired to send them in messages. In groups consisting of letters and figures *each* letter and figure will count as one word. In ordinal numbers, affixes d, nd, rd, st, and th count as one word. Abbreviations of weights and measures in common use count as one word each. Examples:

10 000 000 (figures)	8 words
Ten millions (dictionary words)	2 words
5348 (figures)	4 words
67.98 (figures)	5 words
64A2	4 words
45¼ (figures and bar of division)	5 words
3rd (ordinal number and affix)	2 words

Groups of letters which are not dictionary words of one of the languages enumerated, or combinations of such words, will count at the rate of five-letter or fraction thereof to a word. In the case of combinations each dictionary word so combined will count as a word. In addition USS USCG, etc., written and sent as compact letter-groups count as one word. Examples:

Tyfa (artificial 5-letter group)	1 word
Adecol (artificial 6-letter group)	2 words
Allright, alright (improperly combined)	2 words
Dothe (improperly combined)	2 words
ARRL (improperly combined)	1 word

In handling messages or in any form of amateur communication it is well to observe that it is not always the station that sends fastest that gets best results. Careful, steady, sending gauged to the conditions and receiving speed of the operator you are working with, combined with conscientious attention to use of proper procedure and proper message form, will get your hook clear in a minimum of time. Consider the direction and

(Continued on page 68)



CALLS HEARD



Heard at ZL2KI from April 19-June 21
(Via radio ZL2KI-W8CRA)

(14-mc. 'phone stations)

wigs w1cbh w1lep w1db w1did w1gbe w1htb w1dmd w1dfo
w1cos w2edw w2tp w2hfs w2ahf w2lp w2eco w2eug w2akk
w2an w2cqv w2gqw w2zxc w3md w3zf w3bhf w3si w3ffu
w3dq w3apo w3cm w3baf w3abn w3dho w4axz w4hk w4bxg
w4ahh w4up w4kh w4bez w4ca w4dco w4abt w4aby w4ahj
w5at w5al w5axu w5bee w5ccb w5zs w5bdb w5ba w5za
w5dep w5bgt w5sf w5aeb w5lm w5byj w5lu w5att w5dq
w5ms w6cin w6ert w6eih w6goy w6ibs w6gvs w6abf w6eig
w6am w6aqk w6cne w6wt w6zh w6clh w6ean w6cgg w6edj
w6ish w6py w6avu w6fqy w6uf w6da w6fel w6bay w6buy
w6jcw w6fdm w6ecq w6brh w6eug w6iph w6byw w6ibz
w6bep w6lr w7ark w7qc w7md w7dmt w7bci w7daa w7bby
w7ait w7fp w8fsa w8ike w8aku w8arq w8cvt w8ud w8fhe
w8lr w8dmj w8hfu w8li w8lgy w8dqn w8za w8fgx w8drf
w8joe w8fza w9pep w9app w9cet w9pms w9cko w9bj w9ld
w9ark w9ags w9cmf w9dku w9bpm w9gb w9cjj w9aq
w9ccu w9pv w9cvn w9ods w9jos w9aji w9bif w9jry w9wf
w9jby w9eae w9dof w9pqb w9bv w9dib w9ldm w9erb
w9drd w9dde w9rgh w9bis w9iph ve2bg ve2be ve3by ve3ox
ve3hc ve4ig ve4fi ve5hm ve5bn ve5ha ve5jb x2ah x1w x1g
k6kkp k6baz k6fij k6cmc ti3ay ti2an ti2re hpla k4sa co2wz
co2kp

Alan I. Breen, 58 Pine Hill Terrace, Dalmore,
Dunedin, NE1, New Zealand

(14-mc. 'phones)

co2ll g2dt g2dv g2nh g5bj g5hc g5yy g6xr hc1fg hi7g hi9i
k4aop k4sa k6baz k6fij k6kef k6kkp lu1da lu6hn pa0idw
ti3av ve3kf ve4la ve5ha w1bes w1bic w2akk w2tp w2zc
w3md w4axz w5ahj w5bat w5bee w5bdb w5ms w5sf w5zs
w5axu w5ebu w6abf w6am w6aqq w6bay w6bet w6bho
w6byw w6bky w6clh w6cin w6cne w6cz w6da w6dcq w6dhg
w6diz w6dlf w6duf w6ert w6edy w6fel w6itu w6fdn w6goy
w6ibx w6ish w6izb w6kox w6uf w6zh w7bci w7bby w7qc
w7fhe w8ktv w9ark w9bez w9cva w9dku w9dtt w9jry
w9ld w9zd x1aa x1g x1w x2ah vk2ep vk3kx vk4ap vk5jc
vk7kv

(3.9-mc. 'phones)

w4ib w5afw w5apf w5yh w6ejn w6gnr w6hxp w6ith w7bkc
w9zd k6cmc k6lpl

Harold S. Benner, Radio Opr., S.S. Frederic
R. Kellogg, Standard Shipping Co., 30 Rockefeller
Plaza, New York, N. Y.

(Heard in Straits of Magellan)

(14-mc. 'phones)

w3apo w3cop w3md w5zs w8dud w6uf x1g
(3.5-mc. band)
w3bya w3dvo w3bjx w4aw w6dio w6evs w7awe w7kl
w8lum w9bmn w9hgh ve5hq ve5fi z1at z1cv z1db z1di
z1fd z1hq z1z z1zod z1zqd z1zre

William B. Scott, S.S. Pastores, Colombian Line
(At dock, Puerto Colombia, Colombia, S. A., May 23rd)

(14-mc. 'phones)

w1fvo w2bkv w2alo w2byc w2fz w2btv w3apo w3erg
w3cm w8bk w8htx ve3ox

W1GKM, David Davidson, 20 Essex St., Hartford,
Conn.

(14-mc. 'phones)

g5by g5yv la1g om2ac

W1DZE, Mellen Gulesian, 60 W. Seldon St.,
Mattapan, Mass.

(14-mc. band)

vs7gj vs6aq vs1aj xu8al xu6f kalca px1a ux2a tf5c tf3g
pz7a tglac es5c es7c es5r es2d ar8mo su1fs zb1f zb1i j2lb
j2kj j5ce j2gx ly1ag pk3bm yl2bq u5qe uk3ces u2ne u5hd
u6ah ulcn u3cy

HB9J, Jean Lips, 87 Klosbachstrasse, Zurich,
Switzerland

(14-mc. band, May 15-June 7)

w5brq w5bfq w5lp w6fal w6byu w6hij w6grx w6gri w6cxw
w6awt w6env w6epp w6bip w6vnb w6qd w6inp w7fh w7bd
w7dwq w7dl w7amx w7apg w7bby w7bpj w7dol w7axo
w7qc ve4fd ve4go ve4er ve5hc ve5eu k6esu k6cog k6jpd
lu4dq lu4do lu8fn oa4j hc2mo hc1ps vs1aj vu2dk vu2bl
vu2db vu2fy vu2fp vu2dx tf3g u6ah fb8c j2gx j2cl cx1ce

A. E. Lower, U.S.S. Augusta, China Station, c/o
Postmaster, Seattle, Washington

(Heard at Shanghai, China, April 18, 20 & 21)

(7-mc. band)

cb6a haf3g oh2ok w6awa w6awt w6bgw w6bqo w6clv
w6kz w6imw w6ghd w6ggm w6hgt w6hst w6isg w6iyl
w6jab w6jdd w6jgi w6jta w6jtp w6jxx w6jld w6jpw w6jwl
w6jsw w6kh w6khe w6kjk w6klu w6knd w6flf w6lhc w6lwb
w6lhw w6tm w6ebi w6eap w6ezh w6gop w6gpb w6idr
w6inc w6ira w6lkm w6lmf w6wu w7byw w7blt w7bub
w7csq w7dxz w7jl w7mh vu2cq

(14-mc. band)

eu3q fb8c j2cl on4au pk1df pk3st u3vb u4lh u5ae u5as
u9ab u9af vu2cq vu2fy vu2jl vu2pj vu7fy w6cxw w7dht
w8czz w8cra w8gyb w8ay z66b

BRS 1338, Donald W. Morgan, 15 Grange Rd.,
Kenon, Middlesex, England

(14-mc. 'phones)

vp3gb vp5pa vp5is vp6yb vp8mo vp9r hp1a hi7g lu8dr
hc1fg k4sa su1ch sulro vol1 volp oe6dk oh2ne ok1um la1g
sm5wu ly1j ct1gu ct1by w5eli w5zf w5bee w5aeb w9bht
w9acu w9cys w9ark w9zz w9azz w9ji w9eel w9wa (Eastern
USA & VE 'phones too numerous)

W6KNH, Clyde Schoenfeld, Jr., 1543 31st Ave.,
San Francisco, Calif.

(14-mc. band)

g2pl g5by g5ma g6rb g6qx on4au on4rx on4au f8eo
f8pz f8tq d4csj pa0xf oe1er hb9aq ly1j hc2mo

W7ERY, L. A. Powell, U.S.S. Raleigh, San Diego,
Calif.

(Heard at Dutch Harbor, Unalaska)

(14-mc. 'phones)

k6fjf w6etj w7btr w7et
(14-mc. e.w.)
k6eru k6ibw oe3kh ve5np vk2ky vk5wk w5cho w6cek
w6cgp w6cxw w6erm w6kri w6kth w6qd w7aj w7dxw w7dal
w8nd w9dhw w9fur w9lei w9mcd w9rcr w9amb

Bob Everard, 11 Lindsey Terrace, Standon, Nr
Ware, England

(14-mc. 'phones)

w6byw w7qc w7bcu w5aeb w5bgt w5byj w5axu w5zs
w5bdb w5bee w5eub w5dw w5un w5ccb w5bmm w5dep

w9ark w9ar w9bif w9bht w9ayh w9ehd w9nnd w9dtb w9jhg
w9grv w9zd w9ggy w9fdi w9emf w9bde w9her w9bbr
w9oio w9ago w9ld w9dku w9wcl w9aeq w9aai w9bpm
w9brx w9aji w9evn w9bj w9jov w9epe w9bpb w9hbh w9fdo
w9lgt w9kfa w9cex w9jhy w9ji w9jie w9sp w9des w9jga
ve4vh (W1, 2, 3, 4, 8, VE1 2 and 3 too numerous)

(3.9-mc. 'phones)

oz5o w9ael w9bbu w9mm w5afw w3aeo w3si w3ekd velcr

W6AKY, Charles Stebbins, and W6ITY, Raymond Apostle, 3351 39th St., San Diego, Calif.

(7-mc. band)

zs2x zs5x zs6af zt1r zt2f zt5r zt5v zu3b u0ld ea8af

(14-mc. band)

ea4ao f8eo f8ex f8wb g5qa g6wy

W1AJZ, Rienzi B. Parker, Harwichport, Cape Cod, Mass.

(Heard during April and May)

(14-mc. c.w.)

es7c j2gx j2lu sulsg sx3a u3vc u4ih u5hd u5hj u6ah vk3hw
vp1aa vp2cd z12bz

(14-mc. 'phones)

co2hy co2ll co2qy co2se co2wz co6om ct1by ct1gu ea4ao
ea4bm f8dr f8gs f8zv g2ax g2dv g2em g2nh g2pl g2zv g5bj
g5cv g5gi g5hb g5ml g5rs g5rv g5vb g5vl g5yy g6ag g6dl
g6fs g6gf g6li g6qs g6xr hb9aq hh5pa hi7g hp1a k6baa k6kcp
la1g on4ac on4au on4bz on4sa pa0ld ve5ha ve5hn ve5jb
ve5jk ve5jz voli vp3bg vp5is vp6rv vp9r ti3wd x1g x1k x2n

W8IRC, R. H. Harris, 1201 E. Schaaf Rd., Brookly Heights, Cleveland, Ohio

(14-mc. 'phones)

co2an co2hy co2kc co2ll co2se co2ww co2wz co6om ea4ao
hi7g hpl1a k4sa k6baz k6kcp lu6ap ti2mr ti3av voli vo1o
vp3bg vp9r x1g x1w x2ah

W1LZ, H. G. Burnett, 16 Windsor Rd., Somerville, Mass.

(14-mc. band)

vs6ah vs6aq pk3st pk2dx om2rx ti3g px1a es7c es5c es5r

D. A. G. Edwards, Selwyn House, Chester Rd., Sutton Coldfield, England

(3.9-mc. 'phones)

ve1er veldy velei wadm wlahj w1cg w1dz w1eop w1esz
w1li w2aga w2b2r w2coj w2ffy w3atf w3wx w4acz w4efc
w8sads

(14-mc. 'phones)

co2hy co2ll co2ra co2sg co2ww co2wz co6om hc1fg hh5pa
hi7g hp1a(?) k4sa la1g luida lu8dr t1da ti2fg ve1bv ve1co
ve1cr ve1dc ve1dq ve1dr ve1ea ve1fe ve2bg ve2ca ve2dx
ve2ee ve2hm ve2he ve2hf ve2jv vo1p vp5is vp5pa vp6yb
vp9r w4agp w4agr w4ah w4aah w4auu w4axz w4azi w4bfb
w4bfb w4bya w4cj w4fk w4hx w4ix w4kr w4um w4up w4zf
w5bdb w5bee w5bmm w5sz w9aa w9ark w9bde w9bht
w9bif w9brx w9evn w9fdi w9fj w9hay w9hbh w9jni w9job
w9kaw w9lfn w9ld

W1FOZ, Charles Skeels, Uncasville, Conn.

(14-mc. band)

j5ce j2gx j2hg j2cl j3de j2gw j2lu pk2aj pk3st vs6ah vs6aj
xu8at

(7-mc. band)

ka7oe k7eml

Lewis F. Miller, Apt. 107, 4630 No. Beacon St., Chicago, Ill.

vp3bg vp5is vp5pa vp6yb vp6mo lu6ap hh5pa hi7g k4sa
ct1by ti2fg ti3av hpl1a celbc voli k6baz g5bj g5by g5ml
g6py g6xr x1ai x1ax x1g x1w x2ah x2n co2an co2fg co2hy
co2jm co2kc co2ll co2ra co2ww co2wz co6om ve1br ve1bv
ve1ca ve1ci ve1co ve1dc ve1ea ve2be ve2bg ve2ca ve2ce

ve4bf ve4au ve4cy ve4ea ve4fi ve4fu ve4hq ve4hr ve4hv
ve4hw ve4ig ve4lm ve4ni ve5ha ve5hn

Charles Miller, 309 View Place, Covington, Ky.

(14-mc. 'phones)

g2dv g2mp g2mv g2nh g2oi g5bd g5bj g5by g5jt g5ml g5ni
g5vl g5yv g5yy g6ld g6py g6qs g6xr la1g ct1by ea4ao on4ac
on4au on4za luida lu4bc lu6ap vp3bg vp5is vp6yb vp9r
hc1fg hh5pa hi7g hi8x k4sa hpl1a ti2fg ti3av ti3wd voli

W8FNE, S. H. Schock, 226 N. 12th St., Pottsville, Penna.

(14-mc. 'phones)

g2dv g5bj g5ml g6dl g6py g6xr hpl1a hi7g lu6ap ea4ao
on4ac ct1by vp5is

J2LU, Hiroshi Shimomura, 55 Wada, Honmoku, Nakaku, Yokohama, Japan

(14-mc. band)

w1cun w1foa w2gox w2eko w3aw w3bzb w4cby w8zy
w8enz w8dgp w8era w8cax w9cdm w9aeh w9nns w9piy
w9adn w9cjj w9pri ve1dx ve2ay ve4lx ve4og ve4hw ve5bi
ve5kb ve5hc ve5ko ve5jb ve5np ve5ha ve5hq ve5ec k7dvy
x1am g2dv g2tm g2bk g5yy g5wp g5qy g5qa g6rh g6ni
g6yw f8eb f8eo f8fc pa0yl pa0ff pa0dc pa0sd u3vb u3ag
u3di u3qe u3qt oh3np oh7nf oh8nb ok1fx ok2op on4hm
es2d es7c la3c d4bbk ea3eg sm5vy sp1dc sz1h zs6m zt1g
zt6k fb8c lu1ch lu2am lu6er lu9bv pk1df pk2dx pk3st
pk2ap pk4rf vu2ij vu2bz

(7-mc. band)

lu1ad lu2eg lu3dx lu4de lu5ua lu5bl lu6bj zt1h zt2b zs5z
zs6af zs6am vq4erl fm4af sulec sulch sp1dt f8eo d4bar
d4caf ok1fd ct1ah u3qe u3qt u5kd u6ah u8ih u3cy pk3st
k7zzk vu2ij x1aa x2c x2n cx1bu

W6CUH, Chas. D. Perrine, Jr., 527-23rd St., Manhattan Beach, Calif.

(14-mc. band)

d4bar d4bbm d4bbn d4bhh d4bkk d4caf ea4ao f8eo f8ex
f8fc f8pz f8tq f8bc g2pl g5ma g5qy g6hl g6qb g6pv g6wy
hb9j la1c la1g ly1j oeler oelfp oe3fl oe3wk oe7ej oh2ne
oh3ap oh3np ok2ak on4au on4uu on4rx pa0ce pa0fx pa0xf
sm7yg sm7yn sulsg ulap ulcr u3ag

W9DHJ, Fred F. Hall, Crown Point, Indiana

d4hlt d4bjh d4bdc ea2hd ea3bq ea3ce ea5bp f3cb f3fk f3js
f8en f8wt g2cj g2fb g2da g6ns cr7ae cr6ac j2hg j2ix j2jl j2fa
k7avu k7dev k7em on4er on4ue ok1fl ok1lm ok1rb ok2nf
oh1np oh5ng or2nh k6etf k6cck k6cvq pa0vs sm2vg sm5ry
ti2nc u4ld u6mi u9az vu2jn vu2ls

H. D. Simonsen, Alfred Street, Blenheim, New Zealand

(November 29, 1934 to March 7, 1935)

(3.5-mc. band)

d4bar d4bdr fm8bg fm8fs g6rb hb9al hb9aq hb9y k6dv
k6jlv k7egs n4oi n6fkl n6wt on4vo ve3an ve3lc ve4bf ve4cl
ve4fd ve4ig ve4ht ve4ag ve5is ve5ka ve5mt w1amp w1bkl
w1ciu w1deo w1emz w1eva w1go w1vi w1zl w1adz w1ajl
w1axa w1cab w2coy w2coy w2dcp w2dmh w2dyo w2jge
w2bil w2bm w2esk w2dji w2ciy w2cuh w2foa w2hor w2ul
w3bgo w3cck w3eba w3an w3ux w2ux w5emk w3enb
w4bzw w4abp w4abs w4btq w4dmc w4daa w4dat w4dgm
w4dl w4ic w4nc w5aj w5ati w5bml w5dhu w5dzh w5gn
w5afv w6ape w6afn w6ame w6aot w6axe w6bbd w6bgr
w6bhv w6bme w6bp w6bap w6btj w6bvz w6b2r w6cqm
w6dgr w6dqn w6dsr w6ecb w6eia w6eiv w6ekb w6eoo w6esk
w6evq w6ezd w6fbb w6fj w6fkl w6ftu w6fym w6gcs w6gjl
w6glj w6guj w6gxm w6hah w6hav w6haw w6haz w6hez
w6h2z w6hid w6h1q w6hpn w6h2r w6iga w6ihm w6iik
w6ikg w6lcp w6lob w6lhx w6lize w6jdn w6jgd w6jne w6jpa
w6jrh w6jts w6j2k w6j2p w6kaw w6kcg w6kee w6kfk
w6kfp w6kfx w6k2e w6k1v w6koc w6kge w6kwo w6led

(Continued on page 90)



Adjustable-Length Antenna

With the increasing popularity of the vertical antenna for the higher frequencies, many amateurs will be interested in a method for adjusting the length to match the transmitter frequency. A scheme used by Keith Russell, VE9AL, makes it possible to adjust the antenna length quite accurately without cutting. He writes: "I have . . . noticed that a large number of amateurs are

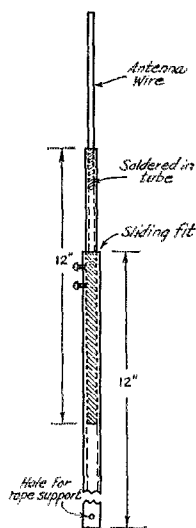

FIG. 1

coming around to the use of 20-meter half-wave vertical doublets, usually fed by a twisted wire pair. The antenna I am using is of this type, fed with a twisted pair made of wire of the type described by W8LUQ in January QST. My frequency is 14,112 kc. so it worked out that each half of the doublet was approximately 16 feet 6 inches in length theoretically. It is well known, however, that contiguous objects such as poles, other wires, etc. have an effect on the natural period of the antenna, and my job was to figure out how to compensate for any such discrepancies with a minimum of exertion to myself. I think I have succeeded in doing this by a device which others might care to copy, as it is so relatively simple.

"I went to the local hardware store and bought two feet each of two brass tubes, the smaller of which made a nice sliding fit into the larger tube. The larger tube has a fairly thick wall, so that it will readily hold a tapped hole and screw. I sawed the two rods both in half, making them exactly one foot in length. I then drilled and countersunk a fairly good-sized hole in one end of each of the large tubes, for attaching the rope or other insulating device. Near the other end two holes were drilled and tapped for 8/32 machine screws. The small tubes were then laid down alongside a steel rule, and with a triangular file nicks were cut every half inch. The two antenna wires were then cut 1 foot 5 inches shorter than the theoretically correct length and one soldered into one end of each of the smaller tubes to a depth of one inch.

A small tube was then inserted into each large tube, and using the nicks as a guide, were pushed in and locked tight with the set screws to form one solid piece. The aerial was then pulled up and feeders coupled very loosely to the transmitter and a plate current reading taken. Then the antenna was lowered away and the inside tubes at each end of the antenna slid either in or out some four inches, the antenna pulled up and the reading taken again. Considerable change will be noticed in the plate current of the transmitter, indicating whether the frequency of the transmitter is getting more closely into resonance with the antenna, or farther away. Corresponding adjustments back and forward will enable a very close match to be made between the antenna length and the frequency of the transmitter. The cut marks in the small tubes enable the adjustments to be made identically at both sides of the antenna to one-half inch.

"This scheme avoids the necessity of clipping off portions of the antenna with a pair of pliers and then finding that you have taken off too much."

Antenna-Filter Variant

Like many other hams I had a bit of difficulty making the Collins filter work between *my* transmitter and *my* antenna, although I had previously used it successfully on other antennas and transmitters. It simply would not permit complete neutralization of the final amplifier. However, like the rest of the gang I was impressed by its advantages, so continued experimenting, and here's the result.

Coil L_2 , Fig. 2, is coupled to the final amplifier tank L_1 in the usual manner, but rather loosely. As a rule, L_2 will have more inductance than the usual pickup coil. Condensers C_1 and C_2 are connected in series, and resonate the pickup coil to the final tank frequency. The feeders (there must be a two-wire feeder system) are connected across one of the condensers. Now the impedance of a condenser is inversely proportional to its capacity, so that by setting condenser C_1 to high capacity and resonating the circuit with C_2 you can work into a low-impedance transmission line, or by setting C_1 to low capacity and once more resonating with C_2 you can work into a high-impedance line.

In my individual case I was forced to use a condenser with a maximum capacity of 1000 $\mu\text{fd.}$ as C_1 , and needed nearly its full capacity, since

the transmission line has very low impedance, I would suggest the use of two condensers with widely different capacities, so that large changes

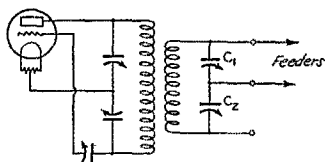

FIG. 2—INDUCTIVELY-COUPLED LOW PASS ANTENNA FILTER

of impedance can be made by switching the feeders across the low-capacity condenser if the feeder impedance is high.

—Al Putzker, W6BOY

Keying System

In trying to eliminate key clicks entirely from the receivers of neighboring hams who were working on the same band, as well as to keep peace with the BCL's, I worked out a keying system which has undoubtedly been used before, but which deserves more general acceptance.

The scheme consists of keying the primary of a small B-eliminator power transformer, the rectified and filtered output of which furnishes the positive voltage for the shield and suppressor of the 59 doubler tube, as shown in Fig. 3. To make cut-off complete, a negative voltage from the regular bias supply is furnished to the two grids through a resistor. Since the primary of the transformer is keyed, it is necessary to supply the filament of the rectifier tube from a separate source.

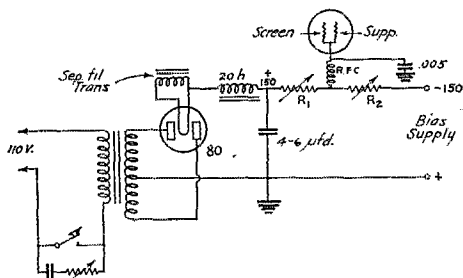

FIG. 3—CLICKLESS KEYING SYSTEM FOR PENTODES R_1 , R_2 ARE 0-1000 AND 0-5000 OHM VARIABLE RESISTORS, RESPECTIVELY

Thus, when the key is open, the grids are made sufficiently negative to give cut-off—in my case about -40 volts, while the control grid was being excited, and with 550 volts on the plate. When the key is closed, the grids go positive by an amount determined by the size of the transformer and the desired operating voltage. The filter on this supply should be not larger than necessary, since too much filter introduces lag.

The advantages of this system are: (1) Better

keying due to the elimination of keying relays, since the small current in the primary of the transformer can be broken directly by the key; (2) less BCL QRM because the noise caused by breaking the small transformer primary is much more readily filtered out than the racket caused by breaking half a kilowatt.

—W. N. Lambert, W9TBX, ex-9CSC

Guying Antenna Masts

In guying antenna masts the only possible advantage of having more than three guys to a set is that in case one of them breaks the remainder can be re-arranged to support the pole, but since any shock strong enough to cause breakage of a properly installed guy will likely bring the pole down anyway, even this advantage is doubtful. All guys of a three-guy set will always be at the same tension, just as a three-legged table never rocks.

Any intermediate guys should be arranged like the top set on the "2 by 2" mast in the *Handbook*; that is, one guy directly opposite the antenna and two front guys, all three evenly spaced 120 degrees apart. This leaves a clear space under the antenna, which is an advantage, particularly when antenna is lowered for repairs or changes.

In the case of the top guys this arrangement is not so good, because when the antenna is tightened it takes the strain off the two front guys and there is a tendency for the rig to rock sideways in a wind. It is better here to reverse the arrangement and have two back-guys, possibly somewhat less than 120 degrees apart, adjusted to pull the pole slightly back from vertical so that when antenna is pulled tight it straightens it up, the antenna and two back-guys forming a three-guy set. A top front guy directly under the antenna merely serves to keep the pole in place when antenna is down, and if intermediate guys are used and the mast is reasonably rigid this third guy will be unnecessary.

When raising a mast which is big enough to tax the facilities available, it is some advantage to know nearly exactly the length of the guys. Those on the side on which the pole is lying can then be fastened temporarily to the anchors beforehand, which assures that when the pole is finally raised the chaps on the opposite guys will pull it into a nearly vertical position with no danger of its getting out of control. The guy lengths can be figured by the right-angled triangle rule that "the sum of the squares of the two sides is equal to the square of the hypotenuse." In other words, measure the distance from the base of the pole to the anchor, square this and add it to the square of the length of the pole up to where the guy is fastened. The square root of this sum will be the length of the guy.

It is advisable to carry the pulley rope back up to the top in "endless" fashion same as a flag rope; then if antenna breaks close to the pole due

to sleet storms, boys using the insulators as targets, etc., there will be no trouble in pulling down the remnants and making repairs. The writer has always used stranded clothesline wire for pulley lines rather than rope; there may be electrical disadvantages in this but it eliminates trouble due to stretching or breaking of ropes. Care must be taken in selecting the pulleys, however, to make sure there is not enough slack between the sheave and the frame for any chance of the wire's climbing the side and jamming.

—W. F. Reeves, VE5CT

Identifying the Freq-meter Signal on a Super

When a heterodyne frequency meter is used in conjunction with a superhet receiver it is easily possible to be misled in checking frequency because of the nature of the receiving method. One way of avoiding confusion is pointed out in the following letter from C. L. Roach, VE2BT:

"In using a frequency meter with a superheterodyne receiver, there are at least two places on the freq-meter dial (assuming that it covers a sufficiently wide band), where a signal on the receiver may be brought to zero beat, as follows:

- (a) Where the freq-meter frequency equals that of the incoming signal.
- (b) Where the freq-meter frequency equals that of the h.f. oscillator in the receiver.

The first condition is the correct one, and here is a way to determine which frequency the meter is generating:

"Adjust the freq-meter to zero beat with the incoming signal, the audio beat oscillator of the receiver, of course, being turned off. Then detune the receiver slightly, which will change the frequency of the h.f. oscillator a small amount. If the freq-meter is on the incoming signal frequency, it will stay on zero beat, but if it is on the h.f. oscillator frequency, an audible note will be heard, rising from zero as the receiver is detuned. With this condition, it is obvious that a different setting will be required on the freq-meter to get back to zero beat, and it is possible to obtain a number of zero beat readings, depending on the receiver setting."

The same thing is true if the frequency meter happens to be set on the image frequency of the signal being received. In other words, the frequency meter is set on the received signal *only* when tuning the receiver slightly causes no change in the beat note between the two, the receiver beat oscillator being off.

A Simple Remote Control System

Recent issues of *QST* have shown that amateurs are turning in greater numbers to break-in operation and, though to a lesser extent, to remote controlling of transmitters. Both of these systems have been considered standard equip-

ment on commercial installations for several years past. The remote controlling system described below has been used at several shore stations in the mobile service and where the receiver is at even a short distance from the transmitter permits perfect break-in operation with the use of a small separate antenna. This same system has been used with amateur rigs where the transmitter has been as much as 7 miles from operating position. In commercial installations the distances have been even greater—limited only by the sensitivity of the relays used. Keying speeds of approximately 250 words per minute have been used with perfect success.

The system's advantages, as may be readily seen, are its great simplicity and its making use of but a single line to perform several duties at the transmitter. The principle of operation is that of having the relays adjusted to operate at different *minimum* values. A careful study of the diagram will make this clear. No values have been shown

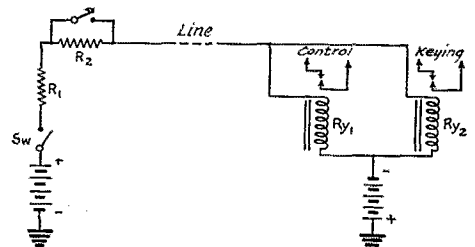

FIG. 4—A ONE-WIRE REMOTE CONTROL SYSTEM USING RELAYS OPERATING AT DIFFERENT CURRENT VALUES

The battery voltages and resistor values will depend upon the characteristics of the relays used.

for the various components. These will all be largely determined by, first the relays, and then the length (resistance) of the line.

The relays used should preferably be of the high resistance-low current "vacuum tube output" type but may, where the length of the line is not very great, be of the ordinary 2- to 12-volt types. Relay 1 is the start-stop control and Relay 2 is the keying control. Relay 1 must be adjusted to close on a current less than that necessary for Relay 2. For example, using relays adjusted to close at 5 and 10 milliamperes respectively, when switch *Sw* is closed resistances *R1* and *R2* will regulate the current flow through the line to 5 mils, which will cause *Ry1* to close and start the transmitter. However, since *Ry2* is adjusted to operate on a minimum of 10 mils it will remain open. When the key is closed, short circuiting *R2* and permitting an increase in current, *Ry1* will stay closed and *Ry2* will close and will follow the make and break of the key circuit.

It should be added that the batteries used may both be at one end of the line. If at both ends it should be remembered that they are still in series

(Continued on page 84)

QSL:

According to advices received from the R.E.F., the French government has established FA as the new national prefix for Algeria and FT for Tunis, replacing FM.

Cards are now once more being regularly forwarded to Italy. They can be routed through either A.R.R.L. or R.S.G.B.

Cards for the Dominican Republic (HI) can be sent to Dr. Enrique de Marchena, Apartado Postal 912, Santo Domingo, R. D.

MX:

Under the title, "Stepping into MX Land," T. Okinishi, K6CQV, contributes the following entertaining account of a visit to Manchuria (Manchukuo):

"MX? Where is MX? It is the Empire of Manchou, a nation newly formed directly north of Korea. This empire is commonly called Manchukuo, and the radio prefix MX is given. In such a new country there are hams, as in the old saying, "Hams, hams, hams all over the world." Funny part of it is that a small town of a little over 20,000 called Penhishu monopolizes all the hams in this huge empire.

"This little town, a historical ground where the Russo-Japanese War was fought, is surrounded by mountains. Over on one hill MX2A, Mr. T. Kanamura's shack, is located, and on another directly opposite hill MX2B, Mr. T. Nagano occupies to see who can hit the other farther.

"Both stations use about the same input power of 30 watts because they are limited in their power by the Manchurian government just like Japanese hams, although they have no time restrictions as J hams. Yet they have both become WAC in less than a year's existence.

"Is this only MX hams' spirit or every ham's? It was 4:30 a.m. on April 1, 1935, when I reached the station of Penhishu and there both MX2A and B waiting for me showing real ham spirit. About ten minutes walk on a hill I was brought to MX2A's shack. There I learned that I, K6CQV was the first ham ever to visit them. Later MX2B brought us to his shack and there we had a real ham chat, and both boast themselves of 100% QSLers and willing to swap fotos with any ham.

"Two hours' ride on train to Mukden, the second largest city in Manchukuo is surrounded by high walls with four gates (North, South, East, West), shows clearly how a city was protected in olden times. In such a big city there are very few modern vehicles, although automobiles and street cars are taking places of carts and

rickshaws. Travelling is done mostly on carts pulled by horses. In this city one can see Manchurian customs from worst to best.

"During just two days' stay in Manchuria I was certainly welcomed and entertained in real ham's style and they will welcome any ham at any time with open hand. So any ham visiting J's or near lands should extend his trip to MX, and he is assured of real home-like welcome, and he shall not forget their hearty welcome for a long time. It is exactly 24 hours' ride on a train from Fusan, Korea, to Mukden, Manchuria."



LEFT TO RIGHT, MX2A, K6CQV, MX2B

General:

New WAC-on-'phone certificate holders: W. H. Lister, ZS6AF, and W. E. C. Bischoff, VK2LZ As of June 30, 1935, a grand total of 1571 WAC certificates have been issued, 198 of them thus far in 1935 Boom year for WAC was 1934, with a total of 349 certificates, almost doubling any previous year's contribution to the list Curious to know the shortest time in which a W9 station has made WAC, L. E. Norton, W9BTW, submits his recent

accomplishment of 18 hours and 10 minutes as a tentative record B. Wickham, G2DW, heard the following 1.7-mc. stations at odd times during the winter months: 'phone, W1HYK, W2DFB, W2HI; c.w., W2GCE, W2GJC, and W8ASI D4BAR's new call is D4ARR W1CNU reports working AR8MO, an Asian contact, at 2200 G.T. on 14,400-plus kc. recently This station also uses 14,260, according to W1TS; QSL via R.E.F. VK5HG and W2CC reached their 1000th QSO on June 18th, each R7 for a fine, long contact They started almost eight years ago, with several skeds each week W2CC goes in for that sort of thing; he has worked W9WR 708 times, W9JO 142, W6CXW 134, VK2AP 64, and VK3HL, VK3HM and VK3HQ each 50 times (as of June 18th) A cordial welcome to all overseas amateurs is extended by E. T. Woodhouse, G6IO, on behalf of the South London & District Radio Transmitters Society Meetings are held on the first Wednesday of every month, commencing at 8 p.m., at the Brotherhood Hall, Knights Hill, West Norwood, London, S.E. 27

Special:

The "N.R.R.L. Bulletin," under the editorship of G. W. Bergstrand, LA2N, combines unpre-

(Continued on page 86)



OPERATING NEWS



Conducted by the Communications Department

F. E. Handy, Communications Manager

E. L. Battey, Asst. Communications Manager

A FIRST principle of battle is to find out all one can about the strength and weaknesses of the enemy position. That's just what your Cairo committee is doing. Commercial occupancy surveys, to show the tough spots and the soft spots, have been ordered. Of course the result of the information, when sifted down, will not be available to anyone but the amateur's representatives for meetings at and before Bucharest and Cairo. The idea is to give our representatives information to enable us to check how much of the Berne list is paper, and which stations are economically unjustified.

The Cairo Committee of the A.R.R.L., a continuing committee with full planning authority appointed by the Board at its May meeting has to determine what frequencies the Board shall ask for, as well as to direct the several lines of action to be taken by A.R.R.L., and in cooperation with foreign amateur societies through the I.A.R.U. in the attainment of our objectives—more operating territory.

As reported in July *QST*, a far reaching commercial occupancy survey was directed by the A.R.R.L. Cairo Committee as a first step, this to cover all the territory between 6000 and 8000 kcs. As we prepare this issue, the Committee has just ordered that the survey plan be broadened to include also the territory 4000 to 4500 kcs. inclusive. This is very promising territory. In the United States and Canada about 40% of our registered operating activity is in the 80-meter and 30% in the 40-meter regions. Also this 70% of all ham work encounters the most difficulty from congestion of stations, so that a double-barrelled project to survey and secure territory in the vicinity of either or both these bands if possible, should certainly meet the approval of all amateurs. The Cairo Committee recently addressed a request to all amateur clubs and all League field organization officials asking for suggestions and comments, and it is undoubtedly in line with the desires of members that efforts be made to include both these bands.

It goes without saying that the practical information to be secured from the 6-8 and 4-4.5 mc. surveys will be invaluable in showing the actual use being made of these channels as contrasted to the much larger "paper" registration on same, as well as indicating the services that could be doubled up with little difficulty. These surveys are of vital importance, and cannot be made fully successful unless the complete support and cooperation of every individual ham with receiving equipment to cover the ranges is accorded the Committee.

Wanted, Volunteers!!

To Survey (1) 4000-4500kcs., (2) 6000-8000 kcs.

Survey blanks with all necessary information will be sent each individual volunteer direct from A.R.R.L. Headquarters. In addition to using amateur receivers with proper coil equipment for the range or ranges mentioned, any all-wave receiver that has a beat oscillator can be used to identify stations.

If you can cover either one or both the ranges mentioned, just report what part of these ranges you can cover so the

proper set of blanks can be sent you, as well as a list of the stations registered at Berne as assigned either block of frequencies that you volunteer to survey. This will help in your checking and calibration work.

All individuals and clubs that have not already signed up for the survey . . . and those who have, who can, in addition cover 4000-4500 kcs. as well as the higher frequency range, are asked to send word by QSL-card, letter or radiogram, so we can send materials, and arrange club-group controls to coordinate survey work wherever possible in different communities. It is up to all us hams to get busy and back up our Cairo Committee, to get the vital information needed.

—F. E. H.

Schooner Morrissey, W10XFP

BOB BARTLETT and his Schooner, *Morrissey*, are again headed north for Greenland on a scientific trip which is being sponsored by several museums for the purpose of adding to their collections of Arctic life.

The vessel has complete high-frequency radio equipment and hams in the 20-meter 'phone band may look forward to many interesting QSO's from the far North.

As a result of the splendid contact work done by Julius and Sully Ross in 1933, Julius Ross, W2KJ, now holds the position of "Sparks."

Two licenses have been issued to the *Morrissey*, WHFZ, a regular ship license, which will be used on the 24- and 36-meter marine bands and an experimental license, W10XFP, which will operate chiefly on 12,862.5 and 8655 kc. Other frequencies assigned with this license are: 6425; 17,310; 23,100 and 27,100 kc.

The radio, with the exception of a few minor changes, is the same as was used under the call W10XDA last summer. Briefly the equipment is as follows:

A 100-watt radiophone transmitter which was fully described in the December 1934 issue of *QST*.

A 500-watt I. C. W. transmitter, which will be used as a spare.

The same Hammarlund Comet "Pro" receiver that has been used on the last two trips and proven itself dependable.

A revamped Grebe CR9 receiver, which will be used for weather reports and other long-wave reception.

The *Morrissey* set sail from New York, Sunday, June 23d, and will make her first stop at Brigus, Newfoundland, Captain "Bob's" home town, and from there will proceed to Turnavik, Labrador, a fishing station owned by the Bartlett family. Then the *Morrissey* will head across Davis Straits to Disco Island, Greenland. From then on the *Morrissey's* movements will depend on the ice conditions which she will encounter.

Tentative schedules will be arranged with W2GOQ at Wayne, N. J., and with VO2Z at Brigus, Newfoundland.

Code Practice

W1ASD, Hartford, Conn., is sending code practice daily except Saturday and Sunday from 7:30 to 8:00 p.m. on 1889 kc. W9TLM, Denver, Colo., transmits practice on 1867 kc. every Wednesday at 7:00 p.m. Daily, including Saturday and Sunday, W8MTE, Detroit, Mich., will be sending code lessons from 8:00 to 8:30 p.m. on 1725 kc. All times are the local time at the transmitting station.

Flood Emergency Communication

AMATEUR RADIO is credited with a long list of public service achievements. Amateurs of Colorado, Nebraska and neighboring states carried on in traditional self-sacrificing fashion in providing communication to flood- and tornado-stricken towns following severe storms in late May and early June.

COLORADO

At the first indication of trouble in Denver the amateur station at the National Guard Radio School was pressed into service. This station, owned and operated by W9FA and W9APR, is used for National Guard training work and as the control station of Unit One, Section Eight, 12th Naval District, of the Naval Communication Reserve. Using the call W9FA the station was operated on 3775 kc.

In Colorado Springs on May 30th, all but one outside wire were down with danger of the one remaining wire going at any time. City power was off, W9OKY, battery-powered emergency transmitter of the Pike's Peak Amateur Radio Association, was put on the air by W9EHC, W9LJF and W9UEK. Before operation hardly was under way, city a.c. power was restored and it was decided that better outside contact could be maintained with higher power. W9LJF's 300-watt transmitter and W9EHC's ACR136 receiver were put into operation at W9LJF's shack.

Communication was established between W9FA and W9LJF at 7:45 p.m. on May 30th. W9AMS and W9EHC in Colorado Springs went on a tour of newspaper offices, police station, railway stations, and telegraph stations to see what traffic could be picked up—and did the traffic pour in!! A continuous watch was necessary. The telephone company put a special operator on LJT's line to handle his calls. The local broadcast station, KVOR, sent regular announcements of the fact that outside communication was available through W9LJF. Police and U. S. Army officers, who were in charge of the emergency work, made extensive use of the service. W9HDI, W9H DU, W9LJF, W9UEK and W9EHC kept W9LJF on the air for a straight forty-eight hours at the start and then for about eighteen hours per day for the next four days. After the second day W9KNZ, W9LFE and W9KI aided in the rush, but the bulk of the traffic continued to go via W9LJF. While the flood was at its height W9DNP, W9DYP and W9H DU took W9KNZ' and W9H DU's 56-mc. transceivers to the edge of the water and sent news reports to KVOR.

In Denver W9PVZ and W9MKN took tricks at the key of W9FA to relieve the regular operator, W9FA himself. Due to the large number of messages coming into Denver it was necessary to call additional stations into service so that W9FA might be left free to contact W9LJF. W9FYY and W9ESA pitched in and took traffic from W9FA, W9ESA handling local deliveries and short-haul work out of Denver, and W9FYY handling distant traffic on 14 mc. Amateurs in other Colorado cities were worked to make sure that no other points had been seriously damaged. Among these were: W9CDE, La Junta; W9GLI, Rocky Ford; W9NUP, Sugar City; W9FCK, Florence; and W9NLD, Pueblo. Some of these assisted in handling Colorado Springs traffic.

As for just how serious the emergency was, let us quote W9FA: "Mere words or pictures cannot describe the damage. Immense concrete and steel bridges torn from their pilings and twisted into knots, houses swept from their foundations and torn to bits, cars rolled over and over before the onrushing torrents, and living souls carried away before the very eyes of their friends with no possible way of helping them. Concrete roadways buckled up as the roadbed washed from beneath." Over 175 messages were handled by the operators at W9FA, not counting the many reports passed back and forth for people seeking information. Other Denver stations handled about 100 messages each.

NEBRASKA

During the wee small hours of June 1st, W9EKQ at Littleton, Colo., picked up the calls of W9POB at Wauneta, Nebr., and called W9FA for assistance in copying the messages. W9POB reported that the crack number 6 train of the Burlington, "The Aristocrat," was stranded at Benkelman,

Nebr., some thirty miles distant, with tracks washed out both east and west from that point and the water flooding the entire area. All wire communication had been severed and the Burlington office did not know the whereabouts of the train. Message after message came through from the marooned passengers. W8POB handled about 50 through roaring static crashes. Finishing about 7:00 a.m., W9POB signed with W9FA to get much needed sleep after his all-night vigil. W9KPA at Enders, Nebr., took up the work where W9POB left off. For three days W9KPA made a daily 60-mile trip to Benkelman to deliver messages to the passengers and train officials and to collect more. He was on the job for three days and most of the nights, all messages being handled through Denver.

McCook, Nebr., a city of 8000, and several surrounding towns were left without electric power, water, railroad, highway or wire communication after 3:00 p.m., May 31st. W9CRB of McCook, assisted by George Vaughn and Mr. McNeal, an ex-amateur, got a battery-powered c.w. rig on the air. Contact was established at 6:00 a.m., June 1st, with W9JFF, Denver. The next contact was with W9COU, Cozad, Nebr., traffic being handled. W9BAE at North Platte, Nebr., was raised at 12:10 p.m. W9FWC assisted in the traffic work at W9BAE. W9KQX, Potter, Nebr., was QSO W9CRB from early afternoon until evening. W9BAE made contact with W9CRB again and carried on until 10:00 p.m. Because of poor conditions, communication was called off at that time and a schedule made for 5:00 a.m. the following day, June 2nd. At that time W9CRB and W9BAE both cleared their hooks. W9BBS, North Platte, then took over the work with W9CRB. Traffic was handled with W9CRB throughout the afternoon and evening by W9BBS, W9EIZ and W9BAE. Regular schedules were maintained throughout June 3rd by W9BBS and W9CRB. On June 4th W9BBS kept schedules until 7:00 p.m. when wire lines were available. W9CRB used c.w. in the 3.9-mc. 'phone band, working 'phone stations. W9BBS, W9BAE, W9KQX and W9COU were all on 'phone. W9CRB was on the air a total of 60 hours. Traffic was handled for the Red Cross, American Legion, Burlington R. R., Nebraska Light & Power Co., Bell Telephone Co. and Western Union.

On June 2nd, at 6:15 a.m., W9FWC, North Platte, Nebr., took rush traffic from W9FA, Denver, for McCook, and telephoned it to W9BAE for relay. W9BNT, Omaha, was worked by W9FWC and received information on conditions at McCook. At 8:12 a.m. W9FWC worked W9KPA, and for one hour and a half took A.P. news to put on the wire at North Platte. The amateurs at North Platte (W9BAE, W9FWC, W9BBS) estimate that upwards of 300 messages were handled from June 1st to June 4th. W9FWC handled about 125 at his own station.

Many small Nebraska towns had not been heard from—Holbrook, Oxford, Orleans, Alma, Republican City—all were isolated. A truck owned by W9EKK and carrying five men (Lewis Cook, W9FWW, A. L. Cook, Bob Mitchell, Milan Kinsey, W9EKK, and Brick Earley) set out from Lincoln early on the morning of June 2nd, arriving at Oxford about 9:00 a.m. Aboard the truck was W9FWW's station equipment and the portable equipment of W9EKK. W9FWW was installed in the Pettygrove (W9EOA) Hardware and Radio Store. W9BNT was raised and schedules arranged. A schedule was also made with W9KPA for western traffic. Messages into McCook were routed via W9FWC and W9BBS. W9FWW was on the air continuously for four days and nights. On June 3rd a plane from Holdrege, Nebr., flew the portable equipment (W9EKK) and two of the party (W9EKK and Brick Earley) to a good hill location about three miles west of Oxford. W9EKK was set up at this point and aided in the rescue work. This was the only means of communication in the flooded area. A tent was flown in and dropped, as were other essentials. Spare storage batteries and food were furnished by the postmaster at Beaver City. A near catastrophe occurred when the crew at W9EKK got caught in quicksand. They had to let the equipment go into the river to save themselves. It was recovered, however. Telephone communication was established June 5th at 6:30 p.m. The emergency communication

party left for home the following day. The trip was under the auspices of the Lincoln Chamber of Commerce. Messages were handled for Western Union, A.P., National Guard, and Red Cross, as well as considerable personal traffic.

W9EWO at Kearney was called upon by National Guard Headquarters at Oxford to keep them posted on height of waters. Official broadcasts were copied and phoned to Major Henninger at Oxford. Two receivers were used at W9EWO in order to keep posted on McCook developments. Traffic was handled through to Kansas and Southern Nebraska via W9DCC, Minden, Nebr.; W9LOD, Republican City, Nebr., and W9OKH, Phillipsburg, Kansas. W9EWO was on 3.5-mc. c.w. W9DCC was on 1.75-mc. 'phone. W9TIP of Wood River, Nebr., and W9SWI, Grand Island, handled the Grand Island end.

W9OJA, Omaha, worked W9TUH, Lincoln, on the morning of June 1st, and was informed to be on the lookout for W9LOD of Republican City. A QRR chain was organized at 8:10 a.m. consisting of W9LOD, W9DI, Tobias, W9TUH and W9OJA. Messages were handled from the flood area to broadcast station WOW and to local newspapers. W9AVX assisted in handling the Omaha end. The stations in the chain were on the air continuously from June 1st to June 3rd. A total of 65 messages were handled. This was on 1.75-mc. 'phone.

The Nebraska towns to which amateur radio provided the only means of communication included Benkelman, Max, Parks, Stratton, Trenton, McCook and all towns between McCook and Oxford to the east.

Amateurs other than those mentioned in the above paragraphs who are known to have assisted in handling traffic or to have helped in any way in the emergency communication are: In Nebraska: W9PZX, W9ATB, W9HNG, W9GFI, W9MKG, W9MGV, W9UDEI, W9HTU. In Colorado: W9KCC, W9NEY W9SVL, W9PWU, W9DCY, W9JFD, W9MGU. In Kansas: W9RIZ, W9R1W, W9CDM, W9JVQ. In Iowa: W9IHO, W9ABE. In South Dakota: W9PFI. In Wyoming: W7EDW. In Minnesota: W9PDL.

We are indebted to the following for the very splendid reports which made possible the complete summary presented above: Glen Glascock, W9FA, Colorado S.C.M.; S. C. Wallace, W9FAM, Nebraska S.C.M.; C. B. Darnell, W9KPA, Nebraska R.M.; Carl C. Drumeller, W9EHC, Sec'y-Treas. Pike's Peak Amateur Radio Association; E. L. Bayles, W9BAE; Lewis H. Cook, W9FWW; T. N. Johnston, W9FWC; Don Griffin, W9EWO; Wilbur Yates, W9OJA; Don Gibson, ex-9FYR; C. M. Delano, Lincoln, Nebr.

28-Mc. Activities

Excellent and unusual results are being reported on 28 mc. LU1EP has been worked by W5JV, W6VQ, X1AY, ON4AU, W1AVV, W4AGP, W1DF, W1ELR, and W2CPA. He has reported hearing many other signals. W5AOT and OA4J made what is believed to be the first United States-South America 28-mc. QSO on June 9th, 4:25 p.m. EST. OA4J also heard W3DLB and W5EME, on the same afternoon. W4MR worked VK2EP on June 15th at about 9:00 p.m. EST. W1AVV QSO'ed E1SB at 4:00 p.m. EST on June 16th. E1SB has worked LU1EP, E1SB and E1BF are on 28 mc. daily from 1800-2000 GT. LU1EP and OA4J are on the band every Saturday and Sunday from about 4:00 p.m. EST. F8BG reports hearing W2CPA, W8CQO and W1DFB on June 16th between 2200 and 2400 GT. During May and June ON4AU had many 28-mc. contacts with many stations all over Europe, as well as northern Africa QSO's and one with LU1EP. He has heard J2CL and was heard by VK3EG. W4AGP has worked L8BAJ and heard F8IIE, W6DOK has heard K6KBV, ZL2BN and ZL2GQ will be on 28 mc. every week-end, calling every half hour from 1930 Saturday until 0530 Sunday (GT). ZL2BN is on 28,500, ZL2GQ on 28,700, approximately. W9FG, Boulder, Colo., has heard W6KWA, W6VQ and W7BRU. W6IVU reports that W6IDF, Los Angeles, has QSO'ed all W districts, VE, K6, VK2, 3, 7, ZL, J and X. W6VQ has been worked by W9KEP, W4MR and W4AJY. W4AJY also worked W6CAL on June 30th. W9DEI, St. Charles, Minn., worked the following during the last week in June: W4MR,

W4AH, VE3DU, W5EKU, W9LLX, W9TIZ and W1ZZG had a three-way QSO lasting from 1:11 to 3:40 a.m. CST on June 21st. These are but a few examples of the many 28-mc. reports received. Not enough is known about "ten meters" to predict what is ahead, but that band certainly has possibilities as is obvious by noting the splendid work done during June.

A.R.R.L. 28-mc. Contest

It's not too late to get into the International 28-mc. Contest. The rules, which appeared first in September 1934 QST are repeated here:

1. The Contest is open to all licensed radio amateurs.
2. The Contest will commence at 0001 GT October 1, 1934, and will conclude at 2400 GT September 30, 1935.
3. Licensed power must not be exceeded.
4. Contacts may be established at any hour and on any day during the contest period.
5. One point will be scored for each completed 100 miles of contact, with a specific station (e.g. a contact with a station 99 miles away scores no points, contact with a station 858 miles away scores 8 points). All distances will be measured by a Great Circle line between stations.
6. In computing his final score a competitor may claim points for each different station worked once during each calendar month.
7. Proof of contact in writing may be required by the contest committee.
8. Re R.S.G.B. Award: (a) A minimum signal strength of QSA 3 must be recorded before a contact counts for points. (b) The decision of the president of the R.S.G.B. will be final in all cases of dispute. (c) Entries must reach the Secretary, R.S.G.B., 53 Victoria Street, London, S.W. 1, not later than November 15, 1935.
9. An A.R.R.L. Award Committee shall consider the file of reports and data submitted by competitors to the A.R.R.L. Its decision will be based on: (1) The number of weekly reports to A.R.R.L. on 28-mc. work, 25%. (2) Equipment description and development work on same, 25%. (3) Number of points in accordance with Rule 5, 50%. Examination of all reports with ratings weighted on these factors will determine the 28-MC. ACHIEVEMENT AWARD. Entries (from W/VE) must all be received at A.R.R.L. on or before October 15, 1935, to be considered for the A.R.R.L. Award.

A bronze charm will be presented by the A.R.R.L. engraved "FOR 28-MC. ACHIEVEMENT OCT. 1, '34-SEPT. 30, '35," and with the call of the winner. One point will be scored for each completed 100 miles of contact. Decision between W/VE competitors will be based on weighted credits. (1) The number of weekly reports to A.R.R.L. on 28-mc. work, 25%. (2) Description of equipment, and development work reported on same, 25%. (3) The number of points scored (monthly contacts with the same stations will be permitted to count), 50%. W/VE entries must be received at A.R.R.L. on or before October 15, 1935. Report your results each week to A.R.R.L., and submit scores and log to both A.R.R.L. and R.S.G.B. at the end of the contest if you wish these to count for all awards.

Starting October 1, 1934, this International 28-mc. Contest will be in progress for one year, concluding at midnight September 30, 1935. This is open to all hams. In addition to an R.S.G.B. International Trophy and certificates to the leading ten stations wherever they prove to be, the A.R.R.L. will award a bronze medallion to the highest scoring United States or Canadian operator-experimenter.

O.B.S.

The following is a supplement to the list of A.R.R.L. Official Broadcasting Stations in October QST (page 49): W3EVA, W4MR, W5DAQ, W5EFV, W6HHM, W6TT, W7CRH, W9GFS, W9KEI, W9SDQ, W9UEU, VE2FG.



Cup Offered for first 28-mc. W.A.C.

A silver plated Loving Cup will be presented by the Lakewood (Ohio) Radio Club to the first radio amateur who Works All Continents on the 28-mc. band after September 1, 1935. The rules covering the award are as follows:

1. The contest is open to all amateurs in all countries, except members of the Lakewood Radio Club. Only individuals are eligible. No entries of club stations or stations at which there are more than one operator will be considered.

2. The contest starts at 1:00 a.m., September 1, 1935, and will continue until the prize is awarded. The prize will be awarded ninety days after the first claim has been received and affirmed. This is to provide enough time for late QSL's to be received. One award only will be made.

3. A copy of the log of the six contacts in addition to the QSL cards must be submitted to the Lakewood Radio Club Contest Committee. A sworn statement that all entries in the submitted log are true must accompany the log. QSL cards will be returned.

4. Either 'phone or c.w., or both, may be used. Both stations in QSO must be working in the 28,000-30,000-ke. band. All contacts must be made after September 1, 1935.

5. Claims should be addressed to the Contest Committee, Lakewood Radio Club, 1457 Warren Rd., Lakewood, Ohio. The decision of the judges will be final.

The cup is well worth working for! It stands 10 1/4 inches high, mounted on a black bakelite pedestal. It is gold-lined and silver-plated. Very attractive and a real trophy. Who will make WAC first after September 1, 1935?



Hamfests Scheduled

Amateurs of Wyoming, Idaho, Montana and Utah will gather together for their third annual meeting at Jenny Lake, Grand Teton National Park, on August 3rd and 4th. This get-together is known as the "WIMU Hamfest." Camping facilities are available and a fine time promised.

A joint round-up of the Evansville, Indiana and Henderson, Kentucky gang is planned for August 24th and 25th at Evansville. Details will be gladly furnished by Darwin Covert, 1400 Parrett St., Evansville, Indiana.

Hams Afloat

How many radio amateurs hold the title of "Sparks," the nickname by which ship radio operators are known? Surely scores of hams are sailing the seven seas as operators. If you're one of 'em, tell us about yourself. We have news of a few "Sparks," as follows: W2BDR is on a round-the-world cruise as op on the *President Harrison*, KDMQ. W9AAR operates on the S.S. *North American*. W7DTG and W7EBG are pounding brass on the Coast Guard Cutter *Pulaski*. W1DBU is leaving for the Pacific Coast where he will be radio operator on a whaling vessel. W6BHM is aboard the *Black Hawk* of Uncle Sam's Navy. W6JQJ answers to "Sparks" on the S.S. *Panamam*. W3QM is on the U.S.S. *Aylwin*. Operator on WICU, the S.S. *Tamiahua*, oil tanker coastwise bound, is W3MC. W2BC is operator on the Yacht *Atlantic*, WQBG, and works hams on 18 and 24 meters. W2CXD is shipping as op on the Grace Liner *Santa Catalina*. W8RN is on the *Cadillac*, KFNN. W9AIR is working WOBL on runs between Dubuque and Minneapolis. C'mon, Sparks, send us the dope on *your* activities.

The American Lutheran Church is interested in projecting a line of communication from its headquarters at Columbus, Ohio, to one of its missionary fields in New Guinea

or the nearest mail point. It has been taking four months via postal service, and it is hoped a trunk line for message service can be established between Columbus and Madung, New Guinea. Any amateurs interested in this work, please communicate with Armin H. Meyer, W8KQO, Capital University, Columbus, Ohio.

W9ECY recently acted as a relay station between two stations in QSO without either of them knowing it. He had his 1.75-mc. 'phone rig turned on and was tuning his receiver on the 3.9-mc. 'phone band. He heard W9MGV, Angora, Nebr., calling "CQ 80 or 160 meter 'phone." W9RNF, who has only 1.75-mc. coils for his receiver, heard W9MGV through W9ECY and started calling W9MGV on 1.75 mc. W9ECY remained tuned to W9MGV during the entire QSO, retransmitting him on 1.75 mc. When the contact was ending up, W9ECY broke in and explained what had been taking place. And were the boys surprised! Hi.

Mr. Oliver Amlie, president of the International 6000-12,500 Mile DX Short Wave Club, is interested in lining up several amateurs for special communication service with numerous foreign countries during October 1935. The points with which contact is needed are: Australia, Fiji Islands, New Zealand, Singapore, Medan, Sumatra, England, France, Italy, Germany, Ecuador. Amateurs interested in cooperating in providing communication to those points are asked to communicate with Mr. Amlie for full details at 56th and City Line Ave., Overbrook, Philadelphia, Pa.

Alaskan Service

Two planes were down at Elim, Alaska, on account of the weather. K7EGC at that point arranged schedules with K7DEV at Nome. For four days (until the weather cleared) these two amateurs QSO'ed regularly at 6:30 a.m., 12:10 p.m., and 7:00 p.m. Weather reports were handled on the morning schedules and traffic the rest of the time. During one noon schedule K7DYU at Gambell was heard urgently calling K7DEV. Contact established, it was found that a nurse at Gambell was badly in need of advice from the doctor at Nome about a certain case. Traffic was handled from the nurse to the doctor and an answer returned. It is by just this type of service that amateur radio saves lives in isolated territory! Alaskan towns have learned to depend on amateur radio for speedy communication.

WIINF

The station of the A.R.R.L. Headquarters Operators' Club, WIINF, transmits the Official Broadcasts, addressed to all amateurs, by radiotelephone on 3984 kc., at 12:15 p.m., Eastern Daylight Saving Time, daily except Saturday and Sunday. This schedule will remain in effect until September 1st, when it will change to "daily except Sunday at 12:00 noon E.S.T." WIINF is equipped for work on both the 75- and 20-meter 'phone bands. At the present time, however, most of the operation is on 75 meters, due to receiving difficulties on "20." Regular scheduled operation on 20 meters will be announced as soon as the difficulties are cleared up. Following the noon-day transmissions of official broadcasts, WIINF looks over the 75-meter band for calls. When possible additional 5 p.m. transmissions are made, and rag-chewing schedules outside regular office hours are kept by individual staff-club-members.

Headquarters operators and their personal "sines": Harold A. Bubb, "HAL," Chief Operator W1MK; F. E. Handy, "FH," W1BDI; E. L. Battery, "EV," W1UE; A. A. Hebert, "AH," W1ES; C. C. Rodimon, "ROD," W1SZ; Ross Hull, W1EBD; Ralph Beaudin, W1BAW; J. J. Lamb, "JIM," W1AL; Don Mix, "DON," W1TS; K. B. Warner, "KEN," W1EH; F. C. Beekley, "BEEK," W1GS; C. B. DeSoto, "DC," W1CBD; George Grammer, "HG," W1DF; A. L. Budlong, "BUD," W1JFN; Vernon Chambers, W1JEQ.

WIMK QRX Thru August

SINCE your A.R.R.L. Hq. station (WIMK) was first installed, and placed in operation in February 1928, there have been practically no shut-downs, the station making regular contacts with thousands of amateurs each year, handling close to 8000 messages annually, giving all hams current "hot" information through regular O.B.S. transmissions, helping beginners gain speed by use of tape transmission, setting a fine example to all amateurs through maintenance of a high standard of operating at all times, through the 40% of its operating time spent in keeping schedules making efficient relaying of information day by day or in emergency possible, exemplifying the amateur spirit of public service.

August 4th, the day after our monthly national get together of A.R.R.L. officials and officers on the air (the first Saturday night of each month, RM-NITE), WIMK will go off the air for a rebuilding spell, during part of which time operator HAL will also take his vacation. The station will reopen in September. In line with the recent appointment of your station by the Signal Corps as WLMK (see page 69 May 1935 QST) to further the emergency readiness of your station and organization, provision for crystal control on 6990 and 3497.5 kcs. will be added. A-T cut crystals will be used, giving sufficient frequency constancy without the necessity for continued use of the WIMK-designed temperature crystal-control box that has seen five years' service; operating position changes to facilitate work with a "mill" are contemplated, also a new exciter unit will be added, with alterations in crystal-switching and band-switching arrangements. The latter is in line with the Board's recent suggestions to all amateurs that greater flexibility in transmitters, and more diversified use of all our bands will increase the effectiveness of our work. Incidentally, this is written in the normal "rebuilding season." It's just the right time to get your outfit revamped and ready for the important activities and sked work to come in the fall. QRV?

E. W. Mayer, K4KD, started in ham radio with a gas engine spark and electrolytic detector in 1911, along with his cousin H. L. Trett, who is now W5GG. He was at it until the "War Seal" was placed on all hams. Enlisting in the U. S. Navy in 1918, he had eight years' active duty. Following that he went to commercial coast station, operating for five years. For the past three years he has been employed in Airways operating work. The call K4KD has been held for ten years. Mayer's radio years total 24, 16 of them being in active ham work. A schedule was maintained between W2FN and K4KD for 17 months. The following are annexed to K4KD's call: WAC, WBE, RCC, A-1, ITK, TBTOC. In addition he was winner for Porto Rico in three International Relay Competitions and three Sweepstakes. Mayer inquires as to the chances of starting an Old-Timers Club, for the lads who started the game with E. I. Co. and Wm. B. Duck catalogs. What say, old-timers?

During the concentrated attempt on May 25th to establish 56-mc. communication between New York City and Philadelphia, W3AMP reports that W2DLG on the Hotel New Yorker and W2AZB, Summit, N. J., came into Trenton QSA5 R8. W3AZG and W3FGN on the Philly end were also received FB in Trenton.

Red Cross Emergency Net

H. J. Burchfield, W6JTV, S.C.M. East Bay Section, A.R.R.L., is chairman of the emergency communication system for the Oakland, Calif., chapters, American Red Cross. An extensive system is now under development. The entire district is laid out in sections with 56-mc. mobile rigs assigned to each. Permanent 56-mc. set-ups are provided at fire stations, hospitals and at the City Hall. Appointments are also being made on the lower frequencies. 7 mc. is used for DX traffic outlets and 3.9- and 1.75-mc. phone for most of the short hauls. The power company has promised to furnish five portable emergency a.c. generators; four of them 2-kw., one a 5-kw. job. These will be utilized at the

homes of five hams. Operators are being assigned to the "key stations" selected on 7, 3.9 and 1.75 mc. Eleven mobile 56-mc. units are already working, and more are promised. Tests of the complete system are planned for the near future.

Radio amateurs in the vicinity of Grand Island, Nebr., played important rôles in the apprehension of a band of gypsies, who had not been too careful in the matter of how they procured their money. William Kearney, residing near Wood River, Nebr., was victimized to the extent of \$25. Starting in pursuit of the gypsies he stopped at a filling station at Wood River, where W9TIP operated his station. W9TIP notified the Wood River marshal, and then, turning to ham radio, raised W9SWI in Grand Island, and passed along the news. W9SWI immediately communicated with the sheriff and police department, both agencies sending out men to halt the fleeing gypsies. The party was caught west of Grand Island and brought to task. Amateur radio again!!

Hawaiian Convention

The annual convention under the auspices of the radio clubs of Hawaii was held June 8th at the Alexander Young Hotel in Honolulu. Over 160 were present. The FB dinner was followed by speeches, which were broadcast over KGMB. Speakers included Mr. Chappell, the K6's new radio inspector, Major L. H. Stanford, U. S. Army, Lt. H. P. Roberts, KA1HR, Mr. Clark of MacKay Radio, and A. O. Adams, K6EWQ, A.R.R.L. S.C.M. L. A. Bagley, K6JFV, was toastmaster. Several prizes were awarded to winners of the various contests held.



WIHRC, AND THE SMILING COUNTENANCE OF ITS OWNER AND OPERATOR, CLAYTON C. GORDON, SECTION COMMUNICATIONS MANAGER OF RHODE ISLAND

7294-kc.

Dedicated to "good fellowship" the "7294-kc. Net," organized by "Pop" Dann, W6ZX, is growing rapidly. As of June 1st the net numbered in its ranks 46 amateurs, whose frequencies fall on or near 7294 kc. There is nothing compulsory about the net. It is simply a means of banding together a group of amateurs who enjoy the close fellowship of brother hams and who abide by the Amateur's Code. "Meetings" are held daily at 7:00 p.m. and on Sundays at 9:30 a.m. P.S.T. The gang has its own bulletin, called "7294 Kilocycles," and edited and published by W6ZX, W6CMQ, W8GTN and W6AZ. It contains news of the members and timely items of general interest. If your frequency is between 7200 and 7300 kc., you are invited to get in touch with W6ZX, 1821 Chestnut St., Berkeley, Calif., for details on "7294." Or, contact any of these members: W1PH GRV W2AOA BEK DBS DUG EVZ

GZS W3BXE COZ CQU W4BTU CDE CEI W5DBR
 W6AZ BLP CI CBX CMQ DSV DUC FDF IGY VS ZQ
 ZX W7DSZ EK EBE ETK W8EIK DRW EPY FEY FTF
 GAF GTN W9DHS ISG KJP LZZ NN SX VE4NH VE5FG.

BRASS POUNDERS' LEAGUE

(May 16th-June 15th)

Call	Orig.	Del.	Rel.	Total
W7AFF	1425	---	---	1425
W7AYO	35	154	1168	1357
W3BND	86	96	896	1078
W7BXQ	14	6	1006	1026
W7DRY	46	76	853	975
OM1TB	383	127	406	916
W7DDE	12	22	862	896
W6GXM	68	132	674	874
W9LEZ	47	131	658	836
OM2RX	237	131	290	658
W8KMC	110	79	455	644
W8JTP	270	121	147	538
KA1EE	193	137	200	530
W9PWU	81	47	390	518
W3BWT	109	88	312	509
W7NH	13	15	476	504
W9JRK	12	10	480	502
W8CDK	19	122	390	501

MORE-THAN-ONE-OPERATOR STATIONS

KA1HR	513	402	838	1753
W62G	587	864	214	1665
W5OW	137	224	440	801
K6DV	67	26	655	748
W7AMA	679	---	---	679
W6EK	128	321	194	643
W3SN	67	60	412	539

These stations "make" the B.P.L. with totals of 500 or over. Many "rate" extra credit for one hundred or more deliveries. The following one-operator stations make the B.P.L. for delivering 100 or more messages; the number of deliveries is as follows: Deliveries count

W6GHD, 385	W7EZD-7, 140	W7DRY**, 103
W7CQL, 320	W7APS, 132	W6HXP, 101
W2CHK, 201	W6BPU, 125	W6AKW, 100
	W6LLW, 118	

A.A.R.S. STATIONS

Call	Orig.	Del.	Rel.	Total
WLVO (W7UJ)	18	127	623	768
WLNM (W2CHK)*	3	239	60	302
WLNB (W2DBQ)*	12	104	78	194

MORE-THAN-ONE-OPERATOR STATIONS

WVQB (K6DV)	255	105	822	1182
WLW (W6ZG)	218	371	187	776
WLVK (W6EK)*	70	108	68	246

A total of 500 or more, or just 100 or more deliveries will put you in line for a place in the B.P.L.

* B.P.L. rating on deliveries.

** Apr.-May.

'Phone Notes

AR.R.L. Official 'Phone Station operators recently voted on a proposal by one of their number regarding the institution of an activity requirement. A second subject for voting was a proposal for a specific requirement that "inactivity in three consecutive quarterly QSO parties should warrant cancellation." The idea evidently met with general favor, for the first proposition was accorded a favorable vote of 2.2 to 1, while the specific proposal for a certain activity requirement of a liberal character passed muster by a vote of 3.2 to 1 with more votes on that proposition. The new rule will go into effect as the majority desire, effective with the July quarterly activities.

'Phone operators generally will also be interested to know that some months ago the whole O.P.S. group voted on whether or not a special system of modulation and quality reports was desirable. The group voted 4 to 1 against a suggested M-scale, individuals making the point that the ability to talk freely, and explicitly describe any operating condition in detail as regards both the depth of modulation, and the quality, possible sources of distortion, etc., was superior to any "abbreviated" system incapable of memorization which requires reference to chart for exact definition. Some voice operators of this viewpoint claim there is not the slightest excuse for any abbreviated "modulation and quality" reporting system. The minority viewpoint have felt a

system justified if actually *not* used a great deal in operating, but kept available for making notations on QSL-cards, for log entries, and for making records in serious experimental work concerning "M" and "Q." We should like to hear from all radiotelephone operators as to how you feel on this subject.

Do you want us to present some papers in QST on the subject of a reporting system whether or not a vital need in 'phone operating work? If so it will be quickly arranged, and if not please let us know, as a representative 'phone ham, what you think on this subject. It is contrary to League policy to officially adopt or impose any set of abbreviations, but if you fellows are receptive to some new ideas in this field, for use by those who do want 'em, let us know. Give us a postal card comment for or against and we'll act as usual on what the majority desire.

Welcome, O.P.S.

We announce with pleasure, a substantial increase in the number of Official 'Phone Station appointees—now well over 200 in our nationwide A.R.R.L. 'phone operating organization. The quarterly activities for both O.R.S. and O.P.S. are designed to aid in (1) testing stations, (2) in making new friendships and QSOs, and (3) in mutual self-help and betterment on our several station and operator problems. Special bulletins and participation in quarterly activities keep the O.P.S. a forward-looking group. We take pleasure in welcoming fifty new operators, who subscribe to the high operating standards indicated in O.P.S. appointment:

W1ETD	W4BFB	W7AYG	W8GLA	W9LKI
W1IDN	W4CVQ	W7BBK	W8HFR	W9MOW
W1INF	W4CYB	W7BUX	W8JZ	W9OEC
W1FD	W4MS	W7DXQ	W8JWL	W9OGU
W2DCF	W6DRZ	W8AAG	W8KJ	W9ONR
W3AVR	W5BUY	W8AJJ	W8RG	W9OOO
W3COT	W6DKS	W8BDD	W8AUO	W9PSP
W3CNY	W6ERT	W8BLP	W9HUO	W9RHT
W3MG	W6PB	W8BYF	W8JZA	W9EAW
W4ABS	W7ANF	W8CHT	W9JZJ	W941P

Many New O.R.S.

ALARGE number of new operators have qualified for Official Relay Station appointment since the last additions to the roster were published. We welcome 126 new members of the group and wish them all success in the activities that are held from time to time as well as in the relaying of traffic which is the "meat and drink" of any O.R.S.

Give these "reliables" and others who "sine" O.R.S. after their call a buzz when you want to move something to its destination speedily and accurately.

W1IOT	W2HNP	W6DXA	W8LIG	W9IFM
W1CTB	W2GVZ	W6DZY	W8LLI	W9RQM
W1DBU	W2HUM	W6DQM	W8LUO	W9SPB
W1DLX	W3BO	W6DNE	W8LXF	W9ZVZ
W1DWO	W3CQR	W6KBF	W8LYH	W9SHI
W1FES	W3CWE	W6LDJ	W8NLG	W9CHM
W1GDE	W3ENB	W6QW	W8KIM	W9SKF
W1GOJ	W3EZN	W6CJD	W8LCW	W9SJP
W1HRV	W3EBP	W6GVT	W8KSY	W9TBM
W1HTS	W3EVA	W6LNI	W8LZK	W9RWB
W1IJR	W3BKZ	W6LJA	W8KKB	W9TGC
W1INW	W3EDA	W6EK	W8IAY	W9TXQ
W1HWZ	W3ETX	W6JM	W8ANR	W9LHQ
W1GMM	W3VR	W6KHE	W9EBQ	VE2OG
W1JL	W4ABS	W6KFC	W9JHQ	VE3JD
W1IGN	W4ABT	W7BSU	W9MQV	VE3SG
W1IAY	W4CXF	W7DLN	W9RAQ	VE3WK
W1HTO	W4CYA	W7EAW	W9RAU	VE4MH
W1BNS	W4TL	W7EER	W9SDQ	VE4MJ
W1BJA	W4BAG	W7UE	W8SES	VE4GE
W2BDR	W4BPL	W7DLH	W7TQG	VE5MO
W2HWS	W4CQ	W7EQC	W9LJF	K6JRN
W2BLU	W4MR	W7BAK	W9PVA	
W2AIP	W4CUB	W7ASW	W7EBD	
W2HTX	W4CM	W8RME	W9ENQ	
W2HBS	W5COK	W8KFQ	W9IPG	

How to Become O.R.S. or O.P.S.

DROP a line to A.R.R.L. Headquarters or direct to your Section Communications Manager, whose address is given on page 5, this issue of QST, for full information on the appointment. Your application will bring you necessary blanks and information, and we'd be happy to have you with us if you meet the qualifications for these traffic-relaying and voice-operating appointments.

The following contribution by Mr. Arnold M. Anderson wins C.D. article contest prize for this month. Your articles on any phase of amateur communication activity are likewise solicited and may win you a bound Handbook, six logs, or equivalent credit applied toward other A.R.R.L. supplies. Let us have your article, and mark it "for the C.D. Contest," please. —F. E. H.

Directional CQ's

By Arnold M. Anderson, W9EGP*

WAS it Horace Greeley or Will Rogers that said, "In winter, a young ham's fancy turns towards thoughts of DX?" Well, nemmine, sufficient that it was said.

With the thoughts of DX in my mind, I bade the YL 88's a bit earlier than usual (the distant church time piece had just tolled 1.30) and meandered shack-ward. 'Twas an ideal evening for DX—in fact everything was very DX'y (if you get what I mean). Crisp and cold was the air and my feet as I tucked Squawface (the Pontiac) in her kennel and strode up to the room housing the powerful xmitter of W9EGP.

A glance at the map was sufficient, sunny California was still missing. Sez I to myself, real soft-like, "California, here I come." Filling my growler, nose-warmer, or what have you, with the usual mixture of rubber bands, pieces of celluloid and bakelite, the OM proceeded to get things in shape for a hot session with Cally (slang, dear readers, for California). A flip of the fingers and the dual 210's cast an eerie light over the hay-wire and nails. Absently scratching a match on a collodian-coated plug-n coil, I next thumbed the "maybe-she'll-ketch-and-maybe-she-won't" MG switch. A momentary dimming of the light and an ominous rumble under my feet announced that gud luck was mine from the start. An omen, thinks I, of better things ahead. Shielding my eyes and face with the Handbook from a possible explosion, the key was very, very gently but firmly pressed. Ah ha, success again. The Jewell trusty-trio, the frequency meter, the clock on the table and my pet corn combined to inform me that the 80 meter band was still sticking around. What colossal luck—soliloquized myself, nothing is impossible now.

Bracing my dogs agin the inductances and firmly gritting my teeth, W9EGP boomed out her announcement to the neighboring BCL's that "CQ CQ CQ Cal" meant business. Remembering the cracks in Quist about lengthy CQ's, I warningly admonished my glass arm that none such would be tolerated. After deciding to my satisfaction that 'nuff "CQ Cal's" had disturbed the ether, the MG was allowed to coast to a standstill and the quest began.

With nervous expectations that sent funny, squirmy shivers up my back, I set the receiver at the bottom of the dial and commenced snooping around. Thinks I, "It's a turning point in my life." Nothing greeted me until half way up the dial where I was greeted with "CQ de W9 ---", not much help there. A few more of the boys were hashin' things out on the way up but they were not for me, Then—omigosh, a faint, oh so very faint QSA 2 squeak that I almost came passing up, shipred out, "-----" "Who sez there's no Sanky Claus, hot dog, in fact a whole hot dog stand, and other expressions of glee," whoops I to the bare walls. My dreams were realized, my ambitions had materialized. Keeping one ear cocked on the incoming sig, I reached and affectionately patted the 210's—good old bulbs.

Visions of a beautiful California QSL card gracing my shack, visions of yours truly poking his fingers in derision at my 40 meter pals who claim that 80 meters is so much hokum, came to me as I continued listening for this much sought-for reply to my call. He was sure long-winded,

* 219 McCulloch St., Stevens Point, Wisconsin.

this chap, but possibly because he was as anxious to QSO as I was. "He's from southern California, speculated I, his hand has a decided brogue." But what cared I, he was the answer to my prayers and that's 'nuff.

After four minutes, or maybe five, I could tell the end was drawing near—mind you, he hadn't signed his call in all this time, but he was faltering. Gone was that sure and hold hand, this poor fellow wore himself out calling me when I was here most of the time. Tsk, tsk.

"Well, well, sez I, it'll soon be over and he can rest." Then it came, "... . . . ??! #@##\$%! " etc. Everything went black for he signed himself, W2 - - - !

The doc sez I can leave the hospital in two more weeks but he asks me to request the boys answering a directional CQ to first ask their maws in which state they are located.

General Utility Portable—Correction

Since publication of his article, "Portable Equipment of General Utility," in July *QST*, W3LW has informed us that in Fig. 5 the low-potential terminal of the power-amplifier plate tank should be numbered (3) instead of (2), in order to agree with the coil data and terminal arrangement given in the table.

A.R.R.L. A-1 Operator Club

THE A.R.R.L. A-1 Operator Club was organized in May, 1933, to promote and encourage a high calibre of operating in the amateur bands. Membership has increased constantly until it now totals 670 of amateur radio's best operators.

Nomination by two operators who already "belong" is necessary before any operator is admitted to membership. A complete and up-to-date list of A-1 Operator Club members is given here—nomination by any two of these operators will make *you* eligible for membership.

It is not sufficient to be merely a "speed king" to rate membership among the "A-1 Operators"—you must be an "all-round good operator" with consideration given to general keying, voice technique, procedure, copying ability, judgment and courtesy. The Club is open to all active radio amateurs, both 'phone and c.w., in any country of the world. Operating qualifications alone are considered without regard to membership in A.R.R.L. or any other society.

Members of the A-1 Operator Club are forever on watch for candidates for membership. Make *your* operating the kind that will bring you to the attention of the members! Nominations are made carefully, members being warned against permitting personal friendships and the like to carry any weight in making selections.

It is hoped that eventually the A-1 Operator Club will number in its ranks *every* amateur operator who lives up to a high standard of operating technique. Only if you do that, bearing in mind the several points considered, can you hope to join the ranks. Watch your operating at all times! Supplements to the membership roster appear in *QST* from time to time as new members are admitted.

A-1 OPERATORS

C.W.: W1ABG AFB AGA AJA JB ABJ ALMG ANC APR APW ARB ATJ ATO BA BB BD BDI BEF BEU BHM BIT BLI BMP BMW BNC BUX BVP BVR BYW BZI (Alma, Elaine, Helen & FS) CDX CFG CHF CJD CPT CRA CRP CTI DAV DDK DF DGG DKO DOW DUK EBM EBT EF EFA EH ERQ ES EVJ FH FIO GC GKM GOG IP KH LZ MK (Hal) OR SB SZ TS UE VB VS WV YU (Bob) ZB.

W2ACD AEN AEV AFV AGL AHC AIQ AWL AYN BAS BCX BG BGO BHZ BJA BJX BMX BPY BZZ CC CHK CO CWC CWK DBE DBQ DRV EGF ETH EVA EWQ EYQ FFL FFS GNK GOX KG LU LW PY QY SC SN UL VH WP ZC.

W3AAJ ADE ADM AHD AKB AKN ALX AMR ANH AQN ARV ATJ ATY BAI BBB BEY BGI BJX BKQ (MW & BNS) BND BNH BWT (ED & C) BYA BYS

CAH CDG CFL CL CLV CMJ COO QCS CTD CVU CWE
 CXL (ED, CB, YB, YX, HC & White) CXM DD DEH
 DFK DML DXG DZ EOP EZ FJ GE GS HC LA MC MG
 NF (ED) NO NR NT (RC) OK OM QN QP QV SN (FX)
 WO WU ZD ZL

W4ABT AFM AG AGR AJX AKH ALK ANZ AYD
 AVT AYV BNI BOU BOZ BRK BTX CBY CE CEN DW
 EG EG FT GL HA JR KK LL MI MO MU OI (Dave &
 Mac) PL QL TO UT ZH

W5AAX AJF ALZ ANU AQ ATF AUL AVF AVG AYZ
 BED BII BKH BMI BMU BQZ BZR CEL CEZ EB ENI
 MN NW OW (H) SI VQ ZC ZD

W6AAN AJP AKW ALU AM AJO AOR BJF BLP BMC
 BPM BPO BSV CDA CGJ CKO CRF CUH CUU CVL
 CXW DEP DEN DJV DVD EGS ELU ENV ETL ETM
 EWB EXH FEX FII FRN FS FVU GXM HT KGO LM
 MV OJ PQ (CV) QA RJ SN UD UO WB ZG

W7AAT ASN ASQ AWH AXJ BAA BB BJZ BME BMF
 BRU CRH DUE FL KO SO

W8AJE AKV APC APQ AQ ARX AVK AZI BAH BA
 BBH BGY BHK BJO BKE BKH BME BMG BMK BQ
 BRC BTI BTK BWL BWY CAT CCD CDK CEO CEU
 CFR CGS CLQ CMI CPE CPY CQA CRA CSE CUG
 CVS DGB DDS DEM DHC DHU DLG DNX DSA DSS
 DVC DVL DWB DYH DYY DZ DZP EDG EEZ EGI
 EIK ELJ EPY EQC ESY EUY EVC FCB FDY FEY
 FFK FJG FLA FTW FWX FX FYF GB GBB GBC GBF
 GEG GLX GOD GFS GQB GRZ GSO GUC GUF GUX
 GZ HB HCS HD HGG HSH IOR IWT JAK JE JES
 (Paul) JIN JM JO JTT KJ KJW KKG KMT KQK KR
 KWA MAH OB PL PQ QT SS UW VD VP YA (NOR,
 Geo. & Faries)

W9ABE ACL AET AIO AMB AND APY ASV AUH AZN
 BAN BAZ BBP BBS BCF BCB BKJ BKK BNA BWJ
 CDA CFL CGV CNE CRT CSI GSK CTP CUY CYD
 DDE DEF DEI DFF DGS DHA DI DMY DNU DOU
 DQT DXY DZW/GP EEW EFC EGU EHW EJC EKY
 ENH EPJ ERU ESA ESU EW EWO FA FAA FAM FFD
 FLG FO FP FQ FQL FRA FUW FWW FX GX GDU
 GJQ GJX HJC HML HPG HSK HSN HTU HUM HUY
 HVA HYR IFL IFZ ILH IOL IYA JRK JZY KJ KJY
 KKT KNZ LCK LEZ LHQ LW MCC MU YU MZD NJS
 OLC OX PDE PLM RHM RYD TA UZ VS YB (Booth/
 8DDP-PV).

K4KD.

K6AJA AUQ COG EWQ.

K7AOA PQ.

VE1DR EP ER 2BB 3AD AU CP GT HA JI NO WA
 WX 4BB BZ DK MW 5AM EU FG GT HP HQ HR

FOREIGN: CT2BK D4BAR EAIAS 4A0 4BE E18B
 F8EO G2BM (H & R) MA G5QY YH J2GW GX NY1AB
 (Van & Mac) OK1AW PA0DC LL QJ VE2BP 3ML 3NG
 5HG VP5PZ ZL1FT 4AI AO FK FR.

PHONE: W1AQM AUJ AVK CCZ SZ W2AWR BYM
 DC JN TP W3AHR AUJ AXT BUY CNY DF DQ GY
 NK WX ZA W4JB OC RV TR W5AOT ZA W6CIN CNE
 KT ZH W8AJ AOM APN KPC DLD FEE KIR LUQ RD
 W9CJJ CPD DRD VE3JI K6FJF.

On 56 mc.

The June 16th boat regatta under the auspices of the Nampa (Idaho) Junior Chamber of Commerce was under way. Things were working out well except that the referee's boat, anchored about 350 feet from shore, was too far out to get word back to the judges without sending in a boat after each race, causing a twenty-minute delay between each event. Enter amateur radio!! W7CGR and W7CGU rushed two portable 56-mc. rigs to the scene of the races. One outfit was installed in the referee's boat, the other in the judges stand, where a public address system was located. W7DOH operated the gear at the judges stand. The set-up worked to perfection, making a success of the regatta.

A 56-mc. test was made May 10th from the "Comet," streamlined train of the New Haven Railroad, while it traveled from Meriden, Conn., to New Haven at 82 miles per hour. W1HNW and W1HLD installed the gear on the train. A transceiver using a type 19 tube in a Unity coupled push-

pull circuit was used. The antenna was a capacity coupled Hertz, 8 feet long, clipped to one end of the push-pull center tapped tank coil. It was inside the aluminum alloy car tied at the free end to the overhead baggage rack. W1FEF, Meriden, was worked as the train sped from that city. Other amateurs heard were W1LHF and W1HVB of Meriden, and W1AVS and W1FRK of Wallingford.

Aboard a 25-foot cruiser as it headed from North Tonnawanda, N. Y., to New Haven, Conn., was W1GYT with a 56-mc. transceiver. The trip was by way of the Erie Canal, Hudson River and Long Island Sound. Stations worked were W8AYN, Rochester, W8NOL, Rochester, W2IAC, New York City, W2GPB, Larchmont, N. Y., W1CVQ, New Haven, and W1DFQ. Others heard were W2AEJ, W2HVQ and W2DRN. So well did W1GYT "git 'em" that the cruiser was officially named "W1GYT" at the conclusion of the trip.

ELECTION NOTICES

To all A.R.R.L. Members residing in the Sections listed below: (This list gives the Sections, closing date for receipt of nominating petitions for Section Manager, the name of the present incumbent and the date of expiration of his term of office.) This notice supersedes previous notices.

In cases where no valid nominating petitions have been received from A.R.R.L. members residing in the different Sections in response to our previous notices, the closing dates for receipt of nominating petitions are set ahead to the dates given herewith. In the absence of nominating petitions from Members of a Section, the incumbent continues to hold his official position and carry on the work of the Section subject, of course, to the filing of proper nominating petitions and the holding of an election by ballot or as may be necessary. Petitions must be in Hartford on or before noon of the dates specified.

Due to resignations in the San Joaquin Valley and Missouri Sections nominating petitions are hereby solicited for the office of Section Communications Manager in this section and the closing date for receipt of nominations at A.R.R.L. Headquarters is herewith specified as noon, Sept. 3, 1935.

Section	Closing Date	Present SCM	Present Term of Office Ends
Eastern	Aug. 1, 1935	Jack Wagenseen	Aug. 7, 1935
Penna.			
Washington	Aug. 1, 1935	Stanley Belliveau	Aug. 15, 1935
Saskatchewan	Sept. 3, 1935	Willard Skaffe	June 15, 1934
Alaska	Sept. 3, 1935	Richard J. Fox	Feb. 16, 1934
San Joaquin Valley	Sept. 3, 1935	Clyde C. Anderson (resigned)	
Missouri	Sept. 3, 1935	Cecil R. Cannady (resigned)	
E. New York	Sept. 3, 1935	Robert E. Haight	Sept. 16, 1935
E. Mass.	Sept. 3, 1935	Joseph A. Mullen	Sept. 16, 1935
Ontario*	Oct. 15, 1935	S. B. Trainer, Jr.	Oct. 18, 1935
Vermont	Oct. 15, 1935	Harry Page	Oct. 20, 1935
San Diego	Oct. 15, 1935	Harry A. Ambler	Oct. 20, 1935
W. New York	Nov. 5, 1935	Dot Farrell	Nov. 10, 1935
British Columbia	Nov. 15, 1935	E. K. Town	Nov. 20, 1935
Connecticut	Nov. 29, 1935	Frederick Ellis, Jr.	Dec. 4, 1935

* In Canadian Sections nominating petitions for Section Managers must be addressed to Canadian General Manager, Alex Kell, 100 St. Lambert, Quebec. To be valid such petitions must be filed with him on or before the closing dates named.

1. You are hereby notified that an election for an A.R.R.L. Section Communications Manager for the next two year term of office is about to be held in each of these Sections in accordance with the provisions of By-Laws 5, 6, 7, and 8.

2. The elections will take place in the different Sections immediately after the closing date for receipt of nominating petitions as given opposite the different Sections. The Ballots mailed from Headquarters will list the names of all eligible candidates nominated for the position by A.R.R.L. members residing in the Sections concerned. Ballots will be mailed to members as of the closing dates specified above, for receipt of nominating petitions.

3. Nominating petitions from the Sections named are hereby solicited. Five or more A.R.R.L. members residing in any Section have the privilege of nominating any member of the League as candidate for Section Manager. The following form for nomination is suggested:

(Place and date)

Communications Manager, A.R.R.L.,
 38 La Salle Road, West Hartford, Conn.
 I, the undersigned member, of the A.R.R.L. residing in the.....Section of the.....Division hereby nominate.....as candidate for Section Communications Manager for this Section for the next two-year term of office.

(Five or more signatures of A.R.R.L. members are required.) The candidates and five or more signers must be League members in good standing or the petition will be thrown out as invalid. The complete name, address, and station call of the candidate should be included. All such petitions must be filed at the headquarters office of the League in West Hartford, Conn., by noon of the closing date given for receipt of nominating petitions. There is no limit to the number of petitions that may be filed, but no member shall sign more than one such petition.

4. Members are urged to take initiative immediately, filing petitions for the officials for each Section listed above. This is

your opportunity to put the man of your choice in office to carry on the work of the organization in your Section.

P. B. Handy, Communications Manager

ELECTION RESULTS

Valid petitions nominating a single candidate as Section Manager were filed in a number of Sections, as provided in our Constitution and By-Laws, electing the following officials, the term of office starting on the date given.

N. Y. C. & L. I.	Edward L. Baunach, W2AZV	April 15, 1935
Maine	John W. Singleton, W1CDX	May 25, 1935
Maritime	Arthur M. Crowell, VE1DQ	June 14, 1935
North Dakota	Hartwell B. Burner, W9OEL	June 14, 1935
Nevada	Edward W. Helm, W6B1C	June 14, 1935
West Virginia	Dr. Wm. H. Riheltdaffer,	July 12, 1935
	W8KKG	
Md.-Del.-D. C.	Edgar L. Hudson, W3BAK	July 15, 1935

In the Southern New Jersey Section of the Atlantic Division, Mr. Carrol D. Kentner, W3ZZ, Mr. Robert N. Irvine, W3APV, and Mr. LeRoy Matsinger, W3YZ were nominated. Mr. Kentner received 85 votes, Mr. Irvine received 36 votes and Mr. Matsinger received 14 votes. Mr. Kentner's term of office began May 8, 1935.

National Highlights

THE VE5 QSO Contest held in early June was a complete success. The number taking part is conservatively estimated as 75. The highest scorer, VE5HC, had 54 contacts. A flood in Del Rio, Texas, wiped out all communication. W5BHO, in town with a 12-watt portable, provided the only means of communication for two days, sending dope to broadcast station WOAI, San Antonio, where it was rebroadcast. The majority of activity in Alabama at the present time seems to center in 1.75-mc. 'phone work. The highlight of the past month in Western Florida was the annual "W4KB Hamfest"; each year the gang enjoys a gala blow-out at W4KB.

Interest is high in the Gulf Coast 56-mc. Emergency Net. Stations in Texas, Mississippi, Alabama and Florida are making tests to perfect this emergency communication channel. W3ASK is the newly appointed 'Phone Activities Manager for Virginia. The following Oregon stations operate on a spot frequency of 3770 kc.: W7UJ, W7BXQ, W7WR, W7ANX, W7CRK, W7LJ, W7BRH. They have outlets for traffic East, and to Washington, Alaska, California, Guam and Hawaii. W7QI, Seattle, schedules Alaska. W7AYO, Yakima, is lining up schedules with W6USA. W1GZL, Western Mass. P.A.M., has worked 65 miles with 56-mc. rig in his car.

The Oklahoma Crystal Contest closed with the May-June report. W5ASF won the crystal as high traffic man for the first six months of 1935. W5AMT and W5BDX placed second and third respectively. A C.C.C. Radio Net is planned for District "1", in South Carolina, and licensed operators are needed. W4CE, A.R.R.L. S.C.M., is Camp Educational Adviser at Co. 419, S.C.P.-53, Effingham, S. C., and has three classes going in radio. A little thing like an operation didn't keep the operator at W4FT off the air—he is now working on 14 mc. from his bed!

W8BDD, new 'Phone Activities Manager for West Virginia, is making plans for a State 'Phone Net on 1.75 and/or 3.9 mc. The Portland (Oregon) Better Housing Show furnished lots of traffic and drew considerable attention to ham radio. W7AMA did fine work at a Sportsman Show station in Spokane. At a dinner held by the Connecticut Brass-pounders Association on June 6th, Frank Hawks, W1IJ, well-known speed flyer, told of numerous interesting experiences in which radio played a part. Emergencies in which amateur radio comes to the rescue are varied in character and are not necessarily always communication line failures; for example, we hear of the case when W1EAK, stuck in the mud, let out a CQ on 56 mc. W1ADR came to the rescue and got him going again! Hi.

While confined as a patient at the Lowell (Mass.) General Hospital W1IDY operated a bed-side portable 56-mc. rig, keeping a regular schedule with his home station, W1DBE operating there. A low-power highlight—W5CPT worked all "W" districts on 14 mc. in five hours with three watts input. The Western Florida A.R.R.L. Section organization leaders are pushing for 100% crystal-controlled stations in that Section; the percentage is already high and steadily increasing. We learn from W8JWL of a 1.75-mc. 'phone network, which meets each noon—its name: The Bologne Network. Amateurs of Colorado during May-June had a busy time

of operating. Flood emergency traffic and traffic from the National Guard encampment kept the operators well occupied!

An amateur station exhibit is being lined up for the Indiana State Fair by W9SDQ. Activity is gaining momentum in Vermont. The St. Johnsbury Club and R. M. WBNS staged a most successful hamfest at West Barnet, Vt., drawing substantial attendance from both sides of the Green Mt. State as well as New Hampshire and Massachusetts. The major event was a 56-mc. transmitter hunt, with W1DQK victor. The Chief Ohio P.A.M., W8HMS, is working up an Ohio network of 'phones on 3.9 mc. The A.A.R.S. operators of Cleveland and surrounding territory held their annual picnic June 8th; about 60 were present. The Connecticut A.A.R.S. gang had an outing at the shore during June.

It pays to advertise, in many ways. W8MFV has his call letters on his spare tire cover. W9DZP from Kentucky was in Dayton on a visit. He drove up behind W8MFV's car, noticed the call on the tire cover, called CQ on his horn and a personal QSO took place. W8MFV directed W9DZP to a street he had been trying to locate, and a new friendship was made, thanks to advertising the call letters. Nebraska ham radio was very much on the job in handling flood emergency traffic in early June. Nineteen towns in northeast Nebraska and northwest Iowa were represented at a hamfest/picnic held by the Northeast Nebraska Radio Club at Pender, Nebr., on June 2nd. W4AYE, W4CXY, W4BQK and W4BBT are operating a Tennessee summer traffic net on 3737 kc.

K6JPT, well known as one of Hawaii's star traffic handlers, is enroute to Washington, D. C., where he will take up duties as one of the operators at WLM/W3CXL. Capt. R. B. Woolverton, WLV/W6ZG, was tendered a farewell party by members of the A.A.R.S. at Arcadia, Calif., prior to leaving for his new post at WLU/W9BNT, Omaha, Nebr. Ham antennas are found fastened "most anywhere, from the church steeple to the city jail. W6IAH has his hitched to two 125-foot oil derricks. W6GHD is a valuable outlet for trans-Pacific traffic; he schedules OM1TB. W6CDA has a schedule with CE3AD, a Pan-American Airways pilot, and invites south-bound traffic.

W6QC, Arizona S.C.M., is now out of the hospital after being laid up following a serious motorcycle accident; he will be on crutches for the next ten months. The Ponca City (Okla.) Key Clickers put on a real state convention; 165 registered, and every last man had an FB time. W4AJY worked 21 stations in one day on 28 mc. That band is more active than ever before. Going South? If traveling through Virginia during August, you will be welcome at the meeting of the Floating Club at Lynchburg on the 18th. The current Alaska S.C.M. report tells us that some nice medical emergency work was done by K7DEV and K7DYU. It is not the first time that amateur radio in Alaska has aided in the preservation of human life! FB.

W2CC and VK5HG completed their 1000th QSO on June 18th! The last 100 QSOs were on regular schedule, with no misses. W9ILH, YF of W9ICN, made the B.P.L. eight times in succession, the eight totals making a grand 10,649 messages!! She "headed" the B.P.L. for two months in succession. W9ILH holds down a position on A.R.R.L. Trunk Line "K" and is alternate station for W9ICN on Line "L." An example of real ham spirit: W8AVK driving 76 miles to help W8EU put new rig on the air! W3ZX, S.C.M., and W3NF, R.M., are planning a Southern New Jersey Net. The June highlight for many amateurs was, of course, graduation from school. For others it was wedding bells. We heard of one well-known ham who spent two days of his honeymoon at a ham convention. Well, at least it's a good way to break her in right! VK3LN, on a visiting tour of the States, visited W9FA and W9APR in Denver. W9IQZ, W9PLF, W9SXN and W9RWE, all in South Dakota, will follow the Stratosphere flight via 56 and 112 mc. The State Convention at Marquette, Mich., was the complete success a hard working committee had tried to make it. Members of Unit Three, Section One, Third Naval District, enjoyed a get-together at the farm of W1AMG, Unit Commander, in late June. Social activities, a buffet lunch, and organization talks were featured.

STATION ACTIVITIES

SOUTHEASTERN DIVISION

ALABAMA—SCM, L. D. Elwell, W4KP—DNI is now crystal-controlled. APU finally took the '03A off the shelf and it's now in the rig. BJJ blew the speech amp. tubes. AJY, a new W.A.C., worked 21 stations in one day on 28 mc. DGM works from 28 mc. on down to 1.75 mc. AAQ-ADL hated to report it, but they just didn't see the antenna when it started down. Hi. DJV is working portable 'phone. DEG makes a very FB report for the first one. CIU reports that his 802 passed out. CYV and ALA are about to consolidate. The 1.75-mc. 'phones seem to be in the majority now as far as activity is concerned. AUP will try 1.75 mc. as soon as he gets a crystal. DID, DEQ, AXU and GN work a lot of cross-band 'phone. CWB has applied for O.R.S. FB, OM. KP is very busy.

Traffic: W4DHG 39 DJV 29 APU 12 KP 5.

EASTERN FLORIDA—SCM, Philip A. McMasters, W4BCZ—CQD is working DX. BIN is building 3.9-mc. 'phone. DAP is building rack and panel rig. BWX acts as relief op. at BXL. COV's brother died. DIO reports A.A.R.S. still strong. BCZ is busy building commercial station. DGW reports following new hams in Gainesville: CEM, DNU, DOD, DOO. DDM tested with BCZ to eliminate back wave. DCZ has new flea-power 1.75-mc. 'phone. COB blew up all tubes and power supply. AYX has worked the great DX of Orlando at last. Hi. CGV and CGW are working on high-power rig. AKA is electron-coupled now. DBA blew a 50 in his modulator. CWR has new rig done in gold and green. BNR is back on 1.75-mc. 'phone. All amateurs interested in getting Tampa made examining point for Class A license, please write BCZ. CQZ was QRL due to City Nuisance Ordinance at Lake City. Please report right through the summer, gang.

Traffic: W4CQD 6 BIN 14 DAP 3 BXL 4 COV 1 DIO 56 BCZ 3 DGW 8.

WESTERN FLORIDA—SCM, Eddie Collins, W4MS—ACB and 4AUW, R.M.'s. The highlight of the month is the annual hamfest held at 4KB's. CTZ has been rebuilding into a new rack job. DGG is working to improve his 1.75-mc. 'phone. BPI is home from the U. of F. BMJ has moved to Panama City where he will at last have a.c. power lines. BJJ is also there. BSJ confines his activities to 14-mc. 'phone for the summer. DEZ is doing nice work on 7 mc. 3FAD/4 is planning higher power. 4DIC with new speech input is getting R9 reports all over the country on his 1.75-mc. 'phone. AQY and AXP are doing FB U.S.N.R. work. ABK is the newest U.S.N.R. station. 3FCD/4 has a new '03A. CMJ is working on two transmitters. BGA gets R8 reports from ZL but craves R9. BFD wants a velocity mike to use on 3.9-mc. 'phone. DAO is collecting apparatus for c.e. CDE is still after that "J." AUW is heard on 7, 14 and 28 mc. Any other fellows who can listen on 28 mc, please get in touch with AUW for tests. BKD should be home from Ga. Tech. CQF has been rebuilding his antenna coupling. VR is having a little receiver trouble. QU handles the U.S.N.R. drills in fine shape. QK is putting in a Collins antenna system. CUV is rebuilding his transmitter. ACB is experimenting on 28 mc. AGS is working with KB in running tests on 56 mc. Let's have more work on 56 and 28 mc. gang. ASV keeps HQ in ship-shape condition. PBW is building a high-power rig. AUA is QRL W.U. CRU is one of our finest operators. CUR is active on 7 mc. COG is thinking about an a.c. superhet. BKQ promises 1.75-mc. rig. DHC is U.S.N.R. station in Pensv. ART has an FB sig on 3.5 mc. UW was a visitor home this month. 5AHW and 4CRA visited the gang this month also. Interest in the Gulf Coast 56-mc. Emergency Net is high with stations in Texas, Miss., Ala., and Fla. making 56-mc. tests. For further information write the S.C.M. or 4GP. MS and BGA are planning more power. The percentage of crystal stations in West Fla. is on a steady increase, but we want 100%, so what say, fellows?

Traffic: W4ACT 7 DAO 6 KB 5 DIC 1 QK 1 HQ 8 QU 4 W4MS 24.

GEORGIA-SOUTH CAROLINA-CUBA-ISLE OF PINES-PORTO RICO-VIRGIN ISLANDS—SCM, Bannie L. Stewart, W4CE—South Carolina: BDT spent two weeks in Charleston Navy Yard on U.S.N.R. training. DLP

is on 3935 'phone and 3571 c.w. in Anderson. BZX has FB 'phone in Columbia. CZA has new mast. AFQ recovered from wreck and is active again. CE will soon be on 3.9- and 14-mc. 'phone. CZP is on 3.5 and 7 mc. in Georgetown. CWY is going to high power. DPC is new in Florence. The Charleston Amateur Radio Club plans to pull a "Ham House Party" Aug. 31st and Sept. 1st. All hams are most welcome. 4CZA of Moultrieville is president of the club. A C.C.C. radio net is planned for District "1" in S.C. and licensed amateur operators are needed. Any of you C.C.C. hams want to transfer to S.C.? 4CE is Camp Educational Advisor at Co. 419, S.C.P.-53, Effingham, S.C. (twelve miles south of Florence), and has three classes going in radio with an initial enrollment of thirty-six. Georgia: Assistant SCM Georgia, Rev. G. C. Hinshelwood, W4BBV. AHT received cards from K5AN and Fife, Scotland, reporting signals heard on 3.5 mc. QSA 4R7. DKZ is completing a crystal Tri-tet for three bands. CSD accompanied BBV with two others on fast trip to Michigan; stop-off made for an hour with 80G at Springfield, Ohio; stop-off made at 4PL's for dinner and sleeping the night, utmost hospitality; stop-off made at WLW, being shown over the station. The Northwest Georgia Amateur Radio Club, organized in 1931, held a spanking fine hamfest in Rome, Ga. The fest was graced by the presence of 4APU, director for S. E. Division. YLs were in abundance, outstanding among whom was 4DAI, well known by the speed of her bug operation. Good ole' southern barbecue was enjoyed by all. 4UC made a fine job of the whole business. Cedartown was represented by 4LL of OT fame. Gainesville Club is aiming to have the next hamfest where some of these birds can climb to the top of some of these Blue Ridge Mountains and test out their ability on 56 mc. or maybe 112 mc.

Traffic: W4BDT 26 BZX 3 CE 8 IR 242 BBV 233.

DELTA DIVISION

ARKANSAS—SCM, H. E. Vette, W5ABI—BMI won 2nd place in O.R.S. Contest. ARQ has RK-20 in final. ABL has no trouble working VK. CPV spends lots of time fishing. DRZ is QRL YL's. EGX uses pair of '45's crystal-controlled. FAL is new station in Little Rock. Welcome. DRR has new ACR-136 receiver. DFZ has moved to Eldorado, Ark. DSU and DJQ are on 3.5 mc. DRW paid visit to ENL. DRY is rebuilding for higher power. EIP spends much time traveling. BKD is new station in Blytheville. CVO is now engineer in charge of KUOA. ENL is now D.N.C. in A.A.R.S., BED in charge. DYF is working DX on 7 mc. ABI made improvements on rig. IQ has dropped A.A.R.S. work for the summer. SI is busy with plans for the fall Delta Division Convention to be held in Pine Bluff. The Radio Club in Little Rock is progressing very nicely.

Traffic: W5BMI 132 ABL 14 CPV 35 DRR 17 DRW 12 DRY 11 EIP 4 ENL 42 ABI 64.

LOUISIANA—SCM, W. J. Wilkinson, Jr., W5DWW—EMS plans to have an RK-20 soon. KC will have new rig. ANA is operator on S.S. Gatun. HR is staying on 14 mc. BPL has decided to wed. Congrats. EBB is now in New Orleans. DAQ rebuilt entire rig. BUK visited in New Orleans. AGM is going on soon. CFG is still around town. WG is working 28 mc. ERV wants QSO on 7 mc. EEZ has new rectifier. EAI is on 1.75 mc. AFV is partially active. AXD, CMG, BN and BNY are A.A.R.S. DKR is busy with convention plans. DWC, ST and EEV are active. AEH is building new receiver. AOZ is building speech amplifier. CXQ is at 826 Octavia St., N.O. DMF and EDZ are building 'phone rigs at school. JW was heard in France. CJO is working on 14-mc. rig. BPN and DIQ are on in New Orleans. GR received QSL from Germany. LA has 1-kw. rig on 14 mc. EDY is building pre-selector. DXK is chief professor at N.O.R.C. Ham School. EVS has RK-18 working FB. OZ is at sea. BYY will soon have new rig. DWW won BZR's receiver. CVW is experimenting with all-wave portable transmitter. ZS and AKI are going strong. Don't forget—Louisiana State Convention, Jung Hotel, New Orleans, La., August 24th and 25th. For full information write DKR—2749 Myrtle St., New Orleans. YL's and YF's will have special group of entertainments. The OM's will be well taken care of also. PRIZES—CONTESTS—BEER (free). Registration fees—OM's \$2.00; YL-F's \$1.50.

Traffic: W5EMS 5 KC 3 HR 7 BPL 1 DAQ 34 DKR 24. TENNESSEE—SCM, Merrill B. Parker, Jr., W4BBT—We are very sorry to hear of the death of Buford A. Mathes, W4ADX, of Johnson City. He was the organizer and, for several years, the president of the East Tennessee Amateur Radio Association, in whose activities he was vitally interested at all times. In amateur radio he was, primarily, an experimenter, with a keen mind and extraordinary ability. He was a real amateur in every sense of the word; courteous, considerate and helpful. With his passing Tennessee loses one of its best hams. We extend our deepest sympathy to his family. AYE, CXY, BQK and BBT are operating summer traffic net on 3737 kc. RO reports complete overhauling of his station near finish. CBS and ARP are building 56-mc. transceivers. CBU is building 1.75-mc. 'phone. AYE spent week-end with BBT. About 35 Tennessee hams attended and thoroughly enjoyed themselves at a hamfest and barbecue held by the Northwest Georgia Amateur Radio Club at Rome. AM, PL, CBU and BBT reaped heavily on the prizes donated, while ARP reaped heavily on the free beer. PL has 200-watt rig that looks plenty good and works even better. 8JZ and YF spent several days with CBA and his YF.

Traffic: W4AYE 154 CXY 111 PL-BBT 50 RO 33 (WLRJ 10) CBA 18 CW 13.

WEST GULF DIVISION

NORTHERN TEXAS—SCM, Richard M. Cobb, W5BII, W5ARS R.M.; W5SP P.A.M.—COK handles traffic on 7 mc. EEW is getting traffic for Celo; he needs local schedules on 7 mc. DXA handled one Colo. flood message; he reports EAV rebuilding and AXK home from Texas A. & M. BII has new receiver and is rebuilding transmitter to increase power. CPB is working DX on 14 mc. CPT worked all W districts on 14 mc. in 5 hours with 3 watts. BXA is on 7 mc. most of the time. EES has moved to Memphis, Texas, but has been laid up in bed and is not on the air yet. IA has new crystal rig on 7 and 3.5 mc. EHM is working for O.R.S.; he made 927 points in Field Day. EIM may join regular Army; he reports that DOG has gone to summer college. FBQ is working everything in U.S. and is fishing for K6's on 7 mc. DNE is just home from hospital and is resuming schedules. The N.T.A.C. Radio Club is now affiliated with the A.R.R.L. The club station is EUV.

Traffic: W5COK 106 EWB 68 DXA 50 BII 39 CPB 26 CPT 21 BXA 12.

OKLAHOMA—SCM, Carter L. Simpson, W5CEZ—CEZ is preparing to take that delayed vacation. AMT attended the convention in Ponca City and will handle schedules for CEZ while the latter is on a vacation. BJJ reports that the new YL op is not interfering with radio. MUCH. ASF wins the crystal as high traffic man for first six months of 1935. AJF works some DX on 14 mc. DDW has a new Sky rider Super. EXZ is a new reporter and applies for A.A.R.S. DQM receives A.A.R.S. certificate and is a new O.R.S. CVA is having trouble getting rig to work on 3.5 mc. KZ reports activity in Okmulgee at a low ebb. The crystal contest closes with this report. The winner is ASF with a total of 1533 for the first six months of 1935. Second place was taken by AMT with a total of 1371, and third place by BDJ with a total of 1336. (The S.C.M. was ineligible.) EFV is a new O.B.S. EQO is off the air due to his B batts having gone west. AIR is back on the air after having an '03A go soft. ARB is building a nice rack and panel job. BAR has been inactive due to his job. PZZ uses a pair of '10's on 14 mc. EMH is building a 1.75-mc. 'phone job using '46's, modulated with 53's Class B. AMS gets the 800 working on 14 mc. ABK says he guesses he isn't living right, as he failed to win a prize at the Ponca City Convention. And speaking of conventions, the Ponca City Key Clickers really put one on. There were 165 registered and everyone had a swell time. Tulsa is making a bid for the Oklahoma 1936 A.R.R.L. State Convention. The date of the West Gulf Division Convention has been set and approved, and will be held in Corpus Christi, Texas, August 16th and 17th. See you there.

Traffic: W5CEZ 292 (WLJC 116) AMT 85 BJJ 67 ASF 51 AJF 19 DDW 18 EXZ 16 DQM 14 CVA 3 KZ 2.

SOUTHERN TEXAS—SCM, Bradfield A. Beard, W5-ADZ—OW says traffic is slowing up. DWN returned from

trip to Big Bend district; used 100-watt portable. ADZ is building new rig. FDI, new ham in Beaumont, is using par. '46's in final. CQY (X-5AAZ) is on in Uvalde with '10's P.P.; wants schedules. DLZ, DYA and ETP operate at. DWN. BEO was in Del Rio when flood wiped out communication. He was only means of communication for two days. He sent dope via his 12-watt portable to broadcast stations WOAI at San Antonio, where it was rebroadcast. FBI EKN is putting in crystal '10's P.P. final. EWZ worked VPIJR. AFV is on 28 mc. and is working many stations, using 'phone and c.w. BUB is building relay rack and using '03A P.P. final. EOO got Radiotelephone Third ticket. CUJ has new RK20 exciter stage. AMJ is on 1.75-mc. 'phone. LP is at G.E. in New York. FDR and FDJ are new hams in Houston. 1935 A.R.R.L. WEST GULF CONVENTION. PLACE: CORPUS CHRISTI, TEXAS, NUCES HOTEL. Date: August 16th and 17th. YOU CAN EXPECT THE FOLLOWING: (1) Prizes, as always. (2) Special prizes for pre-registration. (3) Prominent radio authorities on speaking program. (4) Talks limited to 15 minutes each. (5) Complete convention program for women. (6) Dance and OWL party, Friday night. (7) Inspection of steamships and Coast Guard cutter. (8) Free boat rides. (9) Something doing every minute. (10) The convention is at a time when the Gulf Coast summer season is in full swing, when all summer sports and entertainment can be enjoyed. BE THERE.

Traffic: W5OW 801 DWN 207 MN 69 BEF 22 ADZ 21 FDI 3 EKN 7.

NEW MEXICO—SCM, Joseph M. Eldott, W5CGJ.

Traffic: W5WM 98 (WLJG 23) DZY 78 CGJ 10 ELL 2 DLG 81.

ROANOKE DIVISION

NORTH CAROLINA—SCM, H. S. Carter, W4OG—Greensboro: MR is doing some fine work on 28 mc.; he worked a VK and was heard by an LU. ZH is working and playing ball in Winston-Salem this summer. Warrenton: BHR has been QRL work. CJM thinks a pair of '10s would work better than his '46s are doing, in the QRN. BYD, on 7 mc. says he can't find any traffic there. Wilmington: FT had an operation and is working 14 mc. from his bed now. BKS works plenty of DX on 14 mc. CPA has rating of Staff Sergeant in the National Guard. CPT has a new rig with a pair of RK20s in the final. BRK has moved to a new QRA about a block from FT! BPL is still on 14 mc. trying to raise DX. DIE, a new ham, has an 801 in the final. BQZ is going strong on 14-mc. 'phone and EC is on 'phone and c.w. on 14 mc. BJV has started a chicken farm. Statesville: DQ received Class A ticket, but says don't strain your ears listening for him on 'phone. CJH also received Class A ticket. BV cancelled schedules for the summer and is looking for DX on 14 mc. Charlotte: CXC says since the Army Net went off for the summer traffic has disappeared. The Club is working on the Convention. BQE is building a 'phone rig. AEN received Class A ticket and is going on 14-mc. 'phone. BX says the heat has most of the gang. Siler City: QI reports that there are five hams in the town of 2000 population, and challenges any other town to beat that. BYE works 3.5-mc. c.w. and hasn't changed his rig in two years. DKF hopes to try 'phone in the fall. DKN lives off of power lines and has trouble getting thru QRM with a '19 tube. DOR is a new ham. Durham: CUB, new O.R.S., used his tank condenser in WDNC which kept him off the air most of the month. NP is president of the club. AUK is treasurer. TR is building new rig with an '04A in the final. OC has a new Collins 30FXB and a National HRO receiver. 3BVV from Philadelphia is now working here. Fort Bragg: The rig at DLM has a hard time accommodating the eight ops. CGM has taken CVQ's crown for rebuilding so much. CVQ has a new 14-mc. rig and divides time between 'phone and c.w. Raleigh: BRT is the only one reporting this month! Kings Mountain: There are three new hams here. DOV is on the air and DOZ and DOQ are building. FB, gang. CEI is DXing. CTK applied for O.R.S. Morganton: CYB has gone on 7 mc. to avoid the QRN on 1.75 mc. Tarboro: CGH is working plenty of DX on 14 mc.; he now has 41 countries. Mount Holly: CYY was heard in England six out of seven nights that he tested on 1.75-mc. band. Winston-Salem: CJA returned from school. CJU and CXF visited COK in

Washington, D. C. CGY is looking for DX on 14 mc. CKJ attended the Atlantic Division Convention in Syracuse, N. Y. ABT is on the air with a brand new rig. CYA is working on 7 mc. mostly to avoid QRN. BWC, one of our very loyal club members, is on the air at last. NC made a good score in the Field Day. OG had both hands cut and in bandages at the same time so you know how active he has been. With the 'Phones: DCQ is home from school and has an Eimac 50T on 1.75 mc. AI has his Class A ticket and is going on 14-mc. 'phone to miss QRN on 1.75 mc. BYA works 'phone about 75% and c.w. on all bands the other 25%. RV has a velocity mike and preamplifier and should go to town now. BX got the bugs out of his rig and is now on 14 mc. AEN can't decide what to use in final of his new rig. CLB divides his time between 7-mc. c.w. and 3.9-mc. 'phone. He is a traveling P.A.M. and gets the dope FB. BFB worked a VK on 14 mc. There are quite a few 56-mc. rigs in Charlotte now. BX and CLB visited BTI and CWH in Georgia and traveled 660 miles. Page DW. CDQ has Class A and is now on 3.9 mc. The gang in Gastonia broke up some bootleg operation on 56 mc. FB. BNG has caught up with his plowing and has been on the air more. CEL has a 14-mc. rig ready for the air. AVH has much better quality since getting his new crystal mike. JB is on with a new rig using controlled carrier system. FB. ANU blew the tubes in his receiver. NT is on 14-mc. 'phone once in a while, but works 3.9 mc. mostly. BHS has Radiotelephone First Class now.

Traffic W4BRT 37 CVQ 17 CTK 14 CXC 13 CYA 12 DQ 9 BYA-CYY-NC 8 CUB-DCQ 6 BV-CYB 4 CJA-OG-CEI 3 BER 2 QI-CXF-ABT-RA 1.

VIRGINIA—SCM, Neil E. Henry, W3BRY—EEG leads in traffic this month. ELF went to his first 'fest. FBR is going fine on 1.75-mc. 'phone. BAN is chewing the rag on 7 mc. AAJ is planning details of a contest. BZE has swell new semi-vertical skywire. EDG says N. C. gang can't get ahead of us! BSB is DXing on 14 mc. ASK is new P.A.M. Good luck, OM! DRK likes building rigs better than operating. BRA had swell time at Norfolk fest. BWA is still gunning for a "J". GY is very QRL with work these days. DZW will be back in the winter. FB1 CA keeps schedule with 1ES and 3BZ. CNY is O.P.S. again. Swell! DNW got on 14 mc. at last. EZJ, EHL, BQQ, FBI, and ECQ are rebuilding. BTR makes W.A.C. using a pair of 45's in final. EOO needs batteries to get on. FFI moved to Burkeville. BZ hears lots of "9's" on 28 mc. between 9 and 11 p.m. DVP has gone back to 1.75-mc. 'phone. ENO had swell vacation. BIG is working on a 'phone net. COO is active on 3700 kc. AJJ is having a swell time on 3.9-mc. 'phone. CYM is going on 'phone. BFW is experimenting. EZL has swell portable transmitter. BRY is QRL Virginia "HAM," HII EEN is on 56 mc. all the time. The S.C.M. hopes that all have a nice vacation this year and that all the new rigs perk to beat the band. The August 18th meeting of the Floating Club at Lynchburg is going to be a dandy! Be sure to come and bring all the gang. Swell time guaranteed!

Traffic: W8EEG 24 ELF 6 FBR 3 BAN-EPH 2 AAJ-BZE-EDG-BSB 1.

WEST VIRGINIA—SCM, C. S. Hoffmann, Jr., W8ED —A hamfest was held at OK-WLHB by W. Va. A.A.R.S., on May 19th. A splendid time was had, nearly all W. Va. A.A.R.S. being present with their YFs or YLs, as well as many other hams, from within and outside the State. 55 were present, including Sgt. Ed. Day, Chief Operator at WLM. The most important news this month is that BDD has been appointed P.A.M. for the State, and promises some real things, if the 'phones will cooperate with him. He wants to inaugurate a State 'Phone Net, on either or both the 1.75- and 3.9-mc. bands. BDD asks the 'phones to communicate direct with him concerning the Net; also read the W. Va. S.C.M. Bulletin for other news. New O.P.S.: BDD, KSJ, JWL. Congratulations, fellers! BDD is on 1.75 and 3.9 mc. KSJ is on 3.9 and 14 mc. JWL is on 1.75 mc. and is going up for Class A exam. O.P.S.: in the State now are: BDD, EYV, JM, JWL, KSJ. MOL changed from 1.75-mc. 'phone to 3.5-mc. c.w. AHF is using 14-mc. 'phone. KSJ is going to work at WWVA, operating. GBF is operating at WPAR. KKG (RM) built a 1.75-mc. 'phone, input of 400 milliwatts, he has been QSO over 9 miles with it, using 8 ft. of wire (loaded), for an antenna! LSK worked 9EGZ on

1.75-mc. 'phone, with 20 watts input. CMJ and KWL are working with 56-mc. 'phones. JWL is member of "Bologne Network," which meets each noon, on 1.75-mc. 'phone. CHM says Charleston has eight 56-mc. transmitters. Bluefield Amateur Radio Club participated in A.R.R.L. "Field Day," by installing two portable transmitters and four receivers, at Chimney Cave, Va. Power was derived from gas-driven generators. Practically whole club membership participated in the encampment. Nine operators held the contest, in tricks of one hour operating each. 31 stations were worked, with a multiplying factor of 9. Power input to the two transmitters was 19.4, and 12.8 watts respectively, to the P.A.'s. 3AAF was Camp Supervisor; 8CDE, Chief Operator; EWM, Technician; KBU, Transportation Manager. MCL and KCB tied for highest score honors. This is the first participation of a club in W. Va. in the A.R.R.L.'s Annual Field Day and it was a real one. Congratulations to the Bluefield Club! CHM, HIU, BKI, DMF and OBN also participated in the Field Day, making 339 points with their equipment. LII and LTD apply for O.R.S. JJA worked NY2AB, his best DX. ELK is taking a rest. KKG is building a new transmitter, a pair of '03As in P.P., P.A., into which he expects to pump 800 to 1000 watts, HII CVX joined A.A.R.S. AKQ has bugs in transmitter. JRL returned from trip to Jamaica where he visited VP6PZ. KGT is rebuilding for the 'Nth time! CMJ visited HD. ILK visited KSJ. HD and HWT visited JWL. CMJ visited ELJ and KDP. LTD, LTC and NBH visited ELJ, NKZ, NFU, GAC, MSI and LGB. ADI-NDE visited Washington. The S.C.M. hopes to visit WLM, W1MK-WLMK and W2SC on vacation. CDV and FVU are both installing a pair of Eimac 250-watt tubes! FBQ went to R.O.T.C. Camp. NRD is new Wheeling ham. OBN is new Charleston ham. LXF says message deliveries bad. AZD worked SX3A, YT7VN, YI3FB. ATT applies for A.A.R.S.

Traffic: W8LTD 41 LII 11 JJA 6 MCL 23 KKG 116 (WLHN 66) HD5 (WLHF 4) LSJ 1 LXF 3 MCR 15 HWT 11 ATT 22.

ROCKY MOUNTAIN DIVISION

COLORADO—SCM, Glen R. Glasscock, W9FA—Say, gang, please remember there is a Route Manager in office in the Section. Give him something to do, or at least drop him a card and give him the dope on schedules, etc. He is 9PVZ, 1946 Irving St., Denver. Emergency flood traffic in Colorado and Nebraska as well as Field Day contacts and National Guard traffic has occupied the major portion of the time for all hands during the past month. Please, always, drop a card or letter to the S.C.M. when you take part in such activities so everyone will be reported in QST. NEY handled a bunch of traffic for Nat'l Guardsmen during encampment, and was in the swim in short while during the Nebr. flood emergency and handled a couple of messages from McCook. FQK and RCY handled plenty of traffic at Nat'l Guard Camp. NZJ and RHH spent a couple of weeks at camp. TSQ, TEJ, NLD and others handled the Pueblo end of the Nat'l Guard traffic, where the artillery was located for one week. LJJ handled the Colorado Springs end of the work, where the aviation squadron was located. GII and SSB acted as relay stations when signals got too weak between Denver and Pueblo. FA and APR handled the Denver portion of the traffic. TOS is proud possessor of a new super skyrider. FRQ worked five continents in less than an hour. FB, OM. . . . EEZ is going to 14-mc. 'phone. . . . IFD put up new skyhooks and snagged a J for one of his first contacts. SEX has gone to Canon City for the summer. DRQ and FRQ are building new supers. TOW is rebuilding his transmitter. EII operates in the early morning hours. FDP is fixing up a small portable to use while on the job at Taylor Dam. MOM reports from Rolla, N. D.; he says they are moving to Idaho soon and he is still looking for answers to his Colorado CQ's. NVE is rebuilding. PMF has a 211E perking on 14, 7 and 3.5 mc. OTM hooked a pair of 10's on the 59 and now runs about 100 watts input. NLD is building a portable rig to take along to college next fall. LJJ finally had his wish for traffic fulfilled. Flood traffic and Nat'l Guard encampment kept his station plenty busy all month. AMS is quite active on 56 mc. despite his working nights. DNP and DYP are on a rebuilding spree. EPN was

on for a short while after an absence of several years. EHC got back on the air using an RK-25. FXQ says he can't work anyone, so why keep the rig on the air? HDI likes to pound brass, but does it at LJP's shack because if he got his own rig on the air it would interfere with his rebuilding. HDU is leading the P.P.A.R.A. gang in 56-mc. activity. JAV is on the air again, 56 mc. KI has an RK-20. '03A rig that is a swell-looking and working job; he handled some of the QRR and Nat'l Guard traffic. KNZ peddled his super-het and is building another. LFE helped out during the flood emergency. NHI is off, due to lightning wrecking his station! NRZ is busy 56-mc. man. OKY, the P.P.A.R.A. portable, put in a 26-hour stretch on Field Day. Results were very gratifying. PRF is rumored to be a big-shot in the C.C.C. Camp's radio located at Beulah. TFT is working 14, 7 and 3.5 mc. very nicely with a pair of 801's. UEK is revamping a converter and a super-het with hopes of having a really good ham receiver when he gets thru. URW has an ACR-136, transmitter uses a pair of 801's in the final. USP, another new ham in the Springs, has a super-het and a nice-looking three-stage rig. Ten members of the Pike's Peak gang spent the Field Day week-end atop Cheyenne Mountain, 9200 ft.; three transmitters and three receivers were taken along, but the 801 Hartley and the 3-tube '01A receiver did most of the duty. Both Coasts and Gulf states were contacted with ease, as well as numerous 56-mc. contacts in the Springs. The Pike's Peak gang will put on the R.O.W.H. initiation at the Convention in Greeley this year. All ye lids, beware. TRR in Montrose puts out signals with a pair of '46's and brings 'em in with a skyrider. GYV mustered enough equipment to build a rig of his own and is not hamming at SBJ any more. LZA is a June bride, but he wants to give the credit to the YL. Best o' luck, Bob. EBW overhauls the rig periodically, but it always seems to perk, whether it is upside down or squeeze. IXG feels the bug biting again. SZS is getting plenty of DX with only a '47 osc. and the assistance of a PR-10. RX visited the Montrose gang recently. PWO made a round-robin visiting trip and called on IZA, IOA, IXG, EBW, SZS and MLU. RTQ is chasing bugs for the Bureau of Entomology. We're not sure just what drawer he works in. RTQ reports plans for a Western Slope Hamfest coming along in fine shape. OMN's whistler consists of a pair of '12A's in P.P. T.P.T.G. with about 225 volts of B bats. PVZ is spending his time learning to pound a mill. ESA has cancelled his schedules for the summer, but continues active on 56 mc. MKN says the QRN is about to drive him bugs. APR put on a 56-mc. demonstration for the brass buttons at Nat'l Guard Camp. EMU has a complete

new rig and receiver. BTP is building up a new transmitter. GVN went on a 40-day cruise on the Pacific in connection with N.C.R. active duty. The C.C.R.A. elected new officers: FYY reelected president, PWL elected vice-president, NUU treasurer, PTJ secretary, and HQV activity manager. MOF is building 'phone rig for 1.75 mc. KAO forgot to renew his opr. license. ODS at LaSalle is building a n.e.c. job with a pair of '46's in final. RRS, RXC and PWP jointly operated an '01A portable on Genesee Mtn. during Field Day. RXZ uses a t.r.f. skyrider to pull in the signals. LFA installed a P.A. outfit at Englewood Ball Park. SND made a little over 300 points on Field Day while located at Red Rocks Park. URH is new ham in Denver. PWU has model T Ford rigged up with complete portable rig and house, and plans on a trip thru Colo., Kansas, Okla., and Texas during the summer. EGY has low-power 1.75-mc. 'phone rig working. DSB reports plenty of signals heard on 28 mc. over week-ends. JGF has worked about 40 Europeans in the last couple of months. FYK was married in Chicago recently. IGO keeps right on working. JRV left for Chicago. PGS is working portable in midwest. 9YL is working portable at University Camp. FG takes another whirl at brass pounding on the Great Lakes. AZT and 7BIV left for Nebraska. HIR is about the only active ham left at Boulder. FNR left for Army Camp. KKK moves to Denver. 6GSR left for California. VK3LN was recent visitor at FA and APR. He is on a visiting tour of the U. S. and has a lot of good dope about what the Aussies are doing as he is traffic manager for the Aussie ham magazine.

Traffic: W9PWU 518 LJF 482 ESA 257 LFE 87 PVZ 54 NEY 50 NLD 48 TEL 20 EGY 18 KI 12 PMF 12 TEJ 10 TSQ 6 OTM 4 EHC 1 MOM 8 FCK 160 BJJ 162 PGS 8 AZT 11.

KENTUCKY—SCM, G. W. Mossbarger, W9AUH—Why say more, those not reporting are rebuilding or swimming or swimming or rebuilding or just proerastinatin'. MN goes to C.C.C., RBV threatens in July O.R.S. party. The rest of you guys, gimme sumpin' to put in this here column. 73.

Traffic: W9HBQ 50 ELL 4 AUH 128 HAX 27 FZV 4 SDC 18 ARU 28 BAZ 6 BWJ 2 OX 17 CDA 9 IFM 13 EDQ 16 RBV 14 PKX 1 KKG 146.

MICHIGAN—SCM, Kenneth F. Conroy, W8DYH—Michigan Nines: The Convention went over with a bang and thanks are due to the committee in charge for the very FB job they pulled. 9PDE, Assistant S.C.M. of U.P., is putting up a bigger and better antenna in preparation of next fall's work.

CANADA

MARITIME DIVISION

MARITIME—SCM, A. M. Crowell, VE1DQ—FW boosted power to 40 watts input on 7100 and 14325 kcs. FT is pretty busy with work. FN has been working ZL regularly each night on 14 mc. with the new 860 and QRO. BV's many friends will regret to learn he is under doctor's care, and wish him speedy return to old pep and vigor. EP and HG the Grant brothers' station, though suffering loss of filter, still snags good DX on 14 mc. AW, EX and CR are new ACR-136 boosters, BT and GD keep Berwick on the map with their 3.9-mc. 'phones. CP, FO, AQ and FQ are going in for 56 mc. via the transceiver route. DQ has again hit the 14-mc. band after a rest on 3.9 and 3.5 mc. CR has the 'phone chasing DX on 14 mc. as well as rag-chewing on 3.9 mc. GR, HQ and AR keep things alive on 1.75 mc. DT has hit the air on 3.9 mc. with a nice 'phone—QRA Bathurst. EH has everything under control at last. The Hamfest Committee of the H.A.R.C. is still receiving congrats on the successful party. We are all looking forward to the repeat order next summer. The S.C.M. is especially anxious to get reports from all active stations during the summer.

Traffic: VE1FW 4.

ONTARIO DIVISION

ONTARIO—SCM, S. B. Trainer, Jr., VE3GT—JT is back in the traffic lead. WK's schedules are all going fine in spite of warm weather. GR and ACI have ACR-136's. EG has been QRL tax collecting and is taking rig up to summer home. ZE got his first VK and plans to rebuild. KU is a newcomer in Toronto. QB expects to go back to the farm for the summer. AEZ and AFA are Hamilton's latest. AU is on for the summer at Unionville. AAZ plans a superhet and c.c. TB likes 3.5-mc. c.w. ACC and a lot of others have been QRL exams. VD was visited by W1IDL and XYL. IB has been gunnin' for chicken-stealing cats. TJ is looking for a W6/7. OR has moved to Weston. LN, RL, OO, NU, and IB are planning camping trip. WB, LK, and GI were in A.R.R. L. Field Day and operated at GL. The Windsor gang were out too, running TM. JT and GT ran GT up in Caledon hills. The Queen City Club had a fine outing at Highland Creek. The Hamilton boys had a rare time out with KM. LI won several prizes at Lachute picnic. MX, JJ and 2GP visited Toronto, as did W8CPC. MB is going to rebuild again. HA at Dryden says, "The big fish are here." ABW schedules IH and VZ daily and has been on 14 and 28 mc.

HN is still in Toronto, BZ burned out primary, hence lower power. RK expects to QTA schedules until fall. 9AL is taking portable to summer QRA, Stoney Lake. 3PL will be on at 4TA, Foremost, Alberta. QH is settling down. NH and TQ want DX. DO wishes he were McElroy. QE is using rack job. AEM falls for a new YL every day. ADF is heard a lot on 3.5 mc. QD has s.s. on the way. NT moved to cellar. KM has 400 watts at beach. JU is chief BC engineer at Soo. TG is on 14-mc. 'phone. TO wants new junk for old. VZ likes traffic. ABQ, GZ, ABJ, and XT are going c.c. VJ contemplates higher power. JT and GT went to Syracuse for Atlantic Convention. "XTAL" has been delayed. GG wants to keep Trunk Line "I" going through summer.

Traffic: VE3PL 5 RK 140 BZ 4 ABW 74 MB 117 AU 5 1B 93 BD 8 KU 4 WK 46 SG 5 ZE 3 TH 1 GT 21 JT 311 VA 213 GG 192. VE9AL 20.

QUEBEC DIVISION

QUEBEC—SCM, Stan Comach, VE2EE—The first major event of the warm season was the annual M.A.R.C. picnic. Those who missed that certainly missed a wonderful day's outing. The weather was fine, the track was fast and, if you don't think the prizes were good, ask BO. With HK still out of action, and DR getting a new rig on the air, the traffic situation was serious till ole man Snooper stepped into the breach and did a masterly job; thanks, Doc. DR now has his new rig perking, and packs a hefty wallop. AP is heard occasionally. AX is still calling and working the Asians. GE has heard fourteen 'J's' and blew an RK-20 trying to hook one. IY has been heard on 14 mc. HT is the latest convert to pre-selector. HH has rebuilt. FG has been heard calling the Argentine on 14-mc. 'phone. BO has his rig down on 14 mc. It won't be long before KK (old 3 CJ) is boring a hole in that band. Our old friend Rod at FO is active every evening along with the old-timers, BE, BG, CA, etc. CA is now using Class B. BT is keeping the schedules running. JK is taking traffic from BB every day. II is busy with schedules. We regret to hear that FE is leaving the air for an undetermined period. FI is using an RK-20 grid modulated. HP changed his for a hundred-watt bottle. DJ is active on 7 mc. FQ has gone down to Anticosti with HQ for the summer. CS has a pair of '46's on 7 mc., and has a nice sig. Hats off to JZ who walked away with the Silver Medal for Science studies. Great work, Hank. GK is back on the river again and pounds the key when home. FG is new O.B.S. AB has been actively interested in traffic both from his home station and his summer camp. LA, EM and AX have been heard on 56 mc. chewing the rag by the hour. GN is interested in that band also. How's this for a three-way contact: VP3BG to VE2GA, VE2GA to VE2BG and VE2BG to VP3BG, a 100% relay. We are pleased to hear that young Miss BU is improving.

Traffic: VE2DG 270 HT-JK 32 BT 19 AB 16 LA 8 BB 10 BU 9 EE 6 DR 4 HH 2.

VANALTA DIVISION

ALBERTA—SCM, J. Smalley, Jr., VE4GD—LX is again the traffic leader due to Trunk Line activities; he expects to clear Calgary traffic with his new 'phone rig. GE and QK still schedule and handle considerable traffic. EO will have a rig at the Lethbridge Exhibition. EA works 14-mc. 'phone DX. HM built a new rig for EX. BW has an FB medium-power 'phone. GX and JJ sure keep the hat on the air on 3.9 mc. NH visited Vancouver and worked his own station with AX at the bug. BZ visited Edmonton. LE is building a high-power 'phone for the winter's activities of the Thursday Morning Club. HQ worked his first Aussie on 14-mc. 'phone. FI and HW were very active. SC is now with the R.C.M.P. at Vancouver. AX has a YL. QH has a swell antenna and an FB crystal rig. JW and the OM and YL op's of KO took an auto trip through Washington to Vancouver. GM's arc has joined Noah's. HI. GD is active on 14 and 3.9 mc. along with CY. CW returns to the air on 14-mc. 'phone after an absence of over ten years.

Traffic: VE4LX 157 GE 40 QK 25 EO 4.

BRITISH COLUMBIA—SCM, R. K. Town, VE5AC—Biggest excitement of the month was the VE5 QSO contest. No section contest was as successful as this one! Ask any W7 who was on that Saturday night. HI, EC is still working

Europeans. IC is going strong with a ten. JA's YL is building her own rig. NS made a hole for himself on 3.5 mc. DL and HP visited CT at Duncan. New additions: OP, OQ and OM. The B.C.A.R.A. is planning a station for the Vancouver Pacific Expositions. All stations willing to help should get in touch with the S.C.M., AC, who will line up the schedules. MT is building a new home for his transmitter. IS is believed to be moving QRA. JL leads the island in traffic this month. FB, EZ, V.S.W.C., has installed FB freq. meter-monitor. HP kissed a 50-watter bye-bye. EJ is proud owner of new jr. op. Congrats. IO still schedules YL at J.C. BR, MK and BL are active on Island Net. AS is Vancouver contact with Island Net. MO applies for O.R.S. EP is busy traffic man. EU is mixing DX and traffic. DD has FB 'phone rig. NG is high traffic girl this month. EO had a good time in VE5 contest. KB is going to take heap to camp. AC is lining up schedules to handle exhibition traffic. DZ will be high-power station soon. HC QSP'd Prince of Wales message, VK4GK to G6CJ same night. FB.

Traffic: VE5JL 52 EZ 8 HP 26 JA 1 EJ 9 IO 15 BR 26 MK 16 BL 21 AS 27 MO 57 EP 53 AL 3 EU 14 DD 18 NG 3 EO 12 KB 10 AC 78 DZ 12 GI 17 HC 24 FG 42.

PRAIRIE DIVISION

MANITOBA—SCM, A. J. R. Simpson, VE4BG—This period records the highest traffic total for the season. Trunk Line station AG was kept busy, and leads with the highest score. TV has been maintaining schedules with rural points of Manitoba. MJ of Russell reports schedules with TV, MK, CG and AP. MJ also reports a get-together of AU, AP, UV and MJ at Russell on May 26th. In the Copying Bee contest of Dec. 14/34, MJ placed first in this Section. About forty members of the M.W.E.A. and about thirty members of the St. James Radio Club visited the local broadcasting station on June 8th. DU, who is the engineer at this station, put in a pretty busy afternoon showing the gang around. GC, MV, MY, DU, VI, KU, TO, and others are still at 14-mc. DX. Plans are being completed for the M.W.E.A. picnic during August.

Traffic: VE4AG 341 MJ 145 TV 95 SO 6 KU 3.

SASKATCHEWAN—SCM, Wilfred Skaife, VE4EL—Well, we had a great time at the hamfest; 112 present, just 50% of the licensed hams in the Province! Each hamfest is better than the last. Keep it up, boys. We have two new hams in Regina: Meeds, MU, with c.c. Tri-tet ready for traffic schedules, and Butler, XM, with T.N.T. UL is building freq. meter and schedules Saskatchewan and Regina. MH is building 250-watt rig. TX sends first report. PE is going to Cranberry Portage for 5 months. UH has moved down to 7 mc. QZ has tried all bands and still can't work off the continent. TN and PQ traveled 200 miles to work on morning of 25th. UC has new rig. JB has new M.O.P.A. RI is selling out to buy car. TI is on after long holiday. BF has 14-mc. 'phone rig perking FB. FH from Winnipeg visits the gang at Saskatoon. RB is going 1.7-mc. 'phone with FB rig. TW made \$3.00 on chain letter. HI, RJ has 1.7-mc. 'phone working FB. MB is working out on 3.9-mc. 'phone; he made dandy QSO with LI at the Pas. PW is building c.c. rig. BM now has Comm. ticket and is working for Forestry Service at Isle a La Crosse. FD and EM are active on 14 mc. PQ and QZ are looking for 28-mc. QSO's. AO lost the Ananias contest by narrow margin. SY has new 7-mc. crystal. The Moose Jaw A.R.C. got a meat cleaver to eliminate key clicks! KA is trying out new antenna. OM worked two K6's on 14 mc. Moose Jaw gang held picnic to close season. All are very pleased with hamfest, especially LV. HI. FW is going in for RK20 rig for Trunk Line traffic work. VR is getting out nicely on 1.75-mc. 'phone. GA is trying 3.9-mc. 'phone. KE is finishing Modulator. MD is winding generator. KJ ground crystal to new freq. with razor hone and coil oil. FA sells motor-generator. EL learns insulation is important in output trans. Class B. BN keeps up his traffic total. HI. Bert Wilson joins the benedictos. KJ gets out well and GI improves on 1.75-mc. 'phone. CM has voice level indicator and is getting out fine on 3524-kc. 'phone. Trunk Line "I" is working fine. ES and EB are doing fine on 1.75-mc. 'phone.

Traffic: VE4FW 488 CM 414 UL 50 MH 27 EL 12 TX 8 MU 2 IG 36.

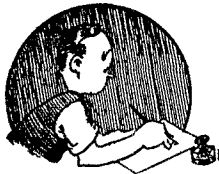

CORRESPONDENCE

The Publishers of QST assume no responsibility for statements made herein by correspondents

Revised R-S-T Scale

Box 979, Riverhead, L. I., N. Y.

Editor, QST:

Since the inception of the R-S-T System it has come to my attention that there is considerable reluctance on the part of many amateurs to adopt this system. Apparently the objectionable feature to them is the signal-strength scale. Why this should be so I do not know. The five-division scale is based on scientific considerations and should be adequate. However, many amateurs feel that a restriction is being imposed on them, and that they can not give as accurate reports with a five-division scale as they can with one of nine divisions. A consideration of all factors involved, the limitations of the human ear, fading ratios, etc., shows that this is not so. The nine-point scale has been used so long that many evidently cannot get out of the habit of using it. The real reasons for the objections are psychological. An S5 report apparently does not sound as satisfying as an R9, although they of course mean the same.

Now if the majority of amateurs prefer a nine-division scale, then they surely should be allowed to have it. I do not believe they should feel that they are being forced into something against their will. I should like therefore to suggest that a change be made in the offending S-scale. This can easily be done without in any way impairing the effectiveness of the system.

Care must be exercised to prevent the signal strength scale from becoming confused with readability and audibility characteristics. These should not appear in this intensity code. The scale must be considered as purely relative, so that like reports may be obtained from observers using different kinds of receivers. The D.A.S.D. of Germany, recognizing the importance of this, has for many years used such a relative scale. The R-scale is not used there in the way that we have come to know it.

The nine-point scale will of necessity embrace the same range of signal intensities as the present five-point one. It will be evident that the intensities indicated by the present 1, 2, 3, 4, 5 must correspond, respectively, to the new 1, 3, 5, 7, 9. A slight rewording of some of the definitions will be necessary, so that a smooth progression of strengths is obtained. Actually, of course, no words can exactly define the successive steps.

They are given merely as aids in estimating the intensity. The scale follows:

SIGNAL STRENGTH

<i>New R-S-T Scale</i>	<i>Old R-S-T Scale</i>
1. Faint—signals barely perceptible	1
2. Very weak signals	
3. Weak signals	2
4. Fair signals	
5. Fairly good signals	3
6. Good signals	
7. Moderately strong signals	4
8. Strong signals	
9. Extremely strong signals	5

Those now using R-S-T should have no trouble in adapting themselves to the change. For those favoring a five-point scale there are the key points 1, 3, 5, 7, and 9. The additional points 2, 4, 6, and 8 will take care of those that prefer the nine steps. It is sincerely hoped that all will find this arrangement satisfactory, and that the systematic procedure and time-saving characteristics of R-S-T will now appeal to everyone.

What do you say, boys? Does this meet with your approval?

—Arthur M. Braaten, W2BSR

Courtesy

1545 Belvidere, Detroit, Mich.

Editor, QST:

My pet peeve in ham radio is the rudeness and lack of courtesy on the 14-mc. 'phone band.

If a foreign 'phone is working a W any number of stations will give him a call whether he has signed or not.

Fellows who would not try such a thing as breaking in on a private conversation have no scruples over attempting to elbow in on a QSO. . . .

On the other side the DX boys also show a lack of consideration in their procedure.

It is very common for a DX station to sign off as many as four times and still keep talking to the same fellow. Every time a DX station signs a number of 'phones will call him so it follows that a lot of totally unnecessary QRM is created on an all-too-narrow band.

A little common courtesy and common sense would greatly improve 14-mc. 'phone—as well as other bands.

—M. J. Stevens, W8IWG

A.A.R.S. and N.C.R.

1653 S.E. Clatsop St., Portland, Oregon

Editor, *QST*:

The action taken by the Board regarding the A.A.R.S. and N.C.R. as recounted on pages 34 and 38 of June *QST* has prompted this explanation of these nets in the hope that a more broad-minded attitude may be taken with regard to these amateur activities in the future.

By requesting the removal of these nets to government frequencies, the Board has demanded ultimate death to these organizations. For if all or most of the net activity is to be restricted to a few frequencies outside amateur bands, how can a newcomer get in on the work of one of these nets? He would have to prove himself on an amateur band. All right so far, but where would he go after that? At present the A.A.R.S. has one frequency outside the forty- and the eighty-meter bands. If all the work of a Monday night drill in district, state, corps area, and army nets is to be concentrated on these two bands, the pandemonium of spark days will be nothing beside the new "jungle channels." This would narrow the work down to a favored few, and the rest of the young hopefuls could play around on the ham bands and talk about the weather, your rig, and my rig.

I have been a member of the A.A.R.S. for two years and know of no more efficiently-operated system for the handling of traffic in the congested amateur bands. During the drill each station participating in a particular net operates on a fixed frequency for that net. In effect this results in the greatest use of any one frequency by the greatest number of stations. Many stations operate break-in and most use crystal control. Stations in a district net are concentrated on one frequency during the drill, and this results in interference to local amateurs on only the one general spot used by the net.

It should also be pointed out that the members of these nets are active amateurs; if they were not drilling on the particular night of the week when the various drills take place, they would be on the air anyway, and having no special frequency to be on, they would be scattered all over the band. This would make a more undesirable QRM problem than ever, and there would be no cure for it except to try to get the stations classified by geographical areas and try to get them all to operate on one channel. We already have this system accomplished to a large extent, so why wreck it?

Furthermore, one of the best defenses we amateurs have (and this has been stressed in more than one *QST* editorial) is the War and Navy Department's attitude because of their desire to see amateurs trained for emergency service.

In conclusion, let me point out that the fields of amateur activity are many and varied. In order to maintain peace and harmony in so great a mutual organization as we have, it is imperative that we look with tolerance upon the other fellow's particular favorite. While we may not like the idea of a group of fellows using "Z" signals and exchanging cipher messages that we can't understand in our bands, let's not be like the savages who desire to destroy everything they do not understand.

—Fred W. Decker, W7ANX

They Do QSL

Helmetta, N. J.

Editor, *QST*:

It may interest you to know that May has been a record QSL month for the second district. A total of 4033 cards were received here this month. Blearly eyed but with much enthusiasm, I would like to see this appear for the benefit of the W9 who a few months back said "Why QSL?" The district managers get the full benefit of what it means to QSL.

—H. W. Yahnel, W2SN

'Phone Standards

Philadelphia, Penna.

Editor, *QST*:

Why all the furor about raising the standards of our 'phone QSO's? I'll admit that 'phone procedure could be im-

proved somewhat, but on the whole there is nothing radically wrong with our 'phone conversations.

Possibly some of the gang do not realize that we are, after all, amateurs, and not veteran BCL announcers. In fact, the stilted, affected manner of conversing when near a microphone is more to be deplored than held up as a shining example to be followed by all 'phone hams.

Amateur radio is a hobby and as such it should be used to further our enjoyment of the game. This cannot be done if the personal touch is taken out of it. . . .

Even the F.C.C. rules that the amateur 'phone stations shall not broadcast anything for entertainment purposes and if the BCL finds some entertainment in a 'phone QSO, then theoretically the amateur is breaking the spirit of the law.

Of course there is room for improvement with regard to a small percentage of the stations, but these consist mostly of new stations, who are still somewhat raw in their procedure and who, given a little time, will blossom forth to uphold the most sacred traditions of amateur radio as a whole.

—B. Berkowitz, WSIC

Ten Meters

Grant Town, W. Va.

Editor, *QST*:

. . . The point needing more consideration than "more frequencies" is our 10-meter band.

Recent articles in *QST* prove 10 meters to be very efficient and compared to other bands much better in long distance work.

These experiments on 10 meters have been carried on by a small group of amateurs, yet results were satisfactory considering the dormant state of the band.

We know that the chief trouble with 10 meters lies in the fact that it is unoccupied by enough amateurs at certain particular periods to offer reliable communication.

Therefore all amateurs should make an attempt to have a transmitter on 10 meters thereby giving us a real DX band. . . .

—Geo. Papuk, Jr., W8KWU

WLM QRM

327 Brandon Ave., Glen Ellyn, Ill.

Editor, *QST*:

I noticed with interest the complaint in June *QST* re ham interference with ZLVA transmissions. I know many other A.A.R.S. have this same trouble. However, of the thirty or forty different texts I have had opportunity to copy from WLM so far this year, not one has been interfered with by QRM. My receiver is a simple t.r.f. job.

This is one reason why so many A.A.R.S. complain of QRM on this special frequency (3497.5): If the operator tunes his receiver to the high-frequency side of WLM's carrier, let us say, for example, he gets a 1000-cycle beat note. An amateur station of several hundred watts power on 3500 kc. will produce a 1500-cycle beat note with the receiver, causing the QRM referred to. If the operator likes higher-frequency beat notes, say 1250-cycles, the station inside the amateur band will appear to be immediately on top of WLM. The remedy is for the operator to tune to the low-frequency side of WLM's carrier, where little or no trouble will be experienced from ham stations.

A station near here, with some 700 watts input, has a crystal on 3500+ kc., and though he usually works 20 meters, QSY'd to 80 for a few evenings. Shortly afterward, he received a number of letters from A.A.R.S. stations giving him "Hail Columbia" for being right on WLM. It did appear that way to the operators who were tuning on the high-frequency side of that special frequency. However, no less an operator than WISZ (who at first thought this local was outside) checked his frequency with an A.R.R.L.-certified meter and found the carrier to be inside the band.

It is true that occasionally some lid wanders out of the

(Continued on page 66)



THE INCREASING USE of 56 MC rigs has put an unusual emphasis on tuned antennas for receiving as well as transmitting. At this frequency, successful operation demands their use, because transmitter output is usually limited. In practice, it is usually also desirable to design the system so that the transmitted signal is radiated at a low angle, because the sky-wave is largely lost in space otherwise. All of which is common knowledge, and great care is almost always given antennas for 56 MC.

For some reason, however, many amateurs do not feel that the same considerations apply to receiving systems for 28 MC. As a matter of fact, most receivers need all the help they can get when operating at ten meters. This applies specially to signal strength, signal-to-noise ratio, and static pick-up, (particularly automobile ignition noise). A receiver is improved in all of these respects when using a good antenna. Furthermore, 28 MC shares with 56 MC the convenience of requiring small physical dimensions in the system, so that there is no good reason why better engineering should not be attempted in this direction.

Not all types of transmitting antennas are generally suited to receiving, because some systems are so sharply tuned that efficient reception is obtained at only a very narrow band of frequencies. We have found that the Pickard antenna is excellent for both purposes however. For 28 MC work, four feet is added to the length of each radiator, bringing the overall length up to about sixteen feet. For a coupling transformer, a standard 56 MC unit, such as the National TRP, may be used.

One peculiarity of the Pickard and various doublets should be mentioned. This is that the antenna and feeders, as a whole, may pick up static and low frequency signals, which are impressed on the receiver by capacity coupling. Consequently, it will often be found that the set is much quieter if the feeders are balanced to ground. This can be done in a variety of ways, of course. The simplest method is usually to ground the midpoint of the antenna coupling coil in the receiver, though some designs make it inconvenient to do this.

Directional antennas are, of course, particularly effective in receiving, as they produce a still further increase in signal strength and a reduction in noise. There has been much interest in them during the past year and one has only to peruse past issues of *QST* to find many excellent types described.

There is one type that has not been described in *QST* and which we think well of. This consists of two vertical half-wave antennas mounted one-half wavelength apart. Both pairs of feeders are brought in to a switch at the transmitter. When the feeder systems are connected in parallel, the antennas will be in phase, and signals will be strongest in a direction at right angles to plane of the system. Reversing the connections of one pair of feeders will cause the two half-wave units to operate 180° out of phase, making the signals strongest in a direction in line with the two antennas.

JAMES MILLEN



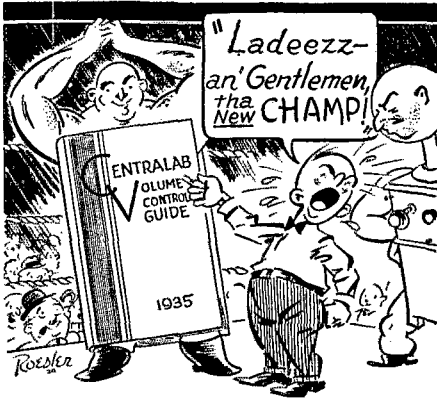

he takes all comers

The new CENTRALAB VOLUME CONTROL GUIDE is the serviceman's champion — he "takes on" the most difficult job and "throws it" for a victory.

This new 1935 revised edition represents the accumulated experience of engineers, consultants and servicemen — all of whom have contributed to make this the most accurate and complete Volume Control Guide yet published. In addition it contains a valuable cross index on controls — all standard Volume and Tone Control circuits and a load capacity chart.

Now you can get the exact, accurate dope on every service job, for there is a CENTRALAB RADIOHM specially made for every replacement. . . . and for emergency replacements — the new Guide shows you how a mere handful of controls will take care of any emergency service requirements.



Every Radio Service Man should be a member of the Institute of Radio Service Men

Centralab

Division of Globe-Union Mfg. Co., Milwaukee

Correspondence Dept.

(Continued from page 64)

band and onto WLM, but we A.A.R.S. should not condemn these other amateurs unjustly, when the fault lies a great deal on our own side.

—John Huntoon, W9KJY

The Southeast Corner Gang

Port Colborne, Canada

Editor, *QST*:

The recent articles in *QST* about crowded conditions and QRM remind me of a letter received by a local ham from an S.W.L. in the U.S.A. The writer congratulated the VE hams on their courtesy in preventing QRM and their willingness to cooperate when it unavoidably occurs.

I believe that a lesson in operating may be learned by listening on the 1775-1800-kc. band any evening. In this immediate vicinity there are quite a number of 'phones with powers from 60 to 175 watts, all operating in the above mentioned 25 kc. and in perfect harmony. When someone QRM's you he is asked in on the QSO, which he does or merely sits and listens. One night a short time ago there were nine of us in on a QSO which included two W9's, a W2 and a VE4.

These days a spot like this on a popular band is an oasis in the desert of QRM. As the SWL put it, "If all the hams could work it the way you fellows do ham radio would be Heaven."

So keep an eye open for "The Southeast Corner Gang" on 1.75. We'll be seein' ya!

—J. W. Wilkes, VE3IIR

Negative Communication

At Sea, M.S. Santa Barbara

Professor Doctor Valodod Turnonanoff,
Hartford, Conn.

Dear Sir:

Your thesis on "Matched Impudence" has come to my attention, and I must say that I find it a worthy successor to your enlightening paper which clarified unrelated relativity for the wondering world. For such valuable research you most certainly receive the proposed award of the "Defunct-201A-With-The-Cement-Base-And-Picture." If you read *QST* you will remember that this award with a picture of a dog howling at the moon was suggested for those who have distinguished themselves with CQs of RECORD length. Your award should have a picture of steam in a fog, or a shadow in darkness.

This letter is an application for the award for negative wavelength communication. I propose to prove what cannot be done, in order to obtain your valuable scientific verification. Here are the details:

Time: March

Place: Off the coast of Peru

Scene: 24 meters, a couple of stations, etc.

Event: The time of day was such that no nice person would file a message. We had cleared Chatham Radio only a few hours before, and nothing was on hand. I had a premonition that he had tfe for us, so I turned on the S.W. receiver. *He was calling us!* There was no reason for him to call us. He had no right to believe that we were listening. There was no good reason why I should have listened to him at that time. Evidently some communication had passed between us, but as I heard the beginning of the call I could not have been receiving 24 sans receiver.

This accomplishment is undeniably a demonstration of the use of a negative wavelength. The mind was the only equipment used, and as it was not the morning after heads were not oscillating.

I have investigated the matter more or less, and find that brains have insufficient resistance to permit use as a multivibrator, a little capacity, and a certain amplification factor the value of which varies from zero for a competent scientist to infinity for a fisherman. However, being unable to find any harmonics on my e.c. freak meter, together with the fact that communication took place, leads me to believe that the negative wavelength spectrum has been pressed into service. . . .

—L. L. Cook

FAIR DEALINGS *plus* FAIR PRICES

We "know what it's about" and go to no end of bother to get numerous specials to give *QST* readers many money saving values. The present rate of exchange makes it profitable for those of foreign countries to buy direct from one of the world's greatest radio markets. We will know just what declarations, etc., your country requires for prompt and economical delivery of your goods. We realize you are far away and fill your orders most carefully.

DELUXE DIALS AND FLUTED KNOBS

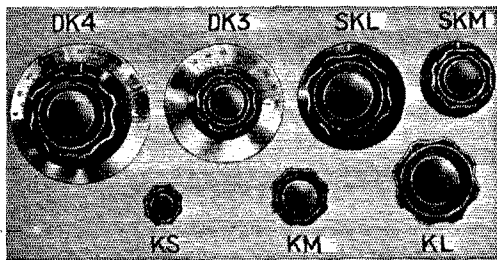

These are the trimmings you have noticed of late on the finest equipment, now available at *these* prices. Dial plates made of circular finished solid nickel silver, not plated brass or aluminum. Fluted knobs are finest quality genuine bakelite.

DK-3. 3 1/2" Dial and Knob	\$.70
DK-4. 4" Dial and Knob	\$.85
SKM. Medium 2" Knob with skirt	\$.24
SKL. Large 3" Knob with skirt	\$.30
KS. Small Knob	\$.15
KM. Medium Knob	\$.21
KL. Large Knob	\$.24

THE NEW BARR DB3 CLASS B MODULATED 5 METER TRANSCEIVER

We were surprised at the marvelous value offered in this transceiver, just as you will be when you own one of them.

PRICE **\$16.20** less tubes, batteries and accessories. Bulletin on request.

OUTSTANDING !!

Gross Crystal Holder

WHITE CERAMIC commercial type crystal holder — priced at less than ordinary holders. Adjustable pressure, dust proof, no tools required to open. Takes crystal to 1 1/4" square. Plugs standard 3/4" spacing. Most efficient job yet..... **\$1.00**

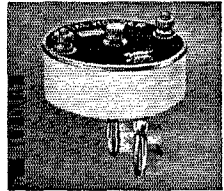

The "EAGLE" Three-Tube Short-Wave Receiver

"Band Spread" over any portion of the tuning range — only finest material used thruout. Employs one '32 R.F., one '32 detector and one '33 Pentode Audio — 15 to 200 meters — four coils, supplied. The "EAGLE" is economical — two dry cells will operate the filaments.

"Eagle" completely wired and tested..... **\$11.95**
Three tubes tested in your receiver..... **\$3.00**

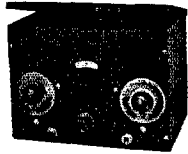

KEYING RELAY

will operate on one dry cell. Can be used as Single Pole Single Throw or Single Pole Double Throw. Sturdy construction, has 1/8" diameter Solid Silver Contacts. Compares favorably with expensive types. Special..... **59c**



GROSS CASED POWER TRANSFORMERS

650 v. ea. side C.T. 350 ma. fila. 2-7 1/2 v C.T. and 1-5 v will give 500 v with choke input using 83 or 5Z3 tubes. You can run your entire R.F. and class B off this trans..... **\$5.50**

750 v ea. side C.T. 300 ma. fila. 2-7 1/2 v C.T. and 1-5 v..... **\$5.65**

750-1000 v ea. side of C.T. 300 watts..... **\$6.65**

850-1350-1500 v ea. side of C.T. 400 watts..... **\$8.75**
(the ideal job to give 750-1000-1250 v D.C. with choke input)

850-1350-1500 v ea. side of C.T. 550 ma..... **\$12.50**

1500-2000 v. ea. side of C.T. 800 watts..... **\$11.70**

WHILE THEY LAST ONLY FEW LEFT CASED FILTER CONDENSERS

OIL IMMERSED silver cased filter condensers with stand off insulators.

Cap.	DC Working Voltage	Price
2 mfd.	1000	\$.95
4 mfd.	1000	\$1.65
1 mfd.	1500	\$.95
1 mfd.	2500	\$1.95

NATURAL BAKELITE 6" SPREADERS

10c, 10 for 90c

GUARANTEED TUBES ISOLANTITE TOPS

800.....	\$4.90
866.....	\$1.25
866-A 10,000 volts inverse Peak.....	\$1.85

THORDARSON CASED TRANSFORMER

600 volts each side of C.T. 200 MA 2 1/2 V. 10 amps. C.T., 5 V. 3 amps., 7 1/2 V. 3 amps. C.T..... **\$2.45**

THORD. CHOKE 12 H 250 MA., **\$1.95**

RAYTHEON RK-28 TUBE

(in stock)
(see P. 28 July *QST*)..... **\$38.50**
Mycalex socket for above..... **\$1.85**

THE NEW PEAK X-4 5 METER TRANSMITTER

10 Watts Output

Uses 76 Speech 6A6 Driver 6A6 Class B one 6A6 Oscillator.
Price, less tubes..... **\$26.70**
Immediate delivery. Bulletin on request.

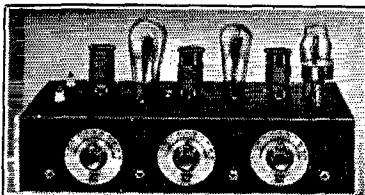

GROSS C C TRANSMITTER — OUTPUT 25-30 WATTS

The "CW-25" transmitter kit due to its low cost makes it possible for anyone to own a modern crystal controlled station. A schematic hook-up and parts layout sheet as well as tuning instructions are furnished, thus enabling the most inexperienced operator to wire and put the set on the air, for real results. The "CW-25" is supplied with a shrivel finished sturdy metal chassis under which all parts are mounted, making the wiring and components dust-proof. A plug-in crystal holder is furnished with the kit. Only one milliammeter is required for tuning the transmitter and each stage is provided with a jack for this purpose. The "CW-25" uses one

'47 as crystal oscillator, one '46 as buffer or doubler and two '46's in the amplifier stage, set of three coils supplied with kit for 20, 40, 80 or 160 band. Additional coils 75c each.

Complete kit, less tubes and crystal..... **\$13.95**

20% DEPOSIT WITH ALL C. O. D. ORDERS

REMIT BY M. O. INCLUDE POSTAGE

Cable Address: GROSSINC

GROSS RADIO, INC., 51 VESEY STREET, NEW YORK CITY

BARR

• DB3 •

Class B Modulated Transceiver

The DB 3 utilizes a Class B Audio amplifier and modulator giving an output of 2.1 watts, which is many times greater than that of ordinary transceivers.

THE SENSATIONAL TRANSCEIVER



AN OUTSTANDING VALUE

less tubes and batteries **\$2700** List Price
40% discount to amateurs

SPECIFICATIONS

CASE: Size 11" long x 9½" high x 6½" wide, black wrinkle finish metal, heavy leather handle. All batteries are self-contained in case. Removable side panel for easy access to the batteries and tubes.

PANEL: Beautifully finished in black enamel with silver scales and lettering.

CONTROLS, ETC.: Two ceramic insulators are supplied for antenna, special large easy tuning knob, volume control on and off switch which acts as such in the receive position, and as a gain control in the transmit position, transmit and receive switch, microphone and headphone jacks.

FREQUENCY: Will cover 56mc to 60mc (amateur 5 meter band).

BATTERY REQUIREMENTS: Three 45-Volt B Batteries like Burgess 5308; two No. 6 dry cells, and one 7½ Volt C battery.

TUBES USED: One type 30 — one type 19 — one type 49.

SHIPPING WEIGHT: 12 pounds.

See July QST for Nearest Distributor

BULLETIN ON REQUEST

BARR LABORATORIES

1476 BROADWAY NEW YORK

A 10-Mc. Band

80 North State St., Concord, N. H.

Editor, QST:

I have been noticing a lot of hollering about increasing the 7-mc. band to 7500 kc. I believe that I have a better suggestion to make. What the amateur needs is not wider bands, but more of them. On our present band-spread receivers the 300 kc. of the present 7-mc. band cover practically the whole dial. As it is now, fellows working on one end of the band seldom get down to the other end. Why not fight for a band in the vicinity of 30 meters, say from 10,500 kc. to 10,700 kc.? This will allow the use of 3.5-mc. crystals and frequency tripling. Think of the different operating conditions on this band, half way between 7 mc. and 14 mc. Do you remember when the Aussies used to pound in on 32 meters? I think that a new band in this territory would open up new operating fields for us and help relieve the congestion on our present 7-mc. band. Why not include 10 to 11 mc. in the A.R.R.L. survey now going on between 6 and 8 mc.? . . .

—Carl B. Evans, W1DMD

About Message Handling

(Continued from page 41)

destination of your traffic; place it in the right hands for reliable handling by willing operators; use common courtesy in all your work, repeating proper names, and difficult portions and allowing a few seconds after each message for the purpose of changing blanks in the "mill" and making time and date notations thereon as each message is received.

Last of all we come to the *delivery* of ham messages. Where these are for third parties it is important that deliveries be made in business-like fashion to give the best impression, and so that in each case a new friend and booster for amateur radio may be won. Messages should be typed or neatly copied, preferably on a standard blank, retaining original for the F.C.C. station file where these are mailed. The designation and address of the delivering station should be plainly given so a reply can be made by the same route if desired. A station-to-station or service message should be filed for the originating station whenever better address is needed or if a message cannot be delivered. Likewise if in doubt about any detail, send a service to cover the point for relaying and delivering station along with the message. Message handling is one of the major things that lies in our power as amateurs to do to show our amateur radio in a respected light, rather than from a novelty standpoint. We shall be glad to send any amateur requesting same copy of a letter that we write members of the public who inquire about amateur message work after having first received an amateur radiogram—or you can send any such inquiries directly to A.R.R.L. Headquarters so we may pass along this information for you.

For those who would disparage some message texts as unimportant perhaps a reminder is in order that in the last analysis it is not the importance to the ham that handles it that counts, but the importance to the party that sends and the party that receives a message. Furthermore, what sort of a communication service is it that concerns itself with what is said in a message, so long as the remarks are not obscene so the transmission is contrary to law? The individual handling of traffic in quantities small as well as large is to a very great extent the material that we

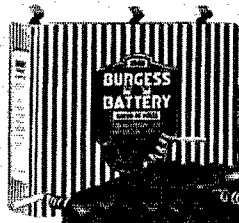

YOU CAN
Spread, Roll or Fold
BURGESS RIBBON BATTERIES

Mr. E. J. Lybert, Burgess Sales Engineer, is shown in the above photo, examining two of the new Ribbon Batteries and comparing them with the No. 2308 regular 45-volt Burgess "B". According to Mr. Lybert, these batteries are assembled in such a way that they can be *spread, rolled or folded*. The absence of box and wax top *saves as much as 25% in weight*.

Mr. Lybert is holding the Z60F—90 volts—and showing how it may be *rolled* into a bundle. On the table is the B60F—also 90 volts; note how it may be *folded* to fit into odd-shaped compartments. The complete Burgess Ribbon Battery line includes a wide range of standard sizes with standard taps from 22½ to 90 volts. It also includes high capacity 3 and 6 volt batteries for "A" use.

Next time—don't build the set to fit the battery—use a *flexible* Burgess Ribbon Battery *which you know will fit the set*. BURGESS BATTERY COMPANY, Freeport, Illinois.

BURGESS

Say You Saw It in *QST* — It Identifies You and Helps *QST*

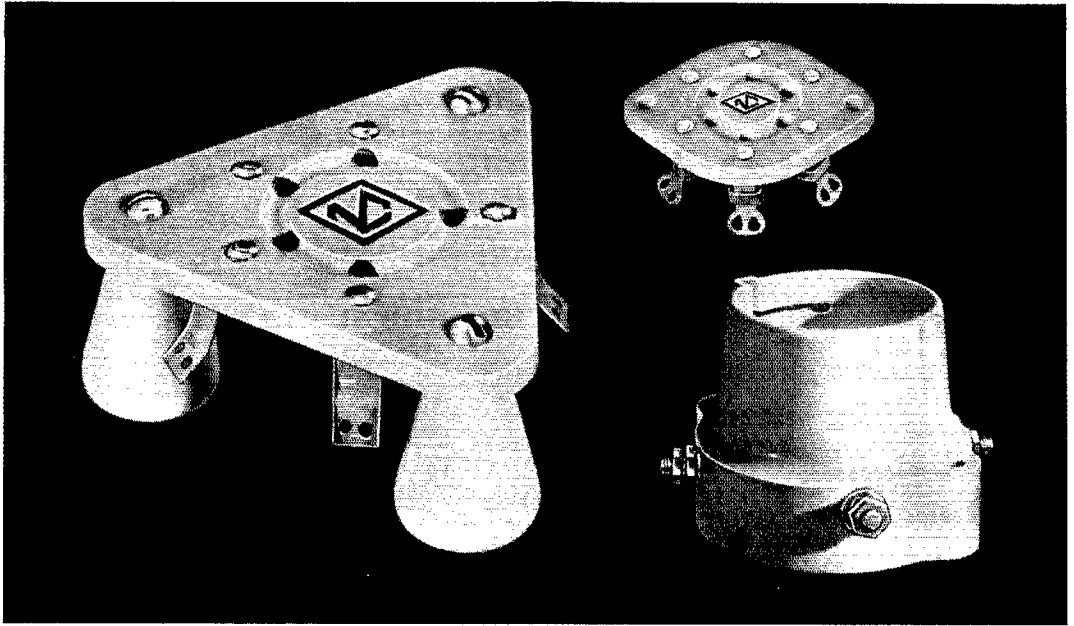

A COMPLETED GROUP

● With the addition of six new low-loss sockets, National now offers a complete line. For the new RK-28 and RCA-803 power pentodes, just announced, the big JX-100 wafer type socket illustrated above is available. Triangular in shape for rigid three-point mounting, Isolantite insulated with the famous National locator groove, and equipped with rugged non-turning positively-located side-wipe contacts, it is as modern as the tubes it serves. Illustrated below, center, is a new Isolantite wafer socket for the octal-base metal tubes. Below, at the left, is a unique socket for the RCA-954 acorn pentode. The socket is of metal with a drawn tube shield for circuit isolation. The contacts are of a new constant-impedance type by-passed to ground, with solder lugs close to the tube terminals. For the RCA-955 acorn triode, a similar socket is available with Isolantite base, also equipped with the improved constant-impedance clips. Because of previous commitments, we are also offering a similar socket equipped with the conventional contacts, though we recommend the newer style. Completing the group is a fifty-watt metal shell socket for use where voltages are not high enough to justify the extra expense of the all-Steatite XC-50.

● In addition to the new types illustrated, the popular Isolantite-Steatite coil and tube sockets are of course still available.

NATIONAL COMPANY, INC., MALDEN, MASS.

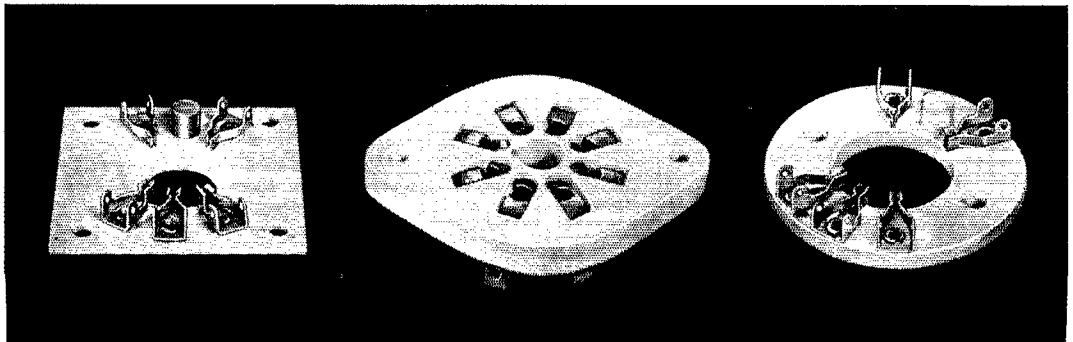

PEAK X-4 10 WATT 5 METER X-MITTER

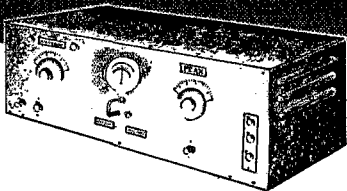

A PEAK PRODUCT AGAIN GOES TO BAT FOR THE HAMS!

Development of the X-4 has produced a low priced transmitter that has all the qualities of an expensive broadcast rig.

Come on fellows, check this instrument and see if it isn't just the job you have been waiting for.

- Two stages of audio amplification
- Class B modulation
- Unity coupled oscillator
- Input gain control
- Milliammeter to read oscillator and modulator current
- Communications switch
- For double or single button mike
- Encased complete in steel cabinet, less power supply, beautifully finished in black crackle
- Any specified ultra-high frequency to order
- Amateur net \$26.70 complete, less tubes and power supply

PEAK P-11 PRE-SELECTOR operates on any type receiver. Enthusiastic owners can tell you of the marvelous S.W. reception in store for users of the P-11. Amateur net \$19.80.

PEAK Q-5, 2½-5-10 meter five-tube Super-het receiver. Amateur net \$21.60.

PEAK M-2 MONITOR is necessary with any radio telephone x-mitter. Amateur net \$19.80.

All PEAK PRODUCTS are unconditionally guaranteed to give absolute satisfaction

Complete descriptive data now awaiting your request

Write to Dept. A

EASTERN RADIO SPECIALTY CO.

Mfrs. of PEAK PRODUCTS

1845 BROADWAY NEW YORK, N. Y.

Slide RESISTORS

Wire-wound. Crack-proof ceramic tube support. Sliding band contact (extra bands available). 10, 30, 50, 75, 100 and 200 watt ratings. All resistance values. Removable mounting brackets.

- Write for resistor and condenser catalog.

AEROVOX

CORPORATION

73 Washington St.,

Brooklyn, N. Y.

this issue.) We hope some points in the above may answer questions for the newcomer on "how it is done." For those "breaking-in" may we say that any O.R.S., Trunkliner or experienced A.R.R.L. traffic handler will be only too glad to answer your questions and give additional pointers both in procedure and concerning your station apparatus and arrangement to help you make yours a really effective communications set-up. Since experience is the only real teacher, we conclude by suggesting to all and sundry that becoming proficient in any branch of the game is partly just a matter of practice. Start a few messages, to get accustomed to the form. Check some messages to become familiar with land-line check, now the official A.R.R.L. check. You will find increased enjoyment in this side of amateur radio by adding to your ability to perform; by your familiarity with these things the chance of being able to serve your community or country in emergency will be greater and credit will be reflected on amateur radio as a whole.

—P. E. H.

Class-B Modulator Economy

(Continued from page 12)

duced in the output transformer was only a fraction of a volt, while no perceptible hum was induced in the input transformer. Different orientation of the power transformer with respect to the output transformer brought the hum up considerably. Although the measurements were made with the aid of an oscilloscope, practically as much can be learned about hum by connecting a pair of 'phones to one of the audio transformer windings and applying 110 volts to the primary of the power transformer. The difference in hum pick-up can readily be checked by changing the relative positions of the two transformers.

The filter shown in the diagram has been found to be ample for eliminating hum in the plate circuits. This consists not only of the two 8- μ fd. electrolytic condensers C_9 and C_{10} and their associated filter choke, L_1 , but also of the individual series resistors in the plate circuits of the first two tubes plus the plate by-pass condensers. On the first tube R_{12} and C_8 serve as the elements of a resistance-capacity filter, while additional filtering is provided in the screen circuit by the dropping resistor, R_{11} , and C_4 , the screen by-pass condenser. On the second tube, R_8 and C_6 function as a filter. R_{12} and R_8 further serve as decoupling resistances to prevent feedback between the two stages.

Aside from the necessity for avoiding short-circuits and unwanted grounds to the metal chassis—not altogether unknown when a large number of parts are put into a small space—the only precaution which it has been found necessary to observe is that of keeping the screen of the 57 pentode at the proper potential. The voltage divider R_{10} and R_{11} serves this purpose. Too-high screen voltage not only reduces gain but causes distortion and may result in oscillation of the speech amplifier at the higher gain control settings. Although it would be desirable to decouple the grid circuit of the 57 pentode in a similar

THE MOST USEFUL GADGET YOU EVER OWNED!

*To give you the answers to
questions like these —*

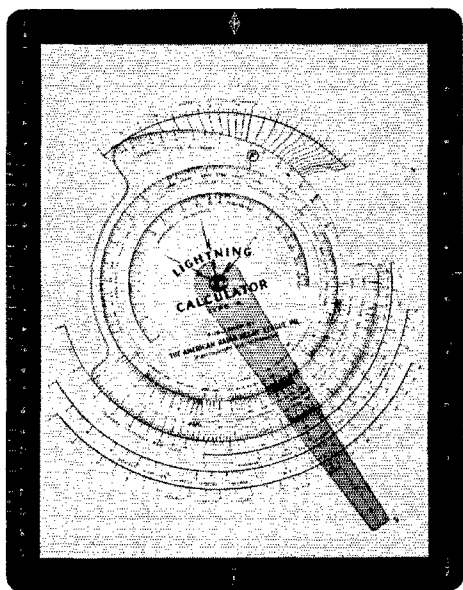

- How many turns?
- How big a condenser?
- What size wire?
- What diameter coil-form?
- How many micromikes?
- What frequency range?
- What shape of coil?
- How many microhenries?
- What spacing between turns?
- What wavelength?
- How long a coil?
- How many turns per inch?

THE LIGHTNING RADIO CALCULATOR

Postpaid \$1.00 anywhere

American Radio Relay League, West Hartford, Connecticut

WHICH "TICKET" are You Going After — Amateur? Commercial?

When you enter the Inspectors' office for the purpose of taking any examination necessary to obtain a License, wouldn't you like to go in with that feeling of absolute CONFIDENCE which always accompanies genuine ABILITY?

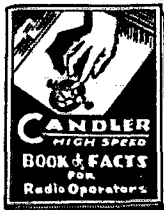

Famous Candler Students

McElroy — official speed 77 wpm., fastest op. of all-time.
Jean Hudson, 9 yrs. old, Champion of World in Class
E. Watson,
W1BGL, Byrd Expedition.

What Amateur and Commercial Radio Operators Can Do with the Help of the CANDLER SYSTEM

They can make perfect copies of WNU press with pencil or "mill"; can cut mimeograph stencils directly from WNU, WHD and KUP press; can copy press 3 to 5 words behind easily without losing out; can count checks automatically and OK copy instantly; can send perfect code groups with key or bug at 30 to 35 wpm. and more.

FREE "BOOK OF FACTS for RADIO OPERATORS" is yours for the asking. Write TODAY.

CANDLER SYSTEM CO., Dept. Q-8

6343 So. Kedzie

Chicago, Illinois

Just what you've wanted!

WRIGHT-DECOSTER.

Metal Cabinet Speakers

for the Amateur who demands results

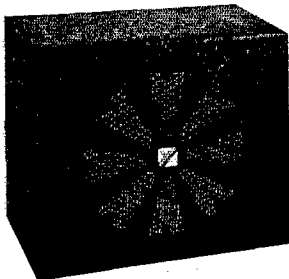

Model 880 Equipped with 6" Dynamic Speaker with Universal Transformer to match all output tubes, 2500 ohm field. List Price..... **\$8.80**

Model 980 Equipped with 8" Dynamic Speaker with Universal Transformer to match all output tubes, 2500 ohm field. List Price..... **\$9.80**
Cabinets finished in black crystalline. Size, 9" high, 10" wide.

Model 470 A.C. Field Supply
Furnishes necessary field excitation for A.C. operation of the above models. So designed as to fit into the housing perfectly. List Price..... **\$4.70**

Write for dealer's discount, catalog and name of nearest distributor. Wright-Decoster distributors are always anxious to cooperate with you.

WRIGHT-DECOSTER, Inc. 2259 University Ave. St. Paul, Minn.

manner to that used in the 57 triode grid circuit, this was deemed inadvisable because it would necessitate working both sides of the microphone above ground. Unless one side of a high-impedance microphone can be connected to ground there is an excellent likelihood that considerable hum will be picked up.

In the second stage the screen, suppressor and plate of the 57 are connected together to act as a triode plate. The volume control is in the grid circuit of this tube, since this is the first point at which overloading is likely to occur. There is no danger that the output of the crystal microphone will overload the grid of the first 57. On the other hand, if higher-gain microphones are used, or if additional pre-amplification is introduced, it might be advisable to put the gaincontrol in the grid circuit of the first 57. Transformer coupling could be used out of the plate circuit of the 57 triode, with possibly an increase in gain, but in this case space considerations precluded its use. There is also some chance that feed-back would occur with the additional transformer.

Jacks are provided for microphone input and for reading plate currents in the 45 and 46 stages, and for reading grid current in the 46 stage. The secondary terminals of the output transformer have been simply brought out to a pair of terminals so that any desirable type of coupling can be used. With the particular transformer used (chosen because its variable output ratio permits adjustment to fit the particular conditions) simply connecting the secondary in series with the Class-C amplifier plate supply gives perfectly satisfactory results. However, coupling through a condenser and choke, to keep the direct current out of the transformer secondary, should result in some improvement in reproduction.

So far as construction itself is concerned, there is little to be said except that it is desirable to plan the layout so that the parts can be worked into place as logically as possible. The leads to the amplifier grids should be encased in grounded shields. "Hot" leads to the volume control also are shielded; this may or may not be necessary, but at any rate the shielding does no harm and may possibly prevent feedback and hum pickup. Liberal use of insulated mounting lugs and rubber grommets obviates a great deal of the danger of short circuits and facilitates the mounting of resistors and condensers. The photographs show the placement of the main parts quite clearly; the others are simply worked in where they fit. Naturally some crowding has to be done, since a great deal of material has to go into a rather small space.

If the values are duplicated and care is used in wiring, there should be no trouble in getting the unit to "perk". In the transition from a circuit diagram to the actual amplifier, only two points caused us any trouble; distortion in the second stage was quickly cleared up when it was found that the cathode terminal of the socket inadvertently touched a grounded point, and distortion and oscillation in the first stage were

For only
\$480

4 BIG IMPROVEMENTS with the New **BLILEY** LD-2 CRYSTAL UNIT

Because the Bliley LD-2 Crystal Unit is manufactured by a radically new principle, it offers four outstanding improvements never before available at the extremely low price of \$4.80.

- 1. EXTREMELY LOW DRIFT.** Guaranteed under 8 cycles/mega-cycle/°C., 2/3 less than an X cut. Gives greater frequency stability.
- 2. IMPROVED HOLDER,** specially designed for the LD-2 Unit, increases crystal efficiency. Permanently sealed.
- 3. GREATER ACTIVITY.** Guaranteed 0.03% accurate in your transmitter.
- 4. AVAILABLE IN 40, 80 and 160 METER BANDS.** Choice from distributors' stocks, or within 0.1% of desired frequency, if specified. One price for all bands, only \$4.80 at your dealer.

All progressive distributors of amateur equipment carry Bliley Crystals. Look for the circular stainless steel name plate on the LD-2 Unit.

BLILEY ELECTRIC CO., ERIE, PA. MEMBER **RMA**

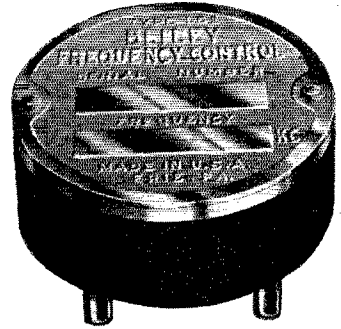

CHECK UP!

don't miss the
Special Offer on page 96.

**DIP or BRUSH R.F. COMPONENTS with
Q-MAX No. 3**

The only Victron base R.F. Coating

Do not destroy the efficiency of your apparatus by the use of ordinary lacquers never intended for high frequency service. USE Q-MAX No. 3. \$.25 per can at your dealer's store.

Communication Products, Inc.

245 Custer Avenue

Jersey City, N. J.

*Radio
Engineering
Complete in
Telegraphy-
Telephony*

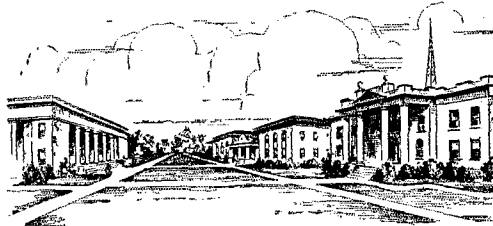

*Studio Technique
and Transmitter
Operating Expe-
rience Guaranteed*

KPAC

500-Watt

1260 Kilocycles

IN 3 to 7 months we train you to secure Commercial Telegraph Second-class, and Radiotelephone First-class government licenses. Course consists of Wireless Code, Radiophone, Microphone-Studio Technique, Service, Police, and Aeronautical Radio. We are authorized to teach RCA texts. At completion of course you receive practical studio technique experience in our commercial broadcast studios located in administration building, and experience as an operator on K-P-A-C (500-Watt Commercial transmitter located on the campus and owned and operated by the college), and WPA, 4000-Watt Commercial Wireless Station. If interested, write for Bulletin R.

FLASH!!

Port Arthur College reduces Radio Engineering Course from \$180.00 to \$126.00 for July enrollment only. Most complete and lowest priced engineering course in America. Application for enrollment positively must be accepted by Registrar before student may enter.

PORT ARTHUR COLLEGE

Port Arthur (world-known port) Texas



Mr. E. H. Rietzke, President of CREI and originator of the first thorough course in Practical Radio Engineering.

"Good Intentions" won't get you a Good Job!

You have to be "TECHNICALLY QUALIFIED" to get to the top in Radio today. This fast-growing industry demands that the GOOD jobs go only to TECHNICALLY TRAINED men, who have kept pace with Radio by intensive training. The hundreds of CREI men who now hold responsible engineering jobs PROVE that radio executives recognize the superiority and ability of CREI-trained men.

RIGHT NOW . . . WRITE NOW FOR FREE ILLUSTRATED CATALOG

This booklet will answer every question and fully describe our courses and 3 plans of study . . . as well as show you how easy it is to pay for them.

**CAPITOL RADIO
ENGINEERING INSTITUTE**
14th and Park Road, N. W. Dept. C-8
WASHINGTON, D. C.



eliminated when the screen voltage divider specified was installed in place of a series dropping resistor first tried. No other changes or adjustments were found necessary.

Working into the normal Class-C amplifier load—600 volts, 140 ma., or approximately 4300 ohms—the output taps on the transformer are set at Nos. 1 and 5, giving an impedance ratio of 1.33:1 from total primary to secondary. This corresponds to a turns ratio of 1.15-1 and makes the per-tube load resistance in the Class-B stage slightly over 1400 ohms, a suitable value. As previously mentioned, the Class-B plate current at 100% modulation is approximately 80 ma.; that is, the plate current should not swing above 80 ma.; as indicated by the plate meter, during speech. Grid current should be between 10 and 20 ma. under the same conditions. It is desirable, of course, that the plate supply for the Class-B stage have good regulation.

During modulation the plate current to the Class-C stage should show no change. With normal speech the antenna current rise will be of the order of 5%, which, as has been pointed out in these pages previously¹, is about all that should be expected at 100% modulation with voice input and an ordinary thermo-meter. If all these conditions can be satisfied, there need be no fear that the transmitter is not being modulated properly—and up to the full legal limit.

Adjusting the 'Phone

(Continued from page 86)

ment or any other effective current or voltage indicating device will show both the increase due to modulation and carrier shift at the same time and there is no way of separating them. Also, these methods of indicating modulation are almost worthless on anything but steady tone because of the inherent inertia of thermo-instruments.

CLASS-B LINEAR R.F. AMPLIFIERS

When more power is wanted, resort is usually had to some form of linear amplifier. Now just because a Class-B r.f. amplifier is operated at the recommended grid and plate voltages, it does not necessarily follow that the dynamic output characteristic will be linear as must be the case if the output is to be undistorted. In fact the contrary is usually true. Output impedance and grid bias will determine almost completely the shape and degree of linearity of the dynamic output characteristic. While it is usually recommended that Class-B amplifier be biased to cut-off, for instance, it is found that a bias slightly less than cut-off value is likely to yield greater over-all linearity. The effect of bias will be seen from the characteristics shown in Fig. 3. The best operating bias is the one which yields the dynamic characteristic having the longest straight portion. Likewise, the characteristics illustrated in Fig. 4 show the effect of output impedance on linearity.

The most ideal way in which to choose the operating conditions of bias and output im-



CORNELL-DUBILIER again leads the field by its introduction to the hams, of a series of capacitors that are the latest in condenser design.

Striking compactness, higher dielectric strength and constant, with marked economy are the outstanding features of Dykanol Hi-voltage x-mitting condensers.

Also

- DYKANOL is non-inflammable. Type TC 300R0 2MFD 3000V.D.C.
- DYKANOL x-mitting condensers are hermetically sealed. Your cost . . . \$13.53
- DYKANOL condensers cannot be affected by high temperatures. At all C-D authorized distributors.

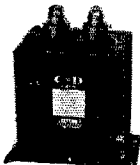

Get your copy of the new No. 128 catalog describing Dykanol x-mitting condensers in complete detail.

CORNELL-DUBILIER
CORPORATION
4373 BRONX BOULEVARD
NEW YORK

A FORTY-EIGHT PAGE PARTS CATALOG

BULLETIN 936

Have you asked for your copy of General Radio's 48-page parts catalog? Everything from audio-frequency transformers to wave-meters — all backed by General Radio's 20 years of catering to the needs of amateurs and experimenters.

Thousands of amateurs have been consistent buyers of General Radio parts. These same parts are incorporated in the communication instruments and apparatus of the Navy, the Army, the Coast Guard and other Governmental services.

May we send you a copy of Bulletin 936?

GENERAL RADIO COMPANY, 30 State Street, Cambridge A, Massachusetts

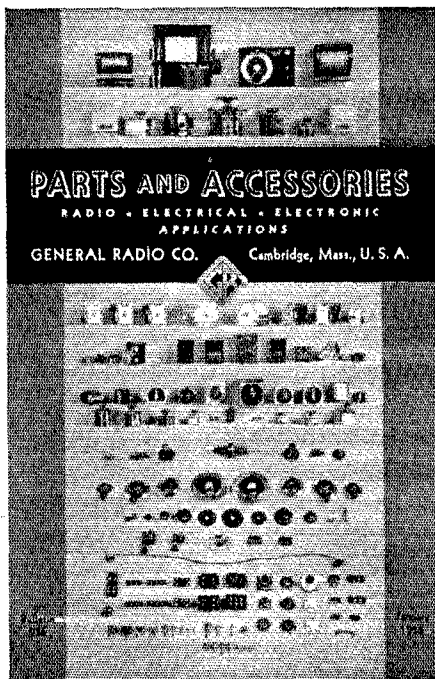

ASTATIC

CRYSTAL MICROPHONES AND PICKUPS

Guaranteed instruments, known for their quality, dependability and ruggedness. Extensively used in both Professional and Amateur fields. Send for your literature today!

ASTATIC MICROPHONE LABORATORY INC., YOUNGSTOWN, OHIO

**WHEN BETTER AERIALS ARE MADE
LYNCH WILL MAKE THEM ...
AND OTHERS WILL TRY TO COPY THEM**

Write for Free Bulletin on LYNCH
PATENTED and GUARANTEED
Noise-Reducing Antennas for Home, Auto Use.

ARTHUR H. LYNCH, INC., 227 Fulton St., N. Y.
PIONEER OF NOISE-REDUCING AERIALS



UNIVERSAL 5-METER HAND SET

A new, 15 ounce, compact hand set — Designed for 5-meter transmitters and 5-meter transceivers — Highly polished, moulded bakelite units — 2000 ohm unipolar receiver — High output, single-button Universal microphone of 200 ohms — 6-ft. 4 conductor cord with color-coded phone tips — List Price, Single-Button microphone \$6.00.

UNIVERSAL MICROPHONE CO., Ltd.
424 Warren Lane Inglewood, Calif., U. S. A.

"The Crystal Specialists Since 1925"

PIEZO-ELECTRIC CRYSTALS

Guaranteed Accurate to BETTER than .01%

SCIENTIFIC RADIO SERVICE
UNIVERSITY PARK, HYATTSVILLE, MD.



SCIENTIFICALLY PRODUCED

VARIABLE CONDENSERS
PLUG-IN COIL FORMS
TRANSMITTING COIL
FORMS
WOUND COIL KITS
MICROPHONE STANDS
MICROPHONE PLUGS
MICROPHONE
CONNECTORS
MICROPHONE JACKS
SOCKETS, RECEIVING &
TRANSMITTING
PLUGS and ADAPTERS
STAND-OFF INSULATORS
DIALS and KNOBS

TEST LEADS
SERVICEMEN'S TOOLS
SOLDERING IRON TIPS
CRYSTAL HOLDERS
R.F. CHOKES
TRANSMITTING CHOKES
AERIAL PARTS
AUTO AERIALS
AUTO SUPPRESSERS
SWITCHES
RADIO CONVENIENCE
OUTLETS
CHASSIS
METAL CABINETS
NAME PLATES

BUD Components are specified by amateurs, experimenters and engineers for Quality, Efficiency and Economy.

BUD RADIO INC. Cleveland, Ohio

Please Send Me Your Latest Catalog FREE!

Name.....

Address.....

City.....

QST 8-35

New HIGH IMPEDANCE VELOCITY MICROPHONE

(Model RB-H)

Operates **WITHOUT** PRE-AMP

A HIGH IMPEDANCE VELOCITY MICROPHONE WHICH OPERATES DIRECTLY INTO GRID OF TUBE

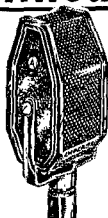

REQUIRES NO PRE-AMPLIFIER WHEN USED WITH REGULAR HIGH GAIN AMPLIFIER (100 DB.)

Replaces condenser and crystal microphones—NO CHANGES or additions necessary! ELIMINATES INPUT TRANSFORMER and its losses. Therefore requires 12 db. less over-all amplification. Eliminates inductive hum. No feedback. Life-like, natural reproduction. Write for Bulletin H.Q.

LIST \$42.00 with coupling.

AMPERITE Corporation 561 BROADWAY N.Y.

AMPERITE 1 POINT Velocity MICROPHONE

pedance for a Class-B r.f. amplifier is to take the actual dynamic output characteristics of the tube to be used. This involves the measurement of the grid excitation voltage which, without proper equipment,³ is not an easy matter. Therefore, certain general rules governing the choice of both the tube and operating conditions will be given:

(1) The higher the output impedance, the more nearly linear will be the dynamic characteristic, but at some sacrifice in output power.

(2) Between two tubes of equal power rating, the one having the higher mutual conductance will give the more nearly linear characteristic for a given output impedance.

(3) Bias voltages slightly less than the cut-off value will yield more linear characteristics than those obtained with cut-off bias.

(4) The length of the straight portion of the dynamic characteristic may be increased by an increase in plate voltage. Whether or not this is permissible will depend upon the insulation and dissipation rating of the tube.

(5) Since the maximum operating efficiency of a Class-B amplifier is about 66% before excessive non-linearity occurs, the unmodulated carrier excitation should be adjusted to that value which yields a plate efficiency of 33%. On 100% positive modulation peaks the excitation voltage is doubled, thereby causing the plate efficiency to increase to the 66% maximum.

(6) If distortionless transmission is to result, the driving source must be capable of delivering full excitation on modulation peaks. Since the input impedance of a Class-B amplifier varies with excitation, it is essential that the driving source have good regulation; that is, that the impedance variations will not destroy the output characteristic so carefully arrived at earlier. This is best accomplished by dissipating large amounts of power in the output circuit of the driving stage. Resistance in series with the tuned circuit or in shunt to it, across the Class-B grids, will serve equally well to provide this condition. A satisfactory state is usually obtained when the power dissipated in the input circuit of the Class-B stage is at least one-fifth of its output power.

The use of the linear rectifier will aid greatly in the proper adjustment of a Class-B amplifier. Its behavior on modulation may be interpreted as follows:

(1) A negative shift usually indicates too high an output impedance, too low a bias or excessive excitation, or all three.

(2) A positive shift usually indicates too low an output impedance or too high a bias, or both.

In conclusion a few remarks about the measurement of modulation at remote points might be in order. Reports from a station claiming to be able to measure modulation on the air are apt to be very misleading and greatly in error unless several conditions are met in the measuring system.

First of all, the receiver from antenna to the output of the measuring equipment must be

³ A method of measurement is described by H. A. Robinson in the article, "Operating Characteristics of R. F. Power Amplifiers," Feb., 1934.—Editor.

SARGENT-10

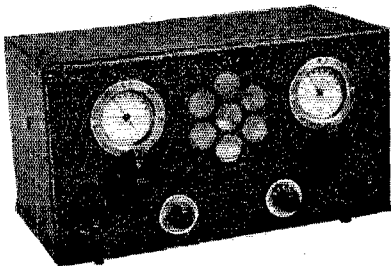

COMMUNICATIONS RECEIVER

— FEATURES —

- Choice of Three Tuning Ranges
- An A-1 Amateur Receiver
- Illuminated Airplane Dials
- Tuning Dial Calibrated in M.C.
- Adjustable Calibrated Band Spreader
- Built-in Jensen Dynamic Speaker
- Wave Changing Switch — No Plug-in Coils
- Built-in Hum-free Power Supply
- Large Tuning Knobs
- Headphone Jack
- Attractive All-Metal Cabinet
- Doublet or Marconi Antenna
- Ideal for Shipboard Installations
- Supplied for Any Operating Voltage — A.C., D.C., or Battery

The BAND SPREADER, a new development, is adjustable so as to give wide spread on Amateur Bands — 20 meters 40°; 40 meters 43°; 75 meter Phone Band 47°. Amateur Bands are calibrated on the dial for direct reading in M.C.

The circuit employs a 6106 stage of sharply tuned R.F. with antenna trimmer, 6C6 regenerative detector with screen regeneration control, a 76 audio driver and a 42 audio output tube. An 80 rectifier is used.

Model 10SA (15-550) complete with tubes, Jensen dynamic speaker, power supply — entirely self contained in metal cabinet — Nothing else to buy..... **\$34.50**

Model 10MA — same as above except for tuning range, — 15-1500 meters..... **\$39.50**
Ranges from 15 to 15,000 meters on special order.

SARGENT 8-34 Super-Het (15-550). Complete..... **\$54.50**
MARINE MODEL 8-34 (15-1500). Complete..... **\$62.50**

MARINE RADIO COMPANY

Eastern Distributors

124-11 101st Avenue, Richmond Hill, New York

Telephone: CLEVELAND 3-2400. Cable Address: "Elecmarine."



LEEDS SPECIALS FOR SUMMER BARGAIN HUNTERS

LEEDS 4B TRANSMITTER — 4 bands, coil switching, no neutralizing, no plug in coils; 120 watts of CW on 1.7; 3.5; 7.0 and 14 mc with split second QSY.....\$130

Write for Bulletin

LEEDS adaptation of the All Star Jr. receiver to single signal reception, is the low priced answer to ever increasing QRM — complete kit of parts and speaker RCA tubes.....\$34.93

READRITE D.C. milliammeters, 0-15; 0-25; 0-50; 0-100; 0-150; 0-200; 0-300; 0-400; each 59c.

H & H toggle switches, 1/2" shank

SPST	SPDT	DPST	DPDT
19c	25c	35c	40c

Westinghouse 10 and 15 amp watt hour meters; for use on 110 or 220 volts, 60 cycles.....\$2.50

General Electric Neon tubes, 1/4— 1/2— 1 watt; each...29c

PAWOOD circle cutters are ideal for making large holes in metal panels. No. 2....\$1.18; No. 5....\$1.88.

The new RCA type TMV-135-A crystal holder.....\$2.50

TRUMBULL knife switches, porcelain base; DPDT each 25c

Army portable antenna, 150 feet stranded phosphor bronze wire with hand reel.....\$1.25

MICARTA tubing 1" square, 1/8" wall, 30" length.....50c

Copper cans 3" diameter, 3" high with base.....10c

GENERAL RADIO dials, with fluted knobs 4" — \$1.50; 3 1/2" — \$1.25; 2 3/4" — \$1.00.

We carry a complete stock of knobs to match; Write for Bulletin.

LEEDS X-CUT 160 and 80 meter crystals \$2.25; 40 meter crystals \$3.25. Unconditionally guaranteed to satisfy the most critical.

We are pleased to present a number of additions to the line of tubes bearing our name. Our success with the popular 210 HF, 866 and 203A makes this possible. They all represent real value backed by LEEDS guarantee of 100% satisfaction.

*203-A	\$8.45	†*801	\$2.95	*852	\$11.50
†210-HF	1.75	†*830	6.75	*860	21.50
866	1.50	†*830-B	7.25	†*865	8.45
*211	8.45	*838	11.75	866-A	1.95
†304-A	9.45	†841	2.45	872	11.75
†800	7.25	845	11.50	872-A	13.25

*Graphite Anode Tubes †Isolantite Base
Tubes Shipped By Express Only

We carry a complete stock of NATIONAL Isolantite insulated condensers. The TMC 300 mmf unit with polished plates, double spaced is a typical value at.....\$3.30

LEEDS CONDENSER SPECIALS 2 mf oil immersed cased units with standoff insulators. 1000 v. \$1.45 — 1500 v. \$2.00 — 2000 v. \$2.45.

BAKELITE PANELS AT SPECIAL PRICES

7 x 10 x 3/16	69c	10 x 10 x 3/16	95c	7 x 10 x 1/8	35c
" 12 "	83c	" 12 "	1.15	" 12 "	42c
" 14 "	97c	" 14 "	1.35	" 14 "	49c
" 16 "	1.11	" 16 "	1.55	" 16 "	56c
" 18 "	1.25	" 18 "	1.75	" 18 "	63c
" 21 "	1.46	" 21 "	2.05		
" 24 "	1.67	" 24 "	2.35		



World Wide Service to Amateurs
45 Vesey Street
New York City
Cable Address, "RADLEEDS"

AX & HS! CRYSTALS OR? ALPHABET SOUP?

Write for dope explaining new alphabetic crystal cuts
HIPOWER CRYSTALS
FROM YOUR DEALER OR DIRECT **\$1.35** and up
You cannot buy a better crystal than HIPOWER at any price
HIPOWER 3607 N. LUNA Ave. Phone
CRYSTAL CO. CHICAGO, ILL. Avenue 5170

RADIO ENGINEERING

RCA Institutes offers an intensive course of high standard embracing all phases of Radio. Practical training with modern equipment at New York and Chicago schools. Also specialized courses and Home Study courses under "No obligation" plan.
Illustrated Catalog on request.

RCA INSTITUTES, INC. Dept. ST-35
75 Varick St., New York 1154 Merchandise Mart, Chicago
Recognized Standard in Radio Instruction Since 1909

PANELS — BAKELITE — RUBBER — ALUMINUM
All Sizes Cut to Order **BAKELITE TUBING & RODS**
Drilling, Engraving & Special Work
ALUMINUM CANS — Stock sizes. Special sizes, made to order.
ALUMINUM CHASSIS — Threaded brass studs for 6/32 screws. Length from 1/2" to 6" — price 5c to 30c.

Insulating bushings for all size shafts **Couplings in brass of Bakelite** — 15c
Bakelite Tubing Threaded to Specifications

UNITED RADIO MFG. CO. Est. 1923 191 Greenwich St., New York
Transmitting frames and racks

New BIRNBACH

5-METER ANTENNAS

\$1.00 to \$2.50

PERFECTED quarter and half-wave antennas for portable transceivers, beam arrays and permanent use. Five models: 2 or 3 extensible sections with threaded end, or flat end for direct front-panel mounting, or including standoff insulator — \$1.00 to \$2.50 list. Inquiries invited on special antennas for all ultra high-frequency transmission and reception.
Write Dept. Q-8 for Details

BIRNBACH RADIO CO., Inc.
145 HUDSON STREET NEW YORK CITY

"Communications-Type" CRYSTAL MICROPHONE

Shure Model 70S

At last... a Crystal Microphone designed especially for 'phone work! Imparts the utmost clearness and intelligibility to radio-telephone signals! Complete with desk mount as illustrated, only \$25 list. Licensed under Brush patents.
Ask your Jobber... or Write today for complete technical data.

21 Shure Crystal Microphone Models... for every application.

SHURE BROTHERS COMPANY
Manufacturers of Microphone Headquarters Telephone DELANDRE 8383
215 WEST HURON ST. CHICAGO, ILLINOIS

The Mu-X

Hits a New High in Microphone Performance and Value

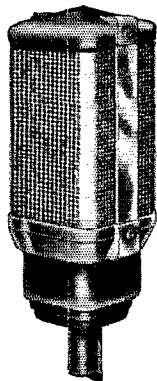

Announced only last month the Turner Mu-X (multiple crystal) microphone has attracted widespread interest among both amateur and commercial stations. It offers several definite improvements over any microphone heretofore available, at a price lower than any instrument of similar characteristics. Available for either push-pull or single grid input, with 4, 6 or 8 crystal units. Licensed under patents of the Brush Development Company. Write for descriptive circular and prices.

THE TURNER COMPANY
CEDAR RAPIDS, IOWA, U. S. A.

HOW IS YOUR SUPPLY OF IDEAS?

If they ever run low, make sure that you have a copy of HINTS & KINKS handy. It is chock full of money-saving ideas and stunts of interest to you. There are many times when you will find it invaluable. The price is 50c postpaid.

**AMERICAN RADIO
RELAY LEAGUE**

West Hartford

Connecticut

strictly linear. Any carrier shift not present in the out-put of the station under measurement but generated by non-linearity in the receiver will cause the measurements to be in error by an amount equal to the shift generated and in the same direction.

Linearity in a receiver can be obtained if the following requirements are fulfilled:

(1) The dynamic output characteristics of all the radio stages, whether they be working at high or intermediate frequency, must be strictly linear over the range of the signal grid swing. This requires a proper choice of tubes together with the adjustment of the load impedance into which each tube works.

(2) If the receiver is of the superheterodyne type, the relation between translation gain and signal input of the first detector must be a straight line when plotted. This can be obtained by a proper adjustment of the first detector bias and the input to the first detector from the high-frequency heterodyning oscillator.

(3) The second detector must be practically linear. A diode with proper load resistance may be used.

(4) The measuring circuits themselves must be practically linear and must be capable of following the fast modulation peaks.

Only if and when the person reporting your modulation has taken all these precautions is it safe to accept his report as a true indication of your transmitter performance. The moral is—use your own linear rectifier for carrier-shift indications.

Iron-Core I.F. Transformers

(Continued from page 25)

likely represents the amateur's preferred performance, the coupling in the iron-core unit can be readily changed to a lower value, and the selectivity of the transformer thereby increased at least 50 per cent while still maintaining a gain equivalent to the better air-core types. Two iron-core transformers used with 58 or 6D6 tubes and adjusted for minimum coupling would produce an intermediate-frequency amplifying system for an amateur receiver which would have adequate gain and greatly increased selectivity in a very compact assembly.

HIGHER FREQUENCIES

The development work on iron-core tuning systems up to the present has been concentrated largely in the intermediate-frequency spectrum, although work undertaken to date in the broadcast-frequency band indicates very promising application for iron-core units. For instance, with iron-core antenna coupling units gains in excess of 20 are obtainable through the broadcast band, representing about three times that obtained with air-core types. In interstage r.f. systems, gains of 150 have been obtained over the entire broadcast band, such gains being conservatively rated at twice that possible with air-core units.

Why You Will Want G-E Instruments

BECAUSE their sturdy construction and large clearances mean extra-long life for the instrument.

BECAUSE their neat, well-balanced appearance will add to the attractiveness of your transmitter.

BECAUSE you can be assured of high quality and dependable operation.

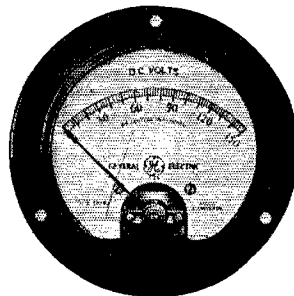

ASK to see these new G-E instruments at your jobber's or radio dealer's. We will gladly send you a copy of our bulletin, SMALL PANEL INSTRUMENTS, GEA-1239B, on request. Radio Department, General Electric, Schenectady, N. Y.

430-54

GENERAL ELECTRIC

MOBILE
and
PORTABLE

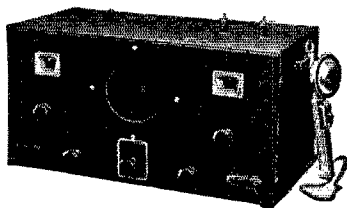

DUPLEX TRANSMITTER-RECEIVER UNITS

Containing Medium Power Transmitters—Tuned R. F. Receivers
WRITE FOR BULLETIN C

RADIO TRANSCEIVER LABORATORIES
86-27—115th Street, Richmond Hill, N. Y.

IMMEDIATE DELIVERY

FROM RECEIVER HEADQUARTERS

NATIONAL HRO.....	\$166.70
RME9Ds.....	112.50
RCA ACR-136 complete.....	69.50
BRETING 12 complete.....	93.00
SILVER 5C complete prepaid.....	74.70
SUPER PRO complete (when available).....	164.64
PR-12 complete prepaid (when available).....	83.70

ALL COLLINS transmitters at lowest prices
TRADE IN YOUR RECEIVER OR TRANSMITTER
All receivers shipped on ten-day trial. Only \$5.00
payment required with order

Complete stock of all amateur apparatus at lowest prices. Your
used apparatus taken in trade.

Every inquiry and order is personally attended to by Robert
Henry, W9ARA; an active amateur for ten years; graduate
E.E. from M.I.T.; and owner of Henry Radio Shop selling
amateur apparatus for six years. Your orders are valued and
appreciated. Write for any information.

HENRY RADIO SHOP

211-215 North Main St. Butler, Missouri



RADIO CODE

is easy to learn when you have your own Instructograph. You practice when and where you like. With each machine, sold or rented, comes Book of Instructions showing how to study to best advantage. Write TODAY for descriptive folder and attractive new terms. You'll be surprised at the low cost.

INSTRUCTOGRAPH CO., DEPT. O8
912 Lakeside Place Chicago, Illinois

Representatives for Canada
RADIO COLLEGE OF CANADA, Ltd., 863 Bay St., Toronto

PRECISION CRYSTALS

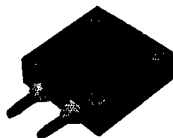

Crystal Holder—\$1.00

'X' and 'AT' cut crystals one inch square carefully ground for frequency stability and maximum output. Be sure of your transmitter frequency—use PRECISION CRYSTALS. Guaranteed to be the highest quality obtainable.

'X' cut PRECISION Crystals carefully ground for maximum power supplied to your specified frequency accurate to 0.1% and calibrated to within 0.03% are priced as follows:

1750 and 3500 kc. bands — \$3.00 each. 7000 kc. band — \$3.50. Add \$1.00 to above prices if plug-in, dust-proof holder is desired. Jacks to plug holder into — \$.15 pair.

The 'AT' cut crystal recently developed has a temperature coefficient of practically zero and will handle more power than ordinary crystals. 'AT' cut crystals ground to your specified frequency accurate to 0.1% and calibrated to within 0.03% are priced as follows: 1750 and 3500 kc. bands — \$6.00 each. Crystal holder — \$1.00. Jacks for holder \$.15 pair.

Crystals and ovens for commercial use quoted on at your request. When ordering our product you are assured of the finest obtainable. Now in our sixth year of business.

PRECISION PIEZO SERVICE

427 Asia Street Baton Rouge, La.



ELECTRICAL MEASURING INSTRUMENTS

for

The Amateurs' Requirements

The Triplet line includes:

- VOLTMETERS
- MILLIVOLTMETERS
- AMMETERS
- MILLIAMMETERS
- MICROAMMETERS
- POWER LEVEL INDICATORS
- THERMO-COUPLE AMMETERS
- OUTPUT METERS
- AC-DC METERS
- RELAYS

COMPLETE LINE OF TESTING EQUIPMENT

Furnished in All Popular or Special Models and Ranges

Write for Catalog

THE TRIPLET ELECTRICAL INSTRUMENT COMPANY

173 Main Street Bluffton, Ohio, U. S. A.

Rathert

ELECTRIC MODEL T9A Microphone with Preampifier

PATENTS PENDING



\$12.50

with
Preampifier

The model T9A is a high quality condenser microphone incorporating unique design features and having excellent frequency response with high output level. The preampifier uses one type 30 tube. The chassis is cushion mounted in an attractive aluminum case. The head and preampifier "B" voltage can be taken direct from the main speech amplifier power supply and the preampifier stage can be efficiently and economically resistance capacity coupled to the speech amplifier eliminating inductive interference.

Truly an outstanding value. — Send for descriptive circular. — Size 3" x 5 3/8". — Sold complete with instruction sheet, circuit diagram and 8' of shielded cable, less tube and stand, \$12.50 net f.o.b. Cresco, Iowa.

RATHERT ELECTRIC CO., CRESCO, IOWA

Because of the more immediate need for iron-core units in the intermediate-frequency and broadcast ranges, sufficient investigation has not been possible at this time on the use of iron at higher frequencies. Creditable results have been obtained up to 4000 kc., however, and it is reasonable to expect that with proper iron core and coil design, good results will be possible at still higher frequencies.

Four Bands With Two Tubes

(Continued from page 19)

bias. At W1AF a multi-point switch reverses polarity, shorts out the keying relay and applies voltage to the speech amplifier, with one motion. Any of the speech-amplifier modulator combinations described in *QST* or the *Handbook* capable of

COIL TABLE

Coil	Turns	Length of Winding	Tap	Wire Size
A	35	1 1/4	4	No. 22 d.c.c.
B	15	1 1/4	2	No. 18 bare
C	7	5/8		"
D	6	5/8		"
E	21	*		No. 12 bare
F	17	**		"
G	6			"

OPERATION WITH CRYSTAL CONTROL

Output	L ₁	L ₂	L ₃	Crystal
3.5 mc.	C ₁ shorted	Coil A	Coil E	3.5 mc.
7 mc.	C ₁ shorted	Coil B	Coil F	7 mc.
14 mc.	Coil C	Coil D	Coil G	7 mc.

ELECTRON COUPLED

Output	L ₁	L ₂	L ₃
7 mc.	Coil A	Coil B	Coil F
14 mc.	Coil B	Coil D	Coil G

Electron-coupled control not used on 3.5 mc. Coils A, B, C and D wound on Hammarlund Isolantite forms.

* Coils for amplifier plate wound on G.R. Forms, 2 1/2-inch diameter, 7 grooves per inch
** Coil E actually is used, a tap being taken off at 17 turns

delivering audio power of the order of 3 watts will fully modulate the RK-20's output.¹ The particular arrangement used here consists of a 57 high-gain first stage, a 53 triode second stage, and 2A5 modulator, working from a Shure 70H crystal microphone.

Typical operating conditions at W1AF are, 400 volts plate and 110 volts screen on the 59; 1300 volts plate and 350 volts screen on the RK-20; grid bias to the RK-20, 45 negative by battery, to limit plate current without excitation, and a series resistor of 15,000 ohms with optimum grid current of 5 to 6 mils; linear operation of the RK-20, with modulation, is reached with 90 volts negative suppressor bias. Plate current to the 59 oscillator is of the order of 20 to 25 ma.; to the

¹ The actual power required is considerably less than three watts, but an excess of audio power is desirable to give good regulation. The peak modulating voltage swing needed is approximately 150 volts.—Ehrron.

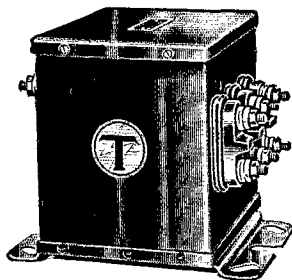

THORDARSON TRANSFORMERS

T-7352 Variable Impedance Modulation Transformer—to couple a 500-ohm line to an R. F. plate circuit or oscillator. Handles 80 watts audio! Secondary is tapped for 5,000, 6,000, 7,000, 8,000, 9,000, and 10,000 ohms. Max. Sec. D. C. 215 m. a. Size 6½" x 5¾" x 8" high. Wt. 16½ lbs. List \$16.00



THORDARSON Transformers are available from your THORDARSON radio distributor for use in all amateur, ship, beacon, police, and B. C. stations. Ask your jobber for Catalog 343.

THORDARSON ELECTRIC MFG. COMPANY
500 W. Huron St., Dept. B, Chicago, Ill.



NEON

TESTER TATTELITES

"tell the tale" in tuning or neutralizing a transmitter, checking ultra-short wave length, and making audio oscillators for modulating, etc. Testing for blown fuses or condensers, open circuits and resistors, live lines, polarity, r.f. — are a few uses. See your favorite dealer or send a \$1.00 bill for postpaid with instructions.

Ask for technical catalog No. 6, describing Instrument, Hi-Voltage and Aircraft Littelfuses, Mountings, etc.

Littelfuse Labs.

4509 Ravenswood Ave., Chicago, Ill.

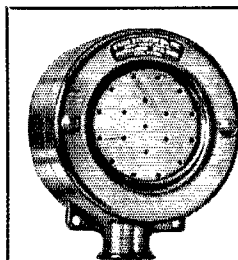

The Superiority of Our DYNAMIC MICROPHONE

Over Other Types Is
Mainly in Its Sensitivity

No high gain preamplification required. No background noise. No Power Supply. AND THE PRICE **\$33**

U. S. PATENTS PENDING

Send for Bulletin 3011

RADIO RECEPTOR CO., INC.
110 Seventh Ave., New York City

GULF RADIO SCHOOL

Radiotelegraphy Radiotelephony
Radio Servicing

SECOND PORT } 1007 Carondelet Street
U. S. A. } NEW ORLEANS, LA.

READ AND SEND CODE

Learn Easily at Home This Quicker Way

No experience needed. Beginners read code quickly, copy accurately. If already an op, speed up your wpm with this amazing improved Master Teleplex. Only instrument ever produced which records your sending in visible dots and dashes on embossed copper tapes then sends back your own key work. Fascinating, fool-proof; gets results because you learn by HEARING as well as seeing. Used by U. S. Army and Navy, R. C. A., A. T. & T., and others. We furnish Complete Course, lend you the New Master Teleplex, and personal instruction with a MONEY-BACK GUARANTEE. Low cost, easy terms. Write today for folder Q. 32, no obligation.

TELEPLEX CO.

76 Cortlandt St.
NEW YORK, N. Y.

MASTER TELEPLEX—"The Choice of Those Who Know"

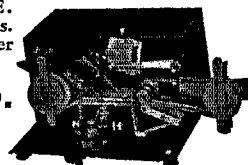

CT-60 TRANSMITTER

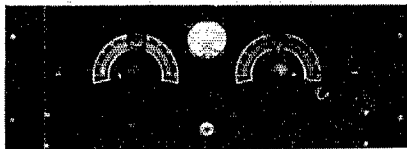

A single tube, crystal controlled transmitter featuring front panel band switching, elimination of all unnecessary controls, and permitting instant QSY with but a flick of the two Onnrite switches. Truly modern and a real value. See April QST, page 41 for full details.

Specifications

OUTPUT: Up to 60 watts on CW, 15 watts phone suppressor grid modulated on crystal fundamental.
 FREQUENCY: Model A-160, 80, 40 meters. Model B-80, 40, 20 meters.
 VOLTAGES: Plate — 1000 at 150 ma. Filament — 7.5 at 3 amperes.
 CT-60 Transmitter, either model, less RK-20 tube, crystals and power supply, **\$33.00**
 CT-60M Modulator with power supply but less tubes. **\$15.60**

Available in N. E. from your jobber. Other sections order direct

FT-30 TRANSMITTER

A very popular, well designed CW and PHONE transmitter of medium power for 4 band operation. Insolantite insulation, antenna network, fixed neutralization, and many other features make the FT-30 a most desirable unit for fixed or semi-portable use. Full data and prices on request.

FT-100 TRANSMITTER

A new 100 watt Radiophone Transmitter designed from commercial specifications and offering the Amateur a real value in appearance, long life, and proper performance.

Write for information on our complete line

HARVEY RADIO LABORATORIES

12 Boylston Street Brookline, Mass.

RK-20 amplifier 100 ma. on c.w., 50 ma. on 'phone. With an input of 130 watts the key may be closed indefinitely without the slightest trace of color on the RK-20's plate. For a given input, it has been my experience that the output is greater with the RK-20 than the 023-A. This is especially noticeable on 14 mc.

That the output of this simple two tube line-up is sufficient to do some real consistent DX work is evidenced by the following work done in its first month of operation: WAC four times, with three different J's on the Asian end; 35 countries worked on c.w.; over 200 'phone contacts with 17 countries in four continents. Oh, yes, the "sky-wire" is a Zepp exactly 32 feet above sea level in a congested neighborhood. This transmitter won't make any station outstanding for its signal strength, but it will put a QSA 5 signal into six continents.

Strays

While on a visit to W9AMT, W9LNH was shown a 200-watt, 50,000-ohm resistance about 12 inches long, which W9AMT bought to use as a grid leak for a pair of push-pull 45's when he first obtained his license!

Wanted!

First-hand information from all amateurs who have participated in emergency work, past or present. This material is to be used in formulating a book of national reader interest concerning the work of all amateurs in emergencies. Material dealing with any unusual phase of amateur endeavour is desired, and proper credit will be given to all whose material is used. In order to get a cross-section of this type of work, we are very desirous of getting all available material. This means such details as times of day, type of country, and all unusual conditions encountered. An attempt will be made to contact all the fellows who send material over W7ABZ in order to get all the first-hand dope possible. The book will be written by a ranking author, will be of a non-technical nature, and will appeal to all the reading public. The Portland Sevens Radio Club are sponsoring this work, and will appreciate and acknowledge any effort on your part in making it a success.

Send all communications to: Ray Cummins, W7ABZ, 4835 North Amherst St., Portland, Oregon.

Experimenters' Section

(Continued from page 46)

and the voltage on the line is the sum of the two. If the line is very long its ohmic resistance must be considered. This, along with the characteristics of the relays, will determine the voltage needed.

—S. Natale di Lorenzo, W2DIE

USE SPECIAL 2 for 1 DEAL

\$52.50 Value for \$35.10!

A new U.S.E. type LS-18 Speech Amplifier—a.c. operated; class AB using 57-57-56-2 No. 45-26-83 tubes; fixed bias; 18 watts output; harmonic content 5%; A-F range 20 to 10,000 cycles + or - 2db; hum 60 db. down; input 1 meg; gain 132.8 db. Built for rack mounting. Regular net price \$35.10.

— plus One U.S.E. type CR-2 Cathode Ray Oscillograph! Operates 110 AC 60 cycles; uses RCA 906—80 tubes (or equivalent); 70 volts DC per inch deflection; 60 cycle sweep circuit; regular net price \$17.40; supplied as illustrated suitable for mounting on your rack.

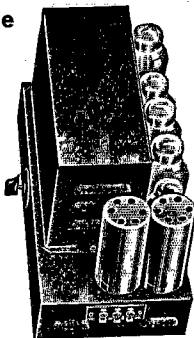

BOTH for \$35.10

if your order is postmarked before September 1st and received at this factory or by any U.S.E. distributor.

Write for latest U.S.E. literature

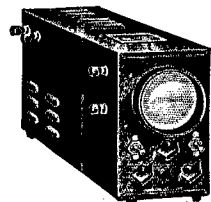

United Sound Engineering Company

Manufacturers of Specialized Sound Equipment

2235 UNIVERSITY AVE.

ST. PAUL, MINN.

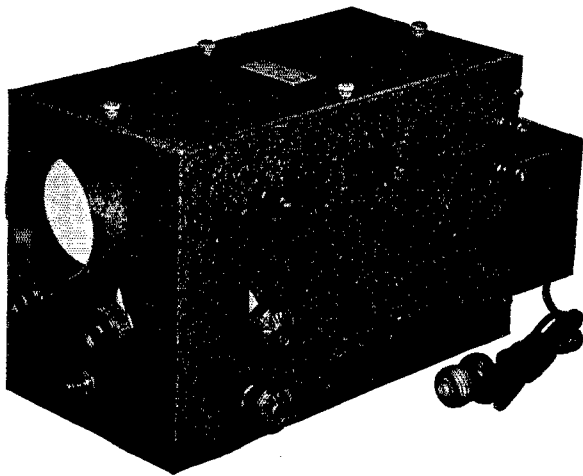

Net Price **\$17.70**

(To Amateurs, Less Tubes)

The new regulations of the Federal Radio Commission require that adequate means for checking overmodulation be employed in every amateur station. The National Oscilloscope is designed for this specific use, and single-purpose design has made possible simplicity in operation, and an attractively low price.



THE IDEAL ANSWER TO THE NEW REGULATIONS

NATIONAL COMPANY, INC., MALDEN, MASS.

LEARN RADIO

New Classes Now Forming! Send for 40-page catalog, explains fully. 190 licensed graduates placed in past 3 years in broadcasting, shipping, police radio, aviation, etc. We teach all branches. Oldest, largest and best equipped school in New England. Equipped with Western Electric sound and broadcasting equipment and RCA marine transmitter. Course prepares for United States Government telegraph or telephone license.

MASS. RADIO SCHOOL, 18 Boylston Street, BOSTON

CHECK UP!

don't miss the
Special Offer on page 96.

**INCREASED
SENSITIVITY
BETTER
TONE**

*-with this new
microphone...*

Here is a single button carbon type microphone that is extremely sensitive yet that has a very good frequency response. You no longer have to put up with an insensitive "mike" to obtain good tone. The high efficiency of this new Stromberg-Carlson microphone enables reduction of amplifier gain for an equivalent degree of modulation or output volume. Available in the two models illustrated.



Full particulars on request

No. 5
\$3.95

STROMBERG-CARLSON TEL. MFG. CO.
Rochester, N. Y.

No. 6
\$12.00

EIMAC

TRANSMITTING TUBES ARE
UNSURPASSED

ON 20 METERS
750 WATTS

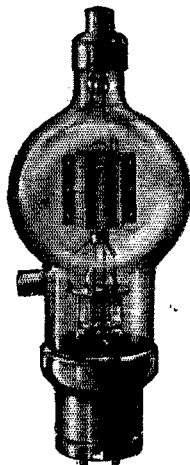

750 watts of 20 meter output with 1 KW input to a pair of EIMAC 150Ts is easily obtained without excessive grid drive or plate voltage.



EIMAC tubes are truly modern in design, construction and performance. They will be just as outstanding in 1938 rigs as they are in hundreds of 1935 transmitters.

150T—\$24.50 50T—\$13.50

AT YOUR DEALER
"COMPARE AND REFLECT"

EITEL-MCCULLOUGH, INC.
SAN BRUNO, CALIF.

To All Amateurs

WHO ARE MEMBERS OF THE

ARRL

IN GOOD STANDING

DO YOU wear an ARRL pin or button? Do you carry on your correspondence with other amateurs on ARRL member's stationery? You should — we are proud to have you as members and you should be proud to show your allegiance to the organization that has done so much for your amateur radio. These items are exclusively for you, and the pins are available with the different colored backgrounds to distinguish between various Communication's appointments.



WRITE YOUR RADIO LETTERS ON LEAGUE STATIONERY. Lithographed on 8½ x 11 heavy bond paper. *Postpaid*, 100 sheets, 50¢; 250 sheets, \$1.00; 500 sheets, \$1.75.

THE LEAGUE EMBLEM, in heavy rolled gold and black enamel, either pin or button. Special colors available for Communications Department appointees. Red background for the SCM, green background for the RM, blue background for the ORS. Red and green colors available in pin type only, blue available both in pin and button types. *Price only \$1 postpaid.*



AMERICAN RADIO
RELAY LEAGUE
West Hartford, Connecticut

I.A.R.U. News

(Continued from page 48)

tentiousness with success. The latest issue to hand, dated 15 May 1935, contains six mimeographed or multigraphed pages in which are presented an astonishing amount of technical information and society news. Our knowledge of the Scandinavian language is non-existent, but inspection and the brief services of a translator disclose that the material is authentic, detailed and interesting; since 54 issues of the "Bulletin" have already been published, Norwegian amateurs must agree with this impression. Amateurs in other countries capable of reading the Norwegian language are urged to communicate with the N.R.R.L. regarding membership, which includes the "Bulletin"; the annual dues are 5 kroner, about \$1.25, and the address is P. O. Box 2253, Oslo, Norway.

Standard Frequency Transmission

Date	Schedule	Station	Date	Schedule	Station
Jan. 4	A	W6XX	Feb. 1	A	W6XX
Jan. 11	B	W9XAN	Feb. 8	B	W9XAN
		W6XX		B	W6XX
Jan. 16	C	W9XAN	Feb. 13	C	W9XAN
Jan. 18	B	W9XAN	Feb. 15	B	W9XAN
	A	W6XX		A	W6XX
Jan. 23	BB	W9XAN	Feb. 20	BB	W9XAN
Jan. 25	BB	W6XX	Feb. 22	BB	W6XX
	A	W9XAN		A	W9XAN
Jan. 26	BX	W6XX	Feb. 23	BX	W6XX
Jan. 27	C	W6XX	Feb. 24	C	W6XX

STANDARD FREQUENCY SCHEDULES

Time (p.m.)	Sched. and Freq. (kc.)		Time (p.m.)	Sched. and Freq. (kc.)	
	A	B		BB	C
8:00	3500	7000	4:00	7000	14,000
8:08	3600	7100	4:08	7100	14,100
8:16	3700	7200	4:16	7200	14,200
8:24	3800	7300	4:24	7300	14,300
8:32	3900		4:32		14,400
8:40	4000				

Time (a.m.)	Sched. & Freq. (kc.) BX
6:00	7000
6:08	7100
6:16	7200
6:24	7300

The time specified in the schedules is *local standard time at the transmitting station*. W9XAN uses Central Standard Time, and W6XX, Pacific Standard Time.

TRANSMITTING PROCEDURE

The time allotted to each transmission is 8 minutes divided as follows:

- 2 minutes—QST QST QST de (station call letters).
 - 3 minutes—Characteristic letter of station followed by call letters and statement of frequency. The characteristic letter of W9XAN is "O"; and that of W6XX is "M."
 - 1 minute—Statement of frequency in kilocycles and announcement of next frequency.
 - 2 minutes—Time allowed to change to next frequency.
- W9XAN: Elgin Observatory, Elgin National Watch Company, Elgin, Ill., Frank D. Urie in charge.
W6XX: Don Lee Broadcasting System, Los Angeles, Calif., Harold Perry in charge.

EVERYTHING FOR THE HAM

DISTRIBUTORS

c - q
de
W5CXQ

DISTRIBUTORS

R.C.A.
Arlab
Alden
Federal
Aerovox
Mallory
Belden
Hammarlund
Clarostat
Carron
Universal

A. R. R. L. CONVENTION

AUGUST 24 & 25

NEW ORLEANS, LA.

New Orleans Radio Club Invites You As Their
Guests When in New Orleans

Call or Phone W5DKR for Information

RCA DeForest Transmitting Tubes

I.R.C.
Kester
Burgess
Sprague
Electrad
Yaxley
Turner
National
Supreme
Thordarson
I.C.A.

SHULER SUPPLY CO.

NEW ORLEANS, LA.

SERVING THE SOUTH

A REMINDER

Have you a goodly supply of ARRL Message Delivery Blanks so that when you handle traffic and deliver messages it will reflect credit on your station and on amateur radio as a whole? Have you a Message File designed to comply with the F.C.C. regulations which require that messages be kept for a period of one year?

THE MESSAGE FILE

has a compartment for each month of the year for easy and accurate filing, as well as space on the front for a complete record of traffic handled. You can't beat it for a practical solution to the problem.

40c each 3 for \$1.00

THE RADIOGRAM BLANKS

The radiogram blank has been revamped to allow for that much needed room for the body of the message and to facilitate copying of messages. 7 1/2 x 8 1/2 sheet padded 100 sheets to the pad. It will reflect credit on your station when you deliver a message on this form.

35c each 3 for \$1.00

AMERICAN RADIO RELAY LEAGUE

West Hartford, Conn.

Where to buy it

A directory of suppliers who carry in stock the products of these dependable manufacturers.

BURGESS BATTERY COMPANY
 "Chrome" protected
RADIO BATTERIES
 Look for the Black and White Stripes
 FREEPORT, ILLINOIS

ATLANTA, GEORGIA 430 W. Peachtree, N. W.
 Wholesale Radio Service Co.
 CHARLOTTE, N. C. 205 W. First St.
 Shaw Distributing Co.
 MIAMI, FLORIDA 1809 N. E. Second Ave.
 Pan American Radio, Inc.
 SAN FRANCISCO, CALIF. 1452 Market St.
 Offenbach Electric Company

Super SKYRIDER

 the hallicrafters

FORT PIERCE, FLORIDA 112 North 2nd Street
 Watkins Radio Service
 SAN FRANCISCO, CAL. 1452 Market Street
 Offenbach Electric Company
 SPOKANE, WASH. 611 First Ave.
 Spokane Radio Company

E.F. JOHNSON COMPANY
 MANUFACTURERS OF
RADIO
 TRANSMITTING EQUIPMENT
 WASECA, MINN
 U.S.A.

ATLANTA, GA. 430 W. Peachtree, N. W.
 Wholesale Radio Service Company
 COLORADO SPRINGS, COLO. 117 E. Pikes Peak Ave.
 Tel-Rad, Inc.
 LITTLE ROCK, ARK. 409 W. 3rd St.
 Beem Radio Company
 MEMPHIS, TENN. 223 So. Front St.
 Riechman-Crosby Company
 MIAMI, FLORIDA 1809 N. E. Second Avenue
 Pan American Radio, Inc.
 RENO, NEV. Arcade Building
 J. D. Mariner Music House
 SAN FRANCISCO, CAL. 1452 Market Street
 Offenbach Electric Company
 SEATTLE, WASH. 2319-2nd Avenue
 Seattle Radio Supply, Inc.
 SPOKANE, WASH. 611 First Avenue
 Spokane Radio Company, Inc.
 TEXARKANA, ARK. Mims Radio
 TULSA, OKLA. 219 S. Boulder
 Radio, Inc.

NATIONAL
 RADIO PRODUCTS 
 NATIONAL COMPANY, INC., MALDEN, MASS.

ATLANTA, GEORGIA 430 W. Peachtree Street, N. W.
 Wholesale Radio Service Company
 FRESNO, CALIFORNIA 2501 Tulare Street
 B. J. DeJarnett
 FRESNO, CALIFORNIA
 Ports Manufacturing Company
 LOS ANGELES, CALIF. 729-31 S. Main St.
 Pacific Radio Exchange, Inc.
 LOS ANGELES, CAL. 1701 S. Grand Avenue
 Radio Television & Supply Company
 MEMPHIS, TENN. 223 So. Front St.
 Riechman-Crosby Company
 MIAMI, FLORIDA 1809 N. E. Second Ave.
 Pan American Radio, Inc.
 NASHVILLE, TENNESSEE
 Braid Electric Company
 NEW ORLEANS, LA. 1700 Poydras Street
 Shuler Supply Company
 OAKLAND, CAL. 12 & Fallon Streets
 Electric Supply Company
 OKLAHOMA CITY, OKLA. 130 West 3rd Street
 Southern Sales Company
 SAN DIEGO, CAL. 744 G Street
 Coast Electric Company
 SAN FRANCISCO, CAL. 1452 Market Street
 Offenbach Electric Company
 SPOKANE, WASH. 611 First Avenue
 Spokane Radio Company

 **de Forest**
RADIO TUBES
 RCA Radiotron Division of RCA Manufacturing Co., Inc.

ATLANTA, GA. 430 W. Peachtree Street, N. W.
 Wholesale Radio Service Company
 DALLAS, TEXAS 107 So. St. Paul Street
 Southwest Radio Supply
 DALLAS, TEXAS 2503 Commerce Street
 Wilkinson Bros.
 HONOLULU, T. H. Mutual Telephone Company
 KNOXVILLE, TENN. 204 W. Clinch Ave.
 Radio & Sound Service
 LOS ANGELES, CAL. 335 N. Washington Street
 Leo J. Meyberg Company

Where to buy it

A directory of suppliers who carry in stock the products of these dependable manufacturers.

MIAMI, FLORIDA 1809 N. E. Second Ave.
Pan American Radio, Inc.

NASHVILLE, TENN.
Braid Electric Company

OAKLAND, CAL. 1020 Oak Street
E. C. Wenger Company

OKLAHOMA CITY, OKLA. 130 West 3rd Street
Southern Sales Company

PORTLAND, OREGON 17th & Irving Streets
Harper-Meggee, Inc.

SAN JOSE, CALIF. 266 South 1st St.
Coast Radio Company

SEATTLE, WASH. Republican & Terry Streets
Harper-Meggee, Inc.

SPOKANE, WASH. S. 122 Lincoln
Harper-Meggee, Inc.

SPOKANE, WASH. 611 First Avenue
Spokane Radio Company, Inc.

TULSA, OKLA. 219 S. Boulder
Radio, Inc.



**AMATEUR
RADIO
EQUIPMENT**

RCA Victor Division of RCA Manufacturing Co., Inc.

ATLANTA, GA. 430 W. Peachtree Street, N. W.
Wholesale Radio Service Company

ATLANTA, GA. 144 Walton Street, N. W.
Dixie Radio Distributors, Inc.

DALLAS, TEXAS 2503 Commerce Street
Wilkinson Bros.

MEMPHIS, TENNESSEE 223 South Front Street
Richman-Crosby Company

MIAMI, FLORIDA 1809 N. E. Second Ave.
Pan American Radio, Inc.

OKLAHOMA CITY, OKLA. 130 West 3rd Street
Southern Sales Company

PORTLAND, OREGON 33 N. Park Avenue
Stubbs Electric Company

SAN FRANCISCO, CAL. 1284 Market Street
San Francisco Radio Exchange

SAN JOSE, CALIF. 266 South 1st St.
Coast Radio Company

SEATTLE, WASHINGTON 2319-2nd Avenue
Seattle Radio Supply, Inc.

SPOKANE, WASH. 611 First Avenue
Spokane Radio Company, Inc.

TULSA, OKLA. 219 S. Boulder
Radio, Inc.

Microphone Headquarters



SHURE BROTHERS COMPANY
CHICAGO, ILLINOIS

ATLANTA, GA. 430 W. Peachtree Street, N. W.
Wholesale Radio Service Company

KNOXVILLE, TENN. 204 W. Clinch Ave.
Radio & Sound Service

LITTLE ROCK, ARK. 409 W. 3rd St.
Beem Radio Company

SAN FRANCISCO, CAL. 1452 Market Street
Offenbach Electric Company

SEATTLE, WASH. 2319-2nd Avenue
Seattle Radio Supply, Inc.

TEXARKANA, ARK. Mims Radio
Radio, Inc.

TULSA, OKLA. 219 S. Boulder
Radio, Inc.



**TRIPLET
INSTRUMENTS**

ATLANTA, GA. 430 W. Peachtree Street, N. W.
Wholesale Radio Service Company

DALLAS, TEXAS 107 S. St. Paul Street
Southwest Radio Supply

LITTLE ROCK, ARK. 409 W. 3rd St.
Beem Radio Company

MIAMI, FLORIDA 1809 N. E. Second Avenue
Pan American Radio, Inc.

SAN FRANCISCO, CAL. 1452 Market Street
Offenbach Electric Company

SPOKANE, WASH. 611 First Avenue
Spokane Radio Company

TULSA, OKLA. 219 S. Boulder
Radio, Inc.

United

TRANSMITTING TUBES

LOS ANGELES, CALIF. 731 S. Main St.
Pacific Radio Exchange, Inc.

RENO, NEVADA J. D. Mariner Music House
Arcade Building

SEATTLE, WASH. 2319 Second Avenue
Seattle Radio Supply, Inc.

SPOKANE, WASH. 611 First Ave.
Spokane Radio Company, Inc.

The New LICENSE MANUAL

WITH THE
FOLLOWING CHANGES

★ Corrected text of the amateur regulations up to date, including amendments made June 18th at the request of the Board.

★ Corrected answers to all the examination questions relating to regulations, where the same are changed by the amendments to regulations made June 18th.

★ Corrections in the text concerning permissible 'phone bands and portable privileges, as have been amended by these changes June 18th.

★ Additions to the text about licensing, to incorporate the existing arrangements in Alaska, Puerto Rico and Hawaii, the right to have code tests administered by government radiotelegraph operators; and a similar paragraph extending to cripples the right to have their material dictated or typewritten.

★ Several notable changes in the way of improved answers to questions in the Class-A 'phone examination, bringing them in line with the modern engineering concept of modulation.

★ Several other improved answers to questions appearing in the Class-B-C examinations.

IT LEAVES THE JOB COMPLETELY UP TO DATE IN EVERY RESPECT.

VALUABLE ALIKE TO THE BEGINNER AND THE ALREADY-LICENSED.

25 Cents Postpaid
(No stamps, please)

The . . . (No. 9 in the series
entitled The Radio
Amateur's Library)

AMERICAN RADIO RELAY LEAGUE

West Hartford, Connecticut

Schedules for WWV

EACH Tuesday and Friday (except legal holidays), the National Bureau of Standards station WWV will transmit on three frequencies as follows: noon to 1:00 p.m., E.S.T., 15,000 kc.; 1:15 to 2:15 p.m., 10,000 kc.; 2:30 to 3:30 p.m., 5000 kc. These emissions are accurate to better than 1 part in five million at all times and are readily useful for calibrating amateur-band frequency meters by harmonics from an auxiliary 100-kc. oscillator, as described in previous *QST* articles (June and October, 1933; February, 1934).

Calls Heard

(Continued from page 43)

w6lej w6leu w6lfg w6lhm w6lgt w6lhk w6ley w6lie w6liz
w6llw w6llx w6luj w6lun w6lvm w6sqh w6xy w6zww w7aax
w7agp w7amf w7aof w7auu w7axg w7bdr w7bdt w7bes
w7bg w7bkc w7bog w7bse w7bsu w7bve w7bzf w7cbp
w7cox w7dcb w7ddo w7dfl w7dpl w7dpl w7dal w7def
w7ejf w7ejm w7eka w7ens w7eoy w7eqx w7ett w7eyn
w7uj w7vl w8aaw w8bas w8bap w8enc w8euy w8gih w8gki
w8gul w8fcm w8icl w8ihx w8klq w8kwi w8leh w8lei w8ljd
w8muz w8aab w8acl w8agu w8afb w8bmn w8bnc w8egh
w9cmq w9dfz w9dkh w9dsx w9dzg w9edj w9efi w9efk
w9ems w9elj w9fxi w9nu w9gpc w9gqk w9hdp w9hqh
w9hql w9hqy w9hss w9huy w9io w9kas w9kbb w9kts
w9lhx w9lex w9lwe w9may w9mbl w9min w9mcr w9nvg
w9oaa w9oir w9pyk w9rns w9ryz w9rvo w9ska w9smc
w9sqz w9ta w9wu

(*Phones)

wk2bf w2abf w3bg w3wx w4ao w5aow w5yh w6agq w6ecm
w6evy w6exp w6dwl w6fca w6gql w6hkk w6hyb w6bbu
w6gk w6kk w6ya

W8JIW, H. S. Bradley, 66 Main St., Hamilton,
N. Y.

(14-mc. 'phones)

co2aj co2fg co2hy co2ja co2jm co2kc co2ll co2mg co2qy
co2ra co2rp co2se co2ww co2wz co2zf co6om co7hf ct1by
ct1gu ea4ao f8vp f8vs g2dy g2nh g2xp g3bj g5by g5ev
g5hb g5ml g5jt g5us g5vb g6vl g5yy g5yv g6ag g6dl g6gf
g6fs g6vk g6xr hb9aq hc1fg hc1iw hb5pa hi7g hi9i hp1a
la1g lulda lu4da lu8ap lu8ab lu8dr oa4b ok2ak oa4ac oa4au
ti2fg ti3av ti3wd voli volp vp3bg vp5is vp6mo vp6yb
vp9r x1aa x1ag x1g x1k x1w x2ah

W5EIP, P. B. Williams, 809 W. Ash St., Blythe-
ville, Ark.

(7-mc. c.w.)

kaius kalhr kalix om2rx om2aa f3cm f8bb f8vp ct2bk
zs6am zs2f zult zu4j celaq

(14-mc. band)

j2gx fm8bg on4gw on4fe on4au pa0dc d4ibu d4caf g2bm
g2pl g2tm g2zq g5xa g5yh g6ku g6rv g6wu ea8af ea3eg
ea4ao ea4ao ei3b f3dc f3gg ce3al ce5aa ce1ai lu7ef lu5bc
lu6dg lu2fe k6kef k6baz g6wy f8ex ct2bk

Strays

These YL's take no chances with ham-relayed messages. W3EHL received a message on February 28 from one of them. The message began: "Easter Greetings. . ."

HAM-ADS

(1) Advertising shall pertain to radio and shall be of nature of interest to radio amateurs or experimenters in their pursuit of the art.

(2) No display of any character will be accepted, nor can any special typographical arrangement, such as all or part capital letters be used which would tend to make one advertisement stand out from the others.

(3) The Ham-Ad rate is 15¢ per word, except as noted in paragraph (6) below.

(4) Remittance in full must accompany copy. No cash or contract discount or agency commission will be allowed.

(5) Closing date for Ham-Ads is the 25th of the second month preceding publication date.

(6) A special rate of 7¢ per word will apply to advertising which, in our judgment, is obviously non-commercial in nature and is placed and signed by a member of the American Radio Relay League. Thus, advertising of bona fide surplus equipment owned, used and for sale by an individual or apparatus offered for exchange or advertising inquiring for special equipment, if by a member of the American Radio Relay League takes the 7¢ rate. An attempt to deal in apparatus in quantity for profit, even if by an individual, is commercial and takes the 15¢ rate. Provisions of paragraphs (1), (2), (4) and (5) apply to all advertising in this column regardless of which rate may apply.

Having made no investigation of the advertisers in the classified columns, the publishers of *QST* are unable to vouch for their integrity or for the grade or character of the products advertised.

QUARTZ—Direct importers from Brazil of best quality pure quartz suitable for making piezo-electric crystals. Diamond Drill Carbon Co., 719 World Bldg., New York.

METTER and Microphone Repairs. Low prices. Estimates free. Quick repair service—broadcasting equipment, all electrical instruments. Sound Engineering Corp., 2200 Kinzie, Chicago.

RADIO engineering, broadcasting, aviation and police radio, servicing, marine and Morse telegraphy taught thoroughly. All expenses low. Catalog free. Dodge's Institute, Byrd St., Valparaiso, Ind.

WANTED: April 1916 *QST* with both covers. Also "Proceedings I.R.E." for 1913, parts 1 and 2; 1914, number 4; 1915, number 3. S. B. Young, "Maplewoods", Wayzata, Minn.

1000W General Electric transformers, 1100-2200-4400 each side center on 110. Sold hams right years. \$13.50. Dawson, 5740 Woodrow, Detroit.

QSLs, SWLs, A-1 stock, real prices. Samples. (stamps.) W8ESN, Toledo, Ohio.

NATIONAL—Hammarlund. Patterson used sets, 60% off list. W3DQ, 405 Delaware Ave., Wilmington, Del.

FOLDER free, crystals, \$1.50. W9DAX, Faberadio, Sandwich, Ill.

WANTED, ACR-136 receiver. W9BZC.

SACRIFICE Silver Xtal Super and new Peak Preselector bandspreaded, \$55. Need cash. W4CCB.

QSLs! QSLs! Made-to-order! Samples? Stamp. W8DED, Holland, Mich.

BLILEY crystals! Order from W8DED.

QSLs. Free samples. Printer, Corwith, Iowa.

SELL—swap. Auto radio, Vibroplex, monitor, WE212D socket, dynatron, power supply, etc. Write for list, description. W3AAJ.

SALE—300 W tube, used, \$13.00. W9AYF.

MIMEOGRAPH complete—fine condition—ink—stencils—styli—cover—three National intermediate transformers—portable typewriter. Write W3AAJ.

CRYSTAL holders while they last, 75¢, three \$2.00. lapped plates, GR plugs. Faberadio, Sandwich, Ill.

WANTED—three ten foot lengths of 3 inch diameter copper, rainin tubular spouting. Write lowest price. Phil Caralan, General Delivery, Marmarth, N. D.

QSL cards, two color, cartoons, message blanks, stationery, snappy service. Write for free samples to-day. WIBEF, 16 Stockbridge Ave., Lowell, Mass.

USED xmtr parts, power supplies, meters and tubes. First class equipment. Write for list. W9HVW, Pleasant Hill, Mo.

AUTOMOBILE call letter plates. Steel. 6"x12". Colors optional. 60¢ pair. W9AIN.

W9ADN crystals. New high activity, low temperature coefficient types. 40—\$3.25; 80—\$2.50; 80AT—\$4.00; 30—\$4.50.

QSLs, 300 one color cards, \$1. Samples. 2143 Indiana Ave., Columbus, Ohio.

QSLs, by W9DGH, 75¢ a 100, for a two color job. Postpaid. 1816 N. 5th Ave., Minneapolis, Minn.

FB7A coils 20-550 meters, inc. 20 bandspread, tubes, pack, \$35. W8EHC, 123 Elmhurst, Detroit, Mich.

SELL, dynamotor 10/350 volts. Best offer. W9IVU, Princeton, Ill.

CRYSTALS; Zero cut. Guaranteed to compensate at near zero without oven control. Your approximate frequency, 80 or 160 meters \$1.85. ½ less drift than X cut \$1.35 postpaid. Plug-in holders 75¢. Fisher Laboratory, 4522 Norwood Street, San Diego, California.

QSLs by Maleco. Finest in country, Free samples. Maleco, 1512 Eastern Parkway, Brooklyn, N. Y.

SELL surplus equipment, list. W2HKH, Charles Brand, 1063 Lafayette Ave., Brooklyn, N. Y.

QSLs, \$1. for 125. Samples and information. W8JSL, 69 Condon Ave., Buffalo, N. Y.

CRYSTALS, excellent oscillators close to specified frequency, 80-160 meters, \$1. 450-500-Kc. \$2. Blanks, 60¢. Herbert Addington, 2252 LeClaire Ave., Chicago, Ill.

WANTED—high powered transmitting equipment, tubes, Jewell meters, a.c. Pro. W8PHY.

SELL Eagle receiver. Shray, 609 Broadway, Joliet, Ill.

INTERNATIONAL Correspondence School mechanical drawing course, instruments, \$25. Shortwave receiver, 3 tube, \$10. 110 V a.c., 100W generator, \$10. Stamp for details. W8FCC, R.F.D. 1, Orland, O.

CODE course, \$15. Steven L. Gabil, Box 333, Pinconning, Mich.

SIX tube TRF receiver, coils, tubes, built-in power supply, \$20. New, unused 830, \$7.50. W8LKB, 257 E. Dewey Ave., Youngstown, Ohio.

TELEPLEXES, Omnigraphs, receivers, Vibroplexes, meters, bought, sold, traded. Ryan Radio Co., Hannibal, Mo.

PATTERSON, RME9D, Skyrider, McMurdo Silver, Sargent, Large stock Cardwells, Bliley, Sangamo, Raytheon, Sylvania, Speed-X. Trade in your receiver. Vinson Radio Company. W5VK, 2123 Broadway, Little Rock, Arkansas.

CRYSTALS: Finest quality one frequency oscillators, unconditionally guaranteed. 160-80 plus or minus 5-kc. Y \$1.25, X \$1.75, A \$2. 40 plus or minus 10-Kc. Y, \$2.50, X \$3. Wright Lab., 5859 Glenwood, Chicago, Ill.

SELL SW-3 tubes, coils twenty, forty, eighty, \$20; home-made four tube, coils, tubes, \$12. W5CQF, 819 Perdido, New Orleans, La.

CLASS B transformers—Universal for two or four 46's, 210's, 300's, RK18's, etc., \$7.75 pair postpaid. 70 watts audio from 46's, 100 watts from 10's. Write for details. W8UD, Douglas, Michigan.

CRYSTALS—1715-4000. 1" X. Within 1% specified, accuracy .03%, \$1.75. Guaranteed. Sensational holders, \$1. Ham Crystals, 1104 Lincoln Place, Brooklyn, N. Y.

CRYSTAL blanks of finest quality, all cuts. Special quantity prices. P. O. Box 164, Carlisle, Pa.

SPECIAL—One Month. 1500-1350-850 each side. 400W. Mounted. Terminal board. 32 lbs. \$7.50. Spear Mfg. Co., Waterville, Ohio.

RECEIVERS—new and used sold and traded in, as Hammarlund, National, Postal, International, etc. Schwarz Radio Service, Dumont, N. J.

SELL W.A.C. transmitter, 59 tritet, 46 buffer, 210 amplifier, 2 power supplies. Full details on request. Kenneth Bishop, W1EWD, 230 Kelsey St., New Britain, Conn.

CALLBOOKS—new Summer 1935 Radio Amateur Call Book, hundreds of late W and VE calls, important changes in prefixes, many pages of new DX QRAs, is yours for \$1.25, or one year (four issues) for \$4.00. (In foreign countries \$1.35 and \$4.35, postpaid.) W9FO-610 S. Dearborn, Chicago.

866's \$1.39; Carbon fifty-watters \$6.95; Carbon 150 watters \$17.50; Transmitters to order. Howard Radio, 5648 Race Ave., Chicago. (Telephone Austin 0177.)

CRACKLE enamel, crystals, liquid Victron, coils ACSW3, SW58, catalog. Radio Specialties, 385 Madison, Brooklyn, N. Y.

FIVE meter transceiver, \$10. Dynamotor 6/400 volt 500 milliamperes, \$15. Quartz crystals traded for radio parts. W6LSH, 1975 Navarro Ave., Pasadena, Calif.

W8GWA selling out. Stamp for list. 270A, \$25.

VIBROPLEXES, rebuilt \$5-\$7. New large base bugs, \$9. Lydeard, 28 Circuit, Roxbury, Mass.

WOLVERINE crystals—"Introduction Sale" see June and July QST Hamads. Sale closes August 31. Wolverine Crystal Service, Calumet, Mich.

IN stock: The new Breting 12 which is similar to the proposed PR-12 net \$93, tuning 9-550 meters complete with 12 tubes, 12" speaker, crystal filter, tuning meter, modulation meter. Shipped on 10 day trial. Send \$5 with order. Also all other receivers. Trade in your receiver. Henry Radio Shop, Butler, Mo.

THE Gamma Punch cuts socket holes easily and quickly in metal chassis. Two sizes—1 3/16" and 1 3/8" diameter. \$1.50 net postpaid. Gamma Mfg. Co., 907 Guaranty Bldg., Detroit, Mich.

GUARANTEED new 866s, \$1.10. Two for \$2.10. D. X. Lab., Irvington, N. Y.

50 watters, \$7.50; 203A and 854s, new. Amateur Service, Fairview, N. J.

WILL trade 160 or 80 meter crystals for tubes, meters or what have you? Bill Threm, W8FN, 4021 Davis Ave., Cheviot, Ohio.

GUARANTEED crystals. 160-80 meter, less than 1", X or Y, within ten kilocycles, \$1.35, within two kilocycles, 1", \$1.75. Rough-cut blanks, 60¢; oscillating 85¢; odds and ends five for \$1. Holders, \$1. Speedy service. William Threm, W8FN, 4021 Davis Ave., Cheviot, Ohio.

ADD that million dollar touch—relay racks. For a distinctive signal—QST specification power equipment. Edison Bs. Rectifier Engineering Service, 4837 Rockwood Rd., Cleveland, Ohio.

851s, new—used. Cardwells, 166B-1666B. 3500 volt 2.8 mf. Westinghouse oil condensers. W9TPC, 6341 Broadway, Chicago, Ill.

FOR sale—Sampson Webster three stage two fifty amplifiers. Bernard test oscillator, sixteen tube Midwest and Silver Marshall all wave receivers. Glenn Watt, Chanute, Kans.

FOR sale—Patterson PR10, \$35—Silver 5C, used 2 months, \$50. Write G. E. Rehl, W8DQY, Galion, Ohio.

HERE's class for that transmitter rack. Beautiful crystalline lacquer airdrics. No baking required. Half-pint can black or brown, 60¢ coin, special brush free. Specimen of finish and directions, 10¢. W3AAC, 38 Jefferson Ave., York, Penna. QSLs, SWLs. W6DOU, Hayward, Calif.

WHAT'S NEW in Resistors and Rheostats

Write for
Catalog 14
Just Off
the Press!

Here are twelve pages of live data and information about resistors, rheostats, potentiometers, Band-Switches, chokes, non-inductive resistors, etc. Find out about the new units which are now available for amateur use—both in transmitters and receivers. Get your copy of Catalog 14.



HIGH FREQUENCY
CHOKES

Extremely useful in five and ten meter rigs. Shown actual size. Will carry up to 1000 milliamperes without overheating. Carried in stock by your jobber.

ORMITE MFG. CO.
631 N. Albany Ave. Chicago, Ill.

★ ★ ★

We Repeat

the F.C.C. requires a record of all transmissions. Have you a separate log for your portable mobile work? You will find that a separate log will help you maintain the standards of your station in the field as you would at its base location.

40¢ each, 3 for \$1.00

★ ★ ★

**AMERICAN
RADIO RELAY LEAGUE, INC.**
WEST HARTFORD, CONN.

★ ★ ★

VALUE!

INTERNATIONAL PLATE TRANSFORMERS

Outstanding for Value. 750 and 1000 volts each side of c.t. at 300 mills. Cased completely in steel, crackle finish. Model 2000.....\$5.95 Model 3000—Same in appearance, 750-1000-1500 each side of c.t., 300 mills.....\$8.95 We know of nothing that equals the value received in these two items

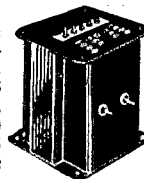

H. D. 866's.....\$1.00 | 2.5V. Fil. Trans. 12A For 66's.....\$1.25

Baldwin C. Phones.....\$2.50

Super.....\$21.60 | Peak Pre. Selector \$19.80

Amperite Velocity Mikes in Stock	15 H-250 Mill Choke \$2.50	Turner Crystal Mike \$13.50
----------------------------------	----------------------------	-----------------------------

The Super Sky-Rider.....\$69.95

Thordarson Plate Trans. 600-0-600v 200 Mill 2.5v-10A \$2.75 7.5v-3A 5v-3A	RAYTHEON TUBES RK20.....\$15.00 RK28.....38.50 RK23.....5.95 RK30.....10.95 RK34.....2.25
---	---

V.T. 203A Graphite.....\$9.00

Used Tubes RCA 860.....\$12.00 RCA 852.....14.00 WE 212D.....17.00 WE 276A.....9.00 RCA 865.....5.00 All Guaranteed	BLACK CRYSTAL PAINT AIR DRY ONE COAT 50c PER 1/4 PINT CAN
---	---

Transmitting Tubes Tested Free Any Type—Bring Them In

MAIL ORDERS FILLED—SEND MONEY ORDER
THE RADIO SHACK
46 BRATTLE STREET · BOSTON

Your Nearest Dealer Is Your Best Friend

Your nearest dealer is entitled to your patronage. You can trust him. He is equipped with a knowledge and understanding of amateur radio. He is your logical and safe source of advice and counsel on what equipment you should buy. His stock is complete. He can supply your needs without delay. His prices are fair and consistent with the high quality of the goods he carries. He is responsible to you and interested in you.

Patronize the dealer nearest you — You can have confidence in him

ALLENTOWN, PENNSYLVANIA

Radio Electric Service Co.
1024 Hamilton Street
Complete stocks transmitting equipment

BALTIMORE, MARYLAND

Radio Electric Service Co.
303 W. Baltimore Street
Everything for the amateur

BROCKTON, MASSACHUSETTS

Ware Radio Supply Co.
913 Centre Street
Hammarlund, Triplett, Ohmite, Raytheon, Bliley, Browning Kits

BUFFALO, NEW YORK

Dymac Radio
216 E. Genesee St. — Tel. Cl. 2080
Complete Stock Amateur Parts — Standard Discounts — WBAWK

BUFFALO, NEW YORK

Kronson Service Company
143 East Genesee Street
Western New York's largest wholesale distributors — W8EHF

ERIE, PENNSYLVANIA

Jordan Radio Laboratory
2512 Peach Street
Amateur, service parts, including Bliley, National, Raytheon. W8CXG

HARTFORD, CONNECTICUT

Radio Inspection Service Company
227 Asylum Street
What do you need? We have it

JACKSONVILLE, FLORIDA

Glover Weiss Co.
Radio Headquarters for Southeast
Distributors: RCA Victor, Stromberg-Carlson, Standard Ham Lines

MANCHESTER, NEW HAMPSHIRE

Radio Service Lab. of N. H.
1008 Elm Street — Tel. 218-W
Branches — Portland, Me. and Barre, Vt.

MONTREAL, CANADA

Canadian Elec. Supply Co., Ltd.
285 Craig St., W.
Quality parts and equipment for discriminating buyers

NASHVILLE, TENNESSEE

Braid Electric Co.
Ham Supplies — Replacement Parts
RCA, National, Hammarlund, and other leaders

PHILADELPHIA, PENNSYLVANIA

Consolidated Radio Corp.
612 Arch Street
Ham receivers, Transmitting tubes, Collins transmitters, etc.

PHILADELPHIA, PENNSYLVANIA

Radio Electric Service Co., Inc.
N. E. Cor. Seventh & Arch Sts.
All nationally-advertised lines in stock

PHILADELPHIA, PENNSYLVANIA

Eugene G. Wile
10 S. Tenth Street
Complete Stock of Quality Merchandise

PITTSBURGH, PENNSYLVANIA

Cameradio Company
601-3 Grant Street
"Ham" Headquarters for Pennsylvania-Ohio-W. Virginia

PROVIDENCE, RHODE ISLAND

Kraus & Company
89 Broadway
Everything for the amateur and serviceman

ROCHESTER, NEW YORK

Radio Service Shop
244 Clinton Avenue, North
Complete stock amateur-BCL parts. Standard discounts. W8NUC

SAN ANTONIO, TEXAS

Straus-Frank Company
Distributors for nationally advertised amateur products
RCA-DeForest transmitting tubes

SYRACUSE, NEW YORK

Roy C. Stage, W8IGF
Complete stock of standard Ham & BCL parts
Standard Discounts. Free technical service

WASHINGTON, D. C.

George's Radio Co.
816 F Street, N.W.
Washington's largest distributor of radio parts

WHEELING, WEST VIRGINIA

Cameradio Company
30 Twelfth Street
Complete stock of amateur Equipment at standard discounts

You Are Protected When You Buy From QST Advertisers

“Advertising for QST is accepted only from firms who, in the publisher’s opinion, are of established integrity and whose products secure the approval of the technical staff of the American Radio Relay League.”

Quoted from QST’s advertising rate card.

Every conceivable need of a radio amateur can be supplied by the advertisers in QST. And you will know the product has the approval of the League’s technical staff.

For Your Convenience

QST’S INDEX TO ADVERTISERS IN THIS ISSUE

Aerovox Corporation	72
Allen Bradley Company	95
Amperite Corporation	78
Astatic Microphone Co.	77
A.R.R.L. Application Blank	70
Bookshelf	4
Hints & Kinks	80
Lightning Calculator	73
License Manual	90
Log Book	92
Reminder	87
Special Offer	96
Supplies	86
Barr Laboratories	70
Birnbach Radio Company	79
Bliley Electric Company	75
Bud Radio, Inc.	77
Burgess Battery Company	71
Candler System Company	74
Capitol Radio Engineering Institute	76
Central Radio Laboratories	66
Cohen’s Sons, I. S.	87
Collins Radio Company	Cov. 2
Communications Products, Inc.	75
Cornell Dubilier Corporation	76
Eastern Radio Specialty Company	72
Eitel-McCullough, Inc.	85
General Electric Company	81
General Radio Company	77
Gross Radio, Inc.	67
Gulf Radio School	83
Hammarlund Mfg. Company	1
Harvey Radio Laboratories	84
Henry Radio Shop	81
Hipower Crystal Company	79
Instructograph Company	81
Leeds	79
Littelfuse Laboratories	83
Lynch, Inc., Arthur H.	77
Marine Radio Company	2, 78
Massachusetts Radio School	85
National Company	65, 71, 85, 87, Cov. 3
Offenbach Electric Company	90
Ohmite Mfg. Company	92
Port Arthur College	75
Precision Piezo Service	81
Radio Receptor Company	83
Radio Shack	92
Radio Supply Company	85
Radio Transceiver Labs.	81
Rathert Electric Company	82
RCA Institutes, Inc.	79
RCA Radiotron Company	Cov. 4
Scientific Radio Service	77
Shuler Supply Company	87
Shure Brothers Company	79
Stromberg Carlson Telephone Mfg. Co.	85
Teleplex Company	83
Thorndarson Electric Mfg. Co.	83
Triplet Electrical Instrument Co.	82
Turner Company	80
United Radio Mfg. Company	79
United Sound Engineering Co.	84
Universal Microphone Company	77
Wright-DeCoster, Inc.	74

A. C. RELAYS

Made by

Allen-Bradley

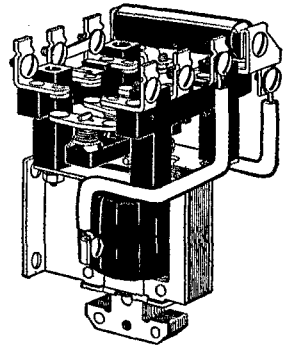
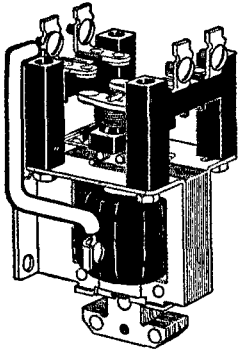

These A. C. solenoid relays are ideal for remote control of transmitters, for control of crystal ovens, and for any general remote control application except for keying. **THESE RELAYS WILL NOT OPERATE IN KEYING SERVICE.** Silver-to-silver double break contacts are used throughout.

The maximum contact rating is 10 amperes at 220 volts. The relay coils are wound for 115 volts 60 cycle alternating current. Relays for other voltages can be supplied on special order. Use coupon below when ordering.

Type No.	Poles	Normally	Circuit Diagram	Price		Type No.	Poles	Normally	Circuit Diagram	Price	
				Open	In Cab.					Open	In Cab.
A107	1	Open		\$3.50	\$4.50	A177	1	Closed		\$7.50	\$8.50
A117	1	Closed		4.50	5.50	A207	2	Open		4.00	5.00
A127	1	Open and Closed		5.00	6.00	A217	2	Closed		6.00	7.00
A137	1	Open		4.00	5.00	A227	2	Open and Closed		7.00	8.00
A147	1	Closed		5.00	6.00	A237	2	Open		4.50	5.50
A157	1	Open and Closed		5.50	6.50	A247	2	Closed		6.50	7.50
A167	1	Open		6.50	7.50			 <p>Radiostat—A stepless graphite compression rheostat for primary of 550 watt filament or plate supply transformer. Range 4 to 150 ohms. Price \$6.50</p>			

ORDER BLANK—MAIL WITH REMITTANCE TO

Allen-Bradley Co., 108 W. Greenfield Ave., Milwaukee, Wis.

Enclosed find money order for \$..... for which please send me, shipping charges prepaid, the following items:

..... for..... Volts..... Cycles

Name.....

Address.....

SPECIAL OFFER

**A Year's
Membership
in ARRL**

**A Year's
Subscription
to QST
and
The Radio
Amateur's
Handbook**

\$3.00
foreign
\$3.50

1935		AUGUST					1935	
SUN	MON	TUE	WED	THU	FRI	SAT		
				1	2	3		
4	5	6	7	8	9	10		
11	12	13	14	15	16	17		
18	19	20	21	22	23	24		
25	26	27	28	29	30	31		

DURING

Take advantage NOW of this exceptional opportunity to ally yourself with the rest of the real radio amateurs in their support of the ARRL. The ARRL protects and promotes your amateur radio interests, with its many services. Assure yourself of keeping abreast of the developments so interesting to you, through QST. It will be delivered to you monthly with its pages of developments, constructional articles, and reports of field activities. Obtain at the same time a copy of the Radio Amateur's Handbook, the standard guide book to short-wave radio, the latest edition, up to the minute, written and revised by the headquarters staff of the ARRL. It represents the best of the world's knowledge of amateur radio.

Enclosed please find \$3.00 (foreign \$3.50) for one HANDBOOK and one year's membership in the ARRL including 12 issues of QST beginning with the issue (please state whether new, renewal or extension.)

Name.....
Street or box.....
City and State.....
Call if any.....

AMERICAN RADIO RELAY LEAGUE
WEST HARTFORD, CONNECTICUT

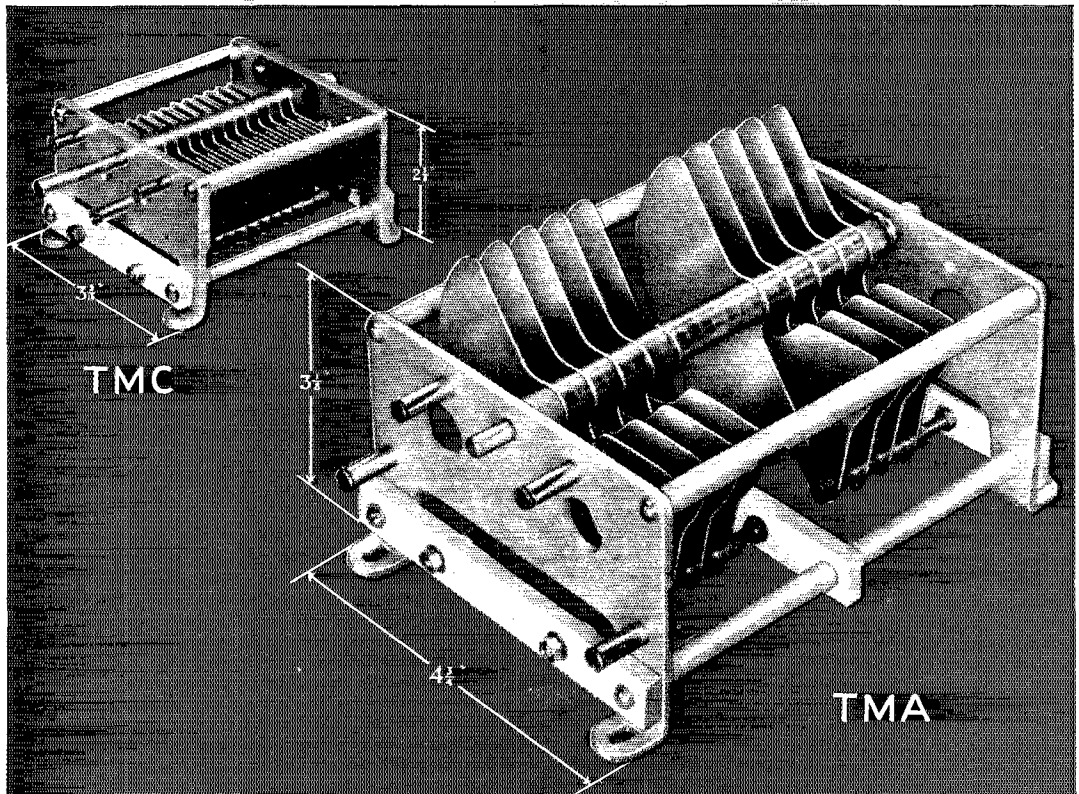

NEW AND LARGER

Newly designed, the TMA is a larger model of the popular TMC. The frame is extremely rigid and arranged for mounting on panel, chassis or stand-off insulators. The plates are of heavy aluminum with rounded and buffed edges. The front bearing is conical: rear bearing radial with single-ball thrust. Insulation is Isolantite, located outside of the concentrated field.

Unusually complete tooling on the new TMA makes possible a remarkably low price, even though its characteristics are of the same high order as the National heavy duty models.

NATIONAL COMPANY, INC., MALDEN, MASS.

Capacity	Peak V	Length	Plates	Cat. Symbol	List Price
50 Mmf.	6000	4 $\frac{9}{16}$ "	9	TMA-50A	\$6.00
100	6000	6 $\frac{7}{8}$ "	16	TMA-100A	9.00
150	6000	6 $\frac{7}{8}$ "	23	TMA-150A	11.00
230	6000	9 $\frac{5}{16}$ "	35	TMA-230A	14.50
50-50	6000	6 $\frac{7}{8}$ "	9-9	TMA-50DA	10.00
100-100	6000	9 $\frac{5}{16}$ "	15-15	TMA-100DA	16.00
300	3000	4 $\frac{9}{16}$ "	23	TMA-350	11.00
200-200	3000	6 $\frac{7}{8}$ "	16-16	TMA-250D	13.50

Presenting The RCA-838 Transmitting Tube

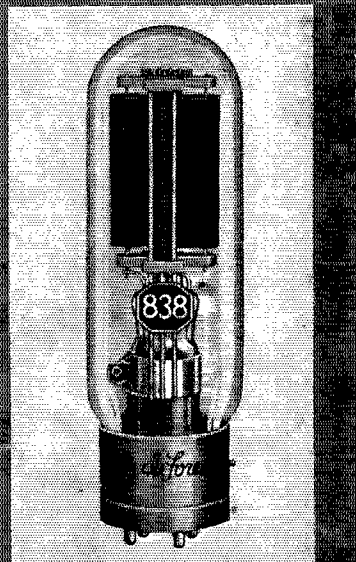

Amateurs' and Experimenters' Net Price, \$18.00

The new RCA-838 offers such outstanding advantages as:

- Zero-bias operation as a Class B Modulator; output (2 tubes) approximately 260 watts with less than 5% distortion.
- Suitable for use in Class B and Class C radio-frequency Service; approximate output in keyed Class C Service, 130 watts.
- Well adapted for grid-leak-bias operation in Class C Service, since plate current drops to safe value if grid excitation is accidentally removed.
- May be used at maximum ratings for frequencies up to 30 megacycles.
- Has maximum plate dissipation rating of 100 watts.

Your RCA deForest Distributor can supply you with the new RCA-838.



For complete technical information, write to:

AMATEUR RADIO SECTION

RCA RADIOTRON DIVISION

RCA MANUFACTURING CO., INC., CAMDEN, N. J.