

QST

July, 1935

25 cents

devoted entirely to

amateur radio

In this issue—

Equipment

for the

Portable

Station



COLLINS SERIES 12 SPEECH EQUIPMENT

High Fidelity

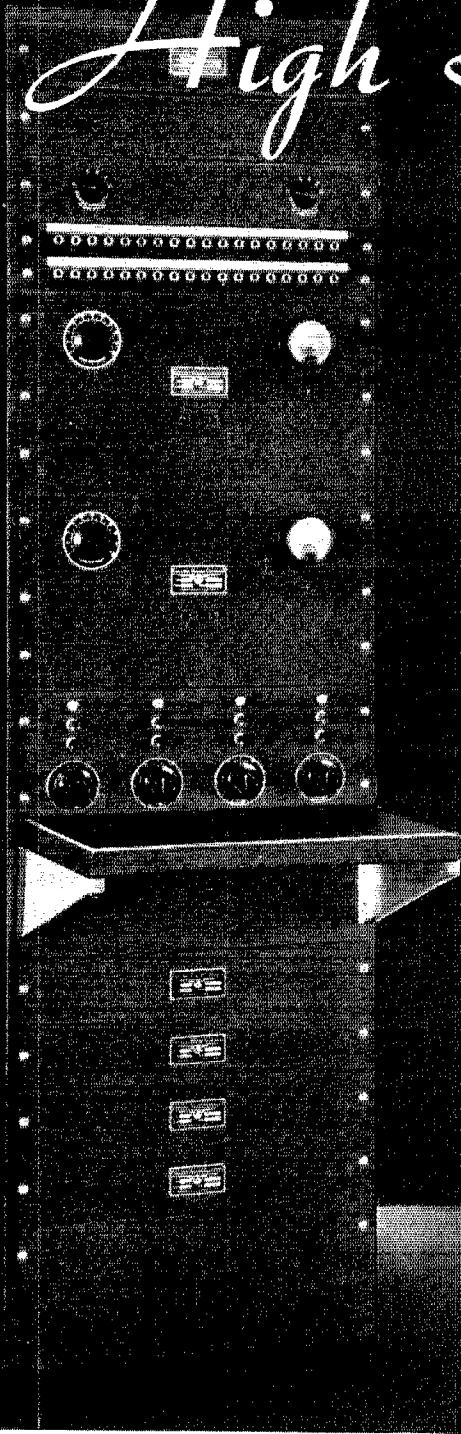

Complimentary copies of the new Collins Catalog entitled "High Fidelity Speech Equipment" are being mailed to all Broadcasting Stations in the United States. Additional copies will be sent gladly. Please enclose ten cents with your request to cover the cost of mailing.



Frequency Response: Plus or minus one decibel from 30 to 10,000 cycles per second.

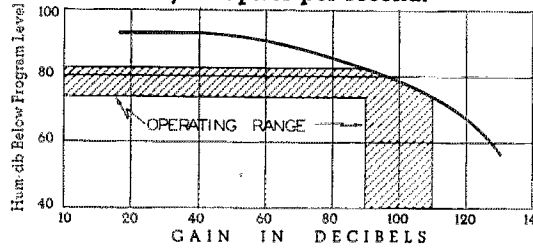

Residual Hum: Minus 65 decibels below program level.

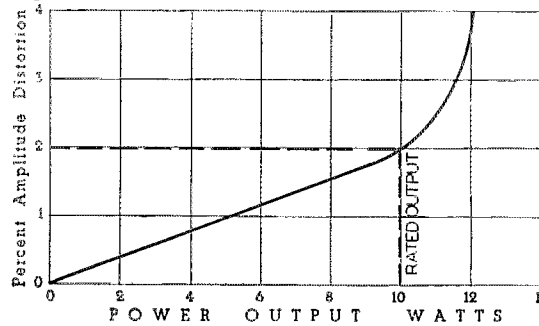

Harmonic Distortion: Less than 3 percent at plus 32 decibels. (Zero reference: 6 milliwatts).

The Collins' Series 12 speech equipment meets an urgent demand for fine high-fidelity studio amplifying and control equipment, possessing the additional feature of complete a. c. operation, easy installation and utmost flexibility. The standard arrangements comprise the apparatus necessary to control various microphones, phonograph pickups, telephone lines, etc. and to amplify their outputs sufficiently to feed a program line or the modulators of a radio transmitter.

Collins Radio Company

CEDAR RAPIDS
New York Office



IOWA, U. S. A.
11 West 42nd S

Continuously VARIABLE SELECTIVITY

Without Affecting Tuning

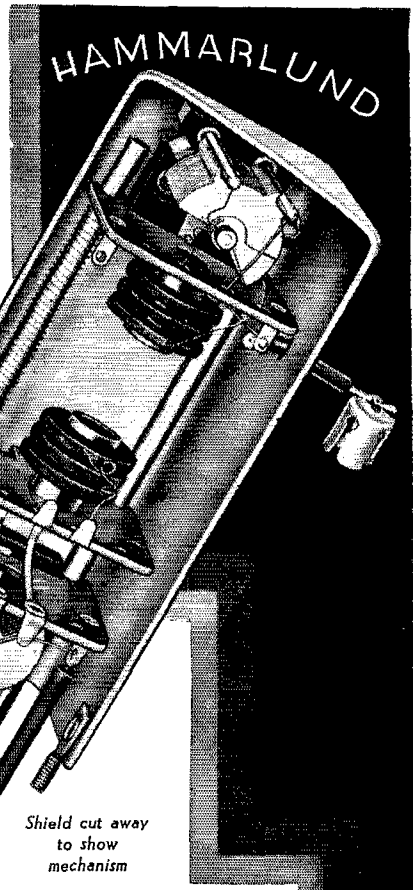
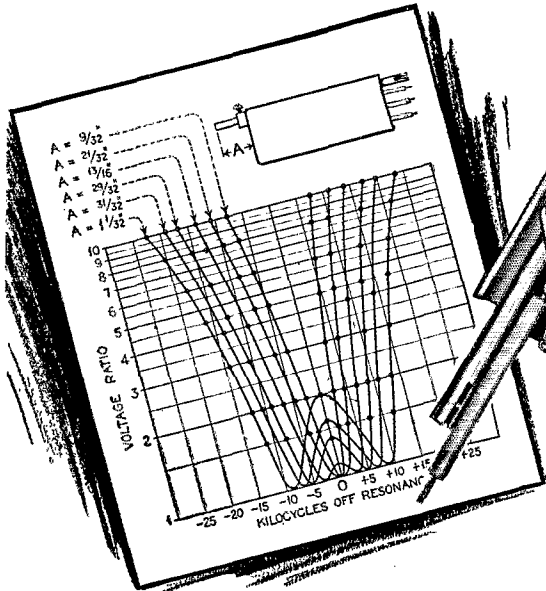

Shield cut away to show mechanism

ANY range of coupling variation may be obtained in this new Hammarlund I.F. Transformer from approximately one-third critical coupling to three times critical coupling.

This means that your I.F. amplifier can be adjusted from needle-sharp selectivity to the flat-top curve required for high fidelity, or any degree of selectivity between — all with a mere twist of a panel knob — all without affecting tuning characteristics of the receiver.

The diagram illustrates the coupling range of a single transformer. Additional transformers having this feature will obviously increase the overall selectivity of the I.F. amplifier.

The variable coupling mechanism for panel control of up to four of these transformers is now available for the COMET "PRO" and other superheterodynes. Or, if preferred, the coupling in each transformer may be fixed at any desired point.

We believe this new transformer feature provides the greatest single improvement in receiver flexibility in recent years.

Transformers available for 465 kc. or 175 kc. List price, \$5.50 each. Variable-coupling mechanism for panel control of up to four transformers, \$2.50 list.

Mail Coupon for Complete Details and General Catalog



Canadian Office:
41 West Avenue North
Hamilton, Ontario

For Better Radio
Hammarlund
PRECISION
PRODUCTS

HAMMARLUND MANUFACTURING CO.

424-438 W. 33rd St., New York

- Check here for details of new Variable-Coupling I.F. Transformer.
- Check here for New General Catalog.

Name

Address

..... Q-7

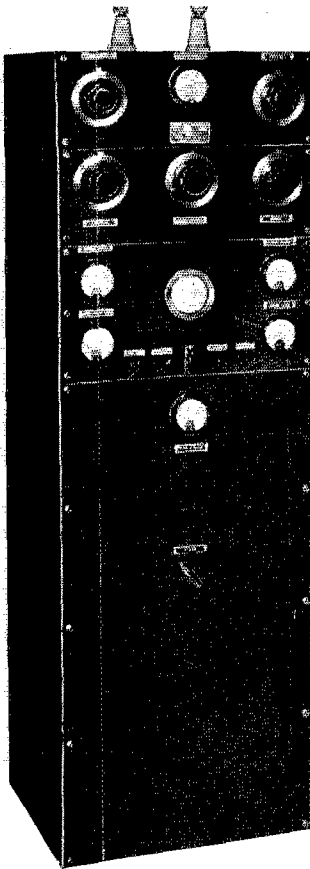

Outstanding IN **PERFORMANCE**
QUALITY
APPEARANCE

MARINE 140-B

WITH BUILT-IN

CATHODE RAY OSCILLOSCOPE

and many other exclusive "MARINE" features

CABINET—The MARINE 140-B transmitter is housed in a steel broadcast station type cabinet rack with detachable hinged rear door and is finished in a baked wrinkled enamel. The Bakelite panel finish is optional. Gloss (illustrated), satin or wrinkled may be had.

DIMENSIONS:

60" high, 19½" wide, 15" deep.

HIGH FIDELITY AUDIO CHANNEL

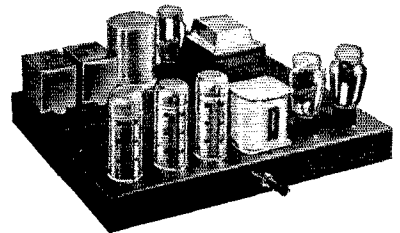

The four stage speech amplifier has a frequency response of 30 to 10,000 cycles, + or - 1½ D.B., with a gain of 125 D.B. which makes it ideally suited for use with a Crystal microphone.

HEAVY DUTY POWER SUPPLIES

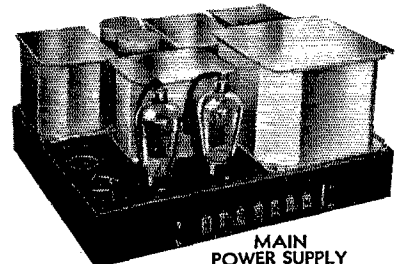

MAIN POWER SUPPLY
NOTE DUAL SECTION FILTERS

CATHODE RAY OSCILLOSCOPE — Acts as a visual distortion and modulation percentage indicator ● **POWER OUTPUT** — Conservative rating 100 watts. Actual output 100 to 130 watts, 100% modulated ● **KEYING IN CRYSTAL STAGE** — Permitting simple effective Break-in system ● **PERMANENT NEUTRALIZATION** — The transmitter is permanently neutralized at the plant before leaving. Changing from one band to another or using different antennas will have absolutely no effect on the neutralization ● **SELF CONTAINED BIAS SUPPLIES** — No batteries of any kind ● **ANTENNA MATCHING NET WORK** — Efficiently matches any type of antenna ● **AUTO TRANSFORMER** — Tapped in 5 volt steps from 90 to 130 volts to accommodate various line voltages ● **ONE-YEAR UNCONDITIONAL GUARANTEE** ● **DESCRIPTIVE LITERATURE** — Send stamp for descriptive folder with detailed information and photographs. You will be astounded at what we are offering at such an extremely moderate price.



GENERAL OFFICES AND PLANT
124-11 - - 101st Avenue
RICHMOND HILL, N. Y.
Telephone: Cleveland 3-2400

MARINE RADIO
C O M P A N Y

EXPORT DEPARTMENT
15 LAIGHT STREET
NEW YORK, N. Y.
Cable Address: "Arlab"

QST

Published monthly, as its official organ, by the American Radio Relay League, Inc., at West Hartford, Conn., U. S. A.; Official Organ of the International Amateur Radio Union

devoted entirely to

AMATEUR RADIO

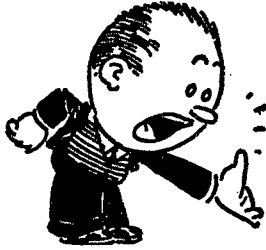

Editorials	9
Coming Amateur Examinations for Amateur Operator License	10
Design for Higher Performance in the Super-Regenerative Receiver G. W. Fyler, W2HLM	11
Radio Equipment of General Utility H. A. Robinson, W3LW	15
A Four-Band Exciter J. Herbert Hollister, W9DRD	21
A Genemotor Crystal-Controlled Portable Using 6-Volt Tubes F. Waddingham, W6EQL	23
An Experimental Station on Wheels H. Selvidge, W9BOE	25
What the League Is Doing	26
New High-Power Transmitting Pentode	28
A Complete Battery-Operated Portable Station E. S. Van Deusen, W3ECP	30
W1XR Alexander A. McKenzie, W1BPI-1XR	33
Data on the Metal-Shell Receiving Tubes	35
Hamdom	36
Further Controlled-Carrier 'Phone Systems	37
Silent Keys	38
San Diego Radio Fiesta	39
A Burlesque M. L. Connes	40
With the Affiliated Clubs	42
'Phone-C.W. Contest Results	44
Vacuum-Tube Voltage Regulators W. F. Priest, W7ERT and D. H. Olney, W7BTA	46
Experimenters' Section	
IMPROVING DETECTOR STABILITY — REDUCING POWER — A GARAGE-TOP MAST — R. F. INDICATORS FOR U. H. F. —	48
I.A.R.U. News	51
Operating Notes	53
Correspondence Department	67
A.R.R.L. QSL Bureau	84
Standard Frequency Transmissions	84
Hamads	91
QST's Index of Advertisers	94

JULY
1935

VOLUME XIX
NUMBER 7

Kenneth B. Warner (Secretary, A.R.R.L.), Editor-in-Chief and Business Manager; Ross A. Hull, Associate Editor; James J. Lamb, Technical Editor; George Grammer, Assistant Technical Editor; Clark C. Rodimon, Managing Editor; David H. Houghton, Circulation Manager; F. Cheyne Beekley, Advertising Manager; Ursula M. Chamberlain, Assistant Advertising Manager.

Editorial and Advertising Offices
38 La Salle Road, West Hartford, Conn.

Subscription rate in United States and Possessions and Canada, \$2.50 per year, postpaid; other countries, \$3.00 per year, postpaid. Single copies, 25 cents. Foreign remittances should be by international postal or express money order or bank draft negotiable in the U. S. and for an equivalent amount in U. S. funds.

Entered as second-class matter May 29, 1919, at the post office at Hartford, Connecticut, under the Act of March 3, 1879. Acceptance for mailing at special rate of postage provided for in section 1103, Act of October 3, 1917, authorized September 9, 1922. Additional entry at Concord, N. H., authorized February 21, 1929, under the Act of February 28, 1925.

Additional second-class entries to cover sectional editions authorized March 20, 1935

Copyright 1935 by the American Radio Relay League, Inc.
Title registered at United States Patent Office.

SPECIAL OFFER

To
Readers
of
QST

1935		JULY					1935	
SUN	MON	TUE	WED	THU	FRI	SAT		
	1	2	3	4	5	6		
7	8	9	10	11	12	13		
14	15	16	17	18	19	20		
21	22	23	24	25	26	27		
28	29	30	31					

DURING

Take advantage **NOW** of this exceptional opportunity to ally yourself with the rest of the real radio amateurs in their support of the ARRL. The ARRL protects and promotes your amateur radio interests, with its many services. Assure yourself of keeping abreast of the developments so interesting to you; through *QST*. It will be de-

The American Radio Relay League

38 LaSalle Road

West Hartford, Connecticut

Say You Saw It in *QST* — It Identifies You and Helps *QST*

A Year's Membership in ARRL

A Year's Subscription to *QST* and The Radio Amateur's Handbook

\$ 3.00
foreign
\$3.50

1935		AUGUST					1935
SUN	MON	TUE	WED	THU	FRI	SAT	
				1	2	3	
4	5	6	7	8	9	10	
11	12	13	14	15	16	17	
18	19	20	21	22	23	24	
25	26	27	28	29	30	31	

DURING

livered to you monthly with its pages of developments, constructional articles, and reports of field activities. Obtain at the same time a copy of the Radio Amateur's Handbook, the standard guide book to short-wave radio, the latest edition, up to the minute, written and revised by the headquarters staff of the ARRL. It represents the best of the world's knowledge of amateur radio.

Enclosed please find \$3.00 (foreign \$3.50) for one HANDBOOK and one year's membership in the ARRL including 12 issues of *QST* beginning with the issue (please state whether new, renewal or extension.)

Name.....
Street or box.....
City and State.....
Call if any.....



W4KM Introduces the New BURGESS Z-30-P

In the photograph above, W4KM—E. T. Kinkade, Burgess Representative in Florida—introduces you to the Z30P, new BURGESS "B" Battery. Mr. Kinkade is a well known amateur. As W4KM he has made hundreds of friends, particularly in the South. We'll let him tell you about the Z30P.

"This new battery is going to be mighty popular with amateurs and engineers. Why, just read the specifications of the portable

Z30P: HEIGHT 3", WIDTH 3 3/8", DEPTH 2 1/4"
WEIGHT 1 LB., 1 OZ. And full 45 Volts!

"To build so much power into such small space, BURGESS used 30 No. Z cells—the size we use in pen-lite batteries! Just look at the Z30P next to a standard size 'B'. You can see why thousands will be used in small amplifiers, in portable transceivers, by amateurs, engineers and experimenters." Order the Z30P from your dealer or write the BURGESS BATTERY CO., Freeport, Ill.

≡ BURGESS ≡

Section Communications Managers of the A.R.R.L. Communications Department

All appointments in the League's field organization are made by the proper S.C.M., elected by members in each Section listed. Mail your S.C.M. (on the 16th of each month) a postal covering your radio activities for the previous 30 days. Tell him your DX, plans for experimenting, results in 'phone and traffic. He is interested, whether you are an A.R.R.L. member or get your QST at the newsstands; he wants a report from every active ham. If interested and qualified for O.R.S., O.P.S. or other appointments he can tell you about them, too.

Eastern Pennsylvania Maryland-Delaware-District of Columbia Southern New Jersey Western New York Western Pennsylvania	W3GS W3BAK W3ZX W8DSP W8CUG	ATLANTIC DIVISION Jack Wagenseller Edgar L. Hudson Carroll D. Kentner Don Farrell C. H. Grossarth	26 Meadowbrook Ave. 1107 Park Ave. 213 Hickok Ave. R. F. D. 3, Eicher Rd.	Llanerch, Upper Darby Laurel, Delaware Collingswood Syracuse Engeworth, Bellevue, Pa.
Illinois Indiana Kentucky Michigan Ohio Wisconsin	W9WR W9TE W9AUH W8DYH W8CIB W9FSS	CENTRAL DIVISION Fred J. Hinds Arthur L. Braun G. W. Mossbarger Kenneth F. Conroy Robert W. Rabin Harold H. Kurth	6618 West 34th St. 5211 Brookville Rd. Box 177 7538 E. Robinwood Ave. 5308 Northcliffe Ave. 631 State St.	Berwyn Indianapolis Camp Taylor Detroit Cleveland Madison
North Dakota* South Dakota Northern Minnesota Southern Minnesota	W9OEL W9PFI W9OMI W9DEI	DAKOTA DIVISION Hartwell B. Burner Mike G. Strahon R. L. Rode Francis C. Kramer	601 S. Grange Ave. W. Bluff St.	Hope Sioux Falls White Bear Lake St. Charles
Arkansas Louisiana Mississippi Tennessee	W5ABI W5DWV W5CWO W4BBT	DELTA DIVISION H. E. Velfe W. J. Wilkinson, Jr. J. H. Weems, Jr. Merrill B. Parker, Jr.	2918 West 15th St. 1624 Allen Ave. P. O. Box 244 1912 Oak St.	Little Rock Shreveport State College Chattanooga
Eastern New York N. Y. C. & Long Island Northern New Jersey	W2LJ W2AZV W2FOP	HUDSON DIVISION Robert E. Haight E. L. Baunach Charles J. Hammersen	1080 Helderberg Ave. 7823 10th Ave. 92 Claremont Ave.	Schenectady Brooklyn Verona
Iowa Kansas Missouri Nebraska	W9LEZ W9FLG W9EYG-JPT W9FAM	MIDWEST DIVISION Phil D. Boardman O. J. Spetter C. R. Cannady Samuel C. Wallace	325 Kirkwood Blvd. 305 Western Ave. Broadway at Ninth Green St.	Davenport Topeka Monett Clarke
Connecticut Maine Eastern Massachusetts Western Massachusetts New Hampshire Rhode Island Vermont	W1CTI W1CDX W1ASI W1BVR W1AVJ W1HRC W1ATF	NEW ENGLAND DIVISION Frederick Ellis, Jr. John W. Singleton Joseph A. Mullen Ceryc C. Noble Robert Byron Clayton C. Gordon Harry Page	19 Merrill Rd. 73 Allen St. 218 Jamaica way 37 Broad St. 12 Humphrey St. 206 California Ave. R. 1	Norwalk Wilton Jamaica Plain Westfield Concord Providence Hinesburg
Alaska Idaho Montana Oregon Washington	K7PO W7NH W7AAT W7AMF W7AYO	NORTHWESTERN DIVISION Richard J. Fox Nellie H. Hart O. W. Viers Frank L. Black Stanley J. Belliveau	Box 301 Box 6 Box 265 1502 McPherson St. Route 7, Box 387	Ketchikan Twin Falls Red Lodge North Bend Yakima
Hawaii Nevada Los Angeles Santa Clara Valley East Bay San Francisco Sacramento Valley Arizona Philippines San Diego San Joaquin Valley	K6EWO W6EAD W6BPU W6BMW W6ITV W6SVC W6DVE W6BVI-W6CC KA1XA W6EOP W6FFP	PACIFIC DIVISION Atlas O. Adams Kenton L. Ramsay Howell C. Brown Charles J. Camp Harold J. Burchfield Alan D. Whittaker, Jr. Geo. L. Woodington Ernest Mendoza Newton E. Thompson Harry A. Ambler Clyde C. Anderson	21st Infantry Brigade 1151 Buena Vista Ave. 120 N. El Molino Ave. 318 Hawthorne Ave. 2940 106th Ave. 78 Elinor Ave. 716 Redwood Ave. 1434 East Madison St. P. O. Box 849 4101 Hamilton St. 931 Orange Ave.	Schofield Barracks Reno Pasadena Palo Alto Oakland Mill Valley North Sacramento Phoenix Manila, P. I. San Diego Fresno
North Carolina Virginia West Virginia	W4QC W3BRV W8HD	ROANOKE DIVISION H. S. Carter Neil E. Henry C. S. Hoffmann, Jr.	115 Crafton St. 1017 Knight St. 57 Lynwood Ave.	Winston-Salem Lynchburg Wheeling
Colorado Utah-Wyoming	W9FA W6GQC	ROCKY MOUNTAIN DIVISION Glen Glasscock Arty W. Clark	1171 Detroit St. 260 So. 9th West	Denver Salt Lake City, Utah
Alabama Eastern Florida Western Florida Georgia-So. Carolina-Cuba- Isle-of-Pines-Porto Rico- Virgin Islands	W4KP W4BCZ W4MS W4CE	SOUTHEASTERN DIVISION L. D. Elwell Philip A. McMasters Edward J. Collins Bannie L. Stewart	1066 Waverly St. 731 Arlington Ave. 1517 East Brainerd St. SC. P53. C.C.C. Camp Lawrence	Tarrant St. Petersburg Pensacola Effingham, S. C.
Northern Texas Oklahoma Southern Texas New Mexico	W5BII W5CEZ W5ADZ W5CGJ	WEST GULF DIVISION Richard M. Cobb Carter L. Simpson Bradfield A. Beard Joseph M. Eldodt	Box 185 2010 So. 4th St. 2030 Quenby Road	Dodd City Ponca City Houston Chamita
Maritime	VE1DQ	MARITIME DIVISION A. M. Crowell	69 Dublin St.	Hallfax, N. S.
Ontario	VE3GT	ONTARIO DIVISION S. B. Trainer, Jr.	4 Shorncliffe Ave.	Toronto
Quebec	VE2EE	QUEBEC DIVISION Stan Comach	780 Brault Ave.	Verdun, P. Q.
Alberta British Columbia	VE4GD VE5AC	VANALTA DIVISION J. Smalley, Jr. R. K. Town	611 1st Ave., N. W. 1754 Graveley St.	Calgary Vancouver
Manitoba Saskatchewan	VE4BG VE4EL	PRAIRIE DIVISION A. J. R. Simpson Wilfred Skafie	71 Thelmo Mansions 2040 McTavish St.	Winnipeg Regina

* Officials appointed to act until the membership of the Section choose permanent S.C.M.'s by nomination and election.

The American Radio Relay League



• **T**HE AMERICAN RADIO RELAY LEAGUE, INC., is a non-commercial association of radio amateurs, bonded for the promotion of interest in amateur radio communication and experimentation, for the relaying of messages by radio, for the advancement of the radio art and of the public welfare, for the representation of the radio amateur in legislative matters, and for the maintenance of fraternalism and a high standard of conduct.

It is an incorporated association without capital stock, chartered under the laws of Connecticut. Its affairs are governed by a Board of Directors, elected every two years by the general membership. The officers are elected or appointed by the Directors. The League is non-commercial and no one commercially engaged in the manufacture, sale or rental of radio apparatus is eligible to membership on its board.

"Of, by and for the amateur," it numbers within its ranks practically every worth-while amateur in the nation and has a history of glorious achievement as the standard-bearer in amateur affairs.

Inquiries regarding membership are solicited. A bona fide interest in amateur radio is the only essential qualification; ownership of a transmitting station and knowledge of the code are not prerequisite. Correspondence should be addressed to the Secretary.

DIRECTORS

President
HIRAM PERCY MAXIM.....W1AW
Box 216, Hartford, Conn.

Vice-President
CHARLES H. STEWART.....W3ZS
St. David's, Pa.

Canadian General Manager
ALEX REID.....VE2BE
169 Logan Ave., St. Lambert, P. Q.

Atlantic Division
EUGENE C. WOODRUFF.....W8CMP
234 W. Fairmount Ave., State College, Pa.

Central Division
EDWARD A. ROBERTS.....W8HC
2699 Endicott Rd., Shaker Heights, Cleveland

Dakota Division
CARL L. JABS.....W9BVH
1822 James St., St. Paul, Minn.

Delta Division
M. M. HILL.....W5EB
P. O. Box 14, Natchitoches, La.

Hudson Division
KENNETH T. HILL.....W2AHC
115 Willow St., Douglaston, L. I., N. Y.

Midwest Division
H. W. KERR.....W9DZW-W9GP
Little Sioux, Iowa

New England Division
G. W. BAILEY.....W1KH
74 Webster Road, Weston, Mass.

Northwestern Division
RALPH J. GIBBONS.....W7KV
3933 N. E. 76th Ave., Portland, Ore.

Pacific Division
S. G. CULVER.....W6AN
2962 Russell St., Berkeley, Calif.

Roanoke Division
H. L. CAVENESS.....W4DW
State College Station, Raleigh, N. C.

Rocky Mountain Division
RUSSELL J. ANDREWS.....W9AAB
1867 So. Lafayette St., Denver, Colo.

Southeastern Division
BENNETT R. ADAMS, JR.....W4APU
1512 Grove Place, Homewood, Ala.

West Gulf Division
WAYLAND M. GROVES.....W5NW
c/o Humble Pipe Line Co., Neches, Texas

OFFICERS

President.....HIRAM PERCY MAXIM, W1AW
Hartford, Connecticut

Vice-President.....CHARLES H. STEWART, W3ZS
St. David's, Pennsylvania

Secretary.....KENNETH B. WARNER, W1EH
West Hartford, Connecticut

Treasurer.....ARTHUR A. HEBERT, W1ES
West Hartford, Connecticut

Communications Mgr....F. EDWARD HANDY, W1BDI
West Hartford, Connecticut

General Counsel.....PAUL M. SEGAL, W3EEA
1010 Shoreham Building, Washington, D. C.

Address all general correspondence to the executive headquarters at West Hartford, Connecticut

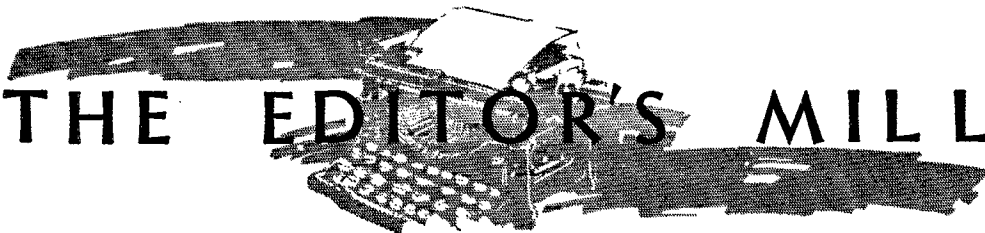

THE EDITOR'S MILL

IT WOULD be a sad mistake for amateur radio to get the idea that the problem of securing more frequencies at Cairo is going to be a push-over, that all we have to do is demand loudly enough and the frequency fences will tumble. Realizing that any rational examination of our problem will be misconstrued in some quarters, still we think it will be helpful for us to look at some of the hurdles that must be hurdled before we find ourselves in the Elysian fields on the other side of the fence.

If only the eighty nations of the world wanted to give us more frequencies, they could do it all right. They could apply some modern engineering to their allocation structure, make more room, move a few hundred fixed stations, and we would be all set. Trouble is they're not going to want to do this, and something more than simple requests or demands will be necessary. Reason for their reluctance is that, in the absence of an engineering plan that makes more channels, they won't know where to put their moved stations. In a note in our last issue we described the conditions obtaining in the high-frequency fixed-service bands. Each one of these stations grimly holds on to its frequency for dear life, because every similar frequency has a station notified on it, priority claimed and all that sort of complication. When any amateur listens to these bands at his own location at any given time, what he mostly encounters is silence, but as a matter of fact there is a surprising number of registrations on the books. A few figures may be interesting. In the fixed-service region between 6000 and 8000 kc., not counting our band, there are approximately 1900 fixed stations registered, with an average density of one every 1.11 kc. From 7300 kc. to and including 7500 kc. there are about 260, an even greater density; and this region also includes some channels used in various countries for the aeronautical and meteorological services, experimental stations and government stations, with a relatively large number of stations on each such frequency. This whole question of international allocation is bughouse. It is more responsive to international politics and jealousies than it is to engineering, and it would take a super World Court to adjudicate its complex irrationalities. Some of the stations notified have never been put in commission and ought not to have the right to obstruct a going station, but such is the international complexity of the problem, such its delicacy

and touchiness, that a better plan has never been worked out. Perhaps a better one will by the time of the Cairo meeting. So long as the world observes the principle that the first notifier has a prior right, regardless of his importance or the date that he actually gets into operation, progress will be very difficult.

Now let no one misunderstand us: The A.R.R.L. is going after more frequencies at Cairo and a committee of our Board has the question under detailed study right now. We cite the above things because it seems to us that there is no proper appreciation of the difficulties and magnitude of the problem, too much of the feeling that it is as simple as "ask and ye shall receive."

There is an amateur movement being started to get more frequencies at Cairo by an action addressed to the Congress of the United States. This country is in an unsettled political condition and strange things happen in Washington politics, perhaps stranger than this. Perhaps it can be done that way; just because this magazine doesn't at this time see how, we're not going to say it can't. Congress of course controls the situation in the United States, because it makes our laws, but we don't need their help with respect to United States laws because our regulations already give us every kilocycle that international treaties permit. Under normal conditions the basic concept of going to Congress for an international action certainly would be fallacious. While the past is no reliable guide to the future, we don't suppose the Congress ever "instructed" a delegation to an international conference—any more than it instructs armies when it sends them to war; it declares war but the executive branch of the government carries on the war. The executive branch of the government also negotiates treaties, decides what it wants to stand for, picks its own delegation and does the instructing. A campaign of education or pressure might much better be directed at the executive arm. Of course treaties may be ratified only with the consent of the Senate, and amateur radio always has available the ability to intercede and probably to prevent the adoption of an unfair treaty. It is even conceivable in this day and time that a senate might make an advance pronouncement of what it would or would not ratify. But unfortunately the rejection of an unsatisfactory treaty by this country alone does not result in the existence of a satisfactory one.

This particular problem is just one aspect of the Cairo question and it is one which is going to be studied in all its potentialities by the A.R.R.L. Cairo Committee and its experts. Our A.R.R.L. is our own organization and it is the only voice through which we American amateurs may expect to be heard successfully. Upon A.R.R.L. and it alone rests the responsibility for carrying out this Cairo job. If there are things that can be accomplished via the Congress they will without doubt be part of our Board's plan. That is to say,

if the idea is any good, your own organization can be counted on to employ it as part of a coordinated whole. Spurious attempts by commercial magazine publishers who are not the voice of organized amateur radio and idle chatter on the part of armchair diplomats affect the actual situation not one whit except possibly by making the A.R.R.L. job harder. Positively we've got to pull together in this thing. Let us QRX until the Cairo Committee reports its plan.

K. B. W.

Coming Examinations for Amateur Operator License

FOLLOWING is a complete schedule of all examinations for amateur operator license to be held by the F.C.C. during July, August and September. All examinations begin promptly at 9:00 a.m. local time. *Examinations are not held on national holidays.* Where dates or exact addresses are not shown, write the Inspector in Charge at the district headquarters as noted.

Washington, D. C., 7333 I.C.C. Bldg., every Thursday.

Boston, 7th floor, Customhouse, daily except Thursdays.

New York, 1024 Federal Bldg., 641 Washington St., every Tuesday, Thursday and Saturday.

Troy, N. Y., sometime in September. Details from New York office.

Philadelphia, 1200 New U. S. Customhouse, every Wednesday.

Baltimore, Ft. McHenry, every Wednesday and Saturday.

Norfolk, 402 New Post Office Bldg., every Friday.

Winston-Salem, N. C., August 2nd and 3rd. Details from Norfolk office.

Atlanta, 411 New Post Office Bldg., every Tuesday and Friday.

Nashville, August 16th. Details from Atlanta.

Miami, 12 New Federal Bldg., daily by appointment.

New Orleans, 326 Customhouse, every Tuesday.

Galveston, 209 Prudential Bldg., daily by appointment.

Dallas, 464 Federal Bldg., every Tuesday and Friday.

Oklahoma City, sometime in August. Details from Dallas.

Albuquerque, N. M., sometime in August. Details from Dallas.

San Antonio, sometime in September. Details from Dallas.

Los Angeles, 1105 Rives-Strong Bldg., every Monday and Saturday.

San Francisco, 328 Customhouse, every Monday.

Portland, Ore., 207 New U. S. Courthouse, every Friday.

Seattle, 808 Federal Office Bldg., every Friday.
Denver, 538 Customhouse, first and third Saturdays of each month.

Salt Lake City, sometime in September. Details from Denver office.

St. Paul, 927 New Main P. O. Bldg., first Saturday of each month.

Bismarck, N. D., sometime in August. Details from St. Paul office.

Kansas City, Mo., 410 Federal Bldg., first and third Saturdays of each month.

St. Louis, August 23rd and 24th. Details from Kansas City office.

Des Moines, July 26th and 27th. Details from Kansas City office.

Chicago, 2022 Engineering Bldg., every Saturday.

Detroit, 1025 New Federal Bldg., every Saturday.

Cincinnati, sometime in August. Details from Detroit.

Columbus, Ohio, sometime in September. Details from Detroit.

Cleveland, sometime in July. Details from Detroit.

Buffalo, 514 Federal Bldg., last Friday of each month, and by appointment.

Pittsburgh, September 19th, 20th, 21st. Details from Buffalo.

Honolulu, Aloha Tower, every Monday and Saturday.

Strays

The Navy is getting a great new long-wave transmitter for NSS. In the factory where it was fabricated it has been set up for test. The front panel is of aluminum, perhaps 10 feet high and getting on to 80 feet long. Throughout its length the bottom 3 feet or so of this panel is occupied by wheels, switches, gadgets, but the huge top expanse is blank. Now there are hams in this factory, as in any. One morning recently when the crew came to work they found that some ham's instinct had got into operation, for the blank top portion of the huge panel carried a large sign: "This space for QSL cards."

Design for Higher Performance in the Super-Regenerative Receiver

Details and Characteristics of a New-Type Three-Tube U.H.F. Circuit

By G. W. Fyler,* W2HLM

Although the super-regenerative type receiver has achieved wide use in u.h.f. communication, after making present popular use of these bands a practical possibility, until recently there has been little serious attention given to developing fully its inherent capabilities. The remarkable tolerance with which the super-regen is gifted, its ability to work fairly well in spite of its handling, unquestionably has encouraged this lack of development. Increasingly rigorous communication requirements now demand more, however, as our own work and that of others has clearly indicated. Can the super-regen meet these requirements, or must we resort to something derived from the more elaborate superhet? The fair answer to this question, backed by competent corroboration, now points to a continuing and brighter future for the super-regen as a generic type. Far from obsolescent, its inherent characteristics give it a long start on the superhet in the field of u.h.f. communication. More thorough development promises to keep it well up in that position. Important steps in this development are described by W2HLM in the following article.—EDITOR.

THE super-regenerative detector first described by Armstrong¹ in 1922 was a remarkable contribution to the radio art. Although its capabilities have not been fully appreciated or realized in practice, because of its apparently temperamental idiosyncrasies, perhaps no radio circuit ever offered as much opportunity for experimentation.

Most of the circuits previously used have had serious disadvantages which limited their application in commercial practice. Complex adjustments for tuning and stability have been required, particularly for covering a wide band of frequencies. A few facts recently discovered have improved the operation of this type of detector and made possible practical commercial equipment utilizing the principle of super-regeneration. An improved super-regenerative receiver, developed by the General Electric Company in Schenectady for police communication in the ultra-high-frequency band 30 to 42 mc., has points which should be of interest to radio amateurs. The circuit is shown, with constants for the 30- to 42-mc. band,

* Radio Transmitter Engineering Dept., General Electric Co., Schenectady, N. Y.

¹ E. H. Armstrong, "Some Recent Developments in Regenerative Circuits," *Proc. I.R.E.*, Aug. 1922; K. B. Warner, "Super-Regeneration," *QST*, July 1922.

in Fig. 1. The receiver uses but three tubes, equivalent to five single-purpose tubes. By reducing the size of the coils, the frequency range may be extended to well above 60 mc.

Some of the remarkable properties of an s.r. detector are, its ability to receive a signal in the presence of ignition and other types of noise-spectrum interference, very high amplification in one tube, the "flat" and instantaneous a.v.c. characteristic possible, and uniform audio-frequency response.

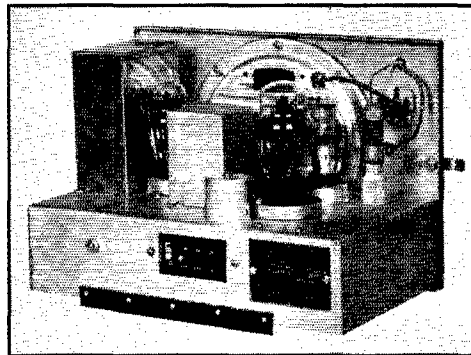

A MOBILE RECEIVER EMPLOYING THE CIRCUIT DESCRIBED

The tube shields have been removed.

ing action exists, the sensitivity will be very low. In other words, if the quench oscillator operates at 20 kc., the detector may self-quench at 10 kc., 6.7 kc., 5 kc., 4 kc. etc., corresponding to the 2nd, 3rd, 4th and 5th sub-harmonics of the quench oscillator frequency. This phenomenon can be demonstrated usually with the s.r.

QUENCHING AND STABILITY

Anyone who has built super-regenerative receivers is acquainted with the various forms of instability which may result from improper adjustment of the circuits. It was found that instability in the plate-quenched detector is very frequently caused by a self-quenching action of the detector at a sub-harmonic of the plate quenching frequency. If this additional quench-

circuits using a split-tank input circuit with a variable capacitor between coil sections. When tuned to an unmodulated carrier to eliminate hiss voltage, a cathode-ray oscilloscope is connected with the quench oscillator voltage on one set of plates and the amplified audio output voltage of

increased slightly in capacitance from an optimum adjustment, various sub-harmonics of the quench frequency will be indicated by the cathode-ray figures. The number of the sub-harmonic is proportional to the amount of capacity used. However, the Hartley oscillator circuit was found to be essentially free from this trouble.

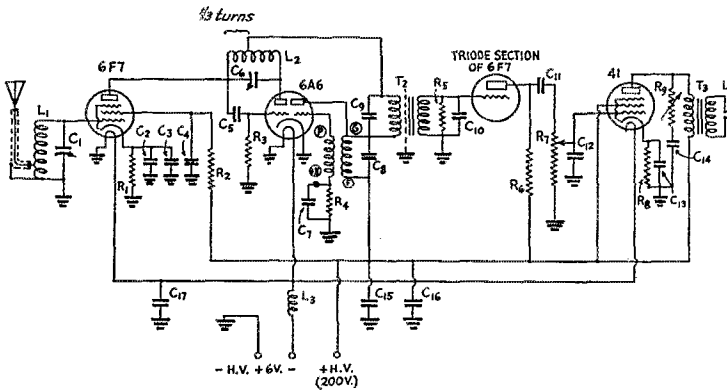

FLAT A. V. C. CHARACTERISTIC

After stable operation of the detector was obtained, several a.v.c. curves were taken, using a signal generator, with different points of coupling the pre-amplifier plate to the detector circuit, with various impedances in the plate-voltage supply lead to the detector tank, and with several values of

FIG. 1—CIRCUIT OF THE NEW-TYPE SUPER-REGENERATIVE RECEIVER

- L1—R.f. coil. For 30-mc. range, 12 turns No. 12 enameled on 1/2-inch diameter Mycalex dowel, turns spaced diameter of wire. Tap adjusted to suit antenna used. Total turns reduced approximately 1/2 for 56-mc. band.
- L2—Detector coil. For 30-mc. range, 9 turns No. 12 enameled on 3/4-inch diameter Mycalex dowel, turns spaced diameter of wire. Approximately 1/2 as many turns for 56 mc.
- L3—Filament choke. 22 turns No. 16 enameled close-wound on 3/8-inch diameter bakelite dowel.
- C1 and C6—50- μ fd. midget tuning capacitors (Hammarlund APC).
- C2—0.006- μ fd. cathode r.f. by-pass.
- C3—1- μ fd. cathode a.f. by-pass.
- C4—0.006- μ fd. screen-grid by-pass.
- C5—50- μ fd. mica grid capacitor for detector.
- C7—0.006- μ fd. quench oscillator grid capacitor.
- C8—0.002- μ fd. fixed, quench oscillator plate tuning capacitor.
- C9—0.006- μ fd. audio primary by-pass.
- C10—500- μ fd. audio secondary by-pass.
- C11—0.02- μ fd. audio grid coupling capacitor.
- C12—0.001- μ fd. audio grid by-pass.
- C13—8- μ fd. audio cathode by-pass.
- C14—0.05- μ fd. tone-control capacitor.
- C15—4- μ fd. plate supply audio by-pass.
- C16—0.006- μ fd. plate supply r.f. by-pass.
- C17—0.006- μ fd. filament supply r.f. by-pass.
- T1—Quench frequency oscillation transformer (National Type OR3 connected as shown by circled letters).
- T2—Interstage audio transformer with static shield between windings. Connect by trial for best audio quality.
- T3—Pentode output transformer. (Included in speaker.)
- R1—500-ohm 1/2-watt cathode bias resistor.
- R2—100,000-ohm 1/2-watt screen-grid resistor.
- R3—2-megohm 1/2-watt detector grid leak.
- R4—10,000-ohm 1/2-watt quench oscillator grid leak.
- R5—100,000-ohm 1/2-watt audio transformer load resistor.
- R6—50,000-ohm 1/2-watt audio plate load resistor.
- R7—100,000-ohm variable volume control.
- R8—500-ohm 1/2-watt audio cathode bias resistor.
- R9—25,000-ohm variable tone control.

grid blocking capacitors and grid leak resistors. The various a.v.c. curves indicated that maximum audio output could exist at either low or high r.f. input levels, a particular frequency giving either a direct or inverse change in audio level with increased signal level. However, when a flat a.v.c. characteristic was obtained, this characteristic fortunately existed over a wide frequency range, as shown by the three curves of Fig. 2. The grid blocking capacitor is 50 μ fd. and the grid leak 2 megohms. The r.f. amplifier plate is connected to the grid end of the detector tank and the plate voltage supply lead to the detector tank is directly tapped on the third turn from the grid end of the coil, and the lead is bypassed to ground through three series-connected capacitors.

A cathode ray oscillograph was used to investigate the r.f. oscillation taking place in the detector circuit for flat a.v.c. A small amount of high frequency r.f. voltage was obtained for one

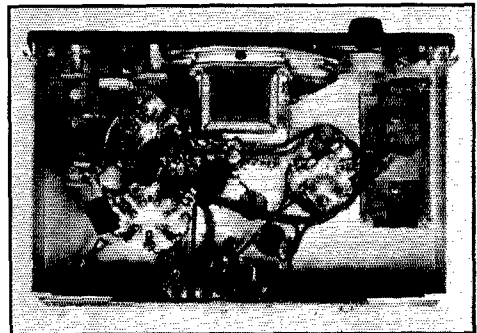

UNDERSIDE OF THE CHASSIS
The detector input circuit is at the upper left.

the detector on the other set of plates. Ordinarily a small amount of quench voltage will get through the audio amplifier and this will give an ellipse or circle on the cathode ray oscillograph.

If the capacitor in the center of the split tank inductance in the above-mentioned circuits is in-

set of plates by coupling to the detector tank coil. The other set of plates was connected to the quench oscillator. The r.f. oscillation for the optimum adjustment of the detector was found to take place over a very small part of the quench frequency cycle when the plate voltage was approximately at its maximum value. The shape of the r.f. oscillation envelope was similar to a single sinusoidal half-wave. It should be realized that the quench voltage is applied to both the grid and plate of the detector, the grid coupling capacity and grid-to-plate capacity reactance being much lower in value than the grid leak impedance at the quench frequency.

With the optimum adjustment of the detector, the plate voltage may be varied over wide limits without affecting the stability of the detector. Fig. 3 shows the variation of output signal as a function of plate voltage applied to the receiver. The quality of the received signal is unchanged over this range in plate voltage. Fig. 4 summarizes audio distortion measurements made on the receiver. The distortion is substantially independent of the r.f. signal level.

Polarity in connection of the interstage audio transformer has an important bearing on distortion. The outside secondary winding tap should be connected to the grid of the first audio amplifier. *Approximately three times as much audio distortion results if the wrong polarity is used in connecting the primary winding, both at 30 and 60 per cent modulation.* The correct primary connection may be determined readily by a listening test, the polarity giving the best quality being the correct one.

The detector tuning element must not upset the optimum relationship between grid and plate r.f. voltages as determined by fixed, interelectrode tube, and stray capacities of the tuned circuit. The receiver may be tuned to any frequency in the 30- to 42-mc. band by the two independent tuning controls located on the front of the panel. The upper left control tunes the r.f. amplifier and the lower left tunes the detector. No other adjustment is required for stabilizing the receiver. The lower right knob is the tone control. This enables a listener to adjust the audio frequency response of the receiver. Some improvement in the signal-to-noise ratio is also possible by this adjustment.

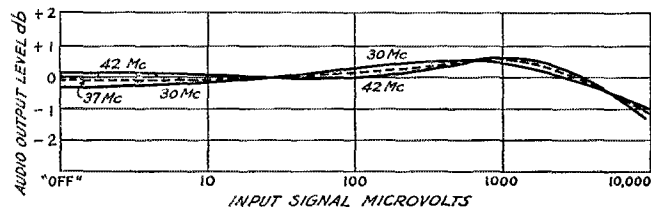

FIG. 2—THE RECEIVER'S REMARKABLE A.V.C. CHARACTERISTIC WITH A 30% MODULATED SIGNAL

A flat a.v.c. characteristic within 1 db over an input signal range of approximately 10,000 to 1 microvolts was obtained for a frequency range of 30 to 42 mc.

One interesting feature of the a.v.c. characteristic is its practically instantaneous action. This is a very desirable feature for mobile service where standing waves of field strength may exist.

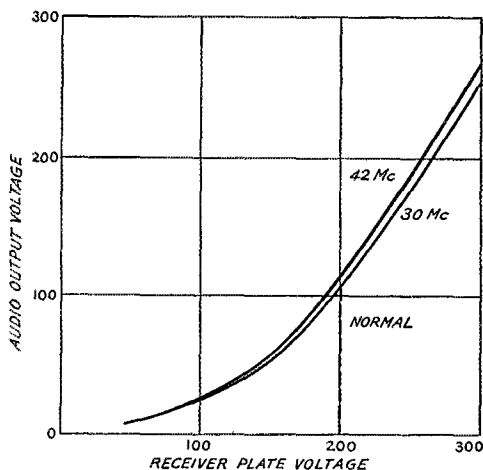

FIG. 3—ILLUSTRATING THE STABILITY WITH CHANGE IN PLATE VOLTAGE

Thus, with reception on a frequency of 42 mc. a car travelling at 60 miles per hour may intercept eight standing waves per second. In practice the standing wave pattern is found to vary considerably in severity depending upon the reflection conditions and is least noticeable in open country. Under average standing wave conditions in large cities, the intelligibility of the received signal may be satisfactory with a super-regenerative receiver having flat a.v.c. and barely understandable with the usual superheterodyne circuits due to inherently slow and non-uniform a.v.c. action. The received signal tends to vary in amplitude over a wide range at a rapid rate.

R.F. AND AUDIO STAGES

The first r.f. amplifier stage is very desirable with a super-regenerative detector in order to improve the signal-to-hiss ratio for weak signals. It also isolates the detector circuit from the antenna to eliminate this variable, prevents radiation, and provides better selectivity. It is possible to operate two of these receivers within 100 feet of each other without mutual interference due to radiation. The r.f. amplifier tube is the pentode part of the 6F7 which is similar to a 78

tube. The triode part of this tube is used for the first audio amplifier. This tube supplies sufficient audio gain to obtain full power from the output pentode. The detector uses one of the triode elements of the 6A6 tube. This tube is the 6-volt version of the 53 which is normally used

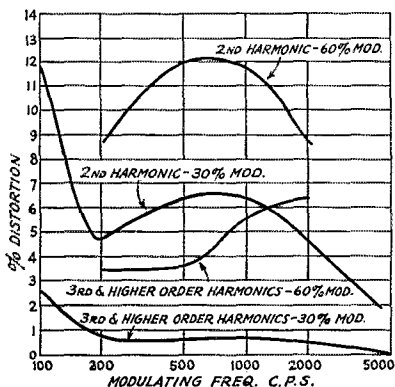

FIG. 4—HARMONIC DISTORTION VS. MODULATION FREQUENCY

Average curves for input levels from 10 to 10,000 μv ., taken at 36 mc.

for a Class-B audio output amplifier. It was chosen for its high mutual conductance and amplification factor and to permit using the other triode element for the quench oscillator. The audio output tube is the conventional 41 pentode.

One of the problems encountered in development of the audio amplifier was the reduction of quench-voltage input to the audio system. The interstage audio transformer was constructed with a shield between primary and secondary to prevent electrostatic coupling, and both the primary and secondary were suitably by-passed to prevent magnetic coupling. Further reduction of the quench voltage at the grid of the 41 is desirable to permit full utilization of this tube. It is desirable to obtain the necessary reduction in two stages rather than in one, to obtain a sharper cut-off at the quench frequency without undue attenuation of the higher voice frequencies. It should be noticed that the by-pass capacitor on the grid of the 41 tube, together with the volume control, also provides a tone-compensated volume control. At intermediate settings of the volume control, the higher audio frequencies are reduced. This is desirable for reduction of the higher hiss frequencies when no carrier is being received. The loudspeaker will deliver 2 watts of audio power for any fully modulated r.f. signal of between approximately 1 and 10,000 microvolts, with the one adjustment of the volume control.

To test for freedom from ignition interference, the super-regenerative receiver was compared with a superheterodyne having about the same

sensitivity. An automobile ignition system was set up in the laboratory with a controllable amount of coupling to a receiving antenna. The super-regen receiver showed a remarkable discrimination against ignition interference in comparison to the usual superhet receiver. Furthermore, an unshielded super-regen receiver without an antenna received a good signal from a 15-watt transmitter $\frac{1}{2}$ mile away when the receiver was within 6 inches of the ignition wires to spark plugs. During tests of the super-regen receiver in a large city, a satisfactory signal has been received from a police car having a 15-watt transmitter cruising throughout the city up to a maximum distance of 10 miles.

The power supply used is a dynamotor filter unit separately mounted. The receiver volume control, power switch and indicating lamp are mounted in a small unit for ease of adjustment.

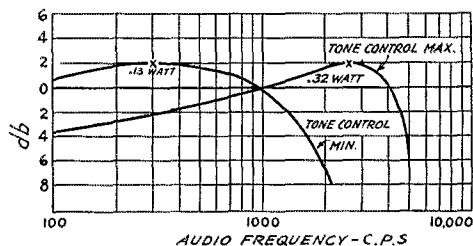

FIG. 5—AUDIO-FREQUENCY CHARACTERISTIC WITH A 30% MODULATED SIGNAL ILLUSTRATING THE TONE CONTROL ACTION WITH THE VOLUME CONTROL AT MAXIMUM

Output voltage was measured across the speaker voice coil.

An interesting mechanical feature is the plug-in chassis design with simple snap clasps permitting quick removal of the chassis for servicing with complete accessibility.



Radio Equipment of General Utility

Flexibility in the Design and Construction of Portable Station and Entertainment Apparatus

By H. A. Robinson,* W3LW

AT SOMETIME in the career of almost every radio amateur there comes a definite need for various units of transmitting, receiving or audio equipment which are considerably more flexible and portable than the usual run of amateur gear. For instance, there is frequently occasion demanding a portable audio amplifier and loud speaker unit, with provision for microphone or phonograph input, for local entertainment or public address work. The incorporation of a flexible radio receiver unit for both broadcast and short-wave bands is but a further step in the design of such equipment. And finally, of course, the portable equipment for the licensed amateur would not be complete without its effective c.w. and 'phone transmitter unit.

With flexibly designed, self-contained portable equipment of this type, the field of useful application is unlimited. There is portable amateur operation on the vacation or extended business trip; the practical demonstration of amateur radio transmission and reception to groups of Boy Scouts, clubs and similar organizations; the use of the amplifier-speaker unit for vacation entertainment and public address work on a small scale; and operation at the home station for the amateur living in the small apartment.

With this fundamental object of universality of application, as well as the usual requirements of economy in size and weight with accessibility and ruggedness accompanied by effective overall performance of each of the component units, the design and development of the equipment shown in the accompanying photographs and diagrams was carried on over a period of many months.

THE GENERAL PLAN

As shown in the photographs, the assembly comprises three distinct units, each mounted on a separate panel and sub-base. The 7- by 14-inch panel size was selected as a standard after due consideration of the requirements of each unit and the overall size of the completed equipment. The justly popular rack-panel type of construction was employed and is recommended for flexibility and accessibility. The rack of $\frac{1}{2}$ - by $\frac{1}{2}$ - by $\frac{1}{16}$ -inch brass angle is bolted into the cabinet with the front surfaces of the $\frac{1}{4}$ -inch aluminum panels flush with the edges of the cabinet. A uniform spacing of panel mounting permits interchanging units. The marking and drilling of holes

and cutting of panels must be done with precision to insure a tight fit and avoid unsightly cracks between units. The details of panel mounting are shown in Fig. 1.

The cabinet (overall dimensions shown in Fig. 2) was constructed of $\frac{1}{4}$ -inch three-ply fir wood. Brass wood screws and molding strip facing insure a tight yet rugged carrying case. The loud speaker, mounted permanently in the rear of the cabinet, is covered with a suitable grill cloth and



THE CASE AT THE RIGHT CONTAINS COMPLETE A.C. OPERATED EQUIPMENT FOR AMATEUR 'PHONE AND C.W. TRANSMISSION, ALL-WAVE RECEPTION, RADIO OR PHONOGRAPH ENTERTAINMENT WITH LOUD-SPEAKER OUTPUT

fitted with a readily detachable cover. At the top end of the cabinet, remote from the speaker, a hinged access door is provided for changing the plug-in receiver coils.

The cover for the cabinet was made sufficiently deep to provide clearance for all the panel control knobs. The space in the cover is utilized for holding the accessories during transportation—hand microphone and extension cord, telegraph key and plug, head telephone, resonance indicator lamp, power cord, antenna and feeder sections, insulators, etc. The cabinet is fitted with detachable hinges for the cover, a convenient carrying handle and two sets of rubber feet. It is intended to be carried on the side much like a suit case, and set upright when installed for operation, as shown in the photographs. The companion unit, an electric phonograph, is a standard type and need not be described.

Before considering each unit separately, a few general remarks influencing the design might

* Silver Lake Farm, Willow Grove, Penna.

prove of interest. The problem of power supply is of primary importance. Except for extremely low-power transmission and reception, the use of dry-battery supplies is out of the question.

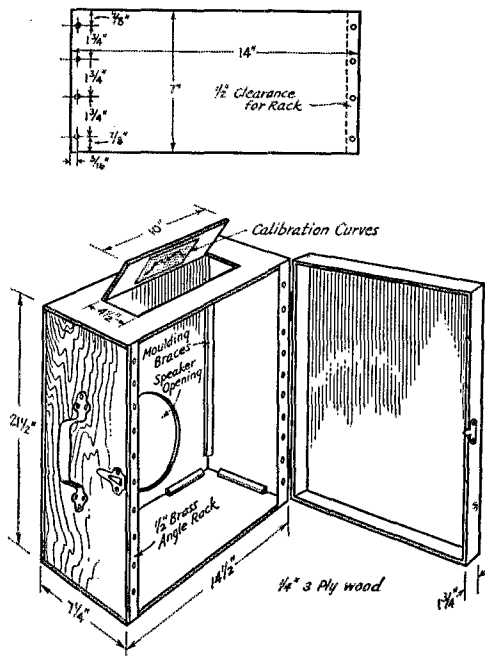

FIGS. 1-2—PANEL AND CABINET DETAILS

While the storage-battery operated vibrator-rectifier power supply is convenient for certain applications, the general availability of 110-volt a.c. supply justified the selection of this type of power source. The a.c. power supply makes possible a substantial audio output for public address work and radio reception; and, in turn, provides sufficient modulation capability for a reasonably powered 'phone transmitter.

AUDIO AMPLIFIER POWER UNIT

The basic unit of the equipment, and likewise the heaviest, comprises the audio amplifier and the a.c. power supply. The photographs show the general construction and arrangement of the components, while the schematic diagram and circuit constants are given in Fig. 3.

A broadcast type power transformer with the required filament windings and a high-voltage winding supplying 350 volts each side of the center tap is employed. The full-wave type 80 rectifier tube has ample capabilities, since the normal current drain is approximately 55 milliamperes during reception and 60 to 90 milliamperes during transmission. The power transformer should be selected with adequate rating for the current drain during reception. The higher drain during

transmission is somewhat of an overload but, being rather intermittent in nature, results in only a slight rise in the operating temperature of the transformer.

For reception and 'phone transmission a single stage of filtering is provided for the output tube utilizing the 1200-ohm speaker field coil as a choke (approximately 40 henrys). This arrangement furnishes adequate field excitation for the speaker and results in a very low ripple output. Dry electrolytic capacitors are employed because of their light weight and compactness. An additional stage of resistance-capacity filtering is effective in the plate and screen supplies to the audio- and radio-frequency amplifier tubes. The detector screen-grid voltage is supplied through a neon tube voltage regulator, reducing to a negligible degree the effects of variations in the a.c. line voltage.¹

The audio amplifier includes a Type 57 pentode tube as the first amplifier, resistance-coupled to the Type 47 pentode output tube.² The output tube is transformer-coupled to the four-ohm speaker winding for reception, or impedance-coupled to the modulated r.f. amplifier stage for 'phone transmission. A volume control is provided in the grid circuit of the first a.f. amplifier tube to control the audio level. A double-pole double-throw toggle switches the audio amplifier from radio reception to microphone or phonograph pick up. In the microphone or phonograph position this switch opens the screen supply to the detector and switches the microphone current (10 ma.). The microphone and phonograph input

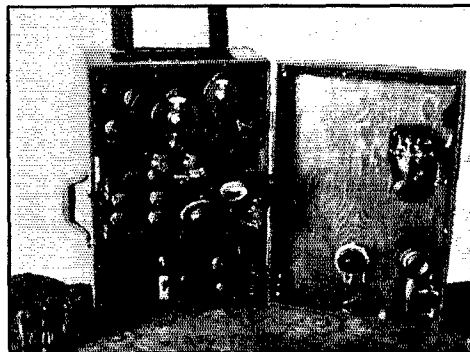

FRONT VIEW WITH THE COVER OPEN AND TRANSMITTER PANEL TIPPED FORWARD FOR COIL CHANGING

[Receiver coils are accessible through the lid in the top.

connections are brought out to telephone tip jacks. For added flexibility, terminal jacks, impedance-coupled to the plate of the output tube, are also provided. The headset jack is con-

¹ Robinson, H. A., "Gaseous Voltage Regulation for Receiver 'B' Supplies," *QST*, Jan. 1935.

² The newer type 2A5 tube is recommended in this application and the new 83-V rectifier replacing the 80 type.

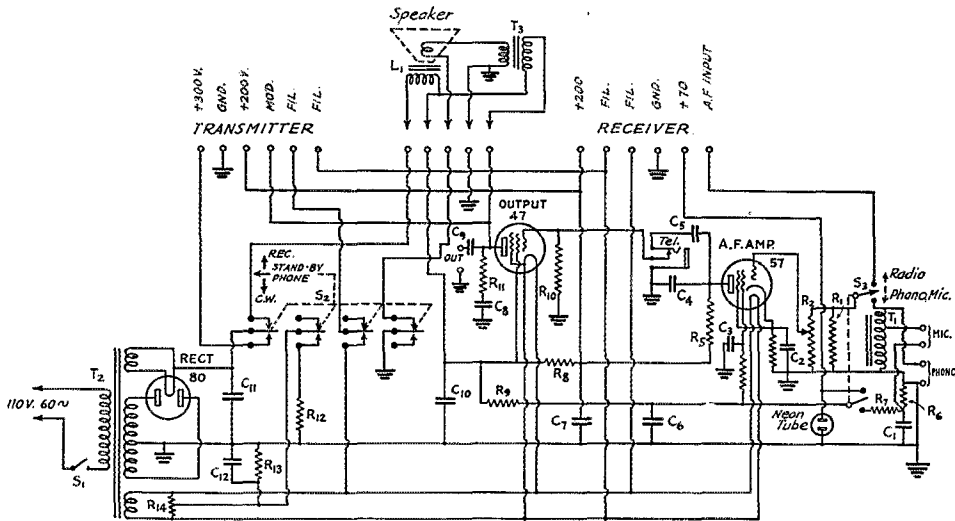

FIG. 3—CIRCUIT OF THE AUDIO AMPLIFIER—POWER UNIT

- L₁—Speaker Field (choke)
- C₁—0.5- μ f.d.
- C₂—4- μ f.d. electrolytic
- C₃—0.5- μ f.d.
- C₄—500- μ f.d.
- C₅—10- μ f.d. electrolytic
- C₇—4- μ f.d. electrolytic
- C₈—0.01- μ f.d.
- C₉—0.5- μ f.d.
- C₁₀—4- μ f.d. electrolytic

- C₁₁—10- μ f.d. electrolytic
- C₁₂—4- μ f.d. electrolytic
- R₁—100,000 ohms
- R₂—500,000 ohms (volume control)
- R₃—100,000 ohms
- R₄—10,000 ohms
- R₅—500,000 ohms
- R₆—250 ohms
- R₇—4000 ohms
- R₈—1500 ohms
- R₉—10,000 ohms

- R₁₀—500,000 ohms
- R₁₁—15,000 ohms
- R₁₂—200 ohms
- R₁₃—400 ohms
- R₁₄—50 ohms, center-tapped
- T₁—Microphone-phonograph transformer
- T₂—Power transformer (see text)
- T₃—Output transformer
- S₁—S.p.s.t. power switch
- S₂—4-pole special switch (see text)
- S₃—D.p.d.t. toggle switch

nected in the plate circuit of the first a.f. tube and, although the receiver is of rather low impedance for this tube, the telephone output level is adequate. The small coupling capacitor effectively cuts the low frequencies, reducing residual hum to a negligible value, while the jack spring opens the input to the output tube, silencing the speaker during head-
phone reception. If higher output and simultaneous speaker and head telephone operation should be desired, the output tip jacks can be used. The circuit constants have been selected with particular thought to their effect upon the frequency characteristic and the overall performance of the unit.

The unusual flexibility of the equipment is made quickly available for a four-pole (Federal) switch employed as a three-position switch by

bending certain contact springs, as shown in the schematic diagram. In the "Receive" position, the plate and filament supplies are removed from

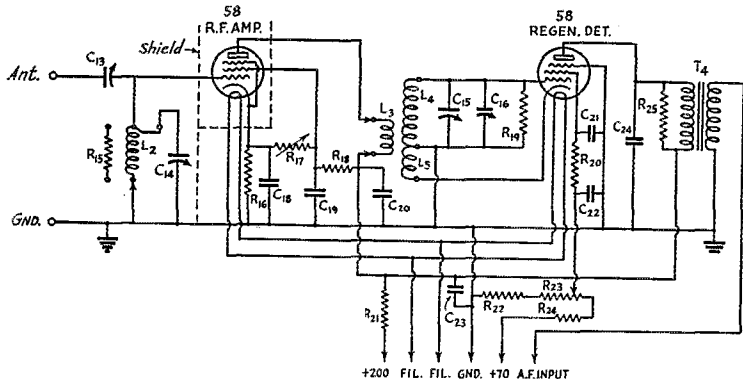

FIG. 4—DIAGRAM OF THE RECEIVER UNIT

- L₂, L₃, L₄, L₅—See coil data
- C₁₃—5-35- μ f.d. mica trimmer
- C₁₄—100- μ f.d. air trimmer
- C₁₅—100- μ f.d. air trimmer
- C₁₆—15- μ f.d. air trimmer (band-spreading control)
- C₁₇—250- μ f.d.
- C₁₈—0.001- μ f.d.

- C₁₉—0.1- μ f.d.
- C₂₀—0.001- μ f.d.
- C₂₁—0.01- μ f.d.
- C₂₂—0.5- μ f.d.
- C₂₃—0.25- μ f.d.
- C₂₄—100- μ f.d.
- R₁₅—250,000 ohms
- R₁₆—400 ohms
- R₁₇—50,000 ohms (sensitivity control)
- R₁₈—50,000 ohms

- R₁₉—1 megohm
- R₂₀—10,000 ohms
- R₂₁—2500 ohms
- R₂₂—15,000 ohms
- R₂₃—50,000 ohms (regen. control)
- R₂₄—40,000 ohms
- R₂₅—100,000 ohms
- T₄—Output transformer (See text)

the transmitter unit, the speaker cone circuit is closed and plate voltage applied to the receiver

and amplifier units. In the mid position ("Phone-Standby") this switch gives connections for low-power c.w. transmission, 'phone transmission or standby-by reception on the head-'phones (or external speaker). In this position the switch opens the speaker cone circuit, applies filament power to the transmitter, connects the bias on the modulator tube and keeps the plate supply on the receiver and audio amplifier units. Also in this

lettering on the aluminum panels. Sockets are provided for the multi-conductor cables which interconnect the several units. There are three such sockets, one for the speaker cable, and one each for the transmitter and receiver units.

THE RECEIVER UNIT

The receiver unit is located at the top of the rack. This location was selected to reduce the tendency towards acoustic howl resulting from the speaker vibrating the plates of the tuning condenser, tubes or other circuit elements. This form of instability, so prevalent in highly selective short-wave receivers, is reduced to a negligible proportion by the use of rugged components and r.f. wiring, along with spacing of the receiver from the speaker.

The circuit, as shown in the schematic diagram of Fig. 4, comprises essentially a single stage of tuned or untuned radio frequency amplification with a Type 58 tube, inductively coupled to the regenerative detector. The detector is Type 58 tube with screen-voltage control of regeneration. A high-impedance coupling

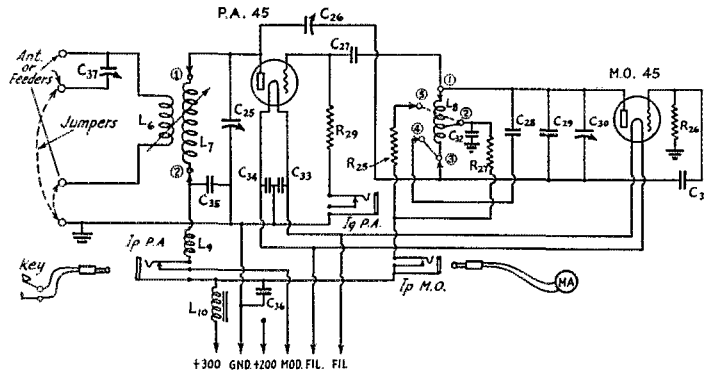

FIG. 5—THE TRANSMITTER UNIT

- L6, L7, L8—See coil data and text
 L9—R.f. choke
 L10—6-henry filter choke
 C25—100- μ fd. air trimmer
 C26—35- μ fd. air trimmer
 C27—250- μ fd. air trimmer
 C28—100- μ fd. air trimmer
 C29—50- μ fd. air trimmer
 C30—35- μ fd. air trimmer—band spread control
 C31—250- μ fd.

- C32—700- μ fd.
 C33—700- μ fd.
 C34—700- μ fd.
 C35—0.001- μ fd.
 C36—1- μ fd.
 C37—100- μ fd. air trimmer
 R26—30,000 ohms
 R27—7500 ohms
 R28—5000 ohms
 R29—30,000 ohms

position, c.w. or 'phone transmission is selected by inserting or removing the plug of the telegraph key in the transmitter unit. Duplex operation, relay re-transmissions on another frequency band, or the transmission of speech or c.w. is possible.

With the switch in the "CW" position, the plate voltage is removed from the receiver and audio amplifier units, the high voltage being taken from across the first filter condenser through a low-resistance filter choke in the transmitter unit, thus providing a much higher plate supply as a result of the decreased current drain with the receiver and amplifier units and speaker field removed from the circuit. The speaker cone circuit is left open, and the transmitter filaments lighted. In this position the maximum power output is available for c.w. telegraph transmission.

A more complete understanding of the flexibility of the equipment can be obtained by tracing the circuit changes accomplished by this switching.

The audio amplifier power unit, being the heaviest, is placed at the bottom of the rack, with the speaker unit directly behind and slightly above it. The components are arranged to provide ample clearance around the speaker cone. The various switches and controls are marked by

transformer (100,000 ohms, 1:1) feeds the audio output to the amplifier unit.

Band-spread tuning is provided by the small 15- μ fd. band-spread capacitor shunting the main tuning condenser (100- μ fd.). A National Type B vernier dial serves as the band spread control and a Type BM dial provides excellent resetability and ease of adjustment of the main tuning condenser.

The plug-in coils are accessible through the door provided in the top of the cabinet. By careful coil adjustment the amateur bands are positioned to give sufficient band spread (one-half to full scale, depending on the band) while still maintaining complete frequency coverage and overlap between coils. The low-frequency coil is equipped with a built-in band switch to give coverage of 550 to 2500 kc. in two bands. In a similar manner, the r.f. tuned grid circuit is provided with a three-band switch permitting coverage from 2500 to 20,000 kc. A resistance coupling can be plugged in when untuned r.f. is employed. These arrangements minimize the number of coils required for complete frequency coverage, a point not to be overlooked when designing portable equipment. Coil data are given in the Table and Fig. 6; however, some slight adjustments

may be necessary where circuit capacities differ.

Spare sockets are provided for carrying the additional coils. A compact calibration chart for ready reference is fastened to the inner side of the coil access door. Capacitive antenna coupling permits variable adjustment (screwdriver) for widely differing antennas. Separate antennas are used for transmission and reception, since the receiving antenna is usually quite short. The panel controls include, in addition to the bandspread and main tuning, r.f. sensitivity control, r.f. tuning and the regeneration control. The r.f. sensitivity control is highly desirable to reduce the level at the regenerative detector when discriminating against strong local signals, preventing blocking or cross modulation.³

The arrangement of components, shielding and general construction of this unit are shown in the photographs. A seven-conductor cable, terminating in a plug, interconnects with the audio amplifier unit. It was thought that a separate shielded lead for the receiver output would be required to reduce hum pick up, but this was not found necessary with the transformer coupling. However, an improvement in hum level would undoubtedly result and shielding would be required when resistance-coupling of the detector was employed.

THE TRANSMITTER UNIT

The third and central panel supports the transmitter unit with its associated controls. A rather extensive series of measurements on a bread-board experimental layout were made to determine the most suitable transmitter arrangement, tube complement and circuit constants. A 100-ohm dummy antenna load was employed and all measurements were made at a frequency of 7 mc. The only limiting requirements were those of available power supply (300-volts 80 ma.) and tube complement (a maximum of two tubes). Circuit arrangements included self-excited t.g.t.p. (single-ended and push-pull), and oscillator-amplifier circuits; while 45, 46, 47 and 56 type tubes were tried. The general conclusions leading to the selection of the present arrangement can be summarized as follows:

(a) Low plate efficiency of self-excited arrangements at the low plate voltage (efficiencies 30 to 50%).

(b) Inadequate output of type 56 tube self-excited, at this plate voltage.

(c) Negligible difference in performance of Type 46 or Type 45.

(d) Low overall efficiency of Type 47 tubes as self-excited oscillator at this plate voltage.

(e) High amplifier plate efficiency of master oscillator arrangements (70-75%).

(f) Ability of Type 56 or 45 as an oscillator to drive adequately a Type 45 as power amplifier.

(g) Desirability of master oscillator-power

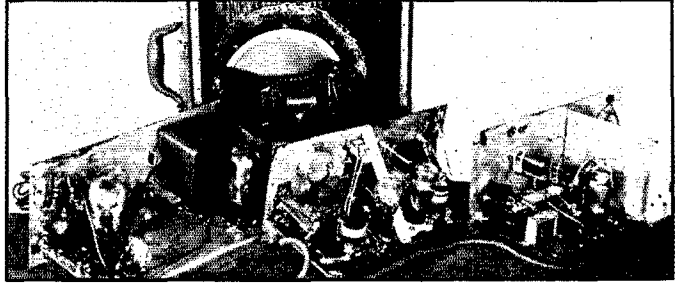

THE THREE PANEL UNITS REMOVED TO SHOW THEIR CONSTRUCTION

The amplifier-power supply unit (left), the transmitter, and all-wave t.r.f. receiver (right).

amplifier arrangement for 'phone operation.

(h) Freedom of m.o.p.a. arrangement from output adjustment affecting the frequency.

Because of the low plate supply voltage, frequency doubling was not feasible; hence the master oscillator operates on the same frequency as the power amplifier. The time lag in the heater of the Type 56 oscillator made the tube unsuited for this application, resulting in the use of the two Type 45 tubes as shown in the schematic diagram of Fig. 5.

The master oscillator uses the 45 triode at low plate voltage in a high-*C* Hartley circuit. This arrangement makes for convenience in neutralizing and provides band-spread for the panel control adjusting the oscillator frequency. The Type 45 power amplifier is inductively coupled to the output circuit by means of a variable coupling. A flexibility of antenna or feeder arrangements, permitting either series or parallel tuning, operation with antenna, feeders, ground or counterpoise, can easily be obtained by means of one or two flexible jumper leads (carried in the cover). The transmitter is designed for operation on three frequency bands, 3.5, 7 and 14 mc. However, excellent performance on the 1.7-mc. band can be obtained readily with somewhat larger coil forms.

The coils are wound on tube-base forms. To minimize the number of coils required for three-band operation, the circuit constants are proportioned so that the oscillator operates with a high-*C* tank, as desired from the standpoint of frequency stability, and the oscillator coil of any one band is of the correct value to function as the power amplifier plate tank coil of the next higher frequency band (where low-*C* is desired).⁴ By

³ Robinson, H. A., "Regenerative Detectors," *QST*, Feb. 1933.

⁴ Robinson, H. A., "Operation of R.F. Power Amplifiers," *QST*, April 1934.

this means, effective three-band operation with only four coils is achieved, a feature of considerable importance for portable equipment.

On the 14-mc. band the oscillator tank fixed capacity is reduced from 150 $\mu\text{mfd.}$, as employed on the two lower bands, to 50 $\mu\text{mfd.}$, and the oscil-

while keying the power amplifier plate circuit. (Caution—the key is “hot” and hence should have an insulating wooden mounting base.) For 'phone transmission, the key plug is removed, closing the plate circuit to the modulation reactor and audio output tube.

A separate filter with a 6-henry choke and 1- $\mu\text{f.}$ capacitor, together with the 10- $\mu\text{f.}$ first filter capacitor in the power unit, provides a very pure d.c. plate supply for the transmitter unit.

This unit has the front panel hinged to the audio amplifier unit below, the hinges being tapped so that either unit can be readily removed. Thumb screws, made from the bakelite tops of binding posts, are used to secure the unit to the rack. By removing these thumb screws, the unit can be tilted forward to give access to the tubes and coils for band changing. The variable condensers for adjusting the oscillator frequency, neutralizing, and antenna or feeder tuning, are insulated from ground by mounting on a small hard rubber panel parallel to the front panel but set back approximately an inch. Insulating shafts are extended to the panel controls.

The panel controls include the following: oscillator frequency, neutralizing, amplifier tank tuning, output tuning and coupling. Air condensers were necessary for the oscillator tank fixed capacitors, a gradual drift in frequency occurring as mica changed their temperature in operation.

ANTENNAS

The antenna equipment, carried in the cover of the cabinet, comprises four light-weight insulators constructed from 1½-inch lengths of ½-inch bakelite tubing, a length of supporting cord for the radiating system, and the following sections of stranded insulated conductor, fitted with suitable lug terminals and supplied with screws and nuts for interconnection:

1-33	foot section		
2-16	“	“	
1-9	“	“	
1-13	“	“	
1-20	“	“	twin conductor
1-3½	“	“	“

These antenna sections, by interconnection, pro-

(Continued on page 41)

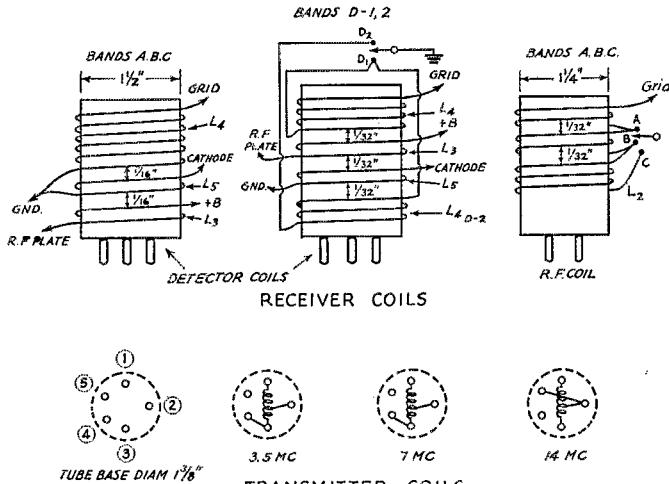

Receiver Coils

Band	Freq. Kc.	Detector Coil			R.F. Coil
		Grid L ₄	Cathode L ₅	Plate L ₃	
A	22,000-10,500	5	1	3	L ₂
B	11,000-5,000	11	1	4	5½
C	5,500-2,600	25	1½	9	33
D-1	2,600-1,200	55	3½	8	-Double Range Coil
D-2	1,200-560	150			

Conductor L₂ and L₄ of Bands A, B, C, No. 26 enam., spaced on A and B bands. All other coils No. 32 enam. close-wound.

Transmitter Coils

Freq. Band Mc.	Total Turns	Tap	Conductor
14	4½	1½	No. 18 enam. spaced diam.
7	7½	2½	No. 16 d.c.c. close-wound
3.5	13½	5¼	No. 26 d.s.c. close-wound

Tap turns from grid end of coil. Coupling coil L₆, 6 turns No. 26 d.s.c. Note. For terminal arrangement, coil diameter, etc., refer to Fig. 6

lator plate series resistor reduced to provide excitation comparable to that on the lower frequency bands. These oscillator circuit changes are accomplished automatically by arranging the coil terminals and jumpers in the tube base coil forms. (See Fig. 6.)

Closed circuit jacks permit the reading of oscillator plate current, power amplifier grid current and power amplifier plate current. A 50-ma. meter, supplied with a flexible cord and plug, is mounted on the panel and serves as a ready check on the tuning and loading,⁴ as well as on the general operation of the transmitter.

The power amplifier plate circuit jack has its closed circuit spring connected to the primary of the audio output transformer which serves as the modulation reactor for 'phone transmission. For c.w. transmission, the telegraph key is plugged into this jack, opening the lead to the modulator,

A Four-Band Exciter

Instant Band Changing With Circuit Switching and Fixed Tuning

By J. Herbert Hollister,* W9DRD

WITH the advent of the click-click method of changing bands in the best receiving circles, came the realization that life could mean something more than one everlasting

popularized by Art Collins and others. The job of bringing order out of chaos can't be done overnight, but by building each new piece of equipment for rack mounting, things about the old static room will soon begin to shape up.

Referring to the rear view of the exciter, shown in Fig. 2, we start at the right with six crystal holders lined up on the edge of the chassis. The mounting was made from a strip of Vietron, using wafer socket clips for contacting the holder prongs. Next, along the rear of the chassis we have the 3.5-mc. oscillator coil, the first 53, the 7-mc. coil, the 14-mc. coil, the second 53, and the 28-mc. coil. The condensers for all four coils are mounted beneath the chassis on the bakelite strip which forms the back edge of the chassis. In the center, directly behind the meter, is the RK23 buffer with its quartette of tank circuits clustered round.



FIG. 1—BAND-CHANGING BECOMES A PLEASURE WITH AN EXCITER LIKE THIS ONE

No tuning adjustments to be gone through—simply flip the "buffer" and "exciter" switches to the band desired and select any one of six crystals on the "crystal" switch. The 53's handle the oscillator and doubler functions; the buffer, always used as a straight amplifier, is an RK-23.

search for the right coil. The net result, of course, is that we now have more time on our hands in which not to wind coils. Then the logical extension of the same line of thought leads to the application of band switching to the transmitter where, at least in the low-power stages, the treatment may be similar to that used in many receivers.

Taking Jim Millen's tip¹ that the 53 tube would best fill the bill as a crystal-controlled oscillator and as a doubler, the exciter-buffer unit depicted in Fig. 1 was developed. The panel is 7" by 19" for standard rack mounting, and there is a lot to be said in favor of this unit type of construction which has been

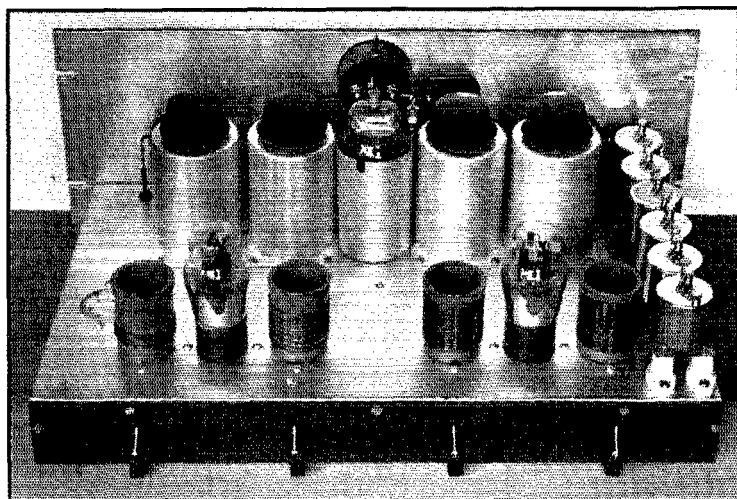

FIG. 2—SEEN FROM THE REAR, THE EXCITER LOOKS A GOOD DEAL LIKE A NEATLY-BUILT SUPERHET

But don't be deceived by its appearance; the output on any of the four bands is sufficient for driving a pair of 800's as modulated Class-C amplifiers. Although the oscillator and doubler coils are wound on plug-in receiving coil forms for convenience, actually they are permanent fixtures. The socket which can be glimpsed behind and to the left of the ten-meter doubler coil is for the power-supply plug.

Now, taking a quick glance at the schematic circuit (Fig. 3), the plot unfolds in all its simplicity. The grid of the first triode section of our first 53 is driven by any of the six crystals which

* R. 1, Knox Rd., Merriam, Kansas.

¹ Millen, "A Pentode Output Transmitter With Six-Band Exciter." *QST*, October, 1934.

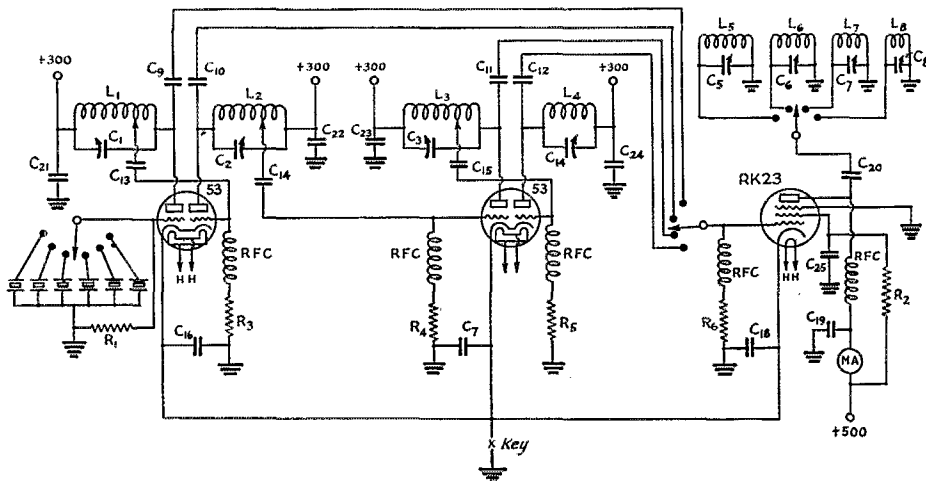

FIG. 3—CIRCUIT DIAGRAM OF THE BAND-SWITCHING EXCITER

- C₁—100- μ fd. midget air condenser
- C₂, C₃, C₄—50- μ fd. midget
- C₅—100- μ fd. midget
- C₆—50- μ fd. midget
- C₇, C₈—35- μ fd. midget
- C₉—C₂₀, inc.—.001- μ fd. mica condensers
- C₂₁—25, inc.—.01- μ fd. mica condensers
- R₁—5000 ohms, 2-watt
- R₂—10,000 ohms, 2-watt
- R₃—20,000 ohms, 2-watt
- R₄, R₅, R₆—10,000 ohms, 2-watt
- L₁—3.5-mc. oscillator coil; 35 turns No. 22, diameter 1 1/2 inches, winding length 1 1/2 inches
- L₂—7-mc. doubler coil; 20 turns No. 16, diameter 1 1/2 inches, winding length 1 1/2 inches

- L₃—14-mc. doubler coil; 10 turns No. 16, diameter 1 1/2 inches, winding length 1 1/4 inches
- L₄—28 mc. doubler coil; 3 1/4 turns No. 14, diameter 1 1/2 inches, winding length 3/4 inch
- L₅—3.5-mc. buffer coil; 30 turns No. 16 diameter 1 1/2 inches, winding length 1 1/2 inches
- L₆—7-mc. buffer coil; 16 turns No. 14, diameter 1 1/2 inches, winding length 1 1/4 inches
- L₇—14-mc. buffer coil; 9 turns No. 10, diameter 1 1/4 inches, winding length 1 1/4 inches
- L₈—28-mc. buffer coil; 3 1/4 turns No. 10, diameter 1 1/4 inches, winding length 3/4 inch
- RFC—Sectional-wound chokes, high-frequency type
- The tuning condensers, C₁-C₈, inclusive, are Cardwell Trim-Aires

may be selected by the six-point switch. These A-cut crystals are ground to frequencies in 3.5-mc. band—which will permit the widest possible

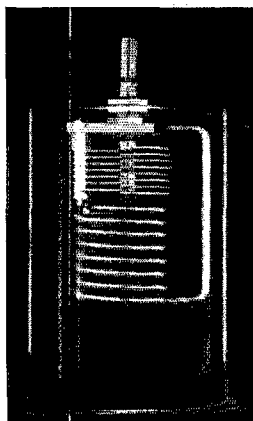

FIG. 4—AN "X-RAY" VIEW OF ONE OF THE BUFFER TANK CIRCUITS

The tank coils are mounted below and suspended from the tuning condenser, a Cardwell Trim-Aire. The individual circuits are beaked at about the center of the band for which they are designed. No fine adjustment has been found necessary in working over the higher-frequency bands with different crystals, as is explained in the text.

selection of harmonics for such interference-free spots as may appear in the four bands, 10, 20, 40, and 80 meters. The second triode section of the same 53 is tuned to 7 mc. The first section of the second 53 is tuned to 14 mc. and the second section of the same tube to 28 mc. These four

tanks once peaked will require no retuning with crystals whose fundamental frequencies fall between 3500 kc. and 3575 kc. It will, of course, be necessary to retune for a crystal in the 3.9 mc. 'phone band, but in this case it is only the oscillator tank condenser; and, after all, it should be worth that extra effort to get to work on the 75-meter 'phone band.

The four sections of the two 53's are permitted to run constantly, and therefore we have excitation voltage in each of the four bands on tap at all times with which to drive the grid of the RK-23 buffer. Capacity feed is used, with the tap coming directly off the plates of the 53's, through a four-point switch the arm of which is hooked to the RK-23 grid.

A good deal of religion was lost in trying to use a tapped coil in the plate circuit of the RK-23. The thing was fairly easy to do, down to 28 mc.; but there it appeared that there was more inductance in the leads than in the coil itself. Accordingly, it was decided to use separate tanks, pre-tuned to the desired bands, and the tank assembly shown in Fig. 4 was tricked up. The can is by National and is not cellophane. The condenser is by Cardwell, and the coil is by winding. The coil turns indicated are quite critical; and in the case of the 14- and 28-mc. combinations, the

(Continued on page 50)

A Genemotor Crystal-Controlled Portable Using 6-Volt Tubes

By F. Waddingham,* W6EQL

The simple, crystal-controlled rig described here should appeal not only to the portable-minded but to the rural amateur as well, since both plate and filament power are obtained economically from a 6-volt storage battery. At a total battery drain of 4 amperes, the input to the amplifier stage of the transmitter is better than 6 watts. The power output can be increased by using a motor-generator of larger capacity, although the battery drain will be correspondingly increased.

—EDITOR

IT IS highly desirable that a station designed for portable work really should be capable of being carried by one person, since occasions often arise when a good location on tour is not always readily accessible to an automobile. The transmitter herein described was designed to meet this condition and at the same time to be economical in power consumption. The entire equipment, except for a 6-volt storage battery, may be carried very easily by one person. Some experimenting was necessary, however, before the final design was decided upon, because such things as suitable tubes, power supply and reasonably compact components must be given consideration.

To have low-power tubes of rugged construction, "automobile-type" tubes were selected, though 01-A tubes were also tried out. At the same voltages, these latter did not seem to be as good. The use of the 6.3-volt tubes eliminates a dropping resistor, though some of us run 01-A tubes direct anyway! Further, the transmitter may be operated on a.c. where possible and desirable.

Inasmuch as some trips mean that there will be no chance to charge a battery, battery drain is a big factor to be considered in choosing the power supply. Bearing this in mind, the plate supply is furnished by an Emerson 6/220-volt 40-ma. motor generator as used for auto-radio receivers. This bit of equipment uses 3 amperes battery current. A larger size Genemotor can be had and used, but of course will take more current. "B" batteries also can be used if desired.

The crystal-controlled oscillator, a Type 41 tube, is shunt-fed, making possible the omission of a grid choke in the amplifier input circuit. The 41 seemed to be a better oscillator than the 38, which was first tried. An 89 might be used. Jacks are provided for the measurement of screen and plate currents by use of a single meter, equipped with a plug. The "B" drain for the oscillator is about 15 ma.

The amplifier is one of the new "double-

* Box 232, Manhattan Beach, Calif.

triode" types, a 79, with the elements paralleled. General characteristics of this tube seem to indicate a higher output than any other 6.3-volt tube, taken singly at least. Comparisons are from such means as were at hand. When coupled to the load, the "B" drain is about 30 ma. This makes the total drain on the Genemotor quite close to the rated 40 ma., without too much voltage drop or overload, so that with the intermittent service characteristic of c.w. transmission, there should



THE COMPLETE PORTABLE OUTFIT INCLUDES THE TRANSMITTER-RECEIVER CASE, 6-VOLT BATTERY, GENEMOTOR, AERIAL REEL AND INSULATORS AND A CONNECTION CABLE

With the exception of the storage battery, all equipment can easily be carried by one person.

be no damage to the equipment. Tuning and neutralizing adjustments are carried out in the same way as with other simple crystal transmitters.

A three-pole double-throw three-position switch makes it possible to have the plate supply of the receiver and the transmitter filaments on, or off, and the transmitter filaments and Genemotor

on, for receiving, out of service, and transmitting, respectively. Experience has shown it to be desirable to "cut" the receiver plate supply when out of service, because of the possibility of discharging the "B" batteries from development of leakage in condensers.

By the use of another switch or a "jumper" wire, the same antenna might be used for both transmitting and receiving. The ground connection is common—the car frame seemed to work fairly well for this purpose. Sometimes the location might be such that this would be the only available ground.

Because cabinet makers seem to make their products with shallow lids, the knob and dial arrangements and clearances must be checked very closely. Some ingenuity was needed to get the Marco dial mounted behind the panel, to attain the necessary clearance for the lid. The receiver was built into the left side of the panel for operating convenience, and to permit the key, which was fastened to the lid, to fit against the right hand side of the panel, behind which are the receiver batteries. Tube bases, modified by use of larger diameter tubing, are used for the transmitter coils, to permit flexi-

bility of operation. The well-known Pilot midget condensers are used for tuning all circuits. The transmitter and receiver coils are all low-C.

The receiver is the conventional two-tube type, using 30's with series filament connections. A high-gain, peaked audio transformer, the old RCA Type UV-712, is used. The 40-meter coil is

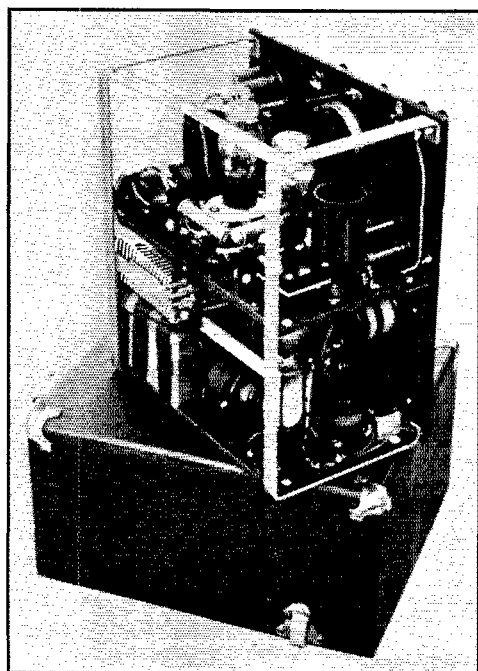

INSIDE THE CASE

The transmitter is on the upper deck, with the oscillator in the foreground. The crystal holder plugs into a mounting at the near corner. The neutralizing condenser is mounted on a small insulating panel near the amplifier tube. Other transmitter components can be readily identified.

The receiver is on the near half of the lower deck, with batteries in the rear.

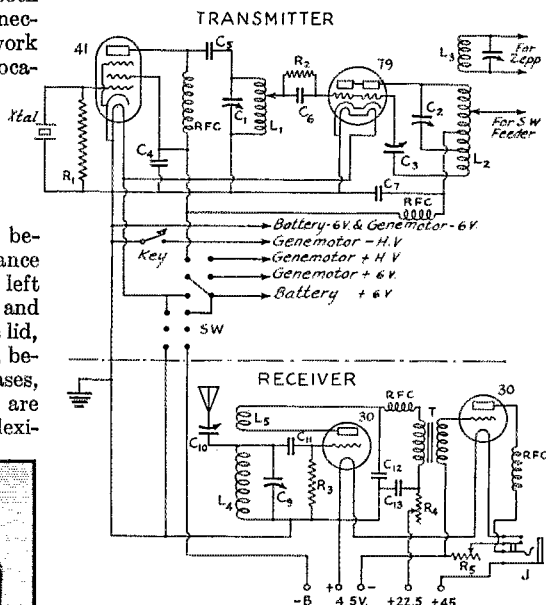

FIG. 1—COMPLETE CIRCUIT OF THE PORTABLE STATION

- C₁, C₂—100- μ fd. midget condenser.
- C₃—15- μ fd. midget condenser.
- C₄, C₅—0.002 μ fd.
- C₆—100 μ fd.
- C₇—0.002 μ fd.
- C₈—100- μ fd. midget condenser.
- C₉—50- μ fd. midget condenser.
- C₁₀—15- μ fd. midget condenser.
- C₁₁—100- μ fd.
- C₁₂—0.004- μ fd.
- C₁₃—0.5 μ fd.
- R₁—40,000 ohms.
- R₂—10,000 ohms.
- R₃—8 megohms.
- R₄—200,000-ohm variable resistor.
- R₅—15-ohm rheostat.
- J—Filament-control jack.
- SW—Yaxley three-pole double-throw three-position switch.
- L₁—30 turns No. 16 enamelled wire for 3500-kc. crystal.
- 15 turns No. 16 enamelled wire for 7000-kc. crystal.
- L₂—40 turns No. 16 enamelled wire for 3500 kc.; C₂ across 30 turns.
- 20 turns No. 16 enamelled wire for 7000 kc.; C₂ across 15 turns.
- L₃—Depends upon type of antenna or feeders used.
- L₁, L₂ and L₃ wound on 1 1/2-inch diameter forms. L₂ tapped at center for plate feed. Coupling taps on L₁ and L₂ must be adjusted experimentally.
- L₄ and L₅—Usual grid and tickler coils for regenerative detector. Suggestions for tube-base coils are: for 3500 kc., L₄, 35 turns, L₅, 10 turns of No. 30 d.s.c.; for 7000 kc., L₄, 15 turns, L₅, 5 turns of No. 30 d.s.c.

carried in a small socket screwed to the wood panel used for "back-mounting" the Marco dial. A filament-control type Yaxley Junior Jack is

(Continued from page 88)

An Experimental Station on Wheels

By H. Selvidge,* W9BOE

A MOBILE radio laboratory which might well be called the answer to a ham's prayer has been constructed at the Cruft Laboratory, Harvard University, in Cambridge, Massachusetts. The object of the mobile unit is to enable laboratory apparatus to be carried into the field to make observations on various radio phenomena. Two main objectives will be pursued with the present apparatus installed in the truck. First, observations on the propagation characteristics of ultra-short waves will be undertaken. It is hoped that observations on several different frequencies say 60, 120 and 240 mc., will lead to a better understanding of the processes of their propagation. Second, ionosphere measurements will be made.

The ultra-high-frequency apparatus consists of a three-band receiver operating on 60, 120 and 240 mc. and is of the super-regenerative type, using self-quenching Hartley circuit detectors. There are three separate detectors, one for each band, and they feed a single audio stage. In this way a very rapid change from one band to the other can be made. The detectors for 60 and 120 mc. are 76's, while the 240-mc. detector uses a 955. A radio frequency stage will soon be added to each, using the new 954's. The audio stage consists of a 42 feeding a small dynamic speaker.

There is a 60-mc. transmitter using three of the 6A6 type tubes; one as a speech amplifier with the elements in parallel, one as a Class-B modulator, and the third as the oscillator in a t.p.t.g. circuit. A novel gadget is the r.f. indicator used with this transmitter. It consists of a flashlight bulb in the antenna lead, the filament being focussed by means of a lens on a jeweled insert in the front panel. Contrary to all predictions, it works, giving a very nice indicating light when everything is working properly. This transmitter is primarily for communication purposes, as most of the ultra-high frequency observations will be made on signals sent out from the laboratory, at a fixed location. The antenna consists of a quarter-wave aluminum rod pivoted at the bot-

tom and mounted on the side of the truck, and is fed by a concentric feeder with the outside conductor grounded. The antenna is arranged so that it can be raised or lowered from the inside, and if it strikes an obstruction while in motion, it folds down, and then springs back up into the vertical position.

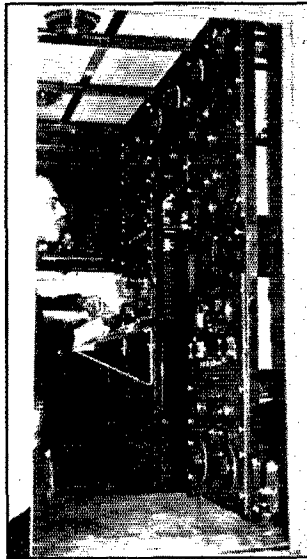

LOOKING THROUGH THE REAR DOOR OF THE MOBILE LABORATORY

Ample space is provided for convenient manipulation of all controls.

For reception on the lower frequencies, a National HRO is carried, with coils covering from 10 to 600 meters. This receiver works very well using the mobile antenna.

A relatively high-power transmitter is carried for the ionosphere measurements. It operates in the 3.5-, 7- and 14-mc. bands, as well as five experimental frequencies in that range. It consists of crystal-controlled oscillator using an RK-20. Crystal switching and plug-in coils provide the means for convenient frequency shifting. The use of AT-cut crystals insures freedom from frequency drift caused by temperature changes. The single-phase r.f. output of the oscillator unit is usually fed through a phase-splitting network which gives two-phase r.f. which is then fed to two amplifiers, each using two RK-20's in push-pull. Normally a single 59 would supply the necessary excitation for the amplifiers, but there is a loss in the phase-splitting network because of the necessity of providing a good wave form, so plenty of oscillator output is required.



CLAD IN COPPER AND WITH CHROMIUM PLATED FITTINGS, THE STATION LOOKS THE PART

The two amplifiers feed through two antenna matching networks, and if these properly phased

(Continued on page 80)

* W1FQV, Cruft Laboratory, Harvard University, Cambridge, Mass.

What the League Is Doing

League Activities, Washington Notes, Board Actions—For Your Information

Station Calls

On May 21st the F.C.C. amended the last sentence of its Rule 28 to read as follows, the new language in italics: "Because of the large number of amateur stations, calls will be assigned thereto in regular order and requests for particular calls will not be considered, *except that on formal application the Commission may reassign calls to the last holders of record.*"

It is the Commission's regular practice to reassign the same call to the same amateur as long as consistent with the station location, and to avoid reassignment to a different individual as long as new calls are available; and now the new language makes it possible to revive a former assignment to the last licensee of record. When an amateur moves into a different call area he of course has to give up his old call and get a new one. The recent modification of the rule makes it possible for the Commission to continue the good work it has done to preserve the stability of records and published call books by reassigning a former call if an amateur moves back into his old call area or revives a lost interest.

The Commission requests us to say for them that except in the special case of an amateur desiring to regain a former call that has never in the meantime been assigned to any other amateur, they positively will not consider any requests for special calls, and they ask that they not be burdened with unnecessary correspondence thereon. (The practice of reassigning old calls will not apply to the old four-letter ZZ group, which is in conflict with present international regulations.)

A two-letter call is a valuable thing for any amateur to hold onto. Knowing no satisfactory basis for selecting which amateur applicant should be favored with a two-letter call that may become vacant, the Commission has never originated any such assignments and has merely renewed old Department of Commerce two-letter calls. But it is interesting to note that if an ex-amateur once held a two-letter call and now returns to the game, and the call has never in the meantime been assigned to anyone else, he may secure it again upon application. Nobody else can. What do you say, some of you old timers— isn't this inducement to get back in the game?

Chain Letters

It is fervently to be hoped that by the time these lines appear in print the chain-letter nuisance will have disappeared from the American amateur scene. But in case it has not:

The idea itself involves bughouse mathematics,

and they have been declared unlawful, and any merit the idea ever may have possessed disappeared when it degenerated into a crooked racket. We are sorry to have seen some evidences of the racket angle in amateur radio. We assert that there is no place for such things in our game and that we're supposed to be fellows of sufficient discrimination not to toy with such mad ideas. Let us clean the thing instantly from our field. If that same urge to correspond could be directed to filling out a few neglected QSL cards, more joy to amateur radio would result and a similar contribution made to the reduction of Mr. Farley's deficit—the only ultimate beneficiary of the chain-letter plague.

Rumors Of all the questions that are asked us the most common one goes something like this: "Why don't you answer in *QST* these charges and rumors that float around amateur circles? Some of the things said are too ridiculous to need rebuttal and almost all of them are too pointless and unfounded really to require an answer. But, just the same, why don't you fight these things in *QST*?"

There is, of course, an excellent answer. *This League is run by a Board of Directors.* We are appointed and hired by the Board. We report to that Board in extensive detail, and only to them. To us it would be unethical and a general violation of corporate practice to short-circuit the governing board in matters in which we feel abused, and take our case direct to the membership. *QST* is a mutually-owned publication in which the officers have no more rights than the ordinary member. They have no right to use it for their own defense, justification or glorification. At each meeting of the Board the individual directors, as well as the Board as a whole, review the annual reports of the officers, examine the conduct of the headquarters, ask such questions as may have been raised by the membership or any other commentator, and in general receive any and all information or explanations that may be necessary. If an individual amateur wants information on such matters, it is almost invariably available from his director; or if it is not, the director can and will secure it. However, all matters of important general amateur interest are regularly discussed in *QST*, the facts given, the policies outlined and the reasons for them. That, in fact, is just what the editorial page and this department are for. Nor can we imagine a more dreary misuse of the good *QST* space that might be devoted to interesting articles

than for us to utilize it in constant reply to what Mr. Roosevelt has called "the preconceived conjectures of ill-informed commentators." We do not think that we should get excited and quit useful work when one of these amateur politicians, dizzy as a revolving door, sits him down before his tripewriter and dashes off some reams of mis-statements. Nor are our headquarters equipped with a Division of Psychopathic Research. We know that the great and sound majority of American amateurs will judge their League and its directors and officers in terms of their works and the present secure status of amateur radio. However:

A Few Facts It is currently being misstated that the League once had a constitution which limited membership to those currently holding amateur licenses, and it is implied that this was changed through some vile shenanigans. Our League started in 1914 and *QST* in 1915, but both had humble beginnings and did not spring full-formed from nothing. The first constitution of the League was adopted on February 28, 1917, and specified eligibility for membership in the following language: "Any one interested or engaged in radio telegraphy or telephony shall be eligible to membership." You may see this constitution printed in *QST* for May of 1917. The language remained in precisely this form until the adoption of the present constitution on December 18, 1923, when it was changed to read: "Any person engaged in or interested in amateur radio shall be eligible to membership." It has remained in precisely this language ever since.

QST before the war was the property of C. D. Tuska, our first secretary-editor. It was published by the *QST* Publishing Co., Inc., owned exclusively by Tuska except for one share of stock each in the name of his mother and of Mr. Maxim, to qualify as incorporators. In the resumption of operations in early 1919 after the war, the League bought *QST* from Tuska, paid him for it, dissolved the *QST* Publishing Company, and has been the owner and publisher since the first post-war issue in June, 1919.

The published operating statements of the League show the profit or loss from the normal operating activities of the headquarters establishment. When there is a profit from operations it goes into surplus. The surplus of course is under the control of the Board of Directors. There are important League activities not associated with headquarters operations which are managed directly by the Board from reserves set aside from such earned surplus. These activities are reported in the minutes of Board meetings, but naturally are not reflected in operating statements. The status of the surplus and appropriations therefrom is constantly known to the directors. If you have any particular questions, ask your director.

The night before these lines were dictated a well-known 'phone amateur was heard to assert on the air that to his positive knowledge the headquarters officers told the directors how to vote on every question that was before them at their recent annual meeting. This is sheer rubbish, and if any of you want to risk the honest indignation of your own director, just ask him about it! We do not like some of our orders for the coming year but nobody cares whether we like them or not. We are not running this League. The Board is running it and we are the manager or administrator, under orders that are the reflections of what the majority of your fellows said you wanted.

Ye Olde Times Pursuing the notes on old-time frequency assignments in this department the past two months: We amateurs used to claim the right to operate on all the wavelengths below 200 meters but as far as we know no amateur was ever licensed to do so. Crack amateurs were rewarded with a Z call and the special right to use 375 or 425 meters. "General" amateurs were all assigned the specific wavelength of 200 meters and occasionally one or two other specified wavelengths such as 175 or 180 meters. "Restricted" amateurs had the same sort of license except that, living within a few miles of a government station, they were limited to a half-kilowatt input. In 1922 it was thought desirable to give c.w. some encouragement over spark so the band 150-220 meters was assigned to c.w., of which 175-200 meters was also open to spark, i.c.w. and 'phone. This year the international conference of Washington was supposed to meet but it was put off and put off. In 1923 the "plus-200" feature was eliminated and the amateur band marked down to 150-200 meters. In 1924, pending the outcome of the international conference, the short-wave bands were added, to endure in the well-known figures until the end of 1928. In 1927 the international conference finally was held and resulted in the world-wide establishment of the amateur bands as they have existed ever since 1929.

Class-A Exams Amateurs in Alaska and Puerto Rico may now take the Class-A exam.

Through the efforts of the League, the Naval District Communications Officer at San Juan, P. R., is now authorized to give Class-A examinations, and any Army official in Alaska may now secure the sealed envelopes for this examination from the inspector at Seattle and administer the exam to any applicant who so arranges with him. We reported the similar Navy arrangement for Guam a few months ago, and of course the opening of a new F.C.C. office at Honolulu. We have now succeeded in bringing the Class-A license to all our territories and possessions under the F.C.C. except for a few small islands.

(Continued on page 72)

New High-Power Transmitting Pentode

200-Watt R.F. Output With Excitation Small

A BIG brother to the RK-20 has been added to the Raytheon transmitting line—a 2000-volt pentode which offers some real advantages for amateur transmitters of the higher-power classifications. The new tube, which will be known as the RK-28, is capable of outputs of the order of 250 watts for c.w. work, and can deliver 60 watts or better of 100%-modulated 'phone carrier, using suppressor-grid modulation. The characteristic pentode economy of excitation is present to the nth degree in the RK-28.

At this writing the power ratings on the tube are only tentative, pending completion of life tests at the factory. The power figures given below therefore are on the conservative side. The plate dissipation rating of 100 watts, for instance, is probably below the actual safe rating, since the plate is a good deal larger than in present tubes having 100-watt dissipation ratings. It is expected that production tubes will come through with a bulb of larger diameter than that shown in the photograph, at which time the size of the radiating fins on the plate will be increased so that the final plate dissipation rating may be in the neighborhood of 150 watts.

The internal structure of the tube resembles that of the RK-20, all elements of course being larger. The RK-28 has its plate brought out to a cap on top of the bulb, with the filament and grids connected to a 5-prong base at the opposite end. The base, of ceramic material, is an enlarged version of the familiar 5-prong receiving tube base, being about two inches in diameter and having much heavier pins. A new type of transmitting tube socket therefore will be needed for the tube; this, however, will mean no hardship except possibly temporarily, since several manufacturers expect to bring out suitable sockets in the near future. The overall length of the new tube is about half again as great as that of the ordinary "fifty-watter", with a bulb of larger diameter. Pin connections are the same as on the RK-20.

The RK-28 can be used for practically every type of r.f. service—crystal oscillator, c.w. power amplifier requiring no neutralization, as a Class-B linear, suppressor-modulated amplifier, control-grid modulated amplifier, and plate-modulated amplifier. Following are the tentative ratings on the tube:

Filament voltage	10 volts
Filament current	5 amps.
D.C. plate voltage	2000 volts max.
D.C. screen voltage	400 volts max.
D.C. suppressor voltage	45 volts max.
Plate dissipation	100 watts
Screen dissipation	35 watts

D.C. grid current	25 ma. max.
R.F. grid current	5 amps. max.
Interelectrode capacitances:	
Grid-plate	0.012 μ fd.
Input	11.0 μ fd.
Output	10.0 μ fd.

WHAT THE NEW TUBE CAN DO

The power amplification ratio obtainable with the RK-28 is tremendous compared with that realized in triodes of similar output rating. The grid driving power required for full output is quite small—a few watts at most. A typical set of operating conditions specified by the manufacturer is given in the following table:

Plate voltage	2000 volts
Screen voltage	400 volts
Suppressor voltage	45 volts
Control-grid voltage	-100 volts
Plate current	140 ma.
Screen current	60 ma.
Screen dropping resistor	26,000 ohms
Control-grid current	10 ma.
R.F. driving voltage	130 volts
R.F. driving power	1.8 watts
Power output	200 watts

It should be pointed out that the measurements in the above table were made in a test set-up operating at 800 kilocycles, and it is therefore natural to expect that because of higher losses the figures would not be quite so favorable at amateur frequencies. However, the tube was given as thorough a test as the limited time permitted in the experimental rig shown in the photograph, and although no attempt was made to make actual measurement of the driving power required it was obviously very low. At 3.5 mc. the tube could easily be driven to full output by a 47 oscillator, more than 200 watts being put into a dummy load with the plate showing no color. D.C. grid current of 5 to 10 ma. represented optimum excitation (bias 90 volts); higher grid current caused a reduction in output and efficiency. Positive suppressor bias is a necessity if best operation is to be obtained; there is a very marked improvement in both output and efficiency with the suppressor about 45 volts positive. Increasing the screen voltage beyond the recommended 400 volts resulted in no apparent increase in output, although causing the plate current to rise. The control-grid bias is not critical; the 100-volt figure recommended above is broadly optimum for efficient operation. If a grid leak is used it should have a value of about 10,000 ohms. At 14 mc. the tube operated equally well, showing about the same output as at 3.5 mc. with the same d.c. grid current. Increasing the grid current beyond the region of 5 to 10

milliamperes again caused a reduction in output and efficiency.

The tube also operates well as a doubler, giving about 100 watts output without exceeding the plate rating. The excitation requirements are similar to those for straight amplification.

SUPPRESSOR MODULATION

Since the carrier plate efficiency with suppressor modulation is a fairly fixed quantity running between 30 and 35 percent, the fundamental factor limiting the output is the tube's rated plate dissipation, assuming the filament emission is ample. This is the case with the RK-28; at the present conservative 100-watt rating the carrier output obtainable is in the neighborhood of 60 to 65 watts. The operating conditions listed below actually represent two modulation methods; the left-hand column gives the figures for suppressor modulation alone, using fixed screen voltage; those at the right are for combined suppressor and screen modulation.

	<i>Supp.</i>	<i>Supp. and Screen</i>
Plate voltage	2000	2000 volts
Screen voltage	400	400 volts
Grid voltage	-100	-100 volts
Suppressor voltage	-50	-50 volts
Plate current	80	85 ma.
Screen current	85	85 ma.
Grid current	11	11 ma.
Peak audio supp. voltage	90	90 volts
Peak audio screen voltage	—	200 volts
A.F. power for full modulation	0.4	7.6 watts
R.F. driving power	2	2 watts
Carrier output	60	65 watts

The higher audio power required in the case of combined suppressor-screen modulation results from the demand on the audio system imposed by the rather low effective screen resistance. The audio swing on the screen is approximately twice that on the suppressor, the actual value not being critical. The combined suppressor-screen system extends and straightens the modulation characteristic, giving somewhat higher output with less distortion. In particular, it brings the characteristic down more sharply to zero, lessening the familiar "tailing off" at the lower end.

A trial of suppressor modulation in our experimental set showed that excellent quality is obtainable. Neither of the sets of conditions shown above were exactly duplicated in this test, the screen being fed through a dropping resistor of about 25,000 ohms from the plate supply and allowed to swing at an audio rate determined by the tube characteristics¹. This gives about the same effect as combined suppressor and screen modulation, although avoiding the necessity for a second audio source. The suppressor bias is not critical so long as it is in the region of 45 to 67 volts, although the selection of suppressor bias within this range to some extent determines the carrier output.

¹"Screen-Grid Supply with Suppressor Modulation", *QST*, March, 1935.

In connection with suppressor modulation, it should be mentioned that the excitation and loading adjustments must be made with some care. As in the case of any grid-modulated amplifier, the adjustments should not be carried out with the idea of obtaining maximum carrier output for the allowable input²; this usually gives too high plate efficiency with the result that the modulation characteristic flattens off on the up-peaks. In practice this means that the antenna



THE NEW RK-28 PENTODE IN AN EXPERIMENTAL TEST SET-UP

A quarter kilowatt output with only a few watts driving power is only one of the things we like about this tube. With suppressor modulation a carrier output of 65 watts or more is readily obtainable, the audio power required being less than one-half watt.

current does not kick up on modulation—it may kick downward—and modulation is accompanied by a drop in d.c. plate current. Using the RK-28 we found it necessary to over-excite the tube—grid current about 10 to 15 ma. against the 5 ma. or so which gave maximum output—to get a linear modulation characteristic. In general, the conditions for suppressor modulation with any r.f. pentode will differ from those for c.w. amplification by requiring somewhat more excitation, relatively high screen current, and a decrease in plate efficiency.

OTHER TYPES OF MODULATION

The RK-28 can be used as a control-grid modulated amplifier, giving a carrier output of

(Continued on page 47)

²"Grid-Bias Modulation for the General Purpose Transmitter," *QST*, March, 1935.

A Complete Battery-Operated Portable Station

A Single 28-Pound Unit Containing Everything from Transmitter and Receiver to Monitor and Tools

By E. S. Van Deusen,* W3ECP

NO DYED-IN-THE-WOOL amateur considers his station equipment complete until it includes some kind of emergency and portable equipment which can be put into operation on the popular 80-, 40- and 20-meter amateur bands when the normal power supply fails, or when traveling in territory where general power distribution is limited or of an unknown character. For those who want a complete portable station of this sort, the equipment described herein, while of very limited power, should answer a great many needs.

For the use outlined, compactness and real portability probably rank first in requirements, while completeness of the station equipment and absolute independence from any external source of power follow closely in order. We have read of

After a study of the requirements and a rather extended period of experimentation, the writer decided upon a battery-operated station. The transceiver type of equipment was discarded as unsatisfactory for operation on the 3.5- and 7.0-mc. bands, although considerable success was attained with experimental equipment similar to that described by Keefer and Grant in the June, 1933, issue of *QST*. For purely pre-scheduled contacts the transceiver is excellent, but does not permit the advantage of fixed-frequency transmission which has been found to be almost a necessity unless contacts are limited to stations with similar equipment. Since the main objects of the equipment to be described are emergency use and the provision an opportunity to make local contacts when away from the home station, power

was sacrificed to the primary considerations mentioned. It can be justly called a "flea power" outfit. Remember, however, that a flea can perform surprising feats for its size; this station is no exception to this fact.

THE CASE AND ITS CONTENTS

The entire station is fitted into the disem-boweled case of a discarded portable Victrola, which was sal-

vaged from younger days of canoeing in the moonlight to the strains of "The Blue Danube" waltz. The photograph shows the arrangement of the equipment. The case is 4 inches deep and the lower part nicely holds the two No. 6 dry cells used as the filament supply, together with 135 volts of standard dry "B" batteries for the plate supply, all of which are strapped into place for security during transit. There is some space left over which is handy for the storage of a small quantity of spare wire rolled to fit. Held in the battery straps is a jointed gun rod which is used as a ground rod when the station is set up in the open with the antenna guyed to a convenient tree limb or telephone pole cross arm.

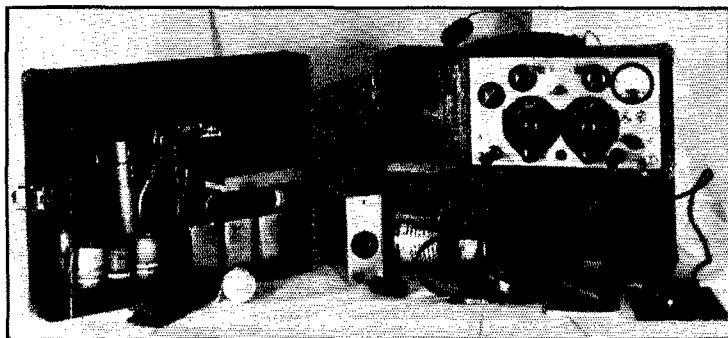

THIS C.W. STATION IS COMPLETE IN EVERY SENSE OF THE WORD

and seen many so-called portable stations which answer the first requirement only if and when the corner grocer is willing to lend friend amateur the use of his delivery truck for the day. On the other hand, we have also heard glowing descriptions of midget transmitters which can be parked in the corner of a suitcase, and of companion receivers of small dimensions, designed to operate from power lines, or even from automobile or self-contained batteries, but rarely have these descriptions mentioned absolutely essential accessory equipment without which operation in compliance with our regulations would be uncertain or impossible.

* Captain, Quartermaster Corps, U. S. Army, Holabird Quartermaster Depot, Baltimore, Md.

The set itself, consisting of a transmitter and a receiver which function separately but are mounted on the same 11-by-6-inch panel, is carried above the battery compartment and at the right. The wooden shelf on which it rests is provided with brass strips to lessen the wear in inserting and removing the set. At the upper left is a compartment large enough to hold a small pair of 'phones with their cord, plug and headband, together with the 66-foot field antenna of ordinary bell wire which is wound upon its bakelite insulators for carrying. Also accommodated are a couple of loading coils which have been found necessary at times to tune the antenna properly, and a ball of chalkline cord which has proved to be the best type of light, but strong cordage for emergency rigging of the antenna. This compartment is closed, when packed for traveling, by a bakelite panel on which the key, with its cord and plug wound upon it, is fastened.

The cover of the case, 2 inches deep, has been provided with removable-pin type hinges and can be detached from the body of the case for convenience when the station is set up. At the upper right of the cover, the monitor, which is only 1 7/8 by 4 7/8 by 6 inches overall dimensions, is carried on a shelf to which it is clamped for carrying. A spare plug, shorted with a resistor of 2000 ohms to match approximately the impedance of the 'phones used, is carried on the monitor clamp, while the two additional monitor coils are fitted into sockets under the shelf. At the lower left are a spare tube and the receiver and transmitter

coils which are not in use. These are fitted into sockets fastened to the cover. Under the monitor shelf are three small metal boxes which are

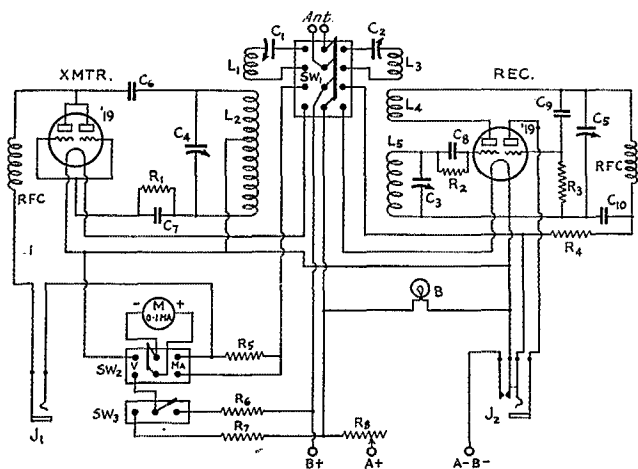

FIG. 1

- L1, L2—Transmitter coil. See coil table.
- L3, L4, L5—Receiver coil. See coil table.
- C1, C2—100- μ fd. midget variable condenser (Star).
- C3—25- μ fd. midget variable condenser (Star).
- C4, C5—140- μ fd. midget variable condenser (Star).
- C6—0.002- μ fd. mica fixed condenser.
- C7—0.0025- μ fd. mica fixed condenser.
- C8—0.001- μ fd. mica fixed condenser.
- C9—0.004- μ fd. fixed condenser.
- C10—0.1- μ fd. fixed condenser.
- R1—10,000-ohm 5-watt resistor, wire wound.
- R2—3-megohm 1-watt resistor.
- R3—250,000-ohm 1-watt resistor.
- R4—50,000-ohm 1-watt resistor.
- R5—Meter shunt resistor. See text.
- R6—250,000-ohm 1-watt resistor.
- R7—5000-ohm 1-watt resistor.
- R8—20-ohm midget rheostat.
- RFC—Radio frequency chokes.
- SW1—4-pole double-throw switch.
- SW2—2-pole double-throw switch.
- SW3—Single-pole double-throw switch.
- J1—Open circuit key jack.
- J2—Filament control 'phone jack.
- MA—D.c. milliammeter, range 0-1.
- B—3-v. pilot light.

very useful to hold spare grid leaks, clamps, connectors, a spare filament battery for the monitor, and such small necessities. A screwdriver and a pair of pliers, always needed and so often forgotten, are mounted in the cover at such positions that they do not interfere with the dials and knobs of the set when the case is closed. A small pen-type flashlight is included in the equipment and has been very useful on several occasions. A flexible insulated lead-in strip is tucked in the cover at the top, while a ground clamp is carried with the tools; and there is space for a small log book and pencil, if desired. When completely packed as described, this equipment weighs 28 pounds, about as much as a well-fitted traveling bag. By the use of some of the newer, lighter types of batteries recently announced, this weight can be reduced somewhat at no sacrifice of battery life.

TRANSMITTER, RECEIVER AND MONITOR

The circuit used is shown in Fig. 1. A Type 19 tube, used in the receiver as a detector and one step of resistance-coupled audio amplification,

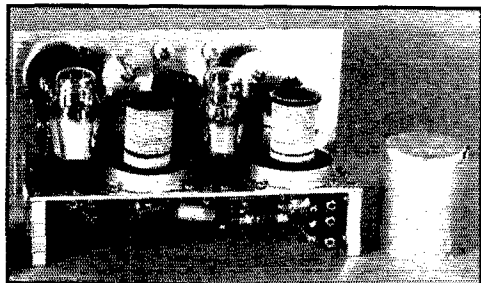

REAR VIEW OF THE TRANSMITTER-RECEIVER UNIT WITH THE COIL SHIELDS REMOVED

The jacks at the right fit into plugs in the rear of the cabinet for making automatic supply connections when the set is slipped into place.

has given results superior to several "peanut" circuits tested. Another 19 tube is used as a simple, self-controlled oscillator, with its plates and grids in parallel in a conventional Hartley circuit, for the transmitting end of the set. This arrangement for the transmitter was chosen, on the score of compactness and simplicity, over push-pull operation, since experiment showed little, if any, difference in results. To date no satisfactory oscillator-amplifier circuit has been found by the writer to provide both functions in a single tube of this type. Change-over from reception to transmission, and *vice-versa*, is accomplished entirely by the 4-pole double-throw switch, *Sw*₁, which controls not only the antenna circuit, but also the filament and plate supplies.

The photographs show the compactness and method of construction of the set itself. The panel is cut from 1/8-inch aluminum. The large dial on the left controls the receiver tuning condenser. The antenna condenser for the receiver is directly above, while the knob at the extreme left is the regeneration control, which, by the way, operates very smoothly in this circuit. At the lower left is the 'phone jack, of the filament control type. At the top-center are the antenna posts, small

carries, from left to right, the receiver coil in its shield, the receiver tube, the transmitter coil, also in a shield, and the oscillator tube. All wiring,

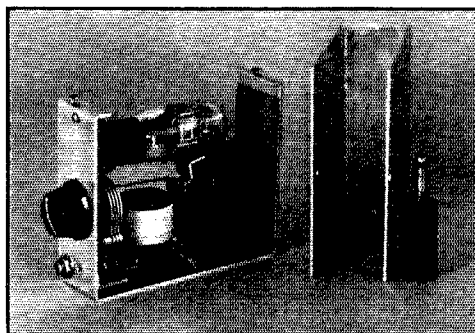

ALTHOUGH CONVENTIONAL IN CIRCUIT, THE SELF-CONTAINED MONITOR IS EXCEPTIONALLY SMALL IN SIZE

fixed condensers and resistors are underneath the sub-panel, and leads are unusually short and direct. In addition, all ground connections are made at a central point. Suitable coil shields to

RECEIVER COILS

Band	Antenna	Grid	Tickler	Wire Size
80 meter	10	44	16	No. 31 d.c.c.
40 meter	8	22	10	No. 22 d.c.c.
20 meter	6	10	6	No. 22 d.c.c.

All coils wound on 1 1/4-inch, 6-prong, plug-in forms. Antenna and tickler coils close wound. Grid coils spaced to occupy total winding space available. Approximately 1/2-inch spacing between coils on the same form.

porcelain stand-off insulators of the through type, and immediately below them is the change-over switch. A jewelled pilot light, fitted with a low-drain bulb, is placed at the bottom-center of the panel. The large dial at the right is the transmitter tank condenser control, and immediately above it is the transmitter antenna condenser. The jack at the lower right is for the key and just above it is the filament rheostat knob. The meter and its switches appear at the upper right of the panel. The metal knobs at the extreme sides, low on the panel, are for the purpose of handling the set into and out of its compartment, in which it is held by a small button and also by the friction of the bannana plugs and jacks which serve in this manner, in addition to providing a quick and simple means of connecting the power leads to the set.

The sub-panel, 2 1/2 inches wide by 10 1/2 inches long, is also of 1/8-inch aluminum and is held in place by two brackets so there is 1 1/2 inches clearance behind the panel. The left-hand bracket also supports the three jacks of the power connector on a small bakelite strip. The sub-panel

Coil Data

TRANSMITTER COILS

Band	Antenna	Grid	Tap	Wire Size
80 meter	10	28	9	No. 22 d.c.c.
40 meter	8	17	8	No. 22 d.c.c.
20 meter	5	6	2 1/2	Ant. No. 22 d.c.c. Grid No. 18 Enamel

All coils wound on 1 1/4-inch, 5-prong, plug-in forms. Antenna coils close wound. Grid coils spaced to occupy remaining space available. Approximately 1/8-inch spacing between antenna and grid coils.

meet the space requirements being unavailable commercially, National flanged shields, of 2 1/2-inch diameter, were modified for this use.

The meter, a high-grade 0-1 milliamper instrument, is arranged so that it indicates either the filament voltage, the available plate voltage, or the plate current drawn by the oscillator tube. Multiplying resistors are used for the voltmeter functions and when indicating plate current the meter is shunted by a resistor, the value of which was ascertained by the "cut and try" method, so that full scale deflection is secured at 30 milliamperes flow.

The monitor is conventional except in size. The insertion of the plug into the jack controls its operation. The problem of batteries in the limited space was solved by using small pen-light batteries for both filament and plate supplies of the 30 tube. Three of these units in parallel are used for the filament, while twelve units supply 18 volts for the plate. The monitor coils are wound on tube bases, using No. 31 d.c.c. wire.

(Continued on page 76)

WIXR

The Story of New England's Highest Radio Station

By Alexander A. McKenzie,* WIBPI-IXR

ALTHOUGH classed by the F.C.C. as a special experimental station, WIXR, amateur operated, close in frequency to the 56-mc. band and in frequent contact with amateurs, becomes a fitting subject for these pages.¹

In the fall of 1932, the Mount Washington Observatory was established upon New England's highest and stormiest peak for the duration of what was known as the Second International Polar Year. The primary object of the privately owned observatory (along with hundreds of other stations in all parts of the world) was to collect meteorological data. Since all branches of scientific endeavor are being tied closer together as time goes on, it was hoped that the radio equipment furnished for communication might serve for other than purely utilitarian purposes. It so happens that it did.

Because of the very great difficulty in keeping up any sort of outdoor structure in high winds, especially a 132-foot sky wire, work on the lower amateur frequencies was eventually reduced to a minimum and then dropped. Another more cogent reason was responsible for this move, too. At the very start of operations, even while the old Stage Office was being renovated for our winter occupancy, Al Sise, W1ASF, and the writer opened up a 5-meter circuit between the Pinkham Notch headquarters of Joe Dodge, W1UN, director of the Observatory, and the summit (portable W1OB). Through the kindness of one of the Observatory's best friends, Mr. Henry S. Shaw, W1FGA, a 5-meter transmitter and a receiver were built up at General Radio Company for use on the mountain. The transmitter employed a pair of 01-A tubes in a push-pull circuit, Heising modulation being accomplished by a pair of 33's. The receiver was the conventional three-tube super-regenerative

type. Similar terminal apparatus was constructed by the writer for Pinkham Notch. From that time until the present, this circuit, over a path a little off the optical, and over two and a half miles in length, has given excellent service on at least twice-daily schedules.

Power for all the transmitters, and receivers, comes from batteries. Storage batteries light the tube filaments while high voltage for the plates is supplied from dry "B" batteries. Five sets of Eveready Layerbilts in parallel furnish the greater part of the push for WIXR, while battery operated vibrators ease the drain on certain occasions when less power is required.

December 28, 1932, was the eventful day on which voice signals were exchanged with W1FGA in Exeter, N. H., who had hoped to work the mountain from Stratham Hill, on an optical path, with a portable outfit. That the signal from his home, farther away (91 miles between Exeter and

Mount Washington) and over a decidedly nonoptical path, should get through so well was a pleasant surprise. The signal has waxed strong with time and attention so that it has proved entirely reliable to the present day. Aside from a couple of months during the summer, daily skeds are run with W1FGA.

From a much weaker beginning, the signals between Seabrook Beach and Mount Washington were gradually built up so that voice communication was possible in

the spring of 1933. This circuit, 98 miles long, with many 5-meter obstacles, proved somewhat unreliable until Mr. Greenleaf W. Pickard, W1FUR, raised both his antennas and his power at which time the signals became "commercial" in both directions.

One fair March day, of that same eventful spring, Arthur E. Bent, W1COO, accompanied Al Sise up Great Blue Hill (near Boston) to see what might be done towards establishing communication between the Blue Hill Observatory of Harvard University and its sister station on

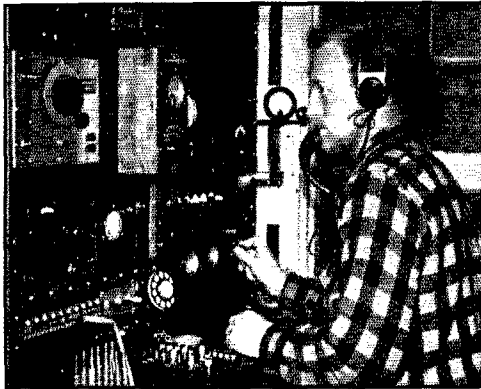

"MAC," IN ARCTIC REGALIA, AT THE CONTROL POSITION

*Mount Washington Observatory, P. O. Gorham, N. H.
¹ Amateur communication is now carried on under the call W1BPI instead of WIXR.

the mountain. Luckily, excellent voice signals were exchanged between W1CSP portable and W1FEX. The distance is 142.5 miles and the right-of-way must be littered with obstacles. Blue Hill's 635 feet of elevation and Mount Washington's 6284 feet above sea level made possible the reception of weak signals emanating from low-power transmitters. It was soon discovered, however, that these signals were weaker at some times than they were at others, and on this



THE HOME OF W1BPI-W1XR — 6284 FEET ABOVE SEA LEVEL

discovery was built up a program of signal measurements. This phase of the work has been recently augmented by a photo-recorder to plot a curve of continuous signal strength from W1XAV, located at Squantum, Mass. After the permanent establishment of a station on Blue Hill, the circuit between there and Mount Washington became, and remains, the longest consistent ultra-high frequency radio circuit ever operated!

Blue Hill became Boston's famed W1XW on 60.5 megacycles; Mount Washington acquired the call W1XR (now on 60.5, 53 and 42 mc.) to go with the amateur calls W1BPI and W1FEX (also W1FMG this winter), and started modulating the 71-A's Class-B. Mr. Pickard added to W1FUR the call W1XZ (same frequency as XR). W1FGA at Exeter adopted the frequency of 60 mc., developed a transmitter which would maintain it to within a few kilocycles and procured a crystal monitor as a further check.

Since January of this year great progress has been made at W1XR in the region of 2.5 meters. Daily contacts with W1FGA are mostly duplex using 2.5 meters one way and 5 meters coming back. The transmitters employ a single 71-A tube as oscillator, Class-B modulated by the same outfit which runs the 5-meter transmitters. The receivers are really adapters plugged into the detector sockets of the five meter super-regeneratives.

A few weak signals have been exchanged between W1XR and W1XZ, but the real DX has

been between Blue Hill and the mountain. Needless to say, the pair of 800's at W1XW pump more signals north than the 71-A is able to push to the south. In fact, the W1XR signal is merely audible. The 2.5-meter path from Blue Hill has been very reliable over a period of weeks. Interestingly, when the 5-meter signal from W1XW was entirely inaudible for almost fifteen minutes on the morning of March 5, during one of the thrice-experienced complete fadeouts, the shorter wave came through as well as ever!

Briefly, this is the history of ultra-high frequency progress on Mount Washington. It doesn't include all the big thrills or all the fun. For instance, how would you like to climb onto a water tank perched atop the very summit of the mountain to readjust a transmitter or to reconnect a broken feeder wire, assuming, of course, a wind of 90-100 m.p.h. and a temperature, let's say, - 10 F.? To be sure, it gets windier (last April 12th we measured a gust of 231 m.p.h.) and the temperature has been known to get down near - 50 F., but we usually find it convenient to postpone our delicate tasks until more moderate weather.

Although there are other transmitters, one in the hotel building and several in the Observatory proper, the water tank seems to be the prize location for good communication with Blue Hill.

A four-foot square box houses the transmitters on 2.5 and 5 meters besides providing a cable vault for the 300 feet of ten pair cable to the Observatory.

Even the present water tank antenna, well-guyed with wood braces, the feeders fastened to a wooden "messenger," is often subject to damage.

There have been memorable QSO's, too. In splendid isolation there stands the 5-meter chat with Ross Hull who pushed a signal through the 190 odd miles between West Hartford and Mount Washington for several hours one night last fall. What a thrill!

Before that, we had thought that the message sent via 5-meter relays from the mountain to New York City, or the QSO's with W1FGA portable on Mount Cadillac, Maine (151 miles distant), were pretty good.

Voice relays have afforded a lot of fun up here. Besides the thrill of sitting up on a lonely mountain monitoring a conversation between two urban centers such as Portland, Maine, and Boston (relay distance via Mount Washington about 210 miles), there is valuable experience gained in the practical application of the ultra-high frequencies to communications problems. Sometimes wire lines enter the relay network. An observer visiting the Base Station at the western foot of the mountain talked successful duplex via 'phone line and radio with a group of fellows at W1OR in Brunswick, Maine. Once, when W1XZ at Seabrook Beach wanted to talk to a friend in Belmont,

(Continued on page 74)

Data on the Metal-Shell Receiving Tubes

Ratings and Base Connections of Nine New Types

SINCE the announcement of the new metal-shell receiving tubes in May *QST*, data on nine types of the family have been made available by RCA Radiotron Division. With the tubes scheduled to make their appearance on the market later in the summer, this information gives us an opportunity to become acquainted with their applications in advance. Tube manufacturers are now equipped to make "tin tubes" and are going ahead with production—so it won't be long now.

In the following summary of the tentative data, notations of approximate equivalents in present types have been included to aid in placing the individual new members. A tabulation of pin connections is also given. As stated in the May announcement, the new tubes have an entirely different pin arrangement and are not interchangeable with present glass types.

Revised Pin Connection

The fact that the octal bases differ from previous base designs in being suitable for a universal socket makes it possible to set up a universal numbering system which is believed to offer ad-

Tube Type No.	Pin Positions and Numbers							
	1	2	3	4	5	6	7	8
6A8	S	H	P	G3 & G5	G1	G2	H	K
6C5	S	H	P	—	G1	—	H	K
6D5	S	H	P	—	G1	—	H	K
6F6	S	H	P	G2	G1	—	H	K8G3
6H6	S	H	P2	K2	P1	—	H	K1
6J7	S	H	P	G2	G3	—	H	K
6K7	S	H	P	G2	G3	—	H	K
6L7	S	H	P	G2 & G4	G3	—	H	K & g5
5Z4	S	H	—	P2	—	P1	—	H & K

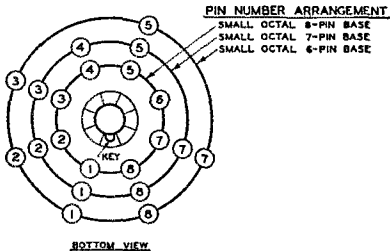

vantages in simplicity. In this new system, numbers are assigned to each of the eight possible pin positions. Numbering starts from the shell connection which is always the first pin to the left of the locating lug when the base is viewed from the

bottom with the lug toward the observer. Numbering is clockwise on the basis of possible pin positions. Thus, the pin numbers for a 6-pin base are 1, 2, 3, 5, 7, and 8. The letters under the pin numbers in the table indicate the elements connecting to the respective pins, "S" for shell, "H" for heater, "P" for plate, "G" for grid, and "K" for cathode.

6A8 Pentagrid Converter

(Similar to present 6A7)

Heater voltage (a.c. or d.c.)	6.3 volts
Heater current	0.3 ampere
Plate voltage	250 max. volts
Screen voltage (G3 and G5)	100 max. volts
Anode-grid voltage (G2)	200 max. volts
Control-grid voltage (G4)	—3 min. volts
Total cathode current	14 max. milliamperes
Maximum overall length	3¼"
Maximum diameter	1¾"
Cap.	Miniature
Base	Small octal 8-pin

6C5 Triode Detector-Amplifier

(Similar to triode section of present diode-triodes)

Heater voltage (a.c. or d.c.)	6.3 volts
Heater current	0.3 ampere
Plate voltage	200 max. volts
Grid voltage	—8 volts
Plate current	8 milliamperes
Plate resistance	10,000 ohms
Amplification factor	.20
Mutual conductance	2000 micromhos
Maximum overall length	2½"
Maximum diameter	1¾"
Base	Small octal 6-pin

6D5 Power Amplifier Triode

(Similar to present power pentodes triode connected)

Heater voltage (a.c. or d.c.)	6.3 volts
Heater current	0.7 ampere
Maximum overall length	3¼"
Maximum diameter	1¾"
Base	Small octal 6-pin

Single-Tube Class A Amplifier

Heater voltage	6.3 volts
Plate voltage	275 max. volts
Grid voltage	—40 volts
Plate current	.31 milliamperes
Plate resistance	2250 ohms
Amplification factor	4.7
Mutual conductance	2100 micromhos
Load resistance	7200 ohms
Undistorted power output	1.4 watts

Push-pull Class AB Amplifier (Two Tubes)

Heater voltage	6.3 volts
Plate voltage	300 max. volts
Grid voltage (Fixed bias)	—50 volts
Plate current (per tube)	.23 milliamperes
Load resistance (Plate to plate)	5300 ohms
Power output	5 watts

(Continued on page 88)

H A M D O M



ENSIGN LEROY HALEY, W9GNK, commanding officer of Section 8, Twelfth Naval District, U.S.N.R., runs the proverbial one-man



town. He is the postmaster, forest-fire warden, weather man, hotel keeper, school director, and superintendent of the hydro-electric plant at Tacoma, Colo. His amateur career began in Kansas in 1911, to be interrupted by the War with its "ten million miles of walking carrying a telephone on my back." Returning in

1919, he continued his studies until 1922 when he married and entered the employ of a utility company as operating engineer. In 1926 he went to "cactus land"—Arizona

—where he was employed on construction and operating of hydro-electric projects, retaining the "6" call acquired on the West Coast in 1924. In 1928 he came to the Rockies and the position he now holds, the call W9GNK following two years later. In 1931 he was commissioned Ensign C-V (S)



and assigned as unit commander. In 1934 he became Section Commander of all Colorado's Naval Reserve. Now he's on 75-meter 'phone and Navy c.w.—a real ham, and his section members think him a great fellow.

WILLIAM M. ATKINS, W9TJ, is known on four bands as "Bill," so we'll call him that, too. He was started in amateur radio in 1920 by 9RR, with a Benwood Rotary breaking 1 kw. Since that time he has had over 29,000 QSO's, worked 97 countries (39 with inputs less than 20 watts), and achieved international contacts on five amateur bands. Outstanding is his current work on 28 mc., his regular sked with ON4AU, and his desire to establish test skeds with all others interested in 28-mc. communication. In the past Bill's done about everything: city manager of Kansas City in the old Inkslingers, O.R.S., O.B.S., R.M., Ass't S.C.M., R.C.C., R.O.W.H.,

CRM U.S.N.R., and Radiotelegraph 1st Class, Radiotelephone 1st Class and Amateur Extra 1st Class licensee. His proud possessions include a beautifully framed stamp collection presented by K5AA; an almost complete file of QST's; and a remarkable monitor that rings bells, waves arms and shouts "Stop!" when the transmitter frequency drifts outside the band.

THE brother-and-sister station of Buffalo, N. Y., W8KYR-W8AOM, is owned and operated by Clara Reger and John Eichman, Jr. With separate transmitters in the same house, they operate simultaneously without interference; but whenever anyone speaks of W8AOM they are sure to ask for W8KYR. John was licensed in 1927, Class A in 1930, and now operates 4-mc. 'phone. He modulates a '10 with an 845. Clara got in the game when John discovered her voice was just dandy to outride QRM, some two years



ago. When she got on the air, though, in late 1933, she turned to 7013-kc. c.w., liking that better. Hams tell her she has an FB fist; being a piano teacher, that seems logical. We got a break; we're the first ham to whom she's sent a picture without having had at least ten QSO's; by then, she says, they're her friends. Both Clara

and John are real amateurs, consistently on the air, well-liked and widely known.

MARK L. MACADAM—"Mac"—to the boys and W1ZK to you—has travelled the road from spark and crystal detector all the way to 56-mc. 'phone. He has pounded brass on 600 meters as a commercial, operated a broadcasting station, installed and tested radio equipment for the Navy, handled over 10,000 words of amateur traffic for MacMillan in the Arctic, built the Massachusetts State Police Radio System, is Section Control in



(Continued on page 47)

Further Controlled-Carrier 'Phone Systems

Suppressor-Grid and Class-C Excitation Methods

THE principle of controlled carrier, initially described for Class-B plate-modulated transmitters in Jan. *QST*, can be applied to suppressor-modulated pentodes, as has been demonstrated by W. E. Davison, VE2BC. The system is essentially simple; enough fixed negative bias is applied to the suppressor so that the plate current is brought almost to zero, and the

for the syllabic modulation; VE2BC used 4000 ohms at R and $0.1 \mu\text{fd}$. at C in his experimental set-up. To illustrate the control range obtained, the unmodulated antenna current obtained under normal conditions—optimum bias, carrier not controlled—was 0.42 amp. at VE2BC. With the control system in operation, antenna current with no modulation was 0.05 amp.; with full modulation, 0.5 amp.

It is important that the speech be "washed out" completely in the bucking or control circuit. This can be checked by connecting the suppressor grid temporarily to the positive terminal of the bucking circuit so that the modulation does not get to the suppressor from the regular modulation transformer. Under these conditions, it should be possible to cause the antenna current to swing from the minimum value (with no speech) to the normal unmodulated value by speaking into the microphone, although no voice modulation should be discernible on the carrier. Possibly some experimenting with the values of R and C will be needed to meet this condition. The resistor R can be made fairly high in value so that relatively little additional load is thrown on the modulator by the rectifier circuit. When R is high, however, condenser C must have relatively low reactance for audio frequencies to prevent audio distortion which might result from current flow in R when the suppressor swings positive on the audio peaks. The small audio suppressor current must flow through the bucking circuit as well as through the bias source and suppressor-cathode circuit itself.

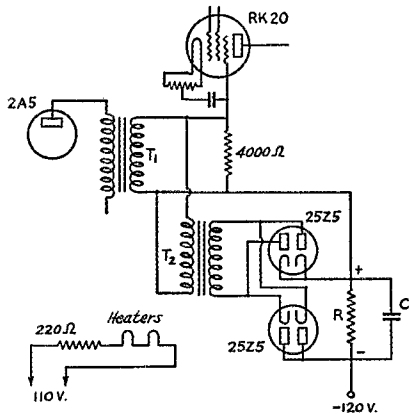

FIG. 1—CARRIER CONTROL WITH SUPPRESSOR GRID MODULATION

Suppressor bias is controlled in accordance with average speech amplitude by means of a bucking circuit, the bucking voltage being obtained by rectifying and filtering part of the audio output of the modulator. Circuit constants are discussed in the text.

output thereby reduced to a very low value, when the carrier is unmodulated; a bucking voltage, the value of which depends on the average speech amplitude, is then introduced into the suppressor biasing circuit so that the carrier amplitude rises and falls with the average speech amplitude. The bucking voltage should reach a value under maximum speech conditions such that the resultant bias is the optimum operating value for the particular type of tube used.

The practical circuit diagram used by VE2BC is shown in Fig. 1. In this rig a 2A5 is used to modulate an RK20. The modulation transformer, T_1 , is an ordinary output transformer designed to work from a 2A5 into a 4000-ohm load; the 4000-ohm resistor tied across the transformer secondary provides the proper load resistance. The bucking voltage is obtained from a second transformer, T_2 , having a 1:1 ratio, and a full-wave rectifier using two 25Z5 tubes in bridge. The resistor R and condenser C should be of values suitable to give a satisfactory time constant

GRID BIAS CONTROL

A system of carrier control applicable to plate-modulated transmitters and having the advantage that a high-voltage plate supply is not required, as in the case where the Class-B modulator performs the control function, has been used successfully by Ted C. Reid, W7HR. Its operating principles are somewhat similar to the suppressor-modulation system described above, the carrier control being obtained by varying the grid bias on the Class-C stage. The control voltage is obtained by rectifying and filtering part of the speech-amplifier output! W7HR describes it as follows:

"The trick is accomplished with a 56 audio detector or rectifier acting as a control tube in the grid-bias circuit of the modulated amplifier. As shown in Fig. 2, audio voltage from a suitable level in the speech amplifier is fed into the detector's grid; this in turn varies the average plate resistance in proportion to the input signal's

amplitude. This varying resistance is used to swing the modulated amplifier's bias between complete cut off and normal operating value.

"The condenser C_1 serves to filter out the audio pulsations and give a smooth and even control of the bias. If this condenser is made too large there

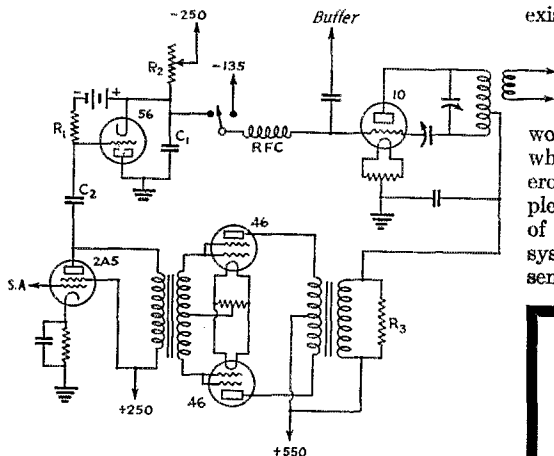

FIG. 2—GRID-BIAS CARRIER CONTROL OF A PLATE-MODULATED AMPLIFIER

- C_1 —1 to 2 μ f., 400-volt rating.
 - C_2 —.05 μ f.
 - R_1 —100,000 ohms.
 - R_2 —High-resistance variable grid leak.
 - R_3 —25,000 ohms, 5-watt rating.
- Circuit parts not listed above are usual for the type of transmitter shown; in this case a pair of 46's modulate a 10 Class-C amplifier. For other powers some modification of the values shown may be desirable.

is a slight lag in the carrier's building up on sharp syllables of speech, and consequently overmodulation is apt to occur; also, there is a delay in the carrier going out at the end of a word. On the other hand, if the capacity is insufficient there is danger of distortion from unwanted grid modulation. A value of 1 or 2 μ f. has been found quite satisfactory.

"It was found that considerable current still flowed in the r.f. amplifier plate circuit even with its grid completely open, so an external bias supply of around 250 volts was fed through variable resistor R_2 to pull the grid still farther negative and obtain more complete cut off when no modulation is present. The proper adjustment of R_2 was determined experimentally.

"Preliminary adjustments were made with the Class-B tubes removed from their sockets. With the gain control set at normal value, the modulated amplifier plate meter can be kicked around at will by speaking into the mike. However, no audio modulation should be present on the carrier when checked on the monitor at this stage. Everything functioning properly, the Class-B tubes were replaced and the revamped signal put on the air. Resistor R_3 is shunted across

the modulation transformer for protection against sudden surges at times when there is no load on the Class-B tubes.

"A switch has been provided to change from automatic control to regular bias.

"With a little patience and ingenuity this arrangement should be made adaptable to any existing 'phone transmitter. Reports on the signals resulting from this system have been very interesting. Reduction of carrier hiss and background at the receiving end greatly improved the intelligibility when working DX. A most peculiar effect takes place when QRM settles on W7HR's frequency. Heterodyne whistles are reported to disappear completely between syllables of speech, leaving a sort of 'crink-a-nope' effect. More general use of this system of automatic control should prove a god-send in our congested 'phone bands."

Silent Keys

It is with deep regret that we record the passing of these amateurs:

- William A. Coday, Jr., W5EAO, Albuquerque, N. M.
- Curtis G. Docherty, W1BML, Providence, R. I.
- Arthur K. Forsyth, W2QW, New Brunswick, N. J.
- Herbert W. Ingersoll, W2BWB, Ossining, N. Y.
- J. E. Martin, W3END, Philadelphia, Pa.
- Joseph Schwartz, W2CIH, New York City
- William Roy Smith, W9AQL, Chicago, Ill.
- N. Eugene Swenumson, W9HJK, Baldwin, Wis.
- Wilbur M. Taylor, W2BMZ, ex-2ATY, Newburgh, N. Y.

Strays

Here's one for the book: Reading his local newspaper, W9GGZ ran across a reference to a chap by the name of Guy Wire!

Add to odd coincidences: First station worked by VE3AAY after a layoff of several years was W3AAY!

W8MJR suggests coating crystals with Higgins Waterproof Drawing Ink to lower the frequency. Frequency changes of as much as 12 kilocycles have been obtained by putting a few thin coats on each side of the crystal. The thicker the coat the greater the frequency change. The ink, which can be obtained from stationery stores or drafting-supply houses, can be washed off readily with alcohol or ether.

San Diego Radio Fiesta

FIESTA! A word symbolic of joy at peak voltage in sunny California on the border of old Mexico. Ham doin's mixed with charming señoritas, technical radio, nudists, the world's believe-it-or-nots, people of all nations, cities of magic, a man-made flaming aurora borealis, old world atmosphere, architectural splendor, magnificent palaces, modern marvels 'neath tropic skies. That's a kaleidoscope picture of the gigantic Radio Fiesta scheduled for July 20th and 21st in the heart of the World's greatest Exposition, Balboa Park, San Diego, California.

One thousand dollars worth of prizes! At least, one grand of iron dollars is being spent by the San Diego ham population for an array of radio prizes such as has never been seen at a similar occasion. Setting a minimum of a carbon-plate type '10 bottle or its equivalent as the lowest prize, the local gang have made positive that the prize you carry home to your shack will be worthwhile. All prizes except those awarded for the many contests will be door prizes. No fiesta profits are anticipated and every dime is being put into rewards for those who attend. At least one thousand amateurs are expected. Hams from all over the western United States have signified their intention of being on deck for the big celebration. The more attendance, the more prizes—there is no upper limit.

Contests galore are on schedule, many new and different. Instead of the usual code speed contest this feature will consist of a QRM readability test. Several different stations will be fed into the p.a. system along with a little broadcast QRM for good measure. The contestant must copy a certain station through this interference.

Ambitious YL's and XYL's with melodious voices will be given a chance for competition in the Mike Audition judged by a real expert, Gary Breckner, well-known C.B.S. radio announcer and KGB station executive, who, by the way, is also master of ceremonies for the ham festivities.

Contributing to ham progress in emergency communication is the big portable contest. These will be judged for design, workmanship, appearance and originality. Both d.c. and "pansy" (a.c.) types of portables are welcomed.

Other contests include a tug-of-war; 'Phone vs. C.W. hams, a hidden 56-mc. transmitter hunt, a prize to the ham coming from the greatest distance, and many other contests that the fertile minds of the Fiesta committee will evolve in the interim.

Trips include a visit to the giant Navy radio station NPL, harbor trips to ships and navy vessels, radio inspection of military radio at North Island where is situated the Navy's largest flying field and the famed Rockwell Field of the Army;

trip to a local brewery (with samples), journey to old Mexico to Agua Caliente and Tia Juana, fishing trips, local broadcasting stations and other attractions.

This year's W6USA, official ham station of the exposition, affords tremendous interest. A powerful one-kilowatt rig of no mean proportions offers amateurs an opportunity to pound the key or use the mike attached thereto. Other transmitters will also be on exhibition. Portable operation will take place before the thousands of visitors to the Expo and offers hamdom a real chance for the publicity it needs.

Railroads, shiplines, and bus companies are joining with San Diego hotels in making rates the



THIS GANG WORKED THREE DAYS MAKING A TRANSMITTING AND RECEPTION SURVEY IN CONNECTION WITH THE SAN DIEGO RADIO AMATEURS FIESTA, JULY 20TH-21ST

lowest possible for those who attend the Fiesta. The women folk of visiting hams who see "no sense" in radio shop talk will find a ten-ring circus in the wonders of the Expo. Mrs. W6FQU will serve as hostess.

The exact schedule for the two-day events are:

Saturday, July 20th

- 9:00 a.m. Beginning of Registration.
- 12:00 to 2:00 p.m. Inspection trip to ABC Brewery. Retire to Exposition.
- 3:00 to 5:00 Ultra-high-frequency equipment contest in Expo grounds.
- 5:00 to ? p.m. Visit Expo exhibits. Technica talks in House of Hospitality. Visit W6USA.

Sunday, July 21st

- 9:00 a.m. to 1:00 p.m. Agua Caliente. Rockwell Field, Naval Air Stn. NPL Receiving and Transmitting Stations. Naval Vessels.
- 2:00 p.m. to 5:00 p.m. Novelty Code Contest. Tug of War—'Phone vs. C.W. Ladies' Audition Contest.
- 6:30 p.m. Meet at Pier—Ft. of Broadway.
- 7:00 p.m. to 11:00 Banquet. Speakers, drawing of door prizes, delivery of contest prizes.

The Fiesta Headquarters will be at the San Diego Hotel, where accommodations may be had for as low as \$1.50 per person or \$2.50 for two persons. The center of operation, which is in the Exposition, will be at the House of Hospitality.

Tickets for the two-day celebration are \$3.00, and include everything, such as two tickets (one each day) to the Exposition, the banquet, other

eats, etc. There will be a \$2.00 ticket, which will include one ticket to the Exposition, a chance in contest and banquet only. (This ticket will not give you a chance at the door prizes.)

Request for reservation tickets and other information should be addressed to the San Diego Radio Amateurs Association, 2340 University Avenue, San Diego, California.

A Burlesque

By M. L. Connes*

LISTENING on one of the 'phone bands the writer was greatly impressed with many things—chiefly that a QSO may last one hour, and the final good-byes about twice as long. The following is purely caricature—friendly, because the writer hopes soon to join the ranks. The characters are purely fictitious, but it should not be difficult to recognize the types.

W2XXX comes on the air about 11 p.m. He hopes to work a few DX stations before retiring. Alone in his shack, he has put a pot of coffee on the gas range in the kitchen, two rooms away from his transmitter. He is very patient and unwilling to sign off, fearing to hurt the other fellow's feelings. He has been hooked up with W3YYY for the past three hours, and is becoming both tired and very, very hungry.

W2XXX (a bit wearily)—Well, old man, I hope you got all that dope on the antenna you should use. It's now 2 o'clock a.m., and we've been at this now for about three hours. I'm starved and I need some 'shut-eye'. I must be up bright and early. I still have a job—I hope. What do you say? 2XXX over to 3YYY.

W3YYY—2XXX, 3YYY back. I don't think I got the last part, old man. I did hear you say something about getting a job next week. Say—a funny thing just happened. Remember giving me the measurements of that new antenna and feeder system about an hour ago? I wrote it down carefully, and what do you think? A gust of wind suddenly came up from nowhere and blew the dope right out of the window. Would you mind giving me the dope all over again? And when you come back, give me a line on my modulation. I'm now about 10 inches away from the microphone. What say? 2XXX, 3YYY by.

W2XXX (Sighing)—2XXX back. I'm sorry, but I think we should end this QSO. I'll send you the dope by mail. I put some coffee on the

gas range in the kitchen a long while ago. It's boiling over. I can smell it burn. I enjoyed the QSO, and am turning it back to you for a final. 2XXX to 3YYY.

W3YYY—Fine business—fine business, I'll say. So you are having a cup of coffee, eh? Don't you know that coffee is bad for the system? It knocks sleep right out of you. While I'm talking to you I have before me a large platter of cold cuts—you know, imported swiss cheese, ham, sturgeon and the rest. I am right now nibbling on a turkey leg. Goes well with this beer. That's one advantage over c.w. You can eat and talk at the same time, hi. By the way, I am now about two feet away from the mike. Tell me if there's any difference between this transmission and the last, old top. 3YYY by for 2XXX.

W2XXX (with alarm)—2XXX back. Say, old man, we must end this. The coffee spilled all over the gas range. I'm smelling gas, I think. Ow! And now my dog, Spotty, just caught his paw in the mouse trap! I don't want to be rude, so I'll turn it over to you for the final honors. Please make it snappy. 2XXX to 3YYY for the final.

W3YYY—3YYY back. All O.K.—all O.K.—one hundred percent—except for just a little weeny QRM, on the last part. Say—that was very funny about your dog chasing a mouse around the shack. Don't let mousie get into your buffer, hi, hi. I hope you are enjoying your coffee the way I'm enjoying this beer. When you come back, give me a check on my quality. I am now standing ten feet away from the microphone. What say?

W2XXX (fearfully)—We simply must end this QSO! I smell smoke! I think the shack is on fire! By George, it is on fire, and the fire engines are just arriving! Best of 73's, old man.

W3YYY—3YYY coming back. Fine business. You are coming in here a good R9 plus, and I don't mean maybe. I may add that your quality is the best I've heard since last

* 1501 Broadway, New York, N. Y.

Tuesday. I had a QSO with a fourth district. We were hooked up for about four hours, when something must have happened to his transmitter or his receiver, because he never did come back to me. Guess it was his receiver. All O.K. about the fire engines. I heard them passing your place, too. There should be a law against ringing bells when an engine passes an amateur's shack, hi. Give me a report on my quality. I am now *fifteen feet* away from the mike. Was there any difference in the last three transmissions? 3YYY over to 2XXX.

W2XXX (*gasping*)—I'm—I'm choking—the smoke—the flames—(*crying pitifully*) I don't care about my things burning up, but I want to save my transmitter. The firemen are just (*gasp*) breaking in—I—I can't wait for a final—I—I

(*There is a complete silence for about two minutes.*)

W3YYY—2XXX—2XXX—2XXX—. 3YYY back. Everything fine business! A good R9, except that your voice seemed to change on the last part, and you faded out a little. You must have been heterodyned, or something. I did not hear you sign off. It must be the band we're working on, hi. I'm now a good *twenty-five feet* away from the—(*Quickly*) There goes the doorbell. It's the XYL back from her mother's. Sorry to cut you off. So long. 3YYY off.

Radio Equipment of General Utility

(Continued from page 20)

vide radiating lengths of $\frac{1}{4}$ - or $\frac{1}{2}$ -wave length for the 7- and 14-mc. bands, and $\frac{1}{4}$ -wave length for the 3.5-mc. band (operating against ground). The shorter lengths are for ground connections, receiving antenna or substitution for different antenna lengths. The twin conductor sections can be employed for feeders, key or microphone extension leads, and similar purposes.

A six-volt dial lamp with socket is also carried in the cover and connected in series in the antenna or feeder lead as a resonance indicator during the preliminary transmitter adjustments. Final adjustments are made with this indicator removed and by noting the milliammeter in the power amplifier plate circuit.

The power cord length of 20 feet permits installing the equipment at a vantage point within that distance of the power outlet.

OPERATION AND PERFORMANCE

In the preceding description of the design and construction of the several units, a number of the operating features, indicative of the extreme flexibility of this type of equipment, have been

brought out. However, the ease with which the several units can be adapted to the various functions of transmission, reception and amplification can only be fully appreciated by actual service tests.

The usual functions of the units need no further emphasis. However, the flexibility and ease of adjustment may not be so readily apparent. In tuning the transmitter, for example, after selecting the coils for the desired frequency band, the receiver coil for a higher or lower frequency band is plugged into the detector and the master oscillator frequency adjusted by beating harmonics, the oscillator band-spreading insuring that a harmonic received in the amateur bands (lower or higher than the frequency of the transmitter) will result in the correct frequency adjustment, due allowance being made for the overlapping of the assigned frequency bands and their harmonics. The above adjustment of oscillator frequency is made with the selector switch in the mid position—"Phone or Standby"—and with the key plugged into the power amplifier plate circuit and the key open. During this monitoring adjustment the speaker cone circuit is open, requiring the use of the headset.

The transmitter is neutralized in this same manner by listening to the reaction of the power amplifier plate tank tuning upon the oscillator frequency and adjusting the neutralizing condenser for minimum reaction. These adjustments can be made very readily, leaving only the final tuning of the power amplifier plate tank and load circuits. For these adjustments the key is removed from the p.a. plate circuit jack and the milliammeter plugged in. The p.a. plate tank is first tuned for the pronounced minimum dip, then the load circuit tuning and coupling are adjusted to load the power amplifier as indicated by the usual rise in plate current, always keeping the p.a. tank tuned for the minimum dip. The antenna or feeder tank indicator prove helpful in securing an approximate adjustment and in coarsely checking the position of the volume control for satisfactory 'phone modulation; however, the final tuning adjustments should be made with this lamp removed.

The various ratings of this equipment are summarized as follows:

Receiver Frequency Range	550 to 22,000 kc.
Audio Power Output	2.5 watts
Amplifier Input Impedance	200 and 100,000 ohms
Transmitter Frequency Bands	3.5, 7 and 14 mc.
Input to r.f. Power Amplifier	14 watts—c.w.; 3.2 watts—'phone
'Phone Modulation Capability	90 per cent.

It is the sincere hope of the writer that the notes on this general utility portable equipment may serve as a stimulus to other members of the radio amateur fraternity in the design and construction of the type of apparatus which meets so many and varied applications.

With the Affiliated Clubs

THE season of outdoor activities is at hand. Many clubs report opening their summer "doings" by taking portable gear up into the hills, to the seashore, or out "under the apple tree" to participate in the Third Annual A.R.R.L. Field Day. This type of club program meets wide approval at this time of year.

COMING EVENTS

At Ocean City, Maryland, July 13th-14th: A real hammy hamfest will be held at the George Washington Hotel under the auspices of the Del-Mar-Va Amateur Radio Club. Wonderful bathing, fine fishing, famous Maryland fried chicken, dancing, prizes—these are just a few of the inducements offered by the committee. Price—\$3.00 per person, with special hotel rates to those who stay overnight. Special discount, if tickets are purchased before July 11th. Write W3BAK, Laurel, Delaware, for advance reservations.

At San Diego, California, July 20th-21st: The San Diego Radio Amateurs' Association promises a memorable time to all who attend the Radio Fiesta at the California Pacific International Exposition. See details elsewhere in this issue.

At Aurora, Illinois, August 4th: The eighth annual hamfest of the Fox River Radio League will take place at Exposition Park. All amateurs and their YFs and YLs are invited.

AKRON PROGRESSIVE SHORT WAVE RADIO ASSN.

Among the clubs affiliated during the 1935 Board meeting is the very active Akron (Ohio) Progressive Short Wave Radio Association. W8MLV is the station of this association, operating crystal controlled on 1820 kcs. Circulation of "The Aerial," club paper, is now in the vicinity of 500; this paper not only includes local Akron items but also covers activities of clubs and individual amateurs throughout the entire state of Ohio. The Buckeye Short Wave Club of Akron is holding quarterly meetings with the A.P.S.W.R.A. to strengthen coöperation and understanding between the members of the two clubs. Firm in the belief that "in union there is strength" Akron amateurs are moving forward!

ANTHRACITE A.R.C. HAMFEST

Amateur Night at last joins hands with Amateur Radio . . . at least the Anthracite Amateur Radio Club (Wilkes-Barre, Pa.) successfully incorporated "amateur night" entertainment into its First Annual Hamfest held March 30th. It met with the approval of the gang and was thoroughly enjoyed. Club entertainment com-

mittees might try a little amateur talent, or, more interesting, might enlist the talent from the club membership and thereby have a true "amateur" program . . . the kind the gang could "appreciate"!! In addition to the entertainment, good speakers, dancing, prize distribution and an excellent dinner kept everyone happy, and there were over 250 hams, YLs and YFs in attendance. Those responsible for the success of the affair: W8EJS, club president; W8KQB, secretary; A. Marth, vice-president; W. Zaverzence, treasurer; W8EKG and W8GHN. Visitors are always welcome at the club meetings, held on alternate Fridays at W8EKG, 89 South Main St., Wilkes-Barre, Pa.

AMATEUR RADIO AT SPEEDWAY

The Indianapolis Radio Club exhibited an amateur station, under the club call W9JP, at the famous Indianapolis Speedway during the 1935 auto race. A collection of photos and QSLs was on display. A p.a. system was used to attract the attention of the crowd, and proved very valuable to this end. Operators at W9JP were W9SDQ, W9DSC, W9TE, W9SPB, W9AUT and W9DNQ. W9MPR and W9UT assisted with "public relations" work. Several hundred messages were handled, being routed through W9JRK, Indianapolis trunk line station. Attendance at the race was about 157,000.

VISIT THE CLUBS

One good feature of the majority of ham clubs is that they don't require a visiting ham to produce a long list of credentials before entering the club portals. By and large, any ham is welcome at any ham club, so don't be bashful about dropping around to your local society. Clubs are splendid places to get acquainted with other amateurs and to participate in interesting discussions on amateur radio. At headquarters we have recorded the addresses of the several hundred amateur radio clubs affiliated with A.R.R.L., their places and times of meeting. Do you want to be put in touch with a club in your vicinity? Would you like to attend a club meeting in another city you are visiting? Address the Communications Manager (enclosing 3¢ stamp, please) for data on Affiliated Clubs in your vicinity.

MILWAUKEE RADIO AMATEURS' CLUB

The highlight of the annual QSO Party Hamfest of the Milwaukee Radio Amateurs' Club on May 18th was a talk by Central Division Director Roberts, W8HC. Nearly 300 hams were present. The club has three grades of membership: (1) Junior Member—anyone under 18 years

of age, (2) Associate Member—anyone over 18 years having a bona fide interest in amateur radio, (3) Regular Member—anyone holding an amateur operators license, who also is a member of A.R.R.L. Only Regular Members are eligible for election to the club's board of directors. At the annual meeting on May 23rd the following were elected to the board: W9HRM, W9GHN, W9RH, W9LJU, W9GSP, W9ANA, W9GVL, W9DIJ. The new officers are: W9HRM, president; W9DIJ, vice president; W9GSP, secretary; W9LJU, treasurer.

SOUTH HILLS BRASS POUNDERS AND MODULATORS

One hundred and twenty hams attended the hamfest under the auspices of the South Hills Brass Pounders and Modulators League of Pittsburgh, Pa., on April 2nd. The general run of hamfest activities kept enthusiasm high. Prizes and good eats left nothing to be desired. The South Hills League has a membership of about fifty, most of which is licensed and active on the air. Officers: W8PX, president; W8GQX, vice president; W8GJM, treasurer; E. J. Port, secretary; W. H. Martin and W8CKO, directors; W8AMY, W8AKJ, W8LCI and W8UK, committee members.

CENTRAL DIVISION HAMFESTS

All attendance records were shattered at the Dinner Dance Hamfest of the Chicago Area Radio Club Council and Mid-West Radio Mart held at the Congress Hotel, Chicago on March 30th. Reports have it that 3000 individuals (hams and their guests) were present!! A decidedly "huge" success! We wonder if it will ever be equalled—except in Chicago!

The Motor City Radio Club of Detroit, Mich., was host to about 500 hams, YLs, YFs, etc., at its hamfest on March 24th. Speakers included Director Roberts, W8HC, Fred Schnell, W9UZ, Dr. Simpson, W8CPC and A. L. Budlong. The entire program was fast moving and there was no lull from start to finish. Entertainment featured artists from local broadcast stations. The M.C.R.C. plans to make the hamfest an annual affair.

56 MC. AT BOAT REGATTA

The St. Joseph Valley Amateur Radio Club (Mishawaka, Ind.) provided communication between the judges' stand, drivers' dock and observers' posts during the annual St. Joseph river regatta, an outboard motor boat race program. 56 mc. was used throughout. W9CRZ at the official float and W9LG at the drivers' tent assisted in dispatching trouble boats to aid racers in distress and in conveying other information to the race officials. W9AB operated in an automo-

bile kept watch at the north end of the course. W9FHB was operated in a boat; this station was kept very busy cruising hither and yon with supplies, instructions, etc. Transceivers were used at all stations.

MISCELLANY

A low power contest, conducted by the Delaware Amateur Radio Club, was won by W3DIA with 12,442 miles, W3FFF second, W3DUK, third. Maximum input allowed was 5 watts. During April a contest was held to determine which member could contact the greatest number of states. Officers of the D.A.R.C.—W3DUK, Chairman; W3DNI, Secretary. . . . The Oakland (Calif.) Radio Club held a 28-mc. contest in May. About 75 members of the club were on that band during the contest. . . . The Springfield (Mass.) Radio Association, W1BWY, celebrated its fifteenth anniversary on June 1st. . . . On April 28th the Columbus (Ohio) Amateur Radio Association conducted a 56-mc. treasure hunt. The first prize winners located the hidden transmitter within about 150 feet on the first attempt. . . . The Connecticut Brasspounders' Association reports making a trip through a local gas and electric plant one meeting night. This is passed along to other clubs as a suggested way to pass an interesting and instructive evening. . . .

—E. L. B.

Strays

A Neutralizing Kink

A note from W6IY gives a useful hint on neutralizing buffer stages: "A wrinkle borrowed from Ole Friend Commercial Practice has to do with the neutralization of a stubborn buffer stage in a 47-10-203-A rig as described in current *Handbooks* and in *QST* some months ago. Using an r.f. galvanometer as an indicator it was impossible to remove all traces of r.f. from the buffer tank. The final amplifier, with its split-stator tank, neutralized perfectly. The 10 stage was stable enough to allow its use as a driver to neutralize the final, which was done according to Hoyle. Then plate voltage was removed from the buffer and full plate voltage applied to the final. If the final is biased to cut-off or slightly beyond, any current flowing in its plate circuit is the result of excitation fed through from the unneutralized buffer stage. In my case, this current could be reduced to zero by adjusting the buffer neutralizing condenser, keeping all tank circuits in resonance throughout the operation, of course. A final check made on the buffer tank with the r.f. meter showed just a trace of residual r.f., the source of which is unknown (probably because coupling the r.f. indicator caused a slight unbalance—*Ed.*), but the whole set operates stably at all frequencies and in a perfectly normal manner."

'Phone-C.W. Contest Results

THE second A.R.R.L. 'Phone-C.W. QSO Party/Contest was held on the two weekends, February 9th-10th and 16th-17th. It was a test to see which 'phone operator could contact the greatest number of c.w. stations, and similarly to ascertain which telegrapher could work the greatest number of 'phone stations. Not only was it an interesting activity from a competitive angle but it made possible QSO's between voice and telegraph operated stations in much greater abundance than in the course of everyday operating. It was in a sense a "get acquainted" party for voice operators and telegraphers, who normally have but few contacts due to the difference between their two modes of communication. To many it brought home the fact that telegraphing and voice-operating amateurs can inter-communicate, and that all amateurs could very well make 'phone-c.w. contacts a regular part of operating routine, rather than something that just happens "during a contest," or "when a choice bit of DX is coming through via the other type of communication." Aside from other considerations, the contest was

"different" and proved highly interesting and enjoyable.

Reports were received from 53 voice-operated and 113 key-operated stations. Actual participation witnessed during the contest indicates that the proportion of telegraph to voice work was even more marked than these figures indicate. W1SZ, leading 'phone operator, worked 199 different c.w. stations! W1EZ, leading c.w. operator, worked 50 different 'phone stations. These records, better than any other medium, will give an idea of the number of c.w. operators participating as compared to 'phone operators.

While working 199 different c.w. stations, W1SZ actually made 223 contacts during the contest!! W1EZ, on the other hand, actually made 72 contacts with 'phones. The tabulation of the accomplishments of the leaders will tell its own story. W1LI, 'phone, worked 182 different c.w. stations; W2DC, 'phone, worked 164, and W8BTP worked 156. Among the telegraphers, W8JTT made the second greatest number of contacts with different 'phones—39, followed by W8BYM with

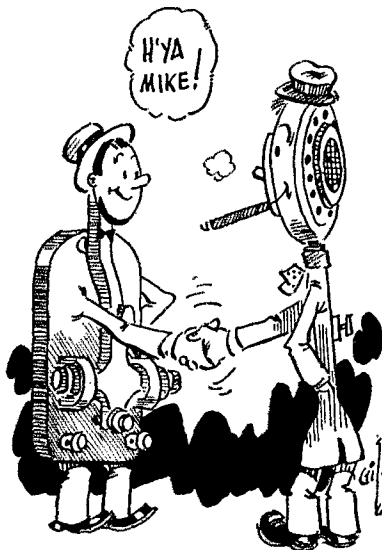

THE TEN HIGHEST C.W. PARTICIPANTS

Station	Score	No. Diff. Stns.	No. QSOs	No. Sects.	Freq. Bands (mc.)	Station	Score	No. Diff. Stns.	No. QSOs	No. Sects.	Freq. Bands (mc.)
W1EZ.....	1512	50	72	21	1.7, 3.5, 14.	W8DPV/3.....	576	26	36	16	3.5
W1EAO.....	1071	37	51	21	3.5 & 14.	W8MQU.....	532	33	38	14	3.5
W8JTT.....	858	39	39	22	3.5 & 14.	W1DVS.....	518	29	37	14	3.5
W9BTD.....	680	37	40	17	14.	W9AYO.....	504	28	28	18	1.7, 3.5, 14.
W8BYM.....	608	38	38	16	1.7 & 3.5	W2GFW.....	496	31	31	16	1.7 & 3.5

THE TEN HIGHEST 'PHONE PARTICIPANTS

Station	Score	No. Diff. Stns.	No. QSOs	No. Sects.	Freq. Bands (mc.)	Station	Score	No. Diff. Stns.	No. QSOs	No. Sects.	Freq. Bands (mc.)
W1SZ.....	6021	199	223	27	3.9	W9HVW.....	4035	114	115	35	3.9
W9CPM.....	5550	127	150	37	14.	W9HSF.....	3906	123	126	31	3.9
W2DC.....	4592	164	164	28	3.9 & 14.	W9HQH.....	3030	95	101	30	3.9 & 14.
W8BTP.....	4576	156	176	26	3.9	W8VZ.....	2464	103	112	22	3.9
W1LI.....	4070	182	185	22	3.9	W9OZS.....	2340	90	90	26	14.

¹ W1DMD using c.w. made 66 additional points. ² W1AGA using c.w. made 70 additional points. ³ W3MG using c.w. worked one additional station. ⁴ VE4IG using c.w. made 9 additional points. ⁵ Two operators at W1OR, W3CBF and W2FEF. ⁶ Operator at W1MK Hal Bubb. ⁷ W1BDI using 'phone worked one additional station.

38, and W1EAO and W9BTD, each with 37.

The honor of working the greatest number of A.R.R.L. Sections goes to W9CPM, 'phone,

and one Canadian district in the first hour and twelve minutes. In 7½ hours operating time on 3.9 mc., with 10 to 15 watts carrier power, W3MG averaged a c.w. QSO every twelve minutes! "It

'PHONE SCORES

(Call, Score, Number Different Stations, Number Sections)

First District		Eighth District	
W1SZ	6021-199-27	W8BTP	4576-156-26
W1LI	4070-182-22	W8VZ	2464-103-22
W1ASY	1125- 67-15	W8TT	689- 53-13
W1CAB	1040- 58-16	W8LUQ	665- 35-19
W1CSC	804- 63-12	W8KSJ	510- 32-15
W1MDM	660- 41-15 ¹	W8TOI	102- 17- 6
W1BLU	372- 31-12	W8JFC	20- 5- 4
W1AGA	98- 14- 7 ²		
W1AGW	40- 8- 5		
Second District		Ninth District	
W2DC	4592-164-28	W9CPM	5550-127-37
W2AVS	1408- 82-16	W9HVW	4035-114-35
W2FGX	476- 34-14	W9HSF	3906-123-31
W2GLM	112- 12- 8	W9HQB	3030- 95-30
		W9QZS	2340- 90-26
		W9DKF	1159- 57-19
		W9ACU	972- 54-18
		W9FSO	611- 46-13
		W9ITA	560- 38-14
		W9BRX	378- 27-14
		W9LKI	338- 26-13
		W9BEZ	204- 17-12
		W9HBB	180- 15-12
		W9OEC	80- 16- 5
		W9LLV	65- 13- 5
		W9KXE	27- 9- 3
		W9DLC	20- 5- 4
		W9ELQ	18- 6- 3
		W9AMY	4- 4- 1
Third District		Canadian Fourth District	
W3BRZ	1134- 50-21	VE4IG	165- 15-11 ⁴
W3PC	1128- 46-24		
W3AZU	1026- 54-19		
W3ZK	846- 44-18		
W3MG	574- 41-14 ³		
W3BAI	325- 25-13		
Fourth District		Canadian Fifth District	
W4AUU	198- 18-11	VE5AM	40- 8- 5
W4TN	140- 14-10		
Fifth District			
W5AOT	1325- 49-25		
Sixth District			
W6ENM	672- 32-21		
W6JIP	64- 8- 8		
Seventh District			
W7MD	1829- 58-31		

who worked stations in 37 sections! W9HVW worked 35 sections, W9HSF 31, and W9HQB 30; 22 of W8JTT's 39 contacts with 'phones were with different sections—a good percentage!

Scoring was simple. Each station worked counted one point, total points being multiplied by the number of different sections worked. Credit was given for more than one QSO with the same station, although in future contests it is the general feeling that this should not be allowed. The main idea of the competition in these 'phone-c.w. contests is to see who can work the greatest number of different stations, rather than make the greatest number of contacts with all stations. The section multiplier adds zest and encourages contacts with all parts of the A.R.R.L. field organization; it helps to decentralize and broaden the scope of contest activities.

SIDELIGHTS

W9BRX, 'phone operator, says, "More 'phone men should work code stations . . . after a c.w. operator calls many 'phone stations with no success he tends to lose enthusiasm for 'even listening to' 'phones." Says W9HQB, 'phone: "Towards the last part of the contest we would stand by after a contact and hear as many as ten c.w. stations calling us." W9HVW used only 50 watts input to final stage to make one of the leading 'phone scores. W9CPM heard 18 c.w. stations calling him after one CQ! He worked all U. S.

C.W. SCORES

(Call, Score, Number Different Stations, Number Sections)

First District		Eighth District	
W1EZ	1512- 50-21	W8JTT	858- 39-22
W1EAO	1071- 37-21	W8BYM	603- 38-16
W1DVS	518- 29-14	W8MQU	532- 33-14
W1IKU	464- 29-16	W8LMI	480- 30-16
W1GME	338- 26-13	W8DED	418- 22-19
W8DHU/1	320- 20-15	W8AQ	368- 23-16
W1CTK	270- 21- 9	W8LYH	221- 16-13
W1OP	242- 22-13	W8VJI	189- 17- 9
W1UE	234- 18-13	W8GWY	180- 15-10
W1ABG	224- 16-14	W8CFD	180- 15-12
W1EOB	187- 17-11	W8KXK	150- 15-10
W1FWT	140- 14-10	W8BMT	126- 14- 9
W1IKP	112- 11- 7	W8HMP	126- 14- 9
W1HQB	112- 11- 8	W8MFP	126- 14- 9
W1GKM	102- 13- 6	W8FYF	108- 12- 9
W1IKC	101- 12- 8	W8MQA	104- 13- 8
W1DJZ	96- 12- 6	W8MCO	90- 12- 6
W1GNF	86- 12- 8	W8FLA	80- 10- 8
W1MK	81- 13- 7 ⁸	W8JUK	72- 9- 8
W1ILV	84- 12- 7	W8JYJ	54- 9- 6
W1BB	77- 11- 7	W8LIG	50- 10- 5
W1CTI	77- 10- 7	W8AQE	36- 6- 6
W1DCH	63- 9- 7	W8FYU	36- 6- 6
W1BDI	32- 8- 4 ¹	W8FFZ	23- 7- 4
W1GKJ	20- 5- 4	W8MAE	24- 6- 4
W1WR	16- 4- 4	W8BFF	16- 4- 4
W1DHH	15- 5- 3	W8KUZ	6- 2- 2
W1CBZ	12- 4- 8	W8JZZ	4- 2- 2
W1FXB	6- 3- 2	W8KWL	4- 2- 2
W1ETE	4- 2- 2	W8AZU	1- 1- 1
W1HKY	4- 2- 2	W8LZE	1- 1- 1
Second District		Ninth District	
W2GFV	490- 31-16	W9BTD	680- 37-17
W2HMJ	435- 29-15	W9AYO	504- 28-18
W2GFX	297- 17-11	W9RQM	378- 27-14
W2DQU	247- 13-13	W9CZB	260- 20-13
W2GGW	247- 19-13	W9CQM	195- 15-13
W2HPC	209- 16-11	W9LFF	176- 16-11
W2EYS	170- 17-10	W9DNY	135- 14- 9
W2CJX	80- 10- 8	W9GCT	130- 13-10
W2HCD	60- 7- 5	W9JCG	128- 16- 8
W2GGE	3- 4- 2	W9ECY	120- 12-10
Third District			
W3DFY/3	576- 26-16	W9DGB	99- 11- 9
W3NF	459- 22-17	W9AGM	90- 10- 9
W3EGN	252- 18-14	W9AND	88- 11- 8
W3EPI	108- 12- 9	W9SJP	54- 9- 6
W3EBD	1- 1- 1	W9SOK	54- 7- 6
W3EBK	1- 1- 1	W9SOW	49- 7- 7
		W9FGT	42- 7- 6
Fourth District			
W4APU	23- 7- 4	W9FZO	42- 7- 6
W4CA/5	20- 5- 4	W9SEI	35- 7- 5
		W9PPE	25- 5- 5
		W9KIK	20- 5- 4
Fifth District			
W5BDW	90- 12- 6	W9PRA	9- 3- 3
W5ELL	80- 10- 8	W9ORY	4- 2- 2
W5EKV	70- 9- 7	W9ZT	4- 2- 2
		W9EVK	1- 1- 1
		W9EYG	1- 1- 1
Sixth District			
W6KEV	255- 17-15	W9JSL	1- 1- 1
W6KRI	170- 12-11	W9PTE	1- 1- 1

was a great contest—enough to make any 'phone man hoarse—despite the number of speech amplifiers."—W2AVS. The following members of the Radio Operators Association of New Bedford, Mass., submitted scores: W1AGA, W1AGW, W1BLU, W1CBZ and W1IKU, who made the best score. Approximately 23% of all 'phone participants are holders of O.P.S. appointments. 31% of all c.w. participants hold O.R.S. tickets. W1SZ made 22 QSO's in his "fastest hour"! Input at W1EZ, c.w. leader, was only 40 watts.

(Continued on page 76)

Vacuum-Tube Voltage Regulators

By W. F. Priest,* W7ERT, and Duane H. Olney,** W7BTA

ONE of the chief objections to the use of a self-excited oscillator is that the ordinary low-voltage power pack has such poor regulation that it is difficult to eliminate chirps. Also, in an m.o.p.a. rig, to get a clear note it is usually necessary to use a separate power pack for the oscillator.

We have been trying for some time to improve the regulation of the standard power pack without installing large chokes, which would increase the cost considerably. At first it was thought possible to use an ordinary mechanical keying relay arranged so that a resistance load was put on the power pack when the transmitter was off, thereby keeping a constant load on the power pack and holding the voltage constant. However, the ordinary relay does not operate rapidly enough to prevent the voltage from rising to the no-load value during the interval while the contacts are moving. This necessitates a higher voltage rating on the filter condensers, and would still give key thumps and chirps.

It finally dawned on us that in a grid-leak biased oscillator or amplifier, the bias voltage could be used to operate a vacuum-tube relay, as shown in the diagram of the transmitters of W7BTA, Fig. 1, and W7ERT, Fig. 2. The operation is as follows: When the key is open, there is no bias on the oscillator or regulator tubes, since there is no grid current flowing in the grid leak.

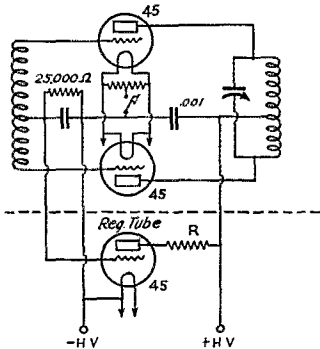

FIG. 1.

The oscillator tubes cannot of course take current, but the regulator tube takes a current which depends on the value of the series resistor, R . Therefore R determines the "no-load" voltage of the power pack, permitting regulation of this voltage to a value higher or lower than the full-

load voltage. The instant the key is closed, all three tubes take current, thus momentarily lowering the voltage until the oscillations have reached full strength and biased the regulator

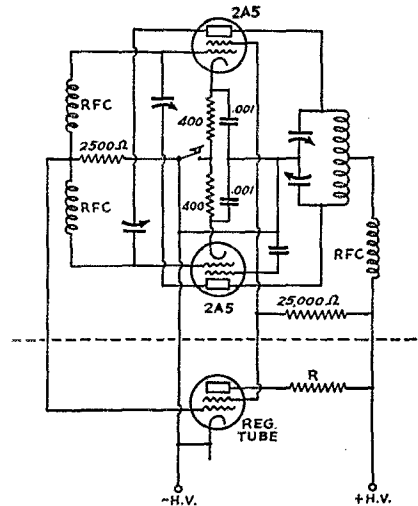

FIG. 2.

tube to cut-off. This momentary lowering of the voltage prevents the oscillations from building up as fast as they would if the no-load voltage was much higher than the full-load voltage, and practically eliminates key clicks and thumps. By the time the oscillations have reached full strength—in other words, the transmitter is transmitting—the voltage has reached the constant value and there is no audible chirp. It will be seen that a power pack with poor regulation from actual no-load to full-load would give a greater momentary drop in voltage than one with a better regulation, thus giving greater protection against key clicks and thumps. The regulator tube operates as rapidly as the oscillator tubes do when keyed.

The transmitter shown in Fig. 1 has a full-load voltage of 450, with a plate current of 100 mls to the two 45's. The no-load voltage without the regulator tube is 650 volts, using a 550-volt transformer. With the regulator tube in R set at approximately 3000 ohms, the "no-load" (key open) voltage was also 450 volts. It is well to note that a poor tube will work fine as a regulator tube, if it has any emission at all, since the plate voltage is low when taking current (150 volts in this case). The regulator tube used in the transmitter shown in Fig. 1 is a gassy 45 which would

*East 11 $\frac{1}{2}$ Fourth Avenue, Spokane, Wash.

**West 918 Gordon Avenue, Spokane, Wash.

not oscillate reliably. The only requirement of this circuit is a separate filament winding for the regulator tube when using center-tap keying.

The circuit shown in Fig. 2, using indirectly-heated tubes (2A5's) obviates this necessity. At first thought it might appear that the full plate voltage would be applied between cathodes and heaters when the key is open. This is not the case, since the only voltage appearing here is the cut-off voltage, or approximately 30 volts with a screen voltage of 150. Also, due to the large dropping resistor in the screen lead, the screen voltage is reduced very much below normal when the key is first closed and all three tubes are taking current, thus more thoroughly suppressing key clicks and thumps. In fact, key clicks did not appear in an ordinary broadcast receiver sitting on the same shelf with the transmitter.

New High-Power Pentode

(Continued from page 29)

about 75 watts. Plate and screen voltage are the recommended maximum values, the screen being supplied from the plate power source through an 80,000-ohm dropping resistor. The screen current under these conditions is about 20 milliamperes. The suppressor should be operated 45 volts positive. The control grid should be biased 140 volts negative and supplied with a peak r.f. voltage of 160 volts. Grid current under no-modulation conditions is less than 2 milliamperes. The peak audio grid swing required is 60 volts. Plate current should be adjusted through loading to 88 milliamperes. Excitation requirements are the same as for suppressor modulation.

As a Class-B linear amplifier the grid bias should be -38 volts, assuming plate and screen voltages of 2000 and 400, respectively. The suppressor should be connected back to filament center-tap. The screen will take 30 milliamperes through a 55,000 ohm dropping resistor. With plate load adjusted to make the tube draw 75 milliamperes, the carrier output is approximately 50 watts. The driving power, exclusive of power dissipated in a regulating resistor, is about one watt.

The tube also can be plate modulated provided the screen is simultaneously modulated as with screen-grid tubes. Present ratings for this type of service specify the maximum plate voltage as 1500, the carrier output being approximately 100 watts. The pure-tone audio power needed for complete modulation is 82 watts for the plate (1500 volts d.c. at 110 ma.) plus 18 watts for the screen; or, if the screen is supplied through a dropping resistor which also consumes audio power, a total of 150 watts. We have operated the tube as a plate-screen modulated amplifier with 2000 on the plate, exceeding the present rating by 500 volts, with no sign of breakdown. The excitation requirements are quite low, running in the

vicinity of a few watts. The question of plate modulation of pentodes will be discussed more completely in an early issue.

CIRCUITS

The RK-28 can be used in any of the circuits which are employed with other r.f. pentodes. Partly for this reason and partly because sample tubes were received at such a late hour that time did not permit running through preliminary tests on the tubes and getting drawings made in time for this issue, none are shown here. The experimental rig shown in the photograph was built up so that all kinds of circuits could be tried without necessitating rewiring, and hence is equipped with a large number of plugs and jacks for circuit changing which would not be required in an ordinary layout.

No shielding about the tube was found necessary, since it has shown no tendency toward self-oscillation when driven from a separate source. By supplying a small amount of feedback—such as bringing a wire from the plate near a similar wire from the grid—the tube will function excellently as a pentode crystal oscillator. Using 2000 volts on the plate and with the feedback "condenser" adjusted so that the r.f. crystal current was less than 100 mils under no-load conditions, an output of 200 watts or better was readily obtainable. The crystal was under no more strain than when used in the ordinary 47 circuit with 400 or so on the plate. Operation of this type illustrates the ease with which the tube can be excited.

As a Tri-Tet oscillator the tube behaves about like the RK-20. Time did not permit a very complete investigation of its suitability for this type of work. The plate voltage was not raised beyond 1000 at which voltage the output was about the same as that obtainable from the RK-20.

With the new tube it should be no trouble at all to build a multi-band 250-watt c.w. transmitter using only receiving tubes at low voltages in the exciter. In such a rig band-switching does not appear so nebulous—in fact, it should be readily attainable. We have something of the sort in mind for an early QST issue.

—G.G.

Hamdom

(Continued from page 36)

the 160-meter Army Net, member of the original OT5 chapter, member of the I.R.E., A.R.R.L. 'Phone Activities Manager, director in the New England Division Radiophone Association, chairman of the planning board of the South Shore Radio Club, lieutenant in the Massachusetts National Guard, and—but that's all we have space to tell. Except that you can call him "Mark," instead of "Mac," and he'll still know you're calling.



Improving Detector Stability

A note from Griffin Chiles, W5TR, offers what seems to be a good suggestion for freeing the regenerative detector from frequency variations with regeneration-control settings and variations in line voltage:

"The sketch of Fig. 1 shows an improved electron-coupled detector arrangement. The oscillating portions of the circuit (I used a 24-A) are orthodox; the improvement lies in the regeneration control.

"The voltage divider consists of two fixed resistors chosen to meet the following requirements: first, to divide the 'B' voltage so as to

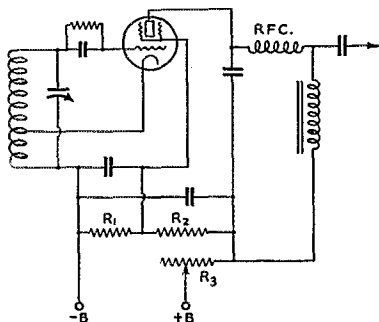

FIG. 1—IMPROVING DETECTOR STABILITY BY CONTROLLING PLATE AND SCREEN-GRID VOLTAGES SIMULTANEOUSLY

provide proper screen voltage; second, to draw sufficient current from the 'B' supply to cause appreciable voltage drop across variable resistor R_3 , which is used to control regeneration.

"The voltage divider circuit is incorporated in the detector circuit wiring, and is entirely separate from other voltage dividing equipment.

"It will be seen that this is a true electron-coupled oscillating circuit and, inasmuch as oscillation starts each time with the same voltage applied across R_1 - R_2 , the calibration is substantially constant. The regeneration control has negligible effect on tuning, and an increase of 20 or 30 volts in the 'B' supply shifts the frequency only slightly. A decrease of course will take the detector out of oscillation, but on reducing R_3 it comes back in on the same frequency. This makes line fluctuations harmless."

If the variable resistor R_3 is 50,000 ohms, a common value, the total resistance of R_1 and R_2

probably should not exceed 50,000 ohms, and preferably should be less for most effective control. Some experimenting with resistor values may be needed for maximum sensitivity and smoothest control. A fair starting point would be to make R_1 about one-fourth the resistance of R_2 .

Reducing Power

Two simple methods of reducing power for tuning, local work, etc., are given in Figs. 2 and 3. The arrangement of Fig. 2 is used by Harry E. Hurley, W6QF, who has found it particularly useful for those tuning operations (such as adjustment of an antenna filter) during which the amplifier tank circuit is likely to get out of resonance. Since the crystal power supply, usually quite low voltage, is connected to all stages when the switch is thrown to the left, the off-resonance amplifier plate current is limited to a fairly low value, thus prolonging the life of the tubes.

The second circuit, in use at W4CBV, uses a s.p.d.t. switch to change a bridge rectifier to the center-tap arrangement so that either full or half voltage can be obtained. In the particular circuit shown, 83's are used in bridge with a transformer

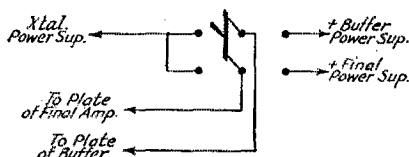

FIG. 2—THIS SIMPLE SWITCHING ARRANGEMENT CONNECTS THE OSCILLATOR PLATE SUPPLY TO BUFFER AND FINAL AMPLIFIER FOR TUNING OR QRP

giving 550 volts each side of center tap. With the choke-input filter, the d.c. output voltage is 960 with the switch on the upper contact, and 480 with the switch on the lower contact.

A Garage-Top Mast

If there are other amateurs who simply have to put up a mast on a typical American two-car pyramidal-roofed garage, they may be interested in my experience. In my case the garage lay in the only direction I could run the antenna and have the feeders clear the house. If I put the mast on the near side of the garage I could not get span

enough; if I put it on the far side, which was the property line, there was no place to run the guys. There was nothing to it but to put the mast on the garage. Besides, why not use that initial height?

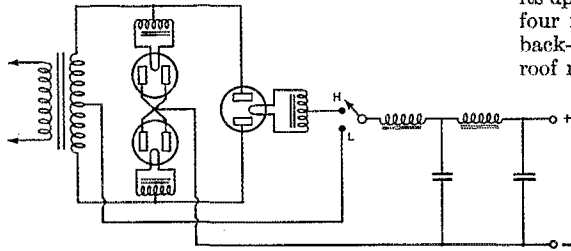

FIG. 3—BRIDGE TO CENTER-TAP FOR VOLTAGE CHANGING

The usual two-car garage is 20 feet square. Because of the slope of the roof, the actual effect of guys placed on the diagonals is as if they were but 8 feet from the base of the mast. While this sounds perilously little, it has proved entirely ample.

I had on hand a 20-foot 3 by 4. To this I bolted an 18-foot 2 1/4 by 2 1/4, with an overlap of 2 feet. Four guys run from the splice to the four corners of the garage. Two back-guys work against the pull of the antenna, but are not at all necessary to support the mast itself. Short pieces of guy wire go through the corners of the roof to the scantlings inside and terminate in turnbuckles

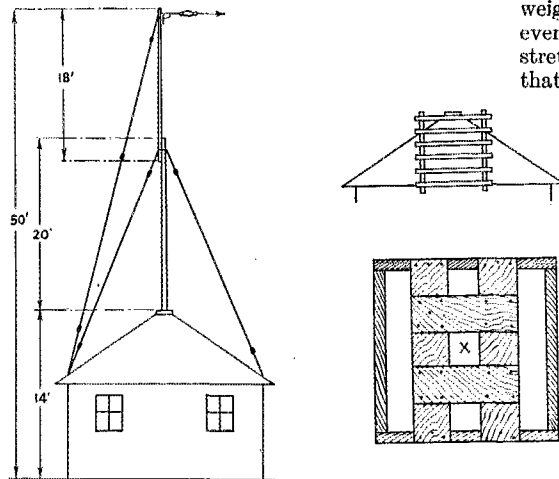

FIG. 4—ANTENNA MAST ON TOP OF A TWO-CAR GARAGE

Details of the mast socket and the placing of the "cattle-walk" for erecting the mast are shown.

immediately outside, to which the guys are made fast. A shallow "nest" surmounts the peak of the pyramid and acts as a footing for the mast; it holds itself in place without fastening.

The mast, with guys attached, was easily stood up against one side of the garage. A "cattle-walk" was temporarily laid down on one slope of the garage and lashed in place. A ladder was leaned against the side of the garage alongside the mast, its upper end reaching to the "cattle-walk." With four fellows to hold the lower guys (the upper back-stays dangling loose), two fellows on the roof readily lifted the mast vertically hand over hand, it being rested on the rungs of the ladder while fresh grips were taken. With the foot of the mast lifted to the edge of the roof, it was then a simple matter to walk it, a foot at a time, up the "cattle-walk" and place it in its step, the guys meanwhile supporting it. Although some days had been spent in preparation, the

mast went up in ten minutes and in another fifteen minutes the guys were fast and true. The result is a thoroughly practical and inexpensive fifty-footer.

The antenna halyard runs through the garage roof at the base of the mast, thence over two pulleys which lead it to one wall where an old grate-bar does duty as a counterweight. Where the halyard goes through the roof it runs through a one-foot length of rubber hose to prevent chafing. I am strong for the counterweight idea. Without it an antenna is always too tight or too slack. When a halyard shrinks after a rain, great strain is placed upon rope and fittings and the antenna wire elongates in a fashion that eventually pulls a Hertz antenna clear out of the band. With a weight just sufficient to keep the antenna taut, even No. 14 soft-drawn copper wire will not stretch. One of its greatest benefits, however, is that it also keeps the feeders drawn up snug. In the absence of an old grate-bar of exactly the right weight, try a bucket of sand, using just enough weight to pull things up tight.

—K. B. Warner, W1EH

R.F. Indicators for Ultra-High Frequencies

While conducting some tests on 56 mc., we found a real need for a very sensitive r.f. meter. The ordinary absorption meter caused a shift in oscillator frequency because of power drain and coupling; a neon tube also was unusable since small variations in power level aren't noticeable, especially during daylight. The problem was solved by building a vacuum-tube indicator of the type shown in Fig. 5.

It is essential that the grid-plate return be connected to the negative side of the filament since a slight negative bias is needed. If the instrument is to be calibrated for laboratory measurements, the filament voltage should be kept constant. Also, it would be necessary to put a potentiometer across the filament

battery with the arm connected to the grid-plate return. The potentiometer is then adjusted for a small positive meter reading.

On our tests, we set the meter near the feeder input to the antenna and adjusted the oscillator

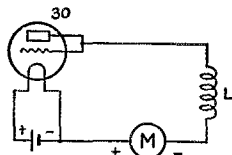

FIG. 5—AN R.F. INDICATOR FOR ULTRA-HIGH FREQUENCY WORK

An instrument of this type is considerably more sensitive than ordinary meters or neon lamps, and introduces negligible loading in the circuit under measurement. The filament of the 30 is lighted by a single dry-cell or flashlight cell. The meter M is a d.c. microammeter or 0-1 milliammeter. L, the pickup coil, consists of a few turns of small diameter.

and the antenna length for real efficiency. The same result was obtained by placing the meter near the antenna ends. Two sets installed in cars were similarly adjusted, while operating over a distance of about four miles, with the result that maximum signal strength was secured.

The pointer of the milliammeter will jump off scale if the unit is brought within four or five feet of a small unshielded oscillator. Its sensitivity and simplicity make it of real value.

—E. E. Comstock, W3FKQ

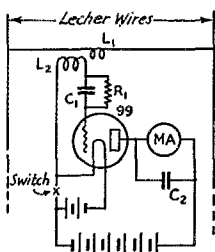

FIG. 6—STANDING-WAVE LOCATOR

L₁—2 turns No. 18 wire spaced about 3/16 inch on a half-inch hard rubber tube the ends of which slide over the Lecher wires.

L₂—3 turns on same tube, spaced same as L₁.

C₁, C₂—.003-μfd. fixed mica condensers.

R₁—7-10 megohms. May not be needed.

MA—0-1 d.c. milliammeter or lower-range microammeter.

The hard rubber tube is about two inches long to accommodate Lecher wires having two-inch spacing.

Another type of indicator which is particularly useful for locating standing waves on Lecher wires is suggested by Richard C. Elliot, of Tacoma, Wash. He writes as follows:

“For those ultra-high frequency enthusiasts who sometimes experience Lecher wire difficulties this little device, which I call a ‘standing wave locator,’ may be an aid. It came about in following Hull’s¹ instructions on Lecher wire measure-

¹Hull, Ross A. “Practical Communication on the 224-Mc. Band,” *QST*, November, 1934.

ments. Because of the physical character of the oscillator and the work room, it was impossible to arrange the meters in a position where they could be read easily from the location of the Lecher wire. Consequently an adaptation of Professor Yagi’s² method of measuring wavelength was made. The diagram is shown in Fig. 6.

“The apparatus, exclusive of the sliding wire and L₁ and L₂, can be put in a metal can or box, making it easily portable. The small-sized flashlight dry cells were used for plate and filament supply as they could be employed to fit in odd shaped cans and increase the flexibility and portability of the locator. Of interest perhaps is the high value assigned to the grid condenser C₁. This value was found to give the greatest dip in plate current when the sliding wire L₁ was at the peak of a voltage node. The node could be detected within a probable accuracy of five millimeters.

“This method would also be useful in searching for unwanted standing-waves in transmission lines. Incidentally most of the parts are to be found in any ham’s junk-box!”

²Yagi, Hidetsugu, “Beam Transmission of Ultra-Short Waves,” *Proc. I.R.E.*, June, 1928.

A Four-Band Exciter

(Continued from page 22)

tanks will not tune to resonance until the load of the final stage is added. For simplicity, the plate of the RK-23 is shunt-fed, so that one side of the coil and condenser may be grounded. One lead from the high side of each coil is brought out through a grommet in the side of the coil shield and is fed through a four-point switch to the RK-23 plate.

In operation the unit is quite nice to handle, and seems to furnish plenty of excitement to make a pair of 800’s very happy in their life work as a final amplifier. What it may do when we get in the habit of modulating a pair of high-power pentodes is anybody’s guess.

Don't forget that the
FIVE-HUNDRED-DOLLAR
GRUNOW COMPETITION

Closes August 31

Full Details were given in March
QST on page 15.

• I. A. R. U. NEWS •

Devoted to the interests and activities of the

INTERNATIONAL AMATEUR RADIO UNION

President: H. P. MAXIM

Vice-President: C. H. STEWART

Secretary: K. B. WARNER

Headquarters Society: THE AMERICAN RADIO RELAY LEAGUE, West Hartford, Conn.

MEMBER SOCIETIES

American Radio Relay League
 Associazione Radiotecnica Italiana
 Canadian Section, A.R.R.L.
 Československi Amatérski Vysilací
 Deutscher Amateur Sende-und-Empfangs
 Dienst
 Experimenterende Danske Radioamatører
 Irish Radio Transmitters Society
 Irish Radio Transmitters Society
 日本アマチュア無線聯盟
 Liga Colombiana de Radio Aficionados

Liga Mexicana de Radio Experimentadores
 Nederlandsche Vereeniging voor Interna-
 tionaal Radioamateurisme
 Nederlandsch-Indische Vereeniging Voor
 Internationaal Radioamateurisme
 New Zealand Association of Radio Trans-
 mitters
 Norsk Radio Relæ Liga
 Polski Związek Krotkofalowcow
 Radio Society of Great Britain

Rede dos Emissores Portugueses
 Réseau Belge
 Réseau des Emetteurs Français
 South African Radio Relay League
 Suomen Radioamatööriliitto r.y.
 Sveriges Sandreamatörer
 Unión de Radioemisores Españoles
 Union Schweiz Kurzwellen Amateure
 Wireless Institute of Australia

Conducted by Clinton B. DeSoto

O.F.C.S.:

The First A.R.R.L. International Test was held in 1928 for the purpose of selecting American Official Foreign Contact Stations for reliable communication with other lands. Utilization of the resultant organization was slight, simply because there was little foreign traffic and the handling of traffic was not permissible, except



A MEETING OF SOME HEAVY ARTILLERY . . . AT CAMBRAI, APRIL 28TH, LAST
 From left to right: ON4HM, F8EB, F8EO, ON4JB, F8WB, F8EX, and F8FC. (Photo by ON4AU.)

under great restriction. The organization consequently fell into decay.

To-day there is need for such an organization, to be used primarily as a medium for internal contact in the I.A.R.U. The Union has grown hugely, not only in proportions but in the significance and responsibility of its actions with respect to the amateur radio world. Yet, to date, official

correspondence between member-societies has been slow and erratic, since it relies on the vagaries of the international mail service.

In the present time of stress, when international planning is so vitally important, with an international conference approaching where the opinion of one nation with regard to amateur radio will count for naught but where we will require the concerted support of many nations—a support which can be achieved only through the I.A.R.U.—a swifter and more responsive means of inter-nation communication is fundamentally essential.

In recognition of this requirement, Union Headquarters has suggested to all member-societies that Official Contact Stations be appointed in the respective countries, not to handle messages, but to conduct amateur correspondence under the terms of the international treaty. At the moment of writing, this Union Network is just getting under way. If immediate response means anything, its success is assured. Already Official Contact Stations have been appointed to function between four countries and the United States:

Australia VK2EL-W9UM (tentative)
 Belgium ON4AU-W2GOX
 New Zealand ZL2CI-W5QL (tentative)
 Switzerland HB9J-W6ENV

Mail service with England being more prompt and reliable than with any other member-society outside the American continents, the R.S.G.B. feels that amateur radio is primarily useful only for urgent matters, in which case use will be made of amateur channels.

The coöperation of all amateurs in this matter

is requested, either in direct handling of correspondence or by facilitating its handling by others where possible. The O.C.S. stations are not a fixed and inflexible group; any American amateur can expect to have important information handed to him from abroad if he happens to QSO at the crucial moment; similarly, American information can be given to any reliable station in the country addressed. But the responsibility for the work, and the bulk of it, will rest with the O.C.S. To them, now as well as later when they will actually be functioning, we offer a vote of thanks for the beneficent job they will be doing on behalf of all amateur radio.

QSL:

On June 1st the headquarters of the R.E.F. were moved. The address is now as follows: *Réseau des Emetteurs Français*, 6 square de la Dordogne, Paris 17^e, France. This address applies to all services, headquarters, QSL, official organ—everything. The old address, 17 rue Mayet, has been abandoned.

The R.E.F. also asks all QSL bureaus to note that *only cards for Morocco* (CN) should be sent to the A.A.E.M., B. P. 50, Casablanca, Morocco. All QSL cards for France (F), Algeria (FM8), Tunisia (FM4), and the French colonies (all other intermediates beginning with F), must be sent to the R.E.F. in Paris. Cards for FM amateurs should not be sent to Morocco, as indicated in previous instructions in this department.

John G. McIntosh, VU2LJ, Baghjan T. E., Doom Dooma P. O., Assam, Northern India, writes: "I note in the I.A.R.U. News, page 90, of the April issue of *QST* that the QSL Bureau is given as Bombay. This is a mistake as the cards have been handled here by me for the last two years, and is entered as such in the Call Book."

As the B.E.R.U. representative in the Federated Malay States, Reginald J. Bee, VS2AG, Malayan Public Works Service, Kuala Kangsar, Perak, F.M.S., will handle QSL cards for that region, which presumably includes the Straits Settlements.

General:

Latest WAC-on-phone certificate goes to Baron Louis Bonaert de la Roche, ON4HM Another one coming up for Marcel Meyvaert, ON4VC Why are all the outstanding international DX 'phone stations apparently located in Belgium? Wray A. Gillette, OA4AA, believes he has set a record, having received 58 QSL's in one mail F. H. Pettit, SU1SG, has been appointed official B.E.R.U. representative for Egypt, Sudan and Palestine As noted last month, he handles QSL's for SU, ST, and ZC

Egypt has up to the present been a ham's paradise, with operation on any frequency and no licenses or interference by the government The advent of the Egyptian Broadcasting Company has put a stop to this happy state of affairs, however, and all operators must now be in possession of an experimental license costing about two pounds yearly plus one shill-



HENRY L. GARFATH, FATHER, AND ROYDON GARFATH, SON, OPERATE G2BM, 166 BIRCHANGER ROAD, SOUTH NORWOOD, LONDON, S. E. 25

Some 2,500 W stations in all districts have been worked, some a hundred times; all continents innumerable times on 7 and 14 mc. The final amplifier works at from 100 to 150 watts input. A single-wire-fed matched-impedance antenna, full wave for 14 mc., averaging 50 feet in height, is used. The receiver has two tubes, detector and pentode a.f. Every possible part of the station is home-constructed.

G2BM is always pleased to welcome any hams visiting London who can find time to run out to South Norwood.

ing for each electronic tube used It is anticipated that the government will be tolerant, and probably no restrictions with regard to frequencies, times of operation, use of 'phone, etc., will be imposed, providing, of course, all operation is carried on in the amateur bands and no interference is caused to BCL's LA1G, snowed under with reports on his 14.34-mc. 'phone to the extent of £4 postage, while appreciating the reports, says he can't afford the bill, and henceforth all reports must be accompanied by international reply coupon to be acknowledged W2BSR heard six J's May 21st, worked four—a total of eight since the first of the year I.A.R.U.-A.R.R.L. Hq gang confirm, with several J contacts recently Owing to VK2ZR's being unavailable, P. H. Adams, VK2JX, is now vice-president of the W.I.A. The Iraq scene is largely denuded of amateur radio, all the old-timers having left—Willis, YI7NN, who has gone to India, Lewis, Knowles, Cunningham—all have gone F. Goodwin, too, left Mosul some time ago, and is now at 203 (FB) Squadron, Royal Air Force, Muscat, Persian Gulf, Coast of Oman, Arabia, where he expects soon to use the call ZZ6FG Al. Santimer, Jr., W8AKX,

(Continued on page 72)



OPERATING NEWS



Conducted by the Communications Department

F. E. Handy, Communications Manager

E. L. Battey, Asst. Communications Manager

IN May *QST* in this column we reported the relative registered interest in each of the several different frequency bands assigned to amateurs. The final questionnaire return reported from 2500 amateurs changed our figures percentage-wise but slightly. Interest based on the complete return is indicated in the following. The highest percentage of operating interest registered was for 80-meter telegraph (30.16%). In order, follow the interest in 40-meter telegraph (29%), 20-meter telegraph (11.8%), 80-meter 'phone (9.4%), 160-meter 'phone (7.4%), 20-meter 'phone (6.1%), 56-mc. 'phone (3.6%), and 160-meter telegraph (1.2%). 10-meter 'phone and telegraph registered interest are equal (.41%) and 5-meter telegraph (.26%). The remainder is distributed over the 1½ and 2½ meter regions, both 'phone and telegraph.

The above takes into consideration the degree of use of each form of activity by each registrant. With the advent of band switching for amateur transmitters and receivers the average ham is better able to change activity from one band to another at will; most of us use two bands, and many can work on three bands. The percentage of all amateurs interested to some extent in using our major interest bands is large. For example, 75% use 80-meter telegraph, 75% use 40-meter telegraph, 50% use 20-meter telegraph when conditions are right, 25% employ 160-meter 'phone, 25% likewise 80-meter 'phone, 20% use 20-meter 'phone and 25% of all of us amateurs go strong, among other radio interests, for 56-mc. 'phone.

It was about 56-mc. work that we wanted to talk this month. Our analysis of questionnaires returned showed for the first time a "major interest" group using 56-mc. 'phone. There is now a substantial 56-mc. interest, which of course is greatest in the more populated centers. There is eight times as much 'phone interest as telegraph interest in 56 mc., for the cheapness of apparatus here equals or exceeds that of telegraph sets; there are no bothersome and expense-causing restrictions such as on 3.5- and 7-mc. bands. The freedom from regulation makes this band "common" and the chance of the unexpected happening adds to the fun on 56-mc. We are in the middle of the biggest 56-mc. year in history.

March *QST* mentioned a thesis on amateur radio growth and diffusion. The author traced the initial rise of the American institution which we know as amateur radio in the states bordering on the oceans, and its subsequent diffusion inland in an interesting manner. Since the transmission of intelligence without wires first and last is a major necessity for mariners, it was natural that the first wireless exploits and the most news of the type creating incipient amateur interest should have appeared in the press in maritime states. An examination of the spread of 56-mc. interest and its extent by Divisions shows the interesting fact that while we have 56-mc. interest in every Division, that the six leading 56-mc. Divisions are thus for those bordering on the oceans. Here are statistics showing the extent of 56-mc. interest in those Divisions, first, as a percent of all operating interest in those particular Divisions, and also, parenthetically expressed as a percent of all telephone operating interest registered in those Divisions:

New England	8.1%	(30.45%)
Hudson	7.4%	(25.5%)
Atlantic	4.1%	(16.1%)
Northwestern	2.77%	(14.3%)
West Gulf	2.66%	(10.8%)
Pacific	2.1%	(8.4%)

—F. E. H.

The S.J.R.A., in 1930, had around 18 paid-up members, others were on the rolls, but perhaps 18 months in arrears in dues. Something had to be done. W3ZX, W3AOC, W3BA, W3AN, W3KW, W3BEI, W3ACD and W3QL considered this situation, studied a club planning board, pioneered, made changes. To-day the S.J.R.A. has an organization of around 85 paid members, with an average attendance larger than this. The club treasury likewise shows a substantial balance and there are no debts. We are pleased to present Mr. Rigor's contribution, to help in the betterment and preservation of all local club organizations.

The following contribution by Mr. Gedney Rigor wins G.D. article contest prize for this month. Your articles on any phase of amateur communication activity are likewise solicited and may win you a bound Handbook, six logs, or equivalent credit applied toward other A.R.R.L. supplies. Let us have your article, and mark it "for the C.D. Contest," please.

—F. E. H.

Improving Club Interest

By Gedney M. Rigor, W3QL *

EVERY locality has a little different club problem than another locality. To promote technical discussions, improve understanding and coöperation, and add to the strength of amateur radio, the local club is a necessity. Various problems can be met best by a local, well-organized and active club, where all those interested in amateur radio as a hobby can get together, exchange valuable ideas, help others, get better acquainted and learn more about radio.

It appears that the mortality of radio clubs has become higher than it should. Many good clubs go on the rocks of disorganization, for reasons that we shall state. Now, how can this be avoided? How can this disintegration be met before irreparable damage is suffered? When the entire membership of any club realizes that the things that break up splendid clubs are some of the following, they will have made the first start towards betterment: (1) One-man domination; (2) petty jealousies and unpleasant personal digs from one member to another during meetings; (3) long-winded arguments over nothing vital, bickering over petty things; (4) non-coöperation; (5) Army vs. Navy arguments; (6) 'phone and c.w. squabbles; (7) finances; (8) selfishness.

If members will use their heads, and endeavor to remedy such situations by taking definite steps to swallow their own egotism (avoiding political expression at every minute of meetings), attendance will increase, membership go upwards, the treasury will be enhanced and the club become more successful. All these things are necessary for a going club. What is about to be suggested is no idle dream or "Utopia," but has been *proven* successful. By instituting proper changes, the club membership may be made happier and meetings will become a joy for all attending.

The first step is the organization of a board of directors, officers becoming automatically members of the board and a given number elected from the membership. Elections should be held once a year. These men should be entrusted with the full powers to run the business of the club. All new ideas or business should be submitted to the secretary or any director for discussion at the directors' meetings, but never discussed on the floor of the club, excepting a change

*412 Second Avenue, Haddon Heights, N. J.

in the By-Laws. Directors should meet one week before the regular club meeting, planning the entire program, taking care of all work. Business that is bashed out in the directors' meeting should never be rehearsed on the floor. Directors who miss more than three consecutive meetings without due cause should be replaced by another member of the club. The majority of the board ought to be licensed radio amateurs.

Any personal animosities, squabbles, hard feelings and troubles with members, should come before the club's directors, who will never allow it to go any further than their own meetings, thus eliminating all that trash from coming before the entire membership.

Endeavor to make every regular meeting of the entire membership a miniature "Hamfest." The business meeting should be limited to one-half hour, adjournment automatic at the end of that time. During this period, the reading of the minutes of the last regular meeting should be approved. All committee reports should be accepted, new committees and changes in committees announced. The reading of the minutes of the club's Board of Directors' meeting should be read to the club as approved by the directors. A financial statement by the treasurer should be given at the end of the meeting. The president should aim to give all new members a welcome into the club and introduce visitors from other clubs, or prospective new members at each meeting.

No discussion irrelevant to the club's business should be permitted, nor arguments between members aired before the membership. If the bone of contention is Army vs. Navy, c.w. or 'phone, or the club's transmitter, then do away with such arguments by not allowing them to be constantly aired, boring the entire membership. Why break up an organization for the promotion, betterment and advance of your hobby just because members differ on two or three subjects? Is it necessary to stir up strife among others who don't care a hoot about the matter, and whose interest lies in learning as much as possible about their fine hobby?

There is no doubt but what such ideas will be labelled by some locals as "Nazism," "Facism," etc. Some will say, "If I can't have something to say, I don't want to join," etc.! But every member can express his ideas before his directors and have them approved or disapproved. If they don't go over before the entire board, then why drag a dead horse across the floor for everyone to see? The man who cries out because his ideas don't go across, or because he can't convince a majority, is a poor sort of specimen. Instead he should try another tack. If he doesn't get one circuit to work in his hobby, he very quickly gets another one tried out.

Do not allow your club to degenerate into a social club, where members become "ossified" before the young high school members. It is not ham radio. There are proper places for that; and the young member of to-day will take the old member's place when he is gone.

Every man who likes his club and wants to see it go ahead will pay his dues. He doesn't want to hear some members get long-winded about what they did or accomplished, unless it really teaches him something. What he is interested in primarily is the fellowship of the club, and the meetings with men who have the same thing in common with him. I.e., amateur radio. He is interested in knowing more about radio, first, last and always. Older members can teach the younger members, thereby learning more themselves.

An Honor Roll, placed conspicuously, with the name and call of each member who is in good standing, helps keep the dues paid. The offering of a free-chance drawing on a piece of apparatus for all members whose dues are paid at the end of the year also is an incentive for members who might become delinquent to pay up.

The nomination and election of officers and directors is the only time in the entire year when it is necessary to go over the half-hour rule. When election comes, the secretary should call off each man's name who is eligible to vote according to the By-Laws, thus eliminating any chance for hard feelings of those who couldn't afford to pay dues at that time. Further, it isn't fair for those who merely visit meetings to have a part in electing officers, when they are not financially interested in the organization, one way or another.

You will always find some who will criticize unjustly;

holler loudly at whatever is done, and never do a thing. They might even talk about it over the air locally. The more successful the club becomes, the louder they holler, but they soon peter out against the growing organization and, if they are not nincompoops, they soon become good hard-working members. Success always brings criticism anywhere.

Club members should see and realize that they are getting nowhere with hot arguments, back biting, kicking, hatreds, envyings, and personal animosities. Let's turn our energies to cooperation, work, pleasure, joy and helpfulness, together with tolerance for the other fellow's views! You will be surprised how quickly the club will then grow. The above ideas have been tried and proven successful. Membership has increased and the treasury became sound and strong. Members have repeatedly said they are enjoying each and every meeting, and are so glad that the club is run on this basis. All that was necessary was intelligence, hard work and a final realization that all forms of communication are here to stay, and that it is up to each and every man in the organization to help his less fortunate associates, thereby helping himself and acquiring many warm friends, together with having a happier outlook on his hobby, which we all know is the best in the world.

There is nothing idealistic about the above; given a fair trial in every club in the land these clubs become increasingly fine gathering places for the most intelligent of young men and boys. You club members who read this, ask yourselves, "Isn't it worth while to lay aside all the pet 'bones of contention,' for the benefit of the whole?" Let us instead work constructively and each strive to add our part to what the club is doing, and make more friendships as well as progress possible. Think it over.

Flood Emergency Work

As this issue goes to press word is received that amateurs assisted greatly in providing communication during the period of the severe floods in western states. In Colorado, W9LJF, W9HDI, W9EHC, W9AMS, W9APV, W9FA, W9NLD, W9NUP, W9JFD, W9UEK and others did excellent work, handling many important messages for Police, Army, and individuals. In Nebraska, W9CRB, McCook, put a battery operated transmitter on the air and opened communication between W9BAE, W9BBS and W9FWC of North Platte. With telegraph wires down and only partial telephone service a large volume of traffic was handled. W7EDW, Casper, Wyoming, writes that he heard W9CRB's c.w. signals in the middle of the 3.9-mc. 'phone band giving out a call of distress and falteringly telling the sad story of isolation, death and destruction. One station after another lined up to aid in handling the only means of communication from the stricken area. Those cooperating in this were W9DCY, W9PWU, W9SVL, W9MGV, W9EIZ, W9BBS and W9KQX, who acted as key station. W7EDW acted as "cop," chasing CQ hounds off the frequencies where the important emergency work was taking place. Further details of the fine work of amateur radio in this flood emergency are expected for the next issue.

W2ASF of New York City took a portable outfit to Pine Camp, New York, with the 101st Cavalry, which is stationed there the last two weeks of June. W2FKL, W2FCN, W2GPB and W2HAN are handling schedules with W2ASF for handling traffic into N. Y. C. The main schedules will be maintained on 3.5 mc., connections into the metropolitan area being via the N. Y. C. 56-mc. net. If you hear W2ASF BT2, give him a buzz.

License Exams at Columbus

Examinations for amateur operator licenses will be conducted in Columbus, Ohio (Council Chamber, 2nd Floor City Hall) June 14th and 15th at 9:00 a.m. and 2:00 p.m. local time.

The Baltimore F.C.C. office advises that examinations for amateur licenses are conducted each Wednesday as well as every Saturday as announced in June QST.

Official Relay Stations Shatter Records in April 27/28 Activities

Radio conditions, participation, and QSOs all worked together for the success of the biggest quarterly party of the years these activities have been scheduled for O.R.S. Five operators of Official Relay Stations shattered the previous record for number of different O.R.S. QSOs made in a single week-end of work. E. F. Henning, W5BMI, topped January records by making the all-time high of 198 contacts in the period of the O.R.S. Party, working 55 A.R.R.L. Sections. Bob at W9ELL was next with 196 QSOs. Les at W9IU won the W9AUE-Trophy Cup with 195 QSOs in 58 A.R.R.L. Sections. W4OG operating at W4NC had 185 QSOs (178 O.R.S. and 7 O.P.S.), and W9MN (previous cup holder) rolled up 169 contacts. Hal at WIMK came within one of making his January record of 160 QSOs (the previous high)!

L. D. Gregg, W9IU, with the record-breaking score of 54,268 wins the O.R.S.-Trophy Cup which will go permanently to the O.R.S. winning it three times. It has been held previously (once only) by W9KJY and W9MN. 191 O.R.S. and 4 O.P.S. contacts were made by W9IU. E. F. Henning, W5BMI, with a score of 50,765 won the Powerack prize, donated by W2WK for second-high scorer, and is putting it to good advantage as portable set power for the June A.R.R.L. Field Day!

In the group of 25 leading operators we find four from Connecticut, three from Indiana, and two each representing Kentucky, West Virginia and Illinois. To possess operating ability to make ones station a member of this group is indeed a real honor. We are proud to present full data on the achievements of these leading operators.

Call	ORS QSOs	Sec- tions	Heard	Score	Power	Section
W9IU	198	58	101	54,268	500 w.	Ind.
W5BMI	195	55	106	50,765	350 w.	Ark.
W9ELL (Bob)	196	52	84	46,644	1000 w.	Ky.
W4NC (4OG)	185	50	130	45,100	600 w.	No. Car.
W9MN	169	46	70	36,237	500 w.	Ky.
W8AQ	154	49	86	35,721	180 w.	Ohio
W9LH	157	47	71	34,075	250 w.	Ill.
WIMK (Hal)	159	45	62	32,535	600 w.	Conn.
WIDMD	141	43	86	29,369	250/400 w.	N. H.
W8CUG (8GUE)	143	41	76	27,593	200 w.	W. Pa.
W9JRK**	135	42	95	27,342	85 w.	Ind.
W3EOP	134	39	139	27,300	250 w.	E. Pa.
W3NE	138	39	119	27,144	—	S. N. J.
W2AYJ	144	40	59	26,400	300 w.	NYC-LI.
W3EBO	135	39	101	25,974	150 w.	Ont.
W9AUT	130	41	77	25,748	—	Ind.
W8DMF	138	42	21	25,200	600 w.	W. Va.
WITS	128	43	43	25,026	90/600 w.	Conn.
W4BOU	122	43	65	24,854	—	Ala.
W1UE	126	38	99	23,864	105 w.	Conn.
W9KJY	119	40	63	22,920	80 w.	Ill.
W1GME	136	36	37	21,384	70 w.	Conn.
W8KKG	104	40	87	21,120	300 w.	W. Va.
W3DVO	109	39	60	20,319	—	Va.
W7AYO**	90	42	—	19,320	—	Wash.

* 47,684 counting 5 more QSOs by Moss.

** 28,686 counting 8 QSOs by a second op.

*** Highest west coast score ever made in an O.R.S. Party.

Official Phone Station Scores

While not breaking new high records, the competition for first place in the April activities of the A.R.R.L. national 'phone group was extremely keen. A battle between W8ICF, W8LJZ and W9JZA for best operating results on this occasion was decided in favor of W8ICF with a score of 1390 to his credit, and that of the Ohio Section. The leading scores were as follows:

Call	OPS QSOs	Sec- tions	Heard	Score	Power	Section	
W8ICF	22	1	10	1390	150/250 w.	Ohio	
W8LJZ	22	1	10	1350	100 w.	Ohio	
W9JZA	20	2	12	1344	—	Ind.	
W9PWU	11	4	10	950	350 w.	Colo.	
W8GJY	12	1	9	6	893	25 w.	N. Y.
W2AVS	7	3	6	29	648	16 w.	E. N. Y.
W4BYA	11	7	8	497	100 w.	No. Car.	
W9LKI	12	2	5	4	390	8 w.	Ind.
W7BJS	8	1	7	10	335	160 w.	Utah-Wyo.
W9DZ	6	1	6	9	318	63 w.	Iowa
W5ZM/ZU	6	5	4	300	80 w.	N. Mex.	
W7ARK	6	2	7	1	294	200 w.	Utah-Wyo.
W9LLV	9	2	4	5	260	31 w.	Ind.
W9HSF	8	1	5	2	245	—	Ind.
W4AI	6	3	3	13	213	40 w.	No. Car.
W8DK	6	4	1	8	198	300 w.	Mich.
W1GZL	6	4	1	8	184	75 w.	W. Mass.
W3BIG	5	3	4	183	100 w.	Va.	

Invitation

The next quarterly activities of the Official Relay Station and Official Phone Station appointees are scheduled for late July. The quarterly July bulletin will be issued in the early part of that month with full information on current matters. The activities of both groups of stations are designed to create opportunity (1) to test station performance, and (2) make new friendships and QSOs. Readiness for emergency work, an active station at all times, operating technique above the average, these are the real meanings in A.R.R.L. O.R.S. and O.P.S. appointment.

League member stations that specialize in traffic handling are invited to become members of the Official Relay Station group, and to get in touch with Section Managers (see address of your S.C.M. on page 6). The quarterly activities for O.R.S. do not stress traffic handling, the first enjoyable duty of an O.R.S., but are designed to maintain and create high standards for snappy operating, that give a different form of enjoyment from that that obtains in daily sked-keeping. Those amateurs who take a pride in the way messages are handled through their stations partake in traffic activity because this end of the game is their chief pride and joy . . . their thanks comes in the knowledge of a job well done. Only those with a sincere traffic interest should apply for O.R.S. appointment. Stations that sign "ORS" are widely known as the cream of operators, and the men behind the set stations take pride in forwarding a message offered them at any time. Preferably messages should be given them at other times than during the quarterly parties. To ask a QSP then is something like giving a postman a sack of mail while he is attending the Postman's annual ball . . . but if emergency requires it we know, that during O.R.S. doings or at any time, an O.R.S. may be depended on to QSP if asked. In fact several O.R.S. have been cited for exceptional work, performed unselfishly when called upon at just such a time! Hams depend on stations that sign "ORS" after their calls.

A.R.R.L. operators who work 'phone mainly are likewise invited to write S.C.M.s about the Official Phone Station appointment. Blanks will be sent gladly on request. The O.P.S. appointment has more pleasant, enjoyable voice operating as its ideal. Two way voice work, rather than any imitation of broadcasting efforts is stressed. There is no such thing as a traffic requirement tied to this appointment. Members who hold O.P.S. appointment receive quarterly bulletins through which they exchange information and receive data from Headquarters. O.P.S. are asked to subscribe to a code of good voice operating ethics, and just as the prospective O.R.S. is examined as to his operating qualifications and traffic-knowledge by an A.R.R.L. Route Manager, each Section's Phone Activities Manager is charged with the responsibility of checking, by QSO or visits, the adjustment of applicant phone stations to see in advance of appointment that adequate means exist to tell when modulation over 100% exists, and that in normal operating it does not occur. Hams using any 'phone band, restricted or unrestricted bands, are eligible to hold this appointment, and when appointed, take part in the operating activities which assist in station testing as well as build fraternalism and strength to a growing national group.

ANNOUNCEMENT TO OFFICIAL PHONE STATIONS

July 27/28 will be the dates of the next national O.P.S. QSO-party. Rules for scoring are as follows: 5 points for each O.P.S. worked, 2 points for each O.P.S. heard but not worked, 5 points for O.R.S. contacts. The sum of all points so made is to be multiplied by the number of A.R.R.L. Sections (see list on page 6) worked. Any or all 'phone band frequencies may be used. The majority of this work has in the past been in the 1800-2000 and 3900-4000 kc. bands. Eleven a.m. to one p.m. on Sunday (local time) has been suggested as the best time to try the 14 mc. band. The first 15-minutes of each hour has been suggested to both O.R.S. and O.P.S. as a good time for 'phone-telegraph QSO's, but use of this period is optional with the individual.

Starting time for the Party is 3 p.m. P.S.T., 4 p.m. M.S.T., 5 p.m. C.S.T. or 6 p.m. E.S.T. (July 27) and the work reported must all take place before the close of the activities 12:01 a.m. P.S.T., 1:01 a.m. M.S.T., 2:01 a.m. C.S.T. or

3:01 a.m. E.S.T. (July 28). This makes a period for operations of 33 hours length, and a new rule will limit actual work to any 30 of these 33 hours and of course the larger number get plenty of enjoyment without approaching the 30-hour limit.

Official Phone Station operators will receive the complete up-to-date list of O.P.S. appointees, too long to reproduce in full here, but of assistance in connection with the announced national activities, by mail just before the July party.

New Rules for July 27/28 O.R.S. Activities—7mc. Work Given Premium for Summer Party

All frequency bands, as usual may be used by O.R.S. in the coming summer activities, but several new factors are being tried out in the summer party, and work on 7000-7300 kc. will be suggested to get around the QRN difficulties incident to the season. We mention the subject in this advance announcement so that O.R.S. may have time to follow the suggestions made by our A.R.R.L. Board of Directors in modifying our transmitters to employ "band switching" and other devices that will make it easy to go from band to band to get the most out of O.R.S. party operating time, and use the frequencies most appropriate to local and DX work. More of which information we hope to include in the July O.R.S. Bulletin!

The **W9AUH O.R.S. Trophy Cup** will be up for the fourth time, for the operator who makes the leading score at any Official Relay Station. Three different men have their calls inscribed on said cup to date as token of their individual operating achievement. Will one of them win it a second time? Whose call will make the cup next? Remember, this trophy goes permanently to any operator who can win it three times! A new scoring plan will be tested in the July Party which is designed to equalize opportunity for participants in the extreme east and in the far western parts of the country, insofar as this may be possible.

A **Model 321 Triplett milliammeter** (any standard scale chosen) will be awarded to the leading O.R.S. operator in the following licensing areas following the conclusion of the July O.R.S. activities: W6 W7 VE4 VE5 K6 K7 and KA.

A **Model 323 Triplett milliammeter** (any standard scale chosen) will be awarded to the operator leading east coast O.R.S. in July activities. The Pacific coast area is defined as the licensing areas indicated in the paragraph just above. The east coast area is defined as consisting of the following licensing areas and the A.R.R.L. Sections named: VE1 VE2 W1 W2 W3 and E. Pa., North Carolina, Georgia, So. Carolina, Cuba, Isle of Pines, Porto Rico, Virgin Ids., E. Fla., W. Fla.

These two special awards as well as the O.R.S. cup are donated by Mr. Griffin W. Mossbarger, W9AUH, A.R.R.L.-S.C.M. of Kentucky.

There has been some correspondence with west coast and east coast participants on the subject of the rules and some changes are being tried in line with suggestions to meet possible objections, mainly resulting from the slight advantage mid-western stations have had in being able to work more stations and sections from their location.

Rules: The basic count of 4 points for an O.R.S. QSO remains the same for all stations between the Pacific and east coast area. Such a QSO will count 5 points for stations in the eastern coastal area as defined, and 7 points in the Pacific area as defined above. "O.R.S. heard" but not worked will be credited at one point each for all bands and all locations, and similarly two points for "OPS heard."

This July activity is going to stress 7 mc. work, where the advantage due to special locations will be minimized, so for this party only, a special score of 9 points per O.R.S. QSO will be given to all participants, in whatever area they reside. If a station is worked in more than one band, score may be counted only for one contact, in no case more than 9 points for same. For two-way contacts with O.P.S. Official Relay Station operators may add one point to the score as above indicated. In addition there are the usual 25 points for starting one message to be relayed to a brother O.R.S. The sum of all points will, as usual, be multiplied by the

number of A.R.R.L. Sections worked. Late scores will be chronicled, but all scores to be considered for the Cup Trophy, or milliammeter awards in the coastal areas, must be mailed to A.R.R.L. Headquarters within ten days of the close of the party.

As usual, O.R.S. parties mean swell operating guaranteed. You may be next to win the O.R.S. Cup, but if you don't, you will be repaid by dozens of solid enjoyable contacts with real operators! Use all bands, but don't forget the premium for 7 mc. work—because this is a summer 7 mc. party. Here's luck, O.R.S. and more dope coming in the summer bulletin soon to be mailed.

New 56-mc. Records in the Making

Thanks to the efforts of some twenty amateurs in the Philadelphia and New York areas, all ready to sacrifice time and contribute efforts, new 5-meter accomplishments of a major nature are on the horizon. Though not often given the acid test, 56-mc. work has high practical value. Beginners as well as old timers find the band a relative haven for a "beautiful" rag-chew, free from the drawbacks of the lower frequencies. The band is large enough to permit comfortable duplex work, and duplexing is a major aid in relaying. With auxiliary 5-meter equipment the last 20 or 30 miles of a relay necessary to accomplish delivery in large metropolitan districts can be easily covered.

Long distance 56-mc. relays can take place with good consistency between stations in high places, and this work is greatly facilitated by use of directive arrays and beam transmitters which multiply the effective power of a receiving or transmitting station many times. One of the aims of east coast experimenters has been to maintain a successful traffic net for emergency and other work to facilitate local deliveries. Another objective close to accomplishment is the creation of an Atlantic coast relay route following completion of the 56-mc. New York-Philadelphia link.

To prepare the way for this 100-mile link the following stalwarts arranged a first test for the date of May 25th. Starting at midnight N. Y. stations called "Philly" for the first five minutes, the next five minute period being assigned for listening for calls from the third district stations participating. Naturally beams were called into service for the big effort, and stations using beams will be indicated with an asterisk. W3EPO put up a thirty foot tower. Other stations were installed in the highest available locations. W2GHJ*, W2CVF, W2EKC*, W2GOY*, W2ETU, W2AMJ, W2AZB, W2DLG, W3AZG*, W3BJQ*, W3AJF, W3AVV, W3FGN, W3FFR, W3CQI and W3GS* all cooperated similarly for the attempt.

Full details of the first test are not available from all who took part at this early date. However, precisely at the scheduled time things happened. It was marvelous to listen over the band and hear not a trace of locals normally making the 56-mc. band a bedlam in either big city, but cooperating because of knowledge of the tests through numerous QSTs transmitted on the subject. W3FGN in Philadelphia was heard by W2EKC and W2ETU in New York and W2DLG (using a pr. of 801s) on top of the Hotel New Yorker was heard and called by W3FGN, operating portable on top of City Hall, Philadelphia, 547 feet above the city. Superreg' receivers were used. A half-wave vertical antenna with 100-foot Zepp feeders was used at W3FGN, with 51 watts input to a pair of '10s. A pair of vertical rods, appropriately oriented were used at W2DLG. But let us quote W2EKC's account of the tests:

"Everything was in working order by about 10 p.m. May 25th and at midnight sharp I started calling Philly. Five minutes of this and I listened, combing the band 12:05 to 12:10 a.m., but N.D. At 12:10 a.m. another five-minute call started. Better luck this time. As I tuned down to 57 mc. W3FGN was heard calling CQ-NY and announcing that he was hearing W2DLG. Immediately I started calling W2DLG to tell him that he was being called. As my beam was set on Philly I wasn't getting into N. Y. C. very well. No answer from W2DLG so I started to call W3FGN myself. However, W2DLG was called by W2ETU who heard W3FGN's call for DLG, and a three way QSO followed, using W2DLG for transmitting and W2ETU for relaying

what W3FGN was reporting. I kept W3FGN tuned in but was unable to raise him after he signed with W2DLG. . . . W3FGN was QSA5 R6, very FB and perfectly 100% here on Long Island."

—Herb Gordon, W1BY

Timing Ski Races via 56 mc.

On Sunday, January 20th, a snow train left Schenectady, N. Y., with a gang of winter sports lovers for North Creek up in the Adirondacks. Stowed aboard were W2ACB, W2ALP and G2KB of the Schenectady Amateur Radio Association, with their 56-mc. gear, prepared to time the ski races. The races were held on Gore Mountain. To reach the starting point of the race W2ALP had to pack his two watt transceiver four miles up the mountain! W2ACB set up his equipment at the finishing point. Transmission and reception were perfect. W2ACB could hear the starter giving the skiers the OK, and the starter was several feet from W2ALP's mike. An Eastman Timer was used at W2ACB. When he heard the starter say "Go," the time registered was noted and likewise it was noted again when the skier crossed the finish line, the elapsed time giving the exact time each racer took to negotiate the course. Many comments were received on the efficient manner in which the races were handled and timed via 56 mc.

The Dartmouth College (N. H.) Radio Association provided accurate timing for the skiing races at the Silver Anniversary of the Dartmouth Winter Carnival. 56-mc. transceivers were used for timing and worked to perfection. All timing was done from the finish line. The starter at the top would stand by the contestant at the starting line, listen in his headphones to the operator at the finish counting off "20, 15, 10, 5, 4, 3, 2, 1, go!", and give the skier a shove at the proper moment. At minute intervals some 70 skiers were sent hurtling down the steep 30-degree slope without a single interruption. After each start the timer would turn it over to the operator at the top for a brief OK—"62 off, 63 up, take it away." The need for accurate timing was well shown by freshman Dick Durrance's time of 58.2 seconds, better than a mile a minute! Amateur radio was on the job, assisting in police work, calling officials and competitors to their proper stations and offering a convenient message service. W1CVF, W1FHE, W1FZB and W1AXH were the amateurs putting this work across.

Operators Wanted

The U. S. Coast Guard is in need of about sixty radiomen, most of whom will be rated radiomen third class as soon as they qualify. Necessary requirements are: clean fist, ability to receive about twenty words per minute, good knowledge of radio and physically and morally fitted for the service. Write Lieutenant (j.g.) E. E. Comstock, U. S. Coast Guard Headquarters, Washington, D. C., giving qualifications, education, etc.

The Newfoundland Amateur Radio Association was formed at a hamfest at St. John's, Newfoundland, on November 12, 1934. Officers elected for the first year: VO8AW (now VO2J), president; VO8Z (now VO2Z), vice-president; VO8H (now VO1H), secretary-treasurer. Present at the organization meeting were VO8H, VO8W, VO8A, VO8HK, VO8Z and VO8AW. During the "hamfest" portion of the activities various ham shacks were visited as well as VONF, broadcast station, and VON, commercial rig. A banquet was enjoyed by all in the evening. The gang is looking forward to a future get-together at which they hope to have all VO's present. Much credit is due VO8H (VO1H) for a major part in organizing Newfoundland amateurs.

George Bonadio, Watertown, N. Y., after listening in considerably, thinks it would be helpful to make it an "unwritten law" to cover the band before going on the air. It certainly would help greatly, if every operator would at least listen on his own frequency before opening up to make sure he is not going to cause unnecessary

QRM, and every good operator always covers the band before CQing.

Station plaque, natural wood letters and carvings on natural wood background. This is the handiwork of John A. Kreher, 404 South Second St., Clearfield, Pa. These plaques are also furnished with aluminum letters on bakelite back-

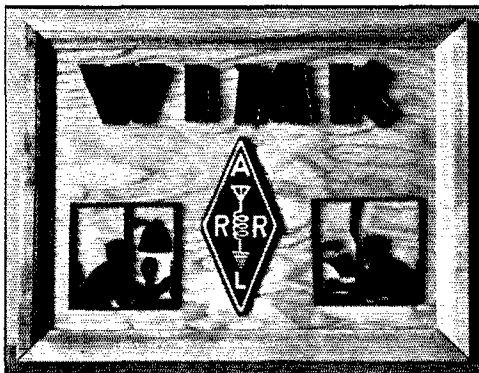

ground. Mr. Kreher offers a complete line of plaques and aluminum or wood letters (for microphone, auto radiator, transmitter, etc.). Prices vary according to size of plaques or letters. Write for quotations.

Operating Savvy

Why do telegraphing amateurs insist on repeating so much after minor mistakes in ordinary conversation? Hams of ordinary intelligence catch on even if a word is missed. Amateurs should correct ONLY the word erroneously sent anyway, but many repeat the whole sentence! That is not making for better operating!

Another thing, amateurs know QRZ as "something about being called by someone." In reality it means, without the absolutely necessary question mark, "You are being called by." QRZ? means "BY WHOM AM I BEING CALLED?" Use the question when you want this meaning. Amateurs should familiarize themselves with all "Q-Sigs."

By consistent malpractice other operators are misled, many following as the proverbial sheep in the flock. Let us think while operating.

If an operator is listening-in (many don't, as should, they CQ instead) and hears a station in the vicinity for which he has a message, said operator is able to call this station if it ends with QRZ?

How many times does this station that put out the familiar QRZ? really cover the band? If not, then why send "QRZ"? But on the other hand it is with great pleasure that an operator listens in to hear an operator "coming" back to him after he has put in a few minutes of calling, after said operator has exercised the good faith and thorough tuning a "QRZ?" warrants.

The whole thing dwindles down to SAVVY! Not every operator will have it, but it is all a part of good operating which even the newest amateur will acknowledge as the best policy.

SAVVY goes a long way in operating. Haven't you heard and admired some fast operators in the amateur bands going like blazes, never a slip betwixt the dots and the dashes? Doesn't it make you want to slide into their stride? Secretly it must.

Study your own individual operating and profit by experience of others. Study and understand Q-sigs as questions or replies depending on whether a question mark is sent. Savvy only comes to one who wants it to. Do you?

—Kenneth Isbell, W6BOQ

Hamfest at Clinton, Iowa

The third annual hamfest under the auspices of the amateurs of Clinton, Iowa, was held on the evening of April 19th in the shack of W9JZM. 110 hams enjoyed the festivities, which included good speakers, free lunch and refreshments, a grab bag, from which everyone received a prize, and a regular prize drawing. W9JZM is located in a theatre, which made an excellent place to seat the "delegates"! The 'fest lasted until 5:00 a.m. The only regret in connection with this affair was the year's wait until the 1936 get-together!!

On a 5000 mile automobile trip to Canada and return W6AM worked 65 hams on 56 mc. enroute. Transmitter was a 50-watt mobile outfit, which is permanently installed in the car. San Francisco hams picked up W6AM 75 miles away; contact was established within 36 miles of the city.

A rush message from WIMK addressed to Maplewood, N. J., was given to W3BWT one evening on regular schedule. W3BWT passed it along to W2GFV (three miles from destination) who made delivery the same night.

On a golden dais, beneath a silken canopy, the Dixie Squinch Owl peers from its priceless ruby eyes upon a sea of hams who bend a reverent knee. The Squinch Owl's shrine is at Fort McPherson, Georgia. There you can see a life sized statue of this symbolic varmint carved in the living cocconut. Only by seeing can one appreciate the really fine points of this work of art. The sculptor is Francis Carroll, W4OK. A platinum plate, studded with precious gems, proclaims as follows: "The Dixie Squinch Owl. Caught by W4AWO/WLRO, Lake Worth, Florida, January 21, 1935." All this is extracted from Issue No. 58 of "The Dixie Squinch Owl," a paper which is in a class by itself. For further details see your nearest Army Amateur, or ask W4IR!

Legion of Frontiersmen

Hugh L. Bennett, VE4SD, 9727 95th Street, Edmonton, Alberta, is organizing a radio unit within "The Legion of Frontiersmen," a semi-military organization of fellows who have served the British Empire and who are banded together to keep themselves fit to help again in any emergency. VE4SD is attempting the organization of a Radio Unit for the purpose of being of use in *any* emergency (QRR work, etc.). He proposes to keep the key stations in shape by running daily schedules and handling ordinary message traffic. Any Canadian amateurs interested in cooperating in such an endeavor are urged to get in touch with VE4SD, giving a brief summary of equipment available, frequencies used, etc.

An excellent demonstration of amateur radio was given to the El Paso (Tex.) Rotary Club on February 7th by W5EQH, with the assistance of other local hams. W5AEC moved his 14-mc. 'phone to the ballroom of the Hotel Paso del Norte in downtown El Paso and set up for transmission, using an antenna approximately 250 feet above the ground. W5ESI's rig was also set up for transmission. A schedule was made with W9FJ, Chicago, and arrangements were made to have a representative of Chicago Rotary send greetings to the El Paso Club. Like arrangements were made with W9BJ, St. Louis, in order that two El Paso Rotary members could speak to their friends in the meeting. At the appointed time contact was made with W9FJ, and the QSO was 100% both ways. Following this W9BJ was contacted and everything went off according to plans. W5AOT received the 14-mc. signals at his shack and retransmitted to the hotel on 3.9-mc. to insure better reception in the downtown area. W5DE and W5EED were standing by at W5EQH ready to take over the retransmission, if anything went wrong. Each amateur cooperating in this demonstration deserves much commendation.

W3EAP and W3EZL of Alexandria, Va., rendered valuable service during the January sleet storm. Early on the morning of the 23rd contact was established with W3BYA, Clifton Forge, Va., and maintained all of that day. On the 24th and 25th contact was established with

Salisbury, Md., W3VJ. Numerous extremely important messages were handled for the Virginia Public Service Company. W3EAP did much of the operating at W3EZL.

Oddities, submitted by R. G. Summers, Buffalo, N. Y.: W8EIT, M. E. Jenkins, lives on Jenkins Street. . . . W8MDK may be a Rug, but don't try to walk on him. . . . W9SOP lives at Green Lake—a wet combination. . . . W9ARK has M. J. McKee for skipper. . . .

W8LUJ, Glens Falls, N. Y., W8MSI, Logan, W. Va., and W9RIZ, Agra, Kansas, are all ready to join the "Police Net" endeavor, W9RIZ having already made some arrangements with his local department.

Strays

A note from W6ASQ brings up a point about eliminating broadcast interference which is not likely to occur to the harassed ham. In investigating a receiver on which his 3500-kc. 'phone caused interference, cleaning up a doubtful-looking splice in the antenna leading to the receiver completely wiped out the 'phone signal, which had been riding in on top of the local b.c. station. His explanation, which seems reasonable, is that the poor splice probably was acting as a copper-oxide rectifier and giving cross modulation.

Would-be hams in Chicago will be interested to know that a course in amateur radio is offered at the Crane Evening School. The dope comes from W9SFR.

We neglected to mention, in the stray which caused all the rumpus resulting in "Shootin' the Works" in the January issue, that the air rifle used should be a high-power affair like the Benjamin. Our contributor, now W2HBB, also writes that when the gun is .22 the long-rifle cartridge should be used. We repeat, don't forget the backstop!

W5DGV says that after counting up the cost of ham radio for the past two years and then dividing it by the number of QSO's, he finds he could have done it cheaper by Western Union!

Almost any crowd will have its quota of hams. While ice-skating one night during the past winter, W3DUN had the inspiration to whistle a CQ to see who might be "on." Two calls and a signature raised W3DML, and then in rapid succession the following were "worked": ex-30J, W3CIZ's son, an op from WAR, an ex-7, and ex-W8AQV! A number of others were heard but couldn't be located in the dark.

W9SYH should be a first-class brass pounder. He pounds brass all day in a horn factory, all evening on 80 meters, and all night in a brass bed!

—W9TE

DX Notes

Y13FB on 14250 kc., and Y17RR on 14300 kc., both with d.c. notes, are reported by W1DZE. At 4:00 p.m. May 29th W1DZE worked Y13FB. . . W1LZ finds 4:00 p.m. E.S.T. a "hot" time on 14 mc. He worked AR8MO and Y13FB at about that time during May and reports "U" stations plentiful, as well as a few SU's. . . W9GMV claims the first QSO between the W9th district and Palestine—with ZC6FF on September 7, 1934. ZC6FF at that time said he had worked W1, W2, and "now W9," indicating that W9GMV was the first W9 QSO. . . G6YL comes forward with the information that NX2Z is the land station of the Danish Polar Greenland Expedition; the operator is OZ2Z. The ship station of the expedition uses the call XOZ7T, or OZWG; the operator is OZ7T. G6YL reports several QSO's with OZ7ESK, which she says is really an NX station. . . 111Y reports hearing the following 14-mc. stations during April at about 8 p.m. E.S.T.: K4SA, K5AA, K5AB, K5AG, K5JE; he is anxious to contact any station in that area. . . AR8MO is at Beyrouth, Syria; his frequency about 14,300 kc. He is on between 4:00 and 5:00 p.m. E.S.T. This information from W1DZE. . . A radiogram from W8DIO advises that LU6DJK desires to QSO K7 and VO1. He is on 7137 kc. from 0800 to 1010 GMT and 14080 kc. from 0000 to 0200 GMT daily. . . W8DIO also advises that VS8AX is on 7181 kc. and 14362 kc. from 1000 to 1200 GMT daily and wants VE QSO's for WBE certificate. . . G5QY sends word via W1CUN that he is anxious to work all states in U. S. A. and needs the following to make it 100%: Alabama, Arkansas, New Mexico, Nevada, Wyoming, Kentucky, No. Dakota, So. Dakota and Nebraska. Hams in these states are asked to look for G5QY on 14 mc. and attempt QSO.

Volunteers Wanted for 6000-8000 kc. Survey!

The A.R.R.L. Cairo Committee, appointed by the Board in May, has lost no time in contacting all clubs and League field organization officials. The first step of the Committee as preliminary to attainment of its several objectives has been to draw up plans for a far reaching occupancy survey to cover 6 to 8 mc. channels. All amateurs are requested to volunteer their services in connection with this work which will require observers not only in the U.S.A. and Canada, but in all parts of the world where the cooperation of other amateur societies in the Committee's plans will be requested.

Suitable blanks and full necessary information will be provided those who volunteer by A.R.R.L. Headquarters. Any all-wave receiver with a beat oscillator that will cover 6-8 mc. can be used, as well as amateur receivers with suitable coil equipment. The only prerequisite is ability to copy code in good shape to identify stations, and a good receiver roughly calibrated for the range named.

Clubs and individuals, all who have not already placed names on record to assist in this important survey, are requested to inform A.R.R.L. Headquarters at once by message, QSL-card, or letter, of willingness to devote time to volunteer observing work. This will make it possible to designate group controls to coordinate the work of observers in each locality to best advantage. As soon as enough volunteers have been obtained detailed information and blanks will be distributed direct or through group controls. It's a big task, but we know that every true ham wants to do his part in support of the plans and program of the Cairo Committee. Don't delay . . . place your call on file for data on the survey to-day.

—F. E. H.

VK 28-mc. Progress

There have been few days when signals have not come through. During November and December it has generally been possible to work some one between 5 and 8 p.m., which times appear the best. Some 30 or 40 VK's and ZL's are active and taking interest in the International 28-mc. Contest. Some approximate scores at the end of 1934 may be of interest: VK4BB 330, VK6SA 132, VK4XN 127, VK3JJ 125, VK2LZ 104, VK3WC 87, VK2HZ 80, VK3RJ 62, VK2NO 62, VK2HY 60, VK2SA 60, VK7NC 57, VK3ML

54, VK3BQ 52, VK7KV 50, VK3OF 50. Others who have scored are VK2XY, VK2YC, VK2PN, VK2EP, VK3CW, VK6MN, VK3WX, VK3NM, VK5HG, VK3JO, VK3OF, VK3FM.

In New Zealand ZL1BA, ZL1CD, ZL1FT and ZL3AJ are doing good work. I would advise U.S.A. stations to keep a close watch for VK's on our Sundays (your Saturday afternoons and evenings), particularly during March, April and May. I am of the opinion that the minimum skip on 28 mc. is lengthening again and would not be surprised to hear of 28-mc. DX contacts.

Owing to the low frequency bands being "under crowded" in Australia and QRM rare, there is little interest in 56 mc. here and most such work is local—10 to 20 mile DX.

At the present time 28-mc. tests are in progress between New Zealand, Eastern Australia and West Australia and are proving very successful. Many contacts have been made over distances varying from 1500 to 2000 miles, while QSO's between 400 and 1200 miles are really too numerous to mention! 28 mc. "came to light" in November this season, and distant contacts take place at all hours of the day and night, even 1 a.m. at times!

—VK3JJ, J. J. McMath

July DX Contest

The Rede dos Emissores Portugueses (Rua 1 de Dezembro, 33-3, Lisbon, Portugal) announces a contest starting at 0000 Greenwich and ending at 2400 on each of the following days: 6th, 7th, 13th, 14th, 20th and 21st of July. All amateur frequency bands can be used. Each Portuguese amateur will send a distinctive five letter group that must be received correctly during the contact and recorded on a W/VE QSL-card. All competitors are requested to submit lists of stations worked and the cards to the R.E.P. before October 20, 1935. Only one contact with a station counts. Certificate awards will be made to the highest scoring stations, based on the number of contacts between Portuguese stations, and points in accordance with your particular prefix, as follows:

- 1 point: EA-F-PX-FM-G-GI-EI-PA-HB-LX-I-CN-ON
- 2 points: OE-OK-SP-OZD-FM 4
- 3 points: SM-LA-LZ-YT-YM-HAF-FF
- 4 points: YX-LY-OH-SV-ZA-SU-VE 1, 2, 3-W 1, 2, 3, 8-YR-ES
- 5 points: W 9-CM-TF-AR-K 4, 5-NY-TI-VP-PA-YN-YS
- 6 points: YV-X-YI-TG-ST-XR-EP-EQ-ET-NX-ZD-W 4
- 7 points: HL-HP-HZ-HC-VK-ZL-VE 4, 5-VQ-U 6 to O-PZ-EJ-W 5-YA-ZE 1-ZK-ZC 1
- 8 points: PY-LU-Z8-ZT-ZU-YJ-ZP-W 6
- 9 points: CE-CP-CX-HS-OA-OB-PJ-ZM-W 7
- 10 points: J-KA-K 6, 7-AC-FB 8-FI-MX-OM-PK-VS-VU-XT-XU

"It seems as though we amateurs are defeating our purpose of bringing all notes 'up-to-date' by resorting to the low racket of 'apple-polishing.' If an amateur has a punk note, tell him about it instead of fishing for a good report in return to satisfy that big conceit. It is only a matter of time until the F.C.C. monitors catch him and all the subsequent pleadings could be avoided if his so-called 'brother' ham brought the offending note to his attention. If the gang would only be more critical of notes instead of casually handing out T9's promiscuously, it wouldn't take long until everyone would be note conscious."

—W6TE

A record "round table" QSO on June 7th included these nine stations: W5DHU, W6FZZ, W7BST, W7BSU, W7BVE, W8UW, W9AUT, W9RYD, VE3JT.

28 Mc.

The following calls were heard on 28-mc. by LU1EP between 1730 and 1950 on June 2nd: W2AER, W5AFV, W4MR, W8CCW, W9EQU, ON4AU, D4BWF, PA0QQ. This information received via W8BT1 is followed by further advices that on June 9th LU1EP was QSO ON4AU, XIAY, W6VQ and W5JV! This represents what is believed to be the first 28-mc. contact between U.S.A. and South America.

BRASS POUNDERS' LEAGUE

Call	(Apr. 16th-May 15th)		Rel.	Total
	Orig.	Del.		
W9RYD	120	151	1348	1619
W3BND	123	139	1292	1554
OMITB	476	191	451	1213
W8JTT	40	43	1028	1111
W9LH	17	73	1004	1094
W9FLG	40	69	876	985
W7DUE	20	81	796	897
W9ESA	56	137	658	831
W6BMC	8	69	673	750
W2BCX	35	68	633	736
W7KL	16	106	607	729
W9LEZ	31	58	606	695
W3ADM	664	13	6	688
OMZRK	225	150	301	676
W5CEZ	39	99	520	658
W7AYO	86	67	502	655
W9KJY	64	119	468	651
W8DVC	10	45	584	639
W6KFC	50	32	548	630
W8DSS	61	62	492	615
W3BWT	119	109	386	614
K6DV	31	77	498	606
W9JRK	50	20	514	584
W3OK	48	43	486	577
W7EXQ	7	69	566	566
W1MK	47	96	400	543
VEZDR	174	116	236	526
W3EZ	25	75	426	526

MORE-THAN-ONE-OPERATOR STATIONS

W6ZG	598	1403	340	2341
W9BNT	209	887	821	1917
KALHR	653	420	728	1801
W5OW	99	347	657	1004
W3SN	99	184	688	971
W9YO	498	35	17	550

These stations "make" the B.P.L. with totals of 500 or over. Many "rate" extra credit for one hundred or more deliveries. The following one-operator stations make the B.P.L. for delivering 100 or more messages; the number of deliveries is as follows: Deliveries count!

W6GED, 202	W1HWZ, 135	W3BYS, 101
KALIE, 170	W9IQL, 126	W9ERP, 100
W8HXP, 163	W6LJ, 126	More-than-one
W8JQE, 149	W6BPU, 120	W6EK, 198
	W7AFS, 115	

A.A.R.S. STATIONS

Call	Orig.	Del.	Rel.	Total
WLMG (W2BZZ)	25	27	1763	1815
WLRH (W4AFM)	3	2	580	585
WLNB (W2DBQ)*	21	119	96	236

MORE-THAN-ONE-OPERATOR STATIONS

WLM (W3CXL)	263	373	1283	1919
WLJ (W5OW)	178	123	980	1281
WVQB (K8EWQ)	311	109	606	1026
WLY (W6ZG)	373	321	112	806
WLMA (W8YA)	9	2	500	611

A total of 500 or more, or just 100 or more deliveries will put you in line for a place in the B.P.L.

* B.P.L. rating on deliveries.

O. B. S.

The following is a supplement to the list of A.A.R.L. Official Broadcasting Stations in October QST (page 49): W1BNS, W5AOP, W6JTV, W8DCI, W9JZJ, W9OXP, VE1AW.

Briefs

W9RIA, So. St. Paul, Minn., heard W5AWT call CQ. He called him, and (things like this happen only once in a lifetime!) W5AWT came back to W9TSV, his sister in Chicago!! VE5LP, Northwest Territory, is the brother of W9RIA and W9TSV—a family of hams! They maintain weekly schedules.

Here is a good traffic record: K6JPT over a period of twenty months averaged 533 messages per month!

A hamfest will be held Sunday (all day), July 14th, under the auspices of the Amateur Radio Association of Northern Jersey, at Woodport Hotel, Lake Hopatcong, which is located between Dover and Sparta, N. J. Admission 40¢. 56-mc. hidden transmitter hunt, other events, swimming,

prizes, all will help to make it a good time. All amateurs are invited, together with their YLs and YFs.

W6GST, Wilmington, California, is the lucky holder of car license 6N 73 88—6 for 6th district, N for N.C.R. prefix, and 73 and 88 speak for themselves!

At the 1935 convention of the National Education Association to be held in Denver in late June one of the exhibits will be an amateur radio station. A complete station will be operated during the entire convention by amateurs who have received their training in the Denver senior high school. W9HOO and W9HYD are maintained by the Denver schools for the use of amateurs who attend the senior high schools.

Finding himself lost touring through Hollywood, Illinois, W9CVO turned on his portable 56-mc. rig in search of some one who could "help him find himself." W9PHV of Riverside worked him, and directed him corner by corner through the town and on his journey!

Gorgas Hamfest

The Gorgas (Alabama) Amateur Radio Society's hamfest on May 19th attracted 54 amateurs and YLs from Alabama and Mississippi. Trips through the Alabama Power Company's steam plants and dispatching station were features of the morning activities and a barbecue and rag chewing session occupied the afternoon. Among those present were W4KP, Alabama SCM, W4APU, Southeastern Division Director, and W4ARJ, president of the Birmingham club. Those directly responsible for planning and executing the affair: W4CCP, W4BSL, W4DJO, W4CVW, W4DNI, W4DIU, and their "better halves."

During May a chess match by radio was conducted between the Easton (Pa.) High School and the Hartford (Conn.) Public High School. The amateurs handling the radio end were W1FXQ and W3EPJ. All work was on the 3.5-mc. band. Hartford High was the victor.

The Use of "ORS" After a Call

One hears more and more use of "ORS" after calls these days. The "ORS" added after a "sine" is the mark of a reliable operator. It helps other amateurs to know an experienced man is on the air, and ready to help in relaying traffic or making deliveries if they will but give him a call. "ORS" are known widely for their good signals, fine operating, courtesy, and general efficiency and readiness for any communicating job. "ORS" sent after a sign-off is hammy and filled with fraternal spirit, in addition to its practical use in establishing "identity." It aids general traffic movement, too. If you have traffic, try to give it to a station that signs "ORS." A postal will bring any League member information on becoming an Official Relay Station appointee.

W1MK Schedule

Official and Special A.R.R.L. Messages to members are transmitted by the Headquarters station, W1MK, on the following schedule. All times given are E.S.T. — Sunday: 8:30 p.m. and midnight on 3825 & 7150-kc. Monday: 8:30 and 10:30 p.m. on 3575 & 7150-kc. Tuesday: 8:30 p.m. on 3575 & 7150-kc. Thursday: 8:30 p.m. and midnight on 3825 & 7150-kc. Friday: 8:30 and 10:30 p.m. on 3575 & 7150-kc. These transmissions are at a rate of 13 or 22 words per minute, and make good code practice for the more advanced beginner.

When two "dyed-in-the-wool" hams want to go on the air, defective equipment or not, they find a way. W6ATP's receiver was "on the bum"; the transmitter at W6HZP was "ditto." But they both had telephones, so—W6HZP listened for a CQ, put the 'phone near the loudspeaker, and W6ATP copied the signals over the 'phone and called the station heard with his transmitter. Several enjoyable QSO's were carried out in this manner; break-in was F.B.; DX worked was about 1000 miles.

National Highlights

AS W9LEZ, Iowa SCM, puts it: "The spring fever microbe, or whatever it is that bites hams at this time of year, is among us again, and stations are being packed away in the mothballs in favor of golf clubs and swimming suits. We wish everyone a most enjoyable vacation."

Radio amateurs at the University of Colorado held a hamfest in conjunction with Engineer's Day, May 23rd. 66 hams registered for the event. A general rag chew session, a few good talks, refreshments and prizes brought "a good time to all." W4BBT, Tennessee SCM, was presented with an SCM's emblem by the code class he conducted at the Chattanooga Amateur Radio Club as a token of appreciation of his efforts. W4CDR, a new member of the A.A.R.S., is the first YL Army Amateur in the Fourth Corps Area. The Northern New Jersey Section QSO Contest held during April and May was a complete success; the leading scorer, W2GFW, made 40,560 points!

The Yakima, Washington club plans to take a 28-mc. rig to the top of Mt. Adams (12,307 ft. high) on July 4th. The Oregon gang plan to climb Mt. Hood at the same time. A chance for some new records. W6AM worked sixty-five 56-mc. stations while on a 4500 mile trip to Canada and return. W2FMT, W2HLQ and W2HIU are hitch-hiking to California, a long trek! The New Mexico section has a new SCM—Mr. Joseph M. Eldodt, W5CGJ, W3BIG, Mr. C. C. Morrison, is now Assistant SCM for Virginia. Since the R. I. got after the 56-mc. "boot-leggers" around Providence, R. I. the gang there claim there are hardly enough legitimates left to make operation interesting! W3EPJ and W1FXQ handled the respective ends of a radio chess match between the Easton (Pa.) and Hartford (Conn.) High Schools.

The South Jersey Radio Association had an interesting booth at the Camden Hobby Show, displaying transmitting and receiving equipment, QSLs, tube collection, 1920 spark transmitter, cup awards, etc. The Del-Mar-Va Communication Reserve Net, better known as the Del-Mar Net, composed of W3WJ (key station), W3CQS, W3DOG, W3EUK, W3BAK, W3EUV, and W3BAK meets each afternoon except Saturday and Sunday at 5:00 p.m. EST on 1.75-mc. 'phone. The territory covered includes Delaware, Maryland and Virginia. W4BBV has replaced W4TL as Georgia station on trunk line "D". Stations in thirty or more Connecticut localities were active during the QSO Party/Contest held in that Section May 10-12. The Worcester (Mass.) Radio Association, W1BKQ, operated a portable at the Worcester Progress Exposition. W5ARS is bridging a gap in trunk line "D" between W5ZM and W5BII.

A message of Birthday Greetings to H. M. King George from Australia was handled via trunk line "I". It arrived at VE3JT May 30th, was sent to VE2DG May 31st, and report of delivery in England was back in Toronto and enroute to Australia by June 1st! One of the newest nets in operation on the 3.9-mc. 'phone band is the "Black and Blue Net." Members of this group include W2FFY, W1BMT, W8LUQ, W2DAC, W2FFQ, W2VO, W3DYS, W3EHK, W3FJU, W4ANU. A secret organization, consisting only of licensed hams, has been formed in the Guadalupe Valley Radio Club (Texas); the purpose is to serve as an inspiration to non-hams to work for their tickets in order to join the "secret order". W1BTS at the Boston Trade School has the following operators: W1LXJ, W1HWJ, W1IUP, W1IBJ, W1IVQ and W1IVI. The three instructors are also "hams": W1ASI, W1CGM, W1AKN. In Western Massachusetts W1AJD and W1IJR are working on the organization of a Police Net.

On May 19th the West Virginia A.A.R.S. Net held a hamfest at Huntington at W8OK/WLHB; attendance was about 60 including practically all net members, their wives, YLs, etc. Speaking of hamfests, there seems to be a regular "epidemic" of them these days—and how natural it is that fraternal brothers should want to meet each other personally! Among the most recent gatherings (as this is written) we find: The Las Animas and Rocky Ford (Colo.) hams held a picnic-hamfest on May 5th. At Pensacola, Florida, 43 licensed operators turned out for a get-together. On May 25th the Queen City Radio Club of Bangor, Maine, entertained the

gang at a hamfest, Manchester, N. H., looked as though there were a meeting of the Isaac Walton League in progress on May 18th—but it was only radio amateurs cruising around with fish poles and rods extending from their cars searching for the "hidden transmitter"—a feature of the annual New Hampshire Section Hamfest!

The club at Alva, Oklahoma, put on a fine hamfest, which was attended by hams from Western Oklahoma, Kansas and the Texas Panhandle. Wilmer Allison, W5VV, well known tennis champion, is leaving Washington, D. C., soon for Europe. An N.C.R. unit is about to come on the air in Abilene, Texas, under Ensign Talbutt, W5AUL, former SCM Northern Texas. W6EMS, Shreveport, Louisiana, took first place at Y.M.C.A. hobby show with his amateur radio station exhibit. The May meeting of the North Carolina Floating Club was held at Greensboro under the auspices of the Greensboro club; a good crowd and a good time! W4AH, Charlotte, N. C., backed by 1 kw. on 14-mc. maintains schedules with SU1SG. The "Mid-American," the Dakota Division Convention, met the expectations of all for a real enjoyable ham get-together.

The Lansdowne (Pa.) Radio Association's 16th anniversary celebration, banquet and hamfest, was attended by several hundred amateurs. W7AYO has daily schedules with OM2RX. W7ALH/WLVX edits a paper for Washington A.A.R.S. entitled the Northwest. W2HXG displayed an amateur radio station at the hobby show in Verona, N. J. An A.R.R.L. exhibit of a complete amateur radio station attracted much attention at the New York City hobby round-up. W9KXD, Illinois O.P.S., is a real ham; his name is H. A. Miller. W9PCU and W9CGP kept four schedules a day while Conservation Department men were taking the moose off Isle Royale, Michigan; valuable message service was furnished. W9RIZ in western Kansas cooperated with National Geographic-Army Air Corps Stratosphere balloon flight. The Hiawatha (Kansas) Amateur Radio Club gave an amateur radio demonstration at local Kiwanis Club.

The Colorado A.A.R.S. 1.75-mc. 'phone net functions well under the leadership of W9DDF. The San Isabel Amateur Radio Association extends an invitation to all hams to attend its annual hamfest on July 13th; the place: Knights of Pythias Building, Pueblo, Colorado. W8GUF, New Kensington, Pa., reports W8USA, San Diego Exposition, coming through nightly at 1:00 a.m. EST on approximately 3885-kc. The University of Florida Amateur Radio Club was sponsor of an exhibit at the second annual Engineers Fair held April 19th on the University Campus.

STATION ACTIVITIES

ATLANTIC DIVISION

EASTERN PENNSYLVANIA—SCM, Jack Wagenseller, W3GS—BYS, EZ, OK and ADM all B.P.L. BYS schedules O.R.S. only. OK reports via radio as usual. AQN's new Jr. op. takes up most of his radio time. AJS is the only W3 working on 1.75 mc. c.w. regularly. AKB finished 14 mc. rig at last. 8AZT made new receiver. 3ADE enjoyed O.R.S. party. Local motor QRM annoys EOP a lot. EPJ is sending moves via radio of the chess tournament between Easton High School and Hartford High School. SLYH just missed B.P.L. 8DMA reports for first time after 11 years on the air. 8FLA is now using '10's in parallel with 200 watts input. 8EU is now a licensed traveling projectionist. 8ASW's antenna fell down. 3AZJ is QRL both A.A.R.S. and 56-mc. work. BXE reports via telephone. EBP is now O.R.S. GS is experimenting on 56 and 14 mc. MC is going on 56 mc. for the summer. DFC and FDH report for first time. 8NMA worked two VK's in two nights with a single '10 on 7 mc. Shamolin Radio Club has P.P. '46's on 7 mc. 8NOD has a 4-A transmitter and ACR136 receiver. The Frankford Radio Club is running a contest for the most contacts on the clubs transmitter. The Delmont Ultra High Frequency club has been experimenting with new beam antenna located at Larchmont for the past few weeks. Several hundred amateurs attended the Lansdowne Club's banquet and hamfest at the Hotel Normandie on June 1st. 3FGN contacted New York from Philadelphia during the recent N.Y.-Phila. 56-mc. DX event.

Traffic: W3ADM 688 OK 577 (WLQA 384) EZ 526 EOP 399 AKB 392 BYS 371 ECD 127 EBP 121 ADE 22 AZJ 20 AQN 18 GS 12 AJS 10 EPJ 6 BXE 4 W8FLA 369 LYH 348 DMA 31 ASW 14 IWT 10 AZT 8 EU 4.

MARYLAND-DELAWARE-DISTRICT OF COLUMBIA—SCM, E. L. Hudson, W3BAK, 3CQS-3SN-3CXL R.M.'s. 3BWT Chief R.M. The Del-mar-va Communication Reserve net, better known as the Del-mar net, composed of 3WJ, Key Station, 3CQS, DOG, EUK, BAK, EUV and AWM meets each afternoon, except Saturday and Sunday, at 5 p.m. E.S.T. on 1.75-mc. 'phone. The Del-mar-va Club will hold a hamfest in Ocean City, Maryland, on July 13th-14th at the George Washington Hotel. Prizes—dancing. A big time for everyone. Tickets, \$3.00. Special price of \$2.75 if ordered at least a week in advance. Tickets on sale now at 3BAK, Laurel, Delaware. Write him. Plan to spend a week-end vacation at this seashore resort. SN is having trouble with remote control and is overhauling transmitter. CXL handled 250 messages with KJTY and WHEW during month. BWT also handled Byrd traffic; he received ten 3.5-mc. calls heard reports from Europe. ABA is going to try 28 mc. this summer. ASO had FB trip to So. Carolina. CDG is going to try 14 mc. this summer. CWE is new O.R.S. DAZ will be on 3.9-mc. 'phone soon. EOZ-EHW has class "A" ticket. CDQ is going to get HRO receiver. DKM has pair of 50 watters. BOR built new Browning super. FLS (Mary English) is new YL ham. 3SN's call is being bootlegged on 7 and 14 mc.; this station works 3.5 mc. only.

Traffic: W3BND 1554 SN 971 CXL 347 (WLM 1919) BWT 614 (WLMB 29) CIZ 223 ABA 183 DML 113 ASO 97 BKZ 24 CDG 18 CWE 10 EKJ 11 EYX 7 DAZ 3 EOZ-EHW 4.

SOUTHERN NEW JERSEY—SCM, Carroll D. Kentner, W3ZX—The South Jersey Radio Association had a very interesting booth at the Camden Hobby Show, displaying transmitting and receiving equipment, QSIs, tube collection, 1920 spark transmitter, cup awards, etc. CQR will resume all his schedules June 6th. COT is wishing it was around Christmas time—he needs a new 865. EKL found he had been operating for some time with a broken feeder. BTS has joined the A.A.R.S. FIV and FJV are new hams in Atlantic City. DNU wants O.B.S. and reports that DOD is being pirated in Phila. on 56 mc. AYZ is extending his O.P.S. activities with a new 56-mc. outfit for the summer. DQO recommends ETM for O.R.S. and is having receiver trouble. FBM visited DBC and had nice rag chew. The Camden Radio Club has regular radio classes with BSC as instructor. EFM is assisting in the A.R.R.L. investigation of commercial occupancy of frequencies adjoining the 7-mc. band. ENB is going 56 mc. FJV is a new ham in Absecon. APV reports a visit from BOB. ZI and 10 fellow hams from Trenton drove down to Haddonfield to the April meeting of the South Jersey Radio Association to hear David Grimes talk. DAJ is on with 350 watts working some good DX and promises regular reports. BEI reports by radio, and says not to mention that he has not yet hooked that Asian. FFE is going "tenny"—tens on ten meters. DOR sends in his first report, and is looking forward to some intense traffic handling. Let's hear from you regularly, OM. ZX wishes to thank the Section for the privilege of serving as S.C.M. for the next two years. We are looking forward to plenty of activity in the South Jersey Section.

Traffic: W3CQR 24 COT 2 EKL 31 BTS 6 DNU 17 CYI 4 AEJ 7 AYZ 12 DQO 40 AVJ 12 EFM 108 BO 26 ENB 3 APV 65 ZI 123 VE 51 DAJ 5 BEI 22 FFE 3 ZX 18.

WESTERN NEW YORK—SCM, Don Farrell, W8DSP —JTT, R.M., is going to New Mexico for the summer. DSS, R.M., had 5279 messages for the year. FB, KMC had 13078 points in O.R.S. Party. JQB is doing very nice work in traffic. LUO has schedules 5 days per week. GWY has a new Class "A" ticket. MQX lost some time moving to new QRA. JE sends first report in long time, FB, OM. CDK took over JTT's schedules for summer. MBY, new man, is doing nice traffic work. AXE keeps schedules for north country. JE does all the operating at WLNE. BGO reports regularly from Gouverneur. KGM wants Sunday schedules. JOT was formerly FTB of Rochester. LUQ has a new 3/2 wave doublet. KBS reports new ham, NVT at Elmira.

BGL reports for first time. BHK is too QRL for much radio work. LUJ says gang hot on 56-mc. band. LGV is busy with soft ball team. GWT reports new S.T.T.A. officers. LVZ has schedules. BJO is only on for R.M. parties. DZF is very much interested in 56 mc. AWM has been rebuilding. CPJ enjoyed the O.R.S. Party. CJJ is working plenty of DX. AFM is still very busy. ACY is back after a lay-off of three years. JJJ is now located in the second district. IBW reports for the first time. MKB has a fine new 'phone rig on the air. AAR has revamped his tri-tet. BR has been rebuilding station for the summer. IYL is on 28-mc. 'phone. FYF will start vacation soon. KXA worked his first VEI. LFN is going on 7 mc. HWR has finished rebuilding. EBR is not on much due to QRL school. BLP worked all districts on 1.75-mc. 'phone. LGR was in New York City for two weeks. ABX has a new 30-watt 'phone and 100-watt c.w. rig with a vertical radiator. FHM was married in June. DT is helping on a new Police and Fire reporting system in Rome. GWZ is home from Florida. JLG lacks dough to finish his new 3.5-mc. rig. MKM wants O.R.S.; he has a fine high power station at Ithaca. CFN reports that some one entered his shack and stole nearly all of his equipment; his entire station was completely wrecked in the bargain.

Traffic: W8JTT 1111 DSS 615 KMC 436 JQE 318 LUO 61 GWY 59 MQX 59 JE 51 CDK 50 MBY 45 AXE 39 BGO 23 KGM 16 JOT-LUJ 15 KBS 12 BGL 8 BHK-LUJ 7 GWT-LGV 6 LVZ 5 BJO-DZF-AWM 3 CPJ 1.

WESTERN PENNSYLVANIA—SCM, C. H. Grossarth, W8CUG—ADY comes out on top this month and says the A.A.R.S. hamfest was swell. YA says the spring vacation didn't help the total! KWA had a good time at the A.A.R.S. hamfest and has acquired a pair of '52's. EFA has a nice bunch of schedules. CUG is still trying to make the P.P. '03A's work. GUF has a new receiver under construction. MHE sends a lot of dope about the Valley gang. IUY had to work the day of the hamfest. MOT invites us to Dubois and says the Brookville hamfest was a success. LOQ put in another buffer so he could work 14 mc. JZZ says the eats and attendance were FB at Brookville. KOB says KFE is building a new rig. INE keeps the traffic moving thru St. Marys. DKL sends a newsy letter and reports much activity on 56 mc. in Erie. GSH keeps busy with A.A.R.S. work. IOH has an 830 in the final now. KXP attended the Brookville hamfest. LIG inquires about O.P.S. appointment. EZT expects to be home from the east about the first of July. CMP has been appointed to serve on the Cairo committee. JZR attended the Brookville hamfest with IOI, NDE, and KXP. RG put in a new '03A, and got an S.W.L. card from England on 3.9-mc. 'phone. KQQ added a peak preselector to his receiver. CQA has his new receiver perking nicely. KNB is planning to rebuild and show us some real traffic totals this fall. GUY says the Beaver Valley Amateur Radio Club is planning a "Field Day." KPU had a good time at the Brookville fest. GLA is rebuilding to eliminate B.C.L. QRM. IZD and JCE have new receivers. HDY, KBQ and KBC are giving 56 mc. a try. GUX is working again but out of town. MST and MKO are working 1.75 c.w. MSV is very busy. NRB is a new ham in Arnold. NUF goes for 1.8-mc. 'phone. NFX threatens to put a 150 watt rig on 56 mc. LOR works 1.8-mc. 'phone. DUT is rebuilding for a pair of '52's. BBA is selling out. ASV has a new receiver and wants to W.A.C.! LBP has a new 56-mc. rig going. IRY is wishing for a pair of '03A's. MJF worked France, his best DX, on 14 mc. MHO hooked an EA on 7 mc. CHT is changing to 14 mc. Keystone Radio Club news: JEK is on with higher power. BFX is back on 1.75 mc. New calls: NIN, NRE, NRM, NTE, NUD. AHX is active on 3.5 mc. IWH is active on 14 and 7 mc.

Traffic: W8ADY 464 YA 301 (WLMA 511) KWA 293 EFA 115 CUG 102 GUF 248 UK 89 MHE 68 IUY 66 MOT 63 LOQ 61 JZZ 40 KOB 39 INE 35 DKL 31 AXD 28 GSH 21 IOH 12 KXP 12 LIG 11 EZT 10 CMP-JZR 9 MSZ 6 RG-KQQ 5 CHT 1.

NEW ENGLAND DIVISION

CONNECTICUT—SCM, Frederick Ellis, Jr., W1CTI—MK leads with the only B.P.L. total this month; Hal received a QSL from FM8BG saying he copied MK's QST on 3.5 mc. GME continues to hold the C.B.A. traffic banner.

UE cancelled schedules for the summer June 1st. DOW keeps Trunk "C" traffic moving. Traffic dropped off a bit at KV. CVL is trying to pick up speed in Morse. DBU worked J2GX for W.A.C. and expects to move to Calif. soon. HSX got a kick from working D4BAR, D4BPJ and ON4VO on three straight calls on 3. GKM graduates from high school. Congrats. CJD will send a copy of "Contact" to all who reported scores in May Conn. QSO party. The Manchester Club met at the combined stations of CLG and DJC recently. APZ thought he was too late with report, so QSO'ed MK and reported direct to HQs. APW says O.R.S. party lotsa fun. HYF handled his total on 4 watts input. AMZ liked Conn. QSO party. IOV is rebuilding and reports new ham, IWT, who is building a superhet. TD made 1656 in O.R.S. party. HTS suggests that chain letters count as traffic. Hi! IKE applies for O.R.S. GTW says 56 mc. is hot. BFS is busy on the farm and overhauling receiver. INF's volunteer operator staff includes A.L.B., IEH, R.A.H., IBDI, IES, 1CBD, IUE and IBAW. EWD worked J2HG again with 6 watts input to final. EAO has a pair of '03A's. Watch your ears when he opens them up, gang. Reports from all Conn. Stations are welcomed, but please mail so as to reach ICTI by the 19th of each month. Your cooperation will be deeply appreciated.

Traffic: W1MK 543 (WLMK 11) GME 425 UE 311 (WLGQ 16) DOW 230 KV 106 CVL 44 (WLGJ 33) BDI 63 AMG 56 DMP 49 DBU 42 HSX 39 DFT 35 GKM 34 HYP 32 CJD 28 DJC 25 APZ 23 APW 17 HYF 15 AMZ-IOV 12 CTI 6 TD-ES-DLX 5 INP 4 HTS-IKE 3 FIE-CTB 1.

MAINE—SCM, John W. Singleton, W1CDX—CDX is back at the head of the list for once. OR will close down for the summer. DEX says new location not so hot. BWR has new crystal rig nearly ready to go on the air. ICM reports by radio. IDN has installed new "the man" power supply. GOJ cancelled schedules until fall. BNC is going strong with a nice rig. INW is in line for O.R.S. ticket. DEH is pushing his '03A to the limit. HUX believes the 59 is a good tube. ERO gets out fine with his crystal p.d.c. note. APX is on about every week-end. HUW handled traffic for the Methodist Conference held in Houlton, FB job. IEH has new bug. CRP went and got hitched. The Queen City Club held FB hamfest May 25th. The 73 Radio Club plans to be on with a crystal rig for the Field Day tests. Has anybody got an idea for a good Inter-club contest, Diddle pom pom diddle—?

Traffic: W1CDX 237 OR 115 DHX 49 BWR 48 ICM 47 IDN 26 GOJ 22 BNC 21 INW 10 DHH-HUX 3 ERO 2 APX-IC 1 HUW 12 IEH 32.

EASTERN MASSACHUSETTS—SCM, Joseph A. Mullen, W1ASI—ASI has new transmitter under way for 3.5 mc. ABG is rebuilding freq. monitoring equipment. KH is working pair of RK30's and RK31's on 56 mc. WV is spending lots of time with A.A.R.S.; he has rebuilt station. EVJ is trying to decide on staying in Mass. BMW is QRL DXing. HWZ has 1-kw. rig almost ready. BZO is expecting job with Pan American Airways. FRO is graduating in June. GCL is rebuilding. CRA is headed for Philadelphia. FPO expects to land a job on the *Flou*, a Bay State Fisheries trawler. IZL will be in So. Orleans this summer. FNZ is still rebuilding. IGN, QTA schedules until fall and is going on 14 mc. ITK is working on 56 and 1.75 mc. at St. Mark's School. SW is QRL digging up dough for the light bill. Hi! QW looks like the long wanted station for county net in Essex County. CGM has new shack all done and Eimacs now on hand with transmitter well under way. AKN is getting set for big summer full of portable activity on Cape. South Shore Radio Club has reelected present officers for 1935-36. Eastern Mass. extends its congratulations to its sister section for the excellent manner that the Worcester boys put over the 1935 division convention. Boston Trade School now has eight operators on its operating staff with visions of a big year next fall. The ops. behind the key of 1BTS will be IXJ, HWJ, IUP, IBJ, IVQ, IVI and the three instructors, CGM, AKN and ASI. We hope to have more. Schedules may be made with other schools through the S.C.M. FRI and GHV expect to leave in June due to graduation. JI and IGN have been appointed O.R.S. FZH has been appointed O.O. and is doing an excellent job. JL is awaiting chance to use his commercial ticket. MD (since 1919) is anxious to get O.R.S. ticket. Six graduates of the Framingham Radio Club

code class took their exams April 22nd; IYJ and IYK have recently received their calls; the club started a new code class on May 15th. The Parkway Radio Association, formed and chartered in March, is going great guns under EKG as president; meetings are held on the first and third Tuesday evenings in the American Legion Hall, Belgrade Ave., Roslindale; a bi-monthly publication, "Ham Scraps," help keep up interest.

Traffic: W1ASI 25 ABG 29 KH 66 WV 36 EVJ 30 BMW 6 HWZ 217 RE 1 BZO 28 FRO 161 GCL 16 BEF 79 FNZ 3 IGN 128 SW 26 QW 19 HKY 89 MD 3 IPG 5 JL 11.

WESTERN MASSACHUSETTS—SCM, Percy C. Noble, W1BVR—DVV is now WLGF on 3497.5 kc., alternate State Net Control Station in the A.A.R.S. BKQ operated portable at the Worcester Exposition. BVR was chairman of the Communications Meeting at the New England Division Convention. DIE has cancelled all schedules for summer. BVG submits his first traffic report, which is a pippin; he is alt. C.A. N.C.S. in A.A.R.S. BOB has joined N.C.R. and QSO'd his 44th state. DWO has enlisted in the Army for training and eventual Signal Corps duty. Sorry to lose you as O.R.S. Best of luck, Bud. DRU kept busy handling Progress Exposition traffic. ARH, how about some news on your monthly cards? IJR is busy experimenting with 56 mc. ASU has been promoted to rank of Lieutenant in N.C.R. AWW is up to his usual summer pastime—catching the little fishes. AJD and IJR are trying to organize a Police Net. More power to you. BNL has 56-mc. rig for home and car. ZB made W.A.C. three times this month (J2GX and U1BA of special interest). APL is working 14 mc. mostly of late. ASY shot an R.K-20. CCH resigned as "N.C.R. Liaison R.M.," which is accepted with sincere regret. COI complains that everything is on the fritz. GXL has new SW3 and new transmitter. HRV is rebuilding. The N.C.R. stations reported their traffic as a group (ASU, ATK, BPN, DDK, DJQ, ICP, and KT). FB! The N.C.R. is installing 56-mc. equipment at the Naval Armory in Worcester. ESG now has Junior opr. Congrats. IIT was QSO Poland on 7 mc. with a '10. FLE of Fitchburg is now K6MAW at Schofield Barracks and works 7 mc.

Traffic: W1DVV 211 BKQ 201 BVR 76 (WLG 184) DIE 74 BVG 70 (WLG 177) EOB 57 DWO 38 DUS 31 ARH 25 IJR 23 ASU 11 AWW 10 KT 7 AJD 6 ATK-DDK 5 BNL-DJQ 4 BPN 3 GYI-ICP-ZB 1.

NEW HAMPSHIRE—SCM, Robert Byron, W1AVJ—The Hamfest Committee wants to thank the gang for the very fine turnout for the hamfest. Manchester looked like a meeting of the Isaac Walton League with so many cars running around with fish poles extending from them. If there is any club or group of hams who would care to put on a hamfest next year, please write to APK or the S.C.M., letting us know, and we will give you all the dope we can about doing it. CUN and DUK are the DX hounds of this section; DUK reports working AR8MO on 14 mc. JT is back on the air with a Collins rig, and by the looks of his thumb there is plenty of r.f. in the final tank. HOV is looking for a bargain in condensers but not any more dummy ones. The whole section seems to be 56-mc. enthusiasts now, and Sunday afternoons you can find the gang scattered over the hills doing their stuff. FCI reports his antenna got tired and came down. IDY has daily schedule on 56 mc. GHT, EAL, HTO, AP, AT, GDE, ICS, FFL and AVJ are busy with A.A.R.S. work. HTO has new Halliater. CGM is back home and looking for a job; we are all glad to know Bruce is feeling so much better. IP says he is slowing up for the summer. ELG had fine time in O.R.S. party. DMD got extra fine score in O.R.S. party. HJJ is off for the summer. What say, gang, about sending in all the dope you can by the 20th of each month?

Traffic: W1UN 90 IIV 71 DMD 73 IP 55 HTO 31 GMM 22 GHT 22 FFZ 20 AVJ 19 IDY 1 HJJ 11.

RHODE ISLAND—SCM, Clayton C. Gordon, W1HRC—The hams in and around Providence miss BML, who passed away the 2nd of May. IAV is new O.R.S. and reports that FAH, IRF, HPE, AWG and himself are all in on 56 mc. in Newport. BJA reports the following besides himself in Woonsocket are 56 mc. enthusiasts: HUT, IHW, FLK, EHW, IOI, BFP, GKD. HUT is coaching a lot of would-be-hams for their tickets. The Providence gang is deserting 56

mc. and some are selling their equipment. It seems that when the R.L. got after the bootleggers there were not enough legitimates left to make it interesting. GTN is rebuilding rack and panel link coupling and will at last know what R.F. current in antenna. ETD has practically deserted 56 mc. for 3.9-mc. 'phone with a new skywire. CAB is working England on 14-mc. 'phone daily with pair of '46's and vertical antenna. DAH is staying with CAB temporarily and helps erect masts, etc. EZW has new 56-mc. superhet. BES on 3.9-mc. 'phone has found out the importance of inches in feeders and has overcome B.C.L. interference. BBA has donated large magazine file to P.R.A. FZG is recovering from bad infected arm and hopes for O.B.S. appointment to be handled over INM.

Traffic: W1HRC 71 BJA 41 GTN 18 IAV 19 IHW-ETD 2. VERMONT—SCM, Harry Page, W1ATF—AHN, AVP, EFC, ERU and GNF report a good time at the A.R.R.L. Convention. GNF won a Weston meter—FB, Al AVP hears only three Vt. 'phones on 3.9-mc. band and requests S.C.M. to "wake 'em up!" FEC QS0d G6FS on 14-mc. 'phone. ELR got the New England high score in the S.S. contest. Congrats, Cliff! The Twin State Radio Club now has twenty members. BNS reports 53 members in the St. Johnsbury Radio Club. BJP has a raise in salary and so much more work entailed that his A.R.R.L. operations are severely reduced. HLH, CCF and GGT visited S.C.M. St. Johnsbury Club advertises hamfest June 22nd. Twin State at White River Junction wants one in July!

Traffic: W1EFC 45 AVP 13 ATF 12 GNF 5 GAE 2.

ROANOKE DIVISION

NORTH CAROLINA—SCM, H. S. Carter, W4OG—I wish to thank the gang again for the wonderful way the reports have been coming in. FB, keep it up. Greensboro: The Greensboro Club had a very good crowd, a good program and a good time was had by all at the State Meeting in May. MR is doing fine work on 28 mc. and is again taking out O.R.S. FB, OM. ZH continues to work plenty of DX, another "J" to his credit. Charlotte: BX has Class "A" ticket and will be on 3.9- and 14-mc. 'phone soon. The reward is still out for BFB. Have you seen him? DKB is on 7 mc. regularly. CXC is handling plenty of traffic on 3.5 mc. CSO, the N.C.R. station, reports. CLB is building 14-mc. 'phone. ALD is rebuilding for 'phone. The club is working hard on plans for the clubhouse and the convention. BX and CLB are trying to get DW's crown for being the hamfested going hams in the District. Raleigh: DW been QRL Board Meeting, but handles plenty of traffic. JB is working on 3.9-mc. 'phone with pair of 50 watts linear amplifiers. BRT keeps plenty of schedules and handles traffic on them all. BTC reports by radio. EG asked to cancel his O.B.S. while he is rebuilding. Wilmington: BRK and CZD report traffic. Say, gang, wake up and give the S.C.M. a break by reporting. Statesville: DQ is on 3.5 mc. and has been experimenting with 56 mc. AGF is handling plenty of traffic and also works 56 mc. BV has new 1.75-mc. 'phone with 175 watts input to Final. Gastonia: CPV is trying to work all the DX with only 60-watts input. CDQ reports conditions bad with him. CTK is keeping plenty of schedules. CEN worked plenty of DX during the month, 25 countries. Winston-Salem: NC went into Field Day. CYA works all c.w. bands and got only R9 from England on 3.5 mc. CGY is on 14-mc. c.w. CJU is still trying to work 48 states. COK has been transferred to Washington, D. C. We sure hate to see Jimmie go but good luck, OM. OG worked O.R.S. party from N. C. BOH bought rig from COK. CXF can't keep his antenna up long enough to work anybody. BIU is back on after a long lay-off. Look for ABT on the air any day now as he is married and has more time at home now. RA doesn't like the lightning playing around his feet, so has taken down antenna for summer. DGV is working 7-mc. and 1.75-mc. 'phone. Durham: CUB is a good traffic ham. CJP reports from college. CCH worked a "J" and is now W.A.C. CYY handles traffic in A.A.R.S. BVD has a new rig on 7 mc. VB is working DX on 7 mc. 8LMU portable is at Rocky Mount. AVT is QRL radio service and plans to experiment with 28 mc. With the 'phones: AI spends plenty of time on 1.75 mc. and handles some traffic. BYA worked a "J" on 14 mc.; he is now the only W.A.C. in Winston-Salem. FB, OM. The 1.75

mc. Net has been discontinued for the summer due to QRN DK1 is going strong on 1.75 mc. CYB has a new rig. BFB works all YL's that CQ on 14 mc. CXS has a 56-mc. rig going. BXB is also on 56 mc. AH has 1 kw. on 14 mc. and keeps schedules with SU15G. BSS is testing his new 1.75-mc. rig. BXF will be on 14-mc. 'phone soon. CXL is being transferred to Asheville. How about waking up that gang up there and sending me a report? BOM is building a new rig for 3.9- and 14-mc. 'phones. DKB works c.w. while he is building his 'phone rig. DCX has the mumps. AHH has 400 watts input on 14 mc. CVQ says the 1.75-mc. gang quit him so is on 7 mc. ANU has a new antenna. BHR was a visitor in Charlotte. CEL graduated from High School. ANU and CLB did some QRR work to get portable 1D1D and a friend a date at the N. C. Woman's College. Who says Amateur Radio isn't worthwhile? AEN took Class "A" exam.

Traffic: W4BTC 129 BRT 112 DW 75 NC 60 CXC 37 CSO 36 AGF 32 CZD 27 CYA 15 VB 9 AI 8 DQ-CUB-BRK 8 CLB 7 BFB-CDQ 5 CXF 4 BV-DGV-BYA-OG-CGY-CEN-BX-ZH-CJU 2 DK1-DKB-CCH 1 CYB 3.

VIRGINIA—SCM, Neil E. Henry, W3BRY—ALF is very busy with school closing. EEN is cancelling all schedules for the summer. EBD handled traffic for Gov. of Va. BZE can switch bands in five minutes. FBL is putting in pair of 211's. BIG is our new Asst. S.C.M. DVP is back on 3.5 mc. EDG has swell new RK-18 rig on 7 mc. DCU is plenty busy with A.A.R.S. BAN says plenty of QRN on 7 mc. now. BWA is on 3.5 and 7 mc. BRE is building new receiver. ELC sends first report in long time. UVA is putting in P.P. '52's. ALJ wants 3.9-mc. 'phone net Sundays 1:30 to 2:30. EOO has swell signal on 7 mc. EAP is redesigning complete layout. COO is back on 3750 kc. BFW is rebuilding and experimenting. BZ is busy with 56-mc. rigs. FBW is on 'phone but says he likes c.w. better. ENO has a '10 on 7 mc. for the summer. DNV is having trouble getting rig on 14 mc. EHL, ENX, and BRA are rebuilding. ELF sends in first report. FBI BTR is having a little agony with the tritet. AAJ has new Dodge sedan. DZW is selling out. EOQ is playing with 56 mc. 2CAW is on 7 mc. from U-VA. 3BSY worked Europe every day for a week! EXW says he's calling DX and working none. FDR is U-VA. club station. AAF took Class "A" exam. FBI BIW is on 56 mc. BRY is trying to get power supply going. CNY is new president of Roanoke club. GY says very QRL at WLVA. APT is on 7 mc. for the summer. The S.C.M. wants to thank all for the splendid work they've been doing this past season and hopes all that can will be on all summer. 3BIG, our new Asst. S.C.M., is going to help lots, especially with the 'phone gang, to keep Virginia 'way out in front. Please give him your fullest cooperation. Thanks! New stations in Petersburg: FHO, FJN, FKD. Much good luck to you, O.M.'s.

Traffic: W8ALF 3 EEN 21 EBD 15 BZE 5 CA 16 FBL 4 CPN 14 BIG 2 DVP 3 EDG 17 DCU 46 BAN-BWA 1 BRE 2 ELC 1 EPH 16 BSB 1.

WEST VIRGINIA—SCM, C. S. Hoffmann, Jr., W8HD—JWL is new O.P.S. LXF is new O.R.S. KSJ and BDD apply for O.P.S. FVU applies for O.R.S. EYV's O.P.S. was endorsed for another year. AZD made W.A.C. As soon as the last QSL comes in, he will claim worked for W.A.C.: VP5AA, LU4DQ, SP1BC, VK3WL, ZU6E, U0MI; he has worked 72 countries. KKG-WLHN and EIK-WLHG work the Army C.A. Net. DMF and KKG report participating in O.R.S. Contest. HWT has been appointed O.B.S. HD is down due to moving. CMJ visited ELJ and KDP. MCL and NLE visited 4NC, also N. C. floating club meeting. JJA will be on with '03A job this summer. FQB is going R.O.T.C. at Fort Knox during summer. The gang send condolences to AKQ whose wife died, and also hope JWL's wife recovers from her operation. Bluefield Radio Club on May 5th elected following for directors: MOP, 3AAF, 8NAU, ING, KBU. The Board elected following officers: ING, Chairman; 3AAF, Treas.; 8NAU, Secy., and reappointed EWM, Tech. Advisor. On May 19th the A.A.R.S. Net held a Hamfest in Huntington at WLHB-8OK, which was attended by nearly all Net members, their wives and others, numbering about 60. KEC applied for A.A.R.S. appointment. ATT is heard on the air again.

Traffic: W8AZD 14 KKG 133 (WLHN 76) EIK 48

(WLMG 53) MCR 14 DMF 15 HWT 59 HD 10 CMJ 8 MCL 10 EWM 5 KEC 16.

HUDSON DIVISION

EASTERN NEW YORK—SCM, Robert E. Haight, W2LU—EGF adds 2nd opr., fine German Police dog to shack. LU hopes to attend Atlantic Division Convention. FQG will see you at Albany Hamfest, 29th June. FKL promises 300 watts on air with Class "A" ticket. BZZ is doing FB work from WLMG with high totals. GTW joined A.A.R.S. ATM reports new club, Westchester Amateur Communications System, W.A.C. System. BJA is all pepped up with no traffic in sight. HAN is R.M. for the 56-mc. net. HCM is dreaming of his dimes coming in from dime chain. GPB gets traffic from 56-mc. net. IEC and W2FXK are in the 56-mc. net. HTH uses '10 with 1000 volts, 86 to 124 watts. CC is still going strong with VK's. W9AAB visited UL on way to Hartford. HCP needs reliable schedules east and west. HJN is on 1.75-mc. 'phone; he graduates from H.S. Congrats, OM. ACY ordered Johnson "Q" ant. for 14 mc. GRV and EGE are QRL exams. CJS is playing with 802. QY is on 3510 kc. and 57 mc. ESO is going to see this summer. BYP and CVJ are W.A.C. BTB is knocking off "J's." EGQ leaves for Spain. CUR is pres. of Tri-States Radio Club. 3AC, while sick at hospital, uses 56 mc. to keep in touch with the boys. FRU is on 3.5 mc. With the passing of 2BWB of Ossining, E. N. Y. Section loses one swell fellow. All who knew him will miss him. HTN wants to know if BSH is on the air. AVS is on 14 mc. and is all set for 28 mc. LU had thrill of life when he met ex-Navy Opr. Yarwood after 15 years; they were shipmates at NPN, Guam, M. I.

Traffic: W2EGF 410 LU 365 FQG 41 FKL 44 BZZ 30 (WLMG 1815) GTW 39 ATM 27 BJA 26 HAN 34 HCM 21 GPB 22 IEC 15 FXK 8 HTH 20 CC 14 UL 14 HCP 7 HJN 2.

NEW YORK CITY AND LONG ISLAND—SCM, E. L. Baunach, W2AZV—EYQ is out for R.M. HBO, IBA and IBT want O.R.S. HIT wants O.P.S. AVW is selling out complete 30-watt job. After five weeks of waiting GNX got Class "A" ticket. FF is lining room with Celotex for 'phone job. HJK can't get out of the back yard with 100 watts input. DOG had to QRT O.R.S. party to fight forest fire. BSR works the J's on 14 mc. in the early morning. HMJ is trying to get 1000 QSO's in one year. Spring gardening keeps HAK from pounding brass. HNJ boasts of a new SW3. DWW is looking for reliable schedules with N. J. and L. I. stations. KI schedules Trunk Line "C." DXO reports DPQ op. at hobby roundup. GDF made high score in O.R.S. party in a few hours. BGO is looking for some good members for the A.A.R.S. CYX completed a one year schedule with 1HR. BPJ has emergency power supply consisting of two dynamos driven from storage batts. FCQ has 1/2-kw. rig on 7 mc. IS has a complete transmitter and receiver on a 17-by-22-inch panel in a two-room modernistic apartment and hangs a 37-ft. antenna from the window. A Jr. opr. arrived at AYJ's house the day of the O.R.S. party! HRA is looking

for a good alarm clock to wake him up in time to hear the VK's. DCF is helping the YL, HPI, to obtain a Class "A" ticket. IAW is experiencing trouble with automatic elevators BRB is now playing with kites for 75-mc. and 56-mc. tests. DRG reports DSA, the N. Y. U. Radio Club, on 56 mc. GYV is getting DX on 56 mc. AJB sends a report for the local 56-mc. gang. The following stations are using these frequencies for regular operation: DBQ, ELK 3510, BNJ 3550, AZV BYL 3570, EYS 3790, HKO 7160, AIK 7130. School exams keep HWS busy. An infected finger keeps AZV from pounding brass.

Traffic: W2DCF 122 BGO 89 DXO 78 CHK 230 (WLNW 74) AIK 48 DWW 47 DBQ 46 (WLNW 236) GYV 40 EYS 35 EYQ 32 AZV 32 KI 28 CYX-GDF 28 AJB 26 FQA 25 HKO 24 HPI 22 BYL 13 FLD-BMM-BKP 12 CP 10 BPJ-ATT 9 CIT-HBO 8 IS-AA-BNJ 6 ENS 5 GWO 4 HMJ 3 FCQ-HAK 2 HNJ-DOG-HJK-AGC-FZM 1.

NORTHERN NEW JERSEY—SCM, Charles J. Hammersen, W2FOP—BCX reports new system of traffic handling inaugurated in Second Corps Area A.A.R.S. GGE is working DX on 14 mc. DCP wants shotgun for some cranky S.W.L. neighbors. GGW now dresses in Naval Reserve uniform. HBS is rebuilding transmitter. HNP is going in for a 50-watt bottle. HHY is gathering parts for a 50-watt rig. GFW wants O.B.S. HEC is rebuilding shack. HXG had rig at hobby show in Verona. ECO gets QRM from new baby YL. Congrats, Lester. ICL is coaching prospective hams. CIZ is operating mobile on 56 mc. HAE received two tickets last month, one Class "A" ham license, the other for traffic violation! HVM's preselector works FB. FBS's big item for month was QSO with J2HG for W.A.C. BZM was appointed alternate key station for N. J. Section 56-mc. net. GUQ is copying commercials for increase in code speed. 3EBC has been working some nice DX on 14 mc. 3COP is several times W.A.C. on c.w. and needs only Africa for W.A.C. on 'phone. ZHRN is radio operator, 212th Coast Artillery, N.Y.N.G. The Tri-County Radio Ass'n recently heard 2BRO speak on the acorn pentode.

Traffic: W2BCX 736 (WLNW 278) GGE 293 DCP 158 GGW 86 GVZ 85 HBS 67 HNP 32 HEY 30 GFW 27 GWJ 23 CJX 20 HHC 18 HXG 15 AIF-ECO-ICL 10 CIZ 8 HTX 3 FOP 4.

NORTHERN NEW JERSEY QSO CONTEST RESULTS

W2GFW, 40,560; CLM, 30,780; DPA, 24,012; GWJ, 22,720; FFG, 22,608; HNP, 21,208; GUM, 20,933; ABS, 16,590; HLS, 16,188; IAT, 15,170; GON, 12,890; GFF, 9990; GER, 8344; CTT, 7392; GGE, 6026; GVZ, 4488; HWY, 4444; HZY, 4268; GGW, 3680; HOB, 3630; DCF, 1848.

This list represents the prize winners only. The first attempt at a section QSO contest was a complete success. Another will be planned for next season. Prizes for the contest were donated by Raytheon, Hammarlund, Aerovox, Sylvania, National, Gross, Biley, Kaltman & Romander, A.R.R.L., W2GNK and W2BCX.

CANADA

MARITIME DIVISION

MARITIME—SCM, A. M. Crowell, VE1DQ—Nova Scotia: By the time this report is in print, what now promises to be "VE1" 's biggest and best HAMFEST will be a thing of the past and, from all signs at the time of writing, the gang is going to be a large and merry one. So we say, "Glad to have seen you all." HG had 116 QSO's in 12 days with Johnson "Q" Ant. EP is going to QRO with 211 soon. AW and DQ had quite a time on 3.9 mc. talking up the hamfest. EH and AG have many FB chats on 3.9-mc. 'phone. ER says the T.L. is going FB again. IA gets out very well on 7 mc. DB quit for the summer. DZ is a low-power man on 3.9-mc. 'phone. HX pokes out well on 3.5 mc. HH sends FB report and says very busy with studies and other work. GM has the 14-mc. rig going and is piling up DX. GU has combined gear with GM on 14 and 3.5 mc. DR still pounds out on 14 mc. GZ does his stuff on 14 mc. in evenings. DM, back from trip, has Class B going very fine. ED and HO contact regularly on 7 and 3.5 mc. FW likes 7 mc. FB and hooks

lots of DX. DZ and BL are quite active on 7 mc. On June 10th FR has been on the air a full year; he uses 90 volts B battery on a 231, c.c. on 3661 kc.; he has had about 700 QSO's during the year.

Traffic: VE1HH 4.

ONTARIO DIVISION

ONTARIO—SCM, S. B. Trainer, Jr., VE3GT—AEQ reports himself for the first time and likes good long QSO's. OT was heard on 3.5 mc. using pair of '45's. PL expects to operate at VE4TA again this summer and wants us to look for him. QB suggests a cycling contest for the hams who roam the country visiting other hams. An idea! VE9AL is arranging with some of the Toronto gang to use amateur radio to aid the Toronto Flying Club Annual Pageant June 15th. VE3SE is handling a bit of traffic. RX is most recent ham in St. Kitts. Glad to see JT back helping out on T.L. "I." VA is keeping T.L. "I" open to GG, and has nice route through to Northern Ontario; he is newest O.R.S. DU is still waiting for TM and QK to come back on the air. QK

has moved. MX is returning to 3.5 mc. MB is now c.c.; he was visited by VE2AR. BZ enjoyed last O.E.S. party. ABW schedules IH and wants schedules with Belleville or Kingston. SG says you can't beat reliable schedules for real enjoyment. NX is rebuilding again! SZ works DX with ACK's transmitter at JV's QRA. HI, WK is on nice route to Eastern U.S.A. and Canada, as well as southwestern Ontario. GG has worked out chain traffic stunt instead of chain letters for boosting traffic activities. How do you like it? YS likes autodyne receiver. GT is decorating an abode for more than one.

Traffic: VE3PL 4 SE 9 JT 245 VA 127 DU 27 MB 118 BZ 10 ABW 23 SG 60 WK 38 GG 138 RK 151 GT 106. VE9AL 26.

QUEBEC DIVISION

QUEBEC—SCM, Stan Comach, VE2EE—We learn with regret of an accident to BU's young daughter and trust that when this appears she will be 100% recovered. Our C.G.M. was down at Hartford for the annual meeting, and we thank him for the steps he has taken on our behalf. FQ has had bad luck with his 50-watters but still gets out with the duds. DR is getting new transmitter lined up; Bill made the B.P.L. this month. Congrats. EC has new rig almost completed, and hopes to be back on the job very soon to join the Tricolour Network again and help HT, AB and the boys carry on the fine work. JK and FG are both handling traffic. Thanks, fellows. JK has the makings of a good operator! AC, our 28 mc. DXer, is experimenting on that band. 56 mc. is becoming inhabited; listen in to AX and GN. We welcome an old-timer back on 14 mc. in the person of Rod at FO. JY has been worked on 14 mc. with a beautiful note. II is making bids for the traffic crown; watch his total grow. The RK20 that once adorned the rig at CO is now over at DU. GO is going high power and GX and GZ are having trouble kicking those 11's. GA is putting in Class A modulation; that 'phone bug bit deep. AY is having great results with a directional antenna. FQ is going to Anticosti with HQ for the summer. Pleasant trip and good hunting. Syd. CU has a new skywire, and at last the rig is going places. CX is having a little trouble with his speech amplifier. AP changed his QRA from the basement to the top story. AW has had a new arrival. Congrats, Hugh. DD is very busy with his boat. IQ is rebuilding for higher power. IY gets out on 14 mc. with old low-powered rig. 3CJ is one of the gang now and hopes to be on with us soon. Welcome, Bud. The call BO is on the air again in the hands of a worthy successor to Bob. FI has been heard again; school must be over; EW contemplates dividing his time between DX and growing tobacco. HI. There are still quite a few out-of-town fellows from whom we would like to hear occasionally; how about a card now and then?

Traffic: VE2DR 526 II 216 BU 25 HT 15 JK 18 BB 24 EC 5 AB 5 AC 4 FG 4 BT 15.

VANALTA DIVISION

ALBERTA—SCM, J. Smalley, Jr., VE4GD—LX is now on Trunk Line "I," and it has given him top score in the province with one of the best totals ever. BZ, also on Trunk "I," is second with another good score. QK and GE are the only other stations handing in traffic reports this month. KN passed commercial exams with a grand average of 96%. FB, OM, LA has been busy building a 'phone for IN at Kirkcaldy. OF has had his ticket endorsed for 3.35- and 14-mc. 'phone. FI and HW are back in Calgary from Varsity. LK worked a W6 for the first reported 28-mc. activity since 1930. The Lethbridge Club has a couple of 56-mc. rigs that are keeping the boys in that city amused. Rod McLeod, Ex4CG, has built a couple for the Army in Calgary, and the ham bunch in the Militia are very much in the fray. Edmonton expects to get in some 56-mc. land-to-air testing when Miss Margaret Fane, a licensed pilot, gets her ham ticket. PH has been to the Navy School at Esquimault. PH and IZ prefer the Army, and will be at Camp Borden all summer. The Y.M.C.A. Camp Chief Hector will be kept in communication with Calgary with equipment and operators from SC, UP, UW and JC. Amateurs in other parts of Canada and the U.S. who intend to come to the Calgary

Stampede July 8th to 13th are invited to attend the big hamfest that will be held during that week with the big doings on Friday, July 12th. Hams intending to attend are asked to get in touch with the S.C.M. not later than the 9th. Lots of prizes and a big time assured. JJ and Ex4CG are to be congratulated on winning King's medals. FB, OM's.

Traffic: VE4LX 226 BZ 110 GE 38 QK 28.

BRITISH COLUMBIA—SCM, R. K. Town, VE5AC—The B.C.A.R.A. hopes to combat the lack of radio activities with an onslaught of social events for the summer. See the Amachewer for dates of activities. FM turned Trunk Line "F" over to EP for the summer. AC got on 7 mc. and worked first DX in three years. All stations keeping schedules are requested to report same to the S.C.M. on the 15th of the month. Reports of any activities are always appreciated. HU is working all bands. DZ worked his first ZL's. EV is working DX and keeping schedules. GI, the wandering ham, is back home. HC handles traffic when not busy working DX. JL is headed for an O.R.S. GC sends first report; he schedules W7COU. AL handles traffic to keep in practise. AM is spring cleaning. CC was heard from for the first time. DD schedules BY on 3.8-mc. 'phone. FG keeps schedules at 9CY.

Traffic: VE5HU 8 DZ 4 EV 23 GI 25 HC 12 EP 56 JL 40 GC 8 AL 13 AM 6 HP 48 AC 82 CC 2 FH 3 DD 12 BY 28 FG 21.

PRAIRIE DIVISION

MANITOBA—SCM, A. J. R. Simpson, VE4BG—Traffic continues to hold up very well, Trunk Line station AG leading with a high score. TV is scheduling MJ at Russell and CG at Winnipegosis. Other points in Manitoba will shortly be hooked up as feeders with the Trunk Line. Any Manitoba station wishing to arrange schedules and traffic nets, please communicate with Cliff Ferg, AG, Winnipeg, who is the new R.M. for this province. Plenty of DX is being worked, DU, VI, KU, TO, NI on 'phone. GC and several others contacting several countries. The record for the fastest long distance QSP is held by DU, who relayed a message from Alberta to Australia within 24 hours; the VK QSPed to destination in Australia within 12 hours and confirmed with DU the next day. The first Russian to be worked by a VE4 in Manitoba goes to DU also, immediately followed by WA. GC now has rig down to a single RK20 exciting a 52. MW is dropping a couple of stages by using RK20. The original LH, who recently sold out, is picking up parts again and will be heard again shortly. IC is active on 14 mc. MJ is applying for O.R.S. Official broadcasts are to be heard each Sunday afternoon at 2:00 p.m. C.S.T. from IP on 14 mc. The M.W.E.A. held a smoker, April 24th, and 50-watters donated by DU were taken away by MW in tall story tellers contest and UX in peanut-pushing contest. HI.

Traffic: VE4AG 315 TV 25 KX 2. (Mar.-Apr. VE4SO 64.)

SASKATCHEWAN—SCM, Wilfred Skaife, VE4EL—UC, PQ, and QZ have already had local QSO's on 28 mc., and more of the gang are building 28-mc. rigs. RI will use Class B Mod. on his 1.75-mc. 'phone. PQ is new ham at Saskatoon. QZ is building Autodyne. The following schedules are running: RZ & MH, PL & CC, CC & MH, MN & TX, UL & TX; these feed into the main Trunk Line. QP and RJ have had more than 300 'phone schedules at noon each day. JS and BN try hard for some DX, but missed it owing to antenna stretching. BN is now in a dry cell town but, with a stop and listen signal and a fist due to 20 lbs. weight increase, should be heard. The Rouleau and Wilcox hams visited BN at Truax. HS now has crystal rig. FM gets T9X reports with Vibrator-Transformer Power supply (QST June 1934). GA, after visiting St. Paul Hamfest and many places over the line, returns to find his antenna in the mud. EH and PM are now in northern Manitoba with the Airways. AU, ES, EB, KJ and G1 are very active on 'phone. Your S.C.M. visited the station of Moose Jaw gang at Fair and heard their activity on the air; this station was in operation 24 hours per day, and VQ, KA, HHH and 4FW took all night shifts. OM has 28-mc. portable. SY has new SW3. VQ and OP have been presented with new YL ops. CM has new ACR-136; he also holds one of the Jubilee Medals for his work in the Signal Corps.

Traffic: VE4CM 245 FW 27 GA 24 UL 12 FL 11.



CORRESPONDENCE

The Publishers of *QST* assume no responsibility for statements made herein by correspondents

Five-Meter Bootleggers

St. Charles, Ill.

Editor, *QST*:

Recently I had occasion to visit my home town of Dayton, Ohio, and was tickled pink over the thought of taking my five-meter outfit along in the car to have a few QSO's with some of my old friends. Upon my arrival, I eagerly blasted out a "CQ," signed and then tuned across the band. Lo and behold, three stations calling at once and all three turning out to be outlaws! I contacted the loudest one and asked him if the Radio Laws had suddenly been rescinded. What do you suppose his answer was? "Well, W9NN, it's like this, 55 per cent. of 64 stations operating on 56 mc. in this area are bootleggers like myself. I'm just trying this rig out to see how far I can talk with it. Where did I get this call, W8PBS? Oh, those are my initials, OM, hi!"

Being too dumbfounded to think of an answer for that crack, I pulled in my antenna and pointed the nose of the old V-8 back to Illinois!

Guess it's a toss-up who gets the 56-mc. band—from my experience I'm betting on the bootleggers!

—Robert E. Baird, W9NN

Jacksonville, Fla.

Editor, *QST*:

In regard to your editorial in May *QST* concerning bootleg operation going on in our five-meter band, one of our licensed members operating on five meters recently contacted one of the bootleggers. At the time he was using the call letters "W4JAX" which as yet have not been assigned by the F.C.C. During the QSO the unlicensed operator stated that he intended to use his "swiped" call until he could think of a better one and even asked our member if he had any suggestions!

. . . The club will carry out the program suggested in your editorial to rid the five-meter band of illegal operation.

—Jax Radio Club

218 Sheetz St., West Lafayette, Ind.

Editor, *QST*:

I certainly agree with you, in your May editorial, that, "There's too much bootleg operation going on in the five-meter band." However, I doubt if this is a problem which can be cured by

the Wouff Hong. There are often more vital reasons for bootleg operation than merely "enjoying the thrill of doing a little 'radio broadcasting.'" The development of cheap and efficient transceivers has solved the problem of providing reliable communication in many cases where wired telephony is impractical. Among the many such examples our own case might interest you.

The Purdue University Glider Club has been using transceivers for glider instruction. Dual instruction is not practical with gliders and our radio equipment has avoided several possible accidents this spring. I am always on duty at the ground set but it would be absurd to require all of our members to secure amateur licenses before using the glider set. Many glider clubs would like to use radio equipment but do not even have a licensed operator for the ground set.

Unlicensed operation has never been a really serious problem on the lower frequencies because offenders operated from fixed stations and could generally only communicate with licensed amateurs. Faked call letters were readily discovered and it was easy to secure sufficient proof of interstate communication to get action from the F.C.C. To-day, with transceivers selling for about ten dollars, we have a much more difficult problem. A very large portion of the illegal communication is portable or mobile work between unlicensed stations and is never detected. Even when we do detect bootlegging we are often powerless. As I understand the regulations, an amateur license is required for the operation on the amateur frequencies of any station engaging in interstate communication or capable of interfering with interstate communication. On the lower frequencies this obviously includes any transmitter in any conceivable location. However, it would certainly take a confirmed optimist to hope to get evidence for a conviction on these grounds in a case of bootleg operation of a fleapower transceiver from a location in the heart of the state of Texas!

In the East, with directive antennas, you have a different situation. However, a law which can be enforced in some cases and not in others is rather unsatisfactory. My observation is that many of these people operating illegally on five meters do not actually wish to break the law. They merely cannot spend a month or more learning the code and studying for an examination which does not specifically apply to ultra-high frequency communication.

At a recent meeting of the Purdue Amateur Radio Club I made a proposal which aroused considerable interest. The proposal is as follows:

1. That we, as licensed amateurs and members of the A.R.R.L. recognize the uselessness of trying to prevent illegal operation on five meters under the existing regulations, and sponsor such modifications of these regulations as will allow anyone readily to comply with them. This means the issuance of a new type of license for ultra-high-frequency communication, with an examination which can be passed without lengthy preparation.

2. That we sponsor the opening of one or more new bands for this semi-amateur or semi-commercial operation, so that users of this new license will not interfere with operation on the existing amateur frequencies. Space above 60 mc. is cheap at present, but may not be in a few more years.

3. That power be limited to about ten watts (carrier) for operation on this band, except where a real need for greater power can be shown.

4. That radiating super-regenerative receivers be prohibited, except for true portable operation and similar uses where the extra weight of more complicated equipment would be a serious handicap.

5. That the new type of license examination be taken in a manner similar to that for our present Class-C license, regardless of the candidate's location, and that it cover only such regulations and theory as specifically apply to ultra-high-frequency communication. *There should be no code requirement.*

6. A new and distinctive type of call should be assigned these stations so that a holder of the new license could not attempt to use his call on the amateur bands.

I feel that the A.R.R.L. would have everything to gain and nothing to lose by sponsoring this movement. It would protect our five-meter band from needless QRM, satisfy the "transceiver gang" and do much to speed the development of ultra-high-frequency equipment.

—S. G. Lutz, W9TJB—*Ex-W9DPZ*

EDITOR'S NOTE.—Although not yet proved from the legal standpoint, the F.C.C. holds that all unlicensed radio operation, no matter where or on what frequency conducted, is illegal—largely because it is capable of interfering with interstate services. The glider-club work herein described is obviously illegal in that unlicensed operators are used. The club should secure some other class of license for which the easily-obtained Radiotelephone Third Class tickets (no code or technical examination) will suffice.

6142 Kimbark Ave., Chicago, Ill.

Editor, *QST*:

As one who has been an active amateur since 1915, may I take the liberty of commenting on your editorial in May *QST* on bootleg operation? It seems to me that you may be somewhat unfair in your attitude toward the bootleg operator. As you mention, many of these persons are not interested in becoming amateurs. Neither are they "thrill-seeking BCLs." There exists to-day a growing demand for space in the ultra-short-wave spectrum for two-way short-range radiophone communication. As more and more people become aware of the possibilities of these frequencies, there will be an overwhelming demand for permission to legally use certain bands for non-commercial, non-amateur, private stations. In my opinion this demand would be both legitimate and reasonable.

At present no provision has been made for this class of service, and the only way a citizen can operate such a station is to become an "amateur," or to operate in violation of the law. If we amateurs are wise, we will recognize from the first that this is a new type of service, as distinct from amateur radio and from broadcasting as these are from each other. We cannot hope to assimilate the majority of these people into our ranks, and if we continue to regard them as potential or unlicensed amateurs, we run the risk of losing what few privileges we now enjoy. Theoretically, as long as these stations do not operate in our bands or appropriate our calls, it is none of our business what they do. Practically, it is to our very great advantage to use what influence we have to help these people obtain a legitimate band, outside the amateur allocations.

The fact that the range is short, Mr. Warner, *does* have a great deal to do with it. These ultra-short waves cannot conceivably cause international interference, and therefore their allocation should be under the sole control of the national governments (in the United States, the F.C.C.) rather than being restricted by the inflexible agreements of an international convention. If I am incorrect, perhaps we had better be prepared at the Cairo conference to claim for amateur use the frequencies between 3.75 and 7.5×10^{11} megacycles. We would find them very handy.

—Kenneth H. Goode, W9BH-W8BDF-W8BQV

How About a Truce?

527 23rd St., Manhattan Beach, Calif.

Editor, *QST*:

Let's have some common sense in this c.w.-'phone controversy. Heated words are heard on every side, words obviously lacking the foundation of constructive thought.

This letter almost started in the same vein after hearing some of the 14-mc. 'phone gang give President Maxim a royal razing to-night for voting in favor of c.w. at the recent Board meeting. Let these fellows add their aggregate years in ham radio and see if H.P.M. is not still the senior of the whole bunch. In other words, there are many more sides to the question than the one so clearly evident to the 'phone man who has just fought a QSO through a half-dozen carriers (or to the c.w. man trying to get a message on the third repeat!). It takes someone out of the heat and temper of battle to make the big decisions; no army is ever commanded by the private in the front line.

Next, let each side know the other a bit better before lining up the firing squad. To-night W9—was overheard saying with blind conviction that DX is absolutely more consistent on 'phone—he for one needs to look on the c.w. side of the fence before making such false statements. The same goes for the c.w. men who characterize all 'phone QSO's as so much drivel; a listen around the 'phone territory will show them plenty of QSO's handled as cleanly as any on c.w.

Though this letter was to have been non-partisan, I cannot help recalling the c.w. r.a.c. QRM of two years ago and how compulsory p.d.c. cured the situation—isn't the 'phone over-modulation QRM a close parallel? Let the bum 'phones first clean up their own unnecessary QRM; otherwise granting more 'phone frequencies will be like letting the hog out of the pen so's the mud won't be so thick when spread over the whole yard.

—Chas. D. Perrine, Jr., W6CUH

EDITOR'S NOTE.—President Maxim voted in favor of neither c.w. or 'phone. His sole vote on the 'phone question was necessitated to break a tie concerning the reopening of the 'phone question for *reconsideration* on the second day; his vote was cast in the affirmative.

XEAW

Mission, Texas

Editor, *QST*:

Some two months ago I wrote you a letter asking what you could do about the second harmonic and numerous sidebands that were covering up the 160-meter 'phone band in South Texas from the Mexican station XEAW. . . .

You might be interested to know that the Mexican government sent a man to XEAW upon receipt of your complaint. I have just had the pleasure of talking to Mr. J. O. Weldon over long-distance telephone. He told me that he had found numerous "bugs" and that there should be much improvement over the whole station beginning to-night (not next year) and that the whole situation would be vastly improved, with new equipment throughout, within the coming month.

Gentlemen—that's what I call service!

Not only have I met a vy fb OM, but I have learned that A.R.R.L. can get action and does "give a damn," something I have heard it didn't.

(Continued on page 70)

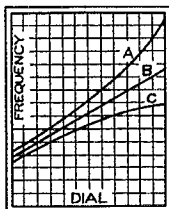

IF THE DESIGNER knows the circuit in which a variable condenser is to be used, it is possible for him to calculate a plate shape which will make the tuning curve a straight line. However, in a different circuit the same condenser is likely to result in a curve on the calibration chart. Apparently many amateurs do not realize this, for occasionally we receive letters expressing surprise that the tuning curves of our receivers are straight for some ranges, and curved for others.

To take a specific example, our worm drive PW condenser used in the HRO is designed for a tuning range of 2 to 1. It consequently has a straight frequency line calibration only when the maximum capacity in the entire circuit is exactly four times the minimum capacity in the circuit. This corresponds to curve B. Suppose the trimming condenser is backed off so that the minimum capacity is lowered. The tuning rate with the rotors all the way in is nearly the same as before, since the rotors are providing most of the capacity in the circuit, so this part of the curve is practically unchanged. However, with the rotors out, the trimmer is all important. The tuning curve, therefore, hooks upward, as in curve A. Similarly, if the minimum capacity is increased, the calibration swings the other way, as in curve C.

Amateurs almost invariably run into this when they build wavemeters and similar equipment, because they wisely use double-spaced condensers, plus heavy padding to provide band-spread. We do not think that a non-linear calibration is particularly objectionable in such equipment, but if it is objectionable for any reason, we have two suggestions. The simplest solution is to use a condenser with straight-line-wavelength plates such as the National EM. When the normal tuning curve of such a condenser is plotted against frequency (instead of wavelength, as intended), the result will be similar to curve A above. When padded to give proper band-spread, the curve will tend to straighten out, since the padding causes curvature in the opposite direction. This very thing is done in the National "Frequency Meter Condenser," which is a combination of EM rotor plates, plus circular plates to give the proper padding for band-spread on 80 and 160 meters.

Where high precision is required, this method is not generally useful, because modern precision condensers usually are available only with SFL plates, the PW condenser being a case in point. If such a condenser is used, the calibration can be straightened by the use of a series trimmer as well as the usual shunt padding condenser. This is, of course, the system commonly used for padding the H.F. oscillator in superheterodynes. As the procedure is described in a number of standard texts, we will omit a complete explanation here. Generally speaking, however, increasing the shunt capacity decreases the frequency at the high end, while decreasing the series capacity raises the frequency at the low end. Needless to say, these padding condensers should be good quality, air dielectric units. However, they do not need to be as precise as the main condenser, as the burden of accuracy is upon the latter.

In closing we wish to answer some specific questions on the PW condenser which have been asked often. The PW has two standard ranges — 12 to 225 mmf. and 10 to 150 mmf. per section. It cannot be made in larger capacities with present tooling, but lower capacity is available on special order. And lastly, it is available with double spacing for use in frequency meters and similar equipment.

JAMES MILLEN



GROSS CB-100

A 100-Watt Radiophone and C.W. Transmitter completely housed in an entirely enclosed floor rack of ingenious design. All units are fully accessible through the removable front gates, for coil changing antenna network adjustments, etc. Incorporates everything from microphone jack to impedance matching antenna network.

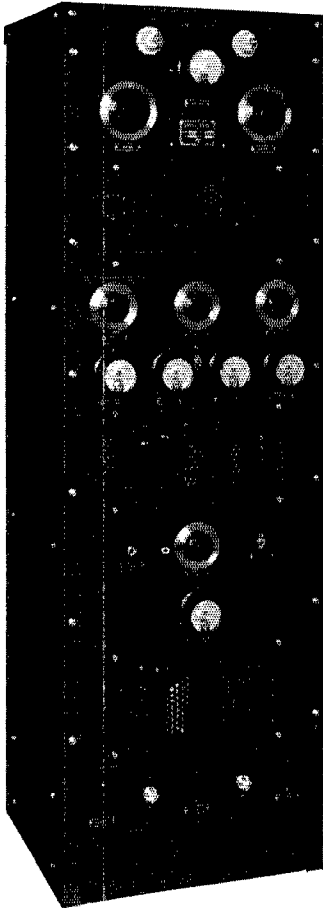

● **R. F. LINE UP** — 47 crystal oscillator, two 46's buffer, 03-A amplifier.

● **FREQUENCY COVERAGE** — 1.7, 3.5, 7 and 14 MC Bands.

● **POWER SUPPLIES** — 1050 and 1200 volts at 400 MA choke input, 8 mfd Pyronal condenser used and 400 volts at 300 MA.

● **SPEECH AMPLIFIER** — Special four stage high gain speech amplifier self contained from microphone jack to gain control.

● **MODULATOR** — Two 800's are used in the Class B Modulator. 100% modulation.

● **BIAS** — No bias batteries of any kind required.

● **ANTENNA UNIT** — Impedance matching network supplied for use with any type of antenna available.

● **OPERATING CONTROLS** — Terminations provided for operating all switches from operating table.

● **SIZE** — 60" high, 19 1/2" wide, 16" deep.

ANNOUNCING!!

NEW GROSS CB-300

Class B Modulated Radiophone Transmitter
250 Watts Output. Attractively Priced.

LEST YOU FORGET:

Gross Radio's Engineering Department is under the direct supervision of J. Gross who has had over 20 years experience in the construction of transmitters of various types. Mr. Gross has for 12 years been actively engaged in manufacturing transmitters. The first crystal controlled transmitter advertised in *QST* was designed by him. Ultimately, the long experience and fine reputation of the company you buy from is your best guarantee of satisfaction.

Descriptive Literature Sent Upon Request

GROSS RADIO, INC.

51 VESEY STREET, NEW YORK • CABLE ADDRESS: GROSSINC

Correspondence Department

(Continued from page 68)

Many thanks again. The whole South-Texas 'phone fraternity appreciates it.

—Herschel S. Peake

EDITOR'S NOTE—To the *Liga Mexicana de Radio Experimentadores* goes credit for opening successful negotiations with the management of XEAW, leading to the highly satisfactory outcome of this situation.

With the recent removal of HJ4ABB, Barranquilla, Colombia, from the 7-mc. band, through the efforts of the *Liga Colombiana de Radio Aficionados*, the American commercial interference situation seems currently under control. Amateurs experiencing persistent interference from any non-amateur source (excluding images in superheterodynes, which constitute almost all the interference now reported!) are requested to advise the Headquarters in order that remedial steps may be taken.

Letters and Character

214 E. Monroe Ave., Jonesboro, Ark.

Editor, *QST*:

I have noticed that frequently when some ham makes a suggestion that appears in *QST* that does not meet with general approval there is some degenerate, black-balling reply. I have never seen anything in such violent contrast to the "gentleman's" part of the amateur's code. I also noticed that those who send in the muck-raking letters do not offer a better suggestion at all, but usually confine themselves to making some biting remarks upon the character of the ham who made the suggestion.

I have never traveled very extensively, but I have met dozens of hams. I can only recall one or two who I believe would be capable of such low comedy.

I am not what is known as an "old-timer," but I have been in the game long enough to know that such sneering letters reflect the character of the sender more than anything else. . . .

—R. J. Slagle, Jr.

Notice

2732 Humboldt Ave., Oakland, Calif.

Editor, *QST*:

Arrangements have been made whereby all amateurs can receive, free of charge, a beautiful illustrated book of California scenes and all the data on the "Golden Gate Bridge" now under construction across the San Francisco harbor entrance. Just send a card to the undersigned.

—Norman Isherwood. W6MDJ

QSL and Harmonics

Golf View Road, Moorestown, N. J.

Editor, *QST*:

I don't think we should abandon the practice of QSLing entirely, but I do think it is unnecessary to QSL when the station is near you. I believe in QSLing after a DX contact, your first QSO in a new district, and your first few QSO's. Some fellows ask for a card before they even know where you are! What is gained by displaying a bunch of cards from locals? And it does cost money to QSL.

I disagree with W8DED about not printing such articles. How are we to make progress unless somebody comes out with a new idea? Besides, look at the fun we get out of calling somebody down for a radical idea. If that letter wasn't printed, think of the fun we would have missed!

Now that I am at it, I might put a word in about 2-mc. 'phone harmonics in the 3.5-mc. band. It seems that very few 'phone men in that band read the article in *QST* for March about 2-mc. 'phone harmonics, and even fewer did anything about it. QRM from 2-mc. 'phones on the 3.5-mc. band is very bothersome to say the least. If every 2-mc. 'phone man would check over his rig to ascertain whether it was radiating a strong harmonic and do something about it, we would be happier all around.

—H. Thorn Greenwood, 3rd, W3FFE

AS USUAL—IF IT'S NEW WE HAVE IT!!

THE NEW BARR DB3 CLASS B MODULATED 5 METER TRANSCEIVER

- ★ Utilizes a Class B audio amplifier and modulator giving an output of 2.1 watts which is many times greater than that of ordinary transceivers.
- ★ Can be operated as receiver, transmitter or both, in a car, plane, boat or while being carried for portable work.
- ★ Working range anywhere between 2 and 100 miles depending upon the location.
- ★ Compact convenient carrying size.
- ★ 30 tube Audio Amplifier—49 tube Super Regenerative Detector or Oscillator—19 tube Class B Audio Amplifier or Modulator.

We were surprised at the marvelous value offered in this transceiver, just as you will be when you own one of them.

PRICE **\$16.20** less tubes, batteries and accessories. Bulletin on request.

NEW!! CARDWELL CONDENSERS MYCALEX INSULATION .200 SPACING

XG18XS. .000018	\$3.23
XG40XS. .00004	\$4.41
XG65XS. .000065	\$5.29
XG100XS. .0001	\$6.76

Split stators in above capacities available. Complete Cardwell line of new models and all regular types in stock at new low prices. There are also special prices on the large commercial type condensers. Real "He Man" condensers now available at prices you want to pay.

Send for new Cardwell catalogue

OUTSTANDING !!

Gross Crystal Holder.

WHITE GERAMIC commercial type crystal holder—priced at less than ordinary holders. Adjustable pressure, dust proof, no tools required to open. Takes crystal to 1 1/4" square. Plugs standard 1/4" spacing. Most efficient job yet. **\$1.00**

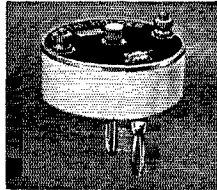

DELUXE DIALS AND FLUTED KNOBS

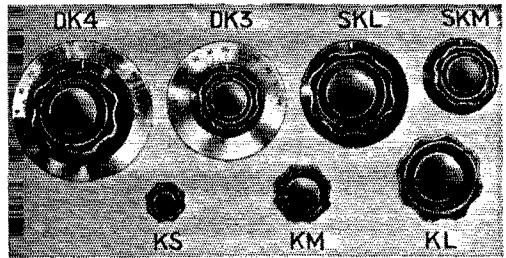

These are the trimmings you have noticed of late on the finest equipment, now available at these prices. Dial plates made of circular finished solid nickel silver, not plated brass or aluminum. Fluted knobs are finest quality genuine bakelite.

DK-3. 3 1/4" Dial and Knob	\$7.70
DK-4. 4" Dial and Knob	\$8.85
SKM. Medium 2" Knob with skirt	\$2.24
SKL. Large 3" Knob with skirt	\$3.30
KS. Small Knob	\$1.15
KM. Medium Knob	\$2.21
KL. Large Knob	\$2.24

The "EAGLE" Three-Tube Short-Wave Receiver

"Band Spread" over any portion of the tuning range—only finest material used thruout. Employs one '32 R.F., one '32 detector and one '33 Pentode Audio—15 to 200 meters—four coils, supplied. The "EAGLE" is economical—two dry cells will operate the filaments.

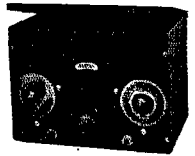

"Eagle" completely wired and tested **\$11.95**
Three tubes tested in your receiver **\$3.00**

GROSS CASED INPUT SWINGING CHOKES

5/25 H, 200 MA, D.C. Res. 140 Ohms	\$2.50
5/25 H, 300 MA, D.C. Res. 105 Ohms	\$3.75
5/25 H, 500 MA, D.C. Res. 70 Ohms	\$6.50

GROSS CASED SMOOTHING CHOKES

12 H, 200 MA, D.C. Res. 140 Ohms	\$2.50
12 H, 300 MA, D.C. Res. 105 Ohms	\$3.75
12 H, 500 MA, D.C. Res. 70 Ohms	\$6.50

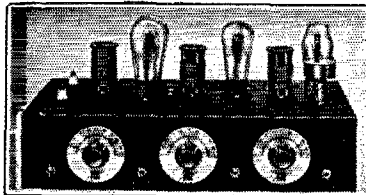

GROSS C C TRANSMITTER—OUTPUT 25-30 WATTS

The "CW-25" transmitter kit due to its low cost makes it possible for anyone to own a modern crystal controlled station. A schematic hook-up and parts layout sheet as well as tuning instructions are furnished, thus enabling the most inexperienced operator to wire and put the set on the air, for real results. The "CW-25" is supplied with a shrivel finished sturdy metal chassis under which all parts are mounted, making the wiring and components dust-proof. A plug-in crystal holder is furnished with the kit. Only one milliammeter is required for tuning the transmitter and each stage is provided with a jack for this purpose. The "CW-25" uses one

'47 as crystal oscillator, one '46 as buffer or doubler and two '46's in the amplifier stage, set of three coils supplied with kit for 20, 40, 80 or 160 band. Additional coils 75c each. **\$13.95**

Complete kit, less tubes and crystal

HALF WAVE TYPE TRANSCEIVER ANTENNA

Composed of an adjustable half wave rod of aluminum, with insulated mountings. Adjustable from 38" to 9 feet. Binding post for feeder. **\$1.95**

DOUBLETT TYPE TRANSCEIVER ANTENNA

Consists of two adjustable quarter wave rods with 12" insulating brackets. Length variable from 52" to 9 feet. Binding posts for feeders. **\$2.95**

THORDARSON CASED TRANSFORMER

600 volts each side of C.T. 200 MA 2 1/2 V. 10 amps. C.T., 5 V. 3 amps., 7 1/2 V. 3 amps. C.T. **\$2.45**

THORD. CHOKE 12 H 250 MA., **\$1.95**

NEW KELLOGG TRANSCEIVER HANDSET

Single button mike, 2,000 ohm receiver. **\$6.60**
(See May QST P. 122)

NEW!! BILEY LD-2 Mounted crystals

40, 80, 160 M. **\$4.80**
(See P. 103 June QST)

AMERICAN S.B. HANDMIKE WITH SWITCH

\$3.95

NEW UNIVERSAL TRANSCEIVER HANDSET

Single button mike, 2,000 ohm receiver. An all bakelite job. **\$3.54**

20% DEPOSIT WITH ALL C. O. D. ORDERS REMIT BY M. O. INCLUDE POSTAGE Cable Address: GROSSINC

GROSS RADIO, INC., 51 VESEY STREET, NEW YORK CITY

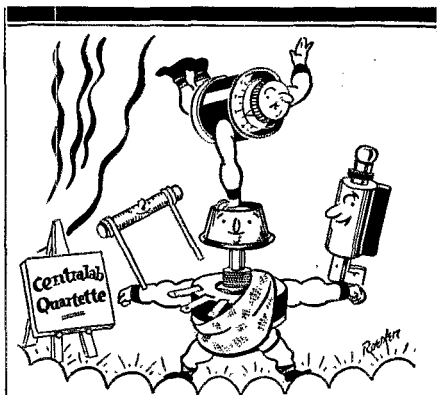

Here's a "Troupe" that Wows 'Em!

Four husky boys, these, that have been on most of the world's best circuits.

Fathered by old man Radiohm himself, he and his three sons Kid Suppressor, Kid Resistor and the new member of the team, Big Boy Sound Projection Control, are in the spotlight of popularity with servicemen and experimenters everywhere.

How these boys can work! It's a pleasure to watch 'em . . . smooth, efficient, noiseless and each performance as reliable as the next.

Note: Mr. Trouble Shooter . . . stock up with Centralab Replacement parts . . . the cheapest in the long run.

Centralab

Division of Globe Union Mfg. Co.

MILWAUKEE, WIS.

RADIOHMS / SUPPRESSORS
RESISTORS

What the League Is Doing

(Continued from page 87)

Financial Statement For the information of members the A.R.R.L. operating statement for the first quarter of this year is reproduced below, at the instructions of the Board of Directors.

STATEMENT OF REVENUES AND EXPENSE FOR THE THREE MONTHS ENDED MARCH 31, 1935

REVENUES	
Membership dues	\$14,175.01
Advertising sales, QST	15,324.68
Advertising sales, Booklets	340.00
Newsdealer sales, QST	12,744.95
Handbook sales	12,302.08
Booklet sales	3,115.18
Membership supplies sales	2,687.03
Interest earned	690.73
Cash discounts earned	198.53
Bad debts recovered	56.01
	\$61,634.20
Deduct:	
Returns and allowances	\$ 4,844.73
Cash discounts on sales	358.42
Exchange and collection charges	17.10
Adjustment covering portion of miscellaneous unclassified sales taken into revenues in prior years, included in revenues for this quarter under proper classifications	1,603.91
	\$ 6,824.16
Less reduction of provision for newsdealer returns of QST	103.45
	6,720.71
Net Revenues	\$54,913.49
EXPENSES	
Publication expenses, QST	\$14,433.85
Publication expenses, Handbook	4,911.34
Publication expenses, Booklets	1,154.71
Membership supplies expenses	1,440.96
Salaries	19,523.56
QST forwarding expenses	714.48
Telephone and telegraph	568.37
Postage	1,442.22
Rent, light and heat	825.61
Traveling expenses	1,179.26
Depreciation of furniture and equipment	223.34
Office supplies and general expenses	2,710.84
Communications Department field expenses	150.13
Headquarters station expenses	44.61
Bad debts written off	138.11
Total Expenses	49,461.39
Net Gain before Expenditures against Appropriations	\$ 5,452.10

Constitution The constitution and by-laws of the League have been reprinted to show all amendments made to date. Any member can obtain a copy from headquarters upon request.

I.A.R.U. News

(Continued from page 58)

reports working Y12FK, but so far we've been unable to identify the operator Similarly in Egypt many of the old crowd have gone, SU1EC, SU6HL, SU1AQ, and SU6SW having

BARR DB3

CLASS B MODULATED TRANSCEIVER

The DB3 utilizes a Class B Audio amplifier and modulator giving an output of 2.1 watts, which is many times greater than that of ordinary transceivers

AN OUTSTANDING VALUE—

LIST PRICE—less tubes and batteries

\$27.00

40% DISCOUNT TO AMATEURS

SPECIFICATIONS

CASE: Size 11" long x 9½" high x 6½" wide, black wrinkle finish metal, heavy leather handle. All batteries are self-contained in case. Removable side panel

for easy access to the batteries and tubes. ● **PANEL:** Beautifully finished in black enamel with silver scales and lettering. ● **CONTROLS, ETC.:** Two ceramic insulators are supplied for antenna, special large easy tuning knob, volume control on and off switch which acts as such in the receive position, and as a gain control in the transmit position, transmit and receive switch, microphone and headphone jacks. ● **FREQUENCY:** Will cover 56mc to 60mc (amateur 5 meter band). ● **BATTERY REQUIREMENTS:** Three 45-Volt B batteries like Burgess 5308; two No. 6 dry cells, and one 7½ Volt C battery. ● **TUBES USED:** One type 30 — one type 19 — one type 49. ● **SHIPPING WEIGHT:** 12 pounds. ● **BULLETIN ON REQUEST.**



ORDER FROM YOUR NEAREST DISTRIBUTOR —

Air-Ola Radio Co.	Huntington, W. Va.	Mid West Radio Mart	Chicago, Ill.
Bond Radio Co.	Detroit, Mich.	Nutter & Cross	Boston, Mass.
Brattle Radio Co.	Boston, Mass.	Pan American Radio Co.	Miami, Fla.
Bulldog Radio	Grand Junction, Colo.	Peterson Lumber & Paint Co.	El Paso, Texas
Burstein-Applebee	Kansas City, Mo.	Power City Radio Co.	Sioux Falls, S. D.
Bushland Radio Service	Chippewa Falls, Wis.	Prest & Dean Radio Co.	Long Beach, Calif.
Cambria Equipment Co.	Johnstown, Pa.	Radio Distributing Co.	Detroit, Mich.
Cameradio Co.	Pittsburgh, Pa.	Radio Distributing Co.	Harrisburg, Pa.
Canadian Tire Corp.	Toronto, Canada	Radio Equipment Sales Co.	Detroit, Mich.
Chicago Radio Apparatus	Chicago, Ill.	Radio Parts Co.	Madison, Wis.
Cohen's Sons Ltd.	San Francisco, Calif.	Radio Service & Supply Co.	Scranton, Pa.
Congress Radio & Battery Co.	New Haven, Conn.	Radio Service Laboratory	Manchester, N. H.
Cushman Radio Service	Fall River, Mass.	Rissi Bros.	Detroit, Mich.
Dakota Electric Supply Co.	Fargo, N. D.	Ross Radio Co.	Youngstown, Ohio
Dymac Radio	Buffalo, N. Y.	Russell Electric & Machine	Tucson, Ariz.
Eastern Radio Co.	Boston, Mass.	Sager Electrical Supply Co.	Boston, Mass.
Electrical Specialties	Detroit, Mich.	San Francisco Radio Exchange	San Francisco, Calif.
G. M. & C. Radio Supply Co.	Oakland, Calif.	Sidles-Duda-Myers Co.	Omaha, Neb.
Gross Radio, Inc.	New York, N. Y.	Smith-Winchester Co.	Jackson, Mich.
Hall's	Harrisburg, Penn.	S. Spencer Moore Co.	Charleston, W. Va.
Harty & Young	Hartford, Conn.	Straus-Frank Co.	Houston, Tex.
Hunter Bros., Inc.	Fayetteville, N. C.	Sun Radio Co.	New York City
Jordan Radio Laboratory	Eric, Pa.	Tel-Rad Inc.	Colorado Springs, Colo.
Krauss Radio Stores, Inc.	Cincinnati, Ohio	Universal Radio Supply Co.	Louisville, Ky.
Lamb Electric Co.	Santa Barbara, Calif.	Valley Radio Mfg. Co.	E. Bakersfield, Calif.
Leeder, John F.	Omaha, Nebraska	Virginia Electric Inc.	Charleston, W. Va.
Low Bonn Co.	St. Paul, Minn.	Walker Radio Co.	Pueblo, Colo.
MacFadden Ignition Co.	Charleston, W. Va.	Walter Ashe Radio Co.	St. Louis, Mo.
Mac's Radio Service Laboratory	Waterbury, Conn.	Watkins Radio Service	Ft. Pierce, Fla.
M. & H. Sporting Goods Co.	Philadelphia, Pa.	Wilcox Radio Sales	Chicago, Ill.
Mariner Music House	Reno, Nevada	Wilmington Electrical Specialties	Wilmington, Dela.

BARR LABORATORIES, 1476 Broadway, New York

Radio
Engineering
Complete in
Telegraphy-
Telephony

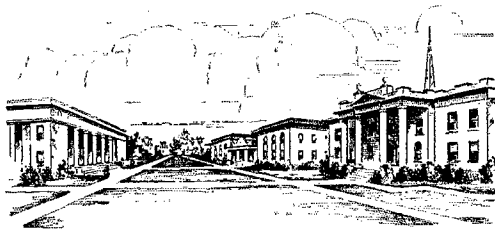

Studio Technique
and Transmitter
Operating Expe-
rience Guaranteed

K P A C

500-Watt 1260 Kilocycles

IN 3 to 7 months we train you to secure Commercial Telegraph Second-class, and Radiotelephone First-class government licenses. Course consists of Wireless Code, Radiophone, Microphone-Studio Technique, Service, Police, and Aeronautical Radio. We are authorized to teach RCA texts. At completion of course you receive practical studio technique experience in our commercial broadcast studios located in administration building, and experience as an operator on K-P-A-C (500-Watt Commercial transmitter located on the campus and owned and operated by the college), and WPA, 4000-Watt Commercial Wireless Station. If interested, write for Bulletin R.

PORT ARTHUR COLLEGE

Port Arthur (world-known port) Texas



Mr. E. H. Rietke, President of CREI and originator of the first thorough course in Practical Radio Engineering.

There's Always a BETTER Job for a BETTER Man!

If you're satisfied and content with your present job, you won't be interested in CREI . . . but, if you're ambitious and can see the bright opportunities that lie ahead in Radio for specialized men who have been *Technically Trained* . . . then, CREI can help you as it has helped others out of routine jobs into top positions in the Radio industry.

"Invest" One Cent Now . . . Write Today for FREE Illustrated Catalog

It will explain our Home-Study course and the one-year Resident course (new term Sept. 23) . . . and explain how easy it is to pay for them. Your inquiries are invited.

CAPITOL RADIO ENGINEERING INSTITUTE
14th and Park Road, N. W. Dept. Q-7
WASHINGTON, D. C.



returned to England The departure of ZC6FF leaves Palestine without an active station Just before leaving, while working VE1BV on 14 mc., ZC6FF was able to reduce his input to .3 watt with his signals still audible in VE! Y2DIB worked four new countries on May 3rd, making a total of 86, the contacts being ZBII, FB8C, YL2BB, and TF3C; he reports SUI5G T9 on 14.4 plus To Frank Finger, U.S.A.: We are holding an undeliverable communication for you from your cousin, Willy Finger, of Bern; please advise us of your address We are informed by H. W. S. Caldecott, Federal Secretary of the W.I.A., that the information concerning Australian standard frequency transmissions in April *QST* was incorrect Such a service was commenced in 1926 by the New South Wales Division of W.I.A., in 1929 by the Victorian and other divisions, and these are still functioning

W.F.S.R.A.:

The World Friendship Society of Radio Amateurs has requested publication of the following pledge, which is the sole obligation for membership in the Society:

"I hereby promise that I will, to the best of my ability, make such use of my amateur radio station as will be conducive to international friendships; that I will never voluntarily permit my station to be used as the tool of selfish nationalistic interests; and that I will do what I can, as a radio amateur and as an individual, to promote world peace and understanding. (To be followed by the signature, address, and station call.)"

Membership in the Society is open to all amateurs in all countries. All that is necessary to become a member is to copy and sign the pledge, and send it to the secretary, Duane Magill, W9DQD, 730 N. 6th St., Grand Junction, Colorado, U.S.A. Copies are preferably to be made in English or French, but may be made in the language of the member.

W1XR

(Continued from page 34)

Mass., he was relayed via W1XR to Blue Hill where he went on a regular telephone circuit to Belmont. The answer came back more directly from the Blue Hill station to Seabrook. (Reason for long relay: QRM on W1XZ at Blue Hill.) Only recently, Joe Dodge, W1UN, addressed a group celebrating the 50th anniversary of the founding of the Blue Hill Observatory. Through the W1XR relay he was heard perfectly. Then he sat back in his home in Pinkham Notch (where only one 5-meter signal ever penetrates) and listened to the rest of the speeches, which were, of course, picked off on a loudspeaker as they passed through the Mount Washington relay station.

At the time of the super-hurricane last April, we happened to be on with W1XW. By hooking up the anemometer contact with a 1000-cycle hummer, we were able to let Dr. Brooks, director

Demand THE NEW NON-EXPENSIVE NON-INFLAMMABLE DYKANOL

TYPE TA 20040
4MFD 2000 V.D.C.
YOUR COST \$6.47

Dykanol Condensers are the safest filters for that xmitter because:—

DYKANOL has a higher dielectric strength and constant.

DYKANOL can be operated at higher ambient temperatures than ordinary oil impregnated condensers.

DYKANOL is non-inflammable—eliminating all fire hazards.

Write today for your copy of the 1935 Catalog describing in full this latest laboratory development.

At all authorized C-D Distributors

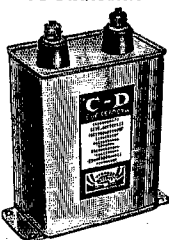

CORNELL-DUBILIER CORPORATION
4373 BRONX BOULEVARD
NEW YORK

Bring Your Frequency Drift Down to U. S. Government Specifications

with the new BLILEY LD-2 CRYSTAL UNIT

All latest government specifications for crystals call for low temperature coefficient plates.

Now, with the new Bliley LD-2 Crystal Unit you can get for the first time a frequency control unit that is **guaranteed** to drift less than 8 cycles/megacycle/°C. that sells for only \$4.80.

See the new Bliley LD-2 Crystal Unit at your nearest dealer at once. Look for the improved permanently sealed holder.

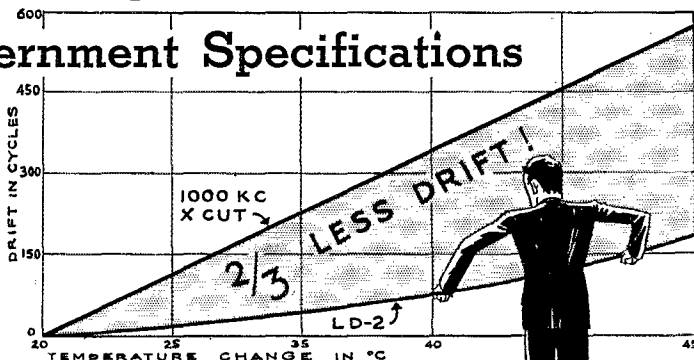

OUTSTANDING LD-2 FEATURES

1. Choice of 40, 80 and 160 meter bands.
2. Greatly improved sealed holder
3. Greater activity.
4. Guaranteed 0.03% accurate in your transmitter
5. Supplied within 0.1% of your desired frequency, or choice from dealers' stock.
6. Costs only \$4.80 at your dealer

BLILEY ELECTRIC CO.
ERIE, PENNA.

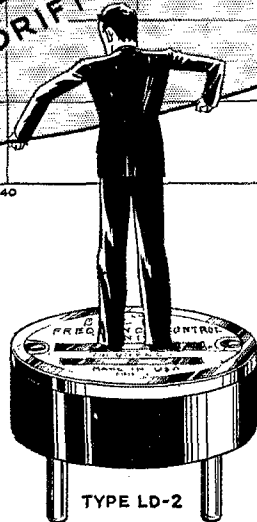

"The Crystal Specialists Since 1925"
PIEZO-ELECTRIC CRYSTALS
Guaranteed Accurate to BETTER than .01%
SCIENTIFIC RADIO SERVICE
UNIVERSITY PARK, HYATTSVILLE, MD.

UNCONDITIONALLY GUARANTEED CRYSTALS
1.7, 3.5 mc ± 5 Kc. X-cut... \$2.00; Exact Kc..... \$3.00
7 mc ± 25 Kc. X-cut... \$3.00; ± 5 Kc..... \$3.75
Precision Amateur Plug-in Holders... \$1.00
Bulletin now ready listing our AT Crystals, 100 Kc. Bars, Amateur Ovens, Air Gap Holders and S.S. Filters.
GENTLEY LABORATORIES
803 W. Maple Ave. Independence, Mo.

Here's What They Say!

about
PYRANOL
2MFD-2000 Volt
(Operating)
FILTER
CONDENSERS

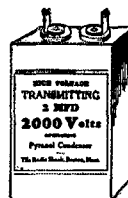

Guaranteed TWO YEARS—UNCONDITIONALLY. No restrictions as to use. Before you buy **\$2.90** insist on this broad guarantee.

"— greatly overloaded for over a year with no serious effect."—L. B., McKeesport, Pa.
"— so far I have not heard of their blowing up. Ship me two more."—G. F. L., Statesville, N. C.
"Those I received from you about 9 months ago have surely given good service and are still going strong."—T. G. H., Stockton, Calif.

866's
Heavy
Duty
\$1.00
Each

Mail Orders Filled—Include Postage
THE RADIO SHACK
46 Brattle St. Boston, Mass.

Black
Crackle
Paint
Aldry
1 Coat
50c Can

The Superiority of Our DYNAMIC MICROPHONE

OVER OTHER TYPES IS MAINLY
IN ITS SENSITIVITY

No high gain preamplification required. No background noise. No Power Supply.
AND THE PRICE..... **\$33**

U. S. PATENTS PENDING

Send for Bulletin 3011

RADIO RECEPTOR CO., INC.
110 Seventh Ave., New York City

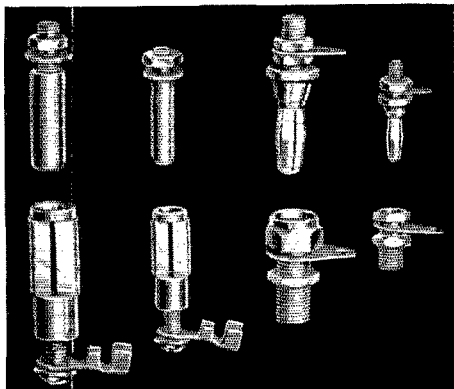

USE JOHNSON DEPENDABLE PLUGS and JACKS

Johnson Plugs and Jacks are distinguished by their sturdy precision construction, close-tolerance dimensions, excellent contacts and easy interchangeability. **Yet, these high-quality trouble-proof parts are surprisingly inexpensive!**

Two styles are available in two sizes—the popular "Banana-Springs" and the original Johnson heavy-duty "Spring-sleeve" types. Complete information on request.

Available from Authorized Johnson Distributors

E. F. JOHNSON COMPANY

Manufacturers of Radio Transmitting Equipment

WASECA, MINNESOTA, U. S. A.

IMMEDIATE DELIVERY FROM RECEIVER HEADQUARTERS

NATIONAL HRO	\$139.80
RME9Ds	112.50
RCA AGR-136 complete	69.50
BRETING 12 complete	93.00
SUPER-SKYRIDER complete prepaid	59.95
SILVER 5C complete prepaid	74.70
SUPER PRO complete (when available)	164.64
FR-12 complete prepaid (available June 15)	83.70
ALL COLLINS transmitters at lowest prices	

TRADE IN YOUR RECEIVER OR TRANSMITTER
All receivers shipped on ten day trial. Only \$5.00 payment required with order

We are jobbers for and stock all amateur apparatus at lowest prices. We stock all newly announced apparatus such as the new Bliley LD-2 crystals \$4.80; RCA V-cut crystals \$12.00; RCA Oscillograph; Eimac tubes; Ohmite switches; controlled carrier parts. Write for any information and bulletins.

HENRY RADIO SHOP

211-215 N. Main St.

Butler, Missouri

WHOA!

Back up to page 4

Special Offer

of the Blue Hill Observatory over 142 miles away, measure our wind velocity, even at that moment the highest ever recorded, and still going up!

Many pleasant QSO's have been had with the very active group of Portland, Maine, amateur 5-meter stations. Since Portland is visible on clear days, the path is, as would be expected, a good one. Interest in 2.5 meters is increasing there now, although no signals have yet been heard on the mountain.

Stations to the south are less regularly worked, perhaps because of the larger number of strong signals competing. Groups in the vicinity of Hampton Beach, N. H., stations in Lawrence, Methuen and Lowell, Mass., have been contacted. At times, when signals are especially good, stations in the Boston area become audible. Even W1VW in Fall River, Mass., sometimes puts in a "local" signal. On several occasions he has been QSO'd, but usually after signals had reached their peak and were starting rapidly downhill.

This extraordinary DX is not the usual thing. Many coming up with transceivers during the summer months are quite disappointed when their fishpoles catch even W1XW too weakly to read. Although equipment here is entirely conventional, it must be kept operating at high efficiency in order to provide the contacts that it does.

These are the high spots of activity at our high frequency vantage point. We could fill a whole copy of QST with tales of our life, our long beards, our skiing and our continual fight with the wind. Failing that we can merely say, "Come up and see us sometime."

'Phone-C.W. Contest

(Continued from page 46)

The procedure used by several of the 'phone operators in stating in which portion of the band they were going to tune was a big help to the telegraphers. This procedure should be more widely used. W8KVX and W8MQA had a private contest, laurels going to W8KVX.

—E. L. B.

Battery-Operated Portable

(Continued from page 32)

Data on the coils for both receiver and transmitter are shown in the table. On the receiver, the 3.5-mc. band spreads over nearly 60 dial divisions, the 7-mc. band over almost 20 divisions, while the 14-mc. band has a spread of more than 12 divisions. The spread of the transmitter tank condenser is, naturally, much less, but ample on all three bands, with a minimum of 4 divisions on 14 mc. so that in an emergency it is quite possible to set the transmitter frequency by dial readings alone with little danger of off-band operation.

THE ANTENNA SYSTEM

Since the output circuit is designed for current

ANNOUNCING

The Remarkable New TURNER

MU-X MICROPHONE

(MULTI-Xtal)



● The new Turner Mu-X (multiple crystal) microphone is a distinct advance in microphone construction. It is outstanding in appearance, performance, durability, and reliability. The Mu-X is available with 4, 6 or 8 crystal units, thus offering a microphone for every type of work.

● The Mu-X is distinguished by improved construction and engineering principles throughout. Exclusive features are new crystal mounting and new flexible diaphragm. Truly a de luxe instrument to meet the most exacting broadcasting requirements.

● Available for either push-pull, or single grid input. Regularly supplied with eight feet of low capacity rubber covered cable. The base of the Mu-X is removable from the microphone proper by loosening an easily accessible screw. Base has a standard thread for stand mounting.

Write for descriptive literature and prices on this fine microphone
Licensed under patents of the Brush Development Company

THE TURNER COMPANY
CEDAR RAPIDS, IOWA, U.S.A.

RADIO ENGINEERING



RCA Institutes offers an intensive course of high standard embracing all phases of Radio. Practical training with modern equipment at New York and Chicago schools. Also specialized courses and Home Study Courses under "No obligation" plan.

Illustrated Catalog on request.

RCA INSTITUTES, INC. Dept. ST-35

75 Varick St., New York 1154 Merchandise Mart, Chicago
Recognized Standard in Radio Instruction Since 1909

PRECISION CRYSTALS



Crystal Holder—\$1.00

'X' and 'AT' cut crystals one inch square carefully ground for frequency stability and maximum output. Be sure of your transmitter frequency—use PRECISION CRYSTALS. Guaranteed to be the highest quality obtainable.

'X' cut PRECISION Crystals carefully ground for maximum power supplied to your specified frequency accurate to 0.1%, and calibrated to within 0.03% are priced as follows: 1750 and 3500 kc. bands — \$3.00 each. 7000 kc. band — \$3.50. Add \$1.00 to above prices if plug-in, dust-proof holder is desired. Jacks to plug holder into — \$.15 pair.

The 'AT' cut crystal recently developed has a temperature coefficient of practically zero and will handle more power than ordinary crystals. 'AT' cut crystals ground to your specified frequency accurate to 0.1% and calibrated to within 0.03% are priced as follows: 1750 and 3500 kc. bands — \$6.00 each. Crystal holder — \$1.00. Jacks for holder \$.15 pair.

Crystals and ovens for commercial use quoted on at your request. When ordering our product you are assured of the finest obtainable. Now in our sixth year of business.

PRECISION PIEZO SERVICE

427 Asia Street

Baton Rouge, La.

Here's Front-Panel Control for Instant QSY!

(Frequency Change)

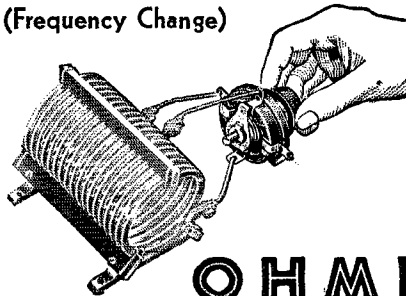

OHMITE BAND-SWITCH

(Patents Pending)

Write Today for Bulletin No. 104

Get around interference with a flick-of-the-wrist! No more cumbersome coil changing and re-tuning to switch from one band to another. One or more Ohmite Band-Switches mounted on your control panel give instant QSY. It's the modern way of changing transmitter frequency. Bulletin 104 gives diagrams for all basic transmitter circuits.

OHMITE MANUFACTURING COMPANY
631 N. Albany Avenue CHICAGO

Bakelite-Case CONDENSERS

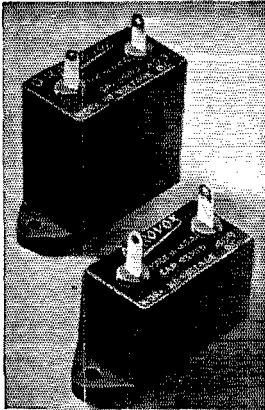

Non-Inductive, long-life paper condensers in attractive bakelite cases. Ideal for radio and audio frequency by-passing; also for resistance and impedance coupled amplification.

High insulation resistance. No leakage between terminals. Popular in experimental and laboratory work. Also in "ham" transmitters.

200, 400, 600, 1000 D.C. working voltage ratings. 0.5 to 1 mfd. Quality through and through.

Send for Data

New 1935 catalog of complete condenser and resistor line. Also sample copy of Research Worker. Your dealer can show you these BETTER components at LOWER prices.

AEROVOX

CORPORATION

73 Washington Street

Brooklyn, N. Y.

CUT THROUGH QRM WITH ASTATIC

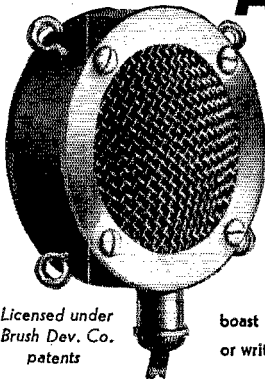

Licensed under
Brush Dev. Co.
patents

Equip your transmitter with this remarkable new Astatic D-104 Crystal Microphone and you'll be amazed at the clarity with which your signal will break through that QRM and it'll give you better All-around performance too. And a dependability you'll want to boast about. See your nearest jobber or write for bulletin 58.

ASTATIC

CRYSTAL MICROPHONES
ASTATIC MICROPHONE LABORATORY, INC.
YOUNGSTOWN, OHIO

"Pioneer Manufacturers of Quality Crystal Products"

feed, either a grounded Marconi antenna or a suitable Hertz type may be used. Both have been used successfully, with the results to date slightly in favor of the Marconi type. Antenna tuning for the receiver, while not absolutely necessary, makes the receiver a real performer, capable of coverage far in excess of the transmitter range and, under good conditions, even world-wide reception. Of course, the transmitter cannot be expected to compete for a place in the band against signals of high power, since the input as operated here is but slightly more than one watt on the 3.5- and 7-mc. bands, and somewhat less than this value on the 14-mc. band. For the purposes for which it is intended, however, it has shown a surprising ability to reach out, and for local communication is fully as reliable as the more powerful regular station equipment, besides reducing the interference to nearby amateurs, of whom we should try to make helpful friends instead of competitors.

When operated at the home station, the set is used with a Marconi antenna 48 feet long loaded to resonate on the 3.5-mc. band, which allows tuning to the 7-mc. band by removal of the loading coil. 14-mc. operation has been with a Hertz type antenna, but has not been carried out to the completion of the experimental stage. For field operation, the 66-foot bell-wire antenna has been used almost entirely. Its characteristics and method of rigging usually vary at different locations to such an extent that any rule for loading cannot be arbitrarily stated but must be determined for each site. The average time required to set up the station in the field and start operating is about five minutes. Experiments are being undertaken with "fish-pole" antennas for mounting on an automobile in hopes that amateur mobile operation on our lower frequency bands may be permitted at some future time, but sufficient data for definite conclusions in this respect are not yet available. Considerable success has, however, attended similar experiments recently carried out by the Q.M.C. Motor Transport School, in conjunction with the Signal Corps Laboratories, using a frequency allocation between the 1.7- and 3.5-mc. amateur bands and quite moderate power input.

OPERATING NOTES

Since the filament drain of the 19 tube is comparatively high, replacement of the filament batteries is usually necessary after about 120 hours of operation. The plate batteries, however, seem never to wear out, and those at present in the case have given nearly six months' service with but negligible drop in voltage. They should be replaced when the signal of the transmitter shows a tendency to "chirp." The usual report received is "crystal note" and only when the antenna is so rigged that it can swing in the wind has any other comment on the note been received. Contacts often say that, although quite anaemic and weak, the signal from this station is easy to read through heavy interference because of its clean and steady character. While no claims for great distance coverage are offered for the station, con-

LEEDS SPECIALS FOR SUMMER BARGAIN HUNTERS

NATIONAL — type TMC transmitting condensers; double spaced, polished plates insulant insulation. 50 mmf. — \$2.40; 100 mmf. — \$2.55; 150 mmf. — \$2.75; 300 mmf. — \$3.30. We carry the complete National line of parts and sets including the SW-3 — FB-7A and AX and the HRO at 40% off list. **LEEDS** cased oil impregnated condensers; 2 mfd capacity only. D.C. working voltage. 1,000 volts — \$1.45; 1,500 volts — \$2.00; 2,000 volts — \$2.45.

Navy type Telegraph Key, List \$3.60. Navy knob — 3/8" Tungsten contacts. Special at \$1.15. With regular knob 95c. Leeds transmitting key, on wooden base, special. . . . \$.65. **KENCO** \$15 automatic key, special \$7.95. Vibroplex Junior, special \$10.

LEEDS CRYSTALS — 160 and 80 meter X cut crystals; plus or minus 1 KC of specified frequency \$2.25. AT cut \$3.00. 7 mc, plus or minus 2 KC of specified frequency; X cut \$3.25. AT cut \$6.50. New Hill all brass adjustable holder, ideal for 40 meter crystals. . . . \$1.65

Monitor dustproof crystal holder fits UV socket. . . . \$1.00
The new RCA type TMV-135-A crystal holder. . . . \$2.50

POWER SUPPLY EQUIPMENT — See our ad in the June issue, page 71 for description and unusually low prices. **LEEDS** guaranteed 866's same uniform quality.

Each only. . . . \$1.50

LEEDS insulant based 210 with thoriated filament and small molybdenum plate is F.B. for 56 mc and 112 mc work.

Each. . . . \$1.75

LEEDS Graphite Anode 203-A specially priced at. . . . \$8.45

RCA receiving tubes; complete line; 40% and 2% off list.

SYLVANIA receiving tubes; we have the complete line; 50% discount from list.

RCA transmitting tubes; at new current net prices.

RAYTHEON trans. tubes; at new current net prices.

RCA Choke; 18 Henry, 100 mil. . . . \$.49

Bases and demi-bases made of 20 gauge steel. Described fully in our Bulletin No. 73.

Demi-Base Units	Weight	Price
8 x 8 1/4 x 2	4 lbs.	\$.55
10 x 8 1/4 x 2	5 lbs.	.65
Full Bases	Weight	Price
4 x 17 x 2	5 lbs.	\$.75
8 x 17 x 2	7 lbs.	1.00
10 x 17 x 2	7 lbs.	1.20

TRIMM 2,000 ohm phones \$1.80. 4,000 ohm. . . . \$2.25
TRIMM featherweight \$5.88. **FROST** 2,000 ohm \$1.45
FROST 3,000 ohm \$1.65. **DX** 20,000 ohm imp. . . . \$2.65
WESTERN ELECTRIC type P-11. . . . \$3.95
PIEZO Astatic crystal microphones; type D-104. . . . \$13.23
SHURE model 70-H crystal microphone. . . . \$13.23
AMERICAN type EL microphone; list \$10. Special. . . . \$4.45
Chrome plated swivel top desk mike stand. Special. . . . \$3.95
NA-ALD black crystalline Lacquer for finishing metal or wooden panels; 2 oz. can — \$2.1. Pint can. . . . \$.75
LEEDS wet processed glazed porcelain antenna insulators 1" diameter, 7" long — 25c. 12" long — 35c. 20" long — 50c. Airplane type strain insulators 4c each. 10 for 35c.

MULLER Pee-Wee clips, all copper, each 7c.

TRIPLETT METERS 2" diameter, bakelite case; all ranges from 5 mills \$2.94; 3 1/4" diameter, all range \$3.75.

GENERAL RADIO coil forms type 677-U price 50c; type 677-V price 75c. G. R. amateur accessories always in stock.

LEEDS type 2 relay; adjusted to operate between 10 and 150 ma. D.C. two contact arms with make or break contacts is supplied. 350 ohms resistance; price. . . . \$2.00

GUARDIAN keying relay, 5 to 16 volts A.C. or D.C. . . . \$3.24

break in relay; D.P. D.T. 110 v. A.C. . . . \$4.41

GUARDIAN non-adjustable overload relays for 250 mils or for 500 mils; either type, special \$4.41. **GUARDIAN** adjustable type overload relay from 150 to 500 mil. . . . \$7.06

Type 1 Midget Relay, in our Bulletin No. 73. . . . 29c

BAKELITE PANELS		Special Prices	
7 x 10 x 3/16	69c	10 x 10 x 3/16	95c
7 x 10 x 1/8	35c	7 x 10 x 1/8	35c
12	83c	12	1.15
14	97c	14	1.35
16	1.11	16	1.55
18	1.25	18	1.75
21	1.46	21	2.05
24	1.67	24	2.35



World Wide Service to Amateurs
45 Vesey Street
New York City
Cable Address, "RADLEEDS"

PEAK Q-5

See June QST ad or write us for details. Deliveries now being made. Amateur net \$21.60 less tubes.

EASTERN RADIO SPECIALTY CO.

1845 Broadway New York, N. Y.
Manufacturers of PEAK PRODUCTS

GULF RADIO SCHOOL

Radiotelegraphy Radiotelephony

Radio Servicing

(SECOND PORT } 1007 Canondelet Street
U. S. A. } NEW ORLEANS, LA.

NOW—The Shure Model 73A CRYSTAL LAPEL MICROPHONE

Now — another original development from "Microphone Headquarters" . . . the *diaphragm-type Crystal Lapel Microphone!* The Model 73A is highly efficient and faithful in voice reproduction due to new development in diaphragm design and improved mechanical system, yet it weighs only 1 1/2 ounces and is only 2 inches in diameter! Equipped with special spring lapel clip and 25 feet of black mercerized cotton-covered cordage. The list price, complete as described, is \$25.

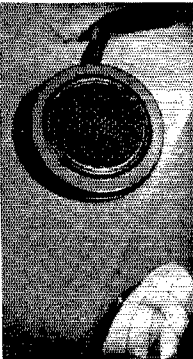

Ask your Jobber for complete technical data

Licensed under patents of the Brush Development Company

SHURE BROTHERS COMPANY
Manufacturers of Microphone Headquarters Telephone
Engineers DELaware 8383
215 WEST HURON ST. CHICAGO, ILLINOIS

HOW TO LEARN CODE

YOU can learn Code — or step up your w.p.m. amazingly — this surer way. No experience needed. Beginners, amateurs, experienced ops get ahead faster with Teleplex. It doesn't merely "show" you code — it IS Code! You actually HEAR dots-dashes any speed you want. Sends you practice messages and SENDS BACK your own key work in visible dots and dashes on copper tapes which no other method can do. For quicker license find out about this better way. Used by U. S. Army, Navy, R.C.A. A. T. & T. and many others. We give you complete course, lend all equipment, furnish personal service on MONEY-BACK GUARANTEE. Low cost, easy terms. Without obligation write for booklet Q31.

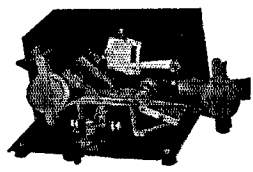

MASTER TELEPLEX
The choice of those who know

TELEPLEX COMPANY

76 Cortlandt Street New York, N. Y.

WITH

Designed, constructed and operated by D. Reginald Tibbetts of 750 Spruce Street, Berkeley, Calif. Five complete transmitters are provided, one for each band.

A splendid-looking job, neat and business-like.

The popular-priced General Radio dials contribute much to the appearance of this station. These dials and many other accessories used by thousands of amateurs who take pride in the looks of their equipment as well as its operation, are described in Bulletin 936.

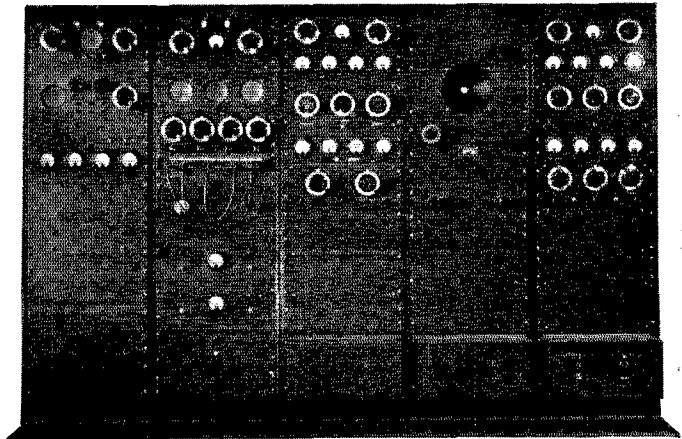

GENERAL RADIO COMPANY

30 State Street

Cambridge A, Massachusetts

Write for a copy

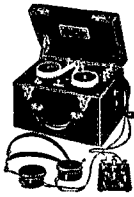

RADIO CODE

is easy to acquire when you have your own instructograph. You practice when and where you like — Book of Instructions explaining each step, just as an instructor would do. Machines for sale or rent. Send Today for descriptive folder and new attractive terms. There's no obligation.

INSTRUCTOGRAPH CO., Dept. Q7
912 Lakeside Place Chicago, Illinois
Representatives for Canada
RADIO COLLEGE OF CANADA, Ltd., 863 Bay St., Toronto

**WHEN BETTER AERIALS ARE MADE
LYNCH WILL MAKE THEM . . .
AND OTHERS WILL TRY TO COPY THEM**

Write for Free Bulletin on LYNCH
PATENTED and GUARANTEED
Noise-Reducing Antennas for Home, Auto Use.

ARTHUR H. LYNCH, INC., 227 Fulton St., N. Y.
PIONEER OF NOISE-REDUCING AERIALS

Quicker than a Short circuit!

LITTELFUSES

- INSTRUMENT LITTELFUSES, for meters, 1/200 amp. up.
- HI-VOLT. LITTELFUSES for transmitters, etc., 1,000, 5,000 & 10,000 volt ranges, 1/2 amp. up.
- NEON VOLTAGE FUSES & Indicators (TATTELITES) 100, 250, 500, 1,000 & 2,000 volt ratings.
- AIRCRAFT FUSES, AUTO FUSES, FUSE MOUNTINGS, etc. Get new Cat. No. 6.

Littelfuse Labs., 4509 Ravenswood Ave., Chicago, Ill.

LEARN RADIO

New Classes Now Forming! Send for 40-page catalog, explains fully, 190 licensed graduates placed in past 3 years in broadcasting, shipping, police radio, aviation, etc. We teach all branches. Oldest, largest and best equipped school in New England. Equipped with Western Electric sound and broadcasting equipment and RCA marine transmitter. Course prepares for United States Government telegraph or telephone license.

MASS. RADIO SCHOOL, 18 Boylston Street, BOSTON

HIPOWER CRYSTALS

You cannot buy a better crystal than HIPOWER at any price. Insist that your dealer get them for you

Y-cut in the 1700-3500 Kc. Bands \$1.35
X-cut in the 1700-3500 Kc. Bands 2.35
A-cut in the 1700-3500 Kc. Bands 3.90
AH-cut in the 7000-7300 Kc. band only 4.25
Type M plug-in bakelite molded holder 1.00

ORDER FROM YOUR DEALER OR DIRECT

HIPOWER CRYSTAL CO.

3607 N. Luna Ave., Chicago, Ill. Phone Ave. 5170
Attention Broadcast stations and commercial crystal users. There are over 60 stations using HIPOWER low temperature coefficient crystals. Write for prices and information.

FLECHTHEIM

SUPERIOR CONDENSERS

YOU can purchase NOW direct from Our Mail Order Dept. FLECHTHEIM PAPER TRANSMITTING CONDENSERS for immediate shipment at the following very low NET Prices.

TC 1 mfd. 1000 VDC	\$1.10 ea. net	TH 1 mfd. 2000 VDC	\$2.85 ea. net
TC 2 " " " 1.95 " " "	TH 2 " " " 3.85 " " "		
TC 4 " " " 2.95 " " "	TH 4 " " " 6.75 " " "		
T 1 " 1500 " 1.65 " " "	HP 1 " 3000 " 7.25 " " "		
T 2 " " " 2.45 " " "	HP 2 " " " 9.50 " " "		
T 4 " " " 3.95 " " "	HP 4 " " " 14.00 " " "		

If your local dealer cannot supply your requirements from his stock write

A. M. FLECHTHEIM & CO., INC.
136 LIBERTY STREET, N. Y. CITY
Ask for Catalog 27

TEN YEARS OF DEPENDABLE SERVICE TO THE TRADE

EIMAC

TRANSMITTING TUBES ARE UNSURPASSED

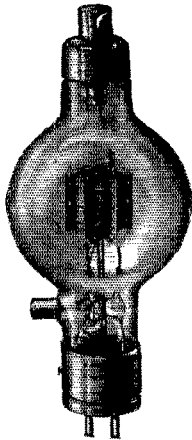

FOR
Class B Audio
As well as at
Radio Frequencies

Push-Pull 50Ts.

Plate Volts	Audio Output
1000 V	150 W
2000 V	200 W
3000 V	250 W

50T—\$13.50 150T—\$24.50
AT YOUR DEALER

"COMPARE AND REFLECT"

EITEL-MCCULLOUGH, INC.
SAN BRUNO, CALIF.

CT-60 TRANSMITTER

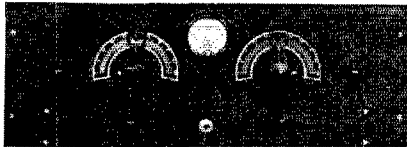

At last, an efficient, one tube, crystal controlled transmitter with 60 watts of CW power at low cost. Designed around George Grammer's April *QST* article, with added band switching of the cathode circuit and standard panel construction, this unit is modern in every detail — 3 band operation, front panel band switching, high grade parts with built-in voltage divider and meter included, and no multi-stages, coils or neutralization controls to bother with — all these advantages at a remarkably low price. Buy direct from this "ad" for immediate shipment, specifying any three adjacent bands.

CT-60 TRANSMITTER for 3 adjacent bands, less tube and crystals (Modulator and power supply available soon) \$33.00
RK-20 TUBE tested in your set 15.00

LILEY CRYSTALS furnished at current prices

Reputable dealers write for attractive proposition

FT-30 TRANSMITTER

A very popular, well designed CW and PHONE transmitter of medium power for 4 band operation. Isolantite insulation, antenna network, fixed neutralization and many other features make the FT-30 an extremely desirable unit for fixed or semi-portable use. Full data and prices on request.

Write for information on our complete line

HARVEY RADIO LABORATORIES
12 Boylston Street Brookline, Mass.

ultra-short wave equipment. A second gives 1000 volts d.c. at 400 ma. for plate voltage on the large transmitter. A third gives 110 a.c. at 150 watts for running the HRO, a soldering iron, or other small a.c. apparatus. The external a.c. is taken in through a long cable, and feeds through a watt-hour meter, so the amount used can be paid for. A 15 ampere tungar charger is used to charge the two power batteries, as well as the car battery, whenever a.c. is available. An a.c. operated power pack supplies the high voltage for the large transmitter when the dynamotor is not used. Two G.R. Variacs are used in this unit to compensate for changes in line voltage which are likely to be found in small communities.

All the units have aluminum panels and dust-covers, and are made for relay rack mounting, thus making it easy to change or replace them. The relay racks are built into the steel framework of the body, which is mounted on a Packard roadster chassis. The steel frame is covered with a layer of linoleum for the inside finish, a half-inch layer of celotex for heat and sound insulation, and an outer skin of copper for shielding purposes. The roof is reinforced and covered with a rubber mat so that it can be used as a platform for setting up various antennas. A socket in the roof is provided so that a collapsible mast can be erected for operating from a fixed location on the longer waves. A loop can also be mounted on the top for direction finding and field strength measurements. Onlookers are always thrilled by the chromium plated ladder giving access to the top. A blanket roll is provided and there is space on the floor in the rear for sleeping. Two trailers are available if there is more to be carried than the truck will hold. The truck and one trailer recently returned from a trip to Washington, D. C., where they were exhibited at the conventions of the American Physical Society and the I.R.E., as well as at the Washington hamfest of April 27. The truck and apparatus behaved in fine style and many interesting contacts were made on the 5-meter band on the way down and back. As a result of this "shakedown cruise" several additional spring leaves were added to the already-reinforced springs in order to carry the load properly.

When operating in the amateur bands the truck signs W1FQV. On the general experimental frequencies it uses W1XAJ portable. For special experimental frequencies in the ultra-short wave region W1XDJ portable is used.

The amateurs associated with the project are Paul B. King, Jr., W2BWF, who is cooperating on the ionosphere measurements and the author, who designed and built the radio apparatus. Both are graduate students at the Cruft Laboratory. Jack Pierce, ex-1EB, was responsible for much of the body work on the truck, and John DeYoung, W1HHW, assisted in some of the construction and testing of the apparatus. This project is being carried out as part of the radio research work in progress at the Cruft Communications and Physics Laboratory of Harvard University, and is under the general supervision of Professor Harry Rowe Mimno of that laboratory.

TO ALL AMATEURS WHO ARE MEMBERS OF THE ARRL IN GOOD STANDING:

Do you wear an ARRL pin or button? Do you carry on your correspondence with other amateurs on ARRL member's stationery? You should — we are proud to have you as members and you should be proud to show your allegiance to the organization that has done so much for your amateur radio. These items are exclusively for you, and the pins are available with the different colored backgrounds to distinguish between various Communication's appointments.



Write your radio letters on League stationery. Lithographed on 8½ x 11 heavy bond paper. Postpaid, 100 sheets, 50c; 250 sheets, \$1.00; 500 sheets, \$1.75.

The League Emblem, in heavy rolled gold and black enamel, either pin or button. Special colors available for Communications Department appointees. Red background for the SCM, green background for the RM, blue background for the ORS. Red and green colors available in pin type only, blue available both in pin and button types. Price only \$1 postpaid.



American Radio Relay League West Hartford, Conn.

PANELS — BAKELITE — RUBBER — ALUMINUM All Sizes Cut to Order

BAKELITE TUBING & RODS
Drilling, Engraving & Special Work
ALUMINUM CANS — Stock sizes, Special sizes, made to order.
ALUMINUM CHASSIS — Threaded brass studs for 6/32 screws.
Length from ¼" to 6" — price 5c to 30c.

Insulating bushings
for all size shafts
Bakelite Tubing Threaded to Specifications



Couplings in brass
or Bakelite—15c

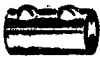

**UNITED RADIO
MFG. CO.**

Transmitting frames and racks
Est. 1923 191 Greenwich St., New York

University Course in RADIO COMMUNICATION

Open to high school graduates. Complete in nine months. High standard of instruction and equipment. Fall term opens September 19.

UNIVERSITY OF WISCONSIN — Extension Division
623 West State Street Milwaukee, Wisconsin

INCREASED SENSITIVITY BETTER TONE

*-with this new
microphone...*

Here is a single button carbon type microphone that is extremely sensitive yet that has a very good frequency response. You no

longer have to put up with an insensitive "mike" to obtain good tone. The high efficiency of this new Stromberg-Carlson microphone enables reduction of amplifier gain for an equivalent degree of modulation or output volume. Available in the two models illustrated.

Full particulars on request



No. 5
\$3.95

STROMBERG-CARLSON TEL. MFG. CO.
Rochester, N. Y.

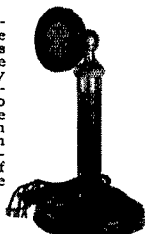

No. 6
\$12.00

USED THROUGHOUT THE WORLD

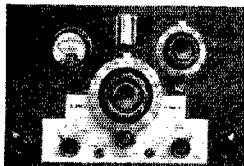

Throughout the world you will find the Ross 4-C 8-tube superheterodyne used by those who demand better-than-average radio performance. Only \$73.50 complete. We specialize in fine custom-built receivers (16-tube crystal unit, 4-tube superheterodyne, etc.) \$25 to \$150. Write for catalog.

A. H. ROSS & CO., Glenside, Penna.

A NEW BOOK—Second Edition of FUNDAMENTALS of RADIO

(426 pages 6" x 9", 430 figures)

By Professor R. R. RAMSEY, Ind. Univ.
Revised, enlarged, changed, reprinted, New cover.



New subjects Multi-electrode Tubes; A, B and C amplifiers; and Cathode Ray Television. Radio theory and practice brought up to May 1935. Problems and questions on each chapter. It still can be said that "Ramsey manages to provide that missing fact which seems to be hidden in other books." Every thing new and enlarged but the price. You can not afford to miss this book.

EXPERIMENTAL RADIO

By the same author. You have heard of the original radio manual of experiments. Get it. Prices: Fundamentals \$3.50; Experimental \$2.75 post paid.

Your check, postal order or C.O.D. brings 'em
RAMSEY PUBLISHING CO. Bloomington, Indiana

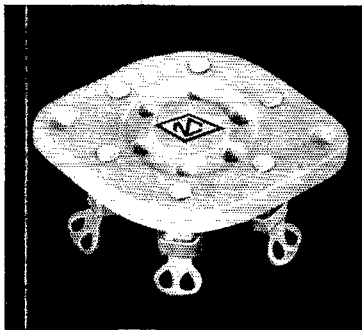

SOCKETS

● The use of low loss Steatite-Isolantite insulation with rugged high-current contacts not only makes National sockets ideally suited for all high and ultra high frequency uses, but also for rectifiers such as 866, etc. List price, all types \$6.00.

In stock at authorized distributors, usual discounts applying.

NATIONAL COMPANY, Inc.
MALDEN, MASS.



★ ★ ★

We Repeat

the F.C.C. requires a record of all transmissions. Have you a separate log for your portable mobile work? You will find that a separate log will help you maintain the standards of your station in the field as you would at its base location.

40¢ each, 3 for \$1.00

★ ★ ★

**AMERICAN
 RADIO RELAY LEAGUE, INC.**
 WEST HARTFORD, CONN.

★ ★ ★

A.R.R.L. QSL Bureau

FOR the convenience of its members, the League maintains a QSL-card forwarding system which operates through volunteer "District QSL Managers" in each of the nine U. S. and five Canadian districts. In order to secure such foreign cards as may be received for you, send your district manager a standard No. 8 stamped envelope. If you have reason to expect a considerable number of cards, put on an extra stamp so that it has a total of six-cents postage. Your own name and address go in the customary place on the face, and *your station call should be printed prominently in the upper-left-hand corner*. When you receive cards, you should immediately furnish your QSL manager with another such envelope to replace the used one. List of managers follows:

- W1—Allen W. Jones, W1NW, 1626 Commonwealth Ave., Boston, Mass.
- W2—H. W. Yahnel, W2SN, Lake Ave., Helmetta, N. J.
- W3—R. E. Macomber, W3CZE, 418 10th St., N. W., Washington, D. C.
- W4—B. W. Benning, W4CBY, 520 Whiteford Ave., Atlanta, Ga.
- W5—E. H. Treadaway, W5DKR, 2749 Myrtle St., New Orleans, La.
- W6—C. E. Spitz, W6FZQ, Box 1804, Phoenix, Ariz.
- W7—L. Q. Kelly, W7BPC, 4919 So. Prospect St., Tacoma, Wash.
- W8—F. W. Allen, W8GER, 324 Richmond Ave., Dayton, Ohio
- W9—George Dammann, W9JO, 319 Sherman Ave., Evanston, Ill.

- VE1—J. E. Roue, VE1FB, 84 Spring Garden Rd., Halifax, N. S.
- VE2—W. H. Oke, VE2AH, 5184 Mountain Sights Ave., N. D. G., Montreal, P. Q.
- VE3—Bert Knowles, VE3QB, Lanark, Ont.
- VE4—Dr. J. J. Dobry, VE4DR, Killam, Alberta.
- VE5—E. H. Cooper, VE5EC, 2024 Carnarvon St., Victoria, B. C.

Standard Frequency Transmissions

Date	Schedule	Station	Date	Schedule	Station
July 3	C	W9XAN	Aug. 2	B	W9XAN
July 5	B	W9XAN		A	W6XK
	A	W6XK	Aug. 7	BB	W9XAN
July 10	BB	W9XAN	Aug. 9	BB	W6XK
July 12	BB	W6XK		A	W9XAN
	A	W9XAN	Aug. 10	BX	W6XK
July 13	BX	W6XK	Aug. 11	C	W6XK
July 14	C	W6XK	Aug. 16	A	W6XK
July 19	A	W6XK	Aug. 23	B	W9XAN
July 26	B	W9XAN		B	W6XK
	B	W6XK	Aug. 28	C	W9XAN
July 31	C	W9XAN	Aug. 30	B	W9XAN
				A	W6XK

(See June QST for times and schedules of transmissions)

Where to buy it

A directory of suppliers who carry in stock the products of these dependable manufacturers.

BURGESS BATTERY COMPANY
 "Chrome" protected
RADIO BATTERIES
 Look for the Black and White Stripes
 FREEPORT, ILLINOIS

- ALBANY, N. Y.** 356 Broadway
 Uncle Dave's Radio Shack
- BALTIMORE, MD.** 303 W. Baltimore St.
 Radio Electric Service Co.
- BOSTON, MASS.** 46 Brattle Street
 Radio Shack
- GLENS FALLS, NEW YORK** 186 Glen Street
 M. Lapham's Sons
- HARTFORD, CONN.** 210 Chapel Street
 Stern & Company, Inc.
- MANCHESTER, N. H.** 1008 Elm Street
 Radio Service Lab. of N. H.
- MONTREAL, CANADA** 285 Craig Street, West
 Canadian Electrical Supply Co., Ltd.
- NEWARK, N. J.** 219 Central Ave.
 Wholesale Radio Service Company
- NEW YORK, N. Y.** 44 West 18th Street
 American Sales Company
- NEW YORK, N. Y.** 100 Sixth Avenue
 Wholesale Radio Service Company
- NEW YORK, N. Y.** 12 Warren Street
 R. H. McMann, Inc.
- NEW YORK, N. Y.** 142 Liberty Street
 Harrison Radio Company
- OIL CITY, PENNA.** 8 West Front Street
 Frank Electric Company
- READING, PENN.** 404 Walnut Street
 George D. Barbey Company
- SPRINGFIELD, MASS.** 349 Worthington St.
 T. F. Cushing
- WILKES-BARRE, PENNA.** 50 Hazel Street
 Radio Service Company

- RICHMOND HILL, NEW YORK** 124-11 101st Ave.
 Marine Radio Company
- WILMINGTON, DEL.** 405 Delaware Ave.
 Delaware Radio Sales Co.

E.F. JOHNSON COMPANY
 MANUFACTURERS OF
 TRANSMITTING RADIO EQUIPMENT
 WASECA, MINN.
 U.S.A.

- MONTREAL, CANADA** 285 Craig Street, West
 Canadian Electrical Supply Co., Ltd.
- NEWARK, N. J.** 219 Central Ave.
 Wholesale Radio Service Company
- NEW YORK, N. Y.** 100 Sixth Avenue
 Wholesale Radio Service Company
- NEW YORK, N. Y.** 142 Liberty Street
 Harrison Radio Company
- PITTSBURGH, PENN.** 603 Grant Street
 Cameradio Company
- READING, PENN.** 404 Walnut Street
 George D. Barbey Company

NATIONAL
 RADIO PRODUCTS
 NATIONAL COMPANY, INC., MALDEN, MASS.

- ALBANY, N. Y.** 356 Broadway
 Uncle Dave's Radio Shack
- ALLENTOWN, PENN.** 1024 Hamilton Street
 Radio Electric Service Company
- BALTIMORE, MD.** 303 W. Baltimore St.
 Radio Electric Service Company
- BIRMINGHAM, ENGLAND** 19 John Bright St.
 The Radio Mart
- BOSTON, MASS.** 10 Boylston Street
 Tremont Electrical Supply Co.
- BOSTON, MASS.** 46 Cornhill
 H. Jappe Company
- BOSTON, MASS.** 46 Brattle Street
 Radio Shack
- BUFFALO, N. Y.** 216 E. Genesee Street
 Dymac Radio
- HARTFORD, CONN.** 203 Ann Street
 Hatry & Young
- MONTREAL, CANADA** 211 St. Sacrament St.
 Canadian Marconi Company
- MONTREAL, CANADA** 285 Craig Street, West
 Canadian Electrical Supply Co., Ltd.
- NEWARK, N. J.** 219 Central Avenue
 Wholesale Radio Service Company
- NEW HAVEN, CONN.** 86 Meadow Street
 Hatry & Young

Super SKYRIDER
 the hallicrafters

- ALBANY, N. Y.** 356 Broadway
 Uncle Dave's Radio Shack
- BOSTON, MASS.** 46 Brattle Street
 Radio Shack
- HARTFORD, CONN.** 227 Asylum Street
 Radio Inspection Service Co.
- MANCHESTER, N. H.** 1008 Elm Street
 Radio Service Lab. of N. H.
- PITTSBURGH, PENN.** 620 Grant St.
 Tydings Company
- PROVIDENCE, R. I.** 32 Broadway
 W. H. Edwards & Co.

Where to buy it

A directory of suppliers who carry in stock the products of these dependable manufacturers.

NEW YORK, N. Y.	Wholesale Radio Service Co.	100 Sixth Avenue	NEW BEDFORD, MASS.	C. E. Beckman Co.	11-35 Commercial St.
NEW YORK, N. Y.	Sun Radio Company	227 Fulton Street	NEW HAVEN, CONN.	Hatry & Young	86 Meadow Street
NORFOLK, VIRGINIA	Newport & 35th Streets		NEW YORK, N. Y.	Federated Purchaser, Inc.	25 Park Place
	Newport Radio Service Company		NEW YORK, N. Y.	American Sales Company	44 West 18th Street
PHILADELPHIA, PENN.	Eugene G. Wile	10 S. 10th Street	NEW YORK, N. Y.	Royal-Eastern Electrical Supply Co.	16 West 22nd Street
PHILADELPHIA, PENN.	N. E. Corner 7th & Arch Sts.		NEW YORK, N. Y.	Sanford Samuel Corp.	136 Liberty St.
	Radio Electric Service Company		NEW YORK, N. Y.	Wholesale Radio Service Co.	100 Sixth Avenue
PHILADELPHIA, PENN.	M & H Sporting Goods Company	512 Market Street	NEW YORK, N. Y.	Harrison Radio Company	142 Liberty Street
PHILADELPHIA, PENN.	Herbach & Rademan, Inc.	438 Market Street	PHILADELPHIA, PENN.	Eugene G. Wile	10 S. 10th Street
PITTSBURGH, PENN.	Cameradio Company	603 Grant Street	PHILADELPHIA, PENN.	Raymond Rosen & Company	117 North 7th St.
PROVIDENCE, R. I.	W. H. Edwards & Company	32 Broadway	PITTSBURGH, PENN.	Cameradio Company	603 Grant Street
RICHMOND, VIRGINIA	Hudson Radio Supply Company	27th & Marshall Streets	PROVIDENCE, R. I.	W. H. Edwards & Company	32 Broadway
SPRINGFIELD, MASS.	T. F. Cushing	349 Worthington Street	PROVIDENCE, R. I.	Kraus & Company	89 Broadway
SYRACUSE, N. Y.	Roy C. Stage	265 Erie Blvd., West	READING, PENN.	Bright & Company	8th & Elm Streets
SCHENECTADY, N. Y.	M. Schwartz & Son	710 Broadway	SPRINGFIELD, MASS.	T. F. Cushing	349 Worthington Street
SPRINGFIELD, MASS.	Springfield Radio Company	397 Dwight Street	SYRACUSE, N. Y.	Roy C. Stage	265 Erie Blvd., West
WILKES-BARRE, PENNA.	Radio Service Company	50 Hazel Street	WILKES-BARRE, PENN.	Radio Service Company	50 Hazel Street
WILMINGTON, DELAWARE	Delaware Radio Sales Company	405 Delaware Avenue	WILMINGTON, DELAWARE	Delaware Radio Sales Company	405 Delaware Avenue



RCA de Forest
RADIO TUBES
RCA Radiotron Division of RCA Manufacturing Co., Inc.

ALBANY, N. Y.	Havens Electric Company, Inc.	31 Hudson Avenue
BINGHAMTON, N. Y.	Southern Tier Electrical Supply Co., Inc.	188 State Street
BOSTON, MASS.	Tremont Electrical Supply Company	10 Boylston Street
BOSTON, MASS.	H. Jappe Company	46 Cornhill
BOSTON, MASS.	Radio Shack	46 Brattle Street
BUFFALO, N. Y.	Radio Equipment Corp.	155 Genesee Street
CHARLESTON, W. VA.	Virginian Electric, Inc.	
HARTFORD, CONN.	Hatry & Young	203 Ann Street
NEWARK, N. J.	Wholesale Radio Service Co.	219 Central Avenue



RCA
AMATEUR
RADIO
EQUIPMENT
RCA Victor Division of RCA Manufacturing Co., Inc.

ALBANY, N. Y.	Capital City Distributing Corp.	1039 Broadway
BOSTON, MASS.	Eastern Radio Company	88 Pearl Street
BOSTON, MASS.	H. Jappe Company	46 Cornhill
BOSTON, MASS.	Radio Shack	46 Brattle Street
CAMDEN, N. J.	Radio Electric Service Company	811 Federal Street
CHARLESTON, W. VA.	Charleston Electrical Supply Co.	
ERIE, PENN.	J. V. Duncombe Company	1011 West 8th St.
GREENWICH, CONNECTICUT	Mead Stationery Company	252 Greenwich Ave.

Where to buy it

A directory of suppliers who carry in stock the products of these dependable manufacturers.

HARTFORD, CONN. Hatry & Young 203 Ann Street
HARTFORD, CONN. Radio Inspection Service Co. 227 Asylum Street
JAMAICA, N. Y. Marine Radio Company 163 Jamaica Avenue
MONTREAL, CANADA 285 Craig Street, West
 Canadian Electrical Supply Co., Ltd.
NEWARK, N. J. Wholesale Radio Service Company 219 Central Avenue
NEW HAVEN, CONN. Hatry & Young 86 Meadow Street
NEW YORK, N. Y. Sanford Samuel Corporation 136 Liberty Street
NEW YORK, N. Y. Wholesale Radio Service Company 100 Sixth Avenue
PHILADELPHIA, PENN. Radio Electric Service Company 3145 N. Broad Street
PHILADELPHIA, PENN. N. E. Cor. 7th & Arch Streets
 Radio Electric Service Company
PITTSBURGH, PENN. Cameradio Company 603 Grant Street
PROVIDENCE, R. I. Kraus & Company 89 Broadway
SYRACUSE, N. Y. Roy C. Stage 265 Erie Blvd., West
WASHINGTON, D. C. Star Radio Company 409-11th Street, N. W.
WILKES-BARRE, PENN. Radio Service Company 50 Hazel Street
WILMINGTON, DELAWARE Delaware Radio Sales Co. 405 Delaware Ave.

READING, PENN. George D. Barbey Company 404 Walnut Street
SPRINGFIELD, MASS. T. F. Cushing 349 Worthington Street
SYRACUSE, N. Y. Roy C. Stage 265 Erie Blvd., West
WILKES-BARRE, PENN. Radio Service Company 50 Hazel Street
WILMINGTON, DELAWARE Delaware Radio Sales Company 405 Delaware Avenue



BALTIMORE, MD. Mattson's 633 W. North Ave.
BOSTON, MASS. H. Jappe Company 46 Cornhill
HARRISBURG, PENN. Radio Distributing Company 1128 Market Street
MONTREAL, CANADA 285 Craig Street, West
 Canadian Electrical Supply Co., Ltd.
NEWARK, N. J. Wholesale Radio Service Company 219 Central Avenue
NEW YORK, N. Y. Wholesale Radio Service Company 100 Sixth Avenue
NEW YORK, N. Y. Sun Radio Company 227 Fulton Street
PITTSBURGH, PENN. Tydings Company 620 Grant Street
PROVIDENCE, R. I. W. H. Edwards & Company 32 Broadway

BALTIMORE, MD. Mattson's 633 W. North Ave.
BOSTON, MASS. Radio Shack 46 Brattle Street
HARTFORD, CONN. Hatry & Young 203 Ann Street
MONTREAL, CANADA 285 Craig Street, West
 Canadian Electrical Supply Co., Ltd.
NEWARK, N. J. Wholesale Radio Service Company 219 Central Ave.
NEW HAVEN, CONN. Hatry & Young 86 Meadow Street
NEW YORK, N. Y. Wholesale Radio Service Company 100 Sixth Avenue
PITTSBURGH, PENN. Cameradio Company 603 Grant Street
PITTSBURGH, PENN. Tydings Company 620 Grant St.
READING, PENN. George D. Barbey Company 404 Walnut Street
SYRACUSE, N. Y. Roy C. Stage 265 Erie Blvd., West
WILKES-BARRE, PENN. Radio Service Company 50 Hazel Street



ALBANY, NEW YORK Uncle Dave's Radio Shack 356 Broadway
NEW YORK, N. Y. American Sales Company 44 W. 18th St.
RICHMOND, VA. Hudson Radio Supply Co. 27th & Marshall Sts.
RICHMOND HILL, NEW YORK Marine Radio Company 124-11 101st Ave.

Bruno The SYMBOL of QUALITY

HAMS

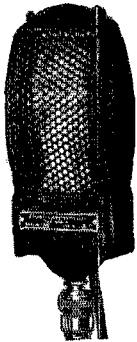

True quality reproduction is what you desire. The Bruno High Fidelity Model "M" microphone will meet your every requirement.

After many years of intensive engineering development and manufacture, Bruno offers you a microphone that has all of the necessary qualifications — CLEAR-CUT TONES — SPARKLING NOTES —.

CHECK these characteristics of "the microphone of tomorrow."

- Output level — 78 db
- Frequency 50 to 12,000 CPS
- Output impedance 200 or 500 ohms

Write to Department R for your copy of the 1935 catalog giving full descriptive information on these microphones

BRUNO LABORATORIES
20-22 West 22nd Street.
NEW YORK, N. Y.

VACUUM TUBE SOCKETS

Johnson "50-watt" and "UX" Type Sockets are standard equipments in the products of outstanding manufacturers of Radio Transmitters. And with all their high quality, they are low in cost!
Write for Bulletin, 933!
Available from Authorized Johnson Distributors
E. F. JOHNSON COMPANY
Manufacturers of Radio Transmitting Equipment
WASECA, MINNESOTA, U. S. A.

New MICA CONDENSERS
Compact
ENCASED IN PORCELAIN

"HAMS" A Real Low-Loss . . . Leak Proof . . . Moisture Proof . . . Excellent Power Factor Condenser. Truly a remarkable Engineering achievement accomplished after many expensive and painstaking experiments. Really a precision unit at even a lower price than most ordinary condensers. Available in 2 1/4% capacity tolerance and 2000 Volt construction. Write for catalog sheet and color Chart.

AMAZING QSL OFFER—SEE HAM-ADS

See your nearest Jobber or write direct to:
FILTERMATIC MANUFACTURING CO.
Tacony, Philadelphia, Penna.

A Genemotor Portable

(Continued from page 24)

used for the 'phones, to make certain that the filaments are "off" when the outfit is put away or packed up. A variable rheostat also is used, and a jack permits measuring and setting the filament current to the proper value by use of the meter, which should be 0-100 ma. The Trimm head-phones manage to dodge all the knobs and binding posts on the panel when packed in the lid. Paper, pencil, and a small log are also secured to the lid, and the 'phone plugs are held by clips, so that the whole outfit is self-contained except for the antenna (which is carried on a reel), the Genemotor, 6-volt battery, and a rope for getting the antenna up into a tree. The accessories may be carried in a box of convenient size. Where trees are not available, a jointed mast might be used for supporting one end of the aerial.

Last year this outfit was operated under the call W6FXP. Reports were always "pure d.c." and "xtal" and, despite the low power (about 6 watts input), the rig got out for about 500 miles in the early morning hours. There has been very little opportunity as yet to give the set a really good workout, but the possibilities seem to be there.

Metal-Shell Receiving Tubes

(Continued from page 56)

6H6 Twin Diode

(New basic type)

Heater voltage.....	6.3 volts
Heater current.....	0.3 ampere
A.c. voltage per plate (RMS).....	100 max. volts
D.c. output current.....	2 max. milliamperes
Maximum overall length.....	1 1/4"
Maximum diameter.....	1 1/4"
Base.....	Small octal 7-pin

6J7 Triple-Grid Detector-Amplifier

(Similar to present 6C6)

Heater voltage.....	6.3 volts
Heater current.....	0.3 ampere
Plate voltage.....	250 max. volts
Screen voltage (G2).....	100* volts
Grid voltage (G1).....	-3 volts
Suppressor (G3).....	Connected to cathode at socket
Plate current.....	2 milliamperes
Screen current.....	0.5 milliampere
Plate resistance.....	Greater than 1.5 megohms
Amplification factor.....	Greater than 1500
Mutual conductance.....	1225 micromhos
Maximum overall length.....	3 1/4"
Maximum diameter.....	1 1/4"
Cap.....	miniature
Base.....	Small octal 7-pin

* Maximum screen volts—125

6K7 Triple-Grid Variable-Mu Amplifier

(Similar to present 6D6)

Heater voltage (a.c. or d.c.).....	6.3 volts
Heater current.....	0.3 ampere
Plate voltage.....	250 max. volts
Screen voltage (G2).....	100* volts
Grid voltage (G1).....	-3 min. volts
Suppressor (G3).....	Connected to cathode at socket
Plate current.....	7.0 milliamperes
Screen current.....	1.7 milliamperes
Plate resistance.....	0.8 megohm
Amplification factor.....	1160

Here's Good News from Receiver Headquarters

We Are Making *IMMEDIATE DELIVERY* on the Following

1935 Amateur Communication Receivers—

**NATIONAL HRO — SUPER SKYRIDER — BRETING 12
RCA — ACR 136 — SILVER 5C — RME9D**

Down Payments Start at \$16.50—Balance on Terms to Suit

Prompt Delivery on Collins Transmitters

We represent all leading manufacturers of Amateur Radio Equipment. Write at once for complete details on any equipment needed, and full information will be promptly sent you

PATTERSON PR12 AND HAMMARLUND SUPER-PRO AVAILABLE SOON

DELAWARE RADIO SALES COMPANY

405 Delaware Avenue, Wilmington, Delaware

Attn: WILLARD WILSON—W3DQ

ESTABLISHED 1920

A REMINDER

Have you a goodly supply of ARRL Message Delivery Blanks so that when you handle traffic and deliver messages it will reflect credit on your station and on amateur radio as a whole? Have you a Message File designed to comply with the F.C.C. regulations which require that messages be kept for a period of one year?

THE MESSAGE FILE

has a compartment for each month of the year for easy and accurate filing, as well as space on the front for a complete record of traffic handled. You can't beat it for a practical solution to the problem.

40c each 3 for \$1.00

THE RADIOGRAM BLANKS

The radiogram blank has been revamped to allow for that much needed room for the body of the message and to facilitate copying of messages. $7\frac{1}{2} \times 8\frac{1}{2}$ sheet padded 100 sheets to the pad. It will reflect credit on your station when you deliver a message on this form.

35c each 3 for \$1.00

AMERICAN RADIO RELAY LEAGUE
West Hartford, Conn.

Latest revised list of available

BACK COPIES OF QST WITH INDEXES

98 ISSUES — \$15

See below

More exceptions noted than ever before — you had better act at once — to-morrow may be too late!

Please consult this list before ordering specific issues referred to in QST and HANDBOOK texts.

1925 copies — (except January, March, May and July)	\$2.00
1926 copies — complete	2.50
1927 copies — (except January and July)	2.50
1928 copies — (except January, February, March, April, August and September)	1.50
1929 copies — complete	2.50
1930 copies — (except January, February and July)	2.25
1931 copies — (except October and November)	2.50
1932 copies — (except February, August, September and October)	1.75
1933 copies — (except January)	2.50
1934 copies — complete	2.50

1935 copies — as issued, each 25c — complete year \$2.50

Complete Set of Copies (except 1935 series) as Listed \$15.00

(Outside U. S. and Possessions, and Canada, add \$3.00 for postage for the complete set.)

Single Copies 25c Each, and Yearly Sets at Price Indicated, Postpaid

Binders to keep these files in order are \$1.50 each, postpaid. Each binder holds 12 issues of QST and index, and does not mutilate the copies.

AMERICAN RADIO RELAY LEAGUE

West Hartford ■ Connecticut

Mutual conductance	1450 micromhos
Grid voltage *	—35 volts
Grid voltage **	—42.5 volts
Maximum overall length	3¼"
Maximum diameter	1½"
Cap.	Miniature
Base	Small octal 7-pin

*For mutual conductance of 10 micromhos
**For mutual conductance of 2 micromhos
° Maximum screen volts—125

6L7 Pentagrid Mixer-Amplifier

(New basic type)

Heater voltage (a.c. or d.c.)	6.3 volts
Heater current	0.3 ampere
Maximum overall length	3¼"
Maximum diameter	1.916"
Cap.	Miniature
Base	Small octal 7-pin

Mixer Operation

Plate voltage	250 max. volts
Screen (G2 & G4) voltage	150 max. volts

Typical Operation

Heater voltage	6.3 volts
Plate voltage	250 volts
Screen voltage	150 volts
Control grid (G1) voltage	—6 min. volts
Control grid (G3) voltage	—20 approx. volts
Peak oscillator voltage applied to G3	25 approx. volts
Plate current	3.5 milliamperes
Screen current	3.0 milliamperes
Plate resistance	Greater than 2 megohms
Conversion conductance	325 micromhos
Conversion conductance at —45 volts bias on G3	2 micromhos

Amplifier Operation

Heater voltage	6.3 volts
Plate voltage	250 max. volts
Screen (G2 & G4) voltage	100 max. volts
Control grid (G1) voltage	—3 min. volts
Control grid (G3) voltage	—3 volts
Plate current	5.3 milliamperes
Screen current	5.5 milliamperes
Plate resistance	0.8 megohm
Mutual conductance	1100 micromhos
Mutual conductance at —21 volts bias on G1; —12 volts bias on G3	10 micromhos

6F6 Pentode Power Amplifier

(Similar to present 42)

Heater voltage (a.c. or d.c.)	6.3 volts
Heater current	0.7 ampere
Maximum overall length	3¼"
Maximum diameter	1.916"
Base	Small octal 7-pin

Class A Amplifier

Heater voltage	6.3 volts
Plate voltage	250 max. volts
Screen voltage	250 max. volts
Grid voltage	—16.5 volts
Plate current	34 milliamperes
Screen current	6.5 milliamperes
Plate resistance	100,000 approx. ohms
Amplification factor	220 approx.
Mutual conductance	2220 micromhos
Load resistance	7,000 ohms
Total harmonic distortion	7 per cent
Power output	3 watts

5Z4 Full-Wave High-Vacuum Rectifier

(New basic type)

Heater voltage	5.0 volts
Heater current	2.0 amperes
A.c. plate voltage per plate (r.m.s.)	400 max. volts
Peak inverse voltage	1100 max. volts
D.c. output current	125 max. milliamperes
Maximum overall length	5¼"
Maximum diameter	1.916"
Base	Small octal 5-pin

HAM-ADS

(1) Advertising shall pertain to radio and shall be of nature of interest to radio amateurs or experimenters in their pursuit of the art.

(2) No display of any character will be accepted, nor can any special typographical arrangement, such as all or part capital letters be used which would tend to make one advertisement stand out from the others.

(3) The Ham-Ad rate is 15c per word, except as noted in paragraph (6) below.

(4) Remittance in full must accompany copy. No cash or contract discount or agency commission will be allowed.

(5) Closing date for Ham-Ads is the 25th of the second month preceding publication date.

(6) A special rate of 7c per word will apply to advertising which, in our judgment, is obviously non-commercial in nature and is placed and signed by a member of the American Radio Relay League. Thus, advertising of bona fide surplus equipment owned, used and for sale by an individual or apparatus offered for exchange or advertising inquiring for special equipment, if by a member of the American Radio Relay League takes the 7c rate. An attempt to deal in apparatus in quantity for profit, even if by an individual, is commercial and takes the 15c rate. Provisions of paragraphs (1), (2), (4) and (5) apply to all advertising in this column regardless of which rate may apply.

Having made no investigation of the advertisers in the classified columns, the publishers of QST are unable to vouch for their integrity or for the grade or character of the products advertised.

QUARTZ—Direct importers from Brazil of best quality pure quartz suitable for making piezo-electric crystals. Diamond Drill Carbon Co., 719 World Bldg., New York.

RADIO engineering, broadcasting, aviation and police radio, servicing, marine and Morse telegraphy taught thoroughly. All expenses low. Catalog free. Dodge's Institute, Byrd St., Valparaiso, Ind.

METER and Microphone Repairs. Low prices. Estimates free. Quick repair service—broadcasting equipment, all electrical instruments. Sound Engineering Corp., 2200 Kinzie, Chicago.

100WV General Electric transformers, 1100-2200-4400 each side center on 110. Sold hams right years. \$13.50. Dawson, 5740 Woodrow, Detroit.

QSLs? None better. Samples? W8DDS, 2156 West 80th St., Cleveland.

QSLs, SWLs. Real prices. Samples (stamps). W8ESN, 1827 Cone St., Toledo, Ohio.

WANTED—850, 800, 865, meters, receiver, class B 800 transformer. W7EMQ, Box 623, Rock Springs, Wyo.

VY FBI "Who's Who in Amateur Radio"—120,000 facts on 3000 amateurs. 130 photos, personal and station info. 170 pages, 50¢ prepaid. Radio Amateur Publishers, 1107 Broadway, New York City.

MAGAZINE subscriptions! Crystals! Write W8DED.

QSLs! QSLs! Made-to-order! Samples? (stamp) W8DED, Holland, Mich.

WANTED: April 1916 QST with both covers. Also "Proceedings I.R.E." for 1913, parts 1 and 2; 1914, number 4; 1915, number 3. S. B. Young, "Maplewoods", Wayzata, Minn.

100 two color modern QSL cards with a 50¢ sample order for two F.M.C. Porcelain Case Mica Low-Loss Transmitting and Receiving Condensers any capacity up to .001 MFD 2½% capacity tolerance 2000v test. Send your call letters and 50¢ for this remarkable \$1.90 value. (Capacity color chart included if ordered at once.) Limited offer. Order now. Filtermatic Mfg. Co., Tacony, Phila., Pa.

QSLs. Send stamp for samples. Printer, Corwith, Iowa.

WANTED—used super, bug. W2EUZ.

CALLBOOKS—new Summer 1935 Radio Amateur Call Book, hundreds of late W and VE calls, important changes in prefixes, many pages of new DX QRAs, is yours for \$1.25, or one year (four issues) for \$4.00. (In foreign countries \$1.35 and \$4.35, postpaid.) W9FO-610 S. Dearborn, Chicago.

SELL—1935 Triplett No. 1210 tester, No. 1201 case; RCA800, 841; miscellaneous parts. Stamp for list. W9GBT.

SEND for the new "Ross" catalog. Ross Electric Co., Inc., Van Wert, Ohio.

CLASS B transformers—Universal for two or four 46's, 210's, 800's, RK18's, etc., \$7.75 pair postpaid, 70 watts audio from 46's, 100 watts from 10's. Write for details. W8UD, Douglas, Michigan.

NATIONAL, FBXA receiver, 80 meter coils, tubes. A-1 condition, used. Cash \$40. W8MKM, D. F. Latham, 513 S. Albany St., Ithaca, N. Y.

WOLVERINE crystals—Introductory offer continued. See June Ham-Ads. 40 meter crystals \$2. Wolverine Crystal Service, Calumet, Mich.

BUY, sell or swap. W4DND.

SELL SW3 coils, 4 bands, extra audio stage, \$22. W1HXZ.

QSL cards, two color, cartoons, message blanks, stationery, snappy service. Write for free samples to-day. W1BEF, 16 Stockbridge Ave., Lowell, Mass.

QSLs. Finest quality. Beautiful designs and colors. Samples! Maleco, 1512 Eastern Parkway, Brooklyn, N. Y.

CRYSTALS for one-spot-nets; 80M, \$2 each, lots of 10 @ \$1.50; 40M, \$3.50 each, lots of 10 @ \$3. Vollmer Radio Lab., 5126-35th St., San Diego, Calif.

W9ADN crystals. New high activity medium temperature coefficient tube. 80, \$2.25; 40, \$3.25. For tripling: 60, \$3.25; 30, \$4.50. 60 AT, \$4.50; 80 AT, \$4.

MAKE offers: A-1 849, meters, transceiver, freq-monitor, condensers. Write for list. W3BBV, York, Penna.

CRYSTALS: Zero cut. Your approximate frequency, 80 or 160 meters \$1.85. Forty meters \$3.95 postpaid, guaranteed to compensate at near zero without oven control. Plug-in holders 75¢. Fisher Laboratory, 4522 Norwood Street, San Diego, California. "Pioneers of low priced crystals."

SWAP transmitter parts, guns, bird-dogs, microscope for Racon speaker units and trumpets or lathe. Miller Watkins, Rte. 7, Nashville.

SELL National FBXA receiver, complete with preselector stage, 2 volt tubes, 20, 40, 80 and 160 meter band spread coils and National 5887 AB power supply with '80 tube. Perfect condition. \$79.50 cash only, no swaps. Miles W. Weeks, W1WV, Chestnut Hill, Mass.

TRADE No. 5 Underwood typewriter for SW3 complete A1 size 116A Kodak for FB7. Radio hooks. Post 1085 drafting set for meters and parts. W6LSH, 1975 Navarro, Pasadena, Calif.

WHY pay cash? Purchase your new receiver on our "Painless Payment" plan. Write us for dope. Wilcox Radio Sales, 180 West Adams St., Chicago, Ill.

OVERLOAD relay, \$2. W9DQH.

QSLs? None better! W6FZQ/W6HEU, Box 1804, Phoenix, Arizona.

NATIONAL SW-3, nearly new. Must sell. Complete with power supply, 6 sets coils, tubes, phones, speaker, \$28. Zalner, 8 Judson Ave., Binghamton, N. Y.

RECEIVERS—new and used sold and traded in, as Hammarlund, National, Postal, International, etc. Schwarz Radio Service, Dumont, N. J.

FOLDER free, crystals \$1.50. W9DAX, Faberadio, Sandwich, Ill.

SELL or swap 56 m.c. outfit complete, transmitter, modulator, receiver and power supply exactly as of QST Aug. '34 and it works. Will reply all. R. G. Tappan, 3435 Tawanda Trail, Knoxville, Tenn.

AUTOMATIC CQ machine from phonograph. Costs nothing to make. Full dope 25¢. W2FIS, Milton Place, Woodmere, N. Y.

SELL used 852, \$7. W8CQC.

CRYSTALS—guaranteed excellent oscillators; approximate frequency 80-160 meters, \$1. 450-500-kc. \$2. Herbert Ad-dington, 2252 North Leclair, Chicago. Successor to W9FHS.

AUTOMOBILE call letter plates. Steel. 6"x12". Colors optional, 60c pair. W9AIN.

FOUR 852s, \$12 each, one 860, \$15. W1GR.

TRADE—xtals for tubes, meters and what-not. W4KP, Tarrant, Ala.

CODE machines, tapes and instruction for rent or sale. Rent may be applied on purchase if desired. Instructograph, 912 Lakeside Place, Chicago.

WAC crystal control three-tube transmitter, \$35. New Sargent 8-34 receiver, \$35. Walter King, Canonsburg, Pa.

CONDENSER microphones—machined of bronze. .002" diaphragm. Good frequency response. Well made and guaranteed 1 year. An exceptional buy. Head, \$5. and 3% tax. W8AER, 200 Dana Ave., Columbus, Ohio.

W8GLY fone transmitter for sale complete. Including remote control equipment, \$500.

NATIONAL—Hammarlund-Patterson used sets. 60% off list. W3DQ, 405 Delaware Ave., Wilmington, Del.

SELL May QST Super. Need cash to experiment. Hubbell, W9ERU.

RELAY racks, power equipment, to boost your output. Edison Bn. Rectifier Engineering Service, 4337 Rockwood Rd., Cleveland, Ohio.

BARGAINS. Rebuilt 204s, new tube guarantee, \$24. 866, new, \$1.60. All types tubes repaired. Send for price list. W2AWZ.

QSLs, SWLs, 75¢ per hundred, two colors, samples on request. W5ECM, 319 Rosetta, Little Rock, Ark.

866s, \$1.39, guaranteed. Transmitters constructed. Howard Radio, 5648 Race Ave., Chicago.

TELEPLEXES, Omnigraphs, receivers, meters, Vibroplexes, bought, sold, traded. Ryan Radio Co., Hannibal, Mo.

CRYSTALS:—1715-4000. 1", "X". Within two kilocycles. \$1.75. Unconditionally guaranteed. Catalogue. Ham Crystals, 1104 Lincoln Place, Brooklyn, N. Y.

SELL—Comet Pro-crystal, AV model. 6 sets coils, tubes. Like new. W3BWVX.

GUARANTEED crystals. 160-80 meters, less than 1". X or Y, within five kilocycles, \$1.35. Within two kilocycles, 1", \$1.75. Rough-cut blanks, 60¢, oscillating, 85¢; odds and ends, five for \$1. Holders, \$1.25. Speedy service. William Threm, W8FN, 4021 Davis Ave., Cheviot, Ohio.

15 watt, 4 band excitation unit for sale. Rack mtg. Universal type. W9DKF, Peoria, Ill.

TRANSFORMER bargains. 1000-0-1000, 320 mils, 750-0-750, 430 mils, \$5.25. 2000-0-2000, 400 mils, \$13.50. Special to order. R. Laursen, 812 Coal, Wilkensburg, Pa. W8EFX.

20 to 12,000 Cycles from the Audio-Tone Model 12-A AUDIO FREQUENCY OSCILLATOR

with Direct Dial Calibration

Licensed Under A. T. & T. Co., Patents

\$48.00 Net, less tubes and power supply

THE AUDIO-TONE OSCILLATOR COMPANY

902 Longbrook Avenue

Stratford, Connecticut

BIRNBACH

5-METER ANTENNA

For **TRANSCIVERS** and
BEAM ARRAYS

\$2.00 and \$2.50

THREE aluminum tube sections, adjustable to desired frequency from 3 ft. (closed) to 9 ft. (open). Tightly locked by brass bushings. High-resistance standoff insulator base (4½" high). Complete with standoff, \$2.50 list. Extensible antenna only, with threaded end, \$2.00 list.

Write Dept. Q-7 for Details

BIRNBACH RADIO CO., Inc.

145 HUDSON STREET, NEW YORK CITY



MOBILE
and
PORTABLE

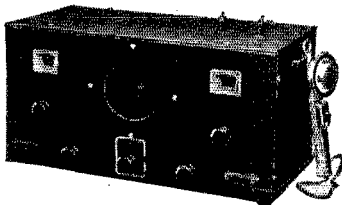

DUPLEX TRANSMITTER-RECEIVER UNITS

Containing Medium Power Transmitters—Tuned R. F. Receivers

WRITE FOR BULLETIN C

RADIO TRANSCIVER LABORATORIES

86-27—115th Street, Richmond Hill, N. Y.

DECIBEL METER

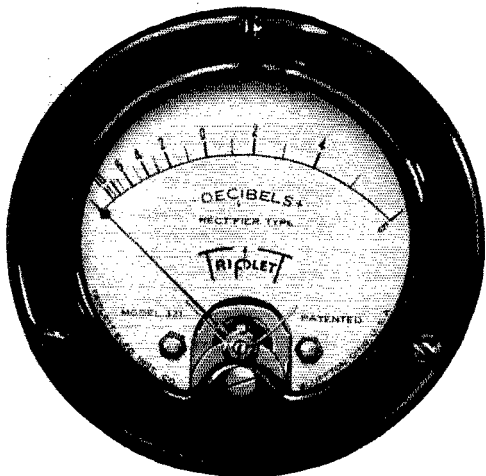

Model No. 321

by Triplitt

POWER level indicators are used to measure sound or noise levels in the amplifying systems of public address, theater, broadcasting stations, etc.—enabling the operator to make immediate adjustments and to keep the system free from distortion.

The standard range reads up 6 and down 10 decibels, 0 level, 1.73 volts, 500 ohm line, 6 milliwatts. Furnished either standard or highly damped. Other ranges to order only. Meter in moulded case, metal as desired.

Write for Free Catalog

TRIPLITT ELECTRICAL INSTRUMENT CO.
168 MAIN STREET BLUFFTON, OHIO

HOW IS YOUR SUPPLY OF IDEAS?

If they ever run low, make sure that you have a copy of **HINTS & KINKS** handy. It is chock full of money-saving ideas and stunts of interest to you. There are many times when you will find it invaluable. The price is 50c postpaid.

AMERICAN RADIO RELAY LEAGUE

West Hartford

Connecticut

Your Nearest Dealer Is Your Best Friend

Your nearest dealer is entitled to your patronage. You can trust him. He is equipped with a knowledge and understanding of amateur radio. He is your logical and safe source of advice and counsel on what equipment you should buy. His stock is complete. He can supply your needs without delay. His prices are fair and consistent with the high quality of the goods he carries. He is responsible to you and interested in you.

Patronize the dealer nearest you — You can have confidence in him

ALLENTOWN, PENNSYLVANIA

Radio Electric Service Co.
1024 Hamilton Street
Complete stocks transmitting equipment

BALTIMORE, MARYLAND

Radio Electric Service Co.
303 W. Baltimore Street
Everything for the amateur

BOSTON, MASSACHUSETTS

Nutter & Cross, Inc.
99A Milk Street
All OMs, OWs, and YLs welcome — W1HRF

BROCKTON, MASSACHUSETTS

Ware Radio Supply Co.
913 Centre Street
Hammarlund, Triplet, Ohmite, Raytheon, Bliley, Browning Kits

BUFFALO, NEW YORK

Dymac Radio
216 E. Genesee St. — Tel. Cl. 2080
Complete Stock Amateur Parts — Standard Discounts — W8AWK

BUFFALO, NEW YORK

Kronson Service Company
143 East Genesee Street
Western New York's largest wholesale distributors — W8EHF

ERIE, PENNSYLVANIA

Jordan Radio Laboratory
2512 Peach Street
Amateur, service parts, including Bliley, National, Raytheon. W8CXG

HARTFORD, CONNECTICUT

Radio Inspection Service Company
227 Asylum Street
What do you need? We have it

JACKSONVILLE, FLORIDA

Glover Weiss Co.
Radio Headquarters for Southeast
Distributors: RCA Victor, Stromberg-Carlson, Standard Ham Lines

MANCHESTER, NEW HAMPSHIRE

Radio Service Lab. of N. H.
1008 Elm Street — Tel. 218-W
Branches — Portland, Me. and Barre, Vt.

MONTREAL, CANADA

Canadian Elec. Supply Co., Ltd.
285 Craig St., W.
Quality parts and equipment for discriminating buyers

NASHVILLE, TENNESSEE

Braid Electric Co.
Ham Supplies — Replacement Parts
RCA, National, Hammarlund, and other leaders

PHILADELPHIA, PENNSYLVANIA

Consolidated Radio Corp.
612 Arch Street
Ham receivers, Transmitting tubes, Collins transmitters, etc.

PHILADELPHIA, PENNSYLVANIA

Radio Electric Service Co., Inc.
N. E. Cor. Seventh & Arch Sts.
All nationally-advertised lines in stock

PHILADELPHIA, PENNSYLVANIA

Eugene G. Wile
10 S. Tenth Street
Complete Stock of Quality Merchandise

PITTSBURGH, PENNSYLVANIA

Cameradio Company
601-3 Grant Street
"Ham" Headquarters for Pennsylvania-Ohio-W. Virginia

PROVIDENCE, RHODE ISLAND

Kraus & Company
89 Broadway
Everything for the amateur and serviceman

ROCHESTER, NEW YORK

Radio Service Shop
244 Clinton Avenue, North
Complete stock amateur-BCL parts. Standard discounts

SAN ANTONIO, TEXAS

Straus-Frank Company
Distributors for nationally advertised amateur products
RCA-DeForest transmitting tubes

SYRACUSE, NEW YORK

Roy C. Stage, W8IGF
Complete stock of standard Ham & BCL parts
Standard Discounts. Free technical service

WASHINGTON, D. C.

George's Radio Co.
816 F Street, N.W.
Washington's largest distributor of radio parts

WHEELING, WEST VIRGINIA

Cameradio Company
30 Twelfth Street
Complete stock of amateur Equipment at standard discounts

You Are Protected When You Buy From QST Advertisers

“Advertising for QST is accepted only from firms who, in the publisher’s opinion, are of established integrity and whose products secure the approval of the technical staff of the American Radio Relay League.”

Quoted from QST’s advertising rate card.

Every conceivable need of a radio amateur can be supplied by the advertisers in QST. And you will know the product has the approval of the League’s technical staff.

For Your Convenience QST’S INDEX TO ADVERTISERS IN THIS ISSUE

Aerovox Corporation.....	78
Astatic Microphone Company.....	78
Audio Tone Oscillator Co.....	92
A.R.R.L. Back Copies.....	90
Bookshelf.....	85
Hints & Kinks.....	89
How to Become a Radio Amateur.....	89
Log Book.....	84
Special Offer.....	4, 5
Supplies.....	83, 89
Barr Laboratories.....	73
Birnback Radio Company.....	92
Bliley Electric Company.....	75
Bruno Laboratories.....	88
Burgess Battery Company.....	6
Candler System Company.....	80
Capitol Radio Engineering Institute.....	74
Cardwell Mfg. Corp., Allen D.....	95
Central Radio Laboratories.....	72
Cohen’s Sons, I. S.....	83
Collins Radio Company.....	Cov. 2
Cornell-Dubilier Corporation.....	74
Delaware Radio Sales Co.....	89
Eastern Radio Specialty Co.....	79
Etzel-McCullough, Inc.....	82
Filtermatic Manufacturing Co.....	88
Flechteim & Co., A. M.....	81
General Radio Company.....	81
Gentry Laboratories.....	75
Gross Radio, Inc.....	70, 71
Gulf Radio School.....	79
Hammarlund Mfg. Company.....	1
Harvey Radio Laboratories.....	82
Henry Radio Shop.....	76
Hipower Crystal Company.....	81
Instructograph Company.....	81
Johnson Company, E. F.....	76, 88
Leeds.....	79
Littelfuse Laboratories.....	81
Lynch, Inc., Arthur H.....	81
Mallory & Co., P. R.....	96
Marine Radio Company.....	2
Massachusetts Radio School.....	81
National Company.....	69, 80, 84, Cov. 3
Offenbach Electric Company.....	90
Ohmite Manufacturing Company.....	77
Port Arthur College.....	73
Precision Piezo Service.....	77
Radio Receptor Corporation.....	75
Radio Shack.....	75
Radio Transceiver Laboratories.....	92
Ramsey Publishing Company.....	83
RCA Institutes, Inc.....	77
RCA Radiotron Company.....	Cov. 4
Ross & Co., A. H.....	83
Scientific Radio Service.....	75
Shuler Supply Company.....	89
Shure Brothers Company.....	79
Stromberg Carlson Telephone Mfg. Co.....	83
Teleplex Company.....	79
Triplet Electrical Instrument Corp.....	92
Turner Company.....	77
United Radio Mfg. Company.....	83
University of Wisconsin.....	83

NEW CARDWELL "XC-100-XS" IS A "★★★★" SMASH HIT!

[AT POPULAR PRICES]

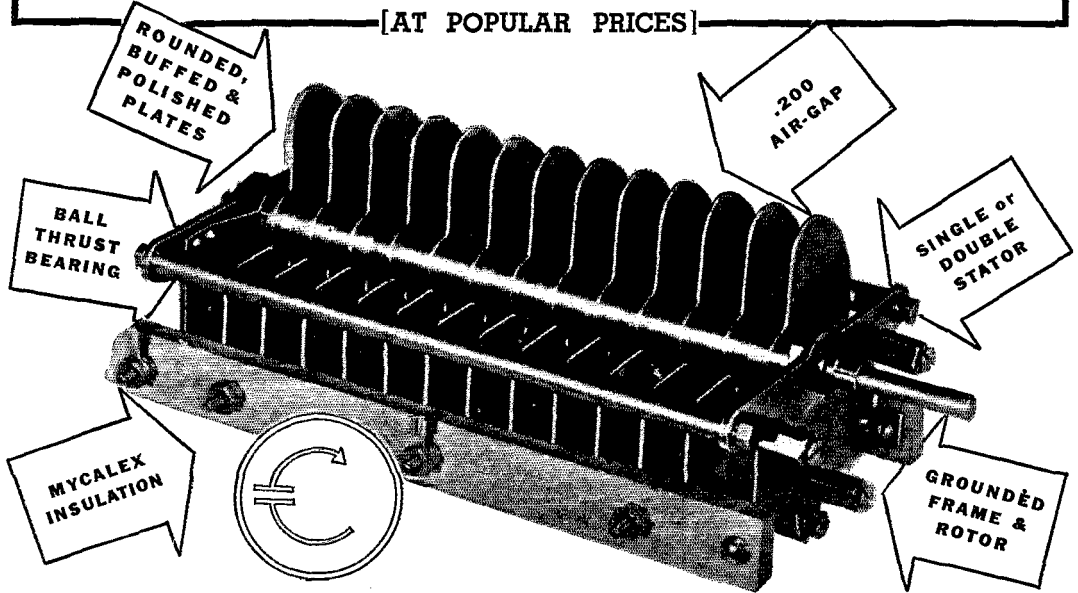

HERE ARE THE COLD FACTS - -NO RASH CLAIMS

- ★ Modern as tomorrow's news!
- ★ Backed by 20 years of condenser engineering.
- ★ .200 Air Gap insures against high voltage flashover.
- ★ Rounded, buffed and highly polished plates.
- ★ Solid, machined brass frame.
- ★ Mycalex Insulation Standard.
- ★ Lowest losses in any condenser!
- ★ Four capacities, up to 100 mmf.
- ★ Available in single or double types.

CARDWELLS' FLASHOVER VOLTAGES ARE RATED IN ACCORDANCE WITH ACCEPTED ENGINEERING STANDARDS, NOT AT FREQUENCIES NEVER USED IN AMATEUR TRANSMISSION!

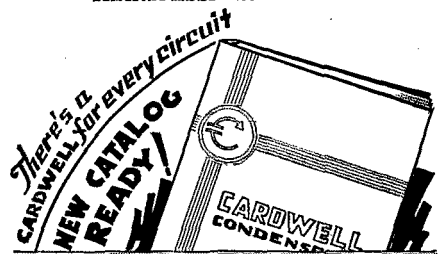

CARDWELL

CONDENSERS

THE ALLEN D. CARDWELL MFG. CORP'N
83 Prospect Street
Brooklyn, N. Y.

Please mail me the New 1935 Cardwell Catalog

Name

Address

City State

Do You Know This?



**There is a Mallory Replacement Vibrator
Available for Every Radio Set!**

At No Greater Cost than Ordinary Vibrators

Service Men now may replace with Mallory Vibrators—the standard of the industry—no matter what the make or model of the auto radio set.

That means better service—greater profit—more satisfied customers—more time saved and a better reputation for the man who does the job. It makes it possible to really build business at the time when the demand for effective service on auto radio sets is growing by leaps and bounds.

Over half of the auto radio sets now in operation are equipped with vibrators made by Mallory. Mallory is the leader—the pioneer in new developments—and Mallory now gives you service such as you never have had before.

Order Mallory Replacement Vibrators from your jobber—Today!



P. R. MALLORY & CO., Inc.
INDIANAPOLIS INDIANA



HRO COMMUNICATION TYPE RECEIVER

Although designed originally for table use, the HRO is now also available for relay rack mounting. The panel is of standard size, of $\frac{3}{16}$ " aluminum and finished in leatherette enamel.

Companion units, finished to match the HRO, are illustrated below. At the left is the power supply unit with the rectifier accessible through the removable ventilated panel. In the center is the coil rack, equipped with a hinged door to protect the five coils not in use. At the right is the monitor speaker panel, equipped with a high grade dynamic speaker with permanent-magnet field.

Your dealer will be glad to furnish complete information on this superlative equipment.

NATIONAL COMPANY, INC., MALDEN, MASS.

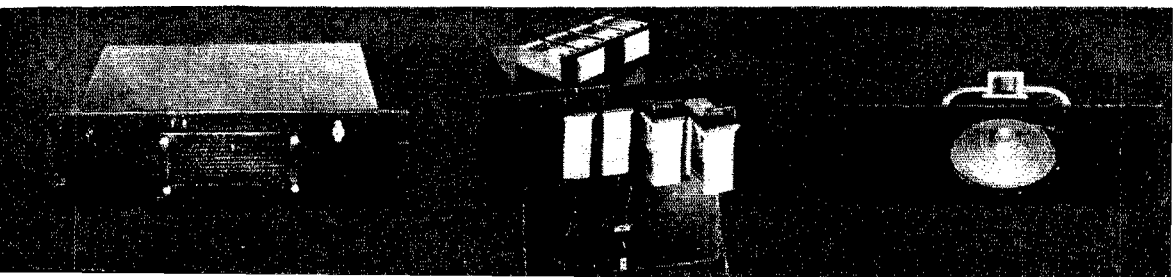

VALUE THAT IS REMARKABLE!

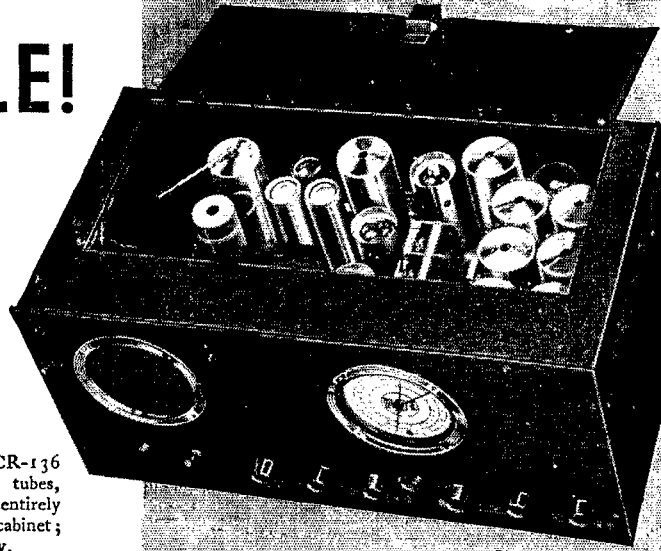

\$69.50

F. O. B. factory. The ACR-136 is sold complete with tubes, speaker, power supply, entirely self-contained in metal cabinet; nothing else to buy.

AMATEURS who have tried and bought the ACR-136 know its value is remarkable. They are using it in maintaining contacts with stations the world over. It is still an outstanding buy for your money, an amateur receiver that has everything you need and even more. Remember this is a 7-tube superheterodyne with one efficient tuned r-f stage, single control, calibrated dial, band change by front panel switch, r-f and a-f gain control, tone control, adjustable beat frequency oscillator, superior sensitivity and selectivity, and 540 to 18,000 kilocycle range. Best of all, it comes complete in a single unit, nothing else to buy. If you want more for your money (as who doesn't?) see your authorized sales outlet and put this real bargain to any test you want. Descriptive folder sent on request.



THE RCA ELECTRONIC SERVICE DIVISION
MANUFACTURING COMPANY, INC.
NEW YORK, N. Y.