

W3ELC

march, 1934
25 cents

QST

devoted entirely to

amateur radio

The Test Issue—

**A
Single-Tube
Two-Band
Crystal
Transmitter**



THE MOST COMPLETE
BOOK ON AMATEUR
RADIO EVER WRITTEN
BY
RADIO AMATEUR
HANDICAP

THE ONLY BOOK OF THE KIND
EVER WRITTEN BY A
HANDICAPPED PERSON

THE ONLY BOOK OF THE KIND
EVER WRITTEN BY A
HANDICAPPED PERSON

THE ONLY BOOK OF THE KIND
EVER WRITTEN BY A
HANDICAPPED PERSON

THE ONLY BOOK OF THE KIND
EVER WRITTEN BY A
HANDICAPPED PERSON

New

HAMMARLUND

Heavy-Duty

**Transmitter
Choke**

*With Peak
Impedance*

**WHERE YOU
WANT IT**

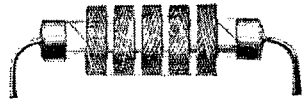
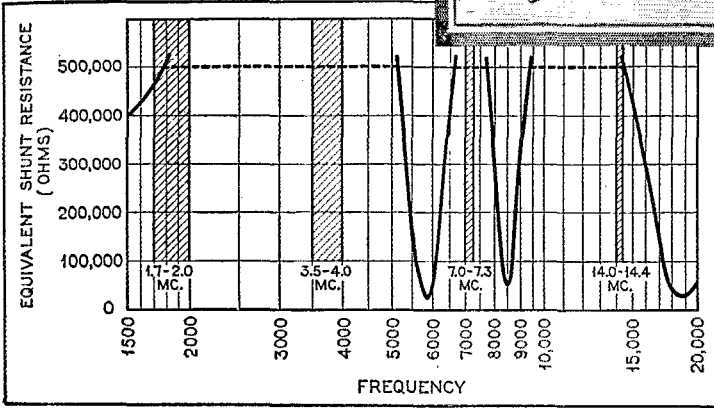
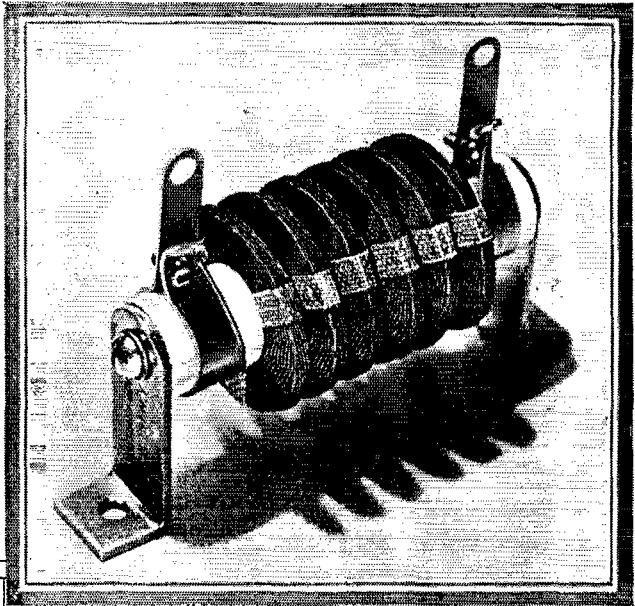

**New MIDGET
R. F. CHOKE**

*Invaluable for small space.
Inexpensive for generous
use. Inductance 2.1 mh. Im-
pregnated pies on Isolantite
core. Tinned copper leads.
Choke Size: 1/2 in. x 1 1/2 in.*

THE only available choke, for parallel feed in high-power transmitters, in which the highest useful impedance is effective *precisely where it is wanted* — at the 20, 40, 80 and 160-meter amateur bands.

Throughout these bands, as the diagram shows, this new Hammarlund Choke has the exceptionally high impedance of more than 500,000 ohms and, consequently, introduces negligible losses. It is also effective from 1500 to 15,000 kc. with the exception of frequencies between 5300 and 6400 and between 8000 and 9000 kc. Its use at these frequencies is not recommended.

Inductance 2.5 mh. Distributed capacity less than 1.5 mmf. DC resistance 8 ohms. Maximum recommended DC (*continuous*) 500 milliamperes.

Six thin universal-wound pies on Isolantite core. Insulated mounting brackets secured by short machine screws. No metal passes through core. With brackets removed, may be mounted with single machine screw. Choke size: 1 3/16 in. x 2 3/8 in.

Mail Coupon for Details



HAMMARLUND MANUFACTURING CO.
424-438 W. 33rd St., New York

.. Check here for information on new Choke Coils. .. Check here for complete 1934 Catalog of Precision Radio Parts. .. Check here for new booklet on COMET "PRO" Receiver with Quartz Crystal Filter and Automatic Volume Control.

Name.....
Address.....
.....Q-3

Say You Saw It in QST — It Identifies You and Helps QST

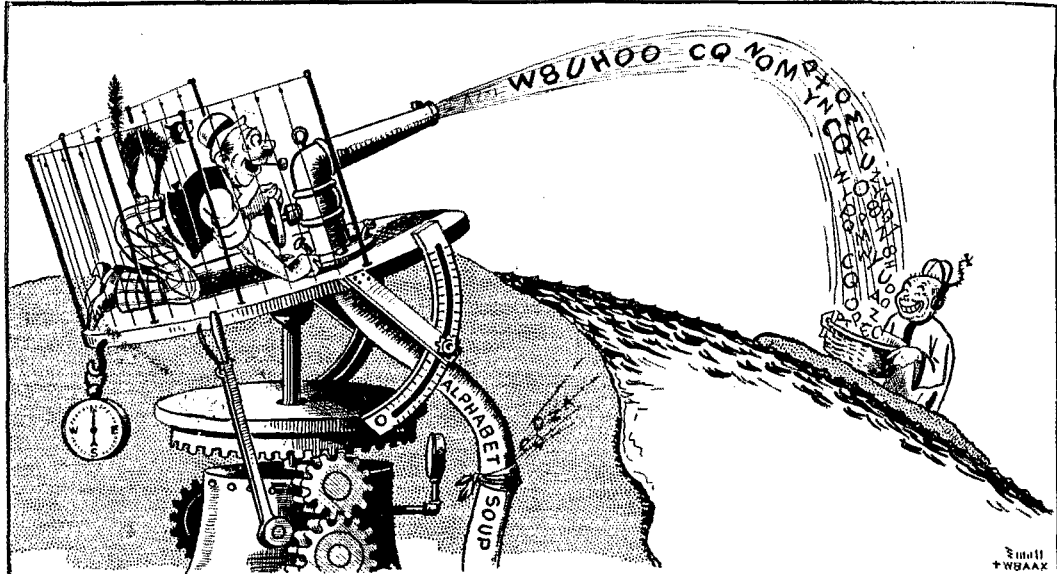

Put your sigs where you want them with a "SIGNAL SQUIRTER" .. and Westinghouse Instruments

EVER hear VK2ME say, "I am now beam-ing at you"? You can "beam," too, and put those 14, 28 and 60 megacycle signals just about where you want them. Then your face will beam with a DX smile.

The space required and the necessary cost have heretofore prevented the amateur from making a wide use of directional antennae. But you don't need a yard as big as the Sahara Desert to put up a "signal squirter." W8U-Hoo carries a folding model in his pocket—a couple of steel folding rules. That old umbrella frame may be just what you need to put your 5-meter sigs in the middle of the next block.

There are several effective forms of di-rectional antennae that do not require much space or material for frequencies of 14 mc. or higher, which will improve signal strength and dependability. This field offers a splendid opportunity for investigation by amateurs.

Westinghouse

Since 1888, manufacturers of highest quality instruments, now available at standard prices. There is no longer any reason for accepting lower standards.

Territory is still open for dealers.



To get started right you'll need a copy of the latest Westinghouse folder on "Directional Antennae." Some of the earlier forms are described briefly but detailed information is given on the double Zepp, the H-type, parabolic or reflector types, and the 4-element beam—with and without reflectors. Procedure in adjust-ments is given as well as dope on the trans-mission lines needed. And, of course, some special kinks are included on the use of West-inghouse instruments, which are very essential in the ultra short-wave field.

Send the coupon for your copy—and the cata-log on MX and NX instruments if you haven't already received one.

SEND FOR INFORMATION

Westinghouse Electric & Manufacturing Company
Dept. 122, Room 2-N—East Pittsburgh, Pa.

Gentlemen: Please send me the booklets checked below:

- F.8327—Directional Antennae for High Frequencies
 Catalog 43-340—Types MX and NX Instruments

Name.....

Address.....

City.....State.....T 7910

Call Letters.....QST 3-34

QST

Published monthly, as its official organ, by the American Radio Relay League, Inc., at West Hartford, Conn., U. S. A.; Official Organ of the International Amateur Radio Union

devoted entirely to

AMATEUR RADIO

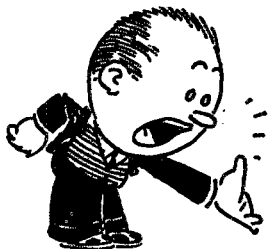

Editorials	7
A One-Tube Crystal-Control Transmitter <i>George Grammer</i>	8
International DX Test Time-Table Forecast	12
A Practical Cathode-Ray Oscillograph for the Amateur Station <i>L. C. Waller, W2BRO</i>	13
Suppressor-Grid Modulation <i>James J. Lamb</i>	19
Tuned R. F. for the Beginner's Receiver <i>Don H. Mix</i>	24
As to Expired Licenses	27
Getting Power from the Winds	28
Triple-Purpose Dual Tubes in "5 and 10" Portables <i>John L. Reinartz, W1QP</i>	31
Biasing the Power Amplifier <i>George Grammer</i>	33
Strays	35
The Light-Bulb Resistor <i>D. C. Redgrave, KAINA</i>	36
Conference on Emergency Communication	38
Armistice Day Message	39
Experimenters' Section	
MORE ON SILVERING CRYSTALS — LONGER "B"-BATTERY LIFE WITH THE RATIONALIZED AUTODYNE — LEAKY TUBE BASES — HALF-WAVE HERTZ FOR RECEIVING — THREADED COIL FORMS FOR THE TRANSMITTER — A SIMPLE VOLUME IN- DICATOR — FREQUETER CALIBRATION FROM B. C. STATIONS	41
Amateur Radio Stations <i>W9FAZ, W2ETD</i>	44
I. A. R. U. News	45
Communications Department	47
Correspondence Department	64
Standard Frequency Transmissions	80
WWV 5000-Kc. Transmissions	82
Hamads	90
QST's Index of Advertisers	94

MARCH
1934

VOLUME XVIII
NUMBER 3

Kenneth B. Warner (Secretary, A.R.R.L.), *Editor-in-Chief and Business Manager*; **Ross A. Hull**, *Associate Editor*; **James J. Lamb**, *Technical Editor*; **George Grammer**, *Assistant Technical Editor*; **Clark C. Rodimon**, *Managing Editor*; **David H. Houghton**, *Circulation Manager*; **F. Cheyney Beckley**, *Advertising Manager*; **Ursula M. Chamberlain**, *Assistant Advertising Manager*.

Editorial and Advertising Offices
38 La Salle Road, West Hartford, Conn.

Subscription rate in United States and Possessions and Canada, \$2.50 per year, postpaid; all other countries, \$3.00 per year, postpaid. Single copies, 25 cents. Foreign remittances should be by international postal or express money order or bank draft negotiable in the U. S. and for an equivalent amount in U. S. funds.

Entered as second-class matter May 29, 1919, at the post office at Hartford, Connecticut, under the Act of March 3, 1879. Acceptance for mailing at special rate of postage provided for in section 1103, Act of October 3, 1917, authorized September 9, 1922. Additional entry at Concord, N. H., authorized February 21, 1929, under the Act of February 28, 1925.

Copyright 1934 by the American Radio Relay League, Inc.
Title registered at United States Patent Office.

LEEDS ALWAYS LEADS

With an array of RADIO APPARATUS
Unequaled in this Country

LEEDS SERVICE FOR FOREIGN AMATEURS

We are thoroughly equipped to take care of your requirements no matter where you are located. Our foreign amateur friends are delighted with our wonderful service. See page 68 of the November issue of *QST* for complete details.

If you have a frequency meter, write for the circular on the Leeds frequency meter checker. The complete kit costs only \$5.31. A thin dime brings you the dope on this \$10 idea.

- GR No. 374-N, 00035 SLF. \$1.25
- GR No. 247-M, 00025 Vernier. \$.95
- GR No. 374-B, 000125 SLF. \$1.25
- GR No. 677-U coil form. \$.35
- GR No. 247-K, 00025. \$.75
- General Radio No. 369 choke coil 98H. \$6.69
- Lynch transposition blocks — kit of 10. \$1.65
- Lynch cage aerial spreaders — kit of 10. \$1.65
- Lynch Hi-Mho transmission line wire, equivalent No. 16, 100 feet. \$.60
- The new TRIMM 2000 ohm all bakelite head phone; per set. \$1.80
- TRIPLETT METER 3 1/4" bakelite case 0 to 50-100-150-200-250-500 milliammeter; 0 to 10-15 v. A.C., special \$3.75
- Complete line of R.C.A. receiving tubes 40% off list.

Sylvania Tubes

- The new 830 — class B audio tube in stock. A pair of these honeys will give you 190 watt audio with 1000 v. plate supply, each. \$10.00
- No. 830 Oscillator, amplifier. \$8.75
- No. 210. \$4.75
- Complete bulletin and price sheet available.
- The new R.C.A. No. 800 tube. \$10.00
- GE Neon tubes, 1/2-3/4-1 watt. \$.40
- General Electric Neon tubes, 2 watt. \$.50
- Haynes Griffin phone jacks, each. \$1.10
- Bud 6 prong Lo-Coil kit; 16 to 200 meters; space wound, ribbed, air core construction, 3 windings; 4 coils to set. \$2.30
- Western Electric No. 18 push back wire, 100 feet. \$.50
- Socket wrenches 2 1/4" shank; set of 4. \$6.60
- Socket wrenches 5" shank; set of 4. \$8.80
- Complete line of Acme Delta transformers in stock.

Thordarson Cased Class B Transformers

- Input and output for 46 tubes, each. \$2.94
- Input to 210 tubes. \$2.94
- Output to 5000 and 10,000 ohm load. \$3.55
- Midget power transformer, for that frequency meter power supply; 250 v. D.C. at 30 MA; 5 v. 2 amps. — 2 1/2 v. 3 amp. \$1.35
- Cardwell audio transformers. \$.49
- Cardwell No. 410-B 50 mmf. \$1.49

Cardwell No. 147-B 440 mmf. double spaced transmitting condenser. \$3.45
Cardwell No. 512-B 50 mmf. each section, split stator triple spaced. \$4.85
We carry a complete line of Sprague condensers.

Universal Microphones

- Model W single button lapel. \$1.75
- Model X single button. \$4.41
- Model X double button. \$5.88
- Model BB double button. \$14.70
- Universal stand chromium plated.
- Model X desk, \$1.75; Model L desk, \$3.54; Model floor, \$9.41.
- Shure 5-N double button. \$5.88
- Shure 22-N double button. \$14.70
- Shure floor stand; automatic adjustment. \$11.76

- Bruno velocity microphone kit. \$5.75
- Bruno condenser kit. \$2.85
- Piezo astatic Xtal mike D-104. \$12.25
- Chrisel cond mike; assembled, guar. \$7.50

Wing 5 Meter Transceiver

is becoming increasingly popular. Light weight, compact size and simplicity make it ideal for portable use. \$16.50
With two matched tubes. \$18.25
Picard type matched impedance antenna for 5 meters complete. \$2.50

Navy Type Telegraph Key

- List \$3.60. Navy knob — 1/2" Tungsten contacts. Only a few left at. \$1.15
- With regular knob. \$.95
- Leeds transmitting key, spec. \$6.65

National

- F.B. pre-selector unit in stock; complete with coil for one band. \$15.00
- FBXA. \$47.70
- FB7A. \$34.70
- All FB coil ranges. \$6.00
- SW 3 receivers. \$17.70
- Short wave coil ranges, each. \$3.00

All the new National insulator products as advertised Jan. 1934 now available. 40% discount from list.

- Genuine Baldwin Type C phones. \$3.75
- Western Electric Type P-11 Signal Corps phones. \$3.95
- Still a few left. Jewell No. 190 — two-inch A.C. Voltmeters. 0-8; 0-10; 0-15; each. \$3.50
- No. 165 two-inch 0-1 Thermo-ammeters. \$4.95

All metal cased instruments

Leeds Relays as advertised last month. \$2.29

Leeds Transformers For Every Amateur Need Mounted Filament Transformers

- 2 1/2 v. 6 amp. 2000 v. ins. \$0.95
- 2 1/2 v. 10 amp. 2000 v. ins. \$1.25
- 5 v. 3 amp. 2000 v. ins. \$.95
- 6.3 v. 2 1/2 amp. 2000 v. ins. \$.95
- 7 1/2 v. 2 1/2 amp. 2000 v. ins. \$1.25
- Two 2 1/2 v. 5 amp., one 5 v. 3 amp. \$2.25
- Two 7 1/2 v. 3 amp., one 2 1/2 v. 5 amp. \$2.50
- Two 7 1/2 v. 3 amp., one 5 v. 3 amp. \$2.50
- Three 5 v. 3 amp. for 83 Bridge Rectifier. \$2.50
- 2 1/2 v. 5 amp.; 5 v. 3 amp.; 7 1/2 v. 3 amp. \$2.50
- 2 1/2 v. C.T. 10 amp. 10,000 v. insulation. \$2.75
- 10 v. C.T. 7 amp. with tap primary. \$3.95

Mounted Plate Transformers

- 1100 v. C.T. 150 M.A. 7 1/2 v. 3 amp.; 5 v. 3 amp.; 2 1/2 v. 5 amp. \$4.75
- 950 v. C.T. 200 M.A. two 2 1/2 v. 5 amp. one 5 v. 3 amp. \$3.75
- Universal cased plate trans. with stand-off insulator terminals, 300 v. capacity; 750-1000-1500 v., each side. C. T. shipping weight 40 lbs. \$10.95
- Announcing a new cased plate transformer for class B 203A; 2500 v. C.T. at 500 mils. \$16.50
- Leeds uncased class B transformer for 46 and 59 tubes, pair. \$3.50
- Carter 20000 w. wire wound potentiometers 3" diameter. \$2.25
- Dubilier, 3 mfd. 400 v. paper condensers, each. \$.49
- R.C.A. chokes; 18 H. 125 M.A. 200 ohm, each. \$.79
- Aerovox electrolytics 12 v. 1500 mfd. \$6.69
- DeForest Audio Trans. 3:1, each. \$4.49
- DeForest tubes, 481-450 only; each. \$3.95
- Kenyon KC 350; 30 H. 75 mils; 350 ohms. \$.75
- Birnback Insulators — We have them. LEEDS' precision crystal holder. \$1.25
- Y cut crystal 10 KC 80 or 160 meters \$2.50
- With crystal holder. \$3.50
- Y cut xtal .1 of 1% accuracy. \$3.00
- With crystal holder. \$4.00
- X cut crystals .1%. \$3.75

SPEAKER SPECIALS

- Wright Decoster 6" dynamic speaker, with 2500 v. field and pentode output transformer. \$2.75
- Wright Decoster 5" midget dynamics with 300 v. field and pentode output transformer. \$2.25
- Hammarlund Crystal "Pro". \$11.72

LEEDS does not publish a catalog. We will be glad to furnish manufacturers bulletins on any apparatus advertised by us if you will specify those you are interested in. We will be glad to quote our lowest prices on any equipment by return mail.



45 Vesey Street, New York City
New York Headquarters for Transmitting Apparatus

Êtes-vous intéressé dans l'appareil Americain? Notre annonce dans le *QST* de Novembre, page 68, vous informe comment l'obtenir dans la manière la plus vite et moins chere. Vous remportez de grands avantages de requérir une translation de notre plan.

Section Communications Managers of the A.R.R.L. Communications Department

All appointments in the League's field organization are made by the proper S.C.M., elected by members in each Section listed. Mail your S.C.M. (on the 16th of each month) a postal covering your radio activities for the previous 30 days. Tell him your DX, plans for experimenting, results in 'phone and traffic. He is interested, whether you are an A.R.R.L. member or get your QST at the news stands; he wants a report from every active ham. If interested and qualified for O.R.S., O.P.S. or other appointments he can tell you about them, too.

Eastern Pennsylvania Maryland-Delaware-District of Columbia Southern New Jersey Western New York Western Pennsylvania	W3GS W3BAK W3QL W8DSP W8CUG	ATLANTIC DIVISION Jack Wagenseller Edgar L. Hudson Gedney Rigor Don Farrell C. H. Grossarth	24 South Fairview Ave. 412 2nd Ave. 213 Hickok Ave. R. F. D. 3, Eichler Rd.	Highland Park, Upper Darby Laurel, Delaware Haddon Heights Syracuse Emsworth, Bellevue, Pa.
Illinois Indiana Kentucky Michigan Ohio Wisconsin	W9WR W9TE W9OX W8DYH W8BAH W9FSS	CENTRAL DIVISION Fred J. Hinds Arthur L. Braun Carl L. Pfumm Kenneth F. Conroy Harry A. Tummonds Harold H. Kurth	6618 West 34th St. 911 Reisner St. P. O. Box 359 7538 E. Robinwood Ave. 2073 West 85th St. 2550 N. 8th St.	Berwyn Indianapolis Louisville Detroit Cleveland Milwaukee
North Dakota South Dakota Northern Minnesota Southern Minnesota	W9DGS-IFW W9DRL W9JIE W9EPJ	DAKOTA DIVISION Wm. Langer C. B. Miller Robert C. Harshberger Norman Beck	313 First Ave., S. 449 N. 5th St. 1200 Faulquier St. 415 Grand St.	Jamestown Redfield St. Paul Winona
Arkansas Louisiana Mississippi* Tennessee	W5ABI W5DDW W5VI W4AFM	DELTA DIVISION H. E. Vette W. J. Wilkinson, Jr. W. P. Allen F. F. Purdy	2918 West 15th St. 1624 Allen Ave. P. O. Box 66 P. O. Box 173	Little Rock Shreveport Jackson Kingsport
Eastern New York N. Y. C. & Long Island Northern New Jersey	W2LU W2AZV W2CO	HUDSON DIVISION Robert E. Haight E. L. Baumach Walter A. Cobb	1080 Helderberg Ave. 7823 10th Ave. 28 Ampere Parkway	Schenectady Brooklyn East Orange
Iowa Kansas Missouri Nebraska	W9FFD W9FLG W9EYG-JPT W9FAM	MIDWEST DIVISION George D. Hansen O. J. Spetter C. R. Cannady Samuel C. Wallace	3734 Summit St. 305 Western Ave. 300 Sixth St. Green St.	Sioux City Topeka Monett Clarks
Connecticut Maine Eastern Massachusetts Western Massachusetts New Hampshire Rhode Island Vermont	W1CTI W1CDX W1ASJ W1ASY-WIRB W1APK W1AFO W1ATF	NEW ENGLAND DIVISION Frederick Ellis, Jr. John W. Singleton Joseph A. Miller Earl G. Hewinson Basil Cutting Stanley Atkinson Harry Page	19 Merrill Rd. 10 High Street 16 Mercier Ave. 33 Cortland St. 186 Magnolia St. R. 1	Norwalk Wilton Ashmont Springfield Pembroke Auburn Hinesburg
Alaska Idaho Montana Oregon Washington	K7PO W7A VP W7AAT-7QT W7ABZ W7AYO	NORTHWESTERN DIVISION Richard J. Fox Don D. Oberbillig O. W. Viers Raymond W. Cummins Stanley J. Belliveau	Box 301 P. O. Box 1271 4835 N. Amherst St. Route 7, Box 387	Ketchikan Boise Red Lodge Portland Yakima
Hawaii Nevada Los Angeles Santa Clara Valley East Bay* San Francisco Sacramento Valley Arizona Philippines* San Diego San Joaquin Valley	K6COG W6EAD W6AAN W6DBB W6ZX W6CAL W6DVE W6BJF-W6QC KA1XA W6EOP W6DZN	PACIFIC DIVISION C. D. Slaten Keaton L. Ramsay Francis C. Martin Barton A. Wood P. W. Dann Byron Goodman Geo. L. Woodington Ernest Mendoza Newton E. Thompson Harry A. Amler G. H. Lavender	Pearl City 1151 Buena Vista Ave. 738 W. Huntington Drive R. 1, Box 722 1821 Chestnut St. 141 Alton Ave. 716 Redwood Ave. 1434 East Madison St. 714 Tennessee 4101 Hamilton St. Route 6, Box 425	Oahu Reno Arcadia Campbell Berkeley San Francisco North Sacramento Phoenix Manila, P. I. San Diego Stockton
North Carolina Virginia West Virginia	W4AVT W3AAJ W8HD	ROANOKE DIVISION G. H. Wright, Jr. R. N. Eubank C. S. Hoffmann, Jr.	2817 Montrose Ave. 100 20th St.	Wendell Richmond Warwood, Wheeling
Colorado Utah-Wyoming*	W9BTO W6GCC-IDM	ROCKY MOUNTAIN DIVISION T. R. Becker Arty W. Clark	1176 Gaylord St. 260 So. 9th West	Denver Salt Lake City, Utah
Alabama Eastern Florida Western Florida Georgia-So. Carolina-Cuba- Isle-of-Pines-Porto Rico- Virgin Islands	W4KP W4NN W4MS W4UT	SOUTHEASTERN DIVISION L. D. Elwell Ray Atkinson Edward J. Collins George A. Love	1066 Waverly St. 4324 College St. 1517 East Brainerd St. 1202 NE Springdale Rd.	Tarrant Jacksonville Pensacola Atlanta
Northern Texas Oklahoma* Southern Texas New Mexico	W5AUL W5BQA W5BHO W5DUI	WEST GULF DIVISION Glen E. Talbutt Sgt. R. F. Hinck David H. Calk Dan W. DeLay	1902 South 11th St. 1st Balloon Co. 6726 Ave. Q 400 North Ash St.	Abilene Fort Sill Houston Albuquerque
Maritime	VE1DQ	MARITIME DIVISION A. M. Crowell	69 Dublin St.	Halifax, N. S.
Ontario	VE3GT	ONTARIO DIVISION S. B. Trainer, Jr.	4 Shorndcliffe Ave.	Toronto
Quebec	VE2AP	QUEBEC DIVISION J. C. Stadler	4334 Westmount Ave.	Westmount, P. Q.
Alberta British Columbia	VE4HM VE5AC	VANALTA DIVISION C. H. Harris R. K. Town	10806 125th St. 1754 Gravelley St.	Edmonton Vancouver
Manitoba Saskatchewan	VE4GC VE4EL	PRAIRIE DIVISION Reg. Strong Wilfred Skaife	711 Ashburn St. 2040 McTavish St.	Winnipeg Regina

* Officials appointed to act until the membership of the Section choose permanent SCM's by nomination and election.

The American Radio Relay League



• **T**HE AMERICAN RADIO RELAY LEAGUE, INC., is a non-commercial association of radio amateurs, bonded for the promotion of interest in amateur radio communication and experimentation, for the relaying of messages by radio, for the advancement of the radio art and of the public welfare, for the representation of the radio amateur in legislative matters, and for the maintenance of fraternalism and a high standard of conduct.

It is an incorporated association without capital stock, chartered under the laws of Connecticut. Its affairs are governed by a Board of Directors, elected every two years by the general membership. The officers are elected or appointed by the Directors. The League is non-commercial and no one commercially engaged in the manufacture, sale or rental of radio apparatus is eligible to membership on its board.

"Of, by and for the amateur," it numbers within its ranks practically every worth-while amateur in the world and has a history of glorious achievement as the standard-bearer in amateur affairs.

Inquiries regarding membership are solicited. A bona fide interest in amateur radio is the only essential qualification; ownership of a transmitting station and knowledge of the code are not prerequisite. Correspondence should be addressed to the Secretary.

DIRECTORS

- President*
HIRAM PERCY MAXIM.....W1AW
Box 216, Hartford, Conn.
- Vice-President*
CHARLES H. STEWART.....W3ZS
St. David's, Pa.
- Canadian General Manager*
ALEX. REID.....VE2BE
169 Logan Ave., St. Lambert, P. Q.
- Atlantic Division*
EUGENE C. WOODRUFF.....W8CMP
234 W. Fairmount Ave., State College, Pa.
- Central Division*
LOREN G. WINDOM.....W8GZ-W8ZG
1375 Franklin Ave. Columbus, Ohio
- Dakota Division*
CARL L. JABS.....W9BVH
1822 James St., St. Paul, Minn.
- Delta Division*
M. M. HILL.....W5EB
P.O. Box 274, Natchitoches, La.
- Hudson Division*
BERNARD J. FULD.....W2BEG
280 Broadway, New York City
- Midwest Division*
H. W. KERR.....W9DZW-W9GP
Little Sioux, Iowa
- New England Division*
G. W. BAILEY.....W1KH
74 Webster Road, Weston, Mass.
- Northwestern Division*
RALPH J. GIBBONS.....W7KV-W7BIX
3134 N. E. 25th Ave., Portland, Ore.
- Pacific Division*
S. G. CULVER.....W6AN
2962 Russell St., Berkeley, Calif.
- Roanoke Division*
H. L. CAVENESS.....W4DW
State College Station, Raleigh, N. C.
- Rocky Mountain Division*
RUSSELL I. ANDREWS.....W9AAB
1867 So. Lafayette St., Denver, Colo.
- Southeastern Division*
J. C. HAGLER, JR.....W4SS
2424 McDowell St., Augusta, Ga.
- West Gulf Division*
FRANK M. CORLETT.....W5ZC
2515 Catherine St., Dallas, Tex.

OFFICERS

- President*.....HIRAM PERCY MAXIM, W1AW
Hartford, Connecticut
- Vice-President*.....CHARLES H. STEWART, W3ZS
St. David's, Pennsylvania
- Secretary*.....KENNETH B. WARNER, W1EH
West Hartford, Connecticut
- Treasurer*.....ARTHUR A. HEBERT, W1ES
West Hartford, Connecticut
- Communications Mgr.*...F. EDWARD HANDY, W1BDI
West Hartford, Connecticut
-
- General Counsel*.....PAUL M. SEGAL, W3EEA
1010 Shoreham Building, Washington, D. C.

Address all general correspondence to the executive headquarters at West Hartford, Connecticut



THE EDITOR'S MILL

BOTH 'phone and c.w. have their special advantages. Telegraphy is cheaper and simpler, has much more range for given power, is a great deal more reliable a means of communicating. Its adherents find special pleasure in their mastery of key and code. Telephony is faster and easier. While both are amateur radio, they are poles apart in technique and procedure. It has always seemed to us that the special virtue of 'phone is that it permits communicating in a supremely natural manner. Words don't have to be spelled out letter by letter and abbreviating isn't necessary to save time. One simply engages in natural conversation with the other fellow. With these advantages of ease and naturalness, we find it difficult to understand why 'phone operators carry over into their work so many of the practices of the telegraph operator. The latter operator is proud of his knowledge of these devices, which are a natural part of his medium, but they are unnecessary encumbrances in voice operation. We would like to suggest that proper pride on the part of 'phone men would lead them to avoid these practices.

To give an example, the telegraph operator has only one way of conveying a laugh—he spells out *hi*. Just why a 'phone amateur doesn't convey laughter by actually engaging in it we don't know, but instead we hear a humorous remark climaxed by the spoken words *hi diddle de dit* or *hi diddle de ertz nay* or some such gem. As Handy says in his first O.P.S. Bulletin, "With a 'phone we should think a ham could laugh and be proud that he had a device that would transmit a real laugh and didn't require hieroglyphics or expanded code abbreviations to put it over."

Whenever we hear a voice station "Calling CQ, calling CQ" it impresses us as being the height of something or other. This is the purely-telegraphic manner of saying that one desires to communicate with any available station within range, but we suggest it has no place in telephone operation. The 'phone operator can *say* precisely what he wants: "Calling any midwest station, calling any midwest station, W1SZ West Hartford calling," or "Calling San Francisco," or "Calling any station." It *fits* voice operation, and the peculiarities of code operation do not. In similar fashion, why should 'phone stations say *doe dee doe* instead of "Go ahead" or "Come in now?"—is it any less fun? And doesn't simply saying "Good-bye" or "Good-night, old man" convey a lot more intelligibility and warmth-of-friendliness than the spoken letters *SK* or the awful *diddle de bump de bump*?

We suppose that these practices have just grown up without much thought, and we believe that sincere 'phone men will agree with our analysis. Amateur radio is founded upon friendly contact. Voice operation has certain superb potential advantages in that respect but they are frequently obscured to-day. We suggest to 'phone operators that the attempt to visit with each other in a natural manner will add enjoyment to the game and will eliminate some practices that often are just a little silly.

BUT there are some 'phone operators who are anything but inhibited and who carry "naturalness" to an offensive extreme. Although fortunately rare, every amateur has run across some of these idiots virtually broadcasting a drinking bout or exchanging smoke-house jokes. Need we affirm that there is no place for this kind of stuff in amateur radio? With no attempt to regulate any man's private life, still we say that what is prohibited on any street corner must be prohibited in amateur radio.

There are a great many short-wave BCL sets these days and these folks listen to amateur 'phone. What they hear in their homes is their chief impression of amateur radio. A sweet sense of the value and dignity and utility of ham radio they will get from that stuff! Amateur radio is pursued for sheer enjoyment but it must not be abused. Come on, now, 'phone men: be sports about this thing; use some judgment and remember that you have a personal responsibility as a representative radio amateur.

WE HAVE been asked why we have not printed in *QST* a complete exposition of our position on the Madrid convention and regulations, in view of the recent discussion of this subject in amateur circles. We have recently prepared a pamphlet on the amateur aspects of the Washington and Madrid regulations, with particular respect to international message handling. It deals with the facts. Any amateur may obtain a copy for the asking. But we have not printed it in *QST* because we do not believe that we should devote large quantities of our space to replying to unfounded criticisms of this, that and every other thing. Nor is there in essence anything to add to our original report to A.R.R.L. members that there is nothing in the Madrid treaty to worry about. The A.R.R.L. is twenty years old this year. It has always worked steadfastly for amateur rights. It is solely because we amateurs have an A.R.R.L. that we have the right to-day to be radio amateurs. Most amateurs know that if this treaty were what some have claimed it to be, A.R.R.L. would have been the first to point it out and the first to propose what we ought to do about it.

K. B. W.

A One-Tube Crystal-Control Transmitter

Practical Two-Band Operation With One Crystal

By George Grammer, Assistant Technical Editor

QST's most recent development—the Tri-tet oscillator—has made the single-tube crystal transmitter a really practical affair at last. Practical because it is now possible to work equally well in two—and, in a pinch, in three—amateur bands with a single crystal. Unless we miss our bet, this particular set marks the beginning of the era in which the new amateur's first transmitter will be crystal controlled. The design of the set is such that other higher power units of similar type can be added at will.—EDITOR

FOR the beginner, crystal control offers advantages which cannot be duplicated by self-controlled transmitters, no matter how simple their construction. Foremost is the all-important feature of positive frequency control; with a crystal of reliable make, delivered with an accurate calibration, the output of the transmitter is quite certain to be very close to the specified frequency. Secondly, the crystal gives an order of frequency stability which can be attained with self-controlled circuits only through the utmost care—and skill—in adjustment. High frequency stability is needed to give a steady, sharp signal free from keying chirps and “wobulation” (change in frequency with a change in power-supply voltage), and to eliminate the

one which specifies that the signal shall be steady, sharp, and free from frequency modulation.

Against this there is the impression that crystal control is “too complicated” for the beginner; that only the experienced amateur is capable of mastering its intricacies. There is some reason in this attitude if the word “crystal” conjures up a vision of complex circuits with many tubes and power supplies. But exactly the reverse is true if the crystal transmitter is a small affair having about the same power output as the self-controlled transmitter with which the average beginner makes his debut on the air. The crystal set can be actually simpler to adjust and operate—as it should be, with the two hardest adjustments, frequency setting and frequency stability, practically eliminated by the use of a crystal as the controlling element. The actual construction of such a set is equally simple, while the expense is little greater than that of an ordinary self-controlled oscillator—the difference being chiefly the cost of the crystal and holder.

Going on a bit farther, a workable crystal oscillator is never a wasted investment, because it always can be used as a driver for higher-power amplifiers as the station grows and as the operator's knowledge and skill increase. Particularly is this so if the first unit is designed with an eye to future expansion, and is made so that its type of construction can be consistently followed out when other higher-power units are added. This has been kept in mind in the design of the simple transmitter shown in the accompanying photographs.

Higher-power stages of the same general construction, all being readily adaptable to the popular frame-type of mounting, will be described in subsequent articles. Of course if this feature is not desired, the transmitter can be laid out in any fashion that may be convenient.

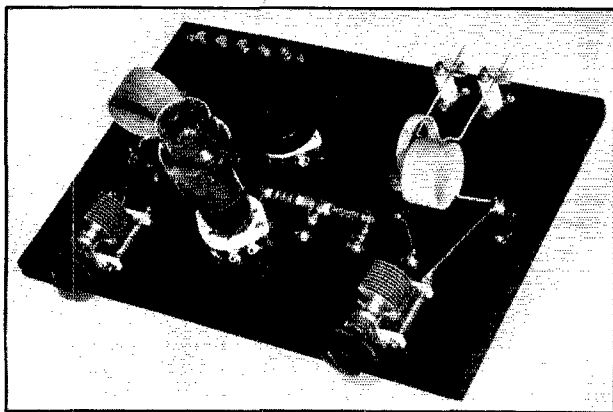

THIS SIMPLE AND INEXPENSIVE TRANSMITTER OPERATES EQUALLY WELL IN TWO BANDS WITH A SINGLE CRYSTAL

With a power pack delivering 350 volts, the power output is between 5½ and 8 watts, depending upon the frequency of the crystal.

effects of swinging antennas and feeders. Thus an inexpensive quartz crystal, with ordinary care in its use, insures immediate compliance with two of the most important of the amateur regulations—that requiring the transmitter to stay inside the assigned frequency bands, and the

A PRACTICAL LOW-POWER CRYSTAL TRANSMITTER

Before the development of the Tri-tet¹ oscillator circuit, which is nearly fool-proof, the operation of a single-tube crystal transmitter was practically confined to a single amateur band—that in which the fundamental frequency of the crystal was located. Because of the high harmonic output of the Tri-tet oscillator, two bands can now be worked equally well with a single crystal, which greatly increases the usefulness of the single-tube crystal set. It is even possible to work in three bands with one crystal, although the power output of the transmitter on the highest-frequency band is considerably lower than on the other two because it then becomes necessary to operate the plate circuit of the tube on the fourth harmonic of the crystal, which is rather weak in comparison to the second harmonic. Nevertheless, fourth-harmonic operation will do quite well for local contacts and can lead to some interesting work on extremely low power. Surprising distances can be covered with a watt or so in the antenna, especially on 14 megacycles.

Primarily, however, the transmitter to be described as the one-tube basic unit is intended to work in two bands with a single crystal. For the beginner, we recommend that a combination of either the 1.75- and 3.5-mc. bands, or the 3.5- and 7-mc. bands, be chosen; the possibilities of consistent work at all hours of the day are greater in those bands than on the higher frequencies. Since the coils and crystal are readily interchangeable, however, the transmitter is adaptable for operation on any band if only a crystal of the requisite frequency is available.

All the apparatus is mounted on a baseboard measuring 10 by 14 inches—half of a 14-by-20 breadboard (or "pastry" board) of the type obtainable at hardware or "up-to-a-dollar" stores in most cities. This particular board has been given a coat of black lacquer for the reason that this and similar units to be described later are intended to be mounted on a wooden rack which will be painted the same color. The two tuning condensers, C_1 and C_2 (see Fig. 1), are mounted along the front edge, each $2\frac{1}{2}$ inches in from the edge, with C_1 at the left. The grid and plate coils, L_1 and L_2 , are mounted on small porcelain standoff insulators located behind their respective condensers, as shown in the photographs. The coils should preferably be mounted with their axes at right angles to prevent coupling between them, although this is not absolutely essential since the two circuits are tuned to different frequencies and are physically well separated in this layout.

¹ Lamb, "A More Stable Oscillator of High Harmonic Output," *QST*, June, 1933; Lamb, "Tri-tet Multi-Band Crystal Control," *QST*, October, 1933; Grammer, "A Simplified Five-Band Exciter Unit," *QST*, November, 1933. The operating information on the Tri-tet oscillator in these three articles will be found helpful.

The screen and plate by-pass condensers, C_3 and C_4 respectively, are mounted end to end just to the rear of and between C_2 and the socket for the 59 tube, by machine screws which pass through the condenser lugs to the under side of the baseboard. The tube socket is mounted slightly to the left of the center of the board to accommodate the length of the by-pass condensers so mounted. The junction between C_2 and

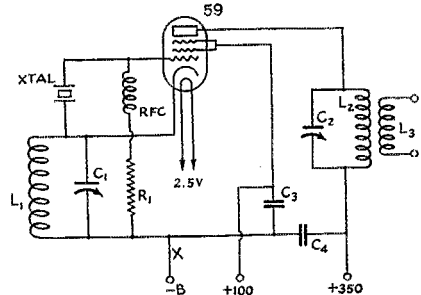

FIG. 1—CIRCUIT OF THE SINGLE-TUBE CRYSTAL TRANSMITTER

C_1, C_2 —100- μ fd. variable condensers (National type ST-100).

C_3, C_4 —0.005- μ fd. fixed mica condensers (Dubilier type 3).

L_1, L_2 —See coil table.

L_3 —See text.

R_1 —50,000 ohms, 2-watt (I. R. C.).

RFC—High-frequency choke (National type 100).

The key is connected in the negative lead at the point marked with an "x."

C_4 is used as a common "ground" point for the circuit. Just behind and parallel to C_3 is the grid leak, R_1 , and next to it the radio-frequency choke, RFC, which is connected between R_1 and the grid of the tube. The tube socket is mounted with the filament terminals (the two large holes) facing the front edge of the board.

The socket for the crystal holder is mounted behind the tube socket. Whether or not this type of socket will be needed will depend upon the type of crystal mounting used, of course. Whatever the mounting, the same position is a good location for the crystal.

Power supply connections are brought out to a bakelite strip mounted flat on the baseboard at the rear left-hand corner. Ordinary 6-32 machine screws are used as terminals. Five half-inch holes in the baseboard underneath the screw terminals give plenty of room for the screw heads and for running in the connecting wires. The two terminals at the left are for the filament supply; leads from the tube socket drop down through the baseboard and run underneath to the terminals. Next in line is the negative plate supply terminal, which connects to the common "ground" between C_3 and C_4 mentioned previously. The second terminal from the right is for the positive screen voltage; a wire from this terminal under the baseboard connects to the screen grid through the machine screw which

fastens the left-hand end of C_4 to the baseboard. The extreme right-hand terminal is for the positive plate voltage; it is connected underneath the baseboard to the machine screw which holds the right-hand end of C_4 in place. All these connections, which are made with bus bar of the same type used for the top-of-board wiring, are sunk in channels cut in the under side of the baseboard so the board will sit flat on the table. An alternative method, making the cut-out channels unnecessary, would be to mount the baseboard on rubber feet so the wires can clear.

The output posts at the right are National Type WGS insulators. Fahnestock clips are mounted underneath the metal heads to hold the antenna coil.

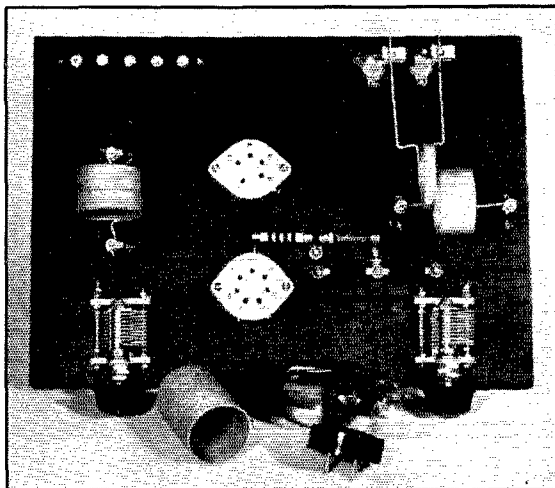

A TOP VIEW WITH THE TUBE AND CRYSTAL HOLDER REMOVED

The coils in place are those used to operate the transmitter as a Tri-tect oscillator for 7000-kc. output from a 3500-kc. crystal. The 3500-kc. output coil and the Bliley crystal holder are in the foreground.

WINDING THE COILS

The self-supporting coils used with the transmitter are easy to make and much easier to mount than coils wound on cylindrical forms, besides having a negligible cost in comparison to plug-in coils wound on regular receiving coil forms. All except the 1.75-mc. coils are wound with No. 16 d.c.c. wire; the 1.75-mc. coils are wound with No. 22 d.c.c. wire. The coil diameter in all cases is $1\frac{1}{8}$ inches.

The method of winding the coils is fairly simple. A $1\frac{1}{2}$ -inch cardboard mailing tube is used as a mandrel. Around it is wrapped a piece of sheet celluloid (sold for repairing side curtains at most auto-supply stores) cut so that it just fits around the tube and long enough to serve as a base for the total length of the coil. It may be held in place temporarily with string or rubber bands until after the coil is wound. The coil is then wound on tightly to the required length, using a machine screw through the mailing tube to hold the starting end of the wire, and tying down the finishing end so it cannot slip. Two or three coats of a good coil dope should then be applied, and the coil allowed to dry out thoroughly. The coil will probably be so tight that it will be impossible to slip out the mailing tube after drying, in which case it is a simple matter to cut it with a knife and to pull out the pieces with a pair of pliers, leaving a solid coil wound on the celluloid base. The No. 16 wire coils for this

transmitter were all wound as a single coil having a total length of about 8 inches; after finishing, the correct number of turns for each coil was counted off, allowing enough over to make the leads, and the required portion cut off, using a sharp knife to cut through the celluloid. To make

sure that the end of the individual coils would not come loose from the celluloid base, a dab of Duco Household Cement was put at the ends of the coils and allowed to set before the wires were straightened out. One of the photographs shows an unmounted coil and illustrates the method of finishing off the terminals. The two coils wound with No. 22 wire are also wound as a single coil and cut to the required number of turns after having "set" solidly. Other types of coils may be used, if desired, so long as

their dimensions are the same as those given in the coil table.

For operation on any two bands with a single crystal three coils will be required, in addition to the antenna coupling coil. The specifications for coils for all four bands are given in the table, together with the combinations used for each frequency.

OPERATING THE TRANSMITTER

If operation on two bands is intended, it will be necessary to purchase a crystal having a frequency such that its second harmonic (twice the fundamental frequency) will fall inside the higher-frequency of the two bands. This has been indicated in the table; for example, if the transmitter is to be used on the 3500- and 7000-kc. bands, the crystal frequency should be between 3500 and 3650 kc., because frequencies outside those limits will not "double" into the 7000-kc. band. Of course for operation in one band only the fundamental crystal frequency can be anywhere between the limits of that band. In purchasing a crystal, too, it is well to consider that later on it may be desirable to add another doubling stage to the transmitter so that more effective three-band operation will be possible. For example, if the 3500-, 7000- and 14,000-kc. bands are to be worked, the crystal frequency

must be between 3500 and 3600 kc. so that the fourth harmonic will fall within the limits of the 14,000- to 14,400-kc. band.

When the transmitter output is at the same frequency as the fundamental frequency of the crystal, the tube operates as an ordinary tetrode or screen-grid oscillator. In this case no coil is required at L_1 , but in order to complete the crystal circuit it is necessary to short-circuit the condenser C_1 . The simplest method of doing this is to bend a corner of one of the outside rotary plates of C_1 so that when the condenser is set at maximum capacity the bent-over plate will touch a stator plate. When the transmitter output is to be twice the fundamental frequency of the crystal, the circuit is converted to the Tri-tet simply by tuning the circuit L_1 - C_1 to produce oscillation at the fundamental crystal frequency, and adjusting C_2 to resonance at twice the crystal frequency.

As an example of tuning procedure, let us suppose that the transmitter is to operate on the 3.5- and 7-mc. bands and that a 3.5-mc. crystal of appropriate frequency is available. The filament and plate voltages indicated in Fig. 1 are connected to the transmitter. The output frequency is to be the same as that of the crystal. A 0-100 d.c. milliammeter connected in the plate-supply "plus 350" lead will be helpful, as will also a neon lamp for indicating oscillation. Coil No. 3 should be used at L_2 . The first step is to set C_1 at maximum capacity, thus making it short-circuit itself. Then C_2 should be turned until there is a pronounced dip in plate current, indicating the beginning of oscillation. With a crystal of ordinary activity, the minimum point of the plate current dip will be in the neighborhood of 10 to 15 milliamperes; when the tube is not oscillating the plate current will probably be 60 or 70 milliamperes. It is generally better to set the condenser C_2 at slightly lower capacity than that which gives minimum plate current, because the oscillator will be more stable under those conditions. The antenna coil may then be coupled to L_2 and the tuning adjusted to give maximum antenna or feeder current. The oscillator plate current should rise to 40 or 50 milliamperes when the antenna circuit is tuned to resonance. After adjusting the antenna circuit, C_2 should be retuned to give maximum output and to make certain that the oscillator "starts" quickly each time the plate circuit is closed. The transmitter should be keyed and the signals monitored to make certain that the keying is clean and certain. It may be necessary to set C_2 slightly off the maximum output point to get the necessary keying stability.

To operate the transmitter as a Tri-tet with output at twice the operating frequency, in this case in the 7-mc. band, coil No. 4 would be connected at L_1 and coil No. 5 at L_2 . Condenser C_1 should be set at about 75% of full scale and C_2 at about 20% of full scale. Apply the voltages

and adjust C_2 for minimum plate current, which should be 15 milliamperes or less. Touch a neon bulb to the stator plates of C_2 and adjust C_1 to give maximum glow. The tuning of C_1 will be quite broad, but there will be a definite region on its scale over which the second-harmonic output, as indicated by the brightness of the neon lamp, will be greatest. Also, the frequency stability will be best (no "creeping") with the lower capacity of C_1 . When these adjustments have been made the antenna may be coupled and tuned as before; it will not be found necessary to detune C_2 from the maximum output point in this case, however. The plate current should again be in the vicinity of 40 or 50 milliamperes with the antenna connected and tuned.

The tuning procedure for any other pair of bands will be similar. The coil L_1 may be left in place all the time, of course, since it will be shorted out when condenser C_1 is set at maximum capacity for operation on the fundamental frequency of the crystal.

ANTENNAS

Antenna systems are so numerous that it is impossible to give very definite specifications for tuning. The antenna coupling coils should be tailored to fit the conditions under which they will have to operate. The coil shown in the photograph, which has five turns of No. 16 d.c.c. wire wound in the same way as the other coils, is about the right size to use for 7-mc. operation with a Zepp antenna having quarter-wave (about 33-foot) feeders, in which case series tuning will be used. With other antenna systems the coupling

COIL DATA			
No.	Wire Size	Turns	Diameter
1	22 d.c.c.	75	1½ inches
2	" "	45	" "
3	16 d.c.c.	40	" "
4	" "	18	" "
5	" "	16	" "
6	" "	7	" "
7	" "	8	" "

All coils close-wound.

Crystal Frequency	Coil at L_1	Coil at L_2	Output Frequency
1750-2000 kc.	x	No. 1	1750-2000 kc.
" "	No. 2	No. 3	3500-4000 kc.
3500-3650 kc.	x	No. 3	3500-3650 kc.
" "	No. 4	No. 5	7000-7300 kc.
7000-7200 kc.	x	No. 5	7000-7200 kc.
" "	No. 6	No. 7	14,000-14,400 kc.

"x" indicates short circuit across C_1 .

coil should be made larger or smaller as the tuning arrangement dictates.

The antenna coupling can be varied by sliding the antenna coil toward or away from L_2 in the Fahnestock clips mounted on the output posts. Maximum coupling will result when the two coils are end to end with their axes coinciding. It is possibly advisable to put a small block of wood or other support under the leads near the coupling coil itself to keep it from vibrating when once the setting for optimum coupling has been found.

For 3.5- and 7-mc. operation, a good antenna system would be a Zepp having a length of 130 feet, with 45-foot feeders. The five-turn coupling coil illustrated will work well with a 250- or 350- μ fd. series tuning condenser for 7 mc., and a 10-turn coil with parallel tuning will suffice for 3.5 mc. The coupling will be fairly tight on 7 mc. and rather loose on 3.5 mc.

Other antenna systems are described in the *Handbook*, together with the tuning considerations involved.

POWER SUPPLY AND KEYING

Any well-filtered power supply having an output of 350 volts at about 100 milliamperes will be satisfactory for use with the transmitter. The powersupply of Fig. 1007, page 151, in the Eleventh Edition *Handbook*, for instance, is well suited to this outfit, and can be built up at little expense. If all the parts for the power supply must be purchased, however, it is well to give some thought to the possibility that a higher-power amplifier will be added later. Since the logical amplifier

tube would be one of the 10 type or similar classification, something might be saved by building a power supply designed to have an output of 500 or 600 volts at 150 to 200 milliamperes and temporarily operating the transmitter with a series resistor or divider to drop the voltage.

If the 350-volt supply used has no voltage divider to give the 100 volts for the screen, a satisfactory divider may be made by connecting a 7000-ohm resistor between the "negative B" and "plus 100" terminals, and a 10,000-ohm resistor between the "plus 100" and "plus 350" terminals. The full output of the power supply may then be connected between the "negative B" and "plus 350" terminals and the voltages will divide in the right proportions. It is important that the screen voltage be kept as nearly as possible at 100 volts. Lower voltage will reduce the output while higher voltage is likely to cause the tube to heat and perhaps stop oscillating after a few minutes' operation.

Keying can be accomplished satisfactorily by

(Continued on page 88)

International DX Test Time-Table Forecast

FOR the benefit of every amateur who plans to enter the Sixth International Relay Competition from March 10th to 18th (and that probably means just about every amateur in the world), we present the following table of probable best times to QSO the U. S. East and West coasts from the major geographical areas of the world. Data for the west coast forecast was contributed by Charlie Perrine, W6QD-W6CUH; that for the

east by Harris Fahnestock, W1ZI. Obviously, since these forecasts were prepared a month and a half in advance, no guarantees as to their absolute reliability can be given, but that they will hit the mark fairly accurately we are confident. Times are, of course, G. T.

Our thanks to W6QD and W1ZI for this detailed information. May it help you to pile your score high!
— C.B.D.

	Eastern U. S.		Western U. S.	
	7 mc.	14 mc.	7 mc.	14 mc.
EUROPE				
OZ, SM, OH, OK, SP.....	2100-2230	1230-1430	} 0700-0900	} 1500-2000
G, F, ON, EA, CT, RY, U.....	2100-0100	1300-1800		
SOUTH AMERICA	2330-0900	1700-2200		
ASIA				
Japan.....	1300-1430	2300 ¹	0700-0900	1500-1700
	0730-0900		1300-1800	0000-0200
	2130-2230 ¹			
China, Hongkong, Siberia.....	0830-1100	2330 ¹	1000-1600	
India, Iraq.....	2130-2230	1230-1330	1400-1600	
AFRICA				
South Africa.....	2300-0500	1700-2000	1530-1800	1900-2100
			0400-0500	
			1500-1600	
Rhodesia, Mozambique, etc.				
Egypt.....	2200-0000	1230-1430	1530-1600	
		1700-2000		
OCEANIA				
Australia.....	1100-1330		} 0600-1600	} 0200-0500
New Zealand.....	0800-1300			
Philippines, Guam.....				
Java, Sumatra.....	1000-1200		0600-1700	
Malay, Borneo.....	2200-2230		1300-1600	1500-1700
			1400-1600	
NORTH AMERICA				
Alaska.....			0200-0100	0000-0200
			1300-1500	
Bahamas.....				2100-2200
Central America.....	2100-1600	1700-2200	0300-1000	2000-0000
Cuba, Jamaica, Porto Rico.....			0100-1200	2100-0000
Mexico.....	0000-1500	1700-2200		
	1300-1500 ²			
Trinidad, Martinique.....			0900-1100	2100-2300

¹ Possible, but improbable. ² Easiest time.

A Practical Cathode-Ray Oscillograph for the Amateur Station

Using the New Types 906 and 885 Tubes in a Complete Unit With Sweep-Circuit

By L. C. Waller, W2BRO*

The cathode-ray oscillograph herewith makes its bow as a highly practical piece of amateur equipment. It no longer can be regarded as too costly, too complex and too delicate for anything but laboratory use because recently-developed tubes are rugged, relatively inexpensive and work in simple circuits. The total cost of the complete unit described in this article is comparable to that of a good receiver, for instance, and it is as easily constructed. The cost per ham can be made really small by group coöperation, with the local club or a neighborhood gang of 'phones "chipping in". It is our intention to present in an early issue the description of a simplified version of the cathode-ray oscillograph.—EDITOR

ONE of the most useful devices known to engineers who are constantly dealing with electrical phenomena is the cathode-ray oscillograph. Since radio amateurs are dealing with electric currents, both direct and alternating, at audio and radio frequencies, it is inevitable that such an oscillograph should sooner or later come into the amateur picture. As a matter of fact, there are so many different valuable services such a device can perform in an amateur station that it is actually difficult to enumerate them all.

Until recently, the cathode-ray oscillograph was a piece of equipment that many amateurs may have heard about, a number may have wished for, but few ever hoped to possess. It was something only to be found in the laboratories of the larger industrial plants and universities. But new developments in the tube field have placed cathode-ray tubes within the reach of the amateur's pocketbook. The purpose of this article is not to theorize or to talk of generalities, but to describe a simple, compact and economical cathode-ray oscillograph intended for amateur use as a permanent piece of station equipment.

Contrary to prevalent impressions, modern cathode ray equipment is neither delicate nor excessive in cost of the parts required. The ever-useful "junk box" will, as usual, come in handy and the total cost can be surprisingly reasonable, all things considered.

HOW IT WORKS

In order that the operation of and the results obtained with the oscillograph may be better understood, a brief review of cathode-ray tube fundamentals is in order. The tube used, Type 906, contains eight useful electrodes; namely, heater-cathode, control electrode, anode No. 1, anode No. 2, and two pairs of deflection plates. The arrangement of the electrodes is shown in

* RCA Radiotron Company, Harrison, N. J.

Fig. 1. The assembly of the cathode, grid, anode No. 1 and anode No. 2 is known as the *electron gun*. This is an apt name, for the electrons furnished by the cathode are controlled, accelerated, and focused by the other gun electrodes into a tiny beam, the cathode ray. This beam of electrons strikes the viewing screen, which is coated with a substance that fluoresces to produce a brilliant green glow at the impact point of the electron beam. The cathode ray thus produces on the front of the screen a luminous spot which is easily visible even in a well-lighted room.

In order to keep the electron beam focused to a small spot-size on the screen, it is necessary to maintain a constant ratio of anode No. 2 and anode No. 1 voltage. The sharpness of focus is usually adjusted by varying the anode No. 1 voltage. The input power to the screen (the product of anode No. 2 voltage and the beam current) controls screen illumination. Anode No. 2 current is controlled by means of the negative bias on the control electrode.

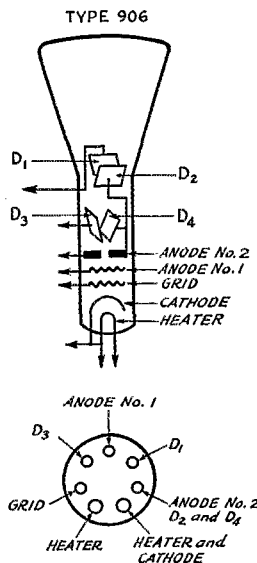

FIG. 1—ARRANGEMENT OF THE ELECTRODES AND BASE CONNECTIONS OF THE TYPE 906 CATHODE-RAY TUBE

SWEEP CIRCUITS

To obtain a useful pattern or wave-form, it is first necessary to move the spot horizontally back and forth across the screen at some convenient frequency and with

some suitable motion with respect to time. This produces a horizontal line of narrow width (equal to the diameter of the spot) in the middle of the screen. The horizontal motion or "sweep" is obtained by applying a suitable a.c. voltage across the deflection plates D_1 and D_2 , which, in operation, are placed vertically (see Fig. 1). For studies

885. The latter is a grid-controlled gaseous-discharge tube of the heater-cathode type designed especially for sweep-circuit service, operating as a relaxation oscillator whose frequency can be controlled within limits by a.c. voltage applied to its grid.

In some applications a linear time base is not

required and the 60-cycle line voltage is sometimes suitable for the horizontal sweep. A transformer having a ratio of about 1:1 is used (T_2 in Fig. 2) to isolate the a.c. line from the horizontal-sweep deflection plates. A Class-B input transformer serves nicely. When S_8 is closed to T_2 , the 885 sweep-circuit is, of course, taken out of operation. A peak voltage of about 150 volts at the secondary of T_2 will usually be adequate.

After a satisfactory sweep has been established, the voltage to be viewed is applied across deflection plates D_3 and D_4 , which are placed horizontally. Thus, the spot is moved not only back and forth, but also up and down. Such movement produces a tracing of the desired waveform of the voltage under inspection. An example is the audio-frequency signal-voltage tracing shown in A. This is the modulating frequency used to obtain the modulated radio-frequency pictures to be discussed later.

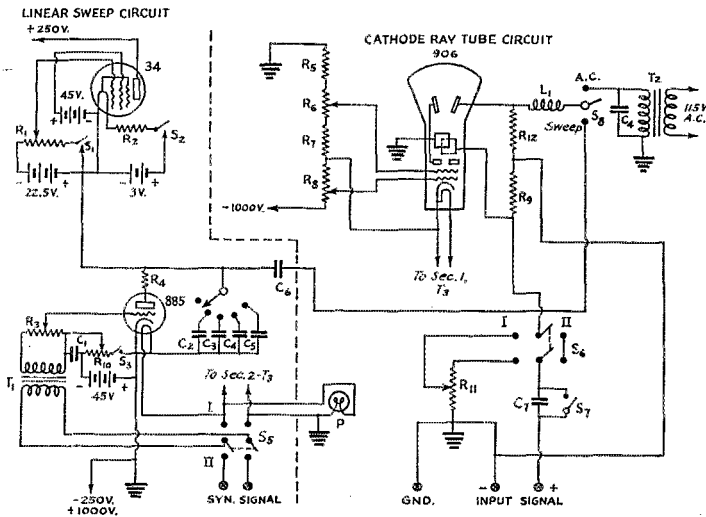

FIG. 2—DIAGRAM OF THE CATHODE-RAY TUBE AND SWEEP CIRCUITS

- R_1, R_{10} —50,000-ohm Centralab potentiometer.
- R_2 —15-ohm 1-watt.
- R_3 —200-ohm Yaxley wire-wound potentiometer.
- R_4 —700-ohm 1-watt.
- R_5, R_{12} —2.0-megohm 1-watt.
- R_6, R_{11} —500,000-ohm Centralab potentiometer.
- R_7 —500,000-ohm 1-watt.
- R_8 —200,000-ohm potentiometer.
- R_9 —10.0-megohm 1-watt.
- C_1 —8.0- μ fd. 450-volt electrolytic condenser.
- C_2 —400- μ fd. fixed mica.
- C_3 —0.001- μ fd. fixed mica.
- C_4 —0.01- μ fd. fixed mica.
- C_5 —0.1- μ fd. 400-volt paper.
- C_6 —0.5- μ fd. 1500-volt paper.
- C_7 —0.5- μ fd. 1500-volt paper.
- S_1, S_2, S_3, S_4 —S.p.s.t. toggle switches.
- S_5 —Yaxley 8-point switch. (Sweep-frequency range control.)
- S_6, S_7 —D.p.d.t. Federal anti-capacity switch.
- S_8 —S.p.d.t. toggle switch.
- T_1 —Line-to-line transformer.
- T_2 —1-to-1 transformer. (See text.)
- L_1 —8-mh. r.f. choke.
- P —2.5 volt pilot light.

of wave-form, a linear time base is generally required; that is, a sweep-circuit wave-form which moves the spot at a constant velocity. Such a wave-form is produced by the sweep-circuit shown in Fig. 2¹ utilizing a Type 34 and a Type

AUXILIARY APPARATUS

A cathode-ray oscillograph requires a power supply and, for convenience and utility, should

¹ Haller, Cecil E., "A Linear Timing Axis for Cathode Oscilloscopes," *Review of Scientific Instruments*, July, 1933.

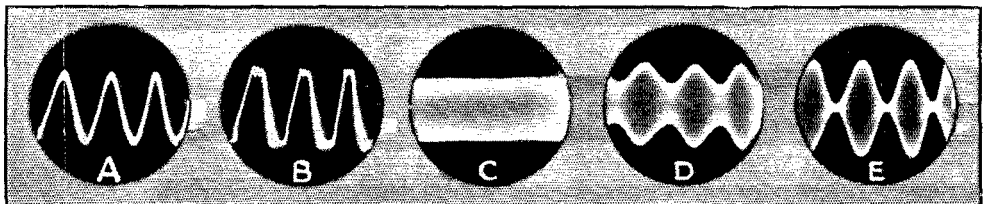

THE OSCILLOGRAMS SHOWN ARE ACTUAL UNRETOUCHED PHOTOGRAPHS MADE WITH THE EQUIPMENT DESCRIBED IN THIS ARTICLE AND PICTURE THE PERFORMANCE OF W2BRO'S 'PHONE TRANSMITTER

A shows the wave form of the 500-cycle modulating signal with the audio stages operating properly while B shows the same audio signal with distortion from over-excitation of the Class-B driver stage. C pictures the unmodulated 14-mc. carrier and D the carrier partly modulated with good wave form. E represents what we all strive for—the carrier properly modulated 100 per cent.

include the linear sweep-circuit. For this particular oscillograph, the necessary 250-volt and the 1000-volt supplies are obtained from the same power transformer by means of the circuit shown in Fig. 3. In addition, the 3-volt, 22.5-volt and 45-volt batteries are necessary, as shown in Fig. 2.

Although a cathode-ray tube requires relatively high voltage, its space current requirements are very small. Therefore, the power supply can be quite simple. No filter choke and almost no bleeder current are necessary (see Fig. 3). A half-wave rectifier using a Type 81 with a 2- to 4- μ fd. filter condenser is adequate. The high-voltage bleeder consists of a 2.0- and a 0.5-megohm fixed resistor in addition to one 500,000- and one 200,000-ohm potentiometer (carbon type). The sweep-circuit supply consists of a Type 80 connected as a half-wave rectifier with a similar type of filter. The voltage output of the 81 is approximately 1000 volts, while the bleeder tap in the 80 circuit is adjusted to give about 250 volts.

The deflection plates are returned to the positive 1000-volt lead, which is grounded for convenience of circuit arrangement. The deflection plates should be connected through 10-megohm resistors as shown in Fig. 2. This arrangement insures that the electron beam is not distorted by d.c. potentials built up by electrons accumulating on the free plates. The negative 1000-volt lead is the one dangerous connection in the cabinet, since the positive lead is grounded to the chassis. However,

since the negative lead is connected only to the potentiometer R_8 , it is possible to use heavily insulated wire and to isolate that connection so that it is practically inaccessible. The heater and the cathode circuits are also at a high negative potential with respect to the cabinet; therefore, these leads should also be protected adequately. In any event, the a.c. line plug should always be disconnected from the oscillograph unit before its lid is removed.

The cathode-ray tube used, the Type 906, is chosen not only because of its low cost and convenient size, but also because it employs electrostatic deflection plates. The electrostatic plates shunted by a very large resistance present an extremely high impedance to most circuits across which they may be connected, with almost negligible disturbing effect on the circuit under observation. While the 906 has a screen only 3 inches in diameter, it has been found that this size is ample for nearly

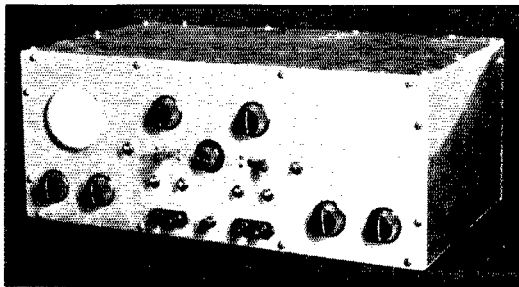

THE VERSATILE CATHODE-RAY OSCILLOGRAPH UNIT IN ITS ALUMINUM CASE

The panel controls, left to right, are identified as follows: Top row, screen end of the 906; signal-voltage-dividing potentiometer, R_{11} ; synchronizing-signal potentiometer for the 885, R_8 .

Second row, signal-voltage series-condenser shorting switch S_1 ; signal-voltage d.p.d.t. anti-capacity switch S_2 ; sweep-circuit shunt-capacity switch S_3 ; synchronizing-signal change-over switch S_4 ; a.c. line switch S_5 .

Third row, grid-bias potentiometer for the 906, R_5 ; Anode No. 1 potentiometer for the 906, R_6 ; filament-battery switch for the 34, S_6 ; sweep-circuit change-over switch S_7 ; bias-potentiometer switch for the 885, S_8 ; bias-potentiometer switch for the 34, S_9 ; bias potentiometer for the 885, R_{10} ; bias potentiometer for the 34, R_1 .

Fourth row, input-signal binding posts; ground or chassis binding post; synchronizing-signal input binding posts.

all amateur applications. The ratings and characteristics of the 906 are as follows:

GENERAL RATINGS

Heater voltage (a.c. or d.c.)	2.5 Volts
Heater current	2.1 Amperes
Direct interelectrode capacitances	
Grid to all other electrodes	10 (max.) μ fd.
Deflecting plate D_1 to deflecting plate D_2	4 (max.) μ fd. (Top Set)
Deflecting plate D_3 to deflecting plate D_4	3 (max.) μ fd. (Bottom Set)

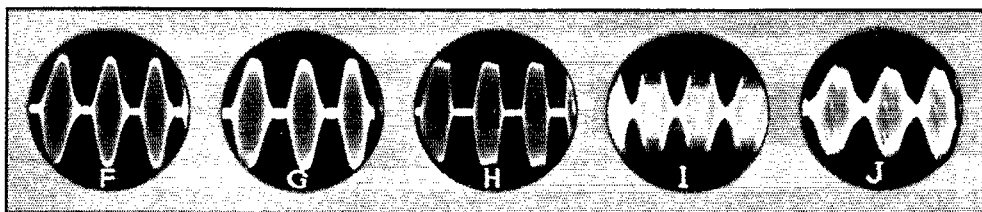

THESE OSCILLOGRAMS ILLUSTRATE COMMON CONDITIONS THAT MAKE A BROAD 'PHONE BROAD

F shows the carrier overmodulated, although with reserve audio power to maintain good wave form on the positive peaks. G was obtained with slight overmodulation but with audio distortion on the positive peaks from overloading. H shows a typically bad combination — heavy overmodulation with overloading causing high a.f. distortion and with insufficient r.f. grid excitation. Inadequate r.f. grid excitation to the modulated stage, indicated by the flattened positive peaks, is further illustrated by I. And J shows what happens when the tank circuit of the modulated stage is detuned from resonance, introducing phase modulation. Every one of the conditions illustrated causes broad signals and needless interference.

Maximum length	11 15/32" \approx 3 7/8"
Maximum diameter	3 1/16"
Bulb	J-24
Base	Medium 7-pin

SWEEP-CIRCUIT OSCILLATOR SERVICE	
Peak plate voltage	200 (max.) volts
Peak plate current	300 (max.) milliamperes
Average plate current	0.5 (max.) milliamperes

AVERAGE CHARACTERISTICS

High voltage electrode (Anode No. 2) voltage	1000 (max.) volts
Focusing electrode (Anode No. 1) voltage	300 (max.) volts
Grid voltage	** Never positive
Grid voltage for current cut-off	-40 (approx.) volts
Fluorescent-screen input power per sq. cm. (average)	10 (max.) milliwatts
Typical operation	
Heater voltage	2.5 volts
High-voltage electrode (Anode No. 2)	600 800 1000 volts
Focusing electrode (Anode No. 1) (approx.)	120 160 200 volts
Grid voltage	* * *
Deflection sensitivity (Plates D_1 and D_2)	0.55 0.41 0.33 mm/volt d.c.
Deflection sensitivity (Plates D_3 and D_4)	0.58 0.44 0.35 mm/volt d.c.

- * Adjusted to give suitable luminous spot.
- ** With approximately 200 volts (to focus) on anode No. 1.

The Type 34 is a 2.0-volt super-control pentode which needs no special discussion, since it is a well-known receiving type. The 885, however, is a new type; its characteristics are as follows:

Heater voltage (a.c. or d.c.)	2.5 volts
Heater current	1.4 amperes
Direct interelectrode capacitances	
Grid to plate	3.5 μ fd.
Grid to cathode	3.5 μ fd.
Plate to cathode	2.5 μ fd.

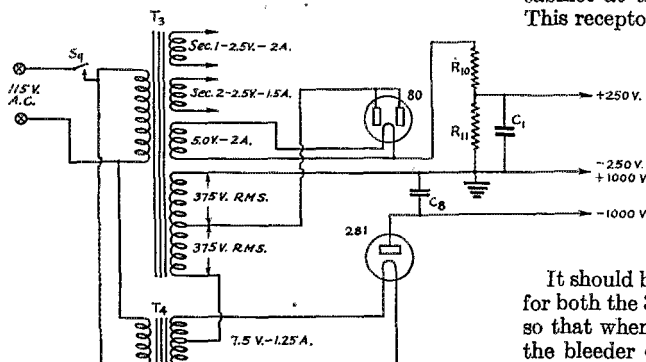

FIG. 3 — CIRCUIT OF THE POWER SUPPLY UNIT. THE TWO SEPARATE HALF-WAVE RECTIFIERS ARE SUPPLIED BY THE ONE TRANSFORMER SECONDARY

- T_3 — Power transformer with windings as indicated.
- T_1 — 7.5-volt filament transformer.
- S_1 — S.p.s.t. toggle switch.
- C_1 — 2- μ fd. 450-volt filter condenser.
- C_2 — 2- μ fd. 1500-volt filter condenser.
- R_{10} — 25,000-ohm-1-watt resistor.
- R_{11} — 50,000-ohm-1-watt resistor.

Tube voltage drop	15 (approx.) volts
Maximum overall length	4 1/4"
Maximum diameter	1 9/16"
Base	Small 5-pin

CONSTRUCTION

The photographs show the general layout of the parts both on the panel and inside the cabinet while Fig. 2 gives the circuit. The aluminum cabinet measures 20 inches by 12 inches by 8 inches high. Any good tin-smith should be able to make a suitable box of either 1/16-inch sheet aluminum or of galvanized iron. If iron is used, it should be free of magnetization which might affect operation of the oscillograph. Except for the cabinet itself, practically all of the other work can be done with the usual tools found on every amateur work-bench.

The individual parts are mounted in the cabinet according to convenience for circuit wiring. Since a sub-base construction is not used, it is rather difficult to conceal much of the wiring. Most of the leads are short, though this detail is not as important as in the case of radio-frequency circuit wiring. The leads from the signal-input binding posts to the anti-capacity switch and to the signal deflection plates are made as directly as possible and are placed apart from other components, because they may carry a radio-frequency signal voltage. Capacity effects on these leads are avoided as much as the arrangement of parts will permit. The a.c. line receptor is in the back of the cabinet at the bottom, near the power supply. This receptor eliminates the necessity of having an a.c. cord dangling in the way when the equipment is not in use.

The layout of the parts can be made with a considerable degree of latitude. Other schemes will undoubtedly present themselves to those who contemplate the construction of an oscillograph. The one shown merely represents an idea of a logical arrangement.

It should be noted that the bias potentiometers for both the 34 and 885 (R_1 and R_{10}) are connected so that when their switches are open (to remove the bleeder drain when the apparatus is not in use), full bias is placed on the two sweep-circuit tubes. It is quite important that the various switches and potentiometers mounted on the panel be of the type which are insulated from their one-hole mounting studs, so that short circuits to the panel are prevented. The circuit is otherwise straightforward and requires no detailed explanation.

OPERATION

When the wiring is completed, all voltages should be checked with a high-resistance voltmeter before the 906 is inserted. Current measurements are not essential. With the 906 in place, switches S_1 and S_2 are closed. With a.c. sweep

voltage applied, S_8 to "A.C.," potentiometers R_9 and R_8 are adjusted to give a narrow, brilliant line which should be near the middle of the screen when everything is working properly. When the tube is operated without sweep voltage, the spot should not be allowed to remain stationary for any length of time. If it is, damage to the screen may result.

Switch S_8 is now thrown to position I and switches S_1 and S_8 are closed; switch S_4 is left on the open contact and potentiometer R_3 is set at approximately center position. Then, with S_8 in the "Sweep" position, potentiometers R_1 and R_{10} are simultaneously adjusted until a narrow horizontal line appears across the entire face of the screen. These operations produce a 60-cycle sweep with a linear time axis, since the oscillations of the 885 are held in step with the 60-cycle line frequency by the small voltage, from secondary 2 of T_3 , which is applied across R_3 through transformer T_1 . The secondary of the latter transformer also furnishes the heater voltage of the 885.

The oscillograph is now ready to have an input signal applied. This brings up the use of condenser C_7 and switch S_7 . When the signal to be viewed is a.c., S_7 may be open or closed. If open, the a.c. passes through C_7 . If a voltage composed of both d.c. and a.c. is to be viewed, however, S_7 is opened. This blocks off the d.c. and prevents an undesirable deflection of the cathode ray, but allows the a.c. component to pass.

The first logical voltage to test is the a.c. line voltage. The line is, therefore, connected to the signal-input posts with S_7 open and S_8 in Position I. This position of S_8 merely places the input voltage across the voltage dividing potentiometer R_{11} , in order to put an r.m.s. voltage on the deflection plates D_3 and D_4 of only 70 or 80 volts instead of the full line voltage of 115 volts, the peak line voltage being 115×1.4 or 161 volts, which will deflect the beam completely off the screen. The maximum deflection-plate peak voltage which the 906 can handle is approximately 100 volts. Then, with switch S_4 moved to C_2 or C_4 , potentiometers R_1 , R_{10} , R_8 and R_3 are adjusted until a satisfactory wave-form is obtained. R_1 and R_{10} should give an adjustment which will hold the picture still and at the same time produce a wave-form with a suitable base-width. Switch S_4 will usually have a "best" setting for different audio frequencies, the lower frequencies requiring a larger capacity at S_4 .

It took only a very few tests to show that the receiver-type potentiometer R_{11} was not especially suited for radio frequencies around 14 megacycles,

because it quickly over-heated. Hence switch S_4 should be kept in Position II (which cuts out R_{11}) when a radio-frequency carrier is being viewed. The amplitude of the carrier can be adjusted by means of coupling to a tuned circuit (a small

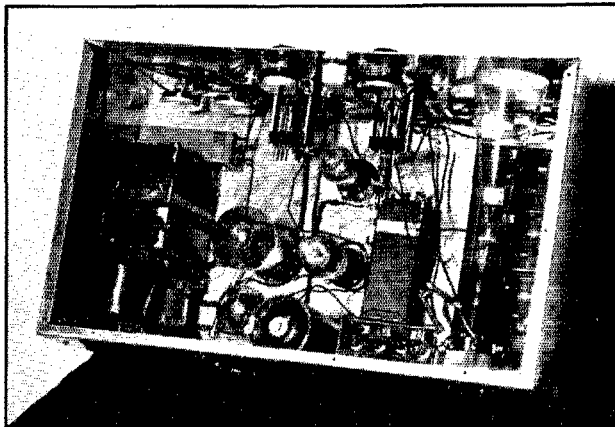

INTERIOR VIEW OF THE UNIT, SHOWING THE TYPE 906 AT THE RIGHT WITH ITS SCREEN END PROJECTING THROUGH THE PANEL

Arrangement of the parts is not especially critical, as explained in the text.

wave-trap will do) connected across the input-signal posts with short leads. A long twisted pair with a two-turn pick-up coil at each end will serve to couple the transmitter output tank to the tuned circuit at the oscillograph.

When checking a modulated carrier it is necessary to throw switch S_8 to Position II and to apply a small amount of audio voltage (one or two volts) from the speech amplifier to the "synchronizing signal" binding posts. This can easily be done with an external 200-ohm-to-grid transformer, the 200-ohm winding being connected to the oscillograph and the high-impedance grid winding being placed in parallel with the plate load impedance of one of the low-level speech amplifier stages. Thus the horizontal sweep is essentially in proper phase relationship with the audio modulation on the carrier. With tone modulation a picture such as that shown in *D* and *E* should result.

To obtain a trapezoidal shape, such as that shown in Fig. 4, switch S_8 is left open and a peak audio voltage of about 40 to 60 volts is applied across R_{12} . This gives a horizontal sweep voltage of the same form and frequency as that modulating the carrier. The trapezoid resulting has a minimum amplitude ($H_{min.}$) proportional to the lowest voltage reached by the modulated r.f. carrier and a maximum amplitude ($H_{max.}$) proportional to the peak carrier voltage. A perfectly modulated carrier (100%) will produce a close representation of an isosceles triangle, the point of the middle apex being approximately equal to

the diameter of the moving spot. A well-modulated carrier modulated less than 100% will give the trapezoid in its more usual form (with "flat" ends). The percentage of modulation is expressed by

$$\frac{H_{max.} - H_{min.}}{H_{max.} + H_{min.}} \times 100,$$

where $H_{max.}$ and $H_{min.}$ are the larger and smaller vertical deflections, respectively.

CHECKING THE 'PHONE TRANSMITTER

With a cathode-ray oscillograph at hand, the first thing an amateur 'phone operator would naturally do is to look at the output of his transmitter. The pictures shown in Fig. 4 and various wave shapes from *E* to *J* show the modulated carrier of W2BRO under different conditions of adjustment. It must be emphasized that a dummy antenna is demanded for such testing. Unnecessary QRM must be prevented.

A modulating signal in the normal audio-frequency range is desirable. If no other signal source of known wave-form is available, 60-cycle voltage from the line may be used for the speech amplifier signal input through a step-down transformer.

A and *B* show the audio signal taken from the input to the 800 Class-B modulators (the transmitter is that described in the December and January issues of *QST*). *A* shows a good wave-form with a proper setting of the gain control. *B* shows the signal with the gain control advanced too far. The flat-topped, distorted wave is attributable to the 2A3 tubes being driven to draw grid current. With a speech amplifier output like *B*, good quality on the carrier could hardly be expected!

C shows the unmodulated carrier. It appears as a solid green band across the screen, the 14,000,000-cycle frequency at which the spot is being deflected up and down being too high to show individual cycles. The width of the band is controlled by the r.f. input coupling.

D and *E* show a partially-modulated and a 100-percent modulated carrier of good audio wave-form. When his carrier looks like *E* an amateur does not have to worry about his quality reports (and when an oscillograph is a part of his station equipment, he does not have to ask anyone how his modulation or quality is). *F* shows an overmodulated carrier with sufficient audio reserve to retain good wave-form on the positive peaks. This type of overmodulation indicates excessive audio input and improper operating conditions for the modulated r.f. amplifier. *G* shows slight overmodulation with some a.f. distortion on peaks.

H shows a heavily overmodulated carrier with high a.f. distortion, an insufficient amount of reserve audio power, and/or inadequate grid excitation. That is, although heavy overmodulation is indicated on the negative audio peaks by the cut-off characteristic, the positive audio peaks do not rise to the expected amplitude, but flatten off badly. *I* shows the ragged peaks and poor wave-form which result when the grid excitation to the final r.f. amplifier is inadequate.

This picture represents the carrier when the two 800's in the r.f. power amplifier had their d.c. grid current reduced to as low as 5 to 10 ma. per tube. *J* was taken with the plate tank of the final amplifier considerably detuned from resonance and shows the distortion resulting from mis-tuning of a circuit handling modulated r.f.

Only two or three of a multitude of uses for the cathode-ray oscillograph have been described. A few other practical uses which it has are the study of transient wave forms, the tracing of vacuum tube characteristics, the measurement of peak voltages, the study of phase relationships, the lining up and wave-form adjustment of intermediate-frequency amplifier stages in superhets, the comparison of different

frequencies, and the checking of audio-transformer quality.

Perhaps some day an oscillograph will be a standard item in as many amateur stations as the simple monitor is to-day. In the interest of better results and the further advancement of amateur radio, let's hope so!

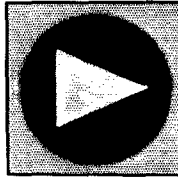

FIG. 4 — THE MODULATED WAVE GIVES A TRAPEZOIDAL FIGURE WHEN A.C. FROM THE SAME SOURCE AS THE MODULATING SIGNAL IS SUBSTITUTED FOR THE LINEAR SWEEP

Its interpretation is given in the text.

Strays

Many Overlooked the Index

Prior to 1933 *QST* yearly index was inserted loosely in each December issue of *QST*. The 1933 yearly index was stitched into the December 1933 issue as pages 97-100 inclusive. Many members failed to note this change in annual procedure.

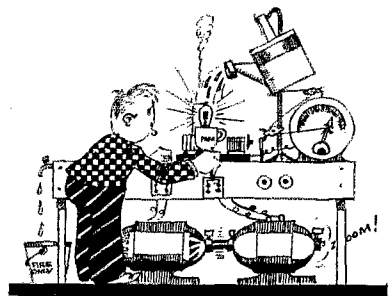

Suppressor-Grid Modulation

Its Application to Low-Power 'Phone and Future Possibilities

By James J. Lamb, Technical Editor

UNDER the head, "Methods of Modulation," in Chapter Eight of the latest *Radio Amateur's Handbook*, mention is made of suppressor-grid modulation with the comment that its application to amateur transmission was hardly practicable because of the lack of suitable pentode-type screen-grid power tubes. At the time we prepared this chapter the utilization of the system did seem little more than something to hope for in the remote future. But experiments that have engaged us more recently convince us first, that at least one type of tube now available, although not ideally suited, is practical for low-power transmission with this system; and, second, that the merits of the pentode-type screen-grid power tube with the suppressor-grid connection brought out to an accessible terminal warrant its production not only for this system of modulation but for general transmitter use as well. We have given this suggestion to tube manufacturers and it is not unlikely that types in the intermediate 50-watt range will become available within the year.

As the name suggests, the modulating signal is applied to the suppressor grid of a tube in the modulated r.f. stage, this tube being a pentode containing also a screen-grid in addition to the cathode, control grid and plate, the suppressor grid being between the screen grid and the plate. This type of modulation is not original, by any means, but the specific method of using the suppressor as a control element to get wide-range linear modulation is a recent development.¹

Now we confess, frankly, that we are not addicted to congenital enthusiasm over every "new" system of modulation. We have grown to be quite hard-boiled on the subject, in fact, and habitually view with skepticism each of the inevitable "new" circuits in the seemingly never-ending stream. As far as *QST* is concerned, to get to first base any modulation system must be able to answer "yes" to these questions:

1. Is it *inherently* capable of giving complete or nearly complete modulation *without distortion*?
2. Will it work with reasonable efficiency and make reasonably economical use of the gear and tubes practicable in an amateur 'phone transmitter?

¹ J. C. W. Drabble, "High-Power Pentode as an Electron-Coupled Transmitter," *Wireless Engineer & Experimental Wireless*, Dec., 1933. This article describes experiments with a special 4-kw. input pentode-type screen-grid tube used as an electron-coupled oscillator.

3. Is it free of trickiness and can it be adjusted for known proper operation by given rules?

Most "new" circuits fall down on the first question; they are prone to be innate distorters and generators of spurious radio frequencies that make needless interference. This is especially characteristic of arrangements that claim to give something for nothing. Others fail to answer satisfactorily the second question, usually in tube

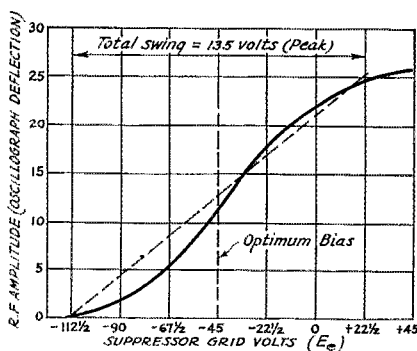

FIG. 1—A NON-LINEAR CHARACTERISTIC RESULTED WITH SUPPRESSOR-GRID MODULATION OF THE UN-NEUTRALIZED DOUBLER STAGE OF THE UNIVERSAL EXCITER UNIT DESCRIBED IN OCT., 1933, *QST*

This run was made with plate voltage of 350 and screen voltage of 125 volts.

requirements that are all out of line with the output they will give. Still others give a disappointing answer to the third question; their adjustment, as far as the amateur is concerned, must be a business of "by guess and by gosh."

First place on all counts has been held, with a fair margin, by high-level plate power modulation in its various forms, including Class-B. Second place goes to grid-bias modulation. Third place—well, there seems to be none to fill it, as far as amateur radio is concerned (and broadcasting too, for that matter). Therefore it appears that any other system must stand or fall in comparison with these two. Plate-power and grid-bias modulation are the established competition. We shall see how suppressor-grid modulation stacks up with them.

TESTING THE SYSTEM

In usual applications of pentode tubes, both of the audio power types (47, 2A5, etc.) and of the r.f. amplifier types (57, 58, etc.), the suppressor

serves primarily to prevent secondary emission from the plate and is connected directly to the cathode. In most audio-power tubes this connection is made within the tube, while in most screen-grid r.f. types there is an accessible base connection for the suppressor. Surveying the variety of available types having the external connection, we find that the most capable appearing tube is, again, the ever-adaptable Type 59. Even though it has less effective screening than the r.f. pentodes, its greater power ability makes it the choice for transmitter use.

Having decided on the tube, the next step is to rig the circuit. In our first trial this was a com-

volts negative, dry B-batteries being used to obtain the variable voltage in 22.5-volt steps. The r.f. amplitude was measured on the screen of a Type 905 cathode-ray oscillograph with a pair of dividers and a ruler. The solid line shows the actual suppressor-voltage—r.f. characteristic and the broken line indicates the ideal linear characteristic that would be desirable for modulation with the suppressor biased 45 volts negative and with a modulating voltage peak of approximately 67.5 volts (a total swing of 135 volts, from 22.5 volts positive to 112.5 volts negative). As is evident, the portion of the characteristic useful for modulation purposes is largely in the negative region, calling for a mean negative bias.

Despite the non-linearity of this particular characteristic, the wave-form of the envelope with tone modulation appeared to be quite good when viewed on the oscillograph screen, suggesting that inspection of the modulation envelope by means of the cathode-ray tube should serve as an approximate qualitative check rather than as a final quantitative measure of distortion.

Suspecting that regeneration in the unneutralized doubler might be responsible for the wobble in the curve, a neutralized stage to operate as a "straight" amplifier was hurriedly assembled on a breadboard, the circuit being that shown in Fig. 2. The Tri-tet oscillator unit described by George Grammer elsewhere in this issue was used as an oscillator-doubler to excite the pentode amplifier. After neutralization, with the handy cathode-ray tube serving as the r.f. indicator, the output was coupled to a dummy antenna and a number of tests were made with different degrees of loading, with various plate and screen voltages, with grid-leak and combination leak-cathode bias and with varied r.f. excitation.

A decided improvement over the first arrangement was immediately apparent, as shown by Fig. 3, the r.f. output varying linearly between nearly cut-off negative voltage and slightly positive voltage. It was found that the linearity was unaffected by r.f. excitation voltage and control-grid bias variation between relatively wide limits and was but slightly affected by changes in load impedance. Needless to say, these operating features, evidencing tolerance in grid excitation, control-grid bias and load-impedance values, are especially desirable in the amateur transmitter. The all-important output power developed to be about what would be expected from an equivalent stage operating as a Class-B linear amplifier and somewhat higher than could be realized with more critical grid-bias modulation of a comparable stage operating at the same plate voltage.

The peak output for a given d.c. plate voltage is about the same as the carrier output would be

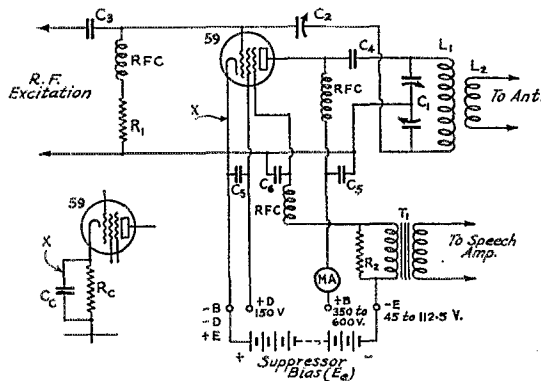

FIG. 2—CIRCUIT OF THE NEUTRALIZED SUPPRESSOR-GRID MODULATED R.F. AMPLIFIER

- L_1 , L_2 and C_1 —As usual for the frequency.
- C_2 —Neutralizing condenser, approx. 5- μ fd. maximum for 1 or 2 tubes. Two $\frac{3}{4}$ -inch diameter brass plates with adjustable spacing.
- C_3 —100- μ fd. input coupling condenser.
- C_4 —500- μ fd. plate blocking condenser.
- C_5 —0.01 screen and plate by-passes.
- C_6 —0.001- μ fd. suppressor by-pass. Should not be large enough to by-pass audio.
- C_7 —1- μ fd. cathode by-pass (if R_c is used).
- R_1 —50,000-ohm 1-watt grid leak.
- R_2 —Audio load resistor. See Text.
- R_3 —1000-ohm 2-watt cathode resistor (if used).
- T_1 —Audio coupling transformer. See text.
- RFC—2.5-mh. r.f. chokes.
- MA—0.50 or 0.100 d.c. milliammeter.

Plate supply (E_b) and screen supply (E_s) can be from same power pack. Suppressor-grid bias (E_s) can be from small "B" batteries or a separate power pack.

paratively simple matter. With the original universal exciter unit ² at hand, only a few minutes' unsoldering and re-soldering of connections of the doubler circuit was required—and it was ready to go. Specifically, the suppressor (No. 3 grid) was disconnected from the screen (No. 2 grid), by-passed to ground with a 0.001- μ fd. condenser and connected to a binding-post terminal through a small r.f. choke. The control voltage for the suppressor grid was applied between this terminal and the common ground (negative B).

The curve of Fig. 1 shows the variation in r.f. output that resulted with variation of suppressor-grid voltage between 45 volts positive and 112.5

² QST, Oct., 1933.

with an equivalent amplifier operating Class-C with plate-power modulation. But the modulator required for suppressor-grid modulation can be of much lower power capability than the plate modulator that would give this four-fold increase in power output; and the d.c. plate voltage can be safely raised to a much higher value than would be allowable on the same tube with plate modulation. In fact, by raising the plate voltage the output of the suppressor-grid modulated stage might approach that which the same stage would give when safely operated with plate modulation. That is, the safe d.c. plate voltage with suppressor modulation may be twice the safe plate voltage with plate modulation, since the peak voltage with 100-percent plate modulation is *twice* the mean or d.c. voltage, while the peak plate voltage on the suppressor-modulated stage is the d.c. supply voltage.

CIRCUIT DETAILS AND PRACTICAL OPERATION

Following the preliminary investigation in which r.f. output was measured over a range of suppressor voltage obtained from batteries, tone modulation was applied with various values of fixed negative bias on the suppressor grid and the form of the modulated wave was observed on the cathode-ray oscillograph screen. The modulator used was the push-pull Type 45 driver stage of a Class-B audio unit that was conveniently at hand, the Class-B input transformer in the plate circuit of the 45's serving as the coupling to the suppressor-grid circuit.

With the output of the audio stage unloaded except for the suppressor circuit, distortion was evident with voltage swings into the positive region, irrespective of the suppressor negative bias. Measurement of the suppressor current showed that this circuit drew a small direct current at positive suppressor voltages, as would be expected, and showed also *that there was a reversal of suppressor current in the vicinity of zero voltage.* There was no current flow with negative suppressor voltage. In a typical case, the positive suppressor current (electron flow from suppressor to cathode in the external circuit) became nearly 1 ma. at maximum positive voltage of 45 or so; and the negative current (electron flow from cathode to suppressor in the external circuit) reached 20 microamperes at zero suppressor voltage. This indicates negative resistance.

Now with a low-resistance transformer secondary in the suppressor circuit this negative resistance might cause oscillation over a small portion of the audio cycle, as also has been noted in connection with Class-B audio amplifiers,² and might account for the distortion that was

observed. Loading of the coupling transformer with a suitable resistor (R_2 in Fig. 2) prevents this "negative-load" oscillation and also stabilizes the load on the audio amplifier between the no-load condition of negative suppressor voltage and the positive load condition of positive suppressor voltage. The value of the load resistance will depend on the modulator tube and impedance ratio of the coupling device, of course, 4000 or 5000 ohms being generally satisfactory with 1-to-1

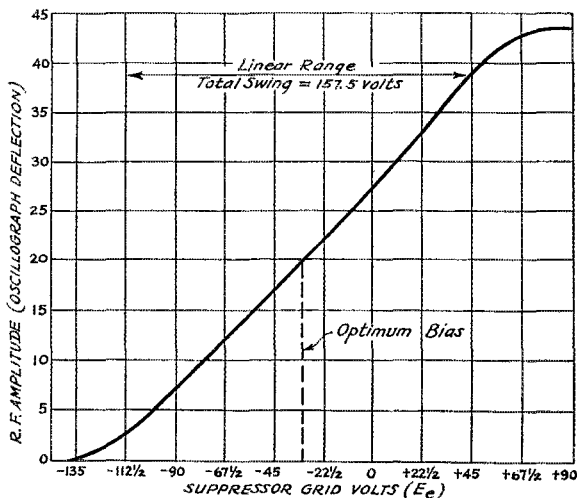

FIG. 3—TYPICAL MODULATION CHARACTERISTIC OF THE NEUTRALIZED AMPLIFIER, SHOWING GOOD LINEARITY

This particular run was made with plate voltage of 350 and screen voltage of 150 volts, and with grid-leak bias.

coupling to Type 45 and other power tubes.

With the audio distortion eliminated, the modulated r.f. wave form confirmed the linearity observed in the "step-by-step" suppressor-grid variation shown in Fig. 3. The d.c. plate current remained constant with modulation over this range, as did the linear-detector rectified current of a superhet receiver used for monitoring.

TRANSMITTER SUGGESTIONS

A recommended circuit arrangement of a suppressor-grid modulated stage for a small transmitter is that shown in Fig. 2, which can be used for a single tube or, for greater power output, for two tubes in parallel. By modifying the circuit suitably, two tubes in push-pull could be used, with their suppressors connected in parallel. Although plate voltages as high as 1000 (!) were used in the experiments, it is recommended that not over 700 volts be used for normal transmitter operation. *In no case should the screen voltage exceed 150 volts*, which seems to be universally the limit with Type 59 tubes. At higher voltages the screen gets too hot and away goes the plate current, even at moderate plate voltage.

It also appears that the *peak* plate current

² A. A. Collins, *QST*, May, 1933.

should not be much higher than 40 ma. per tube, which means that the d.c. plate current for modulated operation should be kept down to 20 or 25 ma. (40 to 50 ma. for two tubes). At higher plate currents, even with proportionately higher plate voltage and suppressor-grid bias, distortion of the modulation envelope results.

The optimum suppressor-grid negative bias voltage runs approximately 15 per cent of the plate voltage value, at least for plate voltages in the range 350 to 700 volts. This bias is not especially critical, although it should be sufficiently negative to insure linear modulation. A good method of determining its value is to read the values of antenna current and plate current for zero suppressor bias (suppressor bias tap connected to negative B), and then to vary the bias negatively until these current values are halved, with plate voltage kept constant. In no case should the attempt be made to modulate with zero bias or very small negative bias. The amplifier just won't take it. It may be a temptation to operate with bias giving the higher carrier current, but the effective r.f. output represented by sideband power will be disproportionately reduced and the distortion will be terrible.

As with any other proper system, the d.c. plate current should remain constant with modulation. "Kicks" show that there is carrier shift (overmodulation) and consequent distortion. Reduce the audio input by backing off on the gain control. The plate current won't rise indefinitely, as with overmodulation of a Class-C stage using plate modulation, but will jump just perceptibly. But don't let it take these jumps, inconsequential as they may appear.

Since the modulator power requirements with this system are relatively small, it might seem that almost any kind of audio amplifier giving sufficient voltage swing might be used for the purpose. As has been pointed out, however, there are variations in the modulator load circuit conditions from slightly below zero to positive suppressor voltage and some fixed loading of the modulator output is necessary if this region of the characteristic is to be used. To be on the conservative side, therefore, a loaded power-type modulator such as a 45 is suggested, although a single 56 working into a 50,000-ohm load or a pair of them in parallel working into a load of 25,000 ohms might work out satisfactorily. As an alternative to the transformer coupling shown in Fig. 2, impedance coupling or even impedance-resistance coupling might be used. The minimum permissible modulator equipment is still to be determined.

TYPICAL PERFORMANCE

What should be expected in the way of performance from a typical amplifier using this system of modulation? Well, using a single 59 in the suppressor-modulated stage, with another 59 in

the unit described by George Grammer in this issue serving as the r.f. exciter, the carrier output to a dummy load was approximately 3 watts for a plate voltage of 600, screen voltage of 150, suppressor negative bias of -112.5 volts, and plate current of 20 ma., the average plate input being 12 watts. As nearly as could be determined by inspection of the wave-form of the modulated output on the screen of the cathode-ray oscillograph, there was no noticeable distortion with practically complete modulation. And there certainly was none detectible in listening tests using the monitoring receiver. The speech quality was decidedly good. The above figure for carrier power output may seem rather small; but don't be surprised at what one or two of these tubes will actually accomplish in low-power 'phone working.

Another application of present tubes worth considering is the use of this system of modulation in the simple modulated test oscillator using a pentode-type screen-grid tube in an electron-coupled circuit.

Performance observed in these preliminary tests indicates that the suppressor-grid system is somewhere between grid-bias and plate-power modulation in point of efficiency and ratio of power output to tube rating. Like plate modulation and unlike grid-bias modulation, it is tolerant of circuit conditions, particularly control-grid bias and r.f. excitation. On the other hand, it has the desirable feature of requiring relatively small modulating power which serves to justify present systems of grid-bias modulation.

Although this application alone would seem to justify the development of pentode-type screen-grid power tubes, there are other applications that also would benefit from their availability. For instance, full-range simple plate power modulation should become practicable with the suppressor eliminating the dynatron kink in the plate characteristic which now makes such modulation impracticable. Also, the suppressor should prove to be a convenient control element for varying transmitter power output and telegraph keying.

It must be realized that the full potentialities of the system are hardly indicated by what a 59 or two can do. This tube is really a make-shift for the job, used because there happens to be nothing better available. But this condition may not be a handicap for long. If our suggestions to tube manufacturers are as fruitful in this instance as they proved to be in the case of the new 50-watt type tubes, we should have some real pentode-type screen-grid power tubes in the not too distant future. In the meantime, Don Mix is giving his best licks to a complete low-power transmitter using this system of modulation and designed to do the most for the fellow with a small pocketbook. Watch for its description in *QST*.

H A M D O M



FROM mile-high Denver in 1930 came Russell J. Andrews, W9AAB-W9ZZX, to represent the Rocky Mountain Division on the Board of Directors of the A.R.R.L. He is one of the old-timers, although amateur activity was curtailed from 1911 to 1920 while he travelled in domestic

and foreign territory for a large automobile manufacturer, whom he joined from Lehigh University, following a course at Nazareth Hall. Automotive work has been his business, with the exception of five years in radio manufacturing in the early '20's. His main hobby is still trying to get some of



Uncle Sam's gold—new silver dollars notwithstanding. The balance of his time is consumed by amateur radio, hunting, camping, and photography, not counting the idle moments spent trying to squeeze more miles out of a gallon of gas.

ANOTHER member of the "twenty year" club is Bob Eubank, W3AAJ, of Richmond, down in ol' Vuhjanny. It was back in 1914 when he started, with the coherer-spark-coil-Duck-catalog combination. When the Navy pulled his antenna down three years thereafter he concluded the only way to keep up with wireless was to join the Navy, so he went through Harvard naval radio school, and thence to NAJ, NAD, NAB, NAJX. His commercial "first" was issued by R. Y. Cadmus in Baltimore in 1923; since then he's been a commercial broadcast op, first with WMAS, then at WBBL, and now as chief operator of WRVA, all of Richmond. His first amateur call was 3CEB, but it was as 3AAJ that he became successively ORS, RM and finally SCM, organized the Virginia Net and published the Virginia Ham News, with the presidency of the Richmond club and a commission as Lieutenant (jg) in the U.S.N.R. among his laurels. Hunting is his outdoor hobby, ham radio the indoor—and he spends most of his time indoors!



TECHNICAL radio's highest honor—the presidency of the Institute of Radio Engineers—has been bestowed this year on C. M. Jansky, Jr., consulting radio engineer of Washington, formerly director of the Dakota Division of the A.R.R.L. Prof. Jansky first achieved prominence in amateur radio at the

University of Wisconsin, initially as student and later as instructor, before 1920. In that year he accepted a call to the University of Minnesota, where as instructor of electrical engineering he was in charge of 9XI for eight years. This famous old station had as many as eighteen operators on

its staff at one time. In 1928 he left Minnesota to serve as engineering consultant; in 1930 he organized Jansky & Bailey, in Washington. The firm specializes in broadcast coverage surveys; it was Prof. Jansky who devised the formula now used in indicating listener coverage. Radio engineering is his hobby as well as his profession. His chief delight is tinkering away in a well-equipped workshop in the basement of his home in Chevy Chase—still the amateur experimenter at heart.



AMATEUR extraordinary is C. Lee Herron, Minnesota amateur golf champion of 1933, several times entrant in the National Amateur

Golf championship tournaments, and a radio amateur since 1916. His national reputation as a golfer was largely achieved by his winning the Minnesota open championship in 1932. At the present time, you'll find him playing in most of the important amateur matches, both national and local. In the intervening intervals, you'll find him operating his xtal station W9DWU on the 7 mc. band.



There are numerous radio amateurs outstanding in the world of sport, as well as in other fields. We want to present these interesting figures in "Hamdom." Your suggestions and contributions in this direction will be much appreciated.

Tuned R.F. for the Beginner's Receiver

Improving Sensitivity and Selectivity with a Simple Amplifier Unit

By Don H. Mix, WITS*

THAT the several versions of the simple battery-operated receiver described in the three editions of *How To Become A Radio Amateur* are extremely popular with the beginner is proved by the fact that, with it, hundreds have enjoyed their initial thrill in the great ham game. Extreme constructional simplicity combined with very low initial cost and thoroughly practical and almost certain performance are its attractions for one taking his first steps into a new and somewhat complicated field.

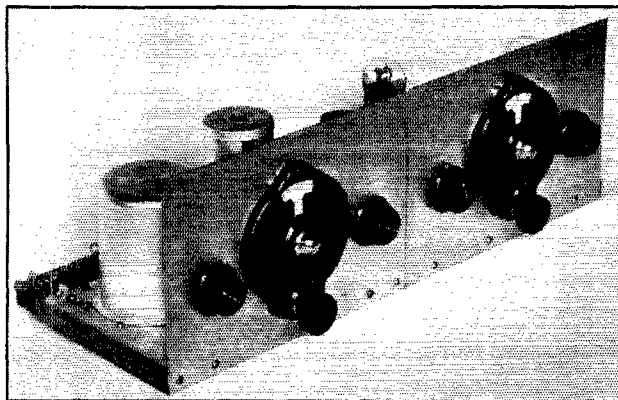

THE TWO UNITS AS THEY LINE UP WITH COIL AND TUBE SHIELDS IN PLACE

Eventually, however, the progressive beginner starts to wonder what and how he may add to this receiver to secure more sensitivity. This is especially true in these days of a.c. receiver "wallop" and the recent trends towards detector stability and the necessity for increased selectivity.

Now it is usually thought that a stage of tuned r.f. amplification may not be added to an open breadboard receiver of this type without complete rebuilding of the existing detector unit into a thoroughly shielded form. As a result of this idea, the fellow looking for some sort of improvement turns to adding stages of audio am-

plification which serve only to raise the level of the general "hash" with little or no real improvement in performance. As has been pointed out before¹ pre-detector amplifiers are desirable from other considerations than that of raising the signal level, not the least of which is to provide a means of controlling the input to the detector to prevent pulling and blocking on strong signals. With the question of the feasibility of adding an r.f. amplifier to a receiver of this type in mind, such an amplifier was made up. We will admit that we entertained no great hope of obtaining results which might be termed startling, but decided it would be worth the attempt even if we found detector isolation from the antenna as the only gain. We were, however, rather unexpectedly surprised when we found a real gain in "wallop" along with a respectable improvement in selectivity—with no serious amount of interlocking between detector and r.f. circuit tuning. That an r.f. amplifier will often eliminate the annoying a.c. hum from near-by power circuits so often encountered with the simple regenerative detector has proved to be especially true

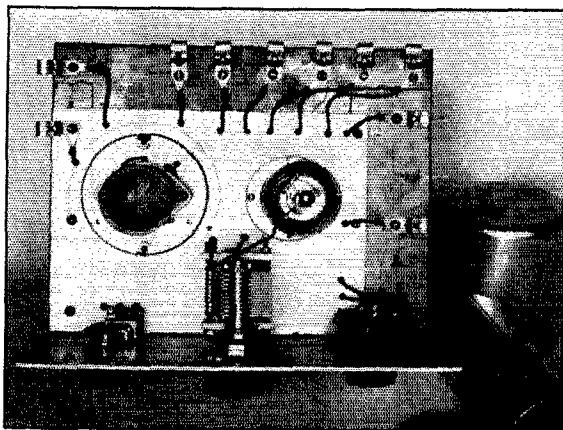

PLAN VIEW OF THE AMPLIFIER UNIT

The terminals from left to right in clockwise direction are as follow: Ground and -B; Antenna; +67.5; +135; -22.5; -A Detector; -A and +C; +A; to antenna terminal of detector unit; to ground terminal of detector unit.

*A.R.R.L. Technical Information Service.

¹"Rationalizing the Autodyne." George Grammer, Jan. 1933, *QST*. Also Chapter Five, *The Radio Amateur's Handbook*.

in this case. For anyone who is using this type of receiver, it is well worth the few hours and few parts necessary to construct the r.f. amplifier.

CIRCUIT DETAILS

Fig. 1 shows the circuit of the r.f. amplifier in combination with that of the beginner's receiver described in the latest (third) edition of *How To Become a Radio Amateur*. It will be seen that no changes have been made in the original circuit. The r.f. portion follows the conventional circuit for such an amplifier with the exception that parallel plate feed through an r.f. choke is used. This was necessary so that the 5-prong detector coil forms might still be used. The advantages of the r.f. gain control have been pointed out in previous articles¹ and need not be repeated here. Since a filament type tube must be used and the filaments of the detector unit tubes are grounded, it was necessary to use the blocking condenser C_4 so that the tuning condenser might be mounted

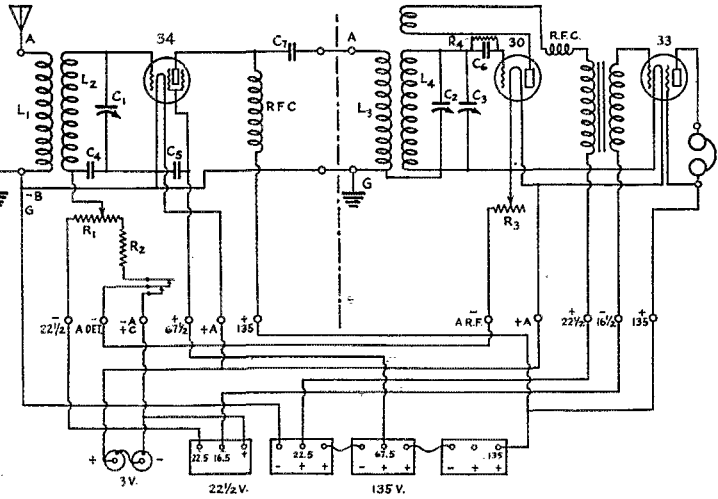

FIG. 1—THE PORTION OF THE CIRCUIT TO THE RIGHT OF THE BROKEN LINE IS THAT OF THE BEGINNER'S RECEIVER DESCRIBED IN THE THIRD EDITION OF "HOW TO BECOME A RADIO AMATEUR"

The portion to the left shows the circuit of the r.f. amplifier unit.

L_1, L_2, L_3, L_4 —See table.

C_1 —100- μ fd. midget—National ST-100.

C_2, C_3 —Two-section midget condenser, 100 μ fd. and 20 μ fd. Hammarlund MC-120-B.

C_4, C_5 —0.005 μ fd. mica condenser—Aerovox.

C_6 —100- μ fd. mica condenser—Dubilier type 3 with lugs

C_7 —0.01- μ fd. mica condenser—Sungamo-Illini.

R_1 —50,000-ohm potentiometer—Frost.

R_2 —5,000 to 10,000-ohm fixed resistor—IRC.

R_3 —10-ohm rheostat—Yaxley C-10-R.

R_4 —2 Megohms.

SW—Double contact switch—Yaxley type 740.

RFC—National Type 100 r.f. chokes.

Coiling Winding Data

Frequency Range	L_1	L_2	L_3	L_4
1000-2200 kc.	10	77	30	70
2250-4200 kc.	10	33	20	30
4200-9000 kc.	5	13	9	11
9000-18,000 kc.	5	5	5	5

All coils except L_1 wound with No. 30 d.s.c. wire. L_1 wound with No. 36 d.s.c. wire.

on the metal panel without short-circuiting the biasing battery. The rather peculiar filament wiring permits the A-battery switch to cut off all three filaments and also to connect the r.f. tube in series with the detector unit rheostat. The Type 34 variable- μ pentode was chosen because it is especially effective in circuits using the variable-bias method of gain control. It is the 2-volt d.c. version of the a.c. Type 58.

The photographs show the general construction. The aluminum panel, which is the same size as that used for the detector unit ($9\frac{1}{8}$ by $6\frac{1}{2}$ inches in this particular case), is laid out so as to accommodate the exact dial and knob arrangement used in the original receiver. Likewise, the base dimensions are the same ($9\frac{1}{8}$ by $7\frac{1}{8}$ inches). This identity of dimensions makes it possible to combine the two units easily and attractively as a complete receiver. Wooden cleats extending the entire length of both units may be fastened by a

few screws to the under side of both bases, making a single solid unit. The metal portion of the r.f. base is of 1/16-inch aluminum $5\frac{1}{2}$ by 7 inches.

On this are mounted the coil socket with its shield can and the socket for the Type 34 tube. A round hole is cut in the base to allow the tube socket to be mounted beneath the base so that a tube shield may be used. The coil shield used in this particular model is a National Type B30 and the tube shield is a National Type TS. Other shields of appropriate dimensions may be used, of course. To keep the losses within reason, the coil shield should not be much smaller than 3 inches in diameter and $3\frac{1}{2}$ inches high. It should also be of a type the top of which may be readily removed for change of coils and which, at the same time, has an overlapping flange joint between the can and base capable of maintaining a good contact. The coil socket used in this receiver is a National 4-prong and the tube socket a National 5-prong. The coil socket should be mounted with suitable spacers between the socket and shield base.

The right-hand knob is the r.f. gain control, the other for the double-circuit type switch which

serves to turn the filaments on and off, removing the r.f. gain control from the biasing battery at the same time.

The resistor R_2 is for the purpose of limiting the minimum bias on the control grid of the r.f. amplifier tube. It may be omitted entirely if a

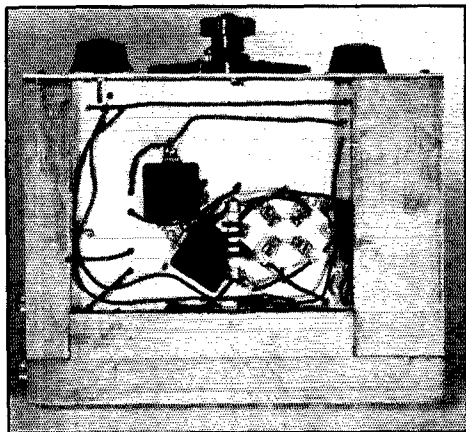

UNDERNEATH THE BASE

The fixed condenser to the left is C_4 . Immediately below is C_5 , and C_7 may be seen at the extreme right hand edge of the tube socket.

plate voltage of 90 or 45 volts is used, but should be used with plate voltages over 90.

SUB-BASE WIRING

The photograph of the under side shows the sub-base wiring and also the manner in which the wooden frame for mounting the metal base is cut out. In this case, the frame was made of three separate pieces of wood, the wide strips being 2 inches in width and the narrow one inch wide. The three strips are assembled by means of wood screws. It would be easier perhaps to make the frame from one piece of wood $9\frac{1}{8}$ by $7\frac{1}{8}$ inches and to cut an opening $6\frac{1}{8}$ by $5\frac{1}{8}$ inches. The panel and aluminum base are fastened to the frame by means of small wood screws. A space of about $\frac{1}{16}$ -inch is left between the panel and the metal base, and the two are connected together by means of a short piece of wire. This method removes the possibility of noise resulting from imperfect contact between the two. The wide strips serve as a means for mounting and insulating the various terminals. All wiring is done with semi-flexible "push-back" insulated wire. All circuit elements which should be grounded are connected to a common ground point by wire, eliminating the uncertainty of paths through the metal shielding.

The screen by-pass condenser and the grid circuit blocking condenser are mounted by means of one of the screws which hold the shield base in place. The r.f. feed condenser C_7 is mounted on its

edge near one side of the sub-base opening. We happened to have one of the small Sangamo-Illini type on hand and used it, since it fits nicely into the small space between the tube socket and the frame. If one of the larger type mica condensers is used, it may be necessary to mount it differently. The value of this capacity is not at all critical providing it is large enough since the coupling coil L_2 determines the degree of coupling between the amplifier and detector. Almost any value, 100 $\mu\text{mfd.}$ or larger, should be satisfactory. The National r.f. choke is connected to the plate terminal of the tube socket. It would be a good idea to wrap tape or a small piece of cardboard fastened with a couple of rubber bands around the choke to circumvent the possibility of the winding or terminals short-circuiting to ground. Looking at the top of the coil socket with the two large holes toward the observer, the left-hand small prong is connected to ground, the right-hand small prong to antenna, the left-hand large prong to the tuning condenser stator and the tube control grid, and the right-hand large prong to one side of C_4 and to the arm of R_1 .

Fahnestock clips are used as terminals and are fastened to the wooden strips by small screws similar to those of the original receiver. The battery connections as well as the connections between the two units are shown in the circuit diagram. It should be noted that the negative B-battery connection is made to the ground terminal in preference to connecting it directly to negative "A" battery externally. This connection is quite important to prevent burning out the tube filaments in case one of the positive "B" battery terminals accidentally comes in contact with any portion of the metal work. The two panels should be connected together with a short piece of heavy wire or metal strip.

COIL CONNECTIONS

The r.f. coils are wound on National 4-pin forms $1\frac{1}{2}$ inches in diameter and are all wound with No. 30 d.s.c. wire. The number of turns for the different frequency ranges is given in the table. The spacing between L_1 and L_2 is not critical, $\frac{1}{4}$ -inch being about right. When looking at the bottom of the coil form with the two large pins toward the observer, the lower end of L_1 is connected to the right-hand small pin, the upper end of L_1 to the left-hand small pin, the lower end of L_2 to the left-hand large pin, the upper end of L_2 to the right-hand large pin.

While the original detector antenna windings may be used satisfactorily without any change, greater signal strength will be obtained, especially at the lower frequencies if these windings are changed to conform with the specifications given for L_2 in the table. If the original windings were wound fairly close to the bottom of the form, it will be necessary to use smaller wire. No. 36 d.s.c. wire was used in this case.

TUNING PROCEDURE

The tuning procedure of the combined receiver is not at all difficult. It is true that the addition of the r.f. amplifier adds another tuning control, but the setting of this is not at all critical—much less critical than the usual regeneration control.

After the coils for any particular band have been plugged in and the filaments turned on and adjusted, the r.f. gain control should be set somewhere near maximum. With the detector padding condenser set at the desired point, the r.f. tuning condenser should be set at as nearly the same capacity as the detector padding condenser as may be roughly judged by eye. The detector unit is then tuned in the usual manner until signals are heard. It will usually be advisable to keep the regeneration adjustment somewhat away from the critical point during preliminary adjustments. Now tune the r.f. amplifier and a point should be readily found where the signal increases considerably as the r.f. stage is tuned through resonance. After this has been done, the regeneration may be brought to maximum and the r.f. gain control adjusted for the desired signal strength. The gain control will be found most useful on loud signals which have a tendency to block the detector with the gain control adjusted for maximum gain.

If the regeneration control is too close to the critical point during tuning, the tuning of the r.f. amplifier or the gain control may throw the detector into or out of oscillation. This is caused by the variation in detector loading and the extent to which this occurs will depend almost entirely on the stability of the detector circuit. It will be found that no adjustment of the r.f. amplifier tuning will be necessary over a fair portion of the detector vernier range.

While a plate voltage of 135 should be used for the r.f. and audio output tubes for maximum performance, very good results may be obtained with a total plate voltage of 90 or even 45. When a plate voltage of 90 is used for the two tubes mentioned, the screen voltage of the r.f. tube should be maintained at 67.5 while the biasing voltage for the audio tube should be reduced to 9. For a total plate voltage of 45, the voltage of the r.f. screen should be 45 and the bias for the output tube 4.5 volts. Since not all brands of "C" batteries have a 9-volt tap, the required voltage may be secured by connecting an additional 4.5-volt "C" battery in series with the 4.5-volt tap on the 22.5-volt "C" battery as shown in Fig. 2.

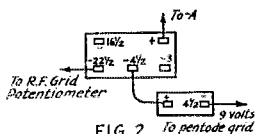

FIG. 2

Strays

Correcting a misstatement in a "Stray" on page 84 of January *QST*:

F.R.C. no longer writes letters to amateur licensees to serve as an extra operator license for the operation of a second station. Since the new regulations of October 1st, Rule 221(a) governs: "In the case of an amateur operator . . . the original operator's license shall be . . . posted or kept in his personal possession and available for inspection at all times while the operator is on duty."

Note it must be the original operator's license. The business of photostat copies applies only to station licenses, where a copy may be used to cover the operation of a portable.

Hams who have trouble keeping dust off their bread-board layouts will find a dry paint-brush just the thing to sweep the dust out from under apparatus and wires.

—W9KWZ

Judging by the sound of a lot of 'phones on the air these days, a good many hams must be using "depression" modulation—89% down from 100%.

—W3CQO

As To Expired Licenses

MANY an amateur is finding himself in the following situation: He became temporarily inactive; his operator license expired; his station license, having been extended automatically, is still in force; he is willing and able to pass the new examination for a new operator license; but Rule 402 seems to require activity of the station before issuing the new form of license, and obviously the station cannot be operated when the operator hasn't an operator license. What to do?

The answer is that the station license doesn't enter into this picture. The amateur should fill in Part I of the application form, applying for a new operator license. It is not necessary to fill in Part II of the form, relating to station license, since the applicant already holds a valid station license. The station license is simply surrendered with the examination papers and then the F. R. C., for its own convenience, issues the new combined license form which not only serves as new operator license but replaces the old station license. If you are taking the examination before an inspector, have your station license with you to surrender. If you are taking the Class-C examination by mail, send your station license along with your examination papers and filled-out application form.

That part of Rule 402 relating to station activity applies only in the case of renewal (and no station licenses expire until next January) or modification (as in case of change of address). It does not apply where the change is to be made only in the operator license.

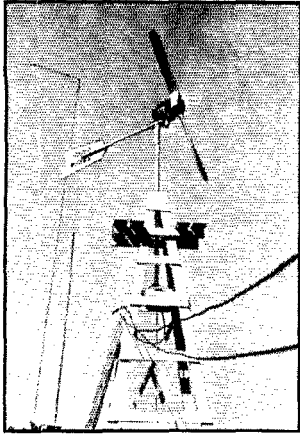

THE WIND-
MILL AT
W9BW X

Getting Power from the Winds

Constructional Details of Wind-Driven Battery Chargers for the Rural Amateur

THE ham living off in the country away from power lines does not need to be reminded of his ever-present problem—getting enough power at the right voltage to operate a transmitter, even a small transmitter of modest power requirements. Now, turning the wind to useful work is far from new, but practical information on how to do it for the benefit of a radio station has been lacking. We are therefore pleased to be able to give the details of the installations used by two midwest amateurs to keep their transmitters on the air.

In both cases a home-made windmill with an airplane-type propeller—which, strictly speaking, is an *impeller*, not a *propeller*—is used to run an automobile generator which charges a bank of storage batteries. The power from the batteries is then converted for the transmitter by dynamotors or other suitable devices. The construction of the windmills will be of most interest to amateurs whose experience has been more along radio than mechanical lines.

The photographs and Fig. 1 give the details of

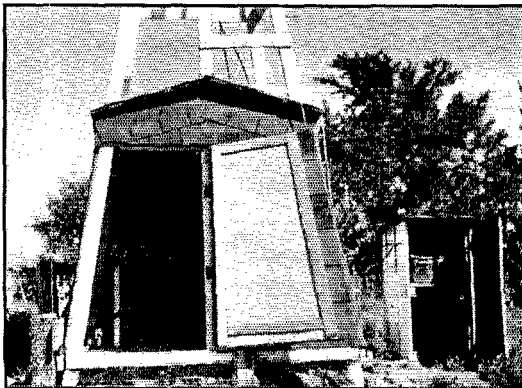

W9BW X'S STATION AND BATTERY HOUSE AT THE
FOOT OF THE TOWER

the windmill built by Lewis Lamar, W9BW X, of Weston, Mo. The windmill and generator are mounted on top of an iron pipe which in turn is secured to a wooden tower. The station is in the shingled building which is built at the bottom of the tower, using the four sides of the tower as corner posts. The main details of the windmill construction should be made clear by Fig. 1. A piece of 1 3/4-inch pipe is the main support. Over it is fitted a short length of 2-inch pipe to the top of which is welded an 8-inch piece of auto frame. The small pipe holding the tail is welded to one end of the frame, while a front-wheel hub taken from an old Model T Ford is welded to the other end with the bearing axis vertical. A steel baseplate, 8x8x1/4 inches, welded to a spindle which fits the hub in its original bearings, supports the impeller bearing and the d.c. generator.

The impeller shaft, a piece of 1-inch steel rod, turns in hardwood bearings 2 inches thick, 3 1/2 inches high and 8 inches long. The bearings are boiled in oil to make them waterproof. Two bolts fasten each bearing to the mounting plate; the same bolts also hold the generator mounting, which is made from small angle irons bolted to the generator frame through small holes drilled in the frame for that purpose. The impeller is held to the shaft by a special machined flange, while at the other end of the shaft a special fitting holds the large timing gear in place. The fitting permits unscrewing the gear so that the wooden shaft bearings can be renewed when necessary.

The mill turns freely on the hub in which the spindle is placed, thus making it possible to turn the mill out of the wind. One end of a rope is fastened to the baseplate as shown in the drawing; the other end runs down through a 1-inch pipe which is centered in the 1 3/4-inch mounting pipe. When the rope is pulled the baseplate swings around, against the tension of the coiled door spring, thus pulling the mill around at right angles to the tail. When the rope is released the mill springs back. To avoid cutting the rope as it comes through the frame a small pipe elbow, not shown in the figure, is screwed in the hole in the frame through which the rope passes.

The positive wire from the post on top of the generator—also from a Model T Ford—

runs down through the inner pipe as shown. The negative side of the generator is grounded to the steel frame of the mill and the connection taken off at the bottom of the supporting pipe. No. 6 rubber-covered wire is used for all leads.

All joints in the mill are welded, and care was taken to see that the mill balanced nicely on the supporting pipe.

THE IMPELLER

The success or failure of the mill will depend upon the impeller. The one at W9BW was built after a design by Prof. L. G. Heimpel, originally described in *Popular Science* for August, 1933. Its dimensions are given in Figs. 1 and 2.

The impeller blank was made by gluing together three 1×7 inch selected pine boards, 6 feet long. These were then roughed out as shown in the upper drawing of Fig. 2 with the aid of a band saw. The straight side is the front. The carving was done with a draw knife and smoothed down to final shape with a wood rasp and sandpaper.

A smooth taper is essential for best results. The lower drawing of Fig. 2 shows typical cross-sections at intervals along the length. The leading edges are rounded while the trailing edges are sharp; the front is straight and the back is tapered. With this particular generator and the gearing system used, the impeller must turn in a clockwise direction. It would be worthwhile to whittle out a small model first to make sure that the direction of rotation will be correct.

At W9BW the mill is used to charge two six-volt storage batteries in parallel. Since the plate-supply dynamotor draws 30 amperes from the battery it is evident that the mill has plenty of work to do. The mill ordinarily runs two or three days a week, and charges at a reasonable rate in a strong wind. The batteries are kept fully charged with normal operation of the transmitter even during the time of the year when the least wind is to be expected at W9BW's location.

The generator cutout is located in the battery shack, although it could be mounted in its original place on the generator. However, it is more convenient to have it with the batteries so that it is accessible when adjustments are needed.

AN ALTERNATIVE DESIGN

Another air-driven charger, working on the same principle but with different constructional details, is shown in Fig. 3. It was built by Rodney

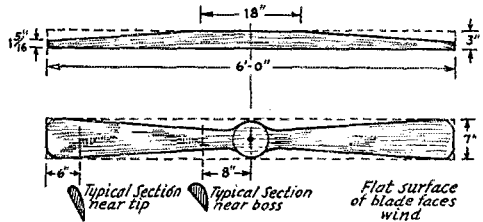

FIG. 2 — IMPELLER CONSTRUCTION

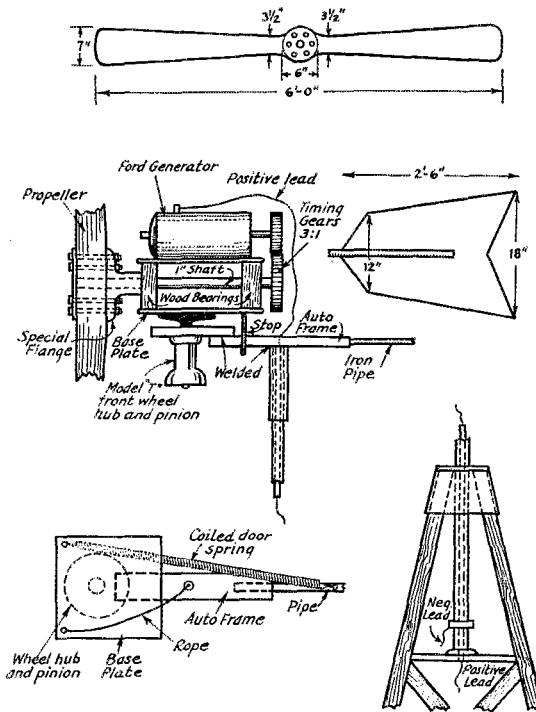

FIG. 1 — DETAILS OF THE W9BW WIND CHARGER
The drawing is not to scale. See text for further details.

C. Mitchell, of Yukon, Okla. Again considerable use is made of parts from the always-useful Dearborn product.

The main bearing on which the mill assembly is mounted is taken from the front axle of a Model T Ford, cut off about 18 inches from the king bolt. The main support of the mill is a wooden head block of the dimensions shown in the drawing. The tail, which may be made of wood or sheet metal, is bolted to a length of pipe which in turn is bolted to the head block. The mounting for the impeller is a second section of Model T Ford front axle and hub (the side with the left hand threads), held to the head block by a bolt through the spring perch hole and

a U-bolt fitting over the axle toward the rear of the piece. A brace should be run from the steering rod to the bolt in the spring perch hole to hold the axle bearing rigid; the king bolt and bushings in top and bottom also should be tight. The impeller is held to the wheel hub by four bolts, the

spacing of which will depend upon the particular type of axle used. The brake drum, mounted as shown in the drawing, is used as a pulley; it should be at least 14 inches in diameter. Particular care should be used to see that the drum is correctly centered on the hub. The drum should be located so that it just clears the head block.

impeller used at W9BWX, although the dimensions differ. The front face makes an angle of 42 degrees with the front of the board at the hub; the angle decreases uniformly until at the tips it is 15 degrees. The blades are $\frac{1}{2}$ -inch thick at the tips and $\frac{3}{4}$ -inch thick at the hub. The impeller should turn in a clockwise direction, unless the generator used is designed for rotation in the opposite direction. Again a small preliminary model will be helpful.

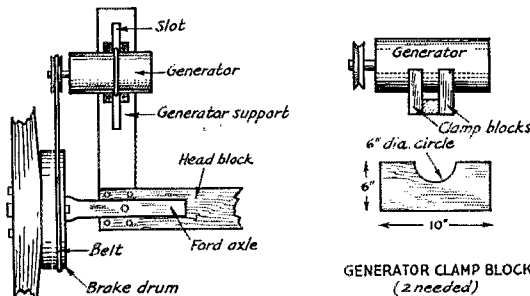
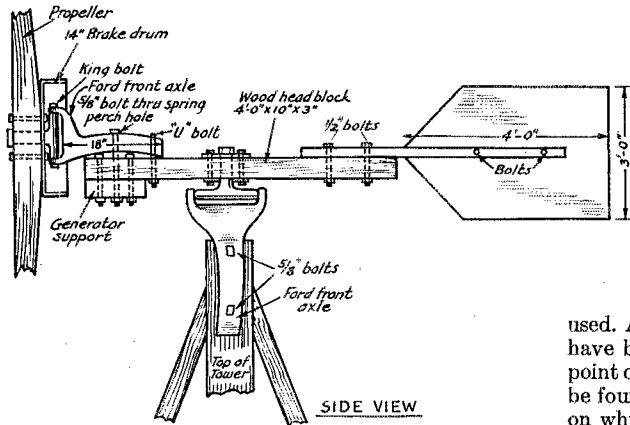

TOP VIEW SHOWING METHOD OF SUPPORTING GENERATOR

FIG. 3—CONSTRUCTION OF THE WIND-DRIVEN CHARGER BUILT BY RODNEY C. MITCHELL
The drawing is not to scale.

Details of the generator support are given in the lower drawings of Fig. 3. The generator rests in half-circles cut in 2-inch blocks, with a small piece of 2×2 between. When the generator is mounted on its support (left-hand lower drawing) a U-bolt goes over it, down between the mounting blocks and through the slot in the support. The support itself is a piece of 2×8, approximately 3 feet long. When bolted to the head block in such a position that the generator pulley will line up with the brake drum, the slot in the generator support permits locating the generator so that the belt will be tight. The belt used by Mr. Mitchell is a Dayton No. 510, $\frac{3}{4}$ -inch, V-type.

The impeller is cut from a 6×8 plank, 8 feet long. Fir or pine free from knots should be used. The general construction is similar to that of the

When the impeller is completed it should be carefully balanced indoors (to avoid air currents) by bolting it on the axle hub and bearing and then taking off thin shavings on the heavy side until it will stay put in any position. Light oil should be used on the bearing when balancing, but when the mill is put into operation cup grease should be used. After the impeller, tail and generator have been mounted on the head block the point of balance of the whole assembly should be found before boring the hole for the hub on which the head block revolves; if this is not done the head block will not be level nor turn freely.

The tower on which the mill is mounted is made 2×4's, with the Ford axle bearing bolted to a short length of 6×6 at the top. The tower should be high enough to give the impeller about 8 feet clearance so there will be no danger of its striking a person walking underneath. It will turn at about 500 r.p.m. in a high wind. The pulley ratio is about 8 to 1, while the generator will charge at 600 to 800 r.p.m.

Wires from the generator are allowed to hang down with three or four feet slack. The impeller is tied to the head block with a rope when not running. The cutout is also installed at the battery location in this case.

—G. G.

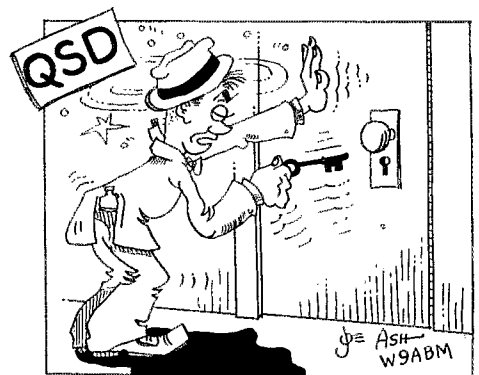

Triple-Purpose Dual Tubes in "5 and 10" Portables

By John L. Reinartz, WIQP*

I NTEREST in the 5- and 10-meter bands is increasing; it is going to be popular to operate in both of these bands during the coming season. All kinds of tubes are being used, from the small 30 to the mighty 800. Other types that should find favor among amateurs for low-power work on five or ten meters are the tubes made for Class-B work, such as the 19 and 53. Although designed primarily for Class-A driver and Class-B audio service, these tubes also make splendid oscillators in push-pull circuits, being especially suitable for unity-coupled circuits where the grid excitation coil is within the plate tank coil. Hence the above triple-purpose designation.

AS OSCILLATORS

The 19 has a two-volt filament drawing 0.25 amperes. Its maximum plate voltage is 135, while the maximum plate mls (instantaneous rating) are 50. As specified for Class-B service, it has an output of 2.1 watts. As an r.f. oscillator, two watts output also can be expected when operated at 135 volts. Hence it would appear to be the very tube we have been looking for to build into that portable transmitter. The 19 is actually two tubes in one, making all connections between elements the shortest possible since all terminals are on one socket.

The 53 is another such tube. Its cathode is of the indirectly heated type for operation on $2\frac{1}{2}$ volts a.c. or d.c., but preferably a.c. With a plate voltage rating of 300 volts maximum and a plate current maximum of 100 mls, it will put up a good scrap on five or ten meters. As in the case of the 19, the unity-coupled circuit finds favor since all connections are at one socket. Ten watts of r.f. output can be expected.

At WIQP both types have been used with good results in the circuit of Fig. 1, the 19 as a portable transmitter tube and the 53 as a.c. operated portable or fixed-station transmitter tube. For five-meter work, the $2\frac{1}{4}$ -inch diameter plate tank coil is composed of approximately two turns of $\frac{1}{4}$ -inch copper tubing with the insulated grid coil inside. A hole is drilled in the tubing just midway—at the voltage node—with the grid center-tap emerging through this hole; this is also the place where the plate supply

connection is soldered to the tubing. For ten meters, the number of turns is doubled, the diameter remaining the same. Some trouble was experienced in fishing the grid wire through the copper tubing, but it was accomplished eventually with exercise of patience. Spaghetti tubing is used as the insulator through which bare copper wire was pushed.

The copper tubing is soldered directly to the tabs on the socket at the plate connections, and the grid wires are crossed over each other to the opposite grid tabs and are soldered there. This arrangement allows the tube socket to be mounted

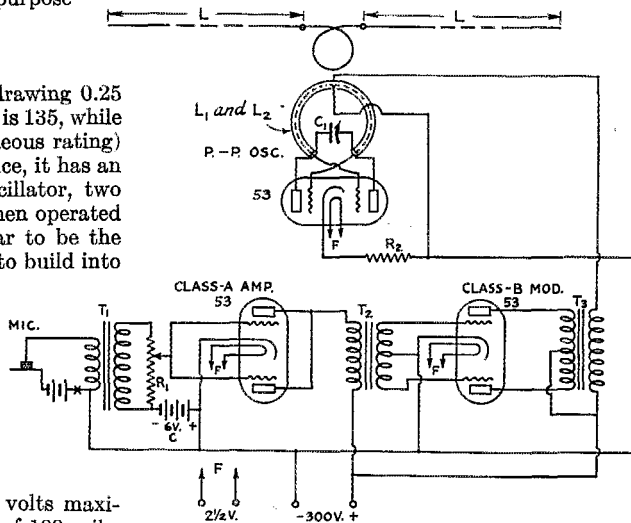

FIG. 1 — CIRCUIT FOR 53'S USED AT WIQP

L — Each 43 inches for 56 mc., 86 inches for 28 mc.

L_1 and L_2 — Plate and grid coils. See text.

C_1 — 50- μ fd. variable.

R_1 — 500,000-ohm volume control.

R_2 — 400-ohm 2-watt resistor. See text.

T_1 — Single-button microphone transformer.

T_2 and T_3 — Class-B input and output transformers. See text.

For tube socket connections see Receiving Tube Table, The Radio Amateur's Handbook, Eleventh Edition.

on a bakelite baseboard so that the tube is above the shelf and the tank coil below. The antenna coupling coil of one turn is mounted so that it goes between the tank coil turns, from a binding post on one side to another on the opposite side. This keeps the antenna coupling fixed and out of the way. The Hertz antenna is connected to the binding posts. For five meters, each antenna-

* 176 Wadsworth St., South Manchester, Conn.

half is 43 inches, while for ten meters it is 86 inches.

A 50- μ fd. variable midget condenser is used to tune the plate tank to the antenna, the antenna length being adjusted for resonance at the desired frequency. At resonance the plate milliammeter reads maximum, readings being less on either side of resonance. This was checked with an r.f. meter connected at the antenna binding post in series with one side of the radiating system.

Self-bias is used for the oscillator. For the 19 (with a separate filament supply), the resistance R_b is 200 ohms, while for the 53 it is 400 ohms. This method of obtaining bias has the merit of providing self-protection, since, as the plate current increases, the bias does likewise. The method, therefore, limits the permissible plate current for any given plate voltage and is preferred to grid-leak bias. This brings us to ways and means for modulating the 19 or 53.

DRIVER AND MODULATOR

Both the 19 and 53 are good Class-B modulator tubes; the 19 will modulate satisfactorily approximately 4 watts and the 53 approximately 20 watts of oscillator plate input. The 19 as a Class-A tube will drive a 19 used as a Class-B tube; and the 53 as a Class-A tube will drive another 53 used as a Class-B tube.

The plate-to-plate load requirement of the 19 as a Class-B tube is 10,000 ohms and must be matched by the 2500-ohm plate circuit resistance of the oscillator (50 ma. at 125 volts). It should be remembered that the 200-ohm self-bias resistor subtracts 10 volts from the total plate supply of 135 volts. Likewise, the plate load requirement of 10,000 ohms for the 53 has to be matched to the input resistance of the r.f. tube, which is some 3000 ohms after the drop through the self-biasing resistor has been taken into account. (Plate input 90 ma. at 265 volts.) The transformer turns ratios are figured accordingly.

If one has a few old cores at hand that have a cross section of at least $\frac{3}{4}$ by $\frac{3}{4}$ inches and with winding space of 0.5 by 1.5 inches, the transformers can be made at home and, even though home-made, should give good results.

For the 19, the input transformer should have a turn ratio of 3.2/1 primary to $\frac{1}{2}$ secondary. With a core of the above size, the primary should be 7000 turns of No. 40 enameled wire, while the secondary has 4400 turns of No. 38 enameled with a tap at 2200 turns. The output transformer for the 19 may have a 2000-turn primary winding of No. 38 enameled wire with a tap at 1000 turns, and 1000 turns of No. 36 enameled wire for the secondary.

For the 53, the input transformer primary is 5500 turns of No. 40 enameled wire, and the secondary 2200 turns of No. 36 enameled with a

tap at 1100 turns. The output transformer will have a primary of 3650 turns of No. 37 enameled wire with a tap at 1825, while the secondary will have 2000 turns of No. 34 enameled wire.

It will be best to wind the coils so that each $\frac{1}{2}$ primary and $\frac{1}{2}$ secondary is a section or pie; there will be four such sections for a transformer. The sections should be insulated with heavy paper, both over the core and between the sections. Afterwards the whole transformer can be immersed in molten paraffin to insure good insulation.

The set diagrammed in Fig. 1, using 53's, has been on the air from W1QP for over a month on both five and ten meters. Locally, the results have been splendid.

Strays

A machinist's scratch awl makes a handy tool to start nuts in tight places. The hooked end also is FB for fishing out small wires.

—W1AUG

FIVE METERS

A Radio Playlet in Three Acts

All scenes are laid in the transmitting plant of one of the large network stations.

Act 1, Scene 1

A full-fledged 56-mc. bug, developed from a larva of the genus bookworm of the special type inhabiting the pages of *QST*, bites several of the operators in unguarded moments.

Scene 2

A 56-mc. transmitter is constructed and put into operation, with the network programs furnishing the modulation.

Act 2, Scene 1

Transmitter gets out. Swell! Decision is made to use regular voice modulation.

Scene 2

During one of the big "Ciggie" programs, the operator calls "Hello W blub blub blub, this is W blub blub blub calling you. Ye gosh, what terrible call letters . . ." — and more of the same.

Scene 3

Telephone begins ringing. BCL's all over town complain that some amateur is interfering with "Ciggie" program.

Act 3, Scene 1

Operators hastily dismantle and hide parts of 56-mc. transmitter.

Finis

Yes, it actually happened. Where and when is a secret we're not giving away.

Biasing the Power Amplifier

Practical Considerations in the Use of Power Packs for "C" Bias

By George Grammer, Assistant Technical Editor

CAN I use a "B" eliminator for bias in an r.f. power amplifier stage? The answer to this question, lately a favorite among those addressed to our Technical Information Service, depends upon the circumstances. For some purposes a "B" eliminator has definite advantages over plain battery bias; it is certainly preferable to getting bias through a grid leak unsupported by a fixed bias-voltage source independent of the excitation. But in certain special cases a "B" eliminator of ordinary design may not fit into the picture at all. We shall point out the specific cases.

Consider first the case of the amplifier in which most of us are interested: the ordinary amplifier which follows—several stages of it, frequently—the oscillator in a c.v. transmitter; or the stages leading up to the modulated stage in a 'phone transmitter. (Class-B linear and Class-B audio amplifiers are in a separate category.) The bias on such a stage is commonly adjusted so that the output power is highest for the excitation available. If such an adjustment can be made as satisfactorily with "B" eliminator bias as with batteries, then there can be no argument against using the eliminator.

Now it might be said that voltage is voltage and it makes no difference whether it comes from batteries or a power pack. That would be true if the characteristics of the voltage source could be neglected; in other words, if the voltage regulation under load made no material difference. Regulation cannot be neglected when a "B" pack is used for bias. Lots of us have used eliminators for bias only to find that after the amplifier is running the eliminator can be shut off without changing the output or tube heating or anything else; obviously there is still bias, otherwise the tube wouldn't work with its former efficiency. The answer, of course, is that there is a grid leak in the circuit, and we don't have to look far to find it.

"B" eliminators are, or should be, equipped with bleeder resistors, which are nearly always tapped so that various output voltages are obtainable. Since the eliminators are inherently low-power devices designed to give small output currents at relatively high voltages, the voltage divider or bleeder must have fairly high resistance. A common value for an eliminator built to deliver 180 or 250 volts is about 15,000 ohms. A 15,000-ohm resistor makes quite a respectable grid leak.

SOARING BIAS

To get a picture of what happens when such a power pack supplies bias voltage in a transmitter, look at Fig. 1. Suppose the eliminator output is 180 volts and the voltage divider has a total resistance of 12,000 ohms, tapped every 3000 to give the voltages indicated. Assume that the desirable bias voltage for the type of tube in use is 90 volts; the negative terminal of the power pack

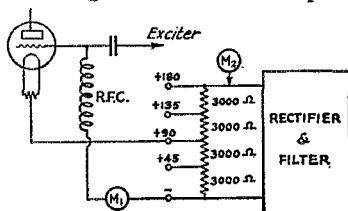

FIG. 1—A "B" ELIMINATOR USED TO BIAS A POWER AMPLIFIER ACTS AS A GRID LEAK AS WELL AS A FIXED-VOLTAGE SOURCE

is connected to the grid and the "plus 90" terminal to the filament center tap. Now between those two taps we have a resistance of 6000 ohms, which can and does act as a grid leak. As soon as the excitation voltage is great enough to make the amplifier tube draw grid current—and practically all amplifiers which operate with fair efficiency do take grid current—that current will flow through the 6000 ohms. Since it flows in the same direction as the normal current supplied to the voltage divider by the rectifier and filter, the two currents add together. The normal bleeder current as read by meter M_2 would be 15 milliamperes in this example, if the grid current of the tube read by M_1 is 10 mils, the result will be 25 mils. If 25 milliamperes flow through 6000 ohms, the voltage across the 6000 ohms will be 150 volts.

Actually, the calculations are not quite so simple, because when grid current starts to flow through the voltage divider the current supplied by the eliminator will no longer be 15 milliamperes. That part of the divider through which grid current flows takes on the characteristics of a small power pack itself and the voltage developed bucks the eliminator voltage so that the divider no longer looks like a simple resistance of 12,000 ohms. The effect of this is that the current read by M_2 decreases so that the resultant of 150 volts arrived at by the simple calcula-

tion in the previous paragraph is inaccurate; the actual voltage would not be quite that high. The situation is further complicated by the fact that the output of the rectifier-filter will not remain constant at 180 volts when the current changes; the voltage regulation of most elimi-

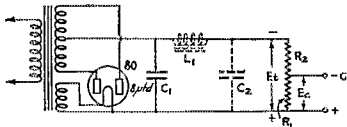

FIG. 2—A PRACTICAL CIRCUIT FOR THE "C" SUPPLY

A single 8- μ fd. condenser often will suffice for the filter, but if trial shows that more is needed, a choke and second condenser, shown in dotted lines, may be added. The condensers should be rated at 500 volts, especially if the "C" supply is to be used on a high-power stage where the excitation is likely to be large.

The bias voltage, E_b , should be approximately that value which will cut off the plate current of the tube at the plate voltage used (roughly the plate voltage divided by the voltage amplification factor of the tube). Resistor R_1 should be equal to the grid leak value ordinarily used with the tube. The required resistance for R_2 can be found by the formula

$$R_2 = \frac{E_1 - E_0}{E_0} \times R_1$$

where E_1 is equal to the peak value of the transformer-rectifier output voltage (r.m.s. voltage of one side of secondary multiplied by 1.4).

nators is so poor that the output voltage is very sensitive to small changes in current. The voltage at the terminals of the divider therefore will rise to some extent. Fortunately the exact determination of bias voltage is of relatively little importance in the case of an ordinary amplifier; it is only necessary to know that the bias will increase when the amplifier is excited. It is desirable to remember this, however: When the grid current is sufficient to cause the voltage to rise to the peak value of the rectifier output voltage (1.41 times the transformer voltage) the rectifier-filter no longer will deliver current. It is possible to exceed this value if a low-voltage eliminator is used to bias a tube of medium power; if this happens watch out for the filter condensers in the eliminator. Some of the older units have condensers which just about stand up under ordinary service; they may go West in a hurry if the bias voltage builds up from grid-current flow.

USING A "C" SUPPLY

For the ordinary amplifier the "B" eliminator would seem to be an almost ideal bias supply. It does several things which should be done. It provides the necessary protection to the amplifier tube should the excitation fail. The actual bias on the tube automatically adjusts itself to the excitation, within limits, so that the tube operates at good efficiency over a wide range of excitation. The only disadvantage is that a single power pack for several stages is rather unsatisfactory for the same reason that a single grid leak resistor for several stages would be unsatisfactory: anything

that causes the grid current on one stage to change (a tuning adjustment, for instance) also changes the bias on all the other stages, since all grid currents flow through a common resistor. Further, if two or three stages are supplied with bias voltage from a common power pack, the voltage drops caused by grid-current flow through the divider resistor add up; the greater the excitation at the last stage the higher goes the bias on the preceding stages. The net result of this is that all the stages are overbiased and the power output is cut down.

From the preceding paragraphs it is obvious that the resistance of the voltage divider used plays an important part in the performance of the "B" eliminator as a bias supply. If, as is often the case, the eliminator is one which has been picked up at a bargain price or inherited from defunct B.C.L. accumulations, it will pay to ascertain just what the resistances are between the various voltage taps. Here is a good rule to follow:

Choose the taps which will give just about the right voltage for cutting off the tube plate current when not excited, and make certain that the resistance between these taps is approximately the value that would be used as a grid leak for the same tube. This really amounts to using grid-leak bias, with all the advantages accruing from automatic bias, and at the same time having the protective feature of the steady voltage from the eliminator. As normally operated, the eliminator voltage does not have much influence unless the excitation is so low that grid current does not flow; with normal excitation the bias will be purely automatic. If the resistance between the correct voltage taps is, on measurement, found to be too high, a resistor of the right value should be connected across the taps. If this is not done the amplifier will be over-biased, just as it would be with a grid leak of excessive resistance. Make certain that the voltage divider and auxiliary resistor are capable of carrying both the eliminator current and the grid current without danger of burnout. A rating of 25 watts for every 5000 ohms should be ample for anything up to a pair of 100-watt tubes.

MAKING A BIAS ELIMINATOR

Although almost any "B" eliminator having a maximum output of about 200 volts will do a good job of biasing a single stage, provided the points enumerated above are kept in mind, there may be some who want to build one up from the ground floor. Comes then the question of filtering, which turns out to be easy. Since the rectifier-filter is called upon to furnish only bleeder current the filter need not be very elaborate. An ordinary brute-force affair with a choke of 25- or 50-mil rating and a couple of inexpensive electrolytic condensers will be plenty; in fact, a single 8- μ fd.

(Continued on page 86)



STRAYS



W9BLE is enthusiastic about the argon tube to replace the neon bulb for touching hot places in the transmitter. A 12- or 14-inch tube can be made up by your local neon sign manufacturer at a cost of \$1.50. It has the advantage that the relative intensity of the r.f. voltage at the point touched can be observed by noting the length of the glow in the tube, whereas the neon tube either glows throughout its entire length or not at all.

Fellows using 83 rectifiers at higher-than-normal voltage now and then run into trouble with breakdown of insulation inside the base and stem, even though the tube elements themselves seem to hold up under the abnormal inverse peak voltage. W9CKZ and W9AIK found that insulation troubles of this sort could be cured by drilling a pair of 1/8-inch holes in the bottom of the base and filling the base with transformer oil. After filling, the holes can be plugged up with sealing wax, or the tube can be mounted in an inverted position.

Live and learn, says W6CKS. It seems that a couple of Los Angeles 'phone hams recently discovered a marvelous new antenna called the "Fuchs," for which extreme DX and ease of installation are claimed. Maybe we ought to put a label on the "simple voltage-feed antenna" that has been in every edition of the *Handbook*. It's called the "Fuchs antenna" in Europe.

W2ESO suggests the slogan "We Doom Our Parts" for those guys who think tubes don't begin to work until you have at least double the rated voltage on them.

"Service Hints" is the title of a highly practical booklet containing outstanding service experiences of numerous service men. The notes are classified according to the make and type of receiver concerned. Copies may be obtained from the Hygrade Sylvania Corporation, Emporium, Pa.

W3BUU wants to know if someone has changed the meaning of "QSP"? The standard answer to the query seems to be "W1 nil hr cul 73"!

At a club raffle W3BZI won a nice bottle with ticket No. 13—and dropped it two minutes later!

The portable described in November, *QST* no longer signs W9ZZAF, the call having passed back to the F.R.C. to be buried in its files, under the new regs regarding portables. W9DLS (with the necessary addendums) is the call now being used.

Cheap transmitting coil forms can be made from old phonograph records. Boil the record in water until soft, then cut in strips and shape them about a cylinder of the desired diameter. After hardening, the forms can easily be drilled for mounting on stand-off insulators.

—W9LSN

W2FIS claims that his rig knows the alphabet. His log shows that he worked 2GH, 8IJ, and 8KL in succession!

W2VY writes that, in using twisted-pair feeders as described in the Experimenters' Section, September, *QST*, the feeders should be taped at the point where they separate, otherwise they may cease to function in rainy weather. At W2VY, the feeders are covered with a layer of rubber tape over which is wound a layer of friction tape, the whole then being given a coat of lacquer. With this precaution the feed line works perfectly even after three or four days of continual rain.

A method of using the 5000-kc. transmissions from WWV every Tuesday to check the frequency of crystals or calibrate frequency meters is described in Letter Circular No. 314, "Use of Standard Frequency Transmissions in Checking Standard Oscillators," published by the Bureau of Standards, Washington. Copies are available from the Bureau on request.

W9FFH finds an old toothbrush handle filed down to work like a screwdriver is FB for adjusting neutralizing condensers, trimmers, and other variables where there is danger of a short-circuit or troublesome body capacity.

Our Information Service often receives requests for data on equipment for locating sources of electrical interference, and those who have occasion to want such information will be interested to know that a portable outfit is now being manufactured by the Tobe Deutschmann Corp., Canton, Mass. It is described in *Engineering Bulletin* No. 232, which is available on request.

The Light-Bulb Resistor

By D. C. Redgrave, KAINA*

A HANDY type of resistor for all sorts of use around the "shack" is the ordinary light bulb. It is cheap and convenient, and can be quickly changed for one of another rating. It has the advantage over other types of resistors of giving a visual indication of the current flowing through it. Furthermore, because of the difference in the resistance-temperature characteristics of metallic and non-metallic filaments, we can choose the type of bulb desired and utilize this characteristic to advantage.

It is generally known that the resistance of a light bulb varies over a wide range as the current passing through it is changed. Of course we can calculate the resistance at rated current and voltage, but this will not give us the resistance when less than normal current is flowing. This very uncertainty is largely responsible for the lack of general use of the light bulb as a resistor, and our purpose here is to present certain data in tabular and graphic form so that we may estimate the resistance of any bulb with a degree of accuracy approaching that required in practice.

Fig. 1 gives the resistance-current curves of two bulbs, one having a carbon (non-metallic) filament, and the other a tungsten (metallic) filament. Observe how the carbon bulb's resistance starts at a value above normal, decreasing non-uniformly until about one-half normal current is reached, and from that point on decreasing with fair uniformity. On the other hand the tungsten filament starts at a very low resistance which increases rapidly at a nearly constant rate as the current is increased. The tungsten bulb is, therefore, not suitable for use where we want a fairly constant resistance over a wide range of current, but it is just the thing to use as a dropping resistor with constant current. Here we get a ballast action which opposes the natural increase of current due to an increase in voltage, and which reduces the drop in current when the line voltage falls. When operating constant-current devices from the house mains at reduced voltage, we can minimize the effect of line-voltage fluctuations by the use of the tungsten bulb as dropping resistor. For intermittent operation where an initial current surge followed by a drop in current is desired—for example, when dropping the voltage down for a keying relay—the tungsten bulb is ideally suited.

The carbon filament, within the range from one-half normal to normal current, is better suited for use where fairly constant resistance under varying load conditions is desired. Within

* Lt., U. S. Naval Station, Olongapo, P. I.

this range the change in resistance is about 24% of the resistance at rated voltage; for smaller variations in current the change would be correspondingly less. If a more constant resistance is desired we might parallel a carbon and a

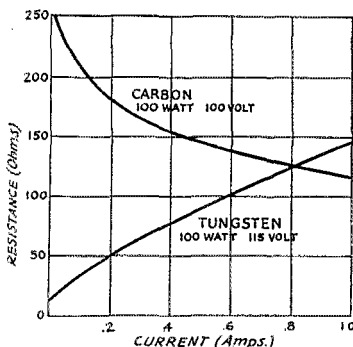

FIG. 1—TYPICAL RESISTANCE-CURRENT CURVES OF CARBON AND TUNGSTEN FILAMENTS

tungsten bulb (each of half the wattage rating required of a single bulb) or use one of each type of twice the required rating in series. In a circuit where we wish to prevent a large initial rush of current or one in which we desire the current to rise gradually after the circuit is closed, the resistance-temperature characteristic of the carbon filament meets our demands.

The table gives the current, resistance at rated voltage, and the approximate cold resistance of a number of bulbs of different ratings. Data for other bulbs may be estimated. The resistance at normal current of bulbs of the same wattage rating varies as the square of the voltage rating. For example, required to find the resistance of a 50-watt, 32-volt bulb. The resistance of a 50-watt, 115-volt bulb is 264 ohms. The resistance required is, therefore,

$$\left(\frac{32}{115}\right)^2 \times 264 = 20 \text{ ohms}$$

Likewise, the resistance of a 100-watt, 240-volt bulb would be

$$\left(\frac{240}{115}\right)^2 \times 132 = 575 \text{ ohms}$$

The resistance of bulbs of the same voltage rating will vary inversely as the wattage rating. For example, required to find the resistance at rated voltage of a 60-watt, 115-volt, tungsten bulb. From the table, the resistance of a 50-watt

115-volt bulb is 264 ohms. The required resistance is therefore

$$\frac{50}{60} \times 264 = 220 \text{ ohms}$$

Fig. 2 gives us the means of determining quickly the voltage drop across any tungsten or carbon bulb, or a bank of either type in parallel, when the current through a single bulb is known. For example, required to find the voltage drop across a 50-watt 115-volt, tungsten bulb when a current of 0.3 amp. is flowing through its filament. From the table, its rated current is 0.44 amps. 0.3 amps is 68% of 0.44. Using the lower (tungsten) curve, we find that 47% of rated voltage corresponds to 68% of rated current. The required drop is therefore 47% of 115 or 54 volts.

Suppose we desire to operate a device which draws 0.3 amp. at a voltage of 90 using the regular 110-volt mains. The above calculations show that the 50-watt bulb would drop the line voltage too much and that lower resistance bulb should be tried. A 100-watt bulb of the same type

would have $\frac{0.3}{0.87}$, or 34% of rated current. Projecting this abscissa to the tungsten curve, we find the ordinate to be 15%, or 17 volts. This drop about meets our requirements, and due to the ballasting action of the tungsten filament the 100-watt bulb will be suitable. The diagonal dashed line in Fig. 2 may be considered as repre-

sented by the tungsten curve, we find the ordinate to be 15%, or 17 volts. This drop about meets our requirements, and due to the ballasting action of the tungsten filament the 100-watt bulb will be suitable. The diagonal dashed line in Fig. 2 may be considered as repre-

Type of Filament	Rating	Current at Rated Voltage	Resistance at Rated Voltage	Resistance Cold (Approx.)
Tungsten	House Lighting			
	10-watt, 115-volt	.09	1320	132
	25-watt, 115-volt	.22	530	43
	40-watt, 125-volt	.32	390	32
	50-watt, 115-volt	.44	264	22
	100-watt, 115-volt	.87	132	12
	150-watt, 115-volt	1.30	89	7
	200-watt, 115-volt	1.74	66	4
	Auto			
	3-cp., 6-volt	0.6	10.0	1.7
	6-cp., 6-volt	0.9	6.7	1.1
	21-cp., 6-volt	2.0	3.0	0.5
	Flashlight			
1.2-volt	0.50	2.4	0.6	
2.2-volt	0.25	8.8	2.2	
3.8-volt	0.30	12.7	3.4	
Carbon	15-watt, 110-volt	0.14	807	1380
	50-watt, 110-volt	0.45	247	438
	100-watt, 110-volt	0.91	121	258

sented by the tungsten curve, we find the ordinate to be 15%, or 17 volts. This drop about meets our requirements, and due to the ballasting action of the tungsten filament the 100-watt bulb will be suitable. The diagonal dashed line in Fig. 2 may be considered as repre-

senting a resistor having constant resistance. Note that the carbon bulb curve more nearly approximates this condition. However, for many

purposes, such for example as the one given above, the tungsten characteristic is more suitable.

Sometimes it is desired to make a rough estimate from the filament glow of the current flowing through a bulb. In the case of house-lighting

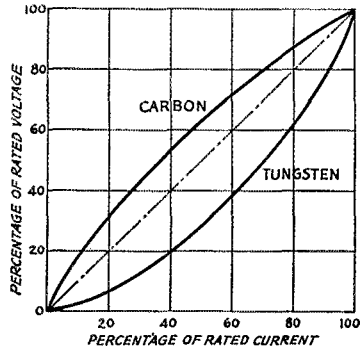

FIG. 2 — FROM THESE CURVES IT IS POSSIBLE TO DETERMINE THE VOLTAGE REQUIRED TO CAUSE A GIVEN CURRENT TO FLOW IN EITHER CARBON OR TUNGSTEN LAMPS PROVIDED THE CURRENT AT RATED VOLTAGE IS KNOWN

bulbs, take one-third of the current at rated voltage for a dull red filament, and two-thirds for a bright yellow filament. For the smaller bulbs slightly greater proportions of the normal currents are required to produce the same color. In auto and flashlight bulbs about one-half normal current will produce a dull red filament and about three-quarters a bright yellow.

The experimenter will find many other uses in addition to those given here for the curves of Fig. 2 when using light bulbs at reduced voltages and, without the usual uncertainty regarding the resistance characteristics, should find more general use for this convenient form of resistor.



Bell Lab. Record On Subscription Basis

Distributed previously on a complimentary basis to a selected mailing list, the *Bell Laboratories Record*, published by the B. T. L. as a companion to the well-known *Bell System Technical Journal* but of less technical nature, is now available on a subscription basis. Although its editorial content covers telephone equipment in general, a goodly share of radio and nearly allied articles make it interesting to people whose principal activity is in the radio field. The subscription price is \$2.00 per year (\$1.25 to employees of companies in the Bell System), foreign postage extra. Subscriptions should be addressed to Bell Laboratories Record, 463 West St., New York City.

Conference on Emergency Communication

We Retain Freedom To Render Maximum Public Service

RECENTLY a proposal was before the Federal Radio Commission to allocate one or more frequencies exclusively for emergency communication. An engineering conference was called by F.R.C. at which all organizations interested in the matter participated in a round-table discussion. Amateur radio undoubtedly being the nation's most useful servant in time of community disaster, we attended the conference. All the government departments interested in radio and most of the American communication agencies were also represented.

The proposal arose from a suggestion made by an emergency-preparedness committee of a southern California city. The basic idea was that all stations of whatever sort participating in relief communication should use certain frequencies reserved for that purpose, and that all such communication work should be coordinated and controlled by a central station under management of the municipality concerned. One of the objectives rather plainly sought was censorship of news from the affected area.

The chief effect of any such unfortunate plan would be to reduce the ability of amateur radio to serve in emergencies—to reduce it about to the vanishing point. We went to the conference, then, in our fighting togs. We had prepared a partial chronological record of amateur service in emergencies and were ourselves amazed at its length and profound evidence of value. At the meeting we pointed out that this service was possible chiefly because there were skillful amateurs everywhere, and that its very success lay in letting each of us continue to use our own methods, our own frequencies. There are so many of us that each amateur may remain free to give his services to whatever emergency plan he elects and still adequately supply all of them with that invaluable blanket of service that only the amateur can give. We showed that such a plan as proposed would throttle off our ability to help, and we demanded in the nation's interests the continuance of our complete freedom to serve as we have in the past. We were completely backed up by the Army Signal Corps, in liaison with whom we maintain the Army-Amateur Radio System, chief instrumentality of amateur assistance in community disaster. The Navy, although willing to coordinate its own emergency communication with any plan adopted, supported our right to liberty without submitting to censorship of compulsory coordination by unknown agencies; so did the Coast Guard. Thus although the suggestion that started the meeting would have tied our hands, our representations were convinc-

ing and the conference agreed with us. We have retained our freedom to render maximum public service. Just another A.R.R.L. job.

The conference brought out the importance of reestablishing wire telephone service after emergencies. Experience has shown that this generally takes one or two days. It is during this period that radio is most needed. Existing radio agencies already cover the United States. There is no need to set up a new national network for emergency communication. However, there is often need for better communication locally within a stricken area. This might well be effected by small complete radio stations strategically placed throughout an area subject to disaster, under the control of special local organizations which could have regular drills and practice, on frequencies suitable for local work. The conference then adopted recommendations, which were later confirmed by the F.R.C., whereunder it was decided not to allocate any national distress frequency and not to foster any new national emergency-communication organization. Local emergency committees are encouraged to organize all existing communication agencies to provide effective emergency communication, but each radio station retains its freedom of action and in any work it does it will use its regular frequencies. Where an emergency network for local communication is needed, the Commission will license special emergency stations. These will use the frequencies of 2726 kc. (for voice work only) and 3190 kc. (for c.w. telegraphy only) and are to be employed only when all forms of wire communication fail, except that they may be used for testing purposes not to exceed two hours per week. Broadcasting and similar stations normally licensed only for a particular purpose or for work between stated points may engage in emergency communication service upon sending notice to F.R.C.

Nothing in this affects amateur radio. We remain individually free to give our emergency-time allegiance to the Army-Amateur Radio System, the Red Cross, the Naval Reserve set-up, our municipality or the public generally—as we elect. Of course it is only proper that all organizations requiring emergency service endeavor to make use of existing facilities of all agencies in their areas, as long as there is no compulsion behind it. We amateurs are tremendously proud of our ability to render service. Many amateurs have already fitted themselves into various planned networks for emergency communication and know just what they are to do if an emergency

(Continued on page 86)

Armistice Day Message

THE fifth annual Armistice Day Message from the chief signal officer of the Army was transmitted on the night of November 6, 1933, from W3CXL-WLM, the Army net control station of the A.A.R.S., located in the War Department, Washington, D. C. Since 1929 this transmission has become an annual event, especially to amateurs affiliated with the Signal Corps in an organization whose origin was sponsored by the American Radio Relay League and which is known as the Army Amateur Radio System.

In accordance with established practice the reception of this message was made a competition for the nine corps area organizations of the A.A.R.S. Each amateur was requested to copy the message and mail the copy to the chief signal officer. The corps areas were scored on the highest percentage of mailed-in copies and also upon the highest percentage of accurate copies. A message was scored as being either accurate or inaccurate. The entire transmission was considered rather than merely the body of the message, this being a step further towards perfection than heretofore. Another change from last year was that the message was transmitted from only one station instead of from two, however, it was transmitted on three frequencies as follows: on 3680 kc. (W3CXL) every hour on the hour, beginning at 6:00 p.m., E.S.T., and continuing until 2:00 a.m.; on 3497.5 and 6990 kc. (WLM) every hour on the half hour, beginning at 6:30 p.m., E.S.T., and continuing until 2:30 a.m. The chief signal officer's message:

TO ALL ARMY AMATEURS: FIFTEEN YEARS HAVE PASSED SINCE THE SIGNING OF THE ARMISTICE. AGAIN IT IS BEFITTING WE PAY HOMAGE TO THOSE WHO GAVE THEIR ALL FOR OUR COUNTRY AND LEFT WITH US THE TASK OF MAINTAINING HER FREEDOM. TO THE ARMY AMATEUR WHO UNSELFISHLY GIVES HIS TIME AND ENERGY TO FURTHER AN UNDERTAKING OF VITAL NATIONAL IMPORTANCE I CAN BUT GIVE MY WHOLE-HEARTED ADMIRATION. YOUR PURPOSE TO PROVIDE AN ORGANIZATION OFFERING A MOST COMPLETE COMMUNICATION SYSTEM NATIONWIDE IN SCOPE AVAILABLE TO THE AMERICAN RED CROSS AND YOUR GOVERNMENT IN TIME OF LOCAL OR NATIONAL EMERGENCY MERITS COMMENDATION OF THE HIGHEST DEGREE.

Irving J. Carr, Major General, Chief Signal Officer

A total of 740 copies was received by the chief signal officer from amateur stations located throughout the United States and Alaska. Of this number 65.4% were accurate in every detail and many more were accurate as far as the body of the message was concerned. The table on the following page shows the relative standings of the various corps areas.

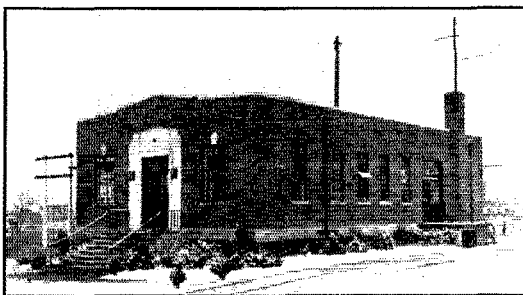

Photo by U. S. Army Signal Corps

WAR, FORT MYER, VA.

This building houses the transmitters of WLM-W3CXL from which station the Armistice Day Message, 1933, was transmitted.

WLNA-W2PF, Radio Aide) respectively. The leaders in percentage of accuracy were: first, the Ninth Corps Area (Mr. J. H. MacLafferty, Jr., WLVA-W6RJ, Radio Aide); second, the Fifth Corps Area, and third the Third Corps Area (Cpl. Robert N. Fox, WLQ-W3SN, Radio Aide).

The chief signal officer is gratified that so many amateurs participated in the competition this year and he feels that the results achieved are most satisfactory.

The Honor Roll for 1933 includes the following stations:

W1AAU-ATF-AP-AXN-BAS-BD-BDU-BFV-BGW-BIQ-BJP-BKG-BLV-BOY-BVG-BVR-BWN-BXF-BZO-CCJ-CGV-BLN-CNU-CPG-CPV-DCH-DLH-DNZ-DVW-DXM-EAY-EOF(FDR)-EOV-ERA-FFL-FGM-FGZ-GGT-HRC-HPA-PI-YU.

W2ACD-AFT-ANV-BGO-BJA-BSZ-BZW-BZZ-CA-CZP-CBY-CHK-CKV-DAT-DBQ-DEN-DIU-DJP-DQW-EKD-EQD-HF-OW-PF-QM-SC.

W3ADE-ADM-ADX-AFF-AKB-AKF-ALX-AOV-APV-AQN-ASO-AWU-BAD-BED-BKQ-BLE-BMM-BWT-BYA-CB-CFL-CFS-CIQ-CJS-CLW-CMS-CTD-CXM-DWZ-FJ-HC-MC-OK-ON-SN-TX-ZI.

W4AAQ-AAY-ABT-AEH-AFI-AFM-AGS-AKJ-ALT-ANT-AP-ATW-ATZ-AVT-AWO-AZM-AZS-BBO-BGE-BHR-BIQ-BKQ-BJZ-BOL-BOZ-BPE-BQM-BQX-BRX-BSL-BUD-BW-BZH-BZW-CDH-CE-CEA-CJP-CM-DL-DW-EG-GQ-GS-HM-IR-JG-KB-KP-KQ-KV-LU-MANM-NU-OH-OI-OL-OX-PM-PT-QZ-RO-RS-SS-TP-UC-ZH-ZS.

W5AA-AAJ-ABA-ABI-ABK-ABT-AFQ-AFW-AHC-AJF-AJG-ALV-AMS-AN-ANI-ANU-AO-AQS-ARS-ASF-AUJ-AUL-AW-BAR-BBR-BCS-BDH-BEF-BEZ-BID-BII-

BJF-BJG-BKE-BKL-BMI-BN-BOE-BQZ-BSG-BUI-BWM(YL)-BXM-BZK-CAV-CBS-CEG-CEZ-CFM-CGJ-CKJ-CKW-CLD-CMC-CMJ-CNC-CNN-CPW-CPX-CRQ(DOA)-CRV-CWQ-CYU-DHN-DKF-FQ-GCB-IA-ID-IQ-JF-JK-MN-OW-RA-SI-VI-WH-WW-ZK-ZM.

W6AAN-AEM-AHD-AIF-AJG-AKW-ALU-AOJ-AXN-ABR-BCP-BEE-BIJ-BJF-BJZ-BKE-BLS-BMC-BOB-BOX-BPC-BPP-BPU-BSE-BSV-BWD-BZU-CDA-CGJ-CGM-CKO-COJ-CPM-CTE-CVL-CVT-CZZ-DAM-DFR-DJS-DKA-DKN-DLI-DOW-DQH-DQN-DQV-DQZ-DSP-DVD-DWP-DYJ-DZW-EAB-EAL-EGJ-EJU(ZZW)-EK-ETJ-ETM-EWB-EXH-EYE-EYS(ZZBN)-FAC-FEO-FEW-(DSU)-FII-GAC-GEQ-GJA-GJJ-GKE-GKZ-GLZ-GMA-GNM-GYX-HAE-HAH-HAX-HEP-HEU-HGL-HJ-IKJ-ISX-IY-PQ-RJ-UO-ZX.

W7ACP(W6AAX)-AEC-AFS-AFT-AFU-AHF-AIG-AJ-AMU-ANX-AOD-ASX-ATX-AVP-AFF-AWG-AWH-AWJ-AXG-AXJ-AYP-AYV-BAA-BCU-BGM-BHH-BJS-BJZ-BLN-BMF-BOF-BOI-BOZ-BVE-BWS-BZA-CEG-CEJ-CHH-CHV-CHK-COH-CPY-CRH-CUK-BVE-CXC-CXK-CXR-CZY-DBR-DP-GL-HP-HX-IC-IG-IY-LJ-LT-MF-WR.

W8AES-AFB-AFU-AGW-AOA-APC-ATN-AVJ-AVK-AXV-BBH-BDD-BDG-BKG-BKM-BME-BMG-BON-BUM-BZB-BZL-CEU-CIO-CMI-CMJ-CN-COW-CRU-CVF-CXN-DBT-DDM-DGW-DMF-DNM-DNV-DRL-DTW-DUP-DVL-DYV-DZU-EBJ-EBY-ECF-EDG-EEN-EEQ-EIG-EIK-EIS-EGX-ELJ-ELU-EPP-EXI-

EZR-FDY-FFK-FGA-FHN-FLA-FPL-FTP-FTW-FU-FUG-FWX-FXH-FYF-GFV-GLI-GNO-GTL-GUC-GUL-GVL-GVV-BZ(ZG)-HD-HFZ-IKN-IMC-IMV-IU-JAI-JAK-JK-JE-JM-JNG-KCT-KIA-KJK-KJS-KKQ-KMC-NP-OK-QC-QV-RN-TI-UW-VD-VE-VP.

W9AAN-ABE-ABI-ABP-ADJ-AET-AFC-AFD-AIJ-AIR-ALO-AMO-AOL-AOT-AQV-ARX-ASV-AUI-AYR(ELH)-AYC-AZR-BAN-BB-BCP-BHE-BHQ-BIB-BIN-BJP-BKK-BKJ-BMT-BQR-BTT-BWF-BWJ-BXC-BYM-CDA-CDE-CGM-AGY-CIM-CIW-CJR-CKV-CNE-CNW-CSU-CSW-CSY-CTT-CUY-CWG-DBO-DCC-DCM-DGS-DH-DI-DJN-DJQ-DLH-DMX-DMY-DNZ-DOU-DPD-DPO-DSW-DUN-DVQ-DXL-DYA-DZK-DZU-DZW(GP)-ECE-EFC-EFE-EHW-EIM-EIV-ENF-EQ-EPD-EPJ-EKQ-EQO-ERH-ESA-EJL-EWN-EWO-EVQ-EXL-EXP-EYY-FCW-FEA-FEP-FFD-FGS-FGJ-FJV-FYK-FLG-FLI-FLM-FGQ-FSF-FTJ-FWL-FYB-FYC-FYM-FYX-FYZ-FXZ-GCM-GCY-GFI-GGF-GNY-GQH-GSB-GSO-GTG-GTK-GVU-GWT-GYV-GZB-HAT-HAX-HCH-HCW-HFK-HIB-HK-HKC-HMM-HNG-HMK-HPQ-HSK-HSN-HSY-HTZ-HUG-HUM-HUY-IBQ-IBL-IEP-IFE-IFI-IFT-IFV-IFZ-IGR-IGX-IGZ-IK-INZ-IO-IOL-IPA-IQE-IQZ-ISB-IUP-IXK-IXQ-IYZ-JAR-JDO-JEE-JNG-JO-JOQ-JQL-JXJ-JUT-JYW-KEH-KFQ-KFS-KNZ-KOY-KRD-KVN-KZK-LBA-LCX-LDQ-LEZ-LFG-LFO-LNW-LSI-MHV-MLH-MZD-NCN-NJS-NNZ-ODV-OPV-OQC-OQL-OQV-ORM-OSL-OUO-OWI(W8CZR)-TY-YC-ZZAF.

K7DJA-PQ-VH.

CORPS AREA RECEIVING COMPETITION RESULTS

Corps Area	Active A.A.R.S.	Copies Received From				Accuracy		Standings	
		Actives	Non-Actives	Total	% Efficient	Nr. Acc-Actives	% Accurate	Efficiency	Accuracy
1	96	29	14	43	30.208	23	79.31	9	5
2	56	45	8	53	30.357	35	77.77	3	6
3	63	33	4	37	52.380	29	87.87	3	3
4	37	57	19	76	65.517	39	68.42	6	3
5	101	91	4	95	90.099	31	89.01	1	2
6	63	41	9	50	65.079	33	80.48	7	4
7	137	122	42	164	39.051	90	73.77	2	7
8	33	62	10	72	74.698	42	67.74	5	9
9	163	123	27	150	75.460	112	91.05	4	1

Strays

QST attempts to maintain a complete list of dealers who are interested in and able to supply amateur radio equipment. We are frequently called upon to tell prospective amateurs where to go to buy equipment. We believe our present list is pretty complete, but if any dealer has the slightest doubt of his name's being on it, we should appreciate a line from him. We should like to know his complete address and any other information, such as lines carried, etc., which might be of value to us. We are, of course interested in hearing of new dealers.

It is much cheaper to replace flashlight bulbs than meters or tubes. Put the bulbs in strategic locations in the circuit—in series with tube plates, meters, neutralizing condensers, etc. The 2.5-volt bulbs blow at about 300 mils and can be used in circuits with potentials as high as 800 volts.

—W2AOY

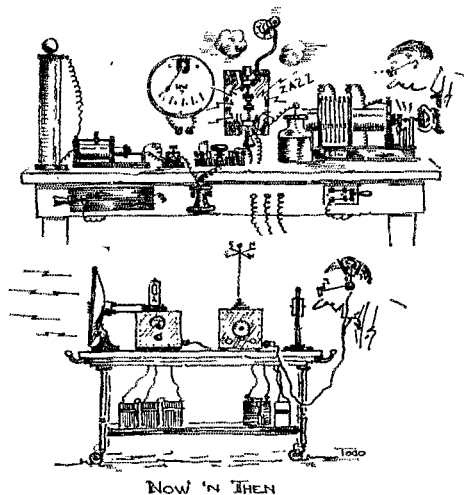

Now 'n Then



More on Silvering Crystals

Recently I came into the possession of a 160 meter crystal which was supposed to double into the 80-meter c.w. band. But for some of those reasons that we can't account for, it didn't.

Past numbers of *QST*¹ had said that the frequency of crystals could be lowered by silvering, so a formula was found that sounded good and the process started. *QST* said that 20- and 40-meter crystals had been done successfully, but no one has handed out anything on 160-meter crystals that I have seen. Anyway, we put on five coats and tried her out. From scratch of 3935 kc., a perceptible but small change was noticed; maybe 5 kc. What a bright outlook, when some of our 20-meter friends had made 20 kc. per coat! Circumstance called for it, therefore we kept on; and after about twenty-five coats we pushed her over for a touchdown, and no more QRM to the noble 'phones! It is my idea that the ratio of the thickness of the coat of silver to the thickness of the crystal is the answer to why one coat here makes so little progress as compared to that made by one coat on a 20-meter crystal.

It is not as bad as it sounds, however, for the formula used would put a coat on in about three minutes, and in another minute the next coat was being applied. This formula was cut down from a five-gallon job, but works nicely:

SOLUTION NO. 1

A—Dissolve NaOH (sodium hydroxide)	1.13 gm.
Distilled water	180 c.c.
B—Dissolve AgNO ₃ (silver nitrate)	1.13 gm.
NH ₄ OH (ammonia)	120 c.c.

Add A to B, then add 2.5 c.c. NH₄OH more to clear solution.

SOLUTION NO. 2

A—Distilled water	23.6 c.c.
Sulphuric acid	2.0 c.c.
B—Distilled water	95.4 c.c.
Cane sugar	17.8 gm.

Bring B to a boil, add 2.25 c.c. of A and boil 15 min. Filter out precipitate and this is Solution No. 2.

PROCEDURE

Add 2 c.c. of No. 2 to 20 c.c. of No. 1, and as soon as it is a good amber color pour over the crystal (which we suspended in an evaporating

¹ *QST*, March, 1932; February, 1933.

dish on ivory pointed tweezers) and leave until the solution turns a muddy brown and looks thick. Remove, wash in distilled water, and put on another coat.

Before silvering, a third solution called "tin stock" was applied to the crystal after it had been thoroughly cleaned. This was washed off with distilled water before the first application of silvering solution. I suppose it was a filler. It was made up of 1 gm. SnCl₂ (tin muriate) to 200 c.c. of distilled water. It does not keep well, but is only used in starting to silver.

After the silvering was finished the edges of the crystal were ground down with fine grinding compound and cleaned with carbon tetrachloride. All results seem to be equally as good as those obtained with the bare crystal, and if ever we are fortunate enough to get into 80-meter 'phone a little nitric acid will clean it with far less effort than it took to put it on.

—Fred D. Armes, W1GMD

Longer "B" Battery Life With the Rationalized Autodyne

Since March I have had a receiver modelled after the January, *QST* autodyne in operation. "B" batteries are used for plate supply because they are without question smoother than any eliminator.

After seven months operation the receiver became noisy and a test of the "B" batteries

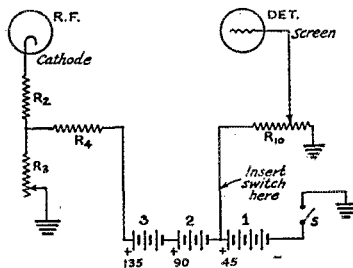

FIG. 1

showed that two of the three used on the receiver were run down. The two that were dead were the 2nd and 3rd (Fig. 1) and the one hooked in the detector circuit was still O.K. This seemed to be unusual as the detector "B" usually runs down first.

The diagram was then dug up and on looking it over the resistors R_3 , R_4 and R_{10} can be seen to be across the last two batteries even when the switch "S" is in the "off" position. The total resistance shorting the last two batteries is 110,000 ohms, which does not seem so much, but by Ohm's law it figures a constant drain of 0.0003 mils. On my receiver a milliammeter shows a little over 1 mil constant drain with the receiver off.

The obvious remedy for this is to install a double-pole toggle switch breaking both the B— lead and the plus-45 lead at the position shown in the diagram. This will give you much longer life from your batteries.

—Robert E. Foltz, W9GBT

Leaky Tube Bases

Here is a kink which may help some of the fellows clear up their notes:

I had trouble in getting a p.d.c. note with my transmitter, a self-excited outfit using a single 10 with 800 volts on the plate. I tried everything imaginable but the note was n.d.c. I found out later that r.f. was leaking from the plate to the grid through the base of the tube.

I took the tube out and filed a slot in the base about $\frac{1}{8}$ of an inch wide and about 3/16-inch deep as shown in Fig. 2. In doing this care must be taken not to file too deeply as one may break the glass tip which is enclosed in the base.

After putting the tube back into service I found that the n.d.c. had disappeared altogether and I got p.d.c., and at times crystal reports. I also noticed that my signal strength increased from an average R6 to R7.

—Andrew Janiga, Jr., W9HPQ

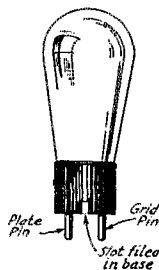

FIG. 2

Half-Wave Hertz for Receiving

The selectivity and signal-to-noise ratio of the National SW3 has been greatly improved by coupling a half-wave Hertz antenna inductively as shown in Fig. 3.

The additional control, C_1 , is not critical. The receiver remains "single control" over ranges of 40 to 60 kc. An optimum and critical value of coupling exists between L_1 and L_2 . When the coupling is properly adjusted, variation of C_1 effectively discriminates between signals which would ordinarily interfere, and such tuning affects the signal strength alone and not the frequency of the beat note.

This attachment has proven very satisfactory

during the past two months. There is no reason why it should not operate equally well at other frequencies when the aerial is cut to a length

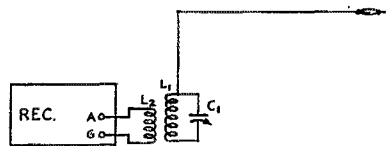

FIG. 3—TUNED ANTENNA TO IMPROVE REGENERATIVE RECEIVER PERFORMANCE

The specifications given below apply to the 7-mc. band. The antenna should be approximately 66 feet long.

- C_1 —90- μ fd. variable condenser.
- L_1 —21 turns No. 22 enamelled wire on $1\frac{1}{2}$ -inch diameter form. Turns should be spaced to make length of winding one inch.
- L_2 —10 turns No. 22 enamelled wire, close wound.

calculated to develop a voltage loop at the end connected to L_1 .

—Robert A. Gallery, W3CTQ

EDITOR'S NOTE: The chief requirement of the circuit $L_1 C_1$ is that it should be capable of tuning over the band to which the receiver is set. It is therefore an easy matter to apply the method to bands other than 7 mc. The antenna will work well on harmonics; it may, in fact, be made approximately 130 feet long and will be suitable for 3.5 mc. and all higher-frequency bands.

Threaded Coil Forms for the Transmitter

The most difficult items to construct in a c.c. transmitter, I believe, are the oscillator and doubler coils. Of course, if we are making them for a low-power job which does not require coils with wire larger than No. 18, these coils can be made very easily. However, when we graduate to higher power where the coils have to be wound with No. 14 or larger wire, then the difficulties increase in proportion to the wire size, especially if the coils are space wound.

I have space-wound doubler coils on a two-inch form only to have the spacing change and the turns slip together when the temperature rose and the wire expanded. In fact, it is almost impossible to wind a coil of this diameter with No. 12 or larger wire by hand and get the winding tight enough to stay put.

Threaded forms are the answer to these difficulties, but did you ever take a form to a machinist and ask the cost to have it threaded? To have threaded forms without having to pay a small fortune for them resort was made to the following scheme:

The forms are drilled for the terminals and then given a thin coat of melted paraffine with a small brush. After the paraffine has hardened, the coil is then wound with the exact spacing required. The wire is then unwound and we have

a marking on the form in the exact position of the winding.

The form is then placed in a vise and using an edge of a small three-cornered file, a "V"-shaped groove is cut in the form, following the wire marking in the paraffine. When the threading has been completed the paraffine is removed by warming the form in an oven and wiping off the paraffine with a rag.

We now have a threaded form on which the wire can be wound with the assurance that it will stay in place indefinitely. Other means may suggest themselves for marking the form other than using paraffine with equal results.

—H. M. Sheffield, W5DX

A Simple Volume Indicator

Those of us who are looking for a simple but effective volume-level indicator may find the one described here, developed for a public address system, of interest. Use is made of a 56 tube biased to cut-off, with a 0-1 milliammeter in the plate circuit as an indicator, as shown in the diagram, Fig. 4. The system takes its heater and plate power from the amplifier on which it is used.

The design shown uses capacity-resistance input to cut down space requirements and to minimize pickup and interaction with the amplifier circuit. A better method from the response

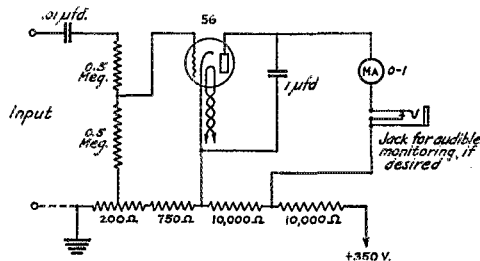

FIG. 4—CIRCUIT OF THE SIMPLE VOLUME INDICATOR

angle, however, is to use an audio transformer. It may either be connected step-up for sensitivity when the comparatively-low impedance of the primary can be tolerated in the circuit, or step-down when the circuit on which it is used must not be appreciably shunted. Using a 3:1 audio transformer as a step-down (secondary as input, primary to indicator grid), 9 volts, 60 cycles, produced a half-scale deflection.

In the hookup shown, the divider system across the input presents a high impedance to the exciting circuit and a reasonably low impedance to the grid-cathode circuit—the latter feature prevents "floating" of the indicator meter. The condenser in the plate circuit is not necessary, but helps show up the peaks and, in case the

indicator is used on high audio frequencies or radio frequencies, bypasses the meter. The values shown work out nicely in my case, but should not be considered sacred.

To operate, disconnect or short-circuit the input, adjust the meter to zero or some convenient low reading by means of the potentiometer supplying the grid bias (it might be well to add that this potentiometer should be set for maximum bias at the ground end to begin with, to protect the meter), and connect the input back to the point at which the level is to be measured—or disconnect your short circuit, as the case may be.

—P. C. Tait, W6AEA

Freqmeter Calibration from B.C. Stations

Some of the fellows are unfamiliar with the fact that highly accurate frequency-meter calibrations can be obtained by utilizing signals that we have with us all day long and most of the night—every day of the year. Stations in the regular broadcast band are required to stay within 50 cycles of their assigned frequencies—better than .01%—and the fact that the assignments are all even multiples of 10 kc. makes it possible to get nice round figures for harmonic spots in the ham bands. We reprint here part of a letter from E. Aymar, W9HVA, outlining an excellent scheme for using the B.C. transmissions. The method requires only one easily-built oscillator in addition to the equipment ordinarily to be found in amateur stations, and can be used by anyone who knows what harmonics are and has a slight knowledge of arithmetic:

"The apparatus consists of two oscillators; one, the regular frequency meter, covering the 1715-kc. band; the second, using the same circuit, covering the broadcast band.

"The two oscillators, a receiver which can tune from 7000 to 8000 kc., and a B.C. receiver are all turned on, with the antenna posts strapped together. Let's tune in WLW on the B.C. receiver. Tune the broadcast oscillator to zero beat with WLW. Shut off the B.C. set. Now you could listen for the 5th harmonic on 3500, but there is an additional advantage in using the 10th at 7000 kc., as I will show later, though we found it most convenient to refer all readings to the 80-meter calibration chart. So we set the receiver near the edge of the 7000-kc. band, and then set the regular frequency meter to zero beat. This gives us one calibration point for the chart, which we will call 3500 kc.

"The same process will give us a 3550 point from WOR on 710, and a 3600 point from WGN on 720 kc. But that's not all.

"Since we are really listening in the 7000-kc.

(Continued on page 73)



Amateur Radio STATIONS



W9FAZ, Chicago, Ill.

W9FAZ is located at 21 Bellevue Place, Chicago, which to local hams means that it is in the d.c. zone. Naturally this factor has been important in the design of the station equipment.

The receiver, a home-made set, has two r.f. stages, one untuned and one tuned, both using

buffer and a final amplifier using the 211. It is mounted on the rack shown in the photograph, together with the power supply and "C" batteries. Room has been left for the installation of modulating equipment at a later date.

W9FAZ has been on the air only for a little over a year, although Monro MacCloskey, its owner, has been interested in radio since 1915.

W2ETD, New York City

EDWIN J. DUNN, owner of W2ETD, is also an operator at WPEF, one of the stations of the Police Department of New York City. Since W2ETD works almost exclusively on 160-meter 'phone, the OM's activities, both work and recreation, are centered in the 150-meter region.

The transmitter is a Collins 32-B, a combination 'phone-c.w. outfit having a 47 crystal oscillator, 46 buffer, and two 46's in parallel in the final amplifier. The speech line-up is a 57 high-gain amplifier, a 46 driver and two 46's in Class-B audio. A double-button Universal Model X microphone is used. Crystals for three frequencies in the 1800-2000-kc. 'phone band are available. A 130-foot Marconi-type antenna is used for transmitting.

A seven-tube all-wave Colonial receiver takes care of the receiving end. The tube complement of this set includes a 56 oscillator, 24-A first detector, two i.f. stages with 58's, a 57 second detector, and 47 audio.

W2ETD has worked five U. S. and three Canadian districts on 160-meter 'phone. Although

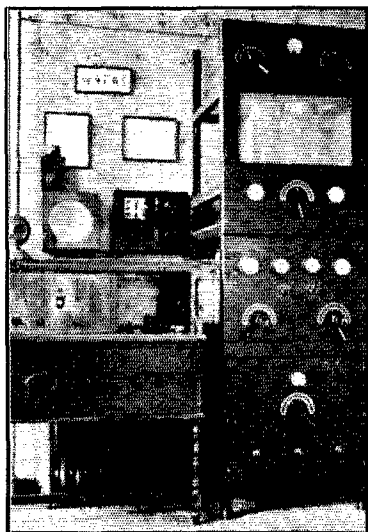

Type 36 tubes, a 36 detector, 37 first audio, and two 12-A's in push-pull as a second audio stage. Filament power is obtained from an Edison battery; plate voltage comes from the 110-volt d.c. line with 70 volts of dry batteries in series. A loud-speaker is used most of the time for reception, although headphones are available.

Power for the transmitter is obtained from a rotary converter whose output is stepped up to 110 volts a.c. by means of a transformer. From then on the power-supply equipment is the usual transformer-rectifier-filter arrangement. Filament and plate power for all the tubes in the transmitter come from this source except the filament current for the final tube, a 211, which is heated from the 110-volt d.c. line with a resistor in series.

The transmitter itself consists of a Type 10 tube in the t.p.t.g. circuit, followed by a 10

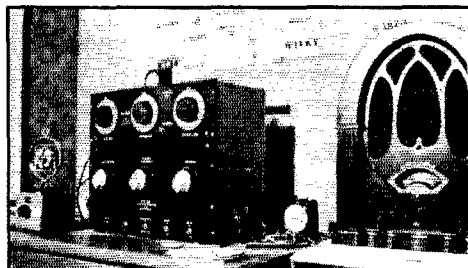

the station has been on the air only since December, 1932, Dunn is an old-timer, having operated 2CHN back in 1922, and has held several commercial tickets in the interim.

• I. A. R. U. NEWS •

Devoted to the interests and activities of the
INTERNATIONAL AMATEUR RADIO UNION

President: H. P. MAXIM

Vice-President: C. H. STEWART

Secretary: K. B. WARNER

Headquarters Society: THE AMERICAN RADIO RELAY LEAGUE, West Hartford, Conn.

MEMBER SOCIETIES

American Radio Relay League
Associazione Radiotecnica Italiana
Canadian Section, A.R.R.L.
Českoslovenští Amatérů Vysílací
Deutscher Amateur Sende-und-Empfangs
Dienst
Experimenterende Danske Radioamatører
Liga Mexicana de Radio Experimentadores

Nederlandsche Vereeniging voor Internationaal Radioamateurisme
Nederlandsch-Indische Vereeniging voor Internationaal Radioamateurisme
New Zealand Association of Radio Transmitters
Norsk Radio Relæ Liga
Polski Związek Krotkofalowcow
Radio Society of Great Britain
Rede dos Emissores Portugueses

Reseau Belge
Reseau Emetteurs Français
South African Radio Relay League
Suomen Radioamatööriliitto r.y.
Sveriges Sandareamatörer
Unión de Radioemisores Españoles
Union Schweiz Kurzwellen Amateur
Wireless Institute of Australia
Wireless Society of Ireland

Conducted by Clinton B. DeSoto

Decade:

Past months have found us commemorating many tenth anniversaries of initial international communications. The first transatlantic communication, the first transpacific communication, the first contact with this country and that continent—they pile up in an amazing array of history-making feats, accomplished by the pioneers of ten short years ago—ten years which span the entire existence of international amateur radio.

Recently we've been looking into some of those old records, checking up on them in the light of ten years, endeavoring to verify them beyond all question for history and posterity. We have one important change to make in the published *QST* account of first workings, both as published ten years ago and in *QST*'s recent editorial on the first transatlantic contact. From unquestionable evidence recently adduced, it seems that the first contact between Canada and Great Britain was not between g5BV and c1BQ in Halifax on the morning of December 28, 1923, as stated. The Canadian station is correctly given, but the honors on the other end go to station g2OD, Mr. E. J. Simmonds, now vice-president of the R.S.G.B. These two stations first worked at 0500 G.T. on December 16, 1923.

Perhaps we'll have something to say later about the first transpacific QSO. At any rate, we want to get the record as straight as we possibly can.

DX:

Conditions continue to change, in many localities decidedly for the better. Down in Aussie signals have been strong, but QRN equally so. In South Africa they find two listening periods for

W stations on 7 mc.: from 1400 to 1600 G.T., and from 0300 to 0500. All nine districts are heard in the latter period; when a big fellow stops, a little one can be heard peeping along in under him, says N. Jervis, ZS2F. Hundreds are heard, mostly on the 7000-kc. end; few stations are heard between 7100 and 7300. The season for W is from October to April.

The 3500-kc. band gets better and better. Recently, W1SZ, working CE7AA, found his 3.9-mc. signals got down to the Straits of Magellan R7-8, while the same power at the same time on 7 mc. brought only R6. Correlative effect on W working noticed by W6CUH-W6QD: when J's are heard on the U. S. east coast, Asia Minor and Northern Africa come in on the west, on 7 mc. Moderately long distances are hard to work just now; the transition stage has apparently centered the best frequencies between 14 and 7 mc., and neither band is particularly good. 7 mc. shows growing promise, however. R9 signals are becoming more frequent, but stations do not clog the bands as formerly.

On January 1st the N.V.I.R. renewed their unique "countries worked" contest, which will run until June 30th. Four bands are used: 28, 14, 7 and 3.5 mc. Points are given for each country or district worked. The PA fellows will appreciate your cooperation in piling up their totals.

General:

G. E. King, ZE1JF, claims the world's low power 'phone record for his contact with W6QD when using 9.57 watts input He is on daily from 1400-1800 G.T. on 7 and 14 mc. KA1WR, Harry Wright, was seriously injured when he fell from the 60' cross-arm of a

Mackay 90' pole, KA1XA told W6AM on their Sunday morning schedule H. Collin, G2DQ, with an input of 10 watts, won the R.S.G.B.'s 3.5-mc. test, with R. A. Bartlett, G6RB, and J. Wyllie, G5YG, placing G2DQ's contacts included two with North American stations Speaking of low power DX records, G. B. Ragless of W.I.A. tells us that VK6SA, while working W6BHQ recently, reduced power to .28 watt! The world's 56-mc. 'plane-ground reception record is claimed by G6FY and PAOHI, operating the R.C.C.'s test ship last August A late listener's report arrived from the north of England confirming transmissions when the airplane was 235 miles distant Band occupancy checks taken by the R.S.G.B. last September showed 706 G stations active on one or more bands, an increase of nearly 200 stations since the March check Organization of amateur radio in Roumania is progressing, with CV5AF, CV5AS, CV5EV, and CV5FD as leaders A. H. Tilse, VK4WO, is another amateur to add to the list of those anxious to welcome overseas amateur visitors, so keep that in mind when you visit Brisbane First overseas applicant for membership in the TBTO Club is R. A. Bartlett, G6RB, whose qualifying QSO's were with VE1BV He's anxious for 3.5-mc. W QSO's

The following amateurs were issued WAC certificates during the year 1933:

Leonard T. Robinson, W6WO; Albrecht Leyn, D4POJ; Bryan Groom, G6RG; Lawrence D. Geno, W8PE; W. Wishart, VK4WT; Arthur Walz, VK4AW; Archie & Bennie Davis, XU1U; George T. Sperry, W9CBJ; Prof. E. Kaply, HAF2G; Edwin J. Sahn, W2CKR; W. J. Crawley, G5NP; A. S. Woolnough, VK3BW; Delbert Avery, W7BGH; Adelbert C. Lawrence, W7BFG; K. R. Rankin, VK3KR; C. L. Ganes, W7AAX; Antonín Machán, OK2MA; M. Libert, ON4CN; Lewis Mims, W5BZT; M. Kohno, J3CX; O. P. S. Ottosen, OZ5X; W. B. Weber, G6QW; Thomas C. Freshwater, CT2AW; Basil Wickham, G2DW; Walter B. von Bergmann, W6BUC; F. Castro Herrera, X1AX; Lawrence K. Jones, W8CTN; G. W. Wigglesworth, G2BH; H. Biltcliffe, G5HB; Jos. W. Ivy, Jr., W9CVZ; C. S. Taylor, VE1BV; Guy E. Wilson, W9EL; J. R. Scott, W8ER, Leonard W. Haeseler, W3BBB; Donald McR. Parsley, W4FT; A. & A. Paquet, ON4GU; A. M. Ralli & D. S. Mitchell, G2II; N. E. Read, G6US; Elmer F. Wurzberger, W9LF; Frank S.

Libbe, W5BBR; R. Mirche, D4UDO; Helmuth Theysohn, D4NGQ; G. A. Shoyer, ZS1H; S. H. Luitwieler, W6GRX; Jack Lees, G2IO; Clyde C. Anderson, W6FFP; Bill Werden, W8DMK; Dr. W. Heinze, D4ADC; L. Aubry, F8TM; P. G. Pretorius, ZT2H; A.R.R.L., W1MK; Miss Nelly Corry, G2YL; M. H. Wilkinson, G2YU; C. Haderka, OK2HM; T. Sargent, ZLICE; H. McCabe, ZL2HA; J. Doesema, PA0GO; L. R. Seal, G2OC; Kraicz Károly Jenő, HAF1C; Kenneth R. Boothe, W5PJ; Veronn Gebhart, W6AOD; Adolph Anderegg, HB9S; Norman E. Huggett, G2PF; S. A. French, G6FN; Charles E. Spitz, W2API; Paul Heineman, OZ4H; Knud Bjarno, OZ7KB; W. Powell Hunter, W4TZ; Charles E. Perry, W9ASV; John Marshall Etter, W1DHE; A. H. Elsner, W6ENV; Louis Lerambert, F8GG; Robert Carlisle, G16WG; LaMonte Rusche, W5AFV; K. F. Iwata, W6FZY; R. Hammer, D4JPC; Roy C. Corderman, W3ZD; Roy W. McCarty, W9KA; Carlos G. de Cosio, X9A; F. L. Hawthorne, ZL1GX; W. G. Collett, ZL4BP; E. G. Ingram, G6IZ, Joao Pinheiro, CT1BG; J. J. Curnow, G6CW; W. H. Bostwick, W2GW; George W. E. Shields, W2VY; Earl N. Schnoor, W9AZZ; Harold C. Turner, G5OJ; R. E. Pinkham, W6BPT; William



G5RV, OWNED BY R. L. VARNEY, CHELMSFORD, ESSEX WAC ON C.W., FIVE CONTINENTS ON 'PHONE, WITH 30 to 50 WATTS INPUT D.C. grid modulation is used.

Breuer, W6TE; M. Hermans, ONK4; W. Metselaar, PA0MM; Domingo N. Cordivola, LU5FV; W. A. Sayles, W8ANO; F. J. Finn, G6UF; Fred E. Ziegler, W8BSF; Herbert E. Snyder, W3CJN; Edward C. Nau, W8CMB; Russell Bassett, W1AFU; W. E. Lane, VQ4CRH; John F. Karlson, SM6UA; George Sinclair, W6GAL; Max Mousty, ON4RUP; Henry Bolley, F8UM; Theo. Githens, W9AEH; Dan L. McPherson, Jr., W5A00; M. R. Campbell, VK3MR; Robert Y. Chapman, W1QV; South African Military College, ZS6B; O. W. Reid, ZS2A; Pippo Fontana, I1AY; Arthur C. Webb, G6WQ; J. S. Owner, G6XA ('phone); Norman LeBlond, W9FNO; Arthur M. Braaten, W2BSR; Ray C. B. Barnes, G6DS; R. A. Hiscocks, G6LM; Eugene B. Kille, W6CRI; Ed. W. Connell, W4AKH; A. Edward Hopper, W2GT; Johs. Fundingsrud, LA2C; E. H. Fritschel, W2DC; W. N. Fellows, W6CIX; S. Riesen, G5SR; Otto Bauman, HB9X; Anisio Soares, CT1CB; A. J. Langlois, W6BCP; Kenneth B. Woodbury, W1TE; J. Müller, HB9AK; George W. Murphy, W8SI; A. Reimann, VK5JO; D. C. Shanks, ZT2A; Maurice Geude, ON4MGM; P. H. A. Hoffmann, PA0CH; Paul Brumbaugh, W8FKY; Julio Murtinheira Machado, CT1DC; Stanley T. Toper, W1CLX; Charles D. Roe,

(Continued on page 88)

THE COMMUNICATIONS DEPARTMENT



F. E. Handy, Communications Manager
E. L. Battey, Assistant Communications Manager



Operation and Cooperation

By G. Merriman, VS6AH *

INTERNATIONAL competitions provide a lot of good fun, and interesting new contacts, and sometimes give us a few problems also. During the recent international competition our major problem was to copy DX signals while five or six truly local stations were all "getting out" with a hefty punch in their signals. The first few days of the contest were gruelling. QRM was heavy, with the dial full of W stations in addition to our local Stentors. Something had to be done! The main trouble seemed to be that there was not a clear space in the whole seven mc. band in which anyone could be sure of copying a W station without fear of a powerful local signal rising to the occasion and blotting him out.

By getting the gang together and getting suggestions from them we hit upon the plan of all using a transmitting frequency *near to each other* so that only one small part of the band was taboo. Accordingly we all swapped and borrowed crystals for the period of the contest which grouped us all somewhere near the low frequency end of the band. Thereafter the rest of the band was left clear for DX signals. This was real coöperation and it worked splendidly. A great deal of unnecessary interference was also eliminated by everyone using the fewest possible radio abbreviations to exchange the test signals and the signal reports. Instead of grinding out each time GE OM UR T8 SIGS QSA5 R7 . . . we tried abbreviating it to UR SIG 857, hoping that the other fellow would get the idea and copy it. This too worked well. Of the hundreds of stations worked by our small gang only one or two failed to get this "frame" report and understand it. Another simple time and interference saver was to end the transmission without an extra sign-off of the other stations call "de" our own, a practice which it is difficult to believe is of any further use in these enlightened times.

Those of us who have not tried anything new for a while would do well to try the simple expedient of sending QRZ? de our own call after finishing a transmission. During the competition in March this year the writer raised no less than forty-four W stations by this method. Think of the time that was saved and the amount of local QRM which was eliminated.

Another useful thing to remember under special conditions or for that matter at any time is that the man at the other end should never be under-rated. While we grind out things at twelve words per minute sending double "to make sure" the receiving operator is often grinding his teeth with impatience wishing we would get a move on. A good operator indicates by the speed of his "come-back" just how fast he wants you to send to him. If he operates short and snappy it is a sure sign that he is trying to get you to do likewise. Those fellows who pound your call solidly and surely as though they were fearful of

you not hearing them are the ones who need your double sending and steady spacing. A little study of amateur psychology can be very often of great help in operation. The moral of this story is that even in the most hamly-populated city it is possible to operate with ordinarily unselective receivers without feeling sore at your neighbor *if only the radio club members will get together* and agree to use one narrow channel in the band to leave the rest of it free, and at the same time agree to cut transmissions to a minimum.

Flying Fun on Fifty-Six

By Stanley P. McMinn, W2WD *

FIFTY-SIX is fun. If you want to find out for yourself take a weeny little transceiver in your lap, climb into an airplane with a trustworthy pilot and go places. I did—and found out a lot of things about five-meter work.

For months a dozen of us in the Garden City Radio Club have been duplexing nightly, using several varieties of station equipment. Dr. L. J. Dunn (W2CLA), pioneering ex-director of the Hudson Division, said to me one day, "Let's try out this flying stuff." Flying is not new to him (he holds a Transport pilot's license), nor is 56-mc. work new for that matter, but neither of us had tried a combination of the two. Dick Depew (W2SB), also an aviator, and an enthusiastic radio amateur as well, built



THE BASE STATION, DESIGNED AND BUILT BY W2WD

A pair of '10s push-pull was used with a pair of 250s for modulation and a single 56 speech amplifier.

himself a honey of a transceiver measuring about 5 inches on a side, and with the two '30 type tubes operating on about 135 volts "B." After operating this equipment all over the neighborhood against a quarter-wave dur-aluminum rod mounted on the radiator cap of his "Chevy" with 8-foot Zepp feeders, he was impressed to function

* G5—, 4 Pennance Terrace, Windmill, Launceston Cornwall England.

* 181 Dover Parkway, Stewart Manor, L. I., N. Y. Editor, *Automotive Merchandising*.

as the ground station for our first flying tests. These were carried out on a not too warm day, January 21st.

So successful were those tests that Arthur Lynch (W2DKJ)—of resistor and antenna fame—joined the group. He and Dr. Dunn organized a much more ambitious



THE GROUP THAT CARRIED OUT THE TESTS

Left to right: Ed. Ruth; S. P. McMinn (W2WD); Arthur Lynch (W2DKJ); Dick Depew (W2SB); Sonny Trunk, who flew one of the ships; Dr. L. J. Dunn (W2CLA), who flew the other ship; and Harry Steenberg (W2AOL).

test. This was run off on Sunday, January 23th, this time using two ships, and a base station installed in one of the Roosevelt Field hangars for the purpose. The base station was the usual pair of 210's in push-pull with a pair of 250's for modulators, Class A, with one stage of speech using a 56 and a single button mike. A Picard-type antenna with feeders about 35 feet long was used, and a manufactured superregen receiver which gave a good loud-speaker signal.

In one of the ships Dick Depew (W2SB) installed his home-made transceiver feeding the same quarter-wave duraluminum rod mounted vertically between the wings and with 8-ft. Zepp feeders. On the other ship we mounted a full-wave antenna split in the center and fed with a twisted pair of random length from a transceiver with 180 volts of B-battery. Heavy duty B-batteries for both base station and the two ships were graciously supplied by the National Carbon Company, as were the necessary 6-volt "hot shots" for filament supply. Installation work was finished Saturday afternoon. Ground tests were made Sunday morning. About 1 p.m. the two ships took off with a gale blowing. The operators in both ships were able to establish contact with the base station practically at will and to receive flying instructions. This permitted quite an eye-filling demonstration. A big gallery had gathered for the tests, thanks to publicity in local papers and QST from WIMK.

Ship to ship contact was difficult due to several causes, the most prominent of which was the difficulty of hearing anything other than really strong signals through the roar of the motor. Ignition QRM gave little trouble, but it is not the easiest thing in the world to devise means of getting radio signals into one's skull without letting in noise from a 9-cylinder Whirlwind. However, a couple of contacts were made. Another great difficulty (and maybe there ought to be a law against it) was transceiver QRM. Literally thousands wanted to hear what the ship operators were saying. This was unfortunate, for these little bloopers blocked out the relatively weaker signals from ship to ship. One lad, with a fairly powerful transceiver mounted on a car parked in front of the base station, had a joyous time taking in the whole proceedings, not knowing or caring about the QRM his transceiver caused.

Another difficulty manifested itself in the choice of microphones. W2SB had a standard Universal single button Handimike which was entirely too sensitive and picked up

an awful lot of the roar of the motor. The mike I borrowed for the occasion was constructed for aircraft use. Hence, it was most decidedly insensitive and it was necessary to shout pretty loud into it. However, the signals produced were far and away better than those produced by the more sensitive mike.

At the base station signals from both ships were R9 even when the ships were as much as ten miles away and the altitude 5000 feet. Reports of R8 to R9 signals were received from a large number of stations all over Brooklyn, Long Island, New York, and nearby New Jersey, and both ships were able to QSO quite a number of stations.

The group including Harry Steenberg (W2AOL), who operated the base station, Randy Enslow (W2BI), Jim Tynan (W2BRI) and those already mentioned are planning to continue the tests, but under conditions that experience will permit us to make more favorable and with equipment that we are reasonably sure will be better suited to the work. We are planning now on a couple of miniature transmitters and receivers which will be quite separate, though operated from the same plate supply. The transmitter in our judgment should probably be a '41 with Class B modulation (for economy) using a 79 to drive another 79. With such equipment we shall be able to put out an even stronger signal than is possible with the flea power available in a transceiver, and we are

hopeful that we may be able to eliminate about 90 percent of the transceiver QRM.

Ties That Will Bind

By D. V. Clack, W7AHZ*

BEING a 'phone ham at heart (but broadminded) I often think how much more friendly an attitude we would have toward each other if we would but strive to have more 'phone-c.w. QSO's. We're missing half the fun of amateur radio, when we don't pull together, and keep in contact with all of amateur radio.

May I suggest a remedy? Here in my own station, I believe I've made many friends who pound brass instead of using 'phone: I quite often call CQ, 'phone or c.w., and sometimes I get an answer on c.w. But not often enough to suit me. It certainly breaks the monotony of station operating to work 'phone-c.w. contacts or vice-versa. Not only that, when you have completed one of these contacts you have almost invariably made a true friend.

Another thing—where is the "dyed in the wool" 'phone ham who doesn't need to brush up on his code work? We're bound to lose code speed if we don't use it once in a while. Come on fellows, let's give this a try. High time we had some friendly 'phone-c.w. QSO's. Are you with me?

Spanish DX Contest

The U.R.E., Spanish amateur radio society, announces a contest to be held between Spanish and foreign amateurs on each of the following week-ends, from 0000 GCT Saturday to 2400 GCT Sunday: March 24th-25th, March 31st-April 1st, April 7th-8th. There will be prizes and diplomas for both Spanish and foreign participants. Contacts between EA (Spanish) and W amateurs will be considered for special awards. In the Spanish organization the highest four scorers in each region will be the competitors for the Asturias Cup, a special prize for Spanish amateurs. Any amateur working an EA station during the weekends mentioned should QSL to the headquarters of the U.R.E., making sure to give the code group which he will have received from the Spaniard. Address of the U.R.E. is Apartado 262, Av. Pi y Margall, 5, 2., Madrid, Spain.

*Creswell, Oregon.

The following contribution by Mr. C. R. Stedman, W7ASQ, wins the C.D. article contest prize for this month. Your articles on any phase of amateur communications activity are likewise solicited and may win you a bound Handbook, or three logs, or message pads. Send yours today.—F. E. H.

Fellowship and Amateur Radio

By C. Raymond Stedman, W7ASQ *

IN YOUR contacts outside Amateur Radio you often hear the expression, "He's a swell fellow," or words to that effect. If you know the man referred to, the chances are 20 to 1 you think he is too. He is what is known as a good mixer; he is friendly, and cheerful. There may be a magnetism about him that attracts all who know him. His popularity is the envy of all.

In our everyday life we all strive more or less towards the goal of such popularity. Few attain the goal. Many measure up to a degree.

In amateur radio practically any of us can rate par, however. When you work a fellow on the air, act as you feel toward him—friendly. If there is no traffic and he seems to be headed toward a "rubber stamp" QSO, a word or two may divert him. When it comes your turn to carry on the conversation, avoid the usual form. Put the weather, the description of your rig, etc., in your own words, add an original remark and finish up in such a way that the ham at the other end feels free to, but not compelled to chew the rag with you. Common courtesy of course demands that you slow down when asked to, and you will find that alone will make a new man remember you favorably years later. Needless to say, a clean signal, good fist and clean operating also contribute their part to the impression you create upon the other fellow.

Frequently a ham who is only occasionally on the air hesitates to refuse a message because he is afraid the other operator will hold it against him. As a result of the League's campaign the past few years, most operators will risk the displeasure of the other man and refuse a message under those conditions, as they should, but frequently spend five minutes explaining *why*. Such a ham is, however, almost invariably fond of a little chat and a few minutes spent this way will make him feel much better, especially when you thank him for refusing traffic he is not in a position to handle.

In amateur radio, being a good fellow doesn't end on the air. You are liked by brother hams as a matter of course. The new-comer to the game usually has yet to learn of the universal fraternal feeling between hams. His inexperience and natural shyness make it doubly easy to unintentionally slight him at club meetings and even when you chance to meet him elsewhere. Talk to him; take an interest in him; when you first started in the game it made you feel pretty good to have one of the old timers take a few minutes to talk to you and get you acquainted with the gang. Just—be friendly; that's all.

When you do these things you are building yourself a reputation as a "Swell fellow." It is a matter of common operating courtesy also. Most of all you are making the other fellow feel that amateur radio is even *more* worthwhile.

TRANS-ATLANTIC DX ON 1.75 MC.

Following the announcement of tests every week-end on 160 meters (p. 52, Feb. '34 QST), the first 1934 two-way transatlantic contact took place on the morning of February 3rd—between G5WU and W1DBM. See last month's announcement, and continue midnight to 2 a.m. (E.S.T.) 1750 kc. testing each Saturday and Sunday morning throughout March, if interested. Remember, starting at midnight, W/VE stations are invited to transmit for 15 minutes, alternate 15-minute periods. Do

* RM Montana, 508 Hollins Ave., Helena, Montana.

not transmit (but listen for G stations) 0015-0030, 0045-0100, 0115-0130, and 0145-0200 E.S.T.

W1DBM, North Falmouth, Mass., worked G6FO 11.35 p.m.—12.50 a.m. E. S. T., Feb. 19/20, 1933 . . . the first W-G contact (two-way) in nine years! This was a result of tests between Group 10A of the R. S. G. B. and W amateurs. Input at G6FO to a P.P. TPTG (1791 kc. xtal. across grid coil) was 9.7 (watts 230 volt mains x 42 ma.).

April 1924 QST (page 46) records the last such work which was trans-Atlantic DX on this amateur frequency band, "1B5D Providence, R. I., worked PCII Feb. 15, 1924, using one UV202, 64 watts input, on 150 meters." This same issue records what was apparently about the first recorded amateur work in spanning the Atlantic by 'phone. In February 1924, g2KF using voice hooked up with u1BDI using telegraph. About this same time u1XAR-BDT using 'phone established two-way communication with various European amateurs using code, so that we believe Mr. Heap holds the record for being the first 'phone amateur to work across the Atlantic using voice from this side. This issue of QST also indicates that Reinartz, u1XAM-u1QP, had just reached the unprecedented high frequency of 4000 kc. (75 meters) in his experiments working PCII (Netherlands) with 30 watts input that same month. The 3500-4000 kc. band became populated rapidly after that!!! . . . and the experimenters went on to the virgin territory at 7 and 14 mc.

On the historic date of Nov. 27, 1923, u1MO, u1XAM and f8AB first demonstrated two-way trans-Atlantic communication on 110 meters on schedule. Following this work, during December 1923 and January 1924 the exodus from 200-meters-and-above was rapid.

"G5WU of Penarth Glamorganshire was heard and called by W1DBM at 0640 Greenwich on Feb. 25, 1933. W1APK, W2ASH, and W1AQF have also been heard. Transocean DX should be easy in 1934 on this band; probably the best time in early January will be 12.30 a.m. to 2.30 a.m. E. S. T.* It is noteworthy that on the last two tests, signals appeared to be better West to East in December, and East to West in February. Results point to a gradual improvement on the low-frequency bands in accord with the 11-year cycle* theory." —AUSTIN J. E. FORSYTH, G6FO.

Traffic Briefs

Byrd Expedition traffic by amateur radio continues to be routed via NY1AB, Darien, Canal Zone. During the period December 15th-January 16th NY1AB handled 1659 relays on schedules with the Jacob Ruppert (KJTY). NY1AB-KJTY schedules are maintained with NY1AB on 14 and 7 mc., and KJTY on 16,400, 11,040 or 8290-kes. In the Canal Zone, KJTY on 8290-kes. is good from Midnight until 0800 EST, on 16,040-kes. from 0800 to 1000 EST, and on 16,400-kes. from 1600 to 2000 EST. NY1AB schedules with the Bear of Oakland (WHEW) were broken when she arrived at Wellington, N. Z. and traffic for her has since been routed via KJTY. Operators McCutchen and Vandekamp at NY1AB would like to thank the stations in the States that are delivering and collecting this Byrd traffic.

An Arizona Hamfest is announced by the Arizona Short Wave Radio Club for March 17th and 18th to be held at Phoenix. Speakers, contests, prizes, banquet, everything that makes for a successful ham-get-together. Inquiries should be addressed to F. Hackman, W6HEU, Sec'y ASWRC, P. O. Box 1773, Phoenix, Arizona.

"Synton," honorary radio fraternity of the University of Illinois, will hold a Hamfest at Champaign, Illinois on

* Going back to some old records, we find that conditions in 1923 and 1924 permitted transatlantic communication in January from the time darkness reached the east coast U. S. A., until contact was interrupted by sunrise in Great Britain. The period "best" for contacts narrowed month by month (as days grew longer, and nights were shorter) until communication in April and May 1924 was possible for only the one or two hours, as predicted by G6FO, when the transmission conditions were most favorable. 1.75 mc. is rapidly "coming into its own" with a return to DX probable on this frequency for the next two or three years.

BRASS POUNDERS' LEAGUE

Call	Orig.	Del.	Rel.	Total
W6RTL	260	510	1644	2414
W8HGG	951	362	908	2221
W6ESA	42	95	1594	1731
W6KQ	29	377	1248	1654
W6BMC	14	26	1406	1446
W6KJY	118	142	960	1240
W8ZG/PQ	799	186	254	1239
W6IFE	66	70	1047	1183
W6GXM	121	233	710	1064
KAINA	292	102	664	1058
W6FTW	50	35	962	1048
W7AMA	264	672	—	936
W7CZY	39	86	789	914
W9NMR	320	441	146	907
W9UM	477	393	4	879
W6BMI	34	71	764	869
W6KNZ	87	107	648	842
OMITB	23	130	366	840
W7WY	10	33	774	817
W8GZ	50	117	648	815
W6CII	75	104	602	781
W7RT	697	137	28	772
K6GUA	383	63	116	762
W6EVJ	58	99	603	760
W6ALU	94	301	354	749
W6FGS	76	21	652	749
W6DQN	35	86	618	739
W6LLE	69	83	580	732
W6GCEZ	123	123	472	718
W7AYO	108	102	501	711
W8AZF	79	75	556	710
W6QWC	81	63	558	707
W3BTL	213	105	387	705
W3CL	—	119	460	677
W2ELB	98	119	460	677
W1FIO	61	256	348	665
W7HD	46	52	564	662
W8SN	76	131	448	655
W6CJU	88	105	462	655
W6KPA	9	20	616	645
W9DI	47	100	494	641
K6JPT	545	56	20	621
W8GUF	72	62	466	600
W4BRG	294	294	6	594
W1AMG	70	121	386	577
W9MZD	47	14	516	577
W9FLG	50	55	464	569
W6FQY	138	176	246	560
W9BRX	30	40	490	560
W4AFM	52	4	472	528
W6RJ	17	74	432	523
VE3WX	65	68	390	523
W6CVZ	251	260	4	515
W8BTI	227	238	50	515
W8RN	282	54	176	512
W4JY	23	202	276	504
W6DSP	68	364	69	501
W9LZU	94	48	359	501
W8BJO	85	63	352	500

MORE-THAN-ONE-OPERATOR STATIONS

W3CXL	451	858	4253	5562
K6EWQ	927	447	1856	3230
NY1AB	305	317	2360	2982
KAIHR	654	414	1400	2468
W6W	513	145	1494	2152
W6EMH/FCE	901	699	2	1602
AC2RT	364	207	312	883
W7LD	100	58	521	679
W6FWJ	175	47	327	549

These stations "make" the B.P.L. with totals of 500 or over. Many "rate" extra credit for one hundred or more deliveries. The following one-operator stations make the B.P.L. for delivering 100 or more messages; the number of deliveries is as follows: Deliveries counted

W6GHD, 329	W8DZ, 121	W8FLA, 106
W9AUB, 198	W1CRA, 119	W3ALX, 105
KAIRC, 189	W6JAL, 118	W8AZU, 103
W9DMA, 167	W2ELK, 115	W8EMW, 103
W2DBQ, 148	W9BWJ, 113	W7DGN, 103
W9FSS, 143	W8DML, 112	W9GBJ, 102
W9GWW, 143	W6ENM, 109	W9DMY, 101
KALG, 141	W1BNW, 109	W7CWL, 100
W4DS, 138	W7BEV, 107	W8DTE, 100
W6AF, 131	W6NF, 107	W6AMM, 100
W8ERZ, 125	W8BHQ, 107	W4CHJ, 100
W9IYA, 122	W1TE, 107	

A total of 500 or more, or just 100 or more deliveries put you in line for a place in the B.P.L. Make more schedules with reliable stations. Take steps to handle the traffic that will qualify you for B.P.L. membership also.

April 7th and 8th. All hams are invited. For further information communicate with Don R. Larimer, W9IYP, 334 Illini Hall, Champaign, Ill.

The Western Massachusetts Amateur Radio Association installed and operated its station, W1FQA (portable), at Longmeadow, Mass. during the Sesquicentennial celebration of that town, October 13th, 14th, 15th, 1933. A good number of messages were handled for the townspeople as well as numerous messages of greetings from the local Boy Scouts to other troops throughout the country, and many new friends were made for "amateur radio." Well done, WMARA.

The Houston Amateur Radio Club is conducting code practice on the 1.7 mc. 'phone band from its club rooms each Monday and Friday from 7:00 to 8:00 p.m. CST. This club also has a class of instruction on the class "B" license examination, with about 50 members enrolled.

Five hundred and sixty amateur radio enthusiasts attended the Banquet of the Federation of Radio Clubs, Southern California, held January 20 under the auspices of the Pasadena Short Wave Club, shattering all records for attendance and interest! Activities started at noon with a complete showing of latest equipment, and continued until the early morning hours. In the afternoon some very fine technical talks were given by W6GHW, W6CUH, W6EHM and Mr. Ray Gудie. Following a most FB turkey dinner, and an entertainment by a group of artists from KMTR, the evening speakers were introduced. Among these were Mr. J. M. Chapple, W6LA, and W6AAN, SCM of the Los Angeles Section. At 11:00 o'clock the long awaited awarding of prizes gladdened some hearts and broke others. This entire affair, the biggest banquet ever held in Southern California, was voted a huge success by all.

W3ZX, So. New Jersey Route Manager, is organizing a transcontinental 'phone traffic route on 14 mc. W5AHK, Wharton, Texas, is the midwest link, with W6AHP, Pomona, Calif., handling the west coast end. W8FSA, Pleasant Ridge, Mich., is northern outlet for W5AHK. A twice-weekly schedule is planned, and the stations involved hope to demonstrate the speed and reliability of 'phone for traffic handling.

Caution! Corps Area Net Control Stations and certain other Control Stations of the Army Amateur Radio System are authorized to use a special frequency of 3497.5-kcs., very close to the edge of the 3.5 mc. band. Many amateurs seem to be using this A.A.R.S. frequency for a "band marker" but in doing so are forgetting that the frequency is 3497.5-kcs., not 3500-kcs. When you hear the stations signing "WLE, WLM, WLT, WLNF, WLVA, etc." near the edge of the 3.5 mc. band, remember they are on 3497.5-kcs. Likewise, the A.A.R.S. has a 6990-kc. frequency, which can hardly be used to spot the exact 7000-kc. "edge."

CM6XJ, Frank H. Jones, Tuinucu, Cuba, is testing with 'phone (records and voice) on 8270-kcs. on the following schedules: Daily, including Sunday 11:00-11:20 a.m. and 2:00-2:20 p.m. EST. Mon., Tues., Sun. 10:45-11:00 p.m. EST. CM6XJ will be glad to arrange two-way schedules with any A.R.R.L. member using 14 mc. 'phone.

W8JK sends the following interesting dope on ON4CSL: Mr. Carroll Stegall, owner and operator of ON4CSL, is a Presbyterian missionary in charge of a school of 700 pupils and 23 teachers at Lubondai, Belgian Congo, Africa. Lubondai is located 200 miles southeast of Lucho on the Lulua River. Mail requires seven weeks to reach the United States. ON4CSL is on 14130-kcs. almost daily at 1900 GCT using a single type '10 with 50 watts input.

Relative Standings of the Ten Highest Sections—December—January

Messages Per Station (25%)	Stations Reporting Traffic (25%)	Gain or Loss (Traffic Report) (25%)	Traffic Total (25%)	Standing Based on Average of All Four Ratings %	Section Communications Manager
P. I. 475.3	Los Ang. (680)* 128	Los Ang. + 32	Los Ang. 11652	Los Angeles 75.	Martin, W6AAN
Hawaii 414.6	Mich. (624)* 99	Va. + 26	Wash. 8310	Washington 62.5	Belliveau, W7A YO
M.-D.-D. C. 369.3	Wash. (374)* 96	Wash. + 22	M.-D.-D. C. 7756	Illinois 42.5	Hinds, W9APY-RR
Colo. 355.7	Va. (150)* 86	N. C. + 19	Ill. 7310	Michigan 40.	Conroy, W8DYH
S. Tex. 264.	Ill. (890)* 85	N. Texas + 14	P. I. 6179	Virginia 40.	Eubank, W3AAJ
Okl. 215.6	N. Y. C.-L. I. (1511)* 82	Mich. + 11	Hawaii 5805	M.-D.-D. C. 40.	Hudson, W3BAK
Nebr. 207.	N. C. (140)* 96	Ill. + 10	Kansas 5496	Philippines 40.	Thompson, KAIXA
San Die. 194.4	Oregon (260)* 60	E. C. + 10	E. Pa. 3314	Hawaii 35.	Slaton, K6COG
Kansas 152.6	Mo. (324)* 55	Mo. + 9	Mich. 5212	No. Carolina 27.5	Wright, W4AVT
W. Pa. 144.1	Ohio (868)* 53	Oregon + 8	Nebr. 4968	Colorado 17.5	Becker, W9BTO



LOS ANGELES carries the Banner for the first time in nine months! FB, L. A., and watch yourselves, you other sections. Note Los Angeles' total! And the number of stations reporting traffic in L. A., Mich., Wash., Va., etc.! Both Va. and N. C. broke their previous plights for stations reporting traffic. During the December 16th—January 15th month, 155 1/2 stations Originated 37,584; Delivered 32,155; Relayed 84,304; Total 154,043. (85.5% Delivery) (83 m.p.s.). The following Sections lead all other Sections in their Divisions, *order of listing showing relative standing of their different Divisions:* L. A., Ill., Wash., M.-D.-D. C., Kans., S. Tex., Col.-U. Wyo. tied, N. C.-Va. tied, Conn., B. C., Ala., N. Y. C.-L. I., S. Minn., Tenn.

* The Section A.R.R.L. membership (approx.) is shown parenthetically, so that the degree of traffic reporting activity may be indicated by comparison.

Traffic Briefs

The simple set-up of a 56-mc. station should be ideal for cross-town communication, and if every ham had such a low cost portable rig for local rag chews, and delivery of messages "across town," it would reduce QRM in some of our other bands. QSLs are welcomed from hams who have such 56-mc. sets. The Communications Department would like to have a record of such rigs in connection with compiling data on availability of local emergency work equipment. Please give tube layout when you send a QSL to A.R.R.L. on this.

1715-KC. CODE PRACTICE

The following is a supplement to the lists of 1.7-mc. code practice stations which appeared in December '33 and February '34 QSTs: W1GMJ, Medford, Mass., 1890-kc. Daily 2:15-2:45, and 6-7 p.m.; W8HSA, Fairmont, West Va., 1870-kc. Tues., Wed., Fri. 7:30-8:00 p.m.; W9HMS, Shiocton, Wisc., 1870-kc. Daily except Sun. 7:30-8:30 p.m.; W9LXK, Highwood, Ill., 1875-kc. Mon., Tues., Wed., Thurs., Fri. 7-8 p.m.; W9NTW, Decorah, Iowa, 1876.4-kc. Daily except Sun. 12:30-1:00 p.m., Wed., Fri. 6:30-7:30 p.m. All times mentioned are "local time" at the transmitting station. These stations send code practice for beginning amateurs on the schedule listed. Other amateurs operating on the 1715-kc. band interested in sending code practice are invited to drop a postal to A.R.R.L. Communications Department for details on this work.

O.B.S.

The following is a supplement to the list of A.R.R.L. Official Broadcasting Stations in September QST (page 44):

W1DUS, W1GOG, W1SG, W3DCU, W4PW, W5AAX, W5YW, W6DXL, W6ENM, W6EWW, W8DED, W8HGG, W9DJU, W9DKL, W9JO, W9JQJ, W9KQJ, W9LLV, VE3GT, VE4MW.

ATLANTIC DIVISION

EASTERN PENNSYLVANIA—SCM, Jack Wagenseller, W3GS—W3AZF, W3ALX, W3GL and W8IWT make BPL. W3CVS is now ORS. W3BWP is first OPS in Section. W3ADM and ALX work west coast on 3.5 mc. daily. W3CQI is rebuilding. W3ASW has QRM from bakery. W3AQN and DXQ want schedules. W8VD has tritret working FB. W8EOH was off with pneumonia. W3CPJ reported via radiogram. W3ATR is perking FB on 56 mc. W3GS, CNP, CMW, CCD, BZC are on 56 mc. The Allentown Amateur Radio League is planning a big hamfest for April 21st. W3CUG is QRL school. W3BOL

and BUI are on from 8th district. Lycoming Radio Assn. (Williamsport) is having a QSL contest and planning a freq. measuring contest. The Western Radio Society is planning annual banquet for March. The Main Line Radio Club (Ardmore) now has 27 members. W3ECM has new pole 35 feet on top of house. Nearly fifty hams attended the Five Meter Club meeting at Maple Shade, N. J.

Traffic: W3AZF 710 CL 702 ADM 400 AKB 375 MC 330 ALX 255 OK 257 AQN 234 AAV 192 QV 164 VR 158 EZ 153 CPV 94 ADE 92 DXQ 96 ATR 69 CPJ 64 ABT 62 ANZ 55 BYS 35 GS 34 CB 33 CIQ 30 TX 22 DZ-EDA 20 BZM 19 BUI 15 BGD 13 AGK 12 BNK-FX 4. W8FLA 224 W8CVS 227 IWT 79 DIG 18 EOH 13 OFF 10 VD-ASW 7 CMF 6.

MARYLAND-DELAWARE-DISTRICT OF COLUMBIA—SCM, E. L. Hudson, W3BAK—RMs W3CXL, W3CQS, W3CJS. Chief RM W3BWT. The University of Maryland Radio Society is on the air with call W3EAX. W3BND is local NCS A.A.R.S. Net of Md.-D.C. Anyone interested in this net, please write W3BND for information. W3CXL, BWT, SN, BND make BPL. Please note W3CXL's modest total of 5562! W3DML joined A.R.R.L. W3BHE has remote control between his bedroom and "cold" shack. W3WU works coast at 11 a.m. on 7 mc. W3CQS has fine West Coast net. Building and rebuilding: W3DPA, DML, CWE, IL. Rebuilding receiver: W3ZD. New receiver: W3DWF, BGI. On 1.7 mc. 'phone: W3CDG, BRS, DJQ, BOR.

Traffic: W3CXL 5562 BWT 705 SN 655 BND 167 ASO 155 CIZ 140 BAK 126 BGI 56 CDG 46 CQS 39 WU 30 BHE 20 BAX 17 IL 12 CWE-DML 8 DWF 4 ZD 3 CRB-DRE-CVV 1.

SOUTHERN NEW JERSEY—SCM, Gedney Rigor, W3QL—W3EGS reports FB DX on 1.7 mc. 'phone. W3CVK has new c.e. job. W3AN gets an OPS. W3ZX reports a coast to coast hookup on 'phone on 14 mc. via W5AHK and W6AHP. W3BDO is building W3KY's transmitter (Atlantic County Radio Assn.). W3ZI reports D.V.R.A. moving to new quarters. All hams in that vicinity are welcome to membership; get in touch with 3ZI. W3DRP rebuilt completely. W3UT is back on the air. W3BYR handled Christmas messages from Wildwood. W3CXV should soon be ORS. W3DSC reports 3.5 mc. FB for traffic. W3CWL reports a gang of nice schedules. W3EDP will QSP anytime he is on the air. W3BEI finished a new rig. W3QL received his "A" license. The S.J.R.A. welcomes inquiries; write the SCM for dope.

Traffic: W3CVK 6 EDP 3 CLQ 2 CWL 146 APV 121 DSC 40 CXV 1 AEF 18 BEI 16 BYR 19 UT 6 DRP 10 ZI 50 EGS 3 ZX 16 QL 3 AN-AVJ 6.

WESTERN NEW YORK—SCM, Don Farrell, W8DSP—W8GWY is new ORS. W8BJO is high traffic man. W8EBR and BQJ have SW3. W8GPO inquires if

"FRC" means "free radio chokes." W8CO is working plenty DX. W8FYF is looking forward to next ORS party. W8DBX has a fine bunch of daily schedules. W8GZM was QSO PA0ASD on 3.5 mc. W8IDJ is putting 1 KW in final. W8BGN is proud father of a YL op. W8GWZ is QRL work. W8FSY and VJ are OPS. W8EMW has new receiver. W8EWP blew three '47s. W8IRH is YL crazy. W8CGW expects to be married. W8AJ is now Airways op. W8JAK works at WPGJ. The Mobawk Valley Brass Pounders are going strong. Code practice is being sent three times per week on 1.7 mc. Following stations report: W8JYK, LFN, AKX, BQX, IMR, ERU, DME, FMX, BWY, GPT, JJJ, AQE, BFG and GPS. New hams in Hamburg: W8KXS, LJJ, JUF. W8JTT needs Asia for WAC. W8KMC received a Discrepancy Report from FRC. Gloversville has two new hams: W8LGU, LHA. W8BDC worked all U. S. and VE districts between 5 p.m. and 2 a.m. on 3.5 mc. W2BIN and W2DQK spent their vacation in New York City. W8AWX is trying to QSO J1EE. W8FDY reports Byrd stations coming through fine. W8ERZ wants ORS. W8EUY has heard several foreign stations on 3.5 mc. W8DHU reports working XM-2S. W8BGO reports the temperature 44° below zero the Friday after Xmas. The Fort Stanwix Amateur Radio Club has a new club room. W8CJJ organized a traffic net in Elmira comprising W8DCX, AYD, GPR, KBT; CJJ is net control. W8JLG reports. W8FTB handles traffic for Epworth League. Everyone in the section interested in making 56 mc. tests on Sunday, May 6th please write the SCM at once.

Traffic: W8BJO 500 DBX 310 EMW 305 CJJ 275 ERZ 255 AWK 248 FDY 188 EUY 161 DHU 126 BQJ 115 GWY 27 AQE-GPT 46 FMC 38 IDJ 75 VJ 45 FSY 93 AJ 57 JTT 80 JAK 42 KYC 35 CQW 20 EBR 18 BWY 4 BR 9 FMX 8 CO 5 GZM 11 GWZ 2 DME 18 EWP 13 ERU 3 BGO 12 DSP 3 BUP 14 JTH 2 FTB 8 DSS 49. W2BIN 40 DQK 24.

WESTERN PENNSYLVANIA—SCM, C. H. Grosarth, W8CUG—W8EGG comes thru with largest total so far this winter. W8DKL, CMK, and HUI were guests at a hamfest at FSZ. W8GUF and KWA are new ORS. W8GBC and GRY report by radio. W8KRQ has tritet. W8ESR visited in N. Y. state. W8KSG has antenna trouble. W8IOH took kick out of his antenna. W8IOI has 1.7 mc. 'phone. W8AVY is shining up the fishing tackle! W8DYY is QRL VCR traffic. W8FKU is getting ready for summer visitors. W8ABS and AYA received OPS appointments. W8DML and GYH want ORS. Christmas vacation brought W8YA total down. W8ITV is c.c. W8GJM wants schedules on 1.7 mc. 'phone. W8GRZ, CUG, KOB and JZR are rebuilding. W8DYV has 830 in final. W8GUB says IKA is looking for schedules. W8CQA reports new station, W8KYW in Warren. W8CMP is getting summer transmitter ready. W8FZG keeps a bunch of schedules. W8AXD is poking out. W8KQK conquered his key clicks. W8HWE gets his share of DX. W8HMJ rebuilt, W8HUL says JQC has new c.c. rig. W8GXU landed a job in State Liquor Store! W8IQB worked PA0ASD on 3.5 mc. W8AJE wants to know who is using his call on 1.7 mc. 'phone.

Traffic: W8HGG 2221 GUF 600 DYY 391 DML 240 CUG 105 YA 100 GRY 80 GBC 69 KWA 54 GRZ 52 DYV 45 GUB 44 CQA 38 CMP-FZG 35 AXD 30 KQQ 29 ESR 25 HUI 24 HMJ 19 HUL 18 GXU 16 KOB 14 IQB 9 AJE 8 ITV 6 GJM-KRG 5 AVY 3 GYH 5.

CENTRAL DIVISION

ILLINOIS—SCM, F. J. Hinds, W9APY-WR—RMS
W9CRT, W9DDE and W9ERU. The boys at U. of I. will hold hamfest on week-end of March 7th. Write for information to Secretary of Illini Hall, Champaign. W9POO is Ex-5FF, 9DPZ, 9EIB. W9ENH sports new pole. W9FOC, AAK and DCI are cutting down operation. W9ERU says Police radio WPGD will soon have three operators. W9PK has S-M Superhet. W9IJJ is back home after year in Los Angeles (W6IMB). W9IKI has four-stage rack job. W9ICN and OW W9LLH send good totals. W9LZF is going c.c. W9MMB, ICN, LGT and

DJG are Sherlocking QRM. W9AYO blew filter and filament transformer. W9MIN has his '52s still in original box. W9CFV has new rig. W9MAS rattled them off with a straight key at 36 and 1/200 W.P.M. at club meeting. W9HQH is anxious to see if he passed Class "A." W9CGT received blue-eyed YL for Christmas. W9GET is trying to modulate 261-A with pair of '50s. W9WC is moving to 3.5 mc. W9KXE blew modulator tubes. W9HZA reports S.O.S. Club of Western Springs has new officers. W9HYI is in Indiana operating "WIND." W9DXP will round out his 20th year of ham radio in April 1934. W9CRT and KJY are doing well with Illinois networks. DX good at W9CZL and PNE. W9NRV and MKK have gone back to work. Another old-timer reports, W9LEH (also W9KPV). W9KEH obtained 25,760 points in the SS. Can someone find Asia for W9FWD and BPU? W9JZY takes the banner for Illinois' highest totals this month. W9SQ is new president of Egyptian Radio Club. Main activity at W9IVF, FYZ and HNK is A.A.R.S. W9IYA is Chicago outlet for three trunk lines. W9MKS and LIG sport new receivers. W9OL will make good traffic man. W9DOU uses pair of '52s borrowed from W9VM. W9KHD and KHG are now c.c. W9GLW and OJJ send first reports. W9HMB obtained new transformer. W9DJG has 250-watter in final. W9EVJ says traffic is driving him mad. W9FXE says low power not so good. W9EWN enlisted in Signal Corps, U. S. Army. W9FP is an OT back with a bang. W9AAY has been working on power supply. YLS have consented to let W9AND get on again. W9KUH is second c.w. op at W9AVB. W9OIQ is first op on 'phone at W9AVB. W9ACU made 10,010 points in SS. W9BIN joined A.A.R.S. W9BYZ schedules W8BYZ nightly. W9LNI turned in his portable, MRY. W9HUX and DBO hold Sunday morning rag chews. W9LIV says SS FB. W9KJX is good A.A.R.S. W9JNB says SS furnished lots of pleasant QSOs. W9JO is working on new layout. Traffic better at W9MDL. W9PHX worked a portable "7" in Chicago. W9MTO is c.c. now. W9MLH has too many YLs. W9MHD is building Tritet. W9AIC is on 56-mc. 'phone. W9FFQ and AIC work 14-mc. 'phone. Rebuilding boys: W9GKI, CEO, IEP, BTQ, ACP, NPW, KA and RO. 1.7-mc. 'phones: W9MAP, MEU, OL, CUH. Good schedule stations: W9CGV, LZU, EZQ, EVJ, KJY, MIN, HPG, CRT, JZY, IYA, DOU, DZU, ILH, CKC. W9OVJ reports W9MYH spoke at J.P.I. Amateur Radio Club of Chicago. The club is looking for members. Actives: W9NUF, CHH, FGV, BSR.

Traffic: W9KJY 1240 EVJ 760 ILH 732 LZU 501 DOU 453 MDL 446 FP 358 IYA 315 KEH 239 ACU 185 FOC 113 CGV 112 DZU 105 HQH-IVF 80 BPU 71 MLH 68 FXE 67 GLW 62 FCW 53 EZQ 50 AD 48 CKC-IWP 44 FYZ 42 FGV 40 HPG 39 HNK-KJX-MIN-ORT 37 CEO 36 CRT-CZL-DJG-ISV-MIM-MKK 35 JO-KA 34 SG 32 ICN-KZV 30 HMB 27 AAY-MKS 25 BYZ-JNB-OJJ 18 FTX 17 AMO 16 CM 15 PFX 14 OL-OQJ 13 LNT-WR 12 FO-OQK 11 FWD-OVW 10 CUH-HZA-KHD 9 HPK-IEP-NPW 8 BRX 7 AVP-DCI-IEH-MNB 6 BIN-JLK-OMA 5 EMN-NRV-RO 4 DBO-KIT 3 ASZ-MTO-PHX-PNE 2 LIV 1.

INDIANA—SCM, A. L. Braun, W9TE—W9AKJ is awaiting FRC license change. W9AXH is RM for Indiana OPS. On 1.7-mc. 'phone: W9AEB, HIU, KKK, I.SB. W9DPL reports regularly. New OBS: W9DJU, LLV. W9EPT is awaiting cards from DX so he can apply for WAC. W9EGQ has his antenna up again. W9FVI worked VP7 and PY2. W9FQ is moving. W9FYB thinks Indiana gang is a flop when it comes to putting on QSO parties. Building: W9HUO, CKB, JLH, APV, PNG, BHM. W9HTP says W1ESK is pounding brass at his QRA. W9HBK wrote 179543874219 words on a government post card for a report. W9HUF has a Collins 4A rig. W9HUV worked a CM on 3.5 mc. New rigs at W9HPQ, LWK, AAL. W9HSF is operating a portable from Ft. Wayne Y.M.C.A. W9JRR worked XM2 in Mexico. New receivers: W9JQO, DET. W9LRH has 211D final c.c. rig. On 7 mc.: W9MQQ, MBL. W9OXG has worked 14 states with 'O1A with 250 volts. W9UM rolled up around 50,000 points in SS. On 14 mc.: W9KFU,

AMM, DHM. W9AET resigned from all amateur activities. W9CKG has been laid up with chicken-pox. W9LQ is doing his part at Mishawaka High School. Lining up schedules: W9JJA, OXM, W9CLW likes the new "minia-ture" tickets. W9MQ works both 'phone and c.w. W9OFA and JJI have c.c. rigs. W9QR uses a '45. New Ft. Wayne hams: W9IBX, LGG, OFG, OIY, PIF, PIR, PKK, PNG, PPI, W9MAT and JOR up at Shortridge High School, Indpls. W9TE has new 6-pound baby girl. W8HTI is at Ind. Tech College. New officers for Wabash Valley Radio Club: W9DOD, pres.; W9DET, secy.-treas.; H. P. Brentlinger, vice-pres.; Chas. Goss, recording secy. The St. Joe Valley Radio Club new officers: W9KYM, pres.; D. L. Wood (W9LG), vice-pres.; Steven Holland, secy.; Stanley Johnson, treas.; George Scheur, publicity. Ft. Wayne Radio Club new officers: W9JJA, pres.; W9JOQ, vice-pres. and communications mgr.; W9JRR, secy.-treas. Kokomo Club is making a drive for 100% A.R.R.L. membership.

Traffic: W9UM 879 HBK 127 HTP 72 DHM 64 JRR 60 MQQ 41 DJU 43 HUV-JJA 41 FYB 28 AAL 20 HSF 23 LSB 33 CKG 20 JOQ 30 KFU 26 TE 21 EPT 13 JQO 11 DET-HUF 10 KDD 9 AXH-EXM 7 HPQ 5 LLV 4 HUO 3 DPL 2 LRH 1.

KENTUCKY—SCM, Carl L. Pfumm, W9OX—Keep your hats off for W9AUH, the "Contest Champion." W9BWJ says, "Move over Moss, I'm coming up." 'Stuff, Thelma, you almost took the honors this month. Those "pink elephant" messages in Ky. QSP parties make ordinary traffic-handling easy, the gang agrees. W9OX takes Jan. 14th Party unconsciously. W9LXN's traffic total continues to increase. W9HBQ shows us how to get traffic off! OUCH—W9GGB didn't report 413 messages last month because he thought SS traffic didn't count! W9ARU has 9 stage speech amplifier. W9OMW finished new c.c. rig. "Who rides motorcycle in Ky. radio?" asks W9CDA. W9FQQ works one station out-of-town in Jan. 14th Party. School exams keep W9OPV QRL. W9BAN is on sick list. W9EDQ joins A.A.R.S. W9HCO is impatiently awaiting Patterson PR-10. W9FZV buys FBX. W9HNV is on 1.7-3.5-7 mc. W9OZO, BZS, MWR, NMQ, KKG, KOX, ZZQ, GON are rebuilding. Big business keeps W9EDV off air. W9CNE says he'll beat W9ETT in National ORS Party. W9BAZ is awaiting transmitter parts. W9HAX has to divide time. W9ACD, ERH, FGK, NEP report. ARTS in Louisville takes over Ether Clippings as its official publication.

Traffic: W9AUH 442 JYO 389 BWJ 292 OX 237 IXN 161 HBQ 123 GGB 118 CNE 98 BAZ 99 OFE 91 ETT 82 HAX 78 ARU 72 QMW 46 CDA-FQQ 42 FGK 41 EQO 36 OZO 33 KKG-MWR-EOM 23 OPV 22 BAN 20 ELL 16 ERH 15 ACD 8 EDQ 6 HCO-FZV-CKH 5 HNV-BZS 2 EDV 1.

MICHIGAN—SCM, Kenneth F. Conroy, W8DYH—Boy, oh boy—99 stations reporting traffic—121 reports! We'll jam as much as we can in here and the rest goes in the Bulletin, issued free to each station reporting to SCM on 16th of each month. W8FTW leads the pack! Traffic scarce at W9EVL. W8HFU worked all except W6 on 1.7-mc. 'phone in 5 hrs.! W9DSJ has the service work well in hand. W8WO finds the "idle" men were busy during depression! W8FDK is teaching the YL—code, of course. W8WV ops WIBM. Applications for OPS sent to W8LKG, DIV, DLT, IGA and KMT—more needed. New ORS: W8CEU, IOR, IFE, DNK. W8GSP joined the Boy Scouts net work. W9IAO is racking and paneling. The M.S.C. Radio Club, W8SE, have invited the Lansing gang to make it a joint club. W9LLD is QRL with new UP paper. W8XIM says traffic handling is great on 14 mc. W8ICM uses a BC umbrella antenna for aerial! W9CWD is on 3.9-mc. 'phone. W8CFZ is busier than a cat these days—that jr. opr! W9EGF and NEZ have their little troubles also! W9OWN is now c.c. W8IFD reports a new club in Kanoo—W8KYH, pres. 'W8IFE is officially a night-owl—new shift. W9CWR is taking 'em skating now! W8JO wants you fellows to get those Emergency Equipment Questionnaires back to him as soon as possible. W8BTK hopes for WAC. W8KOX reports W8DVC showed W8PP the town. W9LJK wonders

who signed his call on 4 mc. W8BMG reports gang pepping up. W8FAV is teaching an adult code class! W8JK made WAC in five hours and is now sailing for Europe. W9MJW reports a write up in the paper for Mohawk gang. Whoops, we got your call straight, W9MXN! W9CGP and DQT furnish people of Calumet with daily WX report from WX Bureau at Marquette. Lake Superior Radio Club sponsors the service. W9FSK still pounds A.A.R.S. hard. W8IUP Bros. QRL City College. W8ARR, DUR, BJ and CYX have their own net work on 56 mc. W8SS, IKZ, EGE, AKN, BIU, KSY, CAT and others are working 28-mc. voice and code. W8CET tells us of W8ND's fine work in Down River Radio Club. W8CEU is now QRS! W8AEQ does his usual fine work. W8BGY keeps QRL U.S.N.R. and A.A.R.S. W8EHD reports with no dirt. W8DZ BPLs on deliveries, delivering majority of Detroit traffic. W8DNM would like to see more traffic. W9PDE makes an FB first report. W8GUC tries tritet. W8EGI is new pres. of Jackson A.R.A. W8DWB and W8DLX are going to make "Silent Keys," claims W8QT! W8KPL is making a snappy comeback. W8GQS' Ideal is haywired, but perks FB. W8JF puts out his voice work on 3.9, 56 and 28 mc. simultaneously. W8HXT four their 'O3A a dud and are holding series of dances for another. W9IQC keeps 50-watter hot. W9IOV reports EXT using old paper polish on his new Radio TG 1st ticket! W9CE has more QRM on his street. W9ADY schedules W9CE daily. Space gone. 73 and, as W8CEV says, I'll be C ing Q!

Traffic: W8FTW 1048 CEU 421 AEQ 265 DZ 249 BGY 247 DNM 238 GUC 206 DVC 164 EHD 118 FX-EGI 105 DWB 101 QT 75 CYP 69 JF 65 BXT 55 GQS 49 KPL 48 SS 46 AW 39 IOR 38 ADU 34 BHH-GRB 32 JK 30 DED-IFQ-KQT 28 FAV 27 BMG 25 BTK 24 FQD-JVI 22 HA-KOX 21 CU 19 AYO-JCS 17 CFM-JO 16 GRN 23 NR 14 HFU-IFE 13 DSQ-GQB-IFD-JTV 12 KOS 11 HBZ 10 CFZ 9 EVJ-GDR 8 KXN 7 AFH-CAT-COQ/LFG-FLZ-HSH-KLR-ICM-IXM 6 BRS-DLT-ND-SH 4 WR-GSP-WW 3 BJ-BKU-FDK-IDB-KMT-MV-WO 2 CSL-FXB 1. IGA 12 CTD 2. W9PDE 223 ADY 87 CE 81 IQC 50 IOV 48 FSK 44 CGP 39 MJD 34 FBC 26 LKJ 25 EVI 26 CWR 14 OWN 12 CWD 8 LLD 6 IAO 4 OZM 2 DSJ 1 DRR 2.

OHIO—SCM, Harry A. Tummonds, W8BAH—Chief RM W8PO, E. Heck, Shelby, Ohio. W8GZ leads state again! In BPL: W8GZ, BTI, RN, DTF. Dist. No. 4: W8HMH is on at Dresden. Power leak at W8WE. W8JGZ has good total. W8PO is getting portable shined up. W8UW is new RM this district. W8FZ reports from Ada. Dist. No. 2: RM W8BKM. New club at Ashtabula. Meets at Y.M.C.A. W8EJY, LAC, HVK, GDF, GGF, CRR and BDB are members. W8IUG works DX. W8UX says W8CGP takes a wife. W8KZA, JOE, GJS are active at Toledo. Active in NCR: W8EJ, EEZ. W8ANU reports new club at Warren, Ohio, Y.M.C.A. FB. Dist. No. 3: W8DIH says W8DDQ is at Norwalk. RM W8APC is now on phone. New rig at W8AEW. Dist. No. 8: W8KYQ is new reporter. New MOPA at W8BKE. Dist. No. 5: W8BDG does FB as OO. W8KLP is planning hamfest about April 14th at East Liverpool. W8EOY is on 7030 kc. W8KWJ worked first G on Jan. 8th. W8FGV was QSO ZSIA. W8AMF is 135 Field Artillery station at Canton. New e.c. osc. at W8ECS. Dist. No. 7: W8VP RM. W8EQB is experimenting with doublet. Dist. No. 6: W8GSO is temporary RM this district. W8LAX is new Dayton reporter. W8JBI works DX on 1.7-mc. 'phone. W8GDC is new OPS RM. W8IZQ boosts for Columbus Hamfest, Feb. 23rd-24th. W8EQC worked VE5 on 3.5 mc. PP '10 at W8HW. W8ISK puts traffic into China. Dist. No. 6: W9ACLE is now at Columbus using W8KQO. Dist. No. 1: W8GLO is secy. Int. Short Wave Club, Local Chapter; W8DI is also member. W8EC is OPS RM this district. W8CIO lists eight frequencies he uses. RM W8BON wants all ORS to write him with data on schedules. W8EPP is on 3580 kc. Good total at W8BAC. W8BAH attends every hamfest he hears about. W8EBJ is new reporter. W8LCY and KYI are new Oberlin stations. W8FNX is troubled with skip. W8HTI attends college in Fort Wayne. W8KIP is rebuilding 'phone.

WSKZL uses '01A. W8EFW says Cleveland Heights Amateur Radio Club is very active. W8AOA works in law office. Intercity Radio Club consisting of hams from Shelby, Mansfield, Crestline, Galion, Congress Tiro, Bucyrus, etc., meet every two weeks. W8DQA of Galion is secy.-treas. W8GDC reports formation of Ohio Highway Patrol Amateur Net, to assist new Ohio State Police organization headed by Captain Black. New OPS: W8ESN. ORS applicants: W8LCO, FGC, LAJ. Schedulers: W8JJK, GOD, AEL, FJW, EBY.

Traffic: W8GZ 815 BTI 515 RN 512 GOD 452 CIO 298 DTF 217 ISK 180 BON 174 EQB 107 EQC 102 HWC 92 HCS 86 ISB 78 GSO 73 LCO 61 GUL 58 EPP 51 BAC 44 UW 42 AMF 38 PO 35 ICC 32 BMK 32 BAH 31 ANU 29 EBY 27 JGZ 26 FGV 23 IZQ 22 ESN-EJWE 16 JJK 15 EBJ 13 BKE-FGC 12 KYL 11 LCY 12 ARW-AEW-FJW 8 FNX 10 GME-DIH 4 UX-GDC-KWJ-HMH 3 AEL-FEZ 2 BRB-LAJ 1. W8FZ 58.

WISCONSIN—SCM, Harold H. Kurth, W9FSS—W9GWK is still leading state. W9FSS BPLs again. W9HGF has been playing checkers on the air. W9JDP, JXU and BCF visited Milwaukee hams. W9DRO is on 3.9-mc. 'phone. W9GFC moved to Iowa. W9IQW has FB7A. W9HSK wants Sunday morning ORS-RM Parties. W9RRH's crystal grinding keeps babies awake. W9DEK sends first report in year and a half. W9ETM took few messages for China. W9GYL is proud of his S.S. receiver. W9NSM is 15 years old. W9JCH plays checkers with HMS. W9KJR claims SCM trying to help power company with long messages. W9HTZ took Annapolis exam. W9DNB has tritret. X-9DYU took exam. W9LJI uses 112s. W9OVE sends first report. W9DNU sent report from sick bed. Rebuilding: W9IYL, ETM, AKT, LFK, JXU, FVG, OYL, IDG, ATO and AON. W9EOB is trying to teach YL code. W9OYQ is back from radio school. W9JAZ is night cop. W9PAX is back again. W9CTH was seen with YL. W9CDC is on 1.7-mc. 'phone. W9CXX is QRL carrying mail. W9HVB and KLL are back after sailing. W9HSU has a Collins transmitter. W9ACK uses '04A. W9NLF and OEH broadcast code practice on 1.7 mc. W9OEH is YL. W9FAW and JAZ were visited by N.W.R.C., and movies of Chicago convention were shown. M.R.A.C. held 3.5-mc. QSO Party.

Traffic: W9GWK 432 FSS 382 HGF 381 JDP 363 DRO 344 OKS 284 GFC 273 IQW 219 HSK 163 RH 158 IYL-DEK 129 ETM 116 HMX 99 AKT 66 GVL 65 NSM 64 JCH 62 KJR 46 LFK 36 HTZ 33 ZY 23 DND 22 LJI 20 OVE 19 JXU-EXH 13 OYL-DNU 5 KLL 4 EYH 6.

DAKOTA DIVISION

NORTH DAKOTA—SCM, Wm. A. Langer, W9DGS
—W9BTJ has a '52 final. W9DYA's '33 puts out two carriers on same band. Hi. W9KZL has spring suspended transmitter. W9JVP reports following for Fargo: W9AOX is working on 56 mc. transceiver for Police Dept. W9HJC is lining up Naval Reserve unit. W9KBE schedules Bismarck. W9DOY and MZE are rebuilding. W9CVV of Hunter took Class C exam. W9PQW and PKG are new comers. W9LHS has new SW3.

Traffic: W9DGS 219 HJC 109 DYA 45 KBE 33 PAI 32 GER 23 PGO 16 JAR 13 BTJ 10 KZL 1.

SOUTH DAKOTA—SCM, C. B. Miller, W9DKL—New stations: W9PEP, PQF, PGV, and PPR. W9TY reports "OW" learning code. W9ORY is new reporter. W9IQD lost an antenna mast. W9CFU put up a Voltage Feed antenna. W9PIO is building new transmitter. W9PLB has receiver trouble. W9IQZ is back at Pierre. W9AQB is on 3.5 mc. W9PQF is on 7 mc. W9PHP has MOPA. W9CAU is operating on shipboard out of Port Arthur. W9IEK and DKL are QRL. W9DKJ is on 1.7 mc. 'phone. W9KCV left for C.C.C. camp. W9DGV reports for Miller gang. W9OED is on 1.7 mc. W9KPK sold out. W9LDU is dealing W9KPK out of FB7A. W9PGV is on 3.5 and 7 mc. W9CRY is changing to 3.5 mc. W9FOQ will be on 1.7, 3.5, 7 and 14 mc. soon. W9FDD is now at Luvern, Minn. **SOUTH DAKOTA FOR NEXT DAKOTA DIVISION CONVENTION.**

Traffic: W9DKL 140 TY 24 CRY 15 FLO 11 GYG 7 IQZ 6 ORY 5.

NORTHERN MINNESOTA—SCM, Robert C. Harshberger, W9JIE—W9GYH is on 3.9 mc. 'phone. W9EKK is on 14 mc. 'phone. W9JIE worked first G5 station. W9PAN would like ORS. W9PFR is new ham of Melrose. W9HNS received Class A ticket. W9BMX wants good DX antenna. W9EKK, JIE, BBL, PKO, LJV, HM, BMX, DYZ, ABK have a QSO party every Thursday night on 14 mc. W9KS is on air first time since 1928. W9IPN has ORS renewed.

Traffic: W9IPN 150 HDN 63 HNS-JIE 26 OOO 4 LFO 79 PAN 13.

SOUTHERN MINNESOTA—SCM, Norman Beck, W9EPJ-EMQ—W9BKK leads the Section with BPL. W9DMA BPLs on deliveries. W9BKK works 14 schedules daily with 12 states! W9EFK worked hard during SS contest. W9CSY: QRL YLs, 'phone and school. W9EPJ is playing six nights week in local beer joint. W9BHZ sends his semi-annual report—hi. W9EYL is trying to get more bucks for radio parts. W9DEI has big ideas—10,000 watt 'phone job. W9HCW reports via radio. W9BNN reports news scarce. W9GUX claims his '47 broke a ligament; W9FCS is rebuilding. W9FNK has new Patterson. W9AIR realisted U.S.N.R. W9OCU and OQA at Sleepy Eye are new reporters. W9EYS expects to install c.c. W9OAK will handle traffic. Your SCM finds it impossible to continue the duties of the office and is therefore resigning. May the successor have a term of office that will be exceeded by no one. Give him your splendid cooperation, fellows. Adios and many thanks for your cooperation.

Traffic: W9BKK 560 DMA 338 BKK 212 BN 160 EFK 157 CSY 154 EPJ 114 BHZ 64 EYL 60 DEI 42 HCW-BNN 29 GUX 19 FCS 17 FNK 12 AIR-OGU 3 OQA 2. (Nov.-Dec. W9KDI 72 HCW 13.)

DELTA DIVISION

ARKANSAS—SCM, Henry E. Velte, W5ABI—W5CVO A has new class A license. W5BDB worked a VP. W5DRY is c.c. on 3780 kc. W5DHN is a shoe cobbler. W5DRW is awaiting supplies. W5BXM sends a nice traffic report. W5BMI continues to lead in traffic. W5ASG and BRW are interested in OPS. W5ABL gets out nicely. W5CPV has four schedules a week. W5BUX was heard in New Zealand and worked PA0ASD. W5DFZ has new bug. W5DHG is planning 3.9 mc. 'phone. Our sympathy is extended to W5DFZ in the loss of his Mother. W5BZK is working DX. W5DGO and DGD bought a stripped Ford!

Traffic: W5BMI 869 BXM 207 BUX 150 DHN 44 ABL 40 DFZ 19 DBG 18 DSW 13 CPV 10 BED 4 BDB 2 CLQ 1.

LOUISIANA—SCM, W. J. Wilkinson, Jr., W5VT-DWW—The Shreveport Amateur Radio Club is making preparations for State Convention to be held in September. W5AGM is president of the club, W5CFE Vice-Pres., and W5AYA Secy.-Treas. W5NM reports from wherever he may be at reporting time. W5ACA is on a tanker. W5BZR has been sick. W5BYY rebuilt. W5AFW visited W4BOU. W5AOZ has 'phone rig. W5BID keeps lots of schedules. W5DMP has new masts. W5DAW likes rag chewing. W5BPL new QRA: 3515 Banks St., New Orleans. W5AXU worked VE on phone. W5DGE is now in Shreveport. W5CIG is on 14 mc. 'phone. W5BFB was home for holidays. W5CEN is studying. W5DKR had W8DZG as visitor. The New Orleans Radio Club moved to club house at 1716 Poydras Street. All visiting hams are welcome at all times. Active: W5CXQ, KC, AN, AYZ.

Traffic: W5DMP 37 BID 22 AOZ 16 DAW-DKR-AXU 12 BZR 28 AYZ 2.

MISSISSIPPI—Acting SCM, W. P. Allen, W5VJ—W5AJT is coming on with an 800. W5BUI has YL fever. W5CWQ has a pair of 800s. W5VJ and DPP visited CO and BQX at Shelby and Parchman. W5ANI is helping CO with new 3.9 mc. 'phone. W5DEJ is installing a '47 Oscillator. W5DAE is on 3.5 mc. W5DBB has a new 'B7.

Traffic: W5CWQ 107 DEF 46 BUI 4 VJ 2.
TENNESSEE—SCM, F. F. Purdy, W4AFM—

W4CBS: QRL TVA job. W9FGJ, formerly of Hannibal, Mo., and former secy of Hannibal Radio Club, is now located in Nashville. W4BPC will soon possess an OPS certificate. W4BMH describes in full an Airway beacon and dispatching station. W4TM has another YL added to his long list of offsprings! W4AYE sends the Nashville dope: W4BM has Tritet. W4ZP bit the corner of his crystal to try to make it oscillate. W4CDU, CZZ, AYW, CW, EX, ACT, LU, AHN, AWB all active. W4CRE is located at WSM BC station. W4WT, formerly of Ft. Lauderdale, Fla., is now located in Knoxville. W4AEP is hobbling around following a major operation. W4BOZ is madly in "loft." W4MU is QRL CWA. W4FR QSO'd a Swedish ship off South American coast. Next morning Joe picked up newspaper and AP had the ship reported as sunk with all hands in the Atlantic! W4KA forgot to pick a good antenna location when he moved. W4BIR has new gross transmitter. W4AM was busy moving. W4BBT has his rig in a two by four closet. W4PL received a speedy racer-like bug for Xmas. A DX Party was held at W4PL's recently; W4BBT worked most mileage; W4CBS the longest hop; W4PL ate the most sausage and waffles. The Bristol gang led by W4AYU are very active. W4RO helps his cousin, W4ZZAR, kill bugs by high frequency currents. W4AFM is busy with AARS.

Traffic: W4AFM 528 PL 373 RO 191 BOZ 50 ACU 17 BPC 18 ACT 14 BM-BUC 10 AYU 10 EX 8 BTQ 7 CBA 4 AYE 3.

HUDSON DIVISION

EASTERN NEW YORK—SCM, R. E. Haight, W2LU —Our congrats to W2CSM and Bob Knapp of White Plains; for their heroic efforts which effected the rescue of lost party in Hudson Bay Region. W2BJA takes traffic honors. W2EQD is perking up 'phone. W2BRS says snow stretched antenna 10 ft. W2ACY uses '10s PP TNT. W2ETH handled message for Byrd Exp. from Holland. Union College Radio, W2GSB, is active in traffic. W2FEQ reports on W2CSM. W2UL trades FBXA for Hammarlund. W2GNI: new ORS. W2DUG contacted PAØASD on 3.5 mc. W2DYC is c.c. on 7102 kc. W2CFU completed new rack and panel job. W2CC reports FB DX contacts. W2DC schedules PAØDC. W1EFM-2 is pounding out well "on ICE." W2EFU: QRL College. W2GTC sends first traffic report. W2BSH is convalescing, having broken two toes. W2CJS' antenna came down for fifth time. W2ATM is rebuilding to c.c. W2GGC makes initial report. W2FEK marries W2CHG's sister. W2ESO reports cricket in cellar CQ hound that never sings. W2GTW is new Port Jervis call. W2BLU, FPH visit W2WP. W2QY is on 1.7-mc. 'phone. W2CWL craves traffic. W3AC is c.c. on 14 mc. W2ENY reports activity coming up. W2BLL and CLL are back from vacations. W2KW reports FB honeymoon visiting French hams.

Traffic: W2BJA 279 LU 120 BRS 63 ETH 62 EQD-ACY 40 GSB 24 FEQ 19 UL 14 GNI 12 DUG 11 DYC 8 CFU-CC 7 DC 6 CSM 5 GTC 4 EFM 3 CJS-ATM-GGC 2 ESO 1 EGF 167. W1EFM-2 4.

NEW YORK CITY AND LONG ISLAND—SCM, Ed. L. Baunach, W2AZV—W2BII is a member of the E.R.C.C. Their QTU 1:00 p.m. daily on 3900 kc. W2FIS says c.c. FB. W2FF has 242A final. W2BTF puts ¼ kw in 50-wattter. W2PF is QRL exams. W2OQ says new QRA, smaller yard. W2BHQ's time is limited. W2DWW is on regularly. W2AYJ sends first report since '28. W2BWL wants to swap flea power rig for YL. W2EQL sends first report. W2FCQ's New Year's resolution: No more RAC note. W2CLC worked U2GU in Moscow on 7 mc. W2BRB RC's with foreigners on 14 mc. W2FBE was reported R6 in Long Beach, Calif. W2GOW reports following on 56 mc.: W2FM, FWZ, GR, BPH, and FDA. W2BIK, BKP, CYX, AA, LC, LR, BPJ, CIT, CP, and BYL are active in NCR. W2EGA schedules his cousin, W3EDF. W2DDE QTA's schedules. W2EWS makes plenty of noise. W2EYQ has YL op. W2CEH has FB portable. W2FBP is QRL A.A.R.S. W2AXN sticks to '46s. W2FDQ is going to get out with c.c. or bust. W2DBQ is WLNA on Monday nights on 3497.5 kc.

W2DJP is building c.c. rig. W2CBB says no traffic since W9USA has been off. W2AZV can now check percentage modulation with new receiver. W2ELB, DBQ, ELK make BPL. W2EYS uses e.c. oscillator. W2AOD is looking for 14-mc. DX. W2BGO needs more A.A.R.S. in Manhattan and Bronx. W2ALD is trying to organize trans-continental NCR traffic net. W2BIP reports new hams: W2GGC and GOO. W2EAF, high-speed Morse man from N.Y.C.R.R., would like to QSO any other Morse men; his QRH 7112 kc. W2DTT is OBS. NBC takes up most of W2BNL's time. W2BMH is in market for s.s. receiver. W2GMP and FXI work two-band QSOs. Married life QRM at W2AEN and CCD. W2BAS worked a CT1. W2ECL can be found on 17 mc. Our Director, W2BEG, is kept busy visiting clubs in Division. W2CLA and WD are holding 56-mc. tests from aeroplanes on Sundays. W2BRI is out for OPS. W2DQW is A.A.R.S. NCS. W2GEI's antenna has "it." W2AOB is at new QRA. W2AOM and DT work 1.7-mc. 'phone. W2AYI has new Comet Pro. W2EXO gets out on 14 mc. W2BSR is rebuilding first time in years. W2HY can be heard on 7 mc. W2EKD works plenty DX. W2FIP is putting up new antenna. New officers of Radio Club of Brooklyn for 1934: W2TI, pres.; W2BNY, vice-pres.; W2APN, secy.; W2AZV, treas. W2DYF now holds Class A ticket.

Traffic: W2ELB 677 DBQ 354 BGO 290 EYQ 209 CBB 207 EYS 171 ELK 167 AOD 140 CUH 128 DJP 114 EGA 97 AYJ 77 DOG 74 BMH 57 GMP 51 BII 46 FIS 40 CYX 37 BNJ-FF 26 BTF 25 QO-PF 24 BQK 19 AZV-QM 20 DWW 15 DRG 13 BAS 14 EQL 13 FCQ 12 GEI-ASG 9 EYB-BNL 8 ALD 10 FPB 12 AA-BKP-BIK-BPJ-AOV-CIT-DJD-BFA-AYK 7 ALZ 6 AEN-FDQ-BSR 5 CCD 4 GPR-BRB-CEH-EWS-FBE-EAF-CAU-AOB 2 BIP-GQC-GOO-FIP-CLC-ECL-EXO-BVT-EWB-DTT-CPY-AGC-KJ-GLJ-KH-LC-LA-FFL 1 LB 24 DQW 35 EKD 40 DBE 32 CHK 50.

MIDWEST DIVISION

IOWA—SCM, George D. Hansen, W9FFD—RM, W9ABE, RM, W9HPA, W9LCK tops with a very good total. W9CWG makes BPL. W9EIV has a good bunch of schedules. W9NTY had FB time in SS. W9CZY is rebuilding. W9HPA is on for IOWA ORS at 6 p.m. Wednesdays. W9ECH uses a fifty last stage. W9FZO may try 1.7 mc. 'phone. W9DUN is working on new trunk line east. W9FYX enlists in NCR. W9NS is N.C.R. Unit Control in new S.C. Federal Bldg. W9LEZ is now A.R.R.S. D.N.C.S. W9FYC says IFT's 7 mc. crystals are FB. W9FFD gets in a lick for a few with N.C.R. W9GXU has new job on the air. W9NYN is club station at Newton. W9IO is in state of complete rejuvenation. W9CYL is experimenting with 'phone. W9DFZ gets first Iowa OPS. W9AFQ has good 'phone schedules. W9JMB wants traffic. W9NVF reports good DX. W9BCL and NVF report QSO with W9PDCI. W9NTW reports activity in his community. W9HMM has been on sick list. W9DIB, OZA, FED, LJD, and DEA report various items of interest. Clubs reporting were, TSARC, NEL, and Newton.

Traffic: W9LCK 420 CWG 336 EIV 228 NTY 175 HPA 163 HCH 136 FZO 95 DUN 92 FYX 83 LEZ 73 FYC 32 FFD 14 GXU 12 NYN 11 IO 7 CYL-DFZ 5 AFQ-JMB 4 NVF-NTW 2 HMM 64.

KANSAS—SCM, O. J. Spetter, W9FLG—W9KG CW RM—W9ESL Phone RM. W9KG leads the Section with grand total. W9NMR is QRL KJTY traffic. W9LGV wishes he could figure some way of getting p.d.c. out of one of those heating pads at the Sanitarium. W9IYT moved to Kansas from Mo. W9ESL, OPS, has new a.c. Ohm-meter-Impedance meter. W9PPC is new Wichita call! W9PGL works both coasts on 1.7 mc. 'phone. W9BEZ at last worked Europe. W9NLZ has transmitter troubles. W9OZN and OHY are in race for speed championship. W9DMF tried Tritet. W9BSX says new neutralizing scheme a la QST increases output and reduces tube blush. W9BOU is giving 1.7 mc. 'phone a fling. W9AWP says bridge is getting radio down. W9BUY is helping EJD rebuild. W9GWI is rebuilding for 1.7 'phone. W9BYV has new receiver. W9CFN is QRL basketball.

W9MUY worked 6FWJ with '26 and 180 volts. W9AHR is QRL U. S. Coast-Geodetic Survey. W9FMZ dropped 212D! W9EHA tried 1.7 mc. 'phone. W9KQJ is in hospital with internal hemorrhage. Club notes: K.V.R.C. election results: W9FRC Pres., W9LJL Vice-Pres., W9CET Secy., W9CJJK Kan Ham editor. Sunflower Radio Club had party Jan. 12. W5ZZD has Jr. op. Wichita Club plans hamfest in spring; committee: W9LFB, DAL, and BSX. HARC has 12 new 11th edition Handbooks in hands of members to be used as text book from start to finish at club meetings. New members: W9FXY, IFF and PET. W9IQI says, "Watch HARC from now on."

Traffic: W9KG 1654 NMR 907 FLG 569 ODV 330 IQI 266 IOL 265 GBP 255 OQC 206 BYM 201 PB 123 IEL 108 ICV 75 KQJ 63 EFE 55 CMV 43 EHA 38 FMX 34 AWP 33 OFR 42 MUY 31 CFN 27 BYV 17 NJS-BUY 10 LFB 8 OZN 6 KQJ 5 LWP-ESL-EYY 3 COA-HJF-FPX-CNW 2 IYT 1 AHR 97.

MISSOURI—SCM, C. R. Cannady, W9EYG-JPT—RMs W9NNZ, W9CJR, W9BMA, W9FA, W9BGE ('phone). W9MZD leads section. W9GBJ makes BPL on deliveries. W9BGE is first Mo. OPS and 'phone RM. W9NNZ is added to RM list. The ACTIVITY CUP RACE Standings will be announced next month! OBP: W9EFC is considering 'phone. W9EZX and PW built new antennas. W9BGE installed automatic 'phone bk-in. W9DLB works at KMOX. W9AAU works for W9ZK. Independence: W9DPE, HRX, NMC, and OMV are staging come-back. W9EDO gets local DX record. W9HRG scheduled RM daily for year. W9JWI with 'OIA gets 5 VE's. W9NAQ is troubled with receiver RF. W9NWM is changing from 'phone to c.w. Kansas City: W9LPZ applies for OPS. W9BMA gets good traffic on 'phone. W9EL is building 14 mc. 'phone. W9JEH with 1 kw. was heard by SWL across town! W9KTC has "parasites" in final. W9JPA is grinding crystals. W9FHV is trying for Class A. W9RR is active in N.C.R. schedules. W9DUD and HVC keep St. L.A.R.C. on the map. W9OEQ is new call of Central College Radio Club, George Atteberry, Pres. St. Louis: W9AAN is on business in Dallas. W9HUZ gets 3 YLs one day. W9LQK, NKK and IJW are c.c. W9HVN is on with tritet. W9NGS and KBV are building c.c., W9LGC e.c. osc. S.M.A.R.A.: W9HUG kept three schedules. W9CJR is QRL circuit court. W9GBJ was on 12 years before he tried 3.5 mc. W9DEN got on Christmas holidays. W9JAP wants more traffic schedules. W9PBZ is new station. W9MMD moved to 7 mc. W9KVN applies for ORS. W9DCD comes back after long absence. W9GLQ reports about 8 new fellows trying to break into game at Joplin. W9GLY reports PQS new Joplin ham. W9LDF turned DX hound. W9AIJ says skip is knocking everything in head. W9CRM is experimenting with angle radiation. W9DLC applies for OPS. W9ENM gets on some for traffic. W9KEF is QRL business. "ARF" of St. L. W9LLN and NBE are on 1.7 mc. 'phone. W9LTH has new crystal. W9CCZ: QRL YL. W9GUQ: QRL work. W9FAB is back on 14 mc. Kemper hams include: W9DTF, JSJ, NQH. W9MLR gets no traffic on 7 mc. Sedalia: W9AZL is puzzled with c.c. W9LVA is looking for schedules. W9EME and AWC are QRL. W9OWQ—the OW of Sedalia—is operating some. W9HUN is going FB. Missouri rebuilders: W9BBM, AC, BEQ, AUC, EQC, BKO, HON, CU, CVP, LBA, MKT, OLC, DIC, KCG, EDK, NBV. W9ASV reports following attended Ponca City convention: W9IEL, CMV, IGN, OUD, KPV, ASV, OSL. A report each month brings you a copy of the Missouri Bulletin with first hand information on state news. Send your report in NOW!

Traffic: W9MZD 577 NNZ 344 BMA 278 ENF 219 GBJ 200 CJR 198 ALJ 119 EDK 90 HVN 62 HUZ 61 NAQ 53 CRM 52 KVN 38 DUD-EFC 36 GTK-NP 35 LLN 34 FJV 25 JAP 22 GLY-HUG 17 OLE 21 RR-LTH 12 ENM 13 BGE 14 IXO 11 FNO 10 DIC-GLQ-MKT 9 LBB-HRG-JPT 7 MND-ZK 6 JWI-EYG-PW-DEN 5 DPJ-EDO-DLC-EZK 4 CFL 3 LBA-JPA-AC 2 FZJ-NGC-HVC-LJW-LCG 1 ASV 262.

NEBRASKA—SCM, Samuel C. Wallace, W9FAM—

W9DI keeps fine bunch of schedules. W9DMY keeps his end up in fine shape. W9EWO is still tinkering. W9FAM keeps Transcontinental line open, Brooklyn, N. Y. to Los Angeles. New ORS: W9FYP, JED, OPP. W9DFF is lining up schedules. W9EHW is acting Alternate SNC for A.A.R.S. W9DGL is DXing. Rebuilding: W9DEA, FXP, GNZ. W9EEW is trying 7 mc. W9IFE is going wild with traffic. W9FGS must be after somebody's hide from the way he is going after traffic. W9KPA is connecting link in Trunk Line, Brooklyn, N. Y. to Los Angeles. W9LSI sends first report. W9GKZ is going to school in Lincoln. W9CUI must be doing something besides buying cream from looks of report. W9HNG is getting back in harness. W9MKG is organizing club at Holdrege. W9PDH complains of someone borrowing his call.

Traffic: W9DI 641 DMY 365 EWO 318 FAM 277 FYP 127 JED 109 DFF 67 EHW 60 OPP 36 IFZ 10 DGL 2 IFE 1183 FGS 749 KPA 645 LSI 19 GKZ 17 JEE 29 CUY 257 EDY 17 GNZ 11 HNG 9 MKG 1 DEP 5 MQY 14.

NEW ENGLAND DIVISION

CONNECTICUT—SCM, Fred A. Ellis, Jr., W1CTI—W1FIO takes traffic honors again this month! W1FIO, AMG and BYW make BPL. W1BDI schedules W3BWT. W1SZ worked his first Asian. W1DGG says a lot of traffic is ancient when he gets it. W1BEM keeps four good schedules. W1GC says conditions better in the morning now. W1DOW has six schedules. W1GGX schedules his brother, AMG. W1BNP reported via W1BDI—FIO—CTI route. W1APW says Radio Bugs Club has a transmitter going strong. W1EWD reports New Britain gang trying to see who works first VK. W1AFB reported via W1GC. W1EEI is active in West Haven. W1GTW sends first report. W1TD handled traffic on 3550 kc. W1CCK is on with e.c. rig. W1GUL worked a W6. W1DFZ has ten foot extension on his key. W1HNF and DNQ are building c.c. rigs. W1DCP is to build a 'phone. W1FXQ uses 600 volts on a '45! W1BQS is back in N. Y. C. W1GKM reports for Bulkeley High Radio Club. W1BFS was sick with gripe. The Harold I. June Radio Club, W1HSU, at Y.M.C.A. in Stamford has 100 watt c.c. rig on the air. W1HLE wants traffic. With the addition of W1HVB and HVF there are seven hams in Meriden High School. W1CLH made a big score in SS. W1HSY is new operator at Kent School. W1HTS, ex W3BDJ, is located in E. Hartford. W1BIC received a dozen cards from England and France reporting his 'phone. W1ABN built new receiver. W1ANG schedules on 1.7 mc. 'phone. W1BDS made new Class B driver stage. W1DCM is on 14 mc. W1CUH is on 3600 kc. W1ESD schedules EMV. W1GUK is grinding crystals. W1FOZ has c.c. rig on 3505 kc. W1GTE was written up in local paper as putting in high power. W1FUY has new antenna meter. W1GXU is on 1.7 mc. 'phone. W1QV schedules G2QY every Sunday. Informal Conn. QSO Parties are held every Sunday starting any time. QSO the local gang on 3.5 mc. and have some nice rag chews. Special broadcasts by W1AMG at 9:30 a.m., 3812 kc. and W1CTI 10:30 a.m. 3864 kc. will keep you informed as to what is going on. *Coming, another Conn. QSO contest—don't miss it.*

Traffic: W1FIO 665 AMG 577 MK 389 CJD 333 BDI 188 UE 184 BYW 172 DGG 171 BHM 170 GC 160 DOW 134 GGX 102 BNP 75 APW 72 EWD 61 CTI 60 AFB 54 EIE 48 GME 46 BWM 17 ES 13 AKI 12 GTW 11 TD 10 DFZ 10 FXQ 7 BQS 6 GKM 9 HAG 1 GUC 4 EAO 2 HLE 3 HSU 2 ?? 1 HSY 1 CUH 4 ESD 30 QV 9 BMP 34.

MAINE—SCM, John W. Singleton, W1CDX—W1OR is putting in 500 watt rig. Don't forget to mail a list of your schedules to W1BOF. W1TE sends a husky first report. W1BTG wants schedule with Bridgeport, Conn. W1GBM has a new "OK-2" receiver. W1EBM is building 'phone rig. W1DFQ is in line for OPS. W1GKC has five daily schedules. W1HYS is new Hallowell ham. W1CRP has been experimenting on 56 mc. W1AQW is QRL college. W1APU is working a lot of DX. W1RJP wants OPS. W1VTF wants schedule with 4th district.

WIFNG is QRL service work. W1HUX is new Wilton ham. WIAPX has gone to work on a tug boat.

Traffic: W1OR—W120 BOF 170 TE 156 BTG 110 CHF 94 GBM 67 EBM 63 DFQ 51 CDX 36 GKC 40 DHH 31 CRP 24 AQW 18 BLI 16 APU-FJP 11 BTA 8 VF 6 FNG-BUX 4 ABQ 26 EF 116 BNC 5.

EASTERN MASSACHUSETTS—SCM, Joseph A. Mullen, WIAS1—W1VS leads again with 417. Close behind is W1CRA, and our beloved Director, W1KH, swings a left with 189, his best month on record. W1BZO is back in harness. W1BMW tried a BC crystal for M.O. W1EVJ takes the reins of RM from AGA, who has done a sweet job. W1BBY is starting his fourth year of VE schedules. W1LM has been away. W1WV's annual survey shows over 8000 QSOs! W1ABG led the section in ORS party for three consecutive times. WIAS1 is on more often these days. W1CLE is on 56 mc. W1GCL is after ORS. W1CNA has tritet going FB. Alice at W1PRO is now ORS. W1FBR is on the air again. What's the matter with the 1.7 mc. 'phones? Let's hear from you on the 16th of each month. Also as the Army net. How about reporting your traffic totals as handled on your drills and get credit in QST for it? W1GEC passed away on Jan. 7th. The gang extends its sympathy to W1UG, who lost his mother Jan. 11th. New officers of Community Amateur Radio Assn. of Framingham are: Pres., W1EIL, Vice-Pres., W1DDM, Treas., W1BWG, Secy., A. L. Schaltenbrand, Activities Mgr., W1BHL.

Traffic: W1VS 417 CRA 264 KH 189 WV-EVE 65 ABG 64 FRO 59 BEF 58 BZO 56 BBY 49 GCL 43 ASI 36 BMW 35 AGA 18 RE 7 CLE 3 EXT 2 CNA 1.

WESTERN MASSACHUSETTS—SCM, Earl G. Hewinson, WIAS1-RB—New OBS: W1DUS and SG. New ORS: W1DUS. W1BVR has been appointed 1st Corps Area NCS for A.A.R.S. W1ETC was on vacation. W1DVW has a portable at M.S.C. W1EVZ says a fine time was had when the YL Club visited WMRA. Miss G. Rood is new YL ham, call W1HRG. W1BKG had a good time at ORS party. A.A.R.S. helped W1BXF on traffic. W1CCH is spending his time on W1FQA's transmitter. W1ARH complains of skip. W1APL is rebuilding. W1BNL has his troubles exciting his amplifiers. W1EBH has a new slogan—"1 Everlasting Bright Ham." W1ZB is a real OO. W1DIE reports for W1BKG. W1DUZ operates ORS on 56 mc. Santa Claus left W1BPN a Comet Pro. W1AJ is having "aerial blues." WIASY wants to QSO a New Mexico ham.

Traffic: W1BVR 393 ETC 126 COI 99 DVW 68 ASY 72 HOD 44 EVZ 37 BKQ 36 BKG 33 BXF 27 DLH 26 COH 22 CHU 15 FJK 14 BWY 11 ARH 10 DUS 9 APL 8 BNL-EBH 5 ZB-DIE 4 DUZ 3 OF 2 HHR 1 AJ 4 FAJ 75 DCF 11.

NEW HAMPSHIRE—SCM, Basil F. Cutting, W1APK—W1CCM has a code class of 12 students at N. H. State Sanatorium. W1FCI has a pair of '10s. W1AUY is playing around tritet. W1AVJ and FFZ have new FB7s. W1GPN had shortest report of month. The St. Paul's School sends an FB report. W1IP ran up a good total in SS. W1DMI renewed ORS. W1BJF has good schedules. W1FPL handles fine total for A.A.R.S. W1CBB has too much volume for his FB7A. W1DMD handles plenty of traffic. W1GKE wrecked new millimeter. W1SK is back with good report. W1UN continues with 56 mc. W1EZT is new OPS. W1GEY is on with tritet. W1HTO is on 1.7 mc. W1FGC is on 7 mc. W1AFD is on 1.7 mc. 'phone. W1ELM works for Sylvania. W1BEJ has new receiver. W1FGC says W1GEY's mast is held up by "six Scotchmen"—six tight guys. Hi. W1HFO says he is not a 'phone ham as mentioned in last issue. W1GDE and HJM are QRL A.A.R.S. W1BII and his sister, W1FTJ, are putting in more power. W1ERQ has a YL. W1GHT uses a Marconi on c.w. W1AGO is on 'phone. W1APK installed temperature control; 'phone frequency is 3950.7 and c.w. is 3782 kc. The SCM invites all hams to visit him in Pembroke. W1EAW works DX on 1.7 mc.

Traffic: W1ERQ 246 DMD 146 UN 112 FFL 101 IP 62 BJF-APK 50 DMI 53 FFZ 37 SK-GKE 4 CBB 10 6PN 24 AUY 11 FCI 28 CCM 12 HFO 11 GEY 35 EZT 6.

RHODE ISLAND—SCM, Stanley W. Atkinson, W1AFO—W1GTN has been elected president of the Providence Radio Assn. W1CAB has 14 mc. 'phone perking nicely. W1ASZ is new OPS. W1DDY has been appointed RM. W1GV has gone 'phone. W1HSA, AWG, and HPE report for first time from Newport. The Providence Radio Assn. Hamfest in Providence on January 20th was a very successful affair with nearly 150 in attendance. Director Bailey and Mr. Quimby of Delta gave good talks.

Traffic: W1GTN 121 CAB 57 ASZ-DDY 32 HSA 14 GV 13 HPE 9 AWG 6.

VERMONT—SCM, Harry Page, W1ATF—W1BJP is pepping up 'phone activity. W1DQK and AXN are 'phone trouble men. A.A.R.S. is "Hot Stuff" in Vt. W1CUN visited BJP and installed DX antenna.

Traffic: W1AXN 124 BD 87 BJP 86 DQK 57 CGV 37 GGT 16 FPS 13 AZV 9 GAE 5 ATF 250 EJF 35.

NORTHWESTERN DIVISION

ALASKA—SCM, Richard J. Fox, K7PQ—K7AVU has gone south. Ex-K7BQE got his class C license. A new YL op aged 13 is on the air at Ugashik. K7BOE has twenty-seven schedules weekly. K7DEV at Nome got married. K7BZX is building to higher power. K7DJA goes c.c. K7VH was forced off the air account terrible local noise.

Traffic: K7AVU 1 DJA 17 BOE 33 PQ 99.

IDAHO—SCM, Don Oberbällig, W7AVP—W7AQK, W7BDX, W7BCU, W7ER and others in Northern Idaho rendered great service during Flood by use of amateur radio. Congrats. W7BCU, KJ are contacting 'phones for SCM. W7AT, AVR are working 3.5 mc. W7DCM visited SCM and scheduled W7AGD at Moscow from AVP. W7AFT is QRL A.A.R.S. W7BHN has new Jr. YL. W7CAT, CHN are hanging up DX records. W7ATN takes trip to Calif. W7APK has new PR10. W7IY organizes A.A.R.S. in Nampa territory. W7CMD uses low-power. W7DBP has about 100 antennas. W7ABK wonders when Boise hams are on the air. W7BMF holds FB schedules as ORS and DNCS. W7DSL has c.c. job. W7ASA is trying to eliminate key thumps. W7DKY won prizes at Ham Feed, Dec. 22. Gem State Amateur Radio Club had first annual feed with prizes; FB feed put up by W7DEQ's father. W7ZN, old timer, is getting the fever again. Ex7LO was married recently. W7DEQ gets 50-watter. W7KV celebrated Christmas eve with SCM. W7CSP gets more coils for FB7. W7CZO received 'bug' for Christmas. W7GU: QRL radio service. W7AXY has selling out idea. New Boise hams: W7FES, EEBZ, W7AYH has new super. W7BRU, HAY, DEQ debate question of radio costs at high school. W7CP will use 38 mc. directional antenna. W7BKF spent holidays at home. W7AYP will be on soon. W7KI, ACP: QRL WUBJ. While W7GL was crossing ferry at San Francisco, man tried to sell him the ferry, but GL with true amateur spirit outsmarted him, demanding delivery in Idaho. W7CFX holds schedule on 3.9 mc. 'phone. W7CHN visited Jerome hams. W7BZJ will have more time for radio. W7BAA has auxiliary transmitter, for emergency work. W7CSW has new shack and transmitter. W7BDY is on 1.7 mc. 'phone. W7DZO is active at Idaho Falls.

Traffic: W7AQK 260 BCU 50 KJ 6 GL 35 CSW 19 BAA 48 BMF 99 CHT 46 IY 10 AVP 223.

MONTANA—SCM, O. W. Viers, W7AAT—W7CCR takes first traffic honors. W7BJZ has power leak. W7AOD holds schedules. W7BZA got R7 from Antipodes. W7BDJ is increasing power. W7BYR is rebuilding. W7BVE sends Official Broadcast on 3645 kc. W7BMX is coming to 3.5 mc. for traffic. W7BDC keeps 1.7 mc. 'phone schedule with Chicago. W7BSU's 560 watt gassy. W7BDS has left 7 mc. W7EDJ is new station at Roundup. W7CPY worked east coast on 1.7 mc. 'phone. W7BYE has class "C" ticket. W7AAT/COX report rotten conditions.

Traffic: W7CCR 221 BVE 139 CPY 134 BSU 115 BJZ 69 BDC 54 BDJ 44 BMX-AAAT 18 AOD 15 BDS 8.

OREGON—SCM, Ray Cummins, W7ABZ—W7HD again makes BPL! W7DP is building 56 and 28 mc. gear. W7ABH is going to a kilowatt. W7SY got crystal going.

W7WR is lining up schedules. W7BKL schedules home town. W7CSQ has trouble with note. W7CCK scheduled W7DXC on Tillamook Lighthouse Rock, while telephonic communication was cut off from the mainland. W7DWQ is going c.c. W7BQY, COQ, and CZD started New Year right by reporting traffic. W7AYV, ABZ, and CUV handled much Christmas traffic. Receiver power pack burns up at W7AIG. '03A at W7AOI. W7BDE moved to Klamath Falls. W7LI has tri-weekly schedule with K6GUA. W7CFM is mainspring of preparations for 56 mc. field day in spring. W7DKI, and DHZ are 1.7 mc. 'phone. W7CBA is c.c. on all bands. W7BIO got car out of hock. W7BDU has 33 year old bug. W7AHZ has PR10. W7BEK is entertaining BCLs on 1.7 mc. 'phone. W7AWL and AZK are returning to the air. W7DGD, EEG, ECQ, and EBV are new hams. W7QW is leaving for south. W7AIY is local interference man for Eugene. W7ADA works the coast with 3 watt 'phone. W7BRH has key-click trouble. Salem has new radio club named Willamette Radio Club: officers: Pres., W7DIW, Vice-Pres., W7AKW, Secy., W7DVU, Treas., W7CYI, activities manager W7ARZ. W7DCI joins C.C.C. W7DEA remodels shack and rig. W7DVX fries eggs on his filter condenser. W8BKD blew his '10s. W7BEE is experimenting with RK18s. W7BLN, and BWD keep Charleston on map. W7BOG wants QRA of TIEFF. Following did their part in boosting this section by reporting: W7MQ, KR, BDN, BZS, AIP, MY, AVB, CTR, APE, NW, AWH, AOL, CAE, ASG, ECH, BVV, CBD, GQ, APJ, AHX, ANB, BGF, UJ, AWL, CVL, ALB, AYN, BNK, ECO, BOO, ALM, AXO, BBO, BDR, BMA, BBO, BCR, COU, EBQ, CHK, CRN, ABD, AER, DKI, MF, DXR, DUE, CEJ, CHB, AXJ, BNK, CWE, BUF, and CSQ.

Traffic: W7ED 662 CUV 439 CUL 247 DUE 241 AXJ 231 BRH 129 MF 120 WR 111 CXK 102 CFM 84 DP-LI 80 AIG 72 BOO 69 BDU 65 ECO 59 CRN 62 CEJ 56 BWD 55 CHB 47 BKL 32 BLN 30 BMA 37 COQ 24 CHK-ABZ 22 AMF 19 BNK 18 BOG 17 BGF-ALB-SY 16 COU 14 ALM 7 ABH 8 AHZ-CBA 6 AHX 5 DCR-AOI-CZD-AXO-BRO 4 EBQ-BXQ-BBO-BUB-ANX 3 BZS-AYN-DGD-ECQ-EBV 2 BDR-BDN-KR-CSQ-BUF-CWE 1 CUV 49.

WASHINGTON—SCM, Stanley J. Belliveau, W7AYO—Flood traffic boosted totals this month. Congrats, gang, for fine way you handled it. Following BPL: W7AMA, W7CZY, W7WY, W7RT, W7AYO, W7LD, W7BEV, W7DGN. W7IG is building c.c. rig. W7CAM and AIT are trying 4 mc. 'phone. W7AIA, ECC, RC, CXK are trying 1.7 mc. 'phone. W7UE reports on an old BCL DX card. W7EDK is out for WAC. W7ABU wishes crystals weren't inclined to oscillate on two frequencies. W7BEV, BIW, AFC, AMA did fine work in QRR flood traffic. W7DZX thinks some Mex. stations could clean up their notes. New ORS: W7DRY. W7AHQ clicks DX on 3.5 mc. W7DNL sends a swell total. W7WY worked all dist. with his '45. W7DUJ schedules home town gang at Yakima. W7ACY is operated by W7TK '01 QSL printer. W7APR says conditions picking up. W7DET would like to have the SCMs new Patterson receiver. W7CTS is building 1.7 mc. rig. W7RT is on 1.7 mc. 'phone. W7ACA gets out fine on low power. W7JZ reports for first time in years. W7TZ would like to know YL. W7DWF's address. .lii . . . W7BYF clicked F30CA. W7CZY keeps 120 schedules a week! W7BBK uses one watt input. W7DGN applies for ORS. Spokane gang lead state in traffic. W7CLR clicks east coast on 1.7 mc. with 3 watts input. W7CHU is ed. of Spokane ham paper. W7DRF has 50 watter in final. W7DJJ is getting 'phone bug. W7APS had ORS renewed. W7CPK has new SW3. W7BBB has c.c. W7DCJ has receiver trouble. Following reported: W7CQJ, CZB, RQ, DSZ, AZI, BQK, CCT, ECM, EAW, EAU, CWN, DLN. Reported via radio: W7AAF, EK, BTW, CCN, CNK, JT, BTZ, CR, BDB, OO, BWS, BGE, AWF, ALH, AMN, ASZ, AGE, DPU, YH, BUW. W7BYB busy. W7BCS has a gypsy transmitter . . . it wanders all over the band.

Traffic: W7AMA 938 CZY 914 WY 817 RT 772 AYO 711 LD 679 BEV 407 ALH 250 DNL 236 CQI 186 BIW 178 DGN 155 AGE 138 ASZ 118 TZ 116 AWF 115 BYF

113 ABU 100 CWL 85 APS 81 EK 65 DJJ 58 BBK 53 AFC 51 IG 47 AQ 46 DPU 44 AHQ 43 DGY 41 BWS 35 DSZ 32 DRY-BBB 30 CJN 25 BYB-AIT 24 DLN 23 AMN 20 BGH-BUW-ACA 19 AWP-ACY 17 OCT-BDB 15 JZ 14 DRD-YH 13 BHM-GZ-CHU-CR-BUK-CYO 10 APR-UE-CAM 9 AG-AZI-DUJ-CDC-AWY 8 BBY 7 DCJ-CR-UVB-EAW 6 JT-CTS-CCN 5 BCS-AAF-EDK 4 BUX-CWN-DRF-DET-ECC-CQJ 3 BUQ-OO-BTZ-CNK-BTW-CFY-EAU-ECM-DZX-CFK 2 CXC-CLR-CNC-AIA-RQ 1 BHH 57 CSK 66.

PACIFIC DIVISION

HAWAII—SCM, C. D. Slaten, K6COG—K6JPT (ex-W8DEL) worked with K6EWQ during eruption of Mauna Loa volcano, handling considerable traffic. K6JPT's poles are 110 ft. high! K6CGK QSOed two Africans. K6JRN has new SW45 on the way. K6HOO is rebuilding MOPA. K6ALM has new 400-watt rig. K6GQF has new 1.7-mc. 'phone. K6CRW reports firecrackers in his 'phone. K6ENE on a fishing expedition in South Seas schedules K6JPT.

Traffic: K6EWQ 3230 GUA 762 JPT 621 GAS 455 FAR 408 GQF 96 AYD 87 EDH 43 HOO 36 JRN 20 DSF 16 CGK 13 COG 10 CIB 8.

LOS ANGELES—SCM, Francis C. Martin, W6AAN—New Year's storm and considerable increase in club activity resulted in nicest gain Section has had for some time. Seven stations make BPL both on totals and deliveries, with two making it on deliveries. Following send news although not handling traffic: W6ALR, CUH, DIX, DZI, ERL, EZK, EXQ, FJK, GKE, GTE, IFC, MA, QD. The Van Nuys Club gave Bell Club run for Section Club Banner. W6OK reported back at San Francisco. W6ICM is joining Navy. W6HDY is moving to Bloomington to take over job of Major since W6BRI left there. Code class being conducted at San Bernardino Naval Reserve Headquarters by W6JZV. W6GKE of the old W6YAU outfit is attending school in L. A. New rig at W6BNM putting out over 300 watts. W6LXH is in camp at Santa Barbara National Forest. W6HZM has new receiver and transmitter. W6HTO pushes pair of tens with 950 volts. Maywood gains new op in person of W6JQD. W6BQF is completely surrounded by new hams. HI. Beam antennae systems at W6MA-AM putting out FB. W6VO gets WAC certificate. W6CII reports QSP from Massachusetts to China in 15 minutes. W6JJU is getting almost the limit with '52—secret—new 800 buffer. Portable W6OY is operating in Ontario. Big wind at Long Beach took both 50-footers for 16V1T. W6EDW is making fine bunch schedules. W6BGN moved into the house for the winter. W6TN is at new QRA. New group in LA known as "International QSO Club" with W6GNZ as Secretary. Changes improve rig at W6DGH. W6AZU flattens two tens and goes carbon plate. W6KBY is new reporter from Hollywood sector. Ex-W3MC is in Section awaiting new 6 call. The Pasadena Club and Federation Quarterly Banquet was largest meeting ever held in Section with 530 paid admissions to dinner. Full credit goes to the gang who put it over. The Montrose flood gave W6EAF-FCE-DSP and several others chance to render fine service to public in the stricken area. Our totals show result of some of this type traffic.

Traffic: W6ETL 2414 EAH/FCE 1602 GXM 1064 CH 781 CUU 655 CVZ 515 DSP 501 AZU 437 NF 321 ETJ 235 IIA 278 BPU 276 GNM 238 ERT 174 CXW 108 AKW 104 BZF 103 AM 93 EDW 82 FIT 71 FGT 70 IGO 67 CKR 56 FTV 53 AIF 52 GFG 49 EQW 42 EK 41 HK-JYS 34 EUV 33 DEP 32 JZV 39 CBG 30 BFL 29 GEX 27 GIG-LC-PD 25 JRX 23 BMN 21 CNO 22 DJC 28 DOK 21 FNG-HXU-IRD 22 KBY 20 AAN 19 DQZ-DYJ-DUC-GQZ-IXH 18 JJU-VT 17 DJS-HJW 16 EUJ-FKF 15 FUU-HTO-TN 14 CAH-DCJ 12 BRY-CEM-DRL-HEW 11 ANN-BGF-CLY-CPM 10 CUV-EAR-GLZ-GWO-HHG-INC 8 BPM-FJK-GVX 7 AAB-DZR-EJZ-GG-HFG-HDC-IBS 6 IXT-IYE-JRQ-KBG 3 DYQ-FXL-HAH-HDC-HFH-HZM-IRA-ITA-JNE-JOJ 2 AGF-FUD-JBY-IZ-VO 1 JAG 6 BQF-GMA-HDV-HT-JWY-ON 5 BMO-BPP-DGH-DHW-FYW-HQS-JGL-JGU 4 EXQ-FNO-FXF-GNZ-HYP 3.

SANTA CLARA—Acting SCM, Barton Wood, W6DBB—W6FQY BPLs both ways! W6YG is stingy with dirt. W6FBW still ties down a flock of schedules. W6AMM stages a comeback—BPL in three days. W6CUZ sez 22914 in SS. W6AZC boasts 152 W9 cards. The freq.-meter at W6QR is calibrated down to a gnat's eyebrow. W6LXJ keeps in good with the neighbors by handling Christmas traffic. New reporters: W6J CZ, KBT, IXJ. W6J CZ has 25 watts c.c. W6YX, Stanford Radio Club, has come to life! W6DBB mixes YLs with radio and gets away with it. W6YL schedules YW. W6GOZ is about to tangle with a new 'phone rig. W6HJF modestly admits "a little DX on 7 mc." W6JUQ, FYD, GBI, JUR put Hollister on the map. W6KBT is going c.c. W6BSO finally rates a new shack. W6BCF is putting an '04A on 'phone. W6CDX took first place in local DX contest. H. K. Huppert gave an interesting talk on radio and X-ray tubes at a PRA meeting. W6BMW is still learning how to tune his FBXA. Keep the FB reports up, gang!

Traffic: W6FQY 560 YG 168 FBW 134 AMM 132 CUZ 67 AZC 44 QR 39 IXJ 29 JCZ 28 YX 23 DBB 14 YL 9 GOZ 8 HJF 5 JUQ 2 KBT 1.

EAST BAY—Acting SCM, P. W. Dann, W6ZX—RM-5AUT came through with an FB report for his gang. Ninth Corps Areas Aide W6RJ has moved his to 230 Mather St. W6GHD is second in traffic handling! FB. W6ZX built an FB new receiver designed by our old friend 6WB in SF. W6AF has schedule with K6EWG. Fine report from W6FLL in Angwin. W6RF is still busy with Naval Reserve drills. W6HRS made over 13,000 points in SS. W6TG is anxious to establish reliable schedule with Philippines, as his mother is now in Manila. W6TT is one of the new OPS. W6JTV is ORS prospect. W6BPC received message from Egypt and only three relays required; came through in less than 24 hours. W6EJA resumed schedules with KA1CO. W6IFP got his Commercial Ticket. W6CBS handled important message with Islands (Hawaiian) via 'phone. Thanks for reports, W6CSV and W6DKJ. W6CIZ, OO, turned in a page and a half of off-frequency and T-1 notes. W6IY is QRL A.A.R.S. W6AGQ is QRL college. W6FAC has new SS super coming up. W6FII tried link coupling. W6APB has a 50-watter. W6JNX is doing FB work with his '10. W6GYA is servicing BCL sets. W6CZN has receiver trouble. W6BPC is giving 'phone a whirl. W6AUT blew power transformer. OMLXU was a visitor at 6BPC's. Listen, gang, Director Culver and myself are having a hard time obtaining speakers for our Section Meetings, and I wonder if some of you fellows can't help us out either by helping us get speakers or making some suggestion. Drop the Acting SCM a postal and you may be sure your suggestions or whatever help you can give will be appreciated.

Traffic: W6RJ 523 GHD 443 ZX 238 AF 156 FIL 62 RF 60 AUT 53 HRS 52 TG 36 TT 31 BPC 26 EJA-IFP 18 CBS 16 CSV-FAC 15 DKJ 14 CIZ 11 IY 6 AGQ 5.

SAN FRANCISCO—SCM, Byron Goodman, W6CAL—Army W6PQ is now signing W6ZG. BPLites: W6ZG, W6JAL, W6ENM. W6ABB is resuming schedules. W6NK is QRL NCR. W6JDG finds 3.5-mc. skip bad. W6GIS is teaching radio at engineering school. W6ZS is looking for that perfect radio location. A 211D at W6ATE couldn't take it. W6GKO's new bug almost runs away from him. W6BVL is QRL new ARA secretary job. W6DDO seeks ORS. W6JMR worked all W districts with 13 watts on 3.5 mc. First VK for W6BJZ's '45s. W6JVG looks longingly at 1.7-mc. 'phone. W6HKA averages two new antennas a day. PP '10s on 7200 kc. for W6VM. A few more 28 mc. W9 QSOs for W6CAL. W6FAJ is QRL school. W6WC is haunting 14 mc. W6CIS moved QRA again. W6MV is QRL work. W6AWA-BGW has three-way QSOs with VP5PZ and W9UZ. How about some reports from the gang in the northern part of the Section? New c.c. rigs: W6HIR, GPB, RH, EQK.

Traffic: W6ZG/PQ 1239 JAL 392 ENM 247 ABB 135 NK 125 JDG 68 BTZ 52 HIR 46 AZK 24 GIS-GPB 22 ZS-ATE 21 GKO 16 BIP-HSA 15 BVL 11 DDO-JMR 8

JBZ 7 RH 6 JVG-HKA 5 VM 3 EKQ-CAL 2 FAJ-WG 1 ATP 5.

SACRAMENTO VALLEY—SCM, Geo. L. Woodington, W6DVE—W6UM. W6FVZ and W6FRP each have taken on a ball and chain. Congrats, fellows. W6BHM is going to the Naval School in San Diego. W6EDV is going strong on 'phone. W6HYF has fine c.c. rig. W6FW is doing fine work as OO. W6AK has a pair of '04As. W6BYB has new 7-mc. c.c. rig. W6KCA is a new Sacramento ham. W6IQH worked a VE4 on 1.7-mc. 'phone. W6FLR is QRL college. W6JPI has new 50-ft. pole. W6IZE worked a K7. W6IMV has new Zepp. W6IMJ is active on 3.9 mc. W6JPI is YLing. W6GR is on 7 mc. W6CKH joined Naval Reserve. W6GVM is building portable rig. W6JVF is new Westwood ham. W6CXI is playing with 56 mc. W6CEA is on 7 mc. W6DZW is in radio servicing business. W6CNC is with C.C.C. W6CKV was home on vacation from U. of C. W6FOD is building complete station for JOR. W6HVM worked his first W9. W6GGB is buzzing on 3.5 mc. W6DFT worked all districts except 3rd and 4th on 3.5 mc. W6SK/AYS is set up at new QRA, Mt. Shasta. W6IEA, Mt. Shasta High School, is rebuilding. W6JDD has transmitter trouble.

Traffic: W6DVE 40 CGJ 34 GHP 9 FWB 12 FRP 2 IHZ 16.

ARIZONA—SCM, Ernesto Mendoza, W6BJF-QC—The ASWRC at Phoenix on March 17th and 18th is going to put over the first Hamfest ever attempted in Arizona. Price: 1½ bucks! Prizes: Lots of 'em! Watch for bulletin being mailed to all active Arizona hams!! W6ALU has FBXA. W6HEU is QRL on "Hamfest" publicity. W6HKX is at Tempe Armory. New rigs: W6IIG, BFA, HAX. An old Navy op works W6BLP at times. W6GZU works AC, KAI, VK. W6IIF is building portable. W6IQY reports for Flagstaff gang. W6DKU has Grebe receiver. W6CQF had W5BQU for visitor. W6FITP worked No. Dak. W6GFK is strictly portable. W6BPV and HBR are on 'phone. W6QC piled up 1,092 points in Jan. ORS Contest. W6EGI attends Tempe Teachers College. W4CCM, of Key West, Fla., is chief op at Phoenix Dept. of Commerce Airways station. W4ANI built Jan. '33 QST Autodyne receiver for use for himself and W4CCM at new QRA. W6CDY has left for Oxnard, Calif. On 7 mc.: W6HEY, ILL, JRK, JMS. W6DSA is a sheepherder. W6GGS has fun with 2-tube super het. W6CKF and DPS returned to Los Angeles Commercial Radio School. W6BRL is counting the days until the Hamfest banquet!! W6BYD is at former QRA with new radio store. W6GDF is active A.A.R.S. W6ERP likes PP TNT. W6IUQ services BCL receivers. W6DKF is becoming a crystal authority. W6DOW has c.c. '47-'10. W6EKU has two '12-Ds to modulate two '11s! W6IUY has her first card, on a contact with Idaho. W6FZQ is becoming general clearing house for traders. W6JIW has abilities as chalk-talker and monolog artist. W6FGO is fire underwriter.

Traffic: W6ALU 749 HEU 60 HKX 39 BLP 19 GZU 16 IIG 12 BFA 10 IIF-IQY 8 DKU 7 CQF-HAX 4 FIP 2 GFK 1.

PHILIPPINES—Acting SCM, Newton E. Thompson, KA1XA—KA1NA worked WIZI two-way on Dec. 29th. This was first time WI district has been worked from P. I.

Traffic: KA1HR 2408 NA 1058 LG 423 RC 382 FS 248 CS 207 FM 139 XA 103 OR 81 CP 68 EE 67. KA9WV 95 OMITB 840.

SAN DIEGO—SCM, Harry Ambler, W6EOP—W6FQU, W6QA, RAs. W6IBK, 'Phone RM. W6BMC leads the Section again with a BPL total. W6DQN and FWJ also BPL. W6FQU has three schedules. W6BAM made 15,050 points in SS. W6BHF has six schedules on 'phone and two on c.w. W6BHV worked India. W6AXN worked Japan. W6CNC uses '52. W6DWA is doing FB on 14-mc. 'phone. W6EFK is now A.A.R.S. 9th Section. W6BOW is on vacation. W6GTM worked a VS8, J and three K6s. W6LD has new 'phone. W6GNT: QRL school. W6KBX is new reporter. W6EOP and IBK are building new 'phones. W6CNK was heard by ZL1DL on 3.5 mc.

W6FKT reports club at Fallbrook has 10 members. W6JRM in two hours worked six DX stations on 1.7-mc. 'phone.

Traffic: W6BMC 1446 DQN 739 FWJ 549 EFK 357 FQU 316 BAM 85 BHF 73 BHV 68 IBK 19 AXN 10 BOW-GTM 7 LD-GNT 4 KBX-EOP 3 CNK-JRM 2 FKT 1.

SAN JOAQUIN VALLEY—SCM, G. H. Lavender, W6DZN—Glad to be back with you, gang. Thanks to W6AOZ for his part as Acting SCM. Fresno is telling world about coming Pacific Division Convention. W6CLP reports thrills on 14 mc. W6EXH is pushing traffic. W6DXG says skip has him down. W6FFU is active OO. W6GFB has an airplane. W6AME is looking for missing link in link coupling. We welcome W6GJJ as a member. W6ENH is after traffic schedules. W6SF is turning out real crystals. W6HLJ is putting in a crystal oven. W6FBQ is giving up 'phone in favor of c.w. W6KBP is new Turlock ham. W6PYM is working DX on 3.5 mc. W6GXL's power supply went west. W6DXL is now an OBS. W6BBC put over a good Italian feed for Stockton Radio Club. W6GQZ is our only YL. W6AOZ went to Washington, D. C., to beg F.R.C. for more time for KGDM. W6BHQ makes BPL as usual. W6BXX is on with '52.

Traffic: W6EXH 209 CLP 129 DXG 65 FFU 53 AME 51 BHQ 153 GJJ-ENH 42 DXL 37 AOZ 38 AGV 21 DZN 19 HLJ 17 DQV 16 GQZ 10 SF 7 BBC 6 FBQ 4 FYM 3.

NEVADA—SCM, Keston L. Ramsey, W6EAD—W6HGL has new transmitter. Portable W6BIG was in operation in Hawthorne. W6HCE is building 1.7-mc. 'phone. W6HEY schedules another marine at Bremerton, Wash., Navy Yard, W7EEU.

Traffic: W6UO 58 HGL 16.

ROANOKE DIVISION

NORTH CAROLINA—SCM, G. H. Wright, Jr., W4AVT—All hams in North Carolina, South Carolina, Georgia, Virginia, West Virginia, and adjoining states are invited to attend Two-Day Hamfest in Charlotte on March 3rd and 4th. Big banquet and Prize distribution on Saturday night. Hotel rates reduced. Registration rates, including banquet and prize drawing, will be \$1.25 for the OM and \$1.00 for the YLs and OWs. If interested make reservation now through W4BX, Gordon S. Smith, 1716 Thomas Ave., Charlotte, N. C. W4CGL has '52 final. W4BHK is rebuilding. W4CRK is new call of old 4NU. W4CJP is DXing. W4UB worked W6 and W7 on 3.5 mc. W4CFL and BST worked all W districts on 3.5 mc. W4CGH and BRK are lined up with FB traffic schedules. W4BMG added a couple of '52s. W4CIM moved to N. Y. C. W4BOH is attending State College. W4BPO and BML: QRL school. W4BHP has new 75 ft. mast. W4BV has new 3.5 c.c. rig. W4FT has new Comet Pro. W4EC has couple of 50 foot masts. W4MR had one QSO on 28 mc. during month. W4CQC, Professor Jennings, of Greensboro College, is new ham in Greensboro. W4HV has new SW5AC. W4BRT and BAH send FB totals. W4ZH kept important traffic schedule with PY1BA, a boat fishing for Tuna off Gallapagos Islands. W4IF says traffic picking up. W4AI is new president of Winston-Salem Club. W4NC is putting up third tower. W4OG schedules K6. W4BYA gets out FB with 1.7 mc. 'phone. W4RA worked an SU. W4IY and BHS send first traffic reports. W4ABT thinks 1.7 mc. only thing to overcome skip. W4BLU is back with c.e. W4AIS worked 4 continents during month. W4EG has new Army call, W4RF, with frequency of 3497.5 kc. W4CNV is new ham. W4CLB visited W1MK. W4AYH has been transferred by W.U. to Florida. W4CP is on daily at 5:00 p.m. EST, on 7248 kc. W4ANU is on 'phone exclusively. W4BMW gets out FB with 3.9 mc. 'phone. W4JB is back after long spell of rebuilding. W4BUE built 1.7 mc. 'phone but it wouldn't get out so he tore it down and returned all the borrowed parts. W4BTC, CGH, and BSS want ORS. W4PW gets OBS appointment. Prof. Caveness, W4DW, editor of the Tar Heel Ham, is getting

some very nice comments on the "Ham." To get a copy send 3¢ stamp for sample; mail a traffic report to the SCM by 20th of the month; or subscribe six months for 25¢.

Traffic: W4AIS 313 BTC 150 AVT 82 BRK 76 BRT 74 ALK 73 MR 65 TP 60 BAH 55 ZH 54 DW 49 BST 48 IF 41 CFL 36 ANZ 28 CJP 25 EG 23 CGH-CS 22 BV 21 BDU 20 UB-BHR-BVA 17 BJV 12 BHP-EC 10 BOH 9 TJ-FT-CP 8 OG 7 ABT-BJZ-CCF-BRT 6 CAY-BLN 5 BVD-RA-BHS-RV 4 CRK-AEH-VV-PFA-IY-BLU-CLB-BX 3 CGL-HV-PA-BXF-BZF 2 NY-BKS-BYA-CFR-ALD-CNV-AEN-BFB 1 ANU 12 AOA 23 BXX 8.

VIRGINIA—SCM, R. N. Eubank, W3AAJ—W3DNR, EBD, DCU, AVL and CZX handled death and sickness messages. New Virginia calls: W3EFZ, DQB, CQK, DVW, EGW, DWE, IZZC—EHL, CTC, EGD, DWW. New transmitters: W3CYU, DNR, AIJ, Peninsula Club; DGT, JG, Petersburg Club, VPI Club, CYW, DVP, EGD, V.M.I., FE. New c.e. rigs: W3BSB, DQD, TJ, ECQ, EHL, BSW, AII, BPA, DWE, DXO. New receivers: W3DQB, AJA, BDZ, CYW, CVQ, AII, ECT, FE. New antennas: W3DSE, EHL, CYU. Official Phone Stations: W3GY, CNY, BIG, CIJ, AEI, ZA, ASK. On 1.7 mc. 'phone: W3DRK, CDW, AJA, BAI, NE, AIJ, FJ, DZW, DDG, AHC, AUG, AKZ, CYK, DVP, CZX. On 3.9 mc. 'phone: W3CZJ, AHQ, ASK, CNY, DXY, AEI, AVL, ZA, GY, AKZ, CLJ, BIG. Traffic stations: W3AAJ, ALF, AOT, AHQ, BAD, CMJ, CFV, CKM, CTC, DCU, BGS, BJX, NT, BPA, IZZC, EBK, CSI, DVO. Rag chasers: W3ASK, AOT, AJA, AEI, AVL, AHQ, AAF, AKZ, DNR, DQB, DSE, DDG, DEH, DVW, GE, CCU, BLE, BKN, BKJ, BZA, BNH, BAD, BDZ, BUR, EBD, ECQ, CIJ, BGS, BPA, BRY, LY, CMT, CYU, CMJ, CDW, CWS, CYK, CTC, MQ, AAJ, ZA, BZA, MT, BIG, CZX. DXers: W3AAF, ALF, AVL, BSB, BLE, BKJ, BAD, BDZ, CZJ, CGR, CNY, CYW, CWS, CYK, CTC, BAN, CMT, LY, DVO, CSI, DNR, DGT, DXY, DEH, DVW, CVQ, MQ, EBD, GY, AKN, CCU, CIJ, DCU, BGS, AG, BZE, CEY.

Experimenters: W3AOT, ASK, AIJ, AVL, AEI, BSB, BZA, BDZ, BUR, DQB, DGT, DFU, DDG, DBI, DVW, AKN, CCU, AII, DXO, ECT, FE, DWW, DVO. Want schedules: W3DNR, AOT, ALF, CMJ, BJX, BPA. QRL: W3BIW, DFU, AGY, GE, BGS, BRY, BPI, CZX. Re-building: W3CA, BZ, DES, EGO, BUR, SKCB, BZE, ECT, VZ. Back on air: W3BZ, BKN, JG, TJ, DZJ, EGW, NT, FE. Formed Scout Radio Crew: W3AMB, BZE, EBK, EBD. Winning lots of prizes: W3BJX. Club news: Virginia Floating Club plans: Roanoke February 18, 2 p.m.—Charlottesville March—Lynchburg April—Richmond May—Sundays. Misc.: W3CVQ is Traffic Mgr. Roanoke Club. W3AKZ is with WDBJ. W3WO is with E.A.T. W3BAD and AAF visiting. W3CFL is at Ohio S. Univ. W3ALF joined Radio Fraternity. W3TJ is adding '10 amp. W3DEH got 34 DX cards one day! W3DXY is moving to W. Va. W3AVL and CZJ worked ZL on 3.9 mc. 'phone. W3AG made WAC Jan. 1. SCMs MESSAGE—Ham activity may be judged by nr. of monthly reports. 425 Va. stations in book but only about 12% report traffic monthly. (See note, top of page 5, QST.) Report on 16th activity or traffic 16th to 15th inclusive. You DO NOT have to BE A.R.R.L. member. W3AHC is 1.7 mc. 'phone R.M. W3GY is 3.9 mc. 'phone R.M. W3CYV is moving to D. C. W4DVO never turned rig off during ORS Party.

Traffic: W3AEI 32 DDG 25 DNR 20 AAJ 19 ALF-DXY 8 ASK-CNY-CZJ 7 BZA 6 BKN-DQB 4 AOT-CDW-MQ 3 CGR-DGT-DQD 2 BSB-DSE-TJ 1 CMJ 36 DEH 11 CYW 8 ZA 3 AHQ 32 EBD 19 CFV 18 CFL 16 GY 14 AAF-BDZ 6 EPZ 1 CVQ 5 CWS 4 AKZ-CKM-CYK 2 DCU 102 CCU 17 BGS-CIJ 15 AG 9 AKN-BSW 2 DVP 1 BJX 122 NT 120 BPA 69 EGD 18 BZE 13 CEY 11 BAI 9 BRY-MT 3 BPI-DWE-DXO 1 CZK 16 BAN 6 BIG 6 CMT 2 LY 1 AMB 5 FJ 147 DVO 25 EBK 10 AVL 1 CSI 28 NE 21 CDW 4 AOT-DDY 2 AEW-APU-BSY-BWA-DAM 1 APT-EGU 2 BYA 60 CUR 4 JG 8 CXM 33. W1ZZZ 23 W8KCB 1.

WEST VIRGINIA—SCM, C. S. Hoffmann, Jr., W8HD—W8EIK changed QTH. W8ELJ was temporary Control

Station for W. Va. Net. Huntington hams pulled a Hamfest, which was well attended by Charleston hams; 40 present. W8EZR, DMF, JQU and HWO: rebuilding. W8CZ is on 3700 kcs. with new tritet. W8IRD is new Huntington ham. W8CHP is on 3.9 mc. 'phone. W8ETX will soon enter fourth stage of Amateur Radio. Hi! W8ELO schedules W9KXC. W8DPO works ZLs and VKs. W8GB is now in Wheeling. W8HCL handles lot of KJTY traffic, clearing through W8ED/WLHF to WLH, Army Net. W8GAD got new receiver. W8JJA worked all U. S. dists. and VE4. W8KSJ was heard in Germany. W8KWL claimed highest station in state—3200 ft. above sea level! W8DFC converted a new 'phone ham. W8AHF is heard by SCM QSA5 R9 on 3.9 mc. 'phone. W8JWL got R9 from west coast. W8HCL desires more schedules. W8GEG is WMMN engineer. W8DSO is residing in Erie, Pa. W8TI made 11662 points in SS. W8KLO attends Marshall College, Huntington. W8AKQ, ZZZ and DOB joined 3700 kc. gang. New ORS: W8HCL, W8GB (reissued). The Ohio Valley Radio Club is planning tri-state hamfest to be held in Wheeling.

Traffic: W8GB 379 EIK 171 OK 109 HD 65 ELJ 63 HCL 42 KWU 41 DPO 34 EZR 33 KKG 29 BDD 26 DNN/GQD 25 JWL 18 ELJ-GAD 16 DMF 13 FQB 7 CYV-JJA 1.

ROCKY MOUNTAIN DIVISION

UTAH-WYOMING—Acting SCM, Arty W. Clark. W6GQC—W6GIO demonstrated and theorized at U.A.R.C. meeting on his newly constructed reflex-vacuum-tube voltmeter. W6ETB, BMB and IWY from Ogden visited U.A.R.C. W6KBL is new SLC station. W6KDL, in Cedar City, is ex-W7AWG. W6EXL turned A.A.R.S. net over to W6DFJ. W6JVB has luck on 14 mc. W6AFN and PRN cut schedules for jobs. W6GQC is coming up for "air." W6BTX is back on for traffic. W6GPJ uses low power portable. W6PYR took two death messages on 3.5-mc. c.w. from Kansas and with aid of W6BLE on 3.9 mc. 'phone within hour placed one in coast town for delivery and other within 150 miles. W6CRX took two messages from Wallace, Idaho, flood area and delivered into Idaho via W.U. W7COH is organizing 7-mc., 3.5-mc. c.w. and 3.9-mc. 'phone net for Wyo. W7ABO is on for Wyo. net. W7CXM is working on new hangar at airport. W7CMP has good note on 3.5 mc. W7COH says schedules catch-as-catch-can on account of skip. W7AMU keeps Casper hams going. W7DES and CVD are active. W7ACG sports new type license. C.C.: W7WNY and EDC. W7CJR is building c.c. W7BXS batching. W7CHR is building new shack. W7AEC has power difficulties. W7CSE is interested in A.A.R.S. Casper Radio Club elected officers.

Traffic: W6GQC 707 AFN 261 FRN 139 BTX 138 AHD 80 GQR 37 JVA 32 JVB 18 BSE 14 EYS-CRX 8 GPJ 7 DEM 5 FFT 4 IOF-IWY-BLE 2. W7COH 91 AOU 73 AMU 26 AEC 16 NY 6 CBL 2.

COLORADO—SCM, T. R. Becker, W9BTO—W9EYN has taken over W9KNZ's duties. The Pueblo crowd are getting started. W9NLD, OTM, and NQV have gone to "Tritet." W9NLN uses low power. W9GJQ has fine lot of schedules. W9EHC landed a job. W9FXQ and brother are combining their rigs. The PPARA's officers for 1934 are: pres., Ed Drummeller; vice-pres., W9DYP; secy.-treas., W9EHC; serg.-at-arms, W9NKQ. W9EY has a regular schedule. W9ESA reports new FBXA "FB." W9KNZ had to drop out of game for a while on account of his health; in making his last report he makes BPL for fourth straight time! W9GLI has been on 'phone. W9MLU has new SW5. W9OYE has new SW3. W9NPP has trouble with MOPA. W9MDN is putting up new sky wire. W9MDN and LQO keep daily schedules. W9CDE has new c.c. rig. W9GNK has been QRL U.S.N.R. W9PPU is new Silverton ham. W9BYK is getting out FB on new 'phone. W9EMU is rebuilding. W9BYV got a new 50-watter. W9FYY makes WAC! W9AAB has new AGSX. W9IPH has a man-size transmitting tank condenser. W9MOF traded his FB7. W9HQV has trouble eliminating key clicks. W9FRP needs another 50-watter for final. W9GVN is soliciting for U.S.N.R. W9GBQ has

new FBXA. W9HLR and YL are on 'phone. W9DNP is fooling with Class "B" 'phone. W9BJN uses 50-watter in final.

Traffic: W9EYN 328 GLG 3 GNK 166 CDE 32 GII 13 KNZ 842 ESA 1731 EGY 20 GIJ 408 EHC 14.

SOUTHEASTERN DIVISION

ALABAMA—SCM, L. D. Elwell, W4KP—W4JY leads the Section with a fine total. W4AAQ changed QRA to Mobile. W4GL reports from Mobile as follows: New stations—W4CQM, CQV, CQW and CRR. W4BSA leaves WODX for WHET, Dothan. W4BXV completed his transmitter. W4BRA and GL are on 14 mc. W4GP is on 'phone. W4BLI, NU, COU, CBI and CNI are fairly active. W4CCP, COA and CPE are the gang at Gargas. W4AJY is at Ga. Tech. W4BOU sent in his papers for ORS. W4BMM is changing his ORS to OPS. W4ZS is to be OPS soon. W4BSL is busy with new transmitter. W4SN is working on grid modulation. W4BJA reports W4IX to be globe trotting. W4APU is the Birmingham Club president and is working on trunk line J (c.w.). W4CHJ has a few schedules. W4BCV is on 'phone. W4BZG is new ORS. W4ASM joined A.A.R.S. 'phone net. W4AP rushed his report via the air. W4BDH got married Xmas. W4AWQ is building Tritet. W4KP is building freq. meter-monitor. If any amateurs in Alabama are not getting the "BULL," let us have your QRA and we will put you on the mailing list.

Traffic: W4JY 504 DS 292 AAQ 234 BOU 264 AJY 125 CHJ 120 APU 118 BZG 106 KP 61 BJA 23 BMM 20 CCP 11 ASM-GL 5 ZS-SN 2 CPE 1.

EASTERN FLORIDA—SCM, Ray Atkinson, W4NN—OPS applications are invited. RMs W4ALP, 4WS, 4ABG report new traffic stations needed badly. W4WS, BGL and NN make "100 total club." W4BGL took traffic from Byrd Expedition. W4BIN reports U. of F. exams keep him busy. W4BNI's power supply went west. W4CCI and TZ are building tritets. W4KM is after traffic! W4AGY promises a letter about the FB work at the air races at Miami. W4VP says two new hams in Daytona; W4CRI is one of 'em. W2AMT, ex W4BRO, will winter in Miami again this year. W4DZ joins the southern emergency net. W4CRN has a Collins transmitter and a Comet Pro. W4AIW is going in for DX. W4BNR is on 14 mc. Nice traffic totals at W4AKJ and AQU.

Traffic: W4NN 214 WS 159 BGL 102 at W4QY 64 AKJ 60 KM 59 ALP 32 VP 30 AGB 29 BIN 10 AJX-TK 8 ANY 13 CCI-BNI 5 BNR-CEO 4 BOX-DZ 2 CRN 1 BBX 20.

WESTERN FLORIDA—SCM, Eddie Collins, W4MS—RMs: W4ACB, W4AUW. W4BGA received WAC. W4MS made WAG again on 7 mc. W4CMJ has an SW3. W4ASV has MOPA rig. W4BGB moved to Pensacola. W4ARV operates on 3.5 mc. W4CQP is finishing transmitter. W4BKQ is interested in 56 mc. W4QU, BOW and SZ do U.S.N.R. work. W4KB handles traffic on 'phone. W4AXP wants South Fla. schedules. W4ABK is QRL school. W4CMB, AQY and AUV are on 1.7 mc. 'phone. W4CDE is on 7 and 14 mc. W4AUW, ACC, CMJ and CDE use Tritet. W4BFD and BSJ use c.c. W4COG has 50 watter. W4QR reports conditions terrible. W4BPI wants new receiver. W4CLP reports. W4BMBJ works gobs of stations. W4BKD is on 28 mc. 'phone. Mrs. W4MS gave the OM an FB7A for Xmas. W4CQG is building new transmitter.

Traffic: W4KB 168 MS 10 AXP 4 ACB 11 AQY 14 AUW 18 CDE 26 BFD 10 BGA 12 COG 15 BSJ 32 QR 2 AUV 2.

GEORGIA-SOUTH CAROLINA-CUBA-ISLE OF PINES-PORTO RICO-VIRGIN ISLANDS—SCM, G. A. Love, W4UT—Assistant SCM, B. L. Stewart, W4CE, W4BRG leads the section! At the annual banquet of Atlanta Radio Club attendance record was broken with 78 present. W4NF and BBR were among out-of-town visitors. CM2RA, NA, SV, QY and MG have 'phone fever. CM2DO, AN and WW use FBXA's. W4GB added pair of 800s. W4CQJ is a new-comer (ex W9HJD) in S. Car. W4BCN is on 1.7 mc. 'phone. W4CPZ

is on 3564 kc. W4BQM is A.A.R.S. W4ANK passed commercial exam. W4AIF moved to Norfolk, Va. W4MN is S. Car. A.A.R.S. control station. W2FLB operates portable at C.C.C. Camp near Georgetown. W4AZT is active in Spartanburg. W4CE worked HRIUG on 3.5 mc. W4VL has a '52 on 7 and 14 mc. W4CM is on 3622 kc. W4CAO is on 3580. W4BW wants ORS renewed. W4UP has elegant new sky-hook built like Eiffel Tower! W4CIR can't get his Zepp to take soup. W4ATZ schedules W2AJY. K4BBN is active on 7 mc. K4AAN schedules CM8YB. W4UT schedules NY1AA and CM8YB. W9ZZAF (DLS) was a two-week visitor. W4AAY schedules W4CAO and BLN. W4SI and ST are rebuilding. W4AEI has 'phone fever. W4BZW has '03A in PA.

Traffic: W4BRG 594 BZW 82 UT 73 AAY 36 GB 26 UP 18 CQQ 16 CE 12 ATZ-CM 10 MO 9 CFJ 6 CBY 5 IN 4 CPZ-RM 2. W9LMS 18. CM2WW 12. CM8YB 143.

WEST GULF DIVISION

NORTHERN TEXAS—SCM, Glen E. Talbutt, W5AUL—W5BII Chief RM; W5BAY Phone RM. District 1: W5ANU RM; W5BII handles traffic for Byrd Expedition. W5BZT is DX Editor for the Section bulletin, the "Nipper." W5BTJ wants schedules on 1.7 mc. W5DAA says Terrell Club coming along fine. W5AHC reports W5EL on 7 mc. W5ATI is getting 800s on air. W5BKC: QRL. W5ANU: QLZ. District 2: W5IA RM. W5BKJ and CPU report new club in Ennis. "YF" W5DQF schedules KA1JR and reports for the "OM," W5AMK. W5BTW, DVV and DFU report from Ft. Worth. W5AJG works 14 mc. 'phone. W5CMS is new ORS. W5CAM has nice traffic. W5CAV: QRL. W5AQS is getting to be a traffic hound. W5CHEJ is on 3.5 mc. W5CXS has two transmitters on 7 mc. and 1.7 mc. 'phone. District 3: W5ARS RM. The RM has 7 schedules. W5IT is yelling on 3.9 mc. W5CIJ and BCW have new c.c. rigs. W5DUU reports from Lubbock. W5CPB and CPT are on the job up in the "pan-handle." W5CJE has new QRA. W5OJ is "op" at KGKO. W5AVA is c.c. W5BYM and CEE are "having at 'em." District 4: W5BKH RM. W5DMD reports traffic. W5BVF worked D4. W5AUJ "says" he worked Azores! W5DQW and BNS are on air too much. W5AW runs second high in traffic. W5SP has new QRA. W5QA and CYU handle traffic on 3.9 mc. 'phone. RM W5BAY spends his time visiting. The Abilene Club is again active. The SCM would like to have news from the Clubs at Dallas, Terrell, Athens, Ennis, Temple, Wichita Falls and any others.

Traffic: W5BII 305 AW 188 ARS 73 CAM 70 CIJ 75 BKH 67 AUL 60 AQS 50 AHC 40 IA 39 CYU 32 CPB-AJG 28 ATI-BKJ-QA 20 AUJ 18 CMS 11 BNS-AVA 10 CXS 9 OJ-IT-SP-BVF 8 DAA-DQW 7 AMK-CEE 6 CJE-DFU 5 DVV 4 BYM-DQF-DMD 2 CPT 1 CPU 4.

OKLAHOMA—Acting SCM, St. Sgt. R. F. Hinck, W5BQA—No applications have been received for OPS yet. All OBS please send the SCM a list of your schedules giving time and freq. used. W5CEZ handled traffic from Maine to Calif. and had answer back to Maine in one hour and twenty minutes! W5ARB at Okla. City is looking for schedules for Saturday and Sunday A.M. Please note: Reports should be mailed on the 16th.

Traffic: W5CEZ 718 BDX 202 BAR 45 ARB 8 CNC 105.

SOUTHERN TEXAS—SCM, D. H. Calk, W5BHO—W5OW transmitters are now remote controlled about one mile from the receivers. W5YL/BWM is back in southern Texas. W5DS reports new QRA Texas City. W5DUO would like schedules any morning. W5MN sends nice traffic report. W5BKE is planning 1.7 mc. 'phone. W5ABH is on the air again. W5ADZ reports lots of fun in SS Contest. W5BB increased power to 160 watts. W5VV schedules K6EWQ. W5AFQ reports by radio. W5CVW reports c.c. rig working FB. W5AKN has FB 1.7 mc. 'phone. W5AKN, JB, CDV, and DTL attended hamfest in Cuero. W5MS reports the "TIP O' TEXAS RADIO CLUB" held first meeting in Corpus Christi, Jan. 28th. W5AEJ is in Cleveland, Texas. The Houston Amateur Radio Club transmitter is working FB on 3.5

mc. W5BKW has new receiver. W5YH is on 3.9 mc. 'phone band. W5AXH reports local QRM bad. X-W5TE reports W5JC has FB 14 mc. 'phone. W5ON, BRC, CTC, and BUB report.

Traffic: W5OW 2152 MN 322 VV 61 BB 30 BEF 27 ADZ 15 AFQ 12 BKE 11 DS 6 DUO 4.

NEW MEXICO—SCM, Dan W. De Lay, W5DUI—W5AAX is new ORS and OBS. W5AOP joined A.R.R.L. W5ASR is on 3.9 mc. 'phone. W5DVU schedules brother in Colo. W5CSR mourns passing of 211. W5CGJ is on sick list. W5BNT turns in third highest total using '45s. W5ZM is building Tritet. W5ZU was working at W5ZM during holidays. W5DSN is new Albuquerque ham. W5CPO is now in Navy Radio School at San Diego. W5CYQ asks for OPS. W5DUI is gunning for bugs in c.c. transmitter. We need more ORS, OPS and an OO. Inquire, act and let's go for a new deal!

Traffic: W5AAX 122 CGJ 50 BNT 44 ZM 29 DYX 22 DVU-AOP 4 DUI 1.

CANADA

THE GOVERNOR-GENERAL'S RELAY

The Dominion-wide Christmas Day relay wherein messages were exchanged between the Governor General and the Lieutenant Governor of each province was a complete success. This enterprise was conceived by Len Walker, VE3JI, and planned with the cooperation of VE2CX, VE2AP and VE3GT.

Amateurs in the capital city of each province were requested to obtain a message of Christmas greetings from the Lieutenant-Governor to the Governor-General. VE3JI obtained a message from the Governor-General to each Lieutenant-Governor (with the exception of Prince Edward Island, whose Lieutenant-Governor was deceased). This message was sent to VE3GT and VE2CX on the day before Christmas, for relay through the chain.

VE1GL handled the Governor-General's greeting and a return message. VE4HM handled the Alberta message and the reply, and also relayed the British Columbia message. VE4JH and VE4EL handled the Regina and Edmonton messages both ways, and the reply from Victoria. SCM VE5AC reports that the British Columbia boys were on the job, delivering the message to the Lieutenant-Governor. All of the Lieutenant-Governors' messages were received in Ottawa through either VE2CX or VE3GT by 3.00 p.m. on Christmas Day.

Stations deserving special mention for their work in this relay are: VE1ER, VE2CX, VE3JI, VE3GT, VE3HA, VE4DK. These stations maintained schedules for nearly 36 hours. Other stations taking an active part in the relay are: VE1GL, VE1EB, VE2AB, VE2AP, VE4JH, VE4EL, VE4GC, VE4HM, VE4NM and VE5FG, VE2GH, VE4DT, VE4MH, VE5HR, VE5MP.

His Excellency, the Governor-General was very pleased with the results, and wishes the Canadian amateurs success for the coming year. It is hoped that an annual relay will be inaugurated for each Christmas Day.

—Alex Reid, VE2BE
Canadian General Manager

MARITIME DIVISION

NOVA SCOTIA—SCM, A. M. Crowell, VE1DQ—1EX leads in traffic. 1ET, EP and DQ are swatting DX. 1DE schedules VE2HK daily. 1BV will supply official logs to members entering BERU tests. 1DH moved to St. John. 1FB, QSL Mgr., is active on 3.5 mc. 1AX will have new 14 mc. rig. 1GE will take traffic for P.E.I. 1FN schedules 1EO. St. Paul's Is. 1GR is on 1.7 mc. 'phone. 1AW is on 3.9 mc. 'phone. Cape Breton Island

dope via 1BN: Active on 3.9 mc.: 1BN, FI, AL, CN, DW, ED. Active on 14 mc. 'phone: 1DR, DM, DW. 1AH is QRL studies. 1CK is selling out. 1CR is QRL BC servicing. 1BM schedules 1BL Labrador. 1FA schedules his brother in states. 1FW is new man at Glace Bay. 1AB built new home. 1AV lost everything in bad fire. 1EK is building tritet. 1YL is on one hour each evening. 1EE worked VE3 without any antenna on 7 mc. 1EA is building modulator for 'phone.

Traffic: VE1EX 36 EP 25 DE 19 GL 11 BV-FN 8 DQ 6 GE-FI-BM 4 AL 3 BN 2 EK 4 EA 27.

ONTARIO DIVISION

ONTARIO—SCM, S. B. Trainer, Jr., VE3GT—3WX makes BPL and Windsor gang lead province. On Jan. 8 at 7:30 p.m., 3WE, who hails from South Africa, worked ZS1M on 3.5 mc. band. Both sent words in Zula as a check. 3GT has gone Goyer Lock c.c. 3JT is new ORS. 3JI has new outfit. 3QB still has QSLs. 3OP worked LU. 3TB is moving to Windsor. 3NM and VD sent newsy reports. Ex 3QK will be on soon as 3MA, 3WO and XT are new Hamilton stations. 3HT is going c.c. The Hamilton A.R.C. hopes to get a booth at Annual Made-in-Canada Show. 3IA awaits receiver. 3IX and JO are on 3.9 mc. 'phone. 9AL is pleased with new 3.5 mc. 'phone. 2S mc. has attracted 3UY. New officers of Queen City A.R.C.: Pres., 3WK, 1st Vice-Pres., 3UY, 2nd Vice-Pres., 3GR, Secy., 3SG, Treas., A. C. Rossborough. The U. of T. Schools have reopened under 3XK. 3TO is putting in '10s. 3EA worked VK5 with '45s. 3NX claims persuasion is needed to make class "C" work. It is said YLs are after 3MI, LR, TA, LI and KN. Reported on 1.7 mc. 'phone: 3HF, VA, QY, XR, RU, QO, JO, RT. 3DU reports 3UC, VR and WW new London stations. Rebuilding: 3GA, NB, MX and JN. 3KG is anxious to become ORS. 3XD is coming along. 3LZ has frequency meter. 3EM reports traffic for first time. Ottawa A.R.C. ran DX contest. 3GO is going to try to modulate his ½ KW rig. 3DW is giving code classes. 3NJ, PT and FZ active. 3YB is newcomer. 3DB and CP operate CKPK. 3CX-tritet-no output. 3FW is going to build an SS. Brothers 3CH, DR schedule each other. 3HU is dolling up CKPE. 3RA blew '83s. 3DX promises few more cycles on his note in 1934. 3FQ, UA, OZ are heard occasionally. 3GS is installing Class B. 3WH uses new "Q" sigs. 3GG gets out well with '04As in PP! 3HA continues to send fine report. 3WA handled RSGB traffic direct. Orillia now has nine stations on air: 3QM, XO, YL, QI, QL, QZ, SV, VP, and VG. 3DM is organizing Simcoe County League.

Traffic: VE3GT 263 JT 120 JI 241 QB 9 OP 12 VD 16 XK 3 DJ 60 QD 78 HP 63 XT-HT 1 IQ 7 IX 11 RF 104 SG 46 UU 2 GI 3 TO 7 RK 77 LI 10 GO 82 DW 66 WX 523 WK 128 KG 17 EM 21 WB 5 HA 8 VF 14 RO 25 OE 18 BZ 22 OC 10 BY 67 WJ 14 WA 15 GP 24. VE9AL 16.

QUEBEC DIVISION

QUEBEC—SCM, John C. Stadler, VE2AP—2GO contacted 2IC when the latter was on a rescue flight. FB, OM. 2DR has new transmitter. 2AW reports good 14 mc. DX. 2DG schedules Anticosti. 2HK schedules G5BJ. 2HP is working 7 mc. 2FZ installed class "B" modulation. 2BG, our first QPS, is organizing trans-Canada 'phone relay line. 2CO has new antenna. 2CX uses e.c. oscillator. 2AM uses TNT on 7 and 3.5 mc. 2BC is trying new 'phone. 2AC, AB, EO, DB, BF and AB have daily 'phone meeting. 2BT works his brother on 3.5 mc. 'phone. 2HQ announces arrival of a YL op. 2HG gets lots of DX. Welcome to 2IJ and IL. 2CG applies for ORS. 2HT keeps 3.5 mc. 'phone going. 2CM threatens to rebuild. 2EX and FQ are doing well on 14 mc.

Traffic: VE2CX 103 AP 63 DR 47 DG 13 HK 55 BG 33 CO 18 AC 12 BT 45 AA 105 FE 142 BB 91.

VANALTA DIVISION

ALBERTA—SCM, C. H. Harris, VE4HM—4EO, AF and OG are new officers Lethbridge Club. 4EA, BV, NC, and CX awaiting 800's. 4HM originated, delivered

and relayed Governor-General Christmas messages. 4PH is now ORS. 4HW and FI are talking 'phone. 4DQ gets good reports with tritet. 4BW is on 1.7 and 3.5 mc. 'phone. 4DX, HQ, BP, EX, NH, AW, LX, AX, and BZ all active. 4CY got himself a wife. 4FG, Calgary YL, displays photo of a prominent local ham. 4GD is on 14 mc. 'phone. 4CJ is BERU representative for VE4th district. 4MG wants schedules. 4QX is new Edmonton ham. 4AH has new rig.

Traffic: VE4LX 45 PH 29 BZ 22 HM 16 MG 8.

BRITISH COLUMBIA—SCM, R. K. Town, VE5AC

—This month brought us a thrill in the shape of an emergency: 5AC, AG, IM, JA handled emergency traffic between Vancouver and Victoria. To better prepare ourselves for emergencies we are forming a B.C. net. QSO drills are held every Sunday, 10 a.m. to noon on 3.5 mc. All VE5 stations interested get in touch with the SCM. 5LE's pole parted. Victoria Club is sponsoring QSO contest. 5HC worked a ZL on 3.5 mc. 5DF, IR, JC have gone c.c. 5EP is reappointed as Route Manager. 5JK and AC became proud fathers of girls. New ORS: 5EP, DO, JA. 5BT still dodging shadow. HI. 5KS is ex VE4EI.

Traffic: VE5AC 50 AL 37 AM 11 EC 6 HP 161 DO 14 EU 23 DF 148 EO 86 ED 23 EP 31 FH 7 GS 41 HC 3 HI 10 HR 59 IM 19 ID 165 HQ 143 JA 108 JC 109 JL 13 KB 15.

PRAIRIE DIVISION

MANITOBA—SCM, Reg Strong, VE4GC—The M.W.E.A. has a series of technical talks. 4LB says Brandon gang is active. 4CS has five watts input on 14 mc. 4BB is op at Airways station up north. 4DK and MV have totals; 4KX and GL have FB 14 mc. 'phones; 4CI has a fifty on 3.5 mc.; 4DU worked some DX. Stations active: 4LH, DJ, KU, AC, LN, IF, NK, MY, NI, GC, NY, AE, DZ, GB, IU, BG, NF, QD, NM, OX, NZ, OB, CP, NW, QA. Rebuilding: 4CD and FP. 4AG has tritet pushing '10s. 4MW schedules are getting touch.

SASKATCHEWAN—SCM, W. Skaife, VE4EL—4GR took part in SS. 4EU made nice QSP on England to Vancouver message. Time 4 hours. New blood on 1.7 mc. 'phone: 4QO, OW, PQ, QP, PA and PY. 4AU is moving to Roblin, Man. 4FA has two 46s in amp. 4OE is changing to MOPA. 4BR blows rectifiers. 4PE is new Saskatoon ham. Moose Jaw gang have nice meeting. 4FY nearly finished multi-stage 'phone. 4IG gets successful modulation on keying tubes. 4CV built 5 band exciter. 4JG got impressive looking rack and panel job half finished. SCM visited 4FY and IG at Moose Jaw and 4CV, JG and ND at Swift Current. 4AV has lots of trouble. 4CC has new power supply. 4DH gets FB results from Ford coil supply. 4HS has nice PDC note from same. 4HL visited Moose Jaw boys.

Traffic: VE4GR 58 OE 26 EU 20 EL 11 ML 10 MQ 9 IG 8 PE-AV-PM 6 CC 3 KA 2 FY-IV 1 GA 34.

Traffic Briefs

W7LD offers: "CQ CQ CQ QRU Seattle? de W7LD." Such procedure is valuable as an aid in routing traffic into the larger cities. Traffic hounds should try it. You may find some traffic for your city floating around awaiting just such an invitation.

I TAPPA KEY

Kenneth Isbell, W6BOQ-W6AMR, Sec'y-Treas., writes as follows: "The ITK amateur division is now being reorganized under the direction of Joe Meloan, W6CGM, Hi-Kilowatt. This ITK is a "frat" composed of only the best and experienced operators in the west, and is organized for the promotion of better operating and operators everywhere. Members meet on the air, the present membership being rather widely separated on the west coast. We would like to be affiliated with A.R.R.L. and we will welcome members both new and old."

A.R.R.L. Route Manager W6AUT (John Claussen, Jr., Napa, Calif.) 7040 kc. crystal-controlled is proficient in American Morse as well as Continental and became a member of ITK last summer.

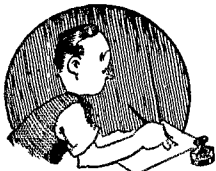

CORRESPONDENCE

The Publishers of *QST* assume no responsibility for statements made herein by correspondents

Automatic Operation

355 Prospect Avenue, Brooklyn, N. Y.

Editor, *QST*:

It seems to me that the editorial in February *QST* is a bit inaccurate as to facts. Just to "keep the record straight" please turn to the "Station Descriptions" section on page 40 of March, 1933, *QST* where you will find a description of an automatically-operated amateur station, W2AYN.

Having visited W2AYN occasionally since 1926, I can testify that W2AYN has been on the air with full automatic equipment since at least 1927. The equipment . . . is completely home-made, with the exception of the Kleinschmidt typewriter-keyboard tape perforator.

I wonder if there are any other claimants to the title of first automatic amateur station in the United States?

—G. P. Casper, W2AGE

CQ DX

723 21 Street, San Bernardino, California

Editor, *QST*:

About this time last year, with the DX contest drawing near, a group of Chicago hams sent cards to the active amateurs whom they heard over the air, asking them to refrain from calling "CQ DX" during the contest, thus eliminating a lot of unnecessary QRM. At the time the amateurs here in town felt this to be a great idea and hoped that the fellows would get the drift. Unfortunately this was not so, and the resulting QRM spoiled many a DX QSO. We are not complaining because we lack power or the DX; to the contrary, we are just asking that needless QRM be eliminated, either by common consent or by ruling in the contest. This only need to apply to the U. S. amateur for we certainly won't complain of too much interference from DX.

We believe that such an idea would make the contest much more democratic and at the same time give all amateurs a chance to pit their operating ability against others, and it would not be a contest of who has the higher power . . .

—J. V. Collett, W6ERM

Courtesy!

1505 E. 63rd St., Long Beach, California

Editor, *QST*:

Sunday evening October 8th I sat down to listen to the ZL stations working Europeans to see if I might hear some Europeans. At 10:00 p.m. PST. I ran across ZL— CQ'ing Europe. Now his procedure was as follows, "CQ Europe CQ CQ CQ de ZL— ZL—" This was repeated several times. I noted that the word "Europe" did not follow his last CQ or come just before his call. However, I stuck till he finished and then covered the band looking for any station calling him. Only one heard was a W9 station. I tuned back to ZL— and imagine my surprise to hear the following words being transmitted "You can go to — as far as I'm concerned. Damfools like you make a darn nuisance of yourselves GN SK CQ Europe CQ CQ CQ de ZL—".

Now just who ZL— said this to I don't know, but I do think that if he has any real ham spirit and manhood about him he will offer an apology to the party he said it to. Is time so short that a ham can't spare a few moments to give a fellow ham a report and a few words of howdy-do? What about the fellow that tuned in on the last three CQ's and so didn't hear the word "Europe"? I have never heard anything like this on the air before, and several old timers also say they have never heard anything like it. Maybe ZL— was just having one of his off days; let's hope so at any rate. . . .

—J. E. Miller, W6AZU

Readability and Audibility

Stratford, Ontario

Editor, *QST*:

Concerning Mr. William W. McLain's suggestions on interpretation of the QSA signals:

Of what benefit is it to indicate receivability in percentage of words missed or copied? I do not see where this is of value, and anyway such a loss of text might not be due to signal strength. Further, it is not wise to have the proposed definition of "QSA1" read "20% of what is sent is received," when the official meaning is "zero % of what is sent is received."

The proper use of "QSA" as I see it is this:

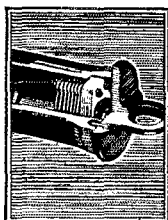

We are seriously interested in our customers' problems and the results that they are able to obtain from our products. It is our plan every month to use this page as a means of bringing to their attention various ideas and suggestions that we may feel will prove helpful to them.

Just for instance, my own phone station is operated mainly in the 3.5 mc band. Recently we shifted to the 14 mc band and for a short time were rather disappointed in the apparent poor performance of our particular FB7A. Of course, the trouble was quickly cleared up — but the incident left us wondering whether or not some other amateurs under similar circumstances might have failed to recall the necessity of readjusting the antenna trimmer to their particular antenna and consequently are not obtaining from their receiver on *all* bands the high degree of performance that the receiver is really capable of delivering.

All of the FB receiver coils are carefully tested and pretuned at our laboratory before shipment. These adjustments are quite critical and should the receiver be used at any time with an antenna differing appreciably from our laboratory standard, it is quite likely that the antenna trimmer condenser will require readjustment. This midget variable air dielectric condenser is located inside of each DET band spread coil and adjusted through the screw driver hole in the handle. Checking of this adjustment is urged in the instructions that are furnished with each receiver and undoubtedly this is done when the receiver is first put into service. Frequently additional coils are added at a later date to the original equipment. We wonder if this important little adjustment is always remembered on such occasions?

Incidentally, if you are in doubt as to just how to make this adjustment properly, why not write for a copy of our booklet giving full alignment details for both the FB7A and FBXA receivers?

JAMES MILLEN



GROSS CB-25

25 Watt Phone & CW Transmitter

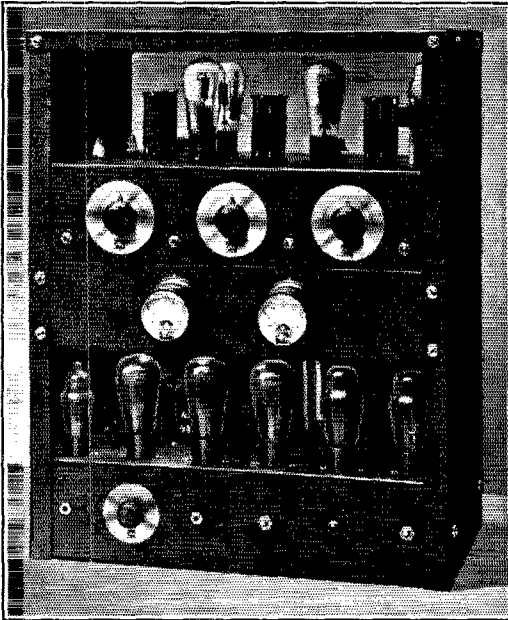

A complete class "B" Phone and C.W. Transmitter kit. Output 25 watts maximum Phone or C.W. Separate Power Supplies for Speech Amplifier and Crystal — heavy duty Supply for Class "B" and Class "C" Amplifier — Speech Amplifier is self-contained. A quality job thru-out. Operates efficiently on all amateur bands including 20 meters. "CB-25"—Less Tubes.....\$66.00

— LITERATURE NOW AVAILABLE —

The GROSS "CW-25" Crystal Control Transmitter Kit — Less Tubes \$13.95

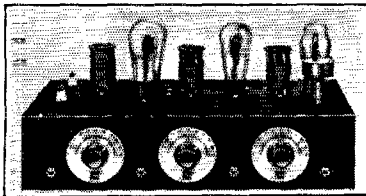

The "CW-25" transmitter kit due to its low cost makes it possible for anyone to own a modern crystal controlled station. A schematic hook-up and parts layout sheet as well as tuning instructions are furnished, thus enabling the most inexperienced operator to wire and put the set on the air, for real results. The "CW-25" is supplied with a shrivel finished sturdy metal chassis under which all parts are mounted, making the wiring and components dustproof. A plug-in crystal holder is furnished with the kit. Only one milliammeter is required for tuning the transmitter and each stage is provided with a jack for this purpose. The "CW-25" uses one '47 as crystal oscillator, one '46 as buffer or doubler and two '46's in the amplifier stage. One set of three coils is supplied with the kit for 20, 40, 80 or 160 meter band. Any additional coils are 75 cents each.

80 or 160 M-xfals — \$2.75 each

The GROSS "CW-25" Power Supply Kit Less Tubes \$8.75

Mounted on shrivel finished metal chassis which matches the "CW-25" transmitter. Heavy duty power transformer, chokes, condensers, bleeder, etc., supplied. Uses one '83 rectifier. This unit and the transmitter make a neat combination as well as an efficient one.

GROSS RADIO, INC., 51 VESEY ST., N. Y. CITY

"5," "4" and "3" should not be used unless there appears a reasonable chance of copying every word; "2" means that for one reason or another it is only possible to read the weak signal in spots; "1" means that signals cannot be read at all. "QSA" does not refer to absolute signal level; a "QSA4" signal may be rendered QSA1 by a steady QSA5 signal on top of it, or by other interference.

Why alter the official meanings? "QSA" is a traffic signal, not an experimenter's signal, and as such seems quite adequate, as it provides a description of every condition from unreadable to perfectly readable. Amateurs, to whom the loudness of signals is of interest, have the "R" system, which appears to fill the bill where accuracy is not needed.

While on the subject of signal intensity, is there a better plan than to use a G.R. or equivalent output meter, and make reports in "db above noise level at this station?" Such a report could be accurate, it would be representative of the signal's effect on the ears, and would indicate its suitability for communication. It would mean something!

—H. S. Gowan, VE3MQ

Traffic vs. Radio Golf

Agana, Guam

Editor, *QST*:

Having been a reader of *QST* since the era of King Spark, and having never before dipped my oar in the troubled waters, I herewith present my first growl.

Perhaps in the past amateur radio has not seemed quite as important as it does at the present time, particularly in regard to traffic handling. Under my present circumstances it has assumed vast importance. Here we sit, roughly five thousand miles from San Francisco with a mail service averaging once in three months! Amateur radio therefore becomes our only method of speedily contacting the States, without resorting to commercial cables. As a rule we are stacked with traffic originating not only on the island of Guam but coming in from the Asiatics as well.

Contacts with the States are easily made; in fact, all hands seem eager to work us. Signal reports are easily exchanged but in a large majority of cases painfully exaggerated. For instance W— reports us "QSA5 R8 XPDC" etc. Upon the exchange both ways of signal reports we request QSP and what do we get? In a few instances really commendable stations take our traffic without trouble but the majority of contacting stations just about reverse the signal report when attempts are made to handle traffic. Why then should such an optimistic view have been taken in the first place? . . .

Then next in line comes the ear-splitting high-power station whose signals are always and without exaggeration a real QSA5. He

The "EAGLE" Three-Tube Short Wave Receiver

"Band Spread" over any portion of the tuning range — only finest material used thruout. Employs one '32 R.F., one '32 detector and one '33 Pentode Audio — 15 to 200 meters — four coils supplied. The "EAGLE" is economical — two dry cells will operate the filaments. See March or April QST for full description of this most excellent value in short wave receivers.

"Eagle" completely wired and tested. **\$11.95** Three tubes tested in your receiver. . **\$3.00**

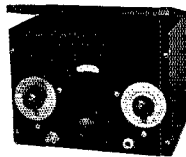

Hoyt Antenna Meter

Hot wire antenna meters. 2 1/4" mounting hole, flange 3" diameter, supplied in 1 1/2, 3 and 5 ampere ranges. Why work without antenna meters when you can buy them at this special price? **\$2.95**

Hoyt Milliammeters and Voltmeters

Perfectly damped meters at a price. These are not to be confused with the usual inexpensive meters. 2" mounting hole, flange 2 5/8" diameter, supplied in the following sizes: 10 ma, 25 ma, 50 ma, 100 ma, 150 ma, 250 ma, 300 ma, 4 V. AC, 10 V. AC, 15 V. AC, 10 V. DC. Price each **\$1.50**, 3 for **\$4.25**

USE BILEY CRYSTALS

Same price 40-80-160 Meters

For greatest precision, power and stability, use Biley BC3 mounted crystals. Within 25 Kcs. **\$4.95**
 BC3 mounted crystals with a frequency within 5 Kcs of specified value **5.75**
 Calibrated to EXACT specified frequency in Kcs. **6.85**
 BCX — inch square crystals, unmounted 40-80-160. **3.90**
 BC2 molded bakelite holder for BCX crystals **1.50**
 Crystal oven **7.50**

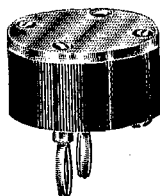

GROSS CRYSTAL HOLDER ONLY \$1.00

A commercial type crystal holder for half the price you have to pay for ordinary holders. New type pressure spring, square inside to prevent movement of crystal, one piece molded body — dust-proof — will take crystals up to 1 1/8" square or round. Plugs standard 3/4" spacing. This holder must be seen to be appreciated for the extraordinary value offered.

UNIVERSAL ANTENNA COUPLING SYSTEM INDUCTANCES

Wound on threaded double X natural bakelite tubing, can easily be tapped with clips. **\$1.75**
 (use one coil for single-wire feed and two coils for two-wire systems)

FILAMENT TRANSFORMER FOR BRIDGE RECTIFIER using 83 tubes 5v-5v-5v 3000 v. insulation 3 amperes each C.T. **\$2.25**

HOYT MOVING COIL METERS
 0-1 MA. 3" wide flange meters. Spec. **\$3.95**

MORRILL UNCASED CONDENSERS
 1 mfd 1000 V. workings. **\$1.17**
 2 mfd 1000 V. workings. **\$1.59**

HIGH QUALITY CASED CONDENSERS
 2 mfd 2000 V. workings. **\$3.95**
 (limited quantity)

AEROVOX 8 mfd 500 volt dry paper case electrolytics **\$4.99**

NEW! BUD six-prong three windings space wound ribbed air core constructed coil kit. 15 to 200 meters **\$2.25**

GO-DEVIL AUTOMATIC KEY . . . **\$6.00**

JOHNSON

Transposition Insulators **\$0.99**
 Airplane Strain Insulators **.05**
 12" Antenna Insulators **.45**
 Tiny-mite 1/2" and 1" stand-off Ins. **.05**
 White or Brown Beehive Ins., doz. **.50**
 Isolantite spreaders 3" long, 10 for **.35**
 Pyrex 7 1/2" antenna insulators **.68**

GROSS CASED POWER TRANSFORMERS

850-1350-1500 V. each side of C.T. 400 watts. **\$8.95**
 (the ideal job to give 750-1000-1250 V D.C. with choke input)
 For use with '83 tube will give an output of 500 volts D.C. at 350 MA with choke input. Run your entire R.F. and Class B off this transformer. The regulation for the class B is about 5%, filaments are two 7 1/2v. and one 5v. Special. **\$5.75**
 A transformer having the same filament windings as above — at 300 MA having 750 volts each side of C.T. Special **\$6.00**
750-1000 V. each side of C.T. 300 watts. Extra special **\$6.80**
1500-2000 V. each side of C.T. 800 Watts **\$11.95**
 Thord. 30 H 75 MA choke **\$.69**
 Thord. 15 H 250 MA **2.95**
 Thord. 30 Henry 500 MA chokes **9.95**
 Thord. No. T-2458 double 18 H 250 MA **6.50**
 Gross-cased 30 H 200 MA choke **2.25**

CARDWELL CONDENSERS

123-B .0005 mmf. **\$2.35**
 164-B .00022 mmf. **2.35**
 147-B .00044 mmf. **4.10**
 T-199 .00033 mmf. **5.88**
 T-183 .00011 mmf. **5.30**

RCA-de Forest Transmitting and Cathode Ray Tubes — in stock

203-A 100 watts carbon plate. . . **\$17.50**
 800 35 watts Low Int. cap. **10.00**
 841 15 watts **3.25**
 852 100 watts R.F. Amp. Osc. **\$3.80**
 865 15 watts Screen Grid. **12.75**
 866-A 10,000 volt Rect. Half Wave **5.00**
 906 3" Cathode Ray. **18.00**

GUARANTEED TUBES

866 Heavy Duty Isolantite top. **\$2.15**
 888 or 871 **1.15**
 83, 47's and 46's **.70**
 481. **.90**
 210's **1.30**
 1/4, 1/2 and 1 watt neon bulbs. **.40**

GROSS SPECIAL TRANSFORMER

600 volts each side of C.T. 200 MA 2 1/2 V. 10 amps., 5 V. 3 amps., 7 1/2 V. 3 amps. **\$3.95**

COMBINATION CASED FILAMENT TRANSFORMER

2 1/2 V. C.T. 10 amps for 866's
 10 V. C.T. 7 amps. for '50's or '52's.
 10,000 volt insulation. **\$3.65**
 Cased 6.3 V. 2 amp. transf. **1.25**
 2.5 V. 6 amp. C.T. (midget). **.80**
 5 V. 3 amp. C.T. for '83 (midget). **.80**
 2 1/2 — 2 1/2 and 5 Volt C.T. **1.45**
 2 1/2 — 7 1/2 and 7 1/2 Volt C.T. **1.45**
 2 1/2 — 5 and 7 1/2 Volt C.T. **1.45**
 5 — 5 and 5 Volt C.T. **1.45**
 5 — 7 1/2 and 7 1/2 Volt C.T. **1.45**

GROSS CASED CLASS "B" TRANSFORMERS

A pair of cased high grade transformers for '46's. **\$4.95**

Filament Transformers shielded in metal cases, center tapped secondaries.

2.5 Volt 10 amperes for 866's. **\$2.50**
 10 to 12 Volts at 8 amperes. **2.50**
 Special 10-12 Volt 7.5 ampere filament transformer, extra special. **1.10**

Ward Leonard Vitreous Resistors 200-Watt 8 1/2" Long with Variable Sliders.

1000 ohms **\$.99**
 2500 ohms **1.05**
 5000 ohms **1.05**
 10000 ohms **1.11**
 15000 ohms **1.20**
 25000 ohms **1.29**
 35000 ohms **1.35**
 50000 ohms **1.44**
 60000 ohms **1.49**
 80000 ohms **1.59**
 100000 ohms **1.65**

MIDGET DOUBLE SPACED NEUTRALIZING CONDENSERS 35 mmf.

— a real buy. **\$.69**
 Pilot J-23 100 mmf. condensers. **.60**

20% deposit with all C.O.D. orders. Remit by M.O. Include postage. Prices subject to change without notice.

GROSS RADIO, INC. 51 VESEY STREET NEW YORK CITY

TRANSMITTER INDUCTORS

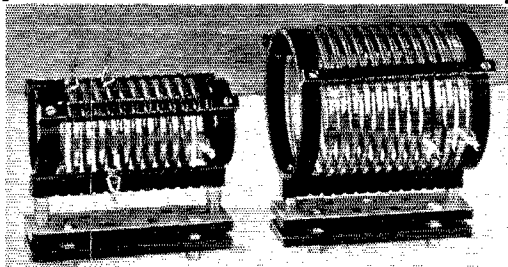

Plug-in inductors for use in power oscillators and amplifiers. Coupling winding may be added outside of supports (grooved). Tubing nickel-plated to prevent tarnish.

Copper tubing — glazed porcelain supports — supplied with copper clips and three Jumbo plugs. Glazed porcelain base has three Jumbo jacks.

	Type 679-A	Type 679-B
Turns	12	7+4
Sections	1	2
Inductance	10 μ h	2+1.5 μ h
Price	\$7.50	\$6.50

Base Type 680 — \$1.25
(not included with coil)

Obtainable direct from:

**GENERAL
RADIO COMPANY**
30 STATE STREET
CAMBRIDGE, MASS.

Made by the makers of
"GR" Plugs and Jacks

CQ's by the hour, directional CQ's to every point on earth, is seldom if ever contacted and when actually contacted, comes back with, "Sorri om this dx stn not interested in handling tlc," and so on to another CQ. . . . If half the stations could hear their signals as others hear them—but oh well, what's the use?

Next we have with us the station who upon being contacted seems tickled to death that his transmitter carries so well. As a rule he says: "Sure gid QSO wl QSP one of your despatches provided that you mail me one of your cards" —and we stacked with traffic! Invariably he sticks to it and about one message is all he will take.

What is it, a racket? Shades of T.O.M! . . . Of what avail is it to be able to work WAC on any good night and never handle traffic? . . . Have we degenerated into a bunch of radio golfers? Is the real spirit of amateur radio buried in the made race for high-power sets and longer DX contacts? As K. B. W. put it in a past editorial, every one of our stations is capable of reaching out, so why so much calling just to see whether they do or not? By now it occurs to me that such should be a proven fact! Other radio services handle traffic over much greater distances daily—in some instances with not very much higher power than some of our so-called best amateur stations. . . . Why should we be so thrilled over a five-thousand mile contact, particularly if all we do is exchange a signal report and request a racket card? . . .

—S. A. Burnett, RM2/c, U. S. N. ex-1AIN

600-Meter DX

S.S. President Grant

Editor, *QST*:

Although I am not technically an amateur by right of owning or operating an amateur station, still I claim at least an honorary inclusion in the fraternity through having gotten a good deal of fun out of radio while making a living at it as a commercial operator for seventeen years. . . .

One thing has been mentioned in *QST* more or less recently which a commercial operator . . . is in a position to add weight to. I refer to the increasing improvement in the last year or so of the lower frequency bands. So much attention has been called to the DX possibilities of the short waves that perhaps many are not aware that considerable real DX is possible right on 600 meters. Back in the days of crystal detectors and "audions" we used to hear some exceptional DX, commonly spoken of as "freaks," on six hundred meters. I have heard JOC, Otchisi, Japan, at Victoria, B. C. on a silicon detector with no amplification, KHK, Honolulu, at Nome, Alaska, at four o'clock in the afternoon on a piece of galena. . . . Then came the days of better receivers, but we got little better maximum distance, though we got

KENYON Dreadnought Line

Class B Components

Because of certain advanced features formerly to be found only in special and costly equipment intended for broadcasting, commercial and Government services, now included in regular production, KENYON is setting new standards for amateur radio practice. The KENYON Dreadnought Line stands for commercial radio equipment at regular ham-pocketbook prices,

featuring:

1. New end castings.
2. High insulation factor.
3. Poured compound dissipating heat better than usual air cooling.
4. Porcelain bushings on all high voltage terminals.
5. All primary and secondary split windings brought to terminal board, as such.
6. All output transformer secondaries designed to carry D.C.

The KENYON Dreadnought Class B Input and Output Transmitting Units, although selling at popular prices, embrace engineering refinements and generous specifications heretofore commanding special prices. Here is a condensed listing:

INPUT TRANSFORMERS — DRIVER TO CLASS B GRIDS

Type	Turns Ratio (tot. pri. 1/2 sec.)	Use	Case	Weight	List Price
TD46	4.7:1	Push-Pull 45 plates to Class B grids Class B tubes: 46's, 59's	2C	3 lbs.	\$8.50
TD10	2.8:1	Push-Pull 45 plates to Class B grids Class B tubes: 10's, 83's	2C	3 lbs.	\$8.50
TD03A	3.2:1	Push-Pull 2A3 plates to Class B grids Class B tubes: 11's, 242A's, 203A	LC3	6 1/2 lbs.	\$12.50
TD800	2:1	Push-Pull 2A3 plates to Class B grids Class B tubes: 800's, 825's	LC3	6 1/2 lbs.	\$12.50
TD841	10:1	Push-Pull 45 plates to Class B grids Class B tubes: 841's	2C	3 lbs.	\$8.50
TD830B	1:7	Push-Pull 2A3 plates to Class B grids Class B tubes: 830B's	LC3	6 1/2 lbs.	\$12.50
TD18	4:1	Push-Pull 2A3 plates to Class B grids Class B tubes: RK18's	LC3	6 1/2 lbs.	\$12.50

OUTPUT TRANSFORMERS — CLASS B PLATES TO R.F. LOAD

Type	Sec. R.F. Load	Sec. D.C.	Use	Case	Weight	List Price
T046	3,000 12,000	140 M A 70 M A	Class B 46-59 plates to R.F. Load — Primary load impedance (plate to plate) — 6000 ohms	LC4	9 1/2 lbs.	\$12.50
T010	4,000 16,000	140 M A 70 M A	Class B 10 — 830-841 plates to R.F. Load — Primary load impedance — (plate to plate) — 8000 ohms	LC4	9 1/2 lbs.	\$12.50
T0800	5,000 20,000	200 M A 100 M A	Class B 800-825 — RK18 plates to R.F. Load — Primary load impedance (plate to plate) — 12,500 ohms	1B	34 lbs.	\$30.00
T011	5,000 20,000	200 M A 100 M A	Class B 11 — 242A plates to R.F. Load — Primary load impedance (plate to plate) — 8,000 ohms	1B	40 lbs.	\$35.00
T003A	2,500 10,000	400 M A 200 M A	Class B 03A — plates to R.F. Load — Primary load impedance (plate to plate) — 5,800 ohms	1B	48 lbs.	\$47.50
T0830B	2,500 10,000	400 M A 200 M A	Class B 830B — plates to R.F. Load — Primary load impedance (plate to plate) — 10,000 ohms	1B	48 lbs.	\$47.50

CLASS B INPUT TRANSFORMERS: By the use of interleaved primary and secondary windings, leakage reactance and distributed capacity have been kept to a minimum, thus eliminating high-frequency transient effects. By the selection of the proper turns ratio, harmonic distortion has been kept down to the tubes' minimum.

CLASS B OUTPUT TRANSFORMERS: All of these transformers are designed to work at the full rating of their associated tubes. Core saturation is impossible, even at highest outputs. Here again leakage reactance and distributed capacity have been kept down to prevent transient effects, while still maintaining windings balanced in all respects. Inductance well over 30 henries assuring good bass response. Core size selected to prevent saturation by plate current of the Class C amplifier. Harmonic distortion, caused by operating core at too high a flux density, is eliminated.

Watch this page for further data on this line. Write for full particulars and bulletin. Meanwhile, ask your nearest amateur radio supply house about these products now on display and in stock for inspection and prompt delivery. These will be supplied you at usual amateur discount.

TO JOBBERS AND DEALERS: This line is being sold through a select group of merchandisers in exclusive territories. Certain territories are still open. If interested, write for our proposition.

KENYON TRANSFORMER Co., Inc.

122-124 Cypress Avenue :: :: New York City

Say You Saw It in QST — It Identifies You and Helps QST



2C

Dimensions:
Length 2 3/4"
Height 3 3/4"
Width 2 3/4"



LC 3

Dimensions:
Length 4 1/2"
Height 4 1/2"
Width 3 1/2"

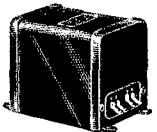

LC 4

Dimensions:
Length 4 1/2"
Height 4 1/2"
Width 3 1/2"



1B

Dimensions vary according to the size of the stack.



**An inexpensive
Cathode Ray
Oscillograph
by National
will be avail-
able April tenth**

National Company, nc., Malden, Mass.



Say You Saw It in *QST* — It Identifies You and Helps *QST*

BACK COPIES OF QST WITH INDEXES

THE LIST given below shows many exceptions, and as time goes on each yearly list becomes more incomplete. The 1931, 1932 and 1933 sets will not be complete when next presented. You'll be sorry some day if you don't stop, look and ACT now—Right Now!

HERE THEY ARE

1923—Only May and November issues	\$ 5.00
1924 — Only November and December issues	50
1925 copies (except January, March, May and July)	2.00
1926 copies — complete	2.50
1927 copies (except January)	2.50
1928 copies (except January, February and August)	2.25
1929 copies (except February, March, April and May)	2.00
1930 copies (except January, February and July)	2.25
1931 copies — complete	2.50
1932 copies — complete (except September)	2.50
1933 copies — complete	2.50
Complete Set of Copies as Listed	\$15.00
Single Copies	25c Each

ALL PRICES INCLUDE POSTAGE

New binders to keep these files in order are \$1.50 each, postpaid. Each binder holds 12 issues of QST and index, and does not mutilate the copies.

AMERICAN RADIO RELAY LEAGUE

West Hartford « » Connecticut

And remember 1¢ cards are *not* returnable unless return postage is guaranteed. Not long ago QST contained an article in which it was stated that if the sender of the QSL would put his return address on the face of the card it would be returned in case of non-delivery. To quote the Postal Laws and Regs: "Single postal cards and post cards (1¢) will be returned to the sender *only* when they bear his return card (address) in the upper left hand corner of the address side together with a pledge to pay return postage." If you do not know the address, then put on a 3¢ stamp, so in case of non-delivery it will come back, and you won't be defaming a good ham's character when you don't get his QSL in return for one of yours which he never received. . . .

—John H. Leacock, W9FDI

Beginner's Signal

One Wall Street, New York City

Editor, QST:

Anent Frank Hawks letter January QST, I have had the same experience. I have been at the game since 1912, on and off, and find that to-day more than ever, the so-called "lid" has little or no chance to get to QSO anyone.

I suggest that those who are slow at code and really want to learn send out, instead of "CQ," the call "CQ CQ CQ QRS"; then only those who *wanted to help and send slowly* would answer, being forewarned. If the signal here suggested is not a good one, possibly the helpful gang can think up one. . . .

—Karl A. Kopetzky, W2GOW

Identifying Harmonics

9323 Rhodes Avenue, Chicago, Illinois

Editor, QST:

On page 42 of the November QST, I note a method of finding the 28-mc. band described by W6FFU. This method involves the use of a slide rule, which is an item not found in every shack. A method using pencil and paper only would be more universal. . . .

More than a year ago I built an electron-coupled freq-meter-monitor whose fundamental frequencies covered the broadcast band. The harmonics were very easily determined for the 160-meter band but were increasingly difficult to identify for the higher-frequency bands. The following scheme was evolved to determine the correct order of harmonic.

The freq-meter was tuned to zero beat with the desired signal in the usual fashion, and then the dial was rotated very carefully until the next higher frequency which caused another zero beat was reached. Both of these fundamental frequencies were determined from the calibration curve, the lower frequency being designated as f_1 and the higher frequency f_2 . Let n be the correct order of harmonic of f_1 to cause

Announcing New **HK** 354 GAMMATRON TRANSMITTING TUBE

HERE'S the power and performance you have been wanting. A transmitting tube with 100 watts output, and much more possible properly handled. New simplified, extra-rugged design for long, hard service. No "getter" to impede heat radiation. No plate-supporting collar on stem, eliminating that cause of stem breakdown (plate suspended from envelope dome). No internal insulators. Grid and plate elements made of Tantalum as protection against gassing. Thoriated Tungsten shielded filament. Nonex glass envelope. *Conservative plate dissipation 100 watts.* Widely adaptable, use unrestricted. Designed, made, and sold by —

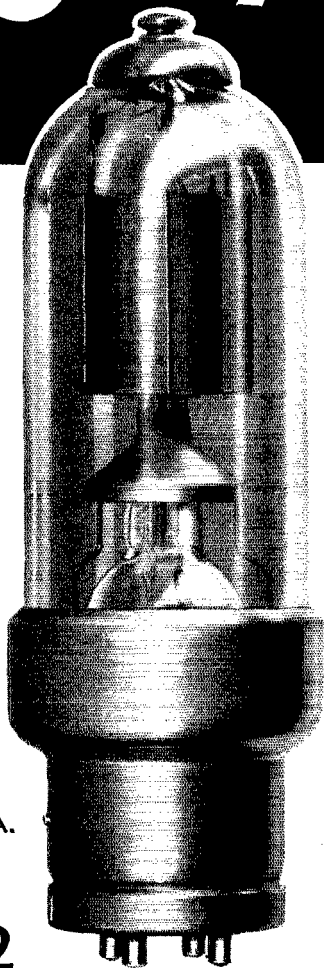

Radio Engrs. and Mfrs.
Since 1919

311 California St.
San Francisco, Calif., U. S. A.

\$ 22.50
If you Act NOW!
price goes up to
\$ 24.50
MAY 1ST

SAVE \$2
by Mailing this
Coupon NOW!

NOTE — Extremely low price prevents sale through dealers. Higher material costs necessitate \$24.50 price, effective May 1st. Order NOW at \$22.50 direct from Manufacturer.

HEINTZ & KAUFMAN LTD., 311 California St., San Francisco, Calif.

GENTLEMEN:

Please send me —

..... new 354 GAMMATRON Tubes at \$22.50 each

..... FOLDERS describing the construction, use, and advantages of this Tube

(NOTE — When ordering tubes, P.O. Money Order, Draft, or Certified Check for full purchase price must accompany Coupon)

NAME.....

ADDRESS.....

TUBES

to fit the depression pocketbook of the amateur fraternity. These tubes are first class products and carry our absolute guarantee for 90 days.

281.....\$.90 211.....\$7.75
866—H.D... 1.50 203A..... 8.95
845.....10.00

We are manufacturing a brand new cathod-ray oscillograph. We solicit inquiries.

POWER SUPPLY — 1200 v. — 250 ma and 600 v. — 250 ma

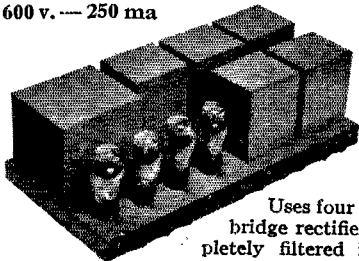

Uses four 83's in a bridge rectifier—completely filtered in both voltage legs.

\$35.00

These units can be had on special order in any size mounting or form

SYLVANIA Graphite { ... 210 — \$4.75
Anode { ... 830 — 8.75
 { ... 825 — 10.00

PLATE TRANSFORMER — two 7½ and two 2½-volt fil. windings — 750-750 v. — 160 mils. **\$3.50**

EXTRA SPECIAL

Filament Transformer — 110 v. pri. — 2 separate 7½ v. center tapped windings — 3 amps., each. **\$1.35**

WESTON 476 AC VOLTMETERS

Reconditioned like new.
0-5 v. **\$3.50**
0-10 v. **3.75**
0-15 v. **4.00**

WESTON 301 DC MILLIAMMETERS

Reconditioned like new. Following ranges only —
0-10 mills. **\$3.75**
0-20 mills.

Baldwin Type C (new model) Phones. . . . **\$3.35**
No. 10 H.D. Enamel — any length — per ft. **.01**
Neon Bulbs — ½ and 1 watt. **.45**
No. 18 Solid push back wire — per 100 ft. **.45**

Johnson 50-watt sockets. **\$1.20**
Bliley X cut 160 — 80 — 40 m. Crystals. . **3.90**
Bliley Xtal holders. **1.50**

HAMMARLUND **\$111.72**
Crystal Pro.

We build transmitters to your specifications
Open Evenings — 7 to 9.30 p.m.

KALTMAN & ROMANDER
62 Court Street Newark, New Jersey

zero beat. Then from the previous consideration that the two harmonics are consecutive the following equation is true.

$f_1 n = f_2 (n-1)$ and solving for n this becomes,

$$n = \frac{f_2}{f_2 - f_1}$$

A typical example from my own freq-meter is as follows:

$f_1 = 790$ kc. and $f_2 = 987.5$ kc. Therefore

$$n = \frac{987.5}{987.5 - 790} = 5$$

$5 \times 790 = 3950$ kc. which is the value of the unknown frequency.

—Leonard Tulauskas, W9LKF

Copying Behind

Sioux City, Iowa

Editor, QST:

... Our local USNR unit had a fine turn-out to copy the Navy Day message and I noticed more than ever before the difference between radio operators that never knew another code than Continental, and the converted Morse-radio operator. Besides myself there was another commercial Morse operator, and at the completion of the NAA broadcast we compared notes. The Morse operator and myself (being a "converted Morse" also) had perfect copies. The regular radio operators had a "perfecter" copy—if there is such an animal. Why? Well as near as I can figure, the regular men copied everything, including the intentional mistakes, while the other chap and I copied it as it should be—a habit of too many years to break, I guess. I copied about six or seven characters back all the time and naturally couldn't hear the intentional mistakes—whereas the boys that rode NAA's tail copied mistakes and all.

... An interesting comparison seldom seen, as it isn't often the two species get together under quite these circumstances. ...

—Leonard Collett, W9DEA

Everybody Loves 'Em!

118 Grapeland Avenue, San Antonio, Texas

Editor, QST:

I've just finished listening to one of those long-winded CQ's.

While tuning around on the 14-mc. band I came across a CQ with an R8 d.c. signal. ... Well, I had listened to about 15 or 18 CQ's when a W3 came on, CQ'ed using the 3 x 3 method for about 2 minutes, then signed. I kept listening for the first station to sign when I heard the W3 come back calling a W6. A report and QRA were given, then he signed. The other station was still CQ'ing and it was just before the W3 came back again that he finally did wake up and sign twice, only to start all over again. I

AN *Accurate* INDICATOR OF CAPACITY VALUES

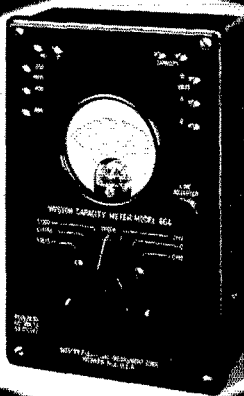

WESTON
Radio Instruments



Here is another accurate indicator of radio's fundamentals — one of a complete line bearing the name Weston. To the dealer and service man this means that the instrument is the "last word" in test equipment . . . that it will prove a dependable and profitable partner in his business.

Like other Weston instruments Model 664 will not become obsolete because of its wide ranges and because it indicates in fundamental units — microfarads and volts. It can be furnished in a leatherette covered carrying case, or will fit into the Weston Standardized Service Kits along with other Weston standardized service units. All the facts are included in the Weston bulletin. Send for your copy. Use the coupon today . . . Weston Electrical Instrument Corporation, 602 Frelinghuysen Avenue, Newark, N. J.

WESTON ELECTRICAL INSTRUMENT CORPORATION
602 Frelinghuysen Avenue, Newark, N. J.

Send Bulletin on Weston Radio Instruments.

Name

Address

City and State

HEY, YOU YOUNG SQUIRTS!

Think you'll ever know as much about radio as Jim Lamb?

Well, you've got to learn, if you ever expect to get there. You can go to school — but the best school is experience. Whatever school you go to, you've got to have the proper kind of textbooks.

There are a lot of grades in radio school. If you're a young lad in junior high you've got a

lot of them to pass before you get in the class of JIL, RAH, GG and the rest of 'em. It won't be so hard, though, if you study the Handbook carefully, and then tackle some of the books in the Amateur's Bookshelf. You'll get there — and we'll be glad to help.

But maybe you aren't even in the Handbook class, yet. Then there's only one answer — the League's famous beginner's booklet.



HOW TO BECOME A RADIO AMATEUR

Although No. 8 in the series entitled *The Radio Amateur's Library*, it's the primary text of amateur radio. Deals with elementary things, told in clear, simple language. Tells how to build a complete, efficient, yet inexpensive amateur station — receiver, monitor, transmitter. Tells how to operate it, too — in fact, it's the complete beginner's guide to amateur radio. And the price is only 25c, postpaid. (No stamps, please.)

Order your copy today, and join our school right now

THE AMERICAN RADIO RELAY LEAGUE, WEST HARTFORD, CONNECTICUT

QST BINDERS

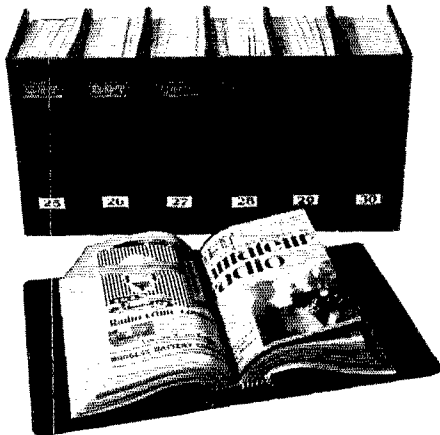

Keep your QST
files in order

Priced at
\$1.50 postpaid

AMERICAN RADIO RELAY LEAGUE
WEST HARTFORD, CONN.

listened about two more minutes, then tuned him out. . . .

Guys like that should have their licenses taken away and have their heads examined. . . .

—*Oliver D. Gassett, W5BVG*

A Real Kick

San Diego, Calif.

Editor, QST:

Your Editorial in the December issue was a prod to recall many old memories. So you think the first transatlantic communication was a thrill—wait until you read of the real kick I got!

Larry Dutton of old 9ZN was with me on the S.S. *Aeolus* running to South America. When in New York one of our hangouts was with Hewitt at his old Brighton Beach Station 2RK. Not getting enough brass pounding at sea we worked hamming ashore.

On our arrival Hewitt was all thrilled about the forthcoming transatlantic test and at being selected to act as a test station. Among other things he was to replace his old sync spark (Grebe, wasn't it?) with a 250-watt tube and send c.w.—correction, r.a.c.w.—60 cycles on the plate direct. The tests were to be about 6 or 7 p.m. that night, if memory recalls correctly. Something delayed us and Hewitt didn't get the tube until late. Anyway, we all arrived at the shack about ten minutes before time to go on the air.

Hewitt sat down and tuned in the other senders and waited his time and turn. Dutton and I were to hook up. We worked frantically, Hewitt tuning around very nervously and reading his code script over and over.

Now I must digress a minute to describe that shack—it was about six feet square, eight feet high and lined with copper screen, connected to ground. Hewitt yelled it was time to start. Dutton was outside cutting the power over to 220 from 110 and I was making the last frantic twist onto the power supply transformer—a special 220 to 6000-volt job that Hewitt had borrowed for the occasion. I had my back against that screen wall and was twisting the last haywire connection onto the transformer secondary when Hewitt hit the key to start. I let out a blood-curdling scream—did a complete somersault and landed in a heap in the corner of the shack. . . .

2RK got across and all was well. But I still think I got the biggest kick out of that transatlantic test!

—*W. H. Martin, W6JEI*

HAMS Hear More DX with TRIMM

24,000 ohm Impedance



Featherweight Phones

The iron being operated near the saturation point in these phones, extra loud signals and static crashes are damped, while the exceptionally high impedance at frequencies above the ordinary voice and music range, reduce to a minimum back-

ground noises, weak signals become prominent.

TRIMM RADIO MFG. CO.

1528 Armitage Ave.

Chicago, Ill.

"How to Become"

Route 4, Barre, Vt.

Editor, QST:

Knowing that you have published another edition of *How to Become a Radio Amateur*, which describes another short-wave receiver, I thought you might like a few facts about the previous one.

I built one . . . using the 2-volt Type 30 tubes and it was very successful. I am still using



English, 14th Century

SHIPS of Yesterday!

SHIPS of the 14th century charted their course pretty much by chance. The magnetic compass was erratic . . . the stars were often hidden by clouds and fog . . . and ships delayed in voyage, or perhaps lost forever, were by no means few.

Transmitters without crystal control are like those poorly guided ships. The unexpected causes many a good transmitter to be off frequency . . . outside its allotted course, or band.

Bliley Crystals are the sure and safe guide. They give greater power output . . . keep the transmitter LOCKED on one chosen frequency . . . and cut thru bothersome interference. Don't take chances! . . . use Bliley's.

For Bliley Crystals see your nearest distributor. If he doesn't have your choice in stock, he can get it for you immediately.

Get our 1934 illustrated folder, and large 3-color frequency chart from your distributor. . . or write us direct. Both FREE for the asking.

BILILEY CRYSTALS AND HOLDERS					
Type	Mc Band	Supplied Within	Precision	Furnished	Price
BCX	1.7, 3.5, 7.0	±25Kc*	0.05%	Unmtd.	\$3.90
BC3	1.7, 3.5, 7.0	±25Kc*	0.03%	Mtd.	4.95
BC3	1.7, 3.5, 7.0	±5Kc	0.03%	Mtd.	5.75
BC3	1.7, 3.5, 7.0	Exact	0.03%	Mtd.	6.85
BC5	100Kc Std.	Exact	0.05%**	Mtd.	9.50
BC2	1.7-3.5Mc, or 7Mc holder for BCX				1.50
BC6	1.7, 3.5 or 7Mc holder-oven for BCX				7.50
SSF	465, 500, or 525Kc S.S. Qtz filter, Mtd.				5.90

* Or your choice from distributor's stock.
** Adjustment by purchaser will greatly reduce this.

BILILEY CRYSTAL OVEN

A scientifically designed constant-temperature holder-oven; compact, holds within one degree C., plugs into standard 5-prong socket. Operating on 7.5 V. For inch sq. 40, 80 or 160 M crystals. Type BC6, \$7.50 each, complete.

BILILEY PIEZO-ELECTRIC CO.

226 Union Station Bldg.

Erie, Pa.

Special Crystals also manufactured between 20 Kcs and 15 Mc



METAL-WORKING LATHE

Precision equipment for the small shop. New designs and manufacturing processes make this amazing bargain possible. Complete metal working lathe with compound slide-rest, combination face-plate and independent chuck and tall center, 6 1/2" swing; 24" length, 20 pounds. Send post-card for catalogue or save time and send \$1.00, balance plus express C.O.D. Lathe for wood-turning alone, \$4. Attachments for milling, grinding, sanding, saw-table, etc., available at low prices.



200 BROADWAY
NEW YORK

AMERICAN MACHINE & TOOL CO., Dept. Q-9

ALUMINUM BOX SHIELDS Genuine stock, silverdip finish. 5 x 9 x 6, \$1.65. 10 x 6 x 7, \$2.65. Any Size to Order. SOMETHING NEW! Your call letters, or any marking for your panel, on BLACK aluminum ribbon. Looks like engraving on bakelite. 5c up to 2 inches, 5c each additional inch. Sample 8c. U.S. Army V.T. 1 tubes 35c, 10 for \$2.50. Foil for condenser or velocity mike 1/2 mil., 25c ft. New Master Teleplex on demonstration.



BLAN, the Radio Man, Inc.

177 Greenwich St.
New York City

Technical Training Station

Phone C. W.

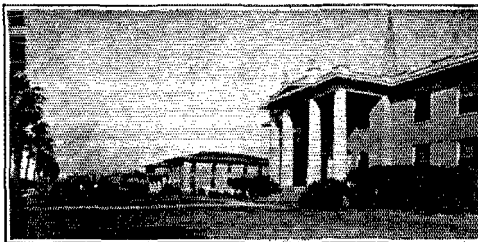

Studio Technique Guaranteed

KFDM

1000-Watt 560
W. E. Kilocycles

In 3 to 7 months we train you to secure Amateur, Commercial Telegraph Second-class, and Radiotelephone First-class government licenses. Course consists of Wireless Code, Radiophone, Microphone-Studio Technique, Television, Service, Police, and Aeronautical Radio. We are authorized to teach RCA Institutes, Inc., texts. At completion of your course you receive practical studio technique experience in broadcast studios located in our administration building, and operating experience on KFDM (1000-Watt W. E. Commercial Broadcast Station), and WPA, 4000-Watt Commercial Wireless Station. Return coupon for details.

PORT ARTHUR COLLEGE

Port Arthur (world-known port) Texas

Name

Street or Box

City and State

To Our Readers who are not A.R.R.L. members

YOU should become a member of the League! That you are interested in amateur radio is shown by your reading of *QST*. From it you have gained a knowledge of the nature of the League and what it does, and you have read its purposes as set forth on the page opposite the editorial page of this issue. We should like to have you become a full-fledged member and add your strength to ours in the things we are undertaking for Amateur Radio. You will have *QST* delivered at your door each month. A convenient application form is printed below — clip it out and mail it today.

A bona fide interest in amateur radio is the only essential qualification for membership

AMERICAN RADIO RELAY LEAGUE
West Hartford, Conn., U. S. A.

I hereby apply for membership in the American Radio Relay League, and enclose \$2.50 (\$3.00 outside of the United States and its Possessions, and Canada) in payment of one year's dues, \$1.25 of which is for a subscription to *QST* for the same period. Please begin my subscription with the issue. Mail my Certificate of Membership and send *QST* to the following name and address.

.....

Do you know a friend who is also interested in Amateur Radio, whose name you might give us so we may send him a sample copy of *QST*?

.....

Thanks

it. I have heard amateurs in forty-five states, Porto Rico, Mexico, Canada and Nova Scotia. On the 75-meter 'phone band I have received all districts. And I logged thirteen foreign countries. Some of these were: VK2ME, HBL; EAQ; HKD; GSA, GSB; FYA; DJB; VE9GW; LSX and others.

Almost daily reception was had from GSA, DJB and EAQ and several South American stations. Also, no end of c.w. communication.

—Edward LaMoy

Sad Story, Mates

1860 Willamette St., Eugene, Ore.

Editor, *QST*:

I'm disgusted. Ever since I first started on my career as an amateur I have been copying the other fellow's idea . . . first receiver was one built after one described in *QST* . . . first transmitter was a self-excited rig described in the *Handbook*. Since then I have been copying other people's ideas, either as is or with a few changes. . . .

Someone explained in *QST* some time ago how an electron-coupled oscillator could be used to excite an m.o.p.a. rig. . . . I built . . . and it worked FB . . . later someone else came out with a circuit of a more stable crystal oscillator that looked very similar to the e.c. circuit. I studied both circuits and figured that it should be quite simple to combine both using a switch to change from e.c. to crystal and have the benefits of either at will.

So I got out the spare parts box and the soldering iron and built it up and it worked. "Ah," says I to myself, "Here is something new. I will write this up and send it into *QST*. Maybe I'll get my name in the Experimenters' Section." I had my plans all made, knew just what I would write and what kind of drawing I was going to send in. Then, disillusionment. . . . The October number of *QST* came and in it a perfect description of my oscillator switching arrangement. My visions of fame and fortune as an inventor are gone. Now I must again console myself to a life of copying others ideas!

—Bradley Thompson, W7CFM, W7CUU

Experimenters' Section

(Continued from page 48)

band, WLW will put an 11th harmonic on a point (7700 kc.) which when referred to the chart becomes 3850, and WOR gives us an additional point at 3905. Since we are working on the 3500-kc. curve we find it convenient to use the term "5 1/2 harmonic," although of course there actually is no such thing.

"The complete list of check points obtainable is much too long to write out here, but I'll tabulate a few so you can see how it goes. You can use practically every broadcast station for a check point by using one of the following harmonics: 3, 3 1/2, 4, 4 1/2, 5, 5 1/2, 6.

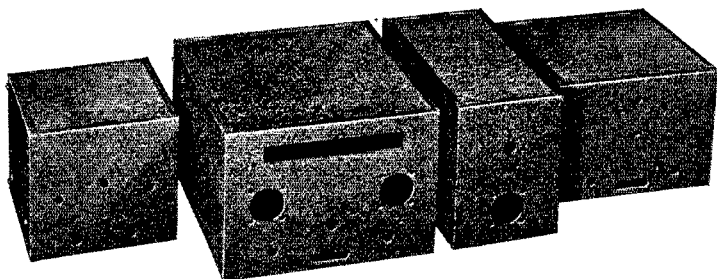

STANDARD CABINETS

● There have been so many requests for standard National Receiver cabinets for use in constructing special equipment, that it has been decided to list them among our regular products. Illustrated above, left to right, are the cabinets regularly used for the SRR and FB-7 receivers, the PSK Pre-Selector, and the SW-3 receiver. Though shown with panels and sub-bases punched for standard assemblies, they are available plain at no extra charge. List prices are as follows, including sub-base and bottom cover: C-SRR, \$3.50; C-FB7, \$7.00; C-PSK, \$6.00; C-SW3, \$5.50. Usual discounts apply.

NATIONAL COMPANY, INC., MALDEN, MASS.

GULF RADIO SCHOOL

Radiotelegraphy Radiotelephony

Radio Servicing

SECOND FLOOR } 1007 Carondelet Street
U. S. A. } NEW ORLEANS, LA.

RK-18 POWER AMPLIFIER



The second in the series of new units being developed by the Harvey Radio Laboratories is the RK-18 Power Amplifier especially designed for use with the Harvey Tritet. By employing newly developed circuits the amplifier is permanently neutralized, and requires no neutralizing adjustments. When excited by the Tritet to a normal input of 85 watts, the measured output of the amplifier is from 50 to 60 watts depending upon the frequency. Built of highest quality parts and designed to follow the Tritet it may also be used with the conventional oscillator-doubler arrangement. Price complete with Raytheon RK-18 tube **\$54.95**

Send stamp for literature giving all details and features of Tritet, RK-18 Amplifier, and accessories.

For 5-meter Transceivers, both 2 and 6 volt models, see advertisement, February *QST*.

HARVEY RADIO LABORATORIES
12 Boylston Street, Brookline, Massachusetts

● FREE ● BOOK OF FACTS

For RADIO OPERATORS,
AMATEURS and BEGINNERS
... Just Out! ...

Gives you interesting story of Championship Code Contests with pictures of Champions and other celebrated Amateurs, Operators and Instructors who succeeded thru **CANDLER SPECIALIZED TRAINING**.

FREE — No Obligation. A card will bring this interesting, instructive 36 page **BOOK** to you. It answers all your questions and describes

SCIENTIFIC CODE COURSE for BEGINNERS, seeking their first license,

HIGH-SPEED TELEGRAPHING for AMATEURS and Com'l Ops who want Championship SPEED and Technique,

TELEGRAPH TOUGH-TYPE-WRITING, trains you to receive fast stuff on your "mill" easily by "touch."

Tell us what you desire to accomplish. We'll give you **FREE** advice based on our 23 years' experience in teaching code and training champions.

CANDLER SYSTEM CO.
Dept. Q-3 6343 S. Kedzie Avenue, Chicago

Candler System Code Guild

An organization of **CANDLER** trained ops sending practice programs daily from their stations all over the U. S.

Become a **CSCG** Member. We furnish Schedules listing all **CSCG** stations, time on the air, speed 8 to 45 wpm.

You can bring in **CSCG** Practice Programs with your **S.W. Receiver**. This is **REAL** practice that costs you nothing. There is no substitute for it. **CANDLER** trained ops will help you develop your code technique.



The NEW 800 Tubes

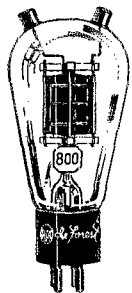

★
Use the RCA-800 Tubes
for improved results

- ✓ As A-F Power Amplifier and Modulator — Class "B"
- ✓ As R-F Power Amplifier — Class "B" (Telephony)
- ✓ As Plate-Modulated R-F Power Amplifier — Class "C" (Telephony)
- ✓ As R-F Power Amplifier and Oscillator — Class "C" (Telegraphy)

RCA-800: Filament, 7.5 v., 3.25 amps. Max. Plate Voltage, 1250.....Price each, net, \$10

No Tri-Tet is complete without the 800

We carry the full line of RCA-de Forest Transmitting Tubes

COMPLETE LINE OF NATIONAL PARTS
including Midget Condensers and Type 51
Sockets, as advertised in QST.

H. JAPPE COMPANY

46 Cornhill

Boston, Mass.

It Cost us
\$17,000.00

to produce—
and it's yours for

\$1.00

POSTPAID ANYWHERE

See the Second Cover

A.R.R.L.

38 LaSalle Rd., West Hartford, Conn.

Here's my dollar. Send me mine.

(Name)

(Street or Box)

(City and State)

Station	Fund. freq.	Check point	No. of harmonic
WLW	700	{ 3500	5
		{ 3850	5½
WOR	710	{ 3550	5
		{ 3905	5½
WGN	720	{ 3800	5
		{ 3960	5½
CKAC	730	{ 3650	5
		{ 3850	5
WBBM	770	{ 3900	5
		{ 3510	4½
WMC	780	{ 3900	5
WOQ	1300	{ 3510	4½
		{ 3900	3

"I might mention in passing that this is the system we use for keeping an accurate check on our frequency meter for calibrating crystals."

To prevent errors, the receiver should be calibrated roughly over the working range to make identification of the harmonics easy. Both the frequency meter and the auxiliary oscillator should be allowed to warm up for a while before the calibration is made, so creeping will be minimized. Care also should be taken to set all the oscillators just as close to actual zero beat as possible because the errors from this source will be multiplied by the number of the harmonic being used. It is not hard to get true zero beat when setting the auxiliary oscillator to the B.C. carrier because beats of the order of a few per second show up quite readily on the voice or music. Finally, the points should be checked against different stations wherever possible so that inadvertent errors or "wild points" caused by the use of the wrong multiplier will show up.

Standard Frequency Transmissions

STANDARD frequency transmissions from W1XP have been suspended temporarily for changes and repairs in the frequency standard equipment at the Round Hill Station. Schedules of the S. F. System's Midwest and Pacific Coast stations, W9XAN and W6XK, continue as usual, according to the following schedule:

Date	Schedule	Station	Date	Schedule	Station
Mar. 2	A	W6XK	Apr. 6	B	W9XAN
Mar. 9	B	W9XAN		B	W6XK
	B	W6XK	Apr. 11	C	W9XAN
Mar. 14	C	W9XAN	Apr. 13	B	W9XAN
Mar. 16	B	W9XAN		A	W6XK
	A	W6XK	Apr. 18	BB	W9XAN
Mar. 21	BB	W9XAN	Apr. 20	BB	W6XK
Mar. 23	BB	W6XK		A	W9XAN
	A	W9XAN	Apr. 21	BX	W6XK
Mar. 24	BX	W6XK	Apr. 22	C	W6XK
Mar. 25	C	W6XK	Apr. 27	A	W6XK
Mar. 30	A	W6XK			

STANDARD FREQUENCY SCHEDULES

Time (p.m.)	Sched. and Freq. (kc.)		Time (p.m.)	Sched. and Freq. (kc.)	
	A	B		BB	C
8:00	3500	7000	4:00	7000	14,000
8:08	3600	7100	4:08	7100	14,100
8:16	3700	7200	4:16	7200	14,200
8:24	3800	7300	4:24	7300	14,300
8:32	3900		4:32		14,400
8:40	4000				

Time (a.m.)	Sched. & Freq. (kc.)	
	BX	
6:00	7000	
6:08	7100	
6:16	7200	
6:24	7300	

FOR PORTABLES

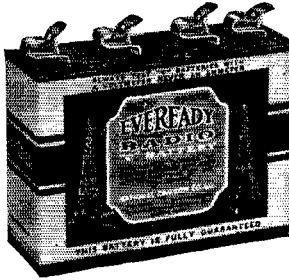

No. 771—4½-VOLT

Tapped at 1½, 3 and 4½ volts.
Length, 4¹/₁₆" ; width, 1½" ; height, 3¾"
Weight, 14 oz.

As an "A" battery with 2-volt tubes; start on 3-volt tap; finish on 4½-volt.



No. 768—22½-VOLT

Tapped at 6, 18 and 19½ volts.
Length, 4½" ; width, 2⁹/₁₆" ; height, 3¾"
Weight, 1 lb., 9 oz.

Can be used as a combination "B" & "C" battery.

Headquarters for battery information

NATIONAL CARBON COMPANY, INC.

30 East 42nd Street, New York City

Unit of Union Carbide and Carbon Corporation



RADIO

ENGINEERING, broadcasting, aviation and radio telegraphy and telephony, Morse telegraphy and railway accounting taught thoroughly. Engineering course of nine months duration equivalent to three years of college radio work. School established 1874. All expenses low. Catalog free. DODGE'S INSTITUTE, Day Street, Valparaiso, Indiana

"HI-MHO"

TRADE MARK REGISTERED

means 'high conductivity'

LYNCH

transmission line wire has been specially developed for simplifying the construction of more efficient h.f. transmission lines, on all ham bands.

Easier to use and a vast improvement over solid copper, especially on frequencies above 14,000 kc.

practical

Technical bulletin on ham antenna and transmission line design on request.

100 foot coll. \$1.00

LYNCH MANUFACTURING CO., Inc.
51 Vesey Street New York, N. Y.

Makers of LYNCH Famous Metallized Resistors

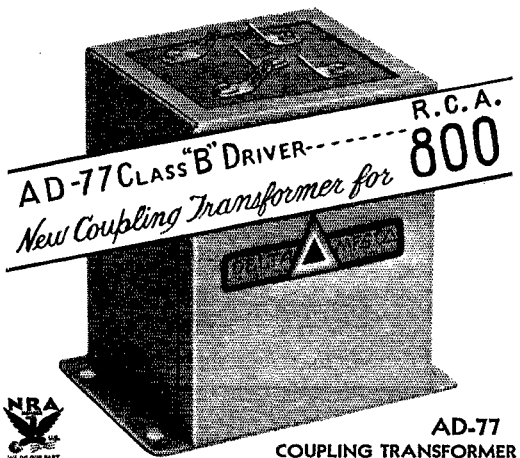

AD-77
COUPLING TRANSFORMER

ACME-DELTA COUPLING TRANSFORMERS

We announce a new AD Coupling Transformer, AD-77, especially developed as a Class "B" Driver for 2 A3 Class A push-pull to 800 Class "B" grids. Our AD-76 Output Transformer should be used as Class "B" output. These two units give a full 100 watts audio power with excellent frequency characteristics and operating efficiency. List prices AD-77 — \$7.50, AD-76 — \$15.50, subject to usual 40% discount. Write for details of these transformers and also those which will soon be ready for the new Sylvania 830B tube.

F. B. Dellenbaugh, Jr.

Pres. &
Chief Engr.

G. E. M. Bertram

Treas. &
Gen. Mgr.



NOW

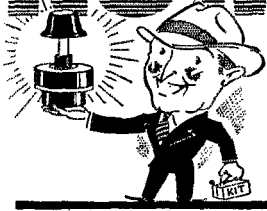

The
New

Centralab Radiohm Replacements

Servicemen everywhere are mighty glad that these new 1 3/8 in. Radiohms are now available for replacements. Smaller — for the new type sets — they are the last word in efficiency. Employ the famous Centralab rocking contact for smooth, quiet, noiseless performance. At your jobber.

Central Radio Laboratories

MILWAUKEE WISCONSIN

PROFIT BY THE EXPERIENCE OF OTHERS—Thousands of Amateurs Have Read **HINTS AND KINKS**

If you haven't yet gotten a copy of this indispensable compilation of the money-saving ideas of 189 experimenters, you'll be glad to know that the original supply, exhausted in less than six months, has been replenished by a second printing. You'll find in it hundreds of good ideas which amateurs have found helpful. It will return its cost many times in money savings — and it will save hours of time. Many of these little dodges would probably never occur to you. Order your copy at once.

HINTS AND KINKS FOR THE RADIO AMATEUR

No. 10 in the A.R.R.L. series entitled The Radio Amateur's Library

EIGHTY PAGES IN ATTRACTIVE PAPER COVERS
50 cents, postpaid anywhere (no stamps, please)

THE AMERICAN RADIO RELAY LEAGUE
West Hartford, Connecticut

The time specified in the schedules is local standard time at the transmitting station. W9XAN uses Central Standard Time and W6XK, Pacific Standard Time.

TRANSMITTING PROCEDURE

The time allotted to each transmission is 8 minutes divided as follows:

2 minutes — QST QST QST de (station call letters).
3 minutes — Characteristic letter of station followed by call letters and statement of frequency. The characteristic letter of W9XAN is "O" and that of W6XK is "M."

1 minute — Statement of frequency in kilocycles and announcement of next frequency.

2 minutes — Time allowed to change to next frequency.
W9XAN: Elgin Observatory, Elgin National Watch Company, Elgin, Ill., Frank D. Urie in charge.

W6XK: Don Lee Broadcasting System, Los Angeles, Calif., Harold Peery in charge.

WWV 5000-Kc. Transmissions

The 5000-kc. transmissions of the Bureau of Standards' station, WWV, are given every Tuesday continuously from 12:00 noon to 2:00 p.m., and from 10:00 p.m. to midnight, E.S.T. The accuracy of these transmissions is to better than 1 cycle (one in five million).

— J. J. L.

Silent Keys

It is with deep regret that we record the passing of these amateurs:

G. W. Cates, W6GAI, Stockton, Cal.
George H. Fischer, Jr., W5CCJ, Abilene, Texas

G. T. Gulde, ZL1FB, Opotiki, N. Z.
Yoshinori Hayashi, Sendai, Japan
Andrew J. Kralovec, W9HXB, Menominee, Mich.

George W. Leach, W5BJU, Abilene, Texas
A. E. McFarlane, G6RM, E. Croydon, England

Argyle B. Proper, W1DZG, Greenwood, Mass.

H. V. Reynolds, VR1HR, Georgetown, British Guiana

Raymond C. Sellers, W9DZM, Sycamore, Ill.

Thomas H. Van Buren, W6GOF, San Diego, Cal.

Information Service Rules

PROMPT handling of inquiries concerning amateur equipment and problems will be greatly facilitated if the following rules are observed when writing to the A.R.R.L. Technical Information Service:

1. Before writing, consult *The Radio Amateur's Handbook* and your files of *QST*. Nine times out of ten you will be able to find the answer in *QST* or the *Handbook*.

2. If reference is made to the *Handbook*, mention the page and the edition to which you refer. If reference is made to *QST* mention the page and issue you have in mind.

Sa. O.M. Have you heard
THORDARSON has just brought
 out an **ALL NEW** transmitting line,
 class B, 800 tubes, 'n everything

Everyone is talking
 about this new line

Eight new heavy duty plate trans-
 formers, all rated at actual D. C.
 volts and mls through the filter.

New swinging and smoothing
 chokes to give you pure D. C. at
 lower cost.

Full line of Class B coupling
 transformers for all tubes, includ-
 ing the new 800's. All Class B
 output transformer secondaries
 carry plate current of Class C
 stage, eliminating cost of chokes
 and condensers.

The new THORDARSON power, filament, modulation, and amplifier
 transformers, and power chokes are everything you would have a
 right to expect from the pioneer builder of amateur transformers.

What's more, they not only embody many brand new engineering
 developments, but they are priced to make your dollars go
 farther. Write for full details or ask your jobber.

Complete data on new
 power amplifier
 and modulator cir-
 cuits from your job-
 ber **FREE** with
 your order for
 Thordarson parts
 or send 10c for
 postage and
 mailing.

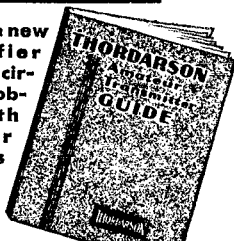

THORDARSON
 Electric Mfg. Co.
 500 West Huron St., Chicago, Ill.

Write for the New **THORDARSON** Transmitter Guide

**DELUXE 5 meter
 antenna impedance
 matching trans-
 former and rods**



— Pickard type—highly efficient—especially suited for port-
 able installations, quickly taken down, self supporting. Now used
 by many 5-meter experts. Enclosed transformer with sockets for
 3/4" brass rods. Outfit including transformer and two 46" brass
 rods \$2.50 complete plus postage.
 Transceiver in aluminum case 6" x 9" x 3".....\$16.50
CHAUNCEY WING'S SONS, GREENFIELD, MASS.

WUXTRY!!!

Low Prices on Ham Equipment

RCA — Radiotron type 866-A M.V. Rectifiers..... \$5.00
 De Forest types: 210, 250, 281, each..... \$1.00
 Johnson type "O" antenna systems: complete 10
 meters, \$3.67; 20 meters, \$5.82; 40 meters, \$10.29;
 80 meters, \$19.25; 160 meters \$37.48.
 Johnson antenna insulators: 7" — 39c, 12" — 45c,
 20" — 65c.
 Transposition Blocks — porcelain, each..... 9c
 Midget porcelain strain insulators, each..... 5c
 Feeder spreaders — porcelain, each..... 18c
 Johnson 50-watt sockets..... \$1.19
 National FB-7A — \$34.20; FBXA..... \$47.70
 National SW-3, AC or DC models..... \$17.70
 National Preselector unit, with 1 plug-in coil for
 FB receivers..... \$15.00
 Hammarlund Comet "PRO" S.W. receivers, with
 coils, tubes and power supply..... \$95.37
 Bruno Velocity Microphone Kit..... \$5.88
 Xmitting chokes 1.93 m.h., 1000 mls..... 85c
 Xmitting chokes 1.75 m.h., 200 mls..... 69c
 Thordarson chokes, 30 hy, 125 mls..... 69c
 Readrite d.c. milliammeters: 0-15 to 0-400 ma., each 59c
 "GO-Devil" Automatic Transmitting Key — \$6.00
 net.

Write for free bulletin. Only M.O. acceptable. Postage extra on
 all shipments. Write for quotations on any part that you may
 need. Orders shipped same day received.

MAURICE SCHWARTZ & SON
 710-712 Broadway, Schenectady, N. Y.

QST

Oscillating Crystals

"SUPERIOR BY COMPARISON"

All "Scientific Radio Service Crystals" are accu-
 rately ground to an accuracy better than .03%
 on equipment tested regularly by the U. S. Bu-
 reau of Standards standard frequency signals.

BROADCAST and COMMERCIAL BANDS

Broadcast Band Crystals mounted in our Standard
 Holder and ground to our usual high degree of
 accuracy now \$35.00 each. Mounted in our NEW
 Isolantite Monel Metal Crystal Holder \$45.00 (ad-
 justable air gap). Prices for other Frequency Bands
 quoted upon application.

AMATEUR BAND

Scientific Radio Service Crystals ground to within
 FIVE Kilo-cycles of your specified frequency in
 either 80 or 160 meter bands \$15.00 each. Mounted
 in our Standard Holder \$5.00 additional. Accurate
 calibration with each crystal.

PROMPT SHIPMENTS ASSURED

Scientific Radio Service

"The Crystal Specialists" Since 1925
 124 Jackson Ave., University Park
 Hyattsville, Maryland Dept. Q-3



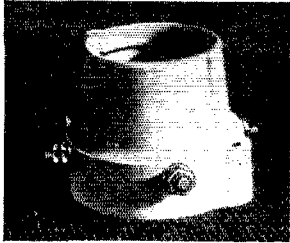

50-WATT SOCKET

● In this quality product, the usual metal shell has been avoided, thus eliminating the usual source of arc-over. The insulation is a one-piece low-loss Steatite shell. The contacts are heavy and of the side-wipe type for low contact resistance. Fifty-Watt Socket. Type XC-50, List price \$3.50.

In stock at authorized distributors, usual discounts applying.

NATIONAL COMPANY, INC.
MALDEN, MASS.



R M E ANTENNA MATCHING NETWORKS



Maximum transferred energy from final tank to antenna — the aim of every amateur.

With these networks accurate matching of external circuits is readily obtained.

No harmonics are radiated from the system.

Installation is very simple.

Feeder lines may be made any length and DO NOT require tuning.

Coupling unit is inserted in the center of a half-wave Hertz.

The system becomes a simple resistive load to the final tank.

Weight of unit approximately 12 ounces.

Specify frequency and approximate height of antenna when ordering.

Units for any frequency. 10 meters to 175 meters, 1000-watt capacity. Any unit, net price..... **\$5.25**

INSTALLATION INSTRUCTIONS INCLUDED WITH EACH UNIT

Feeder lines, accurately built with impregnated, non-slipping spacers every two feet of length. Per foot, net price..... **\$0.10**

COMPLETE DATA FORWARDED UPON REQUEST

For full particulars and information on RME-products, including the now famous RME-9 Super receiver, send 10c in stamps for loose leaf folder.

RADIO MFG. ENGINEERS

147 Cooper Avenue

PEORIA

ILLINOIS

3. Write on one side of the paper only, and use a typewriter if possible.

4. Number the questions and make a separate paragraph for each question. Make the questions as brief and as direct as possible.

5. Make diagrams on separate sheets of paper and fasten them to your letter with a pin or paper clip. All diagrams should be schematic — do not send pictorial diagrams.

6. Print your name and address in full on each sheet of paper. A return address on the envelope is not sufficient, as the envelope is destroyed by the office manager as soon as the letter is opened.

7. Keep an exact copy of your questions and diagrams, and mention that you have done so.

8. Do not ask for opinions on, or comparisons of, business concerns or their products.

9. Enclose postage for the reply but do not send an envelope. It is much more convenient for us to use our own envelopes with our stationery.

10. Address all questions to the Technical Information Service, American Radio Relay League, 38 La Salle Road, West Hartford, Conn.

Any back copies of QST to which we refer you may be obtained from our Circulation Department for twenty-five cents each.

The observance of the above rules will be mutually beneficial.

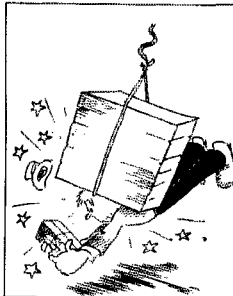

Traffic Brief

With due apologies to the "great fraternity of newspaper reporters" we quote the following from an item found in a local paper by WICTL. The item deals with Federal agents locating an unlicensed radio transmitting station. The "headlines" read, "Unlicensed Radio Cleverly Concealed," and the reporter goes on to relate: "A short-wave set with a 1000 watt transmitter, the apparatus was grounded on the bathtub and used the electric light line as an aerial. Although the walls of the house are thin, no tenants ever had suspected the presence of a radio. Its instruments were well muffled and

Amateur Headquarters • "Everything for the Ham"

A RECEIVER to Suit Every Purse
 National SW \$17.70
 National SW45 19.75
 National FB7A 34.20
 National FBXA 47.70
 Hammarlund Pro 88.00
 Crystal Pro 111.72
 SW Coils for SW3,
 pair, 3.00
 Coils for FB7A,
 pair 6.00
 Write for descriptive Booklet

WE SPECIALIZE IN HARD-TO-GET PARTS

Transformers Designed Especially for the Amateur

M. & H. Plate & Filament TRANSFORMERS

450 volts each side, C.T. 150 mils, 2½ volts — 3 amps, center tapped; 5 volts — 3 amps, center tapped. Designed for Tritet Unit or 47 xtal, 46 amplifier, 83 rectifier combination.

Weight 8¼ lbs.
 Size, 3½" x 4" x 6"

\$6.75

SPECIAL Completely cased

M. & H. PLATE and FILAMENT TRANSFORMERS

750 volts, each side, C.T., 200 mils; 7½ volts, 3 amps, center tapped; 5 volts, 3 amps, center tapped. Designed for 210 or 841 OSC — amp, 83 rectifier combination.

Weight 18¼ lbs.
 Size 5" x 5½" x 6"

\$8.25

Completely cased. SPECIAL

Write for New 1934 M. & H. Radio Catalog

Continued by popular request

M. & H. POWER PACK
 For National SW3, SW45, FB7A, FBXA
 Highest quality parts used throughout
 Specify which set is to be used when ordering \$9.95
 Rectifier Tube, 40c extra

National Pre-Selector R. F. Amplifier

Completely wired in cabinet to match
 FB7A, less Coils \$11.40
 R. F. Coils, \$3.60 each section

Complete Stock of New CARDWELL Condensers
 TYPE 157B, Split, Stator, 100 mmfd. \$4.76
 See Page 12 Feb. QST

NEW ITEMS
 We are Distributors of the Famous RCA Line of

TRANSMITTING TUBES

See full details in our ad in Feb. QST.

Send for Free Amateur Schedule Card

The New Bliley Crystal Oven in stock.....\$7.50

512 Market St. **M. & H.** Philadelphia, Pa.

Sporting Goods Co.

LEARN RADIO

New Classes Now Forming! Send for 40-page catalog, explains fully. 180 licensed graduates placed in past 2½ years in broadcasting, shipping, police radio, aviation, etc. We teach all branches. Oldest, largest and best equipped school in New England. Equipped with Western Electric sound and broadcasting equipment and RCA marine transmitter. Course prepares for United States Government telegraph or telephone license.

MASS. RADIO SCHOOL, 18 Boylston Street, BOSTON

GET THE DOPE ON THIS NEW ROSS SET

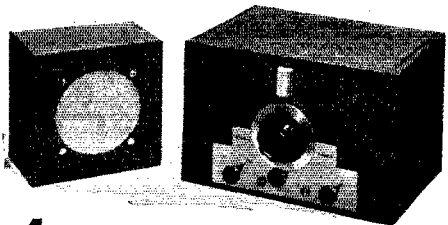

4 AMATEUR BANDS BY TURNING A SWITCH — No Coils to Plug In — No Coils or Other Extras to Buy

Your first cost — and it's surprisingly low — is your last cost on the NEW Ross Jupiter Model. The coils are an integral part of the set. What's more, you can switch from one amateur frequency band to another by the mere flick of a panel switch. Set has many other features as well. Equipped with powerful dynamic speaker. Sold under absolute money-back guarantee. You must be pleased! Complete with speaker and permanently attached coils but less tubes, only \$59.50 net.

A. H. ROSS and COMPANY
 Keswick Ave. and Waverly Rd., Glenside, Pa.
 (Suburb of Philadelphia)

WRITE FOR FOLDER

Learn CODE

in HALF the Usual Time!

It's Easy to Do at Home with



The NEW MASTER TELEPLEX

As a child, you understood spoken English long before you could read or write. You learned by *Hearing*. CODE is the same way! Why make it hard for yourself, trying to learn with old-fashioned printed lessons alone? HEAR as you learn, and learn in half the time, with The New Master Teleplex. This world-famous instrument records your sending *visibly* — then *sends back* to you through headphones! The *natural* method; beginners learn faster, ones speed up their wpm amazingly. Used by U. S. Army and Navy, R. C. A., A. T. & T., and others. We give you Complete Course, lend you instrument, instruct you personally — all under MONEY-BACK GUARANTEE. Low cost, easy terms. Write now for folder QST 3 — no obligation.

TELEPLEX COMPANY

76 Cortlandt Street New York, N. Y.



EFFICIENT AMATEUR STATIONS USE

RK-18 In the self excited oscillator, final amplifier and Class B modulator.

RK-17 In the QST TRI-TET Oscillator. Low internal capacitances and low loss base permit higher output than with the 59.

RK-19 For the power supply. A low drop, high vacuum full wave rectifier designed for the 1000 volt transmitter.

RK-18.....	\$10.95
RK-17.....	5.00
RK-19.....	7.50

Write for Characteristic Data Sheets on these and other tubes for amateurs.

RAYTHEON PRODUCTION CORPORATION

30 EAST 42nd STREET, NEW YORK

or

SAN FRANCISCO — CHICAGO — NEWTON, MASS.

PRECISION CRYSTALS

FOR ACCURATE FREQUENCY CONTROL



Crystal Holder

FREE Plug-in, dust-proof holder with each amateur band crystal purchased.

PRECISION Crystals are of the highest quality obtainable. These crystals are X cut, one inch square, accurately ground for maximum output, thoroughly tested and fully guaranteed. They are accurately calibrated and will be supplied within 0.1% of your specified frequency. It will pay you to buy these quality crystals, 1750 and 3500 kc. They are accurately calibrated and will be supplied within 0.1% of your specified frequency. It will pay you to buy these quality crystals, 1750 and 3500 kc. They are accurately calibrated and will be supplied within 0.1% of your specified frequency. It will pay you to buy these quality crystals, 1750 and 3500 kc.

bands—\$4.50 ea. 7000 kc. band—\$5.50. Crystal holder (illustrated) —\$1.50 (Holder free with each crystal purchased). Jacks to plug holder into—15c pair.

Crystals and ovens for commercial use quoted on at your request. When ordering our product you are assured of the finest obtainable. Now in our 5th year of business.

PRECISION PIEZO SERVICE

427 ASIA STREET

BATON ROUGE, LA.

Write for this Bulletin

METER METER METER

Lists many types — all new meters — big selection: Ammeters, Radio Frequency Ammeters, Thermo-ammeters, Volt-meters, Milliammeters, AC-DC Universal Meters, D. B. Power Level Meters and Volt-meters, Volt-Ohm-Milliammeter Circuits, Resistor Kits, Shunts, Resistors — every item A REAL BARGAIN and guaranteed. Just send postal for this FREE bulletin.

UNIVERSAL METER WORKS

410 N. Leavitt St., Chicago, Illinois

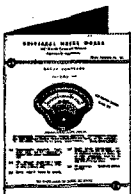

no receiving sets in the house had noticed interference. Its range was estimated at 10,000 miles. So cunningly was the radio apparatus hidden that a maid employed to clean the apartment had never noticed it." . . . MIM

Conference on Emergency Communication

(Continued from page 88)

arises. Those who have made no commitments and who wish to remain free agents, able to help as circumstances dictate, should read our Communications Department's recent suggestions on how best to serve.

— K. B. W.

I. A. R. U. News

(Continued from page 48)

W6FT; Wayland M. Groves, W5NW; Clay Champion, W5CCW; W. H. Jones, W6FYT; Alois Weirauch, OK1AW; Leslie Cooper, G5LC; Jacques Mahieu, ON4U (*'phone*); Francisco Roldan, EAR10; Lorenzo Navarro, EAR38; Joaquin Pérez Cinto, EAR227; Herbert Fehse, D4BCD; P. Castaing, ON4LO; M. G. Brashear, K5AA; Seth O. Perkins, W6FKC; Masamoto Sumiyoshi, J1ES; M. Oshima, J1FF; Orval Wood, W6ASV; A. E. Dyson, G6NJ; Harold E. Wyer, W1DYE; Thomas J. Patterson, W5CEN; Manuel Cañedo, EAR226; John Marshall, W9ARL; Tadeusz Palczyński, SP1BC; Angel Uriarte, EAR12; Luis San Juan, EAR46; Bertram E. Sandham, W6VO-W6EQF; W. Kempston, W6TA; Frederic Gillett, W6HS; Ladislav Záluský, OK1WX; M. Griffin, G2XA; Manuel Joaquim Santos da Cunha, CT1CQ; Elvin Feige, W6TT; B. Th. Fjeld, LA1Y; Gerald Loban, W7BPE; Fumio Horituchi, J5CC (*'phone*); Roberto Castro G., TI2RC; R. F. Loomes, G6RL; Wm. A. Nokes, G2ZG; G. E. King, ZE1JF; Harry W. Schiffman, W4ATS; William F. Erdman, W6CUZ; Lowell Popp, W9AOE; J. F. Stanley, G6SY.

A total of 1034 WAC certificates had been issued at the end of 1933.

Biasing the Power Amplifier

(Continued from page 34)

condenser may suffice. The transformer can be a midget job which furnishes 250 volts or so plus a winding for the 80 rectifier. Figure the voltage divider so that the part of the resistance connected in the amplifier grid circuit will follow the rule given previously, and try to have the output voltage high enough to cut off plate current when there is no excitation. For example: A pair of 10's are to get 90 volts of bias; the output of the rectifier-filter is 250 volts; resistance of the 90-volt portion of the divider is to be 5000 ohms. The remaining divider resistance needed will be

$$\frac{250 - 90}{90} \times 5000$$

or 8000 ohms, closely enough. The values are not critical.



"How's the new examination?"

"Tough, m'lad, tough. You gotta get down and dig, if you want to pass it. Them transmitter questions — wow!"

We'll bet our 1933 auto license plates that a minimum of 10,000 conversations such as the above have occurred since October the 1st, that day of renown on which the new regs took over. But, happily, that isn't the end of the story. Listen to this:

"Yuh don't say! And me what ain't yet been able to see one itty-bitty electron climbing from filament to plate. Ain't there nothin' I can do about it?"

"Sure. Get a copy of

THE RADIO AMATEUR'S LICENSE MANUAL

from good ol' A.R.R.L. It's got all the dope—questions 'n' answers—technical info — the new regs — everything."

"Yeah? How much is it? — that's the burning query these days."

"Just two bits, postpaid. And it tells the whole story on the Class A license for unlimited 'phone, too, and all that complicated stuff on renewals and modifications."

Get your copy today, 25c, postpaid, no stamps, please

THE AMERICAN RADIO RELAY LEAGUE, West Hartford, Conn.

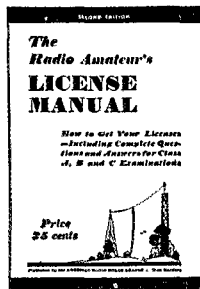

The Radio Amateur's License Manual (No. 9 in the series entitled The Radio Amateur's Library).

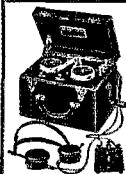

THE INSTRUCTOGRAPH

(Code Teacher)

The Scientific, easy and quick way to learn the code. Send a post card today for literature.

Machines, tapes and complete instructions for sale or rent. Terms as low as \$2.00 per month. Rental may be applied on purchase price if desired. Rent for a month. If the Instructograph meets every requirement, buy it. If not, send it back.

INSTRUCTOGRAPH CO., 912 Lakeside Place, Chicago

LOW RANGE FUSES

- Littelfuses for Instruments: Amps.: 1/100, 1/32, 1/16—20c ea. 1/8, 1/4, 3/8, 1/2—15c ea. 1, 2—10c ea. For milliammeters, ham rectifiers, etc. Use 1/8 for radio B circuits. High Voltage
- Littelfuses: 1000, 5000, 10,000 volt ranges in 1/16, 1/8, 1/4, 3/8, 1/2, 3/4, 1, 1 1/4, 2 amps. Renewable. Price 35c to \$1.25 ea.
- NOW—\$100 PROTECTION GUARANTY. Get New Cat. \$5.

LITTELFUSE LABS.

1784 Wilson Ave., Chicago

"Quicker than a Short circuit"

LITTELFUSES



FOR ULTRA H.F. JOBS

Cornell-Dubilier Type 9 — heavy-duty, low r.f. loss, molded bakelite capacitor for transmitting circuits. Ideal as high current

blocking (plate to grid) unit. Also as by-pass for r.f. around any device or D.C. meter. Short-path connections for h.f. work. In standard bakelite or in special low-loss bakelite for ultra h.f. work. Up to 2000 v. D.C. .00005-.015 mfd.

Write for 1934 edition of C-D catalog, describing this unit and all its options as well as complete line of transmitting and receiving condensers for every radio need.



CORNELL-DUBILIER CORP.

4377 Bronx Blvd.

New York City

Radio Operating Radio Servicing —



Prepare for the new Government Radio Operating license examinations; Radio Operator, Marine and Broadcasting. Also Radio Amateur Telegraph and Telephone. Resident courses.

Write for Booklet

NEW YORK YMCA SCHOOLS

4 West 63rd Street, New York City

BIRNBACH

Standoffs

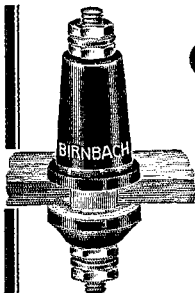

QUALITY insulators for careful amateurs. Compact; rugged; efficient. Pure porcelain, highly glazed. Nickel-plated brass hardware.

All standard types — also new feed-through models (plain or jack) with porcelain insulating collar for metal-panel mounting. Write for Bulletin "Q-3."

BIRNBACH

RADIO CO., INC.

145 Hudson St., N.Y.C.



TRUVOLT RESISTOR

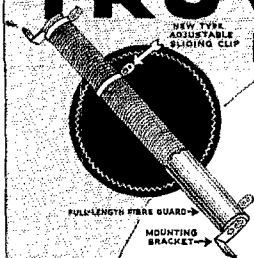

**Adjustable
To Exact
Desired
Values**

THESE exclusive features make TRUVOLTS the most adaptable of all resistors:

1-Patented design permits larger wire and open-air cooling. 2-Double spiral winding insures perfect electrical contacts. 3-Sliding clips provide exact adjustments. 4-1,000 volt insulation. 5-Full-length protective guard.

All Standard Sizes

Write Dept. Q-3 for FREE Catalog and Vest-Pocket Volume Control Guide.



WHERE ELIMINATORS WON'T DO

The foregoing discussion should have made it plain that one of the chief virtues of a "B" eliminator in biasing a power amplifier is that the bias is automatic with protection. When automatic bias is undesirable, as in a Class-B linear amplifier or Class-B audio amplifier, the ordinary "B" eliminator will be unsatisfactory. It is, in fact, rather uneconomical to attempt the design of a power pack for such purposes. The resistance of the voltage divider must be made so low that a very considerable amount of power must be wasted in it if the desired output voltage is to be maintained, and even then it is doubtful whether the type of performance expected from batteries could be duplicated. Adequate filtering would be a severe problem. But for ordinary Class-C operation, or in the operation of c.w. or exciting amplifiers where linearity in the grid circuit is of little consequence, a "B" eliminator, intelligently handled, will be entirely satisfactory for a single stage.

A One-Tube Crystal-Control Transmitter

(Continued from page 12)

connecting the key in the negative power-supply lead. With a crystal of reliable make and correct transmitter adjustments, the keying will be positive and clean-cut at ordinary hand speeds.

POWER OUTPUT

A rough estimate of the power output shows it to be in the vicinity of 8 watts on those frequencies for which a 1750- or 3500-kc. crystal is used. The output with 7000-kc. crystals is not as great, being about 5 watts on both 7000- and 14,000-kc. These outputs are comparable with those obtained from the highly-popular self-controlled pair of 45's in push-pull operating at the same plate voltage because the efficiency of the crystal oscillator is greater than that of the self-controlled oscillator. With the latter, some of the power output has to be sacrificed for the sake of frequency stability. And with the crystal set, being in the band and having a d.c. note are two things that can be crossed off the list of transmitter worries.

CQ-AMATEURS of the West

Just off the Press, send for your copy

1934 CATALOG

All Nationally advertised parts
for Transmitting and Receiving
Lowest Prices

RADIO SUPPLY CO.

H. A. DEMAREST, President
912-14 So. Broadway Los Angeles, Calif.
(W6FBI, located in Building)

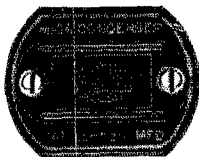

SANGAMO ACCURATE CONDENSERS

Available in 5000 volt construction
for use in short wave transmitters

Write for catalog sheet

SANGAMO ELECTRIC CO.
SPRINGFIELD, ILLINOIS

Strays

The Dallas Amateur Radio Club exhibited and operated station W5FC at the Texas State Fair, Dallas, October 7-22, 1933. This was the second year that W5FC had been in operation at the state fair. The transmitter used was W5PJ's c.c. job with a '52 in the final. Receivers were an FBX and a Comet Pro furnished by W5RJ and Mr. Hammarlund respectively. During the two weeks of operation W5FC became nationally (and internationally) known on its frequency of 7025-kc. A total of 2201 messages were accepted. Of the 417 QSOs at W5FC only 21 were scheduled-contacts. Communication was established with all U. S. districts, 33 states, Hawaii, Mexico, New Zealand and Australia. 27 different operators.

FOR A.R.R.L. MEMBERS

Use the Stationery



Write your radio letters on League stationery. Lithographed on 8 1/2 x 11 heavy bond paper. Postpaid. 100 sheets, 50c; 250 sheets, \$1.00; 500 sheets, \$1.75.

**O
N
L
Y**

Wear the Emblem



The League Emblem, in heavy rolled gold and enamel, either pin or button type, \$1.00 postpaid.

AMERICAN RADIO RELAY LEAGUE, WEST HARTFORD, CONN.

KLAUS RADIO & ELECTRIC CO.

707 MAIN STREET PEORIA, ILLINOIS

RADIOTRONS—Transmitting and Receiving

Standard Lines of RECEIVERS and PARTS

WRITE FOR LITERATURE

PANELS — BAKELITE — RUBBER — ALUMINUM

All Sizes Cut to Order BAKELITE TUBING & RODS

Drilling, Engraving & Special Work

ALUMINUM GANS—Stock sizes. Special sizes, made to order.

ALUMINUM CHASSIS—Threaded brass studs for 6/32 screws.

Length from 1/4" to 6"—price 5c to 30c.

Insulating bushings for all size shafts

75c to \$1.90 per dozen

Couplings in brass or bakelite

—15c

Transmitting frames and racks.

UNITED RADIO MFG. CO. Est. 1923 191 Greenwich St., New York

When Seeking a Radio School

Consider RCA Institutes . . . an institution recognized as an important factor in the radio industry.

The beginner or the experienced man who seeks instruction in any branch of radio will find courses designed for him . . . either at the Resident Schools in New York and Chicago or the RCA Institutes Home Study courses.

Resident Schools are fully equipped — conveniently located — low weekly tuition rates.

FEATURES OF HOME STUDY COURSES

Extension courses for home study on convenient "no obligation" plan. Examination and technical advisory services. Free post-graduate practical training at resident school with modern equipment under instructing engineers.

Illustrated Catalog on Request

RCA INSTITUTES, INC.
Dept. ST-3

75 Varick Street, New York
1154 Merchandise Mart, Chicago



New! UNIVERSAL Stretched Diaphragm Type 1934 MODEL "X"

Here is microphone value without precedent! A brand new 1934 model, stretched diaphragm type. Full Diaphragm Protection 2-button microphone, listing at only \$10.00! Exceeds every reasonable requirement for quality performance.

UNIVERSAL MICROPHONE CO., Ltd.
424 Warren Lane Inglewood, Calif., U. S. A.

WE STOCK—SYLVANIA AND RAYTHEON TRANSMITTING TUBES

HAMMARLUND "PRO"
AND FBXA NATIONAL
WRITE FOR FREE CATALOG

CAMERADIO
603 GRANT ST.
PITTSBURGH - PA.

HAM-ADS

(1) Advertising shall pertain to radio and shall be of nature of interest to radio amateurs or experimenters in their pursuit of the art.

(2) No display of any character will be accepted, nor can any special typographical arrangement, such as all or part capital letters be used which would tend to make one advertisement stand out from the others.

(3) The Ham-Ad rate is 15c per word, except as noted in paragraph (6) below.

(4) Remittance in full must accompany copy. No cash or contract discount or agency commission will be allowed.

(5) Closing date for Ham-Ads is the 25th of the second month preceding publication date.

(6) A special rate of 7c per word will apply to advertising which, in our judgment, is obviously non-commercial in nature and is placed and signed by a member of the American Radio Relay League. Thus, advertising of bona fide surplus equipment owned, used and for sale by an individual or apparatus offered for exchange or advertising inquiring for special equipment, if by a member of the American Radio Relay League takes the 7c rate. An attempt to deal in apparatus in quantity for profit, even if by an individual, is commercial and takes the 15c rate. Provisions of paragraph (1), (2), (3) and (5) apply to all advertising in this column regardless of which rate may apply.

Having made no investigation of the advertisers in the classified columns, the publishers of QST are unable to vouch for their integrity or for the grade or character of the products advertised.

OVER six pounds radio data, circuits, bulletins, 50¢ postpaid. Beyond Rockies 75¢. Kladag, Kent, Ohio.

MICROPHONE and meter repairs. Low prices. Quick service. Sound Engineering Corp., 416 N. Leavitt St., Chicago, Ill.

RADIO engineering, broadcasting, aviation and police radio, servicing, marine and Morse telegraphy taught thoroughly. All expenses low. Catalog free. Dodge's Institute, Byrd St., Valparaiso, Ind.

QUARTZ—Direct importers from Brazil of best quality pure quartz suitable for making piezo-electric crystals. Diamond Drill Carbon Co., 719 World Bldg., New York.

GENERAL Electric 24/1500 volt Dynamotors \$35; 24/750 volt \$25. Westinghouse 27½/350 volt \$10. Mounted pair \$15. 6-15 volt 500 watt Aircraft with propeller \$10. 500 cycle 500 watt with exciter 110-220 volts \$7.50. Dynamotors give pure DC outputs. Perfect results from battery plants. Henry Kienzle, 501 East 84th Street, New York.

FB7A, six pair coils, 5897AB power unit, tubes, speaker. Best offer takes. Ed McCall, Anniston, Ala.

WANTED—meters, testing equipment, Weston, Jewell, Day-Rad or Supreme analyzer, tube tester, metal working tools and machinery, microscope, for cash or trade. Xmitting apparatus and SW receiver (complete station) including wavemeters. F. G. Carr, 75 Sumner St., Lancaster, N. H. WICE.

QSLs! QSLs! Spend just a little more money and get the finest QSL cards printed! Stamp for samples. W8DED, Holland, Mich.

TWO color QSLs, 50¢ up. W9GOF.

SELL, swap, two G.E. 211s, for 852, 860. Parts wanted. W9ERU.

SACRIFICING brand new Weston Model 267, d.c. milliamperemeters, scale 0-50, \$3. each. Wm. M. Miller & Sons, 2553 Madison, Chicago, Ill.

SWAP—hundreds of aviation magazines for transmitter tubes, or parts. Write Carl Fastje, Denison, Iowa.

NEW Voltage Microphone complete with transformer. Three types \$18, \$21.50, \$22.50 list. Send for folder. E. A. Schlueter, 3382-62nd Ave., Oakland, Calif.

SELL, trade: Ludwig Drum outfit for radio apparatus. Anything considered. Inquiries answered. W9JUT.

COMPLETE assembled radiophone transmitter, 10 watt output, 100% modulated, \$35.95. Nothing else to buy! Crystal control, \$41. Crystals ground to specified frequency, 0.1%, 80 or 160 meter bands, \$2.70 (with holder). 0-100, 150, 200, 300 milliammeters, \$3.65 each. ICA short wave coils, 4 for \$1. 2-tube a.c. receiver \$10.75. 5000 ohm 200 watt gridleaks, \$1.40. 15-watt 210 tubes, 89¢. Dunco relays, \$2.65. Heavy duty 866 tubes, \$1.29. Slightly used single signal type Comet Pro. Best offer takes it. Write for list. Ted Chadek, 299-B Ontario St., Albany, N. Y.

CRYSTALS—guaranteed, 160-80 meter, 7/8 to 1", within 15 kilocycles, plus or minus, \$1.35—1" within 5 kilocycles, \$2.50. Hundred kilocycle car \$5. C.O.D. William Threm, W8FN, 4021 Davis Ave., Cheviot, Ohio.

WANTED: 500W 1000V motor-generator that is in good condition. Henry O. Wilson, Angoon, Alaska.

QSLs, two color. Stationery. Send for samples. Printer, Corwith, Iowa.

WANTED: Ballantine's Radio Telephony for amateurs. State edition and condition. W9JKK, 1302 High, Fort Wayne, Ind.

WANTED: FB-7 receiver. Must be cheap. W9GLR, 218-20th S. E., Mason City, Iowa.

QSL cards, two color, cartoons, message blanks, stationery, snappy service. Write for free samples to-day. W1BEF, 16 Stockbridge Ave., Lowell, Mass.

CALLBOOKS—new Spring 1934 Radio Amateur Call Book, many pages of new W calls added and hundreds of new DX stations, is yours for \$1.10. Next four issues for \$3.65 (Foreign \$1.20 and \$3.90). W9FO-610 S. Dearborn, Chicago.

50% off on new Amertran transformers. Limited supply. Mattlin, 2037 Euclid, Cleveland, Ohio.

METERS, transformers. Litz, RCA theater amplifiers. State your wants. Mattlin, 2037 Euclid, Cleveland, Ohio.

REBUILT, 110 a.c. generators. Small, compact, operate transmitter, etc. 300 watt \$12. Neal Brown, Richland Springs, Texas.

CRYSTALS: \$1.35 Hipower oscillators 1700-3500 Kc. bands close to your specified frequency. 7000 Kc. band \$4.25. Plug-in holder \$1.00 complete with mounting. Blanks 65¢. We supply crystals for any purpose. Write for bulletin. You cannot buy better crystals than Hipower. Immediate delivery. Hipower Crystal Co., 3607 N. Luna Ave., Chicago, Ill.

WANTED—Candler Advanced Course. W2DIE.

QSLs by Maleco. Finest in country. Free samples. Maleco, 1512 Eastern Parkway, Brooklyn, N. Y.

SW-3, new, \$11.70. Attention local amateurs. Also new National 600 meter coils, \$2.50. Fred Wilkey, 1784 Linden, Long Beach, Calif.

1000 W transformers (GE) 1100-2200-4400 Volts each side center tap. Same as hundreds sold A.R.R.L. members. Dawson, 5740 Woodrow, Detroit, Mich.

SELL, typewriter, telephones, mike, parts, tubes. Virgil Willey, Watts, Okla.

TEN practical and low-cost changes, converting Dodge 12-V. Ford T.A., Chevrolet Delco 6-V generators into 100-500 watt capacity a.c. generators, or into 32-110V d.c. motor or generator. Dodge is 500-W self-excited. All in one book illustrated with complete simplified instructions and drawings for only \$1. Autopower, 416 S. Hoyne Ave., Chicago.

YOU can't beat our prices FB-7, Comet, SW-3, short wave receivers. Hatry & Young, Hartford.

SPECIAL service: We install automatic volume control, any set, sw or broadcast. Latest, best types. Also repairs, reconstruction. Give details in asking estimates. Tone corrections, all kinds audio rejuvenating, detector to speaker. Hatry & Young, Hartford.

CRYSTALS: Guaranteed excellent oscillators, 160 or 80 meters, your approximate frequency \$1.35 postpaid. Crystal Maker's blanks 1" 65¢-dozen \$6.00. Irregular shapes 25¢. Improved dust-proof Bakelite Holders, 11/8" silvered electrodes increase efficiency. Plugs into G.R. or tube socket mounting, any position. No exposed electrodes; 75¢-dozen \$5.40. Fisher Laboratory, 1200 E. Nevada, El Paso, Texas.

QST superheterodyne preselector, \$10; Universal five-band exciter unit, \$22.50; transceiver 5 and 10 meters, \$13.75; beginners' crystal transmitter, with power supply, \$21.50. Write for new catalog. We build to order. Precision Radio Labs., 109 E. 94 St., Brooklyn, N. Y.

QSL and SWL cards, 200 one color, \$1, 200 two color, \$1.25. W8ESN, 1327 Cone St., Toledo, Ohio.

CRYSTALS, 1 inch power ground. Unconditionally guaranteed. 80-160 meters, 25-kc. \$1.50, 5-kc. \$2. Accurate calibration. 1" blanks 50¢. Holders 50¢. Gentry Lab., 803 W. Maple, Independence, Mo.

CONDENSER microphones \$7.50, desk or suspended amplifiers, \$10. Stands, foil. Literature. Microphone Labs., 345 Eighth, Ann Arbor, Mich.

NATIONAL FBX with tubes, forty meter coils, National pack. Forty dollars cash. Hugh Lewis Nix, 1616 Hemphill St., Ft. Worth, Tex.

NEED cash—Pilot superwasp, complete, good condition, \$3.85; Weston 0-6 voltmeter, \$2.15. Van Leeuwen, 512 12th St., Santa Monica, Calif.

FB7s, Omnigraps, Teleplexes, Vibroplexes, meters, receivers, microphones. Bought, sold, traded. Ryan Radio Co., Hannibal, Missouri.

TRANSFORMERS—quotations given. Frank Greben, W9CES, Accurate Radio Service, 2920 W. Cermak Rd., Chicago, Ill. Phone Crawford 2050.

SELLING station—W2ERA, 33 Godfrey, Upper Montclair, N. J.

GABINETS—metal, chrome finish, 19x13x9 inches. Each \$1, six \$5. Cash in advance. Gates Radio & Supply Co., Quincy, Ill.

HEAVY duty mesh filament 866s, \$2.50, 872s, \$7.50. A few meters left. 212Ds, \$10. Late type Universal S-G quarters, \$15. 849s, 204As, etc. W. E. mikes, recondition, \$5, repacked, \$2. E. Ewing, 1057 Pratt Blvd., Chicago.

TRADE Omnigraph for Master Telex. Will pay difference. W5COV, Chickasha, Okla.

HAYWIRE transmitters rebuilt at moderate prices. Holmes C. Miller, Box 105, Palo Alto, Calif.

QSLs, that get results. Samples. W2ABY.

IN STOCK: National FB7As \$34.20, FBXAs \$47.70, coils \$6; 5897-AB \$15.90; SW3s \$17.70, coils \$3; Comet Pros \$38.20; Crystal Pros \$111.72; Patterson PR-10s \$70.25; McMurdo-Silver 5Bs \$59.70. Hammarlund, Patterson, McMurdo-Silver shipped prepaid. Trade-in your receiver. Guaranteed 866s \$1.95. Teleplexes rented 75¢ week. Lowest prices all Sylvania, National, Hammarlund, Cardwell, Triplett, Thordarson, Biley, Universal, Supreme. Satisfaction guaranteed. Write. Henry's Radio Shop, Butler, Mo.

500 volt generators, \$4. W9FIQ, Lewiston, Minn.

QSLs! Drawings made reasonably. Your ideas printed. W6FZQ, Box 1804, Phoenix, Ariz.

GET my QSL proposition first. Jake, Specialty Printer, Franklin, Penna.

CANADIANS, 300 watt 2880 volt e.t. transformer, 25 cycle \$7.50. 125 watt foreign modulator tube new \$5. 6-400 dynamotor, \$7.50. A Hunter, 430 S. Brock St., Sarnia, Ont.

MORE antenna watts, less kilowatts. Power equipment generating maximum rf, minimum heat. Relay racks. That prized NBC touch. Edison batteries, parts. See January display. Rectifier Engineering Service.

VIBROPLEXES and speed bugs, latest models, \$11. Trades-ins accepted. Lydeard, 28 Circuit, Roxbury, Mass.

CLASS B transformers—for 46's \$4.95 pair. Universal Transformers for two or four 46's, 210's, 800's, RK18's, etc. \$7.75 pair. 70 watts of audio from 46's. Write for details. W8UD, Douglas, Michigan.

QSLs! Snappy ideas! Nifty cuts! Attractive color combinations! 200 two colors, \$1. Samples! Service! W5AUB, 410 Green St., Tupelo, Miss.

I.R.E. Proceedings, QSTs, 1929 to date. John Bullock, Louisa, Va.

SELL, '33 Comet Pro complete, sixty bucks. Eberhardt, 465 W. 159 St., New York City.

CRYSTALS: power x cut within 2 kes., \$2. Biley BC2 holder, \$1.50. Crystal and holder, \$3.25. W8DLM, Rochester, Mich. 160 meter crystal controlled fone transmitter, complete, \$50. W8JOP, Wilkingsburg, Penna.

CRYSTALS: 95¢ in 80 or 160 meter band. Within ten kilocycles your specified frequency. Kleber heavy duty 866s, guaranteed, \$1.49. 866 filament transformers, 15,000 volt mica insulation, \$2.25. Standard relay racks \$7.50. Include postage. Taylor Tubes stocked. Write for circular. Other bargains. Want meters. Kleber Radio Laboratories, W9IOE, Belvidere, Illinois.

SELL—WE 101B, 216A, 3-211D's; GE AC 150 voltmeter; Weston DC 500 milliammeter; Jewell AC 2 ammeter; REL 5" coil; cond. microphone. W9GJR, Mo. Valley, Iowa.

SURPLUS parts, tubes, meters, suitable low power rigs. Will sell or swap. Stamp for list. W6CKS.

NEW process restoring transmitting and rectifying tubes any type if filament and envelope okay. Send two, fix one for other; both for cash. Guaranteed. W5BDB, Texarkana.

FBX and Preselector, power pack, coils, tubes, Magnavox. Make offer. Faber, Sandwich, Ill.

FOR sale—Esco dynamotor, primary 32V, secondary 500 volts, 300 mls. Cecil A. Daniel, 1469 5th Ave., New York City.

CRYSTAL control transmitter, \$8. Class B phone transformers, condensers, receivers, reasonable. W9KQO, Topeka, Kans.

THE most complete line ever made by one manufacturer, A. C. Ross Company, over 1600 items including transformers, chokes, filter condensers, steel transmitter frames, racks, towers, masts, etc. McMurdo-Silver 8 tube superheterodyne 10 to 200 meters, tubes, speaker, complete \$59.70. "Everything for the Ham." Lowest prices. Catalogs. L. I. Marine & Electric Co., Laurel, N. Y.

USED RCA 851, \$37.50. 1/4 kw. screen grid tube, \$14. Esco mg. 500 V, 200 mls. 110 V d.c. motor, \$20. W3CGA.

FOR sale—a.c. super wasp d.c., National Silver all wave, Scott Deluxe, all complete. Glenn Watt, Chanute, Kans.

WANTED, Scott all wave, FB7, Comet, Glenn Watt, Chanute, Kans.

ASTATIC crystal microphones, postpaid in U. S., \$12.25. RK-18 Raytheons, \$10.95 plus postage. Jordan Radio Lab., 1019 E. 5th St., Erie, Pa.

866s, 1000 hour guarantee \$1.49; 825s (7½V) \$4.95; Transformers: 866 filament \$1.93; 1200 volt 250 mil. \$3.62; 520-520 (125 mil), 2½, 2½, \$2.85. Dustproof holders 67¢. 300 mil chokes, \$2.65. Custom-built transmitters. Howard Radio, 314 Pine Ave., Chicago.

HERE'S A NEW DEAL

for the AMATEUR

Now you can buy that new

RECEIVER OR TRANSMITTER

on our

DEFERRED PAYMENT PLAN

Prompt delivery on

HAMMARLUND COMET PRO

PATTERSON PR-10

NATIONAL FB7-FBXA

COLLINS TRANSMITTERS

RCA-SYLVANIA TUBES

TAYLOR TUBES

and all other nationally known lines

WRITE AT ONCE FOR FULL PARTICULARS
STATING YOUR NEEDS

Delaware Radio Sales Co.

405 Delaware Ave., Wilmington, Del.

Attention: W. S. WILSON—W3DQ

ATTENTION OPERATORS

DX Contest—March 10-18

A.R.R.L. 20th Anniversary

Relay—April 7-8

OPS phone party—April

21-22

ORS get-to-gether—April

21-22

Don't let these Communications Department activities find you with a full log—no more pages, and right in the middle of the party! Message blanks will come in right handy too.

See page 70 this issue of QST for full dope concerning essential A.R.R.L. station forms.

THE AMERICAN
RADIO RELAY LEAGUE
WEST HARTFORD CONNECTICUT

Your Nearest Dealer

Your nearest dealer is entitled to your patronage. You can trust him. He is equipped with a knowledge and understanding of amateur radio. He is your logical and safe source of advice and counsel on what equipment

Patronize the dealer nearest you—

<p>ALLENTOWN, PENNSYLVANIA Radio Electric Service Co. 1024 Hamilton Street Complete stocks transmitting equipment</p>	<p>DETROIT, MICHIGAN Radio Equipment Sales Co. 14036 Woodward Avenue, Highland Park A complete stock of amateur, shortwave and service parts</p>
<p>BALTIMORE, MARYLAND Radio Electric Service Co. 303 W. Baltimore Street Everything for the amateur</p>	<p>DETROIT, MICHIGAN Radio Specialties Company 171 E. Jefferson Avenue Ham Supplies — National & Hammarlund Sets and Parts</p>
<p>BOSTON, MASSACHUSETTS Nutter & Cross, Inc. 99A Milk Street All OMs, OWs, and YLs welcome — W1HRF</p>	<p>ERIE, PENNSYLVANIA Jordan Radio Laboratory 1019 East Fifth Street Amateur, service parts, including Bliley, National, Raytheon. W8CXG</p>
<p>BROCKTON, MASSACHUSETTS Ware Radio Supply Company 913 Centre Street Everything in parts. Comet Pro in stock with crystal filter</p>	<p>HARTFORD, CONNECTICUT Radio Inspection Service Company 227 Asylum Street Complete line of guaranteed parts</p>
<p>BUFFALO, NEW YORK Dymac Radio 359 Capen Blvd. — Tel. Univ. 9380 Complete Stock Amateur Parts — Standard Discounts — W8AWK</p>	<p>HOUSTON, TEXAS Straus-Frank Company Distributors for nationally advertised amateur products RCA-DeForest transmitting tubes</p>
<p>BUFFALO, NEW YORK Kronson Service Company 143 East Genesee Street Western New York's largest wholesale distributors—W8EHF</p>	<p>KANSAS CITY, MISSOURI Burststein-Applebee Company 1012-14 McGee Street "Specialists" in supplies for the Amateur and Serviceman</p>
<p>CHICAGO, ILLINOIS Chicago Radio Apparatus Company 415 South Dearborn Street Dependable Radio Equipment. Established 1921. All Standard Lines</p>	<p>KANSAS CITY, MISSOURI Radio Laboratories 1515 Grand Avenue Amateur Headquarters — Complete Stock — Quality Parts</p>
<p>CHICAGO, ILLINOIS Mid-West Radio Mart 520 S. State Street All standard lines carried in stock</p>	<p>LOS ANGELES, CALIFORNIA Radio Manufacturers Supply Co., Inc. 1000 S. Broadway Amateur Headquarters of the Pacific Coast</p>
<p>CLEVELAND, OHIO Northern Ohio Laboratories 2073 West 85 Street Wholesale Distr. for National, Hammarlund, Thordarson, Cardwell</p>	<p>MANCHESTER, NEW HAMPSHIRE Radio Service Lab. of N. H. 1008 Elm Street — Tel. 218-W Northern New England Suppliers of Amateurs and Servicemen</p>
<p>CLEVELAND, OHIO Radio Servicemen's Supply Co. 206 Prospect Street Wholesale Distributors catering to Amateurs, Dealers, Servicemen</p>	<p>MILWAUKEE, WISCONSIN Radio Parts Company, Inc. 332 West State Street Complete stock Nationally Known products</p>
<p>DENVER, COLORADO Inter-State Radio & Supply Co. 1639 Tremont Place Amateur Radio Headquarters in the Rocky Mountain Region</p>	<p>NEWARK, NEW JERSEY Kaltman & Romander 62 Court Street Drop in for an over-counter QSO</p>
	<p>NEW ORLEANS, LOUISIANA Rose for Radio 129 Camp Street Complete stock quality radio parts</p>

This advertisement is paid for by the firms listed above. Qualified dealers

You Are Protected When You Buy From QST Advertisers

¶ "Advertising for QST is accepted only from firms who, in the publisher's opinion, are of established integrity and whose products secure the approval of the technical staff of the American Radio Relay League."

Quoted from QST's advertising rate card.

Every conceivable need of a radio amateur can be supplied by the advertisers in QST. And you will know the product has the approval of the League's technical staff.

For Your Convenience QST'S INDEX OF ADVERTISERS IN THIS ISSUE

American Machine & Tool Co.	77
A.R.R.L. Application Blank	78
Back Copies QST	72
Binder	76
Handbook	80, <i>Cov. 11</i>
Hints and Kinks	82
How to Become	75
License Manual	87
Log Book	91
Supplies	70, 89
Birnbach Radio Company	87
Blan, The Radio Man, Inc.	77
Biiley Piezo-Electric Co.	77
Cameradio Company	89
Candler System Company	79
Cardwell Mfg. Corp., Allen D.	95
Central Radio Labs.	82
Cornell Dubilier Corp.	87
Delaware Radio Sales Co.	91
Delta Mfg. Company	81
Dodge's Institute	81
Electrad, Inc.	88
General Radio Company	68
Gross Radio Company	66, 67
Gulf Radio School	79
Hammarlund Mfg. Company	1
Harvey Radio Labs.	79
Heintz and Kaufman	73
Instructograph Company	87
Jappe Company, H.	80
Kaltman and Romander	74
Kenyon Transformer Co.	69
Klaus Radio & Electric Co.	89
Leeds	4
Littelfuse Labs.	87
Lynch Mfg. Company	81
M & H Sporting Goods Co.	85
Massachusetts Radio School	85
National Carbon Company	81
National Company	65, 71, 79, 84, <i>Cov. 111</i>
New York Y.M.C.A. Schools	87
Port Arthur College	77
Precision Piezo Service	86
RCA Institutes, Inc.	89
RCA Radiotron Company, Inc.	<i>Cov. IV</i>
Radio Mfg. Engineers	84
Radio Supply Company	88
Raytheon Production Corp.	86
Ross & Co., A. H.	85
Sangamo Electric Co.	88
Schwartz & Son, Maurice	33
Scientific Radio Service	83
Sprague Products Company	96
Teleplex Company	85
Thordarson Elec. Mfg. Co.	83
Trim Radio Mfg. Company	76
United Radio Mfg. Company	89
Universal Meter Works	86
Universal Microphone Co.	89
Westinghouse Elec. & Mfg. Co.	2
Weston Electrical Instrument Co.	75
Wing's Sons, Chauncey	83

HERE IS ONE STANDARD YOU MAY DEPEND UPON!



OTHER standards tumble, currencies gyrate, values fluctuate, much merchandise is intrinsically cheapened or unreasonably priced to meet changing conditions, but **CARDWELL** quality, value and efficiency remain unchanged. The same **CARDWELL** quality and the same intrinsic value that for years have afforded a "Standard of Comparison" for Engineers and Amateurs alike are, in spite of changing conditions, still inherent in every **CARDWELL** condenser. Now, as always, there is no better buy than a **CARDWELL**.



- CARDWELL "TRIM-AIR" MIDGET CONDENSERS
 - CARDWELL MIDWAY "FEATHERWEIGHT" CONDENSERS, RECEIVING and TRANSMITTING
 - CARDWELL "STANDARD" MODELS FOR RECEIVERS and MEDIUM POWER TRANSMITTERS
 - CARDWELL 16-B TRANSMITTING CONDENSERS FOR LARGER TRANSMITTERS
 - CARDWELL HIGH VOLTAGE CONDENSERS FOR COMMERCIAL RADIO-TELEGRAPH and BROADCASTING STATIONS
 - CARDWELL S-2244 OIL DIELECTRIC FIXED CONDENSERS FOR HIGH FREQUENCY FURNACES and TUBE BOMBARDERS
- THERE'S A **CARDWELL** FOR EVERY TUBE, PURPOSE and POCKETBOOK

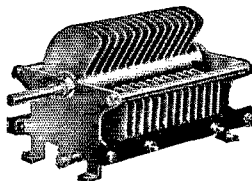

THE CARDWELL "TRIM-AIR" CONDENSER

The **CARDWELL** "Trim-Air", an all-purpose quality midget condenser, and unique in several respects, has recently been added to the **CARDWELL** line. A full description appeared in January 1934 "QST". The "Trim-Air" is well worth your attention if considering midget condensers.

Any reliable supplier should cooperate with you to enable you to get what you want. He can get **CARDWELLS** for you if he does not keep them in stock. Get what you want — insist on **CARDWELLS**. Order direct from us if your dealer will not supply you, or let us tell you where you may buy.

The ALLEN D. CARDWELL MFG. CORP'N.
83 PROSPECT STREET, BROOKLYN, N. Y.

"THE STANDARD OF COMPARISON"

SPRAGUE TRANSMITTING CONDENSERS

**NOW BUY THE BEST—
and Save Money! . . .**

Now — for the first time — amateurs can buy famous Sprague Transmitting Condensers of the same outstanding quality specified by leading industrial accounts for the past three years. Besides being of the smallest size at the highest voltage, they are also surprisingly moderate in price.

You need not "play safe" by purchasing condensers of a higher voltage than you actually require. Every Sprague unit is labelled with the type of circuit for which it is designed as well as the maximum voltage delivered by the transformer secondary. Moreover, you're assured of ample safety factor. Whether you use your Spragues intermittently or for hours at a time, you're sure they'll deliver the goods — and do it for years!



Still Going Strong!

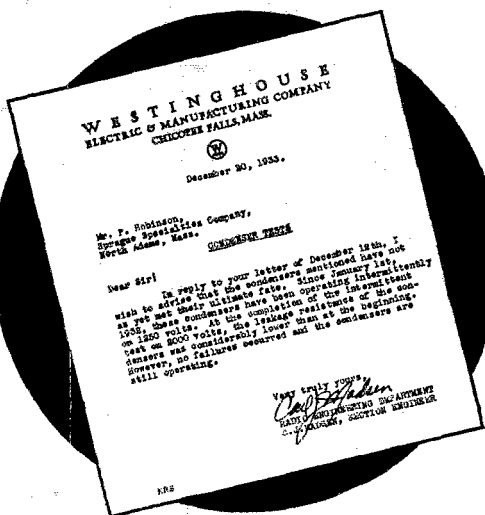

This report by Engineer Carl J. Madsen of Westinghouse on the performance of a Sprague 1000 volt, 2 mfd. condenser speaks for itself regarding Sprague quality. 'Nuf said!

Cat. No.	Capacity	Voltage	List Price
OT-21	2 mfd.	1000 V.	\$4.50
OT-22	2 mfd.	2000 V.	8.00
OT-41	4 mfd.	1000 V.	7.00

Sprague Transmitting Condensers employ the cylindrical type of winding formerly used only in the most expensive condensers. Units are oil impregnated and oil immersed. Isolantite terminals assure perfect insulation. Quality seals guard against oil leakage. Conservative ratings for type of circuit and rectifier tube shown on label. Clamps supplied FREE for ease in mounting.

Today — at the lowest prices in history — there is no need to be satisfied with anything less than Sprague GUARANTEED performance

GUARANTEE: Every Sprague Transmitting Condenser is guaranteed UNCONDITIONALLY against breakdown when used as specified.

SPRAGUE
PRODUCTS COMPANY
North Adams, Mass.



WRITE FOR THE COMPLETE SPRAGUE CONDENSER CATALOG

PARTS *by* NATIONAL

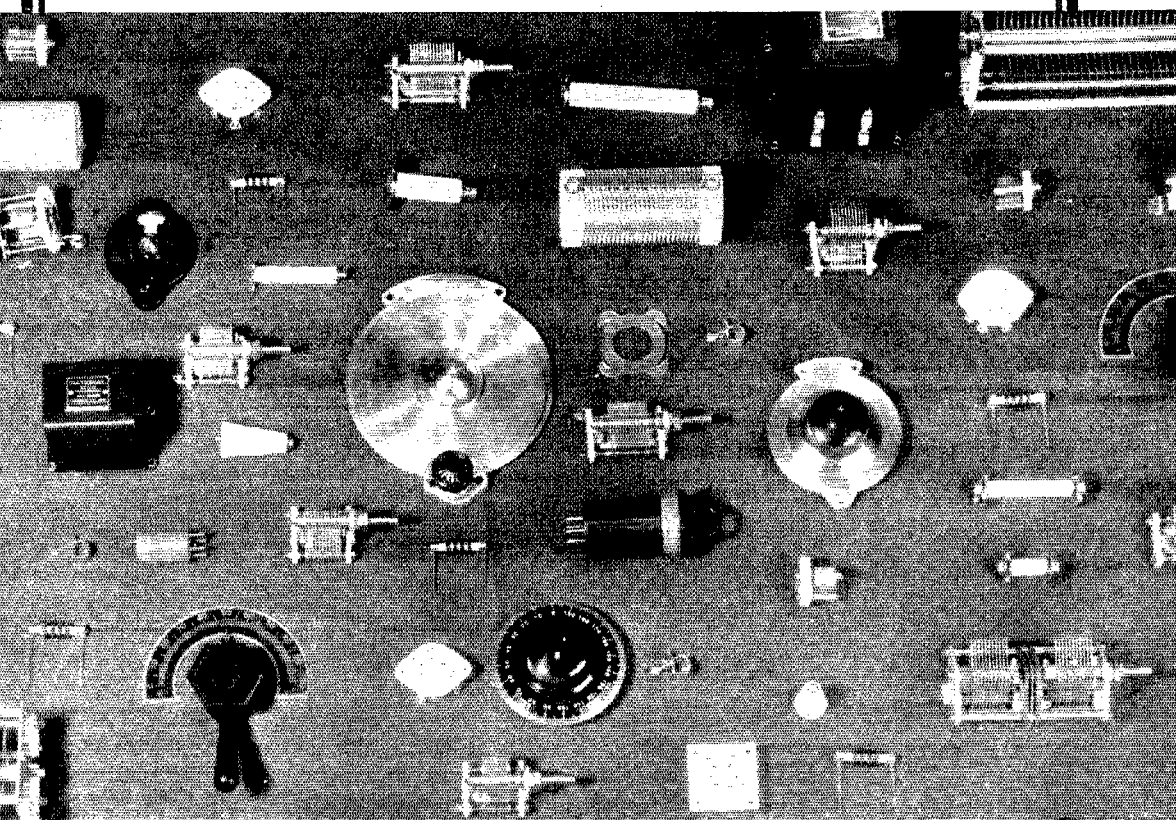

The trite saying that to do a thing well, one must do it oneself, is nevertheless true in receiver manufacture. It is more through necessity than choice that National manufactures such a variety of parts, for in no other way can high receiver performance be maintained.

Only by painstaking design of every important detail, without compromise and without divided responsibility, can National's claim to leadership be valid. To us, this policy brings complete control of National quality. To our customers, it brings the assurance of consistent design in National receivers and of tested fitness in every National Radio Part.

NATIONAL COMPANY, INC., MALDEN, MASS.

A MESSAGE TO RADIO AMATEURS

I have always been keenly and sympathetically interested in amateur radio. ★ ★ My earliest business experience was as a dealer in amateur wireless equipment in San Francisco, beginning in 1911. In 1915 I began the manufacture of vacuum tubes under the name of Audiotron, and as this was several years before the advent of broadcasting, my contacts naturally were almost entirely with amateur operators and experimenters. With the coming of broadcasting the market for our tubes expanded enormously, but my interest in the amateur, with whom I had dealt intimately and exclusively for so many years, has never diminished ★ ★ It has long been a special wish of mine that the RCA Radiotron Company might be better equipped to handle the particular requirements of amateurs. That wish has been fulfilled in the RCA-deForest Amateur Radio Division, which was recently organized to handle both the engineering and sale of amateur types exclusively. This amateur service division includes a number of active amateurs, many of whom have made notable contributions to short-wave communication, and is backed up by the entire resources and facilities of the parent company ★ ★ In soliciting your patronage of the RCA-deForest Amateur Radio Division of RCA Radiotron Company, I wish to assure you that I, personally, and we, as an organization, pledge our complete co-operation and sympathy with your aims and ideals. We invite you to call upon us at any time we may be of service.

E. T. CUNNINGHAM, President
RCA Radiotron Company, Inc., Camden, New Jersey