

QST

DEVOTED ENTIRELY TO

AMATEUR RADIO

PUBLISHED SINCE 1915 BY THE AMERICAN RADIO RELAY LEAGUE INC.

Superb Short-Wave 'Phone Reception

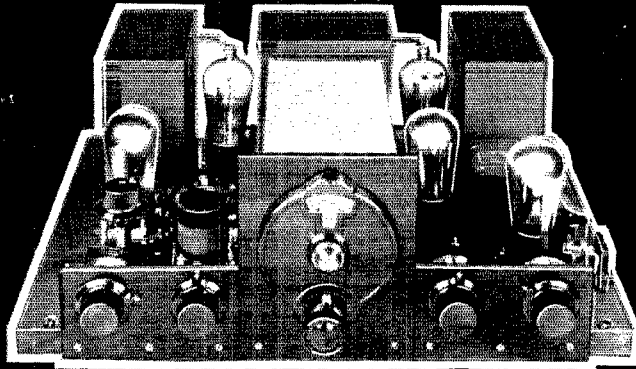

*An All-Purpose Superheterodyne
— In This Issue*

MARCH

1929

25¢

Just Out—
The New Fourth Edition of

The Radio Amateur's Handbook

By HANDY and HULL

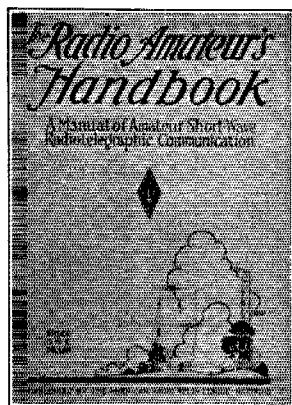

FOR THOSE WHO DON'T KNOW IT:

The Handbook is a practical manual of amateur radio in all its phases, published by the American Radio Relay League, the amateur's own organization. It starts at the beginning and tells the whole story: What amateur radio is, How to be a radio amateur, How to obtain your licenses, How to build the simple apparatus of a simple station, How to build the best known apparatus for the most modern station, How to operate the station. Enough information to keep you busy and interested for five years.

FOR THOSE WHO DO KNOW IT:

For years the Handbook has been the practical working guide of successful amateurs the world over. Now it has been completely revised in terms of 1929, by Mr. Handy, the League's Communication Manager, as to all the aspects of operating procedure, and by Mr. Hull, the director of the League's current Technical Development Program, as to all its features of apparatus and technical matters. Everything in it is on a 1929 basis, replacing the 1928 methods which used to be good enough but aren't any more.

MUCH THAT IS NEW—ALL THAT IS GOOD

Like QST, "Devoted Entirely to Amateur Radio"

Now in its 43d thousand

240 pages, 6½ x 9½, 188 illustrations

In wealth of treatment and profusely of illustration the Handbook is a big book. Printed in usual textbook style it would bulk 500 pages and cost at least \$4, but its publication in the familiar *QST* format makes for handiness and enables its distribution at very modest cost.

ALGERIAN COVER \$1

STIFF BUCKRAM BINDING \$2

Postpaid anywhere in the World

American Radio Relay League, Hartford, Conn., U.S.A.

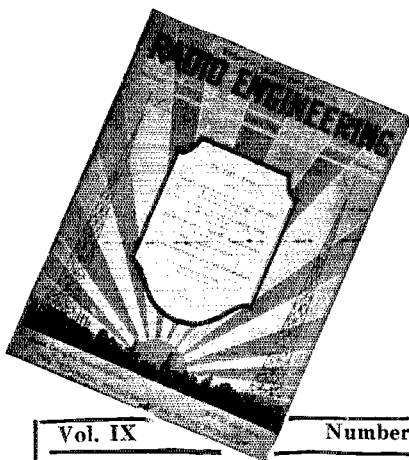

- If -
 You are interested in the
 Engineering develop-
 ments in Radio; if you are
 an engineer, a dealer,
 technician, service man,
 or an advanced experi-
 menter

**Read further and
 Use the Coupon**

Vol. IX	Number 1
Contents	
Characteristics of Electric Wave Filters	
	By Clyde L. Farrar
The Rating of Radio Receivers	
	By G. C. Woods
Gas in Metal Parts of Vacuum Tubes	
	By J. H. Ramage
New Musical Effects Produced by Electrical Means	
	By Edward W. Kellogg
The Engineering Rise in Radio, Part VIII, . . .	
	By Donald McNicol
At the Knee of the Curve	
	By J. E. Smith
Departments	
Commercial Developments:	
	Sound Projector Systems for Motion Picture Theatres
	By Edward O. Scriven
Constructional Developments	
News of the Industry	
New Developments of the Month	
Buyer's Directory	
Index of Advertisers	

RADIO ENGINEERING is particularly valuable for those who are now employed in or connected with the radio industry or trade—in fact the engineering and production personnel of practically every radio manufacturer, is on our subscription lists. The editors, Muhleman, McNicol and Lescarbours, are exceptionally equipped. If you are at present working within the radio field—or if you plan to do so—you ought to be reading Radio Engineering every month.

Well, if you don't use the coupon now, you'll probably forget it.

Radio Engineering is NOT sold on newsstands

(See coupon Below)

BRYAN DAVIS PUBLISHING CO., Inc.
 52 Vanderbilt Avenue, New York, N. Y.

Enclosed find { \$2.00 for 1 year } subscription to Radio
 { \$3.00 for 2 years } Engineering.

Enclosed find twenty cents (20c) for which send sample copy of Radio Engineering.

Name

Address

City State

PLEASE PRINT NAME AND ADDRESS

Please Check Your
 Classification

Manufacturer

Dealer or Distributor

Engineer

Service Man

Technician

Anything Else.....

Here's the answer to every question about the principles, methods, or apparatus, of radio transmitting and receiving--

THE RADIO MANUAL

By G. E. STERLING, Radio Inspector and Examining Officer, Radio Division, U. S. Dept. of Commerce.

Edited by ROBERT S. KRUSE, for five years Technical Editor of QST.

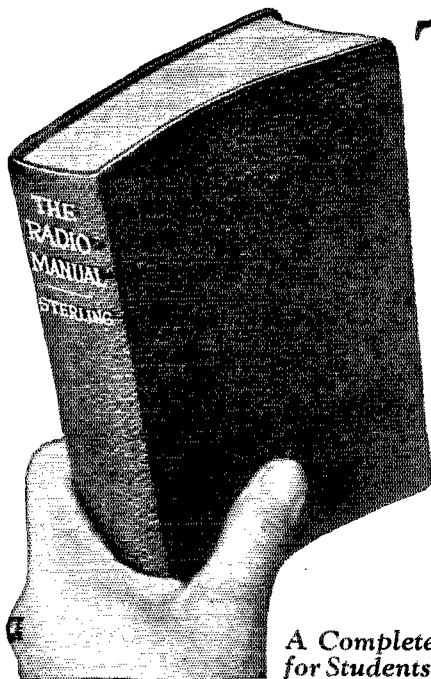

The new procedure adopted by the International Radio Telegraphic Convention is effective January 1st, 1929. THE RADIO MANUAL records it completely. Department of Commerce examinations for operator licenses are changed the first of the year. Only THE RADIO MANUAL presents all the material to meet the requirements of the questions. Progress has been steadily made in perfecting radio theory and practise. THE RADIO MANUAL, since it is the most up-to-date volume on radio, is the surest source of complete and accurate information on all points.

A Complete Handbook of Principles, Methods, Apparatus for Students, Amateur and Commercial Operators, Inspectors

Complete Preparation for Government License. 16 Chapters Covering

- | | | |
|---|--|--|
| <ol style="list-style-type: none"> 1. Elementary Electricity and Magnetism 2. Motors and Generators 3. Storage Batteries and Charging Circuits 4. Theory and Application of the Vacuum Tube 5. Fundamental Circuits Employed in Vacuum Tube Transmitters 6. Modulating Systems Employed in Radio Broadcasting 7. Wavemeters, Piezo-Electric Oscillators, Wave Traps and Field Strength Measuring Apparatus 8. Marine Vacuum Tube Transmitters including detailed description of Model FT-3626 | <ol style="list-style-type: none"> 9. Radio Broadcasting Equipment including, for the first time in any text book, the complete equipment of Western Electric 5 Kilowatt broadcasting Transmitter used in over 75% of American broadcasting stations 10. Arc Transmitters including description of Federal Marine 2 Kilowatt Arc Transmitter Type AM 4151; also models "K" and "Q" 11. Spark Transmitters including description of Navy Standard 2 Kilowatt Transmitter 12. Commercial Radio Receivers and Associated Apparatus including, for first time in | <ol style="list-style-type: none"> any text book description and circuit diagram of Western Electric Superhetrodyne Receiver Type 6004C 13. Marine and Aircraft Radio Beacons and Direction Finders 14. The Development of Amateur Short Wave Apparatus. Complete details of construction, operation and licenses 15. Radio Laws and Regulations of the U. S. and International Radio Telegraph Convention, Quotations of all important sections 16. Handling and Abstracting Traffic |
|---|--|--|

Examine It Free

Never before has so complete a treatment of radio theory and operation been compressed into a single volume. Here is information that otherwise you could secure only by consulting many different books. And every detail is vouched for by authorities of the first rank. The Manual is profusely illustrated with photographs and diagrams. There are 700 pages, bound in flexible fabricoid that is extremely durable. The immediate demand for so valuable a handbook has already nearly exhausted the second large edition. To be sure of receiving your copy without delay, order at once. The volume will be sent for free examination. Pay or return in 10 days.

Order On This Coupon

D. VAN NOSTRAND CO. INC., 8 Warren St. N. Y.
 Send me THE RADIO MANUAL for examination.
 Within ten days after receipt I will either return the volume or send you \$6.00--The price in full.

Name QST 3-29

St and Number

City and State

Section Communications Managers of THE COMMUNICATIONS DEPARTMENT, A. R. R. L.

Eastern Pennsylvania	W3QP	J. B. Morgan, 2nd	431 E. Willow Grove Ave. Chestnut Hill, Phila.
Maryland-Delaware-District of Columbia	W3A1S W3C7G W8PJ	Dr. H. H. Layton M. J. Layton C. S. Taylor	805 Washington St. Box 48, RFD 1 568 Masten St. 309 Third St.
Southern New York	W8PJ	A. W. McAuley	309 Third St. Buffalo Oakmont
Western New York	W8CEO		
Western Pennsylvania	W8CEO		
ATLANTIC DIVISION			
Illinois	W9APY	Fred J. Hinds	3387 Oak Park Blvd. Berwyn
Indiana	W9CYQ	D. J. Angus	310 N. Illinois St. Indianapolis
Kentucky	W9BAZ	J. B. Wathen, III	Box 97, J. C. P. D. 1 Louisville
Michigan	W8CEZ	Dallas Wise	2187 Falcon Ave. Detroit
Ohio	W8BYN	H. C. Storck	594 Carpenter St. Columbus
Wisconsin	W9VD	C. N. Crapo	143 Newton Ave. Milwaukee
DAKOTA DIVISION			
North Dakota	W9DEV	B. S. Warner	209 4th Ave. Enderlin
South Dakota	W9DGR	D. M. Pasek	730 Illinois St. Huron
Northern Minnesota	W9BVH	Carl L. Jabs	1822 James St. St. Paul
Southern Minnesota	W9EFK	J. C. Pehoushek	130 Warwick St., S. W. Minneapolis
DELTA DIVISION			
Arkansas	W5ABI	H. E. Velto	5408 U St. Little Rock
Louisiana	W5EB	M. M. Hill	1708 23rd Ave. Oakdale
Mississippi	W5AKP	J. W. Gullett	Meridian
Tennessee	W4FI	Polk Purdue	7/6 Radio Station WBAW Nashville
HUDSON DIVISION			
Eastern New York	W2CNS	F. M. Holbrook	2 Livingston Ave. White Plains
N. Y. C. & Long Island	W2KR	M. B. Kahn	617 W. 141st St. New York
Northern New Jersey	W2WR	A. G. Wester, Jr.	50 Princeton St. Maplewood
MIDWEST DIVISION			
Iowa	W9DZV	H. W. Kerr	915 Lincoln Ave. Little Sioux
Kansas	W9CET	J. H. Amis	3010 Mercer St. Topeka
Missouri	W9RR	L. B. Lutzro	5605 Cedar St. Kansas City
Nebraska	W9BYG	C. B. Deith	Omaha
NEW ENGLAND DIVISION			
Connecticut	W1ZL	C. A. Weidenhammer	33 Washington Place Bridgeport
Maine	W1BIG	Frederick Best	18 E. Crescent St. Augusta
Western Massachusetts	W1UE	E. L. Battey	29 Royal St. Wollaston
Western Massachusetts	W1UM	Dr. John A. Tessmer	3 Schaffner St. Worcester
New Hampshire	W1ATJ	V. W. Hedze	227 Main St. Claremont
Rhode Island	W1BCR	C. N. Kraus	92 Keene St. Providence
Vermont	W1IT	Clayton Paulette	North Troy
NORTHWESTERN DIVISION			
Alaska	W7WDN	W. B. Wilson	0. S. LHT Fern Ketchikan
Idaho	W7ACN-7TL	James L. Young	393 13th Ave. So. Nampa
Montana	W7AAT-7QT	O. W. Viers	Red Lodge Red Lodge
Oregon	W7PP	R. H. Wright	310 Ross St. Portland
Washington	W7FD	Otto Johnson	3340 30th Ave. W. Seattle
PACIFIC DIVISION			
Hawaii	K6CFQ	F. L. Fullaway	2714 Manoa Rd. Honolulu
Nevada	W6UO	C. E. Newcombe	232 Hanchett Ave. Yerington
Los Angeles	W6AM	D. C. Wallace	209 Pine Ave., Room 410 Long Beach Calif.
Santa Clara Valley	W6NX	F. J. Guement	252 Hanchett Ave. San Jose
East Bay	W6CZR	J. Walter Frates	398 62nd St. Oakland
San Francisco	W6WB	C. F. Barnes	292 Castro St. San Francisco
Sacramento Valley	W6CBS	C. F. Mason	2530 N. St. Sacramento
Arizona	W6ANO	D. B. Lamb	229 W. First St. Mesa
Philippines*	op1AU	M. I. Felizardo	152 Galilea St. Manila
San Diego	W6BQ	G. A. Sears	236 Bonair St. La Jolla
ROANOKE DIVISION			
North Carolina	W4SJ	Enno Schuelke	R. F. D. No. 1 Ridgeway
Virginia	W3CA	J. F. Wohlford	118 Cambridge Ave. Roanoke
West Virginia	W8VZ	F. D. Reynolds	Box 1209. Fairmont
ROCKY MOUNTAIN DIVISION			
Colorado	W9CAA	C. R. Stedman	1641 Alhlon St. Denver
Utah-Wyoming	W6RAJ	Parley N. James	430 "D" St., Salt Lake City
SOUTHEASTERN DIVISION			
Alabama	W4AAQ	S. J. Bayne	9 Park Ave. Montgomery
Florida*	W1HY	E. M. Winter	2144 Rosselle St. Jacksonville
Georgia-So. Carolina-Cuba-Porto Rico-Isle of Pine	W4KU	H. L. Reid	11 Shadowlawn Ave. Atlanta
WEST GULF DIVISION			
Northern Texas	W5AKN	J. H. Robinson, Jr.	522 Cumberland St. Dallas
Oklahoma	W5FJ	L. M. Edwards	515 S. Lincoln St. Enid
Southern Texas	W5OX	H. E. Franklin	1896 Valentine St. Houston
New Mexico	W5TT	L. B. Radka	Tucuman
MARITIME DIVISION			
Newfoundland	VE8AR	Loyal Reid	Avalon House St. Johns
New Brunswick	VE1E1	T. B. Lacey	676 N. B. Power Co. St. John
Nova Scotia	VE1DQ	A. M. Crowell	43 Dublin St. Halifax
Prince Edward Island	VE1BZ	F. W. Hyndman	25 Fitzroy St. Charlottetown, P. E. I.
ONTARIO DIVISION			
Ontario	VE3FC	E. C. Thompson	268 Queensdale Ave. Toronto, 6
QUEBEC DIVISION			
Quebec	VE2BE	Alex Reid	169 Lozan Ave. St. Lambert
VANALTA DIVISION			
Alberta	VE4HA	E. J. Taylor	10107-57th Ave. Edmonton
British Columbia	VE5BJ	E. S. Brooks	2987 Camosun St. Vancouver
PRAIRIE DIVISION			
Manitoba	VE4FY	D. B. Sinclair	205 Cambridge St. Winnipeg
Saskatchewan	VE4FC	W. J. Pickering	514 19th St. W. Prince Albert

*Temporary officials appointed to act until the membership of the Section concerned choose permanent SCMs by renomination and election.

HOT WIRE METERS

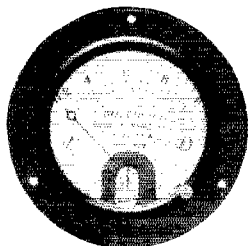

Type 127 A
Flush

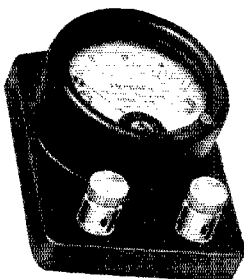

Type 127 C
Portable

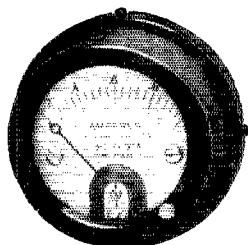

Type 127 B
Front of Panel

The hot-wire meter is at once the least expensive and most rugged type of high-frequency meter and, therefore, ideal for experimental use.

The General Radio Type 127 Hot-Wire Meters are accurate on direct or alternating current of audio or radio frequency. Thus, these meters meet all the ammeter requirements in amateur transmitters. They may be used as resonance indicators, radiation, plate, or filament ammeters. Ranges from one hundred milliamperes to ten amperes are provided in flush, front of panel or portable types.

Prices \$5.75 to \$6.50

Catalogue No. 931 sent on request.

The General Radio "Experimenter" will be sent without charge on request, to interested amateurs.

GENERAL RADIO COMPANY

30 STATE STREET
274 BRANNAN STREET

CAMBRIDGE, MASSACHUSETTS
SAN FRANCISCO, CAL.

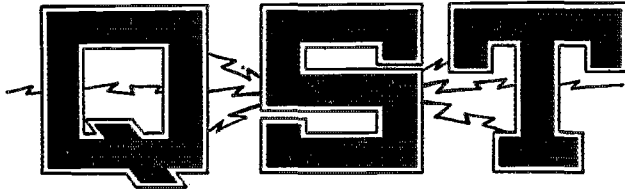

The Official Organ of the A.R.R.L.

VOLUME XIII

MARCH, 1929

NUMBER 3

	PAGE
Editorials	7
Improving Shortwave Phone Reception <i>Ross A. Hull</i>	9
Standard Frequency Transmissions From W9XL	20
The Army-Amateur Radio System is Revised	21
Revised U.S.A. Amateur Regulations	26
The Design of Inductance Coils Part 2. <i>D. R. Clemons</i>	27
We Open a Station-Description Contest	37
New England Division Convention	38
The Return of the Native <i>"Felix"</i>	39
Photographs for <i>QST</i>	40
Experimenters Section	41
Roanoke Division Convention	45
Message Handling Between U.S.A. and Canada	43
Standard Frequency Transmission of WWV	47
Official Frequency Stations	47
What Price Television? <i>M. B. Sleeper</i>	48
The Effect of Regeneration Control Upon Tuning <i>L. W. Hatry</i>	50
I.A.R.U. News	53
Calls Heard	54
Correspondence	55
Communications Department	51
Hamads	91
QRAs.	93
<i>QST</i> Directory of Advertisers	94

QST is published monthly by The American Radio Relay League, Inc. at Hartford, Conn., U. S. A. Official Organ of the A.R.R.L. and the International Amateur Radio Union

**Kenneth B. Warner (Secretary, A.R.R.L.),
Editor-in-Chief and Business Manager**

**F. Cheyney Beekley,
Managing Editor and Advertising Manager**

**Harold P. Westman,
Technical Editor**

**Ross A. Hull,
Associate Technical Editor**

**David H. Houghton,
Circulation Manager**

Subscription rate in United States and Possessions, Canada, and all countries in the American Postal Union, \$2.50 per year, postpaid. Single copies, 25 cents. Foreign countries not in American Postal Union, \$3.00 per year, postpaid. Remittances should be by international postal or express money order or bank draft negotiable in the U. S. and for an equivalent amount in U. S. funds. Entered as second-class matter May 29, 1919, at the post office at Hartford, Connecticut, under the act of March 3, 1879. Acceptance for mailing at special rate of postage provided for in section 1103, Act of October 3, 1917, authorized September 9, 1922. Additional entry as second-class matter, acceptable at special rate of postage provided for above, at Springfield, Mass., authorized September 17, 1924.

Copyright 1929 by the American Radio Relay League, Inc. Title registered at United States Patent Office. Member of the Radio Magazine Publishers' Association.

The American Radio Relay League

The American Radio Relay League, Inc., is a non-commercial association of radio amateurs, bonded for the promotion of interest in amateur radio communication and experimentation, for the relaying of messages by radio, for the advancement of the radio art and of the public welfare, for the representation of the radio amateur in legislative matters, and for the maintenance of fraternalism and a high standard of conduct.

It is an incorporated association without capital stock, chartered under the laws of Connecticut. Its affairs are governed by a Board of Directors, elected every two years by the general membership. The officers are elected or appointed by the Directors. The League is non-commercial and no one commercially engaged in the manufacture, sale or rental of radio apparatus is eligible to membership on its board.

"Of, by and for the amateur", it numbers within its ranks practically every worth-while amateur in the world and has a history of glorious achievement as the standard-bearer in amateur affairs.

Inquiries regarding membership are solicited. A bona fide interest in amateur radio is the only essential qualification; ownership of a transmitting station and knowledge of the code are not prerequisite. Correspondence should be addressed to the Secretary.

DIRECTORS

President
HIRAM PERCY MAXIM
Drawer 2102
Hartford, Conn.

Vice-President
CHARLES H. STEWART
St. David's, Pa.

Canadian General Manager
A. H. K. RUSSELL
5 Mail Bldg.,
Toronto, Ont.

Atlantic Division
DR. EUGENE C. WOODRUFF
234 W. Fairmount Ave.,
State College, Pa.

Central Division
CLYDE E. DARR
187 Hill Ave., Highland Park,
Detroit, Mich.

Dakota Division
C. M. JANSKY, JR.
Dept. of Elec. Eng., U. of M.
Minneapolis, Minn.

Delta Division
BENJ. F. PAINTER
424 Hamilton Nat'l Bank Bldg.
Chattanooga, Tenn.

Hudson Division
DR. A. LAFAYETTE WALSH
220 West 42d St.,
New York City

Midwest Division
PORTER H. QUINBY
817 Lauderman Building,
St. Louis, Mo.

New England Division
FREDERICK BEST
13 East Crescent St.,
Augusta, Maine

Northwestern Division
K. W. WEINGARTEN
3219 No. 24th St.,
Tacoma, Wash.

Pacific Division
ALLEN H. BABCOCK
65 Market St.,
Southern Pacific Co.,
San Francisco

Roanoke Division
W. TREDWAY GRAVELY
Box 245,
Danville, Va.

Rocky Mountain Division
PAUL M. SEGAL
Box 1771
Denver, Colo.

Southeastern Division
HARRY F. DOBBS
c/o Dobbs & Wey Co.,
245 Spring St., N. W.,
Atlanta, Ga.

West Gulf Division
FRANK M. CORLETT
2515 Catherine St.,
Dallas, Tex.

OFFICERS

President HIRAM PERCY MAXIM, Hartford, Conn.
Vice-President CHARLES H. STEWART, St. David's, Pa.
Secretary KENNETH B. WARNER, Hartford, Conn.
Treasurer ARTHUR A. HEBERT, Hartford, Conn.
Communications Manager F. EDWARD HANDY, Hartford, Conn.

EDITORIALS

ELSEWHERE in this issue there is described in considerable detail the revision of the plan of affiliation between the Signal Corps of the Army and the amateurs of the United States which has resulted in what is known as the Army-Amateur Radio System. This is an announcement of great importance, describing a plan which we feel is destined to play a big part in the future life of the American amateur. We earnestly urge that every amateur thoroughly familiarize himself with it.

The plan is a double-barreled one, with many advantages to both parties. Aside from the rendering of public service in time of emergency, the chief function of the plan, it will provide us amateurs with a most interesting field of work, while from the Army standpoint a large number of amateurs will be made familiar with Signal Corps work and learn to like it, so that the plan has value as an element in preparedness. The existence of the plan assures the amateur of the powerful backing of the Army—one of the purposes is cited as the rendering of "such encouragement and assistance as may be desirable to firmly establish and perpetuate the American amateur". The Army training provided by the plan must be regarded, however, as altogether incidental to its main objective, which is to provide a system of communication that will be of public service in times of emergency when land-line communication has been seriously damaged or destroyed. This is the field of service in which the amateur is at his best—where he is a really invaluable public asset, as he has demonstrated times without number in the past. It is altogether fitting and proper that our emergency communications service should be tied in with the Army, inasmuch as it is a part of the plan of government in our country that it is the Army which steps into any situation which has got beyond civil control and which has the duty of assuming charge and bringing about relief, whatever the needs may be. The plan really answers a need which we have felt for some directed control of our amateur emergency work in order that it may be of the greatest effectiveness.

The building up of this system to a point of efficiency is to be secured by weekly practice in a traffic scheme which is detailed in the published plan. This traffic scheme offers good fun for the active amateur and,

in fact, it seems to us provides a perfectly fascinating new field of operating activity, an idea which is new to the amateur ranks and which indeed in time may well revolutionize our methods. It employs the principle of controlled nets, old in military communication but new to the amateur world. The idea is a complex one and there is no blinking the fact that it introduces numerous difficulties which may make progress somewhat slow, but this only adds to the fascination of the scheme. The net idea in communications has been well tried and proved as effective in any communications plan in which orderly operation must be introduced into the activity of a large number of stations. That, of course, is the chronic need in organized amateur communication. There may be some technical difficulties, too, inasmuch as many of the stations in the plan must be prepared to shift frequency quickly and exactly, and it may be that we shall have to call upon our technical development program to produce for us a transmitter of greater flexibility in adjustment than we have been accustomed to in the past. But even this idea is enticing, and adds to the zest which we expect to find in the operation of the new Signal Corps plan.

There is a place in this plan for *every* amateur. Some of the positions will be highly important, offering a real test of the skill of an advanced amateur. A very large percentage of the stations will be operating in two nets and thus will have the opportunity not only of serving as a member of a higher net but of taking their turn as the controlling station for a lower net of subordinate stations. And it takes but one night a week of a fellow's time. There is, we say, a place for everybody, and everybody is needed in order to make the plan of maximum success and to bring to amateur radio the great potential benefits that reside in it. We therefore urge your participation to the fullest, and request all interested amateurs to communicate with their Corps Area Signal Officer, a directory of whom will be found in the Communications Department Section of this issue.

AS HAPPENS every year at this season, the Federal Radio Commission and the Radio Division of the Department of Commerce have been receiving a large number of complaints from broad-

cast listeners of interference caused with the reception of programs by the operation of amateur stations in their vicinity. In a number of cases investigated by the Radio Division, amateur stations have been found operating in such a manner as to cause undue interference. The Division has brought this situation to the attention of the League, expressing the hope that something may be said in the columns of *QST* that will cause amateurs as a whole to be more careful in their operations, and thereby reduce the number of complaints being received.

What shall Headquarters say in the columns of *QST*, fellows, that will cause you to be more careful in the operation of your stations? Consider that we have said it! As a matter of fact, we have, and many times over. Except in the case of absolutely bum BCL sets, now happily becoming rather rare, there is little excuse for interference. In almost every case the existence of interference indicates either an inadequately equipped station or an improperly adjusted one. The subject has been treated at great length in *QST* in just the past few issues, and we can no longer claim that this is so young and imperfect an art that we do not know how to overcome these things—the information is at hand. Interference with broadcast reception is almost always attributable to a perfectly wretched plate supply in the amateur transmitter, to a badly misadjusted transmitter, or to a defective method of keying. Of these the last named is most likely to be the cause of the trouble and the answer is to be found no more distant than in Mr. Hull's study of the keying question in our February issue. See also Mr. McCormick's article, page 23 of *QST* for June last. Don't forget the vast utility of the simple wave-trap inserted in the B.C.L.'s antenna lead. And remember that the Communications Manager has a mimeographed circular of suggestions available on request. But what we at Headquarters most need to find, to meet the Radio Division's hopes, is the words which will inspire each individual amateur to examine the output of his own station and to show enough initiative to apply to it the corrective information which *QST* has so faithfully retailed to the membership in recent months.

A considerable number of complaints of off-wave amateur operation are also being received, largely from Government departments and particularly from the Airways Division of the Department of Commerce. The Radio Division's investigations of these complaints have in most cases disclosed that

the amateur was operating outside of the amateur bands. We haven't got any comeback to the government on this—there just isn't any excuse. We consider that every amateur ought to know now that a monitor is indispensable in this Year of the Washington Convention 1929, and that the use of this simple little gadget as has been so often described in *QST* will make accidental off-wave operation impossible. What, then, can be said for the amateur who is operating on an airways frequency?

These two old troubles of broadcast interference and off-wave operation continue to be blots on the fair record of amateur radio. The Headquarters staff of the League cannot go out and tune the station of every member. However, it can present, and it has presented, the information which will enable every individual member, if he will to adjust these matters easily himself. If he will, fine! If he won't, we can only fear that there will come some day a limit to the patience of the Government.

Bad habits ought to be nipped in the bud. Then they never hurt anyone. Such a bad habit, which ought to be stepped on at once by every sincere amateur, is the suddenly starting tendency, particularly noticeable in the Second District, to employ choppers or some similar device to make I.C.W. out of what would be a reasonably decent C.W. signal if it were left alone.

We feel that we must call upon the users of all such equipment to desist. Our bands are too narrow and too crowded to permit the operation of so selfish and so archaic a method of signalling. The D.C. signal is the best possible DX signal. Our ideal must be the closest possible approach to the D.C. signal, and A.R.R.L. cannot countenance any deliberate imposition of modulation in telegraphy.

The amateur regulations do not contemplate any such fashion of I.C.W. Amateur station licenses of course authorize operation of "C.W., I.C.W. and phone", but the barbaric variety of I.C.W. obtained by mechanical modulation was barred long ago in amateur ranks and the present reference to I.C.W. is merely for the purpose of permitting the use of A.C. C.W., which some folks insist is a species of I.C.W. A.C. C.W. in amateur ranks means 60-cycle supply, and that is quite a different kind of horse, for the frequency is low and the side bands close in, the modulation sinusoidal and the interference not aggravated. There can be no excuse in amateur ranks to-day for the chopper or any of its cousins. Step on it!

E. E. W.

Improving Short-Wave Phone Reception

A Modern Super-Heterodyne for Short-Wave Phone, Code and General Broadcasting

By Ross A. Hull*

Although much of the work of the A.R.R.L. Technical Development Program has been as helpful to the workers in radiotelephony as it has been to the code operators, the phone men doubtless have been wondering when some particular attention would be paid to their problems. The answer is, "Now—here it is". The receiver described in this article is the hottest thing that ever came down the pike for the reception of amateur phone, for which it has been particularly designed. Similarly it is the best thing we have ever seen for short-wave broadcasting and so will be of intense interest to the general experimenter. Although realizing that we are dealing in superlatives, we must also say that it is about the best code receiver we have ever described, and it is similarly splendid as a general broadcast receiver. We are therefore pardonably proud of it. Incidentally, and further for the phone men, the Technical Development Program is now lacking phone transmitters and modulation, on which we hope to have very interesting things to report in our next issue.—Editor.

MOST OF US, at some time or other, have felt the desire to own a receiver which could be expected to provide a completely satisfactory performance irrespective of whether our need at the moment was short-wave code signals, short-wave phone, or broadcasting. But, in the past, we have been faced with

The most recent activities of the A.R.R.L. Technical Development Program have been a study of the problems of short-wave amateur phone reception and the evolution of equipment calculated to satisfy completely its requirements. Early in the work it became evident that a receiver which embodied the sensitivity and selectivity neces-

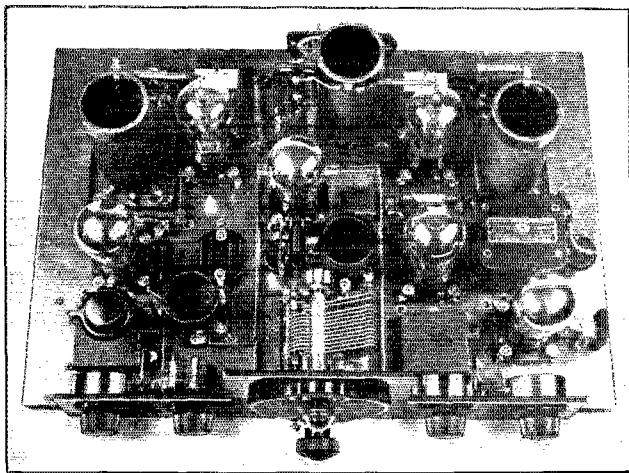

FIGURE 1. A 1929 TYPE SUPER-HETERODYNE

Though designed primarily for short-wave amateur phone reception, this receiver is capable of splendid performance in the reception of short-wave code and both short- and long-wave broadcasting. The shielding, an essential feature of this receiver, was, for this illustration, removed.

the fact that while the two- or three-tube autodyne was fine for short-wave code it was but a dismal make-shift for short-wave phone—that while the expensive broadcast receiver was effective on the broadcast spectrum it was well nigh useless for any other service.

*Associate Technical Editor, QST.
In Charge A.R.R.L. Technical Development Program.

sary for truly effective amateur phone reception also would constitute a splendid code receiver and a highly satisfactory outfit for general broadcast reception. While the equipment built in accordance with the findings of the study is relatively complex, we do wish it to be understood that the complications are fully justified, in our belief, by the several fields of service for which

the apparatus is suited and also by the brilliant performance which is made possible in any of them.

In considering, first, the requirements of the ideal receiver for amateur phone work, we find that selectivity is at once the major problem. The autodyne receiver with its audio-frequency amplifier, for code reception, has its minimum degree of selectivity set by the very principle of beat reception employed in it and affords the possibility of still greater selectivity by the use of a peaked audio-frequency amplifier. Just as soon as the detector is taken out of oscillation for phone reception, however, the selectivity of the receiver is virtually wrecked. Signals 10 kc. away from the station being received which, with the oscillating receiver, produced a beat frequency

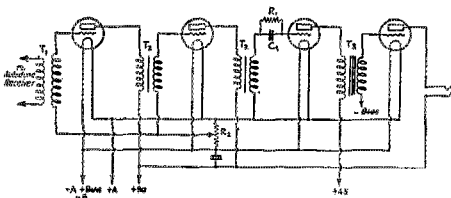

FIGURE 2. THE CONNECTIONS OF THE AMPLIFIER ILLUSTRATED IN FIGURE 1

T1 is the sharply-tuned, and T2 the broadly-tuned, General Radio intermediate-frequency transformers. R2 is the potentiometer used to control oscillation, while R1 and C1 are the usual detector grid leak and condenser. T3 is the audio-frequency transformer.

out of audibility, now are of similar strength to the signal to which the receiver is tuned. Other stations, even 100 kc. away, may well join in the bedlam at relative strengths dependent upon the resistance of the tuned circuit, the degree of regeneration used, and the amplitude of the incoming signals. Under such conditions the most highly peaked audio-frequency amplifier would not be of any service in separating the stations mixed up, as they are, in the output of the detector.

In order to permit satisfactory simultaneous operation of many phone stations in the present phone bands the obvious first requirement is radio-frequency selectivity—and lots of it.

The most generally used method of obtaining high selectivity in the broadcast band is the employment of several sharply-tuned radio-frequency amplifiers ahead of the detector. This scheme, though suited for the broadcast frequencies, is, however, impractical at the present time for use in the amateur phone receiver on account of difficulties in the design, construction and operation of any conceivable outfit employing it, and because of the need for greater selectivity even than that available in the

radio-frequency circuits of such present-day broadcast receivers.

The fact that tuned radio-frequency amplifiers operating on the incoming frequency are really impractical for short-wave work does not, however, mean that short-wave phone reception must always be of the low standard possible with the conventional autodyne type receiver. There is, we find, the super-heterodyne principle, involving many problems but permitting almost any operable degree of radio-frequency selectivity and sensitivity. With the super-heterodyne, unlike other types of receivers, these characteristics are inherent in the system and are not dependent upon the frequency of the signals being received. It is, therefore, the obvious system for phone reception on the high frequencies where all desirable selectivity and sensitivity can be obtained as readily as on the broadcast band.

The most elementary form of super-heterodyne comprises first an oscillating detector tuned to give not an audible, but a super-audible beat with the incoming signal. Also it includes a fixed-tune radio-frequency amplifier to amplify this super-audible beat, a second detector to make audible the modulation on the signal, and an audio-frequency amplifier to provide the necessary output volume. For code reception the arrangement is varied only by making the second detector or the radio-frequency amplifier oscillate in order to provide an audible-frequency beat note in the output circuit. In this simple form the super-heterodyne has long been used for short-wave reception. The amplifier illustrated in Figure 2 (built four years ago) is one

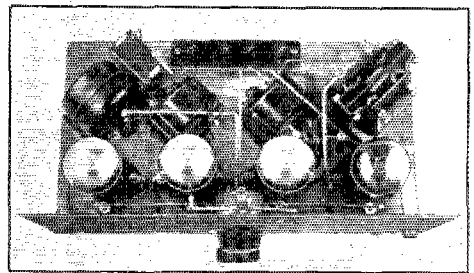

FIGURE 3. AN EARLY TYPE OF INTERMEDIATE-FREQUENCY AMPLIFIER

Though lacking in selectivity and limited in gain, such an amplifier can still be used to advantage in short-wave phone reception. Its performance, however, is far below that of an amplifier incorporating screen-grid tubes.

arrangement suitable for operation in this manner. The input leads to the first radio-frequency transformer are connected in place of the audio-frequency transformer in the plate circuit of the oscillating detector—the ordinary short-wave autodyne being

used in this rôle—and the super-audible or intermediate frequency beat produced between the oscillations of the detector and the incoming signal is amplified by the first two tubes shown, detected by the third, and amplified at audio frequency by the fourth.

an amount equal to the intermediate frequency and a second one when the oscillation frequency is higher than that of the signal by a similar amount. What is more serious, however, is that whereas the required signal differs in frequency from that

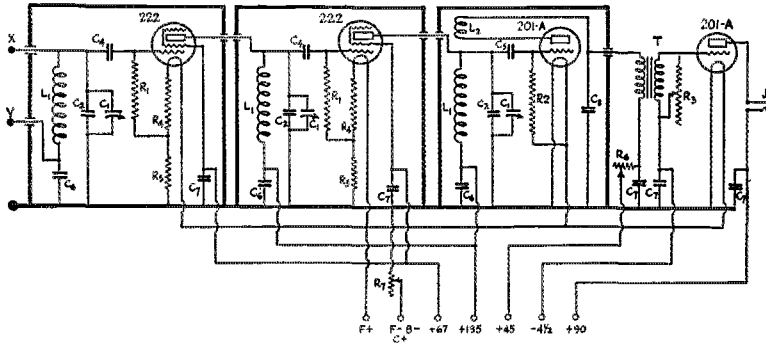

FIGURE 4. THE WIRING OF THE EXPERIMENTAL INTERMEDIATE-FREQUENCY AMPLIFIER ILLUSTRATED IN FIGURES 5 AND 6

- C1—Variable condensers made up of two spring brass plates, 100- μ fd. midgets would be more practical.
 - C2—500- μ fd. Sungsamo fixed tuning condenser for 30 kc., 100- μ fd. midgets would be more practical.
 - C3—4,000- μ fd. fixed by-pass condenser
 - C4—1,000- μ fd. fixed condenser
 - C5—500- μ fd. fixed grid condenser
 - C6—25- μ fd. by-pass condenser
 - C7—1 μ fd. by-pass condenser
 - R1—2-megohm gridleak
 - R2—1-megohm gridleak
 - R3—200,000-ohm Frost variable resistor
 - R4—10-ohm Yarley fixed filament resistor
 - R5—3-ohm resistor of same type
 - R6—50,000-ohm Frost variable resistor
 - R7—3-ohm filament rheostat
 - L1—Coupling impedances wound in $3/8$ " wide slot $1/2$ " deep turned in a $2 1/2$ "-outside-diameter wooden former, 2,000 turns of 34 gauge s.c.c. wire, scramble-wound, for frequencies of the order of 30 kc. 300 turns of 30 gauge d.c.c. wire for frequencies around 300 kc.
 - L2—150 turns wound under L1 for 30 kc. 25 turns for 300 kc.
 - L3—Silver-Marshall type 277 short-wave radio-frequency choke
 - T—High quality audio-frequency transformer
 - J—Output jack
- The terminals X and Y would be connected where the first audio transformer primary usually goes in the conventional autodyne receiver.

For code reception, in this particular arrangement, the entire radio-frequency amplifier is caused to oscillate by adjusting the potentiometer until the grids are run sufficiently negative.

Such a receiver, while having a high degree of sensitivity and considerable selectivity, cannot now be considered satisfactory. The chief disadvantage results from the fact that a relatively low intermediate frequency must be used in order to permit high amplification with three-electrode tubes, and so that the first oscillating detector will not have to be detuned so far in providing the necessary beat frequency. This means that any one signal will be heard on two neighboring settings of the first-detector tuning dial—one when the detector oscillation frequency is lower than that of the signal by

of the detector by the intermediate frequency there will be, in many cases, signals on the other side of the detector frequency which also differ by the same amount. These signals, in addition to the desired ones, will be received. In short, this means that the interference, on our present well-populated bands would, in effect, almost be doubled when such a receiver was employed. The use of a much higher intermediate frequency would not improve matters with an oscillating first detector since there would still be interfering signals—commercial if not amateurs—which would differ in frequency from the oscillations of the detector by the intermediate frequency. Rather would the receiver be still further handicapped by the necessity of detuning the detector much further in order to obtain the necessary

high-frequency beat—so sacrificing signal strength—and by reducing the possible amplification in the intermediate amplifier.

After a study of the problem and detailed experiment with all schemes available to us, we, in the Laboratory, came to the conclusion that the most practical arrangement would consist of a non-oscillating first de-

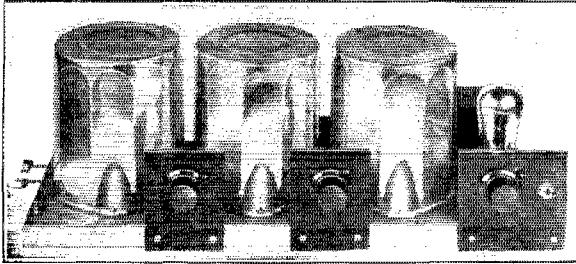

FIGURE 5. AN EXPERIMENTAL SCREEN-GRID-TUBE AMPLIFIER

The apparatus is arranged on a wooden base-board covered with copper sheet. The units comprising each stage are grouped to fit under aluminum water pitchers which serve as shields. The pitchers, with their handles removed and the rivet holes filled by machine screws and washers, are held down to the copper base by wood screws.

detector tuned to the incoming signal, the necessary beat frequency being provided by a separate oscillator coupled to the detector in the manner of a broadcast-type super-heterodyne receiver. This arrangement, of course, would still permit the same "two-spot" tuning and doubled interference, as in the case where an oscillating first detector was used, unless a much higher intermediate frequency was employed. It was therefore necessary to plan on using a frequency of the order of 330 kc. The two possible tuning spots on the oscillator would then be 660 kc. apart and on only those stations operating 330 or 660 kc. away from the frequency to which the detector was tuned, could beat with the oscillator to cause interference. Such signals, due to the selectivity of the first detector, probably would be inaudible.

In order to make possible a high degree of amplification at the high intermediate frequency it was decided to use UX-222 tubes. One of the experimental amplifiers built for the work and employing these tubes is illustrated in Figures 4, 5 and 6. It served splendidly in experiment with many types of input apparatus and at different intermediate frequencies—the tuned circuits being arranged to plug in—and, if duplicated, would pro-

vide an effective super-heterodyne "converter" to be attached to an existing autodyne, either with or without a separate oscillator.

The final receiver, embodying all the features found desirable in the experimental program, is that illustrated in the remaining figures. It consists essentially of an oscillator (the major tuning unit); a regenerative first detector, extremely loosely coupled to a small antenna; two stages of screen-grid-tube intermediate-frequency amplification operating at 330 kc.; a second detector—oscillating for c.w. reception, and a single audio-frequency amplifier. The oscillator and the three intermediate-frequency tuning circuits are shielded the latter shielding being carried out with particular care in order to permit extremely high gain in the intermediate amplifier without the possibility of oscillation of the tubes in it. The receiver is calibrated on the oscillator dial and tuning is accomplished primarily with this control. The first-detector input circuit is fitted with a separate control—a midget condenser with a knob only—but since its adjustment is comparatively broad no difficulty is experienced in following with it the movements of the oscillator dial. Indeed, its adjustment is just so conveniently broad that wide sections of the amateur frequency bands can be "searched" rapidly with the oscillator dial alone. For frequencies of 7,000 kc. and below, the oscil-

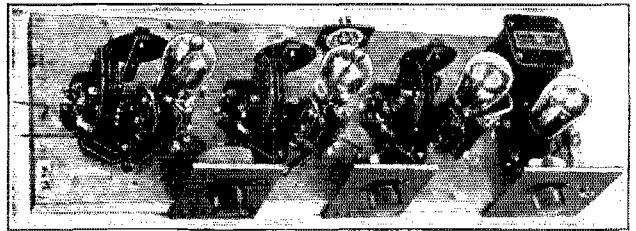

FIGURE 6. THE SCREEN-GRID AMPLIFIER WITH THE SHIELDS REMOVED

Showing the grouping of the apparatus to fit under the aluminum shields.

lator coupling is provided by a few turns wound over the tickler of the first detector plate circuit. For the higher frequencies the coupling provided by the common operation of the oscillator and detector from the same batteries has been found sufficient.

A great many variations in the mechanical and electrical details are, of course, possible. Undoubtedly they will be made by

individuals possessing the confidence to undertake them. At the same time we hope to present a detailed description of the receiver as it exists in order to make clear the arrangement of its essential components.

The foundation for the receiver is a $\frac{3}{4}$ "-thick base-board measuring $17\frac{1}{2}$ " by 12 ". To the upper surface of this board a sheet

THE OSCILLATOR

The unit located centrally in the receiver and fitted with the main tuning condenser is the oscillator. In it, a UX-201-A is arranged, as in Figure 9, in a tuned-plate circuit. The filament return of the untuned grid circuit of this oscillator, L_4 , is not completed within the shield but is run to the

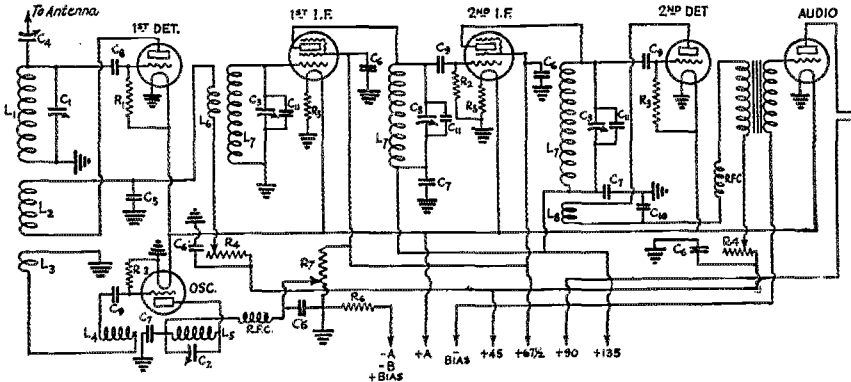

FIGURE 7. THE COMPLETE WIRING OF THE FINAL SUPER-HETERODYNE

C1—"13-plate" Pilot midget first-detector tuning condenser with 4 plates removed.

It is shunted by an external variable of 350 μ fd. for broadcast-band work.

C2—27-plate National Equitune condenser with stator divided (see text).

C3—23-plate Pilot midget intermediate-frequency tuning condensers

C4—5-plate Pilot midget antenna coupling condenser

C5—250- μ fd. Sangamo fixed condenser

C6—1- μ fd. Acme Parvott condenser

C7—25- μ fd. Sprague condenser

C8—250- μ fd. fixed grid condenser

C9—500- μ fd. fixed condenser

C10—4,000- μ fd. fixed condenser

C11—100- μ fd. fixed tuning condenser

R1—4-megohm gridleak

R2—6-megohm gridleak

R3—2-megohm gridleak

R4—50,000-ohm Frost variable resistor

R5—15-ohm fixed filament resistor

R6—2-ohm Carter rheostat

R7—100,000-ohm Frost variable resistor. Oscillator voltage and volume control.

L1, 2, 3—1st-detector coils on Silver-Marshall type 130P coil form.

L4, 5—Oscillator coils on same type form

L6—120 turns of 26 gauge d.c.c. wire wound in a $1\frac{1}{2}$ "-diameter hank.

L7—300 turns of 30 gauge s.s.c. wire on 2" outside diameter bakelite tubing.

L8—12 turns of 28 gauge d.c.c. wire wound in a $1\frac{1}{2}$ "-diameter hank.

RFC—Silver Marshall type 277 radio-frequency chokes. In order to avoid complicating the

diagram, no shielding has been indicated. All battery leads are made with a Yaxley battery cable

type No. 660, the connector plate of which can be seen at the rear center of the base-board.

of thin copper is screwed, the entire apparatus, excepting the controls, being mounted on it. This construction, while necessitating some possible sacrifices in the appearance of the receiver, was used and is recommended on account of its directness and simplicity. In the wiring of the receiver the principle was adopted, of running all radio-frequency wiring above the copper base, no wire being permitted to dive through the base to the underside unless it was first by-passed on top. In this way a maze of wiring on the upper surface or a hot-bed of unwanted inter-circuit couplings on the under surface were avoided.

cathode terminal of the UY base into which the detector coils are plugged. With the lower-frequency detector coils in place, this cathode leads goes through a few coupling turns, L_4 , wound over the detector tickler and thence to the negative filament. In the higher-frequency coils a jumper on the coil form takes the lead from the cathode pin direct to the filament, since no coupling turns are necessary.

The oscillator tuning condenser is a 27-plate National remodeled to provide two insulated stator assemblies—one of a single plate, used on the high-frequency bands, and another of ten plates, for use in broadcast

reception. A single plate is removed from the rotor, leaving two to mesh the single stator and eleven to interleave the ten-plate stator. The particular condenser used is well suited for such amendment and the

whole plate coil, but across a particular portion of it. In order to make this change of connection automatic with the plugging-in of the coil, the stator is connected to the cathode terminal of the UY oscillator-coil base instead of to the plate terminal. When the coils are wound for the lower-frequency

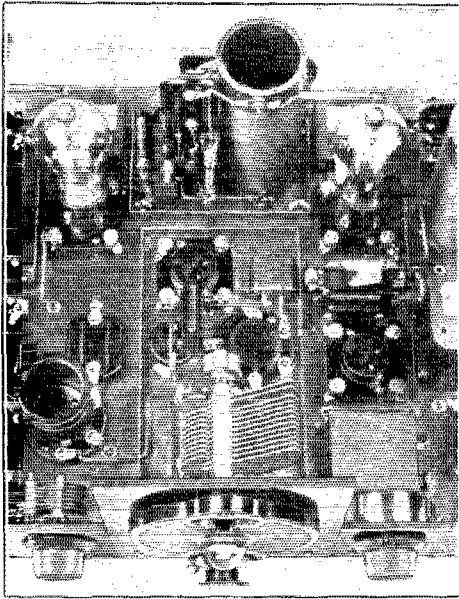

FIGURE 8. A CLOSE-UP OF THE OSCILLATOR UNIT

Studied in conjunction with Figure 9, this view permits an understanding of the arrangement of the components of the oscillator. Immediately behind the oscillator is the apparatus, detailed in Figure 13, which precedes the second intermediate-frequency amplifier.

work does not present any appreciable difficulties. The first move is to remove the third plate from the back-bearing end of the rotor, cutting off the "boss" portion of the plate and replacing it in the form of a washer. Then the stator is removed and the two stator threaded tie rods sawed off so that the single stator can be supported from the back hard-rubber end plate with two small stubs of the tie rod. The remaining ten stator plates are then supported with the remaining pieces of tie rod from the front end plate. The gap between the two sections of the tie rod can be seen clearly in Figure 11. It is jumped with a small piece of folded spring brass when the full capacity range of both sections of the condenser is required for broadcast reception. The smaller section of the condenser is of a capacity to give an open scale on the 3,500- and 1715-kc. bands when connected across the entire plate coil. Open scales are obtained on the higher-frequency bands by connecting the condenser, not across the

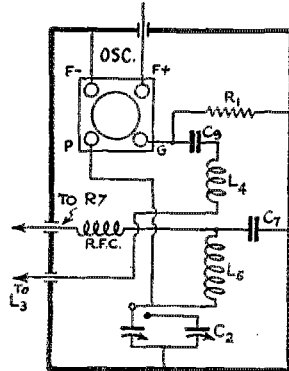

FIGURE 9. THE APPARATUS AND WIRING WITHIN THE OSCILLATOR SHIELD—A SILVER-MARSHALL TYPE 631A.

bands a jumper is connected inside them from the cathode pin to the plate pin. In the higher-frequency coils, however, the cathode pin is connected, inside the coil form, to a point on the coil which will permit

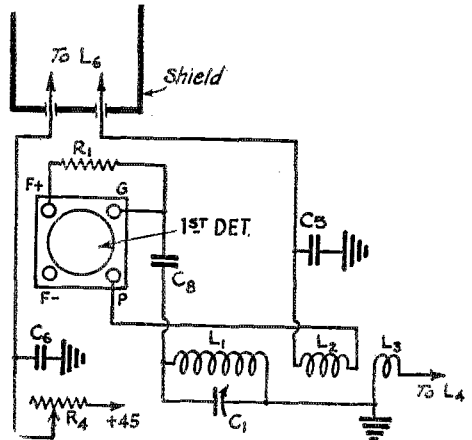

FIGURE 10. THE WIRING OF THE FIRST DETECTOR UNIT, LOCATED AT THE LEFT FRONT OF THE RECEIVER.

almost full-scale coverage of that particular band.

The remaining components of the oscillator unit are the usual grid condenser and leak, the 0.25- μ fd. by-pass condenser, and

the radio-frequency choke. The apparatus, particularly that of the tuning circuit, is arranged in a substantial manner in order to permit a calibration to some extent permanent. This calibration is not actually of the frequency of the oscillator but of the oscillator frequency plus the intermediate frequency.

THE FIRST DETECTOR UNIT

The group of apparatus at the left front of the base-board and detailed in Figure 10 comprises the first detector tube, its plug-in coil system, its grid circuit tuning condenser, the antenna coupling condenser and

amplifiers. Arranged inside the shield, as shown in Figure 12, are the inductances L6, L7, and the tuning capacities C3 and C11. Alongside the shield is the UX-222 amplifier tube, the control-grid lead of which is led from the top of the shield through a piece of copper tube. The inductance L7, tuned to the 330-kc. intermediate frequency by condensers C3 and C11, is similar to the inductances used to couple the succeeding stages. It consists of 300 turns of 30 gauge single silk-covered wire wound on a 5½-inch length of 2" outside diameter bakelite tubing. The use of bakelite tubing permits a solid mechanical job but "mailing tube" could be used in its place. The form factor of this coil is not by any means a high one. The dimensions, however, were fixed by the size of the available shields and the desirability of using the simple single-layer type of winding in preference to the much more awkward "bank" winding. The particular coils in the receiver were built in a few minutes by winding them "lathe fashion" in a twist drill held in the bench vise. The mandrel used to hold the tubing consisted of a tapered chunk of wood pushed into one end of the tubing and fitted in the center of the projecting end with a sawed-off wood screw—this screw being inserted into the chuck of the drill. The primary coil L6 consists of 120 turns of 26 gauge d.c.c. wire wound in a hank and held at the bottom end—the filament end—of the coil with a few blobs of DuPont cement. Its leads are taken to two small machine screws near the bottom of the coil former. The 23-plate Pilot midget condenser used for precise tuning of the circuit is mounted on a brass bracket alongside the coil and it is connected to the 100- μ fd. Sangamo fixed tuning condenser. The shaft of the midget, instead of being fitted with a knob (which would have complicated the fitting of the shields) has a saw-cut in its end. A hole is drilled in the shield opposite this end of the shaft and the condenser can then be adjusted with the shield in place by means of a

"screw-driver" whittled from a piece of hardwood dowel. The apparatus of this and the other shielded units is, of course, mounted on the bottoms of the shields which, in turn, are screwed to the copper sheet on the base board. The arrangement of the UX-222 tube with its screen-grid by-pass condenser is made clear in Figure 13 and in the photographs. It is mounted very close to the shields on both sides in order to reduce the necessary exposed length of grid and plate leads.

The second intermediate-frequency coupling unit in the center rear shield differs

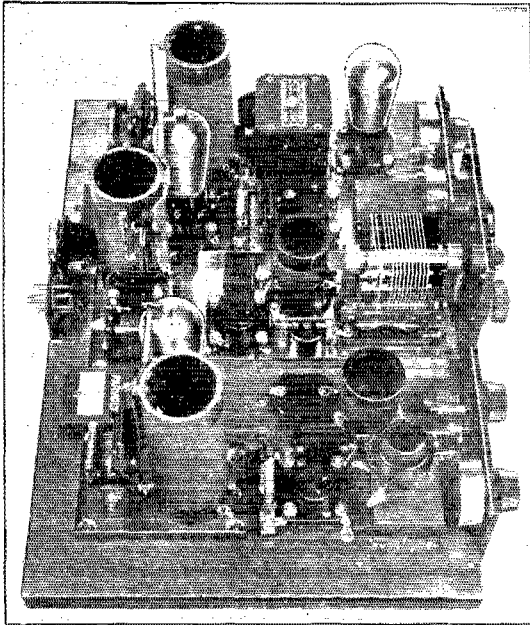

FIGURE 11. THE RECEIVER, WITH SHIELDS REMOVED, VIEWED FROM ITS LEFT END

On the right foreground is the apparatus comprising the first detector. On its left is the first intermediate-frequency stage.

the regeneration control. It is similar in most respects to the detector unit of the ordinary autodyne receiver, differing only in the provision for an oscillator coupling coil and in the use of a midget tuning condenser controlled directly by a knob instead of by a vernier dial. The circuit is fitted with tickler coil and regeneration control but in operation it is not permitted to oscillate.

THE INTERMEDIATE-FREQUENCY AMPLIFIERS

At the left rear corner of the baseboard is the first of the intermediate-frequency

from the first in some respects since it is not transformer-coupled. A more compact arrangement of the apparatus is necessary in order to accommodate the coupling condenser C9, the by-pass condenser C7, and the gridleak R2, shown in Figure 13. In addition the midget tuning condenser must be insulated from the shielding. In this

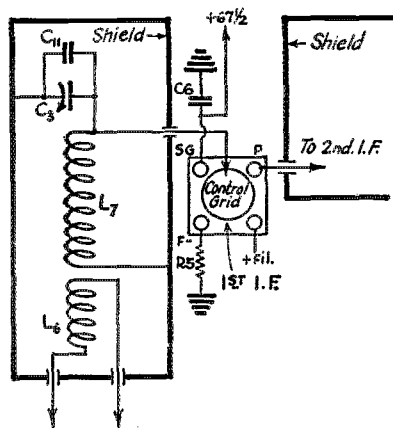

FIGURE 12. THE WIRING OF THE FIRST INTERMEDIATE-FREQUENCY STAGE

The shield indicated by the dark outline is that located at the left rear corner of the receiver. This and the two other i.f.-stage shields are Silver-Marshall type 658.

receiver the midget was mounted on a brass bracket but the bracket was held away from the copper base by two small chunks of hard rubber. The wood screws holding down the bracket go into the wooden base as in the case of the first stage, but clearance holes were first drilled through the copper so that the screws would not make contact with it.

The third intermediate-frequency coupling unit is again slightly different. In this instance the condenser C9 (see Figure 15) and the grid-leak are outside the shield, while the second-detector tickler L8 is added inside the filament end of the tuning coil. It consists of twelve turns of 28 gauge wire wound in a hank and glued into place inside the tube on which L7 is wound.

THE OUTPUT CIRCUITS

The right front corner of the base-board is occupied by the second detector and the audio-frequency amplifier detailed in Figure 16. The apparatus, as in the case of the first detector, is mounted on the copper base and is not shielded above. On account of its close resemblance to the detector and amplifier of the conventional type of receiver, a full description should not be neces-

sary. The output tube may be either a 201-A operated at 90 volts or a UX-171 supplied with 135 volts. The latter is, of course, desirable if a loud speaker is to be used, though it will necessitate the provision of an output filter of the conventional type to prevent the plate current from flowing through the speaker windings. In order to avoid this complication and so as to keep the "B" battery drain at a reasonable figure, a UX-112 might well be used.

ADJUSTING THE RECEIVER

The first move after the completion of the receiver and the thorough checking of its wiring should be the construction of a pair of coils for the oscillator and first detector. These can be wound according to the specifications given in the coil table. Probably they will have to be amended to give the exact tuning ranges when the receiver is running correctly but in their rough form they will serve for the preliminary adjustment work. It is first desirable to make certain that the oscillator is in operating condition. This can be done by inserting the two coils, but only the oscillator tube, and connecting a pair of phones in the plate battery lead to that tube. If the tube is oscillating there will be the usual thump when the plate or grid lead is touched with the finger. The first detector circuit should then be checked in a similar manner by placing the oscillator tube in the detector socket and connecting the phones in place of L6. This detector, though not operated in an oscillatory condition, should have its tickler so proportioned that it will just oscillate as the regeneration control resistor approaches its minimum value.

With the oscillator and first detector in

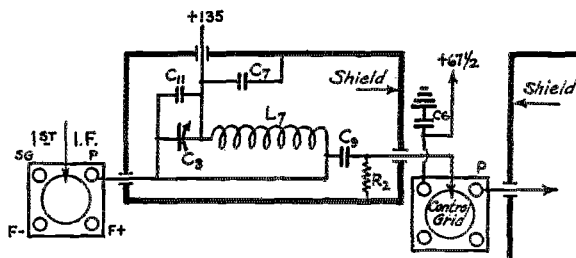

FIGURE 13. APPARATUS OF THE SECOND INTERMEDIATE STAGE CONTAINED IN THE SHIELD SEEN AT THE REAR CENTER OF THE BASE-BOARD

operating condition the remaining tubes may now be plugged in, in order that the intermediate amplifier can be tuned. As in the first tests with any receiver, it is well to connect a flash-lamp in the negative "B" battery lead to serve as a fuse should any wiring be amiss in the set. With this precaution taken, the complete battery leads

may be connected and the phones plugged into place.

It is convenient now to switch on some noise producer such as a vacuum cleaner, electric dish washer or some other labor-saving device equipped with heavily-spark-

second detector oscillate by throwing its regeneration control resistance towards the zero position. Should it oscillate over the entire range of the regeneration control, or should it not oscillate at all, amendment of the tickler will be necessary. A smooth and

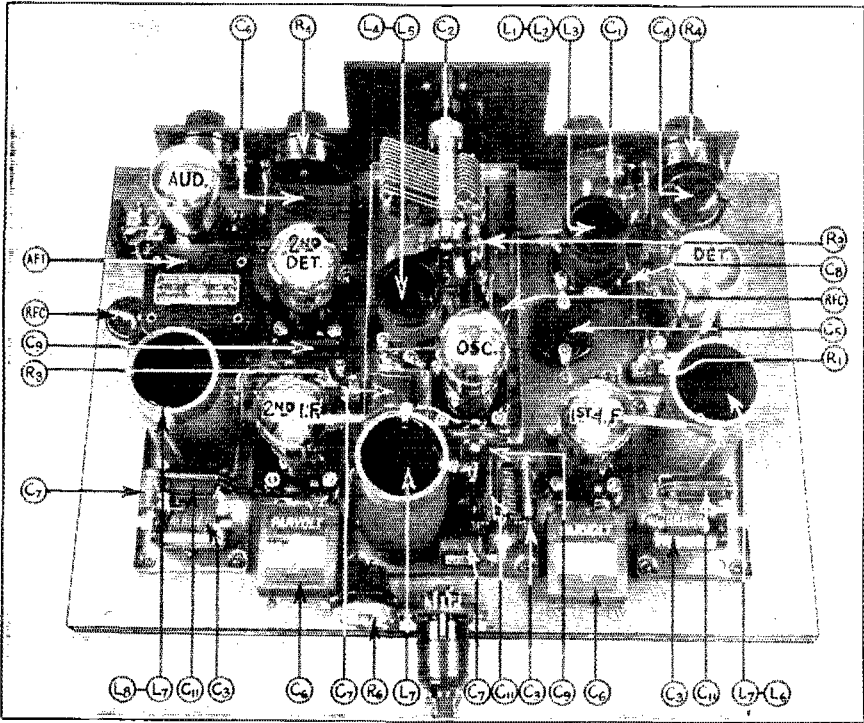

FIGURE 14. MANY COMPONENTS NOT VISIBLE IN THE PREVIOUS ILLUSTRATIONS CAN BE SEEN IN THIS VIEW

The symbols correspond with those of Figure 7.

ing brushes. At any one setting of the oscillator dial this noise should be tuned in at just one setting of the first-detector tuning knob. With this adjustment made, the intermediate-frequency amplifier can be tuned readily in much the same manner as one tuned the old three-dial-type neodynes. There should be no tendency for the amplifier to oscillate and, if everything in the circuit is in order, there should be a distinct resonance spot on each of the midget tuning condensers. In the amplifier of this particular receiver 330 kc. is obtained with the midgets set slightly above the half-scale position. The exact frequency to which the intermediate amplifier is tuned is not, of course, of particular importance but once a setting has been decided upon it should be left untouched in order that the oscillator dial calibration will not be disturbed. At this time it should be possible to make the

reliable regeneration control in this position will be found extremely important.

THE INDUCTANCES

Probably the most difficult proceeding in the entire constructional work will be the winding and adjustment of the necessary coils. As in any receiver it is necessary to see that the tuning ranges are in order but in this receiver it is quite essential that the grid coil L4 on the oscillator, the tickler L2 on the first detector, and the oscillator coupling coil L3, are exactly proportioned. The receiver can be made inoperative or at least hopelessly handicapped by an irregularity in any one of them. The coil table will serve to give an approximate idea of the necessary constants but it should be understood that these values cannot be expected to hold good in the case of all similar receivers. Particularly is this true of the

oscillator coupling coil L3, the value of which is influenced considerably by the effectiveness of the oscillator shielding and by the enthusiasm with which the oscillator per-

of L3 may now be accomplished with the receiver in full operation. Excessive oscillator coupling is characterized by a heavy thump as the first detector and the oscillator are tuned across their normal operating settings. Insufficient coupling results in weak signals or an inability to find any tuning spots at all. In general it is preferable to operate the receiver with less oscillator coupling than that required to give the maximum signal strength.

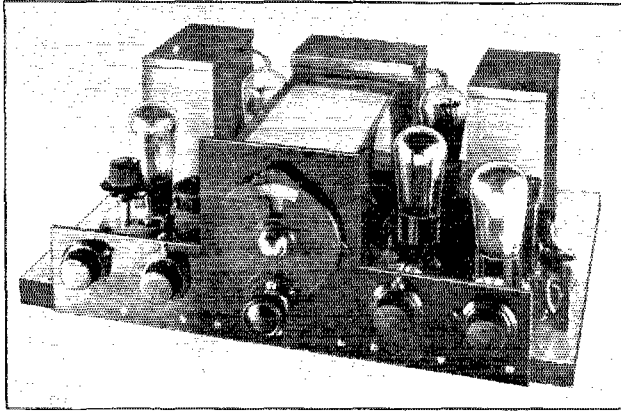

THE COMPLETE SUPER-HETERODYNE AWAITING AN OPPORTUNITY TO BUCKLE UP A FEW LOUD-SPEAKER DIAPHRAMS

forms. In adjusting any oscillator coil the phones should be connected temporarily in the oscillator plate lead and L4 amended

designed, it far surpasses any conceivable autodyne-type receiver or straight radio-frequency amplifier in sensitivity and

THE SUPER IN OPERATION

On the assumption that the control grids of the UX-222's are not connected where the screen grids should have been, and that the receiver has been adjusted carefully in every detail, it is possible to predict quite a brilliant performance. In the rôle of an amateur phone receiver, for which it was specially

Oscillator Coils	Turns L4	Turns L5	Wire L5	Detector Coils	Turns L1	Wire L1	Turns L2	Turns L3	Tuning Range (kc.)
OA	5	5	22 d.s.c.	DA	6	22 d.s.c.	6	0	14,630—11,650
OB	6	7	"	DB	7.5	"	7	0	12,000—9,910
OC	8	9	"	DC	9	"	9	1	10,000—8,630
OD	10	14	"	DD	11	"	10	1½	8,700—6,660
OE	12	17	"	DE	16	"	10	2	6,720—5,330
OF	13	22½	"	DF	20	"	10	2	5,380—4,220
OG	15	30	"	DG	29	"	12	2½	4,290—3,490
OH	35	58	30 d.s.c.	DH	57	30 d.s.c.	15	12	2,220—1,500
OI	43	70	"	DI	85	"	27	20	1,500—550
OJ	9	17	22 d.s.c.	—	—	—	—	—	7,300—7,000
OK	5	6	"	—	—	—	—	—	14,300—14,000

THE SET OF COILS USED IN THIS PARTICULAR SUPER-HETERODYNE

Though these specifications serve to give an approximate idea of the requirements it is highly probable that deviations from the given figures will be necessary. All coils are wound on Silver-Marshall, Type 130P coil forms. L4, L2 and L3, in every case are wound with 30 d.s.c. wire. For the sake of simplicity the turns of L1 and L4 are not spaced. Spacing can be used to advantage in the coils L1 providing due allowance is made in the coil dimension. OJ is a special oscillator coil for 7,000-kc. code work. On it the jumper J (see Figure 13) is connected to the 5th turn from the filament end of L5. This oscillator coil is used in conjunction with detector coil OD. Coil OK is a special oscillator coil for 14,000-kc. code work. The jumper J, in this coil, goes to the 4th turn from the filament end of L5. Coil OK is used with detector coil DA.

For 3,500-kc. phone reception coils OG and DG are used. Coils OH and DH are those employed for 1,715 kc. reception. The broadcast band coils are OI and DI. In order to tune DI across this band additional capacity will be required across C1. In this set a 350-mfd. variable condenser, external to the set, is used. If the receiver is to be operated chiefly on the broadcast band, C1 could be a double condenser exactly similar to C2.

until there are just sufficient turns to maintain the circuit in steady oscillation over the full range of the tuning condenser. With the oscillator shield in place, the adjustment

selectivity. On either of the two phone bands it can fill a loud speaker with the "background" noises of an average location and can, if necessary, produce full loud-

speaker volume from any phone station which is sufficiently above the "background"

receiver has as much selectivity as it is possible to use without seriously impairing speech quality.

For short-wave code signals the receiver is completely satisfactory. Foreign signals of the usual QSA3 audibility on a detector and one step can be brought up to full blast on the speaker and, if there is even slight modulation on the signal, can be copied at full loud-speaker strength with the second

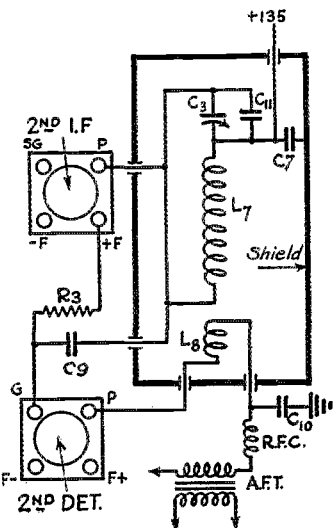

FIGURE 15. THE COUPLING CIRCUIT BETWEEN THE SECOND INTERMEDIATE-FREQUENCY AMPLIFIER AND THE SECOND DETECTOR

The shield indicated in this case is that seen on the right rear corner of the base-board.

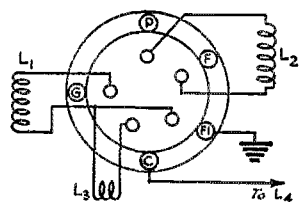
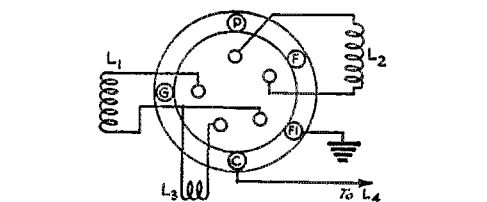

FIGURE 16. THE APPARATUS OF THE SECOND DETECTOR AND AUDIO AMPLIFIER, LOCATED AT THE RIGHT FRONT OF THE RECEIVER, DETAILED IN THIS DIAGRAM

intensity to be intelligible. With the intermediate-frequency stages tuned precisely the



DETECTOR COIL CONNECTIONS

THE TERMINALS WITHIN THE OUTER CIRCLE INDICATE THOSE OF THE UY-TUBE SOCKET INTO WHICH THE COILS ARE PLUGGED

The terminals inside the inner circle represent the pins on the coil former.

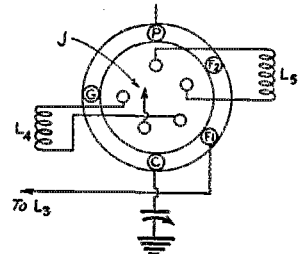

OSCILLATOR COIL CONNECTIONS

THE TERMINALS INSIDE THE INNER CIRCLE ARE THE PINS OF THE COIL FORMER

The jumper J, provided on each coil, goes to the plate pin when the maximum frequency coverage of the tuning condenser is required. For the higher-frequency amateur bands, it is connected to a point along the plate coil in order to give full scale coverage of the bands.

detector not oscillating. With the phones in the detector plate circuit and when using two or three feet of antenna, such signals, we believe, have an improved ratio-to-"background" noise over those obtained with the conventional type of code receiver.

For broadcast reception it is desirable to detune one of the intermediate stages slightly in order to avoid clipping side-bands as the result of excessive selectivity. However, under these conditions, and with a UX-171 as the last tube, the receiver will get down to the average "background" level without difficulty. Operated with an indoor

antenna 12 feet long, full loud-speaker volume is possible from any station above the noise level. The use of an antenna longer than 10 or 12 feet is never desirable and except in particularly wretched locations should never be necessary.

All in all, the receiver is a complex arrangement, difficult to build, and requiring extreme care in its preliminary adjustment. At the same time we cannot help thinking that the expense and labor involved in its construction would be justified even if the receiver was used in only one of the three fields of reception for which it is suited.

Standard Frequency Transmissions From W9XL

STATION W9XL is a special station comprising one of three portions of the "Gold Medal Station," WCCO-W9XL-W9WI at Anoka, Minnesota. WCCO is operated as a broadcast station, W9XL purely as a standard frequency station and W9WI as a general amateur station. The three transmitters have independent equipment and antennas but a common power supply. Through arrangements made by K.V.R. Lansingh of the Official Frequency Station Committee of the Experimenters' Section, A.R.R.L., W9XL is operated on schedules regularly announced in QST. The work of operating the station is done without charge by Assistant Chief Engineer Hugh S. McCartney, with the assistance of Lyall K. Smith, Ivan H. Anderson and George Collier also of the staff of WCCO.

While no guarantee of accuracy is made on a gratis service, it is the aim of the staff to maintain an accuracy of 1/10 of 1%, which is materially better than can be held by most frequency meters. The frequencies are measured by means of standards which have been especially standardized for this purpose by the Bureau of Standards.

A small percentage of tone modulation is employed so that the signal is distinctive and more quickly recognizable.

The fact that this service has been rendered in the past is no guarantee of its continuation indefinitely in the future. It depends upon whether the response received seems to warrant the amount of work and expense involved in maintaining this service to all amateurs. If you take advantage of this service, please acknowledge that you are doing so by notifying the Experimenters' Section, A.R.R.L., 1711 Park Street, Hartford, Conn. You may use ordinary stationery or special blanks may be obtained from the above address. A number

of these blanks has been gathered and as the number grows we will gradually gain a unique and accurate record of transmission phenomena that would be difficult to obtain for any other station.

Schedule "A"		Schedule "B"	
Central Standard Time (PM)	Frequency in kc.	Central Standard Time (PM)	Frequency in kc.
8:00	7,300	3:00	30,000
8:12	7,225	3:12	29,000
8:24	7,150	3:24	28,000
8:26	7,075	3:36	14,400
8:48	7,000	3:48	14,300
9:00	4,000	4:00	14,200
9:12	3,750	4:12	14,100
9:24	3,500	4:24	14,000

Division of Time

4 minutes—CQ CQ CQ de W9XL W9XL

3 minutes—Series of letter "D" with the dash about 5 seconds long. This transmission will be broken about every half minute to give the station call letters.

1 minute—Frequency———kc.

4 minutes—Time allowed to change to next frequency.

DATES OF TRANSMISSION

March Schedule	April Schedule	May Schedule
3rd "B"	5th "A"	3rd "A"
8th "A"	14th "B"	12th "B"
22nd "A"	19th "A"	17th "A"
		31st "A"

All O.F.S. should use these transmissions to keep their frequency meter calibrations within the required limits of accuracy. It will be appreciated if you will send us a report on your reception of these signals.

—H. P. W.

Strays

The Radio Division of the Department of Commerce advises us that the Supervisors of Radio are receiving QSL cards from radio amateurs throughout the country, requesting that the cards be forwarded to addresses not listed in the call book, and without postage affixed to the cards. The forwarding of these cards by a Supervisor is unofficial and government "penalty" envelopes cannot be used for the purpose. The Supervisors therefore cannot forward the cards. The attention of all amateurs is called to the fact that cards *must* have forwarding postage attached to get attention from Supervisors of Radio.

The Army-Amateur Radio System is Revised

Extensive Changes In Our Affiliation With the Signal Corps Make Plan More Valuable and Intensely Interesting for Amateurs

THE Army-Amateur System, the structure of relations between the amateurs of the A.R.R.L. and the Signal Corps of the U. S. Army, has been completely revised as a result of the experiences of the last few years and a study just completed by the Signal Corps and the League. The revised plan goes into effect on March 1, 1929. Major General George S. Gibbs, the Chief Signal Officer of the Army, like his predecessor General Saltzman, is deeply interested in amateur radio. Early in his administration a study was begun of the plan of affiliation between the Army and the amateurs, under which plan the A. R. R. L. is named as the representative of the amateurs. Conferences, correspondence, and ratification by the League's Executive Committee now serve to put into effect an expanded plan which profits by the previous experience and which offers a fascinating new scheme of work for amateurs, while at the same time greatly increasing the effectiveness of the system from the Army's standpoint.

We publish in this article the complete texts of the revised Plan and of the Regulations thereunder, and we urge every amateur to read them and become acquainted with their scope and fundamental ideas. The subject has also appealed to the Editor as being well worthy of comment on the editorial page, and attention is asked to the further thoughts there presented.

The outstanding operating idea in the new plan, the feature which is radically different from the old system and a brand-new venture in amateur work, is the introduction of a system of controlled nets after the Army fashion. The whole structure is based on this idea. Although complex, its possibilities in amateur radio are endless and certainly intriguing.

All Corps Area Signal Officers now have the new plan and are busily at work organizing their nets. The text of the plan follows:

Affiliation of the Signal Corps and the Transmitting Radio Amateurs of the United States.

GENERAL PLAN

1. The Signal Corps desires to cooperate with the transmitting radio amateurs throughout the country for the following purposes:

(a) To provide additional channels of communication throughout the continental limits of the United States that can, in time of emergency, be used to augment or replace the land lines, both telephone and telegraph, that may be seriously damaged or destroyed by flood, fire, tornado, earthquake, ice, riots or insurrections.

(b) To place at the disposal of military commanders of all components of the Army of the United States and of the Red Cross such

amateur radio channels of communication as may be developed under this plan.

(c) To provide civilian radio operators with a knowledge of Army methods of radio procedure and of the basic principles of using radio in the field.

(d) To establish contact with a considerable number of civilian radio operators, acquainting them with the Signal Corps and its activities, and securing their aid in experimental work, tests, etc.

(e) To render such encouragement and assistance as may be desirable to firmly establish and perpetuate the American amateur.

2. The agencies to be employed in this work are the Regular Army and the transmitting radio amateurs. Each corps area signal officer will appoint an officer at his corps area headquarters to act as Corps Area Liaison Agent between a representative of the transmitting radio amateurs of that corps area and the corps area signal officer.

3. Each corps area signal officer will select and appoint one amateur (to be known as the "Radio Aide") as the representative of the transmitting radio amateurs of that corps area.

4. The Chief Signal Officer of the Army will, considering the recommendations of the several corps area signal officers, appoint one amateur (to be known as the "Chief Radio Aide") as the Army representative of all transmitting amateurs of the United States.

5. A general outline of the Army Amateur Radio System is as follows:

(a) An Army Amateur Radio Net comprising

A Message From General Gibbs

To American Radio Amateurs:

In 1925 the Signal Corps entered into an affiliation with the transmitting radio amateurs of the United States. Three years of operation under the original plan have demonstrated the advisability of revising that plan to provide for an expansion of the system to cover more thoroughly all parts of the United States.

The value of such a plan has well been illustrated in such emergencies as the Vermont floods and the Florida hurricane. In the latter case, communication to and from the stricken area for three nights and two days was accomplished through War Department Station WAR (old WVA) and an amateur at West Palm Beach.

Such service to the country by amateurs is of inestimable value, and it is hoped that under the revised plan amateurs will, in a greater degree than before, ally themselves with the Signal Corps for national and community service.

GEO. S. GIBBS,

Major General.

Chief Signal Officer of the Army.

one station in each corps area and in each department in which amateur activities are permitted. The net control station to be located at Fort Monmouth, N. J., and operating under the supervision of the Chief Signal Officer.

(b) There will be organized in each corps area,

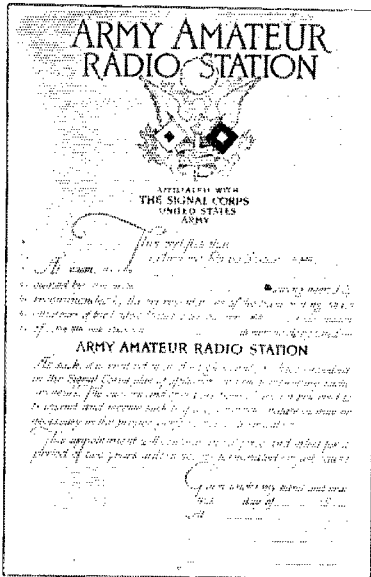

FIGURE 1

by the corps area signal officer, the following amateur radio nets:

- (1) *Corps Area Amateur Radio Net*, comprising one station in the capital of each of its states. A corps area amateur station or a selected civilian amateur station will act as Net Control Station.
- (2) *State Amateur Radio Nets*, based on the division of each state into approximately 5 geographical areas. The stations will normally be located in the principal city or town of each geographical area, or near the center of the area. The state capital station will act as Net Control Station.
- (3) *District Amateur Radio Nets*, each comprising approximately five stations so distributed as to best accomplish the requirements of paragraph 1 (a). The geographical area station referred to in (2) above will act as Net Control Station.
- (4) *Local Amateur Radio Nets*, comprising all amateurs in the local areas for which the respective substations of the District Net may act as Net Control Station. Local Nets will operate on schedules prepared by the net control station and approved by the corps area signal officer.

(c) All nets (except Local Nets) will function simultaneously on the same day of the week. Schedules and frequencies for use in the various nets will be announced from time to time by the Chief Signal Officer.

6. All amateur stations must comply with the Department of Commerce Regulations regarding amateur stations. The licenses for such amateur stations must be obtained from the Radio Inspector for the Radio District in which the station is located.

7. To generate the desired amount of message traffic for the amateur operators to handle, traffic of various kinds will be sent from the Army Net Control Station to all corps area and department stations, which should relay such portions of it to their lower nets as may be advisable. Likewise, all net control stations will originate traffic suitable for their nets.

8. In cases of local emergencies, where the land lines have ceased to function, any and/or all traffic should be sent by Army Amateur Radio. In such cases the local military units should be requested to protect the radio station of the amateur serving them, as this station may be their only means of communication with the outside world.

9. Corps area signal officers will arrange for the distribution of such instruction literature as may be available to the cooperating amateurs within their corps areas. This literature should be of such a nature as to instruct the amateur in tactical radio telegraph procedure, army codes and ciphers, and army apparatus and methods. Tests of a nationwide character will be arranged and conducted by the Chief Signal Officer.

10. Corps area signal officers will furnish their respective Radio Aides with a list of the National Guard and Reserve Units which amateur stations in that corps area should serve in an emergency and/or upon request by the organizations concerned. The Radio Aide will inform individual amateur stations of the units (and their locations) to which radio service should be offered.

11. Amateur radio operators are bound, under the laws and regulations governing radio communication, to preserve the secrecy of all radio messages. They are likewise duly obligated to comply with the above laws and such regulations as the Department of Commerce may promulgate, and participation in this plan does not release them from this obligation. In time of local emergency they should cooperate to the fullest possible extent with the local military organizations. In return, the local military authorities should do everything in their power to protect the amateur's station from the depredation of the lawless element should the occasion arise. The amateur's main value to the working out of this plan is that of cooperating by the use of his own station in the transmission and reception of certain traffic of an official or semi-official nature. He will be expected to handle this traffic by the army methods of tactical radio procedure whenever possible. *He will not, except in emergencies or upon the expressed consent of the corps area signal officer concerned, handle this army radio traffic with stations that have not been designated as army amateur stations in the same way that he has.* He will be instructed in the use of certain codes and will in many cases be required to encode his messages before transmitting them. Likewise he will, before delivery, have to decode such messages as come to him in code.

12. a. Each corps area signal officer will, considering the recommendations of his Radio Aide, designate an alternate station to act as Net Control Station for the corps area net.

b. Each corps area signal officer will, considering the recommendations of his Radio Aide and of the Net Control Station concerned, designate an alternate Net Control Station for each state, district and other lower nets.

13. The Army Amateur Net Control Station at Fort Monmouth, N. J., will be in direct charge of the Army Amateur Liaison Agent and will function under the direct supervision of the Chief Signal Officer. This station will transmit to the other Army Net stations such material as will be of value to them. The Army Amateur Liaison Agent will furnish corps area signal officers with copies of such instruction pamphlets as may be available in The Signal School. Where this material is not available in sufficient quantities, the corps area signal officers will be expected to mimeograph such portions of it as may be necessary for distribution within their corps areas. A station of sufficient power to communicate with all army amateur net stations is installed at Fort Mon-

mouth, N. J., and will be kept open under a regular published schedule.

14. A certificate of appointment will be issued by corps area signal officers to each of the amateur radio stations qualifying and accepting an appointment as a net control, alternate net control, or local station. These certificates will be signed and sealed by the corps area signal officers. They will be supplied by the Chief Signal Officer of the Army. These certificates are a confirmation of their appointment and contain the authority for their handling such official or semi-official traffic as may be given them. The certificate should be posted in a conspicuous place in the amateur's radio station. Renewal of the certificate, by endorsement thereon, will be given only when the service of that station has been "honest and faithful."

15. Stations designated to serve in this plan shall be known as "Army Amateur Radio Stations."

16. No additional funds or personnel will be allotted for this work. Such facilities as are available at corps area headquarters and at Fort Monmouth, N. J., will be utilized to the fullest extent in carrying this project through to a successful conclusion.

17. The outline of organization given above should not be regarded as hard and fast. Local conditions may require modifications. The organization adopted should be that best adapted to carrying out the spirit and purposes of the affiliation.

SOME EXPLANATIONS

For the purpose of explaining and clarifying such portions of the plan and its regulations as may be necessary to permit amateurs to visualize the set-up therein provided, Major D. M. Crawford, the Chief of Training of the Signal Corps, has prepared the following comment for QST:

The plan of affiliation is intentionally made quite general in scope in order that few, if any, changes need be made. The regulations thereto cover more specifically the means for carrying out the spirit of this affiliation, and may be changed from time to time as conditions may seem to warrant.

Fig. 1 illustrates the certificate issued to amateurs affiliated with the Signal Corps under this plan. The proper method of filling-in the blank spaces is described in Section III of the regulations.

The United States is divided, for military reasons, into nine corps areas, each comprising three or more states. Fig. 2 illustrates, as an example, the general lay-out of nets and the set-up for the Third Corps Area, which comprises the states of Pennsylvania, Virginia and Maryland. It is to be noted that the corresponding nets for corps areas other than the Third have been omitted since too great space would be required. Similarly only one net subordinate to each of the other nets in the Third Corps Area has been shown.

The Army amateur net control station is located at The Signal School, Fort Monmouth, N. J., and controls traffic in the ARMY amateur net, which includes one station at or near each corps area headquarters as sub-stations in the ARMY net. The master traffic schedule, illustrated in Fig. 3, controls the operations of all the nets

throughout the United States for the evening (Monday) during which the Army-Amateur system functions.

Referring to Fig. 3, it will be seen that the nets operating during any period are indicated by name in the corresponding

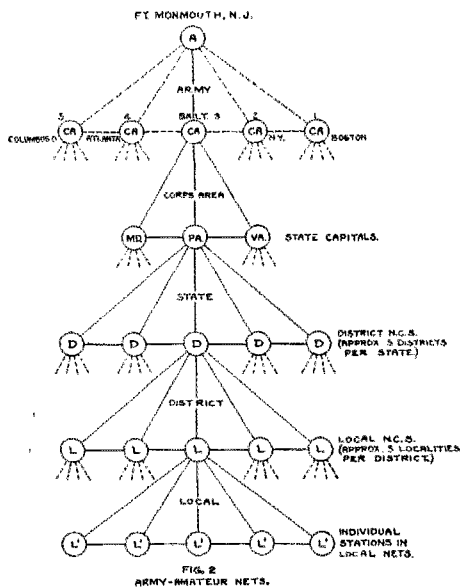

block. Thus, between 9:20 and 10:00 P.M., E.S.T., the following nets will be operating simultaneously:

- a. All Corps Area net control stations for the 1st, 2nd, 3rd and 5th Corps Areas would be sending traffic down to their sub-stations;
- b. All District net control stations for the 1st, 2nd, 3rd and 5th Corps Areas would be receiving traffic from their sub-stations;
- c. The Army net control station would receive traffic from the 4th, 6th, 7th and 8th Corps Area net control stations;
- d. The State net control stations of the 4th, 6th, 7th and 8th Corps Areas would send traffic down to their sub-stations;
- e. In the 9th Corps Area traffic flows both up and down in the District nets.

Let us take the case of a message originating in one of the District nets in Pennsylvania and destined for a District net in Arizona, which is in the Eighth Corps Area. Pennsylvania being in the Third Corps Area, we find that from 6 to 6:40 P.M. traffic may flow from any station in the District net to the District NCS. At 6:40 the District NCS becomes a sub-station in the State net and would transmit to the State NCS

the message received during the previous period. Similarly, at 7:20 the State NCS becomes a sub-station in the Corps Area net and forwards the message to Corps Area NCS; and at 8 o'clock the Corps Area station forwards it to Army NCS at Fort Monmouth, N. J. Now, since the message was addressed to the 8th Corps Area, located in the south central part of the United States, we find that the 8th Corps Area station works the Army net control station during the period 9:20 to 10:40 P.M. Up until 10 o'clock traffic goes UP to the Army NCS while after 10 o'clock the Army NCS sends DOWN to the 8th Corps Area NCS the mes-

THE REGULATIONS

It has been explained that the revision consists of two parts. The general plan itself has been reprinted above. We present now the regulations thereunder, suggesting that a careful reading of the same, in conjunction with Major Crawford's interpretation, will enable every amateur to understand the working of the system. Please see also this month's editorial page.

REGULATIONS FOR ARMY AMATEUR RADIO SYSTEM.

Section I—Net Stations, How Selected

1. Corps Nets.—in the various corps area nets

	C. A. or Dept.	Time																REMARKS
		6:00 6:40	6:40 7:20	7:20 8:00	8:00 8:40	8:40 9:20	9:20 10:00	10:00 10:40	10:40 11:20	11:20 12:00	12:00 12:40	12:40 1:20	1:20 2:00					
EAST	1	Dist.	State	C.A.	Army	Army	C.A.	State	Dist.	Dist.	Army						Arrows indicate primary traffic flow for that period. Arrows pointing UP indicate traffic flow TOWARDS NCS of net named in square.	
	2																	
	3																	
	4																	
	5																	
WEST	1	C. A.	Army	Dist.	State	State	Dist.		Army	C.A.	State						Lines connecting several squares indicate how east and west traffic flows.	
	2																	
	3																	
	4																	
	5																	
FOREIGN	4			Dist.	State	C.A.	Army	Army	C.A.	State	Dist.						Any undelivered traffic remaining at any station at close of net operation should be mailed or phoned to addressee, as his location indicates to be more desirable.	
	5																	
	6																	
	7																	
	8																	
	9						Dist.	State	C.A.	Army	C.A.	Army	Dist.			The slogan of the Army amateur system is:		
	Panama			Army												SWIFT, SURE, ACCURATE		
	Hawaii															or later		
	Philippine																	
																	From Army NCS (Fort Monmouth, N. J.) commencing 6:00 AM, EST.	

FIGURE 3
MASTER TRAFFIC SCHEDULES—ARMY AMATEUR RADIO SYSTEM
Eastern Standard Time—P. M.

sage he received at 8 o'clock from Pennsylvania. This is indicated by the diagonal line marked "a". At 10:40 the Eighth Corps Area forwards the message to the Arizona State NCS; the latter forwards it to the proper District NCS at 11:20; and its ultimate delivery to the proper local NCS occurs at 12 midnight. Similar study will indicate that traffic from the 4th Corps Area would reach the First Corps Area during the period 10:40 to 11:20 P.M. via line "b".

The schedule is designed to permit a message filed anywhere in the United States to flow through the nets as organized and to reach its approximate destination the same night. All messages on hand at any station should be mailed next morning.

the net control station is the station at or near corps area headquarters. The other stations in a corps area net will include one station at or near the state capital in each state of that corps area. Obviously, there may be a number of qualified stations in or near a state capital and it is the function of the corps area signal officer, through contact with his Radio Aide, to determine which of the available stations should be selected as the net control station of the state net. It is not essential that this selection be made immediately but one station may be selected and given a trial for a period of a month or two to determine if the station and the operator are capable of giving service on regular schedules. As soon as a selection is finally made a certificate will be issued to that station announcing it as an Army Amateur Radio Station. An alternate station should be selected for each state capital.

2. State Nets.—The stations selected as indicated in the previous paragraph become the net control stations for the several state nets. In a manner similar to that indicated in the above paragraph, regular

and alternate stations will be selected in each "geographical area" of each state in the corps area. In other words, the state net includes the state capital station and approximately 5 sub-stations located near the centers of the five "geographical areas" of the state. It should be borne in mind that every station of whatever nature ultimately becomes the net control station for the next lower net, hence the station selected should be capable of working in the forward net and in the lower net. Furthermore, the operator must be well qualified and reliable, since all nets (except Local Nets) throughout the United States will function simultaneously. (This idea has the approval of the American Radio Relay League which states that there should be no technical deterrent to its operation).

3. *District Nets.*—Each geographical area of each state is further subdivided into approximately 5 local areas with one station (and its alternate) in each. Naturally, the general idea must be modified in each state, by the corps area signal officer, to fit the circumstances.

Section II—Frequency Assignments.

NOTE: Since each station, except sub-stations in Local Nets, is required to work in two nets care must be taken to select such amateur stations as may be capable of transmitting and receiving in each of the nets to which it is to be assigned.

1. *Army Net.*—The Army frequency near the amateur 40 meter band will be used to all corps areas and departments.

NOTE.—Pending the assignment of a definite Army frequency for this purpose, the 40 meter amateur band may be used.¹

2. *Corps Area Nets.*—Frequencies in the 40 or 80 meter band will be used in all corps area nets. (The American Radio Relay League has indicated that the normal difference in frequencies selected by the several corps area net control stations will be sufficient to prevent interference. In other words, the corps area nets actually operate on nine different frequencies.)

3. *State Nets.*—The 80 meter amateur band will be used. (Again, it is the opinion of the traffic manager of the American Radio Relay League that due to the natural differences in frequencies selected by the state net control stations, no interference will result. Since there are relatively few stations in each net it is believed possible and practicable to have the transmitters and receivers of all stations in a net calibrated to operate on the same frequency throughout the year. If, therefore, on first trial, it is found that the frequency selected by the Maine state control station, for example, conflicts with that of the New Hampshire control station, the corps area signal officer should, if necessary, direct one of them to shift his wave length slightly.)

4. *District Nets.*—Frequencies in the 80 meter band will be used. With about 10 different frequencies within the 80 meter band, it is believed that no interference effects will be encountered anywhere in the country; this of course requires the supervision and cooperation of the corps area liaison officer and the Radio Aide.

5. *Local Nets.*—Frequencies in the 80 or 160 meter band may be used. The particular frequencies selected must be non-interfering with the frequencies used in the higher nets. Local nets will not operate on the same day as the higher nets.

Section III—Certificates.

1. As a general policy army amateur radio station

¹Pending such assignment the Army net control station at Fort Monmouth will sign W2CXL and it and all other stations in the Army net will use 7244 kc. As quickly as a frequency from the government block can be secured for this purpose, all stations in this net will use non-amateur calls and a non-amateur frequency.—Editor.

certificates will be issued for two years to stations qualifying as net control station, alternate net control station, or local station; at the end of two years, if the station is believed worthy and reliable and its service has been "honest and faithful," the corps area signal officer will renew the certificate by endorsement thereon for two years more.

2. A new certificate should be issued to all amateurs qualifying under the new plan, whether or not they hold an old certificate. The present certificate form will be used as follows:

a. The blank space on line 6 will contain "N.C.S.", "ALT. N.C.S.", or "LOCAL".

b. The blank space on line 7 will be filled in to conform to one of the following sample forms:

- (1) the First Corps Area Net
- (2) the New York State Net
- (3) the 2nd Area of Pa. Dist. Net
- (4) the * Local Net.

*Fill in descriptive term applicable to the Corps Area in question.

3. Effort will be made to assign all amateurs now affiliated with the Signal Corps to their logical place under the revised plan.

Section IV—Traffic.

1. Personal messages not of a business nature may be accepted for transmission to any part of the United States, Philippine Islands and Hawaii without cost, providing such messages would not have been sent by available commercial agencies.

2. Philippine and Hawaiian traffic will be routed as follows:

From 9th Corps Area—as prescribed by Signal Officer, 9th Corps Area.

From all other Corps Areas—via Army Net Control Station, Fort Monmouth, N. J.

3. United States traffic will be routed through the channels indicated on attached photostat of nets.

Section V—Schedules.

1. Schedules are indicated on attached photostat of traffic schedules.

Section VI—Reports.

1. After each army amateur night, each corps area signal officer and the Army Amateur Liaison Agent at Fort Monmouth will submit to the Chief Signal Officer a report covering the actual traffic handled by his station during that night. The form used will be as indicated below:

TRAFFIC REPORT FIRST CORPS AREA AMATEUR STATION FOR 10 DEC. 1928.

No. Msgs.	To (State or Army)	From (State or Army)	Remarks
2	Me.	Vermont	
1	R. I.	1 CA NCS (Svce)	
1	Mass.	N. Y.	
1	Army	Conn.	
1	Mass.	Army	
1	Army	Mass.	

Section VII—Emergency Operation.

1. When an emergency of any nature threatens any portion of the United States the army amateur stations in that corps area are expected to man their stations, each net control station will endeavor to mobilize the stations in his net, and stand by prepared to send and receive any traffic to or from the threatened area until such time as he may be notified by the next higher net control station that his services are no longer required.

Section VIII—Weekly Operations.

1. All except Local Nets will function on Monday of each week, according to the general schedule furnished each corps area signal officer.

Revised U.S.A. Amateur Regulations

The New Frequency Bands Are Announced, and All Other Regulations Summarized To Date

THE RADIO SERVICE BULLETIN for December 31, 1928, contained revised United States amateur regulations, superseding those dated September 1, 1928. Since that date the Radio Division Department of Commerce, has published the revised regulations in sheet form, for distribution to amateurs. They are published below at the request of Mr. W. D. Terrell, Chief of the Division, for the information of all amateurs. The A.R.R.L. was advised by Mr. Terrell, under date of December 19th last, as published in our February number, page 54, that the Government did not intend to recall outstanding amateur station licenses but that the new regulations were in process of printing and that their announcement would serve to amend all existing licenses.

Let this put an end to all talk about the 1928 bands still being in effect because the new bands have not been announced by the Government. The new regulations are in effect. We are under careful observation. There are now many other services closely adjacent to ours and it is of great importance to amateur radio that we observe fully the new regulations, particularly as to frequencies.

The most important change, of course, is in the frequency bands. The new bands specified are, in every case, the maximum permitted our Government by the terms of the Washington Convention. The recently-authorized permission for amateur television and picture-transmission work is also incorporated in the regulations, conveniently summarizing everything to date. The complete text follows.

**Department of Commerce
Radio Division
REVISED U. S. AMATEUR
REGULATIONS**

Superseding those dated September 1, 1928

An amateur station is a station operated by a person interested in radio technique solely with a personal aim and without pecuniary interest. Amateur licenses will not be issued to stations of other classes.

Amateur radio stations are authorized for communication only with similarly licensed stations, except as indicated below, and on wave lengths or frequencies within the following bands:

Kilocycles		Meters	
401,000 to 400,000	0.7481	to	0.7500
60,000 to 56,000	5.00	to	5.36
30,000 to 28,000	10.00	to	10.71
14,400 to 14,000	20.83	to	21.43
7,300 to 7,000	41.10	to	42.86
4,000 to 3,500	75.0	to	85.7
2,000 to 1,715	150.0	to	175.0

and at all times unless interference is caused with other radio services, in which event a silent period must be observed between the hours of 8 and 10:30 p.m., local time, and on Sundays during local church services.

Amateur radiotelephone operation will be permitted only in the following bands:

Kilocycles		Meters	
60,000 to 56,000	5.00	to	5.36
3,550 to 3,500	84.50	to	85.70
2,000 to 1,715	150.00	to	175.00

Amateur television and operation of picture transmission apparatus will be permitted only in the following bands:

Kilocycles		Meters	
60,000 to 56,000	5.00	to	5.36
2,000 to 1,715	150.00	to	175.00

Spark transmitters will not be authorized for amateur use.

Amateur stations must use circuits loosely coupled to the radiating system or devices that will produce equivalent effects to minimize key impacts, harmonics, and plate supply modulations. Conductive coupling, even though loose, will not be permitted, but this restriction shall not apply against the employment of transmission line feeder systems to Hertzian antennæ.

Amateur stations are not permitted to communicate with commercial or Government stations unless authorized by the licensing authority except in an emergency or for testing purposes. This restriction does not apply to communication with small pleasure craft, such as yachts and motor boats holding limited commercial station licenses which may have difficulty in establishing communication with commercial or Government stations.

Amateur stations are not authorized to broadcast news, music, lectures, sermons, or

(Continued on Page 23)

The Design of Inductance Coils**

In Two Parts—Part II

By D. R. Clemons*

OWING TO the high frequencies required for electromagnetic propagation, radio systems permitting such high frequencies require very small values of capacity and inductance. In radio transmitting circuits capacities are usually of 500 to 1000 $\mu\text{fd.}$ In receiving circuits the minimum effective capacity, not excluding the inherent and stray coil capacity, is about 80 $\mu\text{fd.}$, and to provide means for tuning to the frequencies used, coils of rather small inductance are required. Coils vary in type and general shape of winding, averaging from 8 to 1200 turns of copper conductor wound about a form of arbitrary dimensions. Dimensions of a coil will be large or small according to the inductance and power requirements. The size and type of wire and the space available for the completed winding must be considered. A coil of very large inductance but of small dimensions may be made of very fine wire and consequently develop enormous resistance. Another coil somewhat larger in dimension but of equal inductance may be made by winding a specially stranded cable or coarser wire which would have lower high frequency resistance in comparison. When a receiver is to cover a large range of frequencies it is necessary to use compact coils of larger inductance. Such coils have enormous inherent capacity in many cases and do not function satisfactorily.

TYPES OF COIL WINDINGS

In Photo A the reader will recognize three familiar types of windings commonly used in radio equipment. Coil A represents a coil of square cross-section and is wound with Litz wire. This coil served as a loading coil in a standard Navy receiver. Coil B is a familiar example of single layer cylindrical coil or solenoid; and C is an example of spiral forms of windings, sometimes called pancake winding. Nearly every coil used in radio equipment is either identical to, or some modification of, these types of winding. Each type has peculiar inherent characteristics which apply quite rigidly to all coils of that particular type.

Probably the most efficient winding for moderate frequencies and a coil applicable in all radio frequency circuits is the solenoid. The solenoid has reasonably low

resistance, large inductance for the length of wire used, and a low distributed capacity which remains remarkably constant. The solenoid does, however, require a larger volume of space than any other coil type of equal inductance—the coil illustrated at B having 3,840 $\mu\text{hy.}$ inductance with but 3.85 $\mu\text{fd.}$ capacity. Spiral C gives very good results in unshielded circuits, having a large self inductance and about the same as that

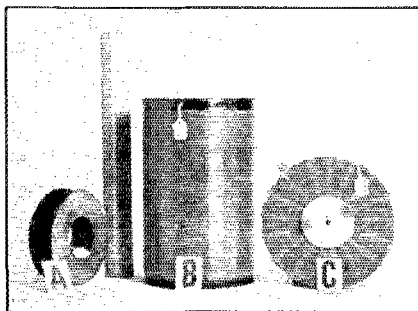

PHOTO A

of solenoid of equal mean radius and wire length. It has comparatively low resistance and moderately low capacity and an inductance of 1,100 $\mu\text{hy.}$ with 6.1 $\mu\text{fd.}$ inherent capacity. In the coil of square cross section A, when properly designed, we have the greatest possible inductance for a given length of wire and, consequently lower direct-current resistance than any coil type of equal inductance; but at radio frequencies the enormous inherent capacity makes this compact type rather undesirable. The coil capacity may be 8 to 50 times greater than for a much larger solenoid of equal inductance, and in addition to this, the compact winding is the only type of winding in which the capacity is appreciably increased by the introduction of impregnations of dielectric material such as varnishes or other compounds. Although other types have a slight increase of capacity due to foreign material, no other type is subject to such direct variation according to the inductivity of the varnish as is the compact winding. Although of lower direct current resistance than any other type of equal inductance and wire gauge, the large capacity gives enormous effective resistance to the compact coil when operated at all higher frequencies. Coil A illustrated is of

*817 Shenstone Road, Riverside, Ill.

**The first part of this article was published in February, 1929, QST.—Ed.

5,402 μ hy. inductance and 29.93 μ fd. capacity; its fundamental is about 375 kc. Any solenoid of equal inductance would average higher than 1000 kc. fundamental, and while both would tune to similar low frequencies, the solenoid will tune several hundred kilocycles higher than compact windings of equal inductance.

Photo B shows several varieties of single layer solenoids at G and H; also 2-layer bank-wound types at I. Photo C shows several spiral windings. Photo D shows

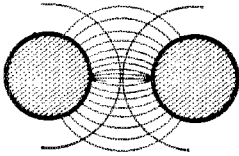

FIG. 7

three types of coils of rectangular cross section, group F being wound in traverse layers in a channel section of a wooden spool, group E being wound in a form, impregnated and taped; group D represents the familiar "honeycomb" type of this compact class.

Coils differ in the inductive nature of their dielectrics, and in some types are very critical to this factor. Two identical windings of equal geometry, turns and wire gauge, but differently mounted or impreg-

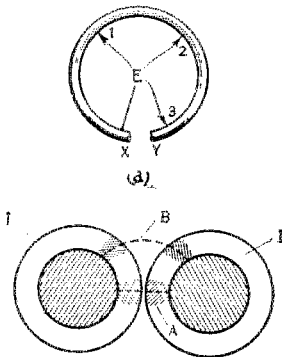

FIG 8

nated will have different capacities. The difference will be slight in solenoids and spirals, but may become large in compact coils of type E and F. Two identical coils will usually have similar capacity when in free space and ungrounded without shields.

Discussions of distributed capacity are mostly confined to hypothetical considera-

tions of distance and uniform charges on adjacent turns, while other actions of equal or greater importance are often excluded. The effects are also thought of as lumped or practically concentrated charge effects of one coil part related to the oppositely electrified part. Let us examine the actual lumped capacity existing between two uniformly charged adjacent turns, and between two coil halves. A tube 13 cms. in diameter was wound with 25 turns of 26 enamelled copper wire. The actual distributed capacity of the free coil was but 3.27 μ fd. Then the central or thirteenth turn was cut, dividing the coil winding into two halves. The lumped capacity between the two adjacent halves was 46.0 μ fd., which seems due to capacity actually between the nearest adjacent turns at the coil center. To check this test two wires of the same material having a length equal to the coil circumference were then stretched close together in parallel. The capacity between the pair was 39.0 μ fd. From this we observe that: At radio frequencies lumped capacity between two adjacent and

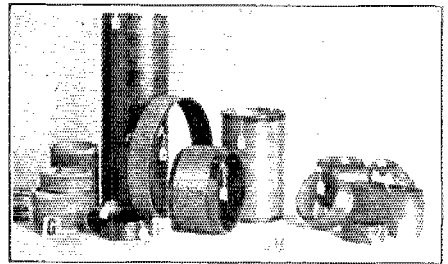

PHOTO B

isolated turns is ten times greater than the distributed non-uniform charge of the entire coil. Obviously, the distributed capacity is the result of a potential distribution extending non-uniformly over the entire coil, and while the shortest distance through which any two points can act would be two points located on adjacent turns, we see that the intensity of these charges and the energy in the space will depend largely on the potential distribution over the entire coil; which potential increased as the reactance of each turn, assuming equal currents and frequency, and such reactance increases as the area enclosed by the turn increases. Hence, initial capacity is found to depend largely on the radius of the winding.

Increasing separation between turns greatly reduces capacity, and the addition of solid dielectrics such as paper, varnishes, bakelised tubes and the like, increases capacity "directly as the inductive constant

of the material added." This has been discussed and advocated in classrooms and texts for some time. Capacity of any coil will be slightly reduced by separating the turns because the field for a given length of coiled wire will be extended through a greater volume of dielectric space and will be caused to act through greater distances; but insulation thickness covering the conductor does not seem to alter the capacity materially so long as the wire centers remain fixed. The actual dielectric effect of enamel insulation on the capacity is very slight because its constant is low, and due to its extreme thinness, enamel occupies but a very small radial depth along any line of flux except for a very small segment where the wires actually touch. Thus, the average flux increase due to the addition of enamel acting between two circular areas would only be several parts in ten thousand, while the average flux increase in the enamel as

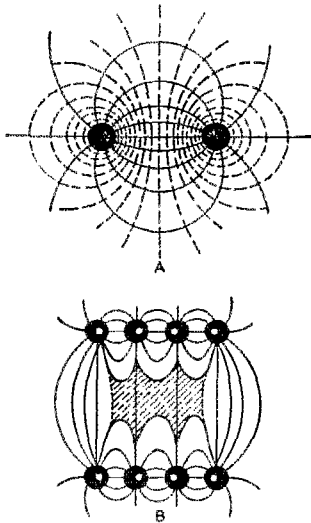

FIG 9

compared with the average field acting over the solenoid, is scarcely greater than several parts in ten million. Hence, any increase of coil capacity actually due to enamel is the result of the increased flux through the segments where the wire surfaces are in contact, as shown in Fig. 7, the shaded area being the only region where the gradient per centimeter of enamel is appreciable or even approximately at its inductivity. If cotton or silk insulation is used in any coil, they are usually impregnated with electrical varnishes or compounds which have constants of 1.38 to 3.1 which is slightly lower than cotton or silk itself, hence the thicker insulation which

may really separate turns and lengthen the coil is off-set by dielectric material of higher permittivity than air. Though cotton and silk have high inductivity, it becomes of secondary importance due to the non-

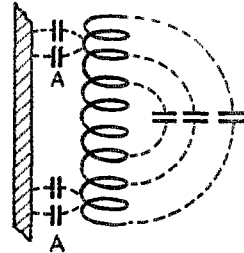

FIG. 10

compact nature of the fibres which make up a rather loose incomplete dielectric of complex nature.

Suppose that a number 20 double cotton insulated wire is bent into a loop 8 inches in diameter and carries one ampere at 6,000 kc. If we represent two adjacent sections of this loop, X and Y in Fig. 8A as in 8B, the potential average between XY over transient periods is 17.4 volts. Now suppose a dense varnish having an inductivity of 3.5 has thoroughly saturated the wire insulation I, giving a dielectric depth of 0.0132 cm. about the wire surface. Along segment A of Fig. 8B, where the wires touch, induction acts through the dielectric, each side having the same depth and inductivity. The voltage divides equally between them, being 8.7 average volts in each segment along the line A. With a dielectric constant of 3.5 the equivalent gradient in the insulation is 612.4 volts per centimeter. Along the segments displaced by the line B there will be some refraction of the line acting through the insulation I, but we observe this particular line extends partly through air a distance of 0.0529 cms., also it passes through two thicknesses of insulation each having a depth of 0.0132 cm. If we assume uniform distribution of potential through the wire cross-section, the potentials acting along B divide into three parts: 14.99 for the air space, with only 1.2 volts acting through each segment of insulation; so the gradients acting along B are but 90 volts per centimeter for the varnish in the insulation I, with 283 volts per centimeter acting in the air space. Obviously a centimeter gradient of 612.4 acting through the continuous dielectric having a constant of 3.5 at A gives much greater flux density there than at B where the gradients have decreased to but 90 volts per centimeter. Without consideration of coil geometry and distribution of currents

in solenoids and spirals, in addition to theories of effects between turns, it becomes difficult to approximate coil capacity, for the effect between turns is not uniform over the entire coil and is but a part of the total energy displaced in the dielectric. While the distribution of magnetic and electrical components between parallel sections of a loop or single turns is shown in Fig. 9A, the distribution of the electric component through a solenoid of several turns is shown at B, where solid lines represent directions along which inductive displacement may take place.

For a cylindrical winding of short length the capacity remains quite uniformly distributed along the current sheet and remains fairly constant for such a free or unshielded coil placed in various positions. However, in performing various experiments one observes considerable capacity

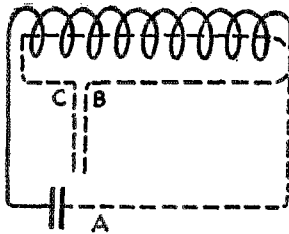

FIG. 11

variations in very long solenoids, which change may become enormous in coils when used in various positions. Near-by objects and wiring may connect to one coil terminal such as connection to condensers, shields and so on, which gives the coil an added capacity equivalent to grounding it. Shielding will often increase the apparent coil capacity several hundred percent. Objects having positions which bring them into the dielectric field will introduce greater flux density about the coil if the added medium has greater permittivity than air as shown at A in Fig. 10. A part of the copper circuit brought near the coil also may increase the coil capacity above normal. Such parts may be wiring, leads, taps and the like. To illustrate this a long solenoid was selected: Diameter 9.8 cms., length 153 cms., turns 900 of 22 gauge d.c.c. wire arranged as shown in Fig. 11. With one coil terminal at some distance from the coil in position A, a coil capacity of 4.395 $\mu\text{fd.}$ was measured. With the lead 4 cms. from the coil surface as shown by line B, the capacity became 4.87 $\mu\text{fd.}$ By running the lead directly through the coil center as shown at C the capacity increased 192 percent becoming 8.43 $\mu\text{fd.}$ or nearly twice the free coil capacity. These effects of short

terminal leads become negligible for very short coils, amounting to but 1 to 2 $\mu\text{fd.}$ increase. The return lead along B permitted an increase of flux at K in Fig. 12A, which increase is very slight for external wiring, but leads and taps inside the winding are related radially to a cylinder permitting a much greater flux in the region as in Fig. 12b. However, for compact coils effects of leads are negligible for any arrangement except bundling of such leads.

Any dielectric other than air, when very close to the winding will increase the coil capacity according to the coil dimensions and gradients generated in the new medium; its inductivity and so on. Such capacity increases in free systems, due to adjacent dielectrics, was probably first noticed by Hertz while conducting experiments with open oscillators having distributed constants. Hertz observed that the potential node and current distribution changed position and modes of oscillations varied when blocks of insulating material were placed in the electric field. Such increases of capacity were found present though the blocks were often removed some distance from the oscillator system's lineal axis. Drude and others have also observed such redistribution of currents through long systems; which effect changes the energy in the dielectric and consequent capacity of the system. Very long coils are seldom used but it is well to remember that such effects may be encountered in operating large loops and radio direction finders, and may occur in moderately long solenoids having a length several times the coil diameter, for such coils are critical to foreign material in their external fields. While very short solenoids are not appreciably altered by changes in material

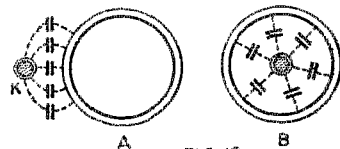

FIG. 12

at some distance from the coil, they are slightly altered for any change of a dielectric medium directly along side and close to the current sheet, although, in the case of solenoids, the effect may be of much less magnitude than is commonly thought probable. Of course, magnetic shielding of metal will also cause an appreciable increase of apparent coil capacity.

Formulas developed by G. Breit have been referred to, and by employing them in calculating the capacity of simple coils having entirely air insulation and a length not greater than 3 times the coil diameter,

these formulas yield fairly well. For long coils, however, the agreement is not so good for reasons set forth above and due to difficulties in evaluating the factor K. It appears that winding pitch and relative surface area, together with the length, if slightly altered, will change both coil constants. To illustrate: A coil 9.8 cms. diameter was wound by hand with 193 turns of 22 d.c.c. wire and was 25.6 cms. long: The pure self inductance was 1,019.8 μ h. and distributed capacity 5.12 μ fd. The turns were then pressed very tightly together, shortening the coil length to 25.1 cms., for which the inductance became 1,159.0 μ h. and the capacity, instead of increasing as expected from theory, decreased to 3.62 μ fd. To investigate effects of coil length where all other considerations such as diameter and inductivity of tubing, winding pitch, wire gauge and so on, remained constant, twelve coils of the same wire were wound of equal pitch on thoroughly dried paper tubes of equal diameters and having lengths of 2.5, 5, 7.5, 10, 20 and so on, up to 150 cms. length, three of them being illustrated at G in Photo B. Variations of distributed capacity with coil length is shown by the graph in Fig. 13. To measure constants of the longer coils, they were suspended high above the

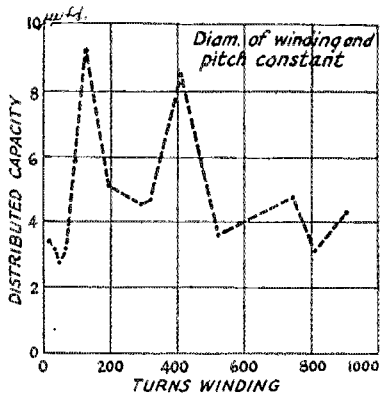

FIG. 13

apparatus, leads of very fine wire being used and their added effects computed in obtaining final coil capacities.

By examination of the Formula (1) for cylindrical coils, we find the coil lengths appear as a term in the denominator, while the coil radius and number of turns in the winding occur in the numerator and have each an exponent of 2. Obviously, then, by holding the coil's length and radius approximately constant, if twice the number of turns is wound along the cylinder, the self inductance of the coil is increased approximately 4 times; hence a much larger self

inductance may be obtained by winding two or more layers in place of a single layer, which method permits retention of coil dimensions, giving a maximum inductance for the length of wire used. The calculation of self inductance by a simple formula involves only the geometry of the

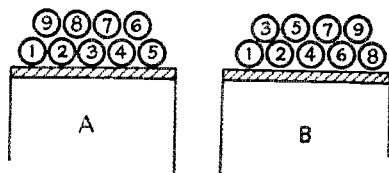

FIG. 14

coil in solving for the magnetic values, no consideration is given to the manner in which the wires are wound over the cylinder. The effective coil resistance depends however, largely on the manner in which these multiple layers are arranged on the

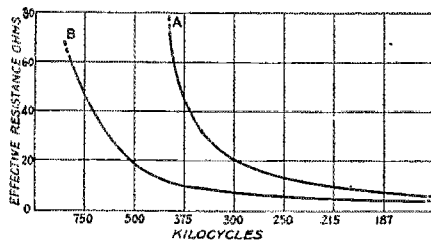

FIG. 15

tube or form. The simplest expedient is to wind one layer immediately back over the first layer, as in plain magnet winding as illustrated in Fig. 14 at A, where the successive turns are numbered. For a 2-layer coil so wound, the dielectric between the first and very last turns (as 1, 2 related to 8, 9) is subject to the maximum potentials of the coil terminals, successive turns being less affected until the effect is a minimum between turns 5 and 6. Acting through such short distances the potential establishes a very great flux density in the medium between the current sheets. The distributed capacity of coils so wound is large, making such types of coil entirely worthless as a radio-frequency inductance. Where the layers are made numerous and the winding length short, the self inductance is large, but the capacity also becomes very great. The latter types of coils as illustrated in Photo D at F, may be employed more or less successfully in various radio circuits, but for cylindrical coils of greater length and of very few layers, this simple method of layer winding is altogether useless. It is possible to wind the equivalent of several layers along the

cylinder and distribute the potential much the same as in ordinary single layer coils. To do this the well known type of "bank winding" is employed as illustrated at B in Fig. 14, for which type of winding the coil capacity becomes normal and relatively small, comparing favorably with ordinary solenoids. But due to the length of wire per unit of coil length being greater, these more numerous potential points acting through a small space permit slightly larger distributed capacity for this coil type than for the same wire rewound into a single-layer coil. Coil capacity remains quite small for 2 or 3 banked layers on coils of good shape but increases and takes the characteristics of compact windings with an increase of layers of too great a depth.

Two cylindrical 2-layer windings of identical dimensions, turns, wire and tube material, were made up, one being "bank" wound as shown at B in Fig. 14, the coil having 71 turns. The second coil of identical dimensions was wound with plain traverse layers as at A in Fig. 14. Although both coils were of identical inductance, the latter developed an enormous distributed capacity of 552.0 μfds , while the bank wound coil gave the more desirable capacity of but 6.18 μfd . A second pair of smaller coils, 395.0 μh ., each similarly wound gave for the plain 2-layer winding a capacity of 85.9 μfd ., while the "bank" type winding gave a low capacity of 2.43 μfd .

The calculated high-frequency resistance of either type of coil just mentioned would be too small. Although both windings are



PHOTO C

of equal wire length and identical resistance to direct currents, curves demonstrating additive effects of capacity on effective coil resistance are shown in Fig. 15. These are for the smaller coils described above. The coil wound in traverse layers would not tune sharply above 300 kc. and positively would not serve above 425 kc. while the "bank" wound coil of very small capacity will tune sharply in receiving circuits to about 1,000 kc. We find the effective resistance of the traverse-wound 2-layer coil, due to parallel effects at resonance, is infinite at about 500 kc. This illustrates effects of distributed capacity and shows

why special types of winding have been developed to reduce it.

Spiral inductances comprise a type of winding used since the days of Ampere. Spirals were introduced by Oersted, were used by Henry and Faraday, and were subject to careful investigation by Maxwell who employed them in his famous experimental determinations for the velocity of light. The spiral permits a large inductance to be wound in a very small volume of space since the winding increases in diameter only. Familiar forms of spirals as used in receiving sets are illustrated in Photo C and at C in Photo A. Although not generally favored in receiving equipment, spirals

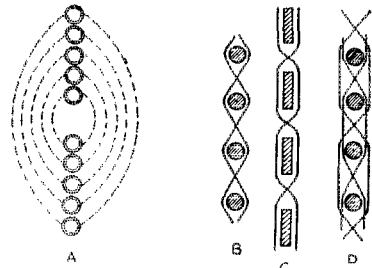

FIG. 16

have always been extensively employed in transmitting systems of all kinds. The true spiral of receiver dimensions is shown at J in Photo C—being a perfectly flat coil. Both the electric and magnetic field in its distribution and geometrical averages resembles that of solenoids having the same mean radius, and we find it true that spirals of reasonable winding depth show approximately equal capacity and self-inductance when compared with solenoids of similar mean radius and wire length. This again illustrates the dependence of capacity more directly to radial dimensions of winding than to hypothetical consideration of lumped effects between turns. The coil J is a strict spiral and has 220.0 μh . inductance with 3.10 μfd . distributed capacity, evidently comparing favorably with solenoids. For such simple windings as type J, Fig. 16a, a large coil diameter is required for large values of self-inductance, and as they are difficult to mount, this particular type of winding is seldom used in radio receivers. It has always been successfully used in transmitters where copper ribbon, cable or flat strip is similarly coiled into spirals.

Spiral Type K is wound through a wooden form consisting of a number of radial wooden pins through which the winding is alternately wound as shown in Fig. 16b. The reader will recognize this once popular type of winding: It permits large wire gauge to be used and may be efficiently employed in transmitting circuits. Types

M and N are essentially the same type of winding over a slotted disc of insulating material as shown in Fig. 16c. Types K, M, and N show reasonably small capacity and have fair resistance characteristics, practically the same as cylindrical windings. Spirals give fairly large inductance for the wire lengths used when wound up in these types.

Type L is similar to other spirals in appearance but is wound as shown at D in Fig. 16. This unique winding, now very common, permits approximately twice the number of turns to be wound in the same winding space as type J, and while the inductance is more than twice greater, its distributed capacity is but slightly more than for a plain spiral of equal diameter. Due to the peculiar distribution of the electric components about spirals, both the self inductance and inherent capacity are largely influenced when the coil is adjacent to metal shields and metal material which may give it an additional grounding effect. Spirals are not entirely satisfactory in precision equipment nor desirable as standards of self inductance. For the free coil, however, the resistance characteristics are identical with solenoids which have about the same inductance and mean radius.

It is commonly thought that separating adjacent turns has effected a great decrease of distributed capacity in spiral types of winding, but the actual decrease is very slight and is usually over-emphasized. The dependence of the constant C_0 seems to yield to the mean radius of spirals much the same as for all normal solenoids in formulas for calculations of distributed capacity.

Coils of square cross-section or compactly-wound coils are shown as class A in Photo A, several types and variations of this form being shown in Photo D. Maxwell gave detailed formulas for the correct design of this coil type which, for a given

ing resistance at higher frequencies, this coil type would seem to have a minimum of resistance as compared with any other coil type of equal self-inductance and wire gauge. The effective resistance of compact windings is actually the greatest of any coil type considered, which high resistance effect, due to the enormous inherent coil capacity, is invariably much greater than for any solenoid or spiral of equal inductance. The enormous capacity is due to the complexity of the electric field. Winding a great many turns into a small channel as in Fig. 1c permits maximum mutual inductance between turns. The flux is not

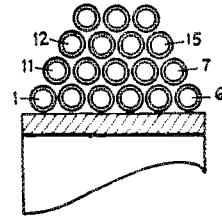

FIG. 18

extended to a great distance as in the solenoid. Here we find the entire series of potential areas of copper confined to minimum distances as shown in Fig. 17, and due to very short distances through which all displacements may act, the dielectric occupies practically the entire length of any single displacement line acting inside the winding surface, consequently the dielectric flux is very large and is equivalent to a large distributed capacity. Such coils will not cover such a broad range of frequencies as may be obtained with a solenoid or spiral of equal inductance; moreover, its high distributed resistance causes a very high effective resistance at all frequencies. Coil A in Photo A is a coil designed correctly, wound with Litzendraht cable and though of only 5402.0 μ h. inductance its capacity is 29.9 μ fd., which is large. A solenoid of equal inductance has, in one case, a capacity of but 4.39 μ fd. Due to the complexity of the dielectric contained within the windings, and to the variation of the constant K for inductivity, compact coils do not yield to formulas for the calculation of inherent capacity.

Instead of a strictly square section, a deep winding is sometimes made up of a succession of traverse layers as shown in Fig. 18, which winding has been called pyramidal winding. A typical coil at E in Photo D is one of these and for its 10,600 μ h. inductance has 75.0 μ fd. capacity. Its constants are equivalent to other compact coils.

Honeycomb and duo-lateral coils are shown at Photo D. According to the idea

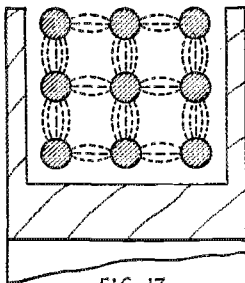

FIG. 17

length of wire, provides greater self inductance than any other type of winding mentioned. Where we consider merely the skin effect of current distribution, increas-

prevailing, it was believed that separating the turns and causing them to cross over at intervals would cause the dielectric field to be minimized and the capacity greatly reduced. This idea has been carried into special types of solenoids also. Coils wound in this manner have long been thought of as possessing very low inherent capacity. Obviously the interior field in the dielectric area is very large in these coils when compared with type E. Now, we would find by experiment that if we designed a strictly compact winding having a certain value of

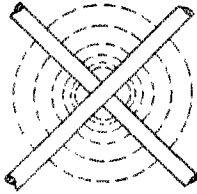

FIG. 19

self-inductance and of the same wire gauge and mean radius as a honeycomb coil, though the compact coil has smaller dimensions and the turns are very uniformly stored in a smaller cross section and should have much greater capacity, its capacity is actually only slightly greater than that of the honeycomb criss-cross type of windings. This is also true for cylindrical windings made in this manner. The familiar type of windings called "low loss" do not necessarily have lower capacity than plain

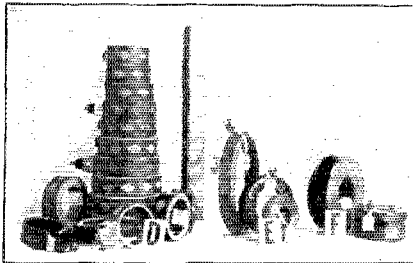

PHOTO D

cylindrical windings of the same dimensions. A study of the action in dielectrics will show that between two parallel conductors, the distribution of flux in the dielectric is fairly uniform along the dielectric flux separating the wires as in Fig. 9a. In Fig. 19 the flux is negligible where the surfaces are widely separated, and where the wires actually cross it is somewhat lumped or concentrated due to the short distance separating the wires. Since the insulation is invariably compressed at this

junction, the gradient there is very large and establishes a greater quantity of energy at such points. The average flux in the cross-over windings is, therefore, quite equal to that of the more uniformly stored energy in the plain compact windings. Also, such coils usually have some impregnation or insulating varnish applied and such material locates as beads at the points of cross-contact. However thin the material may be, it is effective in increasing the local capacity in these numerous points since it occupies a position where the electric flux is densest. Application of varnish increases capacity in these special windings more than for the same volume of material applied to any other type of winding. However, the effect of varnish is too often over-emphasized. In fact, the increase of capacity in compact windings would not exceed 50 percent in normal cases, which is not large when we consider the inductivity of varnish is often 2.5 or 2.78. Though honeycombs take characteristics of other types of compact windings and may be slightly lower in capacity, they do not permit desirable tuning in receivers, especially on the higher frequencies, and for this reason they are not desirable for frequency meters or similar apparatus. For very low frequencies,

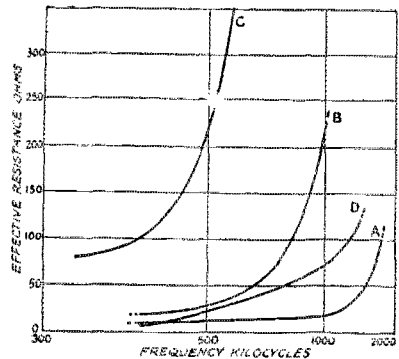

FIG. 20

where other coils would be of large dimensions, compact coils of smaller dimensions may prove of value. The curves of Fig. 20 illustrate the effective resistance of honeycomb windings. Curve A is for a coil of 133.0 μ h. and 29.45 μ fd. B is for a coil of 343.8 μ h. and 25.2 μ fd. C is a 150-turn coil of 1,174 μ h. and 25.6 μ fd. capacity. The curve D is included to demonstrate the lower resistance of a solenoid having an inductance about the same as the compact coil B, the cylindrical winding of 375.2 μ h. having but 2.43 μ fd. capacity, and though of much shorter wire length, the effect of capacity in the compact winding is quite evident. The honeycomb has several hundred ohms effective resistance rapidly ap-

proaching infinity while the solenoid at the same frequency has increased to 100 ohms. The variation of capacity with the turns and coil diameter for honeycombs of three different makes is shown by the graph in Fig. 21.

Three equal lengths of wire, each exactly 36 feet long, were wound into a solenoid, spiral and square cross-section coil. Each coil was designed for maximum inductance for the wire used. The solenoid gave 125.0 μ h. and 3.56 μ fd., the spiral 117 μ h. and 2.84 μ fd.; the compact winding gave 254 μ h. and 7.54 μ fd., showing that though the latter's inductance is over twice greater than the spiral or cylindrical windings, its capacity is also over twice greater in comparison. Next: Three coils of approximately equal inductance were designed for correct shapes using the same gauge wire and providing similar mean radii. The cylindrical type of 556.0 μ h. gave 3.18 μ fd.; the spiral 559.0 μ h. gave 4.678 μ fd., and the compact coil of 570.0 μ h. gave 10.56 μ fd., again showing that for equal lengths of wire used or for equal inductances, or equal geometrical considerations or types of windings, the compact coil,

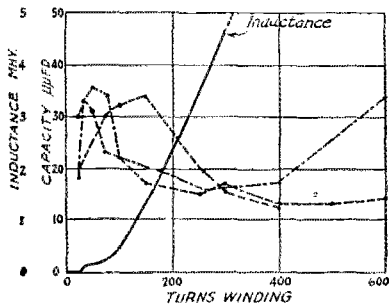

FIG. 21

as expected from theory, has much larger capacity than results from the limited space occupied by the potential acting through the windings. The comparative resistances of coils of equal inductance last described is given in Fig. 22.

TAPPED COILS

In many radio circuits one large tapped inductance coil instead of several smaller coils may be used to cover several progressive bands of frequency. Some switching device is usually provided for selection of some predetermined value of the coil inductance. It is generally believed that tapping a coil more or less seriously affects the constants, but for most normal coils the effect is over-estimated. One acquainted with electrostatical problems involving uniform charges sees a net or group of parallel taps and imagines from their appearance a very large increase of capacity

for even short taps, but since the taps project from the coil surface, the non-uniform distribution of potential and currents permit these lengths of wire to have but small instantaneous potentials between

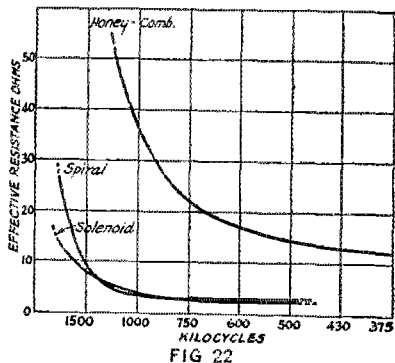

FIG. 22

adjacent wires while taps separated apart to a greater distance, though higher potential, are not appreciably affected by the dielectric between them. The actual increase of capacity due to taps is slight, providing their length is not great and if suitably separated. For long taps of, say, 2 feet in length, the capacity increase is not abnormally large if the taps remain separated. Taps brought together, or bundled as a circular section, develop a large increase of coil capacity and circuit resistance at all high frequencies. Bundled taps have the potential along the leads confined to a dielectric of much smaller volume; the flux is much larger than normal, and energy stored therein increased.

Many really efficient tuners are condemned at sight by the appearance of tapped coils within them. In fact, a tapped coil is often discarded as faulty design. An accurate idea of distributed capacity and some experience in examining tapped circuits will demonstrate that coils may be tapped without great increase of resistance, providing the leads are short and separated a suitable distance, and that their terminals are well insulated. *By providing efficient dead-end switches, the coil suffers no undesirable effects for a large number of taps.*

To represent dimensional and electrical values common in primaries of commercial receivers a solenoid was selected having the following constants: Pure inductance 374.0 μ h.; distributed capacity for the free coil, 4.40 μ fd. The coil was to be equipped with taps and its effective resistance measured with the potential induced in the coil itself, and again with the potential impressed on the winding, representing conditions existing respectively in secondary and primary circuits of a radio receiver.

To give an idea of the change due to taps the coil was first measured without taps, its resistance being given as Curve 1 in Fig. 23 where the e.m.f. is induced directly in the coil as at Fig. 2a. Curve 2, Fig. 23 shows the slight increase of resistance when the e.m.f. is impressed on the coil as in Fig. 2b. Eight leads of No. 22 wire, each 14 inches long, were soldered to equidistant points along the turns of the coil winding, each tap being separated by a celluloid spacer as shown at A in Fig. 24. From the previous free coil capacity of 4.40 $\mu\text{fd.}$, the

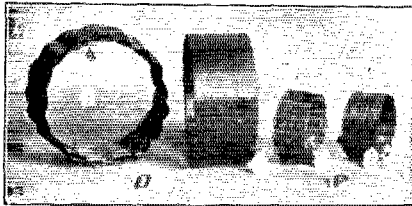

PHOTO E

addition of these taps which are abnormally long increased the value to 9.20 $\mu\text{fd.}$, which value was twice greater than the free coil capacity. Where the potential is generated in the coil its resistance is shown by Curve 3 in Fig. 23 while Curve 4 is with the potential impressed on the winding terminals. The effect of coil capacity becomes evident at 1200 kc. above which a very rapid increase of resistance shows the approaching

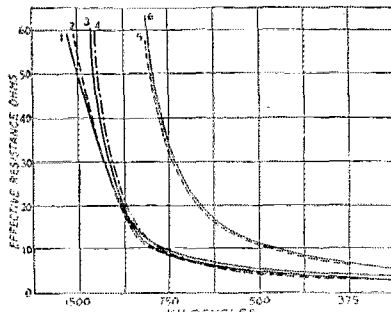

FIG. 23

parallel resonance effects occurring at a much lower frequency than for the untapped coil. Next, the separators were removed and all taps gathered together forming a bundle loosely tied with thread as shown at B in Fig. 24. At once the capacity became 19.51 $\mu\text{fd.}$ which is twice greater than for the separated taps and about five times the free coil capacity. That the coil develops much higher resistance effective for these bundled taps is shown by Curves 5 and 6 in Fig. 23. While some change of

copper resistance may be expected for the certain redistribution of coil currents, the effective resistance has become practically infinite at frequencies that had before developed but 20 ohms effective resistance. While the plain coil with long insulated taps would have a limit of 1500 kc. the coil with bunched taps will tune to higher than 860 kc. without appreciably increasing the resistance. At 500 kc. the addition of well separated and insulated 14-inch taps increased the resistance 15 percent, while the bunching together of the taps increased effective resistance 228 percent, and while such bunching is never resorted to, exactly the same effect with short taps may be observed where leads of this variety run close and parallel to metal shielding material. Finally, by cutting the bundled taps to 6-inch lengths the resistance increase for all normal frequencies was too slight to permit the location of additional curves, and no increase whatever could be observed for 6-inch taps properly spaced and insulated. The same experiment was

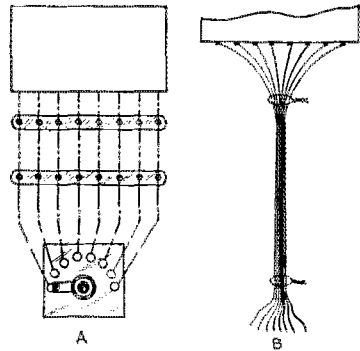

FIG. 24

repeated with a much smaller coil resembling primaries of broadcast receiver couplers. The results were the same excepting of less magnitudes since the constants were much smaller.

We have considered the effects of coil capacity as a lumped capacity without resistance. Leakage may occur where the taps terminate at contact points set into some solid material. The actual terminal absorption and leakage loss is negligible where taps are thoroughly insulated. A large tapped coil was equipped with 6-inch leads terminating at 8 contact points and one switch-arm set into a small block of laminated bakelite, Fig. 24a. For the free coil alone, at 1,000 kc. the effective resistance was 18.2 ohms. For the additionally separated 6-inch taps this became 20.8 ohms, and with the terminals attached to contact points it remained 20.8 ohms show-

(Continued on Page 45)

We Open a Station-Description Contest

FOR THE BEST descriptions of amateur radio stations published in its columns during the year 1929, *QST* offers a handsome cup and a series of cash prizes. Our purpose is to stimulate A.R.R.L. members to send in photographs and descriptions of "1929-type" stations, so that the publication of these articles may lend further help to all amateurs in the technical rearrangement of station apparatus for the new conditions which 1929 has brought to amateur radio.

Through the medium of its Technical Development Program, the A.R.R.L. has presented its membership with much sound information on the rehabilitation of various items in the amateur station. These articles have outlined principles and, we hope, in many cases have changed the angle of view as to what is desirable in amateur apparatus. But it is not to be hoped that we have told the entire story in those articles. From the new background provided by the Program articles, the native ingenuity of practical amateurs can be counted on to carry forward the thought, and without doubt there exist to-day a large number of finer amateur stations than ever before. Descriptions of them would release much new information. A station, too, is something more than a transmitter and a receiver and auxiliaries—it is an entity itself, a smoothly-working machine arranged for two-way communication—and no set of descriptions of separate pieces of apparatus, however valuable, can be a guide in the creation of the Ideal Station. From the early days of the game in this country, photographs and descriptions of actual stations in the "Amateur Radio Stations" department of *QST* have constituted what might be called the School of Station Design and Arrangement in A.R.R.L. circles. In middle 1928, with 1929 rebuilding upon us, *QST* discontinued the publication of the "1928-type" stations, simply because they weren't good enough. To-day it is a different story. The stations exist and we want to revive that interesting department in *QST*, not alone for the technical value attaching to the descriptions but for that vague but undeniable emotion which we all experience when we meet, on the printed page, an old friend of the air.

AND SO—

To encourage members to write up their 1929 stations for publication, we offer a beautiful silver cup for the best description published in our pages in the issues dated 1929. To the second best description we will award a cash prize of \$25, to the third best \$15, and to the fourth best \$10. We have

been unable to prepare a description of the cup for this issue but will display it in our next number. It will be very worth while, not alone for its intrinsic value but for the honor and prestige it conveys to the holder. The rules will be very simple:

AND HOW!

1. The Editors of *QST* will be the judges. The awards will be announced in *QST* for January, 1930.

2. Entries will be received only from members of A.R.R.L. (By ruling of the Board of Directors, members of the A.R.R.L. Hq. staff may not participate.) The member may live in any country, the station may be located in any country. The station must be a bona-fide amateur one.

3. Under normal conditions, but one station description per month will be printed in *QST*. The best description on hand each month, in the opinion of the Editors of *QST*, will be published. The selection will be made from all those received up to that date—not merely from those received in the current month. The final awards will be based on a review of the descriptions thus published during the year. The last date for the receipt at Hartford of descriptions under this 1929 program is October 10th—for the December issue. Bear in mind, though, that at least one description will be published each month, and that the awards will be made on the basis of those thus published.

4. Manuscripts must be neatly written or typewritten, on one side only of the sheet, double-spaced. See articles in 1928 *QSTs*, describing well-known stations, for a general idea of style. Write too much rather than too little. Describe the station thoroughly, particularly with respect to novel and unusual features. The manuscripts are to be property of *QST*.

5. The manuscript must be accompanied by photographs and by pencil or ink drawings sufficient to convey an adequate illustration of the station apparatus, lay-out, and points of novelty. Photographs must be clear enough for magazine reproduction. In general, they should be 4"x5" or larger, sharp, rich in contrast, and preferably "glossies". The product of a commercial photographer practiced in industrial photography is infinitely superior to that of a "portrait photographer". If you take the photographs yourself, read carefully the directions on page 40 of this issue of *QST*. If you use sufficient care you can get perfectly satisfactory pictures. Poor pictures are useless. Have at least one general view of the station, plus close-ups of the

transmitter and the receiver and of any other unusual features of the station, such as an unusual antenna system, a novel switching arrangement, etc. Submit a complete wiring diagram of the station, showing all constants, and rough sketches explaining the construction of any new or unusual features of apparatus. Photographs may be returned to entrants, at the end of the year, if postage for that purpose accompanies them.

6. Power will *not* be a consideration in this contest. The best description may be that of a 7½-watt station. A low-power station may be a much better job of a station than one whose transmitter uses a kilowatt.

The awards are to be made on the apparent relative technical goodness of the stations whose descriptions are published, and the selection of the description to be published each month will be made on the same basis. The following points will be taken into account by the judges:

- Ingenuity employed, in design construction, and arrangement
- The transmitter
- The receiver
- Power supply for transmitter
- The antenna system
- Change-over arrangements
- Provisions for monitoring transmitter output for quality
- Provisions for knowing accurately the emitted frequency of transmitter
- Provisions for working on different bands
- Provisions for rapid and accurate shift of frequency within each band
- The goodness of the keying system
- Workmanship
- Extent to which the apparatus is "home-made"
- Interest and intelligibility of the descriptive manuscript and illustrations

ALL SET?

It seems desirable to point out the large number of nice fat juicy worms accruing to the early birds in this contest. That is, the odds favor the early entrant. Whose station, for instance, gets published in our May number? And in the June issue? Late in the year, on the other hand, there may be a considerable number of descriptions arriving, from which, in all probability, but one can be published each month. We urge, then, some speed in preparation, and suggest that descriptions be forwarded as early as possible. Address simply the Editor, QST, 1711 Park St., Hartford, Conn.

Write us if anything is not clear. Let's go, OM's! QST's cup will be something you will be proud to possess. A cash prize will buy a needed piece of equipment or at the least will make us pay for your photographs. And on top of this, particularly

if you're already rich, will be the consciousness that the publication of your description will do much to help other fellows to put into practical use the new technical ideas that are working successfully in 1929. We're all set here—come on with your manuscripts.

—K. B. W.

Revised U. S. A. Amateur Regulations

(Continued from Page 26)

any form of entertainment, or to conduct any form of commercial correspondence.

No person shall operate an amateur station except under and in accordance with an operator's license issued to him by the Secretary of Commerce.

January 1, 1929.

W. D. TERRELL,
Chief, Radio Division.

New England Division Convention

Springfield, Mass., April 19th and 20th

THE sixth annual regular A.R.R.L. convention is being sponsored by the Springfield Radio Association, and is to be held at the Hotel Kimball, Springfield.

A tentative program shows that the Springfield boys are going to try to outdo all previous conventions and with this in view it is believed that the delegates will find it well worth while to attend.

Director Best will make his first appearance in his official capacity. A.R.R.L. Headquarters are planning to have a good delegation besides the official representatives in the persons of Communications Manager Handy and Treasurer-Fieldman Hebert.

Come all! And if you want any more information write to C. C. Cunningham, Sec., rear 76 Cortland St., Springfield, Mass.

Strays

Recent cleaning operations at Beekley's house revealed two UV-204-A crates. The crates, it was remembered, once contained his two 204-A's which were relieved from voltage overload at WISZ several months ago. For the particular benefit of the low skunk who stole the tubes Rodimon would have it known that he regrets sincerely that the crates were not at the WISZ shack at the time of the theft. Conscience stricken as he is, Rodimon has arranged to place the crates at the rear of the Beekley garage. In this way the present holder of the tubes will be able to collect containers denied him at the time of the snitching without the slight inconvenience of breaking into the house.

The Return of the Native

By "Felix"*

IF YOU GUYS will QRT the tossing of the Bull Durham about voltage feed vs. current feed and quit grousing about the 1929 frequency reductions for a few minutes, I'll whisper mi sad tidings into your brittle, shiny tin ears.

Back in 1927 I was ringmaster for 2 UX-210 jugs wid 500 volts stacked on their necks. I allus kept oil on the troubled rectifier waters an' kept the shack clean an' dustless. Besides belonging to the A.R.R.L. RCC, I had a pretty gud AWOL certificate fm the State Teachers College hr in Denton.

I mfg'd hot dogs an' hamburgers at the OM's hash emporium on the side. There was where I met Lou. Nw, you amp-snatchers if you don't believe there's truth in the gag I'm QST, just cum down here in Texas an' I'll introduce u to Lou—the rest will take care of itself.

This fair snuff hollers fr more scientific study. Boy, she's as gud lookin' as a new RCA 500-watt self-rectified xmtr. She cums in like a 2 Kw. d.c.c.w. on a frosty nite! She's got more curves than 5AKF's 100-foot tower.

Hr in a college town a guy without a leapin' lena or sum kind of bolt cruntcher is abt as popular wid the YLs as a 2 Kw. Thor is wid a 5 watter, so I haff to sink mi dough tt I'd saved for a new 203-A in on a 2nd- or 3d-hand collection of new and used fliv parts. She looks the part of a moulded mud socket in a 5-mtr set, but she runs.

Everything is OK for a while. W5NW skoffs at me fr fallin' fr this hide but W5AA remains silent on the subject, as he is already blest wid a mrs. There is a lot of moonshine in Texas on these winter nites—both kinds of moonshine—an' instead of QSOing the Antipodes I'd be out havin' a two-way confab wid yl-1LOU. I was gg to show these wise birds that they were off when they said that rdo es wimmen wouldn't mix.

Abt the time tt dust got to collecting on the phone diaphragms an egg blew into town fm down W5RG's way. He was a big athlete an' hung on the wheel of a roadster tt made mi cement mixer look like a chewed-up motorcycle. Lou is hay-wire in the clock-works abt these eighth-witted pigskin pushers, so she suggests that I go in fr athletics.

"Is poker an' crap-shootin' athletics?" I asks her.

"Don't be sil," sez she. "Now, Ken made the first string at SMU last winter."

"Yeh," I skoffs, "an' I made Australia, N. Z. an' S. Africa last winter!"

"I thought," she simpers, "that they had been made for several million years. Magellan discovered Africa, or was it Cecil Rhodes?"

Which shows that YL's brains revolve in a counter-clockwise direction, like left-hand threads.

It cost me a big box of candy to induce this frill not to QST a full set of bank-wound hysterics. Finally everything got patched up at the cost of my Acme plate transf to W5AA.

One nite I gives Lou a CQ urgent on the telephone wid AWOL fr an answer. I tried it 3PMs on a strait; it doin' me about as much gud as it did Marconi to call Mars. The ole fossil who kept the boarding house where Lou got her QSLs sed tt there was a bird in a big ice wagon hauled her off not two minutes before—all of which sounded like sloppy-fisted a.c. in hevi QRN to me!

That PM while I was raising the plate voltage on the dogs to mke 'em hot, this Ken mug comes gallopin' up in his chug-wagon with this Lou by his side. There was spare room in the front seat fr a Baby Grand piano!

"Two hamburgers please," she warbles sweetly, "and say, do make it QRQ. We're late to the Country Club hop!"

"Sorry lady," sez I, "but we're just out. I'll order sum from Sears-Roebuck in the mng."

"You'll get cute!" roars this Ken animal, climbin' out of his go-buggy suggestive like.

Valour is one thing an' a bakelite eye is an entirely different thing, so I figgers where brains is in the minority it's foolish to get funny, so I slowly retracted to the emporium, takin' abt 10 ft to a step.

Naturally I swears off this skirt, but she looks so bewitchin every day in Physics lab that it wasn't long before I sent out an SOS. Her QSB (1928 usage) on a family reunion is truly a QSB, an' she lets some hints abt mi curious lookin' struggle buggy. Truth, it did look like somebody had playfully socked it here n' there wid an air-hammer. So next day I journeys forth to the 2nd hand can-venders. The robbers allows that it'll cost me 100 plunks to QSV to the wheel of a classy-lookin' slitely-used land-go'in' rowboat they have.

When I goes into the shack fr mi 7 an a half'er an' mi meters, not to mention a 1st class receiver an' storage batteries, the dust

*W5LS, Denton, Texas.

is about a half an inch thick on the table. Now W5ATU hears OA and OZ as QSA as when his ma calls him fr chow.

Usta, the hard-workin' lite meter groaned day an' nite, tryin' to climb the wall, n' the lite bill looked as big as the National debt, bt nm. It onli takes 2 screws to hold it in place after I bought this oscillating fresno. But the gasoline bill now looks like the invoice to the GE warehouse!

"Have you QRT twiddlin' wid those funny little wires an' gegets?" asks Lou one PM at an all-College hop.

"Yep," sez I, "not QSVing, bt you surely look the part of the queen of Sheeber this PM!"

"You're just downright funny," sez she.

Which goes to prove that there ain't no use tryin' to get in resonance wid these YL's brains as they are allus on the QSV.

The bozo who was furnishin' the high barometer readin fr the clarinet in the orchestra shore ran a mean scale of kc., an' I got all excited as I was in 1923 when I pegged mi first 9.

"Let's QSV to the moonlite," I suggests, thinkin' of a nice bench out by the swimmin' pool.

"I'd love it!" she says. "It" meanin' the moonlite.

"And HOW!" I ejaculates—meanin' her.

I proceeds to open the antenna-ctp circuit, close the key, tune the tank circuit to a given frequency, recouple the antenna circuit an' tune the two circuits to resonance, an' then test for a change of frequency. Pretty soon I was radiatin' on a romantic frequency.

"Lissen, fair rib," I says, "would you er er . . . aw heck, yu know what I mean."

"You foolish, funny boy," she QSOs, insultin' mi manly pride, "didn't yu know that Ken and I are to be married at the end of this term?"

* * * *

W5AA wanted ten bucks for *my* plate trans! It cost me 15 fr mi BT shortwave set an' batteries.

A.C. sure sounds like somebody pourin' gravel on a tin roof, an' it's awfully cruel on UX-210s to run 'em without a fil volt-meter an' onli a flivver headlite bulb fr an ammeter—but the table's clear an' *there isn't a speck of dust on it!*

Photographs For QST

FROM THE LOOKS of most of the pictures that come in to QST one might think it a difficult thing to get good pictures of radio apparatus. On the contrary, very excellent pictures can be taken with the simplest of cameras if sufficient care is taken. There are a few fundamental rules that, if followed, will invariably pro-

duce a sharp, deep, picture with good contrasts—admirably suited for half-tone reproduction.

Here they are:

1. Use a *very small* lens aperture; never over U.S. 32 (f22) and better U.S. 64 (f32). This is the most important rule of all and if not followed one may as well give up hope of the picture being any good. This means a long exposure—but most radio apparatus will sit still if left alone, so there is no objection to making a half-hour or hour exposure. A simple single lens is just as good for this purpose as a rectilinear or an anastigmat—so don't worry if your lens didn't cost a lot of money. If the picture will not come out with normal development or if the negative is "thin," take the picture again and make the exposure lots longer. Don't try to "force out" a thin negative by over-development—it always results in a muddy picture.

2. The best place to take the picture is in a room where there is good light from one or more windows but little or no direct sunlight. Place the apparatus on the side of the room opposite the windows, with the back of the camera toward the windows. Such pictures can be taken out of doors if the day is cloudy but *direct sunlight is useless*.

3. Prints should be made on glossy surface paper. Matt surface is very poor for this purpose.

4. The larger the picture the better, but a small sharp picture is much better than a large "fuzzy" one. However, the size must be governed by the subject to be taken. For instance, $3\frac{1}{4} \times 4\frac{1}{4}$, or even $2\frac{1}{4} \times 3\frac{1}{4}$, may be large enough for a single piece of apparatus but for a group of apparatus 4×5 or $3\frac{1}{4} \times 5\frac{1}{2}$ is about the smallest that can be used.

5. Get a professional photographer to take the picture for you and *keep clear of portrait photographers* if possible. Get a man who calls himself a "Commercial Photographer" and is used to taking pictures of machinery, etc. Portrait photographers always take "fuzzy" pictures. If you can't get any other kind, though, get a portrait photographer and sit on his neck till he agrees to use an aperture not larger than U.S. 32 (f22). Remember that what is wanted is a picture just as cold, hard and sharp as possible. The half-tone will always be much softer than the picture so, unless the picture is very sharp to start with, all the detail will be lost in the half-tone. If a commercial photographer does the job, call to his attention the possibility of making a better picture by using a panchromatic plate. Not all photographers have facilities for handling panchromatic plates.

—F. C. B.

Experimenters' Section

IT APPEARS from this month's correspondence that most of our experimenters have turned their thoughts toward their "1929" receivers. The peaked audio amplifier recommended for obtaining high selectivity in the reception of code signals has been given a considerable amount of attention by those who are desirous of employing their receivers not only for code work but also for the reception of modulated signals. The modulated signal, of course, requires an amplifier of comparatively flat frequency vs. response characteristics and two interesting solutions to the problem have been submitted.

AN AUDIO FILTER WITH VARIABLE PEAK

Editor, QST:

Under the present circumstances, a sharply peaked filter such as described by Ross A. Hull in his article "High Frequency Receivers For The Coming Year" appearing in the November issue of QST is out of the question, in a practical sense, for general all-around work.

It has occurred to me that while it might be advantageous to utilize the full advantage of the sharply-peaked filter on some

of that circuit to be adjustable to suit the taste and the particular signal being received.

The coil and condenser combination described in the article tunes much too sharply for present-day conditions but when the decrement of the circuit is varied by the amount of resistance in it so as to affect the sharpness of the peak, this filter becomes

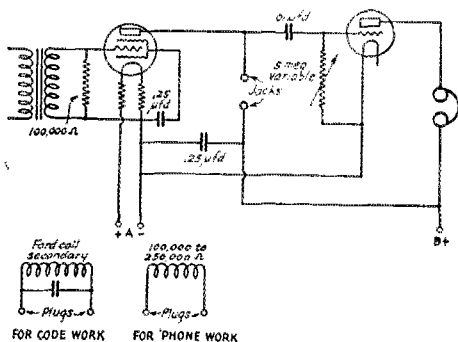

FIGURE 2

In this arrangement of the audio amplifier, a resistor may be employed instead of the tuned trap circuit which gives high selectivity. It does not allow a continuous adjustment of selectivity but when the resistor is employed, the amplifier has a much statter characteristic than can be obtained with the use of a resistor in the trap circuit. Volume control is by means of the variable grid leak in the last tube circuit.

one of the most convenient of "amateur kinks."

—Milton Ausman,
1560 Sacramento St., Apartment 102,
San Francisco, Cal.

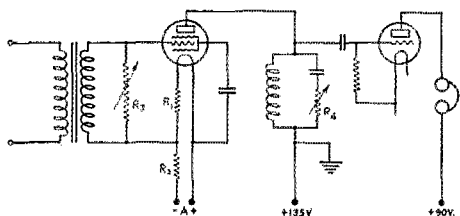

FIGURE 1

The use of a variable resistor, R_4 , in the tuned coupling circuit permits the sharpness of resonance to be varied, thus allowing the characteristics of the amplifier to be changed from the very sharp peak when no additional resistance is in the circuit to a much broader peak when the resistor is adjusted for its maximum value. R_1 and R_2 are 10- and 3-ohm filament resistors. R_3 is a 200,000-ohm Frost variable employed as a volume control. R_4 is a 10,000-ohm Frost variable to control the selectivity of the amplifier.

signals, there are occasions when the use of such high selectivity would be a distinct disadvantage due to the characteristics of the received signal.

The advantages of an amplifier, the selectivity of which may be controlled at will, are many and by the simple introduction of a 10,000-ohm resistor in the tuned impedance output circuit of the screen-grid audio amplifier will allow the sharpness of resonance

Editor, QST:

I am enclosing a diagram of an audio amplifier similar to the one used in the 4-tube "1929" receiver.

Instead of using another receiver for phone or broadcast work, the screen-grid amplifier unit can be adapted to this work by employing a plug-in resistor instead of the Ford coil and condenser arrangement described.

These coupling units may be mounted on bakelite squares with a pair of General Radio plugs or a ready-made base such as is manufactured by General Radio can be used as the receptacle for them if such is desired.

For volume control, a variable grid leak connected between the grid and filament of the last audio tube is used. It should have

a maximum resistance of 5 megohms and can be a Universal Clarostat or some similar unit.

I hope that this will prove useful and not clutter up the receiver too much with plug-in units.

—Harry F. Washburn, W2CL,
354 East Mosholu Parkway,
New York City, N. Y.

A JUNK BOX TRIMMER CONDENSER

The junk box has rightfully been considered by many as the genesis of much that is found in the amateur transmitter or receiver. While the final product may be weird and unusual in its appearance and even, perhaps, lack the dignity that goes with an

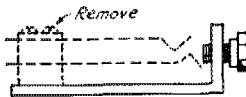

FIGURE 3

The ancient phone jack which became the basis of the trimmer condenser. The contact springs and insulating "stack" are removed to make way for the new "works."

"accepted" piece of standardized equipment, it usually fulfills the purpose for which it was intended and is, therefore, a true child of its mother, "necessity." One experimenter's visit to the junk box is chronicled below. In reading it one might hesitate a moment over the moral contained in the first paragraph or so.

Editor, QST:

While experimenting with a new "1929" receiver, I desired to make use of a small variable condenser as a trimmer across the main tuning condenser. However, I found that W6DYJ, a brother ham who is always borrowing my junk (when I am not borrowing his), had made way with all of my midgets.

My first thought was to rush in to his shack and violently tear all of my parts out of his set but a moment's consideration showed me the folly of such an act inasmuch as I had a couple of his variable resistors in my receiver.

As a last resort, I turned to the old faithful junk box from which I extracted an ancient phone jack. I removed the prongs and insulation from it, keeping only the frame with its threaded head. This is shown in Fig. 3.

About $\frac{3}{4}$ " of the frame was bent down at right angles and a wooden shaft fitted into the hole provided for the insertion of the plug. A short piece of $\frac{1}{4}$ " dowel stock

works fine although the shaft I used was obtained from a "Tinker-Toy."

The shaft should not wobble in its bearing and should be cut long enough for a small knob which can be tightened from the front.

The rotor plate consists of a small rectangular piece of brass about $\frac{1}{2}$ " by $\frac{3}{4}$ ". It is mounted on the other end of the shaft as shown in Fig. 4. Its size may be varied to suit individual needs and in my particular case, the total capacity was not sufficient to completely detune a signal which had been tuned in on the main tuning condenser.

A small brad is driven through the shaft on the inside of the jack to keep the rotor plate from touching the stator. One end of this brad projects from the shaft and acts as a stop. After mounting the condenser on the panel, a second brad is placed in front to prevent any backward and forward motion of the shaft. Flexible leads are soldered to the stator and rotor, the frame of the jack being connected to the rotor of the main tuning condenser.

This trimmer can be built in about 15 minutes, costs very little, and is an efficient, single-hole mounting, affair.

—Orin C. Lewis, W6DZK-W6EFZ,
1928 Lewis Ave., Long Beach, Cal.

A FIXED CAPACITY IN SHUNT OF THE VARIABLE CONDENSER

William Roberts, W2BPZ-W8BQK of 1207 Union St., Schenectady, N. Y. tenders a suggestion for the making of a variable condenser having a section the capacity of which is approximately constant throughout a complete rotation of the dial in addition to the usual variable capacity section. Such a unit might be employed in the monitor in order to obtain an effective High-C circuit and at the same time have but a small frequency range which allows an open scale for the various amateur bands.

One or more of the variable plates can be shifted 180 degrees so that as the condenser

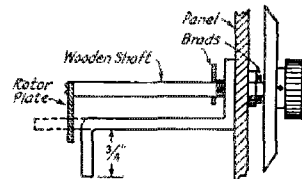

FIGURE 4

A general view of the finished product. A couple of brads driven through the wooden shaft prevent end-play and wobble. It is essential that the shaft fit snugly or the attendant wobble will cause erratic variations in the capacity of the unit.

is normally run from maximum to minimum, these plates will go from minimum to maximum and we may roughly consider that a

given pair of plates that are 180 degrees apart will be equivalent to a circular plate of equivalent area.

The relative capacities of the fixed and variable portions can be adjusted by increasing or decreasing the number of plates that are on a given side of the shaft. For any given rotor assembly, the highest fixed capacity and lowest variable capacity will be obtained when there is one more plate to one side of the shaft than there is on the other side or 180 degrees displaced from the first mentioned plates. The general idea is illustrated in Figs. 5 and 6.

TUNING CONDENSERS IN SERIES

Perhaps many have constructed new receivers having a large condenser in series with a small condenser so that the amateur bands may be spread over the tuning condenser dial. Ralph F. Hunter, W2AKH, of 180 Victory Avenue, Schenectady, N. Y., built such a tuner and had some difficulty with hand capacity effects because both rotors could not be connected to ground.

In an endeavor to reduce the capacity effects, he employed a metallic shield behind the regular panel only to find that under these conditions, the main tuning condenser which was of course located on the grounded side of the circuit, failed to cover the bands desired.

The trouble was found to be due to the fact that a Vernier dial was employed to control the tuning condenser. The rotating portion of the dial consisted of a brass disc which was connected to the rotor plates of

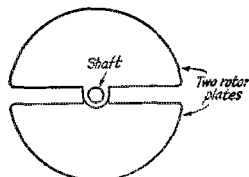

FIGURE 5

An end view of the rotor plates showing the two sets of plates 180° apart on the shaft.

the condenser through the shaft. Thus, the shield and this disc acted like the two plates of a condenser with the panel material as dielectric. Its capacity in addition to the capacity between the end plate of the condenser and the shield gave a combined capacity which was shunted across the tuning condenser. It was large enough to materially affect the tuning condenser's range. This is shown in Fig. 7.

The trouble was remedied nicely by setting the adjusting condenser about 4" in back of the panel and extending its shaft by means of a bakelite rod. This reduced to a very small value the capacity of the adjusting

condenser to the shield and ground eliminating the shunt effect across the tuning condenser and allowing the full effect of the small tuning condenser to be had. Its 50-micromicrofarad capacity is now ample to cover all bands in fine shape. At the same time, it is still possible to employ shielding and hand capacity effects are entirely eliminated.

LOW DETECTOR VOLTAGES

The circuit arrangement shown in Fig. 8 is recommended by John J. Orysik, W2BEQ, of 1724 Dean St., Brooklyn, N. Y. It will be noted that no plate battery is employed, the plate voltage being obtained from the "A" battery. A 30-ohm rheostat is in the positive leg of the filament circuit of the 171-A detector tube and it is the drop across this

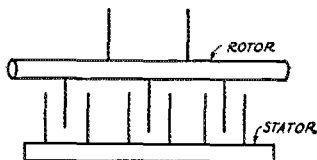

FIGURE 6

In this side view there are five rotor plates, three of which are shifted 180° from the other two. The two upper and two of the lower plates form the "fixed" section while the third lower plate gives the variation in capacity.

resistor that is applied to the plate circuit. This voltage can be reduced still further by means of the resistor, R3, much as is the case in the usual detector circuit using resistance control of regeneration.

No ground connection is used and the circuit oscillates quite readily. It is extremely quiet in operation and it is difficult to tell if the circuit is oscillating or not by listening. The signals stand out very prominently because of the very quiet operation of the set. Because the set is oscillating but weakly, the regeneration control can be set and left undisturbed when tuning over the entire range of the particular coils used.

NOTES ON "A FREQUENCY METER COMBINED WITH YOUR RECEIVER"

Editor, QST:

I should like to offer a few practical hints in regard to the construction of the set described on page 41 of the December, 1928 issue of QST. The set consists of a receiver and a frequency meter built into the same assembly and permanently coupled together. In the course of constructing one, I ran across a point or two that might be of interest to others that are contemplating building such sets.

The coupling condenser between the frequency meter and the detector can easily be

arranged by running the lead from the detector plate connection to one of the unused socket posts of the frequency meter. This may give sufficient coupling but if more is desired, a turn or two of wire around the form supporting the frequency meter coil and connected to the tube base pin corresponding to the socket terminal to which the plate lead is connected will give ample coupling. This will allow independent adjustment of coupling for the various coils. In this way precise adjustment for a given coil can be made and maximum results can, therefore, be obtained.

In winding the coils it is advisable to finish permanently the equipment mounting and wiring, including the frequency meter and coupling lead. A test coil can be wound for each band in order to obtain a rough idea as to the number of turns required. The permanent coils can then be wound with two or three additional turns. The extra turns can then be removed although it must be remembered that the number of tickler turns as well as the coupling to the frequency meter will affect the range of the receiver materially. This is very noticeable when a small tuning condenser just allowing full coverage of the bands is employed, and it is possible to shift the tuning range

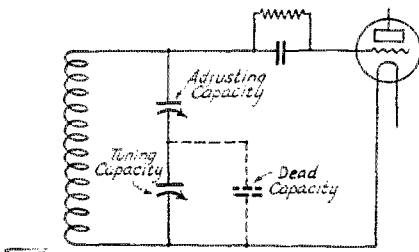

FIGURE 7

The condenser for adjusting the frequency range is located at the grid end so that the actual tuning condenser may have its rotor plates at ground potential. The capacity of the adjusting condenser to ground is in shunt to the tuning condenser and materially affects the tuning range of it. This capacity is shown in dotted lines.

completely over a band by making any large change in these other coils. It is advisable to adjust all the coils to give satisfactory operation and continually make the necessary adjustments which may be required by the other circuits as the grid coil of the detector is reduced in size. If this is not done and the grid coil is cut to exact size, reducing the size of the tickler and possibly that of the coupling coil will probably throw the range off sufficiently to require the work being done over.

If the condenser in the receiver is of the same size as that in the frequency meter circuit, more turns will be required for the

frequency meter coil than for the grid coil of the detector because of the difference in fixed capacity across the coils. In my particular case, 18 turns were sufficient for the detector circuit to reach the 7,000-kc. band,

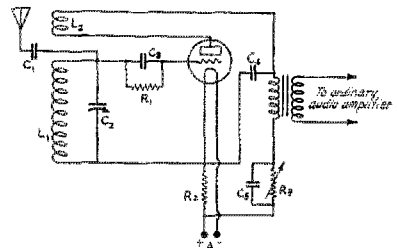

FIGURE 8

The plate voltage is obtained from the drop across the filament resistor, R_2 . R_3 allows further variation by means of which the circuit can be prevented from oscillating. The constants are as follows:

C_1 —Angle bracket condenser.
 C_2 —50 μ fd. R_1 —10 mega
 C_3 —100 μ fd. R_2 —30 ohms
 C_4 —250 μ fd. R_3 —50,000 ohms

If an r.f. choke is necessary in the lead between the tickler and audio transformer, it may consist of about 100 turns of No. 30 d.c.c. wire on a $\frac{1}{4}$ inch diameter form.

while 28 turns were required in the frequency-meter circuit.

One method of eliminating quite a bit of the work required in the matching of the detector coils to the condenser and circuit is to use very small Lorenz coils which are mounted in tube bases and supported only by their leads. The coils are wound of No. 18 annunciator wire and are very rigid although still permitting easy adjustment in regards to the tickler windings.

It would, however, be best to wind the frequency meter coils on the tube bases in the usual fashion. They may then be coated with collodion on your own pet compound to prevent shifting of the wires with its attendant loss of calibration.

Edw. A. Block, W5AFB,
 807 West Page St., Dallas, Texas.

COUPLING TO THE MONITOR

The circuit diagram appearing with the write-up under this caption on page 80 of the February issue was incorrect. The secondary of the coupling transformer should be connected in shunt to the phones rather than in series with them as shown. If the series connection is used, no monitor signal will be heard when the tube filament is not lighted.

FADING

We have a letter from W. E. Bostwick, 206 Willard Wry, Ithaca, N. Y., who states that he is working in conjunction with Prof.

Ernest Merritt of Cornell University upon the problem of fading. They have done a considerable amount of measurement work on frequencies between 500 kc. and 3000 kc. during the past and are now directing their attention to the region between 7,500 kc. and 25,000 kc.

In order that their results will be as complete and exact as possible, they feel the necessity of obtaining reports upon general operating conditions over the entire country. In this way they can more accurately determine just what effects may be discounted as due to general conditions and what other effects deserve more careful and extensive consideration.

They are now deeply interested in reports on general conditions and, in particular, reports on the reception of foreign signals in the 14,000-kc. band during the past four or five months in order that they may check some of the data already collected. Any amateur in a position to supply such information will assist greatly in the work by forwarding it to Mr. Bostwick. In addition to reports covering these conditions of the past, they are desirous of getting in touch with men who would be interested in supplying monthly reports on general conditions during the next few months.

A transmitter is being operated under the call letters of W8ACM and employs directional transmission with different types of polarization. Reports on the reception of these signals from any distance whatever will be of great assistance in the compilation of the data being assembled. Just note a simple report on a post card and drop it in the mail box.

Mr. Bostwick will be glad to receive all reports at the above address and those who are interested in forwarding regular reports each month should get in touch with him by mail.

The Design of Inductance Coils

(Continued from Page 36)

ing that well insulated switch points cause negligible increase of coil resistance. These same contacts were next mounted on a similar block of kiln-dried cypress of the same dimensions as the bakelite product, and although the wood had been thoroughly dried, the coil resistance increased 248 percent, becoming 51.5 ohms at the same frequency. After permitting the wood to take up moisture during 2 hours in a room of 71 percent relative humidity, a further increase of 8 percent caused the resistance to become 56 ohms. This should demonstrate the effects of poor insulation at the terminals for this normal case. There was no increase of distributed capacity evident after attaching the contact points. In fact,

for several similar experimental trials the capacity effects due to very large contact points when set into material of high inductivity is negligible, usually much less than 0.2 or 0.3 μ fd. Finally: Effective resistance of spirals and solenoids is appreciably increased by the use of *abnormally* long taps. Taps, when used, should be as short as possible and separated apart not less than one-fourth inch and carried at some distance from shields. Coils may have fairly long leads and taps without a great increase of capacity and consequent effective resistance if dead-end switches are used.

Roanoke Division Convention

Charlotte, N. C., March 8th and 9th

THE Charlotte Amateur Radio Association are sponsoring this year's annual A.R.R.L. Convention, and extend a cordial invitation to all members and radio amateurs to attend the convention.

Sec. Ralph H. Perry, W4PR, 205 Chase Avenue, Charlotte, North Carolina, requests that all those interested in the forthcoming convention, write him a note, letter or post-card and say they are coming.

The Chamber of Commerce will be the Mecca of all hams.

Strays

On January 2d the Department of State announced that the International Radiotelegraph Convention of 1927 had, up to that date, been ratified by the following governments: United States; Canada; Austria; Belgium, including the Belgium Congo Colony and the Mandated Territory of Ruanda-Ruandi; The Netherlands, including the Dutch East Indies, Suriman and Curacao; Great Britain; British India; Norway; Denmark; Italy; Finland; and Morocco. We presume that word is enroute from many other countries that ratified late in the year, and that many others that did not do so by the first of the year will do so very shortly. Our amateur interest in this matter is because of the fact that countries which ratify the treaty must adhere to its terms, including the business of keeping commercial and government stations out of the exclusively amateur bands, while against countries that do not so ratify we have no recourse. Mexico's representatives, for example, signed the treaty but Mexico is not yet reported as ratifying it, and Mex stations are being heard in our 7000 band. It is, of course, to be both hoped and expected that there will be general observance of the treaty.

Message Handling Between U. S. A. and Canada

IT WILL be remembered, from earlier reports in *QST*, that international message handling by amateurs is forbidden under the terms of the Washington Convention "unless the interested countries have entered into other agreements among themselves." Early in 1928 the A.R.R.L. undertook to bring about such an agreement between this country and Canada, for there is no international border in our amateur radio and we have long enjoyed free interchange of traffic with our Canadian members. Formal proposals eventually were made by Canada, and in our Government were handled by the Department of State, resulting finally in an agreement whereunder Canadian and U.S.A. amateurs may exchange messages. The messages, however, must be of such nature as would not normally be sent by any existing means of electrical communication, except during emergencies or from isolated points not connected by any regular means of electrical communication, and in both of these exceptions the amateur has the obligation of putting such messages on the established commercial telegraph system at the nearest possible point. It is to be understood that this refers only to international traffic between the two countries.

The matter will be more clearly understood after a reading of the following statement made public by the Department of State:

Arrangement between the governments of the United States and Canada, effective January 1, 1929, concerning the exchange of communications between private experimental stations in the United States, its territories and possessions, and Canada:

Article 6 of the General Regulations annexed to the International Radio Telegraph Convention signed at Washington on November 25, 1927, contemplates that the exchange of communications between private experimental stations in the countries which are parties to the Convention shall be regulated through an understanding between the interested Governments.

"Article 6.—Private Experimental Stations: 1.—The exchange of communications between private experimental stations of different countries shall be forbidden if the administration of one of the interested countries has given notice of its opposition to this exchange.

"2.—When this exchange is permitted the communications must, unless the interested countries have entered into other agree-

ments among themselves, be carried on in plain language and be limited to messages bearing upon the experiments and to remarks of a private nature for which, by reason of their unimportance recourse to the public telegraph service might not be warranted."

On October 2, 1928, the Minister of the Dominion of Canada proposed that the Government of the United States enter into an agreement with the Canadian Government which would permit Canadian private experimental stations to handle messages coming within the following classes with the United States and with the Philippine Islands after January 1, 1929:

"1. Messages that would not normally be sent by any existing means of electrical communication and on which no tolls must be charged.

"2. Messages from other radio stations in isolated points not connected by any regular means of electrical communication; such messages to be handed to the local office of the telegraph company by the amateur receiving station for transmission to final destination, e. g., messages from expeditions in remote points such as the Arctic, etc.

"3. Messages handled by amateur stations in cases of emergency, e. g., floods, etc., where the regular electrical communication systems become interrupted; such messages to be handed to the nearest point on the established commercial telegraph system remaining in operation."

The Minister of the Dominion of Canada was informed by the Department of State on December 29, 1928, that the Government of the United States accepted the proposal contained in the Canadian note of October 2d with the understanding that it would be reciprocal and that the first stipulation set forth in Paragraph No. 1 of the Canadian proposal was to be interpreted to mean that tolls shall not be accepted by amateurs for messages handled by them and that they shall not compete with commercial radio stations or telegraph lines.

The following additional provisions were proposed to the Canadian Government:

"1.—The arrangement shall apply to the United States and its territories and possessions including Alaska, the Hawaiian Islands, Porto Rico, the Virgin Islands, the Panama Canal Zone and the Philippine Islands.

"2.—The arrangement to be subject to

termination by either government on 60 days' notice to the other government, by further arrangement between the two governments dealing with the same subject or by the enactment of legislation in either country inconsistent therewith."

Under date of January 12, 1929, the Secretary of State received from the Minister of Canada a note to the effect that the understandings and additional provisions incorporated in this Government's note of December 29, 1928, had been accepted by the Canadian government. The arrangement between the two governments became effective as of January 1, 1929.

The A.R.R.L. has also asked the Department of State to endeavor to negotiate similar agreements with other nations in which there is considerable amateur activity.

K. B. W.

Standard Frequency Transmissions of WWV

THE BUREAU of Standards announces a new schedule of radio signals of standard frequencies, for use by the public in calibrating frequency standards and transmitting and receiving apparatus. This schedule includes many of the border frequencies between services as set forth in the allocation of the International Radio Convention of Washington which went into effect January 1, 1929. The signals are transmitted from the Bureau's station WWV, Washington, D. C. They can be heard and utilized by stations equipped for continuous wave reception at distances up to 1,000 miles from the transmitting station.

The transmissions are by continuous-wave radio telegraphy. The modulation which was previously on these signals has been eliminated. A complete frequency transmission includes a "general call" and "standard frequency" signal, and "announcements." The "general call" is given at the beginning of the 8-minute period and continues for about 2 minutes. This includes a statement of the frequency. The "standard frequency signal" is a series of very long dashes with the call letters (WWV) intervening. This signal continues for about 4 minutes. The "announcements" are on the same frequency as the "standard frequency signal" just transmitted and contain a statement of the frequency. An announcement of the next frequency to be transmitted is then given. There is then a 4-minute interval while the transmitting set is adjusted for the next frequency.

Information on how to receive and utilize the signals is given in Bureau of Standards

Letter Circular No. 171, which may be obtained by applying to the Bureau of Standards, Washington, D. C. Even though only a few frequency points are received, persons can obtain as complete a frequency meter calibration as desired by the method of generator harmonics, information on which is given in the letter circular. The schedule of standard frequency signals is as follows:

Eastern Standard Time (PM)	March 20	April 22	May 20	June 20	July 22
10:00-10:08	1500	4000	125	550	1500
10:12-10:20	1700	4500	150	600	1700
10:24-10:32	2250	5000	200	700	2000
10:36-10:44	2750	5500	250	800	2300
10:48-10:56	2850	6000	300	1000	2700
11:00-11:08	3200	6500	375	1200	3100
11:12-11:20	3500	7000	450	1400	3500
11:24-11:32	4000	7300	550	1500	4000

The above figures are frequencies in Kilocycles.

Official Frequency Stations

THE OFFICIAL Frequency Station system furnishes a service co-operative with, but differing from, that of the Standard Frequency Station, W9XL, which is also operated in accordance with plans made with the O.F.S. Committee.

The chief duties of the O.F.S. to indicate the frequency of each transmission at its termination, to check the frequency of other transmissions when requested and to aid in the general work of keeping all amateurs within their assigned bands. The announcement of frequency at the end of each transmission will be in kilocycles and consist of four or five numerals without any punctuation whatever.

An accuracy of at least 0.5 per cent. is required of all O.F.S. and it is expected that they will check their frequency meters at least once every two months against a suitable standard or Standard Frequency transmissions from W9XL.

The present list is as follows:

W6XAO-W6XV, W5NM, VE3FC, ZL2AC, W6AM, W1CK, W1AWW, W8EQ, W4XE, W5ZAV, W9EJU, W6ZH, W2MU, W4BY, W5SP, W7GQ, W2DS, W1BZQ, W6BGM-W6CVO, W9IG, W1ZL-W1AVW, W2CLA, W8GZ-W8ZG, W9BGK, G2NM, VE9AL, W8APZ, W5OX, W1AAC, W8BZT, VE3CO, G2OD, W6CAE, W9AXQ, W9CPM, W5EW, W1AXA, W9BGH, G2SZ, W6BB, W8DAJ, W9AUG, VE2BE, W2BRB, VE4BT, MH5BG, W4LK, G15NJ, W1CCW, W8BAU, W9UZ, W2EF, W6AKW, W6CDY-W6CPX, W6AYC, W6BRO, W6NW, W6BNW, W6CMQ, W7AAT, W9AHQ, W9EFO, W6QL, W6BAJ, G5YK, W6BZU, W1BD, W5NW, MH7CW, W6EC-W6XE, W6QX, MH5LF, W5BG, W2CDC, W9BVC, W2UV, G6KI, and G5BY.

H. P. W.

What Price Television?

By M. B. Sleeper*

While the author points out many factors that stand in the way of successful commercial television transmission and reception, it should be kept in mind that this is an extremely fertile field for the real experimenter whose thoughts concern the problem itself rather than the beauty and interest of the scene televised. Those who attack this problem with the true experimenter's viewpoint deserve all the encouragement in the world.—Editor.

PERHAPS more money has been spent on television during the last two years than on any other new phase of the radio art. It is interesting to review what results have been obtained by this effort.

If we are to believe what we read about the immediate future of television, we may expect that baseball games, fights, and all kinds of interesting things will soon be seen by television. Not only that, but also may we expect to see them in colors. The inference is that we shall attach the televisor to our radio sets. Thus, perhaps next fall, instead of paying a hundred and fifty dollars for new broadcast receivers, we shall spend about the same amount for televisors instead, and operate them from the sets we now have.

WHAT DO YOU MEAN—TELEVISION?

Taking seriously what we read about the immediate future of television, what do we mean when we say we shall buy television receivers? Do we mean the little one-inch pictures that we saw at the Radio Show last fall? Oh, no! Those tiny, bleary pictures weren't real television. That was just a sort of laboratory demonstration.

Do we mean the large pictures, a foot square? No, that was good, but we are going to see baseball games. Those pictures couldn't even show one man at full figure. Why, when two men were shaking hands, all we saw were the hands.

Of course, in the future, we will expect to hear as well as see at the same time. That much they did do last fall.

So, then, when we say "television," we mean fairly large pictures, big enough for several people to watch, and we want the music or speech to go along with it.

TELEVISION IS READY NOW!

Having agreed on what we want, what about getting it? Well, the American Telephone and Telegraph Company's engineers are ready to produce our television equipment right now. They will give us very good pictures one foot square, with the accom-

panying music. The only hitch being that the cost accounting department has put a price of \$1,000,000.00 on these receivers.

A million dollars for one set! They aren't fooling and they haven't misplaced any decimal points, either, for they built one of these sets two years ago.

Another joker is that this is the only company that ever has built even one such receiver, and they are the only source of supply. Incidentally, the set they built wasn't a radio television receiver, either. It took quite a number of wires to connect the transmitter and receiver. Also, the receiving apparatus occupied the cubical contents of a six-room apartment.

WE MEAN PRACTICAL TELEVISION

To be serious, we haven't a million dollars, and we want to use radio reception, and we want to put our televisors on the living-room table. We had trouble enough in the earlier days of broadcasting to keep our apparatus from being thrown down the dumb-waiter and we don't want to go through all that again. Besides, the articles in the newspapers about the new television sets don't mention absurd things like that; they are getting the scanning discs down so small that women won't mind having the apparatus around the house.

BUT THE SCANNING DISC IS OUT

At this point I decline to track with the optimistic expectants. I am not going to have the popularly anticipated television receiver this fall, or the next. I even doubt if I shall ever have one within the span of my three-score-and-ten.

Consider a photograph—the most perfect means of reproducing any kind of a view. It is made up of millions of tiny particles of silver, held in place by gelatin which has been applied to the paper. Some of the silver particles have been turned more black than others, while in the white spaces, there is no silver but just the gelatin coating on the white paper. In a picture one inch square, there may be millions of dots of silver turned to varying degrees of gray and black.

A printed picture is not as perfect as a

*Sleeper Research Laboratories, Inc., 416 West 53rd Street, New York City, N. Y.

photograph because, although it, too, is made up of dots, there is a limit to the number of dots per square inch. Against the millions of dots in a photo, the finest printing has only 22,500 dots per square inch.

But not to be extreme, let us say that television pictures as good as newspaper printing will be satisfactory. That means only 6,400 dots per square inch. And let us be satisfied with pictures 10 inches square. Then, in the complete picture, there will be a total of 640,000 dots.

In comparison, a 48-hole scanning disc, or other equivalent scanning mechanism, gives only 2,304 (48x48) dots. Therefore a scanning disc to make fairly good pictures 10 inches square, must have about 17 times as many holes as those now in use. That will mean 800 holes instead of 48!

6,000 MECHANICS REQUIRED

Here I can give you a practical view of scanning disc drilling. The same figures would apply to any other equivalent scanning mechanism. A highly skilled instrument maker, experienced in drilling 48-hole scanning discs, can make one disc in eight hours. It would take at least three weeks to produce an 800-hole disc. By employing 6,000 skilled instrument makers, an annual production of about 100,000 discs could be attained. But it would hardly be possible to assemble such a personnel. Still, if that could be done, it would not be possible to find a sales force to dispose of such a production, for the discs alone, without the associated apparatus necessary, would cost at least \$500.00, at retail prices.

THE SCANING DISC MUST BE ELIMINATED

From the foregoing, it is obvious that the scanning disc, or any similar mechanical means of breaking up the picture into dots, must be eliminated. It must be replaced by some inexpensive method adapted to high-speed production. Having found this new means—which no one has so far—there are electrical problems to consider.

First, of course, is the modulating frequency. To produce one picture 10 inches by 10 inches, the degree of light for each dot must be controlled. That means 640,000 control impulses per picture and to make only eleven pictures each second, there must be 7,040,000 dot control impulses per second.

That statement isn't quite correct. If there are any solid whites, for example, the frequency will drop to zero. Consequently because of the changing nature of the pictures, the dot control frequency may vary between zero and approximately 7,000,000 impulses. In other words, the amplifiers at the transmitting and receiving stations must respond, without damaging distortion,

to all frequencies between zero and 3,500 kc., there being two impulses to each cycle, approximately.

TELEVISION ON 3,000,000 KILOCYCLES

At such high modulating frequencies, it will be necessary to transmit at much higher frequencies than we are now accustomed to use. A good frequency would be about three million kilocycles or approximately 0.1 meter.

From this we see that even though the dot control mechanism is developed, plus the necessary amplifiers, plus 3,000 megacycle transmitters, it will be impossible to use even the radio frequency circuits of the present day receivers.

LET'S BE OPTIMISTIC

It should not be thought that fairly good television is not possible. Just to be generous, let's make believe that everyone will be satisfied with what results can be obtained from the equivalent of a 48-hole disc, and assume that the problem of synchronization has been solved—which it has not. Then our maximum frequency variation will be roughly between 12,000 and 17,000 cycles depending upon the number of pictures sent each second. Then, with suitable broadcast transmitters available, it will be possible to employ commercially practical receivers and the television apparatus may be obtainable at the local radio store for somewhere around \$150.

As promised, the television broadcasting company will install the scanning apparatus at the Polo Grounds, hook up by land wire to a high quality transmitting station and put the ball game on the air. When we look in the television receiver created by our optimism, what shall we see? Certainly nothing very suggestive of a ball game!

The distortion introduced by the ordinary land line will ruin the quality of the television signal and if you don't think so, just ask any of those who have tried it. It was not found possible to put these signals over the wires from the studio of one of the New York broadcast stations to the transmitter located just a few miles away.

Since there is no possibility of moving the Polo Grounds to the transmitting station nor of erecting a suitable transmitter at the Polo Grounds, I don't expect to watch any games by television.

It is true that the A. T. & T. did send television signals from New York to Washington, but they had to run a pair of No. 8 copper wires on poles in order to put through 20,000-cycle signals.

WHAT WOULD IT COST?

The public will take up television when it is possible to get fairly good pictures of

(Continued on Page 90)

The Effect of the Regeneration Control Upon Tuning

By L. W. Hatry*

IN SPITE of the fine results obtainable with the screen-grid tube as a radio frequency amplifier, the regenerative detector is by no means out of use yet nor in the near future. As long as the regenerative detector is used there will exist the problem of the tuning effect of the regeneration control and since so many sets exist which use a variable condenser as this control, the experiments to be described are, I think, of considerable interest. And incidentally, the general conclusions from the experiments should apply to any regeneration control means as logic indicates they will.

A non-tuning regeneration control is not wanted as it only would be good to start and stop oscillation and control volume a little. My experience indicates that when one arrives at a non-tuning one its control of volume is negligible. What is wanted is a regeneration control which in its half circle turn or a tone control wavement similarly large, will give about ten to twenty kilocycles of beat note change. In other words, with capacitive control, the change from zero beat to the highest audible beat note will transpire in about fifty divisions of the regeneration control dial's reading; although the number of dial divisions required for the upper as compared with the lower beat note (upper and lower by dial numbers) and zero beat will differ according to the shape of the condenser's capacity curve.

Since the foregoing paragraph implies control of the tuning effect, the following description of some experiments will tell how by cut and try one can change the tuning effect from being, if so, as critical as grid circuit tuning, e.g., 20 kc. for one dial division, until it is as broad as 10 kc. for 100 divisions (semi-circle turn). Such effects can be wrought by a vernier condenser shunted across the regular condenser and if the regeneration tuning effect is great this vernier must be correspondingly small.

1A is the circuit of a regenerative detector with the antenna and ground connections left off. The presumption is that either primary or antenna coil, or a small capacity will be used in coupling to the antenna. Circuit 1B is the approximate equivalent of 1A. C_{gf} is the grid to filament capacity. C_{gp} the

grid to plate capacity and C_{pf} the plate to filament capacity. Since we do not deal with C_{gf} alone in relation to the tuned circuit but which it in series with C_g, the grid condenser, C_{gf} in 1B ought to be considered as C_o as shown 1C, C_o being the minimum capacity in shunt to the secondary coil and is composed of the capacity of C_{gf} and C_g in series plus those stray capacities due to wiring, socket, coil mounting and the variable con-

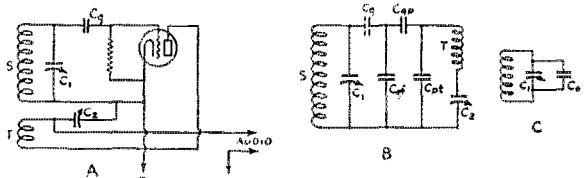

FIG. 1

denser minimum. The mutual inductance between the tickler and secondary is not shown in Fig. 1B because it is essentially fixed.

If a tuning effect is caused by variation of C₂, it is because it results in a variation of C_o. If this is not true, then we must assume that the mutual inductance between the secondary and tickler coils is changing or that some inductive change is occurring when C₂ alone is varied. This we lack reason to believe.

A set was constructed which gave very good performance because of the minimizing of the effective capacity of C_{gp} partly through the mounting of the coil socket and the tube socket as shown in Fig. 3. The plate lead to the tickler coil is a half inch long or less, including the coil jack, the tickler lead, the tube prong and not including the internal leads of the tube. The only reasonable remaining reduction of stray capacity would be in the elimination of the General Radio socket and the debasing of the tube—as long as the 201-A was in use.

The first experiment was to increase the plate to grid capacity by shunting these two elements with a midget variable condenser. First a reading was taken with no shunt capacity. It was made in this fashion: A signal was tuned in, then reduced to its highest beat note near the vanishing point with an adjustment of C₂ on the edge of oscillation. The dial setting of C₂ was noted and then C₂ was varied until zero

*Hatry and Young, 136 Ann St., Hartford, Conn.

beat was passed through and the second highest beat note's inaudible point was reached. The difference between the upper and lower vanishing points is that portion

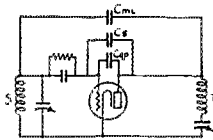

FIG 2

of C2's dial occupied by the signal. The following readings were obtained for a coil covering from 3,150 to 4,800 kcs.

Rotation of C2	Cgp Shunt	Setting of C1
27	0	40.5
6	12.5	27
4.5	25.	10
30	0	40

The first column indicates the number of divisions through which the regeneration control condenser is rotated between the inaudible point above zero beat and below zero beat. The same coil and signal were used for the first three measurements and these clearly indicate how much greater the tuning range of the regeneration control becomes as Cgp is increased. With 12.5 μ fds., the tuning is 4 1/2 times as abrupt while with 25 μ fds. it is six times as bad. The capacity of the tuning condenser C1, had to be reduced as the Cgp shunt was increased in order to tune the circuit to the same signal. A second coil having a tuning range of 7,140 to 8,330 kcs. was constructed and with the tuning condenser, C1, at about the same capacity value as in the first test, the last set of figures was obtained.

Instead of being worse as might be expected because of the higher frequency range of the coil, the detuning is less and the signal may be heard over three additional scale divisions. The 3,150 to 4,840 kc. coil's tickler was too large, Zprf changed too rapidly. The following figures were obtained from measurements made on this second coil:

Rotation of C2	Cg Shunt	C1
20	12.5	92.
3	12.5	10

From this it will be seen that with C1 at nearly maximum capacity, a rotation of 20 divisions ran the signal through its range while with C1 and 10 degrees, the range was covered in 3 degrees of C2. This is to be expected because changes in Zprf affect Co, a small semi-fixed capacity in shunt to C1 and the greater the capacity of C1 the smaller the percentage of variation for a given shift of Co. This points out that an additional fixed capacity will have another useful effect in addition to the one that it is

usually recommended for; i.e., to spread a waveband on the secondary condenser's dial.

Readings were taken with another coil covering the same range but with the tickler wound differently. This coil will be referred to as type B and Fig. 4 shows the constructional difference between it and the first coil, type A. These readings were obtained:

Type Coil	Rotation of C2	C1
A	14	15
B	7	22

No addition Cgp shunt was employed and the type B coil at a higher capacity setting of C1 gave a rotation of C2 of only half that obtained with the type A coil. The reasons may be the large tickler diameter and capacity to all nearby metal and, or the coil's internal wires from the plugs to the windings. In any case the type B is not so good.

As a special case of the type B coil's performance, another coil for the range of

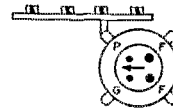

FIG 3

8,330—12,500 kcs. was tested. It was used first as type B, next as type A with the tickler too small and third as type A with an adequate tickler. No shunt across Cgp was used.

Type Coil	Rotation of C2	C1
B	6	18
A (small tickler)	15	27
A (adequate tickler)	9	20

A 6 division tuning effect changed to a 15 on a 10 kc. range, the tickler being too small to allow control over the whole beat note of 20 kc. The tickler that was adequate gave an 18 division change as against the 6, 3 times better but not as good as the over-small tickler although the latter, of course, is worthless, oscillation not occurring over 30 on C1's dial.

So far, we have learned the importance of keeping Cgp small, the tickler diameter small, the tuning capacity relative disproportionate to Co. C1 in this set was 50 μ fds., C2 was 250 μ fds. and the grid condenser of standard size, 250 μ fds.

In order to find out how great an effect the shunting of C2 with a fixed capacity would have, a test was run giving the following figures.

Shunt Across C2	Rotation of C2	C1
300 μ fds.	100	30
200 μ fds.	70	28
100 μ fds.	56	28
0 μ fds.	7	22

A type B coil with a range of from 5,770 to 8,330 kcs. was used and there was no additional capacity across plate and grid. This is another way of getting a "geared down" effect for the regeneration control even though it does not eliminate the cause of it. The first two measurements were on a note from zero beat to inaudibility only.

Since the 199 has a lower C_{gp} than the 201-A, it is preferable.

The importance of C1 immediately leads one to think of the screen-grid tube as a detector. Its C_{gp} is on the order of .025 μ fds. The space-charge connection has no such advantage because C_{gp} is not reduced. Correct connections for the screen-grid tube as a detector with a coupling resistor to the first a.f. amplifier tube is shown in Fig. 5.

However, many of us will not afford the change in equipment required for the screen-grid tube so the design case where the 199 is used will be continued. Already the base

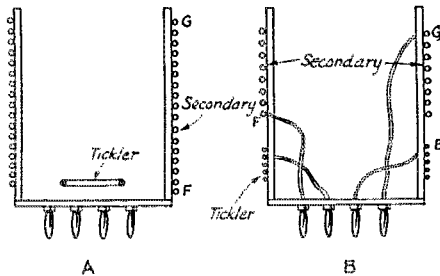

FIG. 4. STANDARD GENERAL RADIO COIL FORMS ARE USED

The secondary is wound with No. 18 bell wire either spaced or close wound as conditions dictate. The antenna is coupled through a small variable condenser of about 7.5 μ fds.

of the tube and the socket have been thrown out. If the arrangement of parts requires a long lead from plate to tickler, or a lead longer than one cares to trust, shield this lead with a copper braid covering or with copper tubing that is grounded. Short leads in this case are preferable to shielding, but by all means shield when advisable. Further limit upon its effect must come through circuit constants.

The grid condenser, C_g , can be 25 μ fds. at 10,000 kcs. if 250 μ fds. is good at 1,000 and we know it is, from practice. C_g of 250 is good at 500 kcs. and I have found 25 μ fds. good at at least 2,000 kcs. Assume

1. This cannot be carried to too great an extreme as the capacity between the plate lead and the grounded shield is in shunt to the plate and filament of the tube. The r. f. energy will be by passed without its passing through the tickler coil and a larger tickler will be required to cause oscillation. Tech. Ed.

3,000 kcs., since the regeneration control's effect can be kept usefully small at 2,000 kcs. without special precautions, and we

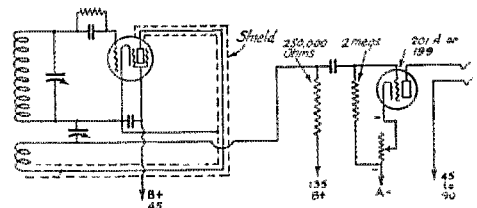

FIG. 5

have 25 μ fds. as a good size of grid condensers over all of the amateur bands. And we lose nothing, for C_g can become still smaller; 12.5 at 20,000 kcs., 6.5 at 40,000 kcs. and 3.5 at 80,000 kcs. This small grid condenser is going to be important. Chelton, Silver-Marshall and others make midgets of 25 μ fds. maximum and these variables will make good grid condensers. Use the grid leak size you like. Remember that a small size of grid condenser often means more turns in the tickler.

Our design continues with a small tickler diameter. As Fig. 4 shows, the tickler diameter was half that of the secondary and the tickler was wound in a lump at the filament end of the secondary.

Finally, the use of a small fixed condenser across C1 will make the minimum capacity of the tuned circuit relatively large and

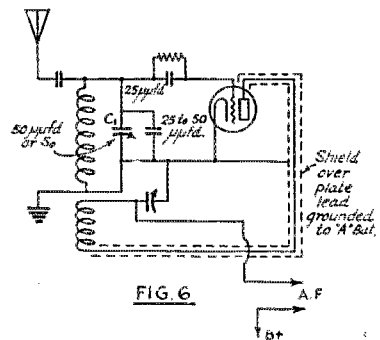

FIG. 6

thus reduce the effect of change. For ordinary tubes, the final circuit might be as in Fig. 6.

As the frequency increases, the design points covered must be more meticulously observed. These design matters are equally applicable to transmitters although how usefully only experiment will tell.

(Continued on Page 99)



I.A.R.U. NEWS

Conducted by A. L. Budlong

IN JUNE of this year the Secretary of the I.A.R.U. will send out a calendar to all members of the Union, presenting a review of the present amateur situation all over the world, listing matters which need attention and action by the Union as a whole, and in general covering all business which should be brought to the attention of the Union.

This notice is to advise all member societies who have any business which they wish to bring up for action by the Union,

clearly to the entire Union membership in the June calendar.

Another important matter which will be treated in this calendar is the question of admission of a number of new societies to Union membership. As previously stated in this department, there are already on hand several formal applications from national amateur societies in various countries for admission to the I.A.R.U. Any other such societies who desire membership in the Union should take steps to communicate at once with the Secretary at I.A.R.U. Headquarters, petitioning formally for admission, enclosing a copy of the Constitution, and giving such other information as is requested under the provisions of the Union Constitution dealing with applications for membership.

— . . . —

It is most encouraging to note that additional governments are issuing amateur regulations in accordance with the terms of the recent Washington Radio Conference. In most cases the privileges are quite liberal. One of the most significant things in connection with these new regulations is the fact that in practically all cases the government authorities are consulting with the amateur representatives before finally issuing new amateur regulations. As reported in the Australian section, the new regulations for Australia are now in force; they seem to duplicate

fairly closely the British regulations, especially in the case of the 80-meter band, which is denied to Australian amateurs at large, apparently. This seems unfortunate, as here in the States we have found that the 80-meter band is of the utmost value for "local" and medium-range work. On the other hand, due to the activity of the Spanish amateurs, the 80-

(Continued on Page 74)

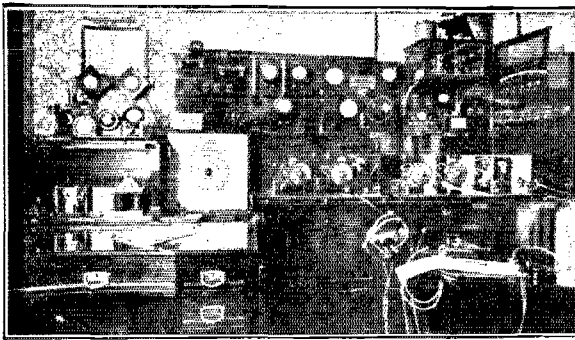

AMATEUR STATION sb-2BA

sb-2BA, shown above, is the station of Dr. Felix Ferras, and is located at Villa Vera, Sao Paulo, Brazil. The transmitter, which may be seen above the desk at the left-hand side of the picture, is a 1929 Hartley, using a UV-210; this is operated on 42 meters, feeding a Zepp system. For short-wave reception a very handsome receiver has been built up using a plate-glass panel, and Aero coils. The receiver on the extreme right is a broadcast tuner. The Doctor is to be complimented on an extremely neat installation, the details of whose construction reflect careful and expert workmanship.

to take steps to get such matter in the hands of the secretary by the first of June, 1929, at the latest. If any society has questions or problems which it thinks should be acted on by the membership as a whole, it should write fully to Union Headquarters, 1711 Park St., Hartford, Conn., giving all details of the matter concerned, and stating what action is desired. It will then be possible for the Secretary to present the matter

Calls Heard



T. H. Streeter, School House, Alford, Nr. Billingshurst, Sussex, England

20 meters

wlaca wlaze wibvy wleci wicfi w2nm w8acm w8axa w8bcu w8ckl oz-3ar ei-1ch

40 meters

w2kr w3bph w3tq w4hy w8dww w9beq w9ef w9fhy nn-1nic es-2nad ew-wy ew-kx ep-lae oa-2hc oa-2ho oa-2jj oa-2no oa-2ns oa-2yi oa-3ax oa-3bq oa-3cp oa-3gr oa-3jr oa-4pn oa-5by oa-5ja oa-7aa oa-7ch oz-2ae oz-2aj oz-2be oz-2ga oz-2go oz-3aj oz-4am oz-4ao oz-4ba oz-4xc.

G2KK, Ralph H. Parker, The Bungalow, Willow Ave., Edgbaston, Birmingham, England

wlaed wlaek wlaic wlaol wibux wladp wikh wlom wirp wlech wlvh wlsz w2aba w2aih w2anh w2apd w2atc w2axp w2bda w2bg w2bhv w2arm w2bie w2bjj w2blb w2bnc w2box w2bxk w2com w2cuf w2eap w2eh w2fa w2fc w2fn w2fw w2gy w2he w2is w2nf w2qs w2tr w2scv w2akw w2ami w2anh w2anv w2aau w2ck w2ckl w2im w2mk w2rb w2sn w2sv w2sau w2abw w2abz w2acn w2acv w2ahk w2any w2and w2arh w2cb w2cn w2ch w2ea wife w2jm w2hf w2oc w2pd w2qb w2sh w2to w2ve w2wa w2afx w2ain w2awq w2ayz w2jd w2pt w2ql w2ads w2ax w2dbb w2ccw w2tu w2vq w2abw w2agv w2ajk w2alr w2bgw w2bjj w2bpl w2bqr w2bth w2bum w2bvy w2cfn w2dds w2dfb w2dhe w2dum w2dpo w2dra w2drs w2dww w2dq w2dvw w2aat w2bhi w2bh w2bi w2bsa w2deb w2dzz w2aih w2afx w2ms w2mw w2xe w2xl w2ak ea-cm ea-2yd ei-oda ek-4dba ek-4qb ek-4yt w9mh w9x w9uu w9xl ac-2al fb-8hl fq-pm fq-8hpq fo-aga fo-1pr ve1dq ve2al ve2am ve2bb ve3ap ve3bi ve3ej ve3fc ve3al ve4pd ve4fv ve4ha ve5av ve5bn ne-3ae ne-3rg kiagf nw-2ac nq-5cx nq-5fi oa-2jy oa-2rc oa-2sh oa-2yl oa-sbk oa-3de oa-3gr oa-3hl oa-3tm oa-wxo oa-5cm oa-5dx oa-5hg oa-7ea oz-2bg oz-2bp oz-2bx oz-3at oz-3aw oz-3az oz-4ae oz-4am op-1dr w6cf k6dju k6ldr k6db k6kq nq-2la nq-2pt nq-2ro nq-3jt nq-5by nq-5cx se-1aw se-1bc se-1cj se-1el se-2ag se-2sh se-2sj se-2az so-1aa so-4nu se-1eg lg-ocya xed-oic.

W1AJS-KDCV, F. P. Keefer, 33 Prospect St., Milford, Conn.

Heard at Cartagena, Colombia

wlom w1zh w1aew w1aha w1aob w1aql w1aif w1emf w2dn w2dq w2ja w2afv w2afo w2ags w2amt w2ap1 w2apq w2bhr w2bkn 2byw w2cod w3av w3ec w3av w3ec w3z w3ahp w3ais w3ajd w3arx w3bvl w3cfc w4ib w4px w4uu w4acv w5eb w5aek w5bjh w6dj w6en w6aov w6ar w6auk w6bzr 6cag w6cuv w6cuk w6dev w7fl w7lj w7ja w7ajv w7li w8qk w8aif w8bbm w8bxw w8cak w8cto w8cxk w8dbm w8dfb w8dqk w9lf w9gv w9aav w9adn w9ain w9aua w9bhf w9ejk w9ewp w9fx oa-5ej se-2ca.

Heard at Guayaquil, Ecuador

w1si w2ol w2no w2ab w2apb w2bhw w2cxl w3sz w4ek w4r w4k w5je w5lp w5ql w5qo w5uk w5yb w5avf w5apo w5aqq w5ave w6fa w6wb w6ajj w6bpo w6dag w7dd w7nic w8fj w8gr w8cau w8ces w8dcm w8dnl w9eaj w9ema w9bir se-2ar se-2ea sb-1bg.

Heard at Guataquil, Ecuador

w2cxl w3cc w4aa w4acv w4ags w5nk w6wo w5bbp

w6ax w6dh w6ix w6uc w6aye w6bpo w6dju w6dww w7ah w8pk w8ds w9aez w9bwo w9clp w9crd w9fhy w9fz xnu-6clv.

Heard at Talara, Peru

wlah w1kb w1mk w1mx w2akv w2cdn w2ds w2fs w2qs w2rs w2sm w2aib w2aky w2ccz w2edm w2cxl w3ael w3alq w4ch w4fa w4gz w4no w4oh w4va w4wo w4acv w4ahl w5bj w5di w5ke w5zk w5bcz w6ax w6bf w6df w6dq w6ec w6ix w6kd w6ave w6bam w6bea w6dge w6bpo w6bxa w6bzf w6cjh w6cny w6cqm w6cut w6dfs w6ec w6sk w6sr w6tj w6aak w6ajj w6anu w6asad w6ciu w6dkv w6dpm w6dus w6eco w7eh w7z w7to w7aln w8bbg w8dim w9ml w9ru w9aez w9baz w9cnd w9ehh w9fjt nj-2pa nr-2ea ny-xn5 se-1ah sb-2aj sb-9af xnu-6clv.

Heard at Callao, Peru

w2cxl w5bj w5pt w5brt w6fs w6ix w6kj w6sa w6sf w6ael w6afv w6am1 w6au1 w6awp w6awv w6ay1 w6bag w6bam w6bgl w6bz w6cuj w6bs w6egr w6ela w6eqm w6gq w6eri w6eyx w6dbd w6dt w6dqj w6djx w6dky w6dhs w6dvp w6dvw wife wifu w9lj w9cuc w9efe w9eno w9eo oz-3ar.

Thomas L. Siglin, 23 Norwich Ave., Providence, R. I.

20 meters

w6am w6aov w6asl w6by w6fs w6eyx w6cxk w6zdz w7it ed-7zg ee-ea65 ef-hqu g2bm g2zv g5kl g5wk g6dr g6yv em-sw4n ep-lae ve4dk ve4io ve5dt.

33 meters

ea-jh eb-4fp ef-8axq ef-8gdz ef-jf ef-8ix ef-8pro ef-8wb ef-8vvd ei-2to ek-4ij ek-4rm ep-1cn nn-1nic nq-2ay nq-5cx ei-2sc sb-1bc sb-2ab se-2ab su-1oa fq-8hpg khah wbsb.

40 meters

eb-4ft ek-vt ve2bb ve2dd ve5nt velcc ve3bq ve9ap nj-2pa nn-7nic np-4q nq-5fc nq-5fl nq-7cx nr-2ags nz-fr5 fm-ocf fq-8hpg.

W2BWR, J. V. Gartland, 1405 Kenmore Place, Brooklyn, N. Y.

w4gd w4oo w4nf w4tk w4zz w4pau w5fu w5ix w5rg w6agr w6avj w6bi w6bjs w6bpo w6bws w6che w6cq w6elo w6dmq w6dvd w6dys w6efh w6elm w6qf w7aes w7afx w7dd w7ego k6bq k6bvb oa-2he oa-2hm oa-2rb oa-3hc oa-3hl oa-5jh oz-2hc oz-3cm nq-5ni nj-2pa su-1oa su-7ax sb-1cm wbt.

Thos. McGeachy, 28 1/2 Pelham Rd., St. Catharines, Ontario

w1abx w1dd w1fy w1amc w1aje w1amq w1art w1asp w1awm w1kb w1nf w1nl w2aad w2adb w2aib w2aih w2aiw w2api w2apq w2aq1 w2arw w2as w2avb w2avd w2avj w2avk w2azo w2azs w2bkw w2bhq w2boz w2byh w2cby w2cvi w2crg w2id w2ky w2mb w2mz w2nu w2uc w2age w2ap w2arb w2cfl w3ev w3ga w3no w3tj w3ua w3c w3acc w3aco w4adq w4aej w4ahl w4aic w4aiq w4as w4fe w4ka w4pf w4nx w4bi w5apo w5axx w5bj w5bhc w5bcm w5kx w6dij velbr ve2bb ve2ca ve3bt ve3he ve5dt nj-2pa nm-1ab nm-1rz nn-1nic nq-5fc nq-5fl nr-2ea nz-fr5 se-2ah.

W9BGA, E. J. Raible, 319 Sylvia St., Louisville, Ky.

20 meters

ee-ea65 ee-ea91 g2kf g2nh g2od g5bv g5bz g5la g5ma g5ml g5ms g5vl g5bd g6by g6ub g6wy g6yq

(Continued on Page 84)

Correspondence

The Publishers of QST assume no responsibility for statements made herein by correspondents.



Keying

Detroit, Mich.

Editor, QST:

Since the publication of recent articles in QST, I have adapted the "High-C" systems to my 40- and 80-meter transmitters. I also expect to re-adjust the 20-meter set in the near future. In this connection I decided some time ago that I must have a plate supply with better voltage regulation and after obtaining all the information I could from various sources (including QST) I worked out the attached system which is giving excellent results.

The plate supply transformer used here is a 500-watt, 1500-volt affair which can be adjusted anywhere from 200 to 1500 or 1600 volts by means of a large rheostat in the

tance made a further improvement in the regulation but tended to overload the rectifier tubes. To eliminate this difficulty I replaced the entire 15,000 ohms and cut in an extra 20-ohm rheostat in the primary lead to the plate transformer. This extra resistance being cut out by auxiliary contact in the keying relay.

To adjust this I simply pressed the key, adjusted the voltage to the desired point by means of the main primary rheostat and then with the key up adjusted the extra rheostat to give the same or a slightly greater voltage. At first there was a fluctuation of the volt meter over a range of about 100 volts but after increasing the voltage on the relay windings from three to six volts this fluctuation practically ceased (due to quicker closing of the contacts) and

I do not believe the actual variation is more than fifty or seventy-five volts. The auxiliary contact on the keying relay is adjusted to close a small fraction of a second before the main keying contact which in this particular case closes the filament center tap circuit. Tests by the Assistant R. I. (with a monitoring receiver) and numerous contacts with other amateurs have shown very gratifying results.

No doubt this scheme for improving the regulation has been used many times before but I do not seem to find anything like it either in the Handbook or in recent QST's.

The expense of the installation is not great even where oversize resistances are installed, as in my case. The three 500-ohm Ward-Leonard Resistors are of 200-watt capacity and list at \$2.80 each. The 20-ohm Ward Leonard Rheostat costs \$5.50 but a cheaper one would doubtless serve the purpose especially for lower powers. The double contact relay was built from an old telegraph sounder and costs possibly \$3.00. The contact, in this case, being made of silver. No extra filter is required in the auxiliary keying circuit because the voltage variation at that point is not sufficient to cause any clicks even in a sensitive receiver four feet away.

—C. H. Vincent, W8RD

(Continued on Page 60)

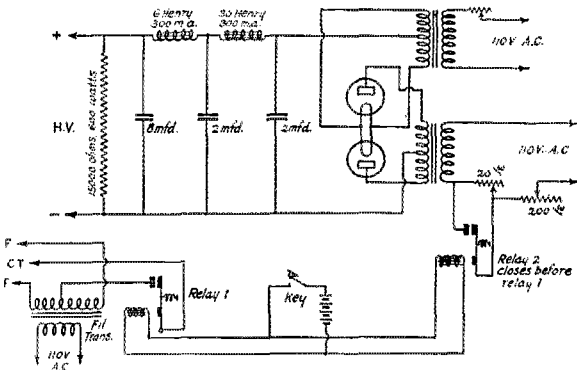

primary. This, of course, gave extremely bad regulation resulting in excessive key clicks and chirps which could not be eliminated with any filter. My first thought was to purchase a new transformer with better regulation but decided this would not be worthwhile as long as the Kenotron rectifiers were used; and besides I did not like to give up the convenient voltage variation obtained with a rheostat in the primary.

Normal plate voltage used here is 1000 to 1100, and the 15,000-ohm resistor placed across the output of the filter made a tremendous improvement but was not quite enough, there still being a variation from 1100 with the key down to approximately 1400 with the key up. Decreasing the resis-

The Communications Department

F. E. Handy, Communications Manager
L. R. Huber, Asst. to Coms. Mgr.
1711 Park St., Hartford, Conn.

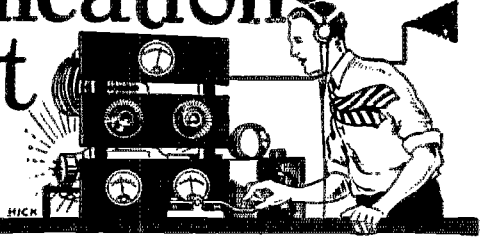

Attention Phone Men and Others

In these days of striving for steady, clear, sharp signals at all amateur stations using c.w.—and in these days of congested bands, when consideration for others is important for the enjoyment of all amateurs, we are receiving too many, far too many letters like the following sample picked at random from a file of the same. It behooves the phone amateur to take action to improve his station and operating practices if he wishes to keep the respect and approbation of the other classes of amateurs who constitute a majority and whose rights should receive consideration. First let's read this letter:

"The writer would like to call your attention to the increasing number of off-frequency phone stations. I do not know whether you have noticed that a large number of phones are working outside their legal rights, thus bringing our good amateur name into disrepute, but I have not only heard these stations out of their band (on Airways' frequencies below 3500 kc.) but also I have even heard phones operated by amateurs in the 700-ke. band.

"Quite a few are operating between 3000 and 3500 kc., but the point that I am more concerned with is the larger number operating anywhere in the 3500-ke. band. It is a known fact that a phone signal is much broader than a c.w. signal and causes much more interference, and with this in mind in connection with the fact that our bands are somewhat crowded for ordinary operation it would seem that popular amateur opinion would be against phones if the situation continues unchanged. I believe that the phone stations should take any individual action necessary before the situation leads to disastrous results for their operation. The very least that can be expected of them is that they OBSERVE THE REGULATIONS and operate IN THEIR PART OF THE BANDS (1715-2000 kc., 3500-3550 kc.), hoping that you will do something to help the situation . . ."

Here is the indictment as received from representative amateurs in the first, third and fifth districts. Other letters emphasize that the men who persist in using broad signals (phone, 500-cycle choppers, and 60-cycle a.c. notes with bad modulation effects) all come in for their share of mention) are *inconsiderate and selfish* to say the least. These letters point out that the transmitters which cut too big a swath through the ether today are comparable in their effects to the unnecessarily broad spark stations in the days of yore. Just as the increased effectiveness of c.w. stations banished the sparks even before the rush to the higher frequencies, we can look to unnecessarily obsolete equipment again to work its own undoing. Such letters all go to point out a growing amateur sentiment against unnecessary interference. In the final analysis the good-will which a station can create for itself (or can destroy with equal ease by lack of consideration) will control the situation. Let us all endeavor so to adjust and use our stations that they are most effective in communicating work, and so that they create good feeling instead of complaints of any kind that may do both individual harm and may in addition hurt all amateurs, either by lessening individual enjoyment or by threatening some of our precious privileges by inviting drastic regulation.

This business of operating outside the amateur band is a serious one, indeed, and one for which there is little excuse. No good amateur will have

any sympathy to waste on the offenders that get into trouble through such activities as out-of-band operation. *The Airways' channels must be kept clear, and so must those on both sides of our 7000 kc. band.* There is no excuse for any phone amateur operating outside those channels for amateur radiophones mentioned in the letter we have reproduced herewith and which are stipulated in every amateur license. Several warning cards have been received at Headquarters from anonymous sources directed at off-frequency phone amateurs, suggesting that these stations would be reported to the Radio Division without further notice unless they mended their ways. In such cases the complaints have been forwarded to the amateur concerned. We hope these have received prompt attention.

Whatever type of apparatus you use, please make sure it complies with the terms of your license and especially with the 1929 bands. Phone men should remember that they are *not* free to wander at will over all amateur frequencies; that they should take steps to prevent wabulation and unnecessary broadness, even while keeping to their own channels. Amateurs using unduly broad i.c.w. or a.c.c.w. signals should have this called to their attention likewise and should consider it a kindness to receive such friendly notification. Let us all give and take constructive criticism in the right spirit, and apply our best thought to the solution of these matters that we may all continue to get full enjoyment from whatever type of operation we prefer.

Important—Changed Reporting Dates

Effective at once, the "message month" is changed. Instead of closing at midnight of the 25th of each month (the report to the S.C.M. becoming due on the 26th), the month will now run from the 16th of one month until the 15th of the next month, inclusive, reports becoming due on the 16th of the month.

This change is made to meet new closing dates for QST copy. Be sure to get your next report in the mail to your S.C.M. on the 16th of March without fail. Otherwise your report will not appear in April QST. We do not want to go to press with the April issue with a single report missing. It will be a short month for traffic workers (February 26 to March 15 inclusive) but the change is necessary due to change of printers at Headquarters and an entirely new "copy" schedule for each Hq. department. Of course the next message month will run from March 16 to April 15 inclusive.

Don't forget—report to your S.C.M. on the work accomplished between Feb. 26 and March 15 promptly ON MARCH SIXTEENTH, and report on the 16th of each month thereafter. All Official Relay Station appointees and other active members should follow this notice in reporting to their traffic officials whose addresses are listed on page three of this issue.

W8CMB suggests that the fellow with several transmitters and only one key should run the key's terminals into a plug so that quick transfer could be made from one set to another. The keying terminals of each transmitter should, of course, end in a jack into which the plug for the key can be inserted.

RCA

RADIOTRON

UX-860

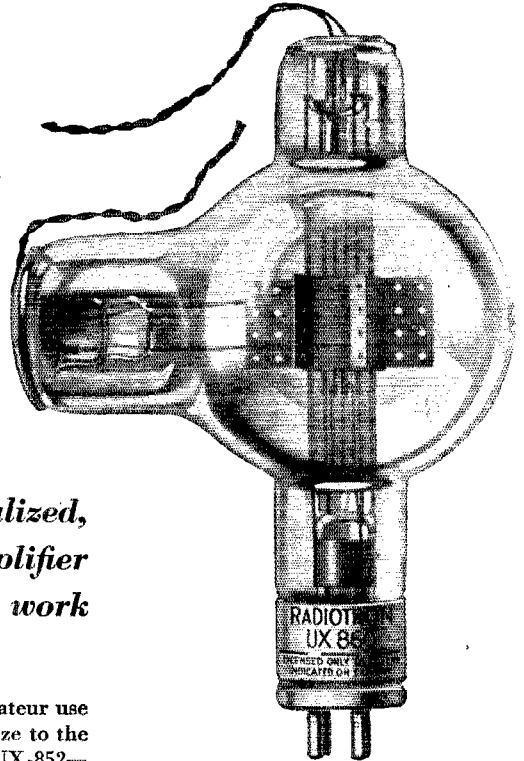

A screen grid, self-neutralized, radio frequency power amplifier tube for high frequency work

The newest transmitting tube for amateur use is Radiotron UX-860. It is similar in size to the well-known amateur tube—Radiotron UX-852—and has the same rugged construction—especially designed to stand the gaff of day-in, day-out operation on short waves.

But more important than this, it has an improved feature—a *screen grid*. This fourth electrode eliminates the necessity for neutralization to prevent feed back and self-oscillation, within the tube, even at the higher frequencies.

The stability, dependability and efficiency of Radiotron UX-860 will be a source of pleasure and satisfaction to the amateur who wants to get his stuff across.

Filament Volts	10
Filament Amperes	3.25
Max. Operating Plate Voltage	
Modulated Plate Volts (DC)	2000
Non-modulated Plate Volts (DC)	3000
AC Plate Volts (RMS)	3000
Max. DC Plate Current (Milliamperes)	100
Max. Plate Dissipation (watts)	100
Max. Screen Dissipation (watts)	10
Nominal Screen Volts	500
Amplification Factor	200

Radiotron UX-860 may, for certain amateur use, be obtained through the RCA District Office nearest you.

Firm Net Price (subject to change without notice) \$37.50

RADIO CORPORATION OF AMERICA

New York—233 Broadway
San Francisco—235 Montgomery Street

Chicago—100 West Monroe Street
Dallas—Santa Fe Building, Unit No. 1

Atlanta—101 Marietta Street

A Silent Dial

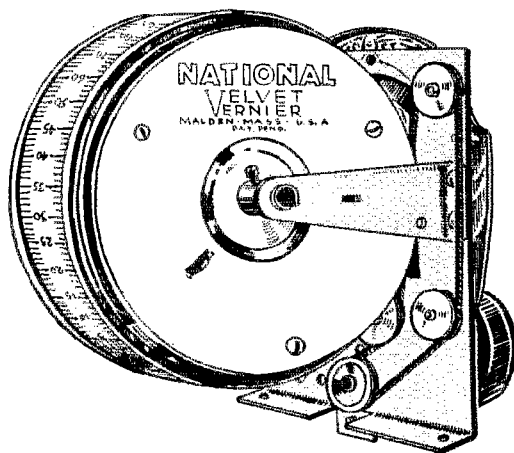

A silent dial for short-wave work because the drive is through a specially braided and treated non-conducting cord which moves the dial to any tuning position without changing any electrical constants.

Look for the drum dial with the **non-metallic** cable drive. It will give you short-wave satisfaction.

Send for Bulletin No. 121-Q

NATIONAL

Velvet Vernier Drum Dial
Type F

NATIONAL COMPANY, INC., MALDEN, MASS

Expeditions

WHDC

The "Nomad" was delayed in getting off for its world cruise, having the misfortune to run aground near Seattle, Washington. The license has been changed in some respects so that WHDC will work on one frequency only, 8370 kc. for work with amateurs in the 7000 kc. band. The Nomad expedition is now flying the flag of the "Adventurers of the World" under whose auspices the voyage will be made. The "Nomad" will probably shove off without a hitch in late February. In addition to the high frequency assignment, 8370 kc., the Nomad, carries transmitters working on 468 and 500 kc. for commercial ship work. Amateurs working the "Nomad" are requested to QSL via A.R.R.L. Headquarters so we may carry a full account of the communication work with the "Nomad".

WFAT-WFBT

In spite of the fact that the operators with the Byrd Expedition have been extremely busy keeping the *City of New York* in touch with the ice base, a large amount of traffic has been handled through amateur channels. Operators on the *City of New York*, WFAT, have had to keep a schedule with WFD (portable set) the first ten minutes of every hour. Every dog team that leaves the ship bound for the ice base (WFD) is reported by radio at both ends, the system being similar to railroad reporting of trains in this country. Eleven dog teams have been busy running supplies to the permanent base, and if one of these is not reported after a certain length of time another team is sent out after it. On January twentieth Hanson made a trip to the base and laid out plans for the houses and radio towers. The houses are now being built. Peterson, operating at WFD was relieved by Berkner after ten days with the portable. The base station will use the call signal WPA, and this will be put in just as soon as the houses are completed, superseding the portable outfit which will continue to carry the call signal WFD when it is taken to advance bases for running-contact work.

The *Eleanor Boling*, WFAT, will make two trips to the ice barrier returning to winter in Dunedin, N. Z. ZL4AO, famous father-and-son station has been assisting in the expedition work. Son volunteered his services and has spent some time on WFAT and he plans to rejoin the party again next summer (November or December). During the latter half of February W1XV maintained a daily schedule with WFAT during its second trip to the ice barrier with supplies, handling about 1500 words of personal messages per week.

Lieut. Hanson is busy installing a complete station on the Fairchild cabin plane "Stars and Stripes". The set is a combination 50-watt high frequency and intermediate frequency outfit using a generator coupled direct to the propeller motor. In addition, all planes carry one cylinder gas engines capable of running the planes equipment in case of forced landings, and doublet antennae are being used instead of the conventional "trailing" type which is a further precaution against the hazards of forced landings.

From W6AM we learn of an interesting QSO with WFBT (approx. 9000 kc.) on February third, a worthwhile exchange of comments resulting with Mason (just off WFAT) and Berkner at the key, and Palmer of W9BTZ, a friend of Berkner's visiting at W6AM. W3KR had an excellent QSO with WFBT on January 24 but without exchange of traffic, also, W5RG was QSO with WFAT on January 27, handling considerable traffic, and working the *Boling* between midnight and about two am CST. From the December number of "Break-In", a magazine issued by the New Zealand Association of Radio Transmitters, we learn that all the radio operators of the Byrd expedition were feted at a dinner and beano held by their Otago branch at Dunedin, N. Z. in late November. The signals from WFBT and WFAT continue to come through splendidly and we presume these stations will continue to work on 9000 kc. for most of the amateur contact work. When the new base station gets on the air sometime within a few months or by winter (June-July) there will probably be even better opportunity for a large number of amateur contacts due to the improved facilities for work from a permanent base station.

W9EDW has been maintaining regular schedules with both WFBT and WFAT and has handled large quantities of traffic. W9EDW also keeps daily schedules with W9BCA through which station he received



COMPETITION *in* QUALITY Pays

There has been a steady increase in the amount of Formica used by the leading electrical manufacturers for many years.

This increase has been due in large part to the fact that cheaper, less reliable materials have been replaced.

By increasing their material costs, manufacturers have reduced costs due to service, replacement and trouble, by a large amount.

Steadily growing use of this non-absorbant, uniform and dependable insulating material, is proof that it pays to use it.

Quick service from a centrally located plant on a quality material made by an organization of specialists.... that's what Formica offers.

FORMICA

Made from Anhydrous Bakelite Resins
SHEETS TUBES RODS

The FORMICA INSULATION CO. 4626 Spring Grove Ave. CINCINNATI, OHIO

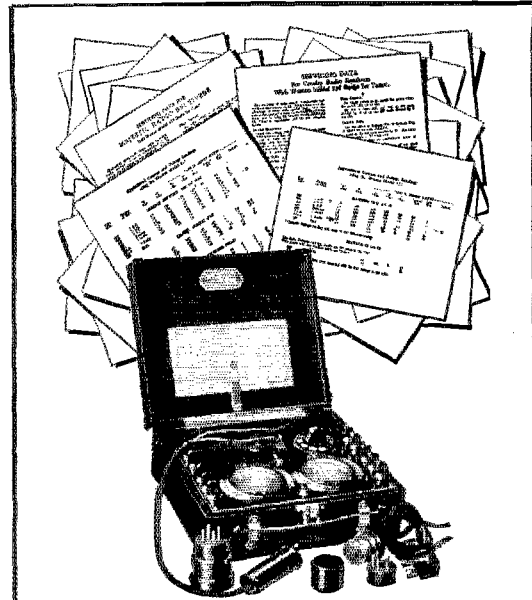

Individual Instruction Cards for Testing Factory-Built Radio Sets

An Added Service of the
WESTON MODEL 537
A.C. and D.C. Radio Set Tester

These Instruction Cards, by covering the specific testing requirements of individual receivers, make the Model 537 a still more useful test set for the service man.

They save the service man's time by giving a complete outline of procedure for testing the principal makes of factory-built sets and, in addition, give the socket voltages and tube plate current for every stage throughout the set, as well as the comparative grid test on the various tubes.

The Model 537 is designed to meet the service requirements of every type and kind of radio receiver. Its use, however, is reduced to still greater simplicity when testing any particular make of set in conjunction with its individual instruction card.

Write to us and we will be pleased to acquaint you with full particulars. Or, better still, address your inquiry to your radio jobber, supply house or our nearest representative—and ask for a demonstration.

**WESTON ELECTRICAL INSTRUMENT
CORPORATION**

602 Frelinghuysen Ave., Newark, N. J.

Weston
PIONEERS
SINCE 1888
INSTRUMENTS

Byrd traffic routed via A.R.R.L. Headquarters and WIMK.

WSBS

This report from the Yacht *Carnegie*, WSBS: (Feb. 11, via WIMK).

"The less said about December and January, the better; conditions in our general locality were fierce. We had a few good contacts during December but these were the exception rather than the rule. January was worse than December. We were at Easter Island from the sixth to the twelfth of December and only able to work two stations during that time. Fortunately Christmas eve gave us best contact with WIMK in long time so KP and I were able to clear all greetings messages at the last minute. As we approached Peru, conditions grew deader and deader every day and after January five, no more stations worked until February eight. We were in Callao from January fourteenth to February fifth. At present things are great. The band is packed with loud signals from all parts of the USA and my signals seem pretty good up there. Let's hope it continues. Since the first of the year, have had a heck of a time raising anyone since few hams listen on thirty-three meters nowadays. Have to do everything by schedules. Tell the gang to listen for me every night from about eight or nine until twelve or one EST on 9056 kc. Am going to try twenty-two meters in early evenings, too, and would appreciate reports. Everything still running smoothly: had a trip up into the mountains in Peru. At an altitude of 16,000 feet, had first cold weather since last July. Hi. Sorry poor weather prevented my wishing you and the gang a great 1929 with lots of DX and traffic. Schedules at present with WIMK, W1SZ, W1XV, W9DPV and NJ2PA. (sig) L. A. Jones, operator, Yacht *Carnegie*.

For the information of amateurs following the progress of this expedition and looking for contacts with WSBS, we repeat that the *Carnegie* will complete the first year of its three-year world cruise in May, 1929. Sailing from Callao, Peru, on February fifth, the *Carnegie* is due at Papete, March 9, at Apia on March 20, Guam on May 11, Yokohama, May 30, and leaving Yokohama, June 24, due San Francisco, July 29.

KFLF

The Yacht *Ripple*, KFLF, had its principle contact with W4IE during its recent trip from San Pedro, Calif. to Sarasota, Florida through the Panama Canal in early February. Between five and ten friendly messages were handled on each of the nightly schedules, and often the friends and family of the yacht owner were visitors at the W4IE to talk directly with their friends aboard the *Ripple*.

WJAY in Cleveland, Ohio, broadcasts code instruction with the co-operation of the Cleveland unit of the USNR on three evenings a week, from midnight to 1:30 a.m.

W6EAF will be glad to make appointments with beginners who have progressed to the point-to-point stage. This is a mighty good chance for getting personally supervised instruction and learn the weak points of your technique.

High Frequency Broadcast by League of Nations During March

Last year the Geneva office of the League of Nations made several broadcasts through the Dutch station PCLL. The speeches were made in turn in English, French, German, Italian, Spanish, Japanese, and Dutch. This year the same sort of a program will be carried out more extensively. Quoting from a recent bulletin from the League of Nations Secretariat, we find that "in view of the generally favorable nature of these results and with the purpose of investigating further the conditions affecting the quality of radio reception in the different regions (of the earth), the Secretariat has decided to continue its experiments. The attempt this time will be to broadcast to certain specified regions under conditions which seem most favorable for each of these regions. In this way an attempt will be made to reach especially the American continent (North and South), Japan, Australia and New Zealand."

These broadcasts appear to be well worth listening for, as a glance at the following schedule will show:

March 12, 19, and 26:

Broadcast to American continents on 7730 kc. (88.8 meters) from 2200 to 2800 G. M. T. (5 p. m. to 6 p. m. E. S. T.) in English, French, and Spanish.

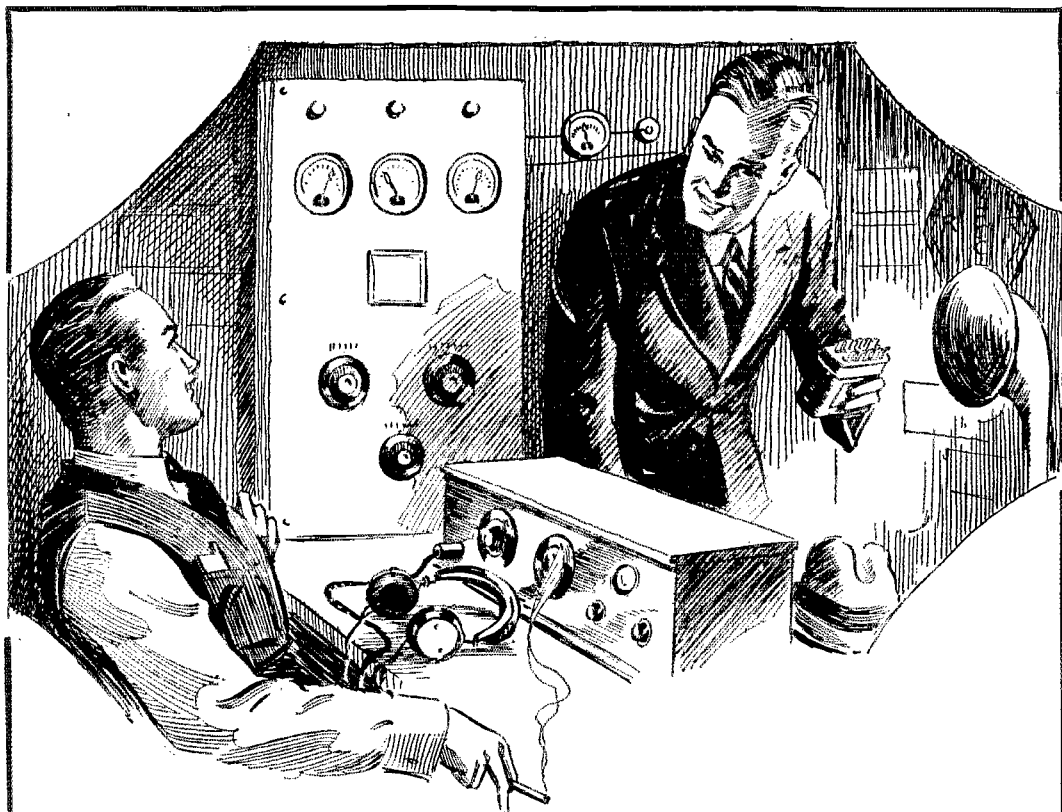

In radio engineering circles

the widespread utilization of Faradon Capacitors is conclusive evidence of ability to deliver dependable service under all conditions.

Of course this result was not obtained over night. More than 20 years of painstaking fabrication experience with each step based

on sound radio engineering data is behind it.

You are invited to avail yourself of the Faradon engineering cooperation on special applications not covered by the more than 200 types of Faradon Capacitors in regular production.

WIRELESS SPECIALTY APPARATUS CO.

Jamaica Plain, Boston, Mass., U. S. A.

Established 1907

Faradon

Electrostatic Condensers for All Purposes

Fixed and Adjustable Resistors for all Radio Circuits



Bradleyunit-B

RADIO manufacturers, set builders and experimenters demand reliable resistors for grid leaks and plate coupling resistors. For such applications Bradleyunit-B has demonstrated its superiority under all tests, because:

- 1—Resistance values are constant irrespective of voltage drop across resistors. Distortion is thus avoided
- 2—Absolutely noiseless
- 3—No aging after long use
- 4—Adequate current capacity
- 5—Rugged, solid-molded construction
- 6—Easily soldered

Use the Bradleyunit-B in your Radio Circuits

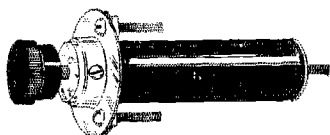

Radiostat

This remarkable graphite compression rheostat, and other types of Allen-Bradley graphite disc rheostats provide stepless, velvet-smooth control for transmitters, scanning disc motors and other apparatus requiring a variable resistance.

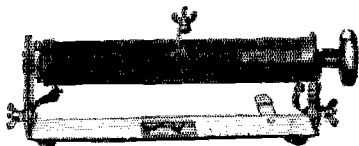

Laboratory Rheostat

Type E-2910 — for general laboratory service. Capacity 200 watts. Maximum current 40 amperes. A handy rheostat for any laboratory.

Write for Bulletins!

ALLEN-BRADLEY CO., 277, Greenfield Ave., Milwaukee, Wis.

Allen-Bradley Resistors

March 13, 20, and 27:

Broadcast to Japan on 16305 kc. (18.4 meters) from 0140 to 0210 G. M. T. (8:40 p. m. to 9:10 p. m. E. S. T.) in Japanese.

March 14, 21, and 28:

Broadcast to Australasia on 16305 kc. (18.4 meters) from 0140 to 0210 G. M. T. (8:40 p. m. to 9:10 p. m. E. S. T.)

All of these broadcasts will be sent from PCLL at Kootwijk, Holland. Readers of QST are invited to listen for these broadcasts and to report reception afterward to the Information Section, League of Nations' Secretariat, Geneva, Switzerland.

Articles Wanted—Communications Department

Again a call for suitable material for these columns is in order. We want to print at least one interesting or educational article in this section each month. If we get enough good material we can make room for more than one article.

To make it worth your while to take time from your operating to set down ideas which you believe interesting or beneficial to other amateurs we are going to offer the particular writer whose material is used in the leading position in the C.D. each month his choice of (1) a copy of The Radio Amateur's Handbook bound in leather cloth, (2) six pads of message blanks, or (3) 500 A.R.R.L. log sheets. This offer is good for the balance of 1929. Manuscripts are not limited in length. They should be clearly written, marked to identify the writer, and to show that the material is submitted for consideration in connection with this offer. We reserve the right to use all material submitted but failing to make the prize position, with the usual credit to the author.

We wish to make this section of QST bigger and better and truly representative of all classes of "communicating" amateurs. New ideas and viewpoints, criticisms of present conditions, suggested remedies for those conditions, suggestions for interesting two-way communication work, using c.w. or phone to report football or baseball games, to conduct contests between remote points, to maintain communication with others while on hikes or touring the country—all these subjects offer possibilities. Interesting material on unusual communication work, on exceptional traffic handling feats, hints on DX work in 1929, articles on the place of radiophones in present-day amateur radio work, all such will be welcomed and given full consideration. Expedition work will receive consideration, too, but remember that the contribution must be of article calibre and not a routine report such as we normally use as part of an expedition article, or as a "Traffic Brief." In short we shall welcome contributions from any individual not a member of the Headquarters staff on any and all phases of amateur communication. Photographs and diagrams may be submitted and can sometimes be used to good advantage in presenting articles. Please bear in mind that station descriptions and technical articles are not included in this offer, however. Such material is welcomed but should be presented to the QST Editorial Department. Also bear in mind that we are not interested in stories or fiction unless they can be shown to bear on timely amateur practices and unless they have either "reading interest" or material helpful in bettering our operating conditions or increasing amateur enjoyment and fun in two-way communication work. What are you doing that is new, better, different, or unusual in the line of "communication"? What amateur operating practices do you note that need improving to increase the utility and efficacy of amateur radio stations? What is the most intelligent way to go about making DX contacts or handling worthwhile traffic? What unusual communication is worthy of record, taking place on 28 mc. or 1750 kc. or other special bands? What suggestions do you wish to make regarding rag-chewing and amateur friendships? What local work have you done in club organization or solving interference problems of long standing resulting from amateur communication?

OFFICIAL BROADCASTING STATIONS

Changes and Additions
(Local Standard Time)

W2AXT-W2BSS 7135 kc. Mon. Tues., Fri. Sun. at 6:45 pm., 14,385 kc. Sunday at 10 am; W8BWP, 7000 kc Mon. Tues., Thurs., Fri., Sun., 5:30 pm.; W9BKJ, Tues. and Thursday at 7 pm; W9APY, 3392 kc., Mon., Wed. and Fri. 7 pm.

Now That You've Had Time To Learn The Value of Precision Equipment ♦♦♦

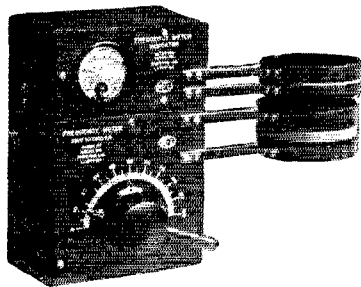

Listen!

An Amateur Frequency Meter — PLUS

WITH THE ADVENT of 1929 operating conditions and narrow frequency bands, the first requirement in an amateur station is a Frequency Meter. It is essential for the very existence of the station. REL has, for more than a year, experimented with different types of Frequency Meters. The very last word in Frequency Meter design has been attained and REL offers to a needy amateur radio world the Frequency Meter pictured above. This precision instrument with its accurate calibration is like balm to the wounds of an injured amateur. Rugged—Dependable—Accurate—This Meter is truly the Amateur's friend. Each Frequency Meter is individually calibrated from a Piezo crystal controlled standard. A detachable resonance indicator is available which can be used with any Frequency Meter. The Meters regularly carried in stock are as follows:

- Cat. No. 173 Frequency Meter 3500 to 4000 KC
(85 to 75 meters).....Price \$15.00
- Cat. No. 177 Frequency Meter 7000 to 7300 KC
(42.8 to 41.0 meters).....Price \$15.00
- Cat. No. 178 Frequency Meter 14000 to 14400 KC
(21.4 to 20.8 Meters).....Price \$15.00
- Cat. No. 179 Frequency Meter 28000 to 30000 KC
(10.7 to 10.0 Meters).....Price \$15.00
- Cat. 180 Frequency Meter Indicator Price \$16.00

New literature describing 1929 amateur equipment is ready for distribution. A copy will be mailed you on request—The second edition of the large loose leaf catalog will be forwarded upon the receipt of 50c.

Supported by This Coil and Condenser!

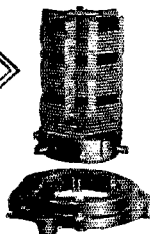

includes inductances to cover the 80, 40 and 20 meter amateur bands. Complete
Cat. No. 182 Coil KitPrice \$10.00

The REL inductance pictured here is similar to those which make up the REL Cat. No. 182 Amateur Band coil kit. This kit used in conjunction with the REL Cat. No. 187E special vernier-tank tuning condenser offers an effective means of spreading each amateur band over the whole tuning scale. This performance is not duplicated by any other apparatus now on the market. The Cat. No. 182 coil kit

The REL Cat. No. 187E special vernier-tank variable tuning condenser shown here solves the problem of full scale coverage of each amateur band. Adjustment easily attained and held permanently by a notched bakelite disc attached to the tank condenser shaft. This condenser is designed to operate in conjunction with the REL Cat. No. 182 Amateur Band coil kit. A very essential instrument in every up-to-date amateur station. Cat. No. 187E special vernier-tank condenserPrice \$6.25

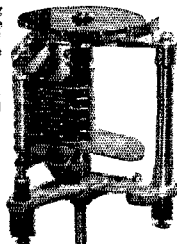

RADIO ENGINEERING LABORATORIES
100 Wilbur Avenue - - - Long Island City, N. Y., U. S. A.

Cunningham RADIO TUBES

1915-1929



High Grade Stations—1929 Signals

LAST MONTH we asked all Section Managers and Route Managers to report the outstanding stations which they considered the "best" ones operating in each band.

Really good signals with the requisite sharpness, steadiness, and clarity of tone which constitute our present-day standards of perfection are not so numerous, if we may judge from the reports. To "make" our list it is necessary that the signals be heard several different times, and reported from more than one source as proof of the consistency of the station and its use of a good signal. Of course stations with perfectly good signals must do a certain amount of operating to be heard and reported. Our list thus credits both outstandingly good signals and consistency or reliability. Of course no stations with choppers or uncalled-for broadness can qualify, and the attention of the observers has been called to this fact so that even the prettiest of signals will not be reported if guilty of being broad and inconsiderate of others.

Stations listed in these reports consistently month after month should be well satisfied with their performance and for good reason. Our first compilation seems to be a little disappointing in numbers, but we feel sure that it will grow, especially if you help your SCM and RM in deciding on their recommendations to QST by submitting small lists of the outstandingly good and consistent stations you hear. Other stations not in our present list will no doubt be able to qualify shortly. Separate reports from each Section in the U.S.A. and Canada will place more emphasis on good station performance, and less emphasis on a small DX record accomplished with brute power and wobbly signals. Since the reports come from all over the country they are equally fair to all station owners. At a later date we may be able to publish individual reports if space permits, thus giving stations listed some idea of their consistent range. Comments on just how these reports may be modified to do the most good would be appreciated, too. It will be noted that separate lists have been turned in for each of our amateur bands. For the information of those who reported and who note certain omissions we add that mention in three separate reports were required to "elect" a station to the list, in the interests of accuracy. We hope that next month we shall have reports on 14,000 kc. in addition to the other communication bands. Either this was overlooked or else our observers failed to find stations at the same time sufficiently sharp and steady and consistently coming through, day after day, on this frequency.

The list of consistent high-quality signals follows:

3500 kc. band:

W1CGR	W2CO	W8DAQ	W9CYQ
W1CJR	W2SC	W8ID	W9EBO
W1IX	W3UN	W9BKJ	W9EKW
W1MK	W4BL	W9CLO	W9DXZ
W1WL	W8AYB	W9CWQ	W9QF

7000 kc. band:

W1AJC	W4EI	W6EIF	W9DSV
W1MK	W4IE	W8LT	W9DWS
W1XV	W4OC	W8UK	W9ECX
W4AAH	W5AFE	W9ARA	W9EGU
W4AFC	W5AFI	W9ANZ	W9EHO
W4AHA	W5BBT	W9BZO	W9ERU
W4AJY	W6CWW	W9COS	W9GEJ
W4BL	W6DYE	W9CRD	KDV5

We hope to receive reports from every S.C.M. and R.M. each month on this subject. Individual stations can also assist materially by giving their Section officials information to help in the compilation of future lists.

One more thing—don't you think your station ought to be on the list, OM? If you have finished the "1929 alterations" and if you are careful to keep the proper adjustments once you have found them, we may find you in our next batch of lists from C.D. officials.

W8COX, in true style of a genius, utilizes the QRM generated by the Junior op by letting him holler into the microphone while he (W8COX) runs outside with the monitor box and listens to the modulation, which is, we shall say, in process of being perfected.

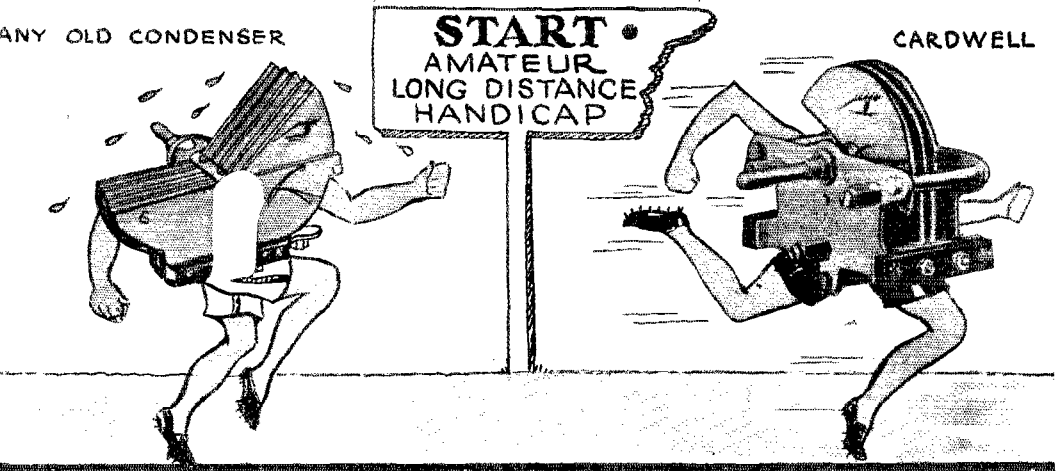

Don't Start With a Handicap!

HOW foolish to spend time and money on a receiver or transmitter from which you expect great results—and then deliberately and knowingly use second rate parts.



Why not use good sense when building the outfit you intend to stay with?

CARDWELL CONDENSERS are *right*—there is no doubt about that—so why risk good time and money when you can just as easily start with the odds in your favor? In other words, why gamble when you can be *sure* with CARDWELLS?



There are few, if any uses for variable condensers that cannot be met by one or more of the many types regularly carried in stock and available at any time. Amateur sizes in transmitting condensers, transmitting condensers for broadcasting stations, fixed air dielectric transmitting condensers, and many types of receiving condensers, notably the rigid Taper Plate, comprise the Cardwell line.

Dispel Any Doubt And Use

CARDWELL CONDENSERS

The Standard of Comparison

The Allen D. Cardwell Manufacturing Corp.
81 Prospect Street, Brooklyn, N. Y.

If your dealer does not stock, send direct to us

The Filter Business

Box 659,
Compton, Calif.

Editor, *QST*:

After reading Mr. Fred A. Blethen's letter on a pure d.c. note with the 1929 transmitter, I will say that obtaining a filter from the fifteen-cent store for a very low-power transmitter is all fine business providing the transmitter is used only occasionally.

As for the amateur that owns the fifty-watt bottle, having less excuse for not having a first class filter, I cannot agree with him. The tuned-grid tuned-plate transmitter at W6AKD is of the 1929 type, but no filter is being used at the present. I have a coupling of eight inches between the plate and antenna coils and all reports that I receive are very sharp and steady. Points as close as two miles, say my signals cover just a fraction of one degree on the dial. Various filter systems have been tried without beneficial results. Several 1750-volt condensers have been blown from the output of two 281's. The 281's are working as a full-wave rectifier, 2000-volt transformer, d.c. output around 900 volts. Some filter, of course, undoubtedly would be a help.

The right kind of filter condensers would cost about thirty-five dollars and half that much for a good choke. Fifty-watt bottles can be purchased for twelve dollars.

However the 1929-type transmitter is all the A.R.R.L. claims it to be. With a 202 at W6AKD, with 350 volts on plate, every district in U.S.A. was worked; also, all continents and twenty-one countries.

—E. P. Jobe, W6AKD, ORS

The New Bands

123 East Matson Ave.,
Syracuse, N. Y.

Editor, *QST*:

The predicted QRM for 1929 did not appear in such quantities as was foretold by many amateurs. Of course, 40 meters is not quite as it was, but the European stations are in the greater part above 43 meters, and in the morning the Aussies and Zedders come right through within the new limits of our band for the W stations are usually weak at that time.

On 20 meters things have not changed at all. There does not appear to be any more stations there. The Germans have been coming through in the morning, D4JL and D4DBA have been worked and the latter reported my signals R7 to R8 at 9:30 a.m. while using a new vertical Zeppelin antenna here.

28,000 kc. is going to be a real band just as soon as the amateurs find out the right time to work with each other. Today I

WATCH Jensen in 1929

Every radio authority knows what Peter L. Jensen did in 1927 and 1928. His perfection of the dynamic speaker assured the qualities in a radio reproducer which the perfection in audio circuits demanded. His reproducers served as the pattern for the entire radio industry.

And now watch Jensen in 1929!

The new Jensen Auditorium Speaker has already been announced. It is designed to operate with all types of amplifiers from the smallest with one tube to the largest with push-pull stages employing type 250 tubes.

And in sensitivity, in brilliance and separation of tones, in its ability to reproduce tremendous volume, this speaker is unmatched by any other reproducer ever made.

Write today for literature and technical data.

JENSEN RADIO MFG. CO.

338 N. Kedzie Ave., Chicago, Ill.
212 Ninth St., Oakland, Calif.

Jensen Patents Allowed and Pending.
Also Licensed under Lektrophone and
Magnavox Patents.

NEW LOW JENSEN PRICES		JENSEN STANDARD DYNAMIC	
D4-8 volt Type		1929 Cabinet Consols	
D4 AC-110	\$35.00	\$55.00	\$70.00
D5-00 to 150 volt A.C.	35.00	55.00	80.00
D4-110 volt D.C.	35.00	55.00	70.00
D4-220 volt D.C.	55.00	55.00	70.00
D4-5 AC-110 volt A.C.	70.00	70.00	70.00

Consols Models to be announced shortly

The
1929

Jensen DYNAMIC SPEAKERS

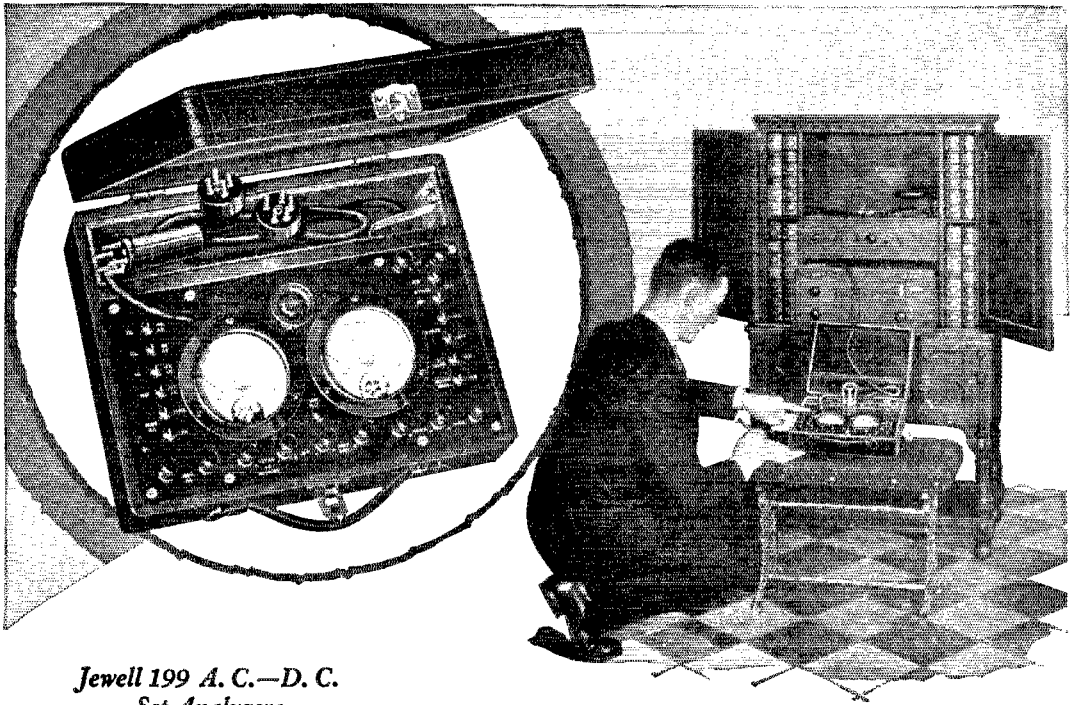

**Jewell 199 A. C.—D. C.
Set Analyzers
Reduce Service Costs**

This efficient radio service instrument quickly locates set troubles. In the Jewell Method of Set Analysis the convenient 5 prong plug or 4 prong adapter is inserted in the tube socket and the complete electrical operation of each stage is thus quickly and accurately checked.

All readings are recorded on the handy Radio Set Analysis Chart, and the results of the test are checked against data covering the receiver, furnished in the Jewell Instruction and Data Book, which contains data on receivers of 25 leading manufacturers.

The Jewell Method of Set Analysis is thoroughly scientific, and therefore thoroughly efficient. It leaves nothing to guesswork, and consequently saves time and provides highly satisfactory results.

Mail the attached coupon for the complete story of Jewell Radio Receiver Service and a copy of the Jewell Instruction and Data Book which contains data on the receivers of 25 leading manufacturers.

**Every Service Man Should Have
a Jewell 199 Set Analyzer**

The Jewell Method of Radio Set Analysis enables service men to locate receiver troubles quickly and with unerring accuracy.

The systematic manner in which tests are made and readings recorded with the Jewell 199 Set Analyzer inspires the confidence of customers.

The accuracy with which radio troubles are diagnosed and eliminated by the Jewell Method assures the customers' satisfaction and good will.

A Jewell 199 Set Analyzer in the hands of every service man is an invaluable foundation for profitable radio business.

Write for information regarding this "service man's friend," today. Mail the coupon.

29 YEARS MAKING GOOD INSTRUMENTS
JEWELL
199 SET ANALYZER.

Jewell Electrical Instrument Company
1650 Walnut St., Chicago, Illinois

Of course we want to know all about the Jewell Method of Set Analysis. Without obligating us send your book, "Instructions for Servicing Radio Receivers."

Name

Address

A whispering campaign...

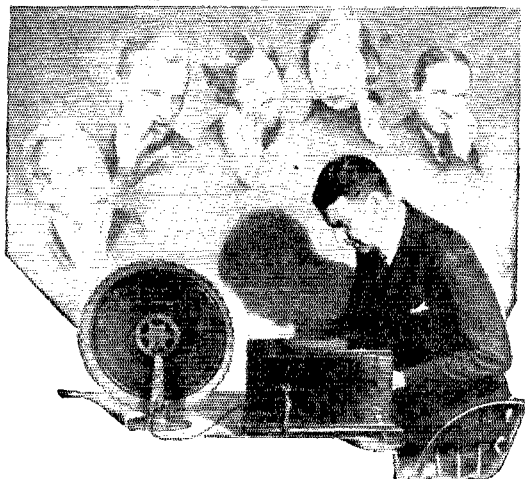

will ruin the popularity of any set owner IF... the set has "ADENOIDS"!

REMEMBER it isn't what they say to your face about your set—it's what they say behind your back. And how those hammers do get busy when they get a set with "adenoids" to talk about.

Preserve the good opinion of your friends—and get the enjoyment you deserve—no matter what the change—if you switch to AmerTran you will improve the quality of your set.

Perform that adenoid operation today—take out the inferior transformers and in their place put AmerTran tone-true radio products.

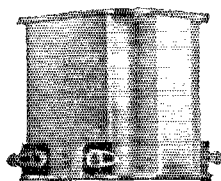

AmerTran DeLuxe Audio Transformer, (illustrated above,) Standard of Excellence, 1st Stage; Turn Ratio, 3; 2nd Stage; Turn Ratio, 4. Price, each \$10.00.

AMERTRAN

TRADE MARK REG. U.S. PAT. OFF.

AMERICAN TRANSFORMER COMPANY
Transformer Manufacturers For More Than 29 Years
42 Emmet St. Newark, N. J.

heard about seven stations, successfully logging four. W6AM came through fine without any fading at 1 p.m. Fading was noticeable later in the day. The possibilities are certainly very bright for this high-frequency band.

—Bruce Hoag, W8AXA

32 Clarence Ave.,
Bridgewater, Mass.

Editor, QST:

In regard to the new 7,000-7,300 band I have a few suggestions to make.

The new band is proving excellent for DX work although some may not agree that this is so. QRM is worse, no doubt, but it has not introduced difficulties which cannot be overcome if each amateur makes an effort.

In the first place, I believe, all United States and Canadian stations should be within a band between 7,125 and 7,300 kc., the rest of the world occupying the frequencies between 7,125 and 7,000 kc. When the Australian and New Zealand stations are audible in this country the Europeans are not. There should be plenty of room.

In the second place, no amateur should ever operate his station unless he has first determined definitely, by means of a monitor, that his signals are of a high standard.

Then, all amateurs should make a determined effort to install a crystal transmitter, a good m.o.p.a. or some apparatus which give a signal of similar quality. I am using an m.o.p.a. myself but a crystal is to be installed in the immediate future.

Let me mention some recent DX which will check my statement that the band, even now is very far from hopeless. Since January 1st I have worked Australia every morning except one. On that morning I worked AC8RV. In the past 17 days I have had to make repeats only four times as the result of QRM. As for Europe, I was in communication with 12 different stations in 3 hours on January 3rd. The contacts then, and since then, were entirely satisfactory. The receiver used at this end differs from that used four years ago only in that the tuning condenser is now of two plates—the rotor being of the "sliding plate" type described in the October, 1928, QST.

Yesterday I made contact with VK5HG at 4 p.m. and this morning I worked VK2AX and VK8VP.

Clance H. Jackson, W1CMP

34-51 73rd St.,
Jackson Heights, L. I.,
N. Y.

Editor, QST:

I am a 3,500 kc. phone man. No other form of amateur radio has the kick for me that a good phone contact provides. My phone, I am proud to say, is fairly understandable.

At the same time, I do not believe that there is room for 3,500 kc. phones any more. I think 3,500 kc. our best DX band now, excepting 28,000 kc., for the 14,000 and 7,000 kc. bands are cut to the bone. Think back on the DX of 1924 and 1925 on the

CROSLLEY

Presents
the
power speaker operating

GEMBOX

together with the famous

CROSLLEY DYNACONE

electro-magnetic power speaker
contained in one unit—
a cabinet of Chinese Chippendale design—the

GEMCHEST

\$94.

without tubes

Crosley adds *style* to the greatest of radio values. Here is radio in its latest and smartest dress—a decorative feature to the modern home—a treat for the eye as well as ear. Available in 3 color combinations, Mandarin Red, Nanking Green and Manchu Black—trimmings in gold.

The Crosley 8 tube SHOWBOX (3 stages of radio, detector and 2 stages audio with 2 power tubes in last stage, plus rectifier tube—8 tubes in all) push-pull amplification—full 180 volts on plates—neutrodyne—built with Crosley Dynacone in same cabinet sells as the SHOWCHEST\$109.

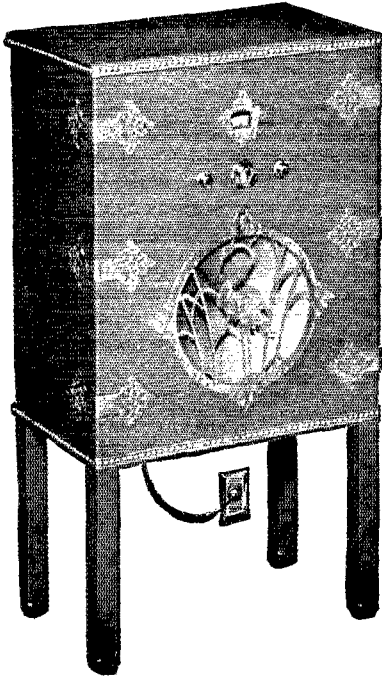

New 8 tube JEWELBOX with power detector tuned antenna circuit uses UY 227 tubes

Power detector makes use of plate rectification instead of grid rectification as commonly used in radio. Result: over-loading prevented and tone improved.

Tuned antenna circuit creates selectivity and sensitivity to a degree of quality never before attained.

8 tubes, 3 radio stages, power detector, 2 audio stages with 2 power tubes in last stage, and rectifier—8 tubes in all.

By use of UY 227 tubes, except in output, filtering of circuits is improved.

Add to these features other improvements such as NEW volume control, improved audio system, full voltage supply, push-pull amplification, no power pack trouble and genuine neutrodyne balancing.

Finish is new black wrinkle brushed with white gold—very smart and very effective in any room setting.

THE CROSLLEY RADIO CORPORATION

Department 18

Cincinnati, Ohio Powel Crosley, Jr. Pres.

Owners of WLW—the nation's station

Montana, Wyoming, Colorado, New Mexico and West prices slightly higher.
Prices quoted are without tubes.

\$105. *without tubes*

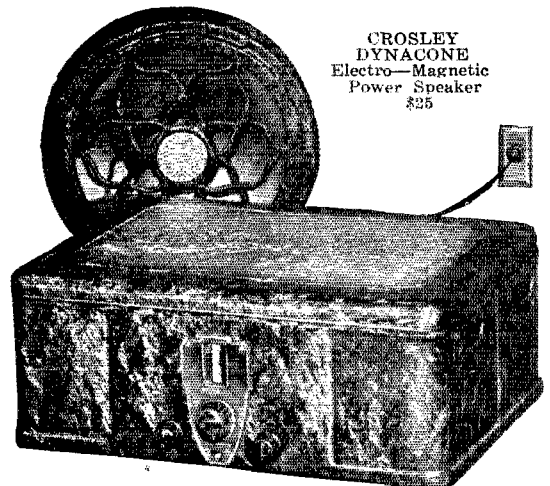

CROSLLEY
DYNAHONE
Electro—Magnetic
Power Speaker
#25

Dubilier

TRANSMITTING CONDENSERS

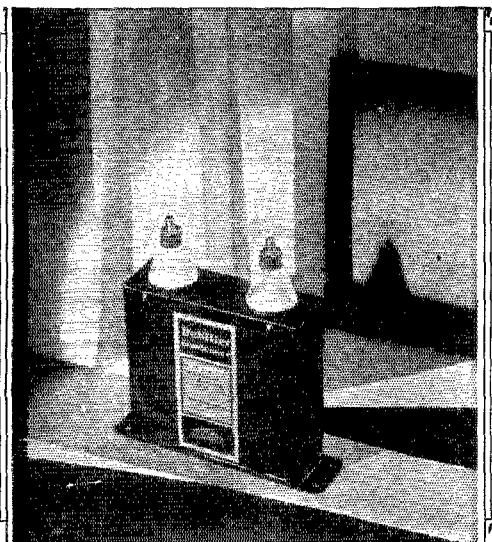

DUBILIER type 686 condensers have the usual Dubilier high safety factors for use in transmitter filter net works. 1000 volt DC rating.

May be connected in series where the working voltage exceeds 1000. Through series parallel connections practically any working voltage and capacity can be obtained.

DC voltage must not exceed 1000; or in A.C. supply filter circuits the transformer voltage must not exceed 750 volts per rectifier plate.

1 mfd. condenser \$5.00
2 " " \$8.00

Write Dept. 44
for free catalog

Dubilier

CONDENSER CORPORATION



10 E. 43rd St.
New York City

80-meter band. The old band should be as good now even with its new name.

Can't the I.A.R.U. give the Europeans from 3,500 to 3,575, the Australian, New Zealand and South African stations from 4,000 to 3,870 and the United States amateur from 3,870 to 3,570 kc?

With 1929 type transmitters I think some such arrangement would simplify matters.

—John R. McKenna, W2AVB, W2XAU,
R.M. of Long Island

Danville Military Institute,
Danville, Va.

Editor, QST:

Everyone seems aware that our 14,000-kc. band is only 400 kc. wide, but what have they done about it? A number have installed 1929 type transmitters with a filter but the remainder seem to think that 400 kc. is 100 kc. wider than the 7,000-kc. band so why should they worry. They don't seem to realize that the 14,000-kc. band has a less effective width than the 7,000-kc. band—that according to the basis used by the Federal Radio Commission in making their assignments, the 7,000-kc. band contains 18 commercial channels and the 14,000-kc. band only 13. For all of this many amateurs have migrated from the 7,000 kc. to the 14,000-kc. band bringing their a.c. and r.a.c. notes with them. AC notes that can be heard 25 kc. from the main frequency seem to be quite popular!

Mr. Hull emphasizes the use of the monitor and of frequency precision in his articles and I for one have tried to take it all to heart. It is a great shame that more amateurs do not do the same.

—John N. Boland, W3HY, W3ASC

Radiogram received from W6AKW
by W1BDI.

A.R.R.L.,
Hartford, Conn.

Thanks for Siberian card forwarded stop Find 1929 jam not at all bad seem hear and work much as usual stop Sometimes it proves more thrilling for DX knowing they're all in there.

Potter, W6AKW

The Beginner's Problems!

72 East Meadow Road,
Lowell, Mass.

Editor, QST:

About a month ago I thought I would build a transmitter. I didn't have any house current but having 90 volts of "B" batteries I thought I would try it. So I built my transmitter with some parts I had, and a 69c 201-A tube. I made some coils for the 3,500-kc. of No. 12 antenna wire. The first day at about 1:00 p.m. I worked a station in Rhode Island, and every night I kept getting better DX, such as Tenn., Chicago, Maine, and New Jersey. About two weeks ago I borrowed 40 volts of "B" from a friend, making 130 volts, and the same night I worked Minn., Oklahoma, and got

Helping WRNY to keep its fine reputation



STATION WRNY, Hotel Roosevelt, New York, is known for the clarity of its recording and transmission.

The engineers here, as in other large broadcasting stations, depend upon PYREX Insulators as an essential to long range and protection of tone quality against transmission noises from adjacent conductors.

PYREX Radio Insulators are made from a special glass embodying excep-

tional electrical resistance, mechanical strength and chemical stability. Initially they are a strong barrier against leakage and eddy losses, and remain so because unimpaired by exposure to rain, fog, soot, dirt and industrial fumes.

Antennae are usually hard to reach for repair, and you do not want the job of replacing insulators that disintegrate, pull apart or fail to insulate completely.

If you want the best transmission or improved reception and one thing less on the trouble list, equip your antenna and lines with PYREX Insulators. The insulating qualities, the mechanical strength, the super-hard smooth time-and-element-resisting surface, and the resistance to destruction originate in the molten glass and are imperishable.

Correct antenna, strain, entering, stand-off, pillar and bus bar types are easily chosen from our booklet, "PYREX Radio Insulators."

Write to us for a free copy of the booklet and get PYREX Insulators from your supply house

CORNING GLASS WORKS, Dept. 64

Industrial and Laboratory Division

CORNING, N. Y.

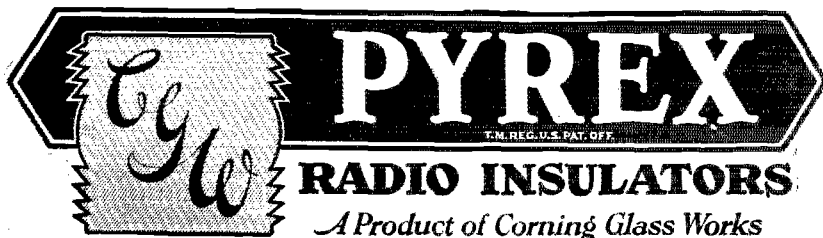

BYRD ANTARCTIC EXPEDITION

Aug. 21, 1938.

International Resistance Company,
420 North 23rd Street,
Philadelphia, Pa.

Dear Sir:

You will be interested to know that we are shipping your
resistors for grid bias purposes to all receivers to be received on
the expedition which will be about thirty in number. The choice
is dependent on the necessity of extreme dependability under adverse
operating conditions and freedom from excessive tube noise which
your resistors have shown in sensitive high frequency receivers
such as will be employed by the expedition.

Yours very truly,

Byrd Antarctic Expedition
Malcolm P. Hanson
Chief Radio Engineer.

4371150

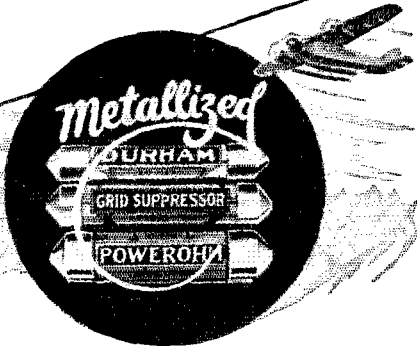

On the Byrd Antarctic Expedition Only DURHAMS are Used!

another tribute to the DURHAM Metallized principle!—
another tribute to the extreme care with which DURHAM
Resistors, Powerohms and Suppressors are made!—
another tribute to DURHAM accuracy and utter
dependability!—read the above letter from Chief Radio
Engineer Malcolm P. Hanson of the Byrd Antarctic Ex-
pedition. In effect he says "We are using DURHAMS
exclusively because past experience has taught us that
they can be relied upon for perfect performance under
even the most adverse conditions." DURHAM Resistances
are available for every practical resistance purpose in
radio and television work from 250 ohms to 100 Megohms
and in ratings for all limited power purposes. Used in
leading radio laboratories, endorsed by leading engineers
and sold by leading jobbers and dealers. Descriptive liter-
ature on the entire line of DURHAM products will be
gladly sent upon request.

DURHAM

RESISTORS & POWEROHMS

INTERNATIONAL RESISTANCE CO., 2006 Chestnut St., Philadelphia, Pa.

an R5 report, North Carolina, 3 Canadians, Kansas and North Dakota. The next night I worked W7DP in Athena, Oregon with a report of R2. The total being 110 stations for 29 days and all districts except the 6th. Have many amateurs had much extra-ordinary success with this voltage on the 3,500-kc. band? I want to say I have met a very decent bunch of amateurs on this band and sure thank them.

—Eugene A. Carr, W1CTC

Office, Supervisor of Radio,
Seattle, Wash.

Mr. K. B. Warner,

Despite the fact that your excellent organization and publication has done much to educate the amateur radio operator in the modern trend of development, there still exist some "hopeless" cases. For your information, I am quoting the following, received in today's mail:

Portland, Oregon.

Supervisor of Radio,
Seattle, Wash.

Dear Sir:

Can I use a Ford spark coil for an induction coil in an amateur wireless telegraph station? If not, why?

Yours truly,—

—Edwin W. Jovejoy, U. S. Supervisor of
Radio, Seventh Radio District.

Report Cards

Box 55, M.I.T. Dormitories,
Cambridge, Mass.

Editor, QST:

It seems that all the articles thus far published in QST on the subject of QSSL cards have had no effect whatever, so as a last resort I hope you will publish this little appeal to the hams.

If I were the only one who received a response of only about 40% to the cards sent out from my station, I would think that there was just something wrong in my particular case. But this is not so. Many of my fellow amateurs feel the same about the matter as I do. One amateur, for instance, will not send out a card any more because he is so disgusted with the situation. Many others will not send a card until they receive one from the other station. I wish that every ham would realize that if this spirit is allowed to continue, it will develop to such an extent that the QSSL card will go out of existence. Suppose everyone decided that he would not send out a card until he received one from the other fellow. It can easily be seen that if this should happen, there would never be a card mailed!

If my reasoning is correct, I think that the QSSL card is a very wonderful thing and an important factor in helping to bind the amateurs together as a single unit, at the same time developing an everlasting feeling of friendship of the highest degree among amateurs. After all, this is one of

SM

S-M Parts Make Powerful and Reliable Radio Receivers

Correspondence CARD

25. L. Service

We are in receipt of your letter, undated, and have pleasure in confirming the items mentioned by you as having been broadcast by this station. We are always glad to hear from over the seas, and hope to hear from you again with regard to our transmission.

Mr. William Parzelt,
128 Post Avenue,
New York City,
U.S.A.

Tube-Socket Plug-In Coils

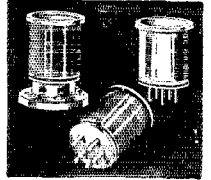

The new "130 Series" S-M Midget Plug-in Coils are wound on extremely accurate bakelite forms, and are very compact, economical and highly uniform. Their winding space is 1½" long by 1½" in diameter, with a slot ⅛" wide and 1/8" deep at the bottom for primary or tickler windings. All forms are equipped with five pins to fit any 5-prong tube socket (as S-M 512). Overall size, 2½" long over finger flange, 1¾" diameter.

Australia—New York Broadcast Reception!

AUSTRALIA to New York City on 353 meters! Direct verification from Station 2BL in Sydney, New South Wales, to a listener by the Hudson—one of the many thousands who have successfully employed the S-M Sargent-Rayment Seven to break through congested local interference.

We congratulate Mr. Parzelt on this feat of reception, and are happy to be able to supply, to all who desire it, a receiver of such caliber.

The 710 is everything the most fastidious listener might want—an ultra-sensitive and knife-edge tuning set, which can, nevertheless, be operated when desired as a real one-dial set—with tone quality unsurpassed even in sets not designed for unusual selectivity. All this at \$130.00 for the KIT or \$175.00 WIRED—both prices including cabinet!

Second only to the Sargent-Rayment, and nearly as famous for its distance records—including reception from Japan in many parts of the U. S.—the S-M 720 Screen-Grid Six brings surpassing radio quality within the moderate-price range. It contains the same matchless S-M Clough-system audio transformers. Price of the KIT, \$72.50; beautiful metal shielding cabinet extra \$9.25. WIRED complete in cabinet, \$102.00.

The Radiobuilder, a monthly publication telling the very latest developments of the S-M laboratories, is too valuable for any setbuilder to be without. Send the coupon for free sample copy, or to enter your subscription if you want it regularly.

SILVER-MARSHALL, Inc., 858 W. JACKSON BLVD. CHICAGO, U. S. A.

S-M Catalog No.	NO. OF TURNS		Meters Range (.00014 Condenser)	Price
	Secondary	Primary		
131T	6½	5½	17.4-32.1	\$1.25
131U	13½	5½	31- 58	1.25
131V	25½	9½	57-110	1.25
131W	49½	15½	104-204	1.25
131X	82¼	19½	190-358	1.25
131Y	155	30½	344-647	1.50
130P	Plain Coil Form with Contact Pins.....			.65
130T	Threaded Coil Form (98 threads) with Contact Pins.....			.65

New S-M Stage Shields

The new S-M 638 copper stage shield, used in the 720 Screen Grid Six and other circuits, is small and compact, with removable top and bottom, and will accommodate all standard tubes, all types of S-M tube-socket plug-in coils with sockets, and the necessary by-pass condensers and resistors. A hole is provided in the bottom for an S-M 340 or 342 type midget condenser. The bottom is pierced with all mounting and lead holes, and is provided with four raised mounting feet, allowing wiring and screw heads to fall beneath the bottom holes. Overall size, 4½ inches long, 5½ inches high, and 2½ inches wide. Sides are ribbed to prevent bending. Beautifully finished in lacquered copper. Price \$1.50.

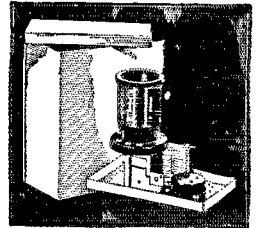

Ask about our Authorized Service Station Appointment!

Silver-Marshall Inc.
858 W. Jackson Blvd., Chicago, U. S. A.
...Send your complete catalog, with sample copy of the Radiobuilder.
...For enclosed 10c, send five selected Data Sheets, including Types 710 and 720.

Name.....
Address.....

Are We Right?

You should have at least two of them — one for your complete 1928 file of copies, and one for each 1929 issue as published.

Keep them as a unit in a

QST Binder

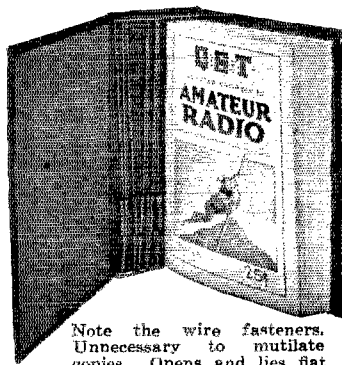

Note the wire fasteners. Unnecessary to mutilate copies. Opens and lies flat in any position.

One-fifty each
postpaid

A binder will keep your QSTs always together and protect them for future use. And it's a good-looking binder, too.

QST

1711 Park St., Hartford, Conn.

the aims of our wonderful organization the A.R.R.L., so let's help it along by bringing back that good old spirit. Send a card to every station you work.

—Jack Wagenseller, W3GS—W1KD

I. A. R. U. News

(Continued from Page 53)

meter band has been reserved solely for amateur use in Spain. Congratulations, EAR's!

In New Zealand, at this writing, the new regulations are imminent. The government officials have had several conferences with officers of the N.Z.A.R.T., and in all probability the regulations will be quite acceptable. In Holland, where for years the government has frowned on amateur operation in any degree, it now appears that a change is due to take place. Government proposals have been drawn up, and, as in New Zealand, have been submitted to the amateur representatives for criticism and comment.

It is excellent to see amateur regulations of a favorable nature being issued by the governments of these countries; it is even better to see such close and friendly relations between the governmental agencies and the amateur societies.

INTERNATIONAL PREFIXES

The list of international prefixes is growing rapidly. We have a number to add to the initial list given in the last months I.A.R.U. list.

It is well to state here that the prefix for Australia shown last month is not correct. We had received several unofficial reports to the effect that it was MH, but it now appears from official sources that the prefix is officially VK.

Austria	UO
Australia	VK
Belgium	ON
Brazil	PY
Dutch East Indies	UI
Ecuador	HC
England	G
Finland	OH
France	F
Germany	D
Holland	PA
Irish Free State	EI
Luxembourg	UL
Newfoundland	VO
Northern Ireland	GI
Norway	LA
Panama	RX
Poland	SP
Roumania	CV
South Africa	ZS
Sweden	SM
Uruguay	CW

Any American or foreign amateurs learning of new prefixes, and sure of the fact that they are official, would help Headquarters and their fellow-amateurs by sending in such prefixes to A.R.R.L. Headquarters

The Finest Receivers Are Thordarson Equipped

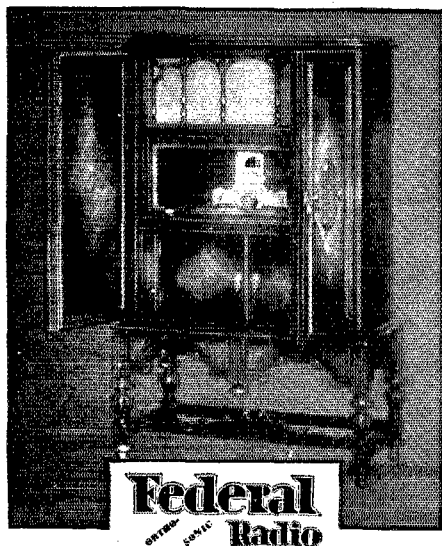

"Thordarson products have been chosen for incorporation in Federal Ortho-Sonic Radio Sets because we have always been certain that we would receive a quality of product entirely in keeping with the high standard set by us for Federal Receivers."

Lester E. Noth.

President,
Federal Radio Corporation

THORDARSON ELECTRIC MANUFACTURING CO.
Transformer Specialists Since 1895
Huron, Kingsbury and Larrabee Streets • Chicago

THORDARSON RADIO TRANSFORMERS

SUPREME IN MUSICAL PERFORMANCE

Be a Commercial Radio Operator

A practical book that should enable anyone of average intelligence to pass the Government's theoretical examination given to applicants for a Commercial Radio Operator's License.

NEW!

Nilson and Hornung's PRACTICAL RADIO TELEGRAPHY

380 pages, 5x8, 223 illustrations
\$3.00 net, postpaid

The book covers in detail the theory and practical operation of every type of modern, 1928, commercial arc, spark, and vacuum tube transmitter. It furnishes complete data on commercial vacuum tube receivers. It covers everything from elementary electricity to the practical operation of radio compasses.

Some outstanding points

1. Very little mathematics;
2. Assumes no prior knowledge of electricity;
3. Covers everything in commercial radio in detail;
4. Complete list of self-examination questions;
5. Simple, yet rigidly accurate;
6. Complete wiring diagrams given.

See the book before you purchase. Fill in and mail just this coupon.

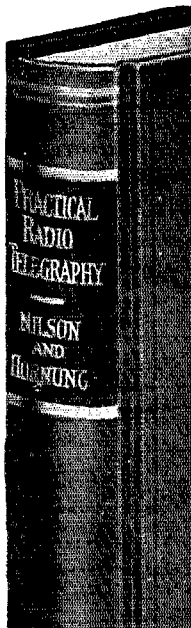

at once. Additions will be published as fast as received.

AUSTRALIAN REGULATIONS

The new Australian regulations, as reported by *New Zealand Radio* are as follows:

WAVEBANDS

60,000 kc. to 56,000 kc.	5.0-5.35 meters
30,000 kc. to 28,000 kc.	10.0-10.7 meters
14,400 kc. to 14,000 kc.	20.8-21.4 meters
7,300 kc. to 7,000 kc.	41.0-42.3 meters
1,990 kc. to 1,715 kc.	150.8-175 meters
1,715 kc. to 1,200 kc.	175.0-250 meters

It will be noted that the twenty- and forty-meter bands allowed are the full width provided by the Washington conference. The eighty-meter band is not open for amateurs, but there is a new band from 175 to 250 meters. This is solely of the making of the Australian authorities, apparently, since the Washington conference does not provide any amateur transmission above 175 meters.

As for message handling, it is specified that transmissions must be confined to experiments and tests, although messages relating to the experiments may be exchanged. Under no circumstances, however, can messages for a third party be transmitted without the permission of the P.M.G. Department, which would seem to prohibit message-handling as we know it in the States.

The correct and careful tuning of transmitters is stressed, and all stations will be required to install approved frequency meters.

Call signals will be preceded by the prefix VK.

The new regulations went into force on the first of January, 1929. The fee for an experimental license is one pound (approximately \$5.00) per year.

BRITISH SECTION NOTES

By G6CL, Social Manager, R.S.G.B.

Conditions in general on the 7500-kc. band showed an improvement. Fade-out in Great Britain occurred between 1800 and 1900 G.M.T. and after this period it was noted as in previous years that only the consistent stations audible were those situated at distances over 1000 miles. Spanish, Portuguese, Russian, and North African stations were heard almost nightly, whilst nearby Europe was, with very few exceptions, completely cut off. During daylight, signals remained fairly consistent in strength. It was noticed on several occasions that stations situated in Finland and Norway were audible during the middle hours of the day. It would be interesting to have information on the reason for these rather extraordinary skips during daylight on this band.

An improvement was noted with regard to transatlantic work, many North American stations being received as early as 2100 G.M.T. From observations, however, it would appear that there is greater difficulty now in effecting two-way communication between Europe and North America than in previous years at the same time.

McGraw-Hill FREE EXAMINATION COUPON

McGraw-Hill Book Co., Inc.,
370 Seventh Avenue,
New York, N. Y.

You may send me Nilson and Hornung's PRACTICAL RADIO TELEGRAPHY, \$3.00 net, postpaid. I will either return the book, postage prepaid, in 10 days, or remit for it at that time.

Name

St. & No.

City

State

Name of Employer

Official Position

(Books sent on approval in the U. S. and Canada only)

QST 8-29

Massachusetts Radio and Telegraph School

18 Boylston Street, Boston

Send for Catalogue

Tel. Hancock 8184 Established 1905

Do you know that the 1929 Handy and Hull Handbook is available in bound form—\$2.00 per copy, postpaid?

When ordering a copy of this new edition, look at your present copy and determine if you want the 1929 copy in more permanent form.



EVERY TRANSMITTING AMATEUR USES THESE FORMS



*—a reminder that
your supply may be low—*

AMERICAN RADIO RELAY LEAGUE
LOG OF STATION

SHEET NO. _____

DATE	CALLED	CALLER BY	CLASS	PROGRAM	REMARKS

A. R. R. L. Log Sheets

Designed by hams for hams. 8½ x 11 bond paper, punched for standard three-ring loose-leaf binder. 125 sheets postpaid for \$1.00 or 500 for \$3.50.

Members' Correspondence Stationery

Write your radio letters on League letter-heads—it identifies you with the biggest radio organization in the world. Lithographed on 8½ x 11 heavy bond paper. 100 sheets postpaid for 75c or 250 sheets for \$1.70. Sold to members only.

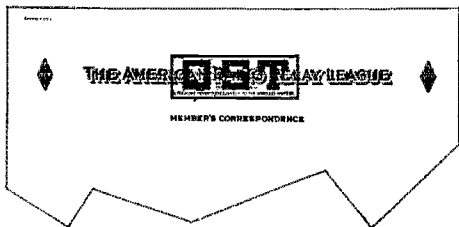

THE AMERICAN RADIO RELAY LEAGUE
HEADQUARTERS, HARTFORD, CONN. U.S.A.

RADIOGRAM

CITY OF ORIGIN: HARTFORD CONN. REGION OR ZONE: NUMBER: DATE: CHECK BY:

(SEE REG 70) 2 000 187 SEP 17 1934

TO: MISS GLADES BARRAN 1ST

5 STUMPER ROAD
P.O. BOX 1000
CHANDLER MASS

THIS MESSAGE WAS RECEIVED AT
CITY: DATE: TIME: OPERATOR:

CONGRATULATIONS ON YOUR GOOD TRAFFIC HANDLING WORK STOP YOU ARE
WELL KNOWN AND ARE BEING WELL SALED BY THE AMERICAN RADIO RELAY LEAGUE
FOR EMPLOYING THE MOST POWER TO ALL ITS AND SALED TO SEE THAT YOU ARE
PUTTING THE OLD ESTABLISHED DIVISION OF THE MAP INTO USE AND TO
WISH WELCOME TO YOUR COMMUNICATIONS DEPARTMENT

Rec'd	FROM STATION	LOCATED AT	DATE	TIME	OPERATOR
Sent	3 WTZ	WATERBURY MASS	11/17/34	1:15 p	WJG:EL

Official A. R. R. L. Message Blanks

Most convenient form. Designed by the Communications Department of the A.R.R.L. Well printed on good bond paper. Size 8½ x 7¼. Put up in pads of 100 sheets. One pad postpaid for 35c or three pads for \$1.00.

RADIOGRAM
AMERICAN RADIO RELAY LEAGUE

TO: _____ DATE: _____

FROM: _____

OPERATOR: _____

Message Delivery Cards

Neatest simplest way to deliver a message to a near-by town. On U.S. stamped postals 2c each. On plain cards (for Canada, etc.) 1c each postpaid.

American Radio Relay League

1711 Park Street

Hartford, Conn.

Martin's Latest and Greatest Bug
THE GREAT NEW VIBROPLEX

Reg. Trade Marks: Vibroplex, Bug, Lightning Bug

No. 6



Japanned Base \$17
 Nickel-Plated \$19

The smoothest, easiest-working bug on the market. Not too fast, not too slow—but just right.

Famous Improved Vibroplex

Used by tens of thousands of operators because of its ease and perfection of sending.

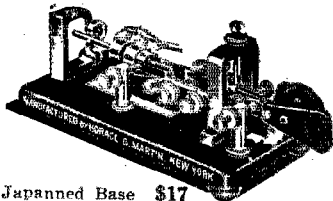

Japanned Base \$17
 Nickel-Plated \$19

Special Radio Bug

Equipped with Extra Large, Heavy, Specially Constructed Contact Points for direct use without relay **\$25**

Insist on the Genuine Vibroplex. The Vibroplex Name-plate is your protection. Remit by Money Order or registered mail.

THE VIBROPLEX CO., Inc. 825 Broadway
 New York City
 Cable Address: "VIBROPLEX" New York

It was noted that several North American stations after having called CQDX were again calling CQ within two minutes of the completion of the previous call, and it is suggested that greater care be taken in searching for European signals, which are on the whole emitted with considerably lower power than those from the American side.

During the month it was noted that a large number of stations, both European and American, were transmitting off-wave but it is anticipated that within a short time this will all be straightened out.

Conditions on the 14,000 kc. band showed no marked improvement during the month, and it would appear that serious work on this frequency is now finished.

Referring to work on the 28,000 kc. band: With the exception of one or two isolated contacts the month seems to have passed without event, but all British stations are particularly anxious to effect initial contacts with new countries and new continents. In this connection a series of special tests on these bands are to be organized in March of this year by our Contact Bureau. All reports on these tests should be sent to Mr. T. P. Allan, GI6YW, 59 Marlborough North, Belfast, Ireland.

The annual general meeting of the Radio Society of Great Britain was held in London on December 21st under the Chairmanship of Mr. Gerald Marcuse, G2NM. Two interesting presentations were made on this occasion, the first to Mr. T. P. Allan, when he received the Rotab Cup in recognition of his fine work in connection with the establishment of the Contact Bureau, and the second, when the Wortley-Talbot cup was presented to Mr. J. W. Mathews, G6LL, as recognition for his pioneer work in the 28,000 kc. band.

The new committee for the year were elected as follows:

Mr. G. Marcuse	G2NM	License	Questions
Mr. Bevan Swift	G2TI	T. & R. Bulletin	
Mr. J. Clarricoats	G6CL	Social Manager	
Mr. Hinderlich	G2QY	QSL Manager	
Mr. Pilpel	G6PP	QRA Manager	
Mr. T. P. Allan	GI6YW	Contact Bureau	Manager
Mr. J. W. Mathews	G6LL	Calibration Service	and instruments

The Committee of the Society will be very glad to receive applications for membership from all foreign and colonial amateurs. All communications should be addressed to the Hon. Secretary, 53 Victoria Street, London.

CANADA

The most important event from the amateur standpoint in Canada was the effecting of a cooperative message agreement between the Canadian authorities and the United States Government. Full details of this agreement are set forth elsewhere in this issue. Similar arrangements with other nations are hoped for by the Headquarters of the A.R.R.L., which are working

AMATEURS!!!
 use **OCTOCOILS**

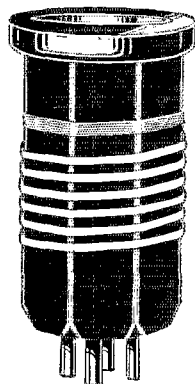

Get Louder Signals

Set of four Octocoils with midget variable condenser covers 10, 20, 40 and 80 meter wavebands with proper selectivity. Space-Wound on distinctively colored bakelite molded forms with Nos. 12, 14 and 16 bare copper wire. Tests prove no increased losses over airwound coils and OCTOCOILS are much more rugged.

LIST PRICE \$4.00
 Per Set of Four Coils
 \$5.00 with midget condenser.

Order Now—Send No Money:

Shortwave and Television Laboratory, Inc.
 104 Brookline Avenue, Boston, Mass.

Send me C. O. D. set(s) OCTOCOILS with midget tuning condenser to cover the amateur bands at \$5.00 per set.

I understand these are unconditionally guaranteed.

Name

Address

BARGAINS

ARMY AND NAVY RADIO SURPLUS

Voltmeter, Weston 267 D.C., 0-70	\$ 7.50	Keys, transmitting, Army practice	\$ 1.00
Ammeter, " 267 D.C., 30-0-30	7.50	" " " Airplane, flame proof, silver 1/2 contacts	1.50
" " 267 D.C., 0-10	7.50	" " " Airplane, flame proof, silver 1/2 contacts	1.50
" " 301 D.C., 20-0-50	5.00	" " " All bronze & bakelite with blinker light	2.00
Voltmeter, " 301 D.C., 0-150	5.00	" " " Navy, 2 K.W. silver 1/2 contacts	5.00
Wattmeter, Rolter Smith AC-DC, 0-750	3.50	" " " Navy, 2 K.W. with twin 1/2" relay	10.00
Ammeter, hot wire, Gen. Radio 0-5	1.50	Relays, Navy, 2-5 K.W. twin 1/2" contacts	7.50
" R.F. Rolter Smith 0-6	2.00	All types of helices, loading coils, oscillation transformers, etc.	
Ampere hour meter Sangamo, M.S. 0-480	10.00	Headphones, Army, with strap 120 ohms75
Ammeter, Westinghouse A.C. 3"-shunt 300-600	10.00	Transmitter, telephone, U.S.N. 30 ohm (used)75
Voltmeter " A.C. 8" with res. 0-175	12.50	Microphone, W.E. airplane with brassplate95
		Filters, W.E. telephone, C.W. 968 in cabinet	3.50
		Magnets, Army, mine type	1.00
		Telephone & telegraph portable set in aluminum case, leather cover & strap, consists of condensers induction coil, batteries, key, transmitter & receiver	3.50
Generator, 1/4 K.W. 500 cycle 110 volt	15.00	Telephone, telegraph & buzzer portable set, like above except for mahogany case and with 3 H.F. buzzers, 3 telephone switches, 3 mid condensers, etc.	5.00
Dynamotor, G.E. 12/350, output 14 amp.	20.00	Kolster Watmeter & decimeter type CN 1215 100-3500 meters, with cur. 50 meter	85.00
" Westinghouse 27/350	15.00	Kolster decimeter, bur. standards type C model C.A.F. 322-300 to 10,000 meters	85.00
" Crocker Wheeler, 25/275 ext. shaft	12.00	Receivers, Navy C.N. 113-114, 300-2500 meters	15.00
" "Snerry" 6/400 output 200 watt shaft	15.00	" " " S.E. 143, 1.P. 500, 300-6800 meters	
Motor-generator, C.W. 110 D.C. 220 A.C. 500 watt Also 1-2-5 K.W. all 500 cycle	50.00	" " " 100, 100A, 500-1000 meters	
Generators, 600 volt D.C. 2-5-10-50-100 K.W.		" " " C.N. 258, C.N. 210, 1000-10000 meters	15.00
Motors, Hamilton Beach, 1/20 H.P. universal 110v	5.00	Amplifiers, Cardwell, 2 step	15.00
" Edison, 1/50 universal	3.50	Detector, Audio, Navy, DeForest	10.00
" Edison, 1/75 D.C. only	2.00	Insulators, Electrose, strain 7"-15, 12"-25, 18"25
" G.E. 1/16 type S.A., 60 cycle 1140 R.P.M.	9.95	Insulators, Electrose, support type, per doz.50
" Westinghouse 1/4" C.A.H. 3735 R.P.M.	11.85	Switch, Send and Receive, Navy, bakelite, back connect.	1.50
Armatures, 12/750, 24/1500 D.C. ball bearing 1000	12.50	" Nickel plate S.P. small ind. push type 250v25
Transformers, Western Elec. input & output	1.50	" Knife, 60 amp. D.P. fused, polished copper, unmounted R.C.50
" Navy, 125 input 15-10-5 output 1/4 K.W.	7.50	Fuses, plug, 3-6-10-15-20-25-30 amp., doz.50
" G.E. 125 input 25.0 output center tap 200 watt	5.50	Fuses, cartridge 1-10-15-20-25-30 amp., doz.75
" 110 PRI, 6000 SEC. 1/2 K.W. 500 cycles	3.50	Wire, No. 18 Stranded, "Simplex" 30% para rubber ins. per C	1.25
" 110 PRI 11500 SEC. 1/2 K.W. 500 cycles	5.00	" No. 18 " double "Simplex" 30% para rubber	
" 220 PRI 8000 SEC. 1 K.W. 500 cycles	15.00	" heavy duty, ft.04
" 2-5 K.W. 500 cycles 1 K.W. 60 cycles 25,000 volts Silicon laminations, high grade .20-35 lb.		" No. 18 Stranded double U.S.N. deck cable heavy duty ft.04
Resistors, Ward Leonard, standard base 600-500-2000 ohms60	" No. 20 " double Bik P.S. cord D.C.C. ft.03
Resistance, Var. 200 ohms 1.5 amp airplane type	1.00	Leads, No. 18, 15 ft. parallel, high tension, armored, with clips each	1.00
Resistance, Var. 1100 ohms 0.1 amp airplane type	1.00	" telephone, W.E. green 6 ft.20
Rheostats, 3 taps 400 ohms 0.3 amp.75	Coils, magnet, small .20 large50
" Variable, W.L. 500 ohm .6-1.2 amp. field control	5.00	" induction small size25
" Variable, W.L.&C.H., 6 ohm, 12-4 amp. bat. chg.	3.00	Largest Radio & Electric Supply House in U.S. devoting eight floors to and specializing on Army and Navy surplus. Write us your particular requirements. New items are continually arriving. Sufficient postage must accompany orders.	
Gasoline engines 1-2-4 cylinders \$25-\$50-\$75			
Condensers, Mica .004 mfd. 12500 volt, also large ass't other capacities, Mica type	1.00		
Condensers, Western Elec. 21AA 1000 volt 1 mid	1.00		
" Kollig 3 mid 500 volt50		
" W. E. "C" 1/20 "21R" 1-1625		
" Marconi & Wireless Spec. Transmitting, copper.			
" Leyden Jar 10,000 volt .002 mfd.	2.00		

MANHATTAN ELECTRIC BARGAIN HOUSE

DEPT. Q

105-7 FULTON ST.

N. Y. C.

LAST MINUTE SPECIALS

R. C. A. Uni-Rectron Power Amplifiers—Model A. P. 935 List \$38.50 ea.	Our Price	\$19.75 ea.
E210 BRADLEYSTATS, list \$4.00 fine for A. C. Line Voltage Control	"	1.60 "
Genuine Black Bakelite Panels 38"x48", 3/16" thick, Reg. Price \$29	"	8.75 "
U. S. Army Aeroplane Spark Transmitters, Gov. cost \$47 each	"	4.75 "
G. E. Kenotron Rectifying Tubes (Type T.B.I.)	"	1.25 "
Gould Kathode Unipower, Automatic Radio "A" Power (6 volt), list \$39.50	"	13.75 "
G. E. V.T.14—5 watt Transmitting Tubes (A good power amplifying tube)	"	1.50 "
2 Henry—250 mill choke coils, D.C. Resistance 20 ohms. List \$25	"	4.75 "

AMERICAN SALES CO., 19-21 WARREN ST., NEW YORK CITY

QST OSCILLATING CRYSTALS

Amateur Bands

POWER CRYSTALS ground in the various Amateur Bands at random frequencies with frequency stated accurate to BETTER THAN A TENTH OF ONE PER-CENT at the following prices:

1715 to 2000 Kcs	\$20.00
3500 to 4000 Kcs	\$27.50
7000 to 7300 Kcs	\$45.00

Add Ten Dollars (\$10.00) to the above prices if crystal is to be mounted in a POWER DUSTPROOF HOLDER. Immediate deliveries and all crystals guaranteed regards to frequency and output.

BROADCAST BAND

We will grind for you a crystal accurate to plus or minus 500 cycles of your assigned frequency (550 to 1500 Kc Band) for \$45.00 unmounted or \$55.00 mounted. Orders filled within three days after receipt of order. In ordering please specify type tube, plate voltage, and the operating temperature.

SCIENTIFIC RADIO SERVICE

"The Crystal Specialists"

P. O. Box 86, Dept. C., Mount Rainier, Maryland.

FROST-RADIO MICROPHONES

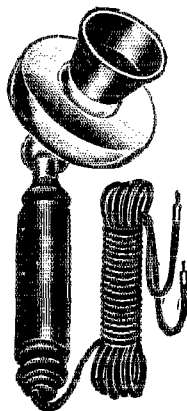

Built of finest quality materials so as to deliver 100% satisfaction for ham use. Solid back, carbon button type. Have unusually sensitive microphones which reproduce all audible frequencies with great fidelity and trueness of tone. Supplied complete with superior quality tinsel cords.

- No. 155 Hand Microphone\$6.00
- No. 159 Desk Microphone\$8.75
- No. 157 Pony Arm Microphone for wall or panel mounting\$4.50

HERBERT H. FROST, INC.,
 Elkhart, Indiana
 Chicago San Francisco

on the matter with the State Department of the U. S. Government.

HOLLAND SECTION NOTES

By W. Keeman, Traffic Mgr., N.V.I.R.

The Headquarters of the N.V.I.R. have received the proposed provisional regulations concerning amateur licenses. A special N.V.I.R. committee has studied this over, and together with a delegation from the N.V.V.R., will participate in a conference with the Postmaster General. Provisional licenses will be issued until the provisions of the international conference held at Prague are fully known. It is not expected that these will materially affect amateurs, however.

The new prefix for Dutch stations will probably be PA.

During December, conditions remained very bad. On 20 meters, mostly only commercial stations could be heard, and on 40 meters conditions were worse than for a long time. Only a few W's could be heard, but some nights W1MK was heard R4 to R5 (new code) and several official broadcasts were copied in the Hague, FB! You fellows of the Headquarters, During the nights good QSO's were possible only with European stations. Several hams observed that the W stations were best at about 22-23 G.M.T. (5-6 p.m., E.S.T.—Ed.). At 2330 the signals went suddenly down to RO, and remained there.

JAPAN

We have received a list of present licensed Japanese amateur stations, and are awaiting only the permission of the J.A.R.L. (Japanese Amateur Radio League) to publish this for the information of QST readers.

Most of the Japanese amateurs are now on 38 meters, apparently, although we do not see how this condition can be maintained very long in view of the Washington conference allocations. Powers are rarely over 10 or 20 watts. Japanese call signs are now made up of a prefix, J, followed by a figure denoting the district, of which there are seven, and two letters. This gives a call identical in form to the U. S. call letters; calls run as J1CW, J3CB, etc.

SPANISH SECTION NOTES

By EAR1, President, Associate E.A.R.

In the latter part of 1928 a meeting and banquet of Spanish amateurs was held, there being present members from Spain, the Balearic Isles, Canary Isles and the Moroccan Zone.

A reception was accorded Sr. Miguel Moya, EAR1, President and Founder of the Association, and for having been appointed a member of the government commission on amateur regulations. A vote of congratulation to Mr. Maxim and Mr. Warner for the work they accomplished for the I.A.R.U. at Washington has passed, and drank a toast to their health.

The President of the EAR has obtained from the official Spanish Radiocommunications

RADIO IN BRASIL

When in Brasil, apply to M. BARROS & CIA for anything you need in connection with radio.

M. BARROS & CIA

70 sob. Rua S. José 70 sob.
 Postal Box 89

Rio de Janeiro

Telegraph address, Radioparte, Rio de Janeiro
 Branch: Avenida S. João 4, S. Paulo, Brasil

PACENT

Duo Lateral COILS

The complete line of all standard turn ratios preferred by leading laboratories and engineers.

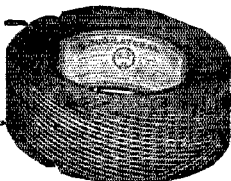

Write for information and prices.

PACENT ELECTRIC CO., Inc.
 91-7th Avenue, New York City

The A.R.R.L. Diamond Is the Emblem of a Real Amateur!



The League Emblem comes in four different forms. Its use by Members is endorsed and encouraged by the League. Every Member should be proud to display the insignia of his organization in every possible way.

THE PERSONAL EMBLEM. A handsome creation in extra-heavy rolled gold and black enamel, $\frac{1}{2}$ " high, supplied in lapel button or pin-back style. There are still a few fellows who are hiding their light under a bushel. Wear your emblem, OM, and take your proper place in the radio fraternity. Either style emblem, \$1.00, postpaid.

THE AUTOMOBILE EMBLEM. Introduced last spring, already more than 800 cars are proudly displaying the mark of the "Radio Rolls-Royce." $5 \times 2\frac{1}{4}$ ", heavily enameled in gold and black on sheet metal, holes top and bottom, 50c each, postpaid.

THE EMBLEM CUT. A mounted printing electrotype, the same size as the lapel button, for use by Members in any type of printed matter, letterheads, cards, etc. \$1.00 each, postpaid.

THE "JUMBO" EMBLEM. You've taken care of yourself, your car and your printing. How about the shack wall or that 100-footer? Think of the attention this big gold-and-black enamel metal emblem will get! $19 \times 8\frac{1}{4}$ ", same style as Automobile Emblem. \$1.25 each, postpaid.

Mail your order and remittance NOW to

The American Radio Relay League : : Hartford, Conn.

EITHER WAY

You need a mercury rectifier. **THE NEW 866 type** (in stock) for stations with limited power requirements, the standard mercury arc for the high power fends. Remember—you can't dinge an arc with 2000—even 10,000 mils. Think what'll happen to your pocketbook when the set goes off resonance!

866 FILAMENT TRANSFORMERS with 20,000 volt insulation. Plate transformers designed to take advantage of the practically perfect regulation of the mercury rectifier—any old transformer won't do. Rectifiers and tuned trap filters that let the D C slip through unimpeded. 30 second time delay relays.

RECTIFIER ENGINEERING SERVICE

4837 ROCKWOOD ROAD

RADIO WSML

CLEVELAND, OHIO

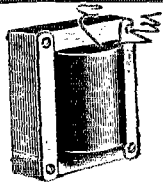

FILTER CHOKES

20 HENRIES

250 MILLS

Just what you want for obtaining a pure D. C. note for your Transmitter. Also can be used in "A" or "B" Eliminators.

Weight 5 pounds. Wiring heavily insulated. New and packed in individual cartons.

AMERICAN SALES CO.
19-21 Warren St. N. Y. CITY

SPECIAL \$2.50
EA.

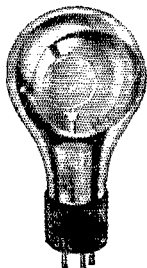

Raytheon

This name represents leadership in tubes for television broadcasting and reception.

Foto-Cell

A Television sending tube in hard vacuum or gas-filled types.

Correspondence is invited from amateurs in regard to Raytheon Television Products.

RAYTHEON MFG. CO.
Kendall Square Building
Cambridge, Mass.

Kino-Lamp

The Television receiving tube adapted to all systems. Price \$7.50.



ACME WIRE PRODUCTS

Coils—Magnet Wire Wound
 Magnet Wire All Insulations
 Varnished Insulations
 Parvot Filter and By Pass Condensers

All products made to Recognized Commercial Standards including those of:

National Electric Mfrs. Assn.
 Radio Manufacturers Assn.
 American Society for Testing Materials.

For 25 years manufacturers and suppliers to the largest and most discriminating users.

THE ACME WIRE CO. NEW HAVEN, CONN.

Branch Offices:

New York Cleveland
 52 Vanderbilt Ave. Guardian Bldg.
 Chicago
 842 N. Michigan Ave.

Look Here Hams! MONEY SAVERS

Thordarson 150 Watt Power Transformer rated at 800 volts, 11 volts center tapped and 4 volts no center \$5.95

Thordarson 60 Henry Double Chokes, 30 henry each choke, 150 M. A. \$4.95

Thomas Andrews 30 mfd. Condenser Block, tapped at 4, 6, 8, 2, 2, 1, 1 and .1, mfd. 400 volts working voltage . . \$3.95

Erla 1,000 cycle peaked audio transformers \$.95

The above transformer, choke and condenser combination will make an ideal power supply for a crystal oscillator.

The full 800 volts can be utilized by disregarding the center tap and connecting the two outside terminals to a bridge chemical rectifier or thermionic half wave rectifier.

The condensers can be connected in series giving 800 volt working voltage. 1,000 cycle audios are a necessity in these days of heavy qrm.

The peak can be tuned by a variable .0005 mfd. condenser shunted across the secondary.

RADIO EQUIPMENT CO.

W9DFW

4611 N. CLARK ST.

CHICAGO, ILL.

tion Commission a reservation for the exclusive use in Spain of the 75- to 85-meter band, which will be of great assistance for work between the EARs. (FB!—Ed.)

The call letters of the Spanish hams will remain the same as at present, being formed of the letters EAR followed by a serial number.

Continental fone communication on the 40-meter band is very difficult at present. The same thing has happened with DX in the 20-meter band, but great interest is being shown in the developments taking place on ten meters.

All Spanish amateurs extend their best wishes to amateurs over the world, and hope that the new difficulties created by the Washington conference will be an inducement to conquer these drawbacks by experimental two-way work, and will eventually result in the accomplishment of even greater triumphs by amateur radio operators.

SHORT-WAVE AMATEUR RADIO IN THE U.S.S.R.

The amateur short-wave movement, although brought to a head only a year or two ago in the U.S.S.R., actually covers a period of some length. In spite of the fact that until lately each short-wave station was comparatively isolated with respect to others interested in the amateur game, there are now about 100 transmitters and more than 500 receiving stations actually registered and participating in tests. These amateurs are all members of the Short-Wave Section (s.k.w.) and show a marked interest and initiative in organized tests. The magazine "RA-QSO-RK", the organ of the Short-Wave Section, gives the results of the work of the section.

It is due to the initiative of a group of amateurs in Moscow and Niji-Novgorod that, some time ago, there was founded this Short-Wave Section, in the hope of systematizing the work of amateurs. The work of the organization has for its principal objects: (1) The collaboration of amateur work through the Union (2) the establishment of transmitting tests among members of the society and the reception and observation of these and foreign signals.

Another object is to facilitate obtaining necessary material for short-wave work, and to help members get transmitting licenses; also to make available some medium for the exchange of QSL cards between foreign amateurs and members of the Section.

The Section registers each receiving station and assigns it a call beginning with RK followed by a figure; for example, RK1, RK85, RK295. It also directs the work of those amateurs who have received an official call from the government, and are licensed to transmit. Transmitting calls have a serial number followed by the letters RA, as, for example, O5RA, 23RA, etc.

Due to the rapid increase in interest in short waves, it has been possible to form sections of the society in most of the important cities of the U.S.S.R. The sections at Niji-Novgorod and at Tomsk are notably

VITROHM Transmitting Grid Leaks and Rheostats now cover the entire line of transmitting tube circuits. ¶The prices on these amateur products are reduced materially. ¶Your dealer should stock Vitrohm Transmitting Products. ¶If you have difficulty in obtaining them, write us direct.

CATALOGUE NUMBER	PRODUCT	RESISTANCE	DISSIPATION	CURRENT	MAX. TUBE RATING	PRICE
507-2	Grid Leak*	5000 ohms	44 watts	90 m.a.	100 watts	\$2.00
507-3	Grid Leak*	5000 ohms	200 watts	200 m.a.	1000 watts	2.80
507-4	Grid Leak†	50,000 ohms	200 watts	60 m.a.	1000 watts	6.50
507-5	Grid Leak†	20,000 ohms	200 watts	100 m.a.	1000 watts	4.25
507-51	Grid Leak*	10,000 ohms	200 watts	135 m.a.	1000 watts	4.00
507-66	Grid Leak**	15,000 ohms	200 watts	120 m.a.	1000 watts	6.00
507-63	Rheostat†*	50 ohms	50 watts	1 amp.		5.50
507-59	Rheostat*††	20 ohms	80 watts	2 amp.		5.50
507-83	Rheostat*††	12.5 ohms	60 watts	2.2 amp.		5.50

* Center-tapped

† DeForest P or R. C. A. 852 Tube
De Forest H Tube

** Steps at 5M—10M—15M

for R. C. A. 852 or DeForest P Tube

†† For Primary Control

††† Filament and Primary Control

Ward Leonard Electric Company

37-41 South Street

Mount Vernon, N. Y.

PANELS

TUBING AND RODS
Formica, Bakelite and Hard Rubber.
Standard or Special Sizes
Drilling — Engraving — Special Work
All sizes of ALUMINUM Cans and Panels
Made and Cut to Order.



UNITED RADIO MFG. CO.
191 Greenwich Street New York



TRANSMITTING GRIDLEAKS

5000 OHMS

These genuine General Electric wirewound Gridleaks have a rating of 55 watts continuous duty.
Large enough for 250 watters.

SPECIAL 65c Ea.

AMERICAN SALES CO., 19-21 Warren St., N. Y. C.

ALWAYS UP-TO-DATE



Issued quarterly, March, June, September and December. Single copies U.S. and Canada \$1.00 (Foreign \$1.10). Yearly subscription \$3.25 (Foreign \$3.50).

Amateur and Commercial Stations from 83 different countries.

Radio Amateur Call Book
508 So. Dearborn St., Chicago, Ill., U.S.A.

DODGE RADIO SHORTKUT

KILLS HESITATION PRODUCES RESULTS

Users have raised receiving speed from 15 to 25 in three and half hours—15 to 30 in five hours—10 to 15 in one hour—4 to 12 in four hours etc., etc. Beginners master code and quality in few days.

REPORTS FROM 500 USERS

telling complete story and who's who with each order. Or with Half Dollar Coupon for 50 cents. Specimen reports on request—sufficient to justify this ad.

W9ANO reports: Personally did not use your Radio Shortkut but had a Ham give it a try and the result was really quite wonderful. He raised his copying speed from 10 to 20 in almost no time. Can truly say your method is the stuff.

DODGE HIGH SPEED METHOD
(Intensive Speed Practice)

Most efficient Code Reading booster known for 25 per Hams. User raised speed from 27 to 39 in 75 minutes practice time. Full details in reports.

W5AHH reports: Radio Shortkut was found to be the thing. Raised copying speed from 6 to 18 in few weeks by attention at odd moments only and now do 27 per. Recently tried High Speed and in five days by putting in about quarter hour each evening was able to copy at 39 per by count—an increase of 12 per by 75 minutes work.

DODGE MORSE SHORTKUT

Master both codes our way and use without mixup.

W8C1K reports: Also tried your Morse method and can now copy Morse at 20 per. Best previous effort about 8 and much confusion with Continental. That trouble entirely disappeared after memorizing Morse your way.

Radio Shortkut \$3.50 High Speed or Morse \$2.50 Money Order. None C.O.D. Foreign add Fifty Cents.

C. K. DODGE
Box 100 Mamaroneck, New York

AEROVOX

**BUILT BETTER
CONDENSERS AND RESISTORS**

Without A Doubt The Most Complete Line of Condensers & Resistors

- | | |
|---|---|
| Filter Blocks
Buffer Blocks
Socket Power
High Voltage &
Transmitting
Condensers
Bypass Units
"A Power" Units
Bakelite Case
Moulded Mica
Interference
Filters | Pyrohm Heavy Duty Units
Edison Base Pyrohms
Tapped Pyrohm Resistors
Universal Tapped Resistor
"Adjustable" Units
Wire Wound Units
Center Tapped A.C. Units
Grid Suppressors
Non-Inductive Lavites
Grid Leaks & Resistors
Resistoformer Kits
Resistor Mountings |
|---|---|

A COMPLETE CATALOG with illustrations and detailed descriptions may be obtained free of charge on request.

AEROVOX WIRELESS CORP.

78 1/2 Washington St., Bklyn., N. Y.

PRODUCTS THAT ENDURE

active; other strong bodies have been formed at Tachkent, Voronej, Samara, and Sverdla.

The head section is located at Moscow. It is the work of this body to effect the exchange of communications between the amateurs of the Union and the amateurs of foreign countries. It also maintains the QSL bureau for the entire Union, and assumes the work incident to the exchange of cards for all the sections. Several thousand cards a year are handled.

At the present time, short-wave work is progressing wonderfully. It is the old story of the benefits of organization. At the beginning, before the organization of the Short-Wave Section, there were only inconsequential tests and observations of signals of European amateurs; but few were expert at DX reception. Transmitting tests were equally modest, and consisted for the most part of each small station (5-20 watts) sending many CQ's; very few actual QSO's were made. After the first thrills incident to DX work, however, much study and investigation were given to short-wave work and apparatus. Regular QSO's were established, more tests conducted, and, thanks to the new Society, it was possible to analyze and systematize this work.

The usual "ham" stages were passed through: first, the thrills of the initial QSO's, then the DX craze, then a craze for records, until finally the Soviet amateur has attained a firm status and is now progressing slowly but surely in a modest study of short waves and short-wave problems.

The great success of the first organized tests attracted the attention of the Communications Commissariat, and this branch of the government decided that it was advantageous to use amateurs for the observation of short-wave signals and encouraged them to participate in this work. It will be remembered that Soviet amateurs manned the short-wave apparatus on the Russian ice-breakers which went in search of Nobile, and their success in this endeavor did much to benefit the amateur in the U.S.S.R.

The material aid which the Soviet short-wave amateurs have received from the Commissariat has given added impetus to the development of the short-wave movement in the U.S.S.R.

—R. Falkin, 15RA,
President, S.K.W.

A.R.R.L. Headquarters wishes to express its thanks and appreciation for the many Christmas cards received from foreign members.

Calls Heard

(Continued from Page 54)

g6yv ek-4dba ek-4ja fl-shpg fm-6kf k4kd k4ra
 uq-2kp sa-cb8 sa-dq4 sa-dt9 sb-1at sb-1aw sb-1em
 sb-2ih sb-3qa se-1ai se-3ej su-2ak ve4hh ve9ep.

40 meters

fl-1ab fo-a50 velem kdvs kfc6 kfr6 k4aan k4kd
 nh-1ug nj-2pa nm-1ab nm-1g nm-1o nm-ab6 nm-1nic
 nn-7nic nn-2ay nn-2iq nn-2jt nn-2kp nu-2ro nu-5ay
 nu-5fc nu-6fl nu-5ni nu-5ry nr-ec nr-2ags nr-2ea
 nx-1xl oa-2aw oa-2eg oa-2hm oa-2ho oa-2no oa-2ns
 oa-2yi oa-3ep oa-3gr oa-3gt oa-3hc oa-3jr oa-3lp

QUALITY
DONGAN
PRODUCTS

There Are No Short Cuts to Quality

If you demand from Radio the beautiful, natural reproduction now possible with modern power tubes and the proper Parts than you must buy or build a Receiver properly designed from the very finest Parts. There is no short cut—quality demands the finest—in engineering, materials—and workmanship.

Dongan Parts—acknowledged as the Standard of Quality—have always been built to give superlative results. You can be confident that a set properly built with Dongan Parts will give you the best that Radio can offer.

For Use with U X 250 Tubes

No. 7568—Transformer for full wave rectification using 2 UX 251 tubes to supply B and C power to receiver and power for 2 UX 250 tubes.....	\$13.50
No. 8529—Transformer similar to No. 7568 with the addition of 2 low voltage windings, one for 225 tubes and the other for 227 tubes so that you can build a power amplifier for either radio receiver or phonograph pick-up.....	\$17.50
No. 6551—Double Choke, for use with audio transformers.....	\$15.00
D-600—Power Amplifier Condenser Unit.....	\$16.50
D-307—A Condenser Block, used in connection with D-600.....	\$10.00
No. 1177—Straight Power Amplifier Output Transformer.....	\$12.00
No. 1176—Same as No. 1177 but of Push Pull type.....	\$12.00

Please Mail Item Checked C. O. D.
 Please Send Detailed Information

(Name)..... (P. O. address).....
 (City)..... (State).....

Send 20c for copy of AC Manual by Merle Duston
Dongan Electric Manufacturing Co.
 2999-3001 Franklin St., Detroit, Mich.

TRANSFORMERS of MERIT for FIFTEEN YEARS

Synchronous Motors for Television

In addition to building reliable and satisfactory motor generators, "Esco" has had many years of experience in building *electric motors* for a great variety of applications.

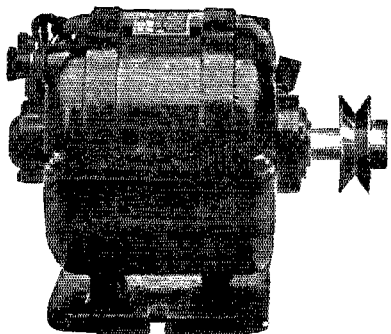

Synchronous motors, small, compact, reliable self starting are now offered for *Television* equipment. They require no direct current for excitation, are quiet running and fully guaranteed.

Other types of motors suitable for Television may also be supplied.

Write us about your requirements.

ELECTRIC SPECIALTY CO.

25 South St.

Trade "ESCO" Mark

Stamford, Conn.

Radio Operators

Raise Your Sending and Receiving Speed
50 to 100% in Short Time

The Candler System Shows How

Write at once for information about The Candler System Course in High Speed Telegraphing and Self-Mastery. Takes the kinks out of sore arms. Strengthens weak arms. Relieves "glass" arm. Restores the grip. Prevents fatigue, paralysis and kindred ills. Increases speed, accuracy and endurance that mean **BIGGER PAY**. Often **DOUBLES** speed of slow operators. Established 17 years. Endorsed by over 40,000 wireless and Morse operators. This is the system that has developed many of the world's fastest and highest-paid operators. It developed McElroy, world's champion radio operator. **Results guaranteed.** If this system doesn't raise your sending and receiving speed 50 to 100% it won't cost you a penny. **Write now!**

THE CANDLER SYSTEM CO.

6343 S. Kedzie Ave. Dept. RL, CHICAGO, ILL.

Send for Western Radio New 1929 Catalog

LATEST and FINEST, nationally known A.C. sets, consoles, cabinets, speakers and accessories at **LOWEST PRICES**. Catalog sent **FREE** on request.

WESTERN RADIO MFG. CO.,

128 W. Lake Street, Dept. RQ-3 Chicago

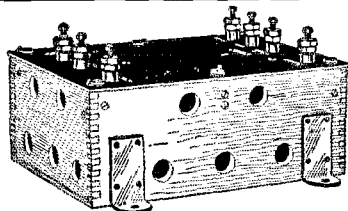

Western Electric FILTERS (TYPE 2A)

These Filters consist of a 2000, 1 Mfd. 1000 Volt Condenser, a 21K 1Mfd. 500 Volt Condenser, a 200 Ohm Core Choke Coil and 2 Resistances mounted in a highly finished box. Made for use as Generator filter but parts can be used in "B" battery eliminator. They are complete with a seven foot extension cord. **NEW IN ORIGINAL CASES.**

PRICE ONLY \$2.50 EA.

AMERICAN SALES CO., 19-21 WARREN ST., N. Y. C.

MORE POWER PER STAGE

Sharper Tuning and No Oscillation Difficulties

Radio Science proves neutralization the only satisfactory method of controlling oscillation in tuned radio frequency circuits, thus increasing actual power per stage of amplification from 25% to 300%

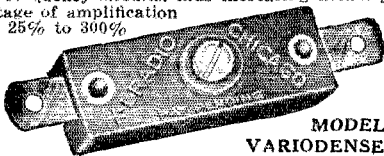

MODEL "N" VARIODENSER

Apply the Neutrodyne principle to your set by the simple installation of X-L Variodensers. The result is an amazing increase in the efficiency and power of the receiver.

Model "N" has Variable capacity, adjustable from 1.8 to 20 micro-micro farads, the price each \$1.00.

Model "G" with grid clips made in three variable capacity ranges. Price, each, \$1.50. New Bakelite insulated X-L Push-Post the most perfect binding post made. Plain or all standard markings. Price each 15 cents.

Write for free book of circuit diagrams X-L Push showing use of X-L Units.

X-L RADIO LABORATORIES
Dept. D 1224 Belmont Avenue, Chicago, Ill.



... formerly

HARDWICK, FIELD INC.

... NOW

HARDWICK, HINDLE INC.

Hardwick, Field Inc. announce, that due to the retirement of Mr. W. Thayer Field and the election of Mr. John C. Hindle as his successor, the name of the company has been changed to Hardwick, Hindle Inc.

The change will in no way affect the management or policies of the company.

Mr. Hardwick remains as President and General Manager. Mr. Hindle will continue in charge of sales.

SALES DEPT.
122 Greenwich
St., New York

FACTORY
215 Emmet St.
Newark, N. J.



oa-3vp oa-3yj oa-4bb oa-4nw oa-4pn oa-5cm oa-5hg
oa-5mb oa-5wr oa-5xg oa-6mu oa-6sa oa-6he oa-7cw
oo-bam oz-1ax oz-2aj oz-2be oz-2nz oz-2go oz-3av
oz-3cm oz-3cp oz-4ae oz-4am sb-5af sb-5oa sb-7ab
sc-3ab se-2ea se-2jm sp-cbl sp-jsl.

G2BOQ, H. E. Bottle, 27 Stormont Rd.,
Buttersea, London

wianh wiarq wiasu wibjk wiblv wicos wictp
widf wifb wlkq wisq w2ahi w2aol w2azu w2azo
w2bec w2bda w2bdh w2bmm w2brb w2zfp w2zgp w2lx
w2mt w2sy w2vq w2wv w3bd w3bh w3ekj w3db
w3nr w4is w4abw w4adg w4asb w4arb w4axa w4ayo
w4bcu w4ber w4ced w4cjm w4cke w4dae w4dec w4df
w4mq w4xf w4bga w4bmx w4bzg w4cgs w4erd w4eta
sa-dtr sb-3qa iq-ocya ve2al ve3he ve4fy ve3bm ve4ek
oh-eh7 fo-1sr.

ef-R357, Rene Allard, 14 Rue du Pont,
Neuilly-sur-Seine, Seine, France

40 meters
wlaaw wlasd w2bhs w2afr w2bda w2cxl wiafz
w6clv

20 meters
wlaad wibyv wifs wiry wlas w2api w2azu w2bfq
w2cuq w3aih w3jn w8axa wscbd w8enz w8dod w9bqv
w9bga ve2bg ve2ca.

W2AZU, Hal F. Dieter, 4103 29th St.,
Flushing, L. I.

w9eve w9efe w9ejo w6aov w9nr w9ben w9enx
w9dnd w9zdd w9alo w9ax w6avj w5aot w6dzd w6am
w5wz w5ayo w6cuh w7aes w6cub w7agb w6drb
w6ack w6at w6dev w6aye w6lp w5qq w6bqv w6cst
w5bbi w5age w5xvj w6bat w5bbe w5bax w6dwp
w5aar w5aam w6eeb w5aqt w6dou w6sj w6az
w6avj w6t w6go w6rg w6dmm w7if w7un w6dna
w6dkx w6apf w6fd w6dev w6emy w6ary w6frq
w6boa w7id w7ai w5bzk w6dth w6awy w6eap w6car
w6anb w6fyz w6baz w6dfy w6anb w6bez ve4dj
ve8ap ve4db ve5go ve5cp ve4fy v6qub v6ux v6rw v6ms
v6yv v6ml v6wk v6bz v6yx v6qv v2ao v6od v6oh
v6ws v6vj v6hp v6wy v6bd v2nh v6nx.

33 meters
nj-2pa nr-2ags sc-1ah ek-4hl ek-4il ne-8ae ef-8ho
ef-8fc.

W2BJK, Rudyard Uzzell, 58-12 165 St.,
Jamaica, L. I., N. Y.

40 meters
w6bch w6ec w6djq w6xb w6cuh w6dvj w6dmg w6cpq
w6hvj w6dky w6cjm w6avp w6ckv w6xi w6zdd w6doh
w6asm w6dwj w6dye w6cth w6eb w7adb w7abg w7dm
w7mc w7ae w7ne w7mf w7gj ve2ae ve2al ve2bb ve3bm
ve3co ve3he ve3do ve3vs ve3cs ve3kp ve3me ve3ai
ve3cx ve3ap ve3xo ve3ay ve4fy ve5dt velax ve1dq
ve2iq ve2xe nq-5fl nq-2ro nq-ise nq-2ay nq-2mn
nq-5fe nq-7cx nq-5ex nq-5ay n2-ajt nm-1n nm-3a
nt-2fp nx-1xl ng-2fz nn-7nic nn-1nic nn-1cab nj-2pa
nj-2ja k4ug k4aan nr-2ags nz-fr5 fq-pm iq-ocya
fl-lab ef-8ed ef-8ud ek-4yt ek-4ar ep-1ms ep-1aa
ep-3nc ep-1cn ep-1ae eg-2xy ea-jh sb-3ag sb-2ae
sb-1aw sb-2ak sb-7ab sb-1ad sb-1an sb-5af sb-2aj
sb-1aa sb-2ah sb-2az sb-1bf se-2jm sa-en8 sc-2ab sc-2as
eb-4au eb-4fp w6bs. xed-0ib xed-0zp nitb nixb.

20 meters
w6bvt w7cyb w6ard w6cyx w6ky w6qy w6ehf w6dev
w6gm w6ajm w7alz v6yv v2bm v6hd v6ms v6yo v6wy
v6vj v6zf v6oh v6ml v6wk v6lf v6hp v6kf v6hs
v2fb v6rw sb-2ab sb-1aa sb-1ae ear-55 ne-8ae ve5cp
ve3gq ve4db ve4io k4agf wnp ve3ap ve4ek.

ef-8AAP, Nantes, France

40 meters
wlaeh wladw wiafz wiaqt wibhs wicej wickp
w1fn w1fs w1om w1rf w2aib w2af w2aih w2akr
w2ang w2aqj w2aub w2ay w2bai w2bar w2bcw w2biv
w2bjg w2bln w2com w2crj w2cni w2cyb w2cyg w2dr
w2kl w2ws w3ael w3apn w3apx w3ato w3ark w3awn
w3bph w3ib w3ge w3sz iwaan w3ag w3ik iwnu
w4tk nu8ch w8ank w8hr w8cfb w8dna w8drj k4ug

20 meters
wiaba wiack wiaew wiafi wiagi wiagd wiazt wibyr
wicmd wifb wifs wila wimo wigh wiry wiaf w2acn
w2arb w2azo w2bcw w2bfg w2evj w2cxl w2fp w2jd
w2mb w2nm w2rs w3adm w3aik w3amn w3jn w4js
w8axy w8auk w8awf w8axa w8erp w8dae w8duw
w9bga w9ejo k4agf velab ve2al

ELIMINATE THE ELEMENT of CHANCE!



Applying the old proverb it can truly be said that a radio set is no more efficient than its smallest part.

Resistances and volume controls, from a standpoint of size, are small parts of a radio receiver, but in their effect upon its overall operation are very important factors.

Design and mechanical construction are

more to be considered than just mere quantitative resistance. A piece of raw carbon or roll of resistance wire may have great resistance value but are of no use as a control of voltage.

Centralab Resistance units of all types are especially designed to perform the function for which they are made. They are accurate, mechanically sound, durable and technically correct in construction and value.

Send for booklet, "Volume and Voltage Controls—Their Use."

- No. 1—Standard Modu Plug \$2.50
- No. 2—Cord Type Standard Modu Plug 2.50
- No. 3—"Easy Chair" Modu Plug 3.00

CENTRAL RADIO LABORATORIES
18 KEEFE AVENUE :: MILWAUKEE, WIS.

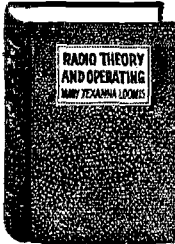

TELEVISION
 RADIO CONSTRUCTION
 RADIO REPAIRING
 RADIO SERVICING
 MARINE RADIO OPERATING
 RADIO COMPASS WORK
 LAND RADIO OPERATING
 BROADCASTING
 AIRWAYS COMMUNICATIONS
 RADIO ACCOUNTING
 MESSAGE FORMS
 1929 RADIO LAWS
 JUNIOR ENGINEERING

The above subjects and many others thoroughly covered in the best radio text and reference book ever produced.

"RADIO THEORY AND OPERATING"

992 Pages 800 Illustrations

By Mary Texanna Loomis, President, and Lecturer on Radio, Loomis Radio College. Member Institute of Radio Engineers.

Fourth Edition—Thoroughly Revised.

Used by all the Government radio schools, nearly all the radio schools in U. S. and Canada and over 200 universities, colleges and high schools.

Flexible binding—Price \$3.50

For sale by practically all bookdealers this and foreign countries. Or sent, postage paid, on receipt check or money order.

LOOMIS PUBLISHING COMPANY

Dept. 5 Washington, D. C.

Ad. Auriema, Inc.
 Manufacturers' Export Managers
 16 Broad Street, New York, N. Y.
 Scientifically equipped to economically export dependable receiving and transmitting radio apparatus.



FOR EVERY RADIO NEED, in brushed brass or Bakelite. Fit standard electrical switch or outlet box. Single plates and in gang in many combinations.

- No. 135—For Loud Speaker \$1.00
- No. 136—For Aerial and Ground 1.00
- No. 137—For Battery Connections 2.50
- No. 138—For A C Connections 1.00
 (Bakelite, 25c. additional per plate)

At Your Dealer's
YAXLEY MFG. CO.
 Dept. S, 9 So. Clinton St., Chicago, Ill.

RADIO OPERATORS WANTED

THE EASTERN RADIO INSTITUTE can train you quickly and thoroughly because:
MODERN AND EFFICIENT METHODS
THOROUGH INSTRUCTION under staff of **LICENSED COMMERCIAL OPERATORS**
MODERN APPARATUS including **SHORT WAVE TRANSMITTER**

SIXTEEN years a RADIO SCHOOL
THE OLDEST, LARGEST and MOST SUCCESSFUL school in New England, **RECOMMENDED BY THE**

A. R. R. L.
 Day or Evening Classes Start Every Monday
SPECIAL CODE CLASSES

Write for Illustrated Prospectus

EASTERN RADIO INSTITUTE

899 BOYLSTON STREET BOSTON, MASS.

SET Builders



Barawik, the first and oldest radio specialty house, offers you unusual service this year. Bigger stocks, quicker shipments, lower prices. Deal with an old established, reliable home. Get honest goods, honest service, honest prices. Barawik service makes you more money. Send now for big new catalog showing lowest wholesale prices on sets, parts, short waves, etc.
BARAWIK CO., 113 CANAL STA., CHICAGO, U. S. A.

Do you know that the 1929 Handy and Hull Handbook is available in bound form—\$2.00 per copy, postpaid?

When ordering a copy of this new edition, look at your present copy and determine if you want the 1929 copy in more permanent form.

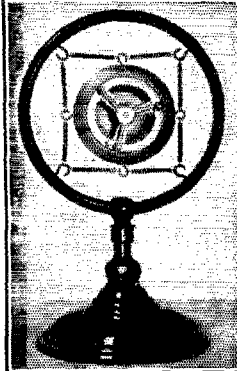

NEED "MIKES"?

Let us prove that ours is all you can expect. Numerous users insist it is superior to all others. A Standard Instrument in all respects.

- Price, less stand...\$67.50
- Desk Stand, as shown...6.00
- Adjustable Floor Stand, 12.00
- Microphone Transformer, 10.00

E. F. JOHNSON CO.
 Waseca, Minnesota



It
Teaches
the
Code!

Learn

Telegraphy with **TELEPLEX**

TELEPLEX is the practical code instructor. Works like a phonograph. Waxed tape records send signals like a real operator. Complete code instructions furnished with every Teleplex. Sends messages, radiograms, etc.—regular code traffic like an expert operator. Used by all leading schools. Endorsed by U. S. Navy. Guaranteed to teach you the code or it costs nothing. Speedy, simple, clear. Ideal for advanced students or beginners.

FREE 10 DAYS TRIAL!

So sure are we that you will be absolutely satisfied with your purchase, that we will let you try it in your own home **ON 10 DAYS FREE TRIAL!** You are the sole judge. Where can you match that astounding offer? **ACT TO-DAY!** Write for full facts about Teleplex. No obligation.

TELEPLEX CO., Dept. C12., 76 Cortland St., New York, N. Y.

ef-8AMDA, Andre Maraud, Loiret, France

wlabd wlabv wlabf wlabg wlabr wlabk wlabd wlabx
wlabw wlabm wlabx wlabt wlabk wlabw wlabq wlabk
wibbt wibbn wibyw wibsp wicfi wicq wikk wikk
wlmk wlry wlom w2api w2aub w2age w2aup w2ahi
w2avb w2bhr w2bid w2bad w2bac w2bob w2bvj w2bkn
w2bse w2exl w2cum w2cuq w2chu w2dl w2fk w2hg
w2ia w2jd w2kl w2kx w2ke w2le w2mz w2mb w2ov
w2ti w2uo w2tr w2vd w2wj w2adz w2anw w2auj
w2bsd w2ckl w2cgl w2ca w2ce w2ec w2ga w2iq w2nc
w2ob w2ac w2ahy w2acz w2age w2akc w2act w2ahl
w2afi w2cdk w2dt w2fu w2gl w2hl w2kv w2nf w2rn
w2pac w2vc w2ja w2ayo w2atf w2apu w2at w2ain
w2axb w2aak w2gr w2jc w2jx w2ja w2ku w2su w2sa
w2aov w2ayu w2avj w2boa w2bak w2vf w2mu w2mx
w2ch w2nr w2kx w2zi w2afu w2aju w2ahm w2aug
w2axf w2awf w2ayo w2atz w2aac w2act w2baz w2brh
w2bky w2bci w2bth w2bhx w2emb w2cft w2cfl w2csw
w2czz w2cnu w2cft w2cfn w2cgy w2cnt w2ctn w2cft
w2ccw w2cnr w2civ w2cbd w2dqw w2dcm w2dnn
w2dys w2dkt w2dyz w2duw w2dyy w2dkk w2ho w2li
w2tn w2auh w2acs w2adm w2adn w2ahz w2agc w2agq
w2bga w2bgh w2bdq w2bcl w2brd w2cec w2erc w2cyd
w2ofc w2brc w2dne w2djh w2epa w2eqp w2eta w2eta
w2ayl w2cap w2ef w2ecx w2erh w2exe w2ein w2eca
w2fqm w2fgp w2fcs w2fom w2fhy w2fxm w2fqz w2fax
w2gx w2iv w2mn w2nf w2rqm w2rv

BRS152, F. Donald Cawley, 85, Hale Road Hale, Cheshire, England

wlabk wlabf wlabk wlabd wlabd wlabr wlabd wlabd
wibhs wibsd wibvy wicfi wicje wicmf wixr wixy
wizw w2ad w2aeb w2aew w2af w2afo w2au w2anq
w2avr w2azo w2au w2bac w2beu w2bvg w2bs w2ain
w2avj w2jd w2jm w2kx w2mb w2rs w2wk w2anb
w2apn w2ato w2av w2baz w2ia w2tr w2pf w2se
w2aba w2ac w2aek w2ajq w2my w2kr w2uj w2vz
w2afi w2bf w2je w2jx w2ox w2bid w2chy w2su w2if
w2is w2agy w2ajv w2ank w2ath w2axa w2baz w2beq
w2bmk w2ciw w2cke w2ert w2ezd w2dcm w2diy
w2dkv w2dme w2duw w2ez w2li w2abu w2atq w2auh
w2bdt w2bga w2bhr w2bl w2fd w2fdw w2fgp w2fkt
w2wa fl-lab fm-30rn fp-4am fq-shgp nc-lga nc-8he
ne-8ae nitb nj-2pa nn-nic k4aag k4aan 4kkd nq-5fl
nx-1xl ny-5ox oz-2aj ox-2be oz-2go oz-4am sb-1ah
sb-law sb-1ca sb-2ah sb-2ih sb-5af sb-6qa sc-2ab se-2ea
su-1ci su-2ak xnu-7eff

BRS188, Basil Hall, 25, Coombe Gardens, New Malden, Surrey, England.

wlaao wlaey wlage wlah wlaie wlaof wlavl
wbea wbeh wibub wicaa wicet wicw wlmk wlmw
wixc wlyb wizo w2ach w2age w2ain w2akd w2au
w2axp w2bua w2bem w2bfo w2blu w2bmm w2bqp
w2erb w2evj w2exl w2hj w2ja w2le w2rs w2vd w2wh
w2xam w2adp w2ajd w2apn w2aqs w2bnu w2kt
w3ky w3nf w3sf w3sn w3ae w4ae w4hy w4is w4on
w4pf w4rn w4rr w4to w4tk w4vp w5asm w6atf
w5ax w5gf w5je w5kn w5px w5rg w5sz w6wa
w6cz w6ju w6adg w6ake w6akz w6alg w6ap w6bj
w6bu w6bx w6bo w6bt w6bv w6bw w6bys
w6cem w6csw w6ddg w6doa w6dtf w6ex w6jq w6aas
w6avz w6bae w6bsb w6cmv w6cpn w6czf
w6dbm w6djh w6dkg w6edw w6epa w6mt w6rd
w6dte ag-7ae ag-7kad as-lad as-lak at-6a au-trk
ct-laa ct-lag ct-lbv cr-lcn cr-3am ea-ee ea-fk ea-fl
ea-hz ea-kl ea-pjc ea-r16 ea-r6 ea-tx ea-wg
ea-lbx ea-let ea-lerma ea-lkx ea-lna ea-2ap ea-2cm
ea-2dy ea-2et ea-2lo ea-2ny ea-2rm ea-3sk ea-4kg
ea-aaz ed-7ab ed-7bk ed-7hq ed-7va ee-earl6 ee-earl7
ee-earl5 ee-earl5 ee-earl6 ee-earl ee-earl ee-earl
ee-ear ee-ear eh-9mq ei-lee ei-let ei-lf ei-lze ei-lp ei-luu
ei-la2b ei-la2g ei-la2v em-smst em-smag em-smxh
em-smyg ep-5af es-2nag es-2nap es-2nm es-2nx es-3am
es-2nk es-3np es-5ng es-5nk es-5ni et-2ua ea-paj
et-trar et-tpk et-tppt eu-2bc eu-2bw eu-2cm eu-2cu
eu-2cy eu-2dm eu-2dn eu-2dr eu-2du eu-2dw eu-2ka
eu-2ox eu-3aj eu-3bd eu-3bg eu-3bl eu-5af eu-5al
eu-5am eu-5ap eu-5bc eu-5bl eu-5ah eu-5ak eu-5ad
eu-9ae eu-oddr eu-lskw2 eu-lskw4 eu-nno eu-rk41
ew-ad ew-an ew-fy ew-hb (b-hyo fk-71o fm-8ev
fm-8kke fm-8rit fm-ain fm-pm fm-erb ha-fab
mm-nerna oo-5ni ra-bs aa-4ab ea-1fb ez-2bg oz-2bo
oz-2ga oz-2gc oz-3cm oz-4ai oz-4am oz-4xc ry-le sb-2ny
sb-2bg sm-2rw sm-5tn sm-7sy sm-71o sp-rpl sx-led
uo-1hz velax ve2ap ve2bb ve2ca vk7ch.

Below 30 meters.

wlaem wlaep wlaid wlaem wlaot wlaou wlaax
wlaiz wlaiz wlaifz wlabnp wlabw wlabg wlabv wlabk
wlabf wlabf wlabf wlabf wlabf wlabf wlabf wlabf

BRING 'EM IN CLEAR AND QUICK WITH ARCTURUS A-C LONG LIFE TUBES

ARCTURUS RADIO CO. NEWARK, N.J.

wlmr wlmv wiry wisz wizz w2aeb w2aed w2afi
w2afr w2ait w2ail w2ajt w2alk w2aog w2api w2arb
w2arq w2ays w2bao w2bcq w2bdh w2bdr w2bg
w2bim w2big w2bjv w2bnk w2bse w2bst w2bxr
w2cfl w2cix w2cyl w2dp w2fp w2gj w2gk w2hq w2jn
w2jz w2mb w2md w2mo w2nm w2ws w2xj w3aoa
w8aqi w8bd w8bhx w8bph w8av w8chk w8cxw w8eq
w8ga w8gi w8ke w8ky w8ahl w8j5 w8nh w8zdd
w8aac w8aau w8abw w8adg w8adm w8agy w8akg
w8apd w8awf w8axa w8ben w8bdk w8bpx w8cfr
w8dww w8kr w8ma w8enr cm-2jt ct-1ca ct-1bx cv-5as
ca-4sta ca-hjo ea-ppz ea-tx ec-1rk ec-4kq ed-7ni
ed-7va el-1aig em-smve et-tpkv fk-4ms fm-8kik fm-8rit
fo-a3a fo-a7d fo-b3v sb-11b vefar vefbq ve2ca ve2am
ve2ar ve2be ve2bg ve2dq ve2es.

**VK3CX, Alan G. Brown, 8 Mangarra Road,
Canterbury, E. 7, Victoria, Australia.**

wicmf wicmw wimk wipe w2cvi w2cxi w2ja w2ws
w3anh w3qe w3qv w4aav w4acw w4ahm w4ahy
w4qb w4tk w4pau w5baz w5ef w5iz w5rd w5qj w6dnd
w6chl w6cin w6ckv w6dmd w6dns w6drd w6eba
w6edt w6edx w6efr w7abb w7iq w7qe w7sg w7uo
w8ajt w8baz w8bci w8bmv w8bpl w8eft w8cfc w8cno
w8cnr w8dnm w8drj w9baq w9bnu w9bpe w9bxj
w9chd w9cmv w9ctw w9cwh w9dwa w9ebw w9ejo
w9eur w9fvd w9fhy w9in w9im w9ml waa7 wsb5
wfat wfbt k7ans k7alm yillm yilmd ef-8axq f8eo
f8gdb f8kv f8orm focx1 es-2nm et-tpar en-0vn ar-8ufm
ac-8lq ac-8rv ac-8aa eb-4bl eb-4fp xeb-4wk xeb-4wx
fo-a8y fo-a4e fo-a7d sc-2ab sc-3ac oo-dgk oo-bam, ctv
nijn arex ardi.

**G6YL, Miss B. Dunn, Acton House, Felton,
Northumberland, England.**

wibea wibob wisi w2ans w2blx w2hr w2uc w3afu
w8bcu w8qec velbr sb-1ca xed-ogr xed-oib xed-ozp
xek-4tb cr-5af au-56rw cz-2ha ez-7ae az-7ao ag-7kad
ag-rb6 ag-rb14 ag-67ra ag-69rb au-8aa fm-8asa
fm-8ev fm-8gkc fm-8vx fm-8rit fm-8kik fm-8mb
fm-tun2 fr-earb fv-ocdb xnu-jeff.

**S.S. Pecos, John H. Stefean, Operator,
R.M.C. of A., 326 Broadway,
New York City.**

wichg wlif w1alb wlepi wibea wibox wiche
w2xg w2ael w2ai w2hp w2bhr w2cqd w2bac w2exl
w2sb w8mb w8alq w2sz w8avf w8dnu w8ck w3udd
w3tr w3aa w3amb w3asg w4sv w4pk w4ctu w4aha
w4rn w4kv w4ut w4zd w4aef w4hy w4iaq
w4eu w4to w5aqe w5bho w5aly w5jc w5mc w6dww
w6dcq w6avj w7aat w7cj w8qj w8cib w8kd w8cnh
w8bto w8alu w8vx w8apr w8dpo w8ciw w8cix w8dkc
w8ayc w8mq w8ame w8gry w9mt w9fca w9ekw w9eey
w9bkz w9jl w9cmv w9fun w9fpa w9xxr w9civ w9avg
w9fbo w9gdh w9czw w9bil w9hw w9exe w9ww w9bqe
w9erd w9alu w9ckz w9mz w9fks w9fam w9gdj w9hwq
w9bmu w9aok w9fpp w9ege w9ffq w9cvi w9cub
w9fqs w9fvm w9dlb w9elx w9dpx w9asx w9dlv w9eyu
w9fma w9ahb w9ema w9bir w9bib.

**WSQ, U.S.C. and G.S.S. Lydonia, General
Delivery, Jacksonville, Fla.**

d4dba d4oa f8btr f8eo f8ceo f8pat f8axq f8fd
f8wb pa-odm pa-oka pa-ozf ok-aa2 z1ax z1zgo vk5hg
vk3yp ct-1na ct-1by ct-1aa sp-3ar on-4fe on-4d1 on-4hp
on-4fq on-4ar on-4dj ear-0 ear-62 ear-116 og2ao
wsbs xcfz.

**G2FN, F. Rodman, c/o Lloyd's Bank, 6 Pall
Mall, London, England.**

w2ayr w1aqq wlcui w2jn w2aol w2civ w2azo w2cew
w5wd w6uf w2tp w2aen w2bjv w2bg w2bda w2avg
wixam w5wz.

**KDUV, John Taylor, S.S. Margaret Dollar,
Shanghai, China.**

k1af k1hr vk7ox w6amm w6bjx w6bhx w6cgz
w7adr w7ef j7kw k1mc w7nr k1cm w6baz w6bux.

**AC-8LQ, Thos. D. Joseph, 51 Rue Paul
Beau, Shanghai, China.**

as-rao3 eb-4ar eb-4rs aj-2by aj-3gn aj-7ab w6am
w6bux w6avj w6hk w6no w6crz w6bzz w6amm w6bgb

Potter Condensers



THE selection of leading manufacturers for the finest radio receivers. In sure the operation of your radio set or power amplifier with Potter condensers.

- T-2900** Condenser Block for the single 250 type tube amplifier **\$20.00**
- T-2950** Condenser for the push-pull 250 type tube amplifier **\$22.50**
- T-2098** Condenser Block for single 210 type tube amplifier **\$20.00**
- SM-673** Condenser Block for Silver Marshall Power Amplifier and Power Supply units **\$20.00**
- 105-05** Interference Eliminator for oil burner and icemachine motors of 110 volt 60 cycle operation **\$3.75**

The Potter Co.

North Chicago, Illinois
A National Organization at Your Service

Complete Parts for SILVER-MARSHALL

No. 730

"Round-the-World" 4

A COMPLETE short wave receiver (17.4 to 204 meters) and two-stage audio amplifier. All wave lengths are covered with no dead spots. Amateur bands fall well to center of tuning dial. Net \$30.00. Completely constructed \$38.80. C.O.D. or cash with order. Postage or express extra.

3000 Volt Recto Bulbs

Now in stock—3,000 Volt Type R3 Rectobulbs. Net price each \$10.00. Also Leach Relays—R.E.L. Products. Omnigraphs—Vibroplexes—Silver-Marshall Shield Grids.

Send for New 1929 Ham Book—FREE

C H I - R A D

CHICAGO RADIO
APPARATUS CO.
415 S. DEARBORN ST., CHICAGO

Screwdriver Resistance for Your Radio



Don't guess at resistance values! You can't fool electricity. Instead, use a **DUPLEX CLAROSTAT**, with its double-barrelled resistances instantly adjustable to any values by means of an ordinary screwdriver. Neat. Compact. Practical. Inexpensive. Foolproof. Just the thing for B and C voltage adjustments, whether your set is new or old, factory-built or home-made.

There's a CLAROSTAT for Every Purpose

Write regarding the **DUPLEX CLAROSTAT** and other **CLAROSTAT** radio aids, and we shall send complete literature. Or ask your local dealer to show you the **CLAROSTAT** line.

CLAROSTAT MFG. CO., INC.

Specialists in Radio Aids

283 N. 6th St. Brooklyn, N. Y.

CLAROSTAT
MFG. U.S. PAT. OFF.

BECOME A RADIO OPERATOR

See the World, Earn a Good Income,
Duties Light and Fascinating.

LEARN IN THE SECOND PORT U.S.A.

Radio Inspector located here. New Orleans supplies operators for the various Gulf ports. Most logical location in the U. S. A. to come to for training.

Nearly 100% of radio operators graduating on the Gulf during the past six years trained by Mr. Clemmons, Supervisor of Instruction.

All graduates placed to date. Start training now for Spring and Summer runs.

Member of the A.R.R.L.—Call "W5GR"

Day and Night Classes—Enroll anytime—Write for circular.

GULF RADIO SCHOOL

844 Howard Ave. New Orleans, La.

SPECIAL TO AMATEURS

Barawik's new short wave dept. has everything that amateurs desire. The Barawik Radio Guide gives full details. Send for it.

FREE RADIO GUIDE

SEND FOR IT!

Shows the latest wrinkles, new developments in radio at startlingly low prices. Get the set you want here and save up to 50%. The best in parts, kits, complete factory-built sets and supplies. Orders filled same day received. Write for free 264-page copy NOW! Wholesale prices to set builders, dealers, agents. **BARAWIK CO., 113-A Canal Sta., Chicago, U.S.A.**



QUARTZ OSCILLATING CRYSTALS

Scientifically Prepared for Maximum Power and Unconditionally Guaranteed 1 in. sections, within 1% of your specified frequency, supplied at the following prices:

75-100 meters	\$15.00
100-200 meters	10.00
200-600 meters	15.00
1 in. Tested blanks, 2 to 4 mm thick	5.00

Sections of any practicable dimensions made to order

prompt delivery

J. T. Rooney, B. Sc., 4 Calumet Bldg., Buffalo, New York

"Ten years' crystallographic experience"

w6xi w6apd kipw klmc klad klgz kldr klc. kllr klaf klcy zilba vk6sa vk2ac sb-3th sa-des sb-1cb w6dr w6mx w6awt w6cih.

C. R. Plant, 1 Albert Rd., Northenden, Manchester, England.

w5afx w5agp w5mx w5ax w5agg w5aoe w5ad w5ah w5am w5amg w5awy w5aqq w5agr w5awj w5bec w5bix w5bec w5bfo w5bhdn w5bhz w5biu w5bhb w5bly w5czk w5cci w5cis w5crz w5cgm w5cui w5chna w5dfu w5dc w5dy w5dhs w5dmg w5dtd w5diw w5drr w5dpo w5dpm w5dei w5edj w5est w5eor w5ekx w5els w5eti w5gi w5kd w5hm w5wsg w5xi w5zbb w5aik w5cs w5if w5tu op-lad op-laf op-lau op-lah op-lbj op-lcm op-lcy op-lgz op-lhr op-lhm op-lpw op-lre op-3aa oh-8avi oh-8emr oh-6ljv vk2og vk3lp vk4mf vk4cg vk5wt odlab od4as od5az us-lae as-lak as-lap as-lag as-2ber ra-o3 aj-2rr aj-4ef au-8aa eu-2cy eu-4ai ef-8g) ai-2by

W5WZ, W5AVS, Wm. J. Zeidlik, Paul E. Bostaph, 1034 Woodland Ave., Fort Worth, Texas.

10 meters

wlaqd wlccz wlefi wlram wlaek wlibd w2tp w2nm w2bg w2aen w2aol w2azo w2avg w2bda w2bvg w2bjv w2bjg w3ajb w3ga w5uf w6ts w6ann w6ouh w6hax w6ju w6za w8ary w9cic ve2be velar z1zcc vk3bq ef-8ct g-2bj

What Price Television?

(Continued from Page 49)

small size if anything of interest, wherever it takes place, can be seen.

The impossibility of putting television signals over ordinary land wires rules it out for years to come. Telephone engineers will tell you that they are doing well to prevent distortion at 10,000 cycles. Visual distortion is very pronounced at that frequency.

You can figure out the answer for yourself. If all the seemingly insurmountable factors which have been enumerated were solved, how long would it take, and then what do you suppose it would cost? It is easy to say, "Given enough engineers and development facilities, it will be done." The next thing is to try and do it.

The Effect of the Regeneration Control Upon Tuning

(Continued from Page 52)

Dead spots due to antenna resonance are usually avoided like open man-holes but with a regeneration control that causes but little detuning, it should be possible to tune the antenna to resonance and then cause the circuit to oscillate by shifting the regeneration control without requiring the setting of the tuning condenser C1, to be changed importantly if at all. Which means that we may yet be able to make use of the increase in volume gotten from true antenna resonance without taking the normal horrible disadvantages in the bargain.

Again, we discover the screen-grid tube standing out pre-eminently, as much so for detection as for r.f. amplification.

HAM-ADS

Effective with the October, 1928, issue of QST the following changes were made in the rules of this department. The Ham-Ad rate is now 15c per word. The restriction which has limited use of this column to members of the American Radio Relay League is removed and advertising may be signed either by company name or by an individual. A special rate of 7c per word applies to advertising which is obviously non-commercial in nature and which is placed and signed by an individual member of the American Radio League. Please read carefully the following conditions under which advertising in these columns will be accepted.

- (1) Advertising shall pertain to radio and shall be of nature of interest to radio amateurs or experimenters in their pursuit of the art.
- (2) No display of any character will be accepted, nor can any special typographical arrangement, such as all or part capital letters be used which would tend to make one advertisement stand out from the others.
- (3) The Ham-Ad rate is 15c per word, except as noted in paragraph (6) below.
- (4) Remittance in full must accompany copy. No cash or contract discount or agency commission will be allowed.
- (5) Closing date for Ham-Ads is the 25th of the second month preceding publication date.
- (6) A special rate of 7c per word will apply to advertising which, in our judgment, is obviously non-commercial in nature and is placed and signed by a member of the American Radio Relay League. Thus, advertising of bona fide surplus equipment owned, used and for sale by an individual or apparatus offered for exchange or advertising inquiring for special equipment, if by a member of the American Radio Relay League takes the 7c rate. An attempt to deal in apparatus in quantity for profit, even if by an individual, is commercial and takes the 15c rate. Provisions of paragraphs (1), (2), (3), (4) and (5) apply to all advertising in this column regardless of which rate may apply.

PLATE POWER for your set, the very heart of its performance. For quietness, DX ability, life-long permanence, absolute dependability, lowest ultimate cost, no other plate source even approaches the achievement of an Edison steel-alkaline storage B battery. Built painstakingly every joint pure nickle, upset electrically welded. Genuine Edison Electrolyte. Our list describes complete batteries, construction parts, enameled aerial wire, silicon steel. Available immediately, filament and plate transformers for the new 866 rectifier, complete plate power units. Rectifier Engineering Service, radio W8ML, 4837 Rockwood Road, Cleveland, Ohio.

HAWLEY Edison element battery and parts standard for over five years. Look at our patent pending connector or no thin wire to drop out—contains 20 times more metal than regularly used. Heavy shock proof cells, fibre holders, etc. Everything for a rapid-fire "B" supply. Complete assembled 100 volt "B" \$10.00. Knock-down kits at still lower prices. Chargers that will charge in series up to 160 volts \$2.75 to \$4.00. Trickle B Charger for 90 to 150 volt "B" \$3.75. Special transmitter "B" batteries up to 6,000 milli-amp capacity, any voltage. Write for interesting literature, testimonials, etc. B. Hawley Smith, 860 Washington Ave., Danbury, Conn.

IMAGINE an organization with over 4,000 clients scattered throughout the world, all radiowave dealers, builders, experimenters, hams. Over \$50,000.00 stock of high grade receiving and transmitting parts only on sets. Spend \$5,000.00 yearly on our own experimenting. Carry nothing until it passes our tests. 50c brings prepaid over four pounds catalog, circuits, data, etc. Weekly data (more than all radio magazines together)—20 weeks—\$1.00, 52 weeks—\$2.50. Sample "Over The Soldering Iron," 22 page experimenter's magazine—25c. Full trade discounts to licensed hams and radiowave builders. We carry approved items advertised in Ohio Kladag Radio Laboratories, Established 1920, Kent, Ohio.

ENSAILL Radio Laboratory receivers and Transmitters are of the most modern designs and are supplied to meet any particular requirements of the radio art. Transmitter designs for radiophone or C. W. Our long experience in the designing of special apparatus is your

guarantee of quality and efficient apparatus. We also build to order any items desired. Literature on any apparatus forwarded on request. Ensail Radio Laboratory, 1208 Grandview Ave., Warren, Ohio.

SPECIAL made rectifier aluminum with small percentage copper, stand more amperage, last longer, square foot \$1.25, Lead \$1.00. Elements, holes punched with bolts and nuts, new kind 1"x4" 15c, 1"x6" 17c, pair prepaid. Best Silicon steel .014" cut to order 25-35c lb. Postage extra. Geo Schulz, Calumet, Mich.

SELL: 1KVA transformers 1100-2200-4400V each side Ct, 110-220 primary. Used by Cornell Uni. at \$12.00. F.O.B. Det. F. G. Dawson, 5740 Woodrow Ave., Detroit, Mich.

SALE—cheap ten to hundred ten meters American Radio Specialty Company's two tube short wave receiver in cabinet with five plug-in coils. Write Fred Merker, Wellsville, N. Y.

EX-NAVY equipment of unusual construction. All ball bearing and new. General Electric 24/1500 volt .233 ampere \$37.50 Shaft for external drive \$3.00. 24/750 volt 2 ampere with filter \$27.50. Shafts \$3.00. Crocker-Wheeler 24/1500 volts 450 watts \$45. Holtzer-Cabot 12/500 volts 35 watts \$20. 1/2KW 500 cycle with exciters \$15. Transformers \$10. 900 cycle 200 watt complete transmitter \$30. Westinghouse 6-15 volt 500 watt generators with propellers \$15. Western Electric Helmets \$10. 1500 volt 300 mill fuses 50c dozen. Following possibly slightly used, guaranteed. General Electric 12/350 volt .143 ampere \$18. Westinghouse 27.5 volt 350 \$18. Westinghouse 10/350 volt \$18. With meter panel and Western Electric filter system new \$30. Literature and fotos. Shipments any quantity, anywhere. Henry Kienzle 501 East 84th Street, New York. Phone Butterfield 0962.

1929 Coils like August QST page 18 for 25 cents per turn. Antenna coils 20 cents per turn. W2VQ 888 North Grove St., East Orange, N. J.

W9EPS will sell—2000 volt Jewell meter, \$15, 500 mil Jewell meter, \$4.50, 15 volt AC Jewell meter, \$4.50, 1000 mil Jewell meter, \$4.50, 8 ampere Jewell No. 25 RF meter, \$8.50, 1 hp. Hobart motor 110 volts, 60 cycle, \$19.50, 2000 volt 500 watt generator and separate exciter, \$65.00, 500 cycle 250 watt generator and exciter, \$15.00, 200 watt Thor filament transformer, \$3.00, new 204A used 20 hours, \$75.00, used 204-300 hours, \$45.00, two ampere 30 Henry Thordarson broadcast choke, \$50.00, 85 meter quartz crystal \$9.00, 84 meter quartz crystal \$9.50, 5000 ohm 200 watt grid leaks each \$1.50, 204 end mountings, pair \$1.50, 203 sockets, \$1, 1/2 hp. Century 110-220 60 cycle motor \$15, 170 meter quartz crystal \$5.00. Want UV206 and high voltage variable transmitting condensers. W. K. McCulla, Wankegan, Ill.

DUBILIER .004 transmitting condensers wanted. Radio, 160 West 22nd St., New York.

BARGAIN—3 tube Aero receiver, 15 to 900 meters (15 plug-in coils). Absolutely complete with tubes, A B C batteries, large Thorola horn and phones. Batteries in same cabinet with set. Cabinet solid mahogany, 10"x20"x 22". (Set portable). \$65.00 All inquiries answered. J. Borsoos, 5346 Westford Road, Philadelphia, Pa.

CRYSTALS: Carefully selected for maximum output. Your complete satisfaction guaranteed, 85 meter band, \$17.50. Blanks \$4.00. W9DRD, Hollister, Edwardsville, Kansas.

WANTED: 50, 75, 250 watt tubes, state condition and price. Also any other apparatus new or used. Will buy for cash all surplus or obsolete stock. Will exchange or trade apparatus. What do you need? Warren Waterman, 125 Madison Avenue, Albany, New York.

One used Vibroplex \$12; Large Neon Lamps .75; All new Flechtheim condensers; 1 mfd. 1500 volt \$2.75; 2 mfd. 1000 volts \$3.75; 2 mfd. 1500 volts \$4.75; 4 mfd. 1500 volts \$6.50; No. 12 Solid Enameled Aerial Wire .30 100 ft.; 1/16" C. P. Aluminum .70 sq. ft.; New 90 volt dry packed Phico storage B batteries \$2; New UK852 \$28.00; New RCA 50 watters \$13; Used GE 211 \$13; New Western Electric 50 watters \$20; Used 250 watters \$40; Amateur Call Books .35. New Cunningham 210 \$6; 3/16" Silver contact corps keys .95; Thousands of other buys, send for monthly ham sheet. What have you for sale or trade? David L. Marks, 125 Madison Ave., Albany, N. Y.

Used 203A and 211 \$13; new 852 \$28; used \$20; used Western Electric 212A and 212D \$60 each; new Cunningham and RCA 210 \$6; new Cunningham and RCA 281 \$5; No. 12 enameled aerial wire \$.90 per 100; Amateur Call Books \$.85; 10" insulators \$.29; Freshman 875V. and two 7 1/2V. center tapped transformers \$2.75; Robbins & Myers motor generator \$65; all types used Jewell meters \$4.75 each; three tube wired Aero coil

set, best equipment \$20; REL 50 watt sockets \$1.50; signal corps 3/16" contact key \$.95; 210 Bradleystats \$1.75; new RCA 50 watters \$13.50; new 217A, 217B, \$23; new 90 volt Philco Storage Btry \$3; free list, lots of used and new apparatus. What have you for sale or trade? David L. Marks, 125 Madison Ave., Albany, N. Y.

FOR SALE—meters—Weston 429, 0-10 AC flush, \$8, Westinghouse 0-15 AC and DC flush \$6.00, Westinghouse 0-150 DC flush \$5.00, RCA 0-150 DC Radiola \$3.00, Westinghouse 0-250 MA-DC flush, \$4.00, Jewell No. 54 0-150 DC with external multiplier, \$8.50, 5 cell 150 AH Edison battery, \$10.00, 5-1 audio transformer coils, 35c, Marle 30 H chokes, \$1.25, Marle audio transformers \$1.25, Western Electric lineman's phone, \$6.00, Marle BT200 eliminator transformer and choke unit, \$6.00, 280 volt 50 MA transformer \$2.50, M. Leitch, Park Drive, West Orange, N. J.

SELL—surplus transmitting and receiving apparatus. L. Moravec, Shevlin, Minn.

SELL—Advance sync \$25. Want large transformer. W2APD.

OMNIGRAPHS, Teleplexes, transmitters, receivers, Vibroplexes, meters, 50 watters, "S" tubes, motor generators, dynamotors, bought, sold, traded. Ryan Radio Co., Hannibal, Mo.

WANTED—one good Radiotron 50 watt model UV-208, filament voltage 10, filament amperes 6.5, plate voltage 1000 or over, plate amp. 0.15. W. O. Williams, Eldora, Iowa.

TRADE—7 1/2 watt TGTP Radiophone complete, Teleplex and receiver. Want late Delta or similar wood working machine. W5AVK, Webb City, Okla.

TWO tube shortwave receiver, sixteen two hundred ten meters. Excellent condition. Sixteen dollars. Howard G. Wacker, 1 Wood Street, Pittsburgh, Pa.

SELL or trade—Vibroplex \$10.00. Acme 200 watt plate and filament transformer, \$10.00. Acme 250 watt plate transformer, \$10.00. Want Kenetrans or Jewell meters. Otto Miller, 69 Barclay, Canajoharie, N. Y.

HAMS—before ordering that Edison element battery or power devices write for best prices. D.L.G. Mfg. Co. 2941 West Lake St., Chicago.

WANTED—copies QST previous 1928. Also Omnigraph. What have you? WSDXJ.

SELLING out—complete 15 watt transmitter. Also have brand new shortwave adapter. W9DBL, Red Cloud, Nebraska.

WANT following QST's. December 1915—all of 1916 except October and December—also August and September 1919. W9APM, Des Moines, Iowa.

ARRL sweater emblems should be worn by all League members. They are yellow and black 5"x8" diamond, felt letters and embroidered symbol. Only \$1.00. Money order or currency only accepted. Eric Robinson, 135 Jefferson Road, Webster Groves, Mo.

BEST offer takes Aero coil receiver. If interested write for description. W9CNM, 7512 Indiana Ave., Chicago.

SELL—transmitting set piecemeal; write for list. Jas. Coe, Box 151, Ft. Sam Houston, Texas.

SELL—600 watt Acme transformer 1000-1500 volts each side with two ten volt filament windings. (list \$33.) \$20. Extremely sensitive Bremer Tully 14-200 meter three tube short-wave receiver, \$23. Also three tube Reinartz \$29. Odds and ends for sale. What do you need? Wanted—84 meter crystal, Vibroplex, high voltage filter condensers. W2AFU, 85-12 165th St., Jamaica, N. Y.

THORDARSON 650-volt power-filament transformers for 7 1/2-wattors \$6.90. Aluminum square-foot 85c; Lead square-foot 85c. UX-210 7 1/2-wattors \$5.25. Mueller 30-wattors \$9.95. Thordarson 1000-1500-volt power-transformers \$16.00. RCA—50-wattors \$15.00. Potter 2000-volt test 1-mfd Condensers \$2.50; 2500-volt 1-mfd \$3.25; 2000-volt 2-mfd \$2.50. 5-dial Omnigraph \$12.50. "Ham-List" 4c. James Curtis, 1109 Eighth Avenue, Fort Worth, Texas.

SELL—set Hammarlund SW coils and condensers. Also other parts. W. Tannenbaum, 2020 Grand Ave., N. Y. C.

HAMS: Get our Samples and Prices on Printed Call Cards made to order as you want them. W9APY Hinds, 19 S. Wells St., Chicago, Ill.

SACRIFICE parts for fifty watt transmitter. Write for list. Ray Hatch, Flora, Indiana.

QSL cards, two colors, \$1.00 per hundred. Free samples. W8DTY, 257 Parker Ave., Buffalo.

SELL—transmitter parts including 24/1500 dynamotor Parmater transmitter, chokes, receiver parts, etc. Write for list. Everything 1/2 price. W9CBC, Wellsville, Mo
8000 Volt 6000 Watt double commutator motorgenerator 10 Hp. 3-phase drive \$685.00 complete. 500 Cycle 1 KW ballbearing motorgenerator, 110V. DC drive \$225.00. 25 Cycle 1 1/2 KW ballbearing motorgenerator 110V. DC drive \$225.00. 2-5 KW. Rotary Spark Gap 110. DC drive \$45.00. 1500 Volt, 500 Watt 3-phase drive motor generator \$125.00. 1000 Volt 200 Watt Escro 1-phase drive \$75.00. 750 Volt 300 Watt \$65.00; 200 Watt \$45.00. 35t Volt 50 Watt motorgenerators \$18.50. 400 Volt 100 Watt generators \$3.50. 1 1/2 Hp. 3450 speed motors \$7.50. Couplings \$1.75. Telegraph motors with controller \$8.00. Large stock filament generators. Queen City Electric 1734 Grand Ave., Chicago.

3000 Volt 4000 Watt double commutator motorgenerator. Generator direct connected to 110-120 Volt, 60 cycle, 1-phase motor. Fields separately excited by another motorgenerator, 1-phase drive. Complete ready for installation, \$550.00. James Smat, 1734 Grand Avenue, Chicago.

CLOSING out complete station equipment cheap. Send for list. C. Fingar, Jr., Hudson, New York.

SELL cheap—slightly used 110 volt dc motor 1/4 hp. W9AKM.

CANADIANS—sell surplus parts perfect condition. 800 volt double current generator and pulley \$20. Resistance to dynamotor from 110 v DC, \$3. Battery charging generator and pulley, \$12. Exide 8v, 120 amp. hour battery \$12. Ideal for 210 in country. VE4FF, Alliance, Alta.

USED parts, bought, sold, exchanged. List. W9CKA Corwith, Iowa.

QSLs 100 two color \$1.00. Radiograms, stationery. W3CKA, Corwith, Iowa.

SELL—REL inductance, set Aero coils, parts. Want Vibroplex. Write W2AEB.

SHORTWAVE set and three tubes, \$15. Radio Corp. Electrola power amplifier with tubes, \$15. First money takes either. W. L. Keifer, Willow Lebanon, Penn.

SELLING out. Escro 400W 1000V generator with GE 1 hp. motor, \$75; WE 212D with socket used 9 hours \$60.00; Jewell meters, 0-15V AC \$4.50; 0-500 MA \$4.50; 0-2.5 and 0-3 T. C. A. \$5.50 ea; 0-2000V without resistance \$4.75; R.C.A. 150W fl. transformer, \$4.75. Cardwell T188 condenser with 40 meter inductance \$7.00; 2 50W sockets ea \$1.10; two stage receiver with Aero coils and tubes in walnut cabinet \$15.00. Exide storage battery 100 amp. \$5.00; Baldwin fones \$4.75; WE 6V relay \$1.25. 7.5 watt oscillator without plate supply, \$35. Also other apparatus. Write for list. Postage extra. Russell Sinds, 1509 Washington St., Cedar Falls, Iowa.

TRANSFORMERS—100 Watt, 60 Cycle, 750 Volts each side of center, 7 1/2 volt Center tapped Filament winding, will operate 1 or 2 210 tubes, \$7.25. 100 Milliamperere filter choke 30 Henries \$5.90. Plate and Filament supply Transformers of any size, for 25, 40, 60, 60 or 500 Cycle supply to order Transformers exchanged. Scott Coil & Transformer Co., New Albany, Miss.

QSL cards. Cartoons. Stationery. Anything hams want printed. H. M. Selden, Cranesville, Pa.

TRANSFORMERS—250 watt unmounted 500-750-1000 volts each side, \$8.75. 100 watt 650-7 1/2-7 1/2 \$6.50. 50 watt 550-5, \$4.00. Chokes adjustable core, 250 MA 20-50 Henry, \$7.50, 160 MA 30-150 Henry, \$5.00. Write for specifications. Radio Parts Sales Co., Orange, N. J.

PANEL engraving—make that receiving or transmitting set look like a factory job by having panel engraved by expert engraver. Single panels four cents per character. Send drawing or blue print for estimate. Panels furnished. Radiophone Equipment Co., 1409 W. York St., Philadelphia, Pa.

THORDARSON transformer mounted practically new. 450 watt 1000-1500 volt each side \$14. Express collect. Victor Schleuder, New Ulm, Minn.

SELL—two DeForest CF340 250 watt tubes used 100 hours, \$40 each. Custom built four tube shield grid (Westman, December 1927 QST) using Hammarlund parts, never used. A buy at \$35. New National 203, \$10. W. K. McCulla, Waukegan, Ill.

5 WATT tubes. Brand new at \$1 each. These are rugged, thoroughly tested tubes. Unloading overstock. Renmo Tube Co., 115 Newbury Avenue Atlantic, Massachusetts.

TRANSFORMERS mounted complete guaranteed, 700 watt 2000-2500 each side \$21.00, 700 watt 1000-1500 each

Q R A SECTION

50c straight with copy in following address form only:

side \$14.50. 600 watt 2000-2500 each side \$18.00. 600 watt 1000-1500 each side \$13.50. 250 watt 550-700 each side \$10.50. 100 watt 350-500 each side \$8.00. Filament winding \$2.00 extra. Can also supply transformers for 500 and 25 cycles. W9CES, F. Greben, 1927 S. Peoria St., Pilsen Station, Chicago, Ill.

NEW push-pull transmitters, 15 watts, metered, 20-40 meters, \$22.00. W2BOA, Box 166, Allenhurst, N. J.

1000 working volts 2 mfd. Polymet filter condensers, \$2.15. Woodrow Darrow, Waterford, Conn.

SALE or trade: 100W xtal transmitter; four xtals; 2 button mike; 24-1500 dyanmotor; 1000V, 300 W generator; 6, 50 watters; mercury arc outfit; 1250-0-1250 transformer. Numerous small parts, W5ARX, Alva, Okla.

Western Electric 50 Watt Tube, \$15.00. Three VT2 tubes, \$2.50 each. Two new Cunningham CX310, in original sealed cartons \$6.75. RCA 3.5 Amp. magnetic modulator \$2.50. 150 watt CX381 power supply, heavily filtered, \$10.00 with tubes. Hal Justice, Canton, North Carolina.

Cardwell .00035 SLF Condensers \$1.50. COD, 30% deposit. Hal Justice, Canton, North Carolina.

MOTOR generator bargains. 750 Volt, 200 Watt, two commutator new General Electric motor generators direct connected to 110 Volt, 60 Cycle, 3500 R.P.M. single phase A.C. motors each \$45.00. 350 Volt, 150 Watt new General Electric motor generators direct connected to 110 Volt, 60 Cycle, 3500 R.P.M. single phase A.C. motors, with field resistance, each \$27.50. New 1/2 HP. General Electric and Westinghouse 110 Volt, 1750 R.P.M., A.C. motors \$8.75 each. New television variable speed motors for 110 Volt Alternating Current \$7.00 each. A limited number of each of the above items. Also many others to 3000 volts all sizes. Write us your needs. Electrical Surplus Company, 1911 Chicago Ave., Chicago, Ill.

FOR sale—Super Sink Disc on Stahl motor, \$25.00, used 204, \$20, 40 amp mercury arc \$15.00, Hoyt 1000 volt meter, \$6.00, 40 amp, D.C. Jewell meter \$4.00, 75 volt D.C. Jewell meter, \$4.00, New Paragon RA-10 fine for fone, \$15.00, W4KL.

CHOKE supplies—30H, 100MA—\$1.75, 50H, 150MA—Dudlo-wound—\$2.40, 50H, 300MA Dudlo-wound—\$3.25, 30H, 400MA—\$3.75. Pure rectifier elements. (Low copper-content aluminum) Cut and drilled, complete. Per pair: 1x4—8c, 1x5—9 1/2c, 1x6—11c. Extra Heavy: 1x4—12c, 1x5—13 1/2c, 1x6—15c. One inch wide heavy lead strip—9c per foot. Aluminum—10c. 1/4" Heavy copper tubing inductance: 3" diameter—10c per turn. 4"—18c. Fada 2.5 Ampere rheostats—34c. 2 Mfd. 400 Volt Filter condensers—47c. 7.5V-215V transformers—\$1.75. Accurate Wavemeters. 15-200 Meters, \$5.00 and \$8.00. Send for "Specials", William Harrison, 35 Ft. Washington Ave., New York City.

WANTED—Navy standard receivers SE143, SE1220-SE-1420, IP500 or IP501. State price—condition. Trautwein, 15 Albany St., New York.

WILL trade complete new Pathex movie camera and projector for any radio equipment worth forty dollars. Sets, tubes, speakers, eliminators preferred. Will accept best offer. P. M. Platten, 103 N. Broadway, Green Bay, Wis.

TRANSMITTER relays—brand new, with Tungsten steel contacts. Will break 2500 volts and follow fast bug. Operated by dry cell or storage battery. Only \$2.00 each. Some slightly used ones at \$1.50 each. All prepaid. Mitchell Radio Co., 635 Waveland Ave., Chicago, Ill.

SELL—S-M screen-grid adapter No. 731, one two step amplifier. Write for particulars. R. E. Heavilon, 53 Main Ave., Frankfort, Indiana.

SAY OM's why not give your guy wires a treat by putting in W2BIR'S hook and eye steel screw hot galvanized turnbuckles? 1 1/2" screw 30c each, 5/16" 35c, 3/8" 45c, 7/16" 55c, 1/2" 65c. Postpaid East Mississippi. W2BIR, D. Troy, 288 Prospect St., Nutley, N. J.

JEWELL meters—lightly used and in good condition. 0-3 thermocouple ammeter; 0-25 d.c. milliammeter; 0-200 d.c. milliammeter. Make offer. L.R.H. c/o A.R.R.L.

FOR sale—By W8PJ. Two UV204s old type. \$30. cash each. Good condition. Nuff said.

HARTY & YOUNG will make that special set. R. S. Kruse, Consultant, L. W. Harty, Firm Member. Anything from 1 to 30,000 meters. Repairs, Overhauling, reconditioning. 126 Ann Street, Hartford, Conn.

W1DQ—Harold C. Bowen, Box 403, Fall River, Mass.

W2GZ—Chas. A. Louis, Jr., P. O. Box 116, Roosevelt, L. I. N. Y.

W7OJ—Waldemar Johnson, 104 S. Division St., Aberdeen, Wash.

W8FC—W. Knight Hamilton, 26 Bay St., Potsdam, N. Y.

W9GEE—Chester B. Franz, 5269 Vernon Ave., St. Louis, Mo.

WIMK

A.R.R.L. Headquarters

R. B. Parmenter, Chief Op. "rep."

The following calls and personal signs belong to members of the A.R.R.L. Headquarters gang:

- W1AL H. P. Westman "ws."
- W1BDI-W1XL F. E. Handy "fh."
- W1BHW-W1EH K. B. Warner "kb."
- W1BMM-W1FL G. D. Meserve "dm."
- W1BUD A. L. Budlong "bud."
- W1CEI-W1SZ J. J. Lamb "jm."
- W1ES A. A. Hebert "ah."
- W1KP F. C. Beekley "beek."
- W1PX C. G. Kenefick "ek."
- W1SZ-W1BIZ C. C. Rodiman "rod."
- L. R. Huber "ou."
- R. A. Hull "rah."

TRANSFORMERS, CHOKES COILS

*of all descriptions made
to your specifications.*

The crying need of the radio constructor and amateur for *efficient* coils, chokes, and transformers for either transmitter or receiver construction, is filled by the "*Most Efficient*" Power equipment manufactured by I. R. NELSON CO.

The new and radical core design developed by this company gives the small power transformers and coils all the efficiency inherent in large electrical construction work. Write in your wants. We will be glad to quote you. You will be surprised at the quality received for your investment. Prompt delivery on all orders.

I. R. NELSON COMPANY
Bond Street Newark, N. J.

To Our Readers who are not A.R.R.L. members

Wouldn't you like to become a member of the American Radio Relay League? We need you in this big organization of radio amateurs, the only amateur association that does things. From your reading of *QST* you have gained a knowledge of the nature of the League and what it does, and you have read its purposes as set forth on page 6 of every issue. We should like to have you become a full-fledged member and add your strength to ours in the things we are undertaking for Amateur Radio. You will have the membership edition of *QST* delivered at your door each month. A convenient application form is printed below—clip it out and mail it today.

A bona fide interest in radio is the only essential qualification for membership.

American Radio Relay League,
Hartford, Conn., U. S. A.

I hereby apply for membership in the American Radio Relay League, and enclose \$2.50 (\$3 in foreign countries) in payment of one year's dues. This entitles me to receive *QST* for the same period. Please begin my subscription with the issue. Mail my Certificate of Membership and send *QST* to the following name and address.

Do you know a friend who is also interested in Amateur Radio, whose name you might give us so we may send him a sample copy of *QST*?

Thanks

FOR YOUR CONVENIENCE QST'S INDEX OF ADVERTISERS IN THIS ISSUE

Arme Wire Company	82
Aero Products, Inc.	3rd cover
Aerovox Wireless Corp.	84
Allen-Bradley Company	82
American Sales Company	79, 83, 81, 85
American Transformer Company	68
Areturus Radio Company	88
Aurisma, Inc., Ad.	87
A. R. R. L. Apparatus	77
A. R. R. L. Embroid.	81
A. R. R. L. Handbook	76, 2nd cover
A. R. R. L. Membership	94
Barwick Company	87, 90
Barros & Cie., M.	80
Burgess Battery Company	4th cover
Candler System Company	85
Carwell Mfg. Corp., Allen D.	65
Central Radio Laboratories	86
Chicago Radio Apparatus Co.	89
Clarostat Mfg. Company	80
Corning Glass Works	71
Crosley Radio Corp.	69
Cunningham, Inc., E. T.	64
Dodge, C. K.	83
Donnan Elec. Mfg. Co.	84
Dubilier Condenser Corp.	70
Eastern Radio Institute	87
Electric Specialty Co.	85
Formica Insulation Co.	59
Frost, Inc., Herbert H.	80
General Radio Company	4
Gulf Radio School	90
Hardwick, Hinde, Inc.	86
International Resistance Co.	72
Jensen Radio Mfg. Co.	66
Jewett Electrical Instrument Co.	67
Johnson Co., E. F.	89
Leeds Radio Company	96
Loomis Publishing Co.	87
Manhattan Electrical Bargain House	79
Mass. Radio & Telegraph School	76
McGraw-Hill Book Co.	76
National Company, Inc.	58
Nelson Co., L. R.	93
Pacent Electric Co.	86
Potter Company, The	89
QST Binder	74
Radio Amateur Call Book Co.	83
Radio Corporation of America	57
Radio Engineering	1
Radio Engineering Labs.	63
Radio Equipment Company	82
Radio Institute of America	95
Raytheon Mfg. Co.	81
Rectifier Engineering Service	81
Rooney, John T.	90
Saugamo Electric Co.	Insert
Scientific Radio Service	79
Shortwave & Television Labs.	78
Silver-Marshall, Inc.	73
Teleplex Company	88
Thordarson Elec. Mfg. Co.	75
United Radio Mfg. Co.	83
Van Nostrand Co., D.	2
Vibroplex Company	78
Ward Leonard Electric Co.	83
Western Radio Mfg. Co.	85
Weston Electrical Instrument Corp.	60
Wireless Specialty Apparatus Co.	61
W. L. Radio Labs.	85
Yaxley Mfg. Company	87

The only course in Radio

sponsored by



Let this short-cut lift you into the real money class

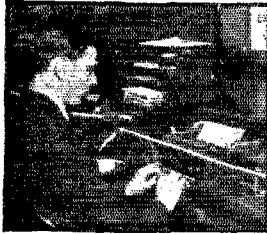

Radio Operator, \$90 to \$200 per month with all expenses paid



Radio Inspector, \$2,000 to \$4,500 a year

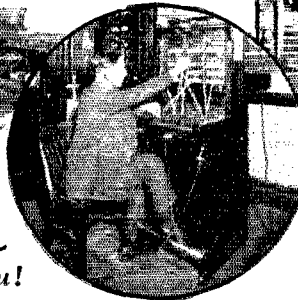

Broadcast Operator, \$1,800 to \$4,800 a year

DON'T look upon Radio as a mere plaything. Thousands of men are making big money at it — and so can you!

Just a little commercial training is all you need to give you that professional confidence and ability. You can secure this training in your spare time . . . through a marvelous home-laboratory course sponsored by the Radio Corporation of America. Our big FREE Radio book tells all about it.

Round out your knowledge with this home-laboratory training

Put the finishing touch to your Radio experience. Get the "How" as well as the "Why" of Radio with this commercial training. Only an hour or so a day—in spare time—is all you need. As part of your course, you receive absolutely free of extra charge—a magnificent outlay of fine apparatus. With this outfit you learn to build fine sets and solve the radio problems that bring big pay. You acquire not only the ability but the confidence to succeed in a big commercial way.

Training backed by
Radio Corporation of America

Our graduates are in big demand everywhere. They enjoy greater success because they're posted right up-to-the-minute in *everything* in Radio. Radio's progress each year is measured by the accomplishment of the great engineers at work in the research laboratories of Radio Corporation of America. This Radio organization sets the standard for the industry.

Money back if not satisfied

The lessons prepare you for success in all phases of Radio—manufacturing, servicing, selling, ship and shore broadcasting, Television, Photoradiograms and Radio equipment. A signed agreement backed by RCA assures you of complete satisfaction upon completion of the training—or your money will be promptly refunded.

Read this thrilling free book

It may mean the turning point in your life. It gives you the real "dope" about Radio and it describes in detail the famous training that has enabled us to place thousands of our students in fine positions, usually from 3 to 10 days after graduation! It tells in 50 fascinating pages and photos all about Radio's brilliant opportunities for adventure and success. Mail the coupon now — the book is absolutely free! Radio Institute of America, Dept. ST3, 326 Broadway, New York.



Radio Institute of America
Dept. ST 3
326 Broadway, New York, N. Y.

Gentlemen: Please send me your big FREE 50-page book which tells about the great opportunities in Radio and about your famous laboratory-method of radio instruction at home.

Name.....

Address.....

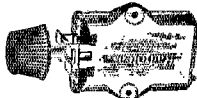

\$4 Bradleystat No. E-210, Special \$1.60

General Radio Type 285



Audio Transformer

Ideal for high and even amplification. Type 285-H—\$ to 1 Type 285-D—\$ to 1 List \$6.00 Now only \$2.95



\$2 Meso Telegraph Key \$1.45 Signal Ruzzer Set International Code on Baseboard \$2.45

Television disks as specified in QST special \$1.95

THORDARSON TRANSFORMER

R-195 Raytheon R-Eliminator transformer, designed as power supply for R-Battery eliminators using the Raytheon B-II tube. Has 2 secondary voltages—low 235 volts either side of centre tap—high 285 volts either side of centre. Transformer will carry the maximum current consumption of the Raytheon tube without overheating.

Listed at \$7.00 While they last only \$2.95

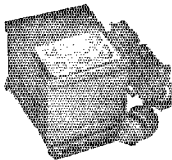

R-197 Thordarson Transformer, 220 volts each side of centre tap; 5 volt filament control each side of centre tap.

List \$7. While they last at \$2.95

ACME TRANSFORMER

Listed at \$5.00. The universal transformer for Super Het. 30 K. C. Limited quantity at \$1.10

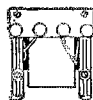

Photo Electric Cell



The well known K. H., the most sensitive tube for this purpose—4 1/2 inches high. Lasts a lifetime with ordinary care.

Never sold for less than \$15. Now Special \$12.

LEEDS

The Home of RADIO
45 VESEY STREET
NEW YORK
New York's Headquarters for Transmitting Apparatus

When in Town Visit Our Store

SPECIALS

- Bolden braid 1/2" wide; ideal for shielded grid tubes, ft. \$.06
- Parrot Deluxe No. 124 Phonovox—The electrical pickup; List \$19.50. Special 7.50
- General Radio 247D .901 cond. plain or with vernier 1.75
- \$15. Imported German head sets; very sensitive 3.45
- Honeycomb Coils unmounted, all sizes in stock 1/2 price.
- \$5 Signal Corps adjustable arm micro-transmitter for panel mounting 2.45
- R. E. L. Transmitting Inductances, per set 8.80
- Bristol 50 Henry choke 2.75
- No. 12 Enameled copper wire, any length, ft. .01
- No. 10 Enameled copper wire, any length, ft. .01 1/2
- Genuine Bakelite Panel 10 x 14 x 1/4 1.50
- Baldwin phones type C, pair 5.95
- Myers \$5 4 1/2 volt Det. or Amp tube, complete with mounting clips .45

Pyrax Low-loss V.T. sockets, each 39c.

R. C. A. socket; porcelain base, metal top 50c

General Radio 3 mfd. Condenser

\$1. List. Tested at 500 v. D Ideal for Filament By Pass



30c.

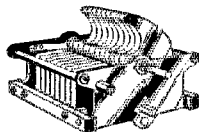

Cardwell condensers, double spaced for transmitting, .00025 cap. **3.45**

Everything in **Cardwell**

Acme
Thordarson
Jewell
Flechtheim
Signal
Bradley
In Stock



We carry the largest stock of GENERAL RADIO PARTS in the country

ACME VARIABLE RATIO



A. F. TRANSFORMER

Recommended for short wave C.W. reception exclusively. Has sharp peak—gives excellent results. List \$2.75 price, \$7.00 each. Special \$2.75

General Radio—200 watt Full Wave TRANSFORMER

Type 565-B. Secondary voltages 1200 volts (with centre tap) 2-7 1/2 volt filament carrying 2 1/2 Amp. each. Maximum current 200 MA. Price.

\$13.50



Two inch space wound Ham. inductance No. 16 d. s. c. green. Special price per inch 35c

MAIL ORDERS FILLED SAME DAY 10% Must Accompany All Orders

PLEASE PRINT YOUR NAME AND ADDRESS PLAINLY TO AVOID DELAY



Ward Leonard Resistance \$4.75 list—6 1/2 inch long—800-1000 - 1200 - 3000 - 6000 - 8000 - 11000 ohms; can be used for 2-50 watt tubes or less, \$1.45.



NEON GLOW LAMPS

Made by General Electric Co., type G. 10 standard base, 101 uses as illustrated in QST May issue page 17 Price only65c

RADIO FOUNDATION

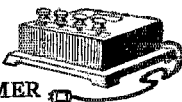

TRANSFORMER Will carry 6 or 7 -327 A.C. tubes tapped at 2 1/2-3-3 1/2 volts. List \$6.00. Special \$2.25

Television Lamp

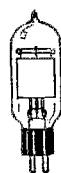

The large K. H. lamp 4 1/2 inches high—contains 1 1/2 inch plate—carrying 5 to 50 M. A.

Special .. \$5.50

New 1929 Short-Wave Products Are Here

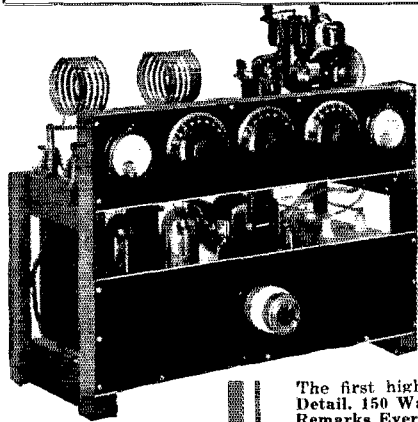

You Have Been Waiting For It! Aero Kit 52—New High Power Xmitter and 150 Watt Amplifier

Operation on
10-20-40-80-100M Bands!

The first high power amplifier to use the UX-860 screen grid tubes, 1929 In Every Detail, 150 Watts of Pure D. C. Signals with a Stability Which Has Caused Favorable Remarks Everywhere. Flexibility that Fills Every Ham Need.

You can use either two UX-852 tubes when using this new Aero Kit No. 52 as a single unit for a transmitter; or two UX-860 (screen grid) tubes, employed when using with Aero Kit No. 55; or as a 150-watt amplifier in any master oscillator combination. For those desiring a master oscillator system, this unit works with a high degree of efficiency as an amplifier. With two screen grid UX-860 power tubes in this arrangement, it requires no neutralizing. Hook this unit on your present oscillator, converting it into a 1929 job, with amplifier power for ham use. It may be operated as an amplifier with Aero's low power No. 55 Radiophone Xmitter, and a complete C. W. and phone set can be had, making a combination 150-watt high-power master oscillator, approached only by commercial broadcast stations. Last, but not least—as a Hartley oscillator using two UX-852 tubes, this unit performs in true 1929 fashion.

Power supply delivers 2000 volts at 250 M.A. Employs two of the R.C.A.'s newest rectifiers, UX-866. Due to the construction of the UX-866 unusually high voltage may be applied safely to them.

Kit No. 52—including the power supply, but not including tubes.

List Price \$259.00

852 tubes, less power supply and tubes,

List Price \$114.00

ROLL CALL OF STATIONS

Don't take our word for it. Hear it any time from 8-12:30 p.m., C.S.T. and be convinced. Following list of stations were worked while developing this Xmitter. Audibility records were from R6 to R9. Ask them!

w6asj	w7hp	w6ajm
w4nen	w3aqd	w6geh
w5aak	w6dij	ve-5js
w8dvc	w6bzy	w8bfa
w5pp	w8ape	w3afe
nz-fr-5	w1wl	w2apc
w8dxe	ve4pj	kdv5
w2bpc	w4ca	w5bdc
w8afe	w6cmx	w1awd
w1lx	w8lh	w3asc
w2kj	w1bal	w6ccq
w6boa	w9ecs	w1cr
w7aw	w4akq	w7ts
w2bmc	w6rd	w2bhr
w7acj	w1no	w8hts
w1bks	w2bz	w8ahc
w8dbm	w6lx	w6zb
w7tu	w1bbi	w1art
w1ack	w8alc	w9ext
w8li	w7alc	w7aet
w4afw	w2bpc	w9bhz
w8dwp	ve-2hr	w8axw
w2bfi	w8ccm	w8bps
w1crw	w1ccj	w5abs
w8alu	w1cw	w1auk
w1bal	w1blo	w6dfr
w7tk	w2avc	w1lf
w2blx	w7ch	w8bbj
w8mi	w5aza	w1ua
w2bob	w8ddc	w7aoo
w6cl	w5cx	w2fo
w1bcw	w2dw	w2avq
w3ql	w2ai	w2cbk
w3erb	w8bda	w6elm
w2biv	w9evo	w8hh
w5abs	w5tx	w4ca
w4si	w4ca	w2bse
w1ccx	w6avj	w2axi
w4oa	w5uf	w5qx
w2aun	w6erb	

New 1929 Receiving Coils

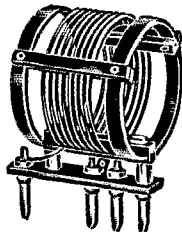

Designed for the new amateur 20, 40 and 80 meter bands, for use with .00003 condenser, including plug-in base with new design adjustable space-wound primary. Complete Kit L. W. T. 13, 3 coils, \$12.50. Single coils—8.2 to 12.6 meters; 19.4 to 21.5 meters; 40 to 45 meters; 77 to 85 meters, \$4.00 each. L. W. T. 100 P, Plug-in base, \$3.00; .00003 Condenser, \$1.50.

New 1929 Transmitting Coils

In accord with 1929 practice, First use of plug-in coils for high power up to 15 amperes. Heavy aluminum carries 500 watts safely. New material space bar superior to glass. Many new features. For use with 440-mumfd. condenser. Kit of 2 coils with plug-in mounts, 9.6 to 27 meters, \$15.00; 14.2-43 meters \$15.00; 21.3-90.3 meters \$15.00. Single Coils, \$5.50 without bases. Plug-in mountings only, Pair \$3.50; Plugs only, with nuts, pair \$2.00.

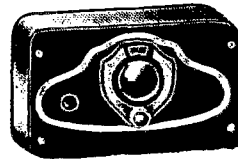
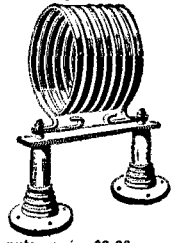

New Aero 1929

Listening Monitor

Now a real necessity for every "Ham"
Are You Working in the Dark?

The Aero Listening Monitor Box virtually turns a flood-light on your transmitter that you might accurately know your station and not be a cripple depending on the reports of fellow hams. Is your note pure D.C.? Do you think it is or do you KNOW from your own observation? BE WISE! BE SURE! and BE SAFE! Secure an Aero Monitor and be able to check your own note. Take a tip from Q.S.T. and don't drive your Lizzle by Watching the Ammeter, but know the road and keep the supervisor away from your shack.

The Aero Listening Monitor is a completely shielded unit, including filament and B supply and operates with a UX-199 type of tube. It is contained in a golden-brown metal cabinet, 8 inches long by 5 1/2 inches high, by 2 1/2 inches deep, crackle finish. It employs a stable circuit and delivers a signal intensity of about R-4 or 5. The battery supply is thoroughly shielded from the R.F.; hence no trouble from this source, thereby giving the operator the opportunity to secure a reliable piece of apparatus which also incorporates automatic filament control. Shp. wt., about 2 1/2 lbs.

List Price—Model M-29—including Dry Batteries But No Tube.....\$15.00
Send for new Short-wave supplement showing new 1929 products. It is free to QST readers

4611 E. Ravenswood
Ave., Dept. 339

AERO PRODUCTS
INCORPORATED

Chicago, Illinois,
U. S. A.

BURGESS BATTERIES

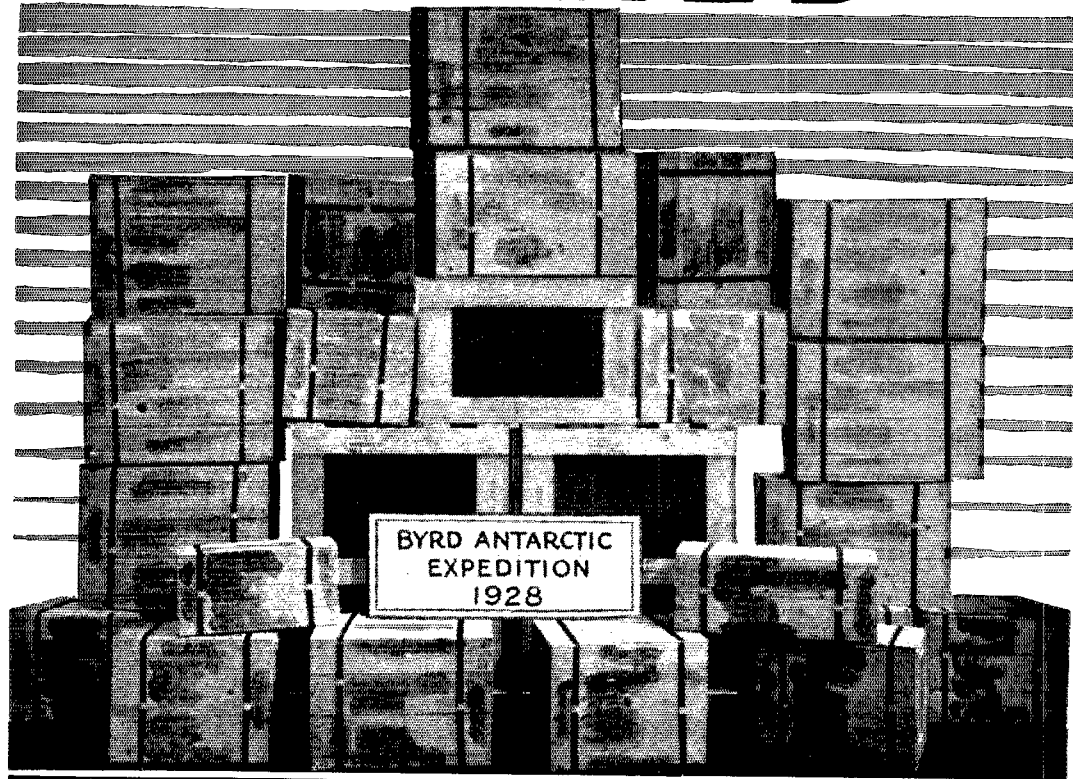

with Commander Byrd's antarctic expedition
"Ask any Radio Engineer"

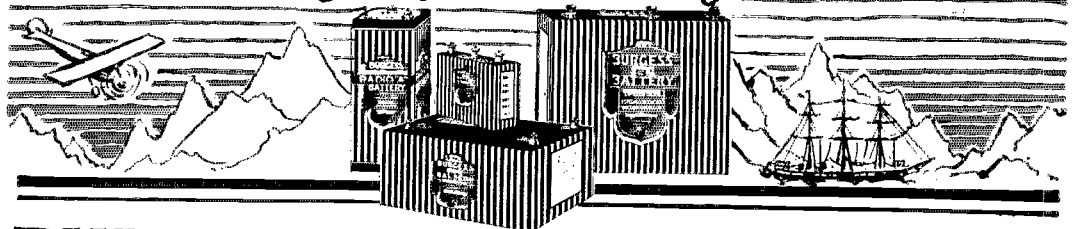

BURGESS BATTERY COMPANY
MADISON, WISCONSIN

VOLUNTEERS WANTED

The 1715-kc. band is becoming more popular every month. We now have several volunteer code practice stations in operation. With the increasing number of beginners, however, still more volunteer stations are needed.

Radiophone stations are preferred, as it is possible thus to instruct more efficiently through the microphone than only with a key. If you have a 1750-kc. radiophone transmitter and care to engage in this most worth-while work, please drop us a line, giving data on your exact frequency, hours of schedule, etc. We have some mimeographed material that is designed to be of use in putting the code practice on the air.

Won't you help us, OM?

BEGINNERS ATTENTION

Schedules that have appeared in the past few issues of *QST* will be an index to the stations in the 1715-kc. (175m.) band who are transmitting code practice. Beginners are urged to get a receiving set in order to listen to these stations. Constructional details appeared in the October, 1928, issue of *QST* (page 46). In addition to what has appeared in *QST* it is suggested that the *Getting Started* chapter of the *Radio Amateur's Handbook* be referred to as a guide in the work of becoming a full-fledged amateur.

Listeners who make use of code practice transmission should never fail to send a card to the volunteer in order to let him know that his work is being utilized and appreciated. The following schedules in the 1715 kc. band are now in effect:

W8SSG, Denison University, Granville, Ohio, will transmit on 1725 kc. on the following schedule:

Monday and Wednesday: 7:30 to 8:00 p.m. E.S.T.
Friday: 10:30 to 11:00 p.m. E.S.T.

W9DDC (Walter Bliss, Durand, Ill.) will be on the air with code practice on Tuesday and Friday evenings from 10:30 to 11:15 p.m. CST, during March. W9DDC works on 1790 kc. and his phone has been reported from the Atlantic coast on several occasions. We are glad to add such a consistent station to our list and recommend these transmissions to beginning amateurs in need of code practice.

W5LY is one of the beginners who has profited from the 1715 kc. code practice program. He writes that he has been on the air just 36 days and has worked 38 stations of both the 'phone and CW type. Four districts and thirteen states are included in his work. His location is Drew, Mississippi, and his DX reaches to North Dakota, Wisconsin, Michigan, Ohio, Pennsylvania, and Colorado. We hope to hear of more new men doing this well. The 1715 kc. band is especially good to "break in" on, since most of the stations there are new and like to spend time "swapping notes". FB.

G P R

The *Washington Radio Club* has been completing arrangements in the national capital for the expeditious handling of traffic for the Governors-President Relay on the third and fourth of March. Several relay chains undoubtedly will be in operation for this event. W8ZF and his Twentieth Century system have notified us that their lanes will be open for the inauguration. But there will be plenty of work left for the free-lance operator who is looking for a pleasant night's work. W1MK will keep an hourly schedule with W8HL in Washington, and in all the time between will listen continuously for outside stations that have GPR traffic.

The Washington stations, of course, will bear the heaviest burden of all. They will be on the job listening for all who call—don't you forget it. Here are their calls and frequencies:

Continuous operation

W8HL — 3600 kc.
W8AGW — 3763 kc.
W8BWT — 3585 kc.
W8GT — 7083 kc.
W8BKW — 7250 kc.
W8AKR — 7150 kc.

Intermittent operation

W3AIM — 7220 kc.
W3AMY — 7275 kc.
W8AU — 7175 kc.
W3CDQ — 7064 kc.

These stations will handle Governors-President Relay traffic exclusively during the twenty-four hours from 5:00 p.m. E.S.T. of the third until 5:00 p.m. E.S.T. of the fourth of March. They will call in the following fashion: CQ CQ CQ GPR de W3XXX W3XXX W3XXX AR. They will listen thoroughly over the whole band in which they are operating. Answering calls from outside stations should take the following form: W3XXX W3XXX W3XXX GPR de W9XXX W9XXX W9XXX AR. After making contact with W3XXX, W9XXX should indicate the state or states in which his GPR messages were originated, in the following way: "HR GPR MSG FM INDIANA MK?" The Washington stations will be in telephonic contact with each other through a central station, and thus will be able to check off the "heard from" states as the messages come in. If it should happen that W3XXX had been notified that the Indiana message had been received at some other Washington station, he would say to W9XXX, "TNY OM INDIANA HRD FM QTA QSK 73". Then W3XXX will be free to return again to general operation and search the band again for incoming GPR messages.

It is urged that all originating stations and all relaying stations give their GPR messages to as many RELIABLE stations as possible. In this way all originated messages will be sure to reach Washington by one route or another.

This procedure will undoubtedly flood the country with GPR messages, which will come trickling into Washington for days after the Relay is over. To stop this unnecessary and undesirable floating about of messages, it is recommended that all GPR messages that are "on the hook" after 8:00 p.m. of the fourth be canceled.

All GPR traffic, whether relayed or not, should be reported in detail to A.R.R.L. Headquarters, in order that we may write a complete report of the Relay. This will be chronicled in *QST* as soon afterward as possible.

—L. R. H.

TRAFFIC BRIEFS

We received a letter the other day that is a bit out of the ordinary. It comes from a BCL who is apparently having some difficulty. We wish to refer it to our membership for perusal. If anybody can think of a good solution of the problem we shall be pleased to hear about it. Here's the letter:

"At your convenience I would like to have you advise me on the following. Since the night before election an electric noise has bothered us here in —. The a. c. plug in set get it the worst and I believe the western side of the village get it the worst. It is in on very cold days, on all windy days and any time of the day or night. The local office of the power co. knows about it and has looked it up but I don't think they found anything and think they have stopped looking for it.

"I haven't or don't know where I could borrow a port. set. The noise, probably an a. c.—hum comes in so strong that the stations are lost. Radio reception has been cut off about 1/2 of the time.

"The N. Y. N. H. & H. RR goes by at about 1/4 mile distant and they have some electrical features there but one of their men have been trying to find what it was.

"Probably no one is on the trail of it now and if you could help us out in any way I wish you would. Would be glad to hear from you if you can suggest a possible course to follow regarding electric condition here described. Thanks."

The following message arrived via W5IZ from ZL2AW. It is, we believe, indicative of the general international DX situation at the present time:

"Tell all W stations that we can hear them answer but sometimes we get QRM at last when call is signaled stop if they don't hear us come back they should go ahead and call again."

sig ZL2AW

W9CKQ has resumed his daily schedule with VK6HG and is a good clearing point for traffic to Australia.

BRASS POUNDERS' LEAGUE

Call	Orig.	Del.	Rel.	Total
K1HR	199	578	75	852
K1CM	312	60	276	648
W3ZF	117	83	374	574
W6AJM	69	22	414	505
W6EEO	15	197	290	502
W9DLB	76	126	270	472
W9DLD	37	34	348	419
W6IP	31	15	356	382
W1ANH	78	78	224	380
W9DGV	3	7	354	364
W9EJQ	14	32	312	358
W6BQ	13	13	292	318
W3ANS	13	34	260	307
W9ELX	32	27	246	305
W9ERU	22	27	253	302
W1ACH	54	86	160	300
W9DAE	—	—	—	300
W2SC	27	42	208	277
W9DBA	20	10	245	275
W6AMM	176	30	10	266
W6AD	32	191	37	260
W9EGU	22	8	227	257
W1BIG	73	63	120	256
W8DYH	61	34	161	256
W8CMB	25	20	210	255
W1CGX	40	17	198	255
W9DXZ	11	81	159	251
W9DOE	—	—	—	242
W5OM	8	17	225	240
W3AKB	21	55	161	237
W1ART	91	45	100	236
W1AUR	66	68	99	233
W3NF	32	25	174	231
W4JY	7	48	74	229
W8ARK	10	46	171	227
W8DED	31	26	168	225
W8CWO	55	19	146	220
W9FLG	98	48	72	218
W2BFG	120	45	52	217
W6ZBJ	6	9	195	210
W9EKW	28	27	152	207
W1LW	22	20	164	206
W9DKG	—	—	—	204
W1AKS	23	22	158	203
W8JA	31	25	146	202
W9BPW	9	32	161	202
W9DEK	26	164	12	202
W8CHC	27	8	176	201
W8DSP	30	51	102	183
W6EC	22	159	1	182
W9DKM	15	53	106	174
W3BWT	31	53	68	152
W1KY	23	74	52	149
W6DWI	13	53	80	146
W9EJO	38	24	78	140
W6UJ	10	53	63	126
W9BCA	19	52	49	120
W7TX	29	56	3	88

Traffic appears to have dropped in quantity during the last thirty days—but the quality of our traffic has probably increased greatly since the holidays, an exceptionally large number of messages being handled for expeditions and stations at remote points. A large number of reliable routes are in operation, and because of this fact an increasingly large amount of traffic, even from distant points is being successfully relayed to destination, saving the delays and trouble incidental to mail deliveries in the past.

The several amateur stations responsible for the best traffic work—the ones that are "setting the pace" in worthwhile traffic handling—are listed right up near the top of our B.P.L., the figures giving the exact standing of each station accurately.

All these stations appearing in the Brass Pounders' League are noted for their consistent schedule-keeping and dependable message-handling work in amateur radio. Special credit should be given to the following stations (in the order listed) responsible for over one hundred deliveries in the message month: K1HR, W6EEO, W6AD, W9DEK, W6EC, and W1MK. Deliveries count! A total of 200 or more bona fide messages handled and counted in accordance with A.R.R.L. practice, or just 50 or more deliveries will put you in line for a place in the B.P.L. Why not make more schedules with the reliable stations you hear and take steps to handle the traffic that will qualify you for B.P.L. membership also!

WIMK

A.R.R.L. Headquarter's Station WIMK operates on frequencies of 3575 kc. and 7150 kc. Robert B. Parmenter, "RP", is the chief operator; his list is familiar to most of the amateur fraternity. Occasionally, other members of the Headquarter's staff operate at WIMK. Their personal signs may be found in the QRA Section of QST.

Throughout this notice time will be given as Eastern Standard Time, which is also known as "75th meridian" or "Zone Plus 5" time.

OFFICIAL AND SPECIAL BROADCASTS are sent simultaneously on 3575 kc. and 7150 kc. at the following times:

- 8:00 p.m.: Sun., Mon., Tues., Thurs., and Fri.
- 10:00 p.m.: Mon. and Fri.
- 12:00 p.m. (midnight): Sun., Tues., and Thurs.

GENERAL OPERATION periods have been arranged to allow everyone a chance to communicate with A.R.R.L. Headquarters. These general periods have been arranged so that they usually follow an *official broadcast*. They are listed under the two headings of 3500 kc. and 7000 kc., to indicate whether the watch is devoted to listening on the 80-meter band or to the 40-meter band.

- 3500 kc.:
 - 8:10 p.m. to 9:00 p.m. on Sun., Mon., Tues., Thurs., and Fri.
 - 10:00 p.m. to 11:00 p.m. on Tues. and Thurs. (No OBC sent before these periods).
 - 12:00 p.m. to 1:00 a.m. (or later) on Sunday night (Monday morning).
- 7000 kc.:
 - 10:10 p.m. to 11:00 p.m. on Sun., Mon., and Fri.
 - 12:00 p.m. to 1:00 a.m. on the following nights (actually on the morning of the day following): Mon., Tues., Thurs., and Fri. (Only on Tues. and Thurs. does the OBC precede these periods).

SCHEDULES are kept with the following listed stations, through any of which traffic will travel expeditiously to A.R.R.L. Headquarters. The frequency included within parenthesis indicates the band in which each individual station keeps the schedule with WIMK:

- W1ACH, Brookline, Mass. (3500): Sun. and Thurs.
- W1BIG, Augusta, Maine (3500): Mon. and Thurs.
- W1BQD, Newport, R. I. (3500): Mon. and Fri.
- W1KY, Cambridge, Mass. (3500): Mon., Tues., and Fri.
- W1VB, Newtown, Conn. (3500): Tues. and Fri.
- W3JF, Jersey City, N. J. (3500): Sun., Mon., Tues., Thurs., and Fri.
- W3HL, Washington, D. C. (3500): Sun., Mon., Tues., Thurs., and Fri.
- W3ZF, Philadelphia, Pa. (3500): Sun., Tues., and Thurs.
- W3ZS, St. David's, Pa. (3500): Mon. and Thurs.
- W4RM, Atlanta, Ga. (3500): Mon. and Thurs.
- W5JC, San Antonio, Tex. (7000): Thurs.
- W8AAG, Oil City, Pa. (3500): Sun.
- W8AYB, Buffalo, N. Y. (3500): Tues.
- W8BYN, Columbus, Ohio (3500): Mon., Tues., and Fri.
- W8DED, Holland, Mich. (3500): Tues. and Thurs.
- W8ZZ, Detroit, Mich. (3500): Sun. and Thurs.
- W9APY, Berwyn, Ill. (3500): Tues.
- W9BCA, Ft. Madison, Iowa (7000): Mon. and Fri.
- W9BLD, Alton, Ill. (3500): Sun. and Fri.
- W9DWS, Kansas City, Kans. (7000): Wed. and Fri.
- W9OX, Louisville, Ky. (3500): Sun. and Thurs.
- W9XI, Minneapolis, Minn. (7000): Mon. and Fri.
- VE9AL, Toronto, Ont. (3500): Tues. and Fri.
- WSBS, Yacht Carnegie (9090): Sun., Mon., and Fri.

TRAFFIC BRIEFS

WIMK is always glad to work any body that calls, but it should be borne in mind that during schedule periods it is almost impossible to work those who do not keep schedules with WIMK. If you call WIMK and find that business is too good to allow QSO, haul down your copy of QST and look up the General Operating Periods. Probably you will find that you called during a scheduled period, during which RP was just too busy to answer you. In the General Periods, however, he usually can work anyone that calls, unless expedition work (WSBS, etc.) interferes.

W2ADC, 569 84th St., Brooklyn, N. Y., will transmit with phone and buzzer modulation on a frequency of 1760 kc. on the following schedule:
 Sunday: 10:30 to 11:30 a.m. E.S.T.

Bob Morris, W4JR, and A. W. McAuly, W8CEO, have kept a consistent, punctual, and very enjoyable schedule for the last *five years!* During this time it has been learned that the 3500 kc. band could be relied on at all seasons for evening work between Gastonia, N. C., and Oakmont, Pa.
 We are sorry to learn that this schedule will now have to be given up for a time, due to Bob's new duties in the control room of WBT, the broadcasting station at Charlotte, N. C. Let's hope that Bob and Mac can get together with their schedule before long. Incidentally, we want to hear about more of these kind of schedules at HQ. If you have something up your sleeve that we ought to know about, OM, send it in!

W9BCA spends about one hour each evening chatting with CAB at Punto Cabezas, Nicaragua. This, of course, takes place after the day's traffic is handled.

ARMY-AMATEUR NOTES

All amateurs interested in Army-Amateur work should address their inquiries to CORPS AREA SIGNAL OFFICER in the Corps Area in which you are located. The map shown below will tell you the Corps Area in which you are located. When you have determined this, you can find the address of the correct Corps Area Signal Officer by referring to the list below the map.

- 1st Corps Area — Army Base, Boston, Mass.
- 2nd Corps Area — Governors, Island, New York City
- 3rd " " — Baltimore, Md.
- 4th " " — Atlanta, Ga.
- 5th " " — Fort Hayes, Columbus, Ohio
- 6th " " — 1819 West Pershing Rd., Chicago, Ill.
- 7th " " — Fort Omaha, Omaha, Nebr.
- 8th " " — Fort Sam Houston, San Antonio, Tex.
- 9th " " — The Presidio, San Francisco, Calif.

The December Army-Amateur and Hudson Division A.R.R.L. meeting at the Army Bldg., New York, was attended by over 400 amateurs. Ross Hull, from A.R.R.L. Hqtrs., spoke on the latest developments in receivers, transmitters, tubes, etc. A demonstration of airplane-to-ground telephone communication

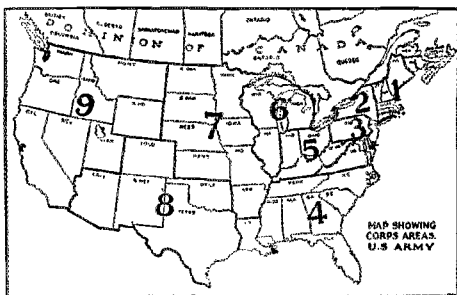

by means of short-wave portable radio sets will be given at the Aviation Show to be held at the Grand Central Palace, New York, from Feb. 6-13, 1929. W2VF is the call of the airplane transmitter and W2VG the ground station's call. The ground station will be located in the A.R.R.L. booth on the third floor of the Exhibition while the plane set will be installed in a Waco plane on the first floor. W2PF assisted by W2ALU and W2TI are arranging this demonstration and communication with Army-Amateur stations in the Eastern N. Y. State Net will be established on 2530 kc.

Western N. Y. State Net: W2BFG acted as N.C.S. in place of W8DME who was unable to keep the last two weekly schedules. More activity is desired from W8CVJ. W8AHK has resumed his activity in the Net. W8DHC is N.C.S. Erie County Net.

Eastern N. Y. State Net: W2KR and W2BPQ continue their good work in keeping all weekly net schedules. W2AY, W2AJL, W2JA, W2ANV, and W2BCU are the active stations in this Net.

New Jersey State Net: W2AOS, the N.C.S., has rebuilt his transmitter according to the 1929 standards but has not missed a single schedule in this connection. W3ATJ is very busy with his law work and is unable to keep all schedules for the Burlington County Net. W3ZI is busy with his broadcast station but manages to keep some schedules. W2AT and W2AAT and W2AOP have not been heard from lately. W2DX will act as alternate for W2AOS when W2JG is unable to be on the schedule.

Announcing 28-Mc. Tests

I WISH to inform you of, and ask for your cooperation in a series of 28 megacycle tests which will be run by British amateurs during March of this year. At the same time, I wish to thank you for the help you gave us in our last small tests, by sending the news out through your Official Broadcasting Stations.

The coming tests will be on a much bigger scale and I hope that the interest shown in this band will be increased by these tests, and that they will help in opening up the band for communication with other continents. It is also hoped that they will clear up some points which have been raised by our members:

- (a) Are signals received from the same station simultaneously at different parts of Great Britain?
- (b) Is low-power as effective as high-power?
- (c) What is the possibility of communication with other continents?
- (d) What is the most suitable transmitter circuit for these frequencies?
- (e) Is R.F. amplification of practical value to the receiver on 28 mc.; i.e. amplification at signal frequency, of course.
- (f) Does any connection exist between solar and magnetic conditions and propagation at this frequency?

This Bureau, which is really an experimental section of the Society, has organized the experimenters into groups of six, each working under a Group Centre, and circulating monthly letter-budgets. There are now a goodly number of groups on 28 mc. work and we are assured of concentrated work during the coming tests.

Non-members of this Society may join this Bureau and obtain the co-operation of our experimenters if they in turn are willing to help our men in their work. There is no fee, but where replies are required from this Bureau, it is requested that they are pre-paid by means of International Postage Coupons as the service is run by myself in an Honorary capacity.

Each month the activities of the members of the Bureau are reported in our organ the "Bulletin."

The tests on 28 megacycles will be continuous from 0000 GMT (GCT—as QST styles it) on March 9th to 2400 March 24th. Each station on this side will transmit a five-letter code word, which should be noted and reported. Schedules may be arranged if the stations concerned agree to limit the schedule to a mere passing of reports, in order that one British station will not occupy the entire attention of a distant one to the exclusion of other British stations. Reports with full details of weather, apparatus, power and other significant items are earnestly requested from transmitters and receivers and the unconfirmed results will be published in the April issue of the "Bulletin", followed as soon as possible by the results which have been confirmed. (These reports should be sent direct to Mr. Allen with a copy to A.R.R.L.—F.E.H.)

I have used "GMT" in the above announcement as I learn from a British Government publication that the use of GCT by astronomers was discontinued some two or three years ago, and GMT is now standard practice in Great Britain. I hope that American amateurs will help us in this effort to increase the knowledge regarding the 28 mc. band.

—T. P. Allen, M. Sc.,
 R. S. G. B. Contact Bureau Manager
 59, Marlborough Park North
 Belfast, Northern Ireland

Pacific Division Trophies

AFTER SEVERAL months of deliberation following the Pacific Division convention in Oakland, A. H. Babcock, Pacific Divisional Director, and Bernard H. Linden, Radio Supervisor of the Sixth District the two judges in the contests, have announced the winners of the Pacific Division Traffic Trophy and the Divisional Wouff Hong Trophy.

The Pacific Division Traffic Trophy, a silver cup donated by W. N. Jenkins of Oakland, went to Bruce Stone, W6AMM, for his exceptional traffic work with K1HR. During 1928, the period covered by the traffic contest, W6AMM handled more than 4000 messages between the coast of California and the Philippine Islands. The trophy was formally presented to him by W6ZD and W6CZE on behalf of the East Bay Section of the A.R.R.L. at a tri-sectional hamfest held by the Santa Clara County Amateur Radio Association in San Jose in which the members of the Santa Clara, East Bay, and San Francisco sections participated.

The traditional Wouff Hong trophy, constructed by the Modesto Radio Club years ago from the plates of burned out transmitting tubes, was awarded to Don Good, W6AJM, who was runner-up to W6AMM in the traffic competition, for having the most consistent station during 1928, under the rules drawn up by the original Wouff Hong committee of the Modesto Radio Club. E. O. Knock, W6BJX, was the other competitor in the Wouff Hong competition.

The judges announced that there was difficulty in making the awards, owing to the general excellence of the competitors. This speaks well for the consistency and operating ability of west coast stations and operators.

—W6CZE

More on WFAT and WFBT

On the morning of December 15, Holiday of W4RN worked WFAT, the S.S. *Eleanor Boling* of the Byrd Antarctic Expedition. W4RN took thirty seven messages in a row on this occasion. WFAT was QSA5 and extremely easy to copy. The *Boling* was at this time 860 miles south of Cape Saunders, N. Z. returning to Dunedin for the second load of equipment. W9EGU reported his communication work "rather patchy" due to other stations working the Byrd expedition and running over into his schedules. Cy Barker reports that operator Berkner is usually at the key of WFBT, the S.S. *City of New York* and that while WFBT is usually not over R3 or R4 that he is reported as R6 to R9 usually with fading starting about 1220 Greenwich. W9EGU's "sked" has been changed to 1130 Greenwich to take advantage of the better signals at that time of day. With the quantity of messages received from all over the U.S.A. for transmission to Byrd's expedition it takes much time to clear the hook and sometimes the daylight will arrive and terminate the contact before all the stuff has been put through. W9ARE had nice QSO with WFAT. W9US (Operators Kamin 'ih' and Lowenthal 'xg') report their station in practically constant touch with both ships of the Byrd Antarctic expedition. Night in and night out, irrespective of weather conditions W9US has consistently met its schedules, including even those days when the ships are in port and work only those stations that have proved their extreme reliability as a source of traffic from home. We have no report from W2KR, W2ALU or W8AHC but suspect that these and several other reliable stations are maintaining their usual good contacts. Report of all expedition work, of whatever type or duration are welcomed for QST. Send 'em in gang.

This is FB, W9TUS! Will everybody else who has good contact with the Byrd Antarctic Expedition please tell us about it, in order that we can put it into QST?

sbPUT

Much of the traffic of the American-Brazilian expedition is still being handled through sb1LB and W8CFR on schedule. However, we have it from operator Palmer of the expedition that the call signal has been changed to sbPUT. The expedition's station works on both 7000 and 14000 kc. bands and has a 1500 cycle modulated note. All amateurs are requested to listen for 'PUT' and to help with the traffic, most of which is for New York City.

The New York Stock Exchange Rifle team has been conducting several matches during the present season, in competition with other rifle teams at a distance from New York City. W2ABU and W2CQD have co-operated in the sport by connecting up with amateur stations in the cities where competing teams were located. Thus matches have been held as far away as Portsmouth, Ohio, where W8CSC was the relaying station.

The New York Stock Exchange Rifle Team is anxious to take on several more matches before the end of the season (about 15 April). Amateurs who can serve as relaying stations in cities where there are rifle teams are invited to correspond with W2ABU and W2CQD, or to write directly to Mr. G. W. Robertson, Personnel Office, New York Stock Exchange, N. Y. C. Let's hear some more of this, OM's!

Long haul traffic routes between the East Coast of the United States and the Orient this winter are not lacking. One runs from W2AKX through W3HL, W9COS, W6AD, and thence to China. Another starts at W3GT and goes through W9EGU, W6REO, and hops to K1HR. Still another finds its way across the Pacific via W6AKW, K1AF, K1CM, and ac2CK. Delivery in the East is taken care of largely through W1MK, W1KY, the W3ZF Twentieth Century System, and various other stations. In the Middle West W9EGU, W9BZO, and W8BYN have served well. There undoubtedly are others in this line of traffic of whose good work we have not been informed. Let's hear more about it.

W9COS says that there is only one sensible way to conform to the new procedure in traffic work, and that is in its entirety. Throw the old abbreviations in the ash can and drill the new ones into the cells that accommodated the old so nicely. If we can't use the new Q signals, then we had better talk "long hand" until we acquire a speaking acquaintance with the new "lingo". It is a lot more than disconcerting to have some one come back at you with the old Q sigs and, when you use the new ones, to have him become all confused. It makes one afraid to use "QSC" on account of the risk of offending the other party.

We believe that W9COS has hit the nail on the head: while there are admittedly several things that we don't like about the new Q signals, still we shall get nowhere by using part of the old and part of the new. **THE ONLY THING TO DO IS USE THE NEW ENTIRELY** and forget the old.

Whatever "extenuating circumstances" the users of tone wheels, buzzer modulation, and the like have been able to dig up as an excuse we don't know. Few such stations have been adequately constructed and adjusted to prevent "wabulation" if the broadness and interference we hear on 7000 kc. nightly is any indication. Even assuming such "suitable" transmitter circuits and adjustment, disposing of the "wabulation" problem, no one has proved that the resultant modulation produces a sharper-tuning signal, or as sharp a signal, in fact, as the same unmodulated signal. It doesn't. Modulated signals are always somewhat broader and less considerate of others than unmodulated signals.

High capacity to inductance ratios in the tank circuits of self-excited transmitters, also push-pull circuits help prevent broadness resulting from "wabulation" or frequency shifts which tend to take place synchronously with the application of modulations. But remember, the *sharpest possible* signal is the goal of all right-minded amateurs. Then the answer to our problem is to avoid the use of choppers and other QRM-devices altogether. Instead of adding such appliances which cover up defective chirps and bad adjustment, let's strive to really improve the basic construction and adjustment of transmitters to put all the energy on one frequency where it will do some good in putting a readable signal through under all conditions. With the new rectifier tubes now available, almost the last excuse for poor plate supplies has disappeared. Watch the number of good, consistent, steady and really respectably sharp signals grow. It's on the increase daily.

How about your outfit, OM? What does the monitor show? Is your call signal listed among the "1929 signals" reported elsewhere by our SCMs and RMs?

TRAFFIC BRIEFS

The Canadian "prayer meetings" will be continued on Wednesday nights on the band of frequencies between 4000 kc. and 8995 kc. (75 and 77 meters).

W2BGB has been lining up amateur stations between Albany and Montreal to assist in reporting weather conditions for the information of the aviators who fly this course daily. VE2BB and W8DQP tie in with W2BGB and these stations are working up a most excellent service with their facilities, incidentally putting amateur radio on the map in a new way. It is hoped that W1CGX can also assist at an early date. Other stations along the route should get in touch with W2BGB if able to help out.

28 Mc. (January Report)

W2ALW noting the desire of the R.S.G.B. Contact Bureau expressed previously in these columns to have stations available for tests during the week has arranged a motor-driven keying device which is used to run his 28 mc. M.O.P.A. outfit from 9.30 to 9.50 a.m., E.S.T., five days a week. He gets at the key himself Sundays and Saturday afternoons.

"Tests from VE2AC will be continued. Fifteen minutes of transmission starting at 9.20 am and 1.35 pm will be followed by a listening period and with unlimited time for QSO after each test. Frequency approx. 29 mc. On Sunday VE2AC is on from 1 pm to 4.30 pm. Stations desiring schedule may write to VE2AC. Heard (Jan. 6) W9DKM W5WZ W6AMW ZL2AC W9CUB W9DRB W5AOT W5OM W5YG W9EVC, (Jan. 13) W5WZ W9EVC, (Jan. 11) KLL, (Jan. 20) W9EVC."—*Athy Blais VE2AC.*

"It has seemed to me that the band was definitely

one for daylight DX. During December W stations were good up to 1600 GMT and on a few occasions as late as 1800 GMT. After darkness G stations come in nicely and reliable short distance QSOs can be established. QZ3AR was heard once. During the whole month of January I have found 23 mc. rather flat—not a signal outside the British Isles since Jan. 6. W2JN, W2BRB and other prominent stations have vanished like ghosts of the past, yet on all other frequencies I have found conditions marvellous. All of our gang have been very weak with the possible exception of G2OD. But I have yet to find QRN on this band, in spite of the fact that it has been pretty evident elsewhere."

—*Cecil R. Beaven, 35 Upper Studley, Trowbridge, Wilts, England.*

W7UB worked W9EF on Jan. 13 between 2125 and 2210 GMT using a single "210" in a Colpitts arrangement. Calls heard at W9EF: W4JK W5AOT W6AM W6BQ W6EC W6JU W6TS W6UP W6VZ W6BAX W8ZF W8DHS W6DWP W7FH W7UB. W1AQD copied W2JN on February third. Quite possibly excellent point-to-point work can be done by use of suitable radiators.

E18B, G2OD and G6VL were heard at W1AQD on February third, indicating a possible return to the previous excellent 28 mc. conditions. Several experimenters have expressed the belief that conditions were satisfactory, but that fewer experimenters have been working in this territory during early 1929 due to fine conditions on other high frequency bands, and to the desire of many amateurs to find out the state of "1929 conditions". Has anyone carried on any experiments showing definite characteristics on the "attenuation" of high frequency signals? At least one individual is interested in this as adding to the material on "angle of reflection theories" that has already been presented and to our knowledge of the characteristics of the 28-mc. band.

DIVISIONAL REPORTS

ATLANTIC DIVISION

WESTERN PENNSYLVANIA—SCM, A. W. McAuly, W8CEO—W8CHC, our leader, has been sick and his traffic has fallen off considerably but he still leads the gang in spite of it. We regret to report the death of Stuart Horner, W8CES, well known to many of us as a fine amateur. W8GI, the RM, has a new "Bear-Cat" receiver. W8CFR lists his frequency as 14316 kc. W8CEO lost part of his aerial in a high wind. W8BNR is active again after a sick spell. W8DHW is experimenting with ultra high frequencies. W8CYP is back on the air after changing location. W8DKS says he thinks he had better get back on 3500 kc. W8CNZ says the MOPA is the best yet. W8DKQ is experimenting with chemical rectifiers. W8ARC has a real job as secretary of the ATA. He finds it hard to get time to pound brass now. W8DBE is getting his ORS certificate. W8AGO still hammers brass when he gets in off the road. W8CUG handled a nice total with storage battery plate supply. He is applying for an ORS. W8AYH has a new 50 watt transmitter. W8DNO always handles traffic and always reports regularly even though he is not an ORS. Just say the word, OM. W8DVZ has ambition to become an ORS. Keep after it, old boy. W8CZE worked F8BW at high noon. He also hooked up with K7BF, Sec. Raymond Wagner, 707 East 5th St. will be glad to accept reports from amateurs in that city for the Erie Amateur Radio Club which is located on the fourth floor of the YMCA. These reports will be forwarded to the SCM. Every member of the ATA is invited to join the QSO parties held on Sunday afternoons between two and four o'clock. The 3500 kc. band is used and several stations are regularly on the air ready for you. W8CMP, the station of our director, is one of the regulars. W8CEO likewise. It is like the old spark days to sit in for a local rag chew on week-ends. Try it. We still need some Official Broadcast Stations. Who has enough faith in his signal and fist to take on the job? Let the SCM hear from some good stations.

Traffic: W8CHC 201, W8GI 47, W8CFR 65, W8CEO 26, W8BNR 23, W8DHW 16, W8CYP 11, W8DKS 7, W8BGW 6, W8CNZ 2, W8AGO 5, W8CUG 91, W8AYH 7, W8DNO 5, W8DVZ 7.

QST FOR MARCH

MD-DEL-D. of C—SCM, H. H. Layton, W3AIS—I wish to take this opportunity to remind the men of this Section to be on the job next month during the Governors-President Relay and show 'em that we are alive. I wish you all the very best of luck.

Maryland: W3BBW expects to handle WSBS traffic soon again. W3APX reports a new 50 watt about ready to go on the air. A radio club has been formed at the academy with 50 members.

Delaware: W3AJH reports taking traffic from EB-4BD. W3ALQ says the 7300 kc. band isn't so bad. W3WJ is moving and is off the air for a few weeks. W3AIS has been very busy with Naval Reserve work as Commander of the Fifth Section, Fourth Naval Dist.

Dist. of Columbia: W3BWT made the BPL this month and reports locating a lost missionary in the Philippines for a local church thru W3ZF's 20th Century System. W3GT was on only 11 days. Rebuilt 1929 High C Hartley 250 watts and wishes to thank W3HL for his cooperation. Hopes to resume sked with WFAT soon. W3AHP reports no skeds. Better make a few before next month, OM. W3ASO seems to be active nowadays. W3ALF made application for an ORS appointment. W3HL keeps schedules with W1MK, W3CKL and W9COS at 7, 5 and 3 pm respectively. His transmitter is a 50 watt operator on 3585 and 7100 kcs.

Traffic: Md. W3BBW 161, W3APX 8, Del. W3AJH 9, W3ALQ 12, W3WJ 1, W3AIS 7, D. C. W3BWT 153, W3GT 68, W3AHP 19, W3ASO 29, W3HL 72.

WESTERN NEW YORK—SCM, C. S. Taylor, W8PJ—W8ABX has just finished a new 1929 receiver. W8AHC has just completed a screen grid receiver. W8AIL has improved his antenna system. W8AKS is off the air due to reconstruction. W8ARG has rebuilt his apparatus. W8BBK has been rebuilding. W8BCM is reconstructing his transmitter. W8BFG has been experimenting with a Zapp antenna. W8RFA is changing his power supply. W8BJO has installed break-in system using dynamotor. W8CMW has gone fone mad for the present. W8CNX has everything going good now and states traffic fine. W8CPC handles all kinds of traffic using three crystal control transmitters and works any frequency in the amateur band. W8CSW states problem 66 experimenters section has netted him grand results.

V

W8CYG has rebuilt transmitter and wow! what an increase in traffic. W8DDL has his new 1929 transmitter in operation. W8DKM is off the air due to blown rectification system. W8DME has installed a new stove in his shack so zero weather won't keep him from getting his share of messages. W8DQP has a new MOPA that works now and W8ALQ has assisted him with many messages. W8DSP has a 4 tube screen grid receiver now and states traffic and signals great. W8DUP states the new ham hands great at his station. W8FC works 7000 and 3500 now and has improved in traffic handling. W8KS now has 1929 transmitter. W8QB has 1929 transmitter working great. Now gang, as you gaze over the fore-going report, you will see the effort the amateurs in Western New York have burdened themselves, the results gained and the general improvement, and the strides which have netted them the honors for themselves and the improved reception for others.

Traffic: W8ABX 2, W8AFG 41, W8AHC 38, W8AIL 2, W8ARK 227, W8AVS 20, W8BBP 36, W8BCM 26, W8BFG 3, W8BHA 4, W8BDL 21, W8BLP 12, W8CMV 21, W8CMT 22, W8CNX 12, W8CFC 44, W8CSW 39, W8CVJ 15, W8CYG 37, W8DDL 20, W8DUI 45, W8DKM 37, W8DME 22, W8DQP 65, W8DSP 183, W8DUP 10, W8FC, 30, W8KS 8, W8QA 73, W8QB 12.

SOUTHERN NEW JERSEY—SCM, M. J. Lotysh. W3CFG—There seems to be little or no difficulty due to the new regulations. W3ARC leads us this month, continuing his usual good work. W3CFG was inconvenienced by working evenings, basketball, and a screen grid receiver that didn't receive. Hi. W3HO turns in another nice report, also the result of good schedules. He and W9EJQ have had a bi-weekly schedule for two seasons missing only one schedule. FB. W3AOC did well in spite of mid-year exams. W3BWJ has a different transmitter for each band. Hi. He has been reappointed as an OBS. W3ARR handled WFBT traffic and is now an ORS. W3ARN also has same title. W3BVG turned in his initial report. Welcome, OM. W3KJ is considering selling out. W3SJ is looking for a boat. W3ATJ has been rebuilding. A good station is wanted for the position of Route Manager and another for Official Observer. There is an Official Broadcasting Station vacancy, also. Let's have a few BPL aspirants next month, fellows.

Traffic: W3ARC 64, W3CFG 63, W3BO 39, W3AOC 31, W3BWJ 25, W3ARR 14, W3BVG 11, W3KJ 7, W3SJ 6, W3ATJ 2.

EASTERN PENNSYLVANIA—SCM, J. B. Morgan, III. W3QP—An average of 163 messages were handled apiece this month with eleven stations reporting and 1788 total. W3ZF leads as usual. The recently appointed ORS are stepping out very nicely. W8DHT, W8AWO, and W8CWO. The boys who mark the location of Scranton on all maps. W8CWO says we credited the use of his 852 to W8AWO in our last. Humble apologies, OM. Anyhow, glad it's working, OK to the tune of 220 messages. W3AKB continues to be the Phila. beach-cat for consistent operating and reports a fine bunch of skeds. W3AVK wants a couple of telegraph poles and a trolley wire for his sky rig so it won't come down so often. W3ADE is learning Morse. W3GDS has been sick. W3AHZ is trying for a "white" ticket. W8NF applies for an ORS and sends in a nice fat total of traffic as a reason why. W8ANS is accumulating a nice bunch of skeds and shows a good total as a result. Five of the gang made the BPL. More power, gang!!!!

Traffic: W3ZF 574, W3ANS 307, W3AKB 237, W8NF 231, W8CWO 220, W8AVK 101, W8AWO 60, W8DHT 40, W3AHZ 8, W3ADE 5, W3GDS 3.

CENTRAL DIVISION

ILLINOIS—SCM, F. J. Hinds, W9APY—Our new year is not so bad as some of you thought. Hi. Don't forget to send in reports of "Good Signals", etc., together with your regular traffic report. Try to get your local ham friends interested in reporting, OMS. Thanks. W9ACU has a new 40 foot Zepp. W9DJ works the fone band overtime. W9FDY blew his plate transformer. W9ALW and W9EYK are both ops at W9NV where they obtained a television picture. They disagreed as to what the picture was and then found out they were both wrong. Hi. W9AFI is working on good fone and modulator for television. W9AD has the 352 going with a crystal. W9BNI has a MOPA and a crystal checked monitor-receiver. W9BRX has the mercury are going in fine shape. W9FO is reorganizing. W9ME can't pacify the BCU's. W9BHM has a new receiver

W9AFX is out for a commercial. W9EJO states DX is very good in the new bands and works Aussies regularly. W9CUH would like to know why the gang isn't using the new "QSA" system correctly (SQ would we all). W9AYB and W9CAR are installing crystals. W9BEX is setting up a couple of UX 866 tubes—has a new YL too. Hi. W9IZ has an indoor Hertz working. W9DGK is now in the USNR and has a Hertz. W9KA has a 1929 TPTG and some DX to show for it. W9AZ spent a week in New York. W9FCW is planning some 1715 kc. work for beginners. (Great stuff, OM). W9BLL is using remote control to his "air-cooled" set which is in the loft of his barn. Hi. W9FI wants to know if there is any cure for power leaks. W9BSH was QSO the S.S. *Eleanor Bolling* of Byrd's expedition. W9AFB likes the new bands although he says there is some QRM yet. W9AFB likes new bands although he says there is some QRM yet. W9EAJ is contemplating a push pull 852 Hartley. Ex-W9AQA is now with KGFH of Glendale, Calif. W9ERU says Illinois will have at least two BPL stations per month in Illinois and gets a (That's the spirit). W9DSS has rebuilt and gets a crystal note out of the chem. rectifier. W9BKB has a 1929 new set. W9FFQ does his DX on 3500 now. W9DLL is starting up again with an 852 power amplifier crystal. W9BOL and W9AQJ who happen to be brothers, have a 250 wattter crystal outfit. W9GGM is EX-W9AWL. W9CKZ is proud possessor of a "QST" monitor and W9ANQ says 1929 isn't such a lemon after all. W9AVL did some 14,000 kc. work with a 210. His best DX is Chile, for this month. W9CNY has sworn off chemical rectifiers. W9CNY wants to know why the 1929 idea of efficiency wasn't started a long time ago—says 1929 is FB. He has the BCLs trained so they give him their dead tubes and he uses 'em in his rectifier circuit. Hi. W9EYA has a MG in a 1929 Hartley. W9CNP says daily schedules are easier to keep than less frequent ones. Did a little emergency work when telephone lines were down between Kewanee and Rockford, Ill. W9DKK has a sync and a 250 going nicely. W9EEX went astray and forgetting himself, got married. W9AHK is "sold" on the low power question. Says it's easier on the rectifier tubes as well as the pocketbook. W9DXZ is a new OBS as is W9ERU. W9CL is getting out again. W9CMX says "getting out" on 14-600 kc. is easy even with low power. W9EPG has a Zepp. 352 and a poking-out signal. W9FWX is in a network that "makes deliveries". W9FLH is getting out well. W9EAS has a very fine fone. Don't forget to report the good signals you hear in your next report, fellows.

Traffic: W9ERU 302, W9DXZ 251, W9EJO 140, W9CNP 75, W9BZO 68, W9EPG 64, W9DKK 41, W9EAJ 40, W9BLL 34, W9ASE 33, W9FCW 22, W9CZL 26, W9CNY 24, W9AD 21, W9ACU 18, W9AFK 17, W9CKZ 17, W9CUH 17, W9BSH 14, W9FDQ 14, W9FT 14, W9AVL 13, W9DOX 13, W9DGK 12, W9AFB 11, W9AP 11, W9FWX 11, W9AGG 10, W9BHM 10, W9BKE 9, W9ECR 9, W9ANQ 8, W9APY 8, W9KA 7, W9FDJ 7, W9KB 7, W9ALK 6, W9BPX 4, W9EAI 4, W9EYA 4, W9ALJ 3, W9BRX 3, W9GHX 3, W9ESN 2, W9ME 2, W9AHK 1, W9DJ 1, W9FDY 1, W9IZ 1, W9NV 1, W9BKB 21.

KENTUCKY—SCM, J. R. Wathen, III, W9BAZ—The hamfest held in Louisville and attended by many of the "faithful" was a *most* success. First of its kind ever held in Kentucky. Hams from Ohio and Indiana added greatly in the recruitment. Next! W9OX works one sited in German. Ach himself! W9GGB reports DX better in Ky. than Okla. W9BWJ has finished his work in Ohio. W9EYW is our newest ORS. W9FZV is investigating 14 mc. W9ELL says 2000 Volt DC will burn and how!! W9AID got a report from Poland while using a 210. W9FKM finally got his MOPA perking. W9CEE sports a new chem. rectifier. W9BAN celebrates return to air by working ZLAC. FB. The pipe mast at W9BAZ looked like an inverted "L" after the storm. W9ETD donated an Aero xmitter to the N.K.R.A. in Covington. W9AWN filled the sockets. (Anybody wanna gimme a water-cooled bottle?) W9DQC went hunting and missed the hamfest. Too bad. W9DDH doesn't like the new QSA stuff. W9ARU hasn't seen anything on his television. Dark doings! W9CRD reports DX fine in 1929. Threatens to install a fone. Don't forget the prize for the first station that totals over 50 messages, each month for three months. Does not have to be consecutive.

Traffic: W9RAZ 51, W9EYW 26, W9BAN 29, W9FZV 20, W9GGB 18, W9FS 17, W9ARU 14, W9ELL 14, W9BKK 13, W9OX 13, W9FTC 12, W9JL 12, W9ENR 6, W9AID 5, W9DDH 4, W9EAC 4, W9BWJ 3, W9CEE 2, W9FKM 2, W9CRD 37.

WISCONSIN—SCM, C. N. Crapo, W9VD—W9DLL had hard luck trying to put up a new 30 foot lattice

tower which failed to stay up. He says all schedules going fine. W9BPW gets good reports on his 310 and contact with all stations very consistent. W9DEK has four good schedules—he is the vice president of the LaCrosse Radio Club. W9EBO lost some of his schedules and has four left, and says he doesn't believe he can equal W9DLD's totals. W9ARE has worked WFAT, K6AOF and others on 7000 during the past month. W9FHU sends in a good total and says he needs more traffic. W9DND works W9DLQ daily and W9EGU, W9AIR and W9COS irregularly. W9DLQ schedules all going good but needs contact in Milwaukee. W9DTK's antenna blew down twice this month. Naval traffic going through OK. W9DJK helps to move some of the traffic through LaCrosse. W9DNB says the snow is nearly up to the top of the mast in Barron. W9BWZ report via Amateur Radio. W9LV is one of Milwaukee's best traffic stations. W9OT has moved back again to his old location at 1104 Burleigh St. W9FAW is working all districts on 3500 kc. W9CVI not on much this month but keeps schedule with W9DLD. W9EMD has a schedule with W9DLD daily. W9EZZ works just as many on 7000 kc. but says QRM is terrific. W9EHD will have crystal on 3500 in a few weeks. W9BJY is on 3750 kc. now and then. W9BQQ uses 3500 kc. lone and works Nicaragua on 14 mc. W9BIB says he hasn't noticed any of the predicted difficulties for 1929. W9VD has cleaned up the shack and back on the air on 3550 and 7160. W9EWY handled a few.

Traffic: W9DLD 419, W9BPW 202, W9DEK 202, W9EBO 183, W9ARE 96, W9FHU 94, W9DND 81, W9DLD 60, W9DTK 36, W9DJK 35, W9DNB 29, W9BWZ 25, W9LV 19, W9OT 19, W9FAW 18, W9CVI 14, W9EMD 10, W9EWY 22, W9EZZ 6, W9EHD 5, W9BJY 4, W9BQQ 1, W9BIB 6, W9VD 6.

INDIANA—SCM. D. J. Angus, W9CYQ—The Indianapolis Radio Club is about to graduate its class of new code artists from the code school that ran this winter. The Radio Inspector had an examination the 17th of January. The casualty list hasn't come through yet. The SCM wants all Indiana operators that think they have a reliable station and a good fist to make application for ORS certificates, provided they can do the necessary operating to be entitled to it. ORS that have not been reporting regularly may miss connections. ORS certificates are cancelled without notice. W9ELX of Newcastle leads the state this month with W9DRA of Washington a close second. Fine work. W9BKJ has to take the exams over as he failed to renew in time. W9EF is putting in a 23 mc. reflector. W9FB reports a junior op. W9EXW working the 6's on 23 mc. W9AIN is rebuilding so not on the air now. W9DBA is using arc rectifier. W9ASX reports some new stations going in at South Bend. W9DBJ has been handling some very interesting work with Central American stations. W9BKJ reports the following new stations at Fort Wayne: W9GEH, W9GFI, W9GFA, W9GGP, W9GGY—the results of their code school last winter. It pays. The new Radio Traffic Assn. of Fort Wayne officers are Springer, W9BWL, Pres.; Leichter, W9DBJ, V. P.; Sherwood York, W9GGY, Sec-Treas. The club has a column in the local press each day in charge of Graue, W9BKJ, covering amateur topics of general interest. W9PFL is handling traffic from Angola regularly.

Traffic: W9ELX 305, W9DRA 275, W9ASX 124, W9AIN 47, W9EXW 42, W9EF 23, W9BKJ 20, W9DBJ 18, W9DSC 21, W9CYQ 18, W9PGC 15, W9GFB 11, W9CNC 6, W9GCO 5, W9APG 4, W9AXH 4, W9AEB 2.

OHIO—SCM. H. C. Storck, W8BYN—The two "old faithful" stations made the BPL for Ohio this month. The percentages for this section are going UP. 41 ORS reported this month and of that number only 6 did not handle traffic. Only 9 fell below 10 messages per. Good work, gang!!! W8CMB should be happy this time for he nosed out W8A. Traffic must be scarce if W8JA doesn't get it. W8CWC is going like a house afire. W8CFL is busy with school work. W8DHI only uses an old UX-201A. W8APB has installed a shielded screen tube and says it is working fine. W8CQU turns in a nice total. Radio must be "going stale" on W8CNO. W8RN blew his 210. W8CRI has a nice complete "1929" set going now, even to the monitor. W8CPQ turns in his total. W8BOR has a 3500 kc. phone about ready for the air. W8CSS has a new mercury arc going. W8DDF was QSO England in Daytime in 14,000 kc. using a UX-112A with 90 volts on the plate. W8BBR surely is having his troubles with power QRM on the 3500 kc. band. W8BAC is QRL night school. W8CXW is still doing good work. W8DAE was with us again for a brief two weeks and is now back at school. W8DDQ still wants schedules with other high school stations. W8BNA is going to school at Ithaca, N. Y. this year

and will operate W8DR there. W8ADS has a new filter. W8DSY is grooming himself for an amateur extra first license. W8CNU handled some. W8ARW reports "all set now". W8ALW is working the 7000 kc. band entirely. W8AYO has been too busy with BCL trouble shooting to do much work on the air. W8BKM reports that the BCLs are kicking because of his keyclicks also he has a good thump filter. See Feb. QST. OM. W8PL blew his 250 wattier. W8OQ handled a few. W8AQU is on 14,000 kc., and 7000 kc. W8DJV says that final exams have him worried lately. W8AVB is on 14,000. W8DDK is busy with work and experimental doings. W8DHS is rebuilding completely. W8DIA has a new transmitter on 14,200 kc. W8DPF has moved and will be back on the air soon. W8EJ is rebuilding also. W8BYN has a lot of rebuilding and experimental work mapped out for his station. Volunteers are needed for the positions of Official Broadcast Station, Route Manager and Official Observer. To qualify for the last you MUST have a good accurate frequency meter. We also need some new ORS.

Traffic: W8CMB 255, W8JA 202, W8CWC 101, W8CFL 88, W8DHI 80, W8APB 79, W8BYN 79, W8CQU 70, W8CNO 69, W8RN 69, W8CRI 55, W8CPQ 38, W8BOR 31, W8CSS 28, W8DDF 26, W8BBR 25, W8BAC 23, W8CXW 21, W8DAE 17, W8DDQ 18, W8BNA 12, W8ADS 12, W8DSY 11, W8CNU 11, W8ARW 11, W8ALW 10, W8AYO 9, W8BKM 6, W8PL 4, W8OQ 4, W8LI 4, W8AQU 4, W8DJV 3, W8AVB 2, W8DDK 1.

MICHIGAN—SCM. Dallas Wise, W8CEP—W8DAQ is active again and reported via radio. W8BAX is doing some good DX with his 210. W8BRB has been on the sick list. W8DWC is doing some low power work. W9BRQ and W8CKZ report. W8DSF didn't forget about the QSO party. W8AUB has a fone. W8ACB is in line for an ORS now. W8CRL is a new station in Detroit. W8ASO plays checkers every Sunday with W9ALM and is active in Naval Reserve work. W8CAT is QRMED by school exams. W8NG just received his "ticket". W8CU worked all the states except Nevada and New Mexico. W8ZF will have one of the test chemical rectifiers in operation shortly. W8BCI is going to New York City to work. W8DFS of St. Joseph is back again. W8BFH reports W8AID building a MOPA set. W8AMB has a xtal xmmitter perking on 8500 kc. W8DVQ, W8MW and W8BV reported via radio thru the Southern Michigan traffic express. W8DED to W8DYH. W8BPS is a busy man on 3500 kc. W8AJG handles his share of traffic. W8DMS has a new antenna system and sure gets out of town now—doesn't have to drive out with his car either. Any of the fellows desiring to attend National Guard Encampment as radio operators get in touch with W8DMS as soon as possible. This is a fine vacation, fellows, and also a chance to get some real experience. W8BGY managed to land in third place. W8DYH leads Michigan's BPL this month. W8DYH, W8BGY, W8DED are the three mainstays of the traffic express. W8DED is keeping schedules with 8 stations, many of them daily and handles 90% of his traffic in that station. W8HL is revamping the transmitter. W8VT is renovating. W8WO and W8COW try their hands once in a while. W8ZZ is putting out a regular 1929 signal with his mercury arc rectifier and xtal.

Traffic: W8AJG 33, W8DVQ 22, W8MW 10, W8BV 5, W8BAX 17, W8BRB 19, W8BTQ 21, W8CKZ 8, W8DSF 46, W8DWM 10, W8AUB 60, W8ACB 5, W8DED 225, W8CRL 9, W8ASO 16, W8CAT 6, W8DYH 256, W8CU 2, W8BCI 19, W8ZF 16, W8DFS 17, W8BGI 1112, W8BFH 17, W8DMS 40, W8CEP 17, W8DAQ 98.

DAKOTA DIVISION

SOUTHERN MINNESOTA—SCM. J. C. Pehoushek, W9EFK—I wish to thank the section for its confidence in me. I want the non-reporting RS and the very low total men to turn in reports and make 'em better. That's the only way I can make out mine and not feel that my Section is going to the dogs. Perhaps some reports were not sent because it was not known that I was to have them. Jabs and his crew are running away around us with much larger totals and more skeds so let's speed up a bit. 7000 kc. seemed to be almost dead for a few nights this month. Sigs are erratic and DX sigs almost nil. WFAT comes through nicely through almost any kind of weather. KFR5 is Walter Berg, France Field, Canal Zone, a DC sig on about 7250 kc. W9COS the RM for this Section again shows the way. He has five skeds—3 of them daily

—and says that is the only way to get traffic in any quantity. He kept a sked with W9ARK when the latter's folks were in the hospital. W9DGE sold the old MG to KSTP and now has a good DC note from tube rectifier. W9BHZ is bashful and says nothing. Tell me about it, OM. W9EFK had a QSK of a time getting anyone to take an 80 word msg. written in "Deutsche". W9XI has been QSO WFRT, Brazil, etc. They are building a new screen-grid receiver. W9AIR, W9BPM. If anyone hears or works SO-IAA, W9GEJ is their call when station operated by ROTC Signal Corps. W9AIR says that the 1929 regulations are not so tough and very much better than anticipated. That's what we all think. W9FCD turns in his first report and says the old 210 is getting out nicely on both 7 and 14 mc. W9DWG of Ivanhoe says that his 201A with 8 watts input from B batts has been QSO Cuba. W9DRC says hobbsledging and rebuilding has kept his total down. W9BKX is installing a new motor generator and we didn't see anything wrong with his old note either. Says he's going to handle traffic on 3700 kc. W9DMA says 7000 kc. has been rotten. W9DHP is very busy trying to make the grade or rather grades at the U. of M. W9EPK will be on daily about 1 o'clock on 7250 kc. so give me a buzz with Twin City traffic. Know of quite a number of stations on noons all with traffic. Principally W9EGU, W9CTW, W9ARA, W9AIR, W9BPM. If anyone hears or works SO-IAA, W9EFK would like all dope. His dad is a Minneapolis man and very anxious to hear any news of him. I think he is a 14 mc. station.

Traffic: W9COS 187, W9DGE 25, W9RHZ 20, W9EFK 19, W9XI 17, W9AIR 10, W9FCD 8, W9DWG 8, W9DBC 3, W9DMA 2.

NORTH DAKOTA—SCM, B. S. Warner, W9DYV—W9CUT takes the lead in the traffic total this month and states that he has to sign off forever as he is too QRL with school work to do any more radio work. Sorry to lose you, OB. W9BVF reports a very nice bunch of traffic and reports handling a message for Scotland. W9CDO has invested in a new dynamotor and a 50 watter in the place of the UX-210. W9FCA is on 1800 kc. W9BJV has been busy with court sessions, as he is clerk of the court. W9FPC is a new station reporting this month. He has three 301A's with 335 volts on plate but promises to increase another 150 volts in the very near future. W9DKQ has a 30 watt MOPA set going fine on 1750 kc. W9IK reports keeping four skeds a week and two new stations in this district, he also keeps code practice skeds during the week.

Traffic: W9CUT 146, W9BVF 86, W9IK 8, W9FPC 5, W9CDO 4, W9DYV 4, W9DKQ 2, W9BJV 2, W9FCA 1.

NORTHERN MINNESOTA—SCM, C. L. Jabs, W9BVH—W9EGU again leads in traffic. He keeps six daily schedules, one of them with WFRT who gives him fine reports since he installed the Zeppelin antenna. He also gives operator Peterson of WFRT 24 hour service on messages to his wife in Chicago. FB, CY, and in another month the crystal prize is fours unless the rest of the gang shows more pep soon. W9ERB works on 3500, 7000 and 23,000 kc. daily and says 7000 kc. is not so good. W9CF reports 1400 kcs. fine. W9CTW is on with crystal control and says his traffic took a slump due to the change over. W9CKI works on 14,000 and 28,000 kc. and will be on with 500 watts soon. W9CPO's 210 works out fine and he is glad to be back in the game again. W9EHL, W9FFU and W9BVH lost their antennas. W9AOK worked 13 continents, 4 continents on 7000 kc. and wants to know who said 7000 kc. wouldn't be any good in 1929. W9EGF is on regularly looking for more traffic. W9AKM mounted his transmitter on plate glass the efficiency going up 100%. W9DOQ had lots of ham visitors. W9BCT has QRM from hockey and is on with a 1929 transmitter. W9CIY has discontinued all schedules to install a mercury arc and crystal control. W9PP is installing a 500 watt transmitter with 500 cycle plate supply. He is chief operator at KSTP. W9BVH is building a shield grid receiver while waiting for the mercury to rise above zero so he can put up his antenna which came down in a recent blizzard. W9BBT is not on due to illness in his family. W9ADS is off due to the untimely decrease of his new 852.

Traffic: W9EGU 257, W9ERB 58, W9CF 23, W9CKI 21, W9CTW 21, W9CPO 17, W9EHL 15, W9FFU 14, W9AOK 21, W9EGF 9, W9AKM 7, W9DOQ 5, W9BCT 4, W9CIY 4, W9BVH 4.

SOUTH DAKOTA—SCM, Dwight M. Pasek, W9DGR—W9DWN lost his antenna in a blizzard but promises to have another one after the first warm day. W9FBB is a new station in Sioux Falls, on 3500 kc. W9DB is having fine success with 3500 kc. fone. He reports bad fading on 7000 kc. after 9 pm. W9EUH had some tuff luck while tuning his TPTG push-pull and blew his transformer. W9AGL has a job for next year with G. E. and will be an "eight". W9DNS and W9DGR are on evenings when the pursuit of a higher education allows them the time. The SCM visited W9DNS and W9EUH recently. He didn't get out to the station at W9EUH but W9DNS—what a station! Watch for a description of it in the bulletin.

Traffic: W9DWN 50, W9DNS 39, W9EUH 30, W9DB 17, W9DGR 11.

DELTA DIVISION

TENNESSEE—SCM, Polk Purdue, W4FI—Looks like things are picking up again. Several reports were received and it looks like the Nashville gang has come to life. W4ABR leads in traffic and has applied for an ORS. W4FX comes second. W4NL didn't give his total but says traffic is getting too heavy to handle without skeds. W4AFS is on with a 50 watter. W4HH has a 50 watter going but says the 210's are better. W4ZZC formerly of Memphis is on regularly in Nashville with two 250 watters back-to-back. W4FU is on with two 50 watters in xtal control, push-pull and worked PY2AK in the old Brazilian band. W4ACW has been appointed ORS and promises to handle lots of traffic. W4WJQ has applied for an ORS. W4DG has been working on a new Colpitts since last strong. W4SP made a lady out of Lizzie but she won't work, says these part jobs are a frost. W4ABZ has been very busy but promises more traffic next month. W4W1U from Signal Mountain spent a week with the Knoxville gang. W4NL worked FL-MUI, a German Zeppelin en route over France.

Traffic: W4ABR 48, W4FX 26, W4HK 10, W4ABZ 2, W4SP 1.

LOUISIANA—SCM, M. M. Hill, W5EB—The new SCM takes this opportunity to thank the gang for their efforts and confidence in electing him to his office. Everything will be done to put Louisiana on the map, with your cooperation. We are all grieved to learn of the passing of two old faithful and fine operators, F. B. Beuhler, W5AQF and Francis Dillon, W5AAY. Both fellows were frank and courteous in their operating and will be sorely missed by this section. Very few stations have reported. Let's have more reports, boys. W5LV has installed a 1929 MOPA. His 1929 DX is VK. W5NS has moved to Alexandria and has a crystal station under construction. W5KH reports fine results from push-pull xmitter. His next venture will be MOPA. W5BDY is a new fellow with a 210 and is doing fine work. W5WF is back with 2-210's and wants ORS. W5BDJ is aspiring to CC his 210. W5AFE has been irregular due to sickness. W5UW has a commercial ticket and has gone to sea. W5KC says his 3 year old 208A refuses to carry full load. W5EB has an 852 cc. On a whole 1929 conditions are FB. With steady DC sigs we have less QRM than with the old rock crushing RAC and AC notes.

Traffic: W5WF 47, W5LV 23, W5EB 18, W5KH 8, W5BDY 5, W5KC 2, W5NS 1.

ARKANSAS—SCM, Henry E. Velte, W5ABI—W5EP again leads the gang in traffic handling. He has worked two ZL and one VK stations this month, and says that the old alarm clock deserves the credit. HI. W5BS is on 1715 kc. fone and gets out well. He has a sked with W9KI daily for the purpose of playing checkers. W5AR is installing a new rotary converter so he can save the wet B batteries on week-ends. W5IQ spent Sunday in Pine Bluff and got W5SI back on the air. W5SI travels most of the time and only gets to operate on week-ends. W5AUU has left the country with the telephone company. W5ZAA does not have much time from his business. W5ATP is still working on his 250 watt transmitter. W5HN is getting out very nicely on 1715 kc. fone and uses a 50 watt ocelators, 852 modulator and 2 step amplifier. He reports traffic, also. W5BCZ has an 852 tube on 7000 kc. W5BDD is going to 50 watts soon. He also has a new MG. W5ABI is on 14,000 and 7000 kc. We have some good prospects in L.R. and expects to have some new stations on the air soon. The SCM has had to cancel three ORS appointments account of not reporting. We need more ORS, fellows, so let's hear from those who

want to become ORS. The SCM will appreciate reports from all the active stations in the state.

Traffic: W5EP 37, W5ARA 6, W5SS 7, W5SI 4, W5IQ 2, W5HN 17, W5ABI 22.

MISSISSIPPI—SCM, J. W. Gullett, W5AKP—W5TX is having trouble with his MOPA. He has just had his motor-generator rewound and as soon as he gets his transmitter working he will be back with us. W5BDE is an old timer with a new call. He is working lots of stations on 7000 kc. W5BBX is having plenty of trouble trying to get his UX-210 going on 7000 kc. W5AED has a new transmitter that will QSY from 7000 to 3500 or 1715 kc. in 30 seconds. He says he is well pleased with the performance of this set, both with CW and phone. He also has a new receiver as his baby used a machine hammer on his old one. W5FQ blew a stopping condenser and burned up a radio frequency choke in his transmitter. W5AJJ says there isn't much of interest to report this month although he turned in a nice bunch of traffic handled. W5AKP has just finished a Schnell tuner with a one step audio and plug-in coils. It was built for a portable receiver and is only 9½ inches long. His antenna was recently torn down by a falling limb and he is putting up a new one that will work on both 7000 and 3500 kc. His brother in Booneville, Miss., will soon be on 7000 kc. with a UX-210 transmitter. Welcome, OM.

Traffic: W5FQ 5, W5AJJ 49, W5AKP 75.

HUDSON DIVISION

NEW YORK CITY and LONG ISLAND—SCM, M. B. Kahn, W2KR—Manhattan: W2SC at Ft. Wood leads in traffic again this month. W2BGO comes through with some complaints as to the 1929 notes. W2KR is using 3500 kc. most of the time and uses extal fone during evening for local contacts with gang. W2AFO received, delivered and returned an answer to NJ2PA in 20 minutes. W2OV is a new ORS. W2BCB lost his job in an orchestra due to his reading QST instead of his music. W2BNL is anxious about the coming Hudson Division Convention.

Bronx: W2CYX has a jump in traffic. W2BPQ claims he can't see any traffic on 3500 kc. W2AET is blessed with ideal BCLs. When they hear him transmit, they turn their sets off. W2APW will be operating from NJ2PA and hopes to work many local hams from there. W2AWU sends in his first report and is a candidate for an ORS.

Brooklyn: W2BFQ, a new ORS, leads Brooklyn in traffic and makes the BPL. W2BIV, another new ORS, comes through with a nice report. W2PF is enthusiastic about the Governors-President Relay. W2BAZ just put a 20A on 14000 kc. and hopes to have it crystal controlled shortly. W2BRB is experimenting with phone. W2CTY had his mast blow down and his mercury arc transformer go west. W2AJL is another who built Hull's 1929 receiver and says it is FB.

Long Island: W2BKZ applies for ORS and turns in a fine report. W2AVP had "flu" and lost his antenna in a storm. W2AWX was home from school for a few days and turns in his report. W2ASS-2AEU reports a new 1929 transmitter that works 'em all. W2AZU claims 7000 kc. is the bunk for traffic. W2ATL, a new station, reports.

Staten Island: Hurray! W2CEP breaks the great silence that hangs over the S. I. gang and reports that he has been away to school and at sea. Hope you stay on the air from now on, OM. Where are all the other stations that claim to be so active? Sure would like to hear from them if they are on the air.—SCM.

Traffic: Manhattan: W2SC 277, W2BGO 176, W2KR 70, W2AFO 18, W2OV 9, W2BCB 7, W2BNL 2. Bronx: W2CYX 106, W2BPQ 64, W2AET 32, W2APV 25, W2AWU 15. Staten Island: W2CEP 21. Brooklyn: W2BFQ 217, W2BIV 50, W2PF 24, W2BAZ 13, W2BRB 9, W2CTY 5, W2AJL 5. Long Island: W2BKZ 33, W2AVP 30, W2AWX 10, W2ASS 8, W2AZU 4, W2ATL 3.

EASTERN NEW YORK—SCM, F. M. Holbrook, W2CNS—W2BFF is handling traffic for 55X. W2AYK now working traffic fine on 3500 kc. W2QU has schedules with KD5 and KFR5. W2AUQ put good traffic through. W2AXX burned up much juice to clear his hook. W2ANV entertained W1AWQ on a two-day visit and hamfest. W2BLN sends in his first traffic report W2BKN is rebuilding the transmitter—all glass enclosed. W2AQL reports Yonkers Radio Club doing well with 10 or 12 hams at meetings and all hams are welcome. W2BPV always ready to QSR. W2SJ is on duty at WGY. W2ACY reports

new station, W2BPN, across the river. W2JE is rebuilding his receiver. W2PV has the station all rebuilt at East Greenbush.

Traffic: W2BFF 62, (December 74) W2AYK 62., W2QU 60, W2AUQ 20, W2AXX 18, W2ANV 12, W2BLN 10, W2BKN 9, W2AQL 8, W2BPV 6, W2SJ 5, W2ACY 2, W2JE 2.

NORTHERN NEW JERSEY—SCM, A. G. Wester, W2WR—Many Jersey ORS have completed 1929 transmitters and receivers and find conditions as satisfactory as ever. W2WR is building a 1929 push-pull oscillator with 2 UV-208A tubes. W2AOS finished a new transmitter and installed a motor generator. W2CP is very QRW with a Vitaphone installation in his play house. W2CW is satisfied with 1929 conditions. W2DX just put his new xtal xmitter on the air for 1929 requirements. W2JC still grubs off DX and traffic. W2KA is on 3750 kc. with fone and CW. W2MD still maintains good schedules with foreigners. W2CTQ expects to be back on the air very shortly. W2CJX jumped to 7000 kc. and dug up plenty of traffic. W2BY can't keep all her schedules because the other operators like to sleep. W2BIR still working the west coast and Europe with his little 210. W2IS just returned from a trip to Florida where he visited both hams and BC stations. W2JX is back on 3500 kc. again and says it is fine for rag chewing. W2AOP gathered 40 messages in one day so he would have a good report, also is busy installing a mercury arc. W2AEB is QRW college but is on the air every week end for DX work. W2AT our ex-ORS reported and sure did help our traffic total. W2AOU, a new ham, reports that he has a 210 in a TPTG circuit and has handled some traffic under the direction of W2CW. We hope W2AOU can be developed into an ORS. W2IH is planning to come on the air with a new fifty wattet and a 1929 signal.

Traffic: W2AOS 14, W2CP 75, W2CW 1, W2JC 18, W2KA 1, W2MD 69, W2CJX 60, W2BY 7, W2IS 4, W2JX 9, W2AOP 50, W2AT 36, W2AEB 6, W2AOU 4.

MIDWEST DIVISION

NEBRASKA—SCM, C. B. Diehl, W9BYG—W9CJT resigns on account of work. Sorry to lose you, OM. W9ANZ is having fine results from xtal. W9QY had to report with pencil on account of the ink being frozen up. Hi, W9FAM surely is going good. W9DNC tops the list this time again. W9DI starts back to school and says his traffic will suffer from it. W9BLW says "open for business" sign is on his door now. W9CHB is in school. W9BBS is busy on his railroad. W9CDB is just starting up again. W9BQR was promoted and is now quite busy. W9CBK comes out with a report this time. W9FUP wants to be an ORS.

Traffic: W9ANZ 6, W9QY 5, W9FAM 18, W9DNC 93, W9DI 60, W9BLW 5, W9CHB 32, W9BBS 15, W9CBK 2, W9FUP 6.

IOWA—SCM, H. W. Kerr, W9DZW—Again W9DZW tops the list; W9EJQ a close second; Goldfield registers again. Credit for much of the Iowa traffic skeds this season is due to R. P. Griffith, W9EJQ, known as a strong factor in the XC Relay Chain (W1BK, W8DSP, W8JA, W9DLD, W9EJQ, W9DKM, W6CPC), and Mr. Griffith is appointed RM. W9EDW missed, is it "flu"? W9BCA hits the BPL again on deliveries. He sends proofs of real service—a message mailed to him for INIC given to CAB at 10:30 pm and delivered at 10:30 am next day—mail takes 17 days! W9EIW reports a "snowbound" party at her home 4 days helped traffic, but hard on B batteries. W9EHN, O.B. we miss your report. W9FZO froze his CR and says it works better now, blew his 210 and worked 14 states in 2 days with a 201A. W9FFD is looking for traffic on both bands. W9EHR is back again but having trouble with his mercury arc shorting the high points and blowing fuses. RM W9CZC says not much traffic with no skeds—listening for VE's too much. W9FQG reports several skeds working fair. W9BCY at Hartley is heard with a strong sig. W9DPL is another "fried" but knocked out traffic. W9FLK on 155.5 meters, some traffic. W9DRA declares romance at Lisbon, he is helping W9PB. Code lessons at KSCJ completed with success—Mr. Finley, pre-war ham coming back to the game. W9DEA still building a MOPA this time. W9BCL finally heard again. W9DZL is trying TPTG and H tubes. W9DZW lank and lazy since having "flu"—Regret is coming! W9BIJ, Geo. Imler at Council Bluffs, gets com'l. ticket. Jot it down—Midwest Division Convention at Ames, Iowa, May 10 and 11. Send the reports.

Traffic: W9DGW 364, W9EJQ 358, W9BCA 120, W9DZW 57, W9EIV 51, W9FZO 34, W9FFD 32, W9EHR 31, W9CZC 28, W9FQG 28, W9CCK 14, W9BCY 10, W9DPL 9, W9FLK 2.

KANSAS—SCM. J. H. Amis, W9CET—As usual W9FLG makes the BPL with a nice total after having a lot of trouble for over half the month with his transmitter. Our technical advisor W9BHR has at last bought a new hat—his old one fails to fit. Hi, W9FYP, one of our new hams turns in a nice total and handled traffic from nn-1NIC. W9CFN says school is clamping down and his traffic must suffer. W9FUG is on 14,000 kc. and sends in a nice report. W9PTY put through a good total. W9DIH is rebuilding. W9DPL claims 14,000 kc. is FB. W9HL is busy at the power plant. W9CKV is in dutch with the BCLs on account of key clicks and is observing quiet hours. Turn to page 9 of Feb. QST. OB. W9CCS has a SW set at school now. FB, OB. W9CET is on 7080 kc. crystal control and will tie the 204A on soon as an amp. W9LN is now able to QSY 14,000, 7000 and 3500 kc. and is a new ORS. Our radio parson, W9ESL, lost both of his sticks and was off most of the month. Hard luck, OB. Don't forget to give the RM, W9FLG, your support, fellows, on ORS nite each Wed. at 8:00 pm CST on 3500 kc. Listen for his QST and give him a call. Starting Feb. 7 the K.V.R.C. will hold a meeting via radio every two weeks on Thurs. nite at 8 pm. All Topeka stations will take part. They will use 7000 kc. The SCM would like to hear from every ham in the section that is doing anything of interest.

Traffic: W9FLG 218, W9CFN 59, W9FUG 105, W9PTY 112, W9ESL 9, W9CCS 9, W9CKV 20, W9HL 4, W9DIH 8, W9CET 140, W9LN 92, W9FYP 65, W9BHR 50.

MISSOURI—SCM. L. B. Laizure, W9RR—W8CNR received the entire Missouri report and forwarded it via mail—FB, OM, and tx1 Activity in traffic for St. Louis was mostly in evidence at W9DOE, W9BEU and W9DLB. W9BEQ and W9DZN come in pretty well. W9DUD is busy with school and work. W9ZK is busy with his profession and work. He is also busy with his radio job. W9DSU was QRMED by moving and had to use indoor antenna. W9BNU works on 28 mc. and asks for QRA of ER3. W9DZN works almost exclusively on the 14 mc. band. He is interested in Army-Amateur work. W9DLB continues his sked with the RM, W9DAE. W9BEV was off part of the month but got considerable traffic. W9DOE worked several new DX records in addition to traffic skeds. W9GKE is a new reporter, after being off the air for five years. W9DAE led with traffic and skeds this month, since the loss of W9AYK who had to move and is still QRT. W9DKG keeps a schedule with Canal Zone regularly. W9DHM applied for an ORS. W9ECS reports plenty of local QRM with all stations in his town using same band. W9BVC of Lutesville, who left to take up a radio job in Mississippi early in the month, was the victim of flu and died there in January. W9ASV kept skeds but was broken up by sickness. W9RJA is recovered from pneumonia and is ready to handle traffic or play checkers by radio. W9CDF is getting FBA reports with the new transmitter. His father, W9ERE, is busy with his business. W9EUB was off most of the time remodeling the shack. W9DCD moved Feb. 1 to Osceola, Mo. where he is to work for the Ford Agent, W9AWE. W9AWE has an 852 tube on 3500 kc. band. W9FRY is getting a new shack. W9DMT is on 3500 mostly but has trouble with BCL QRM. W9FVM keeps sked with Mexican X23A at Saltillo, Coahuila. W9CJB has been laid up with the flu. W9FBF reports much hamfesting in her neighborhood. W9FGJ and W9FSB reports on the ham QRM situation in Hannibal. W9GCL is working both coasts on 3500 with a 201A tube. W9BGO and his fraternity brothers of the Pi Kappa Alpha house started on 14 mc. in the Missouri School of Mines. W9FYM sends a first report and has had many pleasant QSO's from his wheel-chair radio since getting on the air. W9BUL was busy with exams in college but now ready for skeds. W9EPX is back home and putting in xtal. W9BQS says QRM school and job. Former W9CYK is reported working for Canadian Bell Telephone Co. at Toronto. W9AYK has now moved to Kansas City, Kansas, and closed down for the present. On account of the SCM moving, there were several stations missing in the Kansas City reports. W9DQN reports bad QRM from working hours. W9RR has moved to the same QRA as W9DQN. All Missouri stations take notice when mailing their February reports.

Traffic: W9DOE 242, W9BEU 73, W9DLB 36, W9BEQ 31, W9DZN 31, W9BMM 15, W9DSU 10, W9GKE 16, W9ZK 9, W9DUD 5, W9DAE 300, W9DKG 204, W9ECS 72, W9ASV 70, W9BJA 48, W9CDF 18, W9DIH 16, W9EUB 2, W9DCD 9, W9DMT 9, W9FVM 9, W9CUB 4, W9FBF 3, W9GCL 2, W9BGO 1, W9RR 151, W9DQN 14.

NEW ENGLAND DIVISION

NEW HAMPSHIRE—SCM. V. W. Hodge, WIATJ —There were fewer stations reporting this month but traffic totalled just about the same. Our RM, WIIP, would have made the BPL if the BCLs had let him alone! He has been working DX on 14 mc. WIAUY rebuilt his transmitter and says FB now, good sigs and a steady wave. He has applied for an ORS. WIBFT is very busy at college but has a new MO-PA rig on 7000 kc., using an 852 in the last stage. WIAUE is dabbling with xtals and will be going soon. WIAEF is going again after his big blowout; and has a fine DC note. WIMS has been trying 14 and 28 mc. but no results on 28 mc. yet. A new station in Lebanon, W1MB, is kicking out good on 3500. WIBST is very busy these days but gets in a few minutes between punching backs. (He's a chiropractor, Mim.) WIUN is starting up again. All N. H. stations are invited to take part in the Thursday evening rag chews conducted by the SCM from WIATJ on 3500 kc.
WIATJ 154, WIIP 125, WIAEF 40, WIAUE 37, WIBST 30, WIAUY 4, WIMS 4, WIBFT, W1MB 7.

RHODE ISLAND—SCM. C. N. Kraus, W1BCR—W1BCR has been on 3530 kc., 7145 kc., and 56 mc. Handled traffic from nn7NIC. W1BLV has a new YL and so didn't make the BPL. W1MO is training a new 212D to perk on 21 meters. W1CPH—a new ham—is coming along FB and should be in line for an ORS soon. W1BLS operated on 3500 kc. and found conditions very satisfactory. W1AMU has been off the air for the past few months but expects to be back on again sooner or later. WIAWE is waiting for some UX 866's. His best DX this month was Z3 SU. This makes his 40th country. FB. Weekly meetings of the Radio Club of Rhode Island were held during January. Beginners' work during the first half hour of the meeting is supplemented by talks on technical work during the succeeding portion of the meeting. Pres. Kraus is well pleased with the progress being made. Traffic meetings for all members of the A.R.R.L. located in R. I. are held every third Monday of the month in the Radio Club of Rhode Island, Brown Univ., Engineering Bldg. at 8 pm. W1BIL has gone to sea and will be off the air for about four or five months. WIAFS is QRW exams at Brown.

Traffic: W1BCR 96, W1BLV 12, W1MO 6, W1CPH 6, W1BLS 5.

WESTERN MASSACHUSETTS—SCM. Dr. J. A. Tessmer, WIUM—The Worcester Radio Association conducted an auction at their headquarters, 274 Main St., Room 301, on Thursday, February 7. Social events with refreshments were enjoyed. In the future, ORS appointments will be canceled after the third consecutive failure to report. If it was worth the effort to get an ORS in the beginning, it seems that you should continue as one of the limited real live hams. W1ANI is Route Manager. Please co-operate. W1BNC, C. E. Kelley of WTAG, is on 7000 and 3500 kc. regularly. W1ASU was visited by W8DAE and W8ADA by pre-arranged schedule. W8DAE worked his OM while at W1ASU. It is too bad W1AMZ blew his 210 but is having some fun on 201A. W1AKZ has worked several foreigners from his new location. W1BIV's new OL is giving him a chance at the key now. Hi, Say, fellows, if I can't read your report, how can I report? W1FG has rebuilt for 1929 and keeping schedules with W1BKS. W1ADO is rebuilding entire shack and is getting an entire new outfit.

Traffic: W1BNI, 1, W1BVR 2, W1ASU 9, W1BIV 3, W1EO 19, W1AKZ 5, W1AMZ 5, W1UM 4.

MAINE—SCM. Fred Best, W1BG—Four Maine amateurs make the BPL this time! FB, gang! Our totals are beginning to look like the old days when we were up with the leaders in the entire country. W1ANF landed on top again! That's the stuff. Harry OM, W1ART will be in a fair way to win his ORS appointment. Good work, Sis! W1AUR is living up to his reputation for being a hustler along traffic lines. FB, Hal. W1ACV has at last landed his ORS appointment and look at his total! W1BBE just missed catching W1ACV. Nice work, OM. W1CDX, Route Manager for Western Maine, held up his end this time in good fashion. Mrs. W1AJC is gradually getting up with the leaders. She reports a new ham in Portland—W1ABQ. W1KQ's

note has been classed among the real 1929 signals. Congrats, Lester! WIAIO, formerly of the Eastern Maine section, has moved to Portland. Welcome to Maine, Lew. OM. WIAQL, Route Manager of Eastern Maine, reports a new ham, WIALZ. We look for OM WIAJC to give the OW some competition before long. We are betting on Mrs. however! Hi! WIAQD turned in a mighty fine Official Observer's report. WIAUS sent in a good total and we hope he will be able to find more time for traffic the coming month. WIAHY reports some worthwhile messages. WIBFZ is still on 14,000 kc. WIASJ is rebuilding with push-pull and reports that WIAVV is also rebuilding.

Traffic: WIANH 380, WIBIG 256, WIART 236, WIAUR 238, WIACV 87, WIBBE 74, WICLD 70, WIAJC (1) 63, WIKQ 80, WIAIO 19, WIAQD 16, WIAJC (2) 13, WIAQD 11, WIAUS 10, WIAHY 6, WIBFZ 5.

VERMONT—SCM, C. A. Paulette. WIT—At last we have a representative in the BPL for old Vermont! Well done, WICGX. OB, you are surely pounding out the old traffic. I have eight reporting stations this month out of the 14 ORS in this state. I am sorry, boys, but somebody is going to get the ax, as we simply can't carry dead stations; if you are doing nothing and wish to retain your ORS, please write me and I will put you on the inactive list for awhile until you can come back. WIAJG is in the BCL business and says he has sold 160 sets. WIYD reports that radio club there coming fine and expects to have 3 operators by Feb. 15. WIAOO has been off the air due to sickness. WIBCK is going to Fort Henning, Ga. for the winter and says he will report from there and extends 73 to all the gang. WIBJP is still very QRL but manages to pound out a few each month. WIBEB reports some traffic this month. FB, OM. WICGX is going to be our new Official Observer and Chief RM. Please give him your cooperation, boys.

Traffic: WICGX 255, WIT 56, WIBEB 15, WIBJP 12, WIBCK 10, WIAOO 7, WIYD 8.

CONNECTICUT—SCM, C. A. Weidenhammer. W1ZL—The outstanding event of the month was the Connecticut Traffic Night which turned out to be a huge success. The plan was formulated and engineered by WICTI, who deserves our heartiest congratulations. He has planned bi-weekly meeting nights on the air for the ORS. Suggestions as to the most convenient night for those able to participate are in order. Send all your Traffic Night letters to Ella. He is eager to get your reaction to the stunt. WIMK is high traffic station again with WIPE. WIAFB and WIADW all over the one hundred mark. WIAMG and WIMM came close to the century line but just missed out. WIAOI reports that the 7000 kc. boys are starting to make the 3500 kc. band a bedlam. WIBDI has a schedule every other day with W6AKW who, in turn, has regular routes to China through the Philippines. WICKP reports schedules with nx-1XL and fo-PM two or three times each week. FB. WIPE's 203A passed out in the middle of the Conn. Traffic Night. His total this month was splendid. WINE has a new card. A new General Radio frequency meter was put into commission by WIBNS. He was heard in Budapest. WITD and WIBGC have new receivers. WIAFB has some schedules. We are glad to have WIBJK back with us after his bout with influenza. WIBWM appeared a BCL with a wavetrap. WIAMC worked everything in Europe that is workable. WIVB reported. WIBLQ and WIPF handled a few. WIAOX is ecstatic over his new MOPA. WIRP reports a schedule with 55X. WIAVT had receiver trouble. WIBI-BQH promises action now that exams are over. WIVE "crashed through" with a 55X contact. WIADW worked the Pacific coast on 3500 kc. several times during the month. WIAMG states that the Twin City Radio Club is as active as ever. Parmenter reports a partial rebuilding program at WIMK. WIZL has schedules with WIAOI and WICTI. The SCM works in New York, attends Columbia three nights a week, and commutes to Bridgeport daily. WIV is building a portable receiver and transmitter for auto trek work. WIMM made arrangements for a trip to Nicaragua for Mrs. Kail, the wife of a marine who is stationed there. All details were taken care of by radio between WIMM and nn-INIC. A very worthwhile accomplishment, OM Fraser. FB!

Traffic: WIBDI 57, WICTI 64, WICKP 21, WIPE 136, WIBNS 23, WITD 6, WIBGC 4, WIAFB 110, WIBJK 18, WINE 12, WIBWM 26, WIAMC 7, WIVB 24, WIBLQ 4, WIPF 23, WIAOX 16, WIRP 60, WIAVT 3, WIVE 1, WIAOI 58, WIADW 101, WIMK 472, WIAMG 90, WIZL 34, WIMM 92.

EASTERN MASSACHUSETTS—SCM, E. L. Battery. WIUE—The following ORS have been cancelled:

QST FOR MARCH

W1YC, WIADM, WIAHY, W1AXA, W1FL, W1PB and W1BDV. W1GP is moving to New York and W1PB is QRL and are dropping ORS. In some cases, cancellation was made because business or school kept the operators away from home, but the others have inactivity to blame. These cancellations were made in an effort to raise the standard of this section, so the remaining ORS should feel a sense of responsibility now that all the weight is on their shoulders. W1ACH goes over the top again with 800! Too had some more of us can't make that grade. W1LM and W1AKS make the BPL with over 200 while W1KY enters the same class on deliveries. FB. W1GP is moving to New York very soon. We have a new ORS in W1ARS. W1UE blew his filter condenser and is hunting for another. W1PB says very little time to operate since getting married—you should get the OW interested, OM. Hi. W1AKS still pushing at WCC. W1APK worked Savannah, Ga. on fone. W1BVL, one of our 23 mc. pioneers, comes forward and reports working G5ML and G5VL on that frequency. Nice work, OM. For once W1LM reports things rolling pretty. W1KH still works lots of DX and handles traffic to and from Grenfell Mission on his sked with Ne8AE. W1ASI is working on 7000 kc. W1AZE keeps sked with NJ-2PA. W1AGP has a new transmitter, new key (from Santa Claus) and keeps sked with W1ANS. W1BIX expects to move to Worcester soon. W1CQ has a parrot which he is teaching to call CQ for him. W1BLD is now at Northwestern studying electrical engineering. WIAOT sent in his first report. W1RF and W1RY are doing some fone work on 3500 kc. DX has returned with a bang at W1WV. W1CWX is representing USDA for Boston monthly. W1CHK is acting as commander of section three Naval Reserve. W1ACA is working on 3500 kc. W1RL has a new transmitter and will be on again soon. W1AAW expects to have a sked with KD5 in Panama soon. How about that ORS meeting that W1KY suggested in last month's report? All ORS are urged to report every month and thereby keep this section up with the rest.

Traffic: W1ACH 300, W1LM 206, W1AKS 203, W1KY 149, W1AAW 80, W1ARS 58, W1CQ 50, W1KH 33, W1ACA 24, W1AZE 27, W1BLD 20, W1RY 15, W1AGP 11, W1WV 10, W1AOT 9, W1ASI 9, W1BIX 8, W1RF 8, W1APK 8, W1WV 6, W1UE 6, W1BVL 2.

NORTHWESTERN DIVISION

OREGON—SCM, R. H. Wright. W7PP—W7RJ and W7BO are trying High C. W7IQ is using crystal control. W7UN has finished his new transmitter and says its working FB. W7PE and W7AIG are promising new ORS. W7EY, W7PL and W7LT are on consistently. W7WR, also a new ORS, is high man in traffic this month. W7ABH has a mercury arc ready to go but has no time to try it out as he is still operating on board ship. W7UB has been experimenting on 28 mc. He has been QSO with W9EF several times, signal strength of both stations were reported with no QSS to speak of. W7MV has been trying out a Hartley push-pull with 201A's on 7000 and 14,000 kc.

Traffic: W7WR 100, W7EY 39, W7PE 38, W7MV 26, W7PL 25, W7SI 12, W7UN 5.

MONTANA—SCM, O. W. Viers. W7AAT—W7JC, the new OO, surely has an eagle eye and no off-wave stations can get by him. Fine work, Ed, keep it up! W7DD is burning holes in the air with a pair of 50 watters. W7EL has been doing some very nice work on 3500 and 7000 kc. W7FL is still knocking 'em dead on 7140 kc. W7ZU promises to do some good work with the new station. W7AAW is back on the gang. How about notifying him by mail or air about our skeds etc. W7AEM and W7DJ are two stations in Hardin. W7AAT works day and night on 7040 kc. with a new High C TPTG set using seven 45 plate condensers in the plate and grid tanks.

Traffic: W7AAT 165, W7HP 47, W7FL 29, W7DD 29, W7EL 16, W7AAW 2.

IDAHO—SCM, J. L. Young. W7ACN-7JL—Our old friend, W7JF is back with us again and is tickling the ether with a haywire 210. He reports a good total right off the bat. Say, you Boise gang, where is that year's subscription to "QST"? That Clyde won in that traffic contest a couple of years ago? He says he hasn't seen it yet. KUMAKROS W7LJ has moved to Roseburg, Oregon. W7AOC is back again and is building a MOPA. W7EJ is on occasionally, as is W7GU and W7CW. W7UJ is working some real DX with his 500 watt fone set on 1715 kc.

W7ABB is adding power and changing to MOPA. W7YD, ex7YA, has a one KW xtal transmitter under construction. Meanwhile the 250 watt set is stepping right out. W7ALC is pretty busy selling BCL sets but manages to get to the key occasionally. He expects to be on almost continuously as soon as the BCL rush dies down. W7IY has been pretty busy this month. W7KA got his hand hurt so cannot send for a few weeks. He says he took a msg. from ZLIFW and QSP'd it to within 100 miles of destination within 50 minutes. Very good work, OM. Keep it up. W7ACD has been feeling rather punk but managed to work the Hawaiian Islands and make a little total. W7DC claims to be on occasionally. W7HE has been troubled with QRM from his doctor-friend's X-ray set. He has moved his station and expects better results. "Ole" Sholy of Caldwell now signs W7II and is getting his station on the air. W7ACP is getting his station on and wants to meet the gang. W7PR is getting a transmitter hooked up and will start his career as a seven right away. W7ACN is building a new MOPA transmitter; W7ACK is dusting off his outfit. W7CJ has moved back to Ferdinand, Idaho. There are a couple of new hams in Buhl that are getting started but haven't received their calls yet. W7HR, Ted Reid of Orofino says he is "a lil boy with a lil bottle." He is 15 years old and uses a 1920 model of a UV-201 A with 170 volts of B and a Zep. He makes it a rule to "boycott off-wave and broad signals". That's the spirit, Ted.

Traffic: W7JF 48, W7YD 31, W7ACN 15, W7ACD 8, W7KA 7, W7HR 5.

WASHINGTON—SCM, Otto Johnson, W7FD—Seattle seems to be awakening again with many of the old timers coming back and several newcomers doing their bit. W7IX is still the mainstay and handles most of the Alaskan traffic. W7LZ runs second due probably to BCL QRM. He says 3500 kc. is FB but breaks up the BCLs. Hi, W7BR is on with a MOPA using an 852 and 204A. W7AG and W7FD are back. All we need now is old W7GO. He is probably lost to ham radio tho as a recent visit revealed heaps of Aviation magazines in place of QSTs. Hi W7VK is a regular DXer now. He shoots traffic FB. W7WG and W7AOI are newcomers. W7AAV and W7GA are getting into the traffic game. W7OV has a 204 but the filament is a two-piece affair most of the time. W7AOW, our YL op, had most of her set stolen. W7AW also was visited in the same rude manner. The gang will have to take precaution and try to lay the crook by the heels, before more stations are cleaned out. W7AM lost a brand new xmitter some time back. Tacoma is next on the list, and we find activities are on the increase there also. W7KT, W7AAE, W7AFO and several others are active. The club station is on the air regularly also. The call is W7DK. Ye SCM would like more reports from Tacoma stations, and also from other parts of the state. In Everett, W7PH is doing his stuff. He is in line for an ORS. Our old standby, W7EK, will be back soon. He reports a bad case of pneumonia but is OK again and busy on a new xmitter using a 204A. After the way the 50 watt set perked, we fall to see the advantage of a 250. FB, tho. W7GP is putting Olympia on the air. He reports several new hams in prospect, including a YL or two (Mr. Huber, please note). W7ACA in Prosser reports weak B batts, therefore weak traffic report. Hi, W7AOG in Bellingham reports 3500 kc. fones coming thru FB. W7AOB is putting Tekoa on the air again. The Spokane bunch are so busy doing something they failed to report. It may have been delayed due to the snow and cold weather tho. W7AOO is on at Wapato. W7ADB and W7LI are on at Port Angeles. W7LI says he has trouble with his transmitter.

Traffic: W7TX 88, W7PH 40, W7LZ 34, W7AAE 25, W7AOB 20, W7GP 19, W7GA 19, W7VK 13, W7AAV 15, W7AG 15, W7KT 11, W7FD 9, W7WG 8, W7AOG 7, W7ACA 5.

ALASKA—SCM, W. E. Wilson, W7DN—The Alaska Section reports through W7TX as usual. K7ABE makes a total of 145. K7ANM is a newcomer and looks like a real traffic handler. Few stations in Alaska are "on" at present. K7TE at Anvik is carving on, using Burgess B Batt's from the Wilkins Expedition for plate supply until his generator is repaired. (Free ad, Hi.) K7AER seems to handle quite a lot of traffic.

Traffic: K7ABE 145, K7ANM 36.

PACIFIC DIVISION

PHILIPPINES—SCM, M. I. Felizardo, K1AU—Report from K1HR comes this time via radio through W6EEO: Schedules from K1HR with the following: K6ALM, Honolulu, T. H., 4:30 p.m. Friday only;

acWVN, Tientsin, China, 5:30 p.m. daily. ac8ZW, Shanghai Observatory, China, 6:00 p.m. daily; OM1TB, Sumay, Guam, 7:30 p.m. daily; W6AMM, San Jose, California, 9:30 p.m. Tuesdays and Fridays; W6EEO, Williams, California, 8:30 p.m. daily. Traffic through K1HR is handled to the following destinations: W, K, VK, AC, AM and local. K1CM reports by radio via W6AJM. K1CM keeps the following schedules: with acRV, Shanghai, China, 3:00 p.m. daily; W6AD, 9:00 p.m. Mon. and Fri.; W6AJM, 10:00 p.m. daily; G5BY, 10:00 p.m. Sunday and Thursday (14000 kc.).

Traffic: K1HR 852, K1CM 648

EAST BAY—SCM, J. Walter Frates, W6CZR—W6IP is off the air temporarily until he get a new transmitter. He maintains his place as high man in traffic in this Section this month. W6DWI is pounding out in FB style on 7200 kc. W6DTM turned in a fine traffic total before going off the air with W6DKO to accompany the Pacific Fleet to South America for the annual maneuvers. W6AWM is making the 3500 kc. band his happy hunting grounds. Traffic and rag chewing are his favorite occupations. W6CTX promises a great deal of traffic next month. W6EDK is handling four skeds. He is planning to take an active interest in Army net work. W6EMD, the old 15,000 kc. reliable, is coming into traffic work with a vim and says he is very much interested in slop jar rectifiers since the recent debate at the Oakland Radio Club. W6RJ finds 3500 kc. very consistent for sked and traffic work and reports that he and W6BYH are keeping east-west traffic going over their routes with W9GAL and W9AYK. W6SR is very proud that the wave of the station is 7152.5 kc. after working several days to find it. Sgt. Houston, operator of station who also operates W6BDO, is having unusual success with the latter portable, having been QSO with K7AER during a particular bad period for such QSO. He is trying to click with the K's in P. I. W6BZU sends in a fat traffic report, his ragging through W6RJ. Great assist! W6BPC is still keeping his sked at Vallejo with K7ANS. W6CGM, the old P.I. traffic man, has hooked up again with K1AF, but says that reception is very poor there and refuses to believe that it might be due to an ultraodion on this end. W6AWF is off and on the air so much that he is getting to earn the title of "Off Again, On Again" Abbadie. W6BI is back in the traffic game and reports working K7AER, OM1TB in Guam, and two VK's. W6ASJ says he is going to put a bell on his receiver to let him know when the locals quit the 7300 kc. band. W6BMS is building a screen grid receiver with plug-in condensers. W6HJ says that W6DTI is the father of a baby girl. W6AMI has bought a pair of rectobulbs to feed his 852. W6EMI reports a lot of experimenting. W6CLZ managed to handle a message or two on 15,000 kc. W6BUX and W6BJD are trying to make a WAC each year using lower and lower power. He worked ZS5C, formerly FO-A8A. He reports a YL op. W6ETS, and a new OM op. W6ETU. W6COL says he is not getting on until he gets a wavemeter and monitor to guard his QRH. W6ALV says he has just overhauled his antenna system and put up new poles. W6EY is rebuilding with new 852 and rectobulbs. W6IM says he's not using his call with W6CTK's shack so close. W6CZL is on the new 7000 kc. band with Fuch's antenna but ND so far. W6IT, chief OO, is being kept busy these days logging the boys off-frequency. W6ZX is itching to get back on the air and work some DX. W6PU is experimenting with monitor boxes, shield grid receivers, and his xmitter on 15,000 kc. W6ALX is second high man in section on traffic. He is still pounding away on 7000 kc. and is building a new shack. W6EIB is a new ORS at Valeno. W6DDQ at Fairfield is still changing his equipment. Section meeting was held at the Oakland Radio Club rooms with our director, W6ZD; Essex, W6PU, and Wagner, W6BEZ, as the featured speakers. W6PU demonstrated a low priced monitor box he has developed and W6ZD and W6BEZ had a fine discussion on antenna systems.

Traffic: W6IP 382, W6ALX 174, W6DWI 146, W6DTM 105, W6AWM 93, W6CTK 87, W6EDK 72, W6EMD 68, W6RJ 67, W6SR 63, W6BZU 59, W6EIB 54, W6BPC 45, W6CGM 43, W6AWF 32, W6BI 25, W6ASTJ 25, W6BMS 29, W6HJ 6, W6AMI 6, W6EMI 5, W6DDQ 5, W6CLZ 2, W6BUX 1.

SAN FRANCISCO—SCM, C. Bane, W6WB—Reports this month are a considerable improvement over last month with W6AD helping out with a fine total. He also makes the BPL. W6AC reports traffic not so good but DX fair on 14,000 kc. Glad to receive reports from two new boys this month—W6DZZ and W6DWJ. Mighty good to have you boys with us. W6PW continues to demolish milliammeters and says traffic hard to clear through QRM on 7000 kc. W6KJ

claims the new op causes lots of QRM. W6WN building new receiver to match that Hi-C xmitter. W6DYB is now an ORS. All the ORS's that have not been reporting can just consider that they are no longer ORS. They have been warned and should have no complaint to make. Activity in the northern part of the section seems to be nil. W6WS says he only gets on Sundays. W6BGB is now down in S. F. so that leaves Santa Rosa without any active stations. W6DPF is trying shield grid audio and threatens to invade 3500 kc. with fone. W6BGI is about through rebuilding and is coming on with push-pull. Plans also to hop down to 28 mc. W6CHL still undecided what to use. Let's all report next month and see if we can't break the charm.

Traffic: W6AD 260, W6DZZ 34, W6PW 21, W6DWJ 18, W6WB 7, W6DYB 5, W6KJ 5, W6AC 7, W6WN 2.

ARIZONA—SCM, D. B. Lamb, W6ANO—W6BJF using two 281's working steady on nights on 3500 kc. Worked K29A two hours. Gargled espanol. Hi. W6BWS is a new ham coming on the air, working 14 mc regularly and using TPTG. W6CDU hopes to get 25 cycle juice within next month. The MO is still going strong. W6CDY is too busy with school to be on the air except for USNR sked. W6DTU worked a "1" with 201A and 119 volts AC on plate. W6EAA have been off the air winding a transformer for 281's. W6ANO tried 281's but gone back to soup rect. on 7000-3500 kc. W6EFC is using tube rect. and getting out pretty good. W6EOF is using WE50 and working on 7000-14,000 kc. and getting good results. EX-9BCJ is going to op a com'l station for an airport to get weather reports etc. for the planes traveling from El Paso, Phoenix and Los Angeles. A station will be located in the three cities. W6DIB is putting in TPTG. W6DIE is using mercury arc on 7000. W6DTU is a new ORS.

Traffic: W6ANO 25, W6BJF 38, W6BWS 23, W6CDU 8, W6DTU 8, W6EAA 9.

SANTA CLARA VALLEY—SCM, F. J. Quement, W6NX—The SCM's address has been changed to 1343 Hanchett Ave.—stations please note. W6BYH lined up a bunch of stations on sked and moved up to 3500 kc.—his traffic speaks for itself. W6AMM cut down his oPHR sked this month but same did not prevent 266 messages from going over. W6AMM also maintains a sked with op3AA. W6JU is one of five Jr. College stations on circuit. W6HAX worked KCB off Siberian Coast with R9 report. W6BMW burned out his two water cooled rectifiers and will replace them with the new 866 tubes. A new Zep was installed. W6BNH was the only means of communication during a heavy snow storm. The set is located in a power house high in the Mts. W6AJZ moved up to 3500 kc. W6CTE is now in the Orient on KDUV. W6NX is the control station of Section 6, USNR Communication Reserves.

Traffic: W6AMM 266, W6BYH 153, W6JU 16, W6BAX 18, W6BMW 14, W6NX 12, W6BNH 8, W6AME 1.

SAN DIEGO—SCM, G. A. Sears, W6BQ—W6AJM again leads in traffic this month. W6BQ has 4 skeds now. W6EC is doing some work now for USNR on direction finders. W6BAM was heard in Siberia recently. W6DNS sends in best total for a long time. W6BGL reports regularly. W6VXB lost his P. I. sked now. W6BZD reports he let his license expire and is taking the exams again. W6EPZ and W6CPT hope to be ORS soon. W6HY reports a new YL at his home. W6EQJ is moving to new QRA, 1727 Cable St., Ocean Beach, W6BXI is another old ORS come back to life again. W6DGV is rebuilding for 1929. W6BAS has a new receiving antenna. W6CNK is QRL school now. W6AKZ is moving to a new QRA. W6SJ is back in San Diego again. W6BFE has a new 862.

Traffic: W6AJM 505, W6BQ 318, W6EC 182, W6BAM 144, W6DNS 122, W6BGL 68, W6BVX 23, W6BZD 19, W6ANC 18, W6EPZ 13, W6CPT 8, W6HY 8, W6EQJ 7, W6BXI 7, W6DGV 5, W6BAS 2, W6CNK 1.

LOS ANGELES—SCM, D. C. Wallace, W6AM—Two stations make the BPL this month, W6ZBJ and W6UJ. W6ZBJ visited us here in Long Beach when he was down for the YMCA Convention and reports that W6CMY moved with the United Artists Technical Staff in Hollywood; W6DZY is now op at KVD, Glendale. W6BZR has a nice sked to pass what he gets. W6DKV has been helping a blind friend get on the air. W6AKW has been QSO S. S. *Ducklo* in Indian Ocean 9 am PST. W6EGH finds, on altering his receiver, that the new bands are just as good as the old. He drove out 250 miles to have a dollar and a half feed with the ARRC in Los Angeles, and got

some new skeds. W6FT is keeping some good skeds. He is one of our new ORS, who pre-war was 6HZ. W6CHA sends in a fine total. He has been rebuilding. W6UJ makes the BPL with 63 messages delivered. He reports a young fellow in El Monte who was an old W.U. operator was blinded a few years ago, so W6UJ made him a receiver. W6DKV, and others made him a transmitter and he is on the air OK and has QSO'd New Zealand. W6FT lost his night op to the Aero Corp. of America as Radio man at Phoenix, W6CF, ex 9BSC. W6DHM is keeping two good skeds. W6AKD, from the 31st of December to the 1st of January, worked all continents and 8 countries. W6AM reports 6 stations QSO on 28 mc. band in 2 hours and plenty each Sunday. DX is sure fine, under new regulations—much easier to raise foreigners. W6AGR says K7AER reports W6AGR puts a beautiful sig in Alaska. K7AER wants to work us all. He never saw a ham station but his own and is coming to visit W6AGR in August. W6AWP sends in his first report. W6CZO has been sick with the flu for about a month but managed to get a good total. W6COT built a new filter this month, which improves the note 100%. W6AWP intends to install 852 soon. He was QSO WFBT Dec. 31st and got R9 from him. W6APW is trying to find a big power leak. W6HS just received appointments as Route Manager for the ARRC and Assistant Route Manager for the ARRL, Los Angeles Section. W6DSG reports a new station, W6ERU at Ventura on the air now. W6ESA is one of our new reporting stations. W6DLI has been at sea most of the month. W6ASM is Communication Manager for the ARRC, radio club in Los Angeles, and head ORS for them. The ARRC has 6 OBS stations. W6AWQ reports three feet of snow up there in Sunny Southern Calif. He says you can ski, toboggan and ice skate there and drive 20 miles and pick oranges off the trees. W6DPY sends in a good total. W6DEG says the QST 4 tube 1929 receiver works FB there. W6ALR is getting a television receiver soon. He hopes to get a club together there soon, also. W6DZI graduated from school Jan. 30. W6BVM is keeping a good sked. W6CUH was heard in England on the 7000 kc. band. He had great fun grinding his own xtal and it perks. W6AEC is making UX222 receiver in copper can, and put up new stick. W6ZZA had nice skeds with W6MA at Washington, D. C., Kansas City, Mo. and El Paso, Tex. W6CZT just completed a new receiver. W6MA kept a blind transmitting schedule with the Battle Fleet, NEDJ at Panama for three weeks. W6BRO, his transmitter, finished, will be on the air as soon as he finishes his receiver, frequency meter, and monitor. W6DLK has put in 281's and have transmitter nearly finished. Is trying MOPA with fone on 3500 kc. band. W6BJX now holds amateur extra first operator's license. W6AOS says QEM and YL's leave little time for radio. He had a pleasant visit from W6DMK, W6EAF, W6HT, W6OF, also sends in reports. Forty-two stations report this month with 35 handling traffic.

The date set for the next quarterly A.R.R.L. banquet has now been set for Friday, March 22nd. It will be held under the auspices of the Short Wave Club of Pasadena. The PSWC has been having some very interesting meetings. They raffled off a plate transformer at one meeting, and a Vibroplex at another.

The ARRC of Los Angeles held a banquet at the Chamber of Commerce Bldg., Los Angeles, on January 18th.

The Associated Radio Amateurs of Long Beach held a meeting every Friday night at 7:30 pm in the Council Chambers of the City Hall. At one meeting W6AM spoke on receivers. At another W6QF spoke on his eastern trip to act as advisor to the Radio Commission in Washington, D. C. Several auctions have been held at the meetings providing a market for and exchange of radio apparatus.

We received a Christmas card from our ex-chief Route Manager, W6DDO.

Traffic: W6ZBJ 210, W6AKW 155, W6EGH 135, W6FT 133, W6CHA 128, W6UJ 126, W6DHM 74, W6AKD 56, W6AM 43, W6AGR 34, W6AWP 21, W6CZO 19, W6COT 19, W6APW 17, W6HS 17, W6DSG 16, W6ESA 16, W6DLI 16, W6ASM 15, W6AWY 14, W6DOW 14, W6AWQ 14, W6DPY 13, W6DEG 12, W6ALR 11, W6DZI 9, W6BVM 7, W6CUH 7, W6AEC 6, W6ZZA 4, W6DZT 4, W6MA 1.

NEVADA—SCM, C. B. Newcombe, W6UO—Sorry Nevada has not been making better showing. W6ABM is running a BCL store. W6ADQ on 3500 kc. is a new ham in Tobar, Nevada with a 210. Has worked Wisconsin and Michigan. W6UO is getting ready for Governors-President Relay and is installing a REL DeLuxe receiver with screen grid tubes.

Traffic: W6LB 21, W6UO 21.

SACRAMENTO VALLEY—SCM, C. F. Mason, W6CBS—W6EEO keeps four good schedules with W9EGU, K1HR, W6AJM and W9EBO. Traffic from W6EEO this month is splendid and he now holds an ORS appointment. W6AFU is another new ORS and handled a good number of messages. W6DON is a new USDA station for Sacramento as well as new ORS. W6BDX handled a few and also holds a new ORS certificate.

Traffic: W6EEO 502, W6AFU 103, W6BDX 16, W6DON 39.

HAWAII—SCM, F. L. Fullaway, K6CFQ—The new radio laws do not seem to be causing any difficulties at present. Several stations are planning to be on again. I hope more fellows will report this year than in the past. Certainly there is a lot of traffic to be had for the asking. K6DJU has a push-pull xmitter on 7000 kc. and an uita-audion on 14 mc. He also turned in the best report. K6AVL also has a new push-pull xmitter and gets DC reports. He keeps skeds with a five, six and a seven. Our old time friend, and star traffic man is back on the air again. No fooling, that boy K6AFF was good. He wants his ORS again which means that the totals will go up. He says that K6BDL has returned from China and will be on again. The SCM would like to announce that he will give a worthwhile prize to the station handling the most traffic for the year 1929. Let's see if we can't raise our totals to some high mark. Would you fellows like to challenge this Santa Clara section of the Pacific Division to a traffic contest? Let me hear some suggestions.

Traffic: K6DJU 114, K6AVL 74, K6AFF 15.

ROANOKE DIVISION

WEST VIRGINIA—SCM, F. D. Reynolds, W8VZ.—At present there are fifteen ORS in West Virginia according to present records. By checking through my list, I find that W8AGL, W8IT, W8DNN and W8BJB have allowed their QST subscriptions to expire which automatically cancels their ORS appointments. Also that W8ACZ, W8DPO and W8DCM are in danger since their subs expire in Feb. Come on, fellows, let's put out the necessary mazumia and save these ORS tickets. W8BPU is having trouble with BC station but will have 250 watter on 3500 kc. soon. Until we hear from you, please consider W. Va. as only having twelve ORS appointments. W8APN is back with us since the holidays during which it took a fling at the BCL business. We understand that W8DCM has been sojourning in southern climates somewhere near New Orleans. W8SP is building a screen-grid receiver. W8CRS says business and YLs keep him off the air. W8CLQ has some mighty good skeds and says they are reliable. FB, OM. We imagine that somewhere in the mails there are reports from W8DPO, W8CDV, W8HD (former SCM), W8DFC and W8OK—at least we hope so. W8HD is experimenting with a new set. W8AKQ is rethinking. Meek of W8LGG-W8AKT is having quite a time with his WE212D. Just a word before we cut the juice. Notice the report of North Carolina and Virginia in QST and see if you don't think that we can double the combined report. That's going some for twelve ORS but let's do it. I will promise to have an 852 on the air before many days go by and will try and help with the traffic. Am doing second trick at WMMN now and we are pretty busy. From now on we are the Roaring Roanoke Gang, what say? Let me have your reports next month, OM's, Box 1200, Fairmont, W. Va.

Traffic: W8DPO 32, W8DNN 2, W8CLQ 62.

VIRGINIA—SCM, J. F. Wohlford, W3CA—W3AAJ has returned to the radio game. In addition to handling WRVA, he has time to ham around some. Working 7000 now but will be on 3500 soon. W3FJ working sevens at noon on 14 mc. Uses 230's as 291's and says they work fine and perk right along. W3HO is back on the air and on 14 mc. W3ALS had QRM from school this month and experimenting with antenna loading coils at top of antenna. W3AG says he has returned to the old game and found YLs not so good for QSO and too much QSSS. W3KR rebuilt transmitter and will start to work schedules about first of Feb. W3HY says Santa Claus brought him a "bug."

Traffic: W3AAJ 16, W3FJ 10, W3ALS 28, W3AG 9, W3HY 7, W3CA 34.

NORTH CAROLINA—SCM, Enno Schuelke, W4SJ—This month we are pleased to welcome the Radio

Club of Davidson College, Davidson, N. C. operators W4ZG, W4DB, W4JU. They report having a membership of ten, and are using a UX210 and are open for all traffic. FB, fellows, we sure do like to see you and hope to be able to work you sometime soon. W4TS is rebuilding to conform to 1929. He has been appointed Route Manager for this state. W4OC has been on very little because his crystal does not suit him. His QRH is 7190 kc. now. His FQPM sked has been the means of netting him an African CQ drum. Hi. Mrs. FQPM sent Mrs. OC some African jewelry but it is so heavy she can't wear it and be comfortable. Hi. W4AFW still reports ND after nine PM on the 7000 kc. band. W4HV is trying to get traffic but reports no results as yet. W4AEW is waiting to get his skeds going. W4SJ has dismantled the station. He is leaving the division and will get located in Philadelphia where he hopes to get going under a new call in a few weeks. Fellows, it sure has been a pleasure to work with you, and I take this means of expressing to each and everyone my sincere thanks for your fine co-operation. How about giving the new man the same sort of co-operation which I enjoyed. Things have been picking up in this Section lately. Why not get things going so good that everyone will have to say that you are a bunch of real hams. Best of luck and 73.

Traffic: W4ZD 54, W4AEW 16, W4TS 14, W4AFW 9, W4OC 6, W4EL 2.

ROCKY MOUNTAIN DIVISION

COLORADO—SCM, C. E. Siedman, W9CAA—W9DKM suddenly took a spurt and made the BPL this month. Hope you stay with us, OM. He is using a lone 210 with a little over 300 volts on the plate. W9CAA has put in a 2000 kc. phone set but adds that it is only a minor interest, the old 3750 kc. band being home. W9EAM is active in the USDA Net. W9DQV is working two schedules. W9DQD is thinking of becoming an ORS again. W9DGJ is holding his share of the USDA. W9GBQ is a new station. He is on the 3750 kc. and 7000 kc. bands. W9EUR is still having his little troubles getting back on the air. W9CDE is on week-ends as usual. W9BQO is on in the early morning and early evening on 7000 kc. The new set using a 250 watter seems to kick out in fine shape. W9ESA is experimenting on 14,200 kc. W9DNY wants to trade a good broadcast receiver for a ham transmitter or parts. W9GEZ is a new station working on 14,200 kc. W9GGW has a mercury arc all ready to go. W9CSR has been busy with school work. W9CND rebuilt his transmitter along 1929 lines and now is worried because his wave is so sharp. Hi. W9DRV has a wonderful wallop. W9FXW at Boone is on now with DC plate supply and seems to be getting out fine on low power.

Traffic: W9DKM 174, W9CAA 47, W9EAM 15, W9DQV 29, W9DGJ 3, W9GBQ 2, W9CDE 15, W9BQO 18, W9FXW 2.

UTAH-WYOMING—SCM, Parley N. James, W6BAJ—In spite of the disadvantages expected to come with 1929, there is just as much activity as ever. Most of the fellows are busy trying to get their sets up to 1929 specifications. W6BTX and W6EIW take the honors this month. They expect to make the BPL next month, they are getting some new skeds and a fifty Good luck, OM's. W6DXM is putting in a 1929 TPTG set. W6DYE has finished his new set and has it working FB. He has a shielded 210 oscillator, with three 210's for an amplifier, using MG DC on the plates. W6BAJ was on a few days. W6DZX has rebuilt his set and is using pure DC now instead of AC. W6RV has burnt out another tube. W6DPO was too busy with school to get on this month. W6EKF is a new ham in Ogden, says that it is easy to get R7 on the east coast with a 201A. FB, OM.

Traffic: W6BTX & W6EIW 126, W6DXM 20, W6EKF 19, W6DYE 6, W6BAJ 4, W6DZX 3.

SOUTHEASTERN

ALABAMA—SCM, S. J. Bayne, W4AAQ—W4JY makes the BPL this month with a dandy report. W4AAH has had an enjoyable vacation in Florida where he visited a number of the boys. W4AHZ has gone in for DX as a side line. W4VC

QST FOR MARCH

is busy but gets on occasionally. W4AJQ is heard daily at noon. W4AIY's house lights glow when he touches the key. W4MB is home from school and disturbs the ether as per usual. Both W4IA and W4OA are using fone in the 3500 kc. band. W4AHP and W4AHR have received Official Relay Station appointments. Listen for Official Broadcasts from W4AHR Sundays at 8 am and Wednesdays at 7 pm CST in the 7000 kc. band. W4AHP has rebuilt his High C. Hartley. W4AJR is working for an ORS. W4AAQ is selling BCL sets. W4TI has been vacationing. W4VX has moved to Iowa.

Traffic: W4JY 229, W4AJY 48, W4AHR 45, W4AAH 34, W4AAQ 19, W4AHZ 13, W4AJR 12, W4AHP 2, W4AIY 1.

FLORIDA—Acting SCM, E. M. Winter, W4HY--W4AGY and W4AJD at Miami are now holders of Extra First Class licenses. Walter Van Nostrand, Radio Inspector, gave a mighty nice talk to the Miami Radio Club on his last visit. W4AII is now working on his crystal-controlled set. W4BL is "training" a VL operator. W4TK handled a few W4PAW, W4AII, W4ACK, W4ACS and W4ACC handled traffic at the South Florida State Fair. W4MS is helping four stations at Tallahassee get going good. Reports are wanted from the following stations, or a letter explaining their failure to report: W4SD, W4PB, W4IG, W4DD, W4OB, W4AAO, W4IE, W4CH, W4BM, W4ACC, W4CK, and W4OO. We want Florida kept on the radio map and without reports, your SCM cannot tell the world what you're doing. Let's go, fellows, make next month the best in this column.

Traffic: W4BL 45, W4MS 81, W4AGY 20, W4AII 17, W4HY 8, W4TK 3.

GA-SC-CUBA—SCM, H. L. Reid, W4KU—Georgia: W4KL has a sked with DQ around the Bahamas and had the pleasure of meeting the cruisers on their way North lately. W4RM is also very active along with W4RN. W4KU is doing a little work but does not have much time for real skeds. South Carolina: W4EI at Georgetown has been consistent and is doing a nice bit of work in his section. Regular QRH is 7204 kc. with xtal control.

Traffic: W4KL 26, W4RN 26, W4EI 80.

WEST GULF DIVISION

NORTHERN Texas—SCM, J. B. Robinson, W5AKN—W5ATZ at Denton sure is burning the electrons, been using a 201A and QSO'd the 2nd dist. and the 7th dist. He has been handling messages for the YLs at C.I.A. FB, OM. W5BBF is keeping skeds with W5BBO, W5AFI and W5LP. He fixed his transmitter over with a high C and says it is sure OK. W5HY nearly forgot to report but the Land Phone saved his life. He's still using a 400 meter antenna with about 8 wires. W5AAE, using a 201A and a Ford coil for plate supply, has been QSO both coasts. Looks like the bunch is going in for low power. W5AAE says the fone hounds on the higher QRHs don't seem to appreciate code stations in their midst. W5DF still blowing up the rest of his station; looks like he will have to start all over soon and get a new layout. Try a 201A and a Ford coil, OM. W5WW has been winding a plate transformer (he's sure got patience). Says QRM from high lines don't help reception any but still QSO's both coasts. W5BAD is building a new shack and working over the thunder factory. W5JD has been handling traffic like an old timer lately. He is a new ORS and OBS in Dallas. W5RG-W5AKN is building new receivers as per recent QST. W5ANK has at last got the C.C. set all prettied up like a chorus girl (bet it won't work) and about ready to perk. Good luck, OM.

Traffic: W5ATZ 37, W5JD 24, W5BBF 24, W5HY 18, W5AAE 15, W5DF 5, W5BG 4, W5WW 2, W5BAD 2, W5ANK 1.

OKLAHOMA—SCM, J. G. Morgan, W5AMO—The SCM is leaving the reins of office to W5FJ. W5AMO reports QRM from work and therefore gives the office up in favor of an SCM that can serve more accurately. The Tulsa gang report again this month and W5BEE leads the traffic hounds of that city. W5AYF is trying to get crystal control; rumors afloat are to the effect that W5ASQ is a married man. How about it, gang? W5ANT is off the air until he gets a bug. Says the old rock-crusher key

is getting him down. W5ASQ is 100% 1929. W5FJ is just back from a trip to Chicago and bears no marks of a machine gun attack so he must be a peace-loving citizen. W5APG has been pounding out about the same number of messages this month as per sked. FB, OM. W5AAV got a crystal for Christmas with compliments from W5APG. W5QL is still working on the big set. He calls it the "question mark", as he is wondering when he is going to get it going. W5BAG still refuses to get his old rock crusher back on the air. What's the matter, OM? W5BCX has started going back and forth to the Univ. from his home in the city and reports that he will have more time to smooth the old flat out now. W5AAI has gone into the BCL business but still finds time to pound brass occasionally. W5ADV says the 281's are FB for the 1929 type transmitter. W5BCX has an 852 and 281's also. Well, that's about all as press time rolls around. The SCM may be on again with a 199A soon.

SOUTHERN TEXAS—SCM, R. E. Franklin, W5OX—This month seems to have caught a lot of us rebuilding and consequently traffic has suffered a good bit. Don't be afraid of the new bands, fellows, it isn't half as bad as it seems. The Texas A. & M. College station, W5AQY, turns in a nice message total in spite of the fact that they have been experiencing considerable trouble with their transmitter, due to tubes going west, etc. Some of the ops are W5QR, W5IE, W5AQT, W5EO and A. C. Goebel. W5ABQ expects to have a fone going on the 1700 kc. band as soon as the MG he has ordered arrives. W5AHP is the new Route Manager for the Houston district. Get after him, fellows, and help him get things going. W5NW is rebuilding. W5ASM seems to be hitting it off pretty good with his low power set on the new bands. W5LP burned out a grid leak but has another on the way. W5TE has had to shut down for awhile on account of his antenna being too short for the new bands. W5HS is ill and will have to discontinue amateur radio for a while. W5AE has a couple of the new RCA mercury vapor rectifiers in transit and expects to get battery DC reports. W5OX has been busy rewinding his MG.

Traffic: W5AQY 134, W5ASM 22, W5ABQ 20, W5LP 12.

CANADA

MARITIME DIVISION

Weekly prayer meetings are now being held each Wednesday evening on frequencies between 4000 kc. and 3895 kc. (75 and 77 meters).

NOVA SCOTIA—SCM, A. M. Crowell, VE1DQ—I wish to thank the gang for the hearty election to SCM and assure you all that every cooperation and suggestion for advancement of the section is welcomed. Every member is requested to send in report of his activity by the 20th of each month. The Halifax gang are now on the 3500 kc. band and is doing some fine work. VE1DQ worked Dayton, Ohio and got fine report from W5KX on his. VE1BV is going to rebuild with higher power. VE1AW had a sked with VE1AV and still keeps late hours after DX. VE1BN is working on keying system and piling up good reports with his TPTG. VE1AR sprung a surprise by appearing on 3500 kc. band with fone. VE1CC raves about his new 1929 xmitter and backs it up with fine reports. VE1AS is rebuilding. We had a visit from VE1DM who reports much doing down Sydney way. Let's have the dope, gang!

PRINCE EDWARD ISLAND—SCM, F. W. Hyndman, VE1BZ—VE1AP has remodeled his station completely for 1929. A new monitor graces his operating equipment, and he finds that it is the most useful piece of apparatus in the shack. A few messages were handled and Germany was the best DX.

Traffic: VE1AP 5.

ONTARIO DIVISION

ONTARIO—SCM, E. C. Thompson, VE3FC—Central Dist.: Thanks are due W2CUS for radio handling of this report. VE3RC leads the Section in the amount of traffic handled but says that now that the 5700 kc. territory is denied us, his traffic will likely fall off and his DX increase. So say we all. VE3BP is arranging to work on 3750 kc. as well as on 7000 kc. VE3BO says that he finds 1929 conditions not nearly

as bad as he had anticipated, and that working on 14,400 kc. he is having all kinds of fun and contacts with occasionally some traffic thrown in. He hears all kinds of real DX but unfortunately his sigs do not seem to want to leave this continent, except on rare occasions. VE3CL is having tough luck with a stubborn receiver. VE3DF is a new station in Galt, Ontario who is working on 4000 and 1750 kc. using both fone and CW and the operator who is W. J. Stauffer, will be glad to connect with other stations on these frequencies and to handle traffic when it is offered. Welcome, OM, let's hear from you regularly. VE3BK has changed to a tube rectifier and is getting out in fine shape on the three popular bands. VE3BL is preparing to use 3900 kc. more often than of yore. VE9AL, VE3FC and VE3XJ are digging in on 3900 kc. with the object of keeping schedules and getting traffic which seems very elusive. VE3BJ is assumed to be still pounding away on about 3300 kc. Southern Dist: VE3CB is using the new frequency bands to good advantage. VE3IA claims that he is giving up amateur radio. VE3AY has left home in order to get work and so he is only able to operate on week ends. VE3AQ is now permanently on the 3500 kc. band where he is looking for traffic and on the other bands where he is getting DX. Northern Dist: VE3ET again rolled up a very fine traffic total and worked some good DX, also. VE3CJ has been having an exciting time this winter with antennas that refuse to stay up and trees that insist on being blown down if the antenna shows signs of staying up. Northern Lights have also played their part in making work on short-waves quite impossible most of the rest of the time. Storms, such as few of us have ever seen, according to Bud, make living almost unendurable. However, some schedules were kept and traffic handled regardless.

Weekly prayer meetings are now being held each Wednesday evening on frequencies between 4000 kc. and 8895 kc. (75 and 77 meters).

Traffic: VE3BC 36, VE3ET 40, VE3FC 23, VE9AL 16, VE3CJ 16, VE3BK 6, VE3CB 6, VE3BO 6, VE3BP 3, VE3CL 2, VE3BL 1, VE3IA 1, VE3AY 1, VE3AQ 1.

QUEBEC DIVISION

QUEBEC—SCM. Alex Reid, VE2BE—Weekly prayer meetings are now being held each Wednesday evening on frequencies between 4000 kc. and 8895 kc. (75 and 77 meters). Well, here we are in our 1929 bands with more activity than ever. More traffic handled and DX just about as good as it ever was. There are still some 1928 notes on the air but the majority is of the better type. If all our friends of the South would get rid of 8C, our troubles would be over. The first of 1929 will be held at station VE2BE and a large attendance is anticipated. The fone stations are adding to their number each week; eight stations were heard on the air last Sunday. As we have no broadcasting from our local broadcasting station on Sundays, the boys have a great attendance from the BCLs. We are very sorry to report that on account of business, VE2BR will be off the air for a few months. VE2AP has a 1929 receiver and reports it very satisfactory. VE2BG is building a fone set and will join the Sunday gang soon. VE2AX is using a 1929 transmitter with low power and reports fine results. VE2HV will be on with a high powered set shortly. VE2BH worked South Africa at 3 pm January 20th on 14 mc. and got R6. VE2AC had a bad blow-up, lost all his tubes and transformers, but nevertheless, while waiting for new gear, started his portable and turns in a fine traffic report. That is real ham spirit. VE2BB, our old reliable, is doing some very fine work. VE2BE still continues his sked with the Byrd expedition. VE2AM is having BCL trouble. Three new hams have passed and received their licenses during the month.

Traffic: VE2AC 45, VE2BB 16, VE2BE 32, VE2AM 10, VE2AL 9, VE2EM 24, VE2AP 5.

VANALTA DIVISION

Weekly prayer meetings are now being held each Wednesday evening on frequencies between 4000 kc. and 8895 kc. (75 and 77 meters).

ALBERTA—SCM. E. J. Taylor, VE4HA—VE4CU helped us out fine this period. Our banquet of Jan. 5th was a big success. We hold the next one on February 3rd, at 6:30 pm at the Shasta Cafe. Come and hear VE4EY tell us about the screen grid tube. VE4GX is using 1929 xmitter and gets R8 from the 5th and 6th districts. VE4JJ uses Zep antenna and gets DC reports. VE4MJ still using Henry but expects to use DC soon. VE4AF using 250 with generator. VE4CU is our real traffic handler this time.

XVI

This station is official broadcast station and is on each Sunday at 10:00 am and 3 pm on 7145 kc. VE4JP comes in consistently. VE4FF is heard frequently. VE4CS is using 210 with B supply. Glad to see you back again, OM. VE4FT is on regularly. VE4FB, thanks for letter, OM. He gets R7 and 8 in 6th district. VE4GT is on every Sat. and Sun. VE4HM gets out FB and is getting into 28,000 soon. VE4EP and VE4CL rather quiet these days. VE4HA is on 14,000 and 28,000. It is pleasing to hear the nice notes from the above stations which shows the effort being made to comply with 1929 conditions. VE4EY is on right along with a nice DC note. VE4BV also is doing FB. I think we should support this.

Traffic: VE4CU, VE4FT 4, VE4HM 3, VE4GT 2.

PRAIRIE DIVISION

Weekly prayer meetings are now being held each Wednesday evening on frequencies between 4000 kc. and 8895 kc. (75 and 77 meters).

MANITOBA—SCM. D. B. Sinclair, VE4FV—1929 conditions seem to be putting a crimp in this district as far as DX goes. However, VE4DK received a report from England on his 14 mc. signals and VE4FV received a card from the Icebreaker "Krassin" east of Franz Josef Land and north of Siberia reporting his 7 mc. signals. He has now been heard in all continents and still prays for his WAC certificate. The Winnipeg Radio Traffic Assn. have installed a receiver and transmitter which seems to put out a whale of a sock in the 7 mc. band. They are using the old CJCG broadcast antenna and have been licensed as VE4HX. VE4AR says his new 1929 Hartley is "the berries". He reports a new ham, VE4DB has changed over from the Hartley to the Ultraudio circuit and claims it is FB. We were deeply grieved to hear of the death of VE4DP's mother and wish to extend the sincere sympathy of the section to him. He is moving now and will be compelled to give up his transmitter, but plans to keep on the air from the club station. VE4ZR has, at last, received his official call VE4HV. The best DX feat accomplished in this district to date was performed when VE4MO, one of our new hams, succeeded in connecting with G5ML on the 14 mc. band. He was using a 201 A tube with about 5 watts input. VE4FN has succeeded in producing a real 1929 signal from a 210. Almost all his reports are crystal control. VE4DK clicked with VO8RG on 14 mc. and has been beating the "W's" playing checkers over the air lately. VE4HR has changed over from the Hartley to the TPTG and puts out a better sock while still retaining his steady DC note. VE4CQ has been experimenting on 3.5 mc. He has at last handled a little traffic. VE4DJ has changed things around until he now has a real 1929 signal and no key clicks. VE4EK has one of the best notes in the Section. We are privileged to welcome OM and OW Macdonald of Wynyard, Sask to our midst and hope to hear VE4AC and VE4FW on the air here very soon. VE4HN has sold out but hopes to be back on again when he finds some time. VE4BT was home for the Christmas holidays and worked out FB with a 201A and 200 volts of B battery. VE4DI, VE4JB and VE4BU are believed to be active but no news is forthcoming. Buck up on the reporting, boys.

Traffic: VE4EK 2, VE4DJ 11, VE4GQ 14, VE4DK 16, VE4HR 6, VE4FN 17, VE4DB 2, VE4AR 16.

SASKATCHEWAN—SCM. W. J. Pickering, VE4FC—VE4CM says that he would like to hear the SCM on the air once in a while. The SCM will soon be there. VE4CM has a schedule with VE4FN so anyone with traffic east can route it through him. VE4HS is now VE4JG and has a 100 watt set perking fine. VE4IH, a new ORS, likes the 1929 conditions. VE4BR at Battleford seems to be getting out now. VE4BL will be on in a week with either an 852 or a 250 watter. VE4EW is pushing a 210. VE4HP at Landis and VE4HV at Palmer are also on the air. VE4GR isn't getting much time for real DX but says just wait.

Traffic: VE4CM 49, VE4JG 27, VE4IH 23, VE4GR 12.

LATE AND ADDITIONAL REPORTS

W9EEY and W9EKW got their reports in just in time to make this number. W9DM has a 99 tube now but can't use it as it's too cold in his radio shack. W9DYA is still using phone.

Traffic: W9EEY 60, W9EKW 207, W9DYA 14.

QST FOR MARCH

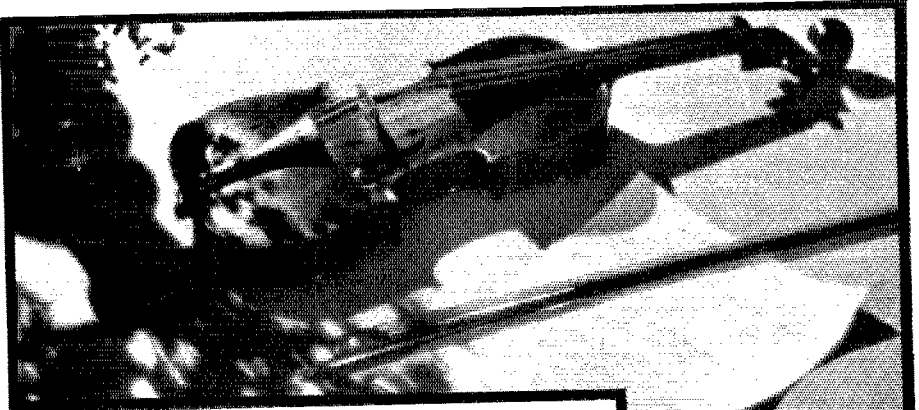

Since radios became musical instruments

✓ ✓ ✓ *Transformers must meet new, exacting standards* ✓ ✓ ✓

Now, we know it was but a semblance of a farflung voice that thrilled us in those early years of radio reception. Today, the novelty is gone—radio must be true and faithful in tone or it is not pleasing—it will not sell!

The wise custom builder or manufacturer knows that he must meet competition in the "audio end" of his product. Distance, selectivity—Yes. But above all—TONE!

Better tubes and better speakers play important parts in faithful reproduction—but transformers are sometimes neglected.

And the science of transformer building is a specialty in itself—it is a field too wide and varied to be handled successfully as a mere step in receiver manufacture. It is best left to an organization like "Sangamo" whose experience, research and precision manufacturing facilities guarantee the result.

Within the Sangamo Audio Line is found specially designed equipment to match specific types of tubes and speakers.

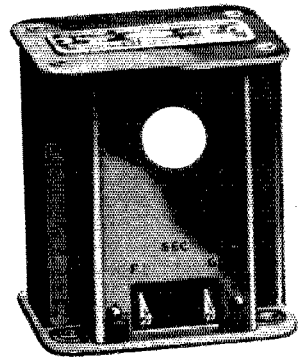

SANGAMO ELECTRIC CO.

SPRINGFIELD, ILLINOIS, U.S.A.

Manufacturers of Precision Electrical Apparatus for 30 Years

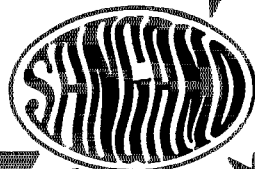

SEE REVERSE

SANGAMO Condensers

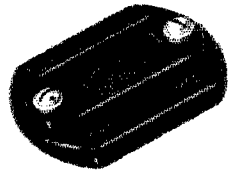

No item can cost so little and cause so much trouble in a receiver as a fixed condenser. This fact is especially appreciated by the manufacturer with an eye to the service problem. Likewise experience has shown that a fixed condenser is not necessarily a good condenser just because it is moulded in Bakelite.

The immunity to thermal changes and to mechanical damage rendered by the Bakelite enclosure is supplemented in Sangamo Condensers by accurate rating and sound construction of the mica condenser within the Bakelite casting.

The standard line of Sangamo Fixed Condensers leave the factory tested to maximum variation of 10%.

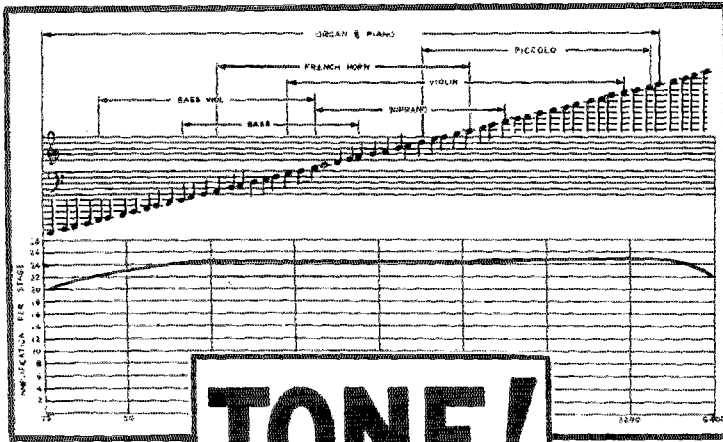

TONE!

Curve of Type "A" or Sangamo Straight Audio Transformer showing uniformity of amplification at all available frequencies.

BETTER Transformers for every radio need!

"X" Line Transformers

- Type AX straight audio amplification list price, \$6.00
- Type BX Push-pull Input unit list price, 6.50
- Type CX-171 Push-pull Output Transformer, for 171 or 250 power output tubes for cone speaker list price, 6.50
- Type DX, same as CX except for 210 and 112 power tubes list price, 6.50
- Type HX Push-pull Output for 171 or 250 Power Output tubes to match the impedance of moving coil of Dynamic loud speakers . . . list price, 6.50
- Type GX, same as HX except for 210 and 112 power tubes list price, 6.50
- Type E output choke to match impedance of the various type power tubes list price, 5.00

"A" Line Transformers

- Similar to X Line but with special core metal to give greater amplification at low frequencies*
- Type A straight audio amplification list price, \$10.00
- Type B Push-pull Input Transformer for all tubes, list price, 12.00
- Type C-171 Push-pull Output, for 171 or 250 type power tubes with cone speaker . . . 12.00
- Type D-210, same as C except for 210 and 112 power tubes 12.00
- Type H-171, Push-pull Output for 171 or 250 power tubes for Dynamic Speaker list price, 12.00
- Type G-210, same as type H except for 210 and 112 tubes 12.00
- Type F Plate Impedance for use as a choke to prevent oscillation and for impedance coupled amplifiers, list price, 5.00

NEW!

Condensers for Manufacturers

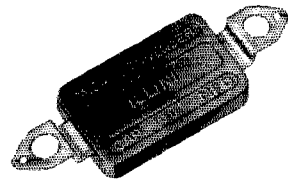

While the Sangamo Condensers shown at the top of the page have always been popular with manufacturers, there has been a demand for condensers of the same quality of a size and shape more suitable for factory set design and production. For manufacturers use only we have designed the Sangamo "Illini." The connecting lugs may be bent to any position required without impairing the condenser.

Prices on request

PIN THIS TO YOUR LETTERHEAD AND MAIL

SANGAMO ELECTRIC CO., Springfield, Illinois, U. S. A. Dept. 3421

(For manufacturers) I am interested in engineering data regarding your transformers and condensers.

(For dealers) Please send data on Sangamo Condensers.

(For set builders) Please send circulars describing your apparatus and latest audio hook-ups.

