

# QST

DEVOTED ENTIRELY TO

# AMATEUR RADIO

PUBLISHED SINCE 1915 BY THE AMERICAN RADIO RELAY LEAGUE INC.

*New Short-Wave Receivers  
for 1929*

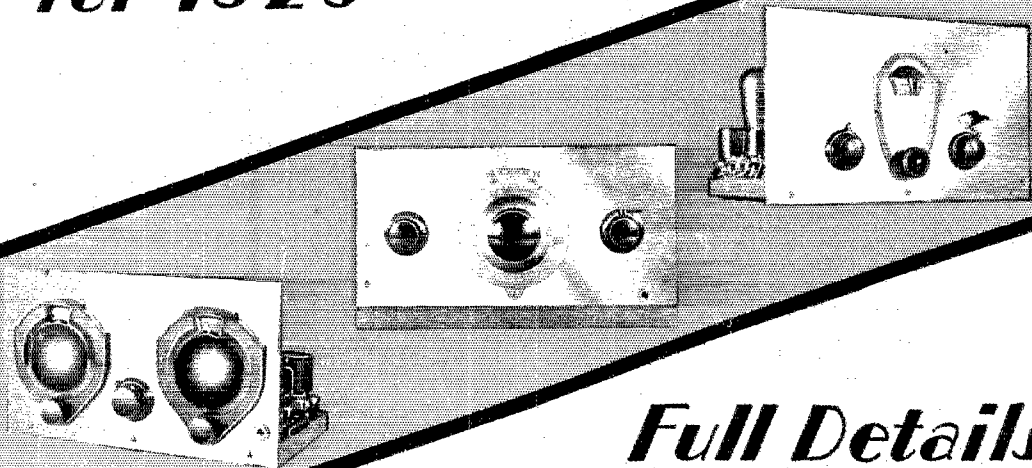

*Full Details  
IN THIS ISSUE*

**NOV. 1928**

**25<sup>c</sup>**

# QUALITY

## AMPLIFIER TRANSFORMERS

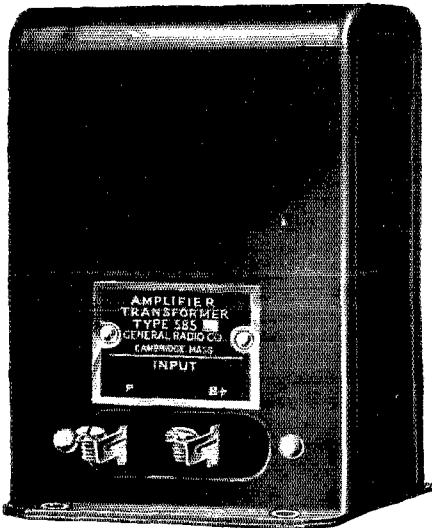

**Type 585 Amplifier Transformer**  
Price . . . \$7.00

The Type 585 Amplifier Transformers are designed particularly for those desiring the best in transformer design. Due to the use of adequate quantities of silicon steel as a core material precautions against overload are no longer necessary as in the case of nickel alloy cores. The electrical characteristics of the Type 585 Transformers are listed below.

### Specifications.

|                             | Type 585-D | Type 585-H  |
|-----------------------------|------------|-------------|
| Primary Inductance          | 79 Henrys  | 71 Henrys   |
| Primary D.C. Resistance     | 2000 Ohms  | 2000 Ohms   |
| Secondary Inductance        | 316 Henrys | 306 Henrys  |
| Secondary D.C. Resistance   | 9300 Ohms  | 11,000 Ohms |
| Amplification Ratio         | 1:2        | 1:3.5       |
| Permissible Primary Current | 5 MA.      | 5 MA.       |

◆◆◆  
**General Radio Co.**

30 State St., . . . Cambridge, Mass.  
274 Brannan St., San Francisco, Cal.

The General Radio Company has always been identified with audio-frequency transformer design. It was the first Company to supply closed core audio-frequency transformers. The new Type 585 and Type 541 groups represent the latest efforts of this Company and are intended for those desiring the utmost in quality reproduction.

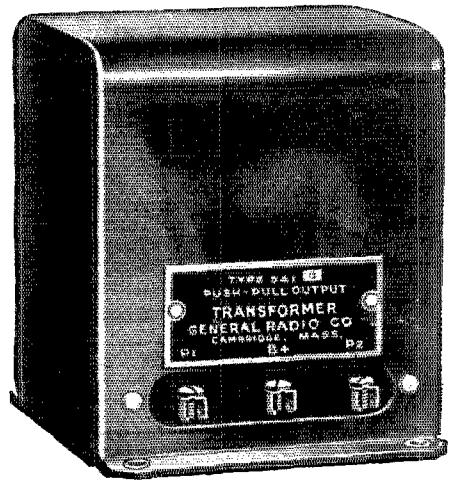

**Type 541-B Push-Pull Transformer**

In the Type 541 Push-Pull Transformers three types are supplied. The Type 541-A Push-Pull Input Transformer has a flat frequency characteristic from 100 to 10,000-cycles, dropping to about 75% of the maximum at 30-cycles. The Type 541-B and Type 541-C are output transformers for use with magnetic and dynamic speakers respectively. The Type 541-A and Type 541-C Transformers are similar in appearance to the Type 585 Amplifier Transformer. Sold in pairs only.

Type 541-A and Type 541-B Push-Pull Amplifier Transformers (for Standard Speaker) . . . . . \$25.00

Type 541-A and Type 541-C Push-Pull Amplifier Transformers (for Dynamic Speaker) . . . . . \$25.00

*Bulletin No. 931 will be sent on request*

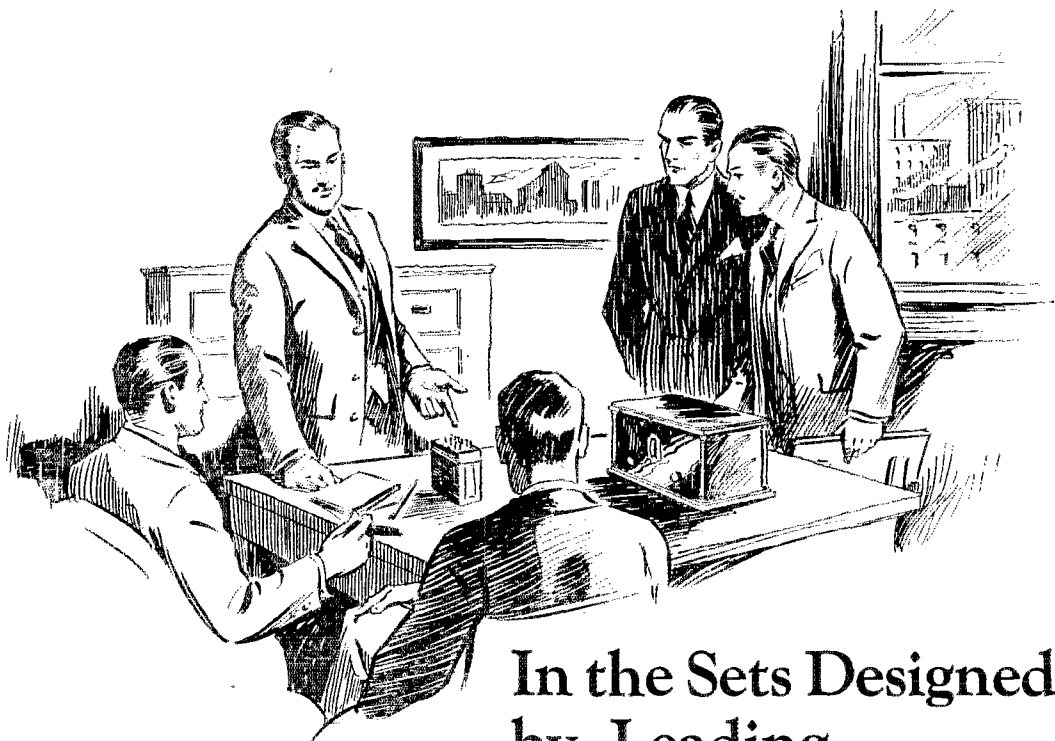

## In the Sets Designed by Leading Engineers

Faradon Capacitors are specified as standard equipment where electrostatic condenser long life and durability is essential.

We will be pleased to cooperate with you on your condenser problems. Faradon engineers gladly supply data on special capacitor problems not covered by our more than 200 types of Faradon units ready for prompt delivery.

**WIRELESS SPECIALTY APPARATUS CO.**  
JAMAICA PLAIN BOSTON, MASS., U.S.A.

*Established 1907*

# Faradon

---

*Electrostatic Condensers for All Purposes*

---



**THEY'RE THERE**  
**IN THE**  
**WORLD'S**  
**FINEST RECEIVERS**

**S**TANDING guard at the door of tone, Thordarson audio and power transformers do their part in making real musical instruments of hundreds of thousands of radio receivers annually.

Leading receiver manufacturers are well aware of the important relationship between the choice of transformers and the musical characteristics of their instruments. No wonder, then, that the majority of manufacturers of quality radio receivers have turned to Thordarson as the logical transformer source.

When buying your receiver, insist on Thordarson amplification and power supply. The set manufacturer who uses Thordarson transformers can be depended upon to have the balance of his receiver in keeping with this high standard of performance.

*Custom set builders will find Thordarson transformers to meet every radio need at their nearest parts dealer.*

**THORDARSON**  
**RADIO**  
**TRANSFORMERS**

**SUPREME IN MUSICAL PERFORMANCE**



# Section Communications Managers of THE COMMUNICATIONS DEPARTMENT, A. R. R. L.

|   |          |                          |  |                         |
|---|----------|--------------------------|--|-------------------------|
| Eastern Pennsylvania                                | 30P      |                          |  |                         |
| Maryland-Delaware-District of Columbia              | 3A1S     |                          |  |                         |
| Southern New Jersey                                 | 3CFG     |                          |  |                         |
| Western New York                                    | 3PJ      |                          |  |                         |
| Western Pennsylvania                                | 3CEO     |                          |  |                         |
| Illinois  | 9APY     |                          |  |                         |
| Indiana   | 9C9Q     |                          |  |                         |
| Kentucky  | 9BA8     |                          |  |                         |
| Michigan  | 9CFP     |                          |  |                         |
| Ohio  | 9BYN     |                          |  |                         |
| Wisconsin   | 9VD      |                          |  |                         |
| North Dakota  | 9DYM     |                          |  |                         |
| South Dakota  | 9DGR     |                          |  |                         |
| North Minnesota                                     | 9GGH     |                          |  |                         |
| South Minnesota                                     | 9RYA     |                          |  |                         |
| Arkansas*   | 5ABT     |                          |  |                         |
| Louisiana   | 5TK      |                          |  |                         |
| Mississippi   | 5AKP     |                          |  |                         |
| Tennessee   | 4PT      |                          |  |                         |
| Eastern New York                                    | 2CNS     |                          |  |                         |
| N. Y. C. & Long Island                              | 2KR      |                          |  |                         |
| North New Jersey                                    | 2WB      |                          |  |                         |
| Iowa  | 9DZW     |                          |  |                         |
| Kansas  | 9CET     |                          |  |                         |
| Missouri  | 9RR      |                          |  |                         |
| Nebraska  | 9BYG     |                          |  |                         |
| Connecticut   | 1ZL      |                          |  |                         |
| Maine   | 1RIG     |                          |  |                         |
| Eastern Massachusetts                               | 1UCB     |                          |  |                         |
| Western Massachusetts                               | 1UM      |                          |  |                         |
| New Hampshire                                       | 1ATJ     |                          |  |                         |
| Rhode Island  |          |                          |  |                         |
| Vermont   | 1PT      |                          |  |                         |
| Alaska  | WVWN     |                          |  |                         |
| Idaho   | 7ACN-7TL |                          |  |                         |
| Montana   | 7AAT-7QT |                          |  |                         |
| Oregon  | 7DP      |                          |  |                         |
| Washington  | 7FD      |                          |  |                         |
| Hawaii  | 6CFQ     |                          |  |                         |
| Nevada  | 6UO      |                          |  |                         |
| Los Angeles   | 6AM      |                          |  |                         |
| Santa Clara Valley                                  | 6NX      |                          |  |                         |
| East Bay  | 6CZB     |                          |  |                         |
| San Francisco                                       | 6VR      |                          |  |                         |
| Sacramento Valley                                   | 6CBS     |                          |  |                         |
| Arizona   | 6ANO     |                          |  |                         |
| Philippines*  | 6n1AT    |                          |  |                         |
| San Diego   | 6RQ      |                          |  |                         |
| North Carolina                                      | 4SJ      |                          |  |                         |
| Virginia  | 3CA      |                          |  |                         |
| West Virginia                                       | 8FD      |                          |  |                         |
| Colorado  | 9CAA     |                          |  |                         |
| Utah-Wyoming  | 6BAJ     |                          |  |                         |
| Alabama   | 4AHO     |                          |  |                         |
| Florida   | 4LK      |                          |  |                         |
| Georgia-South Carolina-Cuba-Porto Rico-Isle of Pine | 4RT      |                          |  |                         |
| Northern Texas                                      | 5AKN     |                          |  |                         |
| Oklahoma  | 5AMO     |                          |  |                         |
| Southern Texas                                      | 5OX      |                          |  |                         |
| New Mexico  | 5TT      |                          |  |                         |
| Newfoundland  | 8AB      |                          |  |                         |
| New Brunswick                                       | 1BI      |                          |  |                         |
| Nova Scotia   | 1BD      |                          |  |                         |
| Prince Edward Island                                | 1BZ      |                          |  |                         |
| Ontario   | 9BJ      |                          |  |                         |
| Quebec  | 2BE      |                          |  |                         |
| Alberta   | 4HA      |                          |  |                         |
| British Columbia                                    | 5BJ      |                          |  |                         |
| Manitoba  | 4FV      |                          |  |                         |
| Saskatchewan  | 4FC      |                          |  |                         |
| <b>ATLANTIC DIVISION</b>                            |          |                          |  |                         |
| J. B. Morgan, 2nd                                   |          | 491 E. Willow Grove Ave. |  | Chestnut Hill, Phila.   |
| Dr. H. H. Layton                                    |          | 805 Washington St.       |  | Wilmington, Del         |
| M. J. Lotysh  |          | Box 49, RFD 1            |  | Cranbury, N. J.         |
| C. S. Taylor  |          | 598 Main St.             |  | Buffalo                 |
| A. W. McAuly  |          | 309 Third St.            |  | Oakmont                 |
| <b>CENTRAL DIVISION</b>                             |          |                          |  |                         |
| Fred J. Hinds                                       |          | 3337 Oak Park Blvd.      |  | Berwyn                  |
| D. J. Angus   |          | 310 N. Illinois St.      |  | Indianapolis            |
| J. B. Wathen  |          | 111, Box 97, R. F. D. 1  |  | Louisville              |
| Dallas Wise   |          | 9187 Falcon Ave.         |  | Detroit                 |
| H. C. Storck  |          | 694 Carpenter St.        |  | Columbus                |
| C. N. Crapo   |          | 443 Newton Ave.          |  | Milwaukee               |
| <b>DAKOTA DIVISION</b>                              |          |                          |  |                         |
| B. S. Warner  |          | 309 4th Ave.             |  | Endorlin                |
| D. M. Casak   |          | 780 Illinois St.         |  | Huron                   |
| C. L. Barker  |          |                          |  | Henning                 |
| D. F. Cottam  |          | 3538 Third Ave. So.      |  | Minneapolis             |
| <b>DELTA DIVISION</b>                               |          |                          |  |                         |
| H. E. Velta   |          | 5408 U St.               |  | Little Rock             |
| C. A. Freitag                                       |          | 129 Camp St.             |  | New Orleans             |
| J. W. Gullett                                       |          | 1708 23rd Ave.           |  | Meridian                |
| Polk Purdue   |          | 70 Radio Station WBAY    |  | Nashville               |
| <b>HUDSON DIVISION</b>                              |          |                          |  |                         |
| F. M. Holbrook                                      |          | 2 Livingston Ave.        |  | White Plains            |
| M. B. Kahn  |          | 617 W. 141st St.         |  | N. Y. C.                |
| A. G. Wester, Jr.                                   |          | 59 Princeton St.         |  | Maplewood               |
| <b>MIDWEST DIVISION</b>                             |          |                          |  |                         |
| H. W. Kerr  |          |                          |  | Little Sioux            |
| J. H. Amis  |          | 915 Lincoln Ave.         |  | Topeka                  |
| L. B. Lalzure                                       |          | 8010 Mercier St.         |  | Kansas City             |
| C. B. Deihl   |          | 5605 Cedar St.           |  | Omaha                   |
| <b>NEW ENGLAND DIVISION</b>                         |          |                          |  |                         |
| C. A. Weidenhammer                                  |          | 32 Washington Place      |  | Bridgeport              |
| Frederick Best                                      |          | 13 E. Crescent St.       |  | Acunsta                 |
| E. L. Battey  |          | 39 Royal St.             |  | Wollaston               |
| Dr. John A. Tessmer,                                |          | 8 Schaffner St.          |  | Worcester               |
| Y. W. Hodge   |          | 227 Main St.             |  | Claremont               |
| Clayton Paultette                                   |          |                          |  | North Troy              |
| <b>NORTHWESTERN DIVISION</b>                        |          |                          |  |                         |
| W. B. Wilson  |          | U. S. LHT Fern           |  | Ketchikan               |
| James L. Young                                      |          | 308 13th Ave.            |  | So. Nampa               |
| O. W. Yiers   |          |                          |  | Ired Lodge              |
| R. H. Wright  |          | 310 Ross St.             |  | Portland                |
| Otto Johnson  |          | 4340 30th Ave. W.        |  | Seattle                 |
| <b>PACIFIC DIVISION</b>                             |          |                          |  |                         |
| F. L. Fullaway                                      |          | 2714 Manoa Rd.           |  | Honolulu                |
| C. B. Newcombe                                      |          |                          |  | Yerington               |
| D. C. Wallace                                       |          | 109 W. Third St.         |  | Long Beach Calif.       |
| F. J. Quement                                       |          | 232 Hancock Ave.         |  | San Jose                |
| J. Walter Frates                                    |          | 308 62nd St.             |  | Oakland                 |
| J. W. Patterson                                     |          | 400 Octavia St. Apt. 29  |  | San Francisco           |
| C. F. Mason   |          | 2530 N. St.              |  | Sacramento              |
| D. B. Lamb  |          | 229 W. First St.         |  | Mesa                    |
| Jose E. Jimenez                                     |          | 835 San Fernando St.     |  | Manila                  |
| C. A. Sears   |          | 236 Bonair St.           |  | La Jolla                |
| <b>ROANOKE DIVISION</b>                             |          |                          |  |                         |
| Enno Schuelke                                       |          | R. F. D. No. 1           |  | Ridgeway                |
| J. F. Wohlford                                      |          | 118 Cambridge Ave.       |  | Roanoke                 |
| C. S. Hoffman                                       |          | 126 Chantal Court        |  | Wheeling                |
| <b>ROCKY MOUNTAIN DIVISION</b>                      |          |                          |  |                         |
| C. R. Stedman                                       |          | 1841 Albion St.          |  | Denver                  |
| Parley N. James                                     |          | 430 "D" St.,             |  | Salt Lake City          |
| <b>SOUTHEASTERN DIVISION</b>                        |          |                          |  |                         |
| A. D. Trum  |          | 217 Catoma St.           |  | Montgomery              |
| C. E. Foutlkes                                      |          | 502 Spearing St.         |  | Jacksonville            |
| H. L. Reid  |          | 11 Shadowlawn Ave.       |  | Atlanta                 |
| <b>WEST GULF DIVISION</b>                           |          |                          |  |                         |
| J. H. Robinson, Jr.                                 |          | 522 Cumberland St.       |  | Dallas                  |
| Glenn Morgan  |          | 763 Asp Ave.             |  | Norman                  |
| R. E. Franklin                                      |          | 1806 Valentine St.       |  | Houston                 |
| L. E. Radka   |          |                          |  | Tucumcari               |
| <b>MARITIME DIVISION</b>                            |          |                          |  |                         |
| Loyal Reid  |          | Avalon House             |  | St. Johns               |
| T. B. Lacey   |          | 670 N. B. Power Co.      |  | St. John                |
| W. C. Forrest                                       |          | 14 Sinclair St.          |  | Dartmouth               |
| P. W. Erdman  |          | 25 Fitzroy St.           |  | Charlottetown, P. E. I. |
| <b>ONTARIO DIVISION</b>                             |          |                          |  |                         |
| W. Y. Sloan   |          | 167 Close Ave.           |  | Toronto                 |
| <b>QUEBEC DIVISION</b>                              |          |                          |  |                         |
| Alex Reid   |          | 169 Logan Ave.           |  | St. Lambert             |
| <b>VANALTA DIVISION</b>                             |          |                          |  |                         |
| E. J. Taylor  |          | 10107-87th Ave.          |  | Edmonton                |
| E. S. Brooks  |          | c/o Forestry Dept. Radio |  | Courr House, Vancouver  |
| <b>PRAIRIE DIVISION</b>                             |          |                          |  |                         |
| D. B. Sinclair                                      |          | 295 Cambridge St.        |  | Winnipeg                |
| W. J. Pickering                                     |          | 514 19th St. W.          |  | Prince Albert           |

\*Temporary officials appointed to act until the membership of the Section concerned choose permanent SCMs by renomination and election.

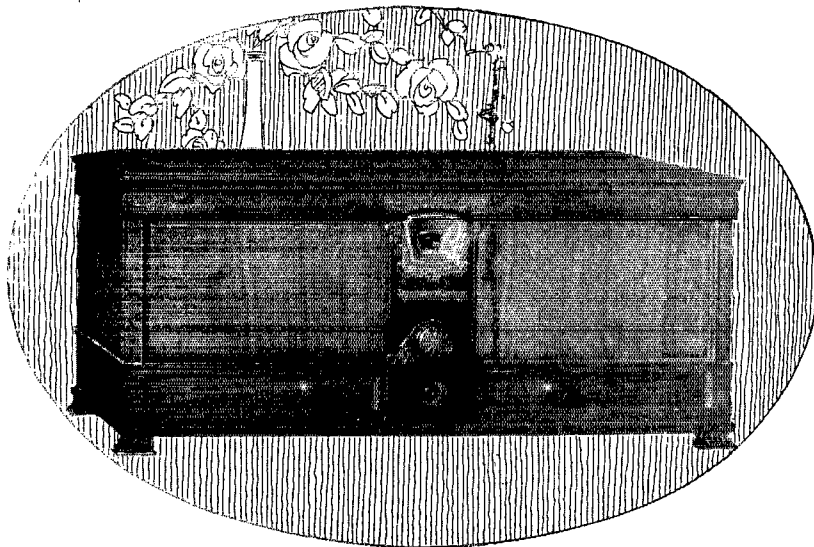

No. 635  
Stromberg-Carlson  
Treasure Chest.  
Price, less tubes \$185.  
Slightly higher prices  
Rockies and West  
and Canada.

# The New Stromberg-Carlson

**T**HIS new Receiver marks the success of long experimentation by Stromberg-Carlson engineers in producing a Receiver having the convenience and simplicity of A. C. tubes and retaining all the glorious tone quality for which Stromberg-Carlsons have long been celebrated.

Handsome in cabinet work — a beautifully grained American Walnut; extremely sensitive; highly selective and producing fine volume over

the entire tuning range from 200 meters to 550 meters it provides a remarkable instrument at a very reasonable price.

As in other Stromberg-Carlsons provision is made for reproduction of phonograph records. It is totally shielded, tunes with a single selector [illuminated], is entirely self contained and operates from any 60-cycle A. C. house lighting circuit, using no batteries or liquids.

Listen to the Stromberg-Carlson Sextette Tuesday evenings at 8 o'clock Eastern Daylight Time, through the NBC and Associated Stations: WJZ, WBZ-WBZA, WJR, WSB, WBAL, WHAM, KDKA, WREN, WTMJ, WCCO, KYW, KWK, KOA, WBT, KVOO, WFAA, WOAI, WMC, WHAS, KPRC.

*Other Stromberg-Carlson Models available for A. C. or D.C. current areas, as well as models operated by batteries*

STROMBERG-CARLSON TELEPHONE MANUFACTURING CO.  
ROCHESTER, N. Y.

# Stromberg-Carlson

MAKERS OF VOICE TRANSMISSION AND VOICE RECEPTION APPARATUS FOR MORE THAN THIRTY YEARS

Say You Saw It In Q S T — It Identifies You and Helps Q S T



# The American Radio Relay League

The American Radio Relay League, Inc., is a non-commercial association of radio amateurs, bonded for the promotion of interest in amateur radio communication and experimentation, for the relaying of messages by radio, for the advancement of the radio art and of the public welfare, for the representation of the radio amateur in legislative matters, and for the maintenance of fraternalism and a high standard of conduct.

It is an incorporated association without capital stock, chartered under the laws of Connecticut. Its affairs are governed by a Board of Directors, elected every two years by the general membership. The officers are elected or appointed by the Directors. The League is non-commercial and no one commercially engaged in the manufacture, sale or rental of radio apparatus is eligible to membership on its board.

"Of, by and for the amateur", it numbers within its ranks practically every worth-while amateur in the world and has a history of glorious achievement as the standard-bearer in amateur affairs.

Inquiries regarding membership are solicited. A bona fide interest in amateur radio is the only essential qualification; ownership of a transmitting station and knowledge of the code are not prerequisites. Correspondence should be addressed to the Secretary.

## DIRECTORS

*President*  
HIRAM PERCY MAXIM  
Drawer 2102,  
Hartford, Conn.

*Vice-President*  
CHARLES H. STEWART  
St. David's, Pa.

*Canadian General Manager*  
A. H. K. RUSSELL  
5 Mail Bldg.,  
Toronto, Ont.

*Atlantic Division*  
DR. EUGENE C. WOODRUFF  
224 W. Fairmount Ave.,  
State College, Pa.

*Central Division*  
CLYDE E. DARR  
187 Hill Ave., Highland Park,  
Detroit, Mich.

*Dakota Division*  
C. M. JANSKY, JR.  
Dept. of Elec. Eng., U. of M.,  
Minneapolis, Minn.

*Delta Division*  
BENJ. F. PAINTER  
424 Hamilton Nat'l Bank Bldg.,  
Chattanooga, Tenn.

*Hudson Division*  
DR. LAWRENCE J. DUNN  
80 Hanson Place  
Brooklyn, N. Y.

*Midwest Division*  
PORTER H. QUINBY  
817 Lauderman Building,  
St. Louis, Mo.

*New England Division*  
DR. ELLIOTT A. WHITE  
Dartmouth College,  
Hanover, N. H.

*Northwestern Division*  
K. W. WEINGARTEN  
3219 No. 24th St.,  
Tacoma, Wash.

*Pacific Division*  
ALLEN H. BABCOCK  
65 Market St.,  
Southern Pacific Co.,  
San Francisco

*Ryanoke Division*  
W. TREDWAY GRAVELY  
Box 245,  
Danville, Va.

*Rocky Mountain Division*  
PAUL M. SEGAL  
Box 1771  
Denver, Colo.

*Southeastern Division*  
HARRY F. DOBBS  
Harry F. Dobbs, Inc.  
245 Spring St., N. W.,  
Atlanta, Ga.

*West Gulf Division*  
FRANK M. CORLETT  
2515 Catherine St.,  
Dallas, Tex.

## OFFICERS

*President* . . . . . HIRAM PERCY MAXIM, Hartford, Conn.  
*Vice-President* . . . . . CHAS. H. STEWART, St. David's, Pa.  
*Secretary* . . . . . KENNETH B. WARNER, Hartford, Conn.  
*Treasurer* . . . . . ARTHUR A. HEBERT, Hartford, Conn.  
*Communications Manager* . . . F. EDWARD HANDY, Hartford, Conn.

# EDITORIALS

**T**IMES of community disaster, as from hurricane or flood, offer the radio amateur his great opportunity for service. He has never been found wanting. In many years no community in distress in this country has been without valiant assistance from amateur radio. The recent West Indian hurricane was no exception.

When this storm hit Porto Rico and the Virgin Islands, ham radio was on the job. The normal communication of these people with the mainland is by navy radio but the navy stations went out with the storm. Amateur radio to the fore! The San Juan naval station got on the air with improvised apparatus, operating in the amateur band for quick contact, and got it in a hurry—amateurs promptly tied them up with the Navy Department at Washington. The naval station at St. Thomas, in the Virgin Islands, similarly was wrecked by the hurricane, but one of the operators there was an amateur and promptly got on the air with his ham station, np4AAN (now K4AAN), and in short order, through the assistance of numerous amateurs, was in direct communication with NAA. Not only that, but this humble amateur station then proceeded to change to a naval frequency and became NBB, succeeding to the call as well as the duties of the wrecked naval station. Up to a few short months ago amateur operation was not permitted in the Virgin Islands. Here was ample demonstration of its worth, with the Governor of the Islands in direct communication with official Washington at a time when it was most important. The amateurs concerned in these activities have received letters of thanks and public commendation by the Navy Department.

With ample warning, this hurricane found the amateurs of unhappy Florida mobilized to receive it. Most of the amateur stations of Florida were on the job, with spare batteries laid by and everything set for a long vigil. Innumerable stations share the honors of that black week. Many of them kept their communities informed on the progress of the hurricane and supplied them with news when wires went out. Much public message traffic was handled. Other amateur stations, in the region where the storm struck, had more serious duties, for they were the only links between cities filled with death and suffering and a nation waiting to help. Of these stations, 4AFC at Palm

Beach was the star performer, and it discharged its duties in full keeping with the traditions of amateur radio and in a way to make the old heart well up in admiration. The station was operated by Ralph Hollis, and Forrest Dana of 4AGR. Dana is a civil engineer, Hollis a driver for the Fire Department, where his station was located. When there were definite signs that the hurricane would hit Palm Beach, these two men went out at 1:30 a.m., hunted up a dealer and bought a set of "B" batteries for emergency power and borrowed some storage batteries, and prepared themselves for the worst. It came. The antenna went, and it seemed the building would too. Risky as it was to go outside, they had to abandon their station; but during a short lull they returned and retrieved the apparatus, found another location at the other end of the building, and under the most adverse and dangerous conditions managed to get an antenna up and signals on the air. From Monday to Thursday of that eventful week that station was continuously on the air. It did a noble job exchanging vital messages with many amateur stations and reporting the scene at Palm Beach to the outside world. The War Department net control station, WVA at Washington, was on the air looking for Florida stations, and with the assistance of other amateurs was hooked up with 4AFC. By this means the first reports to the American Red Cross were made, starting the relief machinery of that organization, and by the same channel the word was conveyed that brought Army blankets, cots and supplies for the stricken area from Atlanta.

The Red cross and the town of Palm Beach have expressed their thanks for the amateur service. The Army, as the branch of our government directly concerned with relief measures in emergencies (the basic idea of the Army-Amateur Affiliation) issued a public statement from which the following is quoted:

"Messrs. Hollis and Dana realized the urgent need for outside communication and established it, clinging to their self-imposed task with a purposeful tenacity worth of highest praise. For three days these two men stayed at their instruments, disregarding personal safety and interests until the regular channels of electrical communication with the outside world were restored. Mr. Dana lost his home, his automobile and all personal effects in the storm. Both men ate what food where and when it could be received and neither slept in a bed during their self-appointed vigil."

And General Gibbs, Chief Signal Officer of the Army, sent them the following message via WVA at the conclusion of the job:

"It has indeed been a pleasure for the Army radio station WVA to work a schedule with your station during the recent emergency in Florida and it is with regret that we discontinue this schedule. Regulations now controlling the operation of the War Department radio station WVA prevent us from competing with commercial companies. Reports from Western Union Telegraph Company and subsequent messages received here show that the Western Union Telegraph Company is now able to handle your traffic. This being the case the Army must sign off and say good-bye to you two men. You are to be commended for your untiring effort and loyal devotion to duty which you have so well expressed during the last three days and we shall always remember this worthy duty well performed."

This West Indian hurricane is "one more for the book". It has brought the amateur very forcibly to the attention of the public, resulting in newspaper editorials of praise

and an increased recognition of amateur value by many agencies of importance in our national existence. In such tragedies of American life as the Vermont and Mississippi River floods, the two Florida hurricanes, the Illinois tornado, the Santa Barbara earthquake, amateur radio has fully demonstrated that it is of the highest utilitarian service to the community and the country at large. We amateurs are now expected to render this service when other agencies fail. A.R.R.L. Headquarters knows that A.R.R.L. members will regard this as a sacred trust; that, without rules and formal organization, every man can be counted upon to get on the air when his neighborhood needs him and do a clean-cut job in the good old A.R.R.L. way—to the continued glory of amateur radio!

K. B. W.

## Standard Frequency Transmissions from W9XL

**S**TATION W9XL is a special station comprising one of three portions of the "Gold Medal Station," WCCO-W9XL-W9WI at Anoka, Minnesota. WCCO is operated as a broadcast station. W9XL purely as a standard frequency station and W9WI as a general amateur station. The three transmitters have independent equipment and antennas but a common power supply. Through arrangements made by K. V. R. Lansingh of the Official Frequency Station Committee of the Experimenters' Section, A.R.R.L., W9XL is operated on schedules regularly announced in QST. The work of operating the station is done without charge by Assistant Chief Engineer Hugh S. McCartney, with the assistance of Lyall K. Smith and Ivan H. Anderson also of the staff of WCCO.

While no guarantee of accuracy is made on a gratis service, it is the aim of the staff to maintain an accuracy of 1/10 of 1%, which is materially better than can be held by most frequency meters. The frequencies are measured by means of standards which have been especially standardized for this purpose by the Bureau of Standards.

A small percentage of tone modulation is employed so that the signal is distinctive and more quickly recognizable.

The fact that this service has been rendered in the past is no guarantee of its continuation indefinitely in the future. It depends upon whether the response received seems to warrant the amount of work and expense involved in maintaining this service

to all amateurs. If you take advantage of this service, please acknowledge that you are doing so by notifying the Experimenters' Section, A.R.R.L., 1711 Park Street, Hartford, Conn. You may use ordinary stationery or special blanks may be obtained from the above address. A number of these blanks has been gathered and as the number grows we will gradually gain a unique and accurate record of transmission phenomena possible with no other station.

| Schedules for November     |                  |                            |                  |
|----------------------------|------------------|----------------------------|------------------|
| Schedule "A"               |                  | Schedule "B"               |                  |
| Central Standard Time (PM) | Frequency in kc. | Central Standard Time (PM) | Frequency in kc. |
| 8:00                       | 7,300            | 3:00                       | 30,000           |
| 8:12                       | 7,225            | 3:12                       | 29,000           |
| 8:24                       | 7,150            | 3:24                       | 28,000           |
| 8:36                       | 7,075            | 3:36                       | 14,400           |
| 8:48                       | 7,000            | 3:48                       | 14,300           |
| 9:00                       | 4,000            | 4:00                       | 14,200           |
| 9:12                       | 3,750            | 4:12                       | 14,100           |
| 9:24                       | 3,500            | 4:24                       | 14,000           |

Division of time  
 4 minutes—QST QST QST de W9XL W9XL W9XL  
 3 Minutes—Series of letter "d" with the dash about 5 seconds long and broken every half minute for station call letters.

1 minute—Freq \_\_\_\_\_ kc.  
 4 minutes—Time allowed to change to next frequency.

| Dates of transmission |          |          |          |
|-----------------------|----------|----------|----------|
| November              | Schedule | December | Schedule |
| 2nd                   | "A"      | 9th      | "B"      |
| 11th                  | "B"      | 14th     | "A"      |
| 16th                  | "A"      | 28th     | "A"      |
| 30th                  | "A"      |          |          |

All O.F.S. should use these transmissions to keep their frequency meter calibrations within the required limits of accuracy. It will be appreciated if you will send us a report on your reception of these signals.

—H. P. W.

# High-Frequency Receivers for the Coming Year

Incorporating Thoroughly Practical and Satisfying Selectivity, Open Scales, and a New Ease in Handling

By Ross A. Hull\*

*The A.R.R.L. Technical Development Program has now turned its attention to the question of receivers, and in this article Mr. Hull reports the very gratifying results which have been attained. Practical selectivity for 1929 has been secured; it is within the reach of every amateur. In tests of the 4-tube model described in this article, in the 7000-kc. band in the early evening hours, when on this coast the activity is great and the interference most intense, we have not found a case where we were willing to admit without reluctance that the signals were exactly "on top of each other". Its sensitivity has been equally pleasing, practically every American signal heard has been of loud speaker strength; most Australasian signals twenty feet from the phones and reduced to comfortable head-phone volume only by disconnecting antenna and setting volume-control at minimum. It is, we honestly believe, a real "hear-cut".*

*Mr. Hull has now covered the fields of transmitting, receiving and measuring. His articles enable every amateur to prepare for 1929 with minimum effort. Further developments will be reported soon.*

—Editor

**T**HE short-wave receiver has always been a subject on which two or more amateurs could argue for indefinite periods.

Indeed the subject has such potentialities for discussion that the individual amateur, unaided, can readily stir up a debate within himself and cogitate into the night upon the details of his next outfit. The receiver, unlike the other more inert apparatus, being so constantly under the demand of a knob-twisting operator, is a splendid comfort, if it works well, or a great curse if it operates poorly. There are few half-measures. It

is, perhaps, for this reason that the amateur, as a general rule, is so fixed in his ideas on the subject and so willing to argue until the bitter end in the interests of the

throttle control or left-hand tuning that he may have been using in his successful outfit. It is, furthermore, for this same reason that we

do not expect any of the three receivers, to be described, to excite the complete approval of any amateur. We do trust, however, that they will be accepted as examples supplied (as in previous apparatus evolved by the Technical Development Program) not to represent the acme of design perfection but merely to illustrate the practical application of features found desirable to meet the requirements of the coming

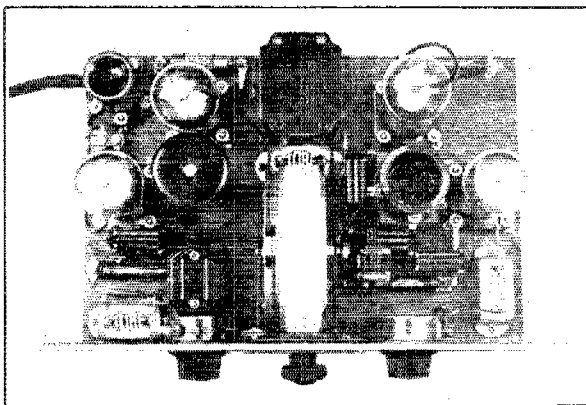

THE FOUR-TUBE RECEIVER

*Being provided with plug-in variable tuning condensers to give full-scale coverage on any band and a screen-grid audio amplifier highly peaked at 1000 cycles to improve selectivity, the receiver is particularly suited for the requirements of next year. To the right of the drum dial the screen-grid antenna coupling tube, the detector and the plug-in coil can be seen grouped near the midget tuning condenser. To the left of the drum dial the two audio tubes and the 1,000-cycle tuned coupling circuit are grouped in somewhat similar fashion. The Ford ignition-coil secondary used in this coupling circuit is enclosed in a tube shield. Immediately in front of it is the bank of fixed condensers used to tune it to the required audio frequency.*

year. It is thought that a study of the features of each of the receivers may facilitate the evolution of an outfit with a combination of desirabilities calculated by the individual to represent his idea of the ideal.

It is very evident, we believe, that the

\*Associate Technical Editor, QST. In charge A.R.R.L. Technical Development Program.

ideals and requirements of the present and those of the future are to differ widely in many respects. It will be well, perhaps, to make a brief review of them.

For the last few years the successful receiver has been one in which an oscillating detector fed an audio-frequency amplifier of one or two tubes. For the tuner some simple arrangement of plug-in coils has

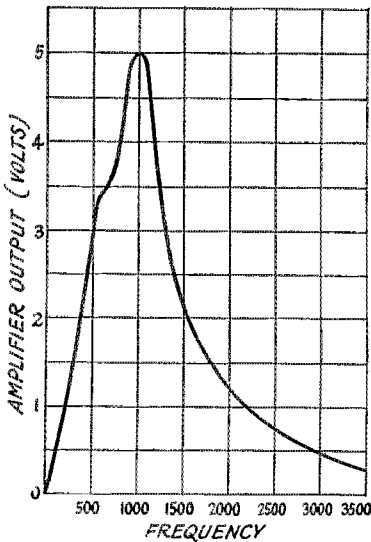

FIG. 1. A CURVE OF FREQUENCY VS. OUTPUT VOLTS TAKEN WITH THE THREE-TUBE RECEIVER

*The selectivity provided by a relatively broad peak of this type is all that is considered practical under present conditions. With the amplifiers described, much more pronounced peaks and greater selectivity can be obtained at will by the use of a lower-resistance tuned audio circuit.*

been required, together with a tuning condenser of sufficiently low capacity to enable the various bands to be fairly well spread across the dial. Since the edges of the bands have been harmonically related, a tuning condenser which gave full scale coverage for any one band has been satisfactory for all others. No particular demands have been made on the circuits of the detector tube except that they be so arranged as to avoid "hand-capacity" effects and permit the adjustment of regeneration without the accompaniment of too serious a variation of tuning. Though some slight interest has been shown in the use of audio-frequency amplifiers "peaked" at some audio frequency, the amplifier usually considered most successful has been that which provided the greatest gain. Since the advent of the UX-222, radio-frequency amplification has been exploited to some extent, but in most of the equipment described so far the constructional complications and the addition of a second major

tuning control have debarred the scheme from general adoption. Further, it has not been evident in practice that radio frequency amplification provides perceptible improvement in the range of the short-wave telegraph receiver, or in the ratio of signal to "background" noises.

#### THE NEW REQUIREMENTS

The reduction in the widths of our future bands and the addition of most foreign stations to them, make it clear at once that selectivity is likely to be one of the most important requirements of next year's receivers. It is certain that there will be many stations within a few hundred cycles of each other which, unseparable with present equipment, must be individually readable with the new receivers. Then, the odd widths of our various bands will introduce another requirement—that of adjusting the range of the tuning unit so that each band is spread across a wide segment of the dial. As has already been explained in the October QST, an ordinary variable condenser which tunes the new 3,500-ke. band across most of its dial would be unsuited for work on the higher-frequency bands since their entire territory would be cramped into some impossibly small slice of the condenser range. With open tuning scales will come another desirability—something approaching permanence of calibration. It will be a decided disadvantage if the tuning circuit, fitted with a suitably small variable capacity to place the limits of the band between 15 and 85 degrees of the dial, is influenced by the antenna to the extent common in most existing receivers, for it would then probably be necessary to wind and adjust the coils for the particular antenna available and amend them for use with any antenna of other dimensions. In present-day receivers where relatively large tuning capacities are used and in which the bands are rarely spread across the entire dial, the importance of this consideration has not been evident. And while we are remodelling our receivers we might well add to the purely "1929" requirements the existing (but rarely attained) desirabilities of freedom from microphonic and tuning noises, and smooth regeneration control without "dead areas" or appreciable influence on tuning. Then, along at the tail end we will mention the obvious requirement that sufficient sensitivity be maintained to enable the receiver to respond audibly to all signals which are not completely buried under the "background" of static and miscellaneous electrical "noises".

In examining the practicalities involved in the attainment of these desirabilities in the 1929 receiver it becomes clear at once that the prime requisite, high selectivity, is a concern of the audio-frequency amplifier. Unlike the broadcast receiver, the oscillating receiver has the selectivity of its radio-



frequency end set by the very heterodyne principle used in its operation. If it is oscillating at a frequency 500 cycles different from that of a c.w. transmitter within its range, a 500-cycle beat frequency will appear in the plate circuit of the detector; and no practicable amount of radio-frequency amplification would eliminate that signal or any undesired signal if its frequency differed from that of the oscillating receiver by a frequency within the limits of audibility. If, however, the audio frequency amplifier was so arranged or so equipped as to make it pass a band of frequencies only two hundred cycles wide at say 1,000 cycles, then all transmitters whose frequency differed from that of the receiver by more than 1,100 or less than 900 cycles would fail to produce signals in the output of the receiver. In other words, just so long as a group of transmitters had their frequencies separated by 200 or more cycles they could be tuned individually at the receiver to give a beat note within the pass band of the audio amplifier, and interference between them would not result.

There are few difficulties in equipping the audio-frequency end of the receiver to provide such a condition, as has been shown by Bourne in his treatment of Acoustic Wave Filters<sup>1</sup>, and, as far as the field of reception is concerned, a complete solution to the problem of selectivity is available. In the specific field of amateur communication, however, the solution is not nearly as complete. If the majority of amateur transmitters were 200 or more cycles apart, if their frequencies were constant and if they did not flutter, wobble and creep across territory measurable only in thousands of cycles, we could sit back and laugh at our problem. But such is not the case. Experiment has indicated that a receiver fitted with a band-pass filter to give it the selectivity available would cause a large percentage of present signals to be unreadable unless they were "followed" continuously with a precise vernier tuning control. An almost equal number of signals probably would be entirely unreadable on account of rapid frequency wobbles and keying chirps which would, in accordance with such frequency changes, intermittently wipe the signal out of audibility. Careful observation and estimation has caused us to decide that even with the vast improvement in signal character expected in 1929 it will not be practical to carry the selectivity of the receiver to the extremes possible. Rather will it be desirable, it seems to us, to limit the selectivity to something of the order of that provided by the four- or three-tube receivers described, an approximate idea of which can be obtained from the response curve given in Figure 1. In such an amplifier the necessary constructional

work and expense are far below those necessary for the acoustic or electric band-pass filters necessary to obtain the highest possible degree of selectivity, yet the simple amplifier provided will contribute greatly to the solution of the interference problem of the immediate future. It will be particularly suited also for operation with the highly selective band-pass arrangements which undoubtedly are to be used generally in the intermediate future.

#### "PEAKED" AMPLIFIERS

The method used to obtain the degree of selectivity considered desirable is none other than the ancient "peaked" or tuned amplifier which has been used for so long in some commercial and amateur stations. The scheme has been made much more effective and more useful, however, by util-

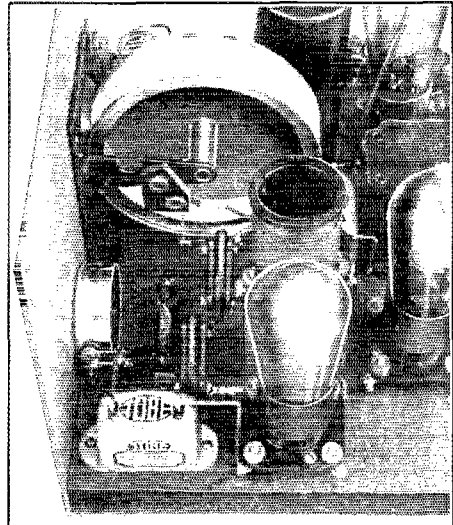

A CLOSE-UP SHOWING THE MOUNTING FOR THE PLUG-IN TUNING CONDENSERS

The drum dial used is seen to be particularly suited for the mounting of the plug-in condensers—even if it does dwarf them in size. Two G. R. sockets mounted on a piece of hard rubber are spaced so as to receive the two pins on the condensers. One of the sockets serves to hold the assembly to the frame of the dial and at the same time makes the ground connection from the condenser to the dial and the panel.

izing those characteristics of the screen-grid tube which have so limited its use as an audio frequency amplifier for the broadcast receiver. Unlike the three-electrode tube the voltage amplification of the screen-grid tube is dependent almost entirely upon the load impedance, and whereas there is an optimum practical value of load impedance for maximum voltage amplifica-

1. "Acoustic Wave Filters and Audio Frequency Selectivity," by R. B. Bourne, QST, August, 1928.

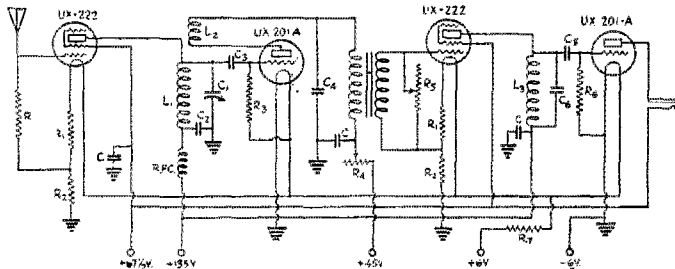

FIG. 2. THE WIRING OF THE FOUR-TUBE RECEIVER

The under surface of the wooden base-board is covered with thin sheet copper to which all the "ground" leads are run. This construction is preferable to placing the copper on the upper surface where it introduces difficulties in the insulation of components from it.

- C1—1- $\mu$ fd. by-pass condensers.  
 C1—Plug-in midget tuning condensers.  
 C2—4000- $\mu$ fd. fixed condenser. (see comment below).  
 C3—100- $\mu$ fd. grid condenser.  
 C4—2,000- $\mu$ fd. by-pass condenser.  
 C5—6000- $\mu$ fd. audio grid condenser.  
 C6—.01- $\mu$ fd. audio tuning condenser (experiment necessary)  
 R—10,000-ohm gridleak-type resistor.  
 R1—10-ohm Yaxley fixed filament resistor.  
 R2—5-ohm Yaxley fixed filament resistor.

- R3—6 megohm gridleak.  
 R4—50,000-ohm Frost variable resistor.  
 R5—200,000-ohm Frost variable resistor for volume control.  
 R6—6-megohm gridleak.  
 R7—Filament ballast resistor for .75 amperes.  
 L1, L2—Tuning inductance and tickler wound on plug-in coil form.  
 L3—The secondary winding of a Ford ignition coil—core and primary removed.  
 R.F.C.—Receiver-type short-wave choke.

Some difficulty may be had in adjusting the tickler turns due to "dead-spots". It is suggested that the capacity of C2 be varied if any such trouble is experienced. The use of a filament rheostat is made unnecessary by the incorporation of a ballast resistor. It is, of course, possible to use a fixed resistor or a rheostat in its place. Though a number of "grounds" are indicated on the diagram it should not be thought that these are "grounds" of the water-pipe variety. They merely indicate connections to the panel or copper sub-base. Ordinarily, no external ground is used.

tion with the three-electrode tube, the amplification available with the screen-grid tube will increase steadily as the load impedance is increased to the limits obtainable in practice. The tuned circuit at its resonant frequency becomes an impedance of a high order, permitting the tube, at this frequency, to provide a degree of amplification which could certainly never be approached with any tube of the three-electrode type. Hence, a tuned output circuit, in the plate circuit of a UX-222 resonating at, say, 1000 cycles, at once gives an effective and highly peaked amplifier. Reduced to a thoroughly practical form by the use of the secondary of one of Ford's now antiquated ignition coils as an inductance, and the elimination of possible screening (with some admitted sacrifice in performance) the arrangement is as shown in Figure 2.

In practice the amplifier operates splendidly, proving a high degree of amplification when the signal is tuned to the resonant frequency of the Ford coil-condenser combination (as can be seen from Figure 1) and dropping other beat notes of appreciably different frequencies to very low values

of audibility. This selection of signals of one particular frequency makes it difficult and sometimes impossible to read stations with chirpy or wobbly signals but in the case of the rapidly increasing army of steady clean-cut signals the improvement in readability through interference is at once obvious.

#### THE TUNER PROBLEM

To continue this examination of the requirements into the field of tuning systems we find that many solutions are available for the problem of providing a different order of tuning-capacity variation for the various band widths. The method which we have found most practical so far is that built into the four-tube receiver shown. It consists merely in the provision for plug-in midget condensers, of which there are three, each adjusted by the removal of plates to give

the capacity range found necessary for the bands on which they are to be used. The condensers used in this particular receiver are Pilot midgets, chosen on account of their satisfactory design and their particular adaptability for the process of plate removing. In order to provide the plug-in connections, G. R. pins are fitted in the manner shown in the photograph of the coils and condensers. For the rotor connection a complete G. R. pin replaces the short machine screw holding the spring contact to the end plate. For the stator connection a G.R. pin, the threaded portion of which has been sawed off, is sweated to the head of one of the machine screws supporting the stator assembly. To provide a mounting for the sockets into which the condenser is plugged, and to provide a readily accessible collar and set screw for the condenser shaft, a National drum dial was chosen. The exact arrangement of the hard rubber socket mounting on the frame of the dial can be seen in the photograph.

It should be pointed out, perhaps, that this is just one possible arrangement. It is to be expected that the ever resourceful amateur will soon evolve an alternative rig more suited to his own ideas and the apparatus at his disposal. The expected difficulties of movement of the condenser in its mountings and destruction of the calibration upon removal and replacement of the condensers have not been found in practice. With accurate spacing of the sockets, the G. R. pins hold the condenser with splendid rigidity, while calibration is restored, when the condenser is replaced, by the simple process of adjusting the condenser to its maximum setting (by pressing the fingers on the edges of the rotor and stator plates) and inserting it in the collar of the dial shaft with the dial set at 100 degrees. The six-plate condenser in its original form has been found satisfactory for the 1,750- and 3,500-kc. bands. For the 7,000-kc. band, two rotor and one stator plates are used, while for the 14,000- and 28,000 kc. bands a single rotor and stator have been found to give satisfactory coverage.

In the three-tube receiver the sliding rotor condenser, which was described on page 13 of the October QST, is employed to illustrate an alternative scheme. It has, in practice, also been found to be a thoroughly practical solution for the problem. On account of the existence of a description of the construction of the condenser and the method of adjusting it, no further details should be necessary.

#### A THIRD METHOD

In the two-tube receiver yet another alternative solution is incorporated for the purpose of illustration. In this case the usual tuning condenser of about 50  $\mu$ fds. is used as the tuning control with a 23-plate Pilot midget condenser connected in series with it and used as an adjustable series capacity to reduce to predetermined values the capacity range of the tuning condenser proper. With the midget set at its minimum capacity the range of the tuning condenser is reduced to the point where its maximum capacity is equal to the extremely small value of the two condensers in series (possible about 5  $\mu$ fds.). As the capacity of the adjustable midget is increased the capacity range of the tuning condenser is increased to the point where the midget is at its maximum. At this point the capacity range of the main condenser will be such that the resultant maximum capacity is of the order of 33  $\mu$ fds.

In operation the arrangement is beautifully flexible since the tuning range is continuously and readily adjustable to any of the values required for the work.

It is, perhaps, unnecessary to mention that this particular method is particularly useful in cases where it is not desired to rebuild an existing receiver entirely, the simple process of fitting a midget condenser being all that is necessary to adapt a receiver suited for the present bands for operation in the coming year. The

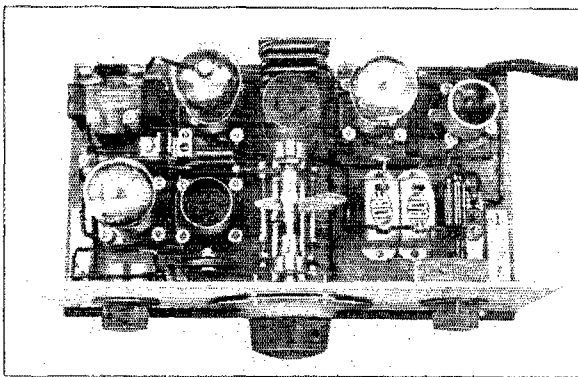

A PLAN VIEW OF THE THREE-TUBE SET

The use of a sliding rotor on the tuning condenser for tuning range adjustment and a peaked amplifier similar to that of the four-tube set make this receiver a practical one for next year's operation. The "tube-base" coil and detector tube can be seen to the left of the variable condenser. Immediately behind the condenser is the Ford coil secondary of the peaked amplifier. The tuning condensers across it are mounted on brass strips immediately behind it.

one slight disadvantage of the scheme is that the tuning curve of the condenser, be it straight-line-frequency or capacity, is disturbed. The straight-line-frequency condenser in the receiver illustrated, for instance, gives a curve somewhat similar to that of a straight-line-capacity condenser when the smaller values of series condenser are used. With the larger values of series condenser the curve departs only slightly from that of the tuning condenser alone.

In conjunction with these variable capacity systems, plug-in coils of the usual type are employed. In the four-tube receiver Silver-Marshall coil forms are used. On account of the small values of tuning condenser across the coils it will be found that their values differ somewhat from those with which we have become familiar. Also, on account of the small frequency range to be covered, and the desirability of placing this range between 15 and 85 degrees on the dial, it will be found that the number of turns is quite critical. It is for this reason that ready-wound coils are not likely to be suitable for the work without the addi-



tual voltage reaching the detector under such conditions is usually of the order of 8-10 volts. If the detector is to be operated at its rated voltage it is obvious that the 45-volt battery lead be used and the ticklers would accordingly to give oscillation at the mid-point of the variable resistor range.

THE AUDIO SYSTEM

The output of the detector is fed to the grid circuit of the UX-222 audio amplifier through an audio transformer of the usual type. Although a broadcast-receiver transformer with a particularly flat frequency characteristic is not necessary, the use of an Amertran or equally high-grade transformer will be found justified on account of the excellent gain provided by it. This does not mean, however, that the transformer used in any existing receiver would not be equally effective in this one.

In the plate circuit of the UX-222 audio tube is the tuned circuit, resonating at 1,000 cycles or some other convenient frequency, which is responsible for the peaked amplification and the improved selectivity of the receiver. The degree of amplification to be obtained with this tube and the sharpness of the peak are matters governed almost entirely by the impedance provided by the tuned plate circuit at the resonant frequency. The value of this impedance, in turn, is limited by the resistance of the circuit. To obtain the greatest peak and amplification, therefore, it would be necessary to use the lowest-loss inductance and condenser possible. Experiment with various forms of inductance (the characteristics of the capacity being somewhat set by the types of condensers available) has shown that an inductance of reasonably low resistance can well provide a peak much in excess of that considered desirable for practical purposes in the immediate future. The characteristic shown in Figure 1 is that obtained with a Ford coil secondary as the inductance, used for the definite purpose of broadening the peak and because of its general availability to the amateurs of any country. Most of the coils tried tuned to about 1,000 cycles by the connection of about .01 ufd. across them. In the four-tube receiver the bank of Sangamo condensers comprising this tuning capacity is mounted on two threaded rods to facilitate experiment with capacities of different values. The Ford coil is mounted by inserting a wooden dowel in the space left by the removal of the core and primary winding, and by attaching this dowel to the base-board with a wood-screw inserted through the base. In this receiver

an aluminum tube shield is inverted over the coil for the purpose of shielding. Its use, however, was not found to be essential.

Should it be desired to produce a sharper peak than that provided by the Ford coil it would be necessary merely to use an inductance of lower resistance. One inductance used in our work (which incidentally gave a peak far too sharp to be practicable for general reception) consisted of

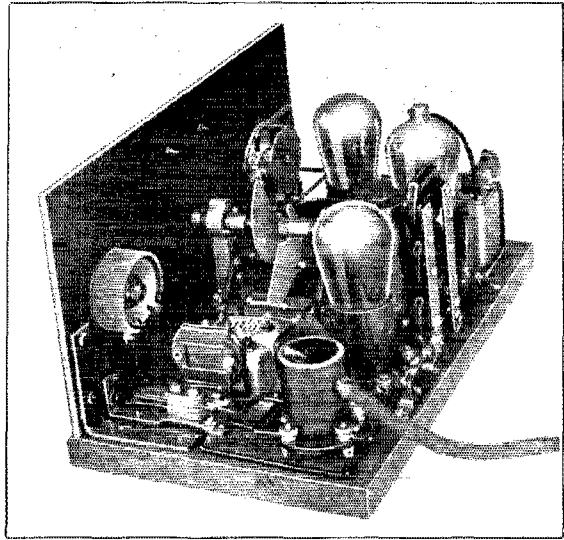

ANOTHER VIEW OF THE THREE-TUBE RECEIVER  
The simple and conventional practice of screwing all apparatus to the base and connecting everything with bus bar has been adhered to.

3,000 turns of 30 gauge s.s.c. wire "scramble"—wound in five 3/4"—square slots turned in a wooden former 2" outside

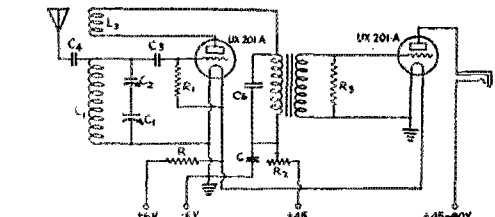

FIG. 4. THE SIMPLE WIRING OF THE TWO-TUBE SET

- ✓ C — 1-ufd. by-pass condenser.
- C1 — 50-ufd. tuning condenser.
- C2 — 25-plate (approx. 100 ufd.). Pilot midget.
- C3 — 100-ufd. grid condenser.
- C4 — Antenna coupling condenser—two 3/4" square plates about 1/2" apart.
- C5 — 2,000-ufd. by-pass condenser.
- R — Half-ampere ballast resistor.
- R1 — Gridleak, 2 to 4 megohms.
- R2 — 50,000-ohm variable resistor.
- R3 — 0.1-megohm resistor.
- L1, L2 — Coils similar to those used in three-tube set.

diameter. About .07 ufd. was found necessary to tune this to 1000 cycles. Ex-

periment with other forms of inductance will be found of great interest and value.

The fourth tube of this receiver is a 201-A arranged in the normal fashion. This tube is not necessary to provide am-

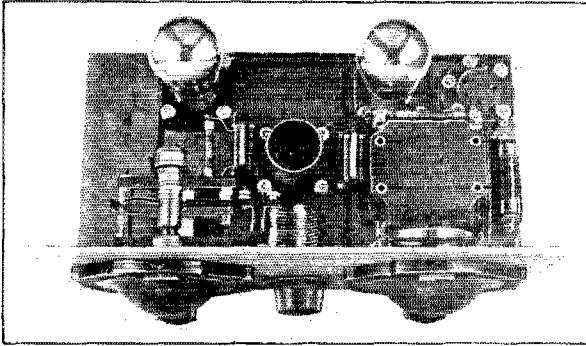

THE TWO-TUBE PHONE RECEIVER

The feature of adjustable tuning range is obtained in this set by the use of a midjet condenser in series with the tuning condenser. The value of this method, as described in the text, is in the possibility of its use to convert an existing tuning system for 1929 use by the simple addition of a midjet series condenser. The usual type of audio-frequency amplifier shown in this receiver will still be necessary in receivers to be used for phone reception.

plification additional to that already available, but is essential to provide a satisfactory output circuit since the phones

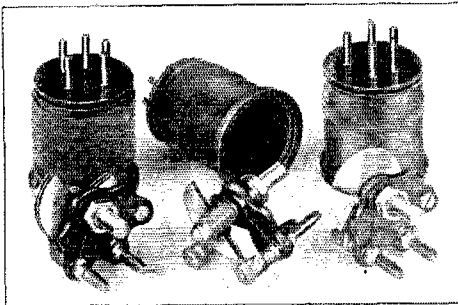

COIL-CONDENSER COMBINATIONS FOR THREE BANDS

Differing from present day practice a separate tuning condenser is used with each inductance in the four-tube receiver to give full scale dial coverage for each band. The grid coils are wound with 20-gauge d.s.c. wire on Silver-Marshall coil forms. As a rough guide it can be said that 8 turns are used for the 14,000-ke. band; 14 turns for the 7,000-ke. band; 31 turns for the 3,500-ke. band. The ticklers found suitable are of 30-gauge d.s.c. wire, 5 turns being used for 14,000-ke., 7 turns for 7,000-ke. and 9 turns for 3,500-ke. It is almost certain that these figures will vary in individual receivers.

could not be operated in the plate circuit of the UX-222. The enormous amplification provided by the two audio tubes makes the use of a volume control essential.

The UY-type socket and UY tube base

to be seen at the extreme left rear corner of the base are used to make all battery connections. An ordinary battery cable is led into the tube base through a hole in one side and the leads soldered to the various pins. The arrangement has been found surprisingly convenient from every possible aspect, and never again will we be guilty of using a string of binding posts unnecessarily monopolizing a long strip of bakelite.

We hesitate to make any mention of the performance of these receivers on account of the many factors which influence it, and because of the possibility of arousing expectations which may be beyond fulfillment in individual cases. We do believe, however, that these four tubes are truly worth while and that the available sensitivity, selectivity and amplification are equal to any reasonable demands that could ever be made on them. In addition, we think that the receiver is particularly suited for the requirements of the future, having provision for tuning range adjustment which would adapt it to any desired frequency band, and having an amplifier which, with simple amendment, could be given any increased selectivity which may be made practicable by wide improvement in the emissions of amateur stations.

#### THE THREE-TUBE SET

In the three-tube receiver, as can be seen in Figure 3, the antenna coupling tube has been eliminated and the usual capacity coupling scheme incorporated. This means the sacrifice of some sensitivity and an increase in the influence of the antenna over tuning calibration. The latter can, however, be reduced greatly by mounting the antenna coupling condenser as close as possible to the grid of the detector tube, and by reducing its capacity to the lowest value consistent with reasonable signal strength. The importance of the placement of this condenser is not, we believe, fully appreciated. Experiment has shown that the connection of the condenser in the antenna lead about six inches from the tube grid terminal can result in serious "hand-capacity" effects and a pronounced increase in the reaction of antenna changes on calibration.

The tuning circuit comprises the "sliding rotor" type of condenser mentioned previously, and "tube base" coils, while the audio amplifier consists of two tubes—a UX-222 and a UX-201-A arranged in the same circuit as that employed in the

four-tube set. The differences in the mechanical arrangement of the apparatus can be seen from the photographs.

FOR PHONE WORK

The two-tube receiver is presented chiefly to illustrate the use of adjustable series capacity to vary the capacity range of the tuning condenser. It is also intended to illustrate the single stage of flat-frequency-characteristic audio amplification which will still be desirable for the reception of amateur phone or short-wave broadcasting. The circuit is shown in Figure 4. The series midget condenser is controlled by the knob in the center of the panel, its positions for the various bands being determined by experiment and marked on the panel. The adjustment of this condenser will be found quite critical if it is desired to restore the calibration of the main tuning condenser when a change is made from one band to another, but this process is simplified very greatly by noting the dial readings for the commercial crystal-controlled stations at one edge of each

soda and brushing it with a very thin coat of Duco clear lacquer.

In the construction of these three receivers no attempt was made to break away from the conventional method of screwing all the gadgets on a base and connecting them together, for we have the idea that there are very few departures from this standard amateur practice which warrant the complications involved by them. In fact, in all the work a definite effort was made to avoid any departure from the simple methods of the present day unless they possessed a definite practical value. We have had at our disposal scores of unusual circuits and arrangements, the merit of which was in their novelty. They were unused, however, because it is our opinion that the practicality of any scheme, in amateur radio, is at once questionable if it involves a sacrifice of simplicity.

**Strays**

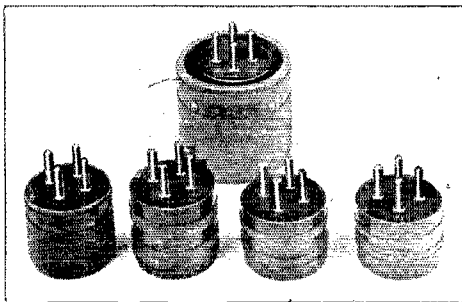

THE TUBE-BASE COILS USED IN THE THREE- AND TWO-TUBE RECEIVERS

Both grid coils and ticklers in these coils are wound with 24-gauge d.s.c. wire. The numbers of turns used are as follows:

| Band       | Grid Turns | Tickler Turns |
|------------|------------|---------------|
| 1,750 kc.  | 49         | 3             |
| 3,500 kc.  | 32         | 7             |
| 7,000 kc.  | 15         | 6             |
| 14,000 kc. | 6          | 3             |
| 28,000 kc. | 3          | 3             |

No spacing is used between turns except in the grid coil for 28,000 kc. where the spacing is 1-8". As can be seen, the 1715-kc. coil is wound on a 2" diameter bakelite tube mounted on a tube base.

band. Then, when the coil has been changed in moving from one band to another, it is merely necessary to set the tuning dial at the place where the "marker" station should appear and adjust the midget until it does. At this position the calibration will have been restored.

In all three receivers the panels were cut from 1/8" thick aluminum sheet. A pleasing finish was obtained by stripping the surface in a strong solution of washing

One of the snootiest methods of mounting the League Auto Emblem we've run across is that of cementing the emblem to the inside of the wind-shield or rear window. The scheme is to remove the eyelets from the emblem, smearing it evenly with DuPont or some other good glass cement and, when the cement has become tacky, press it firmly to the cleaned glass surface. Considerations of visibility make it desirable that the emblem be located on the passenger side of the wind-shield at the lower corner though a position at the lower center of the shield also might be practical. The genius behind the scheme is Meserve of 1FL.

-----

August McCollom, 9BQW-9HS, though blind, is an ardent and successful amateur. Since 1925 he has been on the air, during the summer at his home station 9BQW at Dodge City Kansas and during the remainder of the year from 9HS at the State School for the Blind at Kansas City, Kansas. A CX-310 supplied from a storage battery-driven 400-volt dynamotor is used at the latter station, while at 9QW an 852 does the oscillating. R7 signals have been put into Australia with it. McCollom is able to copy signals with a typewriter but, being unable to read the typing, all traffic is handled in Braille. In this manner he has been able to QSR as many as forty-five messages in a week. 'Taking it all round there is nothing unusual about my amateur activities', says McCollom. 'I build my sets and blow my tubes just as you fellows do.'

## sj5BX

A True "Now-It-Can-Be-Told" Story that Unravels One of the Recent Mysteries of Amateur Radio

By Clair Foster\*

**H**ERE, you fellers who were so curious about sj5BX, the mystery station of last winter, here's your dope. His feet are now back on the soil of U.S.A. and it's safe to tell it. He had literally to shoot his way out; but he's out.

In November, 1927, I received a long letter with a Central American stamp from a chap named Haskell Watson. That's his real name. He was on an expedition. The letter was accompanied by photos and sketches depicting his location at the bottom of an extinct volcano. This old crater was narrow in both directions and the walls in most places were sheer 3000 feet. The letter contained also a list of the radio parts he had on hand. He had built one short-wave transmitter; but he hadn't been able to work anybody and had about come to the conclusion that he had been trying to transmit out of the bottom of a well 3000 feet deep and that it just couldn't be done.

He had other troubles, believe me. He was in a brigand-infested district. It was cold then up on the mountains and some of the brigands used to stick around his camp where it was warmer. He had reason to believe that some of his own helpers belonged to the gang. A guy came in on him one day while he was building his transmitter, and surmised that it had something to do with this radio stuff that the natives had been hearing about. This didn't look so good to a gentleman who didn't desire his whereabouts to be broadcast, so he ordered Haskell to smash it up. Haskell finally convinced him that he knew nothing about radio, that this was a scheme he was experimenting with for assaying minerals. This placated the old boy; but thereafter Haskell kept a sharper watch through the telescope he had trained on the only entrance to the crater. There was only one way to get down; and after anyone was seen coming over the rim Haskell had an hour to hide his stuff. After finishing the set and after trying for many days to work somebody, he decided that what he had told the brigand was no lie.

I had never heard of Haskell before the receipt of his letter. He had been in the war, overseas, from Texas. He had been a ham before the war but out of the game

since. Three of his friends in Texas had wised him up considerably on short-wave apparatus. In the use of a .45 pistol he needed no instruction; all he needed was practice, and he got plenty of that down in the volcano. The natives engaged in the chief industry of the district packed plenty of hardware, but, cartridges costing a dollar apiece in their money, they did no practicing—a circumstance that saved Haskell's life on more than one occasion. He and his friend, Paul, the only other white man in the party, had plenty of ammunition. They shot wolves on the run and eagles in the air, partly for practice, largely to keep the natives in a proper frame of mind. On the whole, from things I have since learned and from things he himself has let slip, I gather that sj5BX is pretty hard-boiled.

Now back to that letter. It came while Ralph Heintz, 6XBB, was spending a weekend at 6HM. If you don't know Ralph from his accomplishments let it be said here that he is as far on the plus side of radio as your Uncle Dudley is to the negative. That implies a world of wisdom. Haskell's material was passed across the table to Ralph. Ole Ralph spit on his pencil and commenced forthwith to scatter Haskell's apparatus over a sheet of paper, doubling up on some parts to get the required values and adapting others. When he had arrived at the best he could do with the parts Haskell had on hand he drew out a radiating system and specified how far it must be located from a sidewall of the crater. "Now," he said, "send your friend this dope and I think he'll get his signals out of that hole." I hadn't told him that Watson was a stranger to me, or that in advising him we might be guilty of compounding a felony. In that country no one is allowed to transmit and you can't even get permission to listen.

Haskell had said that he was signing the call DON. I told him to locate if possible a little below LP1, down among the Australians. In about three weeks I commenced to watch for this DON, with a d.c. note from a 50-watt and dynamotor. And about that time I had to go to San Francisco. Fred Roebuck, (old KFUH), there at 6ARD, said, "Say, have you heard a station signing sj5BX? Where the dickens would that be? There isn't any such intermediate." Herbert Breuer, 6JN, was with us, and we all did a lot of surmising. The next day, just as I was about to leave the

\*W6HM—W2QW, Carmel, California.



hotel for home, Herbert called up with, "Hi! I worked that sj5BX last night! And guess where he is. On Pablo Island, at 90 degrees West and 6 degrees South of the equator." And told me where to look for him. When I reached home I soon found sj5BX, working a Six and giving that same QRA. Also telling the Six, "Not much use sending a card, Old Man, because ships come here only about once a year. Will QSL later." I couldn't find any Pablo Island, or any other kind of an island, at the position named—which would be about 500 miles off the coast of Peru. Then down at our village post-office I met a man who had just been living in Peru. He had never heard of such an island. I explained what the intermediates were for, and that there was no such intermediate as SJ in use. "Oh," he exclaimed, "now I think I can straighten you out on that. The old name for Peru was Juinan." (I leave the pronunciation to those of you who are familiar with Spanish. Those who are not would better leave it alone. It starts with a noise like blowing your soup. Or if you plead not guilty, try, it with the first note of the hoot-owl.) This man said that many of the old-timers refused to use any but the old name, and that this sj5BX was doubtless of one of the old aristocracy of Peru. So that straightened me out fine. And I was just pluming myself over being able to show the boys the breadth of my knowledge when I noticed among the letters I was holding in my hand one with a foreign stamp. These a ham always opens first. "I was afraid of that DON call. It sounded suspicious. So I decided to use a ham-sounding call with an intermediate that nobody could locate." And then the mystery of Pablo Island really was solved. But after that I told many a feller why this old moss-backed Peruvian insisted upon using SJ instead of SP.

Some of you who worked this station will recall that frequently there was a YL at the key. Haskell had taught her the game, and had refused to let her operate the set until she had become letter-perfect. He had done such a fine job with this pupil that he broke his own nose, for she was a dandy operator—better than Haskell. She is a relative of his by marriage, being his wife. And how she did like to bawl a feller out for sending double, or for sending slowly when he could go faster. She was the Helen Wills of the key and you didn't have to soften your game for her! You

fellers who worked sj5BX when she was operating will be sorry that you didn't QSO oftener when I tell you that she is as fine looking as she is fine. It is too bad that the foto I have of her and Haskell is not sharp enough to reproduce with this story. They are both well worth looking at.

Aside from the purely radio features of this tale there is enough of the dramatic and human interest in the doings at sj5BX to fill a book. Goodness knows, it is interesting enough to think of transmitting from the bottom of a hole 3000 feet deep. They came near to working all continents.

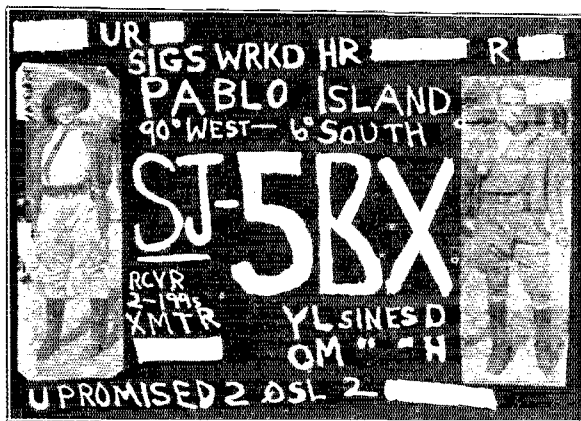

THE QSL CARD OF sj5BX

Home-made, photographically, with a snap of the YL on the left and of the OM on the right. Haskell made only ten of these cards because he says, "Each one we made took about half an hour, and besides that's enough for one for each district and for a special friend or two."

They would have done so with a little more time. For example, they would have if foASV had been able to get them thru his QRN the night I had him on Haskell's trail. The story of Haskell's trip out of the crater for some dynamite that he bought from brigands who had taken it in the hold-up of a mine, and the things that happened on his return with this stuff loaded on three burros (there were three when he started) would make a thrilling tale all by itself. Or an account of the time when two bad eggs started to shoot up him and Paul one dark night just outside their camp, and ended by going to—wherever it is that assassins go. Or the time when another of these gentry tried to kill the house-servant, and had to be dissuaded permanently. Or the time when Donna and Haskell were all alone and were pounced upon by nine. This last fracas I think I must tell you about, because it is this one that ended the career of sj5BX, and you will want to know how the finish came about.

The Watsons had a parrot from which they were only semi-detachable. I think it was a YL parrot, because it used to sit on Haskell's knee and pull the buttons off his coat. She was devoted to amateur radio—all same QST. Just couldn't keep away from the shack, even when nobody else was there. There were so many nice coils and dials to chew on. That's why you seldom found sj5BX twice in exactly the same spot. And while operating was going on she was doing Babe Ruths around the table and over the operator's shoulders. Once while QSO I got a hurry call to QRX while the parrot was being revived. She had got against the plate coil (TG&P, series feed) and hit for a three-bagger. The air was full of blue language and green feathers.

Well, one bright afternoon of a lazy June, Haskell and this YL parrot were sitting peacefully on the porch of their little camp at the bottom of this extinct volcano, telling one another whom they were going to work that night, when all of a sudden it didn't seem quite so darned extinct. Nine gentlemen, dark-complected on the outside and all the way through, appeared suddenly with their hardware erupting in the general direction of the Watson family. Watson et Ux, always living a life of preparedness, got into action, Donna acting as **gunbearer** and passing the loaded pistols while Haskell did the shooting. When the smoke finally cleared away two of the dark-complected gentlemen were dead, others were wounded, and the two Watsons were overpowered. As to the YL parrot I am not informed. I think she fainted.

Donna and Haskell were roped up too tight for comfort and cached temporarily in an adobe hut to ponder on the vicissitudes of ham radio. The one thing that they seemed surest of was that after nightfall they would be taken out and shot. But, just to show that you can't keep a good ham down, what happened when darkness came was that a faithful servant—the one who had been rescued when the bad egg was going to kill him—cut the prisoners loose and guided them out into the bush where he had saddled and hidden their horses. They spent seven days getting out to the nearest town over a bandit-ridden trail, riding and walking hours on end in the pitch dark to avoid being seen. They saved nothing except what they had on and enough money to buy two cans of sardines from a native. These sardines and three quail that Haskell shot with a pistol were all the food they had on this ride. And from what I've seen of the amount of stuff that hams can put away at a hamfest I'll say that this picture hits you fellows in a

tender spot. At this town they had thought they would be safe, but they found that the news of the rumpus had preceded them and that they were being accused of murdering these men in cold blood. The prospect of being thrown into a filthy jail to await the decision of the law of a lawless land didn't appeal. A stranger, a fellow American, gave them some money and then beat it out of town himself. They hired a Chevrolet truck and an armed guard of eight men. With these they slipped out in the night, headed for a larger town. Most of the eighteen hours of that journey was spent in pushing the Chevrolet over a trail that a jackrabbit couldn't have traversed under his own power.

Having had to bribe so many "officials," they arrived in this town again broke. But another good American came to the rescue and they reached the coast and a ship. Eventually they landed where a ham gets a square deal from his government; where 16,000 amateurs were dispossessed of their earned and rightful place on the air by the adroit maneuvering of foreign governments and a comparatively small number of money-seeking commercial interests, but at any rate a country where a ham need not fear going to jail.

Now as to the ethics of the situation; as to the conduct of Haskell's ham friends who were in the know and who had kept his expedition in touch with the outside world: The American Radio Relay League will doubtless disagree with us, for A.R.R.L. is a stickler for the niceties of ham behavior. But this was not just a case of hamming for amusement. Many vital commissions were executed for sj5BX that could not have been handled thru a telegraph station and post-office six hazardous days' ride from him; where all mail and messages were scrutinized, and even their delivery at times denied thru the ignorance and suspicion of officials. I'll say that, when two fellows and the game wife of one of them, go on an expedition that has a perfectly legitimate and laudable aim, into a country where the laws are hand-made from day to day by whatsoever brigand or grafter happens for the time being to be in control, a country so ignorant of the uses of radio that its purposes are regarded as wholly sinister, where large murders for small gains are the rule—I'll say that the ham who had refrained from doing his utmost to aid these people should be read out of any society where there exists a consciousness of right.

Adios, sj5BX. You are a fine guy and a brave gentleman. And so's your OW.

# Frequency Stability by Magnetostriction Oscillators

By Harold P. Westman, Technical Editor

**P**ROF. G. W. PIERCE of Cruft Laboratory at Harvard University has published a paper entitled "Magnetostriction Oscillators" which deals with the magnetostrictive characteristics of certain materials and their application to the stabilization of the frequency of oscillations generated by a triod. This article is based upon the material appearing in that paper.

Like quartz plates, magnetostriction oscillators are dependent upon a mechanical vibration for their stability and although it is not possible to obtain satisfactory output at extremely high frequencies such as may be obtained with the piezo-electric oscillator, it is possible that with the development of suitable frequency multipliers that magnetostriction oscillators may some day be of extreme value in amateur work. Magnetostriction deals with mechanical deformation of certain materials when they are subjected to magnetic fields either of constant or varying strength. If for instance, we take a rod of nickel and subject it to a constant magnetic field of 1 gauss, we find that its length has been shortened by about one millionth. This change is extremely small because it must take place against the enormous elastic force of the material. If, however, the magnetic field is not constant but is made to vary in an oscillatory manner at a frequency equivalent to the resonant period of the rod, the deformation of the rod will be much greater because it does not then take place against the elastic force of the body but is opposed only by its viscosity or ability to yield continually when under stress. Under the varying magnetic field, the mechanical lengthening and shortening of the rod may reach a value as great as 100 times that observed with the field constant.

This effect, as one would suspect, works two ways and if we stretch or compress a magnetized rod, we will find that its magnetic field has been altered. The deformation of a rod under a magnetic field may be considered as the direct effect while the change in the magnetic field due to a mechanical deformation may be considered as the inverse effect.

In order to take advantage of these small effects, it is necessary to use a

vacuum tube and thus obtain enough amplification to allow sustained oscillations to be produced. Figure 1 gives a schematic diagram of the circuit employed. The rod is placed within two coils and rests at its center on a blunt pivot. It does not have to be critically balanced and may even be tightly clamped at the center if that is desired for any reason.

One of the coils is in the grid circuit while the other is in the plate circuit, much

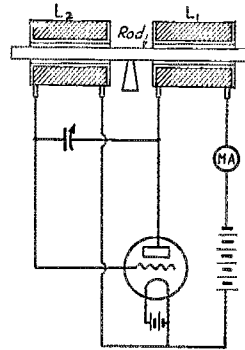

FIGURE 1. THE CIRCUIT ARRANGEMENT FOR OBTAINING MAGNETOSTRICTION CONTROL OF FREQUENCY. The rod rests on the blunt pivot between the coils.

as in the split-coil Hartley arrangement. However, one of the coils is reversed so that feedback from the plate coil to the grid coil without the aid of the rod is not in the proper direction to cause oscillations to be produced. It is possible, though, under certain conditions to cause such a system to oscillate without the use of the rod and as this is not damaging to the stability of the arrangement, it is unnecessary to take precautions to avoid such conditions. A condenser is shunted across both the coils so that the circuit may be adjusted to have a frequency of oscillation equivalent to the period of the rod employed.

Let us assume that the electrical circuit is so adjusted that it is not oscillating of its own accord (without the rod) but that if it did oscillate, it would do so at the same period as the rod. The rod is placed within the coils and the filament of the tube lighted. The plate current will increase as the filament emission becomes greater and this current flowing through the plate coil will cause a magnetic field to be set up about the coil. This magnetic field will act upon the rod and

1. *Proceedings of the American Academy of Arts and Sciences*. Vol. 63, No. 1. This publication may be obtained from the Library of the American Academy of Arts and Sciences, 28 Newbury Street, Boston, Mass., for \$90.

cause it to be deformed (either lengthened or shortened). The deformation will not occur instantaneously along the entire rod but will travel along the rod at a definite speed depending upon the hardness of the material of which it is composed. When the deformation reaches the end of the rod that is within the grid coil, the inverse effect will take place and the magnetic field surrounding the rod will be varied because the physical dimensions of the rod have been altered. This change in magnetic field will effect the grid coil and induce a voltage therein which will be applied to the grid of the tube. This voltage applied to the grid will be amplified and will result in a change in the plate current which will start the cycle again by causing a change in the magnetic field around the plate coil through which it flows. In this fashion the circuit is made to oscillate at a frequency that is dependent upon a longitudinal or lengthwise vibration of the rod, the frequency of which will be controlled by two factors, namely: the length of the rod and the speed at which the deformation is propagated along the rod. This last mentioned factor may be controlled by the choice of the material employed and varies with the velocity of sound in the material. In general, the harder the material, the higher will be the velocity of sound through it and the higher will be its natural period of vibration.

In order that oscillations be produced, the rod must be magnetized and the varying magnetic field is superimposed upon the steady one. This will result in an increase in the magnetization of the rod when the varying field is in one direction and a decrease when it is in the reverse direction. If the rod were not magnetized to start with, the varying field would not cause an increase and decrease but would result in only an increase (or decrease) which means that the length of the rod would increase (or decrease) twice for each cycle rather than give *both* an increase and a decrease for each cycle which is desirable.

The rods may be permanently magnetized by inserting them into a solenoid and passing a heavy direct current through it. The field due to the direct plate current will aid in keeping the rods permanently magnetized and when in this condition the rods should be marked so that they are always inserted in the same direction. It should be unnecessary to have to remagnetize them as most materials will hold their magnetization in spite of the effect of the varying field in which they are operated. At all times, the steady field should be greater than the varying field.

In materials that have but little ability to hold their magnetism, the steady field may be obtained from a small permanent

horseshoe magnet which is placed near the rod. It is not necessary or desirable to have the permanent magnet touch the rod and it may be located several inches from it.

In Figure 2, some experimental curves taken on a rod of Nichrome are illustrated in the circuit arrangement shown in Figure 1. The upper curve shows the change in wavelength obtained for a given rotation of the tuning condenser shunted across the coils. The rod was first held to prevent it from vibrating and the curve ABCDE was obtained which indicates a change in wavelength of from 16,000 meters at 19 degrees of the condenser dial to 19,400 meters at 30 degrees or a change of 3,400 meters for a dial rotation of 11 degrees.

Next, the rod was allowed to be free to vibrate and the condenser rotated from a low reading towards maximum. The curve ABCD'E was then obtained and it will be noted that over portion indicated by D' there is no readable change in wavelength. The condenser was then rotated from maximum towards minimum and the curve EDCB'A resulted. This shows a constant wavelength along the portion of the curve B'. After the rod has started to vibrate it is possible to vary the condenser from 18 to 30 degrees without shifting the wavelength. Thus, over a range of the condenser that gives a wavelength shift of 3,400 meters without the rod, there is no readable wavelength change when the rod is in vibration.

It was impossible to read any shift of wavelength along the stabilized portion of the curve when a precision wavemeter was employed as the measuring device and so some other method must be used to show how much the frequency does vary. Another magnetostriction oscillator was set up and a rod having a frequency of about seven times that of the rod under test was set vibrating. The seventh harmonic of the rod under test would then beat with the fundamental of the second oscillator and a change of one cycle in the test oscillator would cause a change in the beat note of seven cycles. The beat note could be measured to about one cycle which would be equivalent to a shift of but one seventh of a cycle of the rod under test. As will be seen by the second curve of Figure 2, a change of the condenser from 19 to 30 degrees with the rod vibrating causes frequency change of only 1.5 parts in 17,000.

The lower curve of Figure 2 indicates the change in plate current as the capacity across the coils is varied. As the capacity is increased from a low value, the current follows the solid line and when the reverse rotation takes place the current varies as shown by the dotted line. The jump in current of two to four milliamperes takes place as the rod starts to vibrate and the smooth tapering of current as the conden-

ser is reduced towards 18 degrees is due to the fact that the particular circuit conditions caused the electrical oscillations (those not due to the rod but to the electrical circuit alone) to stop when the value of the condenser was less than 18 degrees. Otherwise, the characteristics shown at the higher capacity setting portion of the solid line curve would be duplicated at the lower capacity end of the dotted line.

It must be remembered that in the measurements just cited, the capacity across the coils was varied over a wide range to cause as large a change in frequency as possible and that in actual use, the capacity will always be set at a value that gives the highest plate current. It will, therefore, be possible to obtain a much higher degree of precision in the resetting of the equipment than the possible error shown by the curves might indicate.

We may regard the operation of this system over that portion of its range where frequency stabilization takes place as being equivalent to an inductance-capacitance circuit in which the inductance varies enormously with a change in frequency. We may represent the wavelength-against-capacity curves of Figure 2 by the following equations:

$$\lambda_d = 2\pi\sqrt{L_d(C+C_a)} \text{ for the damped curve}$$

$$\lambda_r = 2\pi\sqrt{L_r(C+C_a)} \text{ for the free curve}$$

from which we obtain

$$\frac{\lambda_r^2}{\lambda_d^2} = \frac{L_r}{L_d}$$

Figure 3 gives the values of this ratio plotted against frequency from which it appears that the change in inductance of the coil and free rod is about 50% for a change in frequency of less than 1/100 of 1% over that range in which the stabilizing action is operative. We may, therefore, consider that if the capacity across the coil is reduced, the shift in frequency causes an increase in the inductance of the rod and coil so that the product of the inductance and capacity is almost the same as it was before the change was made. Likewise, any increase in capacity will cause a decrease in inductance to an amount that will still compensate and the product of  $L \times C$  will be nearly constant. Thus, if the rod is not used, a change in capacity of 50% will result in a frequency change of 25% whereas with the particular rod under test, this change of capacity results in a frequency change of but 1/100 of 1%.

The comparison was made between the rod and a quartz crystal mounted in a vacuum and held in an accurately designed and carefully machined mounting. Repeated measurements indicated that when this crystal was operated under constant conditions, which must be very carefully

checked, that an accuracy of frequency of 1/500 of 1% could be maintained. However, when the circuit conditions for the crystal are changed over as great a range as indicated for the rod, the frequency of

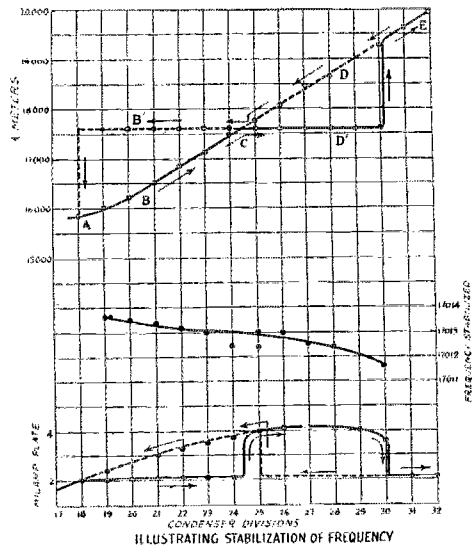

FIGURE 2. THE UPPER CURVE SHOWS THE STABILIZING EFFECT OF THE VIBRATING ROD WHEN THE ELECTRICAL CIRCUIT IS DETUNED AS COMPARED WITH THE ELECTRICAL CIRCUIT ALONE. The second curve shows just how much the frequency does change when the electrical circuit is detuned and the rod is vibrating. This curve is equivalent to the horizontal portion of the upper curve very greatly amplified. The lower curve shows the behavior of the plate current of the tube as the rod starts to vibrate.

the crystal would vary as much as 7/100 of 1%. Thus, the magnetostriction oscillator shows greater constancy under widely varying conditions than does the piezo-electric plate.

The particular Nichrome rod under test showed a variation of 1/93 of 1% for each degree Centigrade change in temperature which is not as good performance as is obtained with the crystal, which changes between 1/200 to 1/1000 of 1% per degree Centigrade. However, by the proper choice of materials it is possible to construct rods having as good a temperature coefficient as is obtained with the crystal. In any case, it is only necessary to know the temperature in order that the proper correction factor may be applied. The effect of temperature is not permanent and rods calibrated at a definite temperature will hold their calibration as long as they are operated at that temperature even though their temperature may have varied considerably in the meantime.

There are various materials that may be

used and the main requirements are that they have large magnetostrictive effects, that their frequency of vibration stay constant in spite of varying temperature and magnetizing force and that changes in the condenser settings, tube characteristics and plate and filament currents shall cause but small change of frequency.

Pure iron and irons with various carbon contents are not suitable because the magnetostrictive effect is very small. Pure nickel is a very active vibrator but its period of vibration will change when the electrical circuit is detuned.

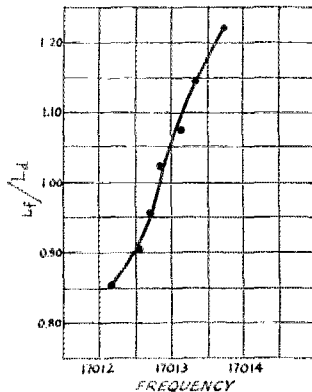

FIGURE 3. THE RATIO OF THE CHANGE OF INDUCTANCE PLOTTED AGAINST FREQUENCY.

Certain alloys of nickel and iron are good vibrators and those having about 36 percent nickel and 64 percent iron, which is about the constitution of invar and stoic metal, are good. Unfortunately, though, their change of frequency with a change of temperature is rather high.

Nichrome and other alloys of chromium, nickel and iron are good vibrators. Perhaps commercial Nichrome is one of the best of the more easily available materials for many purposes.

Monel metal containing 68 percent of nickel, 28 percent of copper and small amounts of iron, silicon, manganese and carbon is a very powerful oscillator but usually requires an auxiliary polarizing device because of the small residual magnetism.

Alloys of cobalt and iron are strong vibrators.

Tubes of nickel may be used for qualitative work, demonstration purposes and for sources of sound and while they are good oscillators they are not so constant in frequency as might be desirable. Such tubes may be wholly or partly filled with lead or type metal which will result in their period of vibration being materially lowered. This

is due to the fact that the velocity of sound in lead is low. By this means it is possible to obtain rods of low frequency without the use of an excessive length.

Composite rods may be used in order to reduce the effect of temperature upon the frequency of vibration. If a tube of nickel which has a negative temperature coefficient has inserted within it a tightly fitting core of a material such as stoic metal which has a positive temperature coefficient, the resultant rod may be made to be practically independent of temperature. These rods are concentrically composite.

Another type of composite rod consists of three rods soldered end to end. The center section is of a material having a coefficient of one sign while the end sections are of a material, the coefficient of which is of the opposite sign. These rods are longitudinally composite.

The frequency at which the rod will vibrate depends upon its length and upon the material of which it is composed. The following table gives the length and frequency of some stoic metal rods which are 0.79 cm. in diameter. The temperature is 20 degrees Centigrade.

| Frequency in Cycles Per Second | Length in Cm. | Length in Meters X Frequency |
|--------------------------------|---------------|------------------------------|
| 10001                          | 20.815        | 2081.7                       |
| 14981                          | 13.87         | 2077.8                       |
| 20003                          | 10.40         | 2080.3                       |
| 24992                          | 8.33          | 2081.8                       |
| 29981                          | 6.93          | 2077.7                       |

The frequency values given in the above table are accurate to within 1/100 of 1%. Because the ends of the rods are not absolutely true, errors in their measurement may be as great as 0.1 mm. which amounts to more than 1/10 of 1% for the shorter rods. If the length of the rod is multiplied by the frequency of vibration, the constants which appear in the third column are obtained. The variations in these figures are

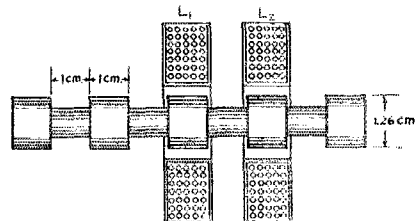

FIGURE 4. THE ROD CONSISTS OF FIVE BEADS CONNECTED BY SECTIONS OF HALF THEIR DIAMETER. All sections are of equal width. This rod vibrates at 295,130 cycles per second. The rod may also be made to vibrate with one of the beads between the two coils and the thinner sections within the coils.

not greater than the allowable inaccuracy in the measurement of the length of the rods. If the constant is doubled, the vel-

ocity of sound in the material is obtained which for stoic metal is:

$$V - \text{stoic} = 4160 \text{ 2m/sec at } 20^\circ \text{ C.}$$

The diameter of the rods is approximately the same and as there is no progressive change in the constant it indicates that there is no appreciable end correction for the determination of velocity.

Accordingly, the length of a rod to give a definite frequency can be computed closely enough so that after having been cut in a lathe the final adjustment may be made with but a slight amount of grinding. If the grinding is carried too far so that the frequency of the rod becomes higher than the desired value, it is possible to correct this by grinding away some of the girth of the rod at its center.

This next table gives the values for a series of Nichrome rods 0.96 cm. in diameter at 23° C.

| Frequency in Cycles per Second | Length in Cm. | Length in Meters X Frequency |
|--------------------------------|---------------|------------------------------|
| 29992                          | 8.27          | 2430.5                       |
| 35002                          | 7.13          | 2495.6                       |
| 40004                          | 6.23          | 2492.2                       |
| 45008                          | 5.53          | 2488.9                       |
| 49996                          | 4.99          | 2494.5                       |
| 55014                          | 4.58          | 2492.1                       |

The magnetostriction oscillator is most valuable at frequencies below 25,000 cycles per second particularly in view of the fact that the quartz crystal is extremely expensive at these frequencies. Between 25,000 and 300,000 cycles the oscillators have a common field of usefulness. The crystal oscillator has more value at frequencies above 300,000 cycles because although the magnetostriction oscillator is active up to 2,000,000 cycles per second, its output is extremely feeble and it is more desirable to employ harmonics of lower frequency rods if points in this range are desired. Frequencies up to several millions per second may be obtained by means of such harmonics.

The higher frequencies (300,000 cycles) may be obtained by three different types of rods. One method is to place very short cylinders within the plate coil with their axes parallel to the magnetic field of this coil. A second method is to use flat sheets or strips of material which are placed between the plate and grid coils and a third method is the use of a beaded rod.

Fig. 4 gives some idea of the shape and position of the rod. The rod was originally 1.26 cm. in diameter and 9 cm. long. Four grooves that are 1/4 the radius deep

are cut. They are 1 cm. wide and 1 cm. apart. The vibrator then consists of 5 beads, each of which is 1 cm. long and is separated from each other by 1 cm. When the rod was placed so that one bead was within one coil and the adjacent bead within the other coil or when one bead was between the two coils, the rod vibrated at a frequency of 295,480 cycles per second. The rod is of stainless steel, the velocity of sound through it being 5,430 meters per second and the length of a vibrator to give this frequency is:

$$\text{Length} = 543,000 \div 2 \times 295,480 = .918 \text{ cm.}$$

This is about 10% less than the computed value of one of the beads standing alone when regarded as a linear vibrator. The system is resonant at other frequencies, the strongest indication being at 19,888 cycles per second.

It is interesting to note that rods of large diameters may be made to vibrate at high frequencies. A thin disc 1.5 cm. in diameter and only about 2 mm. long can be made to oscillate at a frequency of about a 1,500,000 cycles per second. The disc is mounted between corks in a glass tube. Its oscillations are very feeble and are in-

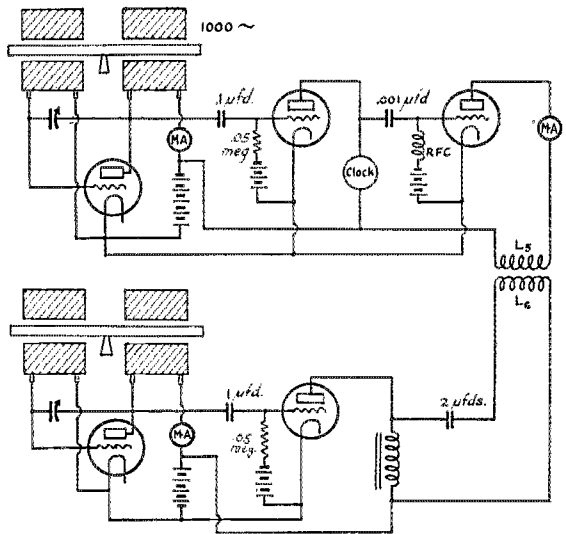

FIGURE 5. THE CIRCUIT ARRANGEMENT FOR COMPARING TWO OSCILLATORS. The upper circuit is controlled by a 1000-cycle rod, the frequency of which is checked by the synchronous clock in the plate circuit of the second tube. The third tube amplifies the harmonic of the 1000-cycle source that beats with the fundamental of the second rod which appears in the lower circuit. The outputs of the two circuits are coupled together through L5 and L6 and the beat difference noted on the millimeter.

licated only by the clicks heard in the telephone receivers when the tuning condenser causes the electrical circuit to pass through the resonant period of the rod.

There are many uses to which these standards may be put and it is possible by means of one rod to obtain points over an extreme range of frequency. These are obtained by the use of a second oscillator, the frequency of which may be varied over wide limits. When higher frequencies than the fundamental of the rod are desired, a harmonic of the second oscillator may be made to beat with the fundamental of the magnetostriction oscillator and if additional points are desired they may be obtained by beating harmonics of the electrical oscillator against harmonics of the rod oscillator.

When calibrating a frequency meter from a rod, the meter is short-circuited and placed near the electric oscillator coil. The electric oscillator is adjusted so that its fundamental (or harmonic) is at zero beat with the harmonic (or fundamental) of the rod oscillator. The frequency meter short-circuiting switch is then opened and as resonance is approached by rotating the dial of the meter, audible beats will be heard which rise in frequency and fall to zero beat again. A further rotation will cause audible beats to be heard again which once more drop to zero. When the frequency meter is adjusted to that position giving zero beat upon each side of which audible beats are obtained, all three units are in resonance (either at their fundamental or a harmonic frequency).

Rods may be calibrated in the following manner. A rod vibrating at the rate of 1000 cycles per second is employed to drive a synchronous clock. By means of weights which may be clamped to it and moved nearer together or further apart, the frequency of the rod can be accurately set. The frequency of one such rod could be varied over a range of about 7 cycles by this means.

A pair of circuit-making contacts are closed for a short period of time each second by the synchronous clock. Electrical impulses supplied each second by a standard clock are passed through these contacts to a loud speaker and when the ticks are heard in the loud speaker it indicates that the standard clock and the synchronous clock are in step. The number of seconds in which the two clocks are out of step indicates the difference between the length of the second of the standard clock and the length of the second of the motor driven clock. Several successive intervals may be timed and an average taken from which the rate of vibration of the rod may be obtained.

The timing of the 1000-cycle rod could be made directly because the synchronous clock was designed to be driven by a 1000-cycle wave. However, if a higher frequency rod is to be calibrated it will be necessary to beat a harmonic of it against the 1000-cycle rod. The 1000-cycle rod is adjusted to zero beat with the nearest harmonic of the rod to be calibrated and the vibrations of the 1000-cycle rod checked against the standard clock. The exact frequency of the 1000-cycle rod may be obtained from which can be computed the frequency of vibration of the smaller rod. It is not necessary to depend upon the beats as heard in the telephone receiver because a d. c. milliammeter made be connected into the circuit and a visual indication obtained.

Fig. 5 shows the circuit arrangement for comparing the two rods. The motor-driven clock takes the place of the choke that would be used for coupling between the first and second amplifier stages. The second stage is used for amplifying the higher frequency harmonic of the 1000-cycle rod circuit and the small coupling condenser between its grid and the plate of the first stage tends to reduce the amplification obtained on the fundamental frequency. A radio frequency choke connected across the input of the grid circuit of the second stage also aids in reducing the amplification of the 1000-cycle fundamental frequency, still allowing the high frequency harmonic to be amplified. The two output circuits are coupled by means of the coils L5 and L6 and as the beat frequency approaches zero it will be indicated visually on the milliammeter. The motor-driven clock may therefore be used to standardize both rods at the same time.

While magnetostriction oscillators may not be directly applicable for the stabilization of transmitter frequencies in the amateur bands, this does not indicate that they are of little or no use to the amateur. Their use in the calibration of frequency meters is extremely valuable particularly when one realizes how much cheaper it is to obtain a series of rods as compared to the cost of an equal number of quartz plates.

We have already accepted frequency doublers in our crystal-controlled transmitters and there is no reason why we may not find it to our advantage to pick off a more remote harmonic of a magnetostriction oscillator for the stabilization of our emitted frequency. The rod is inexpensive and extremely rugged; two factors which are decidedly important from the amateur view point.



## Some Suggestions For 1929

By H. M. Walleze\*

**M**AYBE you have built that new 1929 transmitter and find that the wave is not as steady as the book says it should be, or you have just revamped your plate supply to get a good clean-cut smooth tone but have found that it has a rattle in it. Since my daily grind takes in locating and fixing all kinds of such troubles in about all kinds of transmitters, it is natural that I have learned some of the kinks. Not having seen many such stunts described I want to pass a few suggestions along to add to the many excellent articles that have appeared in *QST* designed to take the hay-wire out of amateur radio for 1929.

At the last Atlantic Division Convention at 8XE I made a remark at a general argument session to the effect that 1929 signals should be strictly pure d. c.! I wonder now how I got home alive and in operating condition! I was almost hauled down and only one brave lad backed me up—after the meeting. The cry was the hardship it would work on the amateur existing on the plunder from kid brother's nickle bank. One already had a 30-henry choke and 6 mikes and still no sign of d. c. and wanted to know how he was going to get the required 150 henrys and 300 mikes more. The answer is that either the filter or the rectifier is badly overloaded or the set very poorly adjusted. Considering the tons of good information already printed on circuit adjustment, the trouble must lie in one or both of the two items first mentioned.

We have heard considerable about brute filters but little on common sense filters, as some one put it. The fellow who hangs a 30-henry choke and 10 mikes on a motor generator has more money than horse sense. I have yet to see a machine, built for radio work, that required over 3 to 5 microfarads in conjunction with a good choke of from 2 to 5 henrys providing many other things are as they should be. To begin with, the condensers must be good ones and the chokes must be large enough (talking of copper and iron) so that the current passed through them is not over 75 percent of their rating and for many of the chokes which the amateur uses the current should not exceed 50 percent of the rating.

If you are using rectified a. c. be sure that the rectifier tubes are plenty large enough so that they can be run somewhat under their rating, which will result in greatly improved voltage regulation and among many

other things the life will usually be increased. The same thing applies to the plate transformer which should be capable of delivering considerably more power than it is called upon for. If you want good regulation the chokes and transformers must be husky and it is only by good regulation that one can hope to have a signal that is not full of key chirps. Running power tubes underrated has been greatly stressed but it must be remembered that the same applies to every piece of equipment in the set. One way to check the quality of your equipment is to put a brick on the key, just as you have been running everything, and then take in a good show. When you come home, three hours later, the set most probably won't be running. Something burnt up. Throw that something out and get another that will stand up to that treatment or else cut the input until your toy "something" can handle it. Any set that can't run half a day full tilt is hay-wire, somewhere.

Perhaps you have cooked the set overnight without a fire, have everthing unloaded and have spent much time in making fine adjustments according to the information given in *QST* and you still find that the would-be pdc note is fine a. c. Well, quite likely you have your rectifier and filter crammed within 3" of the r. f. circuits thereby pumping plenty of r. f. into these units. Besides losing good r. f. you lose a good note because no filter and rectifier can operate properly with a lot of r. f. floating around in it. Even though nothing blows up, the filtration will be poor. Moving this equipment well away from the set and inserting an r. f. choke (plenty of turns on a small diameter tubing) in each supply lead may fix it. If not, quite likely your filament heating transformer is set on the same shelf as the r. f. equipment and the core iron is a little loose and hums quite a bit. The transformer is then just bouncing around at about 120 j.p.m. (jumps per minute), the tube element jumping along with it at the same rate, especially the filament, if it is a little aged and stretched, a lead or so right in phase with them helping matters along. The result is a modulation of the radio frequency wave at 120 cycles plus a few high kicks thrown in for good measure by the keying relay which is probably stuck up on the frame somewhere. Set these units up on sponge rubber after firmly clamping the core of the transformer or, better still, move them out where they can't shimmy the r. f. parts.

If you are using a motor generator with-

\*3BQ, 597 North James Street, Hazleton, Penn.

out a bag or two of cement under it, the same thing probably happens. The machine vibrates, the floor ditto, and the set and signals as well. Even though heavy rigid wiring may be used in the set the chance of vibration is good and it does not take a great deal to spoil an otherwise good note. If the machine is not too large, a bundle of paper towels under each end will fix both the rattle and the signal as well as the rumble down in the OM's bedroom which will help some on midnight work.

The generator may be stirring up a grand hash at the commutator which finds its way to the set via high voltage leads or, more likely, by direct radiation from the machine itself. Move it away or put it in a tin can but don't forget to cut some air-holes which should be covered with copper screening. The can, motor generator frame and the negative lead, should all be connected to a good ground. This may also quiet the BCL across the street.

Perhaps a couple of pointers regarding the crystal-controlled transmitter might not be amiss. Unless you are looking for trouble, the r.f. choke in the grid circuit of the crystal tube should not be so constructed that its natural period falls near that of the crystal. If it does, the circuit will tend to oscillate without the aid of the crystal; being simply an Armstrong circuit. While with proper adjustment, the crystal will control the frequency and the output may be materially better, the increase in the r.f. voltage applied to the grid and consequently across the crystal, may be great enough to rupture the plate. It should be possible to remove the voltage from the amplifier tubes and the quartz plate from its holder and then when the oscillator tank condenser is rotated through its entire range there should be no tendency for the circuit to break into oscillation. If it does oscillate, add some more turns to the r.f. choke until the proper condition can be obtained.

While we are on the question of chokes, why not operate the transmitter with series plate feed so as to reduce the amount of work which the choke is being called upon to perform. If there is any difference in performance between the series and parallel methods of feeding, it is so slight that in actual practice it is negligible.

The same thing applies to the use of biasing batteries as compared with the use of resistors. If variable resistors are used the results obtained will approach so closely to those obtained with the use of biasing batteries that one would have to sit up about 400 nights a year to hear the difference, granting both are properly adjusted. The use of resistors means a lot to the slim bank account as well as in the amount of constructional work necessary. Of course, if

the voltage regulation is not good, the bias may vary considerably but that cannot be blamed on anything but the power supply system.

As far as the receiver is concerned, it should not be considered a disgrace or even a luxury to put a cabinet around it. The "box" won't affect the signal providing it is constructed of good dry lumber and well treated with high grade clear varnish. Don't smear it up with pole paint or something worse.

While many claim that resistance control of regeneration does not give as good signal strength as some other method. If it is built correctly, it will do just as well and perhaps better. Instead of trying to work with a small diameter tickler coil stuck a foot from the secondary, make it the same diameter as the secondary and put it not more than  $\frac{1}{4}$ " away from it. Cut the tickler turns down to 2 or 3 for the higher frequency bands and run the detector plate voltage up to 30 or 35, if necessary. If your tuning condenser is as small as it should be and has a good vernier dial you will then have an ideal receiver with but one tuning control. The regeneration control won't change the note and you can work the detector tube at the point where greatest sensitivity is obtained. There will be no necessity for "edging" up on the regeneration control in order to hold your signal. If you insist upon two tuning controls put in a stage of tuned radio frequency—then sit up some more nights and figure out how much *necessary* gain you have obtained against all the fuss and cost.

### Strays

3AJC had some grid leaks of the coated glass filament variety which were getting noisy after about a year's use. Upon chemical investigation, it was found that the resistance material was germanium, a material which tends to crystalize at the end of about twelve months.

The Radio Division, Department of Commerce, has appointed seven new Assistant Radio Inspectors, with four more contemplated. The new men are receiving training at the District Supervisors' offices and will then be placed at new branch offices which the Department is opening at Buffalo, Dallas, Denver, Los Angeles, Minneapolis and Omaha.

7OK tells us that he was using the condensers out of Ford coils for filters. The first batch he had blew at 850 volts and the second batch has been working on 750 without any sign of going West.

## A 28-Megacycle Crystal-Controlled Transmitter\*

By Howard Allan Chinn†

**D**URING the past few months n1X<sup>M</sup> maintained automatic transmissions on 28 megacycles during certain periods on Saturdays and Sundays in an effort to obtain data relating to wave propagation in this high frequency band recently opened to amateurs, and to provide those hearing the transmissions with a definite point in the frequency spectrum. The transmitter was crystal controlled and the frequency known to be 28 megacycles, within .1 of 1%. This article, describing the transmitter used, is presented not because of any new or radically different features involved but rather to

oratory experimentation, is not especially compact, as a permanent installation could undoubtedly be. The crystal used has a fundamental frequency of 1.75 megacycles and therefore four frequency doublers were necessary. From the circuit diagram we see that the crystal oscillator tube and the first three frequency doublers are UX-201-A tubes. Somewhat greater output can be obtained by using UX-112-A tubes in these positions, but in this particular case the UX-201-A tubes were found entirely satisfactory. The fourth frequency doubler is a UX-210 tube which provides the 28 megacycle voltage to excite the grids of the two

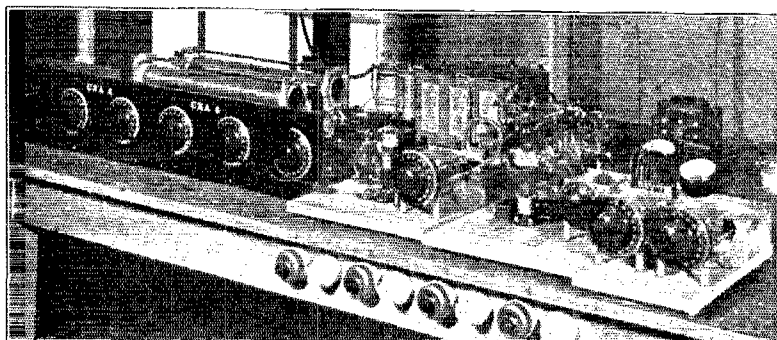

THE TRANSMITTER WITH THE CRYSTAL OSCILLATOR AND FOUR FREQUENCY DOUBLERS PANEL-MOUNTED AT THE LEFT

The crystal holder may be seen at the extreme left. Two slide wires behind this unit are used for the resistors R5 and R7. The first breadboard at the left holds the UX-210 frequency doubler and the second board has the pair of 852's mounted upon it. The midget condenser hanging up in the air above the inductance is the grid tuning condenser to tune the input circuit of the two 852's. The neutralizing condensers are mounted on the shelf above the horizontal arms of the 852's. The breadboard on the extreme right holds the two antenna condensers, the antenna inductance and meter. The two coils behind this board are similar to those used in the frequency doubler circuits. The "B" batteries supply bias for the 210 and 852's.

show the straightforward arrangement of a 28-megacycle crystal controlled transmitter. The procedure and circuit arrangements are not limited to 28 mc. operation but can be modified for operation in any waveband.

The transmitter was assembled of units that were available at the time and as can be seen from the photo, is half panel and half breadboard in construction. The apparatus, being primarily designed for lab-

UX-852 tubes which are operating as straight amplifiers.

The reason for operating the last stage as a straight amplifier and therefore necessitating some form of neutralization was because it was found that when tubes were used as frequency doublers they operated rather inefficiently. Thus, to obtain a given output from a tube it is necessary to operate it with a considerably higher plate dissipation when used as a frequency doubler as compared with that when used as a straight amplifier. Since most of us run our tubes at a maximum safe plate dissipation anyway, it follows that the logical way

\*Contribution from the Round Hills Shortwave Radio Research.

†Electrical Communication Laboratory, Massachusetts Institute of Technology, Cambridge A, Massachusetts.

to obtain most output from a given tube under normal operating conditions is to use it as a straight amplifier rather than as a frequency doubler. The apparatus as originally set up employed the last tubes as frequency doublers (one of the UX-201-A stages being omitted) but the output was far from satisfactory and the tubes ran too hot. By the addition of one UX-201-A the and last stage converted into a straight amplifier the output increased many times with the same input power.

The neutralization arrangement used in the last stage is of interest and its operation is readily seen from consideration of Fig. 2.

Figure 2a shows the last stage amplifier schematically without the power supply, by-pass condensers, etc., and with the grid-plate inter-electrode tube capacities indicated. It is because of feed back through these capacities that the circuit will oscillate. Figure 2b shows the equivalent circuit involving these tubes and the neutralizing condensers. The points  $P_1$  and  $G_2$  can be thought of as representing the grid and plate terminals of tube 1. Likewise  $G_{gr1}$  represents the grid-plate capacity of tube 1. The circuit can be further unscrambled as shown in Figure 2c. Here we see we have an ordinary capacity bridge, the points being lettered the same as in Figure 2b. Thus we see that if the two neutralizing capacities are equal to each other and to the grid-plate capacity of the tubes being used, the bridge will be balanced and any voltage introduced between the points  $G_1$  and  $G_2$  will have no effect upon the bridge points  $P_1$  and  $P_2$ . Thus we see that in adjustment of the circuit we will expect to find the two neutralizing capacities about alike and equal to the grid-plate capacity of the tubes plus any stray capacity due to sockets and wiring. The average grid-plate capacitances of the more common tubes are as follows:

| Tube     | Grid to Plate Capacity (based tube) |
|----------|-------------------------------------|
| UX-201-A | 10.1                                |
| UX-112-A | 11.0                                |
| UX-210   | 8.0                                 |
| UV-208-A | 22.5                                |
| UV-211   | 18.5                                |
| UV-201-A | 19.0                                |
| UV-851   | 57                                  |
| UX-852   | 2.5                                 |

Besides lending itself to easy neutralization the balanced circuit used for the last

stage amplifier has the further advantage that when properly adjusted, practically no radio frequency flows down the center tap leads to the filament or plate supply circuits. The proper point for the center-tap leads (those going to the C minus and B plus) would be to the exact center of the grid and plate inductances if everything were balanced and symmetrical. Different

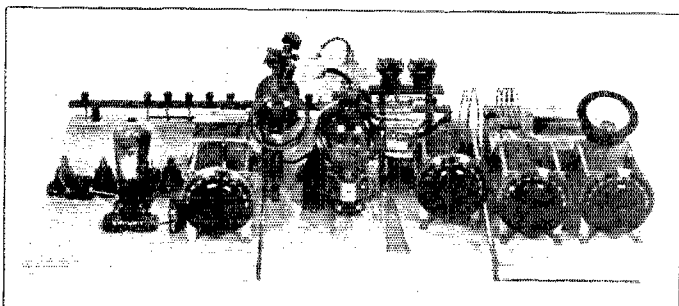

AT THE LEFT IS THE LAST FREQUENCY DOUBLER. A UX-210 This shows somewhat more clearly the input circuit to the pair of 252's and the two neutralizing condensers. The breadboard on the right holds the antenna tuning equipment as well as the meter.

length leads (this should be avoided as far as possible) from the tubes to the inductances may cause a slight unbalancing and therefore the exact points to which the center-tap leads are connected should be found by trial. These voltage nodes may be found by using a screw-driver (or a neon tube) and locating that point on the inductance from which no arc can be drawn. It should be noted that both inductances are "high" above ground and care must be taken to avoid shocks from the plate and grid supplies. In order to avoid any radio frequency current that does come down the center-tap leads getting into the power supply, both the B and C battery terminals are by-passed and provided with r.f. chokes. Incidentally, it might be well to suggest that if you have any sensitive r.f. meters about it is wise to remove them a considerable distance from a 28 or 56 Mc. (ten- or 5-meter) transmitter. Thermocouple meters that were thirty feet from this transmitter and had their terminals shorted have been seen to go half-way upscale.

For convenience, the first four coils,  $L_1$ ,  $L_2$ ,  $L_3$ , and  $L_4$  were wound on bakelite tubing and equipped with G. R. plugs. While this method did not permit the use of adjustable taps that would have permitted a more efficient operation of the frequency doublers, it makes for simplicity and quick interchange of inductances when necessary. Thus the apparatus may be used with a crystal of any fundamental frequency and proper coils quickly plugged-in. In the set-

up, as actually used, a switching arrangement was included to cut out or by-pass as many of the frequency doublers as was desired in order to make the apparatus as flexible as possible.<sup>1</sup> This is shown in Fig. 3.

The coil and condenser values used are given in Figure 1. The values for  $C_1$ ,  $C_2$ ,  $C_3$  and  $C_4$  are the approximate capacitance values actually used. The condensers were all National 500- $\mu$ fd. receiving condensers, adjusted to these values.  $C_5$  and  $C_7$  were National 150- $\mu$ fd. transmitting condensers adjusted to the values indicated in the figure.  $C_6$  and  $C_{10}$  were General Radio 15-

A tubes was approximately 200 volts. This was obtained from the 500-volt plate supply to the UX-210 by suitable resistors  $R_6$  and  $R_7$ . It was necessary to use two re-

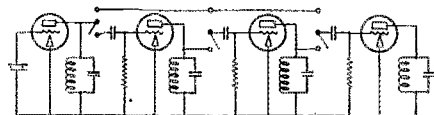
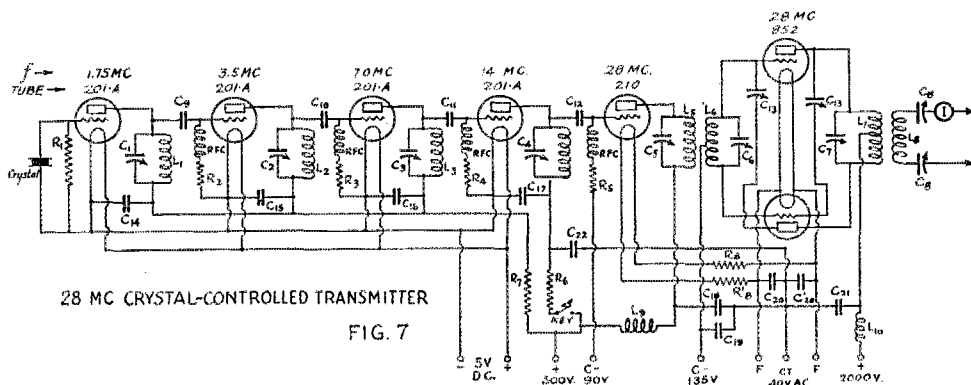

FIG. 3

sistors, and not one common one, since it was desired to key in the plate circuit of the last UX-201-A frequency doubler. If



28 MC CRYSTAL-CONTROLLED TRANSMITTER

FIG. 7

THE COMPLETE CIRCUIT DIAGRAM. THE CONSTANTS ARE AS GIVEN BELOW.

- $L_1$ —3 $\frac{1}{2}$  turns of No. 18 d.c.c. wire on 3 inch form.
- $L_2$ —14 turns of No. 18 d.c.c. wire on 3 inch form.
- $L_3$ —4 turns of No. 18 d.c.c. wire on 3 inch form.
- $L_5$  and  $L_7$ —2 turns of spaced edgewound copper ribbon.
- $L_6$ —8 turns same as  $L_5$ .
- $L_8$ —4 turns same as  $L_5$ .
- $L_9$  and  $L_{10}$ —G.R. choke No. 379-T.
- RFC—Samson choke No. 35.
- $C_1$  and  $C_2$ —125  $\mu$ fd.
- $C_3$ —25  $\mu$ fd.
- $C_4$ —90  $\mu$ fd.
- $C_6$  and  $C_7$ —75  $\mu$ fd.
- $C_8$ —15  $\mu$ fd.
- $C_8$ —50  $\mu$ fd.
- $C_9$ , 10, 11, 12, 13, 19 and 21—.002  $\mu$ fd.
- $C_{13}$ —Double spaced G.R. midget. Capacity probably about 15  $\mu$ fd.
- $C_{14}$ , 15, 16 and 17—.006  $\mu$ fd.
- $C_{20}$  and  $C_{22}$ —.01  $\mu$ fd.
- $R_1$ , 2 and 3—5 megohms.
- $R_4$ —50,000 ohms.
- $R_5$ —zero.
- $R_6$ —20,000 ohms.
- $R_7$ —15,000 ohms.
- $R_8$ —1 ohm.

$\mu$ fd. midget variable condensers, the latter being doubly spaced.

The plate voltage applied to the UX-201-

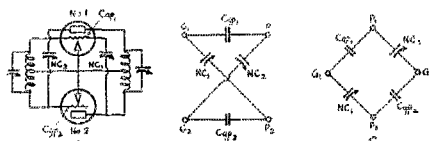

FIG. 2

a common resistor were used and the plate circuit of this tube opened the voltage on the remaining 201-A tubes would rise to a dangerously high value. The plate supply for the 852 tubes was 2000 volts and was obtained from a 2000-volt generator having four commutators which permitted the use of a 500-volt tap for the first five tubes.

1. This entire unit was built over a year ago by R. L. Briggs in carrying out his thesis at Massachusetts Institute of Technology.  
 2. QST, p. 19, March 1928.

The filaments of the 852's and the 210 were fed from a ten volt a.c. source while the 201-A's happened to be lighted from a storage battery although they might just as well have been arranged for operation on a.c. The filament voltage for the 210 tube is dropped from ten volts to seven and one-half by the series resistors R, two be-

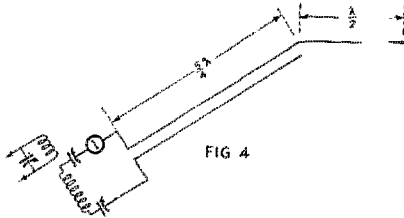
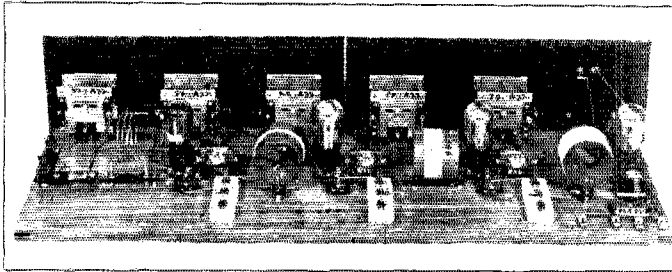

FIG 4

ing used, one in each side of the line in order that the center tap would not be unbalanced. Small resistors of various values suitable for such purposes may be obtained from several manufacturers.

In order to facilitate tuning of the trans-



A REAR VIEW OF THE FREQUENCY DOUBLERS AND CRYSTAL OSCILLATORS

The crystal tube is at the right and the three porcelain-based knife switches are used to cut out one or more of the frequency doublers.

mitter, a 125-milliamperere thermo-couple meter or thermo-galvanometer, shorted with a single three-inch turn of wire was used. The single turn is first coupled to the inductance in the plate circuit of the crystal oscillator tube and the condenser varied until the indication is at maximum. The coupling should be kept as loose as possible in order that the effect of the meter and coupling coil on the tuning of the circuit is a minimum. The meter is next coupled to the coil in the plate circuit of the first frequency doubler and this circuit is tuned until a maximum indication is again obtained. In order to make certain that this tank circuit is tuned to the second harmonic of the crystal a frequency-meter should be coupled to the coil and the frequency checked. It is quite possible with suitable coils to tune this tank circuit to the third or fourth harmonic and to obtain rather weak tank circuit current. This procedure is repeated until all the fre-

quency doublers are in tune, including the 210 stage. With the meter coupled to the coil in the plate circuit of the UX-210 all the condensers can then be slightly readjusted for a maximum current in this tank circuit. If desired, the antenna can be coupled to this plate circuit and the apparatus used as a low-power transmitter.

The bias on the 210 tube and the 852's is such that when the key is up no excitation voltage is being fed to the grids of these tubes, thus their plate current is practically zero. As the r.f. grid excitation voltage is increased, the plate current increases and this also serves as an indication of optimum adjustment. Thus if we watch the plate current of the 210 tube as the first four condensers are adjusted we find it to be at maximum (the key being down) when they are all in tune. This value, incidentally, will be in the order of 50 milliamperes with the grid and plate voltages indicated.

The plate voltage is now supplied to the 852's. The neutralizing condensers are then adjusted with the key up (no r.f. excitation voltage on the grids of the 852's) until there is no self-oscillation of the tubes when the plate and grid circuits are in tune. The key is then closed and with the thermo-couple meter coupled very loosely to the plate inductance of the last stage, the circuit is adjusted to resonance. The antenna

is then coupled and the antenna condensers adjusted for maximum antenna current. Readjustments should then be made throughout the entire circuit in order to secure maximum antenna current.

The antenna employed for these tests was a horizontal half-wave antenna with a  $5/4$  wavelength feeder, the construction and operation of which has been mentioned.<sup>3</sup> See Fig. 4.

The actual length of the antenna flat-top was 17 feet and the feeder length 42.5 feet. The antenna current with this particular installation was .8 ampere with 500 watts input to the last stage of the amplifier.

To adopt the transmitter for operation with crystals of other fundamental frequencies or in other wave-bands it is merely necessary to eliminate or add frequency doublers as necessary, by switching, choose the proper coils and adjust the condensers.

## "Now We're in the Air!"

By Wallace S. Wiggins\*

THE title of this story is not intended to refer to a movie of some months ago, but rather to the rapidly growing "air-mindedness" of amateur radio. Taking a brief squint over our glorious past, we see the real "ham" radio, as it really is, taking part in various enterprises of world note, from Greenland's icy shores to the South Pole with Byrd. We've been in the air before, y'understand, but not to such a degree that we could be called members of the air family. We won't forget WNP as a starter for giving the explorer confidence in ham radio. And we remember with a heartache our old friend NERK, the *Shenandoah*. She was the first to give "wings" to the ham. From then on, ham radio began to get acclimated to its angelic element by means of various notable flights, all the way up to KHAB, the *Southern Cross*, which winged its way from Oakland, California, to Australia.

Of course, radio, technically speaking, has been "in the air" for some time, but much of it wasn't ham radio. They've used sets in planes for army and navy tactics for quite a while. Many other civilian installations have been made in planes, but most of them smacked of the "commercial." The others were ham sets from either an engineering standpoint (good ones, we mean!), or they involved the cooperation of the "gang" to such an extent that it was almost strictly a ham undertaking.

The latest stunt by the Knights (for short) of the A. R. R. L., was one in connection with the 1928 National Air Races, at the municipal airport in Los Angeles, from September 8th to 16th inclusive. The Amateur Radio Research Club of the "City of the Angels," affiliated with the A.R.R.L., provided the star performers for the circus, and even though it was a "ground job," it rated as high in importance as any other official function during the races. It was a great success, it gained favor and friends galore, and above all it paved the way for the "bigger and better" chances for amateur radio to continue to prove its worth.

It's about time I told you about the stunt. I am not following the style of the news story, with the important facts in the first paragraph or "lead," for the simple reason that the technicalities involved are familiar to every amateur operator with any experience at all, and because

it is the significance of the thing rather than the thing itself that is important.

It started this way. During the air meet, which consisted of the finishes of trans-continental races, army and navy demonstrations of airplane tactics, hundreds of stunts by civilians in planes and 'chutes, a



THE HARD-WORKING CREW FROM THE A.R.R.C. OF LOS ANGELES WHO PUT OVER THE JOB. Left to right: Wm. Breuer, W6BZR; Chas Lundblad, W6CYX; Chas A. Hill, W6BRO-W6DRO; Robt. Parrish, W6QF-W6PS-W6XC; Chas. A. Nichols, W6ASM; Bert Fox, W6DY.

mammoth airplane exposition, and other things too numerous even to remember, there were several local races each day. The races were around five- and ten-mile courses marked by pylons, or steel towers, with checkerboard sides and a "wind sock" flying at the top. Pylon Number 1 was on the field, near the judges' stand, Pylons Numbers 2, 3, and 4 were located at distances of one, two, and three miles from Pylon Number 1. The first three pylons marked the five-mile course, while all pylons were used in the ten-mile course.

Observers were stationed at each pylon. It was their duty to see that contestants did not "cut corners," or take parts of the pylon along with them, or drop souvenirs of the plane along the course, or do a hundred other things they might do and maybe some things nobody had ever thought of before. Then the judges had to know, at any instant, just where any plane was and how many laps it had completed. You've guessed it—reliable communication between pylons and the judges' stand was necessary. Enter our hero, with a vacuum tube in one hand and a key in the other. His pockets are filled with spare parts.

The Junior Chamber of Commerce of Los Angeles had charge of the Committee on Communications. Our western friend, M. E. McCreery, W6LJ, was on the committee. Whenever something big is happening or

# Odd Jobs

G. F. Lampkin\*

**T**HE job of cutting a circle in a panel requires, for decent results, some sort of a special tool. Certainly the method of drilling and filing around the circumference of the circle is both laborious and productive of indifferent results. For holes from one to ten inches in diameter, in panelling of thicknesses up to one half inch, the device depicted in Figure 1 will give

or be able to obtain it. Only half the length of the tool will be needed for the circle cutter; any greater length would be in the way. To shorten the tool, clamp it in a heavy vise, half projecting above the jaws, and give the projection a sharp blow. Grind one end of the tool smooth.<sup>1</sup> About  $\frac{3}{8}$ " of the other end should be ground similar to the shape in Fig. 2. The front of the tool is beveled back, to give a raking cut, so that the tool will not grab or chatter. The width of the cutting part is made as small as possible, consistent with strength, for the smaller the cut the less work there will be in making it and the faster will be the job. To prevent the tool from binding on small circles, its outside edge is beveled to the back.

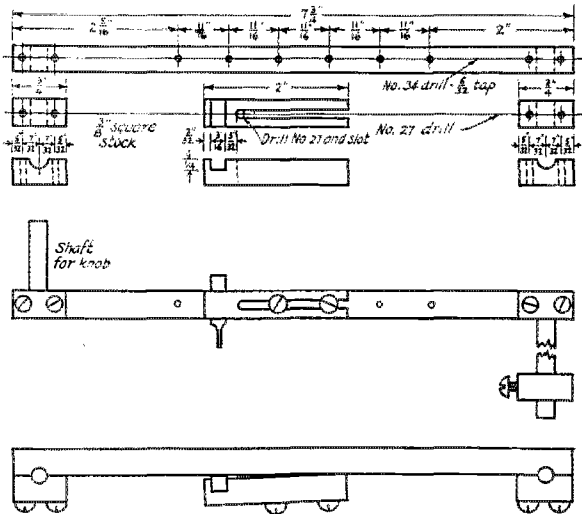

FIG. 1. CIRCLE CUTTER DETAILS

clean-cut results. It was first put together in order to cut an eight-inch by three-eighths inch disc for a sync rectifier as no lathe was available for the job. Later, it was used to cut the circular commutator segments and slip rings from three thirty-seconds inch sheet brass.

The tool requires, in the way of raw material, one foot of  $\frac{3}{8}$ " square brass, or iron bar; five inches of  $\frac{1}{4}$ " round brass, or iron rod; a  $\frac{3}{16}$ " square lathe cutting-off tool and half a dozen 6-32 machine screws. The cutting-off tool may be the hardest item to obtain, though it only costs around a dime. It is a short, approximately three-inch, bar of hardened tool steel, used for making lathe tools. The hardware store should have it

first be bored in the panel before the circle cutter can be used. If the cutter is to be used for light work, and the  $\frac{1}{4}$ " hole is ob-

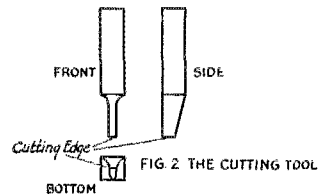

FIG. 2. THE CUTTING TOOL

jectionable, the central-shaft size may be cut down. The handle used was a glass knob from a drawer pull the likeliest thing at hand.

In cutting, the point of the tool should always ride behind the center line of the two shafts. If a smooth edge to the circle is desired on both sides of the panel, the cut

\*3612 Woodbridge Place, Cincinnati, Ohio.

1. A pan of water into which the tool may be dipped occasionally will speed up the grinding process by allowing the heat generated in the tool to be quickly dissipated.—Tech. Ed.



should be taken through about halfway from the one side, and then finished from the other. The work bench, or a box, should be bored for the central shaft of the cutter. The panel should lie perfectly flat on the bench or box. A strip of wood or iron, bored and fitted below the bench and over the lower locknut on the central shaft, can be used handily as a lever to put a slight

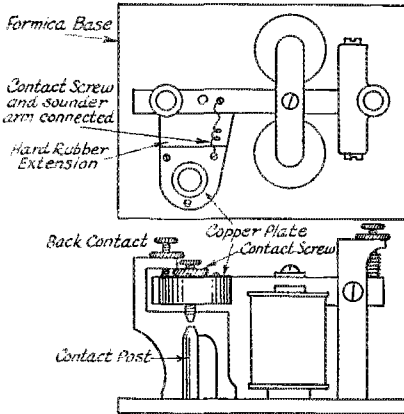

FIG. 3 KEYING RELAY

pressure on the cutting point. Of course some elbow grease is necessary to operate the tool, but even an eight-inch circle can be taken through a panel in a surprisingly short time.

KEYING RELAY

Although making a keying relay from a telegraph sounder is no new job, perhaps a little variety will make another description of such, excusable. The parts of the sounder were removed from the original iron base and remounted, for insulation's sake, on an identically drilled piece of 1/4" formica. The hard rubber extension on the sounder arm and the contact posts were added as in Fig. 3. The contact screw in the hard rubber extension was connected to the sounder arm, and the two were used as the blade of a single pole, double-throw switch. The contact post and the back contact were used as the points of the switch. The connections for keying in the plate circuit of the transmitter were made as in the diagram Fig 4. The resistance load was used to keep a current drain on the transmitter plate supply at all times, so that the voltage would not flicker with keying. The regulation of the supply, like that of most transmitter supplies, was very poor, around 30%. The approximate value of the resistance load was calculated from

$$\text{Ohms} = \frac{\text{Plate Volts,}}{\text{Plate Amps}}$$

and this value in wire-wound resistors used. A bit of experimenting should give a water rheostat, or a lamp bank, that would fulfill

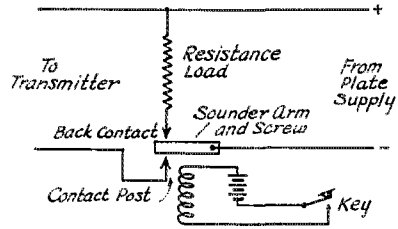

FIG. 4

the purpose. The brass contacts of the relay burned away at a rate of about an eighth of an inch a month, so 3/16" tungsten contacts were obtained<sup>2</sup> and fitted to the relay. After breaking .4 of an amp at 1000 volts for some four months, the tungsten surfaces were still as good as new. If the arc tends to hold after the contacts have opened, condensers should be shunted across the breaks. If possible, the relay should be placed in the negative, or grounded, plate lead. When the sounder arm is connected to the plate circuit, as above, the iron armature on the sounder arm should be kept as far away from the magnets as possible. If the contact screw is used alone, without the resistance load scheme, the hard rubber extension is ample insulation.

AMMETERS

With the half-ampere, radio-frequency ammeters prevalent nowadays for measuring antenna currents, the amateur is sometimes hard put to measure larger radio-frequency currents—for instance, the current in the oscillating circuit of the transmitter, or in the tank circuit of the crystal-oscillator, power amplifier. A shunt of No. 12 tinned bus placed across the terminals of a half-amp Jewell thermo couple meter cut the deflection approximately in half. As this was not enough in some cases, a clip was arranged as in the diagram of Fig. 5. By sliding the clip to the left, the length of the shunt was decreased, while, correspondingly, more wire was added in the meter circuit, so that no matter how large the current flowing in the circuit, the deflection on the meter could be brought to any desired value. No attempt was made at calibration of the meter and shunt, for various clip positions, for only relative readings

<sup>2</sup> Tungsten contacts may be obtained from The Kodak Radio Corp., 507 East Pearl Street, Cincinnati, Ohio.

were desired. Such calibration would undoubtedly be useful, however, if the shunt were used extensively on the meter—and providing the clip settings were accurately marked.

#### STOPPING CONDENSERS

It is a commonly noticed fault of many amateur transmitters that the wave climbs slowly during the first few minutes of transmission—not to mention bona fide wave swinging. At high frequencies the tube

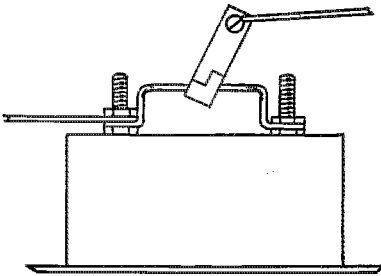

FIG. 5 VARIABLE-SHUNTED R.F. AMMETER

capacities across the helix have appreciable effect on the tuning of the transmitter, and change in the tube capacities, because of heating, or other things, causes wave shifting. When condensers are placed in series the resultant capacity is always less than

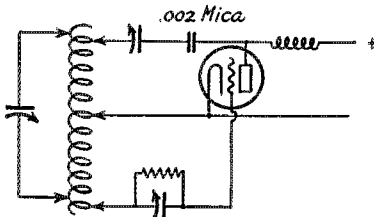

FIG. 6 VARIABLE STOPPING CONDENSERS ON TRANSMITTER

that of the smallest condenser in the group. Variable condensers may be placed in the grid and plate leads of a transmitter, instead of the usual .002 mica stopping condensers. These capacities should be made as small as possible without losing an appreciable amount of output from the transmitter. By careful jockeying, they may be cut down to around 100  $\mu$ fd. each, depending on the wave band in which the transmitter is used, and a much steadier wave will be had. The grid stopping condenser for even high-powered sets may be a receiving condenser. A receiving condenser in the plate lead will stand up with 800 or 1000 volts on the plate, but a transmit-

ting condenser is needed with higher plate voltages. For the sake of safety in either latter cases the .022  $\mu$ fd. mica condenser should be left in the plate lead, so that a direct short would not be had on the plate supply should the variable condenser spark over. Figure 6 gives a schematic transmitter diagram using the variable stopping condensers. The beat note from a 150-watt transmitter, using three ribbon-filament W.E. tubes, would start inaudible at one side of zero beat, pass through zero, and go out on the other side, when keying the set, with the .002  $\mu$ fd. condensers in circuit. Replacing these capacities with approximately 100  $\mu$ fd. reduced the maximum beat-note shift to 150 or 200 cycles.

#### Strays

QST with deep regret must report the death at Seattle in middle August of Mr. O. R. Redfern, Supervisor of Radio for the Seventh District. For the last several years a splendid friend of the amateur, his passing must be regretted by all members. With the exception of war-time service as a Lieutenant, U. S. Navy, Mr. Redfern was continuously with the Department of Commerce since October, 1916. Before becoming Supervisor at Seattle he was attached to the Second District office at New York.

The new Supervisor at Seattle is Mr. Edwin W. Lovejoy, well known on the Coast from his long service as a Radio Inspector in the western offices of the Radio Division. In extending A.R.R.L. congratulations on his promotion we must also express our pleasure that the new Supervisor is one who knows and understands us as well as Mr. Lovejoy does.

The paper entitled "Receiver Characteristics and Their Measurements" that appeared on page 23 of the October issue was originally delivered before the Atlantic Division A.R.R.L. Convention held at State College, Pa., on June 15, 1928. We are indebted to that Convention committee for this most excellent paper and our thanks are tendered herewith.

Horace Wilbert, W6EX and the National Radio Tube Company, takes exception to the omission of his rectifier tubes from Ross Hull's mention, on page 28 of the September issue, of a "truly practical" rectifier for 1929 use with high-power tubes. Hull did not mean that a mercury arc was the only rectifier capable of operating a high-power tube, but that for various reasons he believes it most practical. Of course, Hull is a purist in matters radio, and other individual preferences and conditions may dictate the use of some other rectifier such as Rectobulbs, Kenotrons or chemical.

# 160-Meter Low-Power Transmitter

By George B. Hart\*

WHEN the average broadcast amateur becomes interested in two-way communication, he looks with disfavor upon the 1,750-kc. band, because of the fact that he usually thinks that it is necessary to use high power and expensive apparatus if effective results are to be obtained. While he is pondering over a catalogue of expensive transmitting goods, or, as is more likely, building a low power set for use on the already over-crowded high frequencies, he little dreams that a low power, yet efficient, c. w. set may be constructed from receiving parts. Two 201-A tubes are used as the oscillators in this simple full-wave self-rectifying Hartley transmitter. The 110-volt a.c. line is used to supply the plate and filament through suitable transformers. The entire outfit cost me \$10.06.

Such a transmitter should especially appeal to men interested in the 1750-kc. (160-meter) code practice and rag chewing, which has recently been inaugurated. It has been used here for several months and in addition to working several locals, stations located as far as 300 miles away have been communicated with. Reports ranged from R4 to R9.

The circuit of the transmitter is shown in Figure 1. The antenna and oscillatory circuits are tuned by 500- $\mu$ fd. variable condensers, which in my case were obtained at the local "five and ten." All keying is done in the primary of the plate supply transformer. The 25-watt lamp in series with the power transformer is used to indicate resonance. When the antenna is in resonance with the primary the lamp will burn at about medium brilliancy.

Coils L1 and L2 are wound in the same direction on a 3-inch cardboard tube with No. 18 d.c.c. wire. The coils are spaced  $\frac{1}{2}$  inch. Wind the coils as tightly as possible.

\*SDK, 3267 Nash Ave., Cincinnati, Ohio.

1. The most convenient antenna will probably be a grounded one which should be about approximately 120 feet in length. This includes the lead-in and ground lead as well as the horizontal portion.—Tech. Editor.

2. It is possible to get the polarity of one of the secondaries reversed if the markings are not observed or if by chance one of the windings is reversed. This may be checked by listening to the transmitter with the receiver. When the windings are properly poled, the note will be smoother than when one winding is reversed.—Tech. Ed.

L1 consists of 25 turns tapped at the 12th turn for the filament return L2 is also wound with 25 turns, but tapped every 5 turns.<sup>1</sup>

The leads should be made as short as possible. The wire may be the usual bus bar such as is used in receiving sets. The entire outfit may be mounted on a 7x12 panel and 10x12 baseboard, or may be mounted in breadboard style without a panel. If a panel is used, the outfit may be placed in a cabinet.

The radio frequency choke consists of 350 turns of No. 30 d.c.c. wire on a 2-inch card-

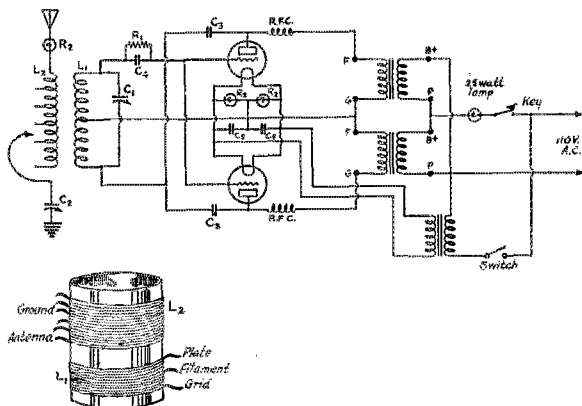

FIG. 1. THE CIRCUIT DIAGRAM OF THE FULL-WAVE SELF-RECTIFIED TRANSMITTER EMPLOYING A PAIR OF 201-A TUBES.

C1, C2—500- $\mu$ fd. variable receiving condensers.

C3, C5—0.02- $\mu$ fd. fixed receiving condensers.

C4—0.01- $\mu$ fd. fixed receiving condenser.

R1—100,000-ohm grid leak (receiving type).

R2—Christmas tree lamps or a center tapped resistor as used

across the filament of an a.c. operated receiving tube.

RFC—A winding of No. 30 d.c.c. wire 3 inches long on a  $1\frac{1}{2}$  inch tube.

board tube. The plate power is supplied by two similar 6-1 audio frequency transformers (mine are of the dollar variety) with their primaries in parallel and their secondaries in series.<sup>2</sup>

The filament supply comes from an 8-volt bell-ringing transformer (dollar variety) which delivers 7.6 volts a.c. to the tubes. Those desiring a lower voltage may place a resistance in series with the secondary winding. If old tubes are being used, this extra voltage may help to obtain enough emission.

When the outfit has been completed it will be a simple matter to tune it. Close the

(Continued on Page 68)

# Experimenting With Bypass Condensers

By John F. Rider\*

**I**N A recent series of experiments conducted in our laboratory, some very interesting light was thrown upon the subject of detector plate circuit bypass condensers. This information is of utmost importance to the radio fan constructor, who is desirous of obtaining the best quality of reproduction.

The experiments conducted were divided into two groups. In the first group, the objective was to determine how effectively the bypass condenser located in the plate circuit of the detector tube, across the coupling unit, from the plate of the detector tube to the negative filament circuit, bypassed the radio frequency component remaining after rectification. In the second group, the objective was to determine the effect of various values of bypassing capacity upon the audio frequency signal remaining after the process of rectification has been completed.

Every radio fan realizes the need for a bypass condenser in the detector plate circuit, connected as mentioned in the previous paragraph, across the first coupling unit primary circuit. But, apparently, every one does not agree upon the correct capacity; values ranging from .00025  $\mu\text{fd.}$  to .006  $\mu\text{fd.}$  being recommended. The figures ascertained in this series of tests will no doubt be of interest to the constructively inclined class of radio fans.

In view of the fact that the greatest interest is devoted to the audio frequency response, the experiments pertaining to the audio frequency signal bypassing were conducted first. The bypass capacities under test ranged from .0005  $\mu\text{fd.}$ , to .006  $\mu\text{fd.}$  The method of testing was as follows: An audio signal of known frequency was passed into a vacuum tube to which was coupled an audio frequency transformer with a high primary inductance. The bypassing capacity was connected across the primary inductance, from the plate of the tube to the negative filament. The output circuit of the audio frequency transformer was connected to a calibrated cathode ray oscillograph tube; that is, the deflections on the screen are calibrated in volts. With uniform input on the various audio frequencies and known values of bypass capacity, the variance in the output as shown on the oscillograph screen, when different values of bypassing capacity are used, is indicative of the bypassing of the audio frequency through the condenser.

The frequencies considered were 3,000, 4,000 and 5,000 cycles. The following figures the various condensers, expressed in the form of a fraction of the original tube output:

|                       | 3000 cycles<br>Percent | 4000 cycles<br>Percent | 5000 cycles<br>Percent |
|-----------------------|------------------------|------------------------|------------------------|
| .0005 $\mu\text{fd.}$ | .05                    | .05                    | 1.75                   |
| .001 "                | 3.00                   | 4.00                   | 6.00                   |
| .002 "                | 8.00                   | 11.80                  | 12.40                  |
| .003 "                | 11.00                  | 14.00                  | 16.40                  |
| .004 "                | 14.00                  | 17.00                  | 20.00                  |
| .005 "                | 15.00                  | 20.75                  | 25.00                  |
| .006 "                | 19.00                  | 23.50                  | 31.00                  |

The disadvantages accruing through the use of excessively large bypass capacities in the position mentioned are very evident in the table. For example, the .006  $\mu\text{fd.}$  condenser bypasses 31 per cent of the total output of the tube on 5000 cycles; 23.50 per cent on 4000 cycles and 19 per cent on 3000 cycles. The .0005  $\mu\text{fd.}$  condenser on the other hand bypasses only 1.75 per cent on 5000 cycles; 5 per cent on 4000 cycles and .05 per cent on 3000 cycles. The figures shown apply to the specific case mentioned.



C IS THE CONDENSER UNDER DISCUSSION

but apply approximately to many similar arrangements where a good grade of transformer is coupled to the detector circuit, or where a fairly high value of inductance is used as the plate load in the detector circuit. Summarizing, we find that as far as audio frequency signals are concerned, the bypassing capacity in the detector plate circuit should never be more than .0005  $\mu\text{fd.}$  or at the highest .002  $\mu\text{fd.}$  A .0005  $\mu\text{fd.}$  is preferable, however.

The selection of the bypass condenser does not rest solely upon audio frequency considerations. It is also necessary to determine how effectively the bypass condenser will bypass all radio frequency signals remaining in the circuit after rectification. It is essential that the radio frequency component in the detector plate circuit remaining after rectification be bypassed to the negative filament, and so kept out of the audio circuits. If a certain value of bypass condenser will bypass the correct amount of radio frequency current in the detector plate circuit, and at the

\*Aerovox Wireless Corp., 70 Washington St., Brooklyn, N. Y.

## Experimenters' Section Report

**I**N the past, these columns have been devoted to the use of the members of this Section only. It is believed that there are many, who though they may not have enough time at their disposal to warrant their taking part in the general program, have time for short experiments that result in interesting information of value to the rest of us. In many cases these men feel that the results of small experiments are not important enough for separate presentation in the form of short articles nor that their results may be written in condensed enough form to allow of their use as "strays". The result is that such information remains unknown to the rest as far as that particular incident is concerned. We, therefore, feel that in justice to all, these columns should be opened to all experimenters regardless of whether or not they are definitely engaged in working out the answer to those problems presented to the members of the Section.

We are also aware of the tendency on the part of various members to refrain from reporting the results of their experiments, chiefly because they feel that the experiment is not complete in that the entire answer to the outlined problem has not been obtained. Unfortunately, very few of us have the equipment and time to completely cover and solve the major problems listed and the result of this reasoning appears in what apparently seems to be lack of interest in the problem. We know that such is not the case and if you are working on a problem and find that although the entire answer may not be at hand that you have uncovered information of interest let us know about it so that it may be reported in *QST*. In this fashion others who may be working on the same problem will have the benefit of your findings and the time necessary to obtain the answer to the problem as a whole materially shortened.

If you have run across some interesting subject that requires further investigation or if you have learned of a new use for some old equipment or if you have found a new kink which will help the other experimenters along, write in and let us know of it so that others may get some benefit from your work. Information that is not distributed among those to whom it will be of value is certainly not being used efficiently.

### SPECIAL PROBLEM 66

This problem concerns the electrolytic rectifier and has been held in abeyance many months due to various reasons. The

Aluminum Company of America has been kind enough to supply us with a limited number of aluminum electrodes to be used in the construction of electrolytic rectifiers. Due to various reasons some of those who were originally interested in taking part in these experiments are now unable to do so and we can enroll a limited number of additional men in this problem.

We are particularly interested in enrolling men who do a considerable amount of operating so that the rectifier will be

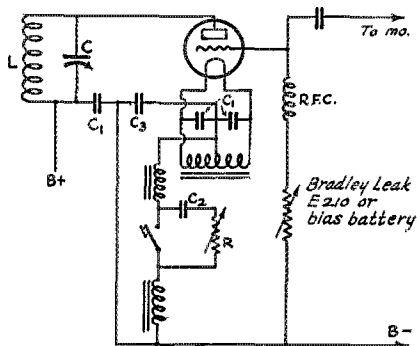

FIG. 1

*L, C, C1 and r.f.c. are of usual values.*

*C2—5 ufd.*

*C3—.005 ufd.*

*R—300-ohm potentiometer.*

*Chokes are of the dollar store variety, used for "B" substitutes. About 30 henries and 85 mls. capacity.*

in operation as many hours per month as possible. The aluminum for the rectifiers will be supplied through the courtesy of the Aluminum Company of America while the lead electrodes and the chemicals are to be obtained locally. Two types of electrolytes will be employed in each rectifier; one half of the jars will use a borax solution and the rest will use a solution of ammonium phosphate. A monthly report covering the action of the rectifier must be made up and submitted so that the performance can be charted. It is absolutely necessary that the drain on the rectifier and the voltage being rectified remain substantially constant throughout the length of the test as any considerable changes in these values would render the results worthless. If you are in a position to run a satisfactory test upon such a rectifier and have the time to fill out and return to us the report blanks which will be sent you each month we would be pleased to hear from you. In your letter give a brief description of the transmitter you are using, telling the type of

tube employed, the plate voltage and plate current together with an estimate of the approximate number of hours the transmitter is in operation each week. A plate milliammeter is essential in order that one may know the amount of current being rectified. It is not necessary that a plate voltmeter be available although this is desirable.

If you have used chemical rectifiers in the past, give a brief outline of their construction and the amount of success had with them. Also state the number of jars to be used so that the correct number of electrodes will be supplied.

#### BARCLAY CHARTS

Some time ago we distributed a number of Inductance-Capacity-Wavelength charts which were supplied by Mr. R. H. Barclay. For some time after our supply of these was exhausted we received requests for them. We were under the impression that the supply had been completely exhausted but we have recently received about 500 additional copies which Mr. Barclay ran across. If those of you who were disappointed in the past will drop us a card, we shall be pleased to mail a copy of this chart to you. A word of thanks to Mr. Barclay, c/o Stone & Webster, 49 Federal St., Boston, Mass., in appreciation would not be amiss.

#### KEYING

H. M. Walleze has supplied the following suggestions for keying the amplifier of a mo-pa set. He states that with this system W8WJ and W8BQ who are less than three blocks apart can work within a few kilocycles of each other without the least sign of key thump.

The by-pass condenser may be of almost any capacity and the chokes will stand quite a wide variation without affecting the results materially.

#### R. F. CHOKES

Clyde C. Anderson of W7JF and K7AD brings to our attention once more the use of the tunable radio frequency choke. The idea is to make a rigging so that a ring of copper or brass which is connected to the plate supply side of the choke may be adjusted along the length of the choke. A Neon lamp may be run along the choke and the ring adjusted so that there is no r.f. at the plate supply end of the choke. Such chokes may be used over a wide band of frequencies and the position of the ring may be marked and thus returned to the proper position when the set is being adjusted to a new frequency.

#### REPORTS

Don't forget to let us have reports on your work as soon as you have arrived at

some information that is of interest to all. In this way others will obtain some benefit from your work which probably would not be obtained if one waits until the complete answer to the entire problem has been arrived at. It is the object of these reports to keep others interested in the same problem in contact with the work that is being done so that the least amount of waste effort will be used.

—H. P. W.

## The Northwestern Division Convention

**H**OTEL BERGONIAN *actually accommodated* the enthusiastic bunch of hams who gathered there from the Northwestern and Pacific Divisions on August 31st. After registration was finished the program commenced with an informal luncheon. At this, talks were given by prominent amateurs.

The afternoon was spent touring the Seattle Times press plant and W7FD, W7TX, W7LZ, W7ACB, W7AEV and W7HO, incidentally taking in a lot of Seattle's "pine mast" scenery along the way.

In the evening a technical meeting was held at the Bergonian. Lieutenants Street and Burleigh of the Naval Reserve, and Louie Huber of A.R.R.L. headquarters gave short talks. Then Dave Sloan took the chalk in hand for the next five hours, explaining antennas, transmitting circuits, feed systems, and—well, was there anything he had not explained by one o'clock the next morning?

The undersized Leviathan that John Waskey chartered for the trip on Puget Sound *did not sink* (it's a wonder) when the gang trod up the plank Saturday morning. Our first port of call was NPC, the Naval Radio Station at Keyport. Chief Radioman Thomas had the transmitter all shined up for us, and gave out blown 500-watt tubes for souvenirs. The large number of V's sent from NPC's high frequency set that morning were occasioned by the enthusiastic group of admirers whose proximity detuned it!! Nobody got seasick on the return to Seattle, even though we did collide with a drifting plank.

The banquet, of course, was the best of all. Seattle's two YL's, Doroles (W7OH) and Louise (W7AEV-AGA), sang some songs for us. With Waskey as toastmaster, the gang heard from 'most everyone. Acting Supervisor of Radio, Clark was there, and His Majesty, J. King Cavalsky, represented the Vancouver bunch, who were there in goodly numbers. For the rest of the evening (and next morning) the brass was pounded *clear flat* at local ham stations.

—L. R. H.

## Another Way of Playing an Old Prank

By Rufus P. Turner\*

IT APPEARS that the practice of connecting a microphone in with one of the audio frequency stages of one's radio receiver, and speaking into that instrument so that the voice issues forth from the loud-speaker, has become almost universal at radio parties. The stunt came into vogue somewhat less than a year ago, subsequent to the appearance of a magazine article which depicted the amusement afforded a group of callers when one amateur incorporated an ordinary telephone microphone in the circuit of his receiver, and made his guests believe they were listening to broadcasting from the Antipodes.

The microphone had easily been included in the primary of one of the audio frequency transformers, having previously been connected with a concealed pair of wires extending from the room, some distance down the hall, in which it was located. Between selections, one confederate obligingly opened the outdoor antenna switch, in order that the real announcer would not be heard, while the second confederate announced some Australian station.

The writer recalls a perfect enaction of the prank at a radio party, where both the confederates were equipped with small, portable receivers in order that they might know exactly when the antenna switch was to come open and the fake announcement made. Also, confederate number two, who had charge of the microphone, knew precisely what selection was to follow and made his announcement accordingly.

The guests, grouped before the loud-speaker, were amazed, to say the least, upon learning so unceremoniously that their host's radio receiver could "pick up programs from across the seas." Not one of them suspected the whole affair to be a practical joke, so nobody consulted a newspaper to see if the program was not being broadcast by one of the local stations.

The affair was such a success that the writer determined to "pull off the stunt" at a coming meeting of other radio men at his amateur station. But the fact presented itself that radio men couldn't be fooled by the microphone prank. They would surely examine the set, discovering the wires connected at the other end to the remotely located microphone.

The difficulty was soon overcome when the writer hit upon the idea of connecting the microphone with the receiver, not di-

rectly, but through the medium of inductive coupling. The concealed wires connecting with the distant microphone were made to terminate in a loop of a few turns. (The number of turns and the proper diameter, it was found, vary with the type of radio set and both must be determined by experiment.) The loop was made of number twenty-two cotton-covered wire, and was carefully placed beneath the cloth cover, upon the table that held the set, in such a way that inductive relation was established between the turns of the coils of the receiver and the turns of the loop.

The loop is similar in performance to that employed by transmitting amateurs in the so-called "loop modulation." It is only necessary to turn on the receiver and, when the loop and one of the coils in the receiver are in inductive relation, speak into the microphone. When the coils of the set and the loop are near enough to each other and the wires connecting the loop and microphone are not too long, the results are quite pleasing. The writer has met with success both with regenerative and radio frequency broadcast receivers.

The prank went over big at the writer's party, providing no little entertainment. The guests, all radio men, searched the set for telltale wires, without success, and appeared quite *non compos mentis* when the secret was subsequently revealed.

### Strays

The O. W. says she can't see why they call them short waves unless it's because there aren't enough to go around.

Dr. Lawrence J. Dunn, Director of the Hudson Division, announces the dates for the Hudson Division A.R.R.L. meetings of the 1928-29 winter season. The dates fall on the first Monday of each month: October 8th, November 5th, December 3d, January 7th, February 4th, March 4th and April 1st. The meetings are held at the Army Building, 39 Whitehall St., New York City, with room for about 300. Interesting programs, with technical talks and discussions of amateur problems, will be provided. There is no charge whatsoever. Members and their friends are invited.

The Y. L. thinks that all political speeches should be broadcast on short waves only—the shorter the better.

\*604 East 51st St., Chicago.

## Some Radio Uses of Lamp Banks

By I. Vee Iversen\*

**H**ERE are a few uses for a lamp bank. These things are really handy to have around. I have just completed a master oscillator outfit and in it have found the use of lamp banks a great help. To start with, I am using W.E. oxide-filament tubes, in which the filaments must be kept warm even when not transmitting.

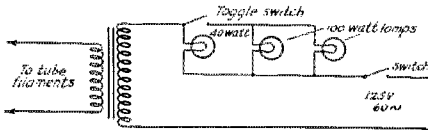

FIG. 1

A lamp bank solves this nicely as shown in Fig. 1. I use one 40- and one 100-watt lamp in the primary of the filament transformer. These take care of the VT-2 and the WE211-D. For a VT-2 and a UV-203, it is necessary to use one 40-watt and two 100-watt lamps to give the rated voltage

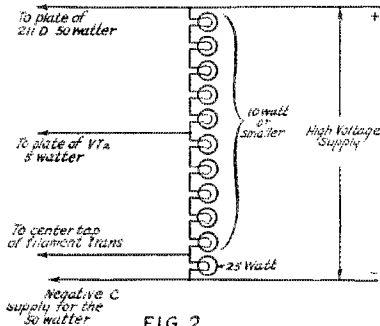

FIG. 2

on the tubes. When I give the "ga" to the other fellow, throwing this toggle cuts the filament voltage in half but keeps the tubes hot.

As you know, the VT-2 will not take the same plate voltage as the 50 watter. Figure 2 shows my way of getting around that. I have a bank of 12 lamps (in series) across the plate supply. Eleven of these lamps are rated at 10 watts and 1 at 25 watts. The voltage drop across the 25-watt lamp is the negative grid bias on the 50-watt amplifier. This eliminates the purchasing of batteries for this purpose and the voltage drop across 6 of the 10-

watt lamps gives me the voltage for the VT-2 plate.

By changing the size of the lamp supplying C-bias the value of bias may be changed. With a 25-watt lamp and the VT-2 drawing 40 mills and the 211-D drawing 160 mills, the drop across these lamps is about 105 or 110 volts, which makes the set work satisfactorily. To my notion, the use of lamp banks should be increased. Since I have gotten used to using lamp banks a new use suggests itself almost every day. For a fellow using a mercury arc for power supply, the above will furnish an admirable keep alive load besides the other uses and at the same time makes a good fuse—on excessive plate currents the C-bias lamp will go west. The C-voltage then goes up, blocks the plate current and saves the tube.

## Standard Frequency Transmissions of WWV

**T**HE Bureau of Standards announces a new schedule of radio signals of standard frequencies for use by the public in calibrating frequency standards and transmitting and receiving apparatus. This schedule includes many of the border frequencies between services as set forth in the allocation of the International Radio Convention of Washington which goes into effect January 1, 1929. The signals are transmitted from the Bureau's station WWV, Washington, D. C. They can be heard and utilized by stations equipped for continuous wave reception within a radius of 500 or 1,000 miles from the transmitting station.

The transmissions are by continuous wave radio telegraphy. The signals have a slight modulation of high pitch which aids in their identification. A complete frequency transmission includes a "general call", and "standard frequency" signal, and "announcements". The "general call" is given at the beginning of the eight-minute period and continues for about two minutes. This includes a statement of the frequency. The "standard frequency signal" is a series of very long dashes with the call letters (WWV) intervening. This signal continues for about four minutes. The "announcements" are on the same frequency as the "standard frequency signal" just transmitted and contain a statement of the frequency. An announcement of the next fre-

\*7AW, 6554 18th Ave., N. W., Seattle, Wash.

(Continued on Page 58)



# Calls Heard



*G. A. Parslow, 27 Eastbourne Road, Tooting Junction, London, S.W. 17, England.*

wlack wlabx wlab wiano wlap wibfz wibyv  
wlbwl wlcki wlci wldv wlls wlky wlnv  
wlxx wlsf wisz wlzi w2aog w2ail w2arb w2avb  
w2bac w2bcc w2bvg w2uom w2cu w2cx1 w2cvj  
w2div w2ky w2nm w2rs w2rx w2tp w2vi  
w2vk w3ac w3abc w3adm w3jn w3nr w3wm w4adm  
w4agf w4aq w8agy w8awf w8ax w8axa w8cfr  
w8cug w8duw sb-laak sb-law sb-2az sb-lat sb-2ig sb-  
law sc-3cj wnp ve2ap ve2bg.

*Alan G. Brown, 8 Mangarra Road, Canterbury, E7, Victoria, Australia.*

wlaao wlasf wlbox w2cx1 w2kl w2tp w8afj  
w3cgf w3hh w3lw w4au w4dt w5aej w5afx w5agc  
w5apc w5ayo w5ba w5bcm w5bf w5bj w5hn  
w5pa w5rg w5qa w5ql w5qx w5bg w5abk w5ags  
w6ahx w6akk w6aoc w6aas w6ap w6apf w6ask  
w6aur w6awe w6ax w6bc w6bf w6fo w6bhv  
w6bjf w6bjx w6boy w6byv w6bws w6bxi w6bza  
w6caj w6chr w6aih w6cuh w6cut w6dca w6dgo  
w6djq w6dlx w6dpo w6dpw w6dq w6dtd  
w6dto w6djj w6eaa w6eah w6eba w6ecg w6edx  
w6eco w6efj w6egx w6eha w6wn w7ac w7bad w7cm  
w7dm w7gj w7gk w7si w7vx w7xb w8afb w8cau  
w8cns w8dca w8tn w8apa w8bcn w8bmw w9cjh  
w9cks w9dbw w9efe w9egm w9ekc w9emr w9epa  
w9ewm w9fdj w9fjg w9gw w9hd w9hn w9pu  
wwel xnu-ig nux-md ac-lpp ac-2mo ac-7sw ac-8ag  
ac-9aa ag-67ra ai-2kw aj-1jx aj-law aj-3ww aj-4zz  
aj-7cb aj-7mf ea-hg eb-4ar eb-4us ee-2un ee-ear28  
ef-8fr ef-8axq ef-8orm ei-leh ei-lgo ei-lpo ek-4aar  
ek-4yt em-smuk ep-lae ep-lae ep-3ap xep-1ma fq-ocdl  
fg-ocdu fq-ocya k7aer k7als k7sc wweg ve8fe ve4cu  
ve8co ve8aa ve8ap nn-1nic nn-7nic nz1rs oc-8xx  
od-lao od-1jr oa-lwa od-1xm od-4as oe-lvw k6akg  
k6bce k6bhk k6ch k6dpg k6dsd k6dvg k6ece k6kx  
k6daq op-lad op-1cm op-1gw op-1hr op-1pw sb-lav.

*ec-RP10, Miss M. Benesova, Prague-Smichov, Plzenska str. 22, Czechoslovakia.*

wlbgq w2rs w2uo w8rau ne-8ae sb-lak sb-1ca  
sb-2aa sb-2ab sc-3ac su-1oa su-2ak fe-egcz fm-8rit  
fo-a3a ag-1eq ag-14rb ai-2kt ai-2kw am-3ab ag-11m  
oa-2lg oa-3ls oa-5hg oa-7cw oa-2ay ea-sa eb-4au  
eb-4cc eb-4ddi eb-4ft eb-4gm eb-4us eb-4yl eg-1ab  
ec-1kx ec-1mx ee-1na ee-1ry ee-1yl ee-2un ee-7md  
ee-ear6 ef-8ct ef-8dmb ef-8ez ef-8gdb ef-8mmp  
ef-8orm ef-8pns ef-8pac ef-8sta g6iv g2nm g6wn  
ei-lah ei-leq ei-lfb ei-lfe ei-lmt ei-lmw ei-lpn ek-4au  
ek-4hf ei-lal em-smuk em-hmzf en-odj en-ofp en-omj  
en-oyy eo-1lz ep-laa ep-lbl ep-lbx ep-lct xep-1ma  
es-2nag et-tpar et-tpkx et-tpao eu-18rb ew-be ew-yy.

*G2BOQ, H. E. Bottle, 27 Stormont Rd., London, S. W. 11, England*

wlaea wlaod wlaof wibcv wibcy wibea wibkf  
wibkh wibqs wibqv wibyh wicje wlcmd wlcra  
wldy wlyg wljg wlmm wllq wlll wllv w2adj  
w2aep w2agn w2ail w2aog w2ary w2avb w2avz  
w2azu w2bac w2bew w2bjs w2bm w2cfk w2chd  
w2cmu w2com w2cwg w2lx w2nf w2rs w2rz w2uk

w2vi w3aok w3ava w3awq w8bm w3cdk w8ahk  
w3ke w3tr w4aba w4acv w8acm w8awf w8bjb w8cau  
w8cnz w8dcq w8dtn w8anq w9fci w9mt veibr ve2bg  
nq-2kp nq-2jj nz-fr5 sa-az2 sb-2ar sc-lai fo-a8z wnp.

*A. Comender, Burg, Meineslaan, 91B, Rotterdam, Holland.*

wlrei wika wlab wlapi wlia wlibv wlcra wlaeh  
wliy wlahx wliaa w2uo w2com w2gv w2kl w2cx1  
w2inb w2avb w2acu w2bo w2nf w2arb w2atr w2dg  
w2rs w3bqv w3ge w3aih w3wj w3cdk w3anh w3auj  
w3jn w4ft w4acx w4acr w4acv w4aej w4vc w4oh  
w4is w8cx w8axa w8cia w9cax ve2br ve2ca vedt  
ve9ap k4agf nq-5fl nj-2pa ag-skww ag-6grb ag-tbl4  
ag-tb64 ag-lmdz as-15rw as-15ra ff-8pj fq-8hpz  
fm-tun2 oz-2aw sa-de8 sb-1ca sb-lbs sb-lid sb-lah  
sb-lbe sb-lcj sb-law sb-laf sb-lbs sb-2ag sb-2af sb-2ai  
sb-2aj sb-2ah sb-2ay sb-6qa sc-2ab sg-a7 su-2ak  
xnu-7ef xnu-7ef xep-1ms xef-8gcr xed-7kb.

*ef-RO91, C. Conte, 24 Allee du Rocher, Clichy-sous Bois, (S. et. O) France*

wlabd wlaek wlabf wlafl wlagw wlaix wlaqp  
wlaqt wlasd wlaqx wlayt wlbtt wlbqg wlcmf  
wlcpc wlcrs wlgx wllm wliy wikk wllc wlsr  
wlasp wlahz wlcnz w2ajb w2alu w2ang w2api  
w2aql w2ate w2ba j w2baz w2bbi w2bek w2hrh w2bic  
w2blx w2bm w2bmx w2bms w2cbk w2cin w2cko  
w2com w2cug w2exl w2dr w2dl wifa w2gj w2kd  
w2rs w2ti w3aic w3amx w3anh w3apn w3ard  
w3avi w3cgl w3chg w3ckl w3ec w3ga w3tr w4aam  
w4aau w4aay w4abl w4acx w4ado w4ahy w4aq w4ca  
w4fe w4fl w4hz w4lc w4nu w4rj w4th w4vl w5apo  
w5ark w5adg w5adu w5agy w5agq w5aht w5afr  
w5aso w5awp w5aze w5baz w5bm w5box w5bpl  
w5bri w5bvg w5cft w5efh w5enr w5enz w5ehr w5cav  
w5cvj w5dtd w5dmf w5duw w5rh w5avz w5bja w5dcm  
w5dpx w5dsy w5ara w5auh w5crd w5cya w5uce  
w5eln w5enr w5ewh w5fqs w5nm w5bqc ngm veibr  
ve3gl nq-2yt nq-2xc.

*ec-RP 19, Alois Weirauch, Mestec Kralove 9, Czechoslovakia.*

wlbox wlnp wlrw w2apv w2ass w2bjg w2bm w8anh  
w3aob w3apx w3hms w4dt w8au w8box w8duw  
w9abv w9rd nj-2pa nn-7nic np-4ug nt-2fp nq-5fl  
nq-7cx nx-lab nz-fr5 fq-pm fq-8hpz fq-8rya oa-3vp  
sa-de8 sb-lah sb-lai sb-lbs sb-1ca sb-1cg sb-1cj sb-1ld  
sb-2ar sb-2ay sb-5af sc-3cj sg-a7 su-lcd su-2ak sb-1bm  
(20 meters)  
wlarq wlaue wlibv wlcmf wifa wix w2adm  
w2api w2azo w2cx1 w2vi w3adm w3edk w8axa nc-lap  
nc-2ca ne-8ae ne-8wg fq-8hpz oa-5gh sb-law wnp.

*ed-7XX, H. Glistrup, Copenhagen, Denmark.*

wlage wlaqt wlbox wliby wlibv wlcmf wifs wlyr  
wlxm w2agn w2api w2arb w2avb w2avz w2bcc  
w2bfq w2cmu w2kx w2lx w2nm w4act w9adn w9bqy  
w9ef ve2bg ve2by ve-2ca sa-2az sb-lat sc-law sc-2aj  
sc-2ig sc-1lt su-lina fg-ocya.

*(Continued on Page 50)*



Conducted by A. L. Budlong

**T**HERE has been a gratifying response to the request that National Sections appoint official I.A.R.U. correspondents, and see to it that regular reports on amateur activity are sent in to this department for publication. Due to the cumulative lags of distance and the month-and-a-half-in-advance publication factor, it will be several months before several new countries become regularly represented here, but the point is that they will be here.

We want to make this a department where, each month, you can be sure of finding the latest advices on changes in legislation or regulations in other countries of the world, future plans and policies of the individual national amateur organizations, and amateur happenings. The coöperation of every national section is necessary in order to accomplish this. Please do your part.

**DR. CURT LAMM, EK4CL, VISITS HEADQUARTERS**

It was a great pleasure, on September 27, to welcome to A.R.R.L. Headquarters, Dr. Curt Lamm, a member of the Executive Headquarters of the D.A.S.D., the German amateur society, a prominent amateur, and the operator and owner of ek4CL. Dr. Lamm is in this country for six months to conduct chemical research work at Cornell University, and hopes at the same time to become thoroughly acquainted with American amateur methods.

His visit to Hartford is greatly appreciated, for the Doctor has to report to Cornell the first of October, and Hartford is not on the way to Cornell.

During the day we looked over the Headquarters office, talked about the I.A.R.U., and cleared up many points which had been hazy in this editor's mind regarding the National Section in Germany.

That evening a dinner was held at a local hotel at which we had Dr. Lamm, Mr. Maxim, Col. Foster, W6HM, Marshall Wilder, of Boston, and the Headquarters Staff of the A.R.R.L. It was a most in-

formal and pleasant evening, and will be remembered by all of us for some time to come. After the dinner there were short speeches by Mr. Maxim and Col. Foster, and a most gracious one by Dr. Lamm. Following this, the affair turned into a thoroughly delightful hamfest. About 10:30 P.M. everyone adjourned to the main dining room of the hotel for coffee and sandwiches, and the hamfest was resumed, to be continued until the management closed up the place at midnight.

We hope Dr. Lamm has a pleasant stay in this country, that he will have time to attend some conventions, and that he will make many NU QSOs. This last fact seems assured, since the Doctor has expressed the intention of taking out an operator's license and getting on the air as soon as possible. For the benefit of American hams, we might say that Dr. Lamm speaks excellent English, that he can receive up to thirty words a minute, and that his sending (as we heard it at 2ALU's the night ek4CL landed) sounds like machine sending at twenty-five words a minute—with a straight key, too!

**FRANCE**

In a recent issue we chronicled the fact that an election had been held in the Réseau Emetteurs Français, and listed the name of the new president. Mr. Robert Audureau has now supplied us with the names of all the new officers, which are as follows:

President: J. Reyt, 8FD.

Vice-Presidents: R. Desgrouas, 8LH; J. Bastide, 8JD.

Secretaries: R. Audureau, SCA; R. Martin, 8DI.

Treasurer: R. Larcher, R010.

Honorary Presidents: Leon Deloy, 8AB; Pierre Louis, 8BF.

President-Founder: Jack Lefebvre, SGL.

Mr. Audureau also advises us that the only address to which communications for the R.E.F. should be addressed is:

Larcher, B. P. 11, Boulogne-Billancourt, Seine, France.

We offer our sincere congratulations to the new officers of the French section. The R.E.F. now has more than 800 members, indicating a steady and healthy growth. This is splendid.

#### GREAT BRITAIN

Great Britain is one of the countries maintaining an official correspondent for this department, and it is a source of much gratification to receive a report each month. The latest one follows:

"What with holidays, dud conditions and fine weather resulting in QRM from cricket and tennis, there does not seem to have been very much DX done during August. Certainly conditions were pretty bad; as 2XV put it, fancy wanting a DX report when first district Yanks, even, are rare as roses in January! 2XV, however, is running a schedule with oa7CH on 23 meters. 2NH, too, worked OA every morning for a month on that band. 2CX keeps a sked with oa5HG and also raised several NUs, including a nine.

"5BZ raised the first, second, third and eighth districts, NC, OZ, OA and SB and needs only to get an Asian station for his WAC, wherefore he finds life good. 5BY says ND, with only about three dozen Yanks, SB and SA. If that's ND, OM, let's have a real report. Hi! 5YK worked SU on 23, but is very busy with ten-meter work. 6SM hooked fk4MS. 2AX moans about conditions, but worked two or three. 5ML worked the U.S., but not much else. 6CI exercised his Morse on the long-wave commercials. FB OM! Hi! 6BY worked some NU's SB and SC.

"6BB worked sc3AC with 4 watts on 23 and NU 6, NC 5 and OA with 8 watts. Good work, OM, and more like the old 20-meter stuff. 5LS ran a nightly sked with NU while un1II was at his shack. 5BQ found things good on 45 and worked several nines. 5YU had a stab on that band, too. Long waves these days, OM's! Several hams have had the pleasure of meeting nu1II, both at their shacks and also at the keys of some of those he visited. nu6BJH also called on 5BZ and 5BY, to their great pleasure."

#### NORTHERN IRELAND

With this report, the series of interesting articles contributed to this department by Mr. Megaw will come to a close. Mr. Megaw is leaving Ireland to conduct research work in London for two years. We congrat-

ulate him most heartily on this appointment, but at the same time we regret very much that his good fortune deprives us of such a satisfactory correspondent. We hope that the R.T.U. will immediately appoint some one to take up the work which Mr. Megaw must now leave to other hands. The report follows, and contains a most interesting resume of amateur progress in Northern Ireland:

"As this is the last time these notes will be penned by the present writer, perhaps a few words in retrospect will not be out of place.

"It is now something over three years since the first amateur transmitting licenses

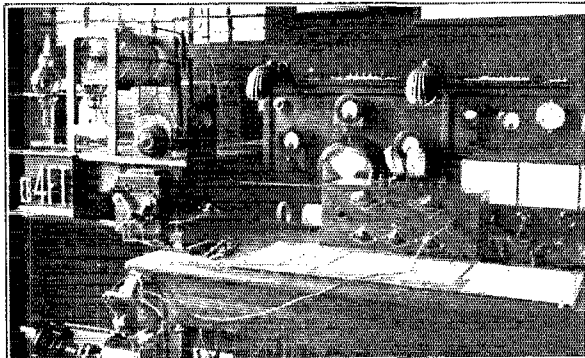

AMATEUR STATION 6b4FT, OWNED AND OPERATED BY GEORGE NEELEMANS, TRAFFIC MANAGER OF THE RESEAU BELGA AT BRUSSELS, BELGIUM, is one of the most widely known amateur stations in the world. The circuits is a Meeny, with two 150-watt Mullard valves. An Esco motor generator supplies 1100 volts for them. The antenna is a half-wave Zeppelin working on 32 meters. All instruments are Westons, and the receiver is a Grebe CR-18. These, with the Esco m. g. and the Vibronlex key 6b4FT, to use the words of its owner "rather a Yank station in appearance!"

were issued in Ireland. At that time, there came into being a few isolated transmitters, all using very low power and operating under somewhat irksome restrictions, and this represented the result of several years of effort on the part of some of those amateurs. (It will be remembered that the unsettled political state of the country was the cause of this prolonged delay.)

"After about a year, the numbers had increased sufficiently to warrant the formation, in September, 1926, of the Radio Transmitters' Union (Northern Ireland), an organization which is run on rather unusual lines and which has been a great success and a considerable factor in the development of amateur radio in this province during the last two years. It now enjoys the recognition of the Post Office and broadcasting authorities. Its membership includes almost all the transmitting amateurs in Northern Ireland and membership of the

(Continued on page 54)

# Correspondence

The Publishers of QST assume no responsibility for statements made herein by correspondents.



## Our New Calls

Box 698,  
Pampa, Texas

Editor, *QST*:

I notice some of the gang are already having their cards printed in this manner: W5NW or W-5NW.

If I understand this new call business correctly they should be printed in this manner: W5NW. In other words, all U.S.A. calls start with the letter W instead of a numeral as theretofore. And the W is as much a part of the call as the numeral and the rest of the letters, and should be given as much prominence on the QSL card. In calling I notice some do not use the letter W every time they send their call. A call should be made in the following way: CQ CQ CQ de W5NW W5NW W5NW.

—Wayland M. Grove, W5NW

Editor's Note: Mr. Groves is dead right. Just as commercial stations have calls beginning with W or K, like WIZ and KWE, so do amateur calls now begin with these letters, like W5NW and K6CFQ. Similarly in other countries where calls are being changed, like G2NM, G16MU, VE1AR, ZL2AC—the initial letter or letters are part of the call, not to be separated, and to be printed in caps. See our October editorial on this subject. We recommend, however, that for calling purposes we use the old "international intermediate" until such time as governments change their amateur calls, and that in written references to such calls we use lower-case letters, thus: ef8HIP, foPM—to avoid confusion with calls legitimately beginning with those letters.

## The Extra First Grade

2631 Garfield St. N. W.,  
Washington, D. C.

Editor, *QST*:

Your editorial on the amateur extra first grade license, in the September issue, was read with great interest by myself, and, I know, many other "hams". I feel, as you have said that we never really appreciated this class of license until it was taken from us.

It may interest you to know that, having read your editorial, I decided to take time by the forelock, and accordingly, was issued yesterday amateur extra first class license number one of the new series. Now that the ball has been started rolling, here's hoping more amateurs will take out this license.

—Willard R. Burton, 3NR

## Undelivered Messages

Uxbridge, Mass.

Editor, *QST*:

On September 14 and 15 the Blackstone Valley Radio Association held a booth at the Uxbridge Fair and accepted messages from the patrons of the Fair. At the end we had 138 messages both 1COS at his station in Milford and 1BZJ operating the Assn's station 1JB were at the key for two days getting off the messages of the hook, some stations they QSO reported them R7 good note very steady but when asked to take traffic all they say was, "lot QRM or QRN gid to QSO u OM, 73," and they would go for somebody else without waiting for any reply from our stations. According to the reports made by some patrons only about 50% of the messages that were sent from our station were ever delivered to the addressee. I think that this is a very low mark, and that it gives our organization a bad name from those whose messages were not delivered. The officers of the association wish to thank those who did take traffic from 1COS, 1BZJ and 1JB and relayed or delivered it. 1AJK of Worcester deserves the credit for the way he stood by for those two days giving us all help in getting the traffic off in his direction. I hope that next year when we have a booth we will be able to hit the 100% mark, and we can do it with the coöperation of the gang. Again I wish to take my hat off to the few but "royal hams" who did coöperate with us this time.

—Walter H. Kozaczko, Sec'y, Blackstone Valley Radio Association

## The Splatter System?

Syracuse, N. Y.

Editor, *QST*:

Are we to gather from E. O. Hurlburt's letter in September *QST*, that an ideal 10-meter beam transmitter can be had by arranging a sea water tank atop the house and allowing the water to spray down behind our 10-meter vertical antenna?

Would you suggest a pyrex pump to return the water to the tank?

—Alfred R. Marcy, Chief Engineer, WFBL

## NEW CONDENSERS SHOWN FOR FIRST TIME-- EXPERTS SAY "SENSATION OF YEAR!"

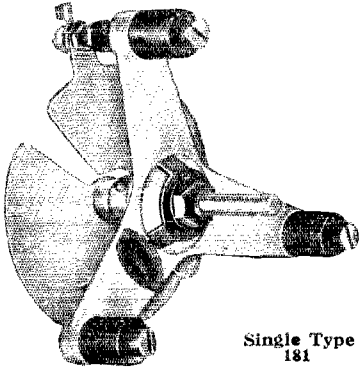

Single Type  
181

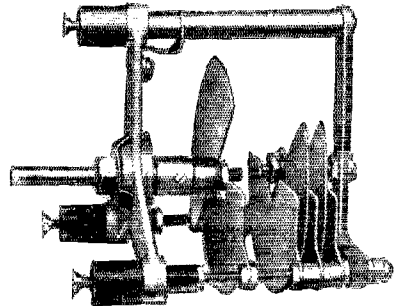

Multi Type 187

### EFFICIENCY AND DX ABILITY NEVER EQUALLED

Announcements of radical new apparatus are not daily occurrences at REL. So when they come, you sit up and look alive; for experience has taught you that REL is pioneering for the good of amateur radio; that they are developing equipment to meet the needs of changed operating conditions. These condensers are what you've been waiting for. They solve the riddle of the narrow bands and afford satisfaction heretofore only hoped for. Nothing has been spared in order to make these condensers **THE BEST**. The results are gratifying; and after all, only results can substantiate our story.

#### NEW! NEW! NEW! 1929 Receivers and Transmitters How to Build and Use Them

A booklet which describes the construction and operation of five modern high frequency receivers is now ready. Included among these are the well-known Standard Regenerative receiver, a circuit employing the Screen Grid tube, a special Super-Heterodyne, etc. A companion book on 1929 transmitters and circuits will be ready next month. Before contemplating reconstruction, secure this new REL data. It's Free.

### CONSTRUCTION EXPLAINED FACTS SPEAK FOR SELVES

The new Variable Receiving Condensers are shown here for the first time. These condensers will be an absolute necessity in 1929, when the wave bands are narrowed causing great congestion. Using either of the new condensers will allow the operator to spread each waveband over the entire tuning scale of his receiver. Several outstanding features are: die-cast aluminum end supports, giving extreme ruggedness. Large single conical bearing, which prevents end play or side thrust. Insulated stand-off bushings, enable these condensers to be mounted on metal panels. The rotor tension is maintained by a large three finger bronze spring, assuring positive, even action during the complete rotation of the rotor. A patented rotor plate contact assures absolutely noiseless action. The rotor shaft revolves in a pool of mercury, making a perfect constant contact. Both the Stator and Rotor plates are of extra hard, heavy sheet brass and the shaft is standard  $\frac{1}{4}$ " allowing the use of any dial.

REL Catalogue No. 181 is a two plate variable condenser, so arranged that the stator plate may be moved permitting any desired maximum capacity to be obtained. This condenser adapts itself to frequency meters and high frequency receivers and is advised by Mr. Hull of the American Radio Relay League on page 14 of the October QST.

REL Catalogue No. 187 is a combination semi-fixed tank and continuously variable vernier condenser. This model is so arranged that a perfectly large semi-variable air-spaced condenser is shunted by a continuously variable two plate condenser. The tank portion of this condenser may be set at a certain desired capacity and the variable element can be used to cover only the exact frequency band desired. A special feature of this condenser is that a pre-determined setting of the tank circuit may be indicated on a disk on the tank rotor shaft, enabling constant re-setting to any desired capacity. This condenser may be advantageously used in a low power transmitter where a "High C" circuit is desired as on page 26 of September QST exceptionally adaptable for receivers where a stated "lump" capacity is needed for each coil so that the continuously variable vernier will spread each band over its entire tuning scale.

The ideal condenser for Westman's Traffic Tuner. (September QST).

RADIO ENGINEERING LABORATORIES, 100 Wilbur Ave., Long Island City, N. Y.

## Beginners

6 Airlie Street,  
Worcester, Mass.

Editor, *QST*:

Here is something that has been on my chest for some time, yes years in fact. Mr. Brown's letter in the July *QST* prompts me to unload it. First and foremost, get me right. I certainly agree with Mr. Brown that we should all have patience with the new hams and give them a slow and good QSO when they call us or when we answer their call. If they ask us to QTA or QRS, do so and be a good scout and not a snob. We were all beginners and well do I remember my own feeble attempts some years ago to get the other fellow's drift.

Now for the load! A number of times, I have had the following happen and only recently was it brought back to me with force. I worked a chap who asked me to send slowly as he was a beginner. I, at once, changed to ten per with QSZ. He gave me a report good enough for any conditions of the air but asked me to send slower. I cut the speed to about six per with QSZ and still he was unable to get what I said. About this time, I realized I was in for a long session and rather than cut it short, repeated the dope all over again and still nd. Now, what would you old timers do in my case when he came back and said he was sorry but would I please send slower? This time I went down to nearly zero per and got "rr ok". Well, that was better, but I saw that there were no signs of my getting away so I reconciled myself to my fate. Now, fellows, it became necessary about this time to call it off so I did but was out of luck as he did not get me. Wasn't I justified in giving him my 73?

Well, I am perfectly willing to spend some time wit hanyone but if he is not able to copy ten per or anywhere near it, he has obtained his license in some incorrect manner and whoever signed his papers is responsible for his being on the air before his time. If a fellow can't copy the required speed, he must expect a little rough treatment. No one should be on the air who can't copy ten per with signal strength and atmospheric considerations.

—Clarence J. Green, 1ASU-1BCO.

(Continued on Page 73)

PATRONIZE THESE

**REL** DISTRIBUTORS

**REL** CENTRAL **REL**  
UNITED STATES

AMATEURS 8th AND 9th DISTRICTS

**CHICAGO RADIO APPARATUS CO.**

415 SO. DEARBORN STREET,  
CHICAGO, ILL.

Dependable Radio Equipment  
Since 1921

Our Organization Understands  
Amateur Radio because it is comprised of  
Well-known old-time "Hams"  
Write for Our New Amateur Catalog

**REL** BRAZIL **REL**  
SOUTH AMERICA

**M. BARROS & CIA**

70 SOB. RUA S. JOSÉ 70 SOB.

POSTAL BOX 89

RIO DE JANEIRO

Telegraph Address, Radioparte, Rio de Janeiro  
Branch: Avenida S. João 4, S. Paulo, Brasil

Send Us Your Specifications—  
Our Engineers are Experts on  
Short Wave Equipment

**REL** ON THE **REL**  
PACIFIC COAST

**RADIO SUPPLY CO.**

920 SO. BROADWAY,  
LOS ANGELES, CALIFORNIA

We Carry Standard REL  
Apparatus—Data Forwarded  
Upon Request

**REL** WEST **REL**

**E. F. JOHNSON CO.**

WASECA, MINN.

Amateur Headquarters for  
1929 Apparatus—Our New  
Bulletin is Ready—Write

BETTER **REL** APPARATUS



WHY SHIELD THE SET?

# New Transmitters in Metal Cabinets Shielded and Stable--Best for 1929

Extremely Compact Equipment  
Comprises the Best of New,  
Improved Parts

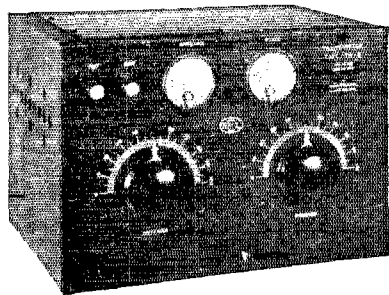

Features of  
Construction  
Described  
in Detail

The new REL shielded transmitter is a radical departure from all other kits on the market. The advantage of shielding is universally acknowledged. The black crystalline finish metal cabinet presents a most pleasing appearance not usually found in a transmitter. New REL equipment specially designed for the 1929 bands is employed thruout. The construction is remarkably rugged and employs standard circuits.

## Who Uses REL Apparatus:

REL equipment is utilized by the leaders of the radio world. In far flung corners of the Globe, you will find REL kits and products. Here's a partial list of REL users.

|                              |                     |
|------------------------------|---------------------|
| U. S. Army                   | WMCA—New York City  |
| U. S. Navy                   | WCAP—Washington     |
| U. S. Marine Corps           | WAAM—Newark         |
| U. S. Coast Guard            | KDYL—Salt Lake City |
| General Electric             | WFBR—Baltimore      |
| Radio Corporation of America | WRNY—New York City  |
| Westinghouse                 | KFH—Kansas          |
| Firestone Tire & Rubber Co.  | KFPW—Missouri       |
| WOR—Newark                   | KFJF—Oklahoma City  |
|                              | WKBS—Illinois       |
|                              | WJAS—Pittsburgh     |

REL Shielded Kits may be used for any 7½ or 75 watt Hartley, tuned plate, tuned grid circuit or any variation of them.

The cabinets are electrically welded, insuring absolute contact on all sides. The panel of aluminum uses a wood base board and the panel and base board slide into the cabinet. These cabinets are of uniform height and are exceptionally well adapted for M.O.P.A. circuits using a 7½ watt oscillator with a 75 watt amplifier. Two cabinets side by side present a very neat appearance besides affording complete shielding. The top is detachable affording easy access to the interior. The sides are ventilated so there is no danger of the equipment heating. **THESE KITS ARE THE ONLY ONES IN THE MARKET, WHICH ARE CONTAINED IN A METAL CABINET.**

The 7½ watt kit is furnished with a new type No. 187 variable condenser and the new type No. 182 interchangeable plug-in coil.

The 75 watt kit uses the large type No. 149 condensers and the old reliable type No. 127 inductors. Weston meters are used in both kits, with other quality apparatus.

**WRITE FOR  
FREE DATA**

**PATRONIZE THESE**  
**REL DISTRIBUTORS**

**REL** **Greater** **REL**  
**New York Area**  
**R. H. McMANN**  
 12 WARREN ST., N. Y. C.  
 Complete Stock of REL Apparatus  
 Always on Hand  
 Our Sales Organization is  
 Equipped to Give Prompt Service  
 Write Us

**REL** **EXPORT** **REL**  
**EXCLUSIVE REPRESENTATION**  
**IN ALL FOREIGN COUNTRIES**  
**AD. AURIEMA**  
 116 BROAD ST., N. Y. C.  
 Literature Describing 1929  
 Designs of REL Short Wave  
 Apparatus now Available for  
 Distribution—Send for Your Copy

**REL** **MIDWEST** **REL**  
**W. C. BRAUN CO.**  
 563 W. RANDOLPH STREET,  
 CHICAGO, ILL.  
 Our Large Competent  
 Staff Invites your Inquiries  
 Ask for Our New  
 "Radio" Catalogue

**REL** **PHILADELPHIA** **REL**  
**and Vicinity**  
**RAYMOND ROSEN & Co.**  
 49 NORTH 7th STREET,  
 PHILADELPHIA, PA.  
 "Ask us About REL"  
 Visit Our Showrooms—  
 Write for Information

**BETTER REL APPARATUS**

For those who are using remote control relays for the making and breaking of the power supply circuit to the transmitter and are objecting to the amount of juice used by the relay it is suggested by oh6DB that a solenoid type of relay be used. He finds that a solenoid and plunger arrangement in conjunction with chain-pull socket works very well. A fuse can be screwed into the socket to complete and protect the circuit. The relay can be operated with a single impulse rather than a continuous current which must flow all the while the circuit is to remain closed.

**Calls Heard**

*(Continued from Page 43)*

**KUTM, Steamer John P. Reiss, Clyde C. Richelieu, Operator**

(40 meters)

wiavg wiaep wibkf wibfz wlcq wlbux wlxj wlxk  
 wlxv wlcnf w2al w2aue w2agn w2ahh w2ahi w2aim  
 w2ahu w2bmm w2com w2adm w2aut w2baa w2bm  
 w2cp w2ctq w2dg w2nf w2wd w2bg w2bkz w2avp  
 w2ea w2zaf w3ard w3anu w3aua w3oh w3tq w3dqv  
 w4is w4mx w4nu w4rq w4ut w4aar w4hk w5aad  
 w5aug w5afe w5afx w5ark w5bj w5bic w5gf w5jc  
 w5mf w5mx w5ql w5uo w5vc w6eze w6xb w7lz w7id  
 w8ahe w8ahu w8bei w8ceu w8bky w8blb w8bm  
 w8bmc w8hts w8eau w8ent w8eze w8cx w8dde w8dem  
 w8cew w8dde w8dgb w8eft w8cnz w8elo w8bgy  
 w8dvl w8hx w8jj w8li w8wo w8iu w9ack w9acu  
 w9ake w9aqe w9bbl w9bga w9bhz w9bnf w9bpq  
 w9bwa w9cej w9ejh w9cph w9arf w9arm w9axo  
 w9axu w9aug w9ben w9'n w9aug w9bab w9bam  
 w9cek w9dap w9doi w9dww w9dzw w9cad w9cyb  
 w9den w9dim w9drj w9dwd w9efe w9ecs w9cnb  
 w9ezd w9ecd w9cep w9eho w9eji w9elb w9enn w9eac  
 w9exc w9eyh w9eak w9dyw w9bpl w9ben w9dfj  
 w9ayu w9bkz w9cjs w9dbk w9dzl w9brp w9btq  
 w9eer w9dwm w9db w9ayx w9ldr w9fyg w9fac  
 w9fdy w9flb w9fis w9fid w9fzk w9fuy w9fsn w9epe  
 w9fcs w9fig w9kw w9lf w9fd w9jmi w9mi w9mq  
 w9my w9rc w9ll w9od oa-2ra oa-2ns oa-3kr oa-2yi  
 oa-5mh oa-3vp oz-4am sc-2ab su-2ak velbr velch k7to  
 k4aaw.

(80 meters)

wibld wiera wicos wiga w3agg w4afw w8aaf  
 w8arb w8arx w8brb w8cno w8ddm w8dsf w8li w8dpi  
 w8bhr w8hwz w9evi w9czf w9dld w9dek w9dgv  
 w9dsc w9ekw w9eru w9faw w9fdw w9efu w9ege w9qd.

(20 meters)

wlanh wialb wiblv wiblv wlecc wlecb wlcio  
 wlida wldf wlkq wljr w2azo w2bdj w2bac w3ath  
 w3aam w8cx w3bph w4gd w4vc w4aaq w5amn w5baz  
 w5bbc w6ano w6cjs w6cuh w6bpm w6dmi w6dwp  
 w6no w7ai w9afx w9agz w9avy w9baz w9neb w9bkz  
 w9cep w9cub w9efe w9fyp w9us nc-4io sc-1ah ni-2xa  
 g6by g6ut.

**W7MF, Harold D. De Voe, R.F.D. 2,  
 Medford, Oregon**

ac1pp aj2by aj2dk aj4ak aj4dk aj4zx aj7mf jxix  
 ef8orm fl1ab foa3e foa3z foa4e foa5o fo8hpz k7to  
 nj2pa nmlg nm9a nlnlc n7uic nncab nq5fl nq5ni  
 nq5ry nqpww nt2fp nx1xl nzfr5 oa2ac oa2cg oa2hm  
 oa2kj oa2lj oa2ns oa2rx oa2zy oa3ax oa3cp oa3hc  
 oa3kr oa3vp oa3wx oa3xo oa4ab oa4bb oa4rj oa5cm  
 oa5hg oa5ja oa5wr oa7ch oa7cw oa7dz oa7jk odlir  
 od4as k6ch k6clj k6ekz cobam oplad oplcm oplhm  
 op1hr op1pb op1pl op1re op9pl oz1ar oz2ab oz2ae  
 oz2bi oz2bz oz2gp oz2ai oz3av oz4am sb1aw sb2ay  
 sc2ab selem se2ea spebl ve3bm ve4di ve4dg ve4di.

**W1BUX, DH. Borden, Touisset,  
 Massachusetts**

(20 meters)

ea-jh eb-4au eb-4bn eb-4rs ed-7bb ed-7hp ed-7zg  
 ee-ar0l ef-1m ef-5axg ef-8bf ef-8brt ef-8ca ef-8ct



## Showing New Receiving-Xmitting Coils for 1929 More About Frequency Meters

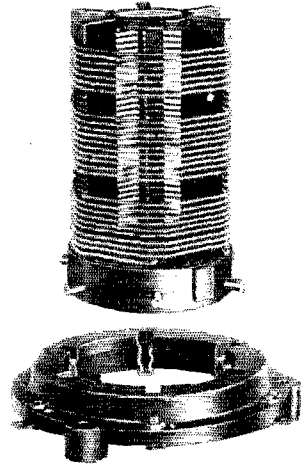
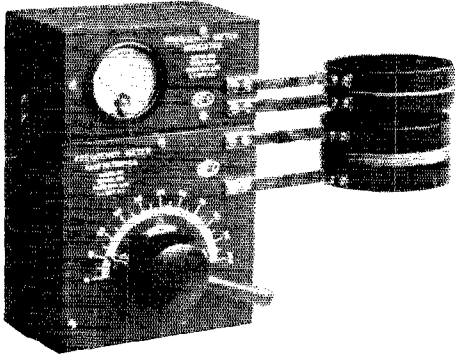

### Frequency Precision Obtained With This Meter

The findings of the A.R.R.L. Technical Development Staff are to the effect that a certain, single capacity cannot be shunted by various coils, and give complete coverage of each amateur band. The new REL Frequency Meters provide a separate coil and condenser for each band. Each meter is accurately calibrated to 1/10 of 1% of the measured frequency by means of a crystal standard.

These frequency meters utilize one of the most accurate resonance indicating systems known. Extremely sensitive and permitting of very loose coupling between transmitter and meter. These meters should be the most important piece of equipment in every "ham" station.

Precision equipment will be an absolute necessity for all stations that are operating after January 1, 1929, because of the narrowed bands and because of the drastic consequences if a station operates "off wave."

The REL Precision Frequency meters

FILL THE BILL

### The New Plug-in Coil

Efficient operation is assured by the use of these plug-in coils wound on one piece bakelite forms. Threaded ribs allow accurate space winding. Construction embodying three windings on one form permit quick changing. Special Spring contacts to take the coil plugs. Employing heavy copper enamelled wire they are suitable for high frequency receivers and 210 type low power transmitters.

The coils are used with the new condensers described in Bulletin No. 2. Together they make a working combination that will set new standards for Short Wave performance.

The plain bakelite forms may be obtained to wind your own coils or they may be obtained complete and wound for transmitting and receiving work. They are also used in combinations of three or four to make kits for the popular circuits.

Free and useful information on How to Build and Use New 1929 Receivers and Transmitters is yours for the asking. Five modern high frequency receivers, including the well-known Standard Regenerative receiver, the circuit employed in the Screen Grid Tube and a Special Super-Hetrodyne is described.



The  
Choice of  
Millions

# Tireless Sentinels

## Cunningham RADIO TUBES

are ever alert. They  
respond to every  
radio wave and  
give you clear,  
natural tone  
reproduction. Ask  
for them  
by name

**E. T. CUNNINGHAM, Inc.**  
New York Chicago San Francisco

Manufactured and sold under rights,  
patents and inventions owned and/or  
controlled by Radio Corporation of  
America

ef-8eo ef-8fd ef-8gdb ef-8hip ef-8ix ef-8jr ef-8orm  
ef-8pro ef-8sm g2ao g2bm g2cx g2kf g2lz g2nh g2nu  
g2od g2sc g2vq g2xv g5bq g5br g5bz g5bz g5bs  
g5ls g5ml g5ms g5vq g5us g5uv g5ux g5vi g5wk  
g5wq g5yx g5zd g5bd g5by g6ci g6cr g6gr g6hp  
g6ig g6nx g6oo g6pa g6qb g6rv g6sm g6ut g6vi  
g6vp g6wl g6wy g6xp g6yd g6yv ei-lau ei-ldy ei-lgw  
ek-4yt ei-laig em-smuk en-opt en-owim en-owr en-oyy  
xen-ocp eo-18b ep-laa ep-laa fm-8kf fm-tun2 fq-8hpg  
fq-ocy ne-8ae np-4adz np-4xx nq-2kp oa-2ac oa-2rx  
oa-2uk oa-2rx oa-2yl oa-3uc oa-5hj oa-5dx oa-5hg  
oa-7ch oh-6dsd oz-lar oz-2aw oz-2bp sb-1at sb-1aw  
sb-2ig sc-lai sc-3ac sc-3cj wnp.  
(40 meters)

ea-jh ea-rx ea-th eb-4au eb-4bc eb-4di eb-4fp eg-4ft  
ei-7ly ea-az28 ei-8axq ei-8brt ei-8eo ei-8er ei-8gdb  
ei-8ij ei-8j ei-8udf ei-8vu ei-8vvd ei-8wb ei-8xd  
ei-8zd g2gk ei-ldy ei-lgw ek-4au ek-4rm ek-4uf  
ek-4yo ek-4yt em-sidg en-ozf ep-lae ep-lbv ep-lcf  
xep-lma et-lf et-tppt fm-ocup fm-ain fq-ocya fq-pm  
ne-8rg nj-2pa nm-9a nn-1nc nn-7nic nn-9nic np-4ug  
nq-2aq nq-5ay nq-5by nq-5cx nq-5fc nq-5fl nq-5ry  
nx-1xl oa-2ac oa-2aw oa-2bc oa-2cu oa-2fp oa-2hc  
oa-2hm oa-2ij oa-2jw oa-2jy oa-2kj oa-2kr oa-2mh  
oa-2no oa-2ns oa-2rc oa-2rf oa-2sm oa-2tm oa-2tr  
oa-2zj oa-2yi oa-3ax oa-3bq oa-3cp oa-3gr oa-3gt  
oa-3hc oa-3hl oa-3jk oa-3ka oa-3lp oa-3ls oa-3my  
oa-3pm oa-3vp oa-4cg oa-4nw oa-4ra oa-4wa oa-5by  
oa-5cm oa-5dx oa-5hg oa-5ja oa-5jh oa-5jp oa-5rj  
oa-5wh oa-5wr oa-5xg oa-6mu oa-6sa oa-7bq oa-7ch  
oa-7dx oa-7hl oa-7jk oa-7lj oh-6hqq oo-1aj oz-2ab  
oz-2aw oz-2ba oz-2bo oz-2ga oz-2go oz-2aj oz-3av  
oz-4ao oz-4av sa-az2 sa-dh3 sa-dq4 sb-1ah sb-1ai  
sb-1aj sb-1aq sb-lar sb-las sb-law sb-lbe sb-lbm  
sb-lbo sb-lbs sb-1ld sb-2ab sb-2ad sb-2af sb-2ah sb-2at  
sb-2ay sb-2az sb-2bf sb-2bg sb-2br sb-2ia sb-2ih sb-lpl  
sb-snni xab-2ak ac-lah ac-lai ac-laz ac-lem ac-2ea sg-a7  
sp-ubl sp-jsl su-lcd su-lcg su-2ak su-2bt.

*E. O. Schwerdtfeger, S.S. Margaret Dollar,  
KDUV*

w5ej w6acz w6alm w6akg w6aov w6arb w6aaj  
w6avj w6avl w6bdy w6bhy w6bqh w6bhl w6ohl  
w6ohn w6out w6ocy w6dfm w6dts w6dkh w6dkv  
w6dlx w6dnu w6dwl w6dwn w6dws w6dxt w7aax  
w7ac w7ar w7akv w7alk w7alr w7ep w8mi w7mo  
w7nr w7ou w7aw w8br w8hak w8pl w8rm w8ban  
oz-2gp op-lem op-ldr op-lhr.

*Ernest L. Petit, 8307 S. San Pedro St., Los  
Angeles, Calif.*

wimk wisi wiajz wibga wicmp wlkx wlack  
w2apy w2agl w2art w2bfq w2bad w2baz w2aup w2qs  
w2gx w2kr w2bip w2alu w3am w3jo w3alm w3bj  
w4atk w4ix w4rm w4vx w5uk w5axf w5ain w5aag  
w6bat w6ah w6pk w6ajt w6bda w6aff w6bbl w6ase  
w6cgo w6eln w6dnf w6dkk w6dr w6us w6cub w6blw  
w6ems w6dzz w6hd w6cia w6fqz w6dqs w6aas w6bdt  
w6dzz w6axu w7dd w7ok.

*Douglas Westfall, U.S.S. Farenholt, c/o  
Postmaster, San Francisco, California*

w6dx w6ut w6bp w6al w6eh w6ya w6to w6bow  
w6en w6ard w7nj w7ad w7ne w7ch w7mf w7tu  
w7ax w7ajz w7ld.

*W1BYV, W. W. Smith, 300 Edgell Rd.,  
Framingham Center, Mass.*

eb-4bn ed-7zg ef-8bf ef-8et ef-8dmf ef-8fd ef-8gdb  
ef-8hip ef-8hpg ef-8ix ef-8jd ef-8jr ef-8orm ef-8pro  
ef-8rpu ef-8rrr ef-8sm ef-8wb g2bm g2fn g2kf g2nh  
g2od g2sc g2vq g2xv g5bq g5br g5bz g5bz g5bs  
g5ls g5ml g5ms g5vq g5us g5uv g5ux g5vi g5wk  
g5wq g5yx g5zd g5bd g5by g6ci g6cr g6gr g6hp  
g6ig g6nx g6oo g6pa g6qb g6rv g6sm g6ut g6vi  
g6vp g6wl g6wy ei-lau ei-ldy ei-lpo ek-4jl ek-4yo  
ek-4yt em-smuk en-ovu ep-laa ep-lae fk-2ms fo-az2  
fq-8hpg na-1mn qu-2kp oa-2bb oa-2rx oa-2yl oa-3ce  
oa-3gr oa-5hg oa-5wh oa-5wk oa-7mn oa-7lj oh-6clj  
oz-2ac oz-2ak ez-2aw oz-2bg oz-4aa sb-1at sb-1aw  
sb-2ab sb-2ar ac-lah ac-lai ac-3cj xen-1bd x-1zz.

*W. N. Holtwanger, Pettit Barracks,  
Zamboanga, P. I.*

w4lx w5ao w5aq w5auz w5hv w5mx w5nw w6abg  
w6acg w6adk w6adv w6agr w6als w6am w6ap w6ard  
w6asm w6aux w6avd w6avj w6avz w6awa w6ax  
w6bfp w6bjd w6bvm w6bvz w6cgm w6cjh w6cia  
w6civ w6cuu w6cxi w6czz w6cca w6cdq w6dfm  
w6dgv w6dhg w6djq w6dmt w6dmn w6dwn w6dri  
w6dvg w6eah w6acg w6efe w6gu w6hm w6af w6ru  
w6tj w6ne w7acx w7acv w7aix w7ajz w7bb w7bm  
w7kj w7ll w7un w8em ec-lax ac-lbs ac-lcb ac-ltb

# 10,000 Inductances Now in Use. New Transmitting Condensers Going Fast

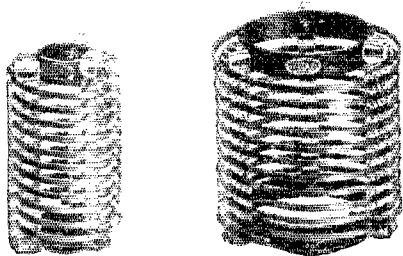

Now Famous REL Transmitting Inductances. Peerless For Years.

REL inductances need no introduction to the thousands of Amateurs who have been using them for years. Here is one piece of apparatus that has won the acclaim of all who know that a transmitter needs inductances. Flatwise wound copper nickel plated wire mounted on crystal glass spacers, they should be used in all circuits using 1-1000 Watts.

There are two types, "L" for 40, 80 and 150 meters wave lengths and "S" for 20 meters and less. Single and Double Units are obtainable in either type. Single Unit includes three clips and the Double Unit has six clips and two glass coupling rods.

If you have not yet used these inductances, don't wait any longer. Join the ever increasing ranks of those who use the best—REL Products.

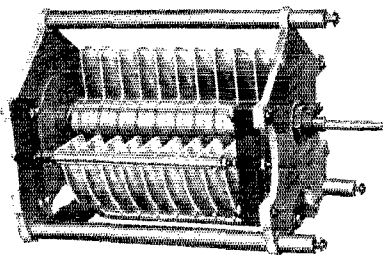

The Transmitting Condenser That Has Caused a Sensation in Short Wave Field.

Introduced as a Super Condenser for the Super-Set, it won immediate attention and popularity. It is used in all the famous REL higher powered transmitting kits and is in increasing demand by set builders. It is a job that is built to stand the gaff. It will prove its true worth under severest service conditions. To say that the construction is Sturdy is but to scratch the surface. Heavy brass plates—cast aluminum end plates—husky steel rotor shaft—conical adjustable bearings. Best possible insulation assured by the use of heavy isolantite blocks—accurate spacing and Over all strength carried to an excess. That is an outline sketch of one of the finest Condensers designed for Short Wave Transmission. Specifications on request. They may now be found in Leading Amateur Stations, U. S. Army and Navy, Commercial Stations and by others who know the best.

**WRITE TODAY FOR  
YOUR DATA ON 1929  
NARROW BAND RULES**

Radio Engineering Laboratories, 100 Wilbur Avenue, Long Island City, New York

# Allen-Bradley Resistors

## for Experimental Work in Television



### Bradleyunit-B

IF you are doing experimental work in television, use Allen-Bradley resistors, both fixed and variable. Bradleyunit-B is the ideal fixed resistor for resistance-coupled amplifiers as plate-coupling resistors and grid leaks because:

1. Resistance values are constant irrespective of voltage drop across resistors. Distortion is thus avoided.
2. Absolutely noiseless.
3. No aging after long use.
4. Adequate current capacity.
5. Rugged, solid-molded construction.
6. Easily soldered.

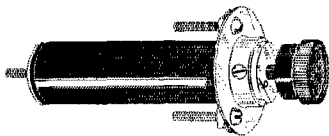

### Radiostat

This remarkable graphite compression rheostat, and other types of Allen-Bradley graphite disc rheostats provide stepless, velvet-smooth control for scanning disc motors.

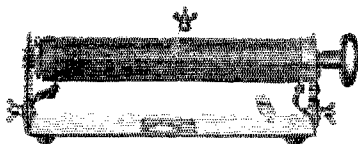

### Laboratory Rheostat

Type E-2910 — for general laboratory service. Capacity 200 watts. Maximum current 40 amperes. A handy rheostat for any laboratory.

Write for Bulletins!

ALLEN-BRADLEY CO., 227 Greenfield Ave., Milwaukee, Wis.

## Allen-Bradley Resistors

ac-2ck ac-2ur ac-3ak ai-2kt aj-jkzb aj-jxix am-3ab  
 eb-4ft eb-4kb ea-2me ea-3hl ea-3ls ea-3wm ea-3wa  
 ea-5bw ea-5by ea-7ew od-1jr od-2ab od-3bk od-4ar  
 k6adh k6akg k6avl k6bde k6bhl k6boe k6bqh k6bxt  
 k6ch k6dp k6dri k6dvq w6dwr.

I. A. R. U. News

(Continued from Page 45)

Radio Society of Great Britain is a necessary condition for membership of the Union, though there is no official connection between the two organizations. Up to the time of writing, 29 transmitting licenses have been issued in Northern Ireland, the majority of these being for a maximum input power of ten watts. In the past, most of the operating has been on 45 meters, 23 meters being used by about 6 station and 32 meters by about 4. The 90-meter wave has only been used rarely in the last few years.

"I shall now mention very briefly some of the achievements of the GI stations.

"In the summer of 1925, 5NJ established the first amateur contact between Ireland and U.S.A., and a few months later the first direct communication of any sort between Ireland and Australia was established by 6MU. Some time later, 6YW made a contact with Porto Rico, using 2 watts input, which was probably at the time a record for low-power DX. Since then, several distant countries, among them Indo-China and Jamaica, have had their first contact with the British Isles through GI stations, and we now have three members of the W. A. C. club (2IT, 5NJ and 6MU).

"In the R.S.G.B. QRP Tests of November, 1926, several GIs were near the top of the list, 6YW achieving the honor of being first in the British Isles. Special mention should also be made of 6TB, to whose painstaking the success of our Union is mainly due, and also of 6YW's recent work as honorary organizer of the R.S.G.B. Contact Bureau, an experimental organization whose work is already beginning to bear practical fruit.

"So much for the past. As regards the future, it is rather early to say much about the probable effects of the changes resulting from the Washington Conference. The conditions of operation will be as set out in the memorandum recently issued by the G. P. O. in London, except that the addition of the letter I to the British prefix G has been sanctioned for stations in Northern Ireland. gi2BX becomes GI2BX, and so on. The general opinion seems to be that the new conditions are not at all bad, and it is likely that a good proportion of the GI stations could operate under 1929 conditions with only slight improvements. It is probable that most of the operating will be in the 7 m c. and 14 m c. bands, though several stations intend to try 28 m c. in the near future.

—E. Megaw, GI6MU."

OCP

The many American and foreign amateurs who have worked this station will no doubt be glad to have some words from the chief operator regarding the origin and development of the outfit. We are sorry that "under cover" operation makes it impossible

# Performance that Challenges the World!

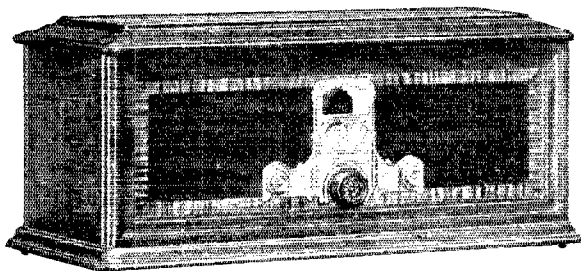

FEDERAL'S engineering accomplishment, in producing the F111, has won the recognition and commendation of radio experts everywhere. Without question it out performs any radio receiver ever before placed on the market.

Antenna and ground operation with four stages of tuned radio frequency, detector, and two stages of amplification brings in the weakest of radio impulses picked up by the antenna and provides phenomenal distance range. Every part of the set bespeaks itself of precise standards of engineering and skilled workmanship. Every unit, including the individual tubes, is fully shielded. The chassis is all metal—the cabinet genuine mahogany.

Prices, without tubes, for battery operation \$145; for light socket operation with Federal's power-tube coupler, 60 cycle, \$220; 25 cycle \$245. (Slightly higher West of Rockies.)

*Ask the nearest Federal Retailer for demonstration or write for complete specifications.*

FEDERAL RADIO CORPORATION, BUFFALO, N. Y.  
OPERATING BROADCAST STATION WGR AT BUFFALO  
Federal Ortho-sonic Radio, Ltd., Bridgeburg, Ont.

# Federal ORTHO-SONIC\* Radio

Licensed under patents owned and/or controlled by Radio Corporation of America, and in Canada by Canadian Radio Patents, Ltd.

\* Federal's fundamental exclusive development making possible Ortho-sonic reproduction is patented under U.S. Letters Patent No. 1,328,470

Say You Saw It In Q S T — It Identifies You and Helps Q S T

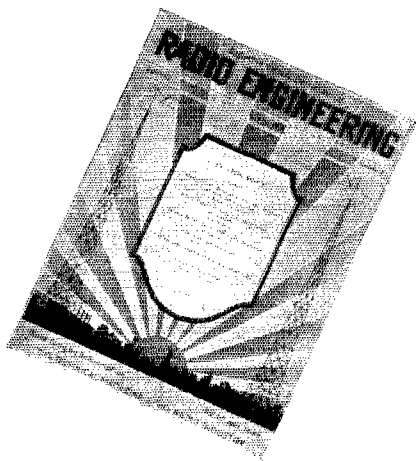

## Detection with the Screen-Grid Tube

Because progress has been slow very little data have been released on the use of the screen-grid tube as a detector, in which place it functions very efficiently.

In the October issue of Radio Engineering the latest first-hand laboratory information on the screen-grid tube's detector qualifications will be found.

The construction and use of a constant-frequency laboratory oscillator will be found also, as well as "The Engineering Rise in Radio," "Mathematics of Radio," etc.

### Radio Engineering Is Not Sold on Newsstands

Radio Engineering,  
52 Vanderbilt Ave., New York City.

Enclosed find  
\$2.00 for 1-year subscription; \$3.00 for 2-year  
subscription; 20c for sample copy.

PLEASE PRINT NAME AND ADDRESS

Name .....

Address .....

(Please check classification)

- |                                       |   |
|---------------------------------------|---|
| <input type="checkbox"/> Manufacturer | <input type="checkbox"/> Professional Set Builder |
| <input type="checkbox"/> Dealer       | <input type="checkbox"/> Technician               |
| <input type="checkbox"/> Engineer     | Anything else                                     |

to give the name of the ship or operator, but as stated, cards and reports may be addressed through the Dutch Section of the I.A.R.U., or through the A.R.R.L.

"For over one year's time now, with more or less regularity, xen OCP has been on the air and much pleasure has been derived by working many amateur stations. The op also pounds brass on a 2 kw. 500-cycle quenched-gap spark set on 600 and more meters.

"The works were started with the most friendly cooperation of three New Orleans amateurs, 5QJ, 5HR and 5UK, to whom xenOCP had been introduced by the Communications Department of the A.R.R.L. For the plate supply, a baby motor-generator was chosen, and the first tube was a one-dollar receiving tube, one of the items secured in your famous 5- and 10-cent stores! However, it soon became fed-up with its transmitting duties and retired.

"Back in Holland, the ship was exchanged for one circling Africa and a Philips 10-watter came on duty. In its present form, the set consists of a loosely-coupled Hartley circuit, housed in a small cabinet, with the coils, mounted on glass rods, on the top of it. It is grounded to the ship's earth and the aerial of spark set is used for the short waves also. This aerial is an inverted L type, two wires of about 80 meters each. The wavelengths in use are 32 and 19.6 meters, with optional 34½ and 44 meters, of which the 32-meter has proven to be the best. The m. g. gives about 300 volts, while the Philips 10-watt tube takes 60 milliamps. The receiver is a conventional O-V-1 (detector and one-step—A.L.B.) in shielded cabinet, to which a Telefunken screened-grid valve will soon be added.

"Along the east African coast, western NU stations can be heard best from 1330 until 1430 GMT, eastern NUs at about 0400, and most of them averaging R3-4. QRN, however, is very troublesome. After 2000, many Europeans are coming in ok on the 32-meter band, especially the EF's and EB's. eb4FT is the most consistent of all.

"In Durban the writer met with a very kind reception on the part of many FO hams, who attended the yearly convention of the S.A.R.R.L.

"xenOCP, whose QSL address is: Dutch Section, I.A.R.U., Noordwyk aan Zee, Holland, is always anxious to work amateur stations and glad to arrange schedules and tests, when these do not in any way interfere with his professional duties."

GERMANY

Germany is one of our national sections which is on the "honor list" by reason of having appointed an official correspondent and forwarding reports regularly each month.

"The most important event during September was our meeting during the holding of the annual Radio Show in Berlin (Announced in last month's issue—A.L.B.). Among the many hams who attended we had the pleasure of being host to eg6FI,

# THE AMAZING NEW 5000 HOUR ELKON RECTIFIER FOR "B" ELIMINATORS

NEW, UNIQUE!



SOLID, DRY!

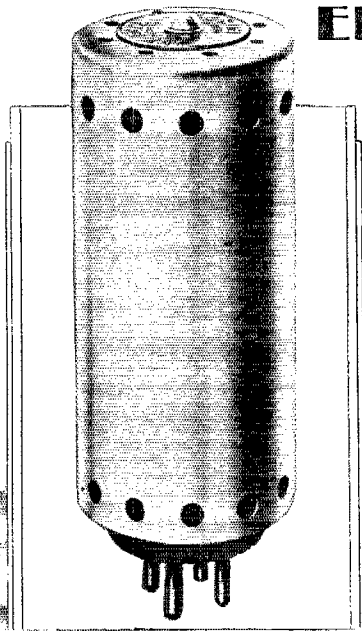

REVOLUTIONARY!



NOT A TUBE!

## ONLY 200,000 AVAILABLE THIS SEASON

JUST as the Elkton dry, low-voltage rectifier revolutionized the design of chargers and "A" Eliminators, the new Elkton "B" type Rectifier will revolutionize the design of "B" Eliminators.

The Elkton EBH Rectifier plugs into any Eliminator using the former standard "B" rectifier tube. Simply take out the fragile 1,000 hour tube—plug in the husky Elkton EBH and the change is made. No changes in wiring—no adjustments.

It is sturdy, solid, dry—has none of the frailties of a tube—not affected by accidental overloads or line surges. It is self healing. The power is smoother, quieter.

From the orders already received from dealers and jobbers in all parts of the country, we know that we will be tremendously oversold this season—only 200,000 of these revolutionary rectifiers will be available.

The elaborate manufacturing, testing and aging equipment necessary to produce the Elkton EBH Rectifier precludes any greater production the first year.

Look for the Red and Yellow display carton on your dealer's shelves. The new EBH is packed in a metal can.

Buy one from your dealer today! Plug it into your "B" Eliminator—Trouble free for at least 5,000 hours!

**ELKON, INC.**

Division of  
P. R. Mallory & Co., Inc.  
350 MADISON AVE.  
NEW YORK CITY

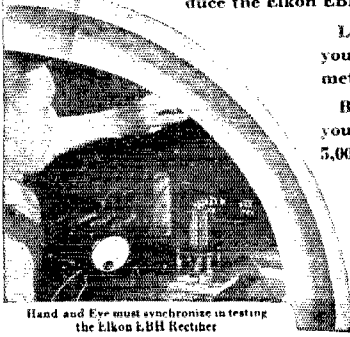

Hand and Eye must synchronize in testing the Elkton EBH Rectifier

ELKON, Inc., Dept. E-15  
350 Madison Ave., New York City

Gentlemen:  
Please send me complete information on Elkton Quality Radio Products.

Name \_\_\_\_\_  
Address \_\_\_\_\_

# Dubilier

## TRANSMITTING CONDENSERS

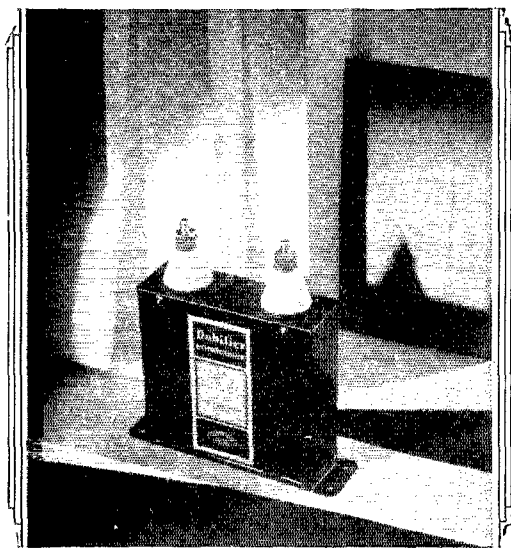

**D**UBILIER type 686 condensers have the usual Dubilier high safety factors for use in transmitter filter net works. 1000 volt DC rating.

May be connected in series where the working voltage exceeds 1000. Through series parallel connections practically any working voltage and capacity can be obtained.

DC voltage must not exceed 1000; or in A.C. supply filter circuits the transformer voltage must not exceed 750 volts per rectifier plate:

1 mfd. condenser \$5.00  
2 " " \$8.00

Write Dept. 40  
for free catalog

# Dubilier

## CONDENSER CORPORATION



10 E. 43rd St.  
New York City

from London, et2UA, from Riga, and ekDCZ, Herr Johnske, the operator of Count Luckner's *Vaterland* on its visit to America. (And well-known as 'Fritz' to many West Coast U.S.A. hams, too—A.L.B.).

"Since last month, DX conditions have not changed very much, and there is little to report in this direction.

"We are pleased to state that eg6PP and eg6FY have become members of our society, the D.A.S.D., their licenses being DEø831 and DEø852. We welcome them heartily and hope that others will follow their example.

"There seems little doubt that after January, 1929, we will be given new intermediates. We regret highly that it is necessary to give up our old and better system of intermediates. With them it has been very easy to identify the continent and country of the transmitter. We also regret that it is not possible to get private transmitting licenses, and hope that by the end of the year we shall have good and favorable regulations to this end. 73's to all.

—E. Reiffen, Sec'y, D. A. S. D."

### Standard Frequency Transmissions From WWV

(Continued from Page 42)

quency to be transmitted is then given. There is then a four-minute interval while the transmittng set is adjusted for the following frequency.

Information on how to receive and utilize the signals is given in the Bureau of Standards Letter Circular No. 171, which may be obtained by applying to the Bureau of Standards, Washington, D. C. Even though only a few frequency points are received, persons can obtain as complete a frequency meter calibration as desired by the method of generator harmonics, information on which is given in the letter circular. The schedule of standard frequency signals is as follows:

| East. Standard Time (P.M.) | Nov.20 | Dec.20 | Jan.21 | Feb.20 | Mar.20 |
|----------------------------|--------|--------|--------|--------|--------|
| 10:00—10:08                | 1500   | 4000   | 125    | 550    | 1500   |
| 10:12—10:20                | 1700   | 4200   | 150    | 600    | 1700   |
| 10:24—10:32                | 2250   | 4400   | 200    | 650    | 2250   |
| 10:36—10:44                | 2750   | 4700   | 250    | 500    | 2750   |
| 10:48—10:56                | 2850   | 5000   | 300    | 1000   | 2850   |
| 11:00—11:08                | 3200   | 5500   | 375    | 1200   | 3200   |
| 11:12—11:20                | 3500   | 5700   | 450    | 1400   | 3500   |
| 11:24—11:32                | 4000   | 6000   | 550    | 1500   | 4000   |

The figures given above are frequencies in kilocycles.

### Experimenting With Bypass \*\*\* Condensers

(Continued from Page 32)

same time not bypass excessively the upper audio register, that value of capacity is best for the purpose. The following figures show the degree of bypass of radio frequency signals using the same audio fre-



# Last Chance for Special Low Price!

The Radio Manual is about to be published. The special advance of publication price of \$4.95 must be definitely withdrawn on November 15th—after which the regular price of \$6.00 will be in force. Order immediately to take advantage of this unusual saving.

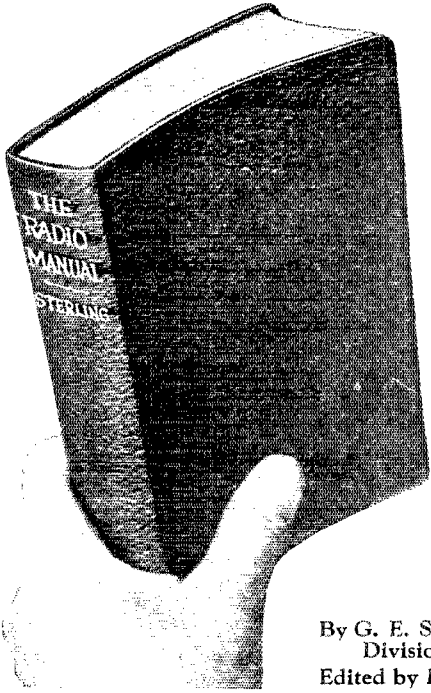

**Radio Operators!** Are you prepared to use the new International "Q" signals which go into effect January 1, 1929? Do you know the correct procedure for obtaining a radio compass bearing as prescribed by the terms of the International Radio Telegraphic Convention, effective January 1, 1929?—the right procedure when distress communications are ended and silence is no longer necessary?—what to do when you hear from a radiotelephone station the spoken expression Mayday?

*These Questions and Thousands More  
Are Answered In*

## THE RADIO MANUAL

*A Complete Handbook of Principles, Methods,  
Apparatus for Students, Amateur and  
Commercial Operators, Inspectors*

By G. E. STERLING, Radio Inspector and Examining Officer, Radio Division, U. S. Dept. of Commerce.

Edited by ROBERT S. KRUSE, for five years Technical Editor of QST.

### Complete Preparation for Government License. 16 Chapters Covering

- |   |  |  |
|---|--|--|
| <ol style="list-style-type: none"> <li>1. Elementary Electricity and Magnetism</li> <li>2. Motors and Generators</li> <li>3. Storage Batteries and Charging Circuits</li> <li>4. Theory and Application of the Vacuum Tube</li> <li>5. Fundamental Circuits Employed in Vacuum Tube Transmitters</li> <li>6. Modulating Systems Employed in Radio Broadcasting</li> <li>7. Wavemeters, Piezo-Electric Oscillators, Wave Traps and Field Strength Measuring Apparatus</li> <li>8. Marine Vacuum Tube Transmitters including detailed description of Model ET-3626</li> </ol> | <ol style="list-style-type: none"> <li>9. Radio Broadcasting Equipment including, for the first time in any text book, the complete equipment of Western Electric 5 Kilowatt broadcasting Transmitter used in over 75% of American broadcasting stations.</li> <li>10. Arc Transmitters including description of Federal Marine 2 Kilowatt Arc Transmitter Type AM 4151; also models "K" and "Q"</li> <li>11. Spark Transmitters including description of Navy Standard 2 Kilowatt Transmitter</li> <li>12. Commercial Radio Receivers and Associated Apparatus</li> </ol> | <ol style="list-style-type: none"> <li>including, for first time in any text book description and circuit diagram of Western Electric Superheterodyne Receiver Type 6004C</li> <li>13. Marine and Aircraft Radio Beacons and Direction Finders.</li> <li>14. The Development of Amateur Short Wave Apparatus. Complete details of construction, operation and licenses.</li> <li>15. Radio Laws and Regulations of the U. S. and International Radio Telegraph Convention. Quotations of all important sections</li> <li>16. Handling and Abstracting Traffic</li> </ol> |
|---|--|--|

## Examine It Free Special Price Now

"The Radio Manual" will be ready in a few days. Over 900 pages bound in flexible Fabrikoid. Regular price after publication will be \$6.00. Orders received now will be accepted at the special advance price of \$4.95. Send no money now. Examine the book first. Pay or return in ten days.

### Order On This Coupon

D. VAN NOSTRAND CO., INC., 8 Warren St., N. Y.  
 Send me THE RADIO MANUAL for examination.  
 Within ten days after receipt I will either return  
 the volume or send you \$4.95.—The special advance  
 price.  
 Name ..... (QST 11-28)  
 St. and Number .....  
 City and State .....

# How's Your Library?

You will be constantly referring to the series of articles by Ross Hull on the work of the A.R.R.L. Technical Development Program. There will be a textbook for 1929 construction and operation. These issues, along with the others, should be preserved in a

## QST Binder

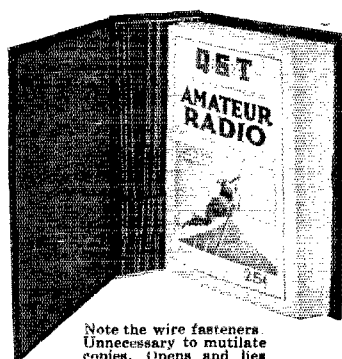

Note the wire fasteners. Unnecessary to mutilate copies. Opens and lies flat in any position.

One-fifty each  
postpaid

A binder will keep your QSTs always together and protect them for future use. And it's a good-looking binder, too.

**QST**  
1711 Park St., Hartford, Conn.

quency transformer, but bypass capacities ranging from .005  $\mu$ d. to .002  $\mu$ d. and carrier frequencies of 15, 33, 100 and 1000 kilocycles.

|                 | 15 Kc.<br>Percent | 33 Kc.<br>Percent | 100 Kc.<br>Percent | 1000 Kc.<br>Percent |
|-----------------|-------------------|-------------------|--------------------|---------------------|
| .00025 $\mu$ d. | 22                | 38                | 57                 | 65                  |
| .0005 "         | 38                | 55                | 76                 | 81                  |
| .0006 "         | 46                | 63                | 80                 | 86                  |
| .00075 "        | 50                | 70                | 85                 | 90                  |
| .0009 "         | 54                | 73                | 88                 | 94                  |
| .001 "          | 57                | 76                | 89                 | 97                  |
| .002 "          | 60                | 87                | 97                 | 100                 |

From the above, we glean the information that the .001- $\mu$ d. capacity is quite satisfactory for bypassing the radio frequency component remaining in the detector plate circuit after rectification. Since the frequency spectrum encountered in radio broadcast reception lies within the 550- to 1500-Kc. band, the values obtaining on 100 Kc. can be considered as criterion. As to the extent of audio frequency bypassing, this value of capacity bypasses only 6 percent on 5000 cycles. Consequently, the selection and use of a .001  $\mu$ d. bypass condenser in the plate circuit is consistent with sound engineering principles.

## Now We're in the Air

(Continued from Page 33)

is about to happen, "Mac" may be counted upon to be there with the proverbial bells (or buzzers) on. He sized the thing up and got into action.

Telephone and telegraph were out of the question as they were too expensive. Beside the expense, the installation of lines would take too long. Radio was the only solution but even that seemed rather costly—if they were to buy equipment and hire operators!

"Mac" got in touch with Robert B. Parrish, W6QF-W6PS, president of the Amateur Radio Research Club of L. A. and manager of the Pacific Engineering Laboratory Company, and explained the idea. "Bob" took to the idea like a small ham to a big bottle and put it up to the members of the A. R. R. C. They gave evidence of their hearty approval and made "Bob" master of ceremonies and installations but told him not to get too swell-headed about it because they expected to have much installation and few ceremonies and that he was also expected to do his share of the work. He did.

The stunt called for five complete stations with their separate sources of power, as there was no power at the pylons. This meant sets, tubes, and batteries, for the most practical operation. Now radio clubs are not usually overstocked with any of these things, especially tubes and batteries, so "Bob" sent out a QRR via land-fone to various friends. George Walters, western representative of the French Battery Company, came forward with "B" batteries for all transmitters and receivers, with each transmitter using 350 volts. The Durkee-

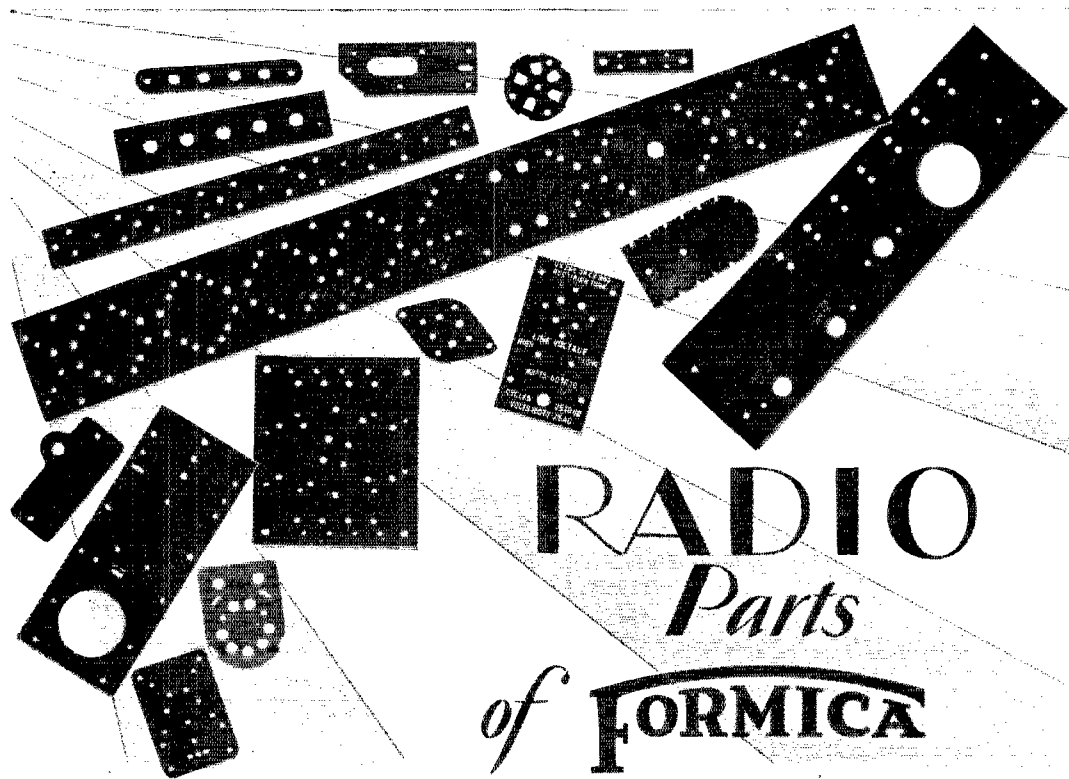

# RADIO *Parts* of **FORMICA**

**F**OR fifteen years Formica has been furnished in changing forms to suit the convenience of the radio engineer and producer. In the early days it was sold in whole sheets and whole lengths of tubing and fabricated largely by hand by the radio builders. Then there were decorated front panels printed in gold and silver. Now there are sanded or threaded tubes punched and cut to length; washers; shelves; sub panels and terminal strips most of them shipped all ready to assemble.

At large expense Formica equipment has been changed from year to year to provide production in quantity at all times of insulating parts that would meet the requirements of the moment. And the quality and uniformity of the material has also steadily advanced.

**The Formica Insulation Company**

4620 Spring Grove Avenue

☐ ☐ Cincinnati, Ohio

# **FORMICA**

# To Our Readers who are not A. R. R. L. members

Wouldn't you like to become a member of the American Radio Relay League? We need you in this big organization of radio amateurs, the only amateur association that does things. From your reading of *QST* you have gained a knowledge of the nature of the League and what it does, and you have read its purposes as set forth on page 6 of every issue. We should like to have you become a full-fledged member and add your strength to ours in the things we are undertaking for Amateur Radio. You will have the membership edition of *QST* delivered at your door each month. A convenient application form is printed below—clip it out and mail it today.

*A bona fide interest in radio is the only essential qualification for membership.*

-----  
American Radio Relay League,  
Hartford, Conn., U. S. A.

I hereby apply for membership in the American Radio Relay League, and enclose \$2.50 (\$ in foreign countries) in payment of one year's dues. This entitles me to receive *QST* for the same period. Please begin my subscription with the ..... issue. Mail my Certificate of Membership and send *QST* to the following name and address.

.....  
.....

Do you know a friend who is also interested in Amateur Radio, whose name you might give us so we may send him a sample copy of *QST*?

.....  
.....

Thanks

Thomas Corporation sent two "Western" 6-volt storage batteries per set to the field each day, freshly charged. The Western Auto Supply Co. donated a whole flock of tubes of various sizes. All of these people said they would take Christmas cards in payment. How's that for cooperation.

"Bob" supplied the main transmitters from his laboratory, and most of the receivers and the other transmitters came from the membership of the club. A period of feverish installation ensued, which began a short time before the races and ended a shorter time before the same. Licenses were finally obtained and calls assigned and most of the hard work was over.

We are sorry to say, maybe, that some of the sets at the pylons would hardly take the Hoover Cup for looks. They made up for their appearance, however, by their performance. 6EMH, for instance, at Pylon Number 2, was a first class replica of my idea of what the first set looked like that belonged to the O. M. himself. The coating of dust was so thick that it actually was necessary to blow some off the meters to read them. But the set worked like a charm, as did the others in more-to-be-desired and less dusty locations.

Tuned-plate, tuned-grid was used in all transmitters. At the pylons a short projecting stick at the top served as a support for the antenna of No. 20 or No. 22 wire, while the counterpoise was run out to a nearby post or tree. Nails and tacks driven into dry boards were the only insulators. Receiving antennas were supported by trees, posts, and sticks stuck into the ground, and ground connections were made to the pylon frame. Pictures of these installations are *not* furnished herewith because they didn't turn out good anyway, and because they would be a source of too much pleasure for the opponents of the "lo-loss" postulates. However, it would not be fair to fail to give due credit to the very snappy job at 6EMF, the control station in the grandstand. This good-looking and efficient transmitter was a panel-mounted affair, artistically and mechanically balanced. Suitable engraving enhanced the glistening black panels but, above all, the evidence of skilled workmanship stood out like a shining jewel. The only visible parts of the set were the specially-wound plate and grid coils, two good-looking chokes, and the tube—in this case a 7½-watter. All other parts were hidden behind panels.

Visualize a busy afternoon. There are 50,000 people in the grandstands. A veritable hill of humanity is gazing at the immense field before it, listening to brief announcements, paging, wise-cracks and what-not, from the announcer over the public-address system. A huge array of Army planes is just over to our right, lined up near the fence, waiting to go on duty. On our far left the Navy is well represented by a detachment of planes and their detailed crews, seemingly always active. Far

# PRECISION

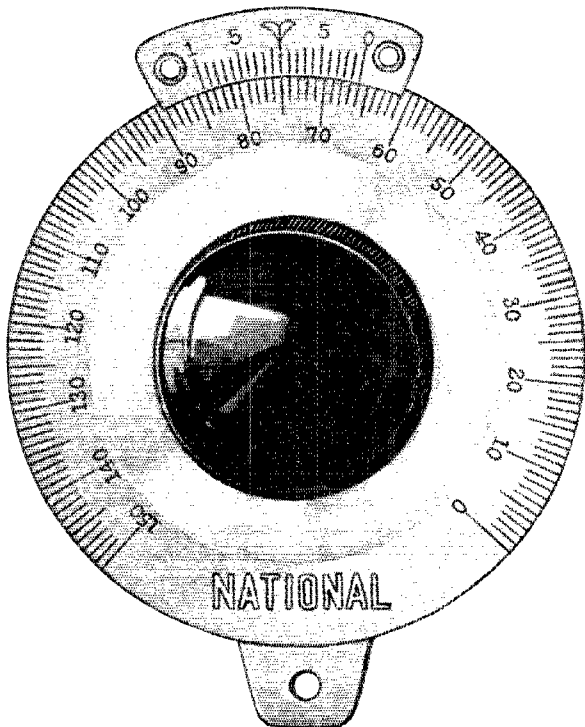

## NATIONAL VELVET VERNIER DIAL TYPE N

This four-inch solid German silver National Velvet Vernier Dial, type N has been developed for use in amateur and other radio equipment requiring the utmost precision of logging. It is equipped with a *real Vernier* making accurate reading possible to one-tenth of a division. The mechanism is the original and unexcelled National Velvet Vernier design, approved and used by transmitting and receiving amateurs all over the world.

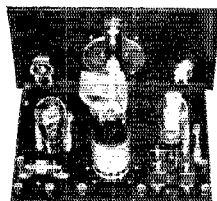

Rear view National screen-grid, short-wave receiver, a non-radiating short-wave receiver.

The tuning knob is of Bakelite and when desired, a Bakelite apron will be furnished at slight additional cost for protection against high frequency burns when the dial is used on high power appliances. Dial attaches to the face of panel at three points making accurate mounting exceedingly easy and simple. The type N dial is made with 3 different styles of division, 100-0, 150-0 or 200-0. List Price \$6.50.

Write today for short-wave bulletin No. 128 ST.

## NATIONAL RADIO PRODUCTS

NATIONAL CO. INC. W. A. READY, PRESIDENT MALDEN, MASS.

# In Stiff Buckram Binding

## The Radio Amateur's Handbook

Lies open and flat at any page

The invaluable Handbook with attractive and durable maroon leather cloth covers.

Will Wear Like Iron.

Price \$2 postpaid anywhere

A. R. R. L.,  
Hartford, Conn.

Stiff  
Binding

Gentlemen:

I've been wanting a better bound copy of the Handbook for a long time. Here are my two dollars.

across the field, in a direct line with our little box on top of the grandstand, are the civilian hangars for visiting planes and non-contestants. Directly in front of the grandstand is a large white circle on the runway. This is used for parachute jumping contests, exhibitions of bombing and numerous other stunts. Running out to the circle from the fence is a connecting white line, used for the "dead stick landing" contests, up to which the winner, making a landing with a "dead" motor, came within three feet.

Over to the left again, in front of the Navy planes, is another white line. Six planes are lined up along the line with motors idling, waiting expectantly. Adjoining our "box seat" in the radio shack are two observers who tell us that Event Number 3 is about to start and is a "free for all," open to all types of ships powered with motors of 720 cu. in. displacement or less, but open to civilians only. The distance will be fifty miles—ten laps of the five-mile course—and prizes will total \$1,500. The operator at the headquarters station (6EMF) at our elbow sends out the following:

"QST QST EVENT NR 3 ABOUT START FREE FOR ALL QRX RACE 6EMF."

He turns the dial between two points, about four "degrees" apart. He finds 6EMH, Pylon Number 1, at 54 on the dial. 6EMH says: "QST OK DE 6EMH AR." He turns the dial to 49.5 and he hears 6EMI at Pylon Number 3 say "QST OK DE 6EMI AR." He would find 6EME, Pylon Number 4, at 45.5, but they are not using this pylon in the five-mile race.

Suddenly the starter twitches his flag and the racers roar toward 6EMH at ten second intervals. 6EMF sends another QST to all pylons: "THEY'RE OFF."

Let's drive out to 6EMI and watch this race from there. The watchman at Pylon Number 3 has a big jar of ice water and there's not so much dust here. Here they come! You'll have to look sharply because... Good nite! *He's coming right at us!* Let me get out of here... here... No, you see he suddenly makes a vertical bank and roars around the pylon and is gone. Whew! That seemed close, though, especially from our lookout in the pylon. They travel comparatively close to the ground, only a few feet above it, and they appear to be attacking us. But we soon get used to that. Here comes a bunch. In four zooms and a sputtering roar they appear, roll over on their sides, make a ninety-degree turn, roll back again and are gone. We get so used to it that we don't watch them any more, and we see that the watchman, relieved during the race, has gone to sleep in his car.

Suddenly an observer calls: "Operator! Plane Number 159 fouled pylon! Sixth lap."

# SM

## We Think You Ought to Know—

**T**ONE quality is an elusive thing—yet all-important. We think you want to know the truth about it—the whole truth. That is why S-M, in spite of having so much to talk about in the way of selectivity and distance range, keeps “harping” on tone quality. We can prove, by laboratory measurements and curves, that the new S-M Clough system audio transformers come closer to doing that than any others we have ever been able to find, at any price. But then, any advertiser can make big claims, draw curves and publish them—so that doesn't necessarily prove anything to you.

But IT'S TRUE, nevertheless. One by one we are getting reports of tests—made by impartial engineers for manufacturers and others who employ them—agreeing with our own findings that there is *nothing on the market* to match the tone quality that you build into an S-M set—or into any other good set, if you so desire—by the use of S-M Clough system audio transformers. That's what the engineers in the world's largest telephone laboratories said. It's what the professors of an old New England engineering school decided.

To the radio-wise public—those who decide, in the end, every question of comparative merit in manufacturers' claims—we offer to prove the absolute superiority of S-M tone quality in any fair way you can suggest. Here are, for instance, the two fairest ways we know of—and we're taking both of them:

**FIRST:** We are building, and operating in the most public places we can find—the big radio shows, hotels, dealers' show rooms—comparison amplifiers which interchange instantly in a circuit, on throwing switches, a set of S-M transformers and a set of any other make desired. We are so well satisfied with the sales of S-M audios resulting from this “hard-boiled” method that we printed and distributed 35,000 copies of an article telling

Use your S-M ROUND THE WORLD FOUR on the broadcast band with these new S-M five-prong plug-in coils—131X for 190 to 350 meters, \$1.25; and 131Y for 360-650 meters, \$1.50.

**SILVER-MARSHALL, Inc.,** 858 W. JACKSON BLVD., CHICAGO, - - U. S. A.

dealers and setbuilders how to build such a “comparator”. Do you know of any other transformer manufacturer who is doing that? If not, why is S-M the only one who is?

**SECOND:** We are giving an absolute guarantee that the S-M Clough System transformers you buy at \$6.00 (list) cannot be surpassed by any transformers of the conventional type—not utilizing the Clough invention with its practical elimination of hysteretic distortion—at any price whatsoever.

If you have a laboratory, with a good audio frequency oscillator and sensitive high-frequency milliameters—by all means verify for yourself the sweeping claims we make. If you haven't—then listen to one of the public S-M comparator tests. If you can't do that—just try a pair. Ask your own ears!

We think you ought to know.

In the chart below, E is the two-stage curve for the large-size transformers (S-M 225, 1st stage; and 226, 2nd stage, \$9.00 each); D is that of the smaller ones (S-M 255 and 256, \$6.00 each). Note the marked advantage over A, B, and C—all standard eight and ten dollar transformers under equal conditions.

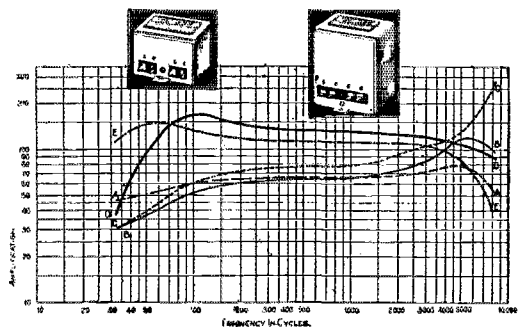

Are you receiving “The Radiobuilder” regularly? No. 5 (Sept.) described a Comparison Amplifier for comparing audio transformers. No. 6 (Oct.) tells about the new “PA” Public Address System. To S-M Authorized Service Stations, it comes free of charge, with all new constructional Data Sheets. If you build professionally, write us about the Service Station franchises.

Silver-Marshall, Inc.  
858 W. Jackson Blvd., Chicago, U. S. A.

...Send your complete catalog, with sample copy of the Radiobuilder.

...For enclosed 2c stamp, send Data Sheet No. 4 on Audio Transformers.

Name.....

Address.....

# Be a Commercial Radio Operator

A practical book that should enable anyone of average intelligence to pass the Government's theoretical examination given to applicants for a Commercial Radio Operator's License.

**NEW!**

## Nilson and Hornung's PRACTICAL RADIO TELEGRAPHY

380 pages, 5x8, 223 illustrations  
\$3.00 net, postpaid

The book covers in detail the theory and practical operation of every type of modern, 1928, commercial arc, spark, and vacuum tube transmitter. It furnishes complete data on commercial vacuum tube receivers. It covers everything from elementary electricity to the practical operation of radio compasses.

### Some outstanding points

1. Very little mathematics;
2. Assumes no prior knowledge of electricity;
3. Covers everything in commercial radio in detail;
4. Complete list of self-examination questions;
5. Simple, yet rigidly accurate;
6. Complete wiring diagrams given.

See the book before you purchase. Fill in and mail just this coupon.

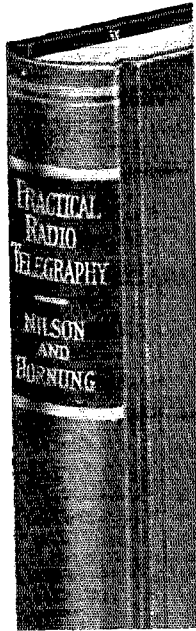

The operator at 6EMI calls 6EMF at the judges' stand. As the latter is always in a continual state of "QRX" and is watching for information to flash to both pylons at the same time, only a few dots and dashes are necessary to raise him. He replies: "6EMI R K", and the following conversation takes place:

"PLANE NR 159 QFP (Fouled pylon) LAP 6 HW."

"OK QRX."

In about a minute: "6EMI DE 6EMF PLANE NR 159 DISQUALIFIED AND FLAGGED OUT NM QSU."

6EMI answers: "E E," and the watch is continued. The unfortunate pilot of Plane Number 159 who misjudged the distance around Pylon Number 3 was saved the trouble of going the last four laps. He was flagged out of the race almost within a minute after passing Pylon Number 3.

And so the race goes on. Few accidents marred the races so that the use of "QRR" for "crash" was rare. But the radio spoke of other things beside "QST TON" (Take-off numbers), "QFP," etc. Transportation was arranged for. Observers at each pylon were given detailed instructions. One day a fire was reported by means of pylon radio. Lost planes were located. An observer had a "date" in Glendale at a certain time, so what was the earliest time he could leave? When do we eat? How many more races are there to day and will they move Pylon Number 4 again after they get it up? Which foot were you using that time? QSD? And a thousand other things of varying importance.

After the first two days or so the novelty of the thing wore off, in spite of the diversified program. But the efficiency of the service remained above par throughout the entire period.

Chairman W. L. Schaffer of the Race Course Committee was asked how the radio had been. He replied: "The radio is O K. I am *very* much pleased with it."

And that, as an expression of the race officials, may serve as a hint as to the satisfaction derived from the accomplishment, by all parties concerned.

### McGRAW-HILL FREE EXAMINATION COUPON

McGraw-Hill Book Co., Inc.,  
370 Seventh Avenue,  
New York, N. Y.

You may send me Nilson and Hornung's PRACTICAL RADIO TELEGRAPHY, \$3.00 net, postpaid. I will either return the book, postage prepaid, in 10 days, or remit for it at that time.

Name .....

St. & No. ....

City .....

State .....

Name of Employer .....

Official Position .....

(Books sent on approval in the U. S. and Canada only)  
Q.S.T. 11-1-28

## YAXLEY

APPROVED RADIO PRODUCTS

### Junior Rheostats

Small in size, but a master instrument. Ask your dealer to show you the exceedingly fine adjustment and velvet smooth action. Diameter, 1 7/16 inches. Up to 400 ohms .....75c  
1000 and 2000 ohms .....\$1.00  
Self-attaching, positive acting switches for Junior Rheostats .....40c

#### RESISTANCE UNITS

Here is where you need absolute dependability and you get it with Yaxley Resistance Units. Run true to rating. Convenient screw eye and soldering lug terminals for easy mounting. Filament and grid type; one to 3000 ohms .....15c to 40c

YAXLEY MFG. CO. Dept. S, 9 So. Clinton St., Chicago

### 160 Meter Low Power Transmitter

(Continued from Page 37)

key and, listening on your own receiver for the signal, turn the dial of C1 until the wave is within the legal band. Then adjust C2 and the taps on the antenna inductance until the 25-watt lamp in the primary of the plate supply transformer glows at about medium brilliancy. At this point, which is a sharp one, the two circuits are in resonance with each other. The transmitter is now in a working condition, so open the key and listen on your receiver for some station's signals. Then put the completed station in operation by calling the station heard.



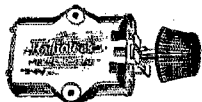

Bradley Leak, absolutely noiseless and stepless, **2.95**

2000 to 30,000 ohm resistance. List \$5, special \$2.95.

\$4. Bradleystat No. B-210 Special .....1.60



Signal Buzzer Set International Code on Baseboard ..... \$2.45  
Belden braid 3/4 inch wide, ft. .06

\$7. Acme B-6--"B" eliminator transformer, 235 v. each side of centre tap. .... 2.45

Acme 500 w. plate transformer, 1000-1500-2000 each side of centre tap, 24.00.

Acme B.H.-1 transformer, 235-510 each side of centre tap; also 2 ft. windings of 4 v. each side of centre tap. \$10.25.

Acme C.W. 30 Henry choke. \$18 list — 150 M. A. single \$14.40; also other sizes at special prices.

# LEEDS

The Home of RADIO  
45 VESEY STREET  
NEW YORK

New York's Headquarters for Transmitting Apparatus

When in Town Visit Our Store

Full Line of Acme -- Thordarson -- Jewell -- Flechthelm -- General Radio -- Signal -- Bradley

## SPECIALS

- Dubilier Mica Condenser .002 cap. 6,000 working volt 1.95
- General Radio 247D .001 cond. plain or with vernier 1.75
- Dubilier cond. 1.7 mfd. 1,000v D.C. test; 650v. working voltage 1.33
- Dubilier cond. 5 mfd. 1,000v D.C. working voltage 1.85
- R.C.A.—U.V. 1716 Super Het. transformer 1.45
- Ward Leonard Resistances; fits standard bases receptacles; sizes 300—600—900—1200 and 2000 ohms 3.95
- \$18. Imported German head sets; very sensitive 3.45
- Honeycomb Coils unmounted, all sizes in stock at 1/2 price.
- \$8 Signal Corp adjustable arm micro-transmitter for panel mounting 2.45
- \$9. Dubilier condenser, 4mfd; 600 v. D. C. working type 903; limited quantity 2.25
- R. E. L. Transmitting Inductances, per set. 8.80
- Bristol 50 Henry choke 2.75
- 6.50 Acme .0005 enclosed condenser .95

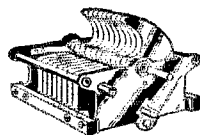

Cardwell condensers, double spaced for transmitting, .00025 cap. **3.45**

No. 12 Enameled copper wire, any length, ft. ....\$0.01

No. 10 Enameled copper wire, any length, ft. .... .01 1/2

Genuine Bakelite Panel 10x14x3/4 .....1.50

Baldwin phones type C, pair 5.95

Myers \$5 4 1/2 volt Det. or Amp tube, complete with mounting clips ..... .85



Ward Leonard Resistances \$4.75 list—3/4 inch long—800-1000-1200-8000-6000-8000-11000 ohms; can be used for 2-50 watt tubes or less. \$1.45

Pyrex Low-loss V.T. sockets, each 39c.

Flechthelm Condensers, all types 35% off list.

Television disks as specified in QST special \$1.95.

General Radio No. 358 Short Wave Meter, 14 to 225 meters, list \$22. special \$14.50.

## ACME POTENTIOMETER RHEOSTAT

A combined Pot. and filament Rheo.

6 ohm rheo-100 ohm pot. 30 ohm rheo-100 ohm pot. 30 ohm rheo-300 ohm pot.

TWIN RHEO for low voltage tubes. List \$3.00. Special each 65c



## ACME TRANSFORMER

Listed at \$5.00. The universal transformer for Super Het. 30 K.C. Limited quantity at \$1.10

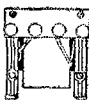

## ACME CHOKE COIL

A high quality choke 1/16 Henry at 100 mls. List \$5.00. Special \$1.25



## GENERAL RADIO

Type 285 AUDIO TRANSFORMER



Ideal for high and even amplification.

Type 285-H-6 to 1  
Type 285-D-8.7 to 1  
Type 285-L-2 to 1

List \$6.00 Now only \$3.25

## ACME VARIABLE AUDIO FREQUENCY TRANSFORMER

Get any ratio you want.

### SPECIFICATIONS

| Type V A-3    |               | Ratios Available |               |
|---------------|---------------|------------------|---------------|
| Primary       | Secondary     | Primary          | Secondary     |
| Binding Posts | Binding Posts | Binding Posts    | Binding Posts |
| 2.5:1         | 1-4           | 5-4              | 4.25:1        |
| 3:1           | 1-3           | 5-6              | 4.75:1        |
| 3.5:1         | 1-4           | 5-7              | 5.25:1        |
| 3.5:1         | 1-4           | 5-8              | 5.75:1        |
| 3.75:1        | 1-3           | 5-6              | 6.5:1         |
| 4:1           | 1-8           | 5-7              | 11.5:1        |

On the primary side the binding post in use having the higher number should be connected to the B-1 and likewise, the secondary post having the higher number should be connected to the grid.

By using binding posts 3-4, still higher ratios may be obtained if desired, but the above selection will usually fill all requirements.

Other specifications similar to type A-2. Price \$7.00 each. Special .....\$2.75

## GENERAL RADIO POWER AMPLIFIER and "B" ELIMINATOR KIT



"R. H" Raytheon tube, List \$50. Special .....\$19.50

All necessary parts; operates from 105 to 125 volts A. C.—gives "A", "B" and "C" for amplification and "B" for set. Type 390 uses type 280 tube. Type 385 uses

## NEON GLOW LAMPS



Made by General Electric Co., type G. 10, standard base, 101 uses, as illustrated in QST May issue page 17 Price only .....65c

## RADIO FOUNDATION TRANSFORMER



Mfg. for McCullough A. C. tubes. Will carry 6 tubes or its equivalent—2 1/2-3-3 1/2 v. List \$6.00 Special ..... \$2.25

## VARIABLE FILAMENT TRANSFORMER

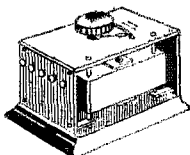

125 watt—110 volt—60c. tapped at 4-7-10-13-17-20-24-30 volts. Limited quantity. List \$19.

Special .....\$4.45



We carry the largest stock of GENERAL RADIO PARTS in the country

MAIL ORDERS FILLED SAME DAY 10% Must Accompany All Orders

Martin's Latest and Greatest Bug  
THE  
Great New **VIBROPLEX**

Reg. Trade Marks: Vibroplex, Bug, Lightning Bug

No. 6

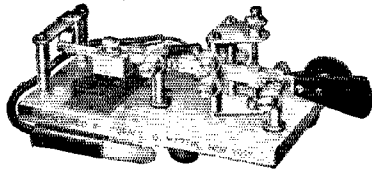

Japanned Base \$17  
Nickel-Plated \$19

The smoothest, easiest-working bug on the market. Not too fast—not too slow—but just right. Works where others can't.

Famous Improved Vibroplex

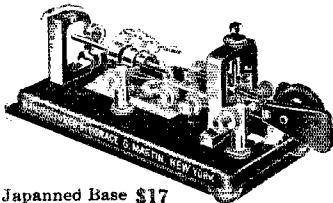

Japanned Base \$17  
Nickel-Plated \$19

Used by tens of thousands of operators because of its ease and perfection of sending.

Special Radio Bug

Equipped with Extra Large, Heavy, Specially Constructed Contact Points for direct use without relay **\$25**

Be sure you get the Genuine Vibroplex. The Vibroplex Nameplate is your protection. Emit by Money Order or registered mail.

**THE VIBROPLEX CO., Inc.** \$25 Broadway New York City  
Cable Address: "VIBROPLEX" New York

Official Frequency Stations

ONE cannot have read *QST* during the past few months without realizing that there are many changes to be made in amateur conditions when the effects of the International Radiotelegraph Conference is felt after the first of January, 1929. Under these new conditions it will be impossible for us to go along with our old opinions concerning the amount of accuracy that is necessary as far as the position of any signal in the frequency spectrum is concerned.

We have in the past been speaking in terms of wavelength and in accuracies of 2% in our Official Wavelength Station work. These will not do for 1929 and some major changes must be made in the requirements which these stations must approach.

*QST* has contained sufficient material on the reasons for referring to the position of a station in frequency rather than in wavelength to make a further discussion of this subject unnecessary. We, therefore, immediately find that we must give all reports in frequencies and the operators of these stations should make a distinct attempt, particularly during the next few months, to not only give official reports in frequencies but to adopt it as their unit of measurement and to learn to actually think in frequencies. About the quickest way in which this can be accomplished is to calibrate your present meter in frequencies and to put the wavelength calibration at the bottom of the biggest pile in the darkest corner of the shack—better still, destroy it.

When we change to the use of frequency the name which this service has borne becomes incongruous and even though sentiment may prompt us to hold on to an old friend, these echoes of the past are dangerous to our future and we will be much better off by starting from scratch. In accordance with this, stations in this service will hereafter be known as Official Frequency Stations or O.F.S.

Our new bands will be materially narrower than are our present ones and an accuracy of 2% as has been demanded in the past is entirely inadequate. Our old 40-meter band, for instance, will extend from 7000 to 7300 kilocycles and 2% of this band amounts to 140 kilocycles. There is, therefore, a band of only 20 kilocycles in the center of this band in which a report indicates that the signal is within the official limits of the band. In other words, if a report on a signal is given that is not between 7,140 and 7,160 kilocycles, the operator receiving the reports is not sure but that he may actually be outside the limits of the band. What is worse than this is the fact that with a 2% accuracy, no report can be given which indicates definitely that a signal is within the 14,000-kc. band as it will be in 1929.

It is impossible for us to obtain with this type of service a degree of accuracy which would be desirable and so it remains for us

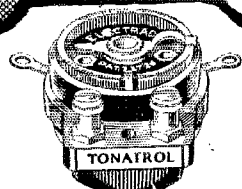

Exclusively Licensed by  
Technodyne Corporation  
under U. S. Patent No.  
1593658.

Volume That Satisfies

**TONATROL**

Trade Mark

A Complete Line of Volume Controls

Smooth, gradual control of intensity under all conditions will be your reward if you incorporate the Tonatrol Volume Control in your receiver. Tonatrols are variable resistors of the famous Royalty type, especially designed with the requirements of different circuits in mind. Furnished in standard types or with battery switch or power switch attached. From \$1.50 to Controls for all Radio Purposes. \$8.00.

Electrad specializes in a full line of Controls for all Radio Purposes including Television.

Write for FREE Hook-Up Circulars

Dept. T-11, 175 Varick St., New York

**ELECTRAD**

# If your radio doesn't operate a power speaker it's obsolete

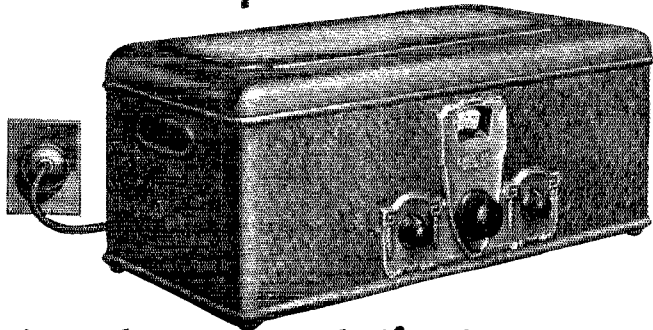

**The CROSLLEY GEMBOX**

## This is the world's lowest priced AC Electric power speaker radio

**NEUTRODYNE**

Here is a radio designed exactly as the most costly receiver. New features that have marked radio advancement this year are incorporated in this 1929 set. The improved AC tubes! Shielding! Low voltage that promises long life to tubes! Volume control! Illuminated dial! Power speaker operation! And Crosley manufacturing methods have kept the price **LOWEST** of any genuine electrically operated radio. Crosley economies in production and marketing are directly responsible for the unmatched price of \$65. Crosley radios are out-selling any others in every market. Sales nearly four times as great as last year's record breaking year, indicate the **VALUE** the public is finding in this latest Crosley success.

**\$ 65**  
WITHOUT TUBES

operating the new dynamic ~ power **DYNACONE**



**\$ 25**

You have a surprise and a treat in store for you. You will delight in the realism and beauty of its tone. You will be amazed so much is possible for \$25.

The **FIVE DAY FREE TRIAL** offer is copied on every hand but let any one deter you from comparing the Crosley with **ANY** set made. You need not be a radio expert to judge the **VALUE** Crosley gives you. Be sure you have the new Crosley dynamic power speaker. For the first time in the popular price field its deep, resonant tone from dynamic power available is a speaker at \$25. No one has even imitated it.

Fearlessly Crosley led the radio industry to home trial before buying. On such a broad selling policy Crosley has won first place in the industry because buyers found Crosley radio outperformed many far more expensive sets. A home demonstration will satisfy you that Crosley is a **GREAT** radio.



8 tube AC Electric **SHOWBOX** \$80  
Genuine neutrodyne  
3 stages radio amplification, detector  
2 stages audio (last one being a 171 push-pull power tubes) and 380 receiver.



6 tube Battery Operated **BAND-BOX** \$55  
The Bandbox is the ideal radio for places where electric current is not available for AC receivers. This receiver can be converted for use from the power lines by means of a suitable power supply unit.  
5 tube Dry Cell Operated **BAND-BOX, JR.** \$35.  
uses 199 tubes with 120 power output tube. Ideal set where recharging of storage battery is inconvenient.



The Improved **MUSIGONE** the fastest selling magnetic loud speaker at \$15

**THE CROSLLEY RADIO CORPORATION**  
Powel Crosley, Jr., President, Cincinnati, Ohio

# CROSLLEY

Montana, Wyoming, Colorado, New Mexico and West, prices slightly higher. Crosley prices do not include tubes.

Where you're there with a Crosley

The Crosley Radio Corporation, Cincinnati, Ohio Dept. 18.  
Please send me literature about your new radio receiver and the new wonderful **DYNACONE**.  
AC Radio..... Battery Operated **DAY**  
Dynacone..... DC Radio..... **5 DAY FREE TRIAL IN MY HOME**  
Name .....  
Address .....

Say You Saw It In Q S T — It Identifies You and Helps Q S T

# Raytheon Kino-Lamp

## As Pioneers in TELEVISION

We invite correspondence from amateurs in regard to these new Raytheon Products, which are being used successfully in the Television broadcasting.

**KINO-LAMP** for receiving—List Price \$7.50.

**FOTO-CELL** for sending—Prices and information upon application

**RAYTHEON MFG. CO.**

Kendall Square Building  
CAMBRIDGE, MASS.

# Raytheon Foto-Cell

to endeavor to maintain as high a degree of accuracy as can be obtained with the equipment that is available to the Official Frequency Stations. Our Standard Frequency Transmissions carry an accuracy of 1/10 of 1% and when one begins to realize the many problems involved in maintaining this accuracy over long periods of time, it is obvious that we cannot expect such precision from the O.F.S. As a result of much discussion, a figure of 1/2 of 1% has been decided upon as being a satisfactory compromise between the desirable accuracy and that which can be obtained without involving any considerable expense or work on the part of the operators of Official Frequency Stations.

Meters that are good to an accuracy of 1/4 of 1% and better are available on the market at prices that should be within the reach of the O.F.S. It is possible for the amateur to construct his own instrument and calibrate it from the Standard Frequency Transmissions from W9XL and WWV. It is extremely desirable that frequency meters be checked at least once every two months to be sure that their calibration is still within the necessary limits. (Please let us know when you have taken advantage of these transmissions and if you have not already obtained report blanks we would be glad to send you a supply.)

Many operators prefer the use of megacycles when referring to the various bands. Unfortunately, it is impossible to specify a frequency in megacycles to an accuracy of 1/2 of 1% without the use of figures to the right side of a decimal point. That is, unless one is referring to a round number of thousands of kilocycles which may be satisfactory for designating bands but which is decidedly unsatisfactory when referring to frequencies within bands. This same thing applies to the use of wavelength in meters. It is possible to refer to any frequency within the amateur bands with an accuracy of 1/2 of 1% by using a full number of kilocycles. This means in practice that all reports may be given in figures of four or five digits without the use of a decimal point and still maintain the accuracy demanded of this service. This, then, constitutes an excellent reason for the use of kilocycles when the matter is viewed purely from a point of convenience.

This is not the only reason for its use, though. The International Radiotelegraph Conference made the kilocycle its standard unit in allocating all bands and our own Radio Division of the Department of Commerce has also adopted this standard. Our licenses specify our bands in kilocycles. Although the limits are also given in wavelength, this is only an approximate value. In view of these factors, we feel justified in employing the kilocycle for our standard unit and all reports should be given in kilocycles. Therefore, in transmissions no commas, periods or other punctuation are

## AMERTRAN PF-250 Power Transformer for UX 250 Power Tubes

A husky transformer built for doing the job, not for looks. The PF-250 is rated at 1200-800 volts plate, 7 1/2 volts power tube, 7 1/2 volts rectifier tube filament. Center taps are provided on each of the filament windings. Continuous rated capacity of plate windings, 160 M.A., continuous rated capacity of each 7 1/2 volt winding, 3 Amperes. DC plate output with two UX250's full wave, up to 450 volts with sufficient excess for "C" Bias. Ask for Bulletin No. 2033 describing fully the PF-250.

Price, each—\$30.00

*Slightly higher West of Rocky Mountains*

**AMERICAN TRANSFORMER COMPANY**

*Transformer Builders for more than 28 Years*

196 Emmet St.

Newark, N. J.

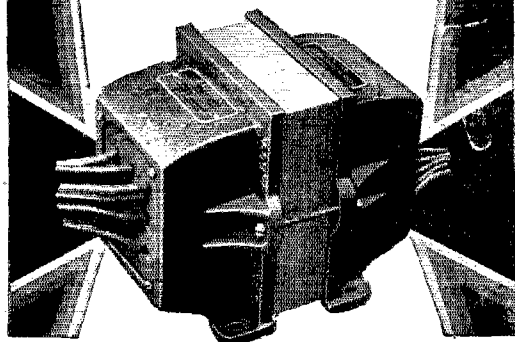



Wide World Photo of the "City of New York."  
From a painting by Chas. Rosner, N. Y.

"We are Depending  
on your product,"

*writes the Radio Engineer of the*

**Byrd**

*Antarctic Expedition*

ON the Antarctic Expedition led by Commander Byrd,—as on his Arctic Expedition and Trans-Atlantic Flight—\*PYREX Insulators will again be depended on for unfailing radio insulation.

These seasoned explorers dare not entrust the success of their expedition—and possibly their lives—to any equipment which had not proven its complete ability to withstand the extreme conditions to be met. Their complete confidence in them is ringingly expressed by M. P. Hanson, Byrd's Radio Engineer.

"We have every confidence," writes Engineer Hanson, "that your products will render good service under the extreme conditions to be met, as they have done in the past."

PYREX Insulators are not affected by acid fumes, smoke or salt fogs. Their exceptionally low coefficient of expansion makes them indifferent to sudden temperature changes. Their dielectric strength is from 15 to 35% greater than porcelain. Their power loss is lower than any substance except pure fused quartz.

For complete technical information and catalogs on either PYREX Power Line or PYREX Radio Insulators write

**CORNING GLASS WORKS**

Dept. Q-4, Industrial and Laboratory Division  
New York Office: 501 Fifth Avenue



\*Trade-mark. Reg. U. S. Pat. Off.

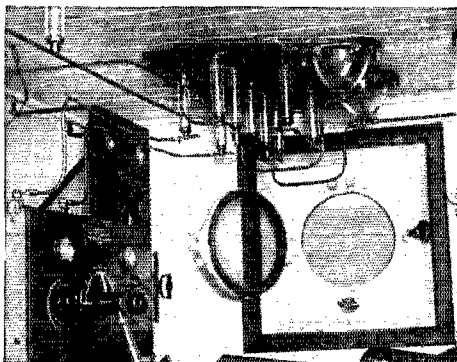

*PYREX Entering bowl and Stand-off Insulators on the ceiling of the radio room of the "City of New York." High power short wave transmitter shown on the left*

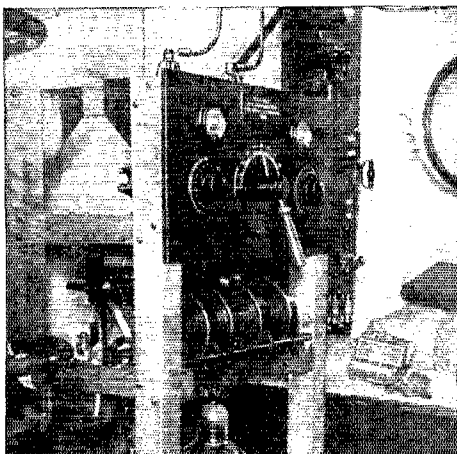

*Lower Section of high power short wave transmitter equipped with PYREX small Lead-in Insulators*

# Potter Condensers

QUALITY UNIFORMITY LONG LIFE ECONOMY

The operation is insured for that radio set and power amplifier equipped with Potter Condensers.

This selection has been made by leading manufacturers for use in the finest radio sets, making it safe to follow their good judgment.



## Potter Interference Eliminator

Radio broadcast programs no longer need be spoiled by interference from oil burners, ice machine motors, fans, etc.

The simple remedy is to connect a Potter Interference Eliminator to the line circuit at the point where interfering device is connected and enjoy your radio set.

### Potter Manufacturing Co.

North Chicago, Ill.

A National Organization of Your Service

necessary to break up the group of four or five digits.

At the present time there are two factors that are used in converting from kilocycles to meters or vice-versa. The more exact one is 299,820 and the more convenient is 300,000. The more exact value differs from the other by 18 parts in 30,000 or 6/100 of 1%. This inaccuracy is insignificant in view of the 1/2 of 1% requirement and the conversion of wavelength-to-frequency is so much more convenient when using 300,000 that once more we can adopt a unit which simplifies calculations without, at the same time, sacrificing anything of importance. We also find that the Radio Division of the Department of Commerce has adopted this factor and that it was used by the Conference. A conversion chart for wavelengths or frequencies between 10 and 30,000 based on this figure has been issued by the Superintendent of Documents of the Government Printing Office at Washington, D. C., at the request of the Radio Division. Copies of this chart may be obtained at 5 cents each from the Government Printing Office. To assist the O.F.S. in changing over to kilocycles, we are having a copy of the chart sent to each one of them with our compliments.

The chairman of the committee handling Official Frequency Stations is Don C. Wallace, W6AM, and if you are already an O.F.S. but feel that you cannot meet the requirements specified above, please notify the Chairman so that your call may be deleted from the list. If you are not an O.F.S. and feel that you can meet the requirements satisfactorily we would be glad to have your call on the list. Communicate with the Chairman. The chief duties of an O.F.S. are to indicate the frequency of his transmission at the end of each transmission, to check the frequency of other transmitters when requested and to aid in the general work of keeping all amateurs within their assigned bands. This is done in the course of their general amateur operation. O.F.S. do not send Standard Frequency Transmissions.

The following stations are members at this time: W6XAO-W6ZV, W5MN, VE3FC, oz-2AC, W6AM, W1CK, W1AWW, W8EQ, W4XE, W5ZAV, W9EGU, W6ZH, W2MU, W4BY, W5SP, W7GQ, W2DS, W1BZQ, W6BGM-W6CVO, W9IG, W1ZL-W1AVW, W2CLA, W8GZ-W8ZG, W9BGK, G2NM, VE9AL, W8APZ, W5OX, W1AAC, W8BZT, VE3CO, G2OD, W6CAE, W9AXQ, W9CPM, W5EW, W1AXA, W9BGH, G2SZ, W6BB, W8DAJ, W9AUG, VE2BE, W2BRB, VE4BT, oa-5BG, W4LK, G15NJ, W1CCW, W8BAU, W9UZ, W2EF, W6AKW, W6CDY-W6CPX, W6AYC, W6BRO, W6WN, W6BMW, W6CMQ.

# Send For WESTERN RADIO New 1929 Catalog

Dealers and Det Builders

THE NEW 1929 Catalog is crammed full of the FINEST, NEWEST, Nationally known A.C. sets, consoles, cabinets, dynamic speakers, kits, PARTS, eliminators and accessories at LOWEST PRICES. Largest stock of radio parts. Prompt delivery.

Write for our FREE catalog  
WESTERN RADIO MFG. CO.,  
128 W. Lake St., Dept. 011, Chicago



"The Big  
Friendly  
Radio House"



The broadcast of the Army-Navy game last year was enjoyed by hundreds of thousands of fans all over the country.

Phillips Carlin broadcasting at one of the big football games.

# The Big Game Comes Over~ BETTER~CLEARER

**M**ILLIONS of enthusiastic football fans are listening this fall to the play by play broadcasts of America's greatest games. They are experiencing almost as keen enjoyment as if they were sitting in the stands. The voice of the announcer comes to them clearly and distinctly because their receiving sets are Aluminum equipped.

Leading radio manufacturers are using Aluminum extensively for shielding, for condenser blades and frames, for chasses, sub-panels, front panels and for many other parts—because Aluminum so ideally meets the varied conditions that radio design presents.

It combines remarkable shielding properties, high electrical conductivity, great strength and extreme lightness.

Examine the set you contemplate buying. If it is Aluminum equipped you may rest assured that the manufacturer has done everything in his power to give you the finest possible reception.

And if you are building a receiving set use Aluminum for finest results.

We will gladly send you the booklet, "Aluminum For Radio," which explains the varied radio uses to which Aluminum is adapted.

**ALUMINUM COMPANY OF AMERICA**  
ALUMINUM IN EVERY COMMERCIAL FORM

2439 Oliver Building  
Pittsburgh, Pa.



Offices in 19 Principal  
American Cities

# ALUMINUM

*The mark of Quality in Radio*

# REMLER

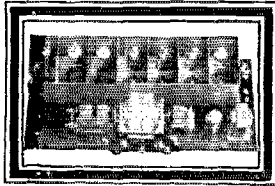

# "29"

*different*

Remler has designed a *new* circuit. It is different and a long step ahead in radio research. Let us tell you all about it and why it will out perform any factory built receiver. Sign and mail the coupon. We will forward an eight-page, two-color folder and set-builders' bulletin.

Q-10

Remler Division, Gray & Danielson Mfg. Co.  
260 First Street, San Francisco, California.

Gentlemen: Please send me:

- All the "dope" on the "29".
- Bulletin service for professional set builders.

Name .....

Address .....

City ..... State .....

## PRESENTING

### The New SRL

*Spreadband and Frequency Meter*

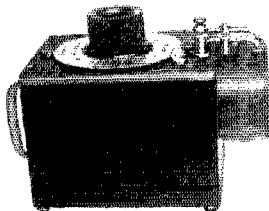

Type  
108-S

10-20-40-80 Meter Bands. Each band covers the whole dial and we don't mean perhaps!

**Don't Check Out January 1st.**

The type 108-S is the solution to your frequency-measuring problem. The low price of \$21 is an introductory offer. Orders will be filled in rotation. Order yours now and save delay.

*Fall Bulletins Out—Write for Them*

(LIVE DEALERS WRITE FOR FULL INFORMATION)

**SEATTLE RADIO LABORATORY**

3335 33d Avenue, South Seattle, Wash.

## STATEMENT OF THE OWNERSHIP, MANAGEMENT, CIRCULATION, ETC., REQUIRED BY THE ACT OF CONGRESS OF AUGUST 24, 1912.

Of QST, published monthly at Hartford, Conn., for October 1, 1928.

State of Connecticut }  
County of Hartford }

Before me, a Notary Public in and for the State and county aforesaid, personally appeared K. B. Warner, who, having been duly sworn according to law, deposes and says that he is the business manager of QST and that the following is, to the best of his knowledge and belief, a true statement of the ownership, management (and if a daily paper, the circulation), etc., of the aforesaid publication for the date shown in the above caption, required by the Act of August 24, 1912, embodied in section 411, Postal Laws and Regulations, printed on the reverse of this form, to wit:

1. That the names and addresses of the publisher, editor, managing editor, and business managers are: Publisher, The American Radio Relay League, Inc., Hartford, Conn.; Editor, Kenneth B. Warner, Hartford, Conn.; Managing Editor, F. Cheyney Beekly, Hartford, Conn.; Business Manager, Kenneth B. Warner, Hartford, Conn.

2. That the owners are: (Give names and addresses of the individual owners, or if a corporation, give its name and the names and addresses of stockholders owning or holding 1 per cent. or more of the total amount of stock) The American Radio Relay League, Inc., an association without capital stock, incorporated under the laws of the State of Connecticut. President, Hiram Percy Maxim, Hartford, Conn.; Vice-President, Chas H. Stewart, St. David's, Pa.; Treasurer, A. A. Hebert, Hartford, Conn.; Communications Manager, F. E. Handy, Hartford, Conn.; Secretary, K. B. Warner, Hartford, Conn.

3. That the known bondholders, mortgagees, and other security holders owning or holding 1 per cent. or more of total amount of bonds, mortgages, or other securities are: (If there are none, so state.) None.

4. That the two paragraphs next above, giving the names of the owners, stockholders, and security holders, if any, contain not only the list of stockholders and security holders as they appear on the books of the company but also, in cases where the stockholder or security holder appears upon the books of the company as trustee or in any other fiduciary relation, the name of the person or corporation for whom such trustee is acting, is given; also that the said two paragraphs contain statements, embracing affiant's full knowledge and belief as to the circumstances and conditions under which stockholders and security holders who do not appear upon the books of the company as trustees, hold stock and securities in a capacity other than that of a bona fide owner; and this affiant has no reason to believe that any other person, association or corporation has any interest direct, or indirect in the said stock, bonds, or other securities than as so stated by him.

5. That the average number of copies of each issue of this publication, sold or distributed, through the mails or otherwise, to paid subscribers during the six months preceding the date shown above is ..... (This information is required from daily publications only.)

K. B. WARNER.

Sworn to and subscribed before me this 22d day of September, 1928.

Caroline S. Crisman.

(My commission expires February, 1931.)

## Calls Heard

(Continued from Page 54)

Sgt. Henry P. Karr, Hq. Btry., 2nd F. A. Bn., Camp at Gatun, C. Z.

(20 meters)

1aba 1aaf 1aga 1afd 1ajd 1akm 1alb 1alw 1amp 1apv 1asf 1asu 1aw 1axp 1axq 1bat 1bdq 1be 1bfz 1big 1bkv 1bms 1bdq 1bs 1bux 1bax 1ca 1cax 1cd 1edi 1ejh 1ekp 1emp 1epi 1da 1de 1du 1dwa 1dy 1ex 1fl 1gd 1hv 1ic 1lo 1jc 1lm 1my 1mr 1nw 1pd 1qh 1qo 1rd 1ry 1sw 1szz ut 1vc 1vk 1vo 1vg 1vw 1wl



**164  
PAGES  
of RADIO  
VALUES**

# A NEW CATALOG JUST OFF THE PRESS

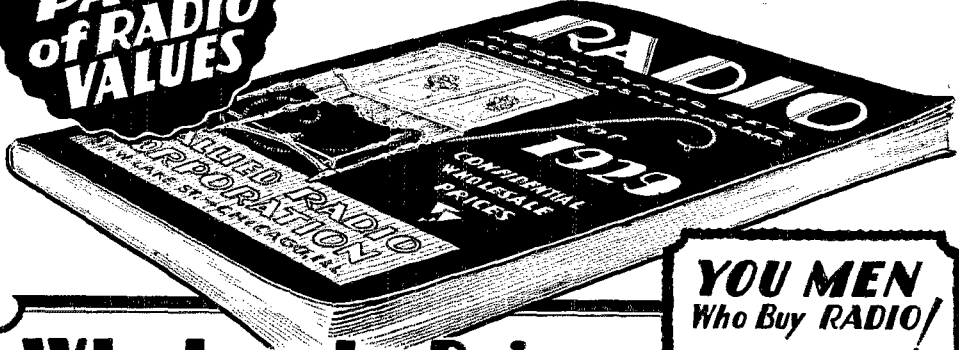

## YOU MEN Who Buy RADIO!

By making your problems our problems, we know the service you require—and to render you such service the entire Allied organization is dedicated—to give you the service you have a right to expect. Tremendous stocks, remarkable values and a real desire to serve, all combine to make Allied your ideal source of supply.

## Wholesale Prices

THIS big new catalog heralds a new era in radio. Never before have you been offered such variety—such quality—such sterling value in radio as you are now offered in this large new catalog. In it, *wholesale prices* are not a myth—but *actual* reality. You will marvel that such merchandise, comprising everything that is *new and worthwhile* in radio can be offered at such prices. Here you will find high quality that is not high priced. If you are interested in radio you cannot afford to be without the *Allied Catalog*.

### SET BUILDERS!

Set Builders, Amateurs and so called "Hams" will delight in the unusual variety—and remarkable values that are offered in standard kits and parts. Tremendous stocks—real organization—prompt shipping service all combine to make Allied your ideal source of supply.

### RADIO DEALERS!

The live radio dealer—the man who keeps pace with the rapid advance of radio will find much of real interest in the Allied Catalog. New A-C Sets, D-C Sets, Dynamic and Magnetic Speakers, television equipment, in fact everything that an impatient radio public is demanding.

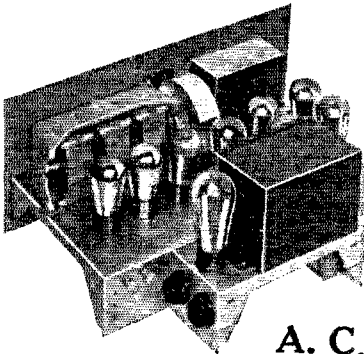

### A. C. ELECTRIC SETS

Allied offers you a new—complete line of A-C Receivers, available in either chassis form or in a wide variety of beautiful console models. Prices range from \$82.95 to \$199.00. Dollar for dollar they stand out as one of the season's leading receivers. Engineered to unusual perfection they offer you features found only in the highest priced sets.

### WHAT ALLIED OFFERS YOU!

Allied Service will prove a revelation to you in what radio service can really be. Allied Executives backed by years of training in radio are practical men. They know radio. Their vast experience has built up around them an organization trained to serve. Months of effort have built up here a tremendous reserve of stock that makes for prompt shipments; and this stock is new stock comprising the seasons pick of such prominent manufacturers as Silver-Marshall, Tyrman, Aero, Hammerlund-Roberts, etc.

#### You Profit When You Buy Right

Buying right is half the battle. From the small set builder to the large dealer, your success depends upon gauging the public pulse of radio and in *buying right*. Everything that is new in radio—the items the radio public is now demanding are here, ready for your call. Write now—the catalog is free for the asking.

Write for Catalog Now

# Allied Radio

## CORPORATION

711 W. LAKE ST., Dept. P, CHICAGO, ILL.

# FROST-RADIO

## New Data Book Now Ready

The new Frost-Radio 16 page Data Book, just off the press, is ready for mailing. It contains a great deal of valuable information regarding circuits but also technical data on rheostats, variable high resistances, filter condensers, etc. We have aimed to make this a complete authoritative manual of interest to every reader of QST. Write for your copy today, inclosing 10c to cover cost of postage and mailing. Also contains full information on the new Frost-Radio items for 1928.

**HERBERT H. FROST, INC.**

Main Office and Factory  
Elkhart, Indiana

Chicago New York City

HERBERT H. FROST, Inc.  
160 North La Salle Street, Chicago

Send me by return mail your NEW 16-page Data Book for which I inclose 10c.

Name .....

Street Address .....

City ..... State .....

## Neutralization Means— More Power From Any Set

Science has proven that neutralization is the only satisfactory method of controlling oscillation in a Tuned Radio Frequency Circuit and that it increases the actual power per stage of amplification 25 to 300%.

The Neutrodyne principle can be applied to practically every set by the simple installation of X-L Vario-densers. The result is an amazing increase in the efficiency and power of the receiver. Send for interesting book of circuits and picture diagrams showing the use of the Variodensers.

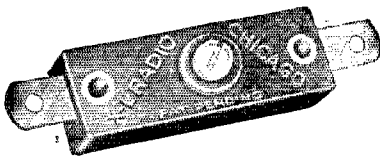

MODEL "N"  
VARIO-DENSER

Has variable capacity, adjustable from 1.8 to 20 micro-microfarads, which is .0000018 to .00002 microfarads. Price each \$1.00.

**X-L RADIO LABORATORIES**  
Dept. D 1224 Belmont Ave., Chicago, Ill.

New Western Electric, Navy Transmitting and Receiving Set, 10 watt, 1 Receiver & Transmitter C. W. 1855, 1 SC No. T 1 Breast plate microphone, 1-1 A Helmet with 194 W. headphones, 1 Westinghouse Dynamotor 12-350 volts D. C., 1 CW 1057 Seaplane Interphone control box and necessary cables with plug connectors. Set is equipped with 8 VIL tubes and 1 CW 1059 Ballast lamp, outfit for \$75.00. Largest stock of Government Radio Transmitting and Receiving material in U. S. Send 2c stamp for our new and latest reduced price list. Ship anywhere. **WEIL'S CURIOSITY SHOP**, 20 South 2nd St., Philadelphia, Pa.

1wu 1xf 1xae 1az 2ag 2aga 2agn 2aic 2ail 2aio 2ang  
2amp 2api 2ar 2avz 2ays 2aza 2azu 2bac 2bal 2be 2bg  
2bha 2bjr 2bke 2bm 2br 2bvq 2bx 2bcu 2byw 2chk  
2ckw 2ex 2fm 2ff 2gp 2jj 2jy 2kz 2md 2mp 2nn 2od  
2ow 2pj 2rb 2rs 2rz 2sh 2tp 2uj 2va 2vi 2vl 2xad  
2xam 2yi 2ac 2adm 2ads 2aic 2aajh 2aacr 2bgg 2cj  
2cv 2ac 2ez 2gr 2ij 2jm 2ke 2mv 2nz 2on 2qv 2wn  
2za 2abz 2acr 2add 2aer 2am 2apj 2bl 2ea 2ek 2fe  
2ir 2im 2jd 2kl 2st 2uo 2abi 2ac 2aq 2asq 2aot 2ats  
2bt 2by 2cl 2gm 2jw 2kg 2pt 2we 2yd 2ago 2ah 2aiz  
2ajm 2alw 2ana 2ann 2avj 2avp 2azr 2acz 2bc 2bct  
2bvx 2bz 2cjj 2csj 2cve 2cx 2czq 2daz 2dhh 2dij 2dl  
2dom 2dud 2jn 2ab 2gp 2gw 2fj 2ah 2ak 2ax  
2vy 2zde 2zgo 2abg 2ago 2awf 2cl 2dd 2ie 2fn  
2fs 2gn 2mr 2vu 2adm 2agy 2ain 2ane 2arj 2ava  
2avb 2avz 2awf 2axa 2baz 2bbj 2bbp 2ben 2bfb 2bhz  
2bk 2bqv 2brq 2brh 2bz 2caj 2ccr 2ced 2cft 2cfr 2cic  
2clp 2clt 2cmb 2cnj 2cph 2cpq 2cpx 2cug 2cvq 2cyg  
2ddn 2dc 2dds 2dey 2dkp 2dpo 2drj 2dsp 2day 2dpt  
2ex 2ez 2fd 2gz 2ij 2jm 2kn 2ng 2oc 2rd 2re 2ul 2xf 2yas  
2afa 2akz 2alx 2ant 2anz 2aod 2aqi 2as 2aur 2auv  
2avv 2asi 2be 2bca 2bcd 2bcb 2bbh 2bbk 2bbl 2bbm  
2bkc 2bmd 2bmv 2bvo 2bvx 2bvy 2bqy 2btw 2byo  
2cfm 2cmv 2cnd 2cnc 2cnd 2cnd 2cnd 2cnd 2cnd 2cnd  
2dpp 2dpk 2dps 2dqy 2dap 2del 2ef 2egb 2ehn 2ein  
2emb 2etk 2eap 2ez 2fj 2gj 2hl 2hm 2in 2mc 2nv  
2oj 2sq 2sx 2sv 2vi 2eb-4au eb-4cb eb-4rs ed-7jo ed-  
8z eg-ear62 ef-8fb ef-8fd ef-8fr ef-8orm eg-2bm  
eg-2nh eg-5by eg-6hs eg-5ma eg-5ml eg-5uw eg-5yq  
eg-6jk eg-6rb ef-6sa eg-6td eg-6yq ej-7dd nc-3ca nc-  
3rg nc-4ny nc-4rn nc-5bv np-4pf np-4zm oa-2no oa-  
5cm oh-6aim oz-4am sa-6avj sb-law sb-lib.

(40 meters)

1aao 1ah 1aiu 1ap 1axx 1bda 1bea 1bhp 1bux 1ca  
1cd 1chg 1fd 1gw 1im 1lp 1m 1om 1rp 1xa 2abe  
2agf 2alp 2apd 2atk 2azy 2bav 2bdh 2bt 2cty 2eub  
2da 2do 2dx 2gu 2nf 2ng 2ov 2vc 2xaf 2aba 2aed  
2alq 2ani 2bnu 2bqz 2cfc 2cp 2fg 2na 2nd 2lw 2tc  
2aar 2acv 2acz 2ap 2caa 2co 2cw 2dq 2ei 2ng 2nu  
2oo 2pt 2qa 2sl 2tk 2tu 2wd 2zx 2ac 2afx 2ahx 2aqe  
2aut 2ave 2axi 2ayq 2bj 2bx 2ef 2ek 2gl 2rv 2ut  
2vx 2wj 2aah 2ac 2avv 2bec 2bhi 2bmv 2bng 2dap  
2dl 2dmh 2dmp 2eb 2em 2gp 2ya 2akq 2bd 2bx 2agv  
2agy 2agz 2akx 2au 2baz 2be 2bm 2brf 2cbf 2cdd  
2cq 2dne 2do 2dqp 2eq 2nf 2ru 2ap 2ama 2aok 2apl  
2ay 2baf 2bam 2bir 2bjz 2cid 2cy 2des 2dp 2du 2ehn  
2ud 2ux oa-wy eb-4cb eb-4cc eb-4ft ef-ear28 ef-8dmf  
ef-8gr ef-8rg ef-8vvd ef-8vb eg-5cb eg-5ma eg-5ml eg-  
5uw eg-5yk ei-1pf ei-1gn ek-4fv eu-rdw nc-2ea nc-  
4cs nn-1nic nq-2cf nq-7cx oa-2rx oa-5mb oa-5ox sb-  
1ah sb-1ao sb-1bq sb-1ca sb-1lic sb-1ld sb-2ad sc-2as  
su-1na.

(80 meters)

1aaw 1abz 1ad 1aef 1afb 1ait 1ahv 1alb 1anl 1api  
1asd 1asu 1awt 1awk 1bbj 1bpt 1bfz 1bi 1bjp 1bqd  
1bvl 1cat 1ebt 1ccw 1edb 1efp 1emd 1era 1di 1dr 1fl  
1hb 1hp 1il 1in 1ku 1mk 1pe 1pi 1qb 1sl 1vb 1wq  
1xy 1yb 2aat 2abi 2ad 2af 2aj 2aif 2aiz 2alo 2aoo  
2aow 2awv 2ayg 2bcp 2bek 2bec 2bfd 2bfi 2bfp 2bgm  
2bhl 2bic 2bf 2bsc 2bcp 2cep 2cp 2cpd 2cpg 2ctm  
2evf 2evh 2cxl 2czr 2dv 2ec 2ev 2gp 2gv 2gx 2ix  
2mt 2sc 2se 2sb 2wz 2xg 2abi 2ac 2aad 2aadm 2aei  
2ael 2afw 2agi 2ahe 2akp 2ale 2aob 2aqi 2aah 2ase  
2awu 2bgs 2bit 2bpl 2bhm 2bns 2br 2bst 2bwt 2ca  
2cee 2cfc 2cuj 2dew 2jh 2cp 2uz 2xa 2zf 2zi 2za  
2aaa 2acd 2af 2bl 2cn 2es 2ff 2fx 2gl 2ie 2lu 2qy  
2rn 2sp 2wc 2wg 2xe 2aqd 2qa 2aod 2don 2aag 2acq  
2acz 2ae 2ais 2ajk 2akc 2ako 2ald 2alo 2amu 2apb  
2arx 2ase 2atq 2atr 2avk 2avb 2ayn 2bcm 2bec 2bcz  
2bfn 2bgd 2bjz 2bmr 2bti 2bts 2byn 2sci 2sch 2sch  
2cjb 2cmw 2cng 2cns 2crf 2cye 2csm 2dbu  
2ded 2dcq 2ded 2dkx 2dme 2dok 2doq 2da 2ey 2jb  
2kr 2mm 2pt 2aaf 2aaj 2ahk 2ain 2amu 2apq 2apy  
2atv 2baw 2bc 2bdt 2bhc 2bhs 2bwi 2bwn 2cmv  
2cpr 2csm 2cyr 2cno 2dca 2dba 2dds 2des 2dgv 2ebo  
2edo 2egq 2ejt 2ekw 2eqi 2ean 2hh 2ox.

W7JC-W7ZC, 434 Clark Ave., Billings, Montana

(40-meter band)

xem-sfv fe-8jcx fm-8az fm-8as na-7to nj-2pa nm-1g  
nn-1nic no-6fl nz-fr5 oa-2aw oa-2cs oa-2gw oa-2hc  
oa-2hm oa-2kb oa-2kj oa-2me oa-2ns oa-2rb oa-2re  
oa-2rf oa-2rx oa-2sh oa-2xi oa-2yi oa-3hm oa-3bq  
oa-3dc oa-3jk oa-3jw oa-3is oa-3me oa-3ml oa-3wh  
oa-2wm oa-3yx oa-4ab oa-4cm oa-4lj oa-4nw oa-5pu  
oa-4wa oa-5by oa-5hg oa-5mb oa-7dx oa-7lj oc-3xz  
oc-6qh oh-6dws oo-1aj oz-2aw oz-2ba oz-2bg oz-2bh  
oz-4xc oc-2ab.

(20-meter band)

eg-5sw oa-2uk oa-2wf oa-2xr k6dqn.



W1WYV, W. W. Smith, 300 Edgell Road,  
Framingham Center, Mass.

(20-meter band)

eb-4bn ef-8cf ef-dmf ef-8fd ef-gdb ef-8hip ef-8ix  
ef-8rrr eg-2bm eg-2kf eg-2nh eg-2od wg-2sc eg-2xv  
eg-5by eg-5bz eg-5ls eg-5ml eg-5ms eg-5qv eg-5vl  
eg-5wk eg-5yt eg-5ut eg-5vp eg-5yv ei-1dy ek-4vo  
ek-5yt en-ovx eg-1ae oa-2xr oa-3ce oa-3gr oa-5ng  
ca-7ch oz-2ac oz-2aw oz-2bg oz-4aa sb-1aw sb-1ib sb-2ab  
ab-2al ab-2ar sc-1ah se-1ai ne-3ae ne-8fd ne-3wz  
nq-2kp wnp.

W1GP 1025 Fairmount Ave., Anniston,  
Alabama

w6adk w6aie w6aim w6ajh w6ami w6aov w6app  
w6arv w6ase w6asj w6awy w6bcq w6bi w6bir w6bmo  
w6bp w6sb w6bxi w6byz w6cah w6cew w6cee w6cdb  
w6cdl w6cdv w6cj w6eri w6etd w6euk w6cxn w6czt  
w6dbo w6dcv w6dfr w6dfs w6dgg w6dhe w6dhs w6dlx  
w6dnn w6dpl w6dpu w6dwj w6dlz w6dza w6fa w6io  
w6oe w6tj w6un w6iy w6va w6vc w6xbb w6zan  
w7aea w7ajh w7alk w7if w7rj w7sg w7ui w7wb w7wi  
nj-2pa nm-1g nm-9a nn-cab nn-1nic nq-2ay nq-2iq  
np-2jt nq-5fc nq-5fl nr-2ea nt-2fp nz-fr5 oa-2kj sa-4ao  
oa-4ra oa-5hg oa-5ht k6alm op-1om oz-1aj sb-1ay  
sb-1aw se-1em se-2ea.

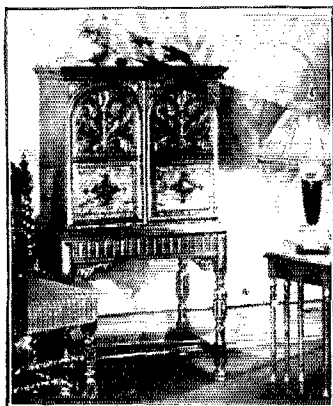

FANSTEEL

# Balkite Radio

IN CABINETS BY  
**Berkey & Gay**

FANSTEEL PRODUCTS COMPANY, Inc.  
NORTH CHICAGO, ILLINOIS

## Correspondence Department

(Continued from Page 75)

### A Ghost of the Past

Glen Avenue,  
Arlington, P. O.,  
Baltimore, Md.

Editor, *QST*:

Last night I happened across an odd file that used to repose on the shelf in the radio shack that nestled under the "old back porch". My thoughts ran back to those hectic days of "nineteen sixteen" when the non-sync spark crashed its "merry" way over the receptive ether.

Perhaps, a few of the "Old Timers" will get a real thrill over something that I found in the box. The "find" bears the stamp of old 3RD at Bancroft Park, Baltimore, Maryland; and the following is self-explanatory.

#### PRESIDENTIAL RELAY, 1916

For the first time in the history of this grand Republic, the amateurs will demonstrate to the public that they can be relied upon to help the Government. We all feel highly honored to be given the chance by President Wilson to demonstrate how well we can pass around this country a message from the white house.

#### PURPOSE OF THE RELAY

First, to get you interested in perfecting your station. Secondly, as the air will be perfectly quiet on the night of this relay, you will have a chance to check up on your receiving outfit. Thirdly, to get a number of good receiving stations that can hear NAA and NAJ, at all times. This list will be turned over to the Government authorities. Fourthly, to satisfy the curiosity of the President of the United States as to our real worth, and assist the Department of Commerce, all of whom have rendered the amateurs valuable assistance. Fifthly, to give prizes to the most successful amateurs.

The message will start from station 9XE, in Davenport, Iowa, and will be relayed through the following stations, on the night

**MIDGET**

**TELEPLEX**

**CODE SENDER**

**ONLY \$3.50**  
Satisfaction Guaranteed Postpaid

Just like having an expert operator in your home.

Be an

## Expert Radio Operator

Travel. Adventure. Good pay.

This amazing instrument teaches you to read code like an expert in half the usual time. Reproduces actual sending of expert operators. Sends you messages, radiograms, etc. at any speed. Provides practice anywhere, anytime. Complete instructions recorded on strong, waxed-tape records make everything simple and clear. You'll be amazed when you hear it send. Just like having an expert operator in your home. Why delay when you can get this simple, practical and efficient code sender with lessons for only \$3.50; or with high-frequency key and buzzer for \$5.50. Satisfaction guaranteed. Money back if not delighted. Send to-day.

TELEPLEX CO. 74-76 Cortlandt St., New York, N.Y.

## ROBERT S. KRUSE

Consultant for Shortwave Devices  
203 Meadowbrook Road,  
West Hartford, Conn.

Telephone Hartford 45327

# It IS Good!

## 38,500 Copies of the Radio Amateur's Handbook

Are Referred to Daily for  
Guidance and Information

### Order Now

We believe that The Radio Amateur's Handbook, by F. E. Handy, Communications Manager, A.R.R.L. is the most valuable book which any amateur or experimenter could own. Its chapter headings will give an idea of the thoroughness with which the subject is covered. They are "What is An Amateur?", "Getting Started", "Fundamentals", "How Radio Signals Are Sent and Received", "Building a Station—The Receiver", "The Transmitter", "Power Supply, Keying and Interference Elimination", "Antennas", "The Wavemeter—Radio Measurements", "The A.R.R.L. Communications Department", "Operating a Station", "The Experimenter".

These chapters each occupy from ten to forty pages—indicating that each subject is treated in a thorough manner. In addition there is an appendix containing a fund of useful data. Then there is an index, occupying six pages, by which the valuable information contained in the book is made available. This in a particularly important point and has been compiled and cross-indexed with great care and thought. Altogether the Book contains 256 pages of the most valuable radio information ever found between two covers.

The Radio Amateur's Handbook starts at the beginning and tells what an amateur is, what the League is, what amateur radio is, how to become an amateur, how to learn the code, how to understand what you hear, how to get your licenses, how to build a simple station, how to build a better station, how to operate your station, how the A.R.R.L. works, how to handle traffic, how to conduct experiments and make measurements, and a multitude of other things too numerous to mention.

Anyone who is at all interested in the technical side of radio can ill afford to be without The Radio Amateur's Handbook.

Regular Cover \$1.00

Postpaid Anywhere

Bound in Leather Cloth \$2.00

*If you haven't  
a copy of The Radio  
Amateur's Handbook you  
are missing the greatest value  
in radio today.*

**DO IT** →  
**NOW**

AMERICAN RADIO RELAY LEAGUE,  
HARTFORD, CONN.

Dear Sirs:

Enclosed find my \$..... Please send  
me postpaid (any where in the world)  
my..... copy of the Handbook.

Name .....

Address .....

# Short Wave Converter Unit

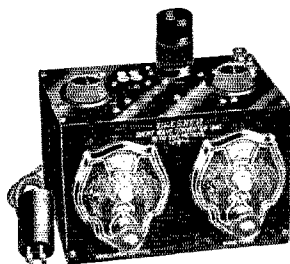

Complete  
\$22.50  
Special

Some of the best entertainment of the air is broadcast on the short waves by many powerful stations. There is no longer any reason why all should not receive these excellent programs from all over the world. The Dresner Short Wave Converter Unit is completely assembled. It efficiently covers a wave band of 15 to 550 meters, and makes reception easily obtainable for all. Offered at the special price of \$22.50—complete ready to plug into your receiver in a few seconds. If your dealer cannot supply you SEND MONEY ORDER DIRECT and we will ship P.P. prepaid. GUARANTEED. (When ordering unit, be sure to specify whether it is to be used on AC or DC set.)

**DRESNER RADIO MFG. CORP.**  
644 Southern Boulevard, Dept. Q11, New York City

## Become an EXPERT RADIO OPERATOR

—The Quick, Easy Way

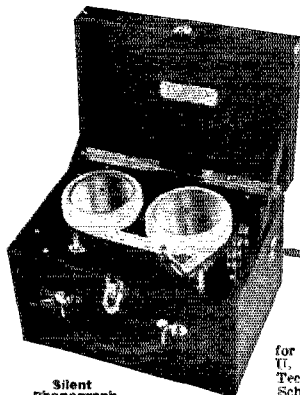

Silent  
Phonograph  
Motor

The TELEPLEX CODE SENDER teaches you at home in half the usual time. Entirely eliminates hit-or-miss methods. Reproduces actual sending of expert operators. Sends you messages, radiograms, etc.—regular code traffic anywhere, any time, any speed. No experience necessary. Tape records complete course of instructions make everything simple and clear. Set of 6 records supplied at no extra cost. Just what every beginner and advanced student needs for home practice. Used by U. S. Navy and leading Technical and Telegraph Schools. Write for FREE booklet.

TELEPLEX CO., RL, 76 Cortland St., New York, N. Y.

### QUARTZ OSCILLATING CRYSTALS

Unconditionally Guaranteed  
1 in. sections ground to 1% of your specified frequency at these prices:

|                                    |       |
|------------------------------------|-------|
| 75-100 meters .....                | 17.50 |
| 100-200 meters .....               | 19.00 |
| 200-600 meters .....               | 18.00 |
| *Tested blanks, 2 to 5 mm thick .. | 5.00  |

Sections of any practicable dimensions made to order.  
Prompt Delivery

J. T. Rooney, B. Sc., 4 Calumet Bldg., Buffalo, N. Y.  
"Ten years crystallographic experience"

of the 27th of October at 10:00 P.M., Central Time. . . . Starting from 9XE on low power, the message will be relayed automatically by Dr. Hall's famous Recording Relay at station 9XR.

#### INSTRUCTIONS

Keep yourself quiet until sending stations have finished. Then, by previous arrangements, which you must make, relay this message to all parts of your state. You have until the night of the general election to land this message anywhere, but don't forget the mistakes. . . .

#### PRIZES

To the amateur, school, wireless club, or association that delivers the message to Mr. Hughs and gets his receipt for it, we will give a 1-Kw. Thordarson transformer.

To the one getting the greatest number of signatures from citizens of the United States, attached to a copy of the message, so that they must read it, we will give a Tubular Audion Panel, mounted and ready for use.

### Changed Times

1229 Chandler Avenue  
Evansville, Ind.

Editor, *QST*:

Until recently, I considered the dusting of cobwebs from a ham transmitter a huge joke. I have, however, gone through that experience and find it one of the essentials in staging a comeback.

A sorrowful surprise unexpectedly awaited me. Upon getting on the air, I found not the old-time pleasure I once collected from the heap. The conversations seemed mechanical and without the zest of personal feeling. The operators all seem to be rookies instead of the good, steady operators of the past.

I began speculating as to the cause of these conditions. Is it possible that it is only I that feel so because I am not as well acquainted on the air as I formerly was? Could it be that short waves have shortened our vocabularies when on the air? Have these waves impaired our operating and caused it to be carried on in this nervous manner? Has the spirit of amateur comradeship and coöperation, that medium which made amateur radio, been lost in this maze of high frequency and lower power?

If, in the course of time, this letter should take up space in *QST*, the real amateur's testament, perhaps some amateurs who feel as I do on the subject, would endorse my remarks and present their views.

—Charles A. Luigs, 9EBW.

### Rotten Fists

336 Burns Street  
Forest Hills,  
Long Island, N. Y.

Editor, *QST*:

1BFX hits a very important point in his letter headed "Help" on page 70 of the July issue.

**VITROHM** Transmitting Grid Leaks and Rheostats now cover the entire line of transmitting tube circuits. ¶The prices on these amateur products are reduced materially. ¶Your dealer should stock Vitrohm Transmitting Products. ¶If you have difficulty in obtaining them, write us direct.

| CATALOGUE NUMBER | PRODUCT     | RESISTANCE  | DISSIPATION | CURRENT  | MAX. TUBE RATING | PRICE  |
|------------------|-------------|-------------|-------------|----------|------------------|--------|
| 507-2            | Grid Leak*  | 5000 ohms   | 44 watts    | 90 m.a.  | 100 watts        | \$2.00 |
| 507-3            | Grid Leak*  | 5000 ohms   | 200 watts   | 200 m.a. | 1000 watts       | 2.80   |
| 507-4            | Grid Leak†  | 50,000 ohms | 200 watts   | 60 m.a.  | 1000 watts       | 6.50   |
| 507-5            | Grid Leak†  | 20,000 ohms | 200 watts   | 100 m.a. | 1000 watts       | 4.25   |
| 507-51           | Grid Leak*  | 10,000 ohms | 200 watts   | 135 m.a. | 1000 watts       | 4.00   |
| 507-66           | Grid Leak** | 15,000 ohms | 200 watts   | 120 m.a. | 1000 watts       | 6.00   |
| 507-63           | Rheostat†*  | 50 ohms     | 50 watts    | 1 amp.   |                  | 5.50   |
| 507-59           | Rheostat*†  | 20 ohms     | 80 watts    | 2 amp.   |                  | 5.50   |
| 507-83           | Rheostat*†  | 12.5 ohms   | 60 watts    | 2.2 amp. |                  | 5.50   |

\* Center-tapped

† DeForest P or R. C. A. 852 Tube  
De Forest H Tube

\*\* Steps at 5M—10M—15M

for R. C. A. 852 or DeForest P Tube

†\* For Primary Control

¶† Filament and Primary Control

## Ward Leonard Electric Company

37-41 South Street

Mount Vernon, N. Y.

## Synchronous Motors for Television

In addition to building reliable and satisfactory motor generators, "Esco" has had many years of experience in building *electric motors* for a great variety of applications.

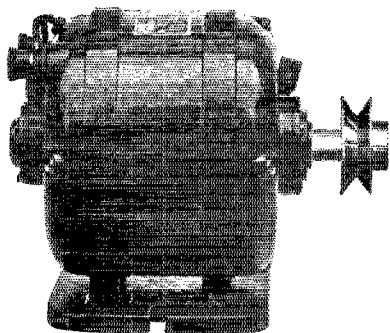

*Synchronous motors*, small, compact, reliable, self starting are now offered for **Television** equipment. They require no direct current for excitation, are quiet running and fully guaranteed.

Other types of motors suitable for Television may also be supplied.

Write us about your requirements.

### ELECTRIC SPECIALTY CO.

225 South St.

Trade "ESCO" Mark

Stamford, Conn



One of the Most successful Developments of 1928

**Power Amplifiers Built Around U X 250 Tubes**

The following are Approved Dongan Parts for use with UX 250 Tubes.

- 7568—Transformer for full wave rectification using 2-UX281 tubes to supply B and C power to receiver and power for 2UX 250 Tubes. ....\$13.50
- 8629—Transformer similar to 7568 with the addition of 2 low voltage windings, one for 226 tubes and the other for 227 tubes so that you can build a power amplifier for either radio receiver or phonograph pick-up. ....\$16.50
- 6551—Double Choke, for use with above transformers .....\$15.00
- D-600—Power Amplifier Condenser Unit ..\$16.50
- D-807—A Condenser Block used in connection with D-600 .....\$10.00
- 1177—Straight Power Amplifier Output Transformer. ....\$12.00
- 1176—Same as 1177 but of Push Pull type \$12.00

*Custom Set Builders can secure any of these items direct from factory at trade discounts. Set Manufacturers are offered the full cooperation of Dongan Engineering department for their individual requirements.*

**Dongan Electric Manufacturing Co.**  
2999-3001 Franklin St., Detroit, Mich.



It is true that fellows do not try to work some of the new gang. I have cut, myself, at times, and so would any man with any respect for the rest of humanity. I do not mind QSZ, and will repeat as often as a chap wishes. I don't mind sending at eight or ten per but I sure can't stand having good Continental murdered the way some of these boys are murdering it today. They are not all newcomers, either. Possibly the chap who can rarely get QSO has such a rotten style or QSC that very few can read him. I tell them and then they get mad, so the only thing to do is to QRT.

Personally, I will not answer a sloppy CQ or call and if others felt the same way, things would sound better on the air. Even the commercial operators are getting sloppy of late and I think it is due to ham influence. Could we not have some incentive supplied by the League which would promote better, cleaner operating? Honest, it's awful.

—A. Adair Leonard, "ld at ex 1AYZ—1ACB—1XAK—WPA—KNU—KFZQ.

**Alpha Lambda Chi**

108 Homer Avenue  
Buffalo, N. Y.

Editor, QST:

Much has been said and written concerning the nuisance of long continued CQs but with apparently little effect in correcting this evil. There seems to be a well-established conviction among many hams that in order to be successful in establishing QSO it is necessary to send a long CQ. I have counted as many as sixty. It is evident that I could have answered after the first three. QST suggests nine, which ought to be adequate. It is my opinion that long CQs are only answered to get the nuisance off the air.

At the recent Atlantic Division Convention, I observed great activity in initiating delegates into various "Greek letter fraternities". As far as I could ascertain, the chief activity of these societies is the initiation. Now, why not add one more and make it a universal one. Call it the Alpha Lambda Chi (meaning "Against Long Calls") and hold an initiation at each convention, the qualifications being only two, viz., (1) Promise not to send long CQs, (2) Promise not to answer long CQs.

I believe that if more of us would ignore long CQs, the practice would soon become obsolete.

—Burton C. Simpson, 8CPC.

G B A

117 North Sixth Street  
La Crosse, Wisc.

Editor, QST:

As a suggestion as to why so many of the QSL cards sent out never receive a reply to the sender in the form of a re-

**TELEVISION**

although still in an experimental stage, has now advanced sufficiently to enable amateurs to build outfits that will give edifying results.

Write today for our price list of television apparatus.

**Photo Electric Devices, Inc.**  
594 Fifth Avenue Brooklyn, N. Y.

**RADIO SCHOOL**

Earn \$35 to \$50 Per Week

The rapid expansion of RADIO has created many new positions on land and sea. Enroll now. New term begins September 10th in both day and evening class. Send for free catalogue.

**MASS. RADIO SCHOOL**  
18 Boylston Street, Boston  
Tel. Hancock 8184 Established 1905





**JEWELL**

## Still the Standard

Jewell thermo couple ammeters for high frequency work are still the standard of the amateur fraternity for making current measurements at radio frequency, for they completely fulfill the requirements of accuracy, low loss and high overload.

The thermo couples of these ammeters, which are available in various ranges, are made from special electric furnace alloys of non-oxidizing nature. A guaranteed overload capacity of 50% is an indication of their ruggedness. The loss in the instrument is held to less than one half of the minimum required by the Navy.

The Pattern No. 64 high frequency ammeter has a three inch, black enameled case. Scales are silvered with black characters and movement parts are silver plated. All Jewell instruments have zero adjusters.

Jewell radio frequency ammeters are described and listed in Radio Instrument Catalog No. 15-C. Write for a copy.

## Jewell Electrical Instrument Co.

1650 Walnut St., Chicago, Ill.

"28 YEARS MAKING GOOD INSTRUMENTS"

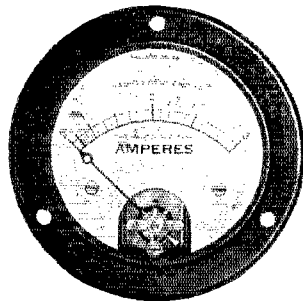

Pattern No. 64  
Radio Frequency  
Ammeter

## New Transmitting Tubes

We expect to have available in a short time the most complete line of transmitting tubes ever sold in this country. Output ratings from 5 to 1000 watts, with prices far below tubes now offered. Particularly adapted to short wave use. If interested, send your name for full details when ready to release.

Quartz Crystals, guaranteed. 160 meter band, \$10.00; 80 meters \$17.50; 40 meters \$25.00.

## Public Address Equipment

Starting with our well known and widely used Two Button Broadcast Type Microphone at only \$40.00, we can supply any equipment for public address work and similar uses. T3020 Microphone Transformer, \$10.00. "Trumpet" Horns, as used in Public Address Equipment, complete with unit, \$25.00.

E. F. JOHNSON COMPANY, Waseca, Minn.

## RADIO IN BRASIL

When in Brasil, apply to M. BARROS & CIA for anything you need in connection with radio.

### M. BARROS & CIA

70 sob. Rua S. José 70 sob.  
Postal Box 89

### Rio de Janeiro

Telegraph address, Radioparte, Rio de Janeiro  
Branch: Avenida S. João 4, S. Paulo, Brasil

## The Best That Money Can Buy

goes into Har-field Resistors. Best both in brains and materials. That's why Har-Field Resistors are so uniformly accurate—why they bear our unqualified guarantee for one year—why more and more of the leading manufacturers are buying them in large quantities for use with their own apparatus. A few of the more prominent we list below:

Stromberg-Carlson Tel. Mfg. Company

Kolster Radio Corporation  
American Transformer Co.  
Pansteel Products Co.<sup>®</sup>  
Zenith Radio Company  
Crosley Radio Corporation

Western Union Telegraph Co.  
A. H. Grebe & Company  
Splittdorf Electric Co.  
Magnavox Corporation  
Electrical Research Lab's.  
Samson Electric Co.  
Philadelphia Electric Storage Battery Company

Tell us about the resistor you want. If we can't supply you from our standard range of sizes, we shall be glad to make up samples for you with prices. Write to

## HARDWICK, FIELD, INC.

SALES OFFICE  
100 Fifth Avenue  
New York



FACTORY  
215 Emmet St.  
Newark, N. J.

# Television Simplified

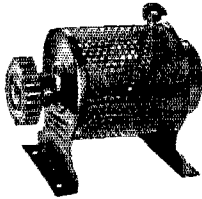

Controlling the receiver scanning disk—that's the big problem in television. Yet there is nothing to it when you have the **SPEED CONTROL CLAROSTAT**. You can bring the scanning disk to speed and hold the image on the screen as easily as you steer your car down the center of the road.

**A Handsome and Useful Device**

## SPEED CONTROL CLAROSTAT

REG. U.S. PAT. OFF.

Controls any variable speed motor of 1/8 h.p. or less, from standstill to practically full speed in several turns of knob. Pushbutton for quick starts and for momentary acceleration. Heavy metal case. Properly ventilated. Protected screw terminals. 25 to 500 ohm resistance range. 30-watt rating. Readily mounted. Convenient. And it sells for \$5.00.

Ideal for television. But that's only half the story. The **SPEED CONTROL CLAROSTAT** has no end of applications in radio and electrical work where a variable or fixed heavy-duty resistance is required.

WRITE for literature regarding the **SPEED CONTROL CLAROSTAT** as well as other Clarostats for every radio purpose. Better still, send a quarter for "The Gateway to Better Radio"—the best investment you ever made in radio!

**CLAROSTAT MFG. CO., Inc.**

*Specialists in Variable Resistors*

283 North 6th St., Brooklyn, N. Y.

## DODGE RADIO SHORTKUT

With Appendix and Hints for Better Key Work. Fixes Signals in mind to stick—Kills Hesitation, Cultivates Speed and Good Elix—Produces Results. Slow Hams raise speed to 25 per in few evenings. Previous Failures qualify and pass exam quickly. Beginners master code and pass in ten days.

### DODGE HIGH SPEED METHOD

(Intensive Speed Practice)

Quickly puts 25 per Hams in 35-40 per class. Five Hama report made this gain in few evenings. One of them by 75 minutes total practice only.

### DODGE MORSE SHORTKUT

Easily mastered by Radio Ops—Kills tendency to mixup or confusion. Either code used as desired.

### REPORTS FROM USERS

Tell the complete story—Mailed on request. Radio \$3.50. High Speed \$2.50. Morse \$2.50. Money order. None C. O. D. Foreign add 50 cents. See our Hamad.

C. K. DODGE, MAMARONECK, NEW YORK.

## 1929 RADIO BOOK

New Hook-ups. This book shows how to make Short Wave Receivers and Short Wave Adapters. How to use the new screen grid tube in D. C. and A. C. Circuits. How to build Power Amplifiers, and ABC Eliminators. Up to the minute information on all new radio developments. Set Builders, Fans, Dealers, send for it today.

**KARAS ELECTRIC COMPANY**  
40301-N. Rockwell St., Chicago, Ill.

Please send me your free book

Name.....

Address.....

City.....State.....

4030-L1



Write for it!

**FREE to You**

turn card, will say that I still get cards reporting my signals and addressed to calls which I have not had for several years.

If the gang would spend four bits for a new call book, they would save that much in lost cards and postage.

Very truly yours,

—Edwin L. Benton.

## Information

Montrose, Iowa.

Editor, *QST*:

For some time you have been telling about the help the beginner is getting from the old timer. They should, no doubt, receive this assistance but there is one phase of the subject that has not been given enough attention.

Since you published my report on 20-meter work in the April issue of *QST*, I have been getting letters from beginners asking all sorts of questions.

First of all, most of them imagine there is some big "hocus pocus Indian Medicine Man" stuff that we say to a set to make the wave do its stuff. The only time that I ever said anything was when a tube blew.

In the second place, they don't even tell you what they want to know. Several have said that they had built low power transmitters that didn't work the way they should and, "What's the matter?" How can any answer be made to that question? If they don't ask any specific questions, they should, at least, enclose a complete diagram of the set giving constants.

Last, but not least, a whole lot of them sealed the letter and forgot to enclose a two cent stamp. To be sure, they ran after the postman but couldn't catch him. In most stations, correspondence is a big item of expense and if we must pay postage as part of the accommodation of answering questions, there will be fewer tubes bought. The questioner should bear his share of it.

To work 20-meters or any other wave, the chief things necessary are a steady note and a good radiating system. This is old stuff. *QST* has been preaching it for years, but it seems that lots of fellows have missed it or else, were in such a hurry while reading it that they don't know what its all about.

Please don't take it from this that I don't like to help a beginner. I sure do. However, I don't want to answer fool questions like, "Can I work so-and-so on 20-meters with my set?" And then, tell me nothing about the set. Neither will I pay the postage or read their minds!

—Bob Heine, 9AWB

This applies to a still greater extent in the handling of the Information Service at Headquarters.—A.T.E.

# Build this modern amplifier at low cost!

Now! Sangamo Transformers at a new low price. And push-pull transformers to match new power tubes and dynamic loud speakers.

A small expenditure and you can have one of these modern amplifiers with plenty of capacity to handle the low notes. Nothing equals the full toned beauty of an amplifier built according to the diagram shown at right.

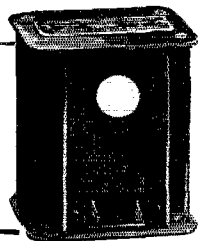
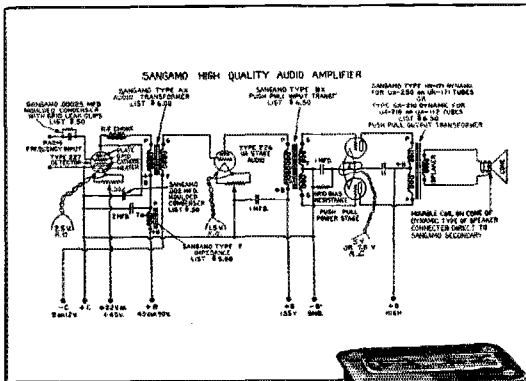

Write for descriptive circulars.

**SANGAMO ELECTRIC CO.**  
Springfield, Illinois

## TRANSFORMERS

Guaranteed—Mounted—Complete

250 watt 550—700 each side ..... \$10.50  
700 watt 1000—1500 each side ..... 14.50  
700 watt 2000—2500 each side ..... 21.00

Also Polyphase and 25-cycle Transformers  
Add \$2.00 for fil. winding

SCES F. GREBEN

1927 So. Peoria Street, Pilsen Sta., Chicago, Illinois

## More Profits To Set Builders

Elections, football games, big National events will boost radio business this year. Set builders will reap a rich harvest. Barawik service will make you money. Everything in A-C sets, short wave, television, parts, supplies. World's largest radio stocks on hand. Orders shipped same day. Lowest rock-bottom wholesale prices.

Write for Free Radio Catalog

**BARAWIK CO.** 1111A Canal Sta., CHICAGO, U. S. A.



## PACENT DUO-LATERAL COILS

FOR laboratories, experimenters, engineers and for special circuits, Pacent Duo-Lateral Coils are the accepted standard.

A complete line of all standard turn ratios are always in stock.

Write for information and prices

Pacent Electric Co., Inc.  
91 Seventh Avenue, New York

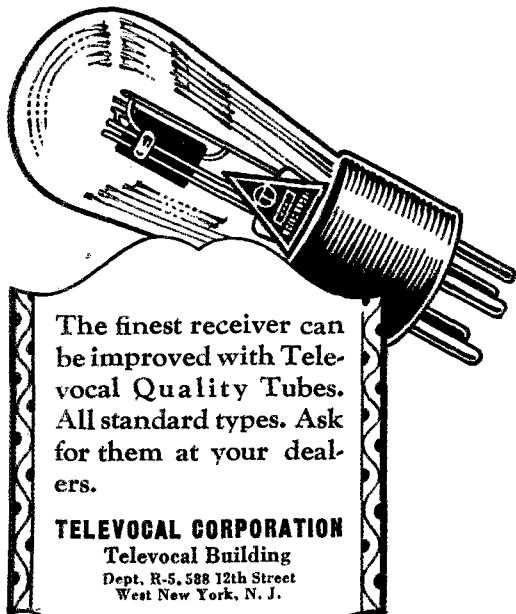
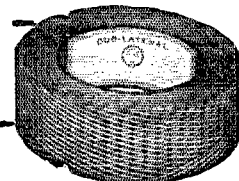

The finest receiver can be improved with Televocal Quality Tubes. All standard types. Ask for them at your dealers.

**TELEVOCAL CORPORATION**

Televocal Building  
Dept. R-5, 588 12th Street  
West New York, N. J.

# Televocal Quality Tubes

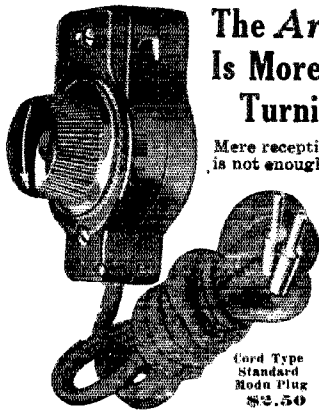

## The Art of Tuning Is More Than Just Turning a Dial

Mere reception of a radio signal is not enough. It has ceased to be, "How many stations did you get?" The thing of importance today is, "How well did you get them?"

Cord Type  
Standard  
Modu Plug  
\$3.50

There are two major operations in tuning a set: locating the station—and modulating it so as to obtain the best quality of tone.

The Centralab Modu Plug is the perfect volume and modulation control. With it, all the true beauty of tone and naturalness of speech reproduction can be obtained.

It is attached to any set in a moment without additional wiring or complicated connections. Equally as adaptable for volume control on phonograph pick-ups and speakers remote from the set.

An interesting book full of picture and wiring diagrams showing the use of Centralab Volume Controls and Resistors is yours for the asking.

CENTRAL RADIO LABORATORIES

# Centralab

18 Keefe Avenue

Milwaukee, Wis.

## A New Condenser

THE amateur will have to keep on his toes if he is to keep up with the fast-growing crop of new equipment which is appearing on the market to meet his needs in the new year. Changed frequency bands, more limited territory and the consequent need for a higher standard of performance is to result in the production of much new apparatus designed to fulfill the more stringent requirements. Falling in this category, the new variable condensers of the Radio Engineering Laboratories are worthy of study.

Departing from normal practice the condensers are fitted with a rugged die cast "Y" shaped end plate in which is mounted the double conical bearing. An unusual

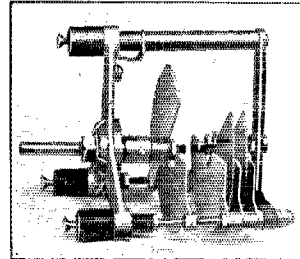

and commendable feature of this bearing is that the shaft runs in a pool of mercury and so is free from the electrically noisy contact which has been such a bug-bear in tuning elements.

Several types of condenser are provided, each with this end plate assembly as a foundation. In one of these, which is fitted with a single stator and single rotor plate, the capacity range is made adjustable by provision for the movement longitudinally of the stator plate. In a second type the capacity range can be varied by adjustment of a lumped adjustable capacity built into the condenser.

In all of the models the plates are of heavy brass, the construction, in general, being splendidly substantial.

*Off the Press September 1*

## "RADIO THEORY and OPERATING"

By Mary Texanna Loomis

Lecturer on radio, Loomis Radio College; Member Institute of Radio Engineers.

492 pages; 800 illustrations. Thoroughly revised; right down to date; contains new "Q" signals and laws and regulations for 1929. Used by hundreds of colleges and all Government radio schools. Sale by bookdealers, or sent, postage paid, on receipt of \$3.50 check or money order.

LOOMIS PUBLISHING CO., Dept 5, Washington, D. C.

## BECOME A RADIO OPERATOR

See the World. Earn a Good Income.  
Duties Light and Fascinating.

LEARN IN THE SECOND PORT U.S.A.

Radio Inspector located here. New Orleans supplies operators for the various Gulf ports. Most logical location in the U.S.A. to come to for training.

Nearly 100% of radio operators graduating on the Gulf during the past six years trained by Mr. Clemmons, Supervisor of Instruction.

Member of the A.R.E.L.—Call "5 G R"

Day and Night Classes—Enroll anytime—Write for circular.

### GULF RADIO SCHOOL

844 Howard Ave.

New Orleans, La.



HIGH RESISTANCE

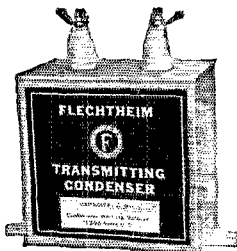

Type T200

# FLECHTHEIM

## SUPERIOR CONDENSERS

A COMPLETE LINE OF HIGH GRADE TRANSMITTING CONDENSERS

### List Prices

| Type T, for<br>1500 V DC | Type TH, for<br>2000 V DC | Type HP, for<br>3000 V DC |
|--------------------------|---------------------------|---------------------------|
| 1 Mfd. \$ 4.50           | 1 Mfd. \$ 8.75            | 1 Mfd. \$20.00            |
| 2 Mfd. \$ 8.50           | 2 Mfd. \$13.50            | 2 Mfd. \$32.50            |
| 4 Mfd. \$14.50           | 4 Mfd. \$22.00            | 4 Mfd. \$60.00            |

PLATE BLOCKING AND GRID CONDENSERS  
For 2000 V DC

.00025—\$3.00; .001—\$3.25; .002—\$3.50

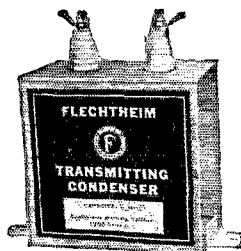

For 1500 V. D. C.

## A More Effective and Dependable Condenser FOR LESS MONEY

That's the unanimous opinion of "hams" everywhere. They stood up for W2APD—the amateur who handled traffic from storm-swept and devastated PORTO RICO. (W2APD was personally commended for his excellent work by the U.S. Navy) and, there are W2ALU and W2KR, the amateur stations that are handling a large amount of the traffic from the BYRD EXPEDITION—WFBT. OF COURSE, THESE FELLOWS USE FLECHTHEIM! YOU, TOO, SHOULD USE THEM.

(sig) 73's W2afs, Chief Engineer

Write for New Catalog X

A. M. FLECHTHEIM & CO., Inc., 136 Liberty St., New York City, Dept. QT

## IT HURTS

To back off your coupling and lose 15%. It cuts even deeper to detune for a total loss of 30%. What'll I do??? Put in a mercury arc and raise your output an easy 30%—same radiation as before—and a 1929 note. Ask 3PF, 5APO, 9DLD, 9BSS, 9EGU, 8CKC, 8DBQ, 1DL, 9PU. Follow the gang, and your rectifier problems are solved.

RECTIFIER ENGINEERING SERVICE

4837 ROCKWOOD RD. RADIO 8ML CLEVELAND, OHIO



## UNI-RECTRON POWER AMPLIFIER



(IDEAL FOR USE WITH DYNAMIC SPEAKERS)

As the Uni-Rectron stands it is a super power amplifier, which can be used in connection with any radio set and loud speaker. Binding posts are provided for input to the Uni-Rectron and output to the speaker. Requires no batteries for its operation. It obtains its power from the 110 Volt, 60 Cycle alternating current lighting circuit of your house.

The UX-210 super power amplifying tube and the UX-216B or 231 rectifying tube are used with this amplifier, which cannot overload. From the faintest

### MODEL AP-935

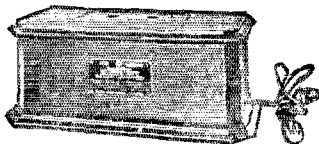

LIST PRICE \$68.50  
(without tubes)

Special \$19.75 EA.

whisper to the loudest crash of sound—R.C.A. Uni-Rectron amplifies each note at its true value. High and low notes are all treated alike.

The volume and quality delivered will be a revelation.

Also by removing the input and output transformers it can be used as a source of power for an oscillating or transmitting tube, furnishing power for all circuits, grid, plate and filament and is the cheapest form of Power Supply for Amateur Transmitting purposes ever offered. New.

## AMERICAN SALES CO.

19-21 Warren St.,

New York City



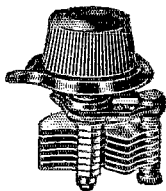

# Pilot Precision Parts for SUCCESSFUL SHORT WAVE SETS

Made in the World's Largest Radio Parts Plant

15 Mmf. Max.  
25 Mmf. Max.  
50 Mmf. Max.  
100 Mmf. Max.

**ORDINARILY** you don't consider price when you buy parts for short wave sets, but when you discover the low cost of **PILOT PRECISION PARTS**, and then consider that all **A.R.R.L.** traffic at the New York Radio Show was handled on an all-**PILOT** receivers,

that Byrd's experts built their airplane sets around **PILOT** coils, that Ft. Wood has chosen an all-**PILOT** S. W. Set, in preference to the many other types, for handling Army traffic -- Then you realize that you better send 4c in stamps for the **PILOT** catalogue listing 200 parts.

**Pilot Electric Mfg. Co. Inc.**  
322-Q Berry Street, Brooklyn, N. Y.

## NEWEST S. W. SETS

**RADIO DESIGN QUARTERLY**, edited by M. B. Sleeper, contains exclusive articles by R. S. Kruse and other S. W. experts. Also articles on shield grid sets, A. C. Sets, airplane radio. Send 25c. for four issues—over 200 pages of the finest construction articles. Send stamps or coin.

25c.--200 PAGES



Red Ring  
17-30M.



Orange Ring  
30-52M.



Yellow Ring  
45-105M.



Green Ring  
98-208M.



Blue Ring  
200-500M

## — LAST MINUTE SPECIALS —

|   |                      |
|---|----------------------|
| LEWELL—high resistance voltmeters 0-250V. D.C. (8 readings) list \$23 .....       | Our Price \$4.75 ea. |
| Genuine Black Bakelite Panels 8" x 4" 3/16" thick. Reg. Price \$29.00 .....       | " 8.75 "             |
| U. S. ARMY Aeroplane Spark Transmitters, Gov. cost \$47 each .....                | " 4.75 "             |
| G. E. Kenotron Rectifying Tubes (type T.B.1) .....                                | " 1.25 "             |
| Eby A.C. Adapter Harness with Volume Control. For 6 tube Sets, list \$10.00 ..... | " 5.00 "             |
| Gould Kathanode Unipower, Automatic Radio "A" Power (6 volt), list \$39.50 .....  | " 18.75 "            |

AMERICAN SALES CO., 19-21 WARREN ST., NEW YORK CITY

**AEROVOX** Makers of high quality resistors and condensers that are Built Better — to endure. Write for The Research Worker. A free monthly publication. **AEROVOX WIRELESS CORPORATION** 68 Washington Street Brooklyn, N. Y.

**SET Builders** FREE LATEST RADIO GUIDE  
Barwik, the first and oldest radio specialty house, offers you unusual service this year. Bigger stocks, quicker shipments, lower prices. Deal with an old established, reliable house. Get honest goods, honest service, honest prices. Barwik service makes you more money. Send now for big new catalog showing lowest wholesale prices on sets, parts, short wave, etc.  
**BARWIK CO.** 1111 CANAL ST. CHICAGO, U. S. A.

# Q S T OSCILLATING CRYSTALS

NOTICE—New Prices Effective November 1st, 1928

AMATEUR BANDS.  
Prices for grinding crystals for use in the various amateur bands are as follows:

|                                   |          |
|-----------------------------------|----------|
| 1715 to 2000 Kilo-cycle band..... | \$20.00. |
| 3500 to 4000 Kilo-cycle band..... | \$27.50. |
| 7000 to 7300 Kilo-cycle band..... | \$35.00. |

The above prices are for grinding a crystal at a random frequency, said crystal to be of the **POWER** type, and its frequency will be stated accurate to better than a tenth of 1%. All crystals are absolutely guaranteed, and immediate deliveries. Add \$10.00 to the above prices if crystal is to be mounted in our **POWER** type of Holder.

### BROADCAST BANDS.

We desire to announce that we can make prompt delivery on crystals ground to your assigned frequency accurate to **PLUS OR MINUS 500 CYCLES** for \$45.00 Unmounted or \$55.00 Mounted. In ordering please mention plate voltage and type of tube used. These crystals are absolutely guaranteed.

We are at your service to grind for you crystals other than mentioned above. We will be glad to quote prices for your particular requirement. Crystals ground to any frequency between 40 and 10,000 Kilo-cycles.

**SCIENTIFIC RADIO SERVICE** The Crystals Specialists P.O. Box 86, Dept. ZC, Mt. Rainier, Md.

# "CHI-RAD"

Complete Stock of  
 Leach Relays  
 R. E. L. Products  
 3000 Volt Rectobulbs  
 Omnigraphs Vibroplexes  
 Silver-Marshall—Shield-Grid  
 Short Wave Receiver  
 Send for New 1929 Ham  
 Book—FREE!

**CHICAGO RADIO  
 APPARATUS CO.**  
 415 S. Dearborn St., Chicago

## RADIO OPERATORS WANTED

THE EASTERN RADIO INSTITUTE can train you quickly and thoroughly because:

MODERN AND EFFICIENT METHODS  
 THOROUGH INSTRUCTION under staff of  
 LICENSED COMMERCIAL OPERATORS  
 MODERN APPARATUS including SHORT WAVE  
 TRANSMITTER

FIFTEEN YEARS a RADIO SCHOOL  
 THE OLDEST, LARGEST and MOST SUCCESSFUL  
 school in New England. RECOMMENDED BY THE  
 A. R. E. L.

Day or Evening Classes Start Every Monday.

SPECIAL CODE CLASSES

Write for Illustrated Prospectus

**EASTERN RADIO INSTITUTE**  
 899 BOYLSTON STREET BOSTON, MASS.

## World's Standard Precision Parts In Karas Short Wave Receiver

Enjoy the thrills of hearing stations thousands of miles away. Karas engineers have developed short wave equipment to highest point. Easy to build. Easy to tune with Karas Micrometric dials. 68 to 1 ratio. Use Karas condensers built like a fine watch. Karas coils and audios—standard of the world. Send to-day for complete information and construction blue print. Free.

### KARAS ELECTRIC COMPANY

4030L2 N. Rockwell Street, Chicago

Name .....

St. and No. ....

City and State .....

4030L2

## THE USEFUL MAZDA LAMP

Mr. F. A. Lidbury of Niagara Falls contributes an idea that most of us should have thought of but did not. It is given herewith.

"Though the idea is an obvious one, I have never seen a note on the usefulness of the ordinary incandescent lamp as a protective resistance in the plate supply of transmitting tubes. In adjusting my 50-watt power amplifier recently, I found a bank of these things invaluable. I have 8-125 volt, 50-watt Mazdas mounted in series on a strip of hard rubber in my 1000-volt plate supply. On a short circuit or its equivalent these limit the current to 400 m.a.; on the other hand, with a normal drain of 100 m.a. the voltage drop over the bank of Mazdas is only about 60; and this 6% loss is low pay for the protection obtained. Of course a short circuiting switch, after adjustment, will get rid of this loss, but I prefer to take it myself on account of the protection obtained should anything unexpected happen in the course of operation. It is not generally realized type would be better for this purpose on when lightly loaded. If it were, I am certain that this very simple device would be more used. Below are tabulated some very rough measurements of the present common form of 50 watt lamp. Column 1 gives the current in milliamperes; column 2 the voltage drop per lamp, and column 3 the voltage drop over the bank of eight lamps described above. This will be sufficient I think, to give an indication of what they will do. The lamps in question are, I believe, gas filled, and the older evacuated type would be better for this purpose on account of the possibility of internal arcing over in case of a filament breakage; but I didn't happen to have any handy at the time, and one usually has to order them specially now. I don't think there would be any essential difference in the use, though the resistance curves are probably different somewhat.

| Mazda Type A 50 Watt 125 Volt |                   |                                   |
|-------------------------------|-------------------|-----------------------------------|
| CURRENT<br>IN M. A.           | VOLTS<br>PER LAMP | VOLT DROP OF 8<br>LAMPS IN SERIES |
| 50                            | 1.4               | 11                                |
| 100                           | 8                 | 64                                |
| 150                           | 19                | 152                               |
| 200                           | 33                | 264                               |
| 250                           | 51                | 408                               |
| 300                           | 74                | 592                               |
| 350                           | 100               | 800                               |
| 400                           | 125               | 1000                              |

I am sending this to you because I found it is useful myself; of course smaller and fewer lamps would be used for a 210, larger and more (or higher voltage lamps) for a 204. I daresay this has been suggested time and time again; but I haven't happened to see it, and I daresay a lot of other fellows haven't. I am told that the vacuum type is what is sold as "rough service". I believe these were actually the ones referred to above."



# HAM-ADS

EFFECTIVE with the October issue of QST the following changes were made in the rules of this department. The Ham-Ad rate is now 15c per word. The restriction which has limited use of this column to members of the American Radio Relay League is removed and advertising may be signed either by company name or by an individual. A special rate of 7c per word applies to advertising which is obviously non-commercial in nature and which is placed and signed by an individual member of the American Radio Relay League. Please read carefully the following conditions under which advertising in these columns will be accepted.

(1) Advertising shall pertain to radio and shall be of nature of interest to radio amateurs or experimenters in their pursuit of the art.

(2) No display of any character will be accepted, nor can any special typographic arrangement such as all or part capital letters, be used which would tend to make one advertisement stand out from the others.

(3) The Ham-Ad rate is 15c per word, except as noted in paragraph (6) below.

(4) Remittance in full must accompany copy. No cash or contract discount or agency commission will be allowed.

(5) Closing date for Ham-Ads is the 25th of the second month preceding publication date.

(6) A special rate of 7c per word will apply to advertising which, in our judgment, is obviously non-commercial in nature and is placed and signed by a member of the American Radio Relay League. Thus, advertising of bona fide surplus equipment owned, used and for sale by an individual or apparatus offered for exchange or advertising inquiring for special equipment, if by a member of the American Radio Relay League, takes the 7c rate. An attempt to deal in apparatus in quantity for profit, even if by an individual, is commercial and takes the 15c rate. Provisions of paragraphs (1), (2), (4) and (5) apply to all advertising in this column regardless of which rate may apply.

**PLATE POWER** for your set, the very heart of its performance. For quietness, DX ability, life-long performance, absolute dependability, lowest ultimate cost, no other plate source even approaches the achievement of an Edison steel-alkaline storage B battery. Built painstakingly every joint pure nickel, upset-electrically welded. Genuine Edison Electrolyte. Our list describes complete batteries, construction parts, enameled aerial wire, silicon steel. Rectifier engineering service, radio 8ML, 4887 Rockwood Road, Cleveland, Ohio.

**HAWLEY** Edison element battery and parts standard for over five years. Look at our patent pending connector—no thin wire to drop off—contains 20 times more metal than regularly used. Heavy shock proof, cells, fibre holders, etc. Everything for a rapid-fire "B" supply. Complete assembled 100 volt "B" \$10.00. Knock-down kits at still lower prices. Chargers that will charge in series up to 160 volts \$2.75 to \$4.00. Trickle B Charger for 90 to 150 volt "B" \$3.75. Special transmitter "B" batteries up to 6,000 milli-amp capacity, any voltage. Write for interesting literature, testimonials, etc. B. Hawley Smith, 360 Washington Ave., Danbury, Conn.

**OW 5YS** reports: "Using Dodge Radio Shortcut idle moments one week mastered code, passed—call 5PJ. Later desiring Commercial First qualified in spare time of three weeks. Now on job assisting husband as instructor." **9UZ** reports: "YL my office without knowledge of code surprised me by copying nine per after three evenings study of Dodge Radio Shortcut. Several men using that method on my recommendation soon copied 20 per. Really surprising how quickly code can be mastered by that method." All Hams and Fans know 9UZ. Method \$3.50 United States. Elsewhere \$4.00 Money Order. C. K. Dodge, Mamaroneck, New York.

**DUBILIER** .004 transmitting condensers wanted. Radio, 150 West 22nd St., New York.

**OMNIGRAPHs**, Telelexis, Natrometers, transmitters, receiver, chokes, meters, 50 watters, 5 tubes, motor generators, supersynca, electric receivers, portable receiver, Vibroplexes, condensers, dynamotors. Bought, sold, exchanged. L. J. RYAN, 9CNS, Hannibal, Mo.

**ARRL** sweater emblems should be worn by all League members. They are yellow and black 5"x8" diamond, felt letters and embroidered symbol. Only \$1.00. Money order or currency only accepted. Eric Robinson, 136 Jefferson Road, Webster Groves, Mo.

**MOTORS** for television experimenters. 100-volt universal with rheostat. Variable speed from 500 to 5000 revolutions, \$7.50 prepaid. Remittance with order. Samara, 41 South St., New York City.

**TRANSFORMER** exchange—plate and filament supply transformers exchanged. What have you and what do you want? 25, 40, 50, 60 and 500 cycle transformers and filter chokes to order. Nat G. Scott, New Albany, Miss.

**COMMERCIAL** operator with amateur experience and sales ability. Federal Railway Institute, 517 Wells Street, Milwaukee, Wis.

**CANADIANS**—24-1500 volt dynamotor centre tapped, with extension shaft and pulley for driving \$40, W. E. 211-D special short-wave 50-wattter \$32, 0-500 Jewell milliammeter and 15 volt A. C. meter each \$6, crystal ground to 167.1 metres \$10, Ward-Leonard leak for fifty \$1. All above new and unused. VESMR, 15 Churchill Ave., Toronto 3, Ontario.

**ENSALL** Radio Laboratory receivers and Transmitters are of the most modern designs and are supplied to meet any particular requirements of the radio art. Transmitter designs for radiophone or C.W. Our long experience in the designing of special apparatus is your guarantee of quality and efficient apparatus. We also build to order any items desired. Literature on any apparatus forwarded on request. Ensall Radio Laboratory, 1208 Grandview Ave., Warren, Ohio.

**MOTOR** generator bargains. 1000 Volt, 300 Watt, Two Commutator new General Electric Motor Generators. Direct connected to 110 Volt, 60 Cycle, 3500 R. P. M., single phase A.C. motors, price each \$75.00. 750 Volt, 200 Watt, Two Commutator new General Electric motor generators direct connected to 110 Volt, 60 Cycle, 3500 R.P.M. single phase A.C. motors each \$45.00. 350 Volt, 150 Watt new General Electric motor generators direct connected to 110 Volt, 60 Cycle, 3500 R.P.M. single phase A.C. motors, with field resistance, each \$27.50. New 14 H.P. General Electric and Westinghouse 110 Volt, 1750 R.P.M., A.C. motors \$8.75 each. New television variable speed motors for 110 Volt, Alternating Current, \$7.00 each. A limited number of each of the above items. Also many others. Write us your needs. Electrical surplus Company, 1911 Chicago Ave., Chicago, Ill.

**TELEVISION**—Make a successful television receiver. Scanning disc easily made with full size template. No laying out or calculations required. Template, blueprints of circuits, and complete instructions \$2.00. Money Order. Wm R. Crooks, 507 E. Luray Street, Philadelphia, Pa.

**SELL**—MOPA transmitter \$150. Cost \$250. 4 Jewell meters—Thordarson Transformers—High-C tank oscillator. All new apparatus—used less than 10 hours. Absolutely guaranteed. Write for further dope. 8CDB—860 Maryland Ave., Syracuse, N. Y.

**TWO** 50 watt tubes and sockets, \$11.00, motor-generator set 750 volt 500 mills, 110 volt A.C. \$65.00, Cardwell transmitting condenser new \$10.00, DeForest H. tube never used \$8.00, General Radio modulation transformer used some \$2.50, Weston 150 volt D.C. voltmeter \$15.00, 43 plate signal condenser \$1.00, Teleplex outfit used very little \$25.00, Victoreon super 8 parts \$35.00, or wires \$40.00, two 1½ Henry choke 150 mills, \$2.00, three VT14 tubes 5 watt \$1.00, filament transformer 75 watt \$5.00, 0-2.5 Jewell thermo ammeter \$7.00. 9BOR.

**EDISON** universal electric motor. Just right for television. \$5.00 plus postage on 9 lbs. Harold J. Steck, 2405 B Street, Calumet, Mich.

**RECTIFIER** elements, pure aluminum-lead: 1"x4", 13 cents; 1"x6" 15 cents; pair complete. Sheets aluminum-lead, \$1.00 square foot. Short wave coils edgewise copper ribbon or tubing 12-20 cents turn. All prepaid on \$1.00 or more. Rest Silicon steel cut to order 25-35 cents pound. Send for list. Geo. Schulz, Calumet, Mich.

**MOTOR** generator set 120 D.C. input, 240 volts 500 cycle output at ½ k.w. 500 cycle transformer 2000 volts. Sell for \$25.00. F. O. B. Laurium, J. P. Sincok, 109 Florida St., Laurium, Mich.

**SELL** or trade—complete accountancy course for station equipment. Best offer gets it. Edward J. Daugherty, Frederick, Maryland.

FOR sale or trade—both transmitting and receiving supplies, receiving sets and tubes. Want guns. What have you? M. E. Eaton, Olney, Texas.

2AUB selling out—complete UV203A 50 watt transmitter cheap. Write for list. Fernand Beck, 5657 Newton Ave., N. Y. C.

WRITE for price list of apparatus used at 1BAT, 132 Bayard St., Providence, R. I.

SELL complete station from bottle to Baldwins. Fifty watt T. P. T. G. transmitter. Heavy nickelled plug-in inductances, no clips. Plug-in chokes. Only the finest of parts and workmanship. Fine D. C. note from new filter and rectifier using new CK381s. Tube runs cold at 250 watts input. Completely copper shielded short-wave three tube receiver using Aero coils. Nothing more to buy, entire outfit for \$200.00 cash. Parts alone cost over \$350. Satisfaction guaranteed; absolutely nothing haywire. Complete list and photos if sincerely interested. R. B. Cooper, 9DCG, 407 Hart St., Vincennes, Indiana.

SELL Aero radiophone transmitter kit as listed March 1928 Citizens Radio Call Book. New and cost \$140. First \$65.00 takes it. Complete less tubes. L. S. Pettygrove, Oxford, Nebraska.

TRANSFORMERS 500-750-1000 each side \$3.00. 325-325, 7¼-7¼ \$5.50, 275-275-5 \$4.00. Specials to order. Chokes 30H, 250 M.A., \$7.50, 160M.A., \$5.00, 100M.A., \$2.00. 3H, 4 amp. \$6.50, 1 amp. \$3.25. Write for specifications. Radio Parts Sales Co., Orange, N. J.

IMAGINE an organization of radio "nuts" with over 3000 elements scattered throughout the world, hundreds of them hams, all of them radiowise—dealers, builders, experimenters. Over \$40,000 stock of high-grade receiving and transmitting parts only, no sets. Spend over \$5,000 yearly on our own experimenting, carrying nothing until it passes our tests. 25c will bring prepaid over four pounds, catalog, circuits, data, etc. Weekly data sheets for experimenters and builders (more reliable data than all radio magazines together)—20 weeks \$1.00, 52 weeks—\$2.50. Full dealer's discounts to licensed hams, and radiowise builders. Fred Luther Kline, Established 1920, Kent, Ohio.

500 VT14 navy five watters \$1.50 each. Same voltages as UX210 C. O. D. on request. Send for list. E. P. Hufnagel, 879 S. 13th St., Newark, N. J.

2500 Volt 1000 Watt Motorgenerator 110-220 Volt, AC drive \$225.00, 1500 Volt 500 Watt motorgenerator 3-phase drive \$125.00, 1000 Volt 200 Watt motorgenerator, 110 Volt AC drive \$75.00, 750 Volt 200 Watt motorgenerator 110 Volt AC drive \$45.00; 300 Watt \$65.00, 400 Volt generators, \$3.50. Couplings 1.75. ¼ Hp. long shaft motors, fine for television \$7.50, ¼ Hp. 3450 speed motors \$3.80. Also larger motors and generators. Queen City Electric Co., 1734 Grand Avenue, Chicago, Illinois.

QSL cards, cartoons. Hams say best made! H. M. Selden, Cranestown, Penn.

TRADE or sell. Generators: 750V, 200W, \$20; 500 cycle 250W, \$20; 110V, 5A, \$15; 32V, 20A, \$20; 200 600V dynamotor, \$25. Sets: 4 tube Aero screen grid \$45; 3 tube plug-in, \$12; 3 tube all electric plug-in, \$45. 400V Edison "B"s \$20; 200V Willard "B"s \$15. Want mercury arc or 50W tubes. SARX, Earl E. Hampshire, 718 Fifth St., Alva, Okla.

SALE—one UP1016 transformer and one DeForest "H" tube, \$20.00. Express collect. Edwin H. Williamson, 1252 Wertland St., Charlottesville, Va.

500 VOLT 100 watt motor generator 110 volt AC drive \$34.50, 350 volt DC generator with 24 volt DC motor \$22.00, James Smat, 1734 Grand Ave., Chicago, Ill.

SALE—Robbins & Myers dynamo 1.5 K. W. 40 volts 38 amp. Switchboard field rheostat and circuit breaker. 9CG, Morris, Ill.

DEFECTIVE audio transformers reclaimed using factory windings. Original guarantee, 90c. "B" units \$1.00. Inquiries invited, 9 S. Reed Ave., Mobile, Ala.

AND now—audio transformers reclaimed 90c. Rock Bottom and a real proposition for enterprising hams. Correct engineering. Previous factory guarantee. Also buy-sell. Inquiries invited. H. A. Sears, 9 S. Reed Ave., Mobile, Ala.

QUALITY Merchandise—No Seconds! Special Thordarson 650-volt power-filament transformer for 7¼-wattors \$6.90. Thordarson power-filament transformer 350-550-750 each side; two filaments \$15.00. Aluminum square-foot 85c. Lead square-foot 85c. Electro-Bugs \$10.50. Potter 2-MFD 1000-volt condensers \$2.50. "Ham-List 4c.

James Radio Curtis, 1109 Eighth Avenue, Fort Worth, Texas.

MUELLER 150-watt input tubes \$15.00. Panel mounted 7¼-watt 20- & 40-meter transmitters \$20.00. Receiver 20- & 40-meters \$17.50. UX210 7¼-wattors \$6.25. Potter 2000-volt tested 1-MFD condensers \$2.50; 2500-volt 1-MFD \$3.25. "Ham-List" 4c. Robert Curtis, 1109 Eighth Avenue, Fort Worth, Texas.

Aerovox 1-MFD 1000-volt tested condensers \$1.30. 5-Dial Omnigraph \$15.00. Slightly used 50-wattors \$20.00. 5-plate variable condensers 49c. Griffith, 1109 Eighth Avenue, Fort Worth.

TRANSFORMERS, 8 volt, 75 watt, \$5.75, 12 volt, 150 watt, \$6.50, new center tapped, mounted. Also cores, end castings, etc. Send for list. Robert Annis, 524 N. Oriental, Indianapolis, Ind.

QSL cards, new forms, two colors, government cards \$2.00 per hundred; white \$1.00. Postage 10c. Free samples. SDTY, 257 Parker Ave., Buffalo, N. Y.

SNAPS—two WE 211Ds Western Electric fifty wattors brand new and in original factory sealed cartons, \$25.00 each. 160 meter power crystal with mounting \$14.00. Postpaid. Radio 2VW, 1305 Foster Ave., Brooklyn, N. Y.

QRH? Are you sure? Let us calibrate your frequency meter from Piezo standards. We calibrate frequency meters to highest possible accuracy. 9BVC, Lutesville, Mo.

QSLs 100 two color \$1.00. Government \$1.90. Radiograms, stationery. Samples. 9CKA, Corwith, Iowa.

SALE—Surplus radio parts, new and used. Send postal for list. H. F. Schmidt, 311 Tenth Avenue, Belmar, N. J.

SELL—Teleplex, 6 tapes \$20. Power transformer RCA UP1016 \$15. RCA oscillation transformer UL1008, \$5. Thordarson 30 watt center tapped 8¼ volt transformer, \$4. 550-350 volt 1000 watt, \$3 Radio 9BQJ, McPherson, Kans.

EVERYTHING for the ham. 6AHB, Amateur Transmitting Supply, 294-12th St., Oakland, Calif. Try us!

TUBES, receiving and transmitting. Write me your needs. Special Perryman UX216B \$3.00. Special UX250 \$8.00. Grebe CR8 receivers 150 to 1200 meters \$12.50. Grebe CR12 receivers \$25.00. Exchange Canadian Ross 303 Cal. rifle for shortwave apparatus. Mac, Box 21, Seaford, N. Y.

275 VOLT direct current generators will give up to 500 volts used \$8. 6 to 400 volt watt dynamotors \$15. 200 watt 500 cycle \$10. 500 cycle motor-generators. Dubilier condensers. R. Wood, 46-20 102nd St., Corona, N. Y.

MORE and more "Hams" are buying Master Radio Wave-meters and saving money. Send for description. Accurate panel-mount meters: 0-25, 50, 100, 500 or 400 milliamperes—\$1.20. 0-10 or 15 AC Volts—\$2.50. Pure rectifier elements and copper tubing inductance. Send for our "Specials" list. Quick Service, William Harrison, 35 Ft. Washington Ave., New York City.

NEW Morton Electric motor generators 1000V 200W \$50.00. 750V 200W \$45.00, Wickboiled. Connected to 110V 60 cycle motor. A. Forbes, 4332 Rice St., Chicago, Ill.

CRYSTALS: 85 meter band \$15.00, 175 band \$10.00. Blanks \$4.00. Hollister, 9DRD, 930 Baltimore, Kansas City, Mo.

Samson 210 power block. Acme Parvot 210 condenser block, all necessary Hardwick-Field and Electrad Tru-volt resistances, Samson Symphonic audio transformer, Samson Symphonic audio input transformer and output choke, for first stage and 210 push-pull amplifier and plate supply, used less than ten hours, \$69. Amertran PF 52 power transformer, 110 volt primary with line compensating switch, 525, 8 and 8 center tapped, \$10. Two Amertran No. 854, 100 henry chokes, \$4 each. General Radio 387-A speaker filter, \$4. All f. o. b. Swarthmore, Pennsylvania. All used very little, perfect. A. K. Higgins, Swarthmore, Pennsylvania.

SELL—160 GR crystal with holder \$12.00. 500 pair Edison elements, brand new, \$10.00. 9CTW.

15WATT laboratory built transmitter—full wave tube rectifier and filter, 95 dollars. Send for photo. 900 cycle generator thirteen dollars. Watson, 4006-155th St., Flushing, N. Y.

3/16 inch contact Signal Corps keys, 95c, 375 volt, plate transformer with 2 center tapped filament windings and C biased, \$2.75, Ward Leonard resistors, 85c to \$1.00, Bradley radiostats, \$5.50, Bradleystat 2000 to 30,000, \$2.75, Bradleystat two ten, \$1.75, VT2, \$2.50, VT1, \$1.00, RCA 210, \$6.00, Brandes phones, \$2.50, Flechtheim 1500 volt 2 mfd. condensers, \$4.50, 4 mfd., \$8.50, used General Radio wavemeter, \$8.00, REL chokes, 84c, REL 50 watt sockets, \$1.50, REL wavemeters, \$15.00, REL Neon lamps, \$1.00, used Gross 8-85 meter wavemeter with galvanometer, \$20.00, Mount Rainier mounted 875 kilocycle crystal, \$20.00, Grebe CR18, \$50.00, Crosley low wave converter \$25.00. Get our mailing list for bargains. What have you for sale or trade? Wanted: All type new or used transmitting tubes, David L. Marks, 125 Madison Ave., Albany, N. Y.

## Q R A SECTION

50c straight with copy in following address form only:

2BUO—Werner H. Olpe, 14 Brooklyn Ave., Jamaica, L. I. N. Y.

9CIG—Ray E. Cryder, Morris, Ill.

W1BN—Frederick L. Shaw, 19 Carrie Ave., Rumford, R. I.

ys1FM—J. Fred Mejia, 7a Avenida Norte No. 19, San Salvador, El Salvador, Central America.

The following stations belong to members of the A.R.R.L. Headquarters gang. Mail for them should be addressed care A.R.R.L., Hartford, Conn. When operating 1MK they use personal sines as indicated.

### W1MK

A.R.R.L. Headquarters, R. B. Parmenter, Chief Op. "rp."  
L. R. Huber "ou."  
R. A. Hull "rah"  
W1AL H. P. Westman "ws."  
W1BDI F. E. Handy "fh."  
W1BHW-W1EH K. B. Warner "kb."  
W1BMM-W1FL G. D. Meserve "dm."  
W1BUD A. L. Budlong "bud."  
W1CEI-W1SZ J. J. Lamb "jm."  
W1ES A. A. Hebert "ah."  
W1KP F. C. Beekley "beek."  
W1PX C. G. Kenefick "ck."  
W1SZ-W1BIZ C. C. Rodimon "rod."



A CONE SPEAKER

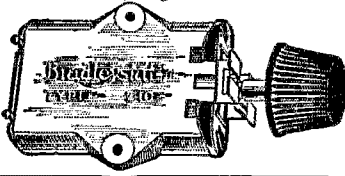

## BRADLEYSTATS—E210

E-210 Bradleystat is fine for controlling the A. C. input line voltage into A. C. sets, thus protecting the tubes from being blown down due to a sudden line voltage surge. Also adapted for filament and plate control. Applications on Power Transformers in Transmitters. Current Capacity 10 amps.

LIST PRICE \$4.00



OUR PRICE \$1.60 EA.

AMERICAN SALES CO., 19-21 Warren Street, New York City

## TRANSFORMERS, CHOKES COILS . . . . .

of all descriptions made  
to your specifications.

The crying need of the radio constructor and amateur for efficient coils, chokes, and transformers for either transmitter or receiver construction, is filled by the "Most Efficient" Power equipment manufactured by I. R. NELSON CO.

The new and radical core design developed by this company gives the small power transformers and coils all the efficiency inherent in large electrical construction work. Write in your wants. We will be glad to quote you. You will be surprised at the quality received for your investment. Prompt delivery on all orders.

I. R. NELSON COMPANY  
Bond Street Newark, N. J.

# ACTS

in 7 seconds

—against 30 seconds to a minute for other tubes—the Arcturus 127 A-C Detector Tube! Put an Arcturus A-C Long Life Tube in every socket for quicker action, better tone, better volume, longer life and immunity to line surge.

Complete line of Arcturus low voltage Tubes: 126H, 126, 071H, 127 and, 180.

Arcturus Radio Company

220 Elizabeth Ave., Newark, N. J.

# ARCTURUS

# OFFICIAL NATIONAL WHOLESALE DISTRIBUTORS

## AERO COIL

This year Aero has a notable line of short wave apparatus for both receiving and sending. We have a complete stock of the entire line and are ready at all times to make instant shipment.

An outstanding number in the new Aero line is Type 50 Transmitter for light socket operation. Lists for \$148.75 and nets the "Ham" at our special price, \$87.46. Order by No. RQ-3630.

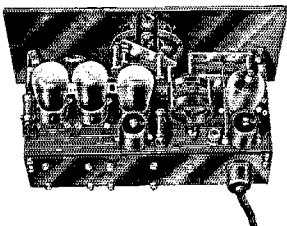

### Aero "International" Short Wave Receiver

New and better. Employs one Stage aperiodic shield grid amplification. Four tubes—one tuning control. New Aero audio transformer. Panel 7 x 14 in. Complete Kit of parts lists at \$55.30, our special price to Hams \$32.52. Order by No. RQ-3670.

### All Hams Should Have Our Big Wholesale Radio Catalog —Write for It

Contains entire Aero line as well as 100 pages of other popular radio kits, parts, sets, accessories, and consoles. Lowest prices. Quick service. Write for your Free Copy.

## Setbuilders Supply Co.

165 Romberg Building  
CHICAGO, ILLINOIS

## FOR YOUR CONVENIENCE QST'S INDEX OF ADVERTISERS IN THIS ISSUE

|                                      |                        |
|--------------------------------------|------------------------|
| Aero Products, Inc.                  | 3rd cover              |
| Aerovox Wireless Corp.               | 59                     |
| Allen-Bradley Company                | 54                     |
| Allied Radio Corporation             | 75                     |
| Aluminum Company of America          | 78                     |
| American Sales Company               | 87, 89, 93             |
| American Transformer Company         | 70                     |
| Areturus Radio Company               | 93                     |
| Auritema, Inc., Ad.                  | 88                     |
| A.R.R.L. Application Blank           | 83                     |
| A.R.R.L. Binder                      | 90                     |
| A.R.R.L. Bound Handbook              | 64                     |
| A.R.R.L. Handbook                    | 77                     |
| A.R.R.L. Stationery                  | 77                     |
| Barawik Company                      | 85, 89                 |
| Barros & Cla., M.                    | 58                     |
| Burgess Battery Company              | 4th cover              |
| Candler System Company               | 88                     |
| Cardwell Mfg. Corp., Allen D.        | 86                     |
| Central Radio Laboratories           | 86                     |
| Chicago Radio Apparatus Co.          | 80                     |
| Clarostat Mfg. Company               | 84                     |
| Corning Glass Works                  | 71                     |
| Crosley Radio Company                | 68                     |
| Cunningham, Inc., E. T.              | 52                     |
| Dodge, C. K.                         | 84                     |
| Dongan Electric Mfg. Co.             | 82                     |
| Dresner Radio Corp.                  | 80                     |
| Dubiller Condenser Corp.             | 58                     |
| Eastern Radio Institute              | 90                     |
| Electrad, Inc.                       | 68                     |
| Electric Specialty Company           | 81                     |
| Elkon, Inc.                          | 57                     |
| Fansteel Products Company, Inc.      | 72                     |
| Federal Radio Corporation            | 87                     |
| Fleischhelm & Company, Inc., A. M.   | 87                     |
| Formica Insulation Company           | 61                     |
| Frost, Inc., Herbert H.              | 76                     |
| General Radio Company                | 2nd cover              |
| Gray & Danielson Mfg. Co.            | 74                     |
| Greben, Frank                        | 85                     |
| Gulf Radio School                    | 86                     |
| Hardwick Field, Inc.                 | 23                     |
| Jewell Electrical Instrument Co.     | 88                     |
| Johnson Co., E. F.                   | 88                     |
| Karas Electric Company               | 34, 90                 |
| Kruse, Robert S.                     | 78                     |
| Leeds Radio Company                  | 67                     |
| Loomis Publishing Co.                | 36                     |
| Massachusetts Radio School           | 32                     |
| McGraw-Hill Book Company             | 66                     |
| National Company, Inc.               | 69                     |
| Nelson Company, I. R.                | 93                     |
| Pacent Electric Company              | 85                     |
| Photo Electric Devices, Inc.         | 83                     |
| Pilot Electric Mfg. Company          | 89                     |
| Potter Manufacturing Co.             | 72                     |
| Radio Amateur Call Book Co.          | 88                     |
| Radio Engineering                    | 56                     |
| Radio Engineering Laboratories       | 47, 48, 49, 50, 51, 53 |
| Raytheon Mfg. Company                | 70                     |
| Rectifier Engineering Service        | 87                     |
| Rooney, John T.                      | 80                     |
| Sangamo Electric Company             | 85                     |
| Scientific Radio Service             | 89                     |
| Seattle Radio Laboratory             | 74                     |
| Setbuilders Supply Co.               | 64                     |
| Silver-Marshall, Inc.                | 65                     |
| Stromberg-Carlson Telephone Mfg. Co. | 4                      |
| Televeal Corporation                 | 85                     |
| Teleplex Company                     | 78, 89                 |
| Thordarson Electric Mfg. Co.         | 3                      |
| Van Nostrand & Co., D.               | 89                     |
| Vibroplex Company                    | 93                     |
| Ward-Leonard Electric Co.            | 81                     |
| Well's Curiosity Shop                | 76                     |
| Western Radio Mfg. Company           | 72                     |
| Weston Electrical Instrument Corp.   | 95                     |
| Wireless Specialty Apparatus Co.     | 1                      |
| X-L Radio Laboratories               | 76                     |
| Taxley Mfg. Company                  | 96                     |

# An Investment that pays DIVIDENDS

An indicating instrument is an essential part of the equipment of every good radio receiver installation, since it aids in maintaining efficient operation, secures the best reception and fully protects the financial investment.

To advanced students of radio and those having professional connections with the industry the selection of instruments is highly important. Unfailing reliability is the first consideration since accuracy of measurement is a fundamental requisite of success in both research work and commercial activities—and pays the biggest dividends on the investment, whether of time or money.

The selection of instruments should be guided by the universal preference of leading engineers and decided on scientific merit. Pioneering in the field of electrical measurement for more than forty years, Weston leadership is acknowledged the world over.

Illustrated herewith are the Weston portable A. C. and D. C. instruments which are extremely popular for general radio service, and make ideal personal instruments.

**WESTON ELECTRICAL INSTRUMENT CORPORATION**

602 Frelinghuysen Ave., Newark, N. J.

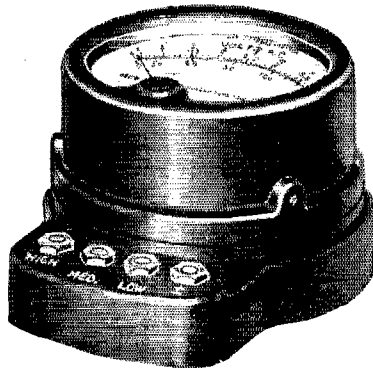

Three Range Instruments for  
A. C. and D. C. Operated Sets.  
A. C. Model 528, D. C. Model 489

These designs are an outstanding achievement in high-grade, small instrument manufacture. They are enclosed in bakelite cases—black for D. C. instruments and mottled red and black for A. C. instruments. Their excellent characteristics and performance commend them to the attention of all who appreciate fine workmanship and demand unfailing reliability. The illustration at the right shows the three-range model—750—250—10 volts for D. C. (1000 ohms per volt). Also made as a three-range A. C. instrument—150—8—4 volts. A. C. \$16.50 D. C., \$28.00.

## Single and Double-Range Instruments

These instruments are also furnished as D. C. double-range Voltmeters—(with either 1000 ohms or 125 ohms per volt)—and as single and double range Ammeters. \$13.50 to \$22.50. For A. C. testing they are supplied as single range Ammeters and Milliammeters and double-range Voltmeters. \$13.50 to \$18.50.

All instruments of the Weston Radio Line are completely described in Circular J—just off press. Write for your copy.

# WESTON RADIO INSTRUMENTS

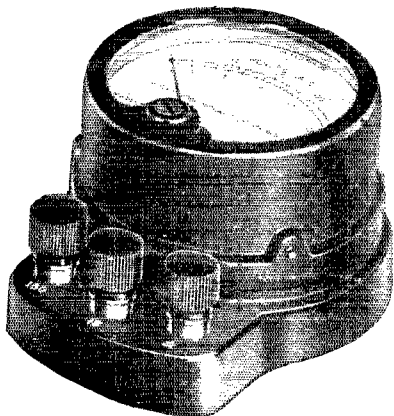

# CARDWELL CONDENSERS

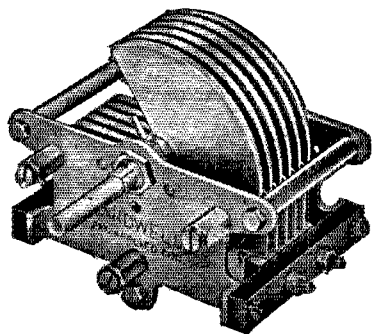

*THE TAPER PLATE TYPE "E"*  
Unexcelled for Short Wave  
Receivers

## Stability is Vital—

in the short wave receiving circuit. ¶ The effect of a rising and falling note so often troublesome in CW code reception, due to instability in the circuit, will obviously play havoc with Broadcast Reception on the short waves, if at all pronounced. ¶ CARDWELL TAPER PLATE CONDENSERS are rigid and vibrationless and will absolutely hold their calibration, thus eliminating one of the important causes of circuit instability in short wave receivers. ¶ The tuning curve is ideal, midway between SLW and SFL, attained without eccentrically shaped plates, thus concentrating the weight of the rotor close to the shaft. It will pay you to investigate.



*The taper plate construction.*

Transmitting Condensers for powers up to 50KW  
and more.  
Receiving Condensers in all standard capacities.  
Send for Literature.

The Allen D. Cardwell Manufacturing Corp.  
81 Prospect Street, Brooklyn, N. Y.



All good Dealers carry Cardwell Condensers.  
If your Dealer does not, send to us direct.



"The Standard of Comparison"

# AERO COIL

Super-Sensitive  
INDUCTANCE UNITS

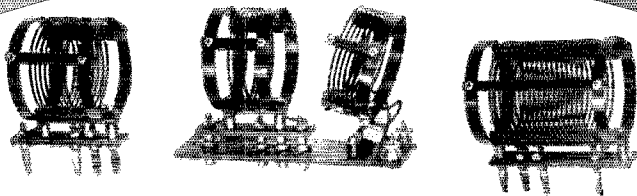

For super-sensitivity in your short wave receiver—for greater distance range and reliable performance—build your set around the famous Aero Interchangeable Short Wave Receiving Coils. Aero Coils are ninety-five percent air dielectric, with less than one-sixth of the losses of celluloid or bakelite. The new two inch diameter coils have already won wide popularity. The Aero Short Wave Tuner Kit No. LWT 12 illustrated above consists of three Aero Interchangeable Coils and base mounting with Primary Coil. Price Complete \$12.50

## Aero Interchangeable Transmitter Kits

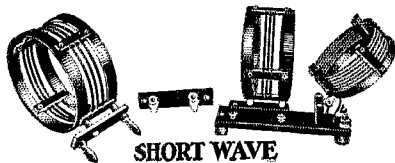

### SHORT WAVE

Aero Coils have proven themselves to be the best low-power transmitting coils on the market. Each kit includes all necessary parts for a tuned-plate transmitter, including base with variable antenna coil, plate coil, grid coil and two choke coils. Kit No. K2040 has a wave length range of 16' to 25' meters; Kit No. K3080 tunes from 35' to 40' meters; Kit No. K3018 has a range of 90' to 180' meters. These Kits are priced at \$12.00 each. Plug-in Coils make it easy to change from one wave length band to another.

The new Aero Green Book contains data needed by every set-builder, 64 pages—wiring diagrams of receiver and transmitters—information about new developments. Send 25 cents for your copy.

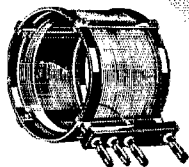

The range of the LWT-12 Kit can be considerably increased by adding Aero Coil No. INT-4. This coil can be plugged into the LWT-125 mounting base and has a range of from 125 to 275 meters.

Coil No. Int-4 ..... \$4.00

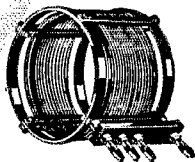

The range of the LWT-12 can be still further increased by adding Aero Coil No. INT-5. This coil has range of from 250 to 550 meters. Coil No. INT-5 ..... \$4.00

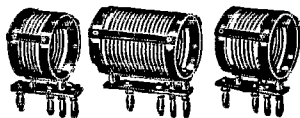

Aero Coil Kit No. LWT-10. For use with Foundation Units containing plug-in mount, or replacing LWT-125 Coils. Same three coils as in LWT-11 Kit. No. Lwt-10 ..... \$10.50

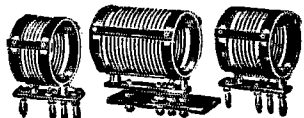

Aero Coil No. LWT-11 contains a plug-in mounting base without primary and three coils for use after a shield grid tube. Range 16.5 to 89.5 meters. Kit No. LWT-11 ..... \$11.50

**AERO PRODUCTS**  
INCORPORATED

Dept. 388

4611 E. Ravenswood Ave.

Chicago, Ill.

# *Again* **BURGESS** *Contributes*

**Type PL 5728 High Potential  
Battery [108 volts, taps at 72  
and 108 volts]**

In keeping with its policy of assisting in the experimental development of the art of radio, Burgess Battery Company contributes a high potential battery particularly necessary for the successful operation of the receiver used in radiovision, television, and other methods of reception where there is the transference of an image, moving or stationary. In photo electric cell experiments, the PL is indispensable. Also can be used for airplane radio, plate supply.

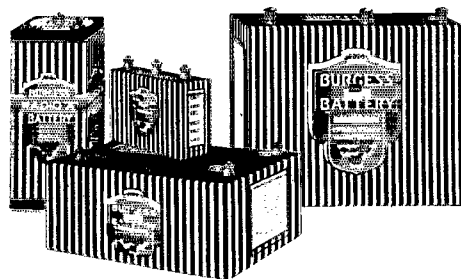
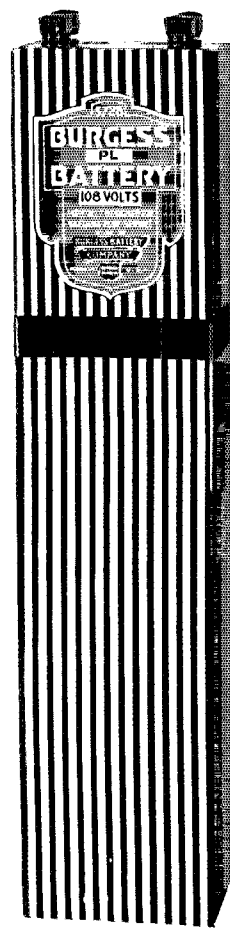
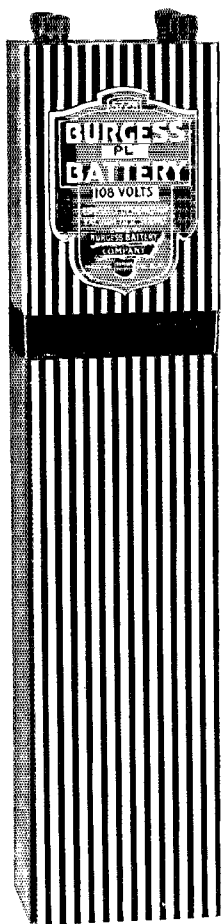

*"Ask any Radio Engineer"*

**BURGESS BATTERY COMPANY**  
**MADISON, WISCONSIN**



# The Communications Department

F. E. Handy, Communications Manager  
1711 Park St., Hartford, Conn.

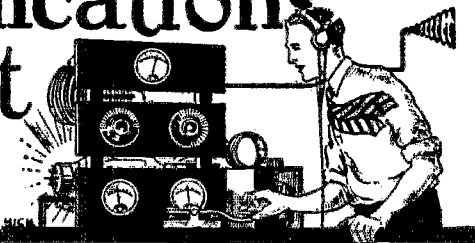

## Changes in the Rules and Regulations

**A**TENTION is called to some changes which appear in the October, 1923, revised edition of the Rules and Regulation of the Communications Department. The major changes that have been made facilitate message handling and League organization work also bringing our operating procedure in line with the Washington Convention.

As much useful information as possible has been included in this eight-page booklet to make it a useful reference for the operators of amateur radio stations. Each Official Relay Station appointee and C. D. official should have received a copy by the time this appears in print. Additional copies of this publication will be sent to any address on receipt of a postal card. Send for your copy today.

The book contains lists of international prefixes, the amateur prefixes when known, examples of calling practise, message cable-count check, "service" messages, an explanation of the new system of indicating audibility, concise lists of internationally understood abbreviations prescribed by the Washington Convention, those meanings in the Q Code for all services that are more especially applicable to amateur communication, material on relay procedure, getting "fills" in messages, League organization, the duties of various A. R. R. L. officials and appointees and how they are chosen for the positions they fill, in addition to a more complete section on the subject of radio communication laws and regulations than has been included in this publication before.

The calling practise determined upon by the International Radio-telegraph Convention specifies that the calling station shall make the call by transmitting not more than three times the call signal of the station called and the word DE, followed by its own call signal sent not more than three times. In amateur practise we find this procedure expanded somewhat as may be necessary to establish communication. The call signal of the calling station must be inserted at frequent intervals for identification purposes. Repeating the call signal of the called station five times and signing not more than twice (this repeated not more than five times) has proved excellent practise in connection with break-in operation (the receiver being kept tuned to the frequency of the called station). The use of a break-in system is highly recommended to save time and reduce unnecessary interference to a minimum.

In covering the subject of "directional" CQs it is suggested that every general call of inquiry be made informative when possible to reduce the number of useless answers and lessen needless interference under the operating conditions that we shall meet in 1929. Stations desiring communication with amateur stations in a particular country shall include the official prefix letters designating that country after each CQ. Until such time as the official prefixes used by the amateurs of various countries are designated by these countries from the block of prefix letters assigned each country by the Convention, and until these amateur prefixes become known, the older I. A. R. U. system of international designations (formerly used as "intermediates") may be used in calling (just like the prefix W or K) or following each CQ to indicate continent and country. The "intermediates" will of course be superseded by prefixes just as fast as these are assigned. Thus a United States station looking for communication with any Canadian amateur station calls: CQ VE CQ VE CQ VE DE W8NR W8NR W8NR AR.

To differentiate domestic from foreign calls in which the directional CQ is used, the city, state, point of the compass, etc., is mentioned only after the third CQ just before the word DE and the thrice-repeated station call. Thus a western station with messages for points in Massachusetts might call: CQ CQ CQ MASS DE W9CAA W9CAA W9CAA AR. Another western station with traffic for eastern points might call as follows when looking for an intermediate relay station: CQ CQ CQ EAST DE W6AJM W6AJM W6AJM AR. As always, the A. R. R. L. method of using the general inquiry call is that of calling three times, signing three times, and repeating three times. After a CQ, the dial should be covered thoroughly for a number of minutes looking for replies.

The new Q Code includes a number of important changes from that indicated by previous international radiotelegraph conventions. For instance, QTA means in effect, "Cancel nr. . . as if it had not been sent." QSP (I will relay to . . .) and QSK (Suspend traffic, I will call you at . . .) have approximately the same meanings formerly attached to QSR and QSU respectively. CQ is now specified for all "general" calls having no special or emergency significance. It should be noted that QST and QRR are now unassigned in the official international list. A number of League members have concerned themselves with the problem of differentiating a general message addressed to all amateurs from a CQ sent by any number of stations desiring to establish communication with other stations not already engaged in communication. It seems to us that the best solution of this difficulty is the adoption of special abbreviations to clarify the calls sent addressed to all amateurs under ordinary circumstances or in emergencies. Please note carefully the following special abbreviations adopted by the A. R. R. L.:

QST General call preceding a message addressed to all amateurs and A. R. R. L. Members. This is in effect "CQ APRL."  
QRR Official A.R.R.L. "land SOS." A distress call for emergency use only.

A new ruling has been added to the provisions for counting messages to eliminate uncalled for passing and re-passing of long distance messages between local stations. The new rule is applicable only to foreign bound messages for points "across-the-water." Messages for all continents except North America may be held one-half the length of time it would take them to reach their destination by mail. The 48-hour time limit for all other messages still applies. In accordance with the article on "counting rubber-stamp messages" which appeared in September QST messages bearing duplicate texts shall count only "one" for each time the complete text, preamble and signature are sent by amateur radio.

Attention is also called to the use of the standard abbreviations indicated by the International Radiotelegraph Convention for requesting "repeats" or "fills". The abbreviations each carry the meanings indicated below. Each is used after a question mark and in most cases followed by a word from the text, to request a repetition.

AA, all after . . .  
AB, all before . . .  
AL, all that has just been sent.  
BN, all between . . . and . . .  
WA, word after . . .  
WB, word before . . .  
ADR, address  
PBL, preamble

TXT, text  
SIG, signature

These and other abbreviations are explained in the revised Rules and Regulations. If you need a copy in your station for reference drop us that card requesting it today. It will be sent gladly without obligation to you.

### PRIORITY IN EMERGENCIES

As exemplified once again in the recent emergency in which amateur radio stations and operators played an important part, the station owners who considered the possibilities of an emergency arising before the trouble actually came to pass were the ones who must be credited with doing the most important work. They were ready, prepared for the crisis when it came. It behooves all of us to think upon these matters, to likewise prepare ourselves for doing a creditable job in each and every future opportunity for such work. The very least we can do is to study the history of such cases so that we may proceed correctly and systematically about our business without losing our heads and passing up glorious opportunities for service in any crisis.

Priority must be given messages from a stricken point asking for relief measures such as food, anti-toxin, blankets, doctors, nurses and necessities of life. Next in order of importance (and also in order of transmission) are the press messages informing the outside world of all that has taken place, the extent of the disaster, perhaps containing public appeals for assistance if the authorities in the affected area believe this necessary. A third class of messages is between friends and relatives, messages of inquiry or messages of assurance to and from the stricken territory. In each emergency many amateur stations at as many different points all over the country get on the air with such messages from anxious friends on the outside. Of course it is necessary for stations with such traffic to stand-by until the relief and press messages are off the hook and opportunity is given for clearing such private messages.

During emergencies it is often possible to send broadcasts to the press generally (or addressed to U. P., A. P., N. A. N. A. etc.) between the transmissions of relief priority traffic. Invariably such messages are correctly delivered to local member-newspapers in such associations, the public kept informed, and amateur radio credited. Such broadcasts should be sent at regular intervals if possible. They have sometimes been overlooked in the rush. Perhaps the last duty of the emergency station is a full report of the work that was done so that the whole achievement might do its bit for amateur radio.

Considerations of an emergency power supply are of first importance in many cases where radio is destined to play a part. If local electric service mains are crippled one may have recourse to B-batteries, dynamotors driven from storage batteries and the like. In a serious emergency, communication is of first importance. By consulting with other amateurs and putting all the available facilities together in the most favorable location a station can be made operative in short order. An order from some competent authority will make supplies of batteries or temporary service from a public utilities company available for emergency stations. It is sometimes as easy to move the amateur station to a power supply as to collect a power supply together and bring it to the amateur station. This is especially true if the transmitter and receiver are built as independent units that may be moved about at will. In some emergencies B-batteries have been provided from local electrical supply stores. In other cases broadcast listeners have been called upon to contribute their individual batteries to the common cause.

It is impossible to tell just when or where will be the next call on amateurs to render service in an emergency. In the North, sleet storms and crippled wire service threaten public safety during at least three months of each year. Floods periodically threaten different sections of the country at different times of year, due to melting ice and snow or to long-continued rainstorms. In the south-eastern states, storms of hurricane intensity are common. The situation in all such emergencies is a serious one. The entire question is one of preparedness for the individual station. Shall we be

ready or not, if and when an emergency arises? Be ready for the emergency call, QRR, when it comes. Jump into the breach with your station if feasible or stand by and avoid interference to those handling emergency traffic if this seems to be the right thing to do.

If you live along the line of a railroad you should get in touch with the local representative of the railroad so he will communicate with you in case amateur radio can help in an emergency. You should likewise make note of the address of Red Cross headquarters, of local military units, police departments, representatives of press associations and the like, if possible putting your station on record with such organizations and other competent authorities so that you will be called upon to assist when emergency communication appears to be necessary. When storms approach or disaster threatens it is best to keep in touch with the situation by radio and to again offer service to these agencies well in advance of the actual emergency. In some cases amateurs have kept hourly schedules in expectation of a coming emergency which did not materialize but in other such cases signal service was performed with credit to the individual amateur and amateur radio operators generally. Emergency work reaps big returns in public esteem and personal satisfaction, if we consider the history of such cases. Emergency work is of lasting benefit to amateur radio from whatever standpoint it is considered.

Every amateur should give some thought today to the construction and installation of a set capable of doing emergency work. A list of organizations and responsible individuals that will want to file priority traffic once radio communication supercedes (or is used in addition to) inadequate wire communication facilities should be prepared for emergency use. The people on the list should be informed of the nature of amateur radio work and invited to make use of our facilities in any crisis. Keep a workable emergency rig in readiness. Know where a power supply can be obtained for this set in case it is needed even if you do not have such a power supply at your station regularly. When the crisis arises, volunteer your services. PREPARE TODAY!  
F.E.H.

### HURRICANES AND AMATEUR RADIO

By Louis R. Huber\*

THE recent hurricane which has done so much damage carries with it a list of achievements for amateur radio. Over a score of stations, most of them amateur, took part in getting relief messages and press messages transmitted to their destinations. Now that the excitement is over a story made up from the reports we have received will be in order. It seems best to start with the hurricane, which hit the Virgin Islands and Porto Rico on September 13. By noon of the same day, NAU, the Naval Radio Station at El Cayey, Porto Rico, was without antennas. Communication and travel between El Cayey and San Juan, where the control station is located, were impossible. Cable service was interrupted. The first communication was effected by means of an improvised high frequency transmitter put together at San Juan, using the call of NAU. WSO was the first station worked. This contact, occurring near midnight of the 14th, was overheard at two points—the U. S. S. *New Mexico* at San Pedro and the Naval Radio Station at Balboa. From their reports, Washington (NAA) was able to get into communication at 4:20 a. m. of the 15th, about five hours after NAU worked WSO. The signals from NAU were not very reliable at this time, and after two hours of communication, daylight caused NAU to fade out in Washington. The next good contact was through W2APD of Brooklyn, who handled a number of important messages during the night of September 15-16.

On the neighboring island of St. Thomas the Naval Radio Station, NBB, was put out of commission by the storm. K4AAN volunteered his apparatus, however, and moved over to NBB with two UX-210's in his Hartley transmitter, using a small motor-generator as plate supply. After communication was established, K4AAN signed as NBB1

\*Assistant to the Communication Manager

W2BS in New Jersey was the boy who put the new NBB into communication with NAA, by a pretty piece of relaying. Schedules were kept from NBB with NAA and NBA (Balboa) for the next week and a half. On the NBB-NBA-NAA circuit the following amateurs helped in relaying traffic: W1RF, W2AFO, W2APD, W2BS, W3SZ, W6BY, W9CRD and W9CTG. W2AFO seems to have received the first details of the extent of damage in St. Thomas.

The hurricane didn't stop in the Virgin Islands or in Porto Rico. It kept right on going and eventually hit Florida—hardest. With this probability in mind, W4AFC and W4AGR in Palm Beach bought a set of emergency "B" batteries and borrowed several storage batteries. Since Hollis of W4AFC is a driver for the Fire Department, the emergency set was installed by Hollis and Dana (W4AGR) in the Fire Station's end of the building that served also for the Police Department and Street Department. Before the storm hit the city the set was tested with W8BUM at 5:00 a. m. of the 16th. During most of this day, as the storm swept over the surrounding country and finally engulfed the whole locality, schedules were kept with W4ACS and W4NU. At 4:00 p. m. the antenna was blown away. The wind increased so that the station had to be vacated until 6:00 p. m., when a short lull allowed the apparatus to be moved to the Police Department's end, which had not suffered such great damage as the former location. The whole station had to be reinstalled and a new antenna had to be erected. Attempts at using an indoor antenna failed, so a bent Hertz type was put up outside amid a shower of brick bats and roof tile. At daylight of the 17th, communication was re-established. W4IX answering the "CQ urgent." W4BN (W4KY at the key) proved to have best contact at this time.

From the time of the worst blow (starting on Monday, the 17th, at 7:30 a. m.) W4AFC, operated by Hollis and Dana, was on the air continuously until relief communication superseded amateur radio's emergency communication (Thursday, Sept. 20, at 3:30 a. m.). Even after this time W4AFC worked intermittently with periodic schedules on Friday and Saturday. The arrival of a Tampa relief radio unit, with call of 4CV, allowed Hollis and Dana to get some much-needed rest.

Perhaps we should mention the fact that Dana (W4AGR) lost his home, his car, and all his personal effects in the storm.

Communications passed through a number of amateur stations and through WVA, the Army's control station at Washington. Owing to the unsettled condition of affairs during the long period of unbroken operation it was almost impossible to keep an accurate log. In making out a report for us, however, Hollis and Dana have listed the following stations in the approximate order of their service: W4TO, WVA, W4NA, W4JM, W8CXW, W4BN, W4ACI, W4ACS, W4NU, W4ACT, W4IQ, W8EW, W4IX, W4KV, W4ADF, W4ACK and W8EQ.

A rough estimate puts the amount of press handled at W4AFC during the week at 8,000 words. Sixteen important rush messages were handled. Seventeen Red Cross messages were handled. Approximately 162 messages of a personal nature were handled.

The Palm Beach officials—especially the Fire Chief—were very helpful throughout the whole time of disaster.

At Homestead, Florida, W4AAO did some excellent work in relaying personal and relief messages. W4EI in Georgetown, South Carolina, handled storm-area traffic in that vicinity. W4IE of Sarasota, Florida, helped the press in that locality. W4BN kept asked with W4HZ and W4ACV. W4OZ, W4WO, W4JM, W4BL, W4NA and W4NE helped in their respective locations.

The interrupted cable service between Bermuda and Halifax was supplemented by communication between n2PA and W2BGB, W4RN—(to W9DSC), W2CUQ—(from W2WK), and W8AAK. W1MK handled several press messages, as did W1AFB and W4AFL. In Cuba, n65AY held up the amateurs' end of things.

Well, OM's, it's all over. We were called on and we answered. If the balances had been handy we could have been weighed and not found wanting. Work of this sort is distinctly worthwhile. In the future, when the hurricane visits you—we trust that amateur radio will be found as the one type of communication that never fails.

#### WFBT

W2KR and W2ALU have been keeping schedules with WFBT, the S.S. City of New York of the Byrd

Antarctic Expedition, each station keeping the schedule on 7850 kc. (88.2 m) on alternate nights. According to a report from operator Berkner of WFBT, these two stations have handled 50% of all the personal traffic from the expedition. In the first two weeks alone W2KR delivered 105 messages and handled between thirty and forty replies. The ship's position has been reported daily to Commander Byrd's office, largely through the efforts of amateur radio operators. One night W2KR handled eleven messages in exactly 22 minutes—not such a bad record for speedy transmission. W8AHC also reports keeping a daily schedule with WFBT since September 9.

The one-kilowatt tube set is being used for most of WFBT's work. Although most of the schedules are kept on 8800 kc. (34 m.), WFBT's distinctive 500 cycle note may also be heard on 12,180 kc. (24.6 meters). Operator Berkner sends us the following list of schedules through W1MK to show the open periods for work with amateurs. Berkner stated that he hoped to work as many amateurs as possible—but that it was sometimes impossible to work all those heard calling the expedition due to impending schedules which must be kept with commercial stations.

We understand that the sister ship, WFAT, left Norfolk about September 27.

It is hoped that the following list of schedules will be useful to everyone interested in the Byrd expedition. Note particularly the times left open for general amateur contact. All times indicated are GCT.

| Time      | WFBT frequency | Remarks   |
|-----------|----------------|---|
| 0000-0100 | 8800 kc.       | General amateur contact on 7000 kc. band.   |
| 0200      | 8800 kc.       | W2UO on 7580 kc. (89.6 m.)  |
| 0255      | 8800 kc.       | NAA time on 8030 kc. (87.36 m.)   |
| 0330      | 8800 kc.       | K2KR and W2ALU  |
| 0500      | 8800 kc.       | W9US on 7080 kc. (42.4 m.)  |
| 0530      | 8800 kc.       | W1MK (M, T, Fri.) on 7150 kc. (41.9m.)  |
| 0600-0630 | 8800 kc.       | W2UO press followed by traffic on 7580 kc. (89.6 m.)  |
| 0700-0730 | 8800 kc.       | W6ARD traffic and ARCX listening for Wadkins.   |
| 0800      | 12,180 kc.     | NPU traffic on 8200 kc. (36.6 m.)   |
| 0815      | 8800 kc.       | General amateur contact on 7000 kc. band.   |
| 0900      | 8800 kc.       | W6ARD press on 7070 kc. (42.5 m.)   |
| 1000      | 8800 kc.       | NBA traffic on 8270 kc. (86.8 m.)   |
| 1015      | 8800 kc.       | General amateur contact on 7000 kc. band  |
| 1100      | 8800 kc.       | W2HF on 7400 kc. (40.6 m.)  |
| 1180      | 8800 kc.       | General amateur contact on 7000 kc. band.   |
| 1200      | 500 kc.        | Commercial two-way work.  |
| 1230      | 12,180 kc.     | General amateur contact on 14000 kc. band.  |
| 1400      | 500 kc.        | Commercial two-way work.  |
| 1600      | 12,180 kc.     | NKF and W2UO on frequencies near or above 16,000 kc.  |
| 1700-2000 | 500 kc.        | Commercial two-way work.  |
| 2100      |                | W6ARD press.  |
| 2200      | 500 kc.        | Commercial two-way work.  |
| 2300      | 12,180 kc.     | W2HF in 14,620 kc. (20.5 m.)  |
| 2330      | 12,180 kc.     | W2BRB traffic on 14,810 kc. (20.2 m.)   |
| 2400      |                | Open for amateur work. WFBT also listens directly after each traffic schedule if there is sufficient time before the next schedule. |

#### VOQ

On September 23 Lansingh and Wallace had a one and one-half hour contact with Ed Manley of VOQ from W6AM giving him the latest dope from QST. In fact Manley reported this the first news he had received for about six months.

From VOQ, "We are now near Bogosloff Islands off Unalaska Island. We plan to make a short stop at Unalaska or Dutch Harbor, the Morrissey (VOQ) then going through Unimak Pass and heading for Icy strait, the entrance to the inside passage. It was forty four degrees below zero here this morning. We should arrive at Prince Rupert in mid-October. We completed our museum walrus group in the Arctic and stopped at Teller and Nome coming south through the Behring sea to the present position off Unalaska Island. We are now waiting to land on the Bogosloff Islands. They are the group that has the crazy idea of disappearing every so

often and reappearing in clouds of steam. Signals surely have been poor. North of latitude 68 was the best place. We found east coast fellows numerous up there. The conditions in the Behring sea were so very poor that we could hardly hear the Pacific coast. Only a dozen or so stations have been heard on twenty meters during this entire trip."

W8DME has been heard at VOQ and has spent some time in attempting QSO, especially when the *Morrissey* was off Wrangel Island in late August.

### WSBS

After leaving Hamburg, Germany, the Yacht *Carnegie* of the Department of Terrestrial Magnetism visited Iceland and Barbados and at the present writing (in early October) is approaching Balboa. Soon after leaving Hamburg a new transmitting antenna of the inverted L type was installed with improved results on 6574 and 9045 kc. During August some "dead" nights were observed, coincidental with the appearance of Aurora Borealis. On these nights no signals were heard with great intensity and once even the reliable NAA time signals failed to break through. During middle August another curious effect was also observed. Contact with the United States would be excellent at about nine and ten P. M. EST but by about midnight all signals, especially those from the eastern part of North America would have faded practically out. WSBS signals faded in the same manner. Stations in the middle west were only slightly affected during these periods.

In August, contact was reestablished with NKF, but not in daylight. Daylight tests were continued but without avail. Atmospheric noises were quite strong but signals strong and steady. Absolutely consistent traffic schedules were maintained four nights per week with W2XAU in New York and three nights per week with W1MK in Hartford. W8DME reports keeping a regular Saturday night "sked" with WSBS.

The most recent report from "LJ" reaches us as the *Carnegie* is nearing the Canal Zone. In Barbados members of the expedition were shown all over the island and in the two weeks they were there, were made members of the Aquatic Club, the Yacht Club and several others. The other scientific work of the expedition doesn't permit a great many hours to be devoted to radio but all of the work is extremely interesting. On one occasion "LJ" reported almost catching a ten foot shark on the line when he was fishing—but it got away when he had it a few feet out of the water. The *Carnegie* is scheduled to leave Balboa October 14 bound for the Easter Islands, Callao, and Papeete. The radio report follows:

S. S. Carnegie WSBS nr 159 Oct. 8, (via W1MK)  
 "Schedules have been worked consistently with W2XAU, W1MK, and W1CEI during September. In addition W9AVZ, W4AHL, W3CXL, W3AVD, W6CUL, W8SX and NKF were worked. Conditions were very good all that time. Schedules were temporarily discontinued the last two weeks of the month while the yacht was anchored in Carlisle Bay, Bridgetown. Barbados although we kept W1CEI up late two nights putting through a rush message for us. A large number of stations have done us favors and thanks are tendered them all. As time goes on we shall be able to add more and more to our "worked" list. We sailed from Barbados on October one and are now about 250 miles from Panama where we shall stay for a few days. Our schedules are again in good working order and conditions excellent. We have had very little trouble with static. Vy 73 to all the gang.

L. A. Jones, Radio Operator, Yacht Carnegie.

### W1MK

W1MK operates on frequencies of 3575 kc. and 7150 kc. Robert B. Parmenter, "RP", is the chief operator. His fist is familiar to most of the amateur fraternity of the air. Less frequently from W1MK the following signs may be heard: "OU" of Louis R. Huber (Assistant to the Communications Manager), "FH" of F. E. Handy (Communications Manager), and "AH" of A. A. Hebert, (the League's Treasurer-Field Man).

"3500" and "7000" are used to designate the frequency band on which operation from W1MK takes place. 3500 kc. refers to what was formerly known as the "eighty meter band", and 7000 kc. to the "forty meter band". Throughout this notice times given are 75th meridian (Eastern Standard) time.

All the latest official and special broadcasts are

sent simultaneously on 3575 kc. and 7150 kc. at the following times:

8:00 p.m.: Sun., Mon., Tue., Thu., and Fri.

10:00 p.m. Mon. and Fri.

12:00 p. m. (midnight): Sun., Tue., and Thu.

PERIODS OF GENERAL OPERATION have been arranged to allow everyone a chance to communicate with HQ. Usually these general periods follow one of the Official Broadcasts. They are listed below under 3500 kc. and 7000 kc.

3500 —

8:10 p.m. — 9:00 p.m. on Sun., Mon., Tue., Thu., and Fri.

10:00 p.m. — 11:00 p. m. on Tue. and Thu. (no official broadcast is sent preceding this period).

12:00 p.m. — 1:00 a.m. on the following nights (actually the morning of the day following): Mon., Tue., Thu., and Fri. Only on Tues. and Thu. does the official broadcast precede.

The following regular schedules are kept with other stations. Traffic to and from HQ will travel quickly through any of the following: (Eastern Standard Time used throughout)

W1ACH (3500) Sun., 7:00 p.m., Thurs., 7:15 p.m.

W1BIG (3500) Mon. and Fri., 7:00 p.m.

W1BQD (3500) Mon. and Fri., 9:00 p.m.

W1KY (3500) Mon. and Fri., 7:30 p.m.

W1VB (3500) Tues. and Fri., 7:45 p.m.

VE2BR (7000) Sun., 9:15 p.m.

W2GP (3500) Sun., 7:30 p.m.; Fri., 9:15 p.m.

n2PA, (7000) Sun., 9:45 p.m.; Mon and Fri.

11:15 p.m.

W3QP (3500) Tues., Thurs., 7 p. m.

W3ZF (3500) Tues. and Fri., 11:30 p.m.

W3ZS (3500) Mon. and Thurs., 7:45 p.m.

W6JC (7000) Mon., midnight

W6BMW (7000) Mon., 11:45 p.m.

W6JN (7000) Fri., 12:30 a.m.

W6OJ (7000) Mon., 1:00 a.m.

W6WB (7000) Fri., midnight

W6ZD (7000) Wed., 1:30 a.m.

W7TX (7000) Tues. and Sat., 1:00 a.m.

W8AAG (3500) Sun., 11:15 p.m.

W8AYB (3500) Tues., 11:00 p.m.

W8BYN (3500) Tues., 11:15 p.m.

W8DED (3500) Tues. and Thurs., 9:30 p.m.

W8ZZ (3500) Sun., 11:00 p.m., Thurs., 9:00 p.m.

VE9AL (3500) Tues. and Fri., 7:15 p.m. (VE9AL on 5720 kc.)

W9APY (3500) Tues., 9:00 p.m. (W9APY on the 7000 kc. band)

W9BCA (7000) Mon. and Fri., 11:00 p. m.

W9OX (3500) Sun., 11:30 p.m.; Thurs., 11:15 p.m.

W9XI (7000) Mon., 11:30 p.m.; Fri., 11:45 p.m.

WFBT (7000) Tues., Wed., and Sat., 12:30 a.m.

WSBS (7000) Sun., Mon., and Fri. at approximately 10:15 p.m.

## About 28-mc. Work

W2JN reports activity on the 28mc. band on the increase. On September 30, PCRR's second harmonic radiation was heard at 1400 GCT, again and weaker at 1500 and unheard at 1600 GCT. The 23.4 mc. harmonic of W5OH was both copied and "worked" by W2JN. On this frequency W5OH was K7 though using but one UX210 with 500 volts. Schedules for further 28 mc. tests to be run on Oct. 7 were arranged by W2JN with W5OH, ef3CT, and ozzAE. It is impossible to give results at this writing (Oct. 5) but we hope to have such material for presentation next month. G6DH (Essex, Eng.) reports through G2NH that he copied W2JN on 28 mc. on Sept. 30 from 1530 until 1730 Greenwich, the signals fading out at dusk. G6DH heard W1TR, W3ADM, W2AZU and W2AVG with good audibilities on the 28 mc. band on October 1 and 2 between 1825 and 1720 GCT. BR598 (Antrobus near Northwich, Eng.) copied the following stations at about 1530 GCT Sept. 30: W2JN calling W2BDA, W2BDA replying to W2JN, W2NM calling W2JN.

W6DWP was copied for about an hour on 28 mc. on Sept. 16 at W8DED. Sackers says that many commercial stations can be heard also and that he believes the success of this band for regular work assured as soon as more stations begin to use it. G6DW plans to operate a beam transmitter on the 28 mc. band this coming season and looks to us for

reports. G2NH expects to transmit regularly each Sunday on 23.6 mc. at 1500 GCT. ef8CT will call U.S.A. on 30 mc. Sundays from 1400 to 1415 GCT. Listening for North American 23 mc. stations from 1415 to 1430 possibly continuing through other periods starting at 1500 GCT.

K6CFQ has been doing a lot of work on this band. He expects to increase power. A 7½-watt tube is used in Ultraudion circuit with a 16-foot two-wire voltage feed system. K6CLJ, W1XR, WZA, and KZOR have been heard on the 23 mc. band by K6CFQ who has also had excellent two-way contacts with K6CLJ and K6JFG on this frequency. K6CLJ has been reported R5 in Salt Lake City, Utah when working on this frequency. W6JU is testing daily, 10.2 meters between 4 and 5 p.m., E.S.T.

W6DZL (Burbank, Calif.) suggests starting a calls heard section for the 23 mc. band. Since Sept. 2 he reports hearing W9DWN, W6ASD, W8ANK, W5ML, W9KBZ, W8AME, W2UK, W9ETA, W9CRR, W8AAC, W2AZO, W9BAL, W5TE, W6BJF, W6BPO, W9BPL, W2KX, W6ALO, W4FO, W4AQ, W9CSR, VE4OB, VE4OJ, and VE5EF, all on this band. K6DJU who had a strong second harmonic falling within the new band was worked by W6DZL. It would be interesting to know how many of the stations listed were heard under similar conditions. If a small amount of "harmonic" energy was responsible for some of these signals, what might a real bunch of 23 mc. transmitters do?

Pacudero, op1DR, is testing each Saturday and Sunday from 0100 to 0200 GCT and from 1300 to 1400 GCT using 100 watts power, frequency 23.4 mc. Reports will be appreciated.

W5AFB and o25AR have arranged some schedules for 23mc. tests. o25AR reports hearing W6XV at 1940 GCT Sept. 29 on about this frequency and suggests that several schedules for testing be arranged at approximately this hour.

The Australian amateurs are holding a "ten-meter CQ party" in November and U.S. hams are invited to cooperate in the tests. o25CP gave us three reports of 23 mc. activity during the month, all received by radio through W5QJL. Nothing startling was reported Sept. 20 but the message chronicled the following new contacts: o25SA worked o27CW and o25MY, o25MY, o27DX, and o25CP worked o21AN and the latter station heard o25BQ and o25KS in addition to those worked. The message dated September 23 reported the first Australian-New Zealand 23 mc. QSO as taking place that date from 0145 to 0215 GCT between o21AN and o25CP. o21FQ reported copying o25HC, o25OR, o25BQ, o25OP, o25KS, o25MY, o25PM, o25HC, o25CH and o25DY, all on 23 mc. We understand that there is considerable activity in Tasmania, also. o27DX works regularly on 29.3 megacycles according to a report from Mr. Bousfield of Bellerive.

WIBUX expects to be with us on the "new" band by January first. He is getting the receiver under way now. He collected the following dope by radio from o25JR and o25BY: K6CLJ has been heard in Australia on 23 mc. according to the report of o25JR. o25JR asks North American amateurs to listen for him each Sunday from 11.30 to 12.00 and from 1400 to 1500 Melbourne time. o25AW told W6AM about the QSO between o25SA and o25BQ (1500 miles), about the work of o25PN, o25RB and o25AW in holding a three-way conversation on 23 mc. recently. According to "Harmonies," a publication of the Victorian Division of W. I. A., o25KS, o25YX, o25OT and o25MY have done excellent pioneer work as well as o25BQ, o25CP, o25VP and o25GR also mentioned. In the words of this journal, "From time immemorial in the era of ham radio the task of surmounting fresh and seemingly hopeless obstacles has been undertaken by a few determined experimenters (the rest being content merely to plod along the same old groove) and in each case the obstacles have been surmounted. It is willing, unselfish cooperation we want and which we must have to win."

#### TRAFFIC BRIEFS

Miss Elizabeth Zandonini, W3CDQ, was among the U. S. amateurs who visited Europe this last summer.

During the National Air Tour the Tulsa gang threw together a set at the Municipal Airport, operating under special license with call letters KGHR for several days. Reports on flying conditions were transmitted from local observers, and SXAA, one of the planes, was copied enroute.

#### BRASS POUNDERS' LEAGUE

| Call      | Orig. | Del. | Rel. | Total |
|-----------|-------|------|------|-------|
| W8CHC     | 206   | 92   | 568  | 866   |
| W6BZR     | —     | 14   | 760  | 774   |
| W6AJM     | 53    | 37   | 566  | 656   |
| op1HR     | 156   | 106  | 392  | 654   |
| W9DWN     | 8     | 15   | 578  | 601   |
| W6IP      | 5     | 23   | 520  | 548   |
| W1MK      | 100   | 160  | 276  | 536   |
| W3ZF      | 54    | 103  | 368  | 515   |
| W6ASM     | 2     | 63   | 418  | 483   |
| W3CFG     | 16    | 14   | 400  | 430   |
| op1CM     | 140   | 127  | 142  | 409   |
| W9ACN     | 26    | 338  | 39   | 403   |
| W6BWS     | 36    | 2    | 354  | 392   |
| W8MQ      | 29    | 17   | 340  | 386   |
| W16AMM    | 96    | 276  | 12   | 384   |
| W9BQO     | 350   | 2    | 8    | 360   |
| W2WK      | 360   | —    | —    | 360   |
| W8CMO     | 21    | 14   | 310  | 345   |
| W8DBM     | 49    | 14   | 278  | 341   |
| W9CAA     | 250   | 8    | 74   | 332   |
| W8AVK     | 40    | 32   | 248  | 320   |
| W6DSG     | 309   | 1    | 2    | 312   |
| W8ARX     | 47    | 21   | 238  | 306   |
| W8WJ      | 30    | 36   | 228  | 294   |
| K7HL      | 24    | 14   | 252  | 290   |
| W9FUJ     | 48    | 19   | 218  | 285   |
| W6CHA     | 74    | 46   | 154  | 274   |
| W2APD     | 79    | 194  | —    | 273   |
| W9EDW     | 7     | 2    | 260  | 269   |
| W3AKB     | 19    | 70   | 177  | 266   |
| W6CCT     | 65    | 76   | 125  | 265   |
| W2KR      | 70    | 157  | 32   | 259   |
| W6ALX     | 4     | 16   | 232  | 252   |
| W8CLQ     | 50    | 16   | 182  | 248   |
| W2ALU     | 50    | 152  | 38   | 240   |
| W9BCA     | 17    | 43   | 179  | 239   |
| W6ZBJ     | 4     | 42   | 20   | 229   |
| W1AKS     | 71    | 24   | 132  | 227   |
| W9DLJ     | 12    | 22   | 190  | 224   |
| W8CMB     | 36    | 23   | 160  | 219   |
| W8CFT     | 12    | 18   | 185  | 215   |
| W6RRO     | 151   | 7    | 54   | 212   |
| W1ASD     | 9     | 7    | 194  | 210   |
| W6ABK     | —     | 1    | 208  | 209   |
| W8APN     | 55    | 9    | 142  | 206   |
| W8ACZ     | 14    | 3    | 188  | 205   |
| W3ADE     | 36    | 27   | 140  | 203   |
| W6AKD     | 5     | 2    | 195  | 202   |
| W6SR      | 200   | 1    | —    | 201   |
| W8DSP     | 46    | 39   | 116  | 201   |
| W6UJ      | 23    | 110  | 65   | 198   |
| W6WB      | 4     | 65   | 122  | 191   |
| W1BIG     | 34    | 133  | 15   | 182   |
| W9EUR     | 165   | 54   | 20   | 179   |
| W8AFP     | 15    | 50   | 108  | 173   |
| W8DFP     | 33    | 50   | 84   | 167   |
| W3CKL     | 38    | 108  | 12   | 158   |
| op1DR-IAE | 50    | 75   | 8    | 133   |
| W6BYZ     | 20    | 106  | —    | 126   |
| W6DPO     | —     | 55   | 46   | 106   |
| W2AVP     | 43    | 52   | 6    | 101   |
| W9CIA     | 14    | 57   | 26   | 97    |
| W6CZR     | 32    | 63   | —    | 95    |
| W7TX      | 24    | 68   | 2    | 92    |
| W8CFL     | 8     | 56   | 11   | 75    |
| W6AGR     | 4     | 50   | 20   | 74    |

W8CHC climbed from seventh to first place! W6BZR handled a bunch of radio show messages, kept a large number of schedules and gave him some close competition. Special credit goes to the deliveries in the message month:

W9ACN, W6AMM, W2APD, W1MK, W2KR, W2ALU, W1BIG, op1CM, W6UJ, W3CKL, op1HR, W6BYZ, W8ZF.

Deliveries count! All stations appearing in the R.P.L. are noted for their consistent schedule-keeping and reliable message-handling work in amateur radio.

A total of 200 or more bona fide messages handled and counted in accordance with A.R.R.L. practice or just 50 or more deliveries will put you in line for a place in the B.P.L. Why not make more schedules with the reliable stations you hear and take steps to handle the traffic that will qualify you for B.P.L. membership also!

WIMK will go on the air on Thanksgiving Day the same as usual for schedule operation.

All who took part in the Scandinavian-American Tests are urged to send their logs to A.R.R.L. Headquarters if they have not already done so—in order that we may have a full report of this competition in QST and so the prizes may go forward to the winners at the earliest possible date.

At the Denver Radio Show, the station of Colorado's Route Manager, W9BQO, was operated by remote control over wires furnished free of charge by the telephone company. About 500 messages were originated.

### LOS ANGELES GET-TOGETHER

The Amateur Radio Research Club of Los Angeles gave an excellent banquet on September 12th, Mr. H. B. Parrish, president of the club, presiding, and the meeting constituting the regularly quarterly meeting of the Los Angeles A. R. R. L. Section. One hundred and seventeen amateurs sat down to dinner on the top floor of the Chamber of Commerce Building, with the distinct understanding that all the noise could be made that was wished.

Director Babcock came down from San Francisco and gave us a fine talk on the new status of Amateur affairs. He always gives us very fine information and it was much appreciated by all. Interesting and high-grade entertainment was furnished by W6AVJ, Master of Ceremonies. Reports

from the various managers of the pylon stations at the Air Meet were received with great applause. Amateur radio scored a big hit for its excellent work at the Mines Field Air Races, as has been reported in QST by Wally Wiggins, W6CHZ. The crowning event of the evening was the introduction of and talk by Mr. James Warner, radio operator on the *Southern Cross* fight. Reports were made by those who handled the A.R.R.L.-A.R.R.C. booth at the Radio Show Beautiful, showing that over 2100 messages were handled during the show. The S. C. M. covered a few of the coming events and sold a few tickets for the coming convention at Oakland. It was certainly a bang-up banquet and was handled very beautifully all the way through.

It is the plan of this Section to have these meetings each quarter, under a different club in the Section. So far meetings have been held under the auspices of the Pasadena Short Wave Club, the Whittier Radio Club, and now the A.R.R.C. From all appearances the Associated Radio Amateurs of Long Beach will take over the next meeting, to be held in early December.—W6AM.

### OFFICIAL BROADCASTING STATIONS CHANGES AND ADDITIONS (Local Standard Time)

W5AQ, Mon., Wed., Fri. 8 p.m.; W6ALZ 7320 kc. (41 m.) Daily except Sat. and Sun. 6 pm.; W6DHU 7000 (40 m.) Mon. Wed. 6:15 pm; W9EGU, 7094 (42.25 m.) Mon. Wed. Fri. 7 pm.

## DIVISIONAL REPORTS

### ATLANTIC DIVISION

**M**D-DEL-D. C.—SCM, H. H. Layton, W3AIS—Delaware: W3ALQ is rebuilding his chemical rectifier for the third time. W3WJ has been off the air rebuilding the station. W3AJH is on 14,000 kc. now. Maryland: W3CKC is now an ORS and has a sked with W3ANS, and W3ADE. W3BBW wants a sked with stations south. W3TR has no trouble in moving traffic. W3RQ will soon be working with crystal control. W3APX is still out in middle west enjoying his vacation after midshipman cruise. D. of C.: W3GT is the busiest man of the Section. Skeds are maintained with W3PT, W3FF, W3BGY, W3ARD, K6ADH, oa-5HG and W7IQ. FB.

Traffic: W3AJH 4, W3AIS 9, W3CGC 42, W3BBW 35, W3TR 25, W3GT 104.

**SOUTHERN NEW JERSEY**—SCM, M. J. Lotysh, W3CFG—W3CFG leads us as usual with highest total in a long time and is the result of six daily schedules. W3ARC amassed a total of 67 in spite of being busy with service work. Some of the others who haven't been reporting had better be careful. W3ATJ is doing fine work. He delivered a message to a man in Phila. from Chicago regarding his wife's operation after this man's being unable to send or receive word via W. U. FB. W3AVS is a newcomer and looks like a good ORS prospect. W3ARN is having antenna trouble at present and you are all expected to report. The radio season is getting under way.

Traffic: W3CFG 480, W3ARC 67, W3ATJ 10, W3AVS 8, W3ARN 5, W3ATP 2.

**EASTERN PENNSYLVANIA**—SCM, J. B. Morgan, 2nd, 3QP—W3ZF sure is piling up the traffic. ZF and W8EU work the set on alternate nights, keeping the "Twentieth Century" from spreading the rails. W8WJ had a lot of Allentown Radio Show traffic. W3QP finds traffic good and doing little 700 kc. DX work too. W3AKB is back in her stride again and has the new bug pretty well under control. W3AVK complains of lack of traffic. Look at his total. School has started to QRM spare time at W3ADE but his total still looks good. FB. W3CDS can't seem to get started at all. W3CWO works now in a radio repair shop, goes to night school and still has time to handle some traffic. That's good business, OB. W8DHT says 3500 kc. has come back to life again up his way. W3BFL is hampered by uncertain hours, as far as we can gather. W8MQ reports for the first time and mi gosh! look at the total. Traffic doesn't sleep there, we've discovered by experience. W8AWO rebuilt and says rac seems better than AC. Now for a good filter and some careful tuning, OB, and no one will be able to say you haven't the 1929 idea. Here's another first time report, W8CMO with a big fat total. He is the western point for W3ZF in the now famous New York-Chicago nightly traffic route. ZF reports W8CMO is a very good op,

fellows. Get QSO and watch those messages sizzle. Congratulations, gang, on the good showing this month! Seven stations in the BPL. Very FB. You have doubled the total traffic each month for the last three months.

Traffic: W3ZF 515, W8WJ 294, W3QP 148, W3AKB 266, W3AVK 320, W3ADE 203, W8CWO 33, W8DHT 158, W3BFL 17, W8MQ 336, W8AWO 25, W8CMO 345.

**WESTERN PENNSYLVANIA**—SCM, A. W. McAuly, W8CEO—W8CHC, a new ORS, takes first place this month with a fine total. The SCM got some of that traffic and the report by radio. W8CNZ has been doing traffic work with nn-INIC. W8DNO is going back to school and will not be so active. W8BGW works daily except Sunday. W8CEO is making a vertical 60 foot antenna. The set will be remote control. W8GI will resume schedules with the return of Standard Time. W8DKS has built a 1929 transmitter a la QST. He will work on 7000 kc. W8AKI has a new Zepp and is all set for the season. W8AGO works a sked with W3SN. He drops to 14 m. c. when static bad. W8AYH worked nr-GC. W8CES is still after skeds. W8XE will be on the air again as soon as repairs can be made. They were damaged by lightning. It is to be hoped that their stolen tubes will be recovered. Crosley reports the arrival of an 8 pound YL. Congratulations. W8VE reports that he will be off the air for some time, perhaps for good. He is studying medicine. W8AJE is a new amateur in Oakmont. W8ARC has been sick with spine trouble. W8DFY asks that his ORS be cancelled until further notice. W8DHW is a new ORS in Pittsburgh. W8BNN will be an ORS. W8CMP, our Director, is building a new oscillator. The SCM serves notice that next month a number of pink cards will be filled out. Only three men reported every month during the summer. Some of you have not reported to me at all. You simply cannot hold an ORS certificate and not report. W8CZE burned out a 250 watter. W8AMA, the Erie Club station, is active. W8CKN is busy rag-chewing. W8BVG will be operating from now on, W8MQ reported direct this time.

Traffic: W8CHC 866, W8CNZ 95, W8DNO 46, W8RGW 34, W8CEO 33, W8GI 13, W8DKS 7, W8AKI 7, W8AGO 5, W8AYH 2, W8MQ 386.

**WESTERN NEW YORK**—SCM, S. S. Taylor, W8PJ—The same bunch are still at it getting in reports on message traffic, etc. W8ADE reports no traffic due to rebuilding, for 1929. W8AFG makes the RPL this month and is after an ORS. W8AKB has just returned home and will be on the air soon. W8ARX makes the BPL with over 300 messages. W8AVS is handling traffic and rebuilding. W8BCM has schedules. Heard also in Australia and handles traffic on a 5 watter, on 7000 kc. W8BFG is rebuilding for 1929. W8BJO is also rebuilding. W8BLP will be

off the air due to going back to school. W8BNJ wants winter schedules and is now active with traffic. W8BQR handles traffic and also his call W2BPV and wants schedules. W8CNX is back on the air regularly now, ready for traffic. W8CPC has returned from Europe and is now after traffic and schedules. W8CSW of Cook Academy lost his 208. W8CVJ is handling Army net work and his new 1929 transmitter is working FB. W8DDL is handling traffic, also states Rochester Amateurs put on great exhibition at the 4th annual radio show there, and also had a television receiver and a collection of short-wave equipment and a 250 watt transmitter of 1929 type in operation at the show. W8BO was the call used. Direct communication was held from the show with nx-1LX, Greenland; nn-1NIC, Nicaragua, besides hams in Costa Rica and the West Coast, also a large amount of Florida hurricane traffic was handled. The exhibit was managed by W8DDL. W8DFW has handled messages but due to school, he has had quite a drop in traffic. W8DII makes the BPL and has schedules with W2OX and W8OX. W8DME has handled traffic with W8BS, XNU-LG, VOQ at 4:00 am and 5:00 am Sundays. W8DQP says due to YL and motor car, the station has been silent. W8DSP has made the BPL with over a hundred messages and also has seven daily schedules. W8DUB is at Manthia college. W8TH has increased to 105 messages and has now a couple of schedules and is remodeling his set. The report this month shows a decrease in activity. W8DSP has moved to 160 Kenwood Ave., Syracuse where he will use the same power and MG there. Let's make out next month ten times as good as this month.

Traffic: W8AFG 178, W8ARX 306, W8AVS 4, W8BCM 23, W8BJO 55, W8BLP 6, W8BMJ 33, W8BQR 9, W8CPC 8, W8CSW 14, W8CVJ 5, W8DDL 9, W8DFW 36, W8DII 102, W8DME 11, W8DFP 167, W8TH 10, W8DSP 201.

#### CENTRAL DIVISION

OHIO—SCM, H. C. Storek, W8BYN—Well, gang, good weather is coming fast, and already the totals are climbing. Four made the BPL this time. W8DBM leads Ohio this month (as usual) with 341. Sure FB and watch his smoke from now on. W8CMB comes next with 219 and W8CFT of Columbus, a newcomer in the BPL ranks, hands in 215. FB, both of you. W8CFL made the BPL with 56 deliveries. W8DBM averaged 11 msgs per day this month which is sure going good. There is quite a war on between W8CMB and W8DBM as to which one will beat the other. Go to it, fellows, W8CFT got all his traffic on 7000 and made the BPL in spite of having done a lot of DX. FR, W8CNO wanted badly to make the BPL and keeps a flock of schedules, but didn't quite make it. Shhhhhh! She's a DX hound, too. Hi. W8DJV took a vacation from work before school started and gathered 117 messages, too. W8CFL is back on 8500 for the winter and is looking for more schedules. W8BBR says he's glad traffic is picking up. W8DDK has been busy rebuilding. W8CKD has been putting in a new mercury arc. W8BUM specialized in special quick delivery traffic this month and surely did good work. W8DSY hasn't had much time on the air and has been DXing that, but got 47 messages just the same. W8DNL has moved to W. Va. W8BOR has only been on a little due to press of work and has been hooking W8DNL. W8CQU is working on 3500. W8CRI reports 25 and calls that "not so good". W8BAC just completed a 222 receiver. W8APB surely is getting interested in traffic. W8DGB reports for the first time. He is ex-9CMJ and will be an ORS soon. W8DDF wants early A.M. schedules on 7000 and 3500. W8BSR is runner-up for ORS. W8ARW has been rebuilding his transmitter. W8CNU praises W8DDK about keeping schedules, and wants more like him. W8AYO is still specializing in DX traffic. He keeps schedules with SE and NH. W8DDQ is going good with W8DIH at the key. W8ARW likes the pennant from the convention. W8ALW has been neglecting his station to work the club station, W8ARS. W8OQ is rebuilding. W8EJ is still too busy to work radio much. W8DIH is too busy to keep many schedules. W8AQU has a commercial ticket now. W8DIA hasn't been on much. W8AVB has put in a 50 wattler. W8AMI is also rebuilding. W8DFP won't be worked much as Keller is operating at W8BEV. W8DHS says the rebuilding is going too slow. W8DJG will have his transmitter back on the air soon now. W8BYB is

putting in MO-PA. W8BKM seems to be very much married but is getting things a little his way now and expects to be on the air soon. W8AOE is completing the rebuilding. W8ADH is getting on the air again, too. W8RN is still pounding brass commercially. W8PL will be on the air again shortly. W8AVX announces that the Maumee Valley Amateur Radio Club has been organized and is going strong, and wants more members.

Come on, fellows, let's get alive and get going, put OHIO on the map bigger than ever with your efforts. It's a problem to know what to do with an ORS who reports each month, but never has traffic. Each station that doesn't have traffic lowers Ohio's percentage. Let's get busy!

Traffic: W8DBM 841, W8CMB 219, W8CFT 215, W8CNO 117, W8DJV 117, W8CFL 75, W8BYN 74, W8BBR 72, W8DDK 53, W8CND 52, W8BUM 51, W8DSY 47, W8BOR 42, W8CQU 32, W8CRI 25, W8BAC 25, W8APB 21, W8DGB 19, W8DDF 16, W8BSE 15, W8CSS 14, W8CNU 12, W8AYO 12, W8DDQ 8, W8ARW 7, W8ARS 6, W8OQ 3, W8EJ 3, W8DIH 3, W8AQU 2, W8DIA 1, W8AVB 1, W8AMII.

KENTUCKY — SCM, J. B. Wathen, III, W9BAZ—Many tnx, fellows, for the honor. Will try to give old Kaintuck a real amateur standing. Quite a few stations did not report. Good stations will report, ORS must. "A new broom sweeps clean"—watch out! W9ARU is trying television. Seeing is believing, sez he. W9AUH works his usual quota of OA's and OZ's. W9BAN's house was badly burned. Radiation reported close to 15 amps. "Tell it to the Marines" via W9BAZ. He has a more or less regular QSR with nn-7NIC. W9BEH reports results fair. Plug-in transmitters are the style at W9BGA. W9RXK and W9KZ are rebuilding. W9EKM leads the state in traffic—mostly originated. A blowout finished all of W9ENR except his 852. Making home-brew, OM? W9JL has a big staff of ops and wants skeds. The USNR has made a start in Louisville headed by W9MN. W9AZY got on the ARRL band-wagon. W9FS reported at last minute by radio. W9CEE applied for ORS. W9OX has discarded his slop-jars in favor of tube rect. 'Lows as how he gets DC. We hope so. The RM position for KY is vacant. Those who think they can qualify for the job are invited to send applications to the SCM.

Traffic: W9EKM 61, W9BGA 41, W9BAN 39, W9FS 38, W9BAZ 36, W9OX 35, W9AZY 21, W9AUA 19, W9MN 19.

INDIANA — SCM, D. J. Angus, W9CYQ—The Fort Wayne Club states that the preferred circuit seems to be the master oscillator this fall. W9BWI is playing with television, transmitting as well as receiving. The Fort Wayne Radio Club membership passed the forty mark. W9AEB is rebuilding his set for 1929. W9AKX is having trouble with line induction but has a clew as to its cause. W9DZX and W9EGE are in college at Angola, Ind., and are working the home folks on 65 volts. W9FOO can't get his fancy looking set to work. W9CLL is craving skeds on 7000 kc. for important traffic. W9BKJ will be on 8500 kc. this winter. W9ASX is going strong with a 1929 Hartley and is also trying television. W9EVA has a new pole, a 1929 Hartley and is playing with television. W9DUZ was stricken with heart trouble and won't be on for some time. W9EF has worked Australia and New Zealand 88 times this month. W9ETA is on 20 meters all the time now. W8CP is getting back on the air with an 852. W9EZ's old ops, Dutton and Jerome are running WWAE at Hammond. W9AIN has been working overtime so has not had much time to operate but again carries off the states high mark of 403.

Traffic: W9AIN 403, W9EF 97, W9DSC 44, W9ASX 21, W9BKJ 19, W9CLL 14, W9FCG 13, W9EGE 12, W9AIP 3, W9ENX 3, W9EVA 2, W9AEB 1.

MICHIGAN — SCM, Dallas Wise, W8CEP—W8AAF is on quite regularly in spite of the QRM from the new op. W9CE reports on time this month. Hi. W8KN will be ready soon with fifteen watts and a voltage feed Zepp. W8CU thinks the USDA stations ought to work on 3500. W8BJQ has been getting good results on 14m.c. and 7000 kc. but will be back on 3500 for handling traffic. W8AMS is still silent due to needed repairs. W8ASO is looking for hams who enlist in the Naval Reserve. W8BRS handled some Florida storm traffic and received a write-up in the paper. FB, OM. W9CSI has been working on 14m.c. most of the time. W8BGY has



several schedules and handles a fine bunch of traffic. W8CKZ says traffic is picking up on 3500. W8DVQ, a newcomer, has been doing fine work. W9BTQ will be heard more often now that the YL QRM is over. W8DSF is back on the air with a 310 and 450 volts of B batteries. W8AUB blew his fifty and is now using a 310. W8BLZ reports to let me know Grand Rapids is not dead. Hi. W8CJT-W8OE is on the air at Ann Arbor with a 210 in the TP & TG circuit. W8DED is very QRW. Work, the ham traffic paper and the station sure keep him busy. With all this, he takes the honors this month as usual. W9CEX reports that he has no news—Guess nothing ever happens up that way. Hi. Everybody all set for the next QSO party, November 16th, 7 p.m. for the 3500 kc. gang and let's have all the fellows on that can possibly get on 3500. Will have some letters out soon also a few test messages to make it interesting. For the 7000 kc. fellows, the date will be Sun. afternoon Nov. 18th at 2 p.m. Both tests will be run in the same manner as the last one. Now let's see how many Mich. stations you can QSO on these dates. More details will follow in the letters. Don't forget to turn in the log. OMs.

Traffic: W8AAF 37, W9CE 21, W8CU 1, W8BJJ 24, W8ASO 26, W8BR8 52, W8BGY 127, W9CSI 3, W8CKZ 18, W8DVQ 20, W9BTQ 34, W8DSF 8, W8AUB 8, W8BLZ 3, W8CJT 6, W8DED 163, W9CEX 24, W8DKX 26, W8CEP 41.

ILLINOIS — SCM, F. J. Hinds, W9APY—Would like to see more ORS and more traffic from this state so let's go, fellows. Make schedules for fast work; if you cannot get them yourselves, call on your RM, W9DXZ. W9AAW was QRX for Florida traffic. W9DXG has a new transmitter. W9EJO has a new antenna and works the world. Ex-W9DGA is now W8A1Y. W9PU is now operating from W9MI. W9CCZ is doing early morning work. Schedules are invited. W9BRX wants to know why there are not some stations on 14,000 Kc. W9ALK is rebuilding. W9BSH worked fl-1AB. W9AFF will be on 1760 kc. with crystal soon—also with television using 48 hole disc with speed of 940 rpm every evening, from 7 to 8 CST. W9CUO has a portable call in, W9FZB. W9CIA states his delivered traffic was 95% foreign this month. He is out for greater DX. W9AHK took a navel cruise, gaining some nice experience. W9ECR now has two transmitters. W9BZO is at em again with an xtal. The ops at W9MI are W9AOA, W9PU, W8CTO and W9CSB—they are going to make traffic dust this year. W9FDJ is rebuilding. W9UY has moved to Bronx, N. Y. Sorry to lose you. OM, W9DDE is on again with a bang. W9ERU will soon have mercury arc going. W9DRI is experimenting with television. W9GE of Cicero, Ill. is running a straw vote among amateurs on the coming presidential election and requests amateurs on 3500 work him, stating their choice: Hoover or Smith. If you can't work him, send a card.

Traffic: W9PU 126, W9BZO 104, W9CIA 97, W9MI 73, W9EJO 72, W9FQS 70, W9ACU 60, W9ERU 58, W9AFX 46, W9FCW 46, W9ASE 42, W9FHY 41, W9CUH 27, W9APY 24, W9BVP 24, W9FDY 22, W9AFB 21, W9CNY 21, W9DDE 16, W9FO 16, W9CUO 14, W9CNB 12, W9FDJ 12, W9AHK 11, W9BLL 11, W9AD 11, W9AMO 10, W9RCR 8, W9FDQ 8, W9ALK 7, W9ANQ 7, W9BSH 4, W9DXG 3, W9RTX 2, W9AAW 1, W9AHL 1, W9RPX 1, W9GE 40, W9AFA 3, W9CZT 6, W9DOX 5, W9ARM 75, W9AMN 6.

WISCONSIN — SCM, C. N. Crapo, W9VD—W9DLD breaks into the BPL again and is keeping 13 schedules. He has re-arranged the entire station and is now using break-in again. W9DND handled a lot of traffic originated at W9CAA, W9CAT, W6PS and W1HD radio shows. W9RWZ lives in a small town but his message totals are large. W9BPW says his 1929 Hartley transmitter and Zepp are working fine. He has two new schedules west. W9EMD is rebuilding but his station is on the air with very little interruption. W9EYH at Troy Centre says he gets DC reports using 25 cycle CRAC input to his 1929 Hartley. W9DEK is on the air regularly and wants a few good schedules. W9LV is on the air as usual and says the BCLs are still kicking—as usual. W9GAO formerly W9DSE sends application for an ORS. W9BSS has finally joined the Radio Club and is now one of the gang. W9CVI sends in a larger total each month, has kept schedule with W9DLD since June. W9RWO says he is PB, weather FB, but DX and traffic not so good. W9SO received six messages from the Byrd Expedition and two naval messages

from Porto Rico regarding the hurricane. W9COT-W9FTI says things are going fine, at the station DX is good and the pole is still up. W9FAW has not been active during the summer but says "watch my smoke." W9DZZ has one schedule with W9AMM but is busy with BCL work. W9EWN reported by radio via W9BSS. W9DTK is with us again using the same old quarter KW and pounding out Navy Drill by the yard. W9EBT has been visiting some of the hams down in Ohio. W9DNB has been off the air most of the month rebuilding. W9VD has finished his 1929 transmitter and the boys say she is okay.

Traffic: W9DLD 224, W9DND 197, W9BWZ 138, W9BPW 125, W9EMD 116, W9EYH 52, W9DEK 51, W9LV 50, W9GAO 49, W9BSS 35, W9CVI 25, W9BWO 16, W9SO 13, W9OT 10, W9FAW 10, W9DZZ 10, W9EWN 10, W9DTK 8, W9EBT 5,

## HUDSON DIVISION

EASTERN NEW YORK—SCM, F. M. Holbrook, W2CNS—Seven stations report 89 messages. W2ABY is now back at old QRA and getting out fine. W2AKD will be on air again soon. W2FN's MG set went bad. W2BKN has built MU-PA and hopes are high. He tried to get some 8 inch electrots insulators from W2BKC who said N. D. as saving them for grid leaks. W2HAC makes his first report. He QSR'd egöWY and returned answer in 10 minutes. Using Hartley Zepp with RAC note. W2AGR leaving for school in Boston. W2AYK during summer visited W1GIB and was at Wiscasset when McMillan and the Bowdoin docked. Went aboard and gave WNP the once-over. W2BJJ is putting in mercury arc. W2ACY is just up from typhoid and was visited by W4OO and W8CRF. W2JE having transmitter trouble. W2BPV, ex-3BQK now at G. E. Co., Schenectady and trying to make transmitter work. He would like to see visiting hams. W2BFF wants an ORS appointment.

Traffic: W2ABY 34, W2BKN 23, W2BAC 14, W2AGR 11, W2AYK 3, W2CNS 1, W2BJJ 8.

NEW YORK CITY & LONG ISLAND—SCM, M. B. Kahn, W2KR—Things are coming along fine and this month's traffic took a big jump. Four stations made the BPL. They are W2KR, W2ALU, both keeping nightly schedules with WFRT which accounts for over 150 delivered, W2APD who did some fine work with Porto Rico during the hurricane and W2AVP who is keeping seven schedules per week. Many stations are sending in reports and are in line for an ORS appointment. Keep it up, fellows.

Manhattan: W2WK was the short wave transmitter installed at the A. R. L. booth at Madison Square Garden during the World's Radio Fair and many BCLs were keenly interested in its operation. Many of N. Y.'s prominent amateurs took their turn at the key. W2KR and W2ALU are alternating with nightly sked with WFRT of Byrd's Antarctic Expedition and several wives of members of the crew have visited their stations and held two-way conversations with their husbands. Their reaction to this experience has been enough reward for the time and trouble necessary to carry this out. W2CUQ is still doing his usual good work with foreign countries. W2CB is still active in spite of his vocation as a saxophone artist. W2BGO is doing his best to get a net organized between NYC and L. I. to facilitate delivery into N. Y. W2AFO increased his power to 50 watts. W2ANX blew his tube so is off the air temporarily. W2BNL got back from his vacation and is now on the air.

Bronx: W2BBX is doing some fine traffic delivery and keeps his DX in spite of the weather. W2ALL has had the flu and missed a month at school but is OK now. W2BPQ hollers for traffic (give it to him, gang—SCM). W2AET handled some Mass. Fair traffic. W2BDH is another who has been QRT on account of illness but has recovered. Brooklyn: W2APD took plenty of Porto Rico and Florida traffic during the hurricane. W2PF is busy with the new Army-Amateur Net. W2BAZ is another station in line for an ORS. Long Island: W2BFY hits another high total and will soon have his ORS. W2AVP due to his many skeds made the BPL. W2AEI has been on vacation which accounts for inactivity. W2ATZ is all set for winter after his outboard motor boat has kept



him busy all summer. W2ALS has been rebuilding ala 1929.

Staten Island: W2AFV has returned from his sea-going op's job and will soon be on the air once again. W2BEX is getting some new hams into the game as well as rebuilding his shack for 1929.

Traffic: Manhattan: W2WK 360, W2KR 259, W2ALU 240, W2CQU 163, W2BCB 59, W2BGO 51, W2AFO 36, W2ANX 19, W2BNL 2, Bronx: W2BBX 68, W2ALL 51, W2CVX 43, W2BPQ 43, W2BAD 16, W2AET 10, W2BDH 9. Brooklyn: W2APD 273, W2BAZ 28, W2PF 10. Long Island: W2BFY 194, W2AVP 101, W2AEU 29, W2AIZ 19.

NORTHERN NEW JERSEY—SCM A. G. Wester, W2WR—ORS are failing to report and unless conditions change at once, some fellows' ORS certificates will be cancelled without notification. Some good stations are needed as ORS and anyone interested, please get in touch with SCM Wester, W2WR. W2AT just returned from a business trip. W2WR, W2BDG and several other amateurs welcomed ek-4CL when he arrived in this country on board the Homeric. W2EY is trying out a vertical Hertz. W2KA relayed some messages en route to N. Y. from WFBT. W2BDF is off due to building three high power transmitters to cover all bands, all being crystal controlled. W2ANG handled a fair amount of traffic. W2MD handled the most traffic this month for the section. W2CTQ is attending Newark Technical School which keeps him from the air. W2CJX is away on a business trip and will be off for a brief period. W1OS and W1AGE paid a visit to W2BY. W2BY is having trouble with her ears which makes it hard for her to listen to signals. W2IS has built a MOPA and is awaiting reports on the results. W2AOP is now doing radio service work. W2LT and W2TR have combined and have a fine 500 watt station on 700 kc. W2BHI blew out his grid leak and has a strong desire to install a Zepp antenna. W2BJI is now located in the YMCA building in Hackensack. W2BGG is the only ham in his Section handling traffic. W2BIW is trying very hard to get in operation on 14 meg. W2CHD is completely remodeling for a 1929 station. W2AMT continues to step out in all directions. W2ABE just got his commercial first class ticket. W2AER has gone back to M. I. T. and will be off the air until Christmas. In the meantime, he will be heard from W1MX. W2AEC is a new station in Weehawken using a 210 on 7000. W2ADL expects to be back in Jersey during October.

Traffic: W2AT 8, W2EY 2, W2JC 4, W2KA 26, W2ANG 22, W2MD 60, W2CTQ 3, W2BY 3, W2IS 2, W2AOP 8, W2BJI 1, W2BGG 9, W2ABE 46, W2AER 29.

#### DAKOTA DIVISION

NORTHERN MINNESOTA—SCM, C. L. Barker, W9EGU—This report brings to an end the SCM activities of W9EGU. My term was up Oct. 2nd and I take this opportunity to thank most sincerely each and every one of the stations and operators in this Northern Minn. Section for the very fine cooperation they have given me during my two terms as SCM. The work has been most enjoyable and has added greatly to the pleasures I have derived from my radio activities. My work in the future will be devoted to the USNR and to insurance, which is my occupation. The Section's work would gladly be continued if there were time for it—but there is not. My amateur activities through W9EGU will not decrease in the least, and I hope to work all of you often via my station. Send reports to me until the close of the election. W9EGU has his new screen grid receiver percolating in fine shape. W9EFP, our good old-timer from Barnesville has visited W9EGU several times. W9FFU is a new ORS. He is putting up a new 50 foot pole for his antenna. W9EHI, another new ORS, puts in good reports, and reports another new station in Duluth, W9FZM—Roy Cross—chief operator at WME—the Duluth commercial station. W9DPR reports QRM to start from college and football. W9BBT works on both 3500 and 7000 meters, looking for traffic. W9CWA is working in the Androy Hotel, Hibbing and has his transmitter in his room. W9CKI has gotten back from the Lakes again, and is on with a 75 watter. W9ABV was QRM'd by work. His usual large traffic figures have slumped, as a consequence. W9CTW got on the air with a real hamfest one Sunday, a short time ago.

He has a 1929 75 watter, using Hartley circuit arrangement. W9DOQ was visited by the Radio Inspector and as a result, got his first class ticket instead of the temporary permit. W9AKM is building a monitor box, for easy tuning in 1929. W9DUV is rebuilding for 1929 operation. W9CF is back with us again now. W9KV is on the SS *Chas. Hutchinson*, WMIU until December. He reports that W9BJD has gone to Purdue University. W9EGF uses a 7½ watter when he is on. W9BVH is about through rebuilding for a quick and easy QSY to 3500-7000-14,000-23,000 kc.

Traffic: W9FFU 40, W9EHI 39, W9DPB 33, W9BBT 13, W9CWA 11, W9CKI 9, W9EGU 9, W9ABV 5, W9CTW 2, W9DOQ 2, W9AKM 1.

SOUTHERN MINNESOTA—SCM, D. F. Cottam, W9BYA—This month has brought two official meetings of the Twin City Radio Club to outline the work for the coming winter. They were held at the home of Dr. G. W. Swinnerton (W9IL) and with him at the helm, many things were discussed. These meetings were topped off with very delightful lunches and general station discussion. Several St. Paul hams were present and from all indications they will have some very fine 1929 stations. W9EFO has sold all his old junk and is buying all new apparatus with plenty of power capacity. W9BYA has moved to a first floor apartment and is almost out of luck for a place to put the junk, but is rearranging the house in general so it won't be long now. W9DBW has been QSO 49 times with foreigners this month and most of his traffic has been with foreigners, but did handle some from the Los Angeles Radio Show. His signal strength is very good all over the world. W9EFK's time is very limited but made traffic deliveries from foreigners and also originated traffic for them. W9COS has dressed up his transmitter as per QST and says results are very gratifying. He is writing So. Minn. gang for their skeds to line up the coming season's work. W9AIR has been besieged with hamfests at Good Thunder, Janesville and had one when the Luverne gang came through. Three of the Luverne gang were in Minneapolis also and made a general tour of Twin City stations. Cy Barker, W9EGU was also a caller in Mpls. W9CRW made his first com'l. exam and then missed a job on the Lakes so he is driving at taxi for awhile. No matter how bad the traffic on the street is, he sends code on the horn whenever he sees another ham. W9EYL has a new antenna with good results but has had some trouble with the RCLs. W9DBC does not have much time to be on the air but will keep skeds very shortly. W9DMA's junk went on the Fritz but is on once more. W9DEQ has business QRM. W9BKX is on the air a la 1929.

Traffic: W9DBW 52, W9EFK 36, W9COS 25, W9AIR 5, W9EYL 5, W9DBC 3, W9DMA 2.

SOUTH DAKOTA—SCM, Dwight M. Pasek, W9DGR—W9DWN deserves honorable mention for his high traffic total. He keeps 9 skeds including one with oa-5HG. W9DNS reports school QRM R9 but manages to be on week-ends. W9FOQ and W9DGR are in about the same class. The Sioux Falls gang had a booth at the annual radio show and handled some extra traffic. The BCL part of the show was reported a flop. W9FJR is a new station in Fort Pierre. W9DB has an xm'ter that brings him reports a la 1929. W9DBZ and W9DZI have returned to the School of Mines while W9DKL is giving commercial operation on the high seas another try.

Traffic: W9DWN 601, W9DNS 23, W9DB 12, W9DGR 11.

NORTH DAKOTA—SCM, Bert S. Warner, W9DYV—9CUT has gone to school at Valparaiso, Ind. to get a commercial ticket. Good luck, OM. W9DYA is going strong on 1790 kc. with fone but says he is coming down 7000 soon with the rest of the gang and use CW. W9DYV is very QRW with railway work at present. W9BVF is the new RM in this Section now as W9DKQ was too busy in the filling station to handle the job any longer. I hope all the members will give the new RM their kindest support and also wish to thank W9DKQ for what he has done for the No. Dak. Section.

Traffic: W9CUT 4.

#### DELTA DIVISION

ARKANSAS—SCM, H. E. Velte, W5ABI—I wish to thank the gang at this time for my election to the office of SCM for Ark. I will endeavor to do my best and continue the good work of our retiring SCM, W5AIP. We are glad to note that traffic has taken an upward jump this month.

W5BCZ, one of our newcomers, leads the gang in traffic handling—he handled a bunch of traffic from a Radio Show in Calif. W5ANN is spending a lot of time and effort on his new transmitter. W5ABI has been improving on his transmitter. He reports some traffic. We have several prospects in Little Rock. W5EN is QRW as is most of the L. R. gang. W5SS is QRW working in the harvest fields, but managed to hand in a traffic report. Says he is making some money so that he can build a bigger and better station, FB, OM. W5RH has moved to Missouri and will be heard from there with a "9" call. W5IQ is the proud father of a new baby girl, Congratulations, OM. W5AUU is still looking for that power supply. W5ZAA is busy getting his grocery business going again. He expects to be on this winter. Only two ORS reported this month which is not a very good showing for us. Fellows, I invite you all to drop me a line to let me know what you are doing in radio, or what you are planning to do. If the gang will lend their assistance to the SCM, I am sure the Arkansas gang can and will lead the Delta Division, so let's go!

Traffic: W5BCZ 46, W5ABI 24, W5AQX 19, W5SS 8.

LOUISIANA—SCM, C. A. Freitag, W5UK—W5UT is a new phone ham on the air. Local phone work is continuing to be done here. W5RD is now located in New Orleans and is working on 14,000 kc. exclusively. W5LA is back in the game again but I do not think it will be long before he will have another attack of YL QRW and his station will be closed again until he has recuperated. Hi.

Traffic: W5RD 4, W5UT 40.

MISSISSIPPI—SCM, J. W. Gullett, W5AKP—W5AED reports that his plate transformer expired peacefully one Sunday not long ago at 10:45 CST and that he is negotiating for a motor-generator to provide his 1929 signals. W5AJJ is rebuilding again and will use a TP-TG on 14 m. c. and 7000 kc. instead of the familiar Hartley that he has been sticking to so long. W5GG who is ex-5API says he is still going strong with phone on 1720 kc. and that W5LY at Drew, Miss. and W5QB at Greenwood, Miss. are keeping him company as they are also using phone on the high waves, too. W5FQ is now on after so much talk getting down to the serious business of rebuilding his big 250 watt set. W5AGS and W5AQU have departed to college where they will endeavor to absorb a little knowledge. W5AKP has rebuilt his antenna system and also has a new receiver and transmitter that work beautifully on 14 m. c. and 7000 kc. He is now employed as a BCL repair man at the Radio Service Company.

Traffic: W5AKP 37, W5GG 10, W5FQ 12, W5AED 4.

#### MIDWEST DIVISION

NEBRASKA—SCM, C. B. Diehl, W9BYG—W9ANZ is back from his vacation and says that he is among us for another year. W9FEW is very QRW with RR work. W9DVR is still at 'em. W9EW is QRW with work and can't be on much. W9DFR is operating at WOW. W9BYG is still tinkering. Tinkered so hard that he cracked the crystal. W9DVR is still high man: some of you OI' Timers better get QRW or he will run you all off. W9FAM would like schedules with eastern stations as has a fine schedule west, wants an outlet. W9DI is rebuilding for 1929 between licks at school. W9BOQ is on 3500 for traffic. W9CHB moves a little traffic between times after working the MO-PA set over. W9BQR is on 14,000. W9AEZ comes out for first shot with 42 that's quite a mark. W9EUT breaks out with 50 this time. FR, boys, come again, and show up some of these lazy ORS boys.

Traffic: W9ANZ 6, W9DFR 1, W9DVR 80, W9FAM 12, W9DI 6, W9BOQ 1, W9CHB 10, W9AEZ 42, W9EUT 50.

IOWA—SCM, H. W. Kerr, W9DZW—The month's traffic appears to have been a race of the ORS and non-ORS, with one of the latter topping the list. FB, folks. It looks as if Iowa might be the pivot thru which traffic centers. May we urge, tho, when a fellow says R5 to R7 that the ops refrain from QSZ. It will help a lot in totals and good feelings. W9EDW is heard daily but won't answer the SCM. Hi. Anyway he leads! Hamfest on chix improves W9BCA's totals. He is a good clearing point in

any direction. W9DGW is on 80, upholding Goldfield's reputation. W9EHN has time for traffic the QRW BCL sets. W9CZA renews his Denver skeds. W9CKQ is forced to abandon most of skeds, QRW electric station. W9AYU is QRW traffic with a fine sig. W9PQ gets R8 in Australia—glad to be back after summer inactivity. W9EIW always reports some traffic but has a glass arm from trying to keep a schedule with nu-CAB. W9DEA is back with reports—has combined with W9EIV their QRA now Sioux City and QRW all traffic most any hour of day. Let's have news and skeds, gang. Our thanks to Wis. for their cooperation in traffic skeds.

Traffic: W9EDW 269, W9BCA 239, W9DGW 168, W9EHN 158, W9DZW 84, W9CZC 64, W9CKQ 65, W9AYU 42, W9PB 36, W9EIW 16, W9DEA 13, W9EJQ 7.

KANSAS—SCM, J. H. Amis, W9CET—With only 50% of the section reporting, the SCM is well pleased with the traffic results. Let's go, gang, and put Kansas on the map. W9JU has left the section and will soon sign a 5. W9LN continues to work OZ and keep a lot of skeds. W9CFN is still the star traffic man and says skeds does it with a nice total from the Denver Radio Show. W9HL is moving his station and will be going strong again. W9CKV is rebuilding for a big traffic season on 3500 kc. W9FLG wants skeds with Iowa and plenty of them. W9DNG has been operating at W9EBM and is working lots of YLs. W9DIH is showing some activity again. W9BPL works EG on 14,000. W9BUI has gone to Cuba on his vacation. W9CV and W9BER are QRW with the convention. W9CET is building two 1929 transmitters for 14,000 and 7000 kc. and worked OA, OZ, SC, and FO. W9FKZ takes 26 messages at one setting. W9DFY is going strong with a 210 and combines traffic handling with DX. The SCM wishes to warn all ORS that 8 months is the limit so let's go, gang, and report each month on time.

Traffic: W9CFN 144, W9DIH 16, W9DNG 12, W9FLG 27, W9CKV 11, W9BPL 17, W9LN 31, W9DFY 31, W9FKZ 37, W9CET 25, W9CV 13, W9BER 19.

MISSOURI—SCM, L. B. Laizure, W9RR—St. Louis Stations reported FB this month. W9DSU is a new arrival in St. Louis, moving from Illinois and requests transfer of his ORS. W9CHQ gets the thanks of the SCM for his very complete report by letter. Ex-9EDK is co-operator of W9CHQ. W9AAO reports arranging numerous skeds. W9FUN is another newcomer. W9BHI and W9BEU were the high traffic stations. W9DZN and W9BMU handled some traffic but had various troubles. W9DAE, RM, is QRW for traffic skeds and improving his outfit to handle them better. W9AYK is a prospective ORS. W9CDF resigned his W. U. job and is coming home to go into the radio business at Stockton. W9BQS put up a big antenna and arranged skeds to cover football with W9DAE. W9ECS had a good month. W9ASV remembered we all like news, says that W9EUB and W9AJW are away at college. W9BZM and W9FEQ still on but rather QRW school. W9EPX sent in another good report with three good skeds and promises he will occupy the 3500 kc. band soon. W9CJB reports he is ready for any traffic moving thru Festus. W9DKG has the assistance of W9ARA for second operator. W9BFB is keeping two skeds on 164 meters with good results. W9LLI is keeping a watch for traffic when he can get time off from work. W9ERM applied for ORS and plans QRO. W9BJA reports his OBS schedule is going fine and he gets numerous QSLs. W9GAR is a new station at West Plains, moving there from his old QRA, 5RH. W9CCQ, well known in these parts last winter, has moved to Livingston, Mont. Where he will remain indefinitely and sends his regards to the gang. W9BRO drops in with another good monthly record, but says he is bothered by key click troubles. W9BSV is a new station in Webb City. Kansas City: W9ENU is away for the season at Illinois Univ. W9FTO will try to keep all his skeds and will try to QSO W9ENU via W9MI at Urbana. W9DQN beat the bush for reports for the SCM and is keeping three skeds plus OBS. W9EQC led Kansas City for traffic this month. One of W9DQN's office partners is on the air with a brand new crystal station. W9RR didn't get much traffic this month but got in on the Florida hurricane, copying dope from several stations who were having trying experiences, if one may judge from the log. Several messages were handled from parties having friends

or relatives in the storm zone. The USDA Net lost two stations in K. C. when W9RR was obliged to QSK due to job and W9ENU left for school. W9FIO and W9DOJ are still on the skeds. W9BSB is still off doing experimenting. W9BUR is having his hands full as president of the ham club, plus job QRM at this season—he is in the furnace business. The USNR is going strong in this state with units being organized in St. Louis, Kansas City, and at Lutesville. Others will be organized just as soon as the necessary applications are on hand. W5AFK has moved into this state from Arkansas, locating at Mansfield. The newly established office of the RI in Kansas City is expected to get organized this month. Prospective applicants for exams take notice. Address U. S. Supervisor of Radio, Post Office Bldg., Kansas City. This office will cover Missouri, Kansas, Iowa and Nebraska and probably somewhat beyond. Several of the Kansas City gang will attend the Kansas Convention at Topeka in October.

Traffic: W9BHI 38, W9BEU 64, W9BMU 11, W9DSU 1, W9DZN 5, WCHQ 29, W9DAE 18, W9CDF 8, W9ECS 35, W9ASV 9, W9EPX 17, W9DKG 12, W9FBF 2, W9ERM 21, W9BJA 41, W9RBO 21, W9EQC 142, W9DQN 38, W9RR 15, W9AYK 92.

### NEW ENGLAND DIVISION

AINE—SCM, Fred Best, W1BIG—Attention gang! The SCM wants at least one more Official Observer station to team up with W1AQD on observer work. A good frequency meter is the main essential. Also two stations with a good punch are desired to send the OBS at least three evenings per week. Let's hear the gang on these assignments, pronto! W1AUR sends in a real total this month. This shows what a few schedules will do for a traffic man. Congrats Hal. W1CDX is located on 7320 kc. and 3940 kc. and wants the gang to know that he is ready at all times for traffic on both hands. Hop to it, gang, and relieve his desire for real messages. W1ANH pulled off the best bit of relay work of the month. He heard VE2AL calling CQ NYC RUSH for 40 minutes without response, so he answered and told 2AL he could relay. Harry took the message, and called QST NYC three times, at which W2AT came right back and took the message. The message in question was in a race with a like message mailed thru regular mail and was delivered in NYC in fifteen minutes after first relay. Harry says credit for good relay work should go to all three stations, FB, OM, that's the kind of work that really counts, and we are glad that a Maine station was such an important link in such an important relay. FB, W1AIT sends in his last report, as he is quitting the game. We hate to lose you, CP, OM, and trust that you will not be able to stay away long. Good luck! W1BFZ reports very QRW with work now. He continues on 14,000 kc. and has thus far kept up the good DX work for which he has become famous in this Section. Mrs. W1AJC reports for both the OM and the OW. She says they have a fine 1929 model transmitter almost ready to go on the 3500 kc. band. W1AVQ is still on the sick list, but we hope to hear him on the air again real soon. W1ARR, the Queen City Radio Club, is functioning in the usual fine style, and the boys are busy with the details of next year's Second Annual Maine Section Convention which will be held in Bangor, and which should be very FB. W1COV, a new Norway ham, sends in his first report. We trust he will keep up the good work and land that ORS which is bound to come sooner or later with a little hard work. W1AUR, W1AQD, W1CDX, W1ANH, W1KY, W1BTT, W1COV, W1AJC, and W1AHY are all interested in the Maine Section of the USNR and plan on joining soon. FB.

Traffic: W1BIG 182, W1AUR 101, W1CDX 81, W1ANH 28, Mrs. W1AJC 14, W1AIT 9, W1BFZ 7, W1AJC 6, W1AQL 5, W1COV 2, W1ART 19.

EASTERN MASSACHUSETTS—SCM, E. L. Battey, W1UE—W1AKS leads in traffic with over 200. That's the best total for this section for a long time. W1BTT and W1BIX are now ORS. W1KY is trying to get Boston in W3ZF's 20th Century Route. FB, W1NQ and W1BDV are back at college. W1BDV has rebuilt. W1RF took 4 messages from NITB and did some good work during the hurricane with NBB. W1CMZ is using 2-210's with 150 watts input.

WINK visited W1AWQ at North Lovell, Maine with W1BOB and W1CLM and report a fine station. W1ACH is making new receiver per Sept. QST. W1RY worked 5 OA's in a row plus QSO with FK, FM and OZ. W1GP is QRW with study and YLs. W1ACA is going strong once more and reports working Scotland. W1AZE is doing some good work and holds sked with ne-8AE for Boston traffic. W1UE has a new tube but does not expect to be on so much due to Night School. Acme is keeping W1APK busy so not much news. W1ATO sends in his first traffic report. FB, OM, why not try for ORS. W1AKS and W1AHV still hold the fort at WIM-WCC. They report W1CY in Chatham manned by WCC ops. W1VR has returned from Europe after taking in the Olympics. Things are picking up at W1BZQ, which sounds good. We don't hear that very often. W1AAW is overhauling and says if things go the way they have been going, he will be on the air about 1942. Hi. W1KH has an acoustic filter which he made himself and he says it cuts out static and QRM. Hurrah. W1BVL is operating occasionally at W1KX, Danvers. Dick says YLs and work ruin Radio. W1ASI is trying hard to get a sked with WFA, FB and good luck. The Eastern Mass. Amateur Radio Assn. has started up again. The meetings being held in Mifflin Hall, Cambridge. W1RL is building a new shack. W1CRA is running a straw vote and reports Hoover ahead. W1WV gets better reports with his new MG and he keeps several good schedules. W1BMS is back from his trip to Europe on NFU.

Traffic: W1AKS 227, W1CRA 141, W1ACH 109, W1BZQ 64, W1KY 47, W1KH 35, W1UE 29, W1ATO 25, W1ACA 24, W1AGS 21, W1BIX 20, W1WV 26, W1RY 19, W1ASI 17, W1RF 11, W1AAW 8, W1CMZ 7, W1GP 7, W1BVL 4, W1BTT 3, W1APK 2, W1APK 2.

WESTERN MASSACHUSETTS — SCM, J. A. Tessmer, W1UM—Huray, fellows! Greetings and best wishes to the Blackstone Valley Radio Assn. The station call is W1JB, 138 messages in 2 days at the Uxbridge Fair is sure fine business. Chief operator was Lester Irons, W1BZJ. Code classes are being held two times a week. L. L. Irons is president; W1COS, treasurer; and Walter H. Kozacko, secretary. Western Mass. may expect a lot of activity from this new peppy organization. Who is going to help W1GR take down his stick, paint it and put it up again? It is going to be a zeppelin antenna this time. W1EO will be back on the air this fall. W1ADO is a new ORS. W1FG will be active during the winter. W1AZD is all set for 1929. W1ANI is lining up his schedules with his new 852. Some of the Worcester Radio Assn. members had a fine time visiting W1MK. W1AMZ will QSO from college station. W1APL's set is OK now for 1929 schedules. W1BVR will be QRT except during school vacations. W1AKZ has schedule with W1AVC, Monday, Wednesday and Friday, 11 p.m. W1ANI cooperating with W1AOF will be the OBS of Western Mass., W1AOF on 14,000 and 7000 kc. and W1ANI on 3500 kc. W1BKQ had a shack warming party Oct. 3rd. Will someone go and see W1BIV and ask him how come? After his active interest of the past, we wonder how and why? W1ASU is using split coil Hartley on 7000 kc. and says its FB. W1AMW is all lined up for 1929, crystal control.

Traffic: W1AOF 22, W1AMZ 21, W1BKQ 6, W1ANI 5, W1AZD 23, W1FG 2, W1ADO 5, W1EO 10, W1AKZ 6, W1APL 7, W1JB 138.

CONNECTICUT—SCM, Carl Weidenhammer, W1ZL—Traffic has started to amass itself in imposing totals. W1MK, in true Ben Adhem fashion, led all the rest. W1ASD was a very satisfactory second. He handled most of the Conn. State Fair traffic with W1AIC. W1AFB has a daily schedule with nj-2PA. Two hundred words of hurricane traffic and twenty-five messages of the same variety were handled with Florida and the West Indies. W1AMC also stepped in and did his bit during the deluge by handling relief traffic with np-NBB. Nice work, fellows. W1VE is in a quandary. To get away from BCL antennas, he must erect his sky-wire over a municipal tennis court. We eagerly await the results of his interview with the City Fathers. Good luck, John. W1CTI is nicely settled in his new home and has opened up on 3500 with a 210. Several schedules are in the works. Our old friend, W1HJ, reports that his set will be torn to the very ground

soon to give way to an ultra-keen "1929 type" installation. We hope that the whole gang is following suit. WIPE had a very pleasant vacation. Schedules with WIWV at 6:30 am on Sunday, Tuesday, Thursday and Saturday and with WIBEA at 6:00 am on Monday, Wednesday and Friday are being kept by WIBNS. WIAMG and WIAUQ spent a few days with their congenial friend, WIAWQ. Schedules were kept by WIAMG with WIBAV and WIAWQ on Monday, Wednesday and Friday and with W3QL daily except Sunday. He also did some relief traffic handling. FB, OM, WIOS, our charming YL op, WIAEQ and WIAGE of Mass. paid the SCM a visit a few weeks ago. Everything was discussed from cabbages to kings, and "Yours Truly" certainly did enjoy the call. There's a big "Welcome" on the mat. Won't you all please make it a point to drop in? But getting back to reports, we find that WIOS worked San Salvador on her "one gnat-power" "B" battery transmitter. FB, WIBGC is on the 7000 kc. band. WITD wants an outlet for his Hartford traffic. He is keeping a schedule with W3AKB on Monday, Thursday and Saturday at 7:30 pm. His schedule with WIBI-WIBQH was resumed on October 3. WIVB keeps his schedule with WIMK at 8:45 pm on Tuesday and Friday. WIBI-WIBQH is having difficulty with a DC power supply in his Boston residence. He expects to overcome the obstacle shortly. Parmenter of WIMK reports that he now has schedules with every district. Through an unfortunate misplacement, WIBKI's report was not included in last month's write-up. We apologize. The Gullan's brothers are on the air in Brantford whenever they can get the time to journey up from the city. WIRP expects to get a mercury arc rectifier very soon. He still gets reports of R9 from both Europe and the sixth district. Very pretty. WIQV of Mystic wrote and told of conditions in that part of the state. There is an unprecedented number of stations on the air and there should be no difficulty in moving Rhode Island and Mass. traffic. WIBHM is back in New Haven after a great summer in the Catskills. He is all ready to go on 3500 kc. and reports a prospective candidate for ORS in WIBAV.

Traffic: WIMK 536, WIASD 210, WIAFB 60, WIAMG 43, WIVE 42, WIBNS 34, WIRP 30, WIBKI, 26, WIAMC 22, WITD 20, WIPE 17, WIHJ 10, WIVB 5, WIBGC 4.

**NEW HAMPSHIRE**—SCM, V. W. Hodge, WIATJ—WIIP again leads the Section and says that things are picking up. WIMS is DXing on 15000 kc. with a sepp. WIAUE says he and his new transmitter are going to be busy in the BPL next month. WIAEF lost a 210 but is pounding out with a 1929 transmitter. WIAUY is getting out well. WIAOQ is operating at WICAN at NHU. WIAFD reported by radio. WIBST, a new ORS in Berlin, is now on and ready for traffic and schedules. WIBFT is busy getting the set going at Durham. The SCM is proudly pointing out to callers the Extra First Class ham ticket now at WIATJ. Mim. Activities in this Section point to a most successful traffic season. Most of the gang have finished rebuilding and are getting down to schedules and regular operation.

Traffic: WIP 49, WIAUE 31, WIATJ 32, WIBST 10, WIAEF 8, WIAUY 1.

**VERMONT**—SCM, C. A. Paulette, WIIT—The SCM takes the booby prize this month with just one message delivered but say, boys, I have surely been a busy man this summer. I am intending to get busy pretty soon—then look out. Haven't got very many report cards this month—come on, boys, and let us know what is going on. WIBJP turns in a report this month, also WIAOQ who says that due to being very QRW, he has not done much traffic work this month. WIBCK has been moving his outfit all over the state lately and is now setting it up in the Armory and hopes to get it going soon. WINH is on every Sat. and Sun. night. QRW experimenting with television.

Traffic: WIAOQ 19, WIBJP 14, WIIT 1, WINH 10.

**RHODE ISLAND**—WIBQD has resumed activity for the winter. Revamped transmitter to a 1929 variety. WIBLS's transmitter is perking well again and traffic seems to be picking up. WIMO says 14,000 kc. is a little better now but not much for skeds. WIAWE hasn't been on much lately but is QSO most everything he hears. WICKB says traffic is a little better this month. WIBDQ is back on the air again and going strong with a brand new UX-250. The

Coast Guard Cutter *Marion* has returned from its northern trip and is now stationed at Block Island with the call letters WICHC. Any communications should be addressed to Officer in Charge, Block Island Radio Station, Block Island, R. I.

Traffic: WIBQD 24, WIBLS 9, WIMO 10, WIAWE 11, WICKB 13, WIBDQ 4.

#### NORTHWESTERN DIVISION

**IDAHO**—SCM, James L. Young, W7ACN, W7JL—This is the first report from your new SCM, and he will appreciate the cooperation of everyone in his section in bringing the section to the front. W7ACN has been traveling this summer, doing photographic work with W7ACK but he hopes to be on as soon as he gets a lot of work off his hands. W7ACK-W7ALI is the instructor of the Nampa High School Radio Class which has 25 pupils. W7HK is the call of the school station and it will be on regularly during school hours, with plenty of ops. W7IO, one of the oldest of Idaho's old timers, will be on all winter with a pair of 852's on nearly all the ham bands. W7ABB and W81Y are the only active ORS to hand in a traffic total this month. W7AOC, ex-9BKH, is on regularly in Boise, and is after DX and what-have-you with a 7½ watter. W7YA, another Idaho school station, is on again with a radio class of seven and some good ops behind it. The school no longer owns KFAU. W7UJ, of Eugene is the new op for the new KFAU and he will be on all winter, using his ham set. W7YA is putting in a 500 watt ham set at the Idaho State Fair. W7ST-W7ALD, our last SCM, is going to Eugene to school where he will also operate KORE, W7AMG, formerly of Eugene, will be on in Boise this winter looking for DX and traffic. W7EJ is on the air. W7AFK is getting a set going and will be on steady this winter. W7IY got R7 from ex-2GO two nights in succession. He is using 7000 and 3500 with a fifty. W7ACK-W7ALI will be on all winter, also with a fivev and 210 in parallel. We fear that W7ZN has quit us. W7CJ is on quite a bit.

Traffic: W7IY 29, W7ABB 21.

**MONTANA**—SCM, O. W. Viers, W7AAT—W7AAW snapped out of it and took first place in traffic this month. W7ZZC-7JC of Portland, Ore. who is now located at Billings, works on 7000 and is looking for traffic. W7DD reports that a new ham is getting ready to go on the air at Glasgow, Mont. FB, W7EL says he's vy QRW with his apple crop but will be on more from now on. W7FL says his UX-250 doesn't perk right. W7AAT had QRM from motorcycle.

Traffic: W7AAW 55, W7ZZC 30, W7DD 23, W7EL 3.

**OREGON**—SCM, R. H. Wright, W7PP—W7MF has worked all continents—also worked aj-7MF. He says that 14,000 kc. is improving. W7UN has been on consistently, handling traffic, his 1929 transmitter is working FB. W7GO has kept regular contact between na-7AY and his parents for 10 weeks. Alaskans are very easy to raise from his location. W7SI finds 14,000 kc. excellent for QSR east, he will be on soon on all bands. W7AMQ, a comparatively new station is doing some good relay work. W7ALK is on consistently. W7ABH has worked another FO station. W7ACV is installing a 50 watter. W7JN has decided to install either a 50 or 75 watt crystal controlled station. W7ALT took his portable W7AFL on his vacation and managed to move traffic through it. W7YK has a new transmitter and receiver and will be on soon. W7AJW is being rebuilt for higher power and 1929.

Traffic: W7MF 100, W7UN 82, W7GQ 26, W7SI 25, W7AMQ 19, W7ALK 17, W7ABH 14, W7JN 12, W7LT 8, W7AFL 2.

**WASHINGTON**—SCM, Otto Johnson, W7FD—W7LZ and W7TX continue as clear stations for Alaskan traffic. W7LZ is experimenting with different antenna systems. W7BR, W7AM, W7KO, W7FD and several others help keep Seattle on the map. W7ACS seems to be Tacoma's only active ham—he reports school QRM. W7TZ in Casey is heard frequently. Many hams are getting sets on the air at the different schools. W7BB has returned from Alaska and will help out the Seattle totals. W7AG is building a new radio room. W7LR will soon be on. An attempt to QSO with Mason of the Byrd Expedition is to be made by Seattle stations. All

ORS are requested to report to the SCM each month. Another house-cleaning may be necessary to keep live stations only in the ORS list.

Traffic: W7LZ 104, W7TX 92, W7BR 22, W7ACS 15, W7AM 10, W7OV 10, W7FD 6.

ALASKA—SCM, W. D. Wilson, WWDN—K7HL sends in a real total to celebrate the close of the canning season. K7ABE and K7AER will probably be the mainstays of Alaskan traffic over the winter. They both keep schedules with W stations.

Traffic: K7HL 290.

### PACIFIC DIVISION

LOS ANGELES—SCM, D. C. Wallace, W6AM—Nine stations made the BPL this month: W6BZE, W6ASM, W6DSG, W6ZBJ, W6BRO, W6ABK, W6AKD, W6UJ and W6AGR. W6BZR made a few skeds for Radio Show traffic. W6ASM reports that the ARRC handled 2152 messages at the Radio Show, which was a huge success. The club wishes to thank all stations that helped send the traffic. W6DSG has been very busy with his outfit at the Ventura County Fair. In three weeks he has also started three new hams by ordering and delivering each a copy of Handy's handbook, and getting each a subscription to QST. W6ZBJ is very QRW work. W6BRO operated at Mines Field during the National Air Meet of one week. He says it was quite an experience, trying to copy signals with planes passing within 25 ft. with their motors wide open. W6ABK just QRO'd to 50 watts. W6AKD wants to have another Radio Show so we will not run out of messages. W6UJ handles some traffic from KNT, also few from Byrd's ship "City of New York." He says W6ZBJ and his family stayed all night with him a couple of weeks ago, and W6ZBJ wanted to swipe his ship clock. W6AGR had a two hour contact with W2LX of New York City. W6BCO is trying to convert his station in to a 1929 model but is having trouble keeping the plate current down below 200 mils on his UX210 with about 800 volts on the plate. W6GHT announces that old 6AJI of Redlands is now on the air again at Long Beach signing W6HT and rarin' to go. W6OF is building his 14 m.c. set into a 1929 layout. W6AWY is a new ORS and sends in a good report. W6DKV delivered a message of U.S.S. Arizona from nn-7NIC and got a long letter of appreciation. W6APW has tried out a tube rectifier. W6DEM is a new A.R.R.L. member and says it is a relief to have QST come in the mail instead of having to buy it at the newstands. W6EEB has been keeping some good schedules and is on regularly. W6QL reports that at last cards have been mailed to headquarters for the WAC certificate and everybody's happy. He says he hears lots on 28 m.c. W6CUH has been keeping a sked with sc-1AH for two months now, and will be glad to QSR all South American traffic. Sigs are R8 at both ends. W6PY is back at the key again. W6AOS reports DX very good now, FO being worked twice and a report of R7 from FO-A4E received. Now he only needs Europe for WAC. W6COT is using two 216 U's for rectifiers now and finds them very efficient. W6DHR hasn't had much time this month due to work but expects to get fired pretty soon and will have more time then! W6DEG reports that W6ANO is sure a FB op. He stood by one AM with break-in and got an important message a word at a time through heavy QRM from two hams. This is W6DEG's third winter sked with him and he wishes he could find a couple more like him. W6ALR has gone into business. W6AEC expects to move in the near future, near center of L.A. W6APY is experimenting with a spark coil plate supply. W6GHT is running coastwise on the S.S. Covena. Keap, but manages to handle a few messages from W6GHT when in port. W6CZT sends in a report as usual. W6BJX QSO'd SPCL. The Pasadena Short Wave Club picnic was successful, with 25 present and a good time had by all. W6AKW will begin the old game again in earnest in another month. W6EAF started transmissions for new hams, code practice, etc. W6SJ has been transferred to San Diego. W6ALZ's report comes like a voice from the dead—he was on a summer trip to the Hawaiian Islands. W6DHU is playing football in addition to his ham work. W6DLK went to visit W6DNI who is in the hospital. W6BVM has been off the air for a while. The Associated Radio Amateurs of Long Beach met Sept. 10 and awarded low power prize to W6ANN and W6HT. W6ANN was QSO Australia on 3 watts. The Amateur Radio Research Club of Los

Angeles held the quarterly banquet in L.A. on Sept. 12 with 117 present. It was one of the most successful affairs of its kind we have ever seen. Director Babcock came down from San Francisco by airplane and gave us a fine talk. W6AVK was master of ceremonies and furnished very fine entertainment. Mr. James Warner, radio operator of the Southern Cross, gave a fine talk, and said that "outside of a little unpleasant weather, practically nothing eventful happened!" The Short Wave Club of Pasadena held a meeting on September 7th at the Pasadena Public Library with an interesting program. It included a talk on the proposed Pasadena Radio Institute given by Mr. Whitney; an open discussion conducted by W6KA and special entertainment features. Business brought up included important changes in the club constitution, change in frequency of meetings and the coming A.R.R.L. convention. The ARRC did some good work at the National Air Races at Mines Field: Ten hams helped, with Bob Eldridge in charge and Bert Fox as right-hand man. There was one man with a set at each of the pylons to check up on the fliers. McGreery, W6LJ, was in charge of the entire project with Bob Parrish, president of ARRC, assisting. W6CAG is still trying to make skeds whenever possible. W6CZU has been sick for two weeks with the mumps. He is QRW college, also. W6DYU received a message from oo-BAM, phoned it to Los Angeles, got an answer and called oo-BAM and delivered the answer. FB, OM. W6CHA got a fine total from the Radio Show. FB.

Traffic: W6BZR 774, W6ASM 483, W6DSG 312, W6ZBJ 228, W6BRO 212, W6ABK 209, W6AKD 202, W6UJ 198, W6AGR 74, W6BCO 122, W6HT 82, W6OF 63, W6AWY 52, W6DKV 44, W6APW 43, W6DHM 40, W6AM 32, W6EEB 31, W6QL 23, W6PY 20, W6AOS 18, W6DHR 11, W6DEG 10, W6ALR 9, W6AEC 8, W6DPY 5, W6GHT 4, W6CZT 2, W6BJX 2, W6AKW 1, W6SJ 2, W6CAG 7, W6DYU 35, W6CHA 274.

EAST BAY—SCM, J. W. Frates, W6CZR—Traffic went up again in the E.B. section this month for a variety of reasons. In the first place, W6IP and W6CCT staged and impromptu private traffic contest, the loser to buy the winner and the SCM an expensive dinner. W6IP won hands down with a big total secured from five schedules. W6CCT, however, expects to stage a comeback next month. During the Admission Day celebration of the Native Sons and Daughters in Oakland, W6BDO established W6SR in the Joy Zone and fed a steady stream of traffic to W6IP and W6ALX for various parts of the world. W6CZR was the fifth station in the section to make the BPL through his deliveries from skeds with op-IPW and K6BQH. W6CTX brought up quite a mass of traffic in spite of spending a lot of time going after DX stations in FO, OA, OZ and AJ. W6CGM reports the power leak easing off and traffic work getting better. He is changing over his UX-852 tuned plate tuned grid to a high C circuit a la Ross Hull and claims it is hot stuff and almost makes inductance warm enough to heat up the coffee he is always drinking. W6HJ complains that traffic is off but says his sked with K7AER is FB since they have taken up checker playing over the air. K7AER still holds the lead. W6HJ offers to QSR any traffic for any point in Alaska. W6BL, a new ORS, and a Naval Reservist, is doing considerable traffic work between the coast and Hawaii as well as working OP and trans-Pacific occasionally. W6BOY spent another of his periodical visits home from sea duty running up some more ham traffic totals. Hi. He has just shipped out on KDQJ after getting off WHM, but says he will be back in time to send in another report next month. W6DTM has his station on the air again and all set to get back the old traffic totals and sked which went haywire when he blew his 852. W6AWF is still pounding away in the Berkeley hills back of the Univ. of Calif. and is coming up as a traffic man. W6BZU at Concord has no skeds at the present time but he wants some as soon as he can get them. FB. W6ASJ getting across the Pacific in fine shape, subbing with op-lpw in great shape when his W6CZR sked went haywire. W6BSB and his Ultraudion on 14,000 and 7000 kc. are coming up in the traffic work. W6CDA says things are a great deal better this month, thanks to an 852 and a shield grid receiver. W6DKO pounded his own station and was one of the operators who assisted in the carnival work of W6SR. W6EDK ground out some traffic, as well as pounding out the ARRL broadcasts on the convention. W6AMI is

still on 7000 kc. and handling some traffic. W6CUG interspersed his experimenting on 28 m. c. with traffic work on 7000 kc. W6BUX reports a new transmitter and says he is starting a couple of Asiatic skeds. W6EDR has a 210 and is rebuilding a Ia 1929. W6BMS is on the air with a UX112 with 250 volts DC. W6EY has been away for most of the month and is rebuilding both his transmitter and receiver. W6CLZ is QRW school but has hooked up again with K7AER on 14,000 kc. W6CMG says he has been trying to get the set going all summer but expects success soon. League section meeting was held this month in Vallejo, the Oakland, Berkeley, and Alameda gang going north by automobile. W6BPC, W6DTL, W6HJ and others of the Vallejo gang put on a nice meeting and lunch, and conducted a tour of Vallejo stations. Everybody had a good time and found the Vallejo gang a FB bunch. Order of Night Hawks was organized during the month for the purpose of banding traffic men together to work out mutual problems. SCM and CRM are the presiding officers, and W6BDO was appointed secretary. To become a member, one must have 50 messages a month mailed to SCM, and 50 messages a month thereafter. Failure to get the 50 msgs means a cent for each message less. At end of three months, the membership decides whether to drop a man for lack of traffic or keep him because of circumstances beyond his control. Chapters can be organized in other sections.

Traffic: W6IP 548, W6CCT 265, W6ALX 252, W6SR 201, W6CZR 95, W6CTX 94, W6CGM 69, W6HJ 44, W6BI 54, W6ROY 64, W6TMD 29, W6AWF 28, W6RZU 23, W6ASJ 23, W6BSB 19, W6CDA 16, W6DKO 12, W6EDK 12, W6AMI 11, W6CUG 7, W6BUX 1.

SANTA CLARA VALLEY—SCM, F. J. Quemont. W6NX—W6AMM continues to lead the section in message handling due to his reliable daily schedule with opIHR. Right through the worst static season, his signals continue to pound in at IHR. This month 276 delivered messages! If ever an amateur deserved credit, Bruce Stone, 6AMM should receive it. It looks like a cinch for him to win the Pacific Division Traffic Trophy to be awarded during October. op3AA visited this section during the month and many pleasant air acquaintances were confirmed in person. W6DRI expects to ship to sea in the near future and consequently his station will not be on the air for some time. W6BHY rebuilt his transmitter and power supply and is ready to bust the ether with a genuine 1929 signal. W6BAX with 18 watts input into a 201A received R8 from sc-1AH. He is now a WAC and the 12th member of the Santa Clara County Amateur Radio Association to join this exclusive club. W6ALW is another SCV ham on the air with a 1929 signal. He will use the 14 m. c. and 7000 kc. bands with 1929 performance. W6AJZ is again back on the air. W6KG has a SG receiver perking. His mercury arc is producing a 1929 note.

Traffic: W6AMM 384, W6DRI 39, W6BYH 10, W6BAX 7, W6NX 1.

ARIZONA—SCM, D. B. Lamb, W6ANO—W6BWS leads the state in traffic this month. FB. W6BWS's YL came back from Kansas and suggested that he go to college. We now find BWS in college. W6CDY is back at the U. of Ariz. and can be found at 5 pm MST daily except Sunday. School KRM makes him QRW. W6BJF has been on 14,000 kc. mostly. Also QRW work. Been QSO quite a bit DX during this month. W6AZM still works radio between spare time. Will do more traffic handling this month. W6EAA is playing with a UX 222 receiver. W6DTU reports and has applied for an ORS. W6ANO is on the air mornings from 8 am to 9 am MST. W6DCQ is on occasionally. W6CCL is in Phoenix from Fresno, Calif. and will be on the air soon with 50 watts. W6SW is also heard occasionally. YL takes his spare time. Ex6ACG has returned to college at Stanford.

Traffic: W6EAA 11, W6BJF 36, W6CDY 8, W6BWS 392, W6ANO 70, W6DTU 8.

SAN DIEGO—SCM, G. A. Sears, W6BQ—W6AJM is again at the top with two daily schedules with the Philippines. He expects to move into a new shack soon. W6BYZ is also handling daily schedule with Philippines and has a good traffic total. W6BQ found time to handle a few messages this month. W6EC has a daily schedule with the Philippines and nu-INIC. He has been spending his spare time

recently in making wave meters and building a grid meter driver. He plans on crystal control shortly. W6DNS reports the passing of one of his much loved 50 watters. W6BAG has been rebuilding. W6DAU had a few days' leave and sends in his report again. Was keeping a schedule with WCBWS. W6DGW don't find much traffic on 14,000 kc. W6CNK is back at school again. W6BAS now has four complete transmitters ready to go and is QRV to recalibrate wave meters from his crystal oscillator. W6BAM is rebuilding for 1929. FB. W6BFE has installed 281a. W6BGL reports QRW ranch work. High frequency transmitter using call NDT on the 3500 kc. band will soon be in commission at USNR headquarters, San Diego. The shack is being repainted in readiness to install the equipment, most of which has now arrived.

Traffic: W6AJM 656, W6BYZ 126, W6BQ 46, W6EC 40, W6DNS 35, W6BAG 26, W6CNK 20, W6DGW 16, W6DAU 13, W6BAS 13, W6BAM 8, W6BFE 4.

HAWAII—SCM, F. D. Fullaway, K6CFQ—Let's improve our showing next month, fellows. K6CFQ, K6DPG, K6CLJ and K6DTG were active experimenting on 28 m. c. K6CLJ was heard in the U. S. first. Who is next? K6DQQ had the most traffic. He was in the U.S. several days and visited some of the gang. K6AVL has two ops now and wants skeds. He has a shield grid receiver. K6ALM is an officer in his high school radio club and is very active. K6DPG has a new 1929 high C transmitter. He rectifies 500 cycle for plate supply. He is active on 28 m. c. K6DJU still works. He QSO's W's with a 201A tube. K6CFQ is trying 28 m. c. and at the same time, attending the University. K6DLJ is FB on 28 m. c. He is also on 14 m. c. and 7000 kc. K6DCU built a 1929 transmitter and K6CFQ put up his new Zepp and guaranteed results. He got them—R7 on the coast. Let's see more reports even if you are not an ORS. We need them, gang.

Traffic: K6DQQ 85, K6AVL 36, K6ALM 34, K6DPG 32, K6DJU 26, K6CFQ 21, K6CLJ 13, K6DCU 1.

PHILIPPINES—Acting SCM, J. E. Jimenez, op1AT—This report via radio from opIHR via W6AMM; from opIDR via W6AMM; from opICM via W6AJM. Lt. Bicher of opIHR keeps schedules with the following: ac8ZW (Shanghai Observatory) 6 pm daily; ac2AB (Tientsin) 6:45 pm daily; opIRC (Cavite) 8 pm daily; ac2MO (Hainchou, China) 8:30 pm daily; W6AMM (San Jose, Calif.) 9:30 pm daily. Traffic may be routed efficiently for the U. S., Hawaii, China, Straits Settlements, Aden, and the Philippines. opICM has schedules with ac7SW (Hong Kong, China) 7 pm daily; acWUQ (Tientsin, China) Mon. Wed. Fri. 7:30 pm; W6AJM (San Diego, Calif.) 9:30 pm daily. Escudero of opIDR keeps schedules with opIAH and opIRC locally and with am8AB weekly. opIAE works in conjunction with opIDR.

Traffic: opIHR 654, opIDR-1AE 133, opICM 409.

#### ROANOKE DIVISION

WEST VIRGINIA—SCM, C. S. Hoffman, W8HD—There has been a marked increase in traffic handling for the month. W8CLQ has been doing some very good traffic handling work for the past several months. He also reports his brother breaking in the game and W8AIC a new station. W8APN and W8ACZ also made the BPL this month. W8BPU operating new BC station "WMMN". W8DCM is doing some good DX and traffic work. W8DNN made a trip to several BC stations in Ohio, getting dope for his new zone set. W8DPO still using 7800 kc. (33.7 m.) and 15,400 kc. (19.5 m.) W8AUL and W8HD brushing off cobwebs for another fall season. W8BBM resigned as ORS as is QRW college. W8ADI and W8VJ have been cancelled. The SCM hopes the gang will avail themselves of the opportunity now to get one of the new Extra First Operators licenses. WSOK is proud father of a baby girl.

Traffic: W8CLQ 248, W8APN 206, W8ACZ 205, W8DCM 74, W8DPO 20, W8DNN 2, W8BCN 1, W8AIC 3.

VIRGINIA—SCM, J. E. Wohlford, W8CA—W3CKL at present has the following operators, W2ASE, W3BHM, ex-3AJJ, W3ARX, W3AWX and W4AB. We would like to see some more reports like this from some of our stations. W8BZ continues to work skeds with W8CMP and W8ZZ. W8BZ works on 7000 kc. (40 meters.) W8CMP and

W8ZZ working the 3500 kc. (80 meter) band. W3AMB reports using single 210 in 1929 Hartley feeding Zep voltage feed antenna, chemical rectified. W3ASA is on the air with one 18-year old ham and a YL ham. W3FJ and W3OH are two new stations at Richmond. W3ASC has opened up at Danville with the call W3HY. W3ALS handled eight death messages to New York and beat WU by six hours. Has a flock of skeds and wants more. W8KU is still at sea working KEGC and expects to be back on the ham waves soon. Says W3WM is lonesome without W3CEB and W8KU. W8KU visits the hams in ports. Let's hear from some more of the ORS. Some of you are getting a little careless about reporting as you signed up to do. Let's have a card if nothing else to let us know that you are still living and on the air at times.

Traffic: W3CKL 158, W3AMB 8, W3ALS 46, W3CA 8.

**NORTH CAROLINA—SCM, R. S. Morris, W4JR**—Fellows, I want to thank you all for your fine cooperation during the several years in which I have acted as ADM and SCM. It has been a pleasure to work with you and I only wish that time permitted me to continue. Lend a helping hand to the new SCM, W4SJ, and let's see if we can't bring amateur radio to the front in this section. See you on the air often now. W4TO takes the honor roll position this month with 185. He handled lots of emergency traffic to the Florida storm section. W4OC has put in 7120 kc. crystal for 1929. W4TS has his new set on the air. W4VH reports little traffic and lots of rag-chewing on 7000 kc. W4JR is sticking closely to 3500 kc. with the advent of cooler weather. W4VH reports good work with a 201-A on 7000 kc. W4AEH has quit the tuned grid tuned plate circuit for the Hartley. He reports QRM fierce on 7000 kc. (try 3500, OM, its FB). W4AFW is thinking of applying for ORS appointment. W4SJ will be working in Norlina for the next six months so he is moving his set there. W4AEW has fine skeds north and south.

Traffic: W4TO 185, W4AEW 16, W4OC 48, W4VH 17, W4AFW 16, W4JR 10.

#### ROCKY MOUNTAIN DIVISION

**COLORADO—SCM, C. R. Stedman, W9CAA**—Things are picking up in fine shape here so early in the season. Four Colorado stations made the BPL and totals show a good increase for most other stations. Part of the large total can be blamed on the Denver Radio Show. It would be larger had all the stations who handled radio show traffic reported. W9BQO, whose station was remotely controlled from the radio show booth, takes first place. W9CAA handled most of the balance of the radio show traffic, most other stations being afraid to tackle the job as usual. Hi. It might be added here that W9DWN at Pierre, So. Dakota did some fine work in clearing the traffic, handling as much as 75 messages in an hour's time at the peak of the rush. W9FYU at the Springs has applied for an ORS and shows he is in earnest by holding down a bunch of schedules and piling up a fine total to take third place. W9EUR at Pueblo took a lot of messages at the State Fair and made his total go up. He has also applied for ORS. W9CCM, the YL who so successfully vamped the Division Convention, had some trouble with the transmitter but after she got it working, did things up in fine shape. W9CSR is planning a master oscillator outfit built along 1929 principles. W9BYC is building a 400 volt B battery supply for his transmitter. W9DKM is moving to a new QRA but will probably be on again with only a day or two interruption. W9DGJ decided to quit his job and go back to college and then at the last minute, he changed his mind. He still thinks self-rectified is the stuff. W9CAT, W9FEM and W9DRV at Pueblo are on the air. W9EHP and W9EAB at Trinidad are doing what they can to help the cause along. W9ERN says he had 60 messages to report last month and forgot to send them in. Hi. Well, the SCM isn't a mind reader. That applies to other stations in the section, too, some of whom have never been heard from. W9CDE is on week-ends. W9EAM still gets on some, but says he won't be ready to go in the good old way for about two months yet. W9CVE wants to know if any stations are active in Durango. Well, if there are any active ones, let's hear from them. It's been over a year since signs have rippled from that burg. W9ASB says he has hopes of becoming an ORS and is getting some schedules lined up in preparation. W9CND

is on again and doing good work. W9ND is off temporarily and is spending some time in the hills. W9BJN is on when he has time. The OM at W9CHV is leaving town for a while. We trust his wife, who recently took out her license, will keep W9CHV on the air. W9AAB is back after a long lay-off. W9ESA has come to life.

Traffic: W9BQO 360, W9CAA 332, W9FYU 235, W9EUR 179, W9ERN 41, W9ASB 25, W9CCM 39, W9CVE 58, W9CSR 23, W9EAM 26, W9CDE 7, W9BYC 35.

**UTAH-WYOMING—SCM, P. N. James, W6BAJ**—Most of the inactive ORS have been cancelled. W6DPO made the BPL on deliveries this month. FB, OM. He has been keeping five schedules. W6BAJ was on about eight days and handled a little traffic. W6RV says that he is having success using two CX381's as plate supply for a fifty. W6DZX is using a pair of 201A's on 14 m.c. and 23 m.c. He has heard K6CLJ on 14 m.c. W6DPZ promises to be on the air by the middle of Oct. W6BUH is still very QRW.

Traffic: W6DPO 101, W6BAJ 51, W6RV 18, W6DZX 10.

#### SOUTHEASTERN DIVISION

**FLORIDA—SCM, C. E. Ffoulkes, W4LK**—The SCM is very glad to see the large number of new men showing up in the section and will be looking for a report from them soon. Have a new ORS prospect in W4AI. He surely handles the traffic. The U.P. sent press thru W4TK during the recent "Blow" here. W4AGY is applying for ORS. W4NE is on the air regularly now at noon. The storm kept W4OB up into the "wee small hours of the morning" with traffic. W4HY put a message through from Hawaii to Calif. in 20 minutes. FB. W4ACC's outfit blew and he is moving again. W4AAO offered his help to the W.U. in Homestead during the storm. A TP-TG outfit is making history for W4AKF. Good work, OM. W4OO is back in St. Petersburg after a summer north. A nice 250 is perking away for W4MS. Have you met the OW? W4LK lost his mast and all the antenna system. Always glad to hear from any of the gang that care to write.

Traffic: W4AI 145, W4TK 21, W4AGY 48, W4NE 20, W4OB 15, W4HY 12, W4AAC 9, W4AAO 9, W4AKF 7.

#### WEST GULF DIVISION

**NORTHERN TEXAS—SCM, J. H. Robinson, W5AKN**—Well, gang, school has started and our grand total has dropped but we have quite a few new stations coming on which will help, two ORS have been appointed since the last report and one renewed. When this gets in print, our West Gulf Convention will be history and I'm sure, glorious history. W5HY is leading the North Texas bunch. He has three schedules. W5BBF has a schedule both north and south. W5HF was the station of the Comanche gang at the Comanche Annual roundup. All the fellows there assisted with the station keeping it on the air 24 hours a day, getting all the messages for the visitors. W5AQ has been busy with the Convention. He also went to N. Y. to see the bright lights. W5ATZ has started to college, but says the set will get all the time possible. W5AKN has been putting in his time trying to figure a way to get some of the prizes at the convention. W5JX is a new ORS: being an ex-bartender, he can hand them out most any way. He uses an 852 with a mercury arc rectifier. W5ACL is trying to make his receiver work like some that appear in QST but finally put it back as per P. H. Schnell. W5JA has been in La. on a vacation. While there, he used a portable call keeping in touch with home. W5AHU is at college but keeps a week-end schedule with W9ML. FB. He is the official reporter for the Comanche gang. W5VW has got two new stations on the air. He is putting in complete new equipment. W5DF, a new ORS at Paris, Tex., will be open for traffic. W5JD has had QRM from a new Chevy. He rebuilt his station for the convention, adding a 250 watter. W5ANK is now with us putting in a crystal control set.

Traffic: W5HY 60, W5BBF 49, W5HF 26, W5AQ 20, W5ATZ 3, W5AKN 10, W5JX 6, W5ACL 4, W5AHU 2, W5VW 7, W5DF 1, W5JD 1, W5ANK 1.

**SOUTHERN TEXAS—SCM, R. E. Franklin, W5OX**—We are going to make this the leading section of the West Gulf Division. Get busy, fellows, and make some good schedules and handle that traffic that has been waiting for you. The SCM is always



in touch with stations wanting skeds. Write me. Non-reporting ORS are warned that we have no place in our files for dead wood. The SCM had the pleasure of a visit from W6BBF and W5ATM. Glad to have you, OMs, call again. AARS W6AIN has applied for an ORS and heads the list in traffic this month as well as DX, having worked twelve foreign countries this month alone. FB, OM, W5LP, a new ORS in Houston, has just got his new 352 working and reports having worked France on 14,000. Our old friend W5MS is rebuilding his outfit and expects to head the list in traffic. Better watch him, fellows. W5KP is on op on the S. S. *Beasmer City*. Our ex-SCM, W5YK expects to have a 100 watter going on 7000 by next month. Good luck, OM. W5EW has just completed a 250 watter that he expects to wreck a few "cans" with. W5PY is doing some good work with a lone H tube. W5OX has a 250 watter going with raw AC but has a mercury arc in transit and expects to have a MOPA going in the near future. W5PO has a new lathe and turns out those hard to get radio parts. FB, OM, W5ALA has moved from Miranda City to Aransas-Pass and expects to operate W5TO until he gets the set up again.

Traffic: W5AIN 167, W5OX 33, W5LP 15.

**OKLAHOMA**—SCM, Glenn Morgan, W5AMO—With the passing of summer, everybody is heaving a sigh of relief. It looks like a big winter for the Okla. section. W5APG says 3500 kc. is getting good again and also says that band is FB for traffic. Now that our ex-SCM is relieved of official burden, we are anticipating an increase in his traffic. W5AAV and W5AGN both report QRM from college work. W5AYO cops the prize for activity this month. While studying for a commercial ticket, he found time to play a few chess games by radio and a gob of traffic thrown in. W5AEF and W5BAE have become public spirited and are building a set for Central High School. W5RAZ reports that 14,000 kc. is great and says it's not getting its share of the popularity. W5BCX is a freshman at Okla. Univ. now and thinks he'll put up a set in his room at the dorm. W5AFX was all for making the BPL this month but he blew his 250 watter and ended a promising record. W5QL is wondering if 1929 will ruin the DX possibilities of his crystal rock crusher. W5VH worked his first Aussie with the 1929 type Hartley and is sold on that set. W5AZG is wondering how much of a set it would take to work W5VH with. W5SW reports that business has kept him from pounding brass as much as he would like. W5AJR is building a new crystal transmitter. W5ARX has been working on television and reports that he has as last got some positive results. Let's hear from some more of you television fellows. W5AMO and W5FJ started to build a big crystal set but the ornery crystal cracked. W5AMO is using the old 352 again and says it will have to do till depleted finances recuperate. W5FJ has gotten back from South America and advises all travel lorn to see America first. W5BAG has moved and says the old 211-d will be purring again in a few days. W5ANT is getting out good with 90 watts on his 852. He handles traffic, also. Well, that is an ant's-eye view of the Okla. section. Keep the ball rolling, gang. We have a good start.

Traffic: W5RAZ 20, W5VH 41, W5APG 33, W5ANT 17, W5AFX 140, W5AMO 46, W5AYO 64, W5AIR 3.

## CANADA

### ONTARIO DISTRICT

**ONTARIO**—S.C.M. W. Y. Sloan VE9BJ—Central Dist: VE3BL is keeping a regular schedule on 5700 kc. (52.5 m.) and wants to know why so few of the fellows are on there of late. He says that tests with the portable receiver show that conditions improve soon after the city is left behind, but the mosquitoes get worse. VE3BO is stepping out in great shape on 14,000 kc. after successfully getting a Zeppelin to work. VE3BC says no DX yet but it won't be long now. He is persuading his Belgian Lantern to digest a little more juice to the tune of many more mills. His traffic total indicates that some of us had better get going and look to our laurels. VE3CJ has left for a power development near North Bay where he will be employed for the next year. VE3DY will be acting RM in place of "CJ" while the latter is getting located in the north. All those interested in traffic schedules, please get in touch with

VE3DY. We do not know what VE9AL is doing, but we may expect to hear him again soon as he is now permanently back from vacation. VE3FC has been inactive but promises to open up again soon. VE9BJ is still on vacation, Southern Dist: VE3CS and VE3IA are rebuilding and promise a renewed activity soon. VE3CB has been on occasionally to handle traffic. VE3AY says that on 7500 kc it is next to impossible to get anyone to relay traffic even tho signals are reported very good. VE3AY has rebuilt and is on the air again. Eastern Dist: Kingston is heard from. VE3HO is inactive. VE3HE and VE3VS are on 14,000 kc. and reaching out to greater DX, the former worked North Africa and the latter France. Northern Dist: VE3EL is somewhere in the North beyond Port Arthur, and is keeping in touch with the World by a schedule with VE3BL.

Traffic: VE9AL 16, VE3CB 19, VE3VS 17, VE3EL 15, VE3BL 11, VE3CJ 10, VE3HB 9, VE3CB 4, VE3AY 4.

### VANALTA DIVISION

**ALBERTA**—SCM, E. J. Taylor, VE4HA—Here we are again after a couple months in the woods. The gang has been pretty quiet during the summer months but we are all brushing up the old sets again getting lined up for the 1929 conditions. VE4HM is back again from England and says the boys over there are sure FB on technical dope. He will have lots to tell us at our next feast. VE4GT sure has some station in his new location—DX all the time! VE4EP will be in Calgary for some time but will be on the air soon. VE4AH is busy with CJCA station these days. We heard VE4FF peeping thru lately. VE4HA is on 14,000 kc. VE4CU has been off the air for some time, but expect him back soon. VE4CL likewise. VE4FH most consistent station during the warm months. Let's have the dope on time so that we can get a real write-up for the coming DX months.

**BRITISH COLUMBIA**—SCM, E. S. Brooks, VE5BJ—VE5AL has gone back to the 3500 band and expects traffic to be a little better there. Five of the B. C. A. R. A. members attended the N. W. Convention at Seattle and report having a good time. VE5CT is back on 3500 and is open for traffic in that band. VE5GO puts in a fair traffic report. Yukon—by VE5AW—Using two 210's VE5AW worked EF, EG and RA03, Siberia. Works VOG nearly every night and has QSO'd VGSR while at Herschel Island. Has worked KNT and OA's by the dozen. Has been reported in Czechoslovakia. VE5AQ is a newcomer away up north and will soon be open with a 210. Watch for him, gang.

Traffic: VE5GO 23, VE5AL 12, VE5CT 1.

### QUEBEC DIVISION

**QUEBEC**—SCM, Alex Reid, VE2BE—Vacations are over, and with the long evenings at hand, the gang is busy overhauling the old sets for 1929 operation. We will this year as usual have a booth at the Radio Show and expect to have a station in operation for transmitting and receiving the Show traffic. We also hope to have some new exhibits this year. VE2BH has returned from the Arctic and reports that contact with amateurs very poor and only Canadian heard was VE2BE. Ross Smythe who has gone North with the Hudson Bay Expedition for twelve months would like all Canadian hams to listen for VE2AQ in the 14,000 and 7000 kc. bands, starting Oct. 10th. VE2AP made his first DX when he clicked EG-5MS on 14,000 kc. VE2AC now has three transmitters, one for 14,000, 7000, and 1875 kc. He is our leading traffic man, and is looking for more skeds. VE2BB has an 352 and will be on with more pep shortly. VE2BG has a Zepp and claims it is the best, and that means something when Tommy speaks. VE2AX is on with high power and will also have his xtal on soon. VE2BE relayed the Tunney-Heeny fight returns direct to Heeney's family with great success. The final returns were put into Heeney's home-town in 8 minutes from the ringside. VE2CA worked over forty foreigners during the month of August. VE2AL is QRW flying mail planes and DX is suffering. VE2BJ will be on the air October 15th.

Traffic: VE2AC 27, VE2BB 15, VE2BR 11, VE2BE 16.

### LATE AND ADDITIONAL REPORTS

W2ASZ was busy taking college entrance exams. W5ALA has just applied for renewal of license with new QRA: Arkansas Pass, Texas. W5TO is working in Corpus Christi.

Traffic: W2ASZ 6.